

**TESTS: MARK LEVINSON • DISCWASHER • KLH
CAMBRIDGE SOUNDWORKS • DGX AUDIO • THIEL**

AUDIO

THE EQUIPMENT AUTHORITY

MARCH 1995

**THE RYKODISC
STORY
BETTING HEAVY
ON CDs**

**A/V RECEIVER
FOR AUDIOPHILES
MARANTZ SR-92 MK II**

**PACKED WITH
FEATURES JVC'S
MINIDISC RECORDER**

**OUTSTANDING
PARASOUND
CD PLAYER AND
D/A CONVERTER**



US \$3.50
UK £1.95
CAN \$3.95

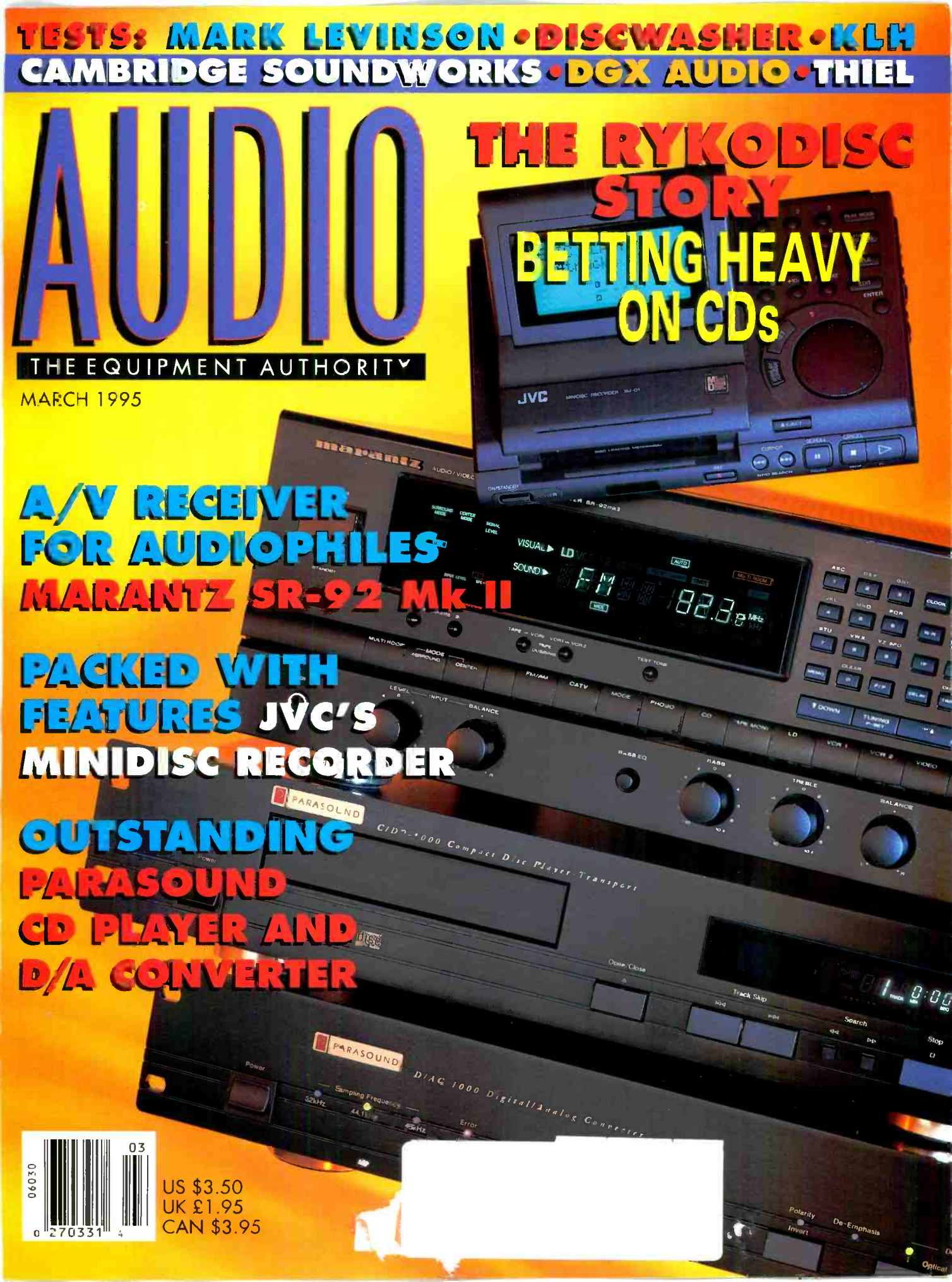



*Y*ou've waited in the rain, paid your seven bucks, bought your real buttery-flavor popcorn and snagged the best seat in the house. When somebody decides to sit in the second best seat in the house.

You know, of course, the solution is to create the ultimate theater in your home. And as anyone will tell you, a truly moving theater experience is built around sound even more than the picture. But not just any sound. Parasound.

You see, we've built our company around the notion that a



P/SP-1000 Dolby Pro Logic Surround Processor. This is what the home theater world has been waiting for. The latest in surround technology using the very finest audio components and circuitry.

Dolby Pro Logic is a registered trademark of Dolby Laboratories Licensing Corp. THX is a registered trademark of Lucasfilm, Ltd.



person shouldn't have to spend a fortune to hear the finest that technology has to offer. And now that we've applied that principle to home theater, the cinematic experience will never be the same. Just look at our remarkable new Dolby Pro Logic® Surround Processor. It combines a high-end preamplifier with all the features that even the most fervent audiophile turned movie buff could ever want. We also offer the widest variety of THX®-certified and six channel amplifiers available, as well as the most powerful and most accurate subwoofer on the planet.

So to hear audio that's well above the crowd, head to your nearest Parasound dealer or authorized custom installer. And let someone else deal with the spud with the big head.



PARASOUND

affordable audio for the critical listener

Parasound Products, Inc. 950 Battery Street, San Francisco, CA 94111
415-397-7100 • Fax 415-397-0144

AUDIO

**Rykodisc's
Bootsy
Collins,
page 42**



Marantz, page 50

features

BUILD A MONO, 100-WATT CLASS-A AMP,
PART III Dr. Norman E. Thagard 34

THE AUDIO INTERVIEW: RYKODISC'S BIG FOUR
 Michael Bieber and Michael Tearson 42

equipment profiles

MARANTZ SR-92 Mk II A/V RECEIVER Edward J. Foster 50

**PARASOUND D/AC-1000 D/A CONVERTER AND
 C/DP-1000 CD PLAYER/TRANSPORT** Bascom H. King 58

JVC XM-D1BK MINIDISC RECORDER Edward J. Foster 66

KLH V-01 REAR-CHANNEL SPEAKER David L. Clark 72

auricles

**MARK LEVINSON NO. 30.5 D/A CONVERTER
 AND NO. 31 CD TRANSPORT** Anthony H. Cordesman 76

**CAMBRIDGE SOUNDWORKS BY HENRY KLOSS
 SPEAKER SYSTEM** Edward M. Long 80

playback

**DISCWASHER HYDROBATH CD CLEANING SYSTEM,
 THIEL CS5i MONITOR LOUDSPEAKER,
 AND DGX AUDIO DDP-1 DIGITAL PREAMP** 104

departments

FAST FORE-WORD Eugene Pitts III 4

WHAT'S NEW 6

AUDIO ETC Edward Tatnall Canby 8

CURRENTS John Eargle 14

SIGNALS & NOISE/ERRATUM 16

AUDIOCLINIC Joseph Giovanelli 26

recordings

CLASSICAL 84

JAZZ & BLUES 88

The Cover Photographer: Bill Kouirinis Studio
The Cover Equipment: JVC XM-D1BK MiniDisc recorder, Marantz SR-92 Mk II A/V receiver, and Parasound D/AC-1000 D/A converter and C/DP-1000 CD player/transport

Audio Publishing, Editorial, and Advertising Offices,
1633 Broadway, New York, N.Y. 10019

Subscription Inquiries:
Phone, 303/604-1464; fax, 303/604-7455

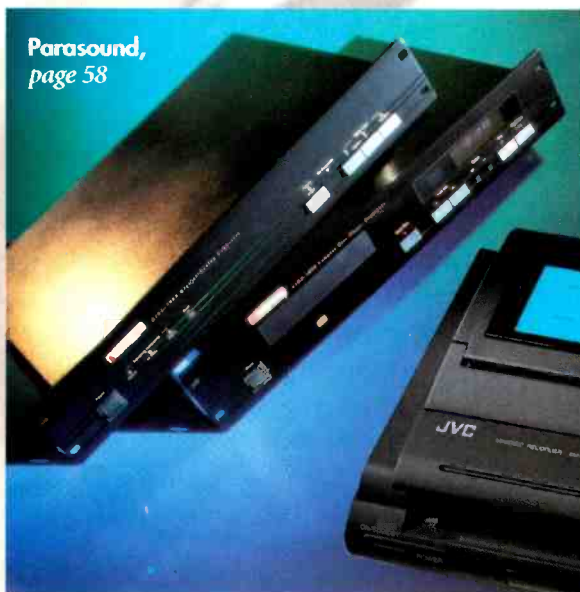

*Parasound,
page 58*

JVC, page 66

T H E A R A G O N C O L L E C T I O N

the limited production 8008



The point where music and art meet.

M O N D I A L D E S I G N S L I M I T E D
20 Livingstone Ave., Dobbs Ferry, NY 10522 • 914-693-8008 • Fax 914-693-7199

Enter No. 22 on Reader Service Card

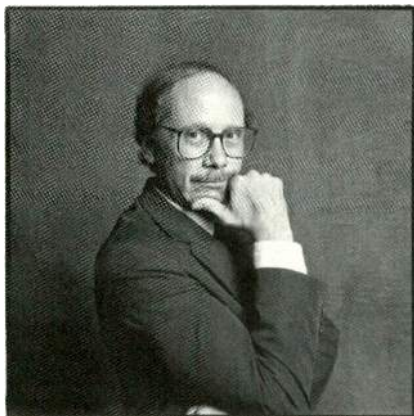

With a good deal of brotherly admiration, I would like to call your attention to the 50th anniversary of *CQ* magazine. Why "brotherly"? Well, there are two answers, one long and one short, and I'm going to give you the short one.

Fifty years is a rather long time for a magazine to be alive, and most don't last anywhere near that long. In fact, magazine industry pundits say that as many as a third of all newly started magazines fail within their first three years. The cause, they usually say, is lack of funding sufficient to carry them through their infancy. While I would certainly agree that adequate funding is essential during those early years, I think that there is another, more powerful process at work then—a sort of natural selection of magazines. What the founding publisher and editor may see as an essential niche, readers and advertisers may see as redundant or—worse—irrelevant.

But why "brotherly"? Because both *CQ* and *Audio* were started by the same publishing house, Radio Magazines, *CQ* in 1945 and *Audio* in 1947. But indeed, the whole publishing house can make a legitimate claim to be nearly 80 years old, since it grew out of a magazine, *Pacific Radio News*, which was started by the San Francisco Radio Club in 1917.

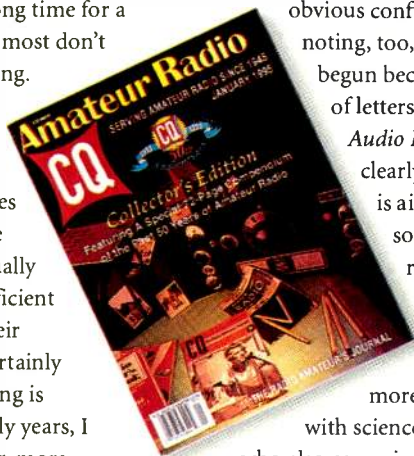

"CQ" is the ham radio operator's invitation to talk over the airwaves, and is quite appropriate as the title for a magazine covering the field. The January 1995 issue of *CQ* is their 50th anniversary issue, and contains some photos we ran in conjunction with an article by John Wolkonowicz in May 1982 when we turned 35.

Audio was purchased during the late '40s by C. G. "Mac" McProud, who was owner-editor-publisher until 1966, when he sold the magazine to North American Publishing of Philadelphia. Mac had bought a curious magazine, aimed mainly at broadcast, recording, and sound reinforcement engineers. Its original title, *Audio Engineering*, was as appropriate as that of its older brother, but when the Audio Engineering Society started its

Journal in the early 1950s, there was obvious confusion. It's worth noting, too, that the Society was begun because of an exchange of letters that appeared in *Audio Engineering*. But clearly, *Audio* no longer is aimed principally at sound engineers; rather, we are for the most-committed hi-fi enthusiasts, those who feel more reasonably at home with science than marketing, but who also can enjoy owning a piece of audio gear simply because it is physically well made.

If you would like to see what that 50th anniversary issue of *CQ* looks like, write to CQ Communications, 76 North Broadway, Hicksville, N.Y. 11801 and enclose a check for \$5.50, which includes shipping.

AUDIO

THE EQUIPMENT AUTHORITY

V.P./EDITOR-IN-CHIEF
Eugene Pitts III

ART DIRECTOR
Cathy Cacchione
ASSOCIATE ART DIRECTOR
Linda Zerella

TECHNICAL EDITOR
Ivan Berger
MANAGING EDITOR
Kay Blumenthal

ASSOCIATE MANAGING EDITORS
Teresa Monge, Douglas Hyde

DIRECTORY EDITOR
Ken Richardson
ASSISTANT EDITOR/MUSIC
Michael Bieber
ASSISTANT EDITOR
Gerald F. McCarthy

ASSOCIATE EDITOR
Edward Tamall Canby

SENIOR EDITORS
D. B. Keele, Jr., David Lander, Edward M. Long

CONTRIBUTING EDITORS/ARTISTS
Michael Aldred, David L. Clark, Anthony H. Cordesman, Ted Costa, John Diliberto, Frank Driggs, John Eargle, Edward J. Foster, Joseph Giovanelli, Dawn Joniec, Ken Kessler, Bascom H. King, Robert D. Long, Paul Moor, Jon W. Poses, Jon R. Sank, John Sunier, Michael Tearson, Jon & Sally Tiven, Michael Wright

V.P./GROUP PUBLISHER
Tony Catalano 212/767-6061

V.P./ADVERTISING DIRECTOR
Scott Constantine 212/767-6346

GENERAL MANAGER Greg Roperti
BUSINESS MANAGER Christine Z. Maillet
PRODUCTION DIRECTOR Silvia Coppola
PRODUCTION MANAGER Lynn O. Onoyeyan
RESEARCH MANAGER Dru Ann Love
OFFICE MANAGER Aline J. Pulley
OPERATIONS MANAGER Sylvia Correa
AD COORDINATOR Linda Neuweiler

ADVERTISING
REGIONAL V.P./AD DIRECTOR, EAST COAST
Charles L. P. Watson 212/767-6038
REGIONAL ACCOUNT MANAGER
Christine B. Forhez 212/767-6025
MIDWEST ADVERTISING MANAGER
Jerry Stoekigt 312/923-4804
REGIONAL V.P./AD DIRECTOR, WEST COAST
Bob Meth 213/954-4831
WESTERN MANAGER
Paula Mayeri 213/954-4830
NATIONAL RECORD LABEL SALES
MAG Inc. Mitch Herskowitz 212/490-1715
Steve Gross 212/490-1895



CHAIRMAN Daniel Filipacchi
PRESIDENT, CEO, AND COO David J. Pecker
EXEC. V.P. AND EDITORIAL DIRECTOR
Jean-Louis Gimibre
SR. V.P./GLOBAL ADV. Paul DuCharme
SR. V.P./DIR., CORP. SALES Nicholas Matarazzo
SR. V.P./CFO & NEW BUSINESS
DEVELOPMENT Paul DeBenedictis
V.P., GENERAL COUNSEL Catherine Flickinger
V.P., MFG. & DISTRIBUTION Anthony Romano
V.P., CIRCULATION David W. Leckey
V.P., RESEARCH & MKTG. SERVICES Susan Smollens
V.P., COMMUNICATIONS & SPECIAL
PROJECTS Keith Estabrook
V.P., MAGAZINE DEVELOPMENT Marcia Sachar
V.P., DIR., CREATIVE SERVICES, CORP. SALES
Lynn Chaiken



The perfect week:
Saturday, Sunday, Saturday, Sunday,
Saturday, Sunday, Holiday.

Southern Comfort Company, Liqueur, 21-50% Alc. by Volume, Louisville, KY © 1995

Take it easy.



WHAT'S NEW



TDK CD-Recordables

TDK uses a new cyanine dye material, a new high-precision stamper, and an advanced injection-molding process to produce CD-Rs that are designed to operate in all types of audio CD-R and CD-ROM writers, including double- and

quadruple-speed designs. Improved recording sensitivity is also used to compensate for the shorter exposure time in higher speed recording. The CD-R74 has a capacity of 650 MB of data storage or 74 minutes of digital audio; also available are the CD-R63 (550 MB or 63 minutes), the CD-R21 (180 MB or 21 minutes), and the CD-R18 (150 MB or 18 minutes). The discs have a label area for writing notes with permanent-ink markers. Prices: CD-R74, \$31; CD-R63, \$30; CD-R21, \$28, and CD-R18, \$27. For literature, circle No. 101



Pioneer Elite Cassette Deck

The CT-W54 twin auto reverse cassette deck, from Pioneer's Elite line, has Dolby S NR to reduce low-frequency noise by 10 dB and high-frequency hiss by as much as 24 dB. A proprietary frequency-level expander is used to restore high frequencies and deliver clearer sound from old or

poorly recorded tapes. Each transport has Super Auto BLE, which—via three calibration frequencies—provides individual optimizing of bias, level, and equalization during recording. Other features include synchronized CD player start, for dubbing, and a mike input with volume control. Price: \$475. For literature, circle No. 102



CT Consolidated Technology Remote-Control Holder

"Where's that confounded remote?!" If your home echoes to that refrain, you may want to investigate the CT-Tower—which not only holds remotes but also accepts, according to CT Consolidated Technology, "calculators, timers, alarms, flashlights, and radios, as well as note pads, clips, photos, and more." Whatever the items, they're held in place with hook-and-loop fastener strips. Small, smooth pads allow the holder to be rested upright without marring a tabletop. Price: \$19.95. For literature, circle No. 100

Ring-a-Lite Telephone Signaler

You've got headphones on, and the phone rings. You might not hear it, but you can see it with help from the Ring-a-Lite, which installs with phone cords between the telephone receiver and the wall outlet. Plug a light source into the unit's two-prong, 110-V receptacle, and with each ring of the phone, the light will flash; if the light is already switched on, it will flicker. Price:



\$39.95 plus \$5 shipping and handling. For literature, circle No. 103



Niles Amp

Niles Audio bills the SI-1200 as a "systems integration amplifier" that can simultaneously distribute stereo, mono, and surround sound to different rooms. Each of the unit's 12 channels delivers 25 watts and has an individual level control, as well as independent thermal and short-circuit protection. For large rooms or power-hungry speakers, the SI-1200 bridges to six channels at 50 watts each. Price: \$799.95. For literature, circle No. 104

Sacrifice Nothing.

B&W's Matrix HTM Home Theater Speaker resolves the movies versus music debate once and for all. COREY GREENBERG, *Home Theater Technology*

WHAT STARTED OUT AS A RAGING DEBATE HAS ENDED WITH RAVE REVIEWS. HERE B&W PRESENTS THE CONSIDERED OPINIONS OF TWO RESPECTED CRITICS, COREY GREENBERG of *Home Theater Technology* [Nov 1994 issue] AND TOM NOUSAINE of *Sound & Image* [Fall 1994 issue].

GREENBERG: "The main reason the HTMs are so superior to any movie speakers I've heard is solely because these are music speakers first and foremost."

NOUSAINE: "This speaker is accurate. Dialogue and vocals are always intelligible and natural. Music sounds sweet and clean."

GREENBERG: "The sound of the B&W Matrix HTMs is so much better than any of the movie speakers I've heard, even systems costing many times the price of the HTMs, that it's a joke."

NOUSAINE: "The Matrix HTM is a tremendous performer. It makes a terrific center speaker and a pair of them would

even do a great job as mains in a music-only system. I'd be proud to own one."

GREENBERG: "This is the best sound I've ever had in my home theater, bar none. Whether I played movie LDs or music CDs, the sound of the B&W Matrix HTM was honest, accurate, and the very definition of the term 'high fidelity.' It's a speaker system you'll want to live with for a long, long time."

What else can we say? For the name of a B&W dealer near you, call 1-800-370-3740. And hear why the critics' choice in music speakers is the critics' choice in movie speakers.

Not only can the Kevlar

cones used in the B&W

Home Theater Monitor

stop a stray bullet, they

reduce surface standing

waves to minimize

coloration – whether

you're listening to music

or watching movies.

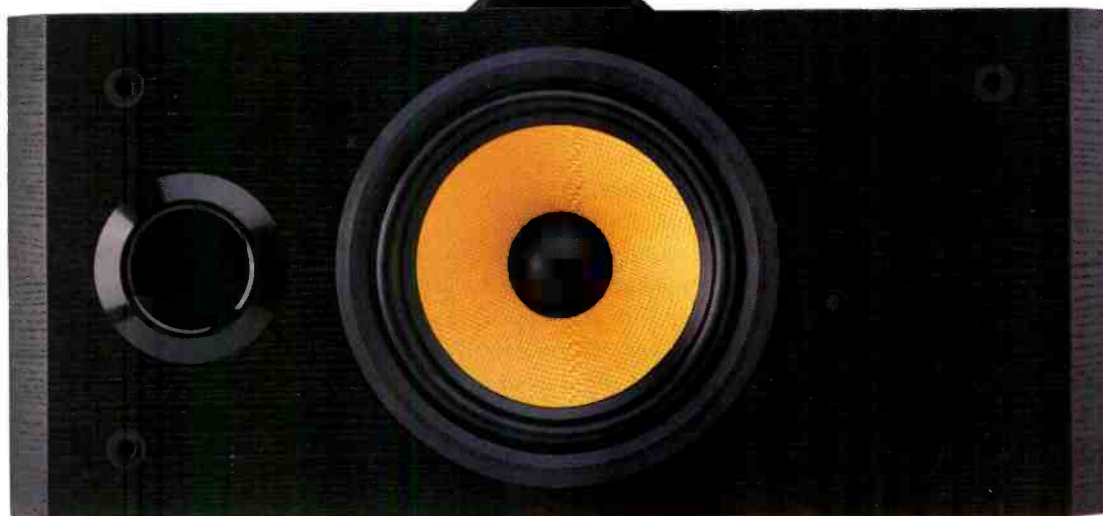

EDWARD TATNALL CANBY

ARTISTS VS. ARTISANS



Do you know the difference between an artist and an artisan? It is the 19th century! In Europe. What a crazy time still to serve as our overwhelming background in so many ways. I mean, of course, crazy as we look back today; it seemed plenty reasonable to the people who lived in it.

Short of slavery among the ancients, the 19th century's early years in Europe were the worst of all for hideous exploitation and impoverishment of the supposedly liberated multitudes caught up in the Industrial Revolution. And simultaneously—don't we always have opposites?—it was the most flamboyant era for Great Art, as a thing made sacred. And for the Artist, who suddenly became a demigod (if eccentric and usually unhealthy!) far

above other human beings, including kings and emperors.

Previously, in times before the era of grim coal mines and hideous industrial sloth, there had been art of every variety, needless to say; just go look in a museum. Also genius, and to spare, from the early "re-birth" (Renaissance) years to the 18th-century Age of Enlightenment when, foolishly, men thought that they had at last solved all the problems of knowledge and human existence. And from Giotto to Leonardo and Michelangelo and Raphael, to Rubens and Van Dyck to . . . And

IN AUDIO,
WE HAVE BOSSES AND
TEAMS OF WORKERS,
FORCED TO COOPERATE
AS ARTISANS.

from Dufay and Machaut to Mozart and Haydn, not to mention Bach. But these great people, over centuries, were not artists in the 19th-century manner! They were, we might say, high-end artisans. Supremely skillful workers. The word "art" originally meant skill. That is precisely where they operated, not in a world apart but simply surrounded by an aura of reverence for their particular superiorities. And therefore not different from other people, including all sorts of artisans without distinction.

That is where the 19th century, industry and all, changed things forever or, rather, unto the present. And that is why art versus artisan has a lot to do with audio—the equipment, the microphones and speakers, the reproducing skills—and the music, equally, from the inaudible background to commercials, on to every kind of pop, musical, film and video, opera, and—another bit of strictly 19th-century terminology—classical. All just part of the whole. Our thousands of "artists" (including directors, producers, composers, performers) are, in plain reality, artisans—whatever they may think. Or would be if they could see it my way. How good it would be if all of them could get this idea through their heads! Like scientists and engineers.

Those are people who have always worked in teams, who honor their own in terms of skills, not Art. Have you ever read Richard Feynman? What a wonderfully ordinary guy he was, if super-concentrated, one of the great scientific and mathematical minds of our day. He was the very essence of an artisan, stratospheric: Skillful at many things high and low, including his favorite (and useful) side skill, picking supposedly secure locks for the Atomic Energy

Illustration: Mary Schuck

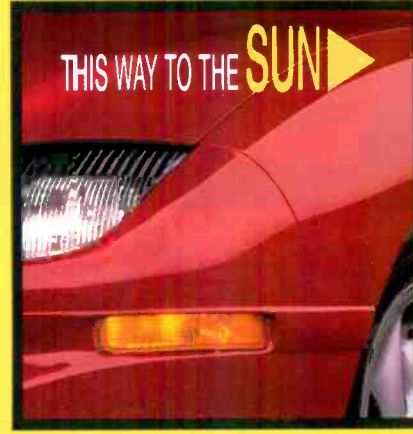
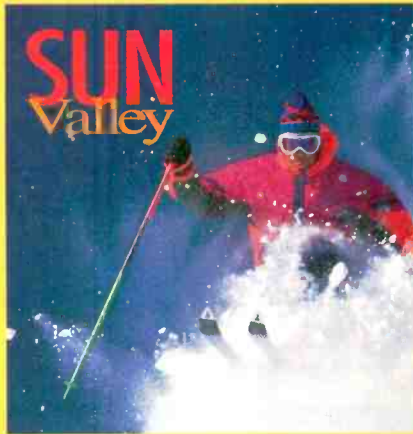
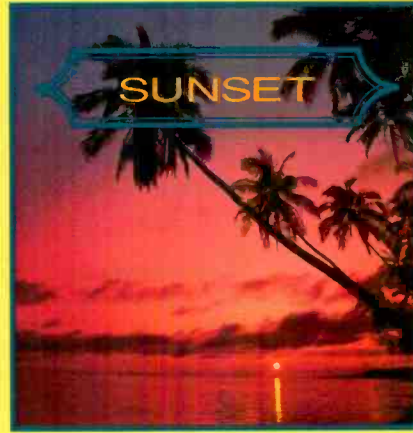
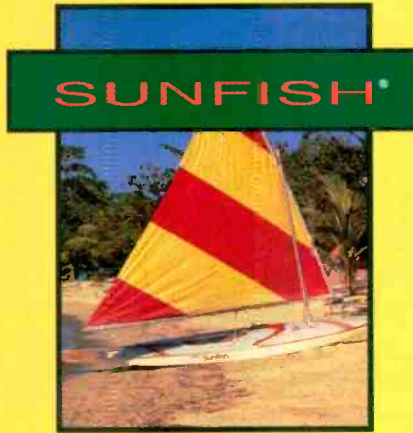
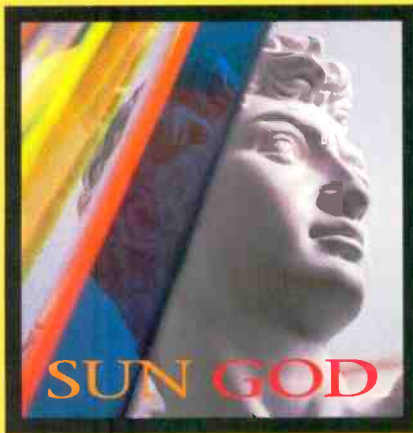
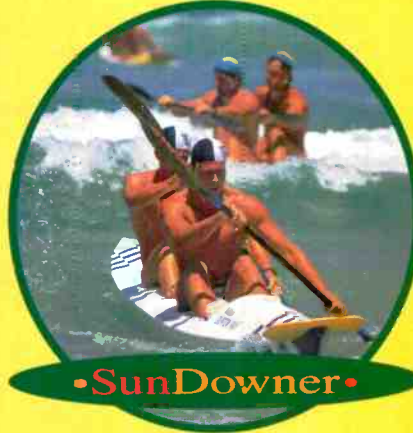
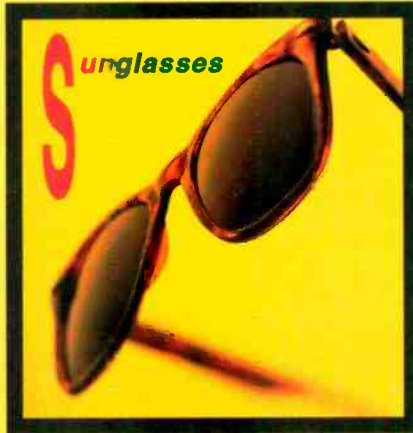
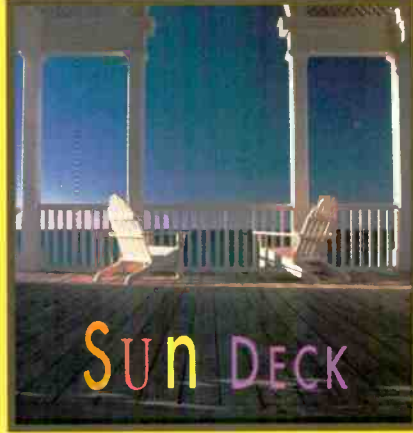
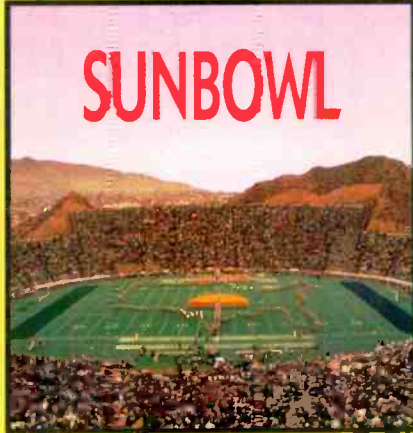

High-revving, 120-horsepower, fuel-injected engine (hey, this car's for driving, not just looking at)

5-speed transmission — you expect that on a real set of wheels, but one for around \$12,500? (yep)

Power steering — (we told ya lots of good stuff is standard)

Great sporty looks, inside & out, that say "Hey, ya wanna have fun?" (say yes) 

Tubular rear axle with spring-over shock sport suspension and progressive ride tuning — (means it's great on curves — you'll understand once you drive it)

Instrument cluster has microprocessor-based design — meaning fewer wires & connectors (that's a good thing) 

Dual airbags — two things you don't need until you really need 'em (and always wear those safety belts, even with airbags)

Anti-lock brakes — why should only big, fancy, expensive cars have all the cool stuff?

Safety-cage construction —  hey, we like you

PONTIAC CARES — call an 800 number, get free Roadside Assistance — for flat tires, dead battery, even if you run out of gas or lock yourself out (Pontiac® wants to see you & your Sunfire™ driving)

Oh, Courtesy Transportation — that's part of PONTIAC CARES too (see? we really do care)

Corrosion protection —  tells rust to go chew on someone else's car



Aluminized stainless steel muffler and tailpipe (see above)

Air conditioning —  Air conditioning?? For around 12,500?? (we told ya it was a cool car)

INTRODUCI

SUN

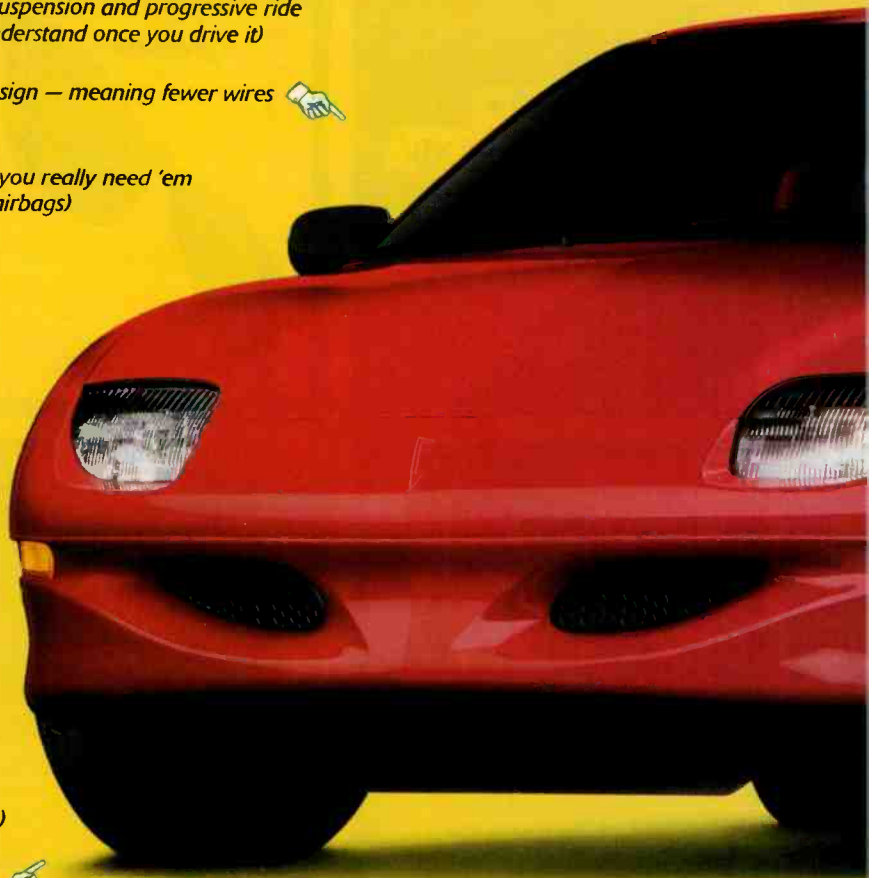

Watch "LIVE FROM THE HOUSE OF BLUES PRESENTED BY PONTIAC

Finally, a real set of wheels for

*\$12,545 MSRP including dealer prep and destination charge. Tax, license and other optional equipment extra. Prices higher in CA and NY. Price as of 9/28/94, subject to change.

NG PONTIAC

FIRE

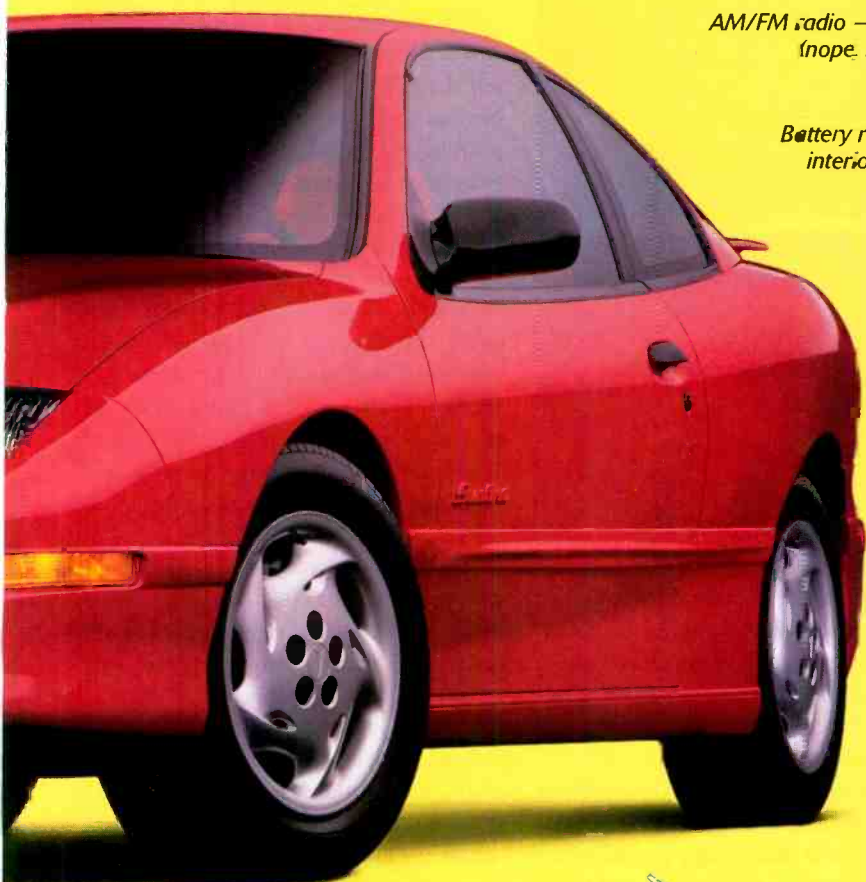

Delay wipers — when Mother Nature can't decide whether to rain or just sprinkle

Interior roominess (room like a big car inside, only it's not a big car — go figure)

Fold-down rear seats — in case you win some 9-ft. teddy bear at the carnival (hey, it could happen)

Theater dimming of interior lights — they turn off slowly, like at the theater

AM/FM radio — what, you mean it's not standard on every car? (nope, it's not) (you wanna spend a little more, you can have a built-in CD player)

Battery rundown protection — you accidentally leave the interior lights on, the Sunfire will turn 'em off — so you don't walk home (remember to say "thanks")

A HUGE glovebox — big enough for a 12-pack of sodas (or some really, really big gloves)

Dual outside mirrors — so you can see folks in other cars who spent more and got less

Single-key locking — one key locks & unlocks doors, trunk and all the fun of Sunfire

Clearcoat paint — paint you can't see keeps the paint you can see looking good (see?)

Cup holders (you supply the cups)

Tachometer — those pricey cars got 'em, and those owners don't even know what they're for

Great sporty looks, inside & out, that say "Hey, ya wanna have fun?" (that one's worth mentioning twice)

Your choice of a great-looking coupe (shown) or sporty four-door sedan (both so good-looking — you might have a tough time choosing)

SUNFIRE™ every Friday and Saturday night on TBS midnight Eastern/9:00pm Pacific.

around \$12,500*

©1994 GM Corp. All rights reserved.



For more information, call 1-800-2PONTIAC.

Enter No. 27 on Reader Service Card

Commission! Also playing Latin music in local Latin bands. An inveterate prankster with a huge sense of fun (unlike Beethoven). Read him, and rejoice.

You surely can see, then, that we in audio are really returning to the pre-19th-century idea of the artisan. Any art, skill, or trade, just as then: It could be anything from wheelwrights (Joseph and Michael Haydn's father) to jewelers, cooks and bottle washers, dramatists, and even poets. In England, both Shakespeare and George Frederick Handel were canny managers, businessmen, fund-raisers, patron-chasers (not foundations but princes, dukes, queens and kings, or newly wealthy merchants). In Italy, the composer Palestrina, whose music the 19th century enshrined as pure and otherworldly, actually did quite a bit of heavy real estate dealing on the side—just an extra helpful skill—as a matter of course. As most of us know, the great mind of Leonardo da Vinci was mainly occupied with the business of designing for the military (weapons, forts, redoubts, vehicles, almost anything) and on the side, a few li'l items like an aeroplane. Michelangelo, Leonardo's near contemporary, was much in demand for his sacred frescoes on wet plaster church walls, one of the toughest and most backbreaking of all the skills of his day. Sixteen hours at a time on his back, high on a scaffold? *That's art?*

Of course, in those days, unlike ours, there were not a hundred thousand diverging specialties, every one moving further and further from the rest and ever more technical, like the expanding universe. Nevertheless, coordination between skills was just as vital then as for us in audio. The famed *bottega*, the artist's (artisan's) workshop, was a hive of creativity and plain manual labor—and never forget that most of the big painters et al. farmed out the actual detail work to their more gifted apprentices, just as architects and Supreme Court judges do today. So it goes in our recording studios, film productions, and so on—not just one Great Genius off in his special world, but dozens of team workers and even a lot of bosses, forced to cooperate as artisans even if they still think they are sheer Genius itself! Just a leftover 19th-century conceit, that.

Then there is the 19th-century sense of high dramatic tragedy. Ah, take pity on the

poor Artist, doomed to die for his *art!* Chopin, dying of consumption, i.e., tuberculosis—how appropriate, all in all, for those times! He surely couldn't have done better. A robustly healthy composer almost had to waste away before anyone would pay the slightest bit of attention to him. Late in the century, when opera finally began to catch up with all this, that familiar character Mimi (*La Bohème*), the



**THERE IS NOTHING
MORE DIFFICULT
TO UNDERSTAND
THAN THE OBVIOUS.**

Bohemian Girl living in a Paris attic, dies soulfully on stage of—what else?—consumption. Just like Chopin. Art, as they said, imitating Life? Actually, in this case it was Art imitating Art. We aren't above that ourselves today. How about Interactive imitating Interactive? All over the place, and ever so serious, just like Mimi.

So, you see, it is worlds within worlds, as usual. Our audio area is essentially an artisan world, and increasingly so every day. But there remain among us the holdouts, those who, by the thousands, are blissfully unaware of any change, who live with the Great Art concept as if it were eternal. They are not to be blamed—rather, they should be admired, staunchly aboard their slowly sinking ships, though this they will surely deny. How can it be otherwise? Adapt or perish! Believe me, they will adapt, ingeniously. They are, if as the snail and the tortoise.

Yes, I know, I am serving up a passel of big generalities that may seem obvious to some of our readers. Yet there is nothing

more difficult to understand than the obvious—difficult to see in perspective, tough to integrate into daily life. I think that if each reader of these words will take a moment to provide the details of my picture, to visualize specifically his own audio experience, whether pro or consumer, he will see the truth of what I am promoting. Is yours an artisan shop? Do you sense that it is indeed an artisan audio world, in spite of too many would-be geniuses therein? Is your home and car listening receptive to the artisan viewpoint? Are you able to appreciate real skills rather than fathomless Grrreat Arts?

I am sorry to say that the most unreconstructed performers in respect to this are not the audio people, not the musicians, but that legion of office workers who supposedly keep us all in business, the publicity people. As you may know, one of their favorite terms is "Creative." I remember several top-level Directors of Creative Services in one of our biggest (former) record companies. In fact, the bulk of this "creative" work is precisely the opposite—secondhand, thirdhand, from any source that seems to know what it is talking about. So seldom an original—i.e., creative—idea! This is not good for ongoing change in our thinking, though change will surely go on, even so.

Take me, as an outside "authority" just waiting to be put to use. I am now, to my wonderment, quoted right and left in all sorts of CD releases and even in live concerts; I hit the jackpot recently as "that astute musicologist" (which I am not) in a program booklet for a Carnegie Hall concert! Little do they know, these quoting souls, that the words they quote were written *30 or 40 years ago*, in the '50s and '60s, from a spate of LP liner annotations I did at the time. Am I now out of date? I think *they* think I'm writing today. Very strange. Luckily, the notes have stood up pretty well, thank heavens. They have been inherited, of course, by the present owners of the original tapes, who are busily doing CD reissues. So am I now forever? I do hope not. I'd really prefer never to be a cat with nine lives.

Nor should the audio profession and the music world. We've used up eight of our lives already, and time flies, as I say, like the snail and the tortoise. **A**

Adcom would like to make this perfectly clear.

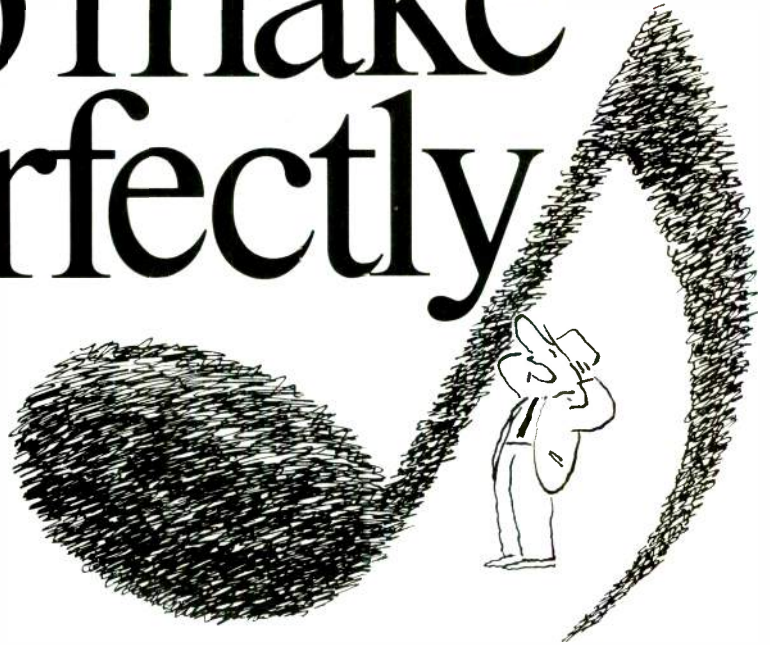

Again, The Critics Agree

"Electronic equipment (especially digital audio gear) is vulnerable to both annoying and catastrophic power-line problems. Your stereo gear should have line spike and surge protection, with hash filters thrown in too. Line protection—you can pay a little for it now, or you can pay a lot for it later."

—Ken Pohlman, *AUDIO*, November 1987.

Regardless of how sophisticated your stereo and video system is, it may never achieve its full performance if plugged directly into an AC outlet. Raw and unprocessed AC power can severely diminish the clarity of audio signals and reduce the resolution of your video picture.

ADCOM's ACE-515 AC Enhancer significantly improves the performance capabilities of your system by filtering and processing raw AC power, unveiling a pure, noise-free power source.

Listen To The Critics

"...the effective suppression of AC 'RF hash' by the ACE-515 improved clarity and lowered noise in all three CD players. . . .the significant improvements in instrumental and vocal harmonic retrieval and hall ambience are superb. . . . it simply appears to allow musical information to be passed through to the listener with less veil and electronic 'haze.'"

—Lewis Lipnick, *Stereophile*, Vol. 11 No. 4, April 1988.

Recommended accessory in *Stereophile*, Vol. 12 No. 4, April 1989.

Line Protection: It Pays For Itself

The ACE-515 also protects your valuable equipment from harmful high-voltage spikes and surges. And, its sequential turn-on/turn-off control circuit guards your speakers from disturbing, damaging thumps.



ADCOM®

details you can hear

JOHN EARGLE

THE NAME IS CD: CD INTERACTIVE

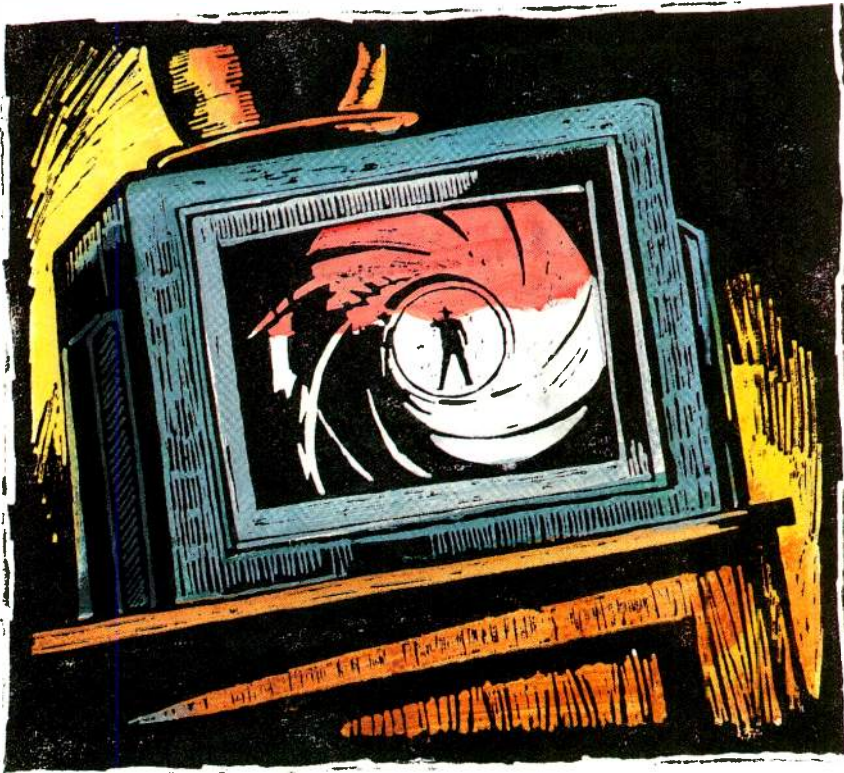

Philips' CD-Interactive format has made a number of strides in recent years, and the added option of Video CD playback is a great advantage. I commented on this last year when I first saw a movie played back from a CD (see "Currents," October 1994). At that time, I was looking at a relatively small screen in a very bright display area. The picture looked good, but I was anxious to take a system home and judge its performance under better conditions and on a larger screen.

Recently, a Magnavox CDI450 interactive CD player arrived for evaluation, along with a sampling of appropriate discs. Of these, only two were pure video: The James Bond classic *Goldfinger* (in a two-CD set) and a Pete Townshend promotional

music program. The remainder of the discs were games of various sorts.

The Magnavox player is extremely lightweight, has a low profile, and is powered by a plug-in ± 5 V power supply. An additional accessory is a small r.f. unit that assigns the player's output to the channel 3 or 4 carrier frequency, for ease in interfacing the system with a typical stand-alone TV set. The r.f. unit also accepts the normal antenna (or cable) feed, so the player does not interfere with everyday use of your TV set. The top of the player has two com-

partments. One accepts a multi-pin module that "programs" the unit to handle Video CDs. The other compartment contains the CD player mechanism itself. In addition to interactive CDs, the Magnavox unit also plays standard audio CDs and Photo CDs.

The video and audio encoding methods used are the MPEG-1 (Motion Picture Experts Group) Standards, and the video portion operates at an astounding 140-to-1 data-reduction ratio! The actual video data rate is 1.15 megabits/second, and that of the stereo audio tracks is 224 kilobits/second. (See Robert A. Finger's excellent article in the December 1994 issue for details on this encoding technology.)

As with all forms of perceptual encoding, whether for audio or video, the designers who set the parameters for the system make certain assumptions regarding the playback environment. For example, when audio is perceptually encoded, established masking thresholds are assumed, and this implies that the playback in the home will not exceed a certain level. If it does, then there is a chance that something which should have been masked may not, in fact, be masked. So it is with video. The visibility of certain data-reduction strategies may depend on picture size and brightness.

Some of the techniques used in Video CD data reduction are fairly benign. For example, horizontal and

vertical resolution have been cut in half, to 352 lines horizontal and 240 lines vertical. The eye does not readily observe this, but if there were an adjacent monitor showing

the original, unreduced video signal, the difference might be quite visible.

On the other hand, there may be telltale signs of data reduction that will be visible to anyone, trained or otherwise. This is precisely what

**CD-I's PICTURE QUALITY
IS CLEARLY BETTER
THAN THAT OF
MASS-DUPLICATED
VHS videocassettes.**

happened when I first viewed *Goldfinger*. I was bothered by a phenomenon called macroblocking. This is the appearance of distinct blocks, or squares, in the picture that stand apart from each other in overall luminance value. These, of course, vary from frame to frame, and in *Goldfinger* they were apparent primarily in dimly lit scenes. A knowledgeable friend of mine stated that the "psychovisual annoyance" of this artifact can usually be minimized by adjusting controls on the TV set, making the dark scenes a bit darker. Taking this ad-

**THE VISIBILITY
OF DATA-REDUCTION
STRATEGIES MAY DEPEND
ON PICTURE SIZE
AND BRIGHTNESS.**

vice, I carefully adjusted the brilliance and contrast controls, and sure enough, the effect was minimized. I could then get on with the movie without being bothered. However, if I made an effort, I could still spot the macroblocking.

The Pete Townshend disc presented the artist in a 30-minute program, filmed in New York. The notes stated that the disc was compatible with a standard audio CD player. Obviously, the disc was encoded in two 30-minute sections: The first was standard CD linear encoding of audio, while the second was in the MPEG-1 audio and video formats.

Of course, with movies there is not much available in the way of user interaction. A plug-in CD-I controller lets you call up a control strip at the bottom of the screen. Here, you can fast-forward, freeze-frame, change volume, or go into a variety of slow-motion modes. Since all of this is done digitally, there is none of the raggedness that you have probably become accustomed to with your VCR. The Video CDs are indexed, so you can go directly to any point in a movie.

Overall, I would say that the picture quality of these Video CDs was clearly better than that of mass-duplicated VHS videocassettes—in other words, very good, but not up to the standard set by the LaserDisc.

Will the Video CD ever unseat the LaserDisc? Perhaps not in its present form. But there is sure to be a standard that will. The LaserDisc has the disadvantages of being analog, bulky, and hard to manufacture. A replacement for it will be smaller, and it is possible that it will require a shorter laser wavelength in order to pack more information on the small disc. But for the purposes of interactive CD, the present standard is quite good enough.

There are many things to be considered in setting new video standards: Ultimate

quality of performance must be balanced with considerations of compatibility, manufacturing convenience, and the impact of HDTV. We won't know for perhaps a year or two what direction things will go.

Incidentally, judging from the remainder of the Philips CD-I discs sent for evaluation, things have generally improved over the last couple of years. The booklets (read: operating instructions) have certainly improved, and it seems to me that the games themselves are better executed. You might ask your teenagers for their comments. A

WE PLAY TO RAVE REVIEWS!

"The PSB Alphas are simply one of the greatest buys in audio, providing a musically satisfying sound for a paltry \$200 ... For the price, the PSB Alphas are a sensational audio bargain. Now get out those checkbooks!"

Jack English, *Stereophile*,
Vol. 15, No. 7 (July, 1992)



psb
SPEAKERS

**A UNIQUE VOICE IN
THE CROWD**

For your nearest PSB dealer call TOLL FREE 1-800-263-4641

Enter No. 29 on Reader Service Card

PSB Alpha SE

“Planning a Home Theater System”: Erratum . . . and Expansion

Dear Editor:

I like your magazine and would like to start a subscription. However, I have noticed some mathematical discrepancies that you may want to know about.

The first is in William R. Hoffman’s “Planning a Home Theater System: Where Do You Begin?” (November 1994), most of which I enjoyed. I was confused, however, by the method of determining amplifier power, particularly in relation to the experience I have had with my own system. At first, Mr. Hoffman says to find my speaker’s sensitivity on the horizontal scale of Fig. 3. I have the Martin-Logan CLS IIIa, whose sensitivity is about 86 dB. This gives me a power ratio of about 11. My room is 1,650 cubic feet with average absorption, which, according to Fig. 4, gives me a power multiplier of about 0.6. According to Fig. 5, comparing the power ratio to the power multiplier, I need *less* than 30 watts per channel to run my system (since the chart does not go below a multiplier of 1). Now, I might agree that most people do not need as much power as they think they do, but 30 watts? Have you ever driven Martin-Logans on 30 watts? Did I miss something?

I have a Lexicon CP-3 preamplifier feeding an Adcom GFA-555 amplifier (rated at 200 watts per channel) into the loudspeakers. A second GFA-555 amp powers separate subwoofers. Only powering frequencies above 80 Hz, I still cannot set the THX reference level with the Martin-Logans. They will not put out that much volume. How can I expect them to be sufficient with 30 watts?

The other discrepancy I noticed has to do with your subscription rates. According to the Business Reply postcards that are inserted into your magazine, a one-year introductory subscription is available for \$12.97. A three-year subscription costs \$38.97; that’s 6 cents more than the one-year subscription renewed two times. Since the postage is paid, how, then, is the

three-year deal a better value? Please sign me up for a one-year subscription.

Mike Wood
Lafayette, Cal.

Author’s Reply: Regarding my article, “Planning a Home Theater System,” an error did indeed creep into the values for power shown in Figs. 5 and 6. Also, I have heard from some readers who have mentioned that these same graph scales, when used to find values for small rooms (with low power-multiplier [M] values), are very difficult to read accurately. In order to accommodate both changes in one set of graphs, I have rescaled them, and they are reproduced here. Please use these graphs instead of the ones in the original article.

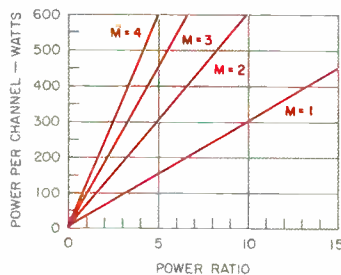

Fig. 5—Curves for determining amplifier power requirements.

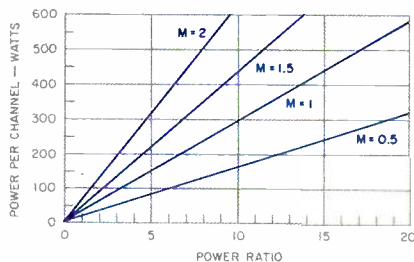

Fig. 6—Curves for determining bass power requirements.

I apologize for any inconvenience the error may have caused. If there are any further questions or comments on the article, please feel free to contact me through these editorial offices.—W.R.H.

Editor’s Reply: Regarding the introductory subscription prices, our circulation staff says the prices should have been \$12.97 for

a one-year subscription, \$25.94 for two years, and \$38.91 for three years.—K.R.

Dear Editor:

I want to expand on William R. Hoffman’s “Planning a Home Theater System,” in particular the section relating to audio.

Surround sound for the millennium will actually begin in 1995 with the introduction of Dolby AC-3 and DTS Zeta home entertainment systems. These platforms follow the SMPTE 5.1 discrete audio channel format and also recommend full-bandwidth performance from the primary four channels, i.e., left and right front as well as left and right surround. The center, or screen, channel is also to have full-bandwidth performance, even though its primary function is for augmentation in order to lock mono dialog onto the screen. With regard to the .1 special-effects channel, it is no longer accurate to refer to it as a subwoofer channel, in view of the fact that the five main channels already are capable of full-bandwidth performance from 20 Hz to 20 kHz. The idea that low frequency is nondirectional is now a myth from any viewpoint.

With regard to loudspeaker choice and placement, it is not the role of surround sound hardware to diffuse (and confuse) the surround sound image. That is a creative decision that *must* be in the hands of the creative person at all times, and not deferred to loudspeaker design or placement! It is assumed, of course, that motion-picture soundtrack creators will learn to take full advantage of surrounds that are on all of the time with full frequency response—and that some music and sound creators have never forgotten how to do it in the first place! Thus, it seems obvious to me that the Dolby/THX recommendations for dipole surround loudspeakers, diffused array and/or side wall locations, based upon the original Schrieber SQ quadrasonic matrix scheme of the ’70s, are obsolete.

If one is interested in getting the optimum performance from a 5.1 system, the following guidelines will prepare you for the surround sound for the millennium, and will also allow for the current crop of matrixed surround-sound tracks to be reproduced without degradation from the original mix beyond what the matrix has already done to it.

JUST ADD BACARDI



Bacardi® rum. Made in Puerto Rico. BACARDI, THE BAT DEVICE, AND THE WAVE DEVICE ARE REGISTERED TRADEMARKS OF BACARDI & COMPANY LIMITED. ©1995 BACARDI IMPORTS, INC., MIAMI FL. 40% ALC. BY VOL.

How Do You Improve On “.. Put It O

Announcing Our First National Sale On Ensemble

Audio Magazine once said that our Ensemble speaker system may be “the best value in the world.” Dozens of critics and thousands of customers have applauded our Ensemble and Ensemble II speaker systems. Designed by Audio Hall of Fame member Henry Kloss, (founder of AR, KLH and Advent), these systems have become best sellers by offering very high quality construction and accurate, wide-range music reproduction with precise stereo imaging – all at factory-direct prices, with no expensive middlemen.

We are now pleased to introduce new versions of our Ensemble and Ensemble II systems, as well as our new, ultra-compact Ensemble III system.



the sound you want. This is one of the reasons *Esquire* described Ensemble by saying “you get 30 days to return the speakers or keep them, but you’ll keep them.”

So What’s New?

New Ensemble maintains the tonal balance, frequency range and quality of construction of the original. There are two basic differences.

1. New “long throw” subwoofer speakers with built-in heat sinks.

New Ensemble uses the 8” long throw woofer designed for our Powered Subwoofer II. The woofer’s extremely long “throw” (almost 1”) provides for more linear cone excursion for more accurate bass. A unique integral heat sink provides improved power handling.

2. New frequency balance controls.

New Ensemble’s satellite speakers use the same high quality 1 3/4” tweeter, 4” midrange driver and crossover as the original Ensemble, but with newly designed midrange and high-frequency balance control switches.

A two-position midrange switch on each satellite lets you choose the same output in the key 800-1600 Hz octave as in the original – or you can flip the switch to emphasize that octave by 2 dB. The original Ensemble’s response was tailored to avoid the “boxy” characteristic typical of many speakers. This results in an “open” sound on large-scale musical works. For some music, switching to the higher output position provides a “warmer” sound that some listeners may prefer.

A second, high-frequency switch has three positions:

A) The same balance as original Ensemble.

B) A 2 dB high-frequency increase.

C) A 2 dB high-frequency decrease.

Rather than affecting tonal balance as does the midrange control, the high-frequency switch can subtly increase the system’s “airiness” (Increase) or it can reduce any tendency towards “edginess” (Decrease).

Real Life Performance, Real Value.

In terms of “real life” performance (your music, your listening room), we believe our New Ensemble system competes with speakers selling for hundreds more. Available factory-direct with black vinyl-clad subwoofers, reg. \$549-Now \$499, or with black-laminate subwoofers, reg. \$629-Now \$599.

The New Ensemble II.

New Ensemble II is an improved version of our best-selling speaker system, Ensemble II. It’s more affordable than New Ensemble because it uses one cabinet to house both subwoofer speakers. Its satellite speakers are identical in every way to those used in the New Ensemble, including the new high-frequency and midrange balance controls.



The New Ensemble

New Ensemble is an improved version of our original, dual-subwoofer/satellite speaker system. New Ensemble maintains the dual subwoofer design of Ensemble, which allows for maximum room placement flexibility. Placement of bass and high-frequency speakers in a room—and how those speakers interact with the acoustics of the room—has more influence on the overall sound quality of a stereo system than just about anything. New Ensemble’s two ultra-slim subwoofers give you more placement flexibility than any speaker system we know of, and is most likely to provide the performance you want *in the real world...in your room*. Having two, compact subwoofers lets you move them around, experiment, and find that placement that gives you exactly



So What’s New?

New Ensemble II maintains the overall tonal balance, frequency range, power handling and quality of construction that have made the original Ensemble II one of the country’s most popular speaker systems. There are two basic differences. The first is

The Best Value In The World”? n Sale!



Speakers - Now Through March 18, 1995.

that its satellite speakers use the same high-frequency and midrange balance controls as our New Ensemble system (see previous description). The satellites also use the same gold-plated 5-way connecting posts as New Ensemble. The second difference involves a redesigned subwoofer cabinet.

New flared subwoofer port. New Ensemble II's subwoofer cabinet encloses twin 6 1/2" long throw woofers mounted in a sealed "acoustic suspension" chamber. They project into a second chamber fitted with a single, flared port. The new port provides smoother air flow, virtually eliminating the generation of any extraneous noise on strong, low bass notes.

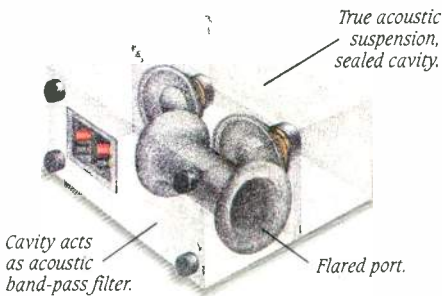

“...Beyond Its Price And Size Class

Stereo Review said that the original Ensemble II “performs so far beyond its price and size class that it can be compared only with much larger speakers at substantially higher prices.” We believe New Ensemble II carries on this tradition, clearly outperforming other speakers in its category, including well-known models that sell for about twice the price. Available factory-direct, reg. \$439 - **Now \$399.**

The Ensemble III

Now you can bring the clear, balanced wide-range sound of Ensemble speakers to a small room. Our new Ensemble III speaker system is ultra-compact: a pair of two-way satellite speakers measuring 4 1/2" x 6 1/2" x 3" and one subwoofer



YOU MUST MENTION COUPON CODE WHEN ORDERING

Save \$30 On Ensemble III*
Reg. \$529 - Sale Ends 3/18/95
\$299 Code: C120195A

Save \$40 On New Ensemble II*
E.g. \$439 - Sale Ends 3/13/95
\$399 Code: C120195B

Save \$30-\$50 On New Ensemble*
Vinyl-Cad Subwoofers. E.g. \$549
Laminate Subwoofers. Reg. \$629
\$499 \$599
Code: C120195C Code: C120195D

*Sale price may not be combined with any other special offers.

cabinet measuring just 8" x 8" x 15".

Surprising Accuracy and Musical Range at a Low Price.

Compared to our New Ensemble II system, Ensemble III gives up a little in the way of power handling, low bass range, and efficiency. Unlike the "cube" satellite speakers you'd expect to find in similarly priced systems, Ensemble III's satellites are true two-way speakers with a 3 1/2" midrange driver, a 3/4" tweeter and a crossover. Ensemble III's 6 1/2" woofer uses two separate voice coils (one for each channel) in a cabinet using a special flared port for smooth air flow.

With most recordings Ensemble III will sound virtually identical to New Ensemble II. It simply won't play quite as loudly. Its construction quality matches that of our other

Ensemble speakers. Ensemble III is available factory-direct, reg. \$329 - **Now \$299.** It is perhaps the best speaker value of all time.

Risk Free, Satisfaction Guaranteed.

All Cambridge SoundWorks speakers are backed by a 30-Day Total Satisfaction Guarantee. So you can audition your speaker the *right* way - in your home, with no salesman hovering nearby. If within 30 days you're not happy, return your system for a full refund. We even reimburse original UPS ground shipping charges in continental U.S.

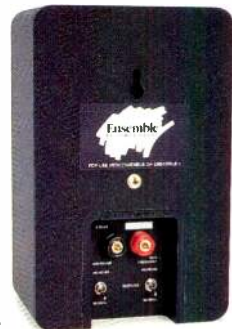

The satellite speakers used in the New Ensemble and New Ensemble II include midrange and high-frequency tonal balance controls, and gold-plated 5-way binding posts.



All three Ensemble speaker systems come with 100 feet of speaker wire, a wire cutter/stripper, accessories, and our Guide To Surround Sound.

For A Free Catalog, Call
1-800-FOR-HIFI

We Know How To Make Loudspeakers!



311 Needham Street, Suite 104M, Newton, MA 02164
Tel: 1-800-367-4434 Fax: 617-332-9229
Canada: 1-800-525-4434
Outside U.S. or Canada: 617-332-5936

© 1995 Cambridge SoundWorks. Ensemble is a registered trademark of Cambridge SoundWorks, Inc. KLH is a trademark of KLH, Inc. AR and Advent are trademarks of International Jensen, Inc. Cambridge SoundWorks is not affiliated with KLH, Advent or AR.



CAMBRIDGE
SOUNDWORKS
BY HENRY KLOSS



FREE Audio Catalog

At Cambridge SoundWorks we make speakers and music systems designed by Henry Kloss (founder of AR, KLH & Advent). We sell them—and components from companies like Sony, Pioneer, Philips, Carver and others—factory-direct, with no expensive middlemen. For example, a Dolby Pro Logic Surround Sound system with Model Six speakers, rear speakers, a Sony Pro Logic receiver and remote is only \$747. Call today and find out why *Audio* magazine said we may have “the best value in the world.”

- Call toll-free for factory-direct savings.
- Save hundreds on components and systems from Cambridge SoundWorks, Sony, Pioneer, Philips, Carver and more.
- Audio experts will answer your questions before and after you buy, 8AM-Midnight (ET), 365 days a year—even holidays.
- 30-Day Total Satisfaction Guarantee on all products.
- 7-Year Parts & Labor Speaker Warranty.

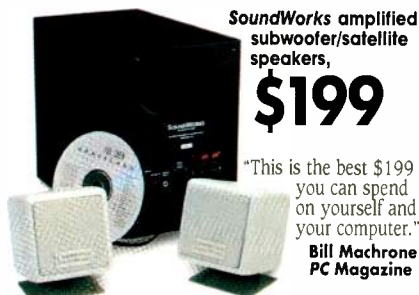

SoundWorks amplified
subwoofer/satellite
speakers,

\$199

“This is the best \$199
you can spend
on yourself and
your computer.”

Bill Machrone
PC Magazine

1-800-FOR-HIFI
We Know How To Make Loudspeakers.

**CAMBRIDGE
SOUNDWORKS**

311 Needham Street, Suite 104M, Newton MA 02164
Tel: 1-800-367-4434 Fax: 617-332-9229
Canada: 1-800-525-4434 Outside U.S. or Canada: 617-332-5936
©1995 Cambridge SoundWorks.

One should create an audio space that is generally square or rectangular and use point-source loudspeakers of equal power, voicing, and bandwidth. They should be placed in each of the four corners of that listening space. A good rule of thumb would be to face the speakers inward at about 45°, each producing about 90° dispersion with a frequency response of 20 Hz to 20 kHz (include a subwoofer with each speaker if necessary). The remainder of your system requirements will become apparent depending on personal choice with regard to the center-channel loudspeaker and the .1 special-effects bass channel.

Be advised that *audio-only* multichannel (surround) programming is on the way, and none of it has been mastered with the THX EQ curve that is so prevalent in motion-picture soundtracks (and one of the reasons that some of these soundtracks sound so . . . ah, digital?). Therefore, make certain that you have a THX EQ defeat switch in your system and use it according to personal preference.

It seems to be rather clear that we do not walk around our own little worlds with our hands cupped behind our ears, shutting off phase- and frequency-coherent ambient sound. Why should our surround sound entertainment programs be any different?

Brad S. Miller

Mobile Fidelity International
Incline Village, Nev.

Directory Discourse

Dear Editor:

I am upset with the coverage your Annual Equipment Directory (October 1994) gives to digital recorders. Pioneer Elite, Panasonic, Tascam, and Fostex all have current offerings on the digital recorder market; none were mentioned. The lines offered by Marantz and Sony are only partially mentioned. Tascam is not even listed among the manufacturers, while some that retail only one product to audio consumers are included.

Your Directory does mention amplifiers and D/A converters that cost a small fortune, so I can't believe that editorial policy dictates omitting those machines that are designated “professional models.”

Digital recordings are obviously the medium of the future. Digital recorders are a necessary and wonderful addition to the

stereo of the future. If the average audiophile cannot record music, then he is limited to what the music industry puts in front of him, and this is no audiophile. If a publication such as yours were generating rather than stifling interest in digital recorders, perhaps more models would be available, and the prices would be coming down faster. Also, the whole question of D/A and A/D conversion, as it relates to digital recorders, is important to me, and I would like to see it addressed in your publication. Does one need a converter for recording/playback? Which decks have good built-in converters? What would make them better? Do a series on digital recording, please.

Your failure to mention commercially viable digital recorders is, in my opinion, irresponsible.

Martin P. Hanlon
Syracuse, N.Y.

Editor's Reply: We do indeed have an editorial policy not to list products of professional-only companies. This doesn't mean you won't find any pro models at all in the Directory; a consumer manufacturer may mix one or two pro models in a listing, or the company may include a product intended for both markets. But companies that cater to the pro market are not listed, as *Audio* is aimed primarily at the consumer market. This explains the absence of Fostex and Tascam.

This, too, likely explains Mr. Hanlon's view that the other companies he mentions are underrepresented. Suffice it to say that these companies supplied us with all the products they chose to list in the Directory. It is impossible for us to verify each manufacturer's submitted listing for completeness of models in all 18 product categories; that responsibility must remain with the company when it fills out our forms.

In response to Mr. Hanlon's implication that *Audio* is “stifling” rather than generating interest in digital recorders, let me say that I personally, as Directory Editor, have called and reminded certain companies to send us that specific form when they obviously overlooked it. (After all, the stakes are higher today, now that our former “Digital Recorders” category has blossomed into “DAT, DCC, & MD Player/Recorders.”) And articles that we have

Movie Theatre Performance with Flexibility

The Bryston 8B THX® Amplifier



8B THX

Bryston is pleased to announce our new 8B THX four channel audio power amplifier. With today's interest in quality home theatre the 8B THX amplifier provides state-of-the-art performance with the unquestioned quality, value and **R**eliability for which Bryston has gained an international reputation. All Lucasfilm Home THX certification parameters are easily met for its' intended use within a multi-channel audio/video installation. The 8B THX is an extremely versatile and flexible amplifier designed for all **Y**our THX theatre installations. The amplifier can be instantly connected to provide 2 channel, (400 watt output), 3 channel, (two @ 120W plus 1 @ 400W), or 4 channels at 120 watts output. This provides extreme ease in integrating the power requirements for any THX Home Theatre system. The THX stipulation for separate center channel, left and right main speakers, decorrolated dipole surround channels and one or two subwoofers, is provided in a **S**imple elegant package. Among the 8B's notable features is the use of four independent power supplies, one for each channel, to prevent any signal interaction among the individual channels. This provides a sonic soundstage with images locked in position with an almost holographic effect. Other features include both balanced XLR, 1/4" and unbalanced RCA input connectors to allow for flexibility in a wide variety of installations. All connectors throughout the amplifier are gold plated to provide freedom from corrosion, assuring perfect signal integrity for many years to come. **T**ri-colored LEDs glow green for power-on, yellow for short-term transient clipping and red to indicate continuous overload or any departure from linearity, including shortened-output or strong out-of-band information like RF or DC. **O**bviously, the goal of all this technology is to transport you to the scene of the movie. Experiencing all the drama, excitement and emotions as if you were right there in the show. We feel we have accomplished this with all the **N**ew Bryston THX amplifiers. Experience the movie as intended and audition the Bryston 8B THX today.

BRYSTON

For more information contact:
57 Westmore Dr., Rexdale, Ontario, Canada M9V 3Y6
Tel: (416) 746-1800 Fax: (416) 746-0308

Enter No. 5 on Reader Service Card

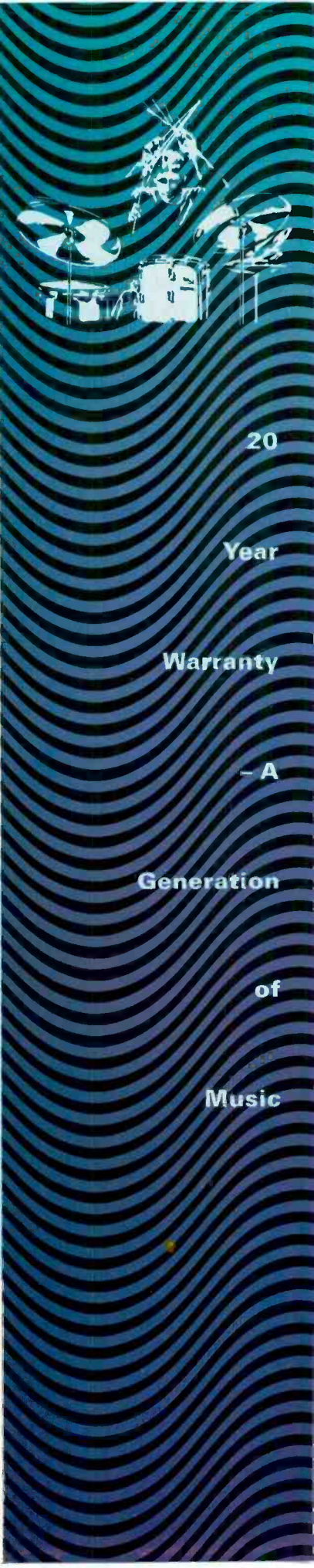

20

Year

Warranty

- A

Generation

of

Music

published recently that relate to digital recording—in addition to this issue's report on JVC's XM-D1BK MiniDisc deck—include an interview with digital-recording pioneer Tom Stockham and a report on the Sony MDS-501 MD deck (both November 1994), as well as reports on Sony portable and home DAT units, the TCD-D7 (June 1994) and the DTC-2000ES (January 1995). The latter begins with a lengthy discussion on the current state of home digital recording and recorders.—K.R.

Dear Editor:

I'm a longtime subscriber to *Audio* magazine, and I am very pleased to receive the October Directory issue every year. For me, this is my bible, and I rely heavily on it. So I wish to know if the Directory is available in software form or in a database format.

I use my computer regularly for reference. In the past, I used to type all the information of your Directory into a database file, and it took me forever to complete. But when the database was ready, I could cross-reference all the data, which is very practical.

I'm sure that lots of people who own a computer would agree with me: A database *Audio* Directory could be used as a reference by the entire industry, or simply by people like me.

Marc Dehandschutter
Kihei, Maui, Hawaii

Editor's Reply: For quite some time, we have been discussing the possibility of making the Directory available on CD-ROM. Over the past year, *Audio* and all other publications of Hachette Filipacchi Magazines have completed the changeover to desktop publishing, so the prospect of a Directory CD-ROM is now more realistic. In fact, one of our sister publication's directories, the *Car and Driver Buyers Guide to 1995 New Cars*, is expected to be available on CD-ROM by spring. We'll keep you posted on our own progress.—K.R.

Dear Editor:

As a longtime subscriber to *Audio*, and as one who looks forward to the Annual Equipment Directory, I have several suggestions concerning the latter.

Inasmuch as the Directory *is* intended to be a year-round reference work, would it not be better to print the page numbers at the lower outer edges of the pages, rather than in the center? After referring to the contents page to find the desired section, it would be so much easier to locate that page if the number were at the outer edge.

One more thing: I realize that reel-to-reel tape recorder/players are almost ancient history, but are there none being manufactured currently? If there are, how about some listings?

Also, you have never listed small, portable analog cassette recorder/players, such as the great Marantz PMD series or the Sony TC-D5M. A section on this category would be very welcome.

Ray Van Steen
Chicago, Ill.

Editor's Reply: The last time we listed open-reel tape decks was in the 1991 Directory. The following year, Editor-in-Chief Eugene Pitts explained our decision to make "another change away from pro-oriented recording" by dropping open-reel decks

the ultimate surround sound

Life is stressful. You could spend a few thousand dollars rushing to a weekend getaway at a rejuvenating retreat. You could mortgage your home for one of those "quiet as a recording studio" motor cars you've seen on television. Or you can keep the family fortune and relax in the sanctity of your own home with a pair of Sennheiser headphones. Discover the ultimate in surround sound... at a budget you can easily afford.

 **SENNHEISER**

6 VISTA DRIVE, P.O. BOX 987, OLD LYME, CT 06371 • TEL: 203.434.9190 FAX: 203.434.1759
IN CANADA: 221 LABROSSE AVE, POINTE-CLAIRE, PQ H9R 1A3 • TEL: 514.426.3013 FAX: 514.426.2979

Enter No. 32 on Reader Service Card



ALL BIPOLARS ARE NOT CREATED EQUAL!

**8 Critics' Choice Awards* and
5 Product of the Year Awards* in the past year alone,
and over 40 Awards since 1990 makes Paradigm
the number one choice for critical listeners!**

“Stunning!”

- The Inner Ear Report on the Esprit/BP

Paradigm's spectacular bipolar speakers are an engineering and sonic marvel! With years of design expertise and our highly advanced R&D facility, Paradigm engineers and acousticians set out to build the world's finest bipolar speakers, *regardless of cost!*

The Paradigm Advantage

Bass/Midrange Drive Units:

- Diecast chassis with built-in heatsinks
- (AVS™) air-flow ventilation system
- Ventilated Apical† formers
- Symmetrically-focused-field magnet geometry

High Frequency Drive Units:

- (PAL™) pure-aluminum convex domes
- Critically coupled diecast chassis
- Oversized damping chambers
- Oversized magnetic structures

Cascade™ Enclosures:

- Sophisticated cascade of interlocking, full perimeter horizontal and vertical braces
- 1" thick MDF front and back baffles
- High velocity, low turbulence ports



“Awesome!”

- Audio Ideas Guide on the Eclipse/BP

**THE ULTIMATE IN
BIPOLAR SPEAKERS
START AT AN
INCREDIBLE \$499/EA.**

These astonishing state-of-the-art bipolar speakers combine exceptional spaciousness, precise image placement, superb timbral balance, extraordinary resolution, thunderous deep bass and tremendous dynamics for absolutely staggering realism!

Combine any of our bipolars with our Ultra-Clear™ center channels, amazing ADP™ surrounds and astounding PS powered subwoofers for the absolute finest in home theater!

The Critics Agree...

Paradigm has achieved the highest standard of performance in bipolar design. **So don't settle for less, listen to these sensational speakers today!**

Paradigm®

ENGINEERED FOR BETTER SOUND

AUDIOSTREAM, MPD BOX 2410, NIAGARA FALLS, NY 14302 (905) 632-0180
IN CANADA: PARADIGM ELECTRONICS INC., 101 HANLAN RD., WOODBRIDGE, ON L4L 3P5 (905) 850-2889

Enter No. 25 on Reader Service Card

* Sound & Vision Critics' Choice Awards
* Audio Video International Grand Prix Awards

† Apical is a trademark of DuPont

Q: Are there car speakers that sound great *and* install easily?

A: Sure. Advent Mobile speakers fit the bill. Here's why:

You get true high fidelity sound—an exclusive design suspends the tweeter in the acoustic center of the speaker for greater musical realism and improved stereo imaging.

And installation couldn't be easier—Advent® Mobile speakers fit behind virtually every factory grille with no cutting or modifying.

You'll find hundreds more audio and video solutions in the Crutchfield catalog. Call us today and let us send you a copy, free.

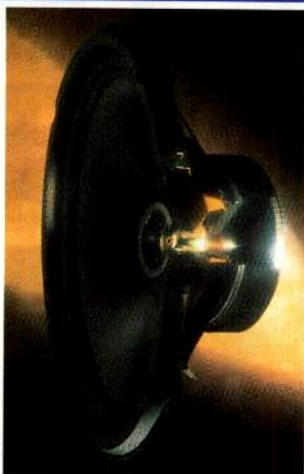

See more of Advent Mobile's speakers and amps in the Crutchfield catalog.

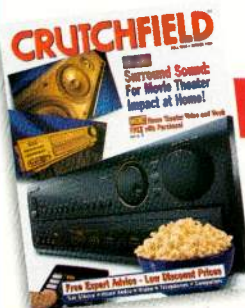

FREE CATALOG! 1-800-890-4302

8 am-Midnight (eastern time), 7 days a week

The Crutchfield catalog—over 100 pages of car stereo, home audio, video and home theater. Full descriptions, exclusive comparison charts and helpful consumer tips. Call us for a free copy.

Or write: Crutchfield,
Dept. AU, 1 Crutchfield Pk.,
Charlottesville, VA 22906

CRUTCHFIELD™

"Few speakers at any price have done this well in my listening room."

That's John Atkinson of *Stereophile*. He continues, "That the \$795 Spica can do it is a testament to the talent of its designer [John Bau]...Every audio reviewer lives for the moment when he or she hears true high-end sound quality emanating from affordable components. Which is why I got excited by the Spica TC-60."

Tony Cordesman of *Audio* says, "...the TC-60 does an exceptional job of creating the illusion of a live performance from a small enclosure...a properly set up TC-60 is one of the rare exceptions that can make you forget its size and lose yourself in the music."

Martin DeWulf of *Bound For Sound* says, "On absolute terms, the strongest performance aspect of the Spica has to be its ability to flat out physically disappear in the listening room...It too has legend potential."



3425 Bryn Mawr NE • Albuquerque, NM 87107 • Division of Parasound Products • 415-397-7100
Stereophile, December, 1994, Vol. 17, No 12. *Audio*, January, 1995. *Bound For Sound*, 11A-94

from the Directory: By 1991, the recorders had become "almost totally devoted to studio or location use by the music industry."

A few companies still make open-reel decks, and we suggest you write to them for more information. They include: Fostex (15431 Blackburn Ave., Norwalk, Cal. 90650), Nagra (240 Great Circle Rd., #326, Nashville, Tenn. 37228), Otari (378 Vintage Park Dr., Foster City, Cal. 94404), Studer (1865 Air Lane Dr., Suite 12, Nashville, Tenn. 37210), and Tascam (7733 Telegraph Rd., Montebello, Cal. 90640).

The portable/desktop analog cassette units you mention are, again, primarily for professional purposes (note that the Sony TC-D5M is marketed under the company's Pressman line). These units shouldn't be confused with their smaller cousins, the Walkman-type personal stereos, which we also don't include in the Directory. We do, however, list portable formats of more concern to our audiophile readers—namely, CD, DAT, DCC, and MD.

When it comes to the placement of page numbers, you're in Art Department territory—i.e., page design. The centered pagination is not new; it was introduced in January 1993 as part of a redesign of *Audio* intended to give the magazine a cleaner, more modern look. No matter how many months are spent laboring over a redesign, it's always difficult to ensure that every element will please our readers, not to mention ourselves!—K.R.

McIntosh Man

Dear Editor:

I would like to suggest that you do a review of the McIntosh commemorative-issue Gordon J. Gow MC-275 tube amp. It is an incredible piece of equipment. Also, I would like to know if you plan to do any reviews of McIntosh equipment in 1995. Thank you.

Phillip R. McCreary
Columbus, Ga.

Editor's Reply: No doubt you were pleasantly surprised when, shortly after mailing your letter, the January issue of *Audio* appeared with a report on the McIntosh MC500 amplifier and C40 preamplifier. You should also go back to the February 1994 issue for our cover report on the MC1000 mono amp.—K.R.



At one time you understood how this worked.



FIVE BLOCKS MADE A COTTAGE, ten a castle, and a hundred your own private empire. With Linn components, it's just that simple. You can start out with the system that's right for you today and, using our building-block approach, improve and expand your system over time in affordable steps. Some steps will improve the performance of your system, others will expand your system throughout your home, but each and every step has one thing in common. It delivers more music. **PEOPLE NEED MUSIC.** Music is important. Exploring the world of music in the comfort of your own home is therapeutic. It will help you relax, stimulate your imagination, change your mood, and provide entertainment and pleasure for your whole family.

1-800-LINN HI-FI
music for life[™]

A SOUND INVESTMENT. At our innovative factory in Scotland, we produce the most advanced and best sounding hi-fi. Skilled and dedicated people and our unique single-station-build philosophy ensure a standard of construction and reliability simply not possible on a production line. And, with your Linn retailer on hand to provide assistance long after your initial purchase, you can expect your hi-fi to last a lifetime. People who love music have built our business, so we look after them. **MUSIC FOR YOUR LIFE.** To learn more about Linn Hi-Fi and the many ways in which Linn can make music a more important part of *your* life, phone Audiophile Systems, Ltd., our U.S. distributor, at 1-800-546-6443.

CD Tracking Problem

Q *I recently purchased a CD that one of my three players consistently refuses to play. When I load this disc, the unit displays the track and time information. When I press "Play," that button blinks indefinitely, as though the machine is in "Pause" mode. On those rare occasions when the music does play, it is accompanied by a noise that sounds like crumpling cellophane. All other CDs continue to play properly. What's causing this strange problem?—David A. Bertrand, Aurora, Colo.*

A I once had a similar problem. In my case, the belt that moves the laser carriage had stretched. But before you look for this, make certain the CD is clean. Then, as a check, attempt to play the problem child. Immediately after pressing "Play," use the forward-skip button (not fast-forward or cue) to skip to the second track. If the player finds it successfully, use the reverse-skip button immediately to go back to the start of the first track. Should matters work as they did for me, you will successfully play the first track. If your problem is the same as mine (which it strongly resembles), you will eventually find that more and more of your discs fail to play. All will be well when you replace that defective belt.

A dbx Problem

Q *My cassette deck includes both dbx and Dolby noise reduction. When I record with dbx NR (especially on certain musical passages such as solo guitar and, sometimes, when dubbing from other tapes), the background noise on the tape increases dramatically when sound is not present. I do not find this rise and fall of noise when using the Dolby system. In fact, it is not always present when I use dbx NR. Why is this? Even more important, what can I do about it?—John R. MacLaren, Dedham, Mass.*

A You're experiencing the phenomenon known as noise pumping, which is common with systems that use heavy compression and expansion, as dbx NR does. Noise pumping occurs when the

spectral content of the music being recorded fails to mask the spectral content of the noise. This happens most often when you have a sound with narrow-band energy, such as acoustic guitar. Also, it's easy to record a guitar at a low level, so that its energy is not sufficiently higher than the background noise for masking to take place. You can help the situation by recording at a higher level.

If you're dubbing from tapes that don't incorporate dbx NR, noise pumping should not occur. But when you're dubbing a dbx-encoded tape, the noise from the two tapes may be just high enough to become unmaskable. You'll probably get best results if you copy dbx-encoded tapes straight, without decoding and re-encoding. (This is, of course, precisely the opposite of what you must do when dubbing tapes encoded with Dolby NR.)

I've occasionally had problems when making dbx-encoded recordings from high-level signals, such as those from CD players. (Where some components produce perhaps 0.1 or 0.3 V, a CD player might well produce 1 V or more.) In some recorders, the signal feeds into the dbx chips ahead of the volume control. If the signal's level is too high, the dbx circuitry may have trouble handling it. The cure is to use a voltage divider of some kind between the output of the program source and the input of the recorder; try 6 to 12 dB of attenuation.

Tape Deck Motor

Q *When the motor of my 1969-vintage Astrocom Marlux 407 open-reel tape recorder warms up, its speed decreases. I can't find a replacement for its hysteresis-synchronous, dual-speed, bidirectional capstan motor. Can you help?—Name withheld*

A I have no idea where you might obtain a replacement motor. My first thought is that you should place an ad in our Classified section, asking for such a motor. My second thought is that you actually might not need a new motor—you might be able to repair it.

First, look for a bipolar electrolytic capacitor wired in series with one of the motor's field windings. (Such "motor-starting capacitors" bring about a 90° phase difference between two magnetic fields, which makes the motor work.) If this loses capacitance over time or loses capacitance when it heats up, the motor won't run at proper speed. Determine its value, and replace it. Shops specializing in motor repair are often a good source for these capacitors.

Also, your motor's bearings might need relubricating. (These bearings are supposed to be permanently lubricated, but nothing is permanent.) There is no obvious way to add more lubricant without dismantling the motor. What I have done is to take the motor apart, removing the upper and lower sections of the housing and carefully removing the rotor. Any pulleys fixed to the rotor shaft must be removed before you can remove the rotor assembly. Liberally lubricate the shaft bearings. (I temporarily plug up one end of each bearing so that the light oil can stay inside overnight. This allows time for the bearings to absorb the oil.) Do not soak the electrical windings! Reassemble the motor, and all should be well again.

Testing with Equalizers

Q *I understand that some people make tests and adjust their equipment by using equalizers. What is involved?—Name withheld*

A I suspect you're talking about people whose equalizers include real-time analyzers, or RTAs, which use a bank of LEDs to show signal or sound levels in each of several frequency bands. If your equalizer has no RTA, you should obtain one that does or get a separate RTA. Either way, the device should come complete with a properly calibrated microphone. The microphone is placed in your favorite listening position. The analyzer can produce bands of "noise" that will be fed into your loudspeakers and eventually be picked up by the microphone, and the RTA display

If you have a problem or question about audio, write to Mr. Joseph Giovanelli at AUDIO Magazine, 1633 Broadway, New York, N.Y. 10019. All letters are answered. In the event that your letter is chosen by Mr. Giovanelli to appear in Audioclinic, please indicate if your name and/or address should be withheld. Please enclose a stamped, self-addressed envelope.

Sanus Systems

Give Your Music a Sound Foundation®



Performance with Style

Are you getting the most out of your speakers? Did you know that proper mounting and room placement dramatically improves sound quality? Most major speaker manufacturers recommend loudspeaker supports for optimum performance; many of the best known brands specifically recommend or use Sanus Sound Foundations. Demand the most from your audio dollar. Give your music a Sound Foundation!



Most leading satellite speakers securely bolt mount to Euro Sats. Sanus Systems is not affiliated with speaker brands that are shown.

Euro Foundations®

Euro Foundations are a contemporary alternative to the utilitarian look of most steel loudspeaker supports. Performance is on par with the finest European and domestic designs, yet the price is affordable. The new generation of satellite and surround speakers bolt mount to Euro Sats for better performance and safety. (Many competing stands use two sided tape!) Euro Foundations feature sand fillable steel bases, adjustable floor spikes, neoprene isolation pads, and a hidden wire path.

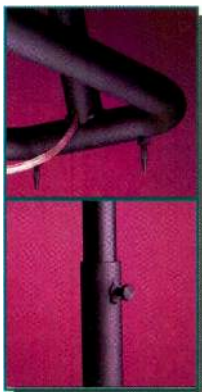

All Euro Foundations feature adjustable floor spikes to ensure stability on carpeted surfaces. A concealed speaker cable path keeps wire neat and organized.

The Euro Sat features a unique adjustment knob that allows speaker height and angle to be varied to perfectly match the requirements of your listening room.



Euro Sixteen

Euro Twenty Four

Euro Sat

1973 W. Cty. Rd. C2 Roseville MN 55113 (800) 359-5520 (612) 636-0367 FAX

Enter No. 31 on Reader Service Card

will show your system's frequency response at the microphone position. (Response at other mike positions will vary.) This will let you test the entire listening system, including the loudspeakers and the acoustics of the room in which the equipment is housed. Most analyzers can also be plugged into some output on your system, in order to check the performance of individual components.

If you like, the equalizer can be adjusted until the response shown on the RTA display becomes flatter. (In the real world, you can never get response to be completely flat.) Check each adjustment from several mike positions to make sure the correction you're adding for one spot in the room does not make things worse in other spots; equalize only those frequency irregularities that are found generally throughout the listening area. And start by cutting down the peaks, before you try filling in the dips; dips which can't be filled should be left alone.

Personally, I don't bother with all of this. I listen to a program. If the sound isn't

right and I feel like tinkering, I make a few small adjustments to the equalizer's controls till that particular program sounds better, and I leave it at that.

Editor's Note: Some authorities feel that this sort of equalization is worse than the problem it supposedly cures. These equalizers can easily add phase shift and ringing, while often having too coarse an adjustment to fix one band without hurting another.—E.P.

Noisy Lecture Recordings

Q *I record lectures. Unfortunately the quality of my recordings is frequently poor; the voice levels are poor, and there's a lot of background noise. Can I re-record my originals to improve them? Is there some digital signal processor, not too expensive, that I can use to achieve better quality, one that will remove background noise, etc.? Must I use a conventional graphic equalizer? Should I use Dolby B or C NR? Would using high-bias tapes help? I would also appreciate any hints that would help me improve my first-generation recordings.—Name withheld*

A If a lecture is poorly recorded to start with, there are very few ways to clean it up. I do not have a lot of experience with digital processors, but it is my understanding that the noise which they are sometimes successful in treating is steady-state noise—such as buzzes from power-line interference, tape hiss, etc.

In dealing with poor recordings of lectures, I have used some relatively sophisticated filters as well as graphic equalizers. Neither of these tools will remove the sound of chairs scraping along the floor, loud coughs, the roar of a slide projector, or who knows what. If most of the background noise is air-conditioning rumble or the like, you can roll off the bass with either an equalizer or a filter. You can sometimes make the speaker's words a bit more intelligible by adding highs, for added clarity and to make the speaker's voice stand out from the background noises. My efforts have not always been rewarded with success, especially when I've had to deal with an overly reverberant room on top of the background noise.

AN EXTENSION
OF EXCELLENCE.

PROAC USA 112 SWANHILL COURT • BALTIMORE, MARYLAND 21208 • 410-486-5975

PROAC
RESPONSE 3.5

McIntosh

C39 AUDIO/VIDEO CONTROL CENTER

SAT
TV
LV
VCR 1
VCR 2
V-AUX

PH/AUX
TAPE 2
TAPE 1
TUNER
CD 2
CD 1



39

% VOLUME

16
12
HALL MIN

CINEMA 1
CINEMA 2

McIntosh THX® Components. To call them "Home Theater" would be false advertising.

When McIntosh set out to design a Home Theater System, we had to answer to two masters: the stringent Dolby® and Lucasfilm™ requirements as well as our own 44 year tradition of the most exacting standards for high fidelity music reproduction.

The resulting components startle everyone who hears them: Not only are movie soundtracks reproduced with unsurpassed precision and accuracy; the overall fidelity is

among the best you will hear in *any* theatrical venue.

Equally surprising is that genuine, American-built McIntosh Home Theater Components cost the same or little more than run-of-the-mill systems. So you can enjoy realistic Home Theater and still afford a home.

Look for the beautiful, NEW McIntosh Laser Disc Player arriving shortly at your authorized McIntosh Dealer.



McIntosh Laboratory Inc., 2 Chambers St., Binghamton, NY, USA 13903-2699
(607) 723-3512 Fax (607) 724-0548 Distributed in Mexico by Sistemas de Sonido de Mexico, S.A. de C.V.
Home THX Audio is a registered trademark of Lucasfilm Ltd. Dolby Surround, Pro Logic and the Double-D Symbol are registered trademarks of Dolby Laboratories Licensing Corporation.

Enter No. 18 on Reader Service Card

McIntosh®
Components of Excellence.



With Cinema DSP, you'll be amazed

Only Yamaha Cinema DSP creates phantom speakers. It sounds so real, you'll swear you hear sounds in places you don't even have speakers.

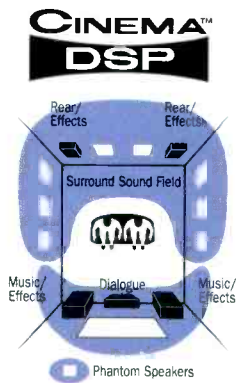

Bats screech overhead. Wolves howl in the distance. And footsteps crunch across your living room floor. No, it's not your imagination. You're hearing sounds placed around the room, just as the director intended.

All courtesy of Yamaha Cinema DSP. The home theater technology that gives dialogue more definition. Music, more dimension. And sound effects, more graphic detail.

Only Yamaha Cinema DSP creates phantom speakers that fully replicate the experience you get in multi-speaker movie theaters. It sounds so real, in fact, you'll swear you hear sounds in places you don't even have speakers.

As you might imagine, a breakthrough like this is no small feat. It's accomplished by multiplying the effects of Digital Sound Field Processing and Dolby Pro Logic.[®]

Digital Sound Field Processing is Yamaha's unique technology that electronically recreates some of the finest performance spaces in the world.



at what comes out of the woodwork.

And Dolby Pro Logic is the technology responsible for placing sound around the room, matching the dialogue and sound effects with the action on the screen.

Together, these two technologies allow Yamaha to offer a complete line of home theater components that outperform other comparatively priced products on the market.

Stop by your local Yamaha dealer for what could be a very eerie demonstration. Maybe we can't talk you into a system, but that doesn't mean we can't scare you into one.

For the sales location nearest you, call 1-800-4YAMAHA.

YAMAHA®



Considering that your original tapes are often noisy, I do not believe that Dolby noise reduction or the kind of tape used will significantly improve your second-generation copies, though either of these can keep the copy from gaining much additional noise. The main advantage of a second-generation copy is that it lets you edit out long pauses and short bursts of noise and lets you add comments about the lecturer's visual aids and such. This may clarify a point being made in the lecture.

The main thing is to make better first-generation tapes. It is always important to place your microphone as close to the talker as possible. Use directional mikes, which pick up less room noise. The best mikes for this purpose are "shotgun" types. These are hard to use because they must be precisely aimed at the talker—which seems simple enough, until you run into a lecturer who walks around the room as he speaks. I have also found that recording lectures in stereo makes the words more intelligible. Condenser mikes are very popular, but some have noisy preamplifier stages, as do the

mike inputs of many recorders. If your mike is noisy, get a quieter one, preferably with high output, to minimize input-preamp noise. If your mike input is noisy, use a mixer with quiet mike circuitry.

Some recorders can be switched to an "automatic level" mode. Although this is

**IT IS ALWAYS IMPORTANT
TO PLACE YOUR MIKE
AS CLOSE TO
THE LECTURER
AS POSSIBLE.**

not a useful tool when recording music, it is quite useful when recording lectures. However, the level of noise from the room, your mike, or your preamp will seem to rise as the lecturer speaks more softly and fall when he gets louder. (All too many speakers "do a slow fade," and this will be annoying during playback when you hear the background noise rising and falling.)

While room noise is the main enemy, anything you can do to minimize tape hiss will still help. It can help to use Dolby B and C NR in your original recording. Better yet, use DAT, which offers long recording time (up to 2 hours) without interruptions for turning or changing tapes. If you can find a DAT machine that lets you record analog sources at the 32-kHz sampling rate, you can get up to 4 hours of continuous recording. This sampling rate will reduce high-frequency response somewhat, to about 14 kHz rather than 22 kHz, but for lecture applications this is still excellent response.

Adding a Subwoofer

Q I want to use a subwoofer with my new receiver, which has no subwoofer output. I suppose that I must somehow route the signals from both the left and the right channels into the subwoofer so that it can work properly. Since I only want to use one subwoofer, I would guess that it would need two separate voice-coils if I am going to drive it from both output channels.

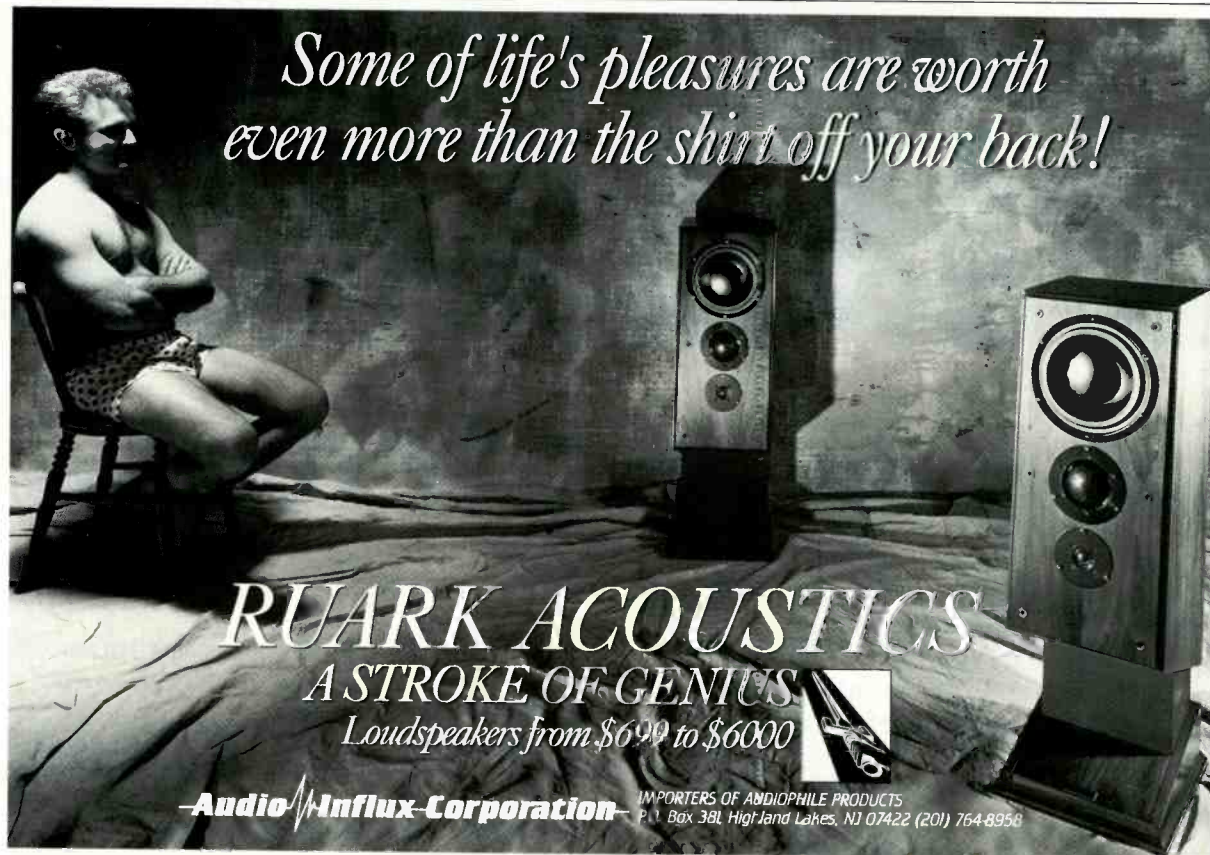

*Some of life's pleasures are worth
even more than the shirt off your back!*

RUARK ACOUSTICS
A STROKE OF GENIUS
Loudspeakers from \$699 to \$6000

Audio Influx Corporation IMPORTERS OF AUDIOPHILE PRODUCTS
P.O. Box 381 Highland Lakes, NJ 07422 (201) 764-8958

Enter No. 2 on Reader Service Card

My satellite speakers are 8 ohms. Should the subwoofer also be 8 ohms? And should I use my receiver's 4- or 8-ohm output setting? Would it be better to use a separate power amp to drive the subwoofer?—Leonard Shedler, Folsom, Cal.

A Because most subwoofers have inputs for both channels, plus high-pass crossover outputs to feed satellite speakers, the easiest hookup is usually to connect your receiver's speaker terminals to the subwoofer's inputs and the satellites to the subwoofer's high-pass outputs. It will probably simplify things and ensure that the crossover works at its designated frequency if you get an 8-ohm subwoofer and use your receiver's 8-ohm setting.

There are three methods subwoofers use to deliver both channels' bass. Some subwoofers have dual drivers, one per channel, in a single box (though that box may be divided into two enclosures). Others, as you surmised, have one driver with dual voice-coils, each fed by a separate crossover. Most add the bass from the two channels together, to feed one driver with one voice-coil.

Many subwoofers (especially the single-driver type without dual voice-coils) have their own amplifiers built in or are supplied with external amplifiers. (The impedance of a self-powered subwoofer is not critical; the subwoofer and the satellites are not tied together by a passive crossover network.) Either way, there will usually be both speaker-level inputs, which you connect to your receiver's speaker terminals, and line-level inputs for use with subwoofer outputs or the main outputs on preamps. Most power amps, however, only have line-level inputs, which means you can only use them if your receiver has an output jack whose level varies with volume-control setting—such as the subwoofer jack you lack.

Where practical, I prefer a separate power amplifier because it frees the amplifier in a receiver from the need to handle the full audio spectrum. Most self-powered subwoofers have level controls to take care of any imbalance between the satellites' and the subwoofer's efficiencies. If you are thinking of using a passive subwoofer without such a control, try to get one whose sensitivity (sometimes called "efficiency," in spec sheets) is within 3 dB of that produced by the satellite loudspeakers. **A**

A GREAT SOURCE FOR ADVENT® SOUND.



America's best value in speakers can be heard at Sears Brand Central. These versatile Mini-Advent II or Indoor/Outdoor Mini-Advent II speakers along with the Subwoofer III rival much bigger systems for room-filling bass, yet take up only a fraction of the space. Call 1-800-274-9555 for the Sears Brand Central location nearest you or for more information on Advent products.

SEARS Brand Central

©1994 Advent is a registered trademark of International Jensen Inc.

solidsteel

AUDIO EQUIPMENT STANDS

Italian designed and manufactured, these audio stands are based on ultra-rigid steel frames, castoline brazed like a fine motorcycle frame

Steel crimped reinforcement and adjustable bottom spikes assure rigidity. Fillable tubing enhances solidity.



solidsteel model 410

Each shelf is constructed from MDF and features 3 Duraluminum cones for total isolation.

Other 3 and 4-leg stands, as well as amplifier and speaker stands, are available in both black and silver finishes.

Distributed by Golden String, Inc.
9593 153rd. Ave. NE, Redmond, WA 98052
(206) 558-0991 Fax (206) 558-0891

Build a

100-Watt

Class-

by dr. norman e. thagard

Mono

amp

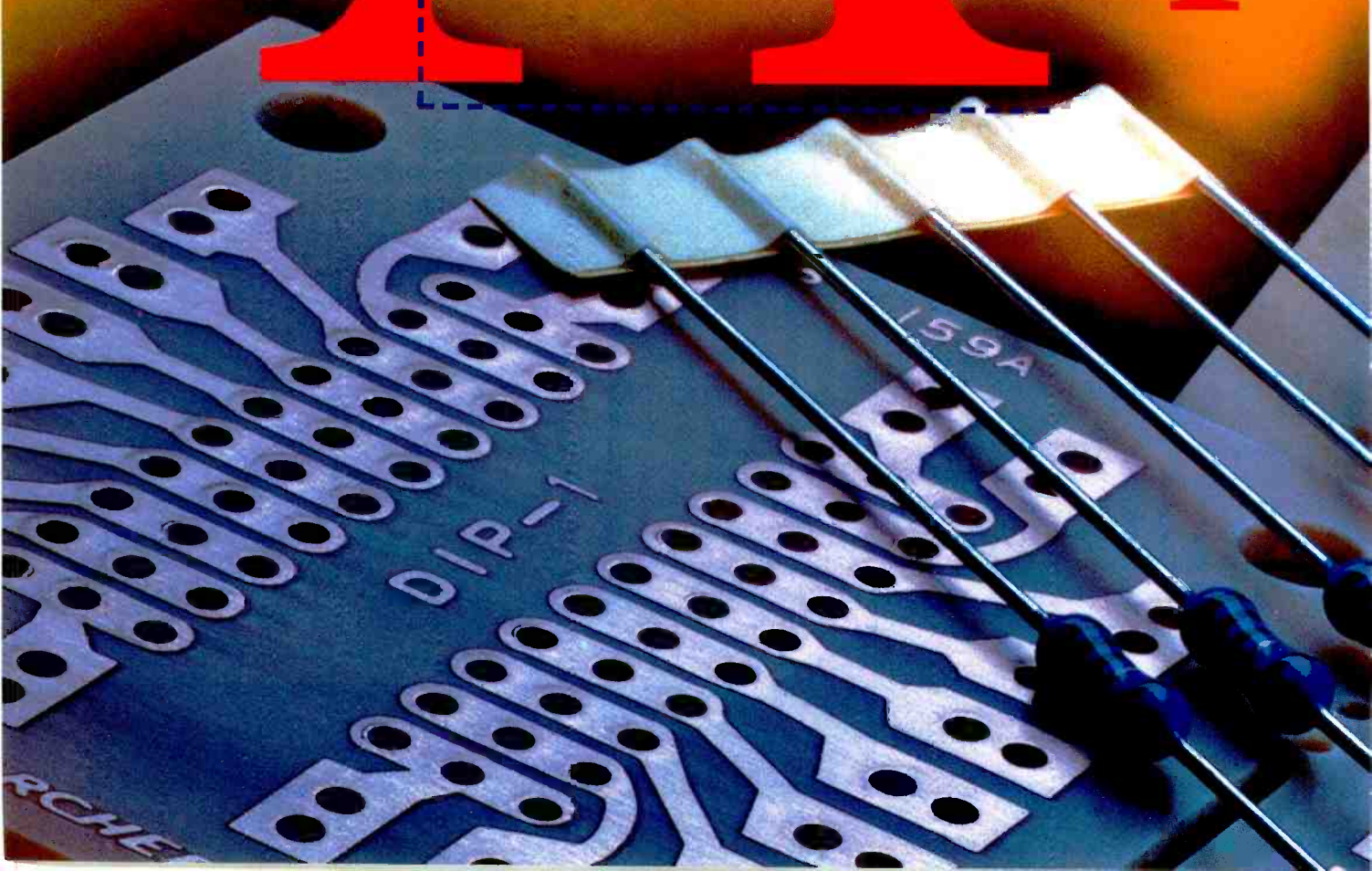

PART III

In the prior installments of this construction project, I described the amp's design philosophy and circuitry. In this final installment, I will detail how to build, set up, and trouble-shoot this 100-watt Class-A amp, and the parts you will need.

Construction Details

I would expect that builders would use various construction ideas based on experience, individual tastes, and, frankly, availability of chassis, heat-sinks, and other hardware. The amplifier, built in accordance with this article and using the components specified, should be fairly tolerant of variations in layout. Component substitutions may well require changes in the compensation scheme to ensure stability. I

recommend a p.c. board for the front-end; the pattern provided (Fig. 4) worked very well. Printed-circuit boards were also used for the voltage doubler/regulator and for the output MOS-FETs and associated components. These patterns are also provided (Figs. 5 and 6).

There are not many absolutes, but I shall mention the potential problem areas. Foremost in importance is that heat is the enemy of electronic equipment, and a 100-watt Class-A amplifier can double as a space heater! The output stage of this amp

Norman E. Thagard, M.D., is a NASA astronaut who has been selected as the prime crew member for a three-month flight on the Russian space station Mir this spring.

PHOTOGRAPH: CARL ZAPP



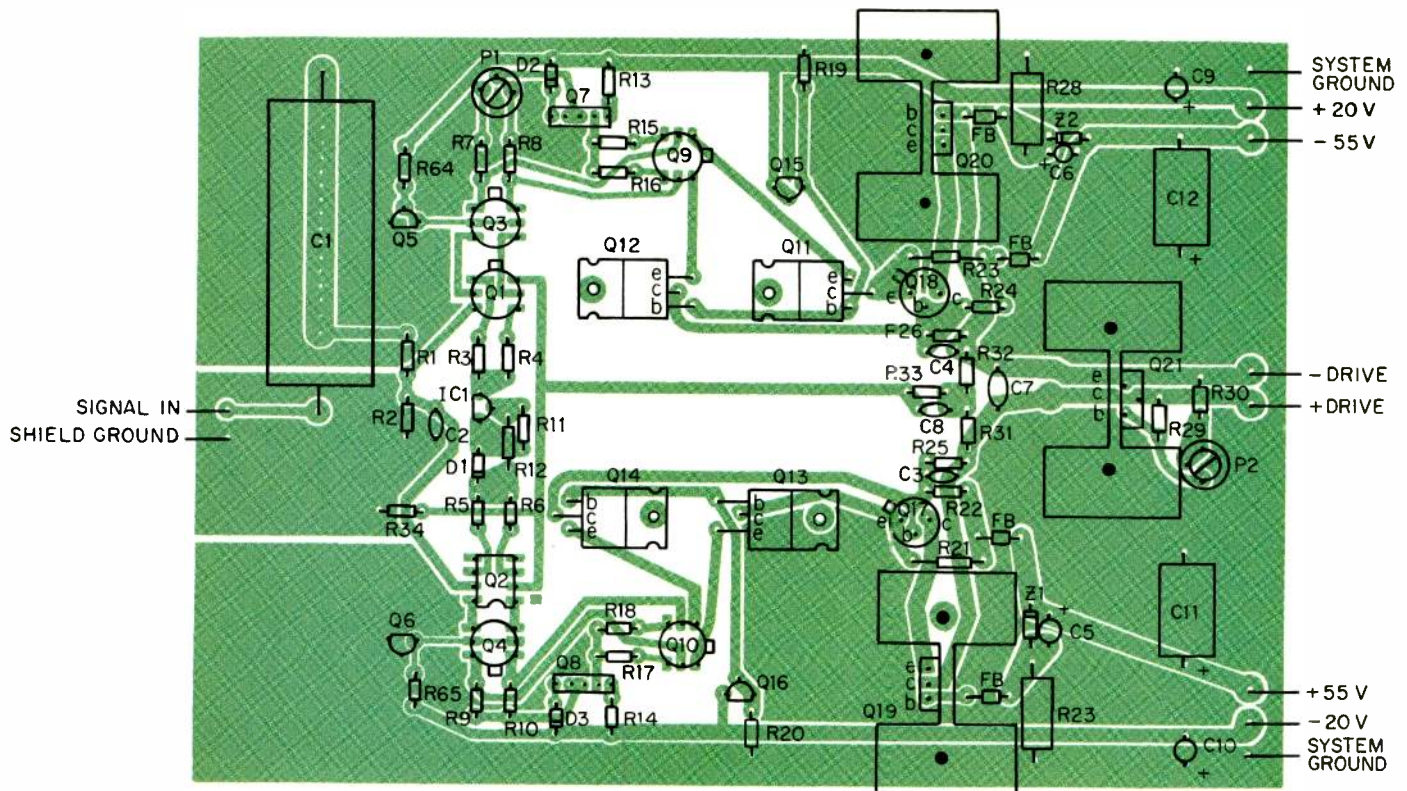

FIG. 4A—Front-end component arrangement.

is constructed from very rugged devices operating at only a fraction of their rated capability—even when derated for their operating environment in this application. Nonetheless, I recommend large heat-sinks for Q36 through Q47, since they collectively dissipate about 200 watts. Unless you use forced air cooling, I recommend building the amp as a mono unit. Although this means two enclosures and two power supplies for stereo, Class-A amps at this power level are not well suited to stereo construction if only passive cooling is available. I do

not like cooling fans in a sound system, and this unit dissipates more than 0.25 kilowatt per channel. On the prototypes, heat-sink fin area was 840 square inches for one channel. The fins were 1/16-inch aluminum, painted black. Even so, the hottest device rose to 60° C above ambient. The follow-on units used commercial heat-sinks with significantly more fin area and commensurately lower temperature increases. I would try to provide an area of at least 100 square inches for each output bipolar transistor. Constant-current source

The driver transistors Q19 and Q20 dissipate about 4 watts, so they definitely must have heat-sinks appropriate for this power level. Although not strictly required, I used small heat-sinks on second-stage, common-base transistors Q11 through Q14. As discussed, Q21 should be placed on a heat-sink to avoid excessive sagging of the output bias level.

You should note that the front-end p.c. board pattern grounds all of the heat-sinks, which were solderable-pin types made for p.c. board mounting. Because the heat-sinks are grounded, you must ensure that the transistors mounted on them are electrically insulated with mica insulators. Use plenty of thermal grease to restore thermal conductivity across the insulators. Because series-pass regulator transistors Q101 and Q102 dissipate about 4 watts, they need the same sort of heat-sinking used for the driver transistors.

With all of the heat-sinking, it is still necessary to ensure that the internal volume of the enclosure is ventilated. I recommend that the top and bottom covers have ports or louvers, or be built from metal with a mesh or grid pattern. Obviously, it

transistors Q22 and Q23 dissipate about 10 watts each. They can be placed on the same heat-sink as the output transistors or even on the chassis. The MOSFETs are in TO-220 packages; I found it convenient to mount them on their own common heat-sink, placed at the rear of the chassis. The ones I used were black anodized 1/16-inch aluminum with 150 square inches of fin area.

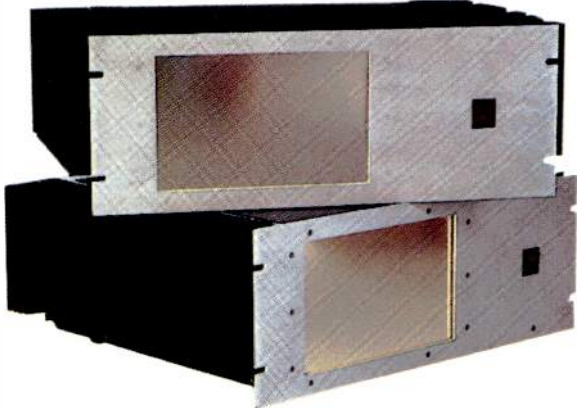

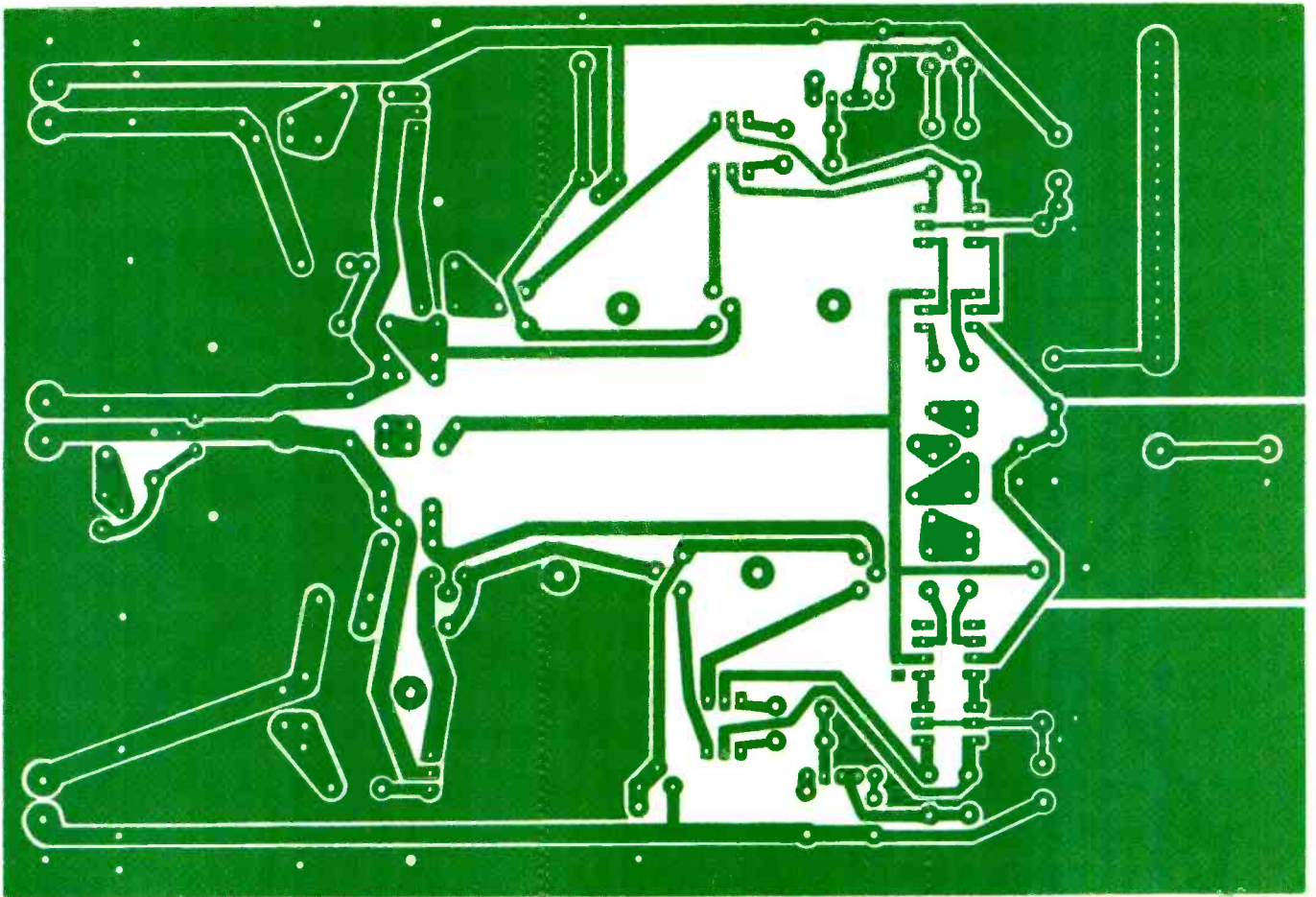

FIG. 4B—Foil pattern of front-end board shown 90% of actual size.

is not advantageous to place this amp in a small, closed space. If you intend to do this, you should use some form of forced air cooling.

Having said all of this, with a total of 10 years combined failure-free operation with four of these units, I am emboldened to say that they are probably tolerant of some amount of abuse. After all, the prototypes have woefully undersized heat-sinks, were placed near the ceiling directly under 300-watt light bulbs, and got painfully hot (with no apparent ill effects). I do not recommend such abuse, however. Conservatism in design and use are the keys to extended, trouble-free operation. If you are worried about your particular installation, thermal fuses can be placed on the heat-sinks to remove power, thus protecting against overtemperatures. Thermal fuses are available in various ratings; for instance, 84° C devices can be specially ordered through Radio Shack (although I didn't use them in my amplifiers).

Minimize wire lengths between the driver and the MOS-FET gates, between the

**Despite abusing
them a bit,
I'VE GOTTEN
10 years of trouble-free
USE FROM MY
4 mps.**

MOS-FET drains and the power bipolar emitters, and between the power bipolar collectors and the supply rails. The lead length between driver and MOS-FET gate should be the first priority. The importance of physically separating input and output was previously addressed.

Gate resistors R40 through R51 should be attached right at the MOS-FET gates. The MOS-FET heat-sink should be grounded to the chassis, as should the output bipolar transistor heat-sinks. This is automatically accomplished with all-metal construction, but double-check with an ohmmeter. Bipolars Q36 through Q47 and MOS-FETs Q24 through Q35 should be insulated from their heat-sinks with mica insulators and silicone grease, as described for the p.c. board-mounted heat-sinks. Again, double-check with an ohmmeter to be sure that there are no shorts from transistor to heat-sink. This, unfortunately, can easily happen in the course of mounting the transistors, especially if you should overtorque the attachment screws or have a faulty insulator.

Initial Adjustment and Operation

Only two adjustments are required in initial operation. Before initial power up, it is a good idea to recheck all wiring. The

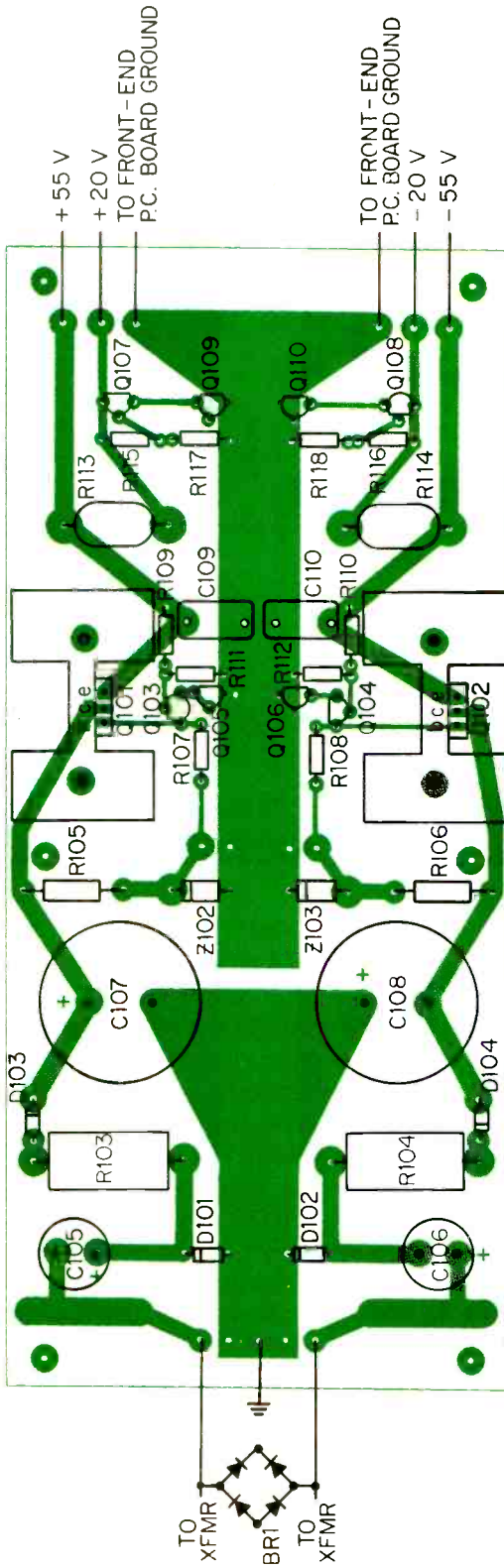

FIG. 5A—Doubler/regulator component arrangement.

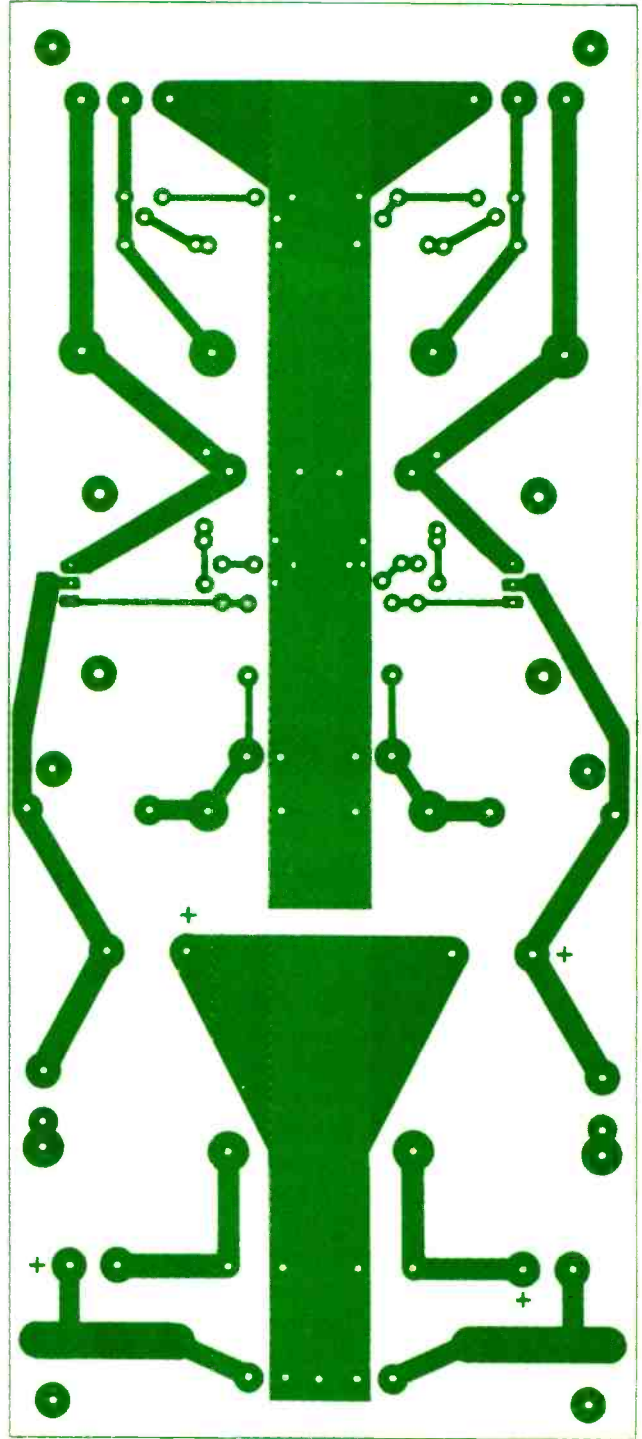

FIG. 5B—Foil pattern of doubler/regulator board, shown 90% of actual size.

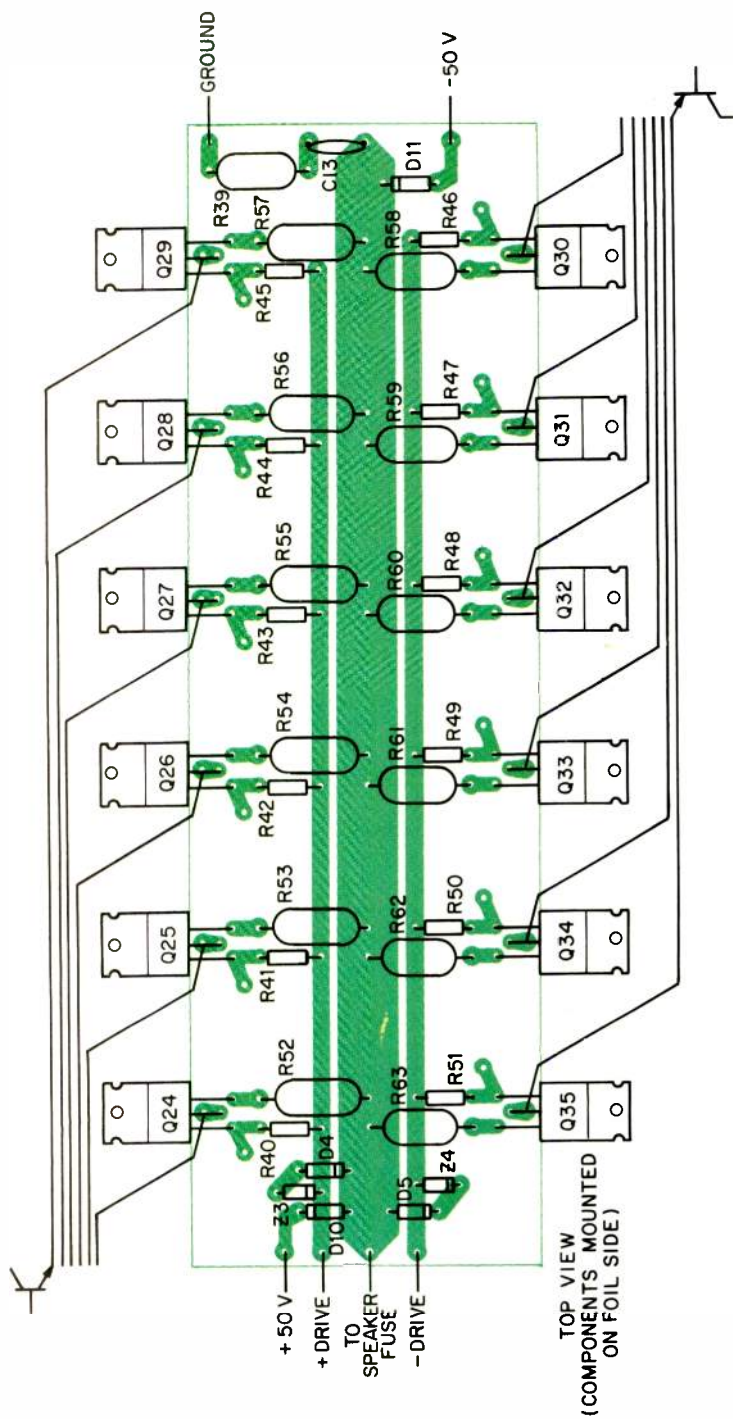

FIG. 6A—Output MOS-FET component arrangement.

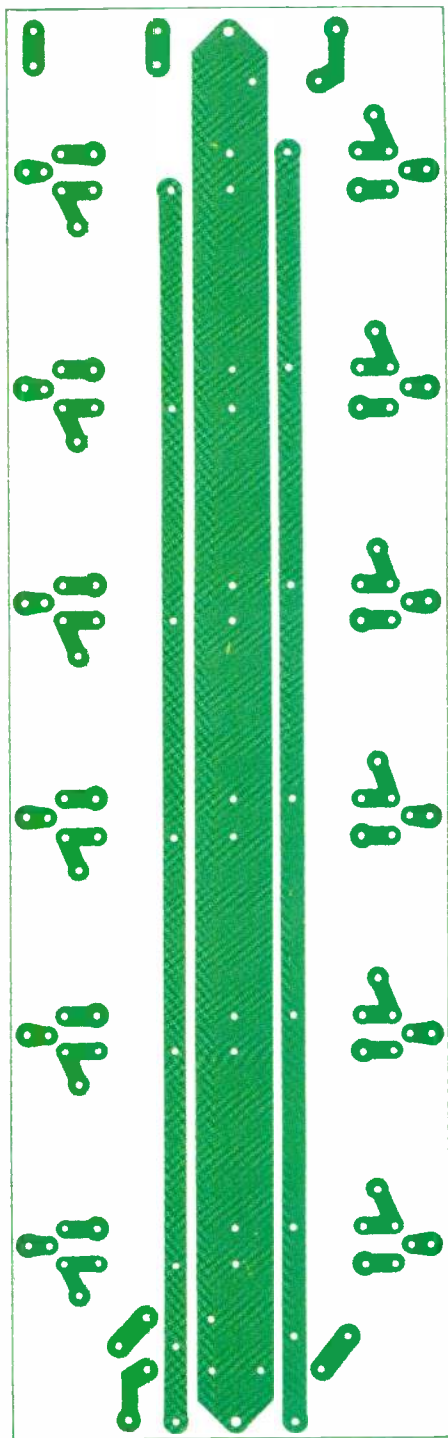

FIG. 6B—Foil pattern of output MOS-FET board, shown 90% of actual size.

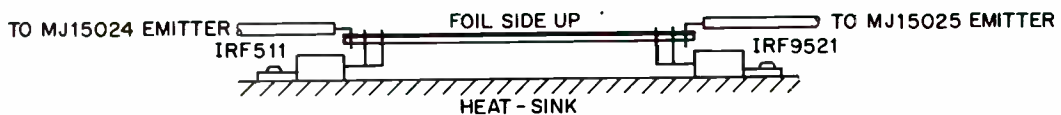

Fig. 6C—Mounting details for output board.

PARTS LIST

This 100-watt Class-A amplifier is constructed as a monaural unit, so these parts are for one channel only.

Audio Circuitry

All resistors are 0.25 watt, 1% metal film unless otherwise specified.

R1, R29—2.0 kilohms.
 R2—51.1 kilohms.
 R3-R6—300 ohms.
 R7, R8—1.1 kilohms.
 R9, R10—1.2 kilohms.
 R11, R15-R18—68.0 ohms.
 R12—682 ohms.
 R13, R14—43.0 ohms.
 R19, R20, R31, R32—10 kilohms.
 R21, R23—30.1 ohms.
 R22, R24—332 ohms.
 R25, R26—36.5 kilohms.
 R27, R28—3.0 kilohms, 2 watts, 5% metal oxide.
 R30—120 ohms.
 R33—16.9 kilohms.
 R34—1.0 kilohm.
 R35, R36—2.2 kilohms, 2 watts, 5% metal oxide.
 R37, R38—3.9 ohms, 2 watts, 2% metal oxide.
 R39—10 ohms, 2 watts, 5% metal oxide.
 R40-R51—470 ohms.
 R52-R63—0.22 ohm, 1 watt, 5% metal oxide.
 R64, R65—44.2 kilohms.
 R66, R67—27 ohms, 2 watts, 5% metal oxide.
 R68—10.0 ohms.

P1—200-ohm, p.c.-mount trimpot.
 P2—100-ohm, p.c.-mount trimpot.

All capacitors are 200-V metal film unless otherwise specified.

C1—3 μ F.
 C2—390 pF.
 C3, C4—47 pF, silver mica.
 C5, C6—10 μ F, 16 V, electrolytic.
 C7, C13—0.1 μ F.
 C8—5 pF, silver mica.
 C9, C10—10 μ F, 35 V, electrolytic.
 C11, C12—47 μ F, 100 V, electrolytic.

D1-D9—1N4148 signal diode.
 D10, D11—1N4004 rectifier diode.

Z1, Z2—5.1 V, 1 watt, 5% zener.
 Z3, Z4—10 V, 1 watt, 5% zener.

IC1—LM334 adjustable current source (National).

Q1—2N5912 matched dual n-channel J-FET (Intersil).
 Q2—AH5020 analog switch (National); contains monolithic dual p-channel J-FET.

Q3, Q10—2N2920 matched dual NPN (Motorola).

Q4, Q9—2N3811 matched dual PNP (Intersil).

Q5, Q6, Q15, Q16—MPSA92 PNP (Motorola).

Q7—SK9428 dual PNP (RCA replacement series).

Q8—SK9427 dual NPN (RCA replacement series).

Q11, Q12—SK9467 PNP (RCA replacement series).

Q13, Q14—SK9466 NPN (RCA replacement series).

Q17—2N2905A PNP (Motorola).

Q18—2N2219A NPN (Motorola).

Q19—SK9042 PNP (RCA replacement series).

Q20—SK9041 NPN (RCA replacement series).

Q21—TIP29 NPN (TI).

Q22—NTE332 PNP (NTE replacement series).

Q23—NTE331 NPN (NTE replacement series).

Q24-Q29—IRF511 n-channel MOS-FET (IRF).

Q30-Q35—IRF9521 p-channel MOS-FET (IRF).

Q36-Q41—MJ15024 NPN (Motorola).

Q42-Q47—MJ15025 PNP (Motorola).

F1—Fast-blow speaker fuse (see text).

FB1-FB4—Ferrite beads.

Miscellaneous Parts

Metal chassis.
 Panel-mount RCA phono jack.
 Heavy-duty, five-way binding posts (two, one red and one black).
 P.C. boards (two, one for front-end and one for MOS-FETs).
 Solderable-pin TO-126/TO-220 heat-sinks (three).
 Mounting hardware and insulators for heat-sink-mounted transistors.
 Other miscellaneous hardware (stand-offs, solder lugs, wire, etc.).

Sources

MJ15024/MJ15025 transistors and solderable-pin heat-sinks from Arrow Electronics (25 Hub Dr., Melville, N.Y. 11747; 800/777-2776).
 2N2920/2N3811/2N5912 transistors and Wakefield heat-sinks from Newark Electronics (see Yellow Pages for local listing).
 AH5020, MOS-FETs, resistors, caps, in-rush current limiters, diodes, rectifier, and transistor sockets from DigiKey (P.O. Box 677, Thief River Falls, Minn. 56701-9988; 800/344-4539).
 Power transformer from Toroid Corp. of

Maryland (2020 Northwood Dr., Salisbury, Md. 21801; 410/860-0300).

Power Supply and Voltage Regulators

All resistors are 0.25 watt, 1% metal film unless otherwise specified.

R101, R102—470 ohms, 5 watts, wire-wound.

R103, R104—47 ohms, 5 watts, wire-wound.

R105, R106—1 kilohm, 0.5 watt, 5% metal oxide.

R107, R108—4.99 kilohms.

R109, R110—47.5 kilohms.

R111, R112, R117, R118—7.68 kilohms.

R113, R114—1.5 kilohms, 2 watts, 5% metal oxide.

R115, R116—12.1 kilohms.

C101—0.01 μ F, 1 kV, disc ceramic.

C102—50 μ F, 50 V, electrolytic.

C103, C104—Computer-grade electrolytic filter cap (see text).

C105, C106—470 μ F, 63 V, electrolytic.

C107, C108—1,000 μ F, 150 V, electrolytic.

C109, C110—0.1 μ F, 100 V, film.

D101-D104—1N4004 rectifier diode.

Z101—24 V, 1 watt, 5% zener.

Z102, Z103—75 V, 5 watts, 5% zener.

Q101—TIP29C NPN (TI).

Q102—TIP30C PNP (TI).

Q103, Q107—MPSA05 NPN (Motorola).

Q104, Q108—MPSA55 PNP (Motorola).

Q105, Q106, Q109, Q110—MPSA92 PNP (Motorola); substitute 7-V zener as necessary.

BR1—600 PIV, 25-ampere rectifier bridge.

T1—Power transformer, 80 V, center-tapped, at 5 amperes.

TM1, TM2—KC011L thermistor in-rush current limiter (Keystone Carbon Co.).

F101—3-ampere slow-blow fuse.

F102, F103—4-ampere fast-blow fuse.

RL1—24 V d.c., 4PDT, 10-ampere relay (Sigma 76R4-24DC-SCO or equivalent).

S1—SPST, 10-ampere power switch.

Miscellaneous Parts

Three-conductor a.c. power cord.
 Fuse-holders for F101-F103 (three).
 P.C. board for doubler/regulator.
 Solderable-pin heat-sinks for Q101, Q102 (two).
 Other miscellaneous hardware (nuts, bolts, stand-offs, wire, etc.).

fusing used should give reasonable protection against many pitfalls, but the best protection is care and caution. Because this amplifier uses dangerous voltages, you must exercise care when testing and making the adjustments. (*Editor's Note:* Please be careful, as we cannot be responsible if you make an error.)

Trimpot P1 should be preset at its approximate midpoint, while P2 should be at its maximum resistance. Maximum resistance can be fully clockwise or counter-clockwise, depending on the trimpot's manufacture. You will have to double-check this with an ohmmeter. Since P2 sets output bias level, excessive current can flow if it is misadjusted. This should only blow the d.c. fuses, but why tempt fate?

Place a voltmeter across one of the output source resistors R52 through R63. The voltmeter should be on its 200-mV range. If you have a second voltmeter, set it to the 1- or 2-V range and connect it to the output terminals. These initial adjustments should be performed without any load attached.

Turn power on. If the voltage across the source resistor is greater than 50 mV, power down and recheck P2 for maximum resistance. (The prototype ran about 35 mV at power up.) Measure the voltage across all 12 source resistors. They should match within 20% or so; if they don't, either the

Test the amp CAREFULLY, AS ONE SLIP WITH a probe in a live CIRCUIT COULD RUIN YOUR DAY!

MOS-FETs are poorly matched or there is a failure or wiring error. It is prudent to power down the amplifier before moving the voltmeter probe from each of the various test points to the next one. One slip of the probe with power applied could ruin your whole day!

Next, measure the output offset voltage. If it is more than a few hundred millivolts, power down and verify that P1 is in the middle of its adjustment range. If you did not use the matched J-FETs specified for Q1 and Q2, you may simply have inadequately matched input transistors. You must, however, rule out some other problem before proceeding. If the voltage offset is reasonable, null it to zero by adjusting P1. It is normal for this voltage to fluctuate a few millivolts, even during short time periods.

Now you are ready to set the output bias to Class-A levels. Again, place your voltmeter on its 200-mV range, and again connect the probes across a source resistor. Since R52 through R63 are 0.22-ohm devices, the current through them is about five times greater than the level of voltage you measure. This is simply Ohm's law: $I = V/R = V/0.22 = 4.54 \times V$. Since we determined earlier that we need 2.5 amperes through our output, each of the six paralleled legs should conduct one-sixth of this, or

about 420 mA. We want our voltage, then, to be 92 mV (420 divided by 4.54); slowly adjust P2 until the voltmeter indicates this.

Allow the amplifier to come to operating temperature; 30 minutes or so should do. Again, readjust P2 for a 92-mV reading (it should have decreased somewhat below this level during the warm-up). It is not a bad idea to recheck the currents through all 12 output transistors to ensure that no current hogging is occurring. If matching was reasonable before, then hogging is unlikely. It is possible for it to occur, however, especially if one of the MOS-FETs is not firmly attached to the heat-sink.

At this point, re-zero the output offset with P1. With P1 set for zero offset following warm-up, I obtained 50 and 60 mV of offset for the two prototypes at power on. This is an acceptably low d.c. drift.

This completes the initial adjustments. I recommend periodic checks of bias and offset, but none of my four units have ever required a readjustment. If you replace anything other than the fuses, you may well have to reinitialize these adjustments.

If you have an oscilloscope, a signal generator, and an adequately rated 8-ohm dummy load, you might want to check out the amp on the test bench before connecting a speaker. However, if it performed as described in the initial adjustment phase, it is unlikely that serious problems exist. Place a fast-blow fuse rated at no more than 1 ampere in the speaker fuse-holder. Connect a loudspeaker to the output terminals and a signal source set to minimum volume to the input. Power on the amplifier; the turn-on transient should be barely audible. If the speaker fuse does not blow, carefully turn up the signal source volume and listen. If it sounds okay, then you are all set.

Commercial amplifiers capable of 100-watt pure Class-A operation are few in number—and all of them are very expensive. I hope that this project can help people who, like me, have hi-fi tastes on a mid-fi budget. At the least, I hope it serves to give you some insight into modern power amplifiers. The project occupied much of my spare time over two years and resulted in an amplifier whose objective performance is superb. The critical test for performance, however, will be in the mind and ears of the listener. A

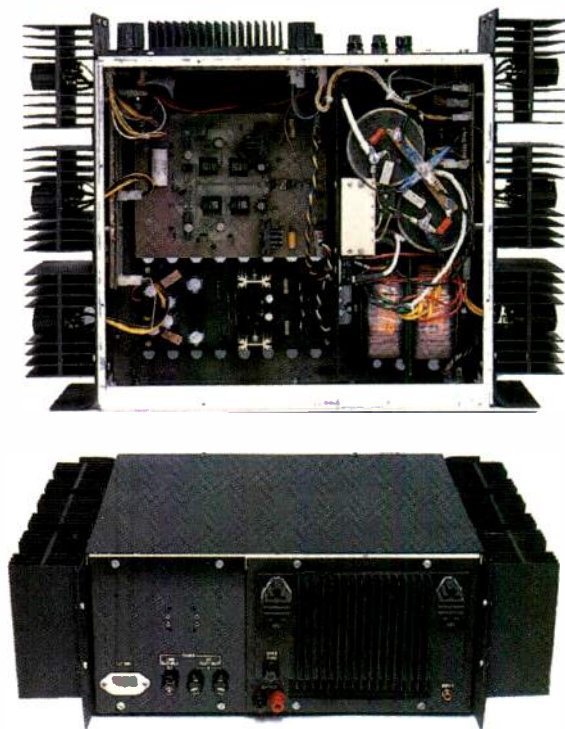



PHOTORAPH: ROBERT LEWIS

RYKODISC

THE BIG INDIE

by
Michael Bieber and Michael Tearson

More than a decade after its origin, Rykodisc stands unique as a major record company without benefit of distribution through one of the Big Six companies (WEA, BMG, Sony, MCA, PolyGram, and EMI); in the past decade, the Big Six have purchased virtually all the great independent labels . . . Virgin, Geffen, A&M. When it was founded in 1983, Rykodisc was the only label to offer CDs exclusively, a bold move, since no record business visionary could then see how totally the CD would replace the vinyl album.

Early releases included anthologies of Rounder Records material and a series of several environmental albums called *A Day on Cape Cod*. But what put Rykodisc on the map as a real player was the deal it cut in early 1986 with Frank Zappa to reissue his back catalog on CD. Zappa's commitment to the fledgling Rykodisc convinced many industry wags that Frank had lost it, but the highly respectful treatment his material received and the project's marketplace success made others take notice. Indeed, Rykodisc has purchased the Zappa catalog outright. A year later, Rykodisc released the previously unissued *The Jimi Hendrix Experience: Live at Winterland* followed by a set of the Hendrix Experience from performances on Radio One of the BBC.

The label's class, musicianship, and treatment of Zappa were key factors in

convincing David Bowie to sign his 16-album catalog over to Rykodisc, where it was bonus-tracked and released under the *Sound + Vision* fabric.

In 1991, Rykodisc acquired Hannibal and Carthage Records and associated publishing holdings from Joe Boyd, who then became director of project development and European point man for Rykodisc. His labels' catalog of Richard Thompson albums and reissues of Sandy Denny, Fairport Convention, Nick Drake, and Kate & Anna McGarrigle classics, plus a variety

of world music and British artist titles, was a perfect complement to Rykodisc's own holdings.

The next key acquisition was the Elvis Costello catalog, formerly on Columbia. The initial release included Costello's first three al-

bums plus an incendiary 1977 live set recorded at Toronto's El Mocambo club.

While these titles might give the impression that Rykodisc/Hannibal is essentially an archivist venture, Rykodisc has been aggressive in releasing new recordings at the cutting edge, including an early release by Living Colour's guitarist Vernon Reid and jazz guitarist Bill Frisell. Texas songman Jerry Jeff Walker remains extremely pleased with the label.

Other notable artists include Nils Lofgren, Bootsy Collins, Lloyd Cole, Martin Zellar, Mouth Music, Native American songwriter/poet John Trudell, and Mickey Hart of The Grateful Dead. Hüsker Dü

OPPOSITE: JOE BOYD,
ROBERT SIMONDS,

THE AUDIO INTERVIEW

ARTHUR MANN,
AND DON ROSE

I LIKE
TO THINK WE PUT
RECORDS OUT
BECAUSE WE THINK
THE MUSIC
IS IMPORTANT.

— MANN

RYKO

along, Rykodisc is a diverse, vital, thriving label with terrific releases in many genres.

In addition to Boyd, Rykodisc's current Big Four includes three of the four gentlemen who drafted a plan for success on a cocktail napkin at the 1983 Cannes MIDEM music industry convention: President Don Rose, business affairs VP Arthur Mann, and Simonds. Doug Lexa was the only founder to move on to other projects, though his influence lives on in the company's dealings, and its name. It was Lexa who suggested "Ryko," a Japanese word meaning "sound from a flash of light." Recently, *Audio* Contributing Editor Michael Tearson and Music Editor Michael Bieber spoke with the current Big Four at the label's quarterly summit meeting at Mann's Ardmore, Pennsylvania offices.

Tearson: *The place to start is that infamous story about how this collaboration began. Don, tell us about that scene in Cannes, where you wrote up your business plan on a napkin.*

Rose: Well, we usually refer to it as the "sacred napkin" because there were four of us from different areas of music industry background who found ourselves at the same café table talking about the advent of the Compact Disc.

Tearson: *This was 1983?*

Rose: Yeah. And Rob was looking to expand his audio-ophile Japanese import business, for which he was a distributor, into the world of Compact Discs. We were sharing a room, and he began to ask me about the label side of things, essentially what's involved in getting the rights to X, Y, or Z project, because he sensed the demand, in the very early days, for a whole lot of stuff that wasn't available at that time. So that discussion expanded to include a couple of other guys, Arthur Mann and our original fourth partner, Doug Lexa, who was involved in Japanese music products . . . import, export. And he became our connection to manufacturing because six out of seven of the world's Compact Disc plants were in Japan at that time.

founder Bob Mould's current band, Sugar, and Boston's Morphine are two of the label's most recent successes.

The label's conscience has had an impact in the American marketplace. The campaign to eliminate the CD longbox, the costly and wasteful outer packaging, began with sales & distribution vice president Rob Simonds. Several of the label's releases have benefited various causes. A dozen or so years

Tearson: *At that point, none yet in the U.S.*

Rose: Correct. And the association was responsible for our initial leg up as an independent in being able to even manufacture CDs.

So, to get back to the cocktail napkin. There were four of us having lunch. Rob and I were talking about perhaps acquiring some rights to manufacture CDs. Arthur had his background and contacts in the legal and agency end of the music business and had a lot of major label contacts to bring into the picture. So, we had the essential ingredients, we felt anyway, for the foundation, and we wrote them down on the napkin. The fact that we lived in four completely different cities never really occurred to any of us as a difficulty at that moment.

Tearson: *Where is that napkin today?*

Mann: It's in the vault.

Bieber: *The first time you heard a CD, or even digital audio, were you immediately taken with what you heard or at least with the convenience of the technology?*

Simonds: Well, I brought in a player from Japan, a Sony CDP-101, when they were first introduced—at great expense—because I was doing business with Japan, bringing vinyl in. It wasn't like a revelation when I first heard it, because all I had to listen to

was a demonstration disc for about four or five months. But it was very clear to me that for

the audiophile market—the people who were buying high-quality virgin vinyl, which was the bulk of the business that I was in—this was going to make that market, the vinyl side of the market, quickly obsolete. The fact that it was expensive and the discs were hard to get wasn't really that significant. It was quite clear from the outset that this end of the market was going to be very much attracted to the new format. As I spent more time with it, it became more and more clear to me that it was going to be dramatic, the convenience aspect, the amount of music, the sheer sonic quality. Even the Sony CDP-101, which cost me \$1,200, plugged into my relatively cheesy stereo, gave me sonic quality

that my system had never had before, one comparable to a much more expensive system. So, it was pretty clear that there was

something dramatic about it as well. None of us really imagined that it would catch on with the mainstream consumer anywhere near as quickly as it did.

Bieber: *So, that's quite a gamble when you think about it. Both the hardware and the software, which wasn't readily available in the initial stages, were so expensive but you still wanted to try and launch a business based on the CD.*

Simonds: Well, it wasn't a gamble at all, actually, though it looks like a gamble in the context of the size of the business we now have.

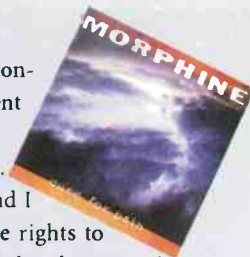

B
O
O
T
S
Y
C
O
I
L
I
N
S

When we started this, it was a modest business that was secondary, really, to all of what we were doing. We had other businesses. We started it with the idea that we already knew that the market was out there to be able to sell "X" number of hundred pieces of almost anything that we put out on CD. We didn't have a lot of capital up front to invest, so it's not like we were risking a lot of money. It was a niche market. But the fact that CDs became as successful, and as mainstream, as fast as they did actually made it riskier for us. When we started the company we were perfectly happy to have this limited, very audiophile-oriented approach to what we did. That it became so successful meant that the idea of starting a CD-only label was going to quickly become irrelevant because everybody was going to be making CDs.

Rose: The success of the company was not at all based on the mainstream dominance of the Compact Disc.

Simonds: But that created more challenges, I think.

Rose: Yeah, and you could argue it's a bigger gamble to go into a huge market with lots of intense competition than to be automatically in a position of prominence in this tiny market.

Tearson: When this whole thing started, did you have any kind of preconceived idea of where you wanted to take this musically?

Bieber: And how tough was it to come up with titles?

Rose: Well, from the very beginning we were distinct from almost any other independent label in that we had already defined our niche as the format. Generally, the way any label gets started is as being specialists in a particular type or genre of music. Since we had already defined the niche as the label, the musical niche was wide open, and just because there were four of us from four different backgrounds, we were pretty democratic about these things in the beginning. But we took our inspiration from labels like Island Records in the '70s, which had a vast range of musical styles, all bound together by some perception of quality or value. So we wondered, why couldn't we do the same? It was really hard because for every time you put out a new release, you had to completely redesign your outreach and marketing campaign to encompass different writers, radio station formats, and media. So it was a liability in certain respects, but in the long run it's proven to be a strength.

Tearson: This seems to have presented some special problems for distribution in getting the recordings out to the people who would be interested in them. Did it?

Rose: Yeah, sure. Because you can't necessarily follow up something that you just did successfully with something that's aimed at a similar target.

Tearson: You've set up a distribution company, the REP Company. Has this helped solve the problems in getting the music out there, or has it created new problems?

Simonds: It's given us more control over our ability to get it out there and, I think, it solves more problems than anything. It's still a challenge. There are still a lot of records being put out by a lot of companies, and there's a lot of competition for shelf space. Most record distributors are fueled by having hit records regularly; they sell mil-

lions of copies that don't require our type of education and work. They have their superstar artists, known quantities, that are guaranteed to sell "X" amount. That really finances the company's ability to distribute other things, or overshadows, in some cases, their effectiveness in doing other things. Our advantages are that we have a

specialized distributor for the type of music that we put out and control, that we can hire the types of sales reps that are more music-oriented, and that the distribution company isn't looking at other people's priorities and other types of product.

Tearson: Increasingly, this business is a global business, rather than American or British. Joe, a lot of your focus is on Europe and much of the rest of the world. Have there been any special problems in getting Rykodisc out beyond the States?

Boyd: When Rykodisc took over the Hannibal label, which was my label, Hannibal's orientation as a company was very much based around Europe. I would say

we were selling 60% of our records in Europe and 40% in North America. And I have been based in London off and on, primarily more on than off for many years, and Hannibal has always had a London office since it was formed in 1980. My theory about Europe has always been to try and treat it like the United States of Europe, although that's an oversimplification because there are so many different cultures that you can't really do it the same way. You aspire to simultaneous release in all European territories, to try and basically use the model of jazz labels, manufacture in one place, distribute and don't license, and the whole catalog is always available in every territory. That's the approach Rykodisc has taken in Europe as part of its acquisition of Hannibal. I would say it's moderately successful, and we hope it will get more successful.

Tearson: Is this eventually going to expand to a global setup?

Mann: No. REP is a U.S.-only distribution setup.

Boyd: We use other distributors around the world.

Mann: We were very successful in establishing a base in other parts of the world where our repertoire cannot be considered a traditional, Western music-oriented catalog. We represent music from all over the world; sounds trite, but the artists that we represent are from Hungary, Bulgaria, certain African countries. . . .

Tearson: The Mickey Hart series.

Mann: Well, certainly the Mickey Hart series. But there are other world music titles, on the Hannibal label in particular, that in those countries represent the hit in that territory or a very respected music lane. You can transplant that into other parts of the world and present it as important music. There's a different process that you go through in selling music in different parts of the world.

R
i
c
h
a
r
d

T
h
o
m
p
s
o
n

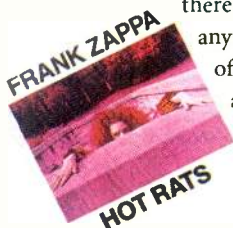

Tearson: *What's easier to sell, the hands-down best folk singer in all of Hungary or another rock album of four white guys playing guitar?*

Simonds: Four talented white guys.

Rose: Joe has an acronym, WPSIE projects, which stands for White People Singing in English. And that's something Hannibal decidedly does not specialize in on the basis of that theory.

Tearson: *Obviously, there have been major thrusts with key catalogs—the Zappa, the Bowie, the Costello, and a couple of key Hendrix recordings. The catalogs have been helpful in providing volume and give you more ability to go after some of the unknown artists. How important is it, then, to make new artists successful, and how is the energy split?*

Rose: Well, it's all part of being a well-rounded entity. The availability of catalog is limited. On the other hand, it's just as scary from our point of view to be dependent on creating hits or having breakthroughs with new artists, because so much of what happens in that process is so far out of control. Our M.O. has been to increase our abilities. Our reputation is staked on the high-profile catalogs. But at the same time it's become important for us to develop the new-artist side.

Bieber: *How tough is it breaking new artists?*

Rose: Real tough.

Bieber: *In the video markets, as well as for radio?*

Rose: Well, anything that pits us head-to-head against the majors—the primary activities of the majors, I should say—takes us further away from developing niches, where our small size and sensibility make us be better than they can be.

Mann: Well, we just have to find and try to sign new artists that aren't going to be promoted with mainstream radio and video. Because we already know going into it that we're up against some very, very big and powerful people that have a lot more money than we do to spend. And the types of artists that we tend to sign either have established a base that we can build on or have a certain unusual approach that might get us some non-traditional publicity or media attention.

It's not that we don't want one of our artists to have a video or his own taped show on MTV and to be prominent on radio. It's the route you take to get there that's different for us than for a major.

Boyd: We need something to be unique, the only one of its kind, so that we're not actually in competition. There is nobody else doing what Mickey Hart is doing. John Trudell is a completely unique artist. There is nobody else like Outback or Morphine.

Tearson: *From my own experience of working at a mainstream rock 'n' roll radio station, I know that a lot of the stations' thinking of what they're going to pick comes from label support of a given record. So this again puts you right up against the Big Six in a tough way.*

Rose: I think it even puts us at a disadvantage just because of the perception of the kind of support that we're able to give. Just because we're independent, it's presumed to be lower than that of the majors. I still believe that the mainstream media will have reservations about the ability of an independent company to support a mainstream rock act to the level that the majors do.

Simonds: When we signed Bob Mould, we signed without having heard the Sugar record, and I think that it wasn't under the idea of "Let's sign Bob Mould because he's the kind of artist that could make a great mainstream rock record that we could successfully sell to mainstream rock radio and get a video on MTV." Arthur's point is that if an artist delivers that type of a record, we're going to work just as hard, if not harder, as any other record company to get those things for that artist.

Boyd: I think one of the reasons Bob Mould came to a parting of the ways with Virgin and came to Rykodisc was because Virgin was trying to be major label-ish with him and say, "Your last record only sold X; you need to multiply that, so therefore you need this type of producer." A lot of heavy major-label A&R-ing was going on, which he had no interest in. The main thing was that we gave him the freedom to do the record that he wanted to do.

Mann: The majors put music out to satisfy the pipeline that's been established by major radio and the TV outlets. I like to think we put records out because we think the music is important.

Bieber: *Here's a hypothetical situation: Michael Bolton has delivered his last record to Columbia. . . .*

Rose: No. Next question.

Bieber: *He says, "I want to sign with Rykodisc; they do great work." Here's a guy who could contribute immensely to the bottom line, and he singles you out.*

Rose: We could debate forever, you know, why Michael Bolton? He is good, he is bad; is he fish, or is he fowl? But I think the question that's really important here is "Why Rykodisc?" And I would say, "No," not out of something snobbish about that kind of a mainstream artist, but about knowing who we are. And just knowing that to realize the fullest potential of an artist of that character does not correspond with the abilities that we've developed here at Rykodisc.

Tearson: *This is then one way in which Rykodisc maintains its independence and its own character in the marketplace.*

Rose: Knowing who we are, you know.

Tearson: *And knowing who you aren't.*

Rose: Yeah, good point. I mean, we're not like a small version of a major record company; we're something completely different. We're a medium-sized record company and proud of it.



S
U
G
A
R

WE'RE NOT LIKE
A SMALL VERSION
OF A MAJOR
RECORD COMPANY;
WE'RE SOMETHING
COMPLETELY
DIFFERENT.

— ROSE

RYKO

Tearson: Regardless of their status right now, what in your various cases might be a dream artist's catalog that you would like to acquire or work with?

Rose: I would have answered that question at almost any point over the last 10 years with "Elvis Costello."

Simonds: There are, also, the types of artists that we think would lend themselves very well to the types of things that we do and who may not be our individual personal favorite artist.

Boyd: One of the prototypical things that we would have liked to have done was the Jimi Hendrix catalog. That would be the kind of thing that we would be really proud to be associated with.

Tearson: You've done real well with the two Hendrix releases you have. Are they going to stay here, or are they ultimately going to be moving over with the rest of the catalog?

Rose: Ultimately they'll be moving over. It was a whole catalog MCA purchased.

Tearson: Now, suppose an important jazz, blues, or R&B catalog became available. Would that be of interest?

Rose: Sure. It's not so much the genre. You have to look at the specific thing and compare it to our marketing strengths and see if they're compatible. Does that extend to R&B? Sure, in some cases, and probably not in others.

Tearson: Jazz has been a very small part of what you've done. Is that just a matter of fate?

Rose: For us, there are fewer opportunities in those genres, whereas we can jump into world music and do very well in it. We're perhaps the most successful group of labels within the world music genre. Jazz and classical, I think, are tougher that way.

Boyd: We're all jazz fans.

Simonds: That's probably the one genre that we all share the most enthusiasm for. But we did try some things in the earlier part of the company's history and really found that the label identity to a jazz consumer is so significant that for us to really get serious about jazz, we would have to either put in a tremendous amount of effort and build a catalog and build a name for ourselves, or...

Tearson: Or possibly start a separate label.

Simonds: Possibly a separate label. Or even better, as you suggested, if an established label catalog became available to us, that would be probably the ideal way to get into the jazz market. [Editor's Note: Rykodisc has since purchased the Gramavision catalog.—E.P.]

Tearson: The visual aesthetics of the company over the years have been quite innovative. The green jewel box tray has become a trademark and helps the label's identity in the store because it stands out. And the box sets you've done have been very distinctive and very vibrant designs—a Grammy for Bowie's Sound + Vision box. The box sets are obviously a higher ticket in the store. How hard is it to come up with a design that will catch the eye and, hopefully, the imagination?

Rose: It's not hard at all.

Simonds: The hard part is coming up with a design that is affordable, even with the higher priced box set, because you can go nuts, if you want, with design. The challenge of the Bowie box, in particular, was we had an incredible genius design given to us by a very talented graphic designer. When we first saw it, it was like, "It looks incredible, but how the hell are we ever going to make this thing so that it will be affordable once the product actually gets out there?"

Tearson: Rykodisc started as a CD label and eventually added vinyl for a while, and occasionally cassettes as well. Now we have the other emerging formats, digital tape and the MiniDisc, neither of which have really taken off rapidly, yet you've been active with them. Will they have a chance to take off and become as important as the CD? Is there something else on the horizon that will be more successful than these things have been?

Rose: Well, you know, the CD had a real need in the marketplace defined for such a thing. Lifestyles were changing; the baby boomers were growing up, and people were moving into smaller spaces. The whole digital information thing was on the cusp; the CD walked right into it, and people responded to it because it met a lot of needs that preexisted. There's much less of a need from a consumer's standpoint to go beyond that at this moment. We're involved on the basis of being intrigued by the technology, and we like to have as much experience with the emerging technologies as we can. However, I think that combined with the lack of consumer need, the biggest problem with the success of either DCC or MiniDisc is that there are two formats that are being promoted simultaneously.



Tearson: Competing for the same niche.

Rose: It adds up to total frustration and even hostility, I'd say, on the part of the consumer, who says, "What are these guys trying to sell us now?" And meanwhile the complete read/write CD system, at a popular price, might just be around the corner. That would solve all the format compatibility issues. There is really no rush that we foresee.

Bieber: So you were planning to release your titles on DAT when the wrench was thrown into the machinery?

Mann: We had the first commercially available DAT, did we not?

Rose: First sampler.

Bieber: Were you hoping that DAT would be a format that would have presented itself to the marketplace?

Rose: We didn't really have a hope that DAT would succeed; we were just prepared to deal with it in the event that it did.

Tearson: Summing up here, five years from now do you foresee a major change in Rykodisc, in its philosophy?

Rose: I hope not.

Bieber: Are you happy with the current state of the company, regarding size, amount of business that you're doing, things like that?

Rose: Of course. Do we hope to expand our opportunities and share of influence? Of course.

Simonds: There are certainly days when we feel like we've created a monster, but all in all, we're quite happy.

Mann: We're very optimistic.

Simonds: No, ecstatic.

M
a
r
t
i
n
Z
e
l
l
a
r

Sunfire

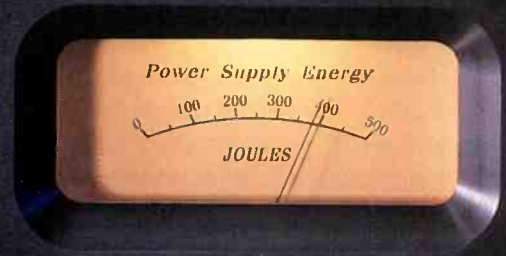

Load Invariant High Fidelity Stereo Power Amplifier

Imagine. A muscular 600 watt amp with the soul

Current output:

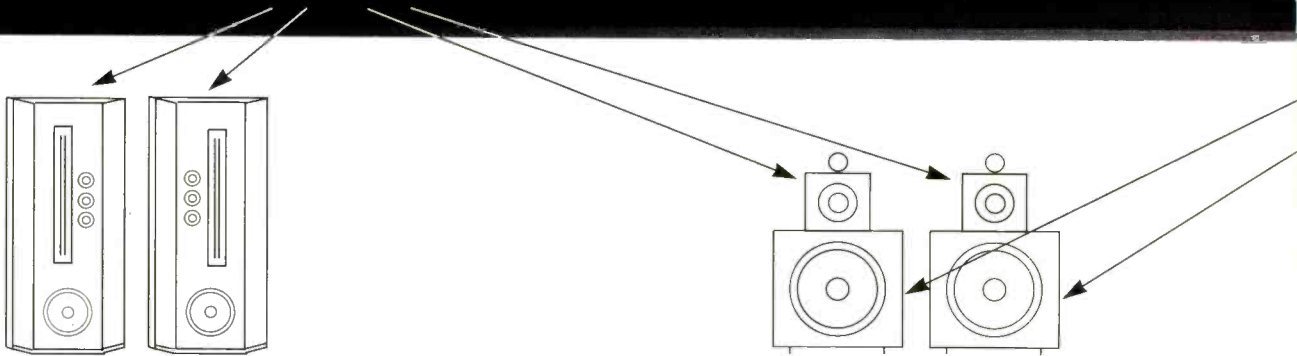

The new Sunfire stereo amp: sonic magic by Bob Carver.

It's not a 9 watt triode of course, and we wouldn't want it to be, but it does share a very important characteristic with one. It incorporates the current-source (high output impedance) property of a triode -- the very property that is *the* dominant factor (perhaps ninety percent) of the sonic magic that makes listening to classic vacuum tube amplifiers so much fun. So when you choose our current-source output connections for your system, you'll have a sumptuous high end, and a midrange that positively glows.

At the same time, the new Sunfire amp, with its uncanny tracking downconverter, has the ability to raise goose bumps with its awesome power. Using 12 herculean International Rectifier Hexfets, it can drive *any* load to *any* rationally usable current or voltage level.

A choice of outputs.

You can connect most speakers to the voltage-source

Sunfire Corporation

.....from the mind & soul of Bob Carver

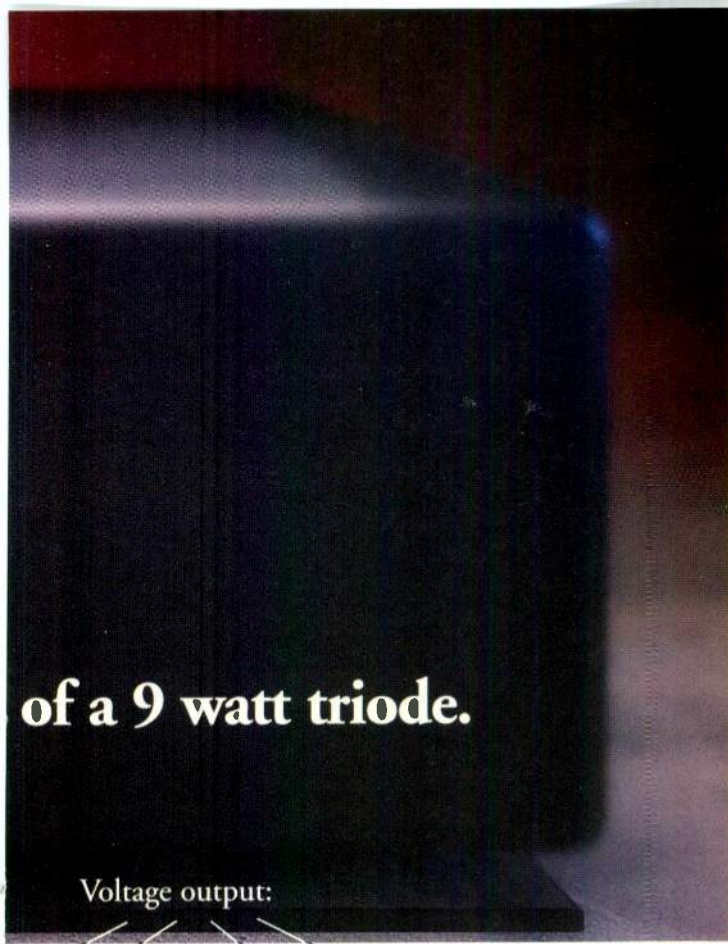

of a 9 watt triode.

Voltage output:

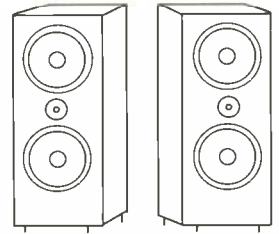

output, with its near zero impedance, to experience the powerful dynamics and tight bass you've always wanted more of.

Or let's say you own electrostatic, planar magnetic or ribbon speakers, then connecting the higher impedance current-source output can coax forth a sensuous, delicately detailed musical voice associated with low-powered classic tube amplifiers.

Or if you're able to biwire, you may just arrive at the best possible interface: voltage output to woofer

Price: \$2,175

* F.T.C.: 300 watts continuous per channel, both channels driven into 8 ohms from 20 Hz to 20 kHz with no more than 0.5% THD

Inputs are gold XLR balanced and gold RCA standard.

for incredible bass whack, current output to midrange and treble for a huge three-dimensional soundstage with detail retrieval so stunning that you will often hear musicians *breathing*.

Each choice will reveal the delicate musical soul that complements this amp's astonishing muscle and control. And each will lead to a multilayered soundstage so deep and wide it will take your breath away.

Performance that's difficult to believe.

The basis for all this is designer Bob Carver's versatility. He's worked successfully for over twenty years with both tube and solid state designs, and he understands the intrinsic subtleties of each.

For the new Sunfire, he insisted on an enormous 138 ampere peak-to-peak output current capability with 600 watts rms per channel continuously into 4 ohms* and 2400 watts rms into 1 ohm on a time-limited basis. Courtesy of 24 massive Motorola triple-diffused output devices, each capable of 20 amperes without taxing current reserves.

Imagine all that in a single amp. Or better yet, visit a Sunfire dealer. That's where you'll hear for yourself how it all comes together.

Dealer inquiries invited. (206) 335-4748 Ask for Bob Carver.

For more information on the Sunfire, and especially the uncanny tracking downconverter, use the reader service card or write to Sunfire Corporation, PO Box 1589, Snohomish, WA 98290

Enter No. 35 on Reader Service Card

MARANTZ SR-92 Mk II A/V RECEIVER



Many audiophiles view automation with a jaundiced eye. I don't subscribe to that notion, but there are times when you can do for yourself better than some automatic thingamajig can do for you. Take the case of adjusting input balance on a Dolby Pro Logic decoder. Most products do the job automatically, presumably on the manufacturers' assumption that consumers are too lazy or too dumb to do it themselves. That may be true for the mass market, but it doesn't necessarily apply to 'philes of the audio or video persuasion. Marantz apparently counts itself in the latter camp, for the SR-92 Mk II is the first A/V receiver to come my way in some time with user-operated input level and balance controls. I doubt that this is a matter of saving a few pennies; gain-control chips are probably far cheaper than potentiometers and knobs.

Proper input balance is essential for obtaining best separation among the five Pro Logic sound channels; a proper mating of input level with processor circuitry gain, while less critical, impacts the dynamic range you can expect from the final panoply. Today's gain-control chips can probably obtain close to optimum dynamic range, but the same can't be said for their handling of channel balance, where Dolby Labs' permitted tolerance can reduce separation from upwards of 40 dB to, perhaps, 20 dB.

The Marantz SR-92 Mk II distinguishes itself from run-of-the-mill receivers in other respects as well, especially with its tuner, which harkens back to the good old days when audiophile receivers were expected to have close to state-of-the-art tuners. Alas,

many of today's A/V receivers are pedestrian at best in this area, which makes me stand up and take notice when one this good comes my way. But I'm getting ahead of myself.

The SR-92 Mk II is rated at 110 watts in each main front channel, 75 watts in the center, and 35 watts per channel in the surrounds—all with 8-ohm loads. With 4-ohm loads, power bumps up to 140 watts per channel in front, 120 watts in the center, and 55 watts per channel in the surrounds. Receivers today lean toward providing equal power for all three front speakers, but Marantz contends that this is unnecessary; they say that most customers use a small center speaker and so the processor should be operated in the "Normal" center mode, which redistributes bass energy from the center to the main front speakers. Argument noted—if not necessarily bought completely. Marantz also suggests that some receivers specifying equal power for the three front channels at lower rating than for a standard stereo pair actually have similar power distribution to the SR-92 Mk II. No matter, because the power difference (front sides to center) in the SR-92 Mk II is less than 1.7 dB, not exactly overwhelming. And Marantz provides a decent total of 70 watts for the surrounds, somewhat more generous than many other A/V receivers.

Control Layout

In addition to Dolby Pro Logic surround for movies, the SR-92 Mk II has two music surround modes ("Matrix," which sends a delayed difference signal to the rear, and "Hall," which routes a delayed summed signal rearward) plus simulated stereo to jazz up monaural programs. Modes are chosen by tapping the "Mode/Surround" button

(second from left in the array above the input control knobs) until the desired legend appears in the display. The "Mode/Center" button, just to the right, chooses among four center options: "Normal," "Phantom," "Wide," and "Off." (The last is used when adjusting the input balance control situated below and to the right of the mode

**THE MARANTZ
DOES A FINE JOB
OF DECODING
AND DELIVERING
MOVIE SOUND.**

buttons. The idea is to switch off the center and adjust balance for minimum dialog in the two main channels.) The input level control, to the left of input balance, is adjusted until the input level "Peak" indicator flashes occasionally on loud passages.

To the left of "Mode/Surround" is a "Multi Room" button that, in conjunction with Marantz accessories, permits listening to the same (or a different) source in another room. Above the "Multi Room" and mode switches are buttons to engage either or both of two pairs of main speakers. Similar buttons to the right allow dubbing from tape to VCR 1 or from VCR 1 to VCR 2. A final small button engages the "Test Tone" sequencer for balancing the five speakers.

Physically similar to the mode and "Multi Room" buttons, and clustered to

their right, are the input selectors. The first three—"FM/AM," "CATV," and "Mode"—affect the tuner, which has inputs both for a 75-ohm FM antenna and for cable television. The "FM/AM" button toggles between AM and FM reception using the FM antenna, "CATV" switches to the CATV input, and "Mode" toggles between automatic stereo and mono reception. Three audio selectors come next—"Phono," "CD," and "Tape MONI"—followed by four A/V choices: "LD," "VCR 1," "VCR 2," and "Video," the last of which selects the front-panel inputs at the extreme lower right. Below the input selectors are bass, treble, and balance controls and a "Bass EQ" switch, which engages a boost that is centered at roughly 60 Hz.

Sandwiched between the display and the motorized volume control are a cluster of

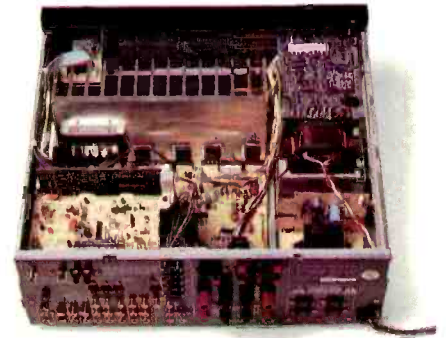

IT'S BACK TO THE GOOD OLD DAYS, WHEN AUDIOPHILE RECEIVERS HAD STATE-OF-THE-ART TUNER SECTIONS.

buttons that operate the tuner and certain other functions. The 10-button alphanumeric keypad is used to set the clock, to enter station names, and to recall presets; the "0" also serves as a "Clear" button in several modes. To the left of "0/Clear" is a "Memo" button to memorize what you've entered, and to its right is an "F/P" button that toggles between displaying stations by frequency or preset number. Below are three larger pads—"Down," "Tuning/P-Set," and "Up"—that change tuner frequency, switch preset channels, and, when "Delay" is pressed, adjust delay time in all surround modes.

The "IF" button above "Delay" toggles between wide- and narrow-band FM reception, while the "N•R" button above it activates a high-frequency blend to quiet noisy stereo stations. "Clock," which is the top button, displays the time on the front panel. "Sleep," to its right, activates a sleep timer, while the button below it, "AM/PM S•N," serves two functions: It toggles between a.m./p.m. and 24-hour clock display and also is used to load station names. To the right of "IF" is "P•S," which scans through the preset memory. The final button, "Timer/Check," can be used to set and check the timer and to cancel previous settings.

On the back panel are F connectors for the two FM inputs and binding posts for the (supplied) AM loop. Audio inputs and tape recording outputs have gold-plated

SPECS

AMPLIFIER SECTION

FTC Power Rating, Stereo Mode (Both Channels Driven, 20 Hz to 20 kHz):

110 watts/channel at less than 0.09% THD into 8 ohms, 140 watts/channel at less than 0.1% THD into 4 ohms.

Power Rating, Five-Channel Mode:

Front left and right (both channels driven, 20 Hz to 20 kHz), 110 watts/channel at less than 0.09% THD into 8 ohms, 140 watts/channel at less than 0.1% THD into 4 ohms; center, 75 watts into 8 ohms, 120 watts into 4 ohms; surround, 35 watts/channel into 8 ohms, 55 watts/channel into 4 ohms.

S/N, A-Weighted: MM phono, 75 dB; line, 82 dB.

Input Sensitivity: MM phono, 3.5 mV; line, 220 mV; front main (left, right, and center), 1.5 V; surround main, 1.0 V.

Input Impedance: MM phono, 47 kilohms; line, 40 kilohms; main inputs (front, center, and surround), 20 kilohms.

Preamp Output Level and Impedance: 1.7 V from 0.5-V input; 1 kilohm.

Subwoofer Crossover: 12 dB/octave at 70 Hz.

Phono Overload, 1% THD: 120 mV at 1 kHz.

FM TUNER SECTION

Usable Sensitivity: Mono, 13.5 dBf (1.3 μ V at 75 ohms).

S/N at 65 dBf: Mono, 76 dB; stereo, 68 dB.

Capture Ratio: 1 dB.

Alternate-Channel Selectivity: Wide, 60 dB; narrow, 70 dB.

Stereo Separation: 40 dB at 1 kHz.

THD at 1 kHz: Mono, 0.2%; stereo, 0.5%.

Image Rejection: 50 dB at 98 MHz.

Output Level: 940 mV at 1 kHz for \pm 75 kHz signal deviation.

AM TUNER SECTION

Sensitivity, Loop Antenna: 500 μ V/m.

Selectivity, \pm 20 kHz: 70 dB.

S/N: 50 dB.

Distortion at 1 kHz and 30% Modulation: 0.5%.

GENERAL SPECIFICATIONS

Power Consumption: 640 watts.

Power Supply: 120 V a.c., 60 Hz.

Dimensions: 17 $\frac{1}{8}$ in. W x 5 $\frac{3}{4}$ in. H x 15 in. D (45.4 cm x 14.6 cm x 38 cm).

Weight: 34.1 lbs. (15.5 kg).

Price: \$1,149.

Company Address: 440 Medinah Rd., Roselle, Ill. 60172.

For literature, circle No. 90

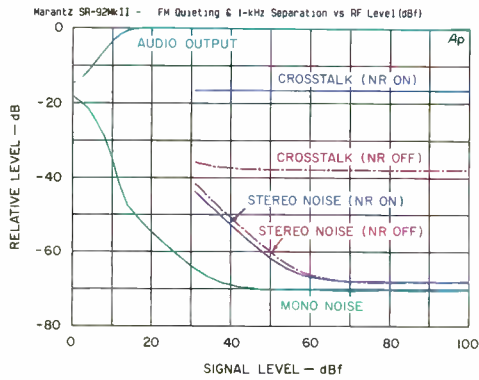

Fig. 1—FM quieting and crosstalk.

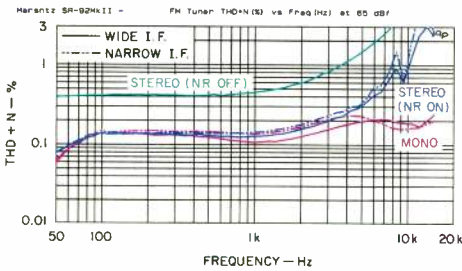

Fig. 2—FM THD + N vs. frequency.

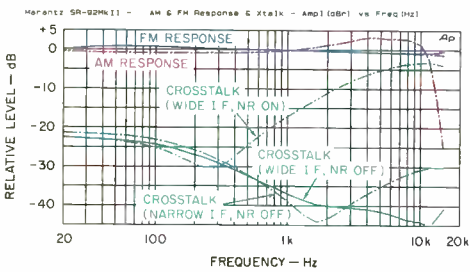

Fig. 3—Tuner frequency response and FM crosstalk.

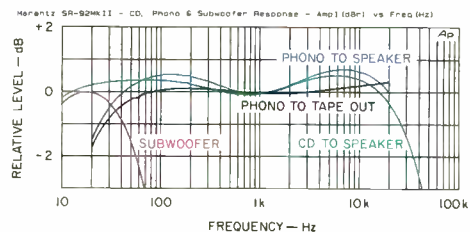

Fig. 4—Frequency response, CD and phono inputs and subwoofer output.



RCA jacks; composite-video connections are standard RCA jacks. The LaserDisc, VCR 1, and front-panel video inputs have S-video connectors as well as pin jacks for composite video, and there's an S-video output to record on VCR 1. Of course, an S-video connector is provided for the main monitor output, and there are composite-video phono jacks for it and a second display.

Each of the five preamp outputs—front left/right, center, and surround left/right—is externally linked to its power amp input, so you can readily upgrade to a more powerful front amplifier and use the internal front amps to provide more drive to the surrounds. Connecting a powered subwoofer is equally simple, thanks to a filtered line output for that purpose.

A pair of RCA jacks near "Subwoofer Out" permits the SR-92 Mk II to be daisy-chained with components that use Marantz's D-BUS (RC-5) remote control to provide integrated control of an entire system. A "Multi Room" jack is provided to interface with Marantz's multiroom accessories. Reasonably heavy-duty multiway binding posts are provided for two pairs of main front speakers; however, the posts are not on standard centers, so GR-type dual-banana plugs can't be used. The surround and center speakers connect to spring-loaded clips; a second set of clips (below the surround terminals) powers speakers in an outlying room when the receiver is in the multiroom mode. Three switched outlets (100 watts total power) and one unswitched outlet (150 watts maximum) complete the back panel. The Marantz SR-92 Mk II comes with an imposing 70-button, three-switch, universal programmable remote.

Measurements

Although the SR-92 Mk II is, first and foremost, an "A/V" product, I can't help beginning the dis-

cussion of my bench tests with the tuner section, since I find it impressive compared with most others in today's market. It's rather rare, these days, to be offered a choice of i.f. bandwidth and a noise-reduction (blend) option to trade stereo separation for lower hiss. Even with the wide i.f., however, Marantz's tuner is more selective than average. I measured adjacent-channel selectivity of 9.4 dB and alternate-channel selectivity of 65.5 dB in that mode and 15.5 and 82.5 dB, respectively, in the narrow mode. Image rejection (51 dB) wasn't affected by i.f. bandwidth, but capture ratio

THE AM SECTION'S WIDEBAND RESPONSE IS AMAZING, ACTUALLY MAKING IT ALL THE WAY OUT TO 10 kHz.

and, to a lesser extent, AM rejection were. Capture ratio clocked in at a very good 1.1 dB with the wide selection and degraded to only 1.7 dB with the narrow choice. The AM rejection figures were arguably better than average, too, at 63.2 and 62.7 dB, respectively. Overall, this tuner should handle multipath conditions unusually well, especially in wideband operation.

The FM front-end also had excellent sensitivity, with 50-dB quieting achieved at 16.1 dBf in mono and 39.2 dBf in stereo—figures that weren't affected by i.f. bandwidth. The i.f. can affect IHF usable sensitivity (really, IHF unusable sensitivity), which measured 13.8 dBf in the narrow mode and 14.5 dBf with the wider bandwidth. Marantz's NR (blend) option improved 50-dB quieting sensitivity in stereo by almost 2 dB (to 37.3 dBf) but had a negligible effect on stereo signal-to-noise ratio at 65 dBf (which came in at 67.3 dB with NR off and 67.5 dB with it on). In mono, ultimate quieting just topped 70 dB. The i.f. bandwidth usually affects distortion rather severely, but that didn't seem to be the case with the SR-92 Mk II—perhaps because even the wideband mode is really quite narrow. With NR off, stereo-mode distortion was virtually the same regardless of i.f. setting: 0.40% at 100 Hz, 0.46% at 1 kHz, and 1.95% at 6 kHz. In mono, the i.f.

A speaker good enough to be appreciated by almost no one.



The new Infinity Reference Standard Epsilon is designed to appeal to an exceedingly small segment of the population: the impossible to please, highly critical, uncompromising listener. Revolutionary in design, Epsilon performs in a league previously occupied only by the most exotic, and much larger, multi-enclosure systems. An entirely new generation of Infinity's unique EMIM,[™] EMIT,[™] and L-EMIM[™] planar drivers respond instantaneously to even the most complex musical passages. And Epsilon's new Servo-Controlled IMG woofer, acoustically isolated within the enclosure, delivers exceptional low-frequency response. For a personal demonstration, visit your Epsilon dealer or call

1-800-8EPSILON.

 Infinity

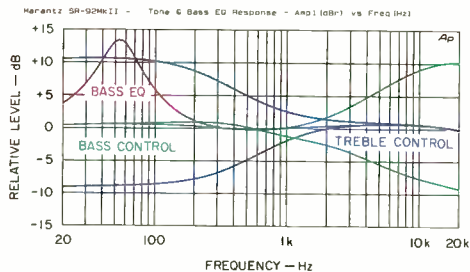

Fig. 5—Tone-control and "Bass EQ" response.

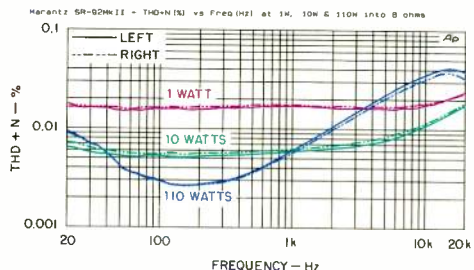

Fig. 6—Amplifier THD + N vs. frequency.

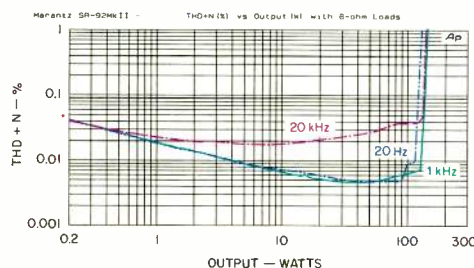

Fig. 7—THD + N vs. output.

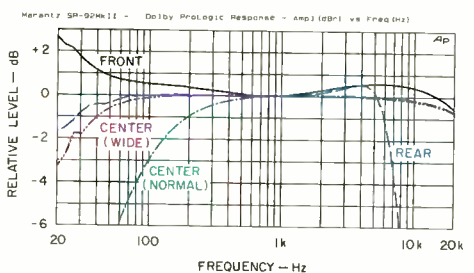

Fig. 8—Frequency response, Dolby Pro Logic mode.

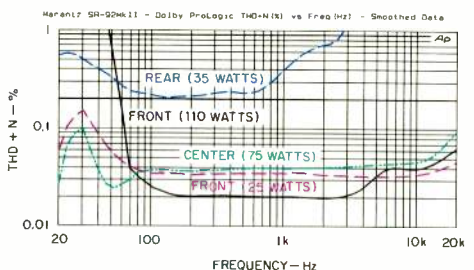

Fig. 9—THD + N vs. frequency, Dolby Pro Logic mode.

bandwidth did have a slight effect at 1 kHz, where distortion rose from 0.11% in wideband mode to 0.14% in the narrow band. At 100 Hz and 6 kHz, however, the figures were close to the same—about 0.14% and 0.21%, respectively.

What did affect distortion in stereo operation was the NR circuit, which, by blending the highs, cancelled many of the noise and distortion products that were generated in the demodulator. With NR, THD + N dropped by about two-thirds, to 0.14% at 100 Hz, 0.13% at 1 kHz, and 0.41% at 6 kHz (although the narrow i.f. increased 6-kHz THD + N a trifle, to 0.52%). But if you're willing to sacrifice separation and choose the stereo NR mode, the tuner quiets faster, and distortion is little worse than it is with mono reception.

These results are plotted in Figs. 1 and 2. Figure 1 is the normal FM quieting curve, on which I've overlaid the crosstalk (1 kHz) you can expect with the NR off and on. There are separate stereo quieting curves for each condition as well, albeit the two are identical from 70 dBf up. These measurements were taken with the wide i.f. setting but were almost identical in the narrow mode. Figure 2 is a plot of THD + N as a function of frequency (65-dBf input) for all combinations of i.f. and NR settings. Since, with NR off, stereo distortion is unaffected by the choice of i.f., only one stereo curve is given for the NR-off condition.

Figure 3 shows FM stereo frequency response and crosstalk with a 65-dBf input. Response is only slightly affected by NR setting: +1.06, -0.66 dB from 20 Hz to 15 kHz with NR off (solid curve) and +1.06, -1.30 dB with it on (broken curve). The i.f. bandwidth had no meaningful effect on response, no effect on crosstalk with NR on, and a relatively minor effect on crosstalk with NR off. Three crosstalk curves that did display a difference are shown. In

general, separation with the NR (blend) off is upwards of 24.5 dB from 100 Hz to 15 kHz in the wide mode and better than 23 dB over that range with the narrow i.f. From 350 Hz up, separation is more than 30 dB (wide) and 29.4 dB (narrow). Separation at 1 kHz is slightly better in narrow (39.8 dB) than in wide (37.6 dB). Activating the NR blends left and right signals progressively above 350 Hz, but there's a decent 16.8 dB of separation at 1 kHz and 11.1 dB at 2 kHz even with NR on. By 5 kHz, separation has diminished to 5.6 dB and drops to 3.6 dB at 12 kHz. Figure 3 also shows the AM tuner's amazing wideband response. This is the first AM tuner I think I've ever measured that really makes it out to 10 kHz. Response is within +3.4, -2.3 dB from 20 Hz to 11.5 kHz!

All tuner measurements were made to the tape output and so were not affected by the tone controls. I also checked pilot and subcarrier levels there (which is where they count), with great results. The 19-kHz pilot was at -54.3 dB, and the 38-kHz carrier

**THE NUMBERS SHOW
A POTENTIAL
MAIN-CHANNEL
DYNAMIC RANGE
OF 100.3 dB.**

was 52.8 dB down. This is a tuner you can tape from without having the recorder's Dolby circuit mistrack, even on cassette decks that lack effective filters of their own.

I made a point of mentioning that the tuner measurements were taken at the tape outputs because all other measurements were made to the speaker terminals and include the effect of the tone controls. Unfortunately, the tone controls can't be defeated—one of my few quibbles with the Marantz SR-92 Mk II.

Figure 4 shows frequency response from the CD and phono inputs (the latter corrected for the RIAA curve, of course), as well as the characteristics of the low-pass filter on the subwoofer output. The curves shown were taken on the left channel; the right responded in the same fashion.

Including the effect of the tone controls, response from the CD input is flat within

DYNAMIC ENERGY



Model

860

Stereo Power Amplifier

- MATCHED MOS-FET OUTPUT DEVICES
- DC COUPLED with SERVO CONTROL
- ULTRA LOW NOISE and DISTORTION
- 100 WATTS RMS/CHANNEL INTO 8 OHMS



polyfusion audio

30 Ward Road Lancaster, New York 14086 USA
Phone (716) 681-3040 Fax (716) 681-2763

Enter No. 26 on Reader Service Card

+0.56, -0.30 dB from below 10 Hz to 20 kHz, with a -1 dB point at 27.5 kHz and a -3 dB point at 43.7 kHz. Phono response after RIAA correction is roughly similar over its expected range, except for a bit more low-end roll-off. It's within about ± 0.75 dB from 26 Hz to 20 kHz and down 1.42 dB at 20 Hz. (Although the curve isn't shown, I also checked phono response at the tape output. It was a good bit flatter: ± 0.35 dB from 42 Hz to 20 kHz, -1 dB at 26 Hz, and -1.65 dB at 20 Hz.) Crossover to the subwoofer occurs at 71 Hz (the -3 dB point) and attains an ultimate slope of 12 dB/octave.

Figure 5 shows the tone-control range and the effect of the "Bass EQ." The latter is a resonant circuit tuned to 53 Hz, with a "Q" of approximately 1.7. When activated, it boosts 53-Hz response by 13.2 dB and may be helpful in restoring a bit of bass to small bookshelf speakers that can take the gaff. Both tone controls offer a bit more boost than cut. The bass EQ has a range of +10.1, -8.6 dB at 100 Hz, below which it shelves to a maximum of +10.6, -9.1 dB at 20 Hz. The treble EQ elicits an 8.7-dB boost or a 7.9-dB cut at 10 kHz, with an ultimate range of +9.9, -9.5 dB at 20 kHz.

Figures 6 and 7 show, respectively, THD + N versus frequency (at 1 watt, 10 watts, and rated output) and THD + N versus output (at 20 Hz, 1 kHz, and 20 kHz). Figure 6 shows both channels; Fig. 7 was taken on the left, which, at 20 kHz, was slightly less capable than the right. These measurements were taken with 8-ohm loads, both channels driven, in stereo. I also ran curves with 4-ohm loads, but they proved so similar to the 8-ohm curves (except for extending to higher power) that they are not displayed.

The general shape of the curves in Figs. 6 and 7 suggests that, except at the highest frequencies, midrange THD + N is more noise than distortion at up to 80 or 90 watts. Above about 5 kHz, distortion creeps into the 10-watt curve (Fig. 6), and, at rated power, distortion predominates from about 800 Hz up—but the distortion remains well under 0.02% at 10 watts and peaks out at 0.04% at 15 kHz and rated power.

Output power at clipping measured 145 watts (21.6 dBW) per channel with 8-ohm loads and 190 watts (22.7 dBW) per chan-

nel with 4-ohm loads. With the IHF tone burst, dynamic power reached 150 watts per channel into 8 ohms and 215 watts per channel into 4 ohms, which computes to be dynamic headroom ratings of 1.3 and 1.8 dB, respectively.

Damping factor measured 150 at 50 Hz, and output impedance remained reasonably well contained over the audio range: 50 milliohms at 1 kHz, 80 milliohms at 5

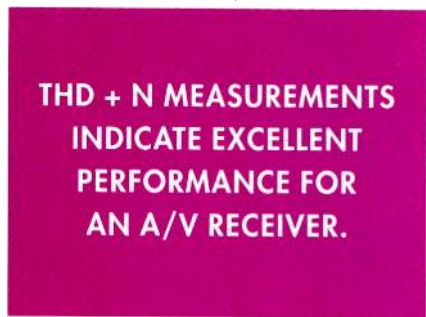

kHz, 135 milliohms at 10 kHz, and 185 milliohms at 20 kHz. It required a 24.8-mV signal at the CD input to produce 1 watt into 8 ohms, 260 mV for rated output. Corresponding figures at the phono input (1 kHz) were 0.42 and 4.40 mV, respectively, which is about typical. Input impedances were 46 kilohms for CD and 49 kilohms in parallel with 165 pF for MM phono, and input overload occurred with an 8.1-V signal at the CD input and with a 128-mV signal (1 kHz) at the phono input. No problems here. Channel balance with the IHF volume setting was within ± 0.024 dB, and there was adequate signal at the tape recording outputs: 0.5 V from a 0.5-V CD input, 0.29 V from a 5-mV (1-kHz) phono input, and 1.02 V from a fully modulated FM transmission. Tape output impedance was a bit high, at 2,850 ohms.

Channel separation from the CD inputs was better than 47 dB from 20 Hz to 5 kHz in either direction and, worst case, dropped to 36 dB at 20 kHz. A noise-spectrum analysis revealed small, power-line-related hum components at 60 Hz and its first five harmonics, but the greatest of these (at 180 Hz) was only -95 dBW. On the whole, the SR-92 Mk II's noise spectrum was as much as 10 dB below that of some receivers I've measured. On an A-weighted basis, noise (CD input) was -88.6 dBW, which implies an excellent S/N ratio of 109.0 dB re: rated power. The phono figures weren't bad either: -74.1 dBW for an S/N of 94.5 dB.

After adjusting input balance, the Dolby Pro Logic system delivered excellent channel separation. I checked all combinations at 1 kHz; even the worst of them, surround to center, was a superb 41.6 dB. The best combination, interestingly, was the other way about, center to surround, which clocked in at 65.7 dB.

Figure 8 shows the response of the decoder channels in the "Normal" and "Wide" center modes. Main front-channel response is within ± 0.6 dB from 70 Hz to 20 kHz and, at lower frequencies, rises gradually to +2.7 dB at 20 Hz. The center channel has about the same high-end response and doesn't display the low-end rise. In the "Wide" setting, its response is within +0, -0.75 dB from 46 Hz to 20 kHz (-3 dB at 21 Hz). In the "Normal" center mode, high-end response is the same, and the lows roll off at 6 dB/octave below 98 Hz (-3 dB point) as per the Standard. Surround-channel response is within ± 0.5 dB from 35 Hz to 5.7 kHz and rolls off rapidly above 6.8 kHz (-3 dB point), with an initial slope of about 36 dB/octave—on the money. Surround-channel response is down 1.7 dB at 20 Hz.

Figure 9 shows THD + N versus frequency for the various Dolby Pro Logic channels. The center and surround measurements were taken at rated power (8-ohm loads) using the "Wide" center mode, but I'm showing two curves for the main front channels—one at rated power, the other at 25 watts. During my tests, the SR-92 Mk II would not deliver rated power in the front channels (with maximum volume setting) without lighting the "Peak" input level indicator. It would deliver 25 watts without firing a warning, so I ran the second curve at this level. I should point out that, had Marantz not included the indicator (other companies do not), I simply would have accepted the results of the full-power measurement. They're not unusual. In fact, THD + N of under 0.065% from 67 Hz to 20 kHz (the result for the full-power front-channel measurement) is excellent performance from an A/V receiver! Center-channel THD + N remains below 0.095% at rated power over the full frequency range (again, excellent!), and distortion in the surround channel, although substantially higher (0.6% from 20 Hz to 1.5 kHz), is certainly not atypical.

With 8-ohm loads, front-channel output power at clipping (ignoring the indicator) came in at 130 watts (21.1 dBW) per channel; the center topped out at 98 watts (19.9 dBW) and the surrounds at 45 watts (16.4 dBW) per side. The A-weighted noise levels with Dolby Pro Logic processing measured -79.2 dBW in the left front, -77.1 dBW in the center, and -75.0 dBW in the surround channel. Tie it all together, and you have potential dynamic range figures of 100.3 dB in the main front channels, 97.0 dB in the center, and 91.4 dB in the surround.

Use and Listening Tests

Properly adjusted, the Marantz SR-92 Mk II does a fine job decoding and delivering movie sound. Its music surround

**THE SR-92 Mk II
DISTINGUISHES ITSELF
IN MANY RESPECTS
FROM RUN-OF-THE-MILL
RECEIVERS.**

modes are modest but pleasing. Its remote control is complex but competent (with a learning ability that means you're not limited to using particular products whose codes have been preprogrammed). This receiver's tuner is exemplary. Its power reserve is adequate, delivering clean, quiet sound. Its input complement should satisfy many audio/videophiles (although I, for one, would have liked to have seen the fourth video input replicated on the back, where it would also be useful for permanent connection to, say, a satellite receiver). And the SR-92 Mk II is easily upgradable. It's a fine product.

In deciding whether the Marantz is for you, you have to ask yourself these two fundamental questions: Will you, in fact, adjust input balance and level (from the front panel, as the controls aren't accessible via the remote) whenever you change program sources? If not, automation will start looking mighty nice! And if you are the "I'd rather do it myself" type, will you spend your time watching movies or waiting for the peak indicator to flash? Only you can answer these questions; I can't.

Edward J. Foster

SUPPORT RESEARCH.

It Works Wonders.

American
Heart
Association



Discover Boxless Theater!

VANDERSTEEN AUDIO



"Superior on both film and music, VANDERSTEEN's full-range speakers dispel the myth that video requires unique main speakers."

Model 3
High resolution, phase correct loudspeaker

In its pursuit of perfection, high-end audio has established lofty standards that only the best speakers can reach. Now your family entertainment system can meet these same standards. Experience open natural voices, astonishing definition, powerful bass and vivid imaging with legendary VANDERSTEEN boxless speakers.



VCC-1
Phase correct center speaker

For almost 20 years, VANDERSTEEN AUDIO has built affordable loudspeakers true to both science and music. If you are looking for speakers that accurately reproduce the entire frequency range and dimensions of the original sound, we can direct you to your nearest carefully selected VANDERSTEEN dealer.

Please write or call for a brochure and name of your nearest dealer.

VANDERSTEEN AUDIO™
116 West Fourth St, Hanford, CA 93230
(209) 582-0324

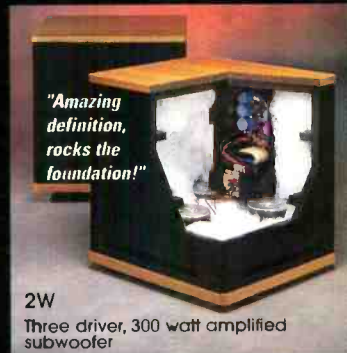

2W
Three driver, 300 watt amplified subwoofer

DIMENSIONAL PURITY. Models available from \$495.

PARASOUND D/AC-1000 D/A CONVERTER AND C/DP-1000 CD PLAYER/TRANSPORT

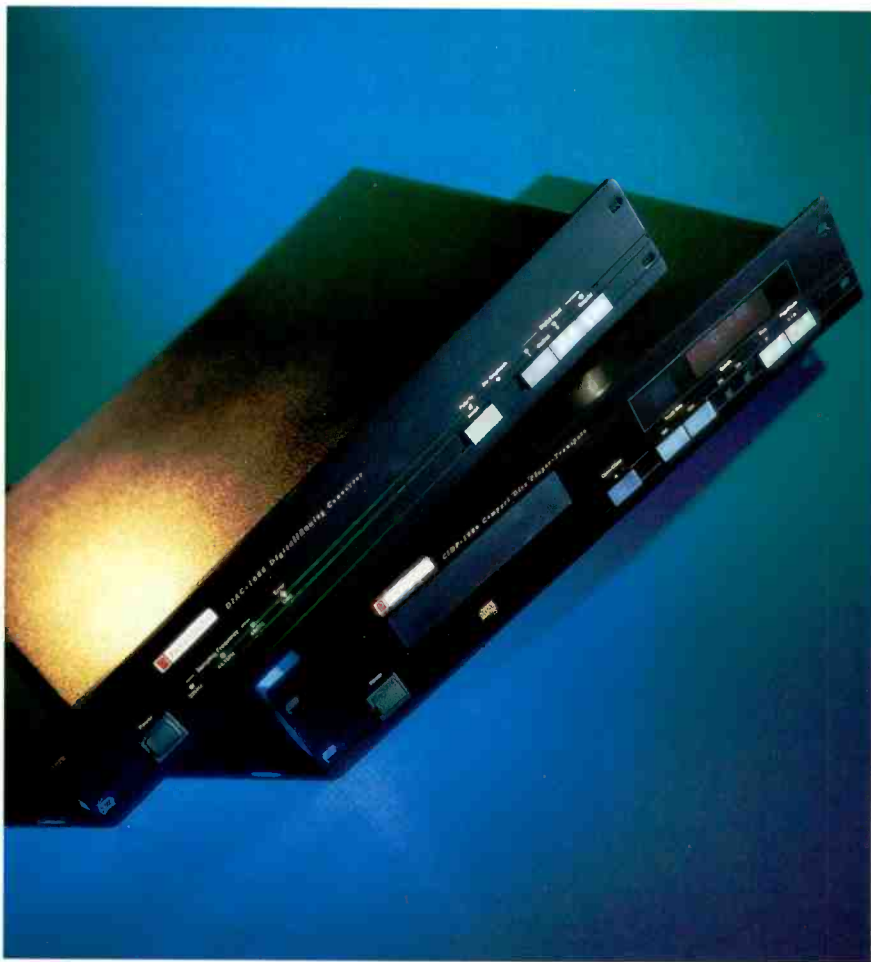

Parasound has quite an impressive and extensive product lineup these days, including several pre-amps, power amps, CD players and transports, D/A converters, and a widely discussed subwoofer. Under review here are the C/DP-1000 CD player/transport and the D/AC-1000 D/A converter. Both are rack-mount width and about 3 inches in height.

The C/DP-1000 serves both as a stand-alone CD player with its own built-in DAC (an 18-bit Burr-Brown PCM67) and as a transport to feed an external D/A converter. (It is relatively easy to equip a CD player

with a digital output, which is a smart marketing move: Start with the CD player, and later add one of our external D/A converters!) In addition to the standard high-quality, RCA coaxial phono jack for S/P DIF digital output, my review sample of the C/DP-1000 included the Advanced Digital Adapter Module (ADAM), a \$225 option that adds an AES/EBU balanced XLR output connector and an AT&T (ST) optical connector. Parasound says that this is the only user-installable output module with AES/EBU and ST outputs they are aware of and that the insertion can be done in less than two minutes. Besides the digital

and analog output connections mentioned, the rear panel of the C/DP-1000 also has an IEC a.c. power cord connector and a special mini phone jack to accept input from an external infrared remote-control repeater to allow control from other rooms. Parasound now has a CD changer version, the C/DC-1500 (\$650), with all the features I've just mentioned.

Similar in appearance to the C/DP-1000, the D/AC-1000 D/A converter is one notch down from Parasound's top-of-the-line D/AC-1500. At the left end of the front panel is a rocker-type a.c. power switch. To the right of that, sampling frequency is indicated by separate LEDs for 32, 44.1, and 48 kHz. A data-error indicator completes the left section of the panel. To the right are four momentary-contact switches. The "Polarity Invert" switch is separated by a "De-Emphasis" indicator light from the switches that select the three digital inputs (two optical, one coaxial). All four switches have status-indicator lights. Among the rear-panel connectors are the aforementioned three digital inputs (a high-quality RCA phono jack for coaxial, and Toslink and ST optical connectors). An IEC line-cord connector and a pair of RCA phono jacks for analog output complete the rear-panel lineup.

Looking inside the D/AC-1000, it is easy to see that the designers were pretty serious about power supplies, which take up half of the internal space. One p.c. board has three power transformers along with associated rectifiers, filter capacitors, and film bypass capacitors. A smaller board sports five voltage regulators (all with big heat-sinks), more electrolytic capacitors, and more film bypass capacitors. A pair of small p.c. boards behind the front panel interconnects or carries the front-panel switches and LEDs. Finally, we come to the main circuit board. Again, plenty of film bypass capacitors are in evidence. This main p.c. board is populated with numerous high-quality parts. All of the rear-panel connectors are mounted directly to it, with the exception of the IEC a.c. socket. The overall build quality of the D/AC-1000 is reasonable and adequate to the task.

Circuit Description

In the D/AC-1000 D/A converter, the selected digital input signal is applied to the

Photos: Michael Groer

TO BUILD THE WORLD'S BEST SUBWOOFERS, WE WENT BIPOLAR. AGAIN.

At Mirage, we've proven the sonic superiority of Bipolar loudspeaker design. Now we're proving it once again with our powerful new line of Bipolar subwoofers.

From the compact 100-watt BPS-100 to the flagship 250-watt BPSS-210, all four feature dual bass drivers in a unique Bipolar configuration. This eliminates transfer of low frequency energy to the floor, a major source of coloration in single driver subwoofers.

All feature our new "Auto-On" circuitry. And, for the ultimate in outboard control convenience, combine any of them with one of our LFX-Series of external crossovers.

From the original Bipolar explorers comes the world's first complete line of Bipolar subwoofers, the ideal means of adding dramatic new depth to both audio and home theater systems. Track one down and explore the possibilities yourself.



Mirage
THE ORIGINAL BIPOLAR LOUDSPEAKER™ 3641 McNicoll Avenue, Scarborough, Ontario, Canada M1X 1G5 (416)321-1800 Fax (416)321-1500

Enter No. 19 on Reader Service Card

CT-27v



Carver separates. The essence of total control.

Enticed by the sweetness of separates for your home theater system?

But a nightmare image of a bazillion boxes and unruly wires has given you the heebie jeebies?

Re-l-a-x.

Now you can obtain a powerful home theater command center, combining the musical brilliance of separates with the ease of a receiver, all in one versatile package: Carver's CT-27v Dolby Pro Logic™ A/V Preamp/Tuner.

The CT-27v pairs flawless sound with exceptional Dolby processing, including a generous selection of DSP effects (wait 'til you experience an old movie like *Casablanca* on our "Matrix"

mode), yet without the extraneous gimmicks that undermine aural integrity.

When matched with a Carver amplifier (models from basic stereo to multi-channel), the CT-27v lets you direct power to any array of speaker combinations – a task for which a mere receiver is woefully undermanned. So you'll achieve wider frequency response and have the dynamic headroom necessary for those explosive moments in great movie soundtracks.

In sum: the CT-27v is the heart (and soul) of the most uncompromising home theater system. For more of the story, contact Carver today for a feature length brochure.

CARVER
Powerful • Musical • Accurate

CARVER CORPORATION, P.O. BOX 1237 LYNNWOOD, WA 98046 • (206) 775-1202

© 1994 Carver Corporation

Distributed in Canada by Evolution Audio, Oakville, Ontario (416) 847-8888

Dolby Pro Logic™ is a registered trademark of Dolby Labs Licensing Corp.

Enter No. 9 on Reader Service Card

SPECS

D/A CONVERTER

Type: 20-bit, push-pull, eight-times oversampling; independent for each channel.

Frequency Response: 2.5 Hz to 20 kHz, ± 0.25 dB.

S/N: Greater than 105 dB, typically 110 dB.

Channel Separation: Greater than 100 dB at 1 kHz.

THD: Less than 0.0015% at 1 kHz.

Amplitude Linearity: Greater than 95 dB, typically 98 dB.

Phase Linearity: $\pm 0.1^\circ$ at 20 kHz.

Maximum Jitter (IHF): Less than 50 pS, rms.

Absolute Polarity: Selectable, 0° or 180° .

Dimensions: 19 in. W x 3 $\frac{5}{8}$ in. H x 11 $\frac{1}{2}$ in. D (48.3 cm x 9.2 cm x 29.2 cm).

Weight: 15 lbs. (6.8 kg).

Price: \$775.

CD PLAYER

Converter Type: Hybrid, one-bit/18-bit linear.

Frequency Response: 3 Hz to 20 kHz, ± 0.2 dB.

S/N: Greater than 110 dB, A-weighted.

Dynamic Range: Greater than 100 dB.

Channel Separation: Greater than 115 dB at 1 kHz.

Low-Level Linearity: ± 1.5 dB down to -90 dB.

THD: Less than 0.002%.

Wow & Flutter: Unmeasurable.

Interchannel Phase Shift: Less than 0.6° at 20 kHz.

Disc Defect Tracking: Up to 2,000 μ m.

Dimensions: 19 in. W x 4 $\frac{1}{8}$ in. H x 10 in. D (48.3 cm x 10.5 cm x 25.4 cm).

Weight: 16 lbs. (7.3 kg).

Price: \$495.

Company Address: 950 Battery St., San Francisco, Cal. 94111.
For literature, circle No. 91

input of the now almost universally used Crystal Semiconductor CS8412 input receiver. Recovered output signals from the CS8412 are passed on to an NPC SM5813 eight-times-oversampling digital low-pass filter. Outputs from the filter feed two Burr-Brown PCM63P multibit DACs, one per channel. Current-to-voltage conversion is handled by an Analog Devices AD841 op-amp. A passive RC de-emphasis network is connected between the output of the current-to-voltage converter and the input of an AD845 wired as a voltage follower. Next, a third-order anti-imaging low-pass filter is implemented in the form of a frequency-dependent negative-resistance (FDNR) filter. (A more thorough discussion of this type of filter appears in the August 1993 issue of *Audio*, in my review of the PS Audio UltraLink D/A converter.) These filters use an AD712 dual op-amp for each channel. A final AD845, wired as a voltage follower, buffers the output of the FDNR filter and drives the outside world.

As previously mentioned, power-supply circuitry in the D/AC-1000 is extensive. In addition to the three-terminal regulators that provide regulated $+18$ and -18 V, each signal channel has a pair of Darlington-connected capacitance-multiplier circuits. These circuits reduce and also filter the 18-V supplies to about $+12$ and -12 V for the analog circuitry.

Measurements

Measurements were first made for the D/AC-1000 D/A converter. Frequency response with and without de-emphasis is plotted in Fig. 1 for instrument loading. (IHF loading gave substantially the same results.) Since the two responses shown are so close, one could say the de-emphasis error, from the point of view of the difference between the curves, is essentially zero. However, the way I see it, it's better to say that the response with

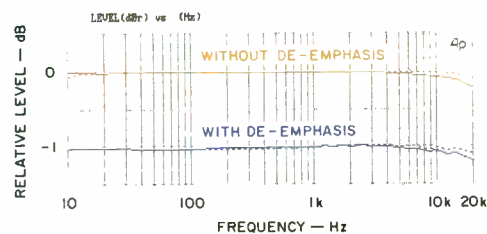

Fig. 1—Frequency response, D/AC-1000; solid curves are for left channel, dashed curves for right.

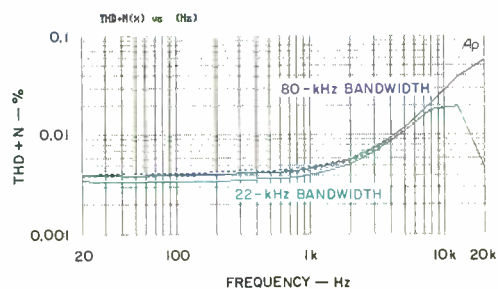

Fig. 2—THD + N vs. frequency at 0 dB (digital full scale), D/AC-1000.

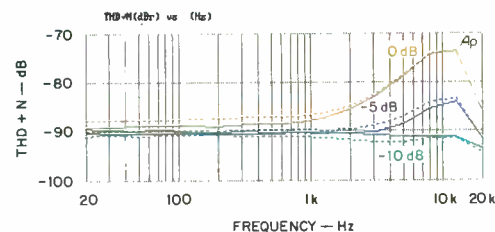

Fig. 3—THD + N vs. frequency and level, D/AC-1000.

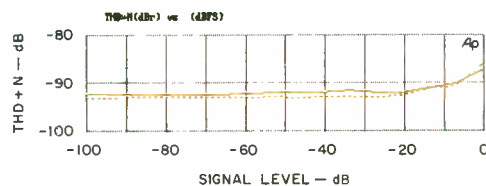

Fig. 4—THD + N vs. signal amplitude at 1 kHz, D/AC-1000.



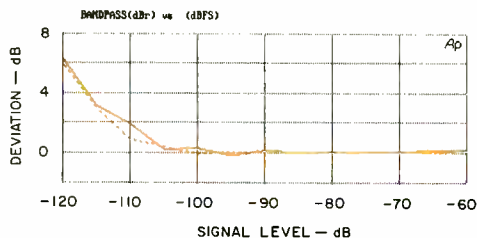

Fig. 5—Input/output linearity, D/AC-1000, for 500-Hz signal.

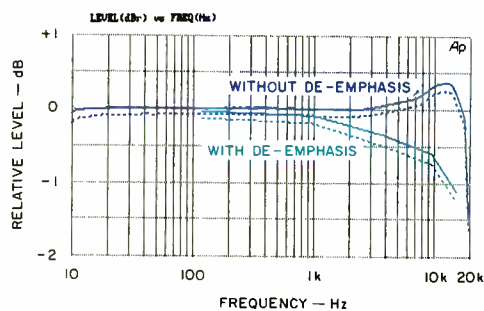

Fig. 6—Frequency response, C/DP-1000.

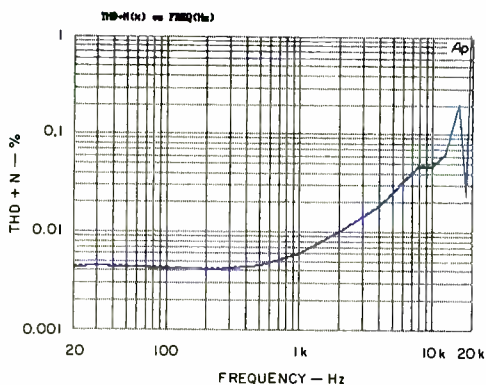

Fig. 7—THD + N vs. frequency at 0 dB (digital full scale), C/DP-1000.

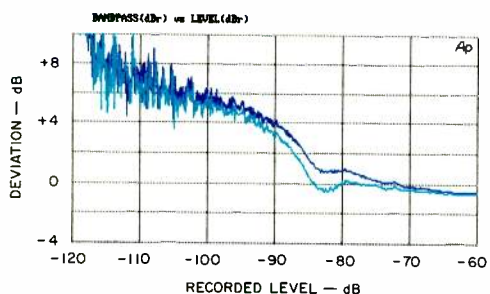

Fig. 8—Deviation from linearity, C/DP-1000, using CBS CD-1 test disc.

de-emphasis is deviant from flat, in the manner shown. Square and impulse waveforms had the usual linear-phase appearance—symmetry about the center of the impulse or a vertical center line of a square-wave half cycle. Additionally, the absolute output polarity was correct with the front-panel switch in its normal setting.

Total harmonic distortion plus noise versus frequency at digital full scale is shown in Fig. 2 for measurement filter bandwidths of 22 and 80 kHz. This technique is good for seeing how much the wider bandwidth raises the in-band distortion values, due to out-of-band noise. In the case of the D/AC-1000, the great similarity between the curves in the area from 20 Hz to 1 kHz, where distortion is lowest, shows that the out-of-band noise contribution is very low. This will also be evident in the wideband S/N figures. Figure 3 shows how THD + N versus frequency varies with signal amplitude near digital full scale (0, -5, and -10 dB). To make the presentation more meaningful, I have chosen to show THD + N in dB relative to full scale so that the noise floor won't vary as a function of the reading—as it would if I were measuring it as a percentage of signal amplitude, the way I did in Fig. 2. (For reference, -80 dB is 0.01%, -90 dB is 0.00316%, and -100 dB is 0.001%.) As can be seen, the rise in high-frequency distortion goes away pretty quickly with decreasing signal amplitude. The curves for THD + N versus signal amplitude at 1 kHz (Fig. 4) show good behavior in this test. Input/output linearity looks quite good in Fig. 5, which is a plot of deviation for a 500-Hz signal.

Another look at low-level linearity is a noise-modulation test devised by Dr. Richard Cabot of Audio Precision, which uses a low-level 40-Hz signal at input levels of -60, -70, -80, -90, and -100 dB full-scale. For each of these in-

put levels, the output is analyzed by sweeping a third-octave filter over the range from 300 Hz to 20 kHz. If things are in order, these five curves basically overlap each other. This was the case for the D/AC-1000.

Interchannel crosstalk was outstanding. Crosstalk was equal to or better than 115 dB from 20 Hz to 20 kHz.

Signal-to-noise ratios, quantization noise, and dynamic range results for the D/AC-1000 are given in Table I. Out-of-band noise is very low, as can be seen in the "Wideband" data. In-band noise was low enough that one can easily see the three-state (+1 LSB, 0, and -1 LSB) nature of a -90 dB, undithered 1-kHz signal on an oscilloscope.

I was unable to get the sampling-frequency lights on the D/AC-1000's front panel to respond to changes in the actual

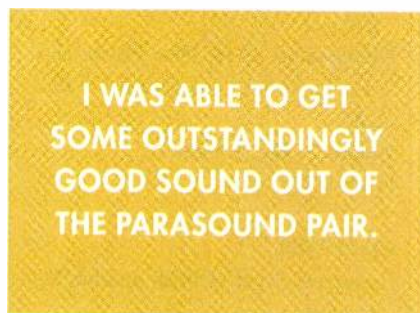

incoming sampling frequency or to my changing the value of "byte 3" in the data stream's channel-status block to the proper codes for the various sampling frequencies. The 44.1-kHz light was always on. Parasound says this was due to shipping damage, which seems reasonable.

A few final measurements for the D/AC-1000: Output voltage at digital full scale was 3.242 V, somewhat higher than the standard 2 V for CD players; Parasound says current units are set at 2.75 V. Output impedance for both channels measured about 47 ohms. The a.c. line draw was about 200 mA. Overall, the D/AC-1000 exhibited very good measured performance.

The performance of the C/DP-1000 player/transport was not quite the same caliber as that of the D/AC-1000 D/A converter. (The tests to follow were done with the CBS CD-1 test CD.) Frequency response, with and without de-emphasis, is shown in Fig. 6; IHF loading didn't affect high-frequency response but did start to have an impact in the region from 10 to 20 Hz. Total harmonic distortion plus noise is

The Sound of the Future is Now.



"A musically pleasing experience. They also stand as a signpost toward the direction speaker design should go."

— Dr. Robert E. Green, *The Absolute Sound*

"Soundwave loudspeakers create a breathtaking stereo image, offer tremendous dynamic range, and are harmonically correct. They're the most musical speakers I've ever heard."

— Dr. Christopher Reuse, world renowned composer of classical music

"Detail is virtually unmasked in the Soundwaves, and purity reigns."

— Dr. Robert E. Greene, *The Absolute Sound*
Vol. 19, Issue 97, August 1994

"Soundwave speakers are the most accurate I've ever heard. The clarity and focus are superb... I have never heard the human voice so accurately reproduced... members of the New York Audio Society are in awe of the sound reproduced by your great design."

— Robert Kreisler,
President, New York Audio Society

Introducing Soundwave Point Source Loudspeakers

A revolutionary design accomplished with the utilization of acoustic intensity mapping techniques, Soundwave Point Source loudspeakers

have a patented "baffleless" enclosure and unique drive units. This new design propagates a coincident, coherent, hemispherical soundwave

— the theoretical ideal. The result is sound so natural and three dimensional, you'll think you're hearing a live musical performance.

Soundwave
by Vero Research Corp.

1150 University Avenue, Building 5, Rochester, NY 14607 • 1-800-318-6731 • Fax 716-271-8799

Enter No. 34 on Reader Service Card

Did
your
last
component
leave
you
stranded

?

We didn't convince the power company to run solid wires into your house. Perhaps Edison was an audiophile. Luckily, all you need to change is that relatively short run of wire from your audio gear to the wall.

You'll be shocked (sorry) at the improvement in dynamics, depth and drive from your audio system.

To audition our power cables please call or write for your nearest dealer.

audioquest

P.O. Box 3060
San Clemente
CA 92674 USA
TEL 714.498.2770
FAX 714.498.5112

Table I—Signal-to-noise ratios, Parasound D/AC-1000 D/A converter. Quantization noise was -92.1 dB in the left channel and -91.1 dB in the right; dynamic range was 95.4 dB in the left channel and 95.8 dB in the right.

Bandwidth	S/N, dB			
	-120 dBfs Signal		Digital Zero Signal	
	LEFT	RIGHT	LEFT	RIGHT
Wideband	91.8	91.9	97.5	96.8
22 Hz to 22 kHz	93.2	93.5	104.2	105.0
400 Hz to 22 kHz	93.6	93.8	107.0	107.6
A-Weighted	95.4	95.7	108.7	109.3

plotted in Fig. 7; the high values of distortion near 20 kHz are real and are a result of difference tones starting to appear, due to aliasing. (Parasound's design decision was that a separate anti-aliasing filter would diminish sound quality.) Deviation from input linearity is depicted in Fig. 8. Square-wave and impulse responses (not shown) had linear-phase characteristics. As with the D/AC-1000, the absolute output polarity of the C/DP-1000 was correct. Output resistance was a rather high 1 kilohm. As would be expected, when one repeats these tests with the D/AC-1000 decoding the C/DP-1000's digital output, the results are generally similar to those from the D/AC-1000 itself when fed from the Audio Precision digital generator.

Use and Listening Tests

The C/DP-1000 was used as a CD player and also as one of the transports (along with a Counterpoint DA-11A and a PS Audio Lambda) feeding the D/AC-1000, as well as the Sonic Frontiers SFD-2, Resolution Audio Reference 20, and other (experimental) D/A converters.

Analog source equipment used in my system during the review period included an Oracle Audio turntable fitted with a Well Tempered Lab arm and a JVC X-1 moving-magnet pickup, used with my own tube phono preamp or a Quicksilver Audio preamp. Other analog signal sources included a Nakamichi ST-7 FM tuner and 250 cassette recorder and a Technics open-reel recorder. Preamplifiers used included a Quicksilver Audio Unit and Forssell tube line drivers (and in some listening, I used no preamp at all). Power amplifiers used were a Crown Macro Reference, Quicksilver M-135s, and a pair of Cary Audio Design CAD-805s. Loudspeakers used were B & W 801 Matrix Series 3s, augmented

from 20 to 50 Hz by my stereo subwoofer system using a JBL 1400Nd driver in a 5-cubic-foot ported enclosure for each channel.

When I initially got the Parasound equipment, I tried out the C/DP-1000 as a CD player first,

because I couldn't get signal lock when coupling the Counterpoint DA-11A transport to the Parasound D/AC-1000 D/A converter through an ST glass optical cable. It turns out that the Counterpoint and PS Audio transports have unusually high ST optical output levels, according to Parasound, who supplies a little adaptor that spaces the end of the incoming cable out a bit from the ST input connector on the D/AC-1000; it took care of this difficulty.

My impression of the sound of the C/DP-1000 as a CD player was quite favorable. I was able to play certain recordings, which tend to sound irritating on my higher resolution gear, in a refreshingly listenable manner, albeit with some loss of ultimate resolution.

When I fed the D/AC-1000 from the C/DP-1000 with an ST glass fiber cable, I was happier yet. Overall, the C/DP-1000 and D/AC-1000 combination had good balance from top to bottom, excellent sense of space, well-defined and "tuneful" bass, and an airy, generally low-irritation sound. An especially good-sounding combination resulted when feeding signals to the Cary Audio CAD-805 single-ended triode power amps, through the signal selector/attenuator in my tube phono preamp. In other equipment combinations, I was able to get some outstandingly good sound out of the Parasound pair.

Operation of the Parasound equipment was pleasurable and easy. I especially liked the way the C/DP-1000's drawer operated. No problems were encountered save the aforementioned need for the ST optical adaptor (supplied with the D/AC-1000) for use with some CD transports.

In concluding, I very much enjoyed my time with the C/DP-1000 and D/AC-1000. Go out and give these products a listen.

Bascom H. King

THE RAVE OF AUDIO INSIDERS, NOW AT "INSIDER" PRICING.

"Considering their price and fine all-around performance, the Digital Phase AP-1s would be a good addition to any audiophile's system."

D.B. Keele, Jr.
AUDIO Magazine

"The best performance and value in the marketplace today, period."

Maurice Paulsen
Crown International

"After 15 years in the speaker industry, I've heard about a lot of 'major breakthroughs.' Digital Phase is truly innovative. I cannot imagine a system more accurate. The AP-2s are now in my home."

Woody Jackson
Audio Industry Consultant

Yes, the audio industry is raving about DIGITAL PHASE. And for good reason.

Thanks to the new, patented Acousta-Reed™ technology, DIGITAL PHASE brings bass depth and definition to a level never before realized.

Thanks to the special one-piece tweeter of spun titanium, DIGITAL PHASE delivers an uncommon freshness and sweetness to high frequencies.

And now, thanks to factory-direct pricing, DIGITAL PHASE makes true audiophile-quality sound affordable to virtually everyone. The DIGITAL PHASE AP.5, for example, is just \$449 a pair in genuine oak cabinetry.

This is not a close-out of old technology. This is a factory-direct offer on the latest, patented technology. And with our 30-day return policy, you simply can't lose. So there's absolutely

no reason to wait. Call us today with your order, or just to find out more.

1-800-554-7325

DIGITAL PHASE. The rave of audio insiders, now at "insider" pricing.

Digital Phase™
ACOUSTA-REED™ TECHNOLOGY

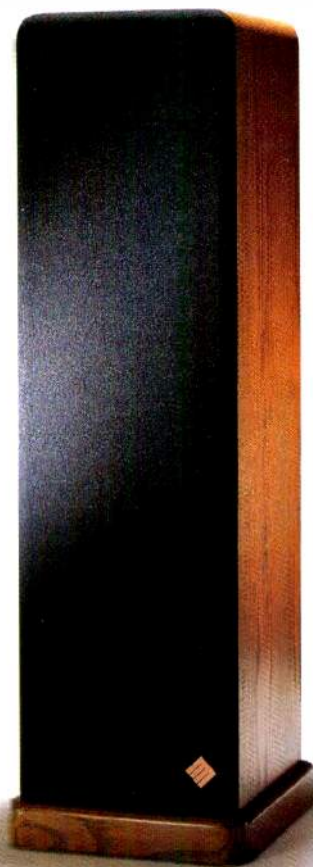

Send me info as indicated

Place my order as indicated

AP.5 bookshelf system, \$449/pair SM-1, \$649/pair AP-1, \$899/pair

AP-2, \$1199/pair AP-4, \$2199/pair

Name _____

Street Address _____

City/State/ZIP _____

Telephone (____) _____ VISA MC AMEX Exp. _____

Card No. _____ Signature _____

Mail to: DIGITAL PHASE Insiders • 2841 Hickory Valley Rd. • Chattanooga, TN 37421

Pictured, the AP-1, one of five DIGITAL PHASE systems with patented Acousta-Reed technology.

JVC XM-D1BK MINIDISC RECORDER



Part fish, part fowl, JVC's XM-D1BK MiniDisc recorder is an intriguing product. If d.c. operation qualifies a device as being portable, the XM-D1BK is definitely portable; it comes with a 6-V, rechargeable nickel-cadmium battery. But compared with some other MD portables, this one is large, and, weighing in at 29 ounces with battery installed, rather hefty. Yet its size is what makes it interesting; this is a small MD deck that even fumble fingers should find easy to use. To top it off, it is packed with "big-deck" features.

For one, this is a recording deck—not just a player—that handles both analog and digital sources. The latter must come at a 44.1-kHz sampling rate (which is fine for copying CDs but not home-brewed DATs) and arrive by way of an optical Toslink input, since no wired digital input

is provided. Digital copies from the XM-D1BK also are possible via a Toslink output, but with the SCMS copy-management system, only first-generation digital-to-digital transfers are permitted. Stereo mini-jacks on the back (where the Toslinks are

**JVC'S XM-D1BK
STRIKES ME AS BEING
A REASONABLY SOLID,
FIRST-GENERATION
MINIDISC SYSTEM.**

also located) serve as line-level analog inputs and outputs, and stereo mini-to-phone-plug adaptor cables are provided. Another back-panel jack, "Compu Link-3 Synchro," provides unified system control if the other components are compatible with the "1," "2," and "3" versions of JVC's CompuLink interface.

The battery snaps into place on the back of the deck, with the connections protected by a cover when the battery is not used. The battery/cover "Release" button is underneath the deck. The supplied a.c. adaptor (110 to 240 V) serves to charge and/or "refresh" the battery. The refresh cycle drains the battery before recharging, a procedure that helps extend its life and avoids the notorious "memory" of nickel-cadmium batteries. It takes 3½ hours to refresh a battery and 1½ hours to charge it. A fully charged battery is claimed to provide 100 minutes of playback or 80 minutes of recording. The a.c. adaptor can also power the XM-D1BK via an umbilical cord that plugs into the back of the deck.

What first attracted my attention to this deck was its microphone input, once again by stereo mini-jack (but I can live with that), and a three-position "MIC LC/MIC ATT" switch. According to the manual, the first two switch positions give a choice of mike-preamp gain (full or attenuated by 20 dB) with unadulterated dynamic range. The third position, "LC On," is chosen "for automatic sensitivity adjustment," which

SPECS

Frequency Response: 20 Hz to 20 kHz, ± 1 dB.

Wow and Flutter: Less than measurable limit.

Rated Input: Line, 500 mV rms; microphone, 7 mV rms.

Minimum Input: Line, 100 mV rms; microphone, 1.4 mV rms.

Output: Line, 1.2 V rms into 10 kilohms; headphones, 10 mW into 16 ohms.

Power Requirements: Using supplied nickel-cadmium battery, 6 V d.c.; using supplied power adaptor, 110 to 240 V a.c., 50/60 Hz.

Power Consumption: Power on, 9 watts; standby mode, 2 watts.

Dimensions: 7½ in. W x 2¼ in. H x 5½ in. D (18.7 cm x 5.7 cm x 13 cm).

Weight: 1.8 lbs. (0.8 kg).

Price: \$1,299.95.

Company Address: 41 Slater Dr., Elmwood Park, N.J. 07407.

For literature, circle No. 92

implies activation of some type of limiter/compressor to set recording level automatically. This would seem to offer the best of both worlds—unattended recording with automatic level control when necessary, clean dynamics when you can adjust recording level yourself.

A reasonably sized “Input Level” thumb-wheel makes it easy to set the recording level, but there’s no way to adjust channel balance. With only seven segments spanning a 60-dB range, the dual recording-level indicators leave something to be desired by way of precision, but the display is generous in size and has good contrast. It is also well backlit, which makes it easy to

**AMONG THE UNCOMMON
FEATURES ARE
A DISPLAY THAT TILTS
FOR EASY VIEWING
AND A BUILT-IN TIMER.**

read. You can pivot the display up from the case, so it can be viewed at an angle. Although there are only three fixed detents, the display nevertheless remained at any angle I set it for.

Headphone output is set by a thumb-wheel to the left of the “Input Level” control, and the headphone mini-jack is to the left of the microphone input. (The latter is color-coded, with a red ring to distinguish it from the headphone jack.) An “Input Selector” chooses the active input, “Analog” or “Digital,” and an adjacent “Hold” switch permits you to lock the current operating mode.

The controls described above are on the right side panel; the front carries an “On/Standby” power button and the main operational controls: “REC,” two-way “Auto Search,” “Pause,” “Stop,” “Play,” and “Eject”—some of which serve dual functions. On top is a jog dial and a number of buttons used for editing, display control, and title entry. During playback or pause, the jog dial permits you to advance or return to any point on the disc, guided by the display’s indication of track time. When recording a title, a mode selected by pressing the “Title” pad, the jog dial scans through the available character set. If you

don’t wish to use the jog dial, you can go through the character set by pressing the “Scroll” key, the second function of the transport “Pause” pad. Characters can be toggled between upper and lower case by pressing “Display/CHARA” and entered by pressing “Set.” If you happen to make a mistake, you can erase a character by advancing to it with the “Cursor” buttons (the second function for the two-way “Auto Search” pads) and erasing it with the “Cancel” button (the second function of the transport “Stop” key).

Tracks can be joined, divided, renumbered, or erased by tapping the “Edit” key until the desired function appears in the display. “Join” combines two adjacent tracks, “Divide” splits one track into two, “Erase” deletes a track, and “Renumber” rearranges tracks in any desired order. Nothing is permanent until you press “Enter,” which causes the changes to be written to the table of contents.

When recording, tracks can be marked manually or automatically. The “Track Marking” key chooses the mode and, when manual marking is selected, new track numbers are recorded by pressing “Set.” With auto marking, a new track number is recorded for each 3-S break in the signal. In playback, the XM-D1BK offers 32-track programming with random play and the ability to repeat one or all tracks. There’s also an “Intro” mode that plays the first 15 S of each track.

The JVC XM-D1BK’s internal clock is used not only for unattended recording and playback (wake up to music!) but also to time and date recordings as they’re made. This feature is accessible only via the infrared remote control, a slimline 24-button device that accesses all transport functions and gives direct access to any track by its number. (Direct track access is also possible from numeric pads on the XM-D1BK’s top

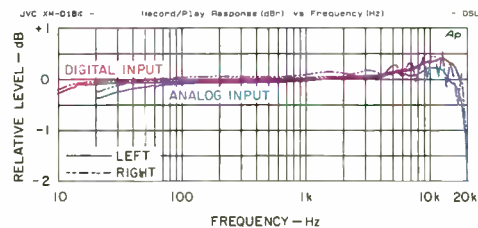

Fig. 1—Record/play frequency response.

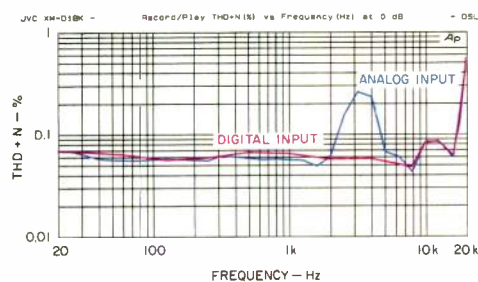

Fig. 2—Record/play THD + N vs. frequency.

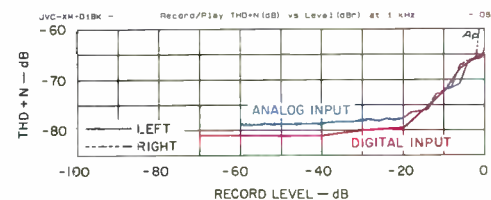

Fig. 3—Record/play THD + N vs. record level.

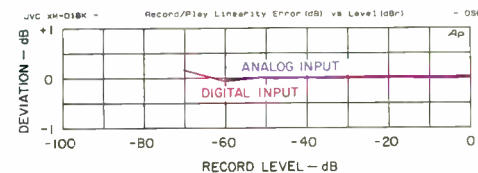

Fig. 4—Record/play linearity error.



The snap-on battery can handle up to 100 minutes of playback, 80 minutes of recording.

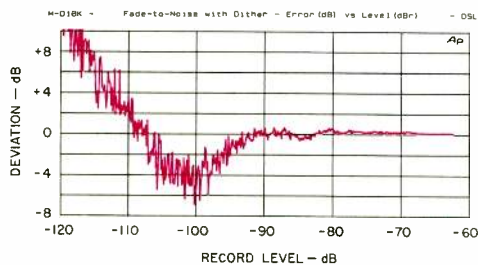

Fig. 5—Fade-to-noise test (dither applied).

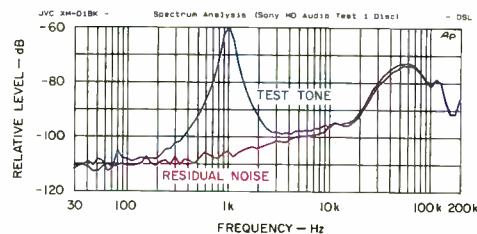

Fig. 6—Spectrum analysis of test-tone and residual-noise tracks.

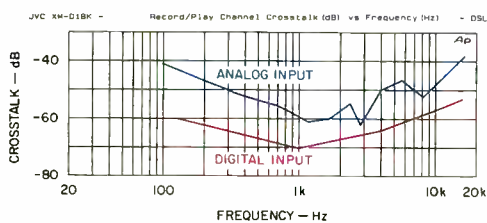

Fig. 7—Record/play crosstalk.

surface.) Clock time is maintained for only 10 minutes after power is lost; if the a.c. supply is unplugged or the battery runs down, you may have to reset the clock. The clock, which functions on the 24-hour military system, can gain or lose up to 2 minutes a month. Therefore, you should check it when you set up for unattended recording of an important broadcast.

Measurements

I have a penchant for live recording, so the JVC XM-D1BK particularly intrigued me. Few consumer recorders sold in this country have microphone inputs, and this one, being reasonably small and battery operated, struck me as ideal for “in camera” taping. (Whoops! Discing.) But when I exercised the microphone inputs in the

lab, I was chagrined to find that the overload points were barely above the minimum signal needed to make a 0-dB recording. For example, with the input attenuator set at 0 dB and the recording-level control fully advanced, the XM-D1BK needed 3.18 mV to reach the 0-dB level. However, with the recording-level control turned down, the input circuits still clipped at 4.26 mV, barely 2.5 dB higher. With the 20-dB attenuator switched in, the minimum signal level and clipping point were precisely the same, 29.7 mV. This means that unless you operate the recorder with the level control fully advanced, you’ll not be able to obtain a 0-dB recording level prior to clipping!

The “LC” switch setting essentially prevents input overload (it’s a whopping 900 mV in this position) but at the price of compressed program dynamics. Limiter/compressors like this are great for casual recording but hardly ideal for music. JVC’s manual suggests that the recording-level control should be advanced fully whenever you use the limiter/compressor. Under this condition, I found that the XM-D1BK required 1 mV to reach a -10 dB recording level and that, as signal level increased, the limiter

clamped the maximum recording level to -0.85 dB. The calculated sensitivity of the microphone preamp in the “LC” mode is therefore the same as that in the 0-dB position, 3.18 mV.

The line inputs are free of overload problems (they handle levels in excess of 10 V), and my analog measurements were made from these. The minimum input required to obtain a 0-dB recording was a relatively high 0.226 V, and I decided to make all measurements with the recording-level control fully advanced to avoid the channel imbalance that occurred when the control was turned down.

Frequency response from these analog line inputs is shown in Fig. 1. Ripples in the right-channel response can be seen at high frequencies, but the response is still

within +0.43, -0.62 dB from 20 Hz to 18 kHz. The left channel is relatively free of ripple, and its response is more uniform.

Left-channel THD + N (in percent) at the 0-dB level is plotted as a function of frequency in Fig. 2. It’s well under 0.1% over most of the band—with the exception of a region surrounding 3 kHz, where distortion and noise jump to a peak of 0.27%. Overall, I rate distortion from the analog inputs as being no more than 0.27% from 20 Hz to 16 kHz at maximum recording level.

Figure 3 shows THD + N (in dB relative to recorded level) as a function of level, using a 1-kHz test tone. Here, the results from both channels are shown, since the right channel exhibits different characteristics from the left channel near the maximum recording level. At 0 dB, right-channel THD + N hit -50.4 dB (off the scale of the plot, and equivalent to 0.30%) while left-channel THD + N was about -64 dB (approximately 0.06%).

Figures 1 through 3 also show the results when the XM-D1BK does a direct digital-to-digital copy via the Toslink input. These

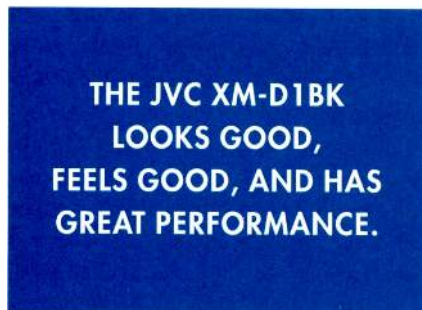

tests were made by copying the CBS CD-1 test Compact Disc to the XM-D1BK. As you can see from Fig. 1, the left and right response curves are almost identical in the digital transfer, so the rippling right-channel response with the analog inputs is probably caused by the A/D converter’s anti-aliasing filter. Why this should differ on the two channels remains a mystery.

The digital transfer posed a puzzle too. When I transferred the frequency sweep from the CD-1 to the XM-D1BK, the recorder didn’t seem to respond correctly to the pre-emphasis flag. The CD-1 sweep is recorded without pre-emphasis, i.e., the level remains at zero across the entire sweep. The XM-D1BK’s display indicated constant level in both channels, but the recorder apparently decided to set its own

pre-emphasis flag, since, when the disc was reproduced, the response rolled off in the highs exactly as one would expect from deemphasizing a recording that was not pre-emphasized.

The "Digital Input" curves you see in Fig. 1 were taken by copying the CD-1's discrete set of test tones instead of the sweep. These tones are also recorded without pre-emphasis, but the XM-D1BK had no trouble deciphering the preambles of this set. As you can see, response is quite flat: +0.41, -0.08 dB from 20 Hz to 18 kHz (-0.74 dB at 20 kHz). I have no explanation for why the XM-D1BK had trouble understanding the sweep track's pre-emphasis flag but not those of the tone set or any other transfer I made from the CD-1. However, the error occurred time and again, and I used two different test discs. When I played a disc that I had transferred from the CD-1 using a different recorder, the XM-D1BK's response was flat. Therefore, the problem obviously occurs in recording, not playback.

As you can see in Fig. 2, THD + N with a digital transfer parallels the results with the analog inputs except that distortion remains low from 2 to 5 kHz with digital dubbing. In general, it's no more than 0.087% from 20 Hz to 17 kHz. The curves in Fig. 3, of THD + N versus level, are also better with digital dubbing than when the analog inputs are used. In the digital transfer, the two channels perform identically, with a THD + N of less than -63.7 dB (0.065%) from 0 to -70 dB—and if you ignore the 0-dB point, the contamination is no greater than -65.7 dB (0.052%) from -1 to -70 dB. The higher levels of THD + N at reduced recording levels with the analog inputs are to be expected because of analog circuit noise.

Figure 4 shows linearity error when recording from the analog and digital inputs. The error is negligible to as low a level as I could measure; noise precluded locking onto signals below -62 dB with the analog inputs and below -70 dB in the digital transfer. To probe deeper, I transferred the fade-to-noise track of the CD-1 onto a MiniDisc and reproduced the MD. The results, shown in Fig. 5, suggest excellent linearity down to -90 dB (although the error mounts considerably at lower levels). Good linearity to -90 dB jives well with the mea-

surements I made of dynamic range. These came in at 89.7 dB (unweighted, 93.3 dB with A-weighting) when dubbing a CD digitally and 90.0 dB (unweighted, 95.3 dB with A-weighting) when playing a prerecorded test MiniDisc (Sony MD Audio Test 1 Disc).

Although dynamic range and linearity measured up pretty well, the XM-D1BK left something to be desired by way of quantization noise (-67.0 dB from the prerecorded test disc, -64.0 dB when I dubbed the CD-1) and in A-weighted S/N ratio, which was actually a trifle better when transferring the CD (88.3 dB) than when playing the test MD (87.5 dB).

Figure 6 is a spectrum analysis of residual noise and of a -60 dB, 1-kHz tone, two tests contained on the Sony test MiniDisc. I used the a.c. line adaptor to power the XM-D1BK; hum-related components are conspicuously absent. The rise in noise power

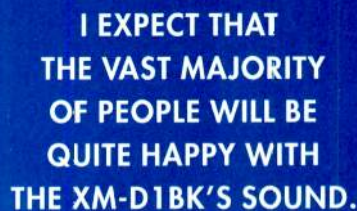

I EXPECT THAT
THE VAST MAJORITY
OF PEOPLE WILL BE
QUITE HAPPY WITH
THE XM-D1BK'S SOUND.

above 20 kHz reflects the "noise shaping" used in the XM-D1BK's D/A converter.

Figure 7 shows crosstalk. With the analog inputs, separation is greater than 41 dB from 100 Hz to 10 kHz; with digital transfer, it is greater than 57 dB from 125 Hz to 10 kHz.

Among the more mundane tests, output level from a 0-dB recording was approximately 1.3 V (open circuit) at either the line or headphone output. Output impedance was 1,370 ohms (line) and 42 ohms (headphone), which implies a rather generous power output to headphones: 10.8 mW into consumer-like, 50-ohm 'phones and 2.65 mW into a professional, 600-ohm headset. Line input impedance was 43 kilohms and that of the microphone preamp was 31 kilohms.

Use and Listening Tests

In my listening room, JVC's XM-D1BK did a pretty good job on prerecorded MiniDiscs. Put it this way: Without direct com-

parison to a CD, I expect that the vast majority of people would be quite happy with the sound. So was I, pretty much, but then again, I don't have the world's largest MiniDisc library—and much that I do have is (shall we say) not all that taxing.

Furthermore, I'm convinced that the sound quality of any perceptual encoding system depends, in large measure, on the complexity of the encoding algorithm. I suspect that studio encoders used to create MiniDiscs for commercial release are more adept than the ones found in consumer recorders. Certainly, I found more fault with the discs I dubbed than with the commercial genre—but then again, I had the original CDs for comparison. (For the record, the flag problem that arose on the test bench did not occur on any of the discs I copied in the listening room.)

Admittedly, the material I tried to dub was meant to tax a perceptual encoding system: Some of it was solo instrument in a nonreverberant environment, while other was commercial fare of the type that strains the wits of an encoder, e.g., finger cymbals buried in a sea of sound. And also admittedly, my tests were neither double-blind nor conducted with a listening panel of sufficient depth to yield scientifically valid results. However, the couple of pairs of ears I was able to drum up could distinguish original from copy fairly reliably on a number of instruments, particularly those of a percussive or bell-like nature (glockenspiel, castanets, harpsichord, piano, and the like). Depending on the instrument, the difference could be characterized as a dulling of the transient or as an accompanying noise puff or "echo." In general, the sound of MiniDiscs made on the XM-D1BK seemed "heavier" and less open than that of the original CDs. And often, low-level highs, such as on the finger cymbals mentioned above, were either absent or notably dulled when other sounds preoccupied the encoder.

All in all, the JVC XM-D1BK strikes me as a reasonably solid, first-generation MiniDisc system. I find it good looking and good feeling, and I think it has great ergonomics. Its stumbling on the test bench, together with somewhat dated MiniDisc sound and a relatively hefty price, preclude my giving it the most enthusiastic support. *Edward J. Foster*

Hi.

GOTTA RUN.

With all the new Dodge Neon Sport Coupe has going for it, you can see why it's anxious to get going.

Its 2.0 liter, dual overhead cam, 16-valve engine delivers 150 peak horsepower...making it a bit more impatient than its four-door sibling. Plus, it sports distinctive cast aluminum wheels. A rear spoiler. Tight-ratio power steering. And a four-wheel independent performance suspension.



Driver and front passenger airbags are standard. And so are four-wheel anti-lock disc brakes, a great stereo, fog lights, and more.

In short, it's a rush. So say hello to the other Dodge Neon...the Sport Coupe. At a friendly Dodge dealer today.

NEON SEDAN & COUPE



THE NEW DODGE
1-800-4-A-DODGE

Always wear your seat belt.
Enter No. 23 on Reader Service Card

KLH V-01 REAR-CHANNEL SPEAKER



The V-01 surround speaker is the most unusual component of the KLH Video Series, which also includes matching front left, right, and center loudspeakers. Each upward-sloping side panel of the V-01 holds an 8-inch woofer and a 1-inch dome tweeter. Billed as a “dipole” speaker (part of the requirements for Lucasfilm’s THX certification), the V-01 is really two speaker systems sharing a common box. In order to be a dipole, the two systems would have to be wired in opposite polarity, and this is not recommended in the instruction sheet. Dipole speakers, when placed on the side walls, can provide a very diffuse surround sound. Wired as directed, the V-01 could be called a “bipole” speaker, which is probably a better design for the system’s intend-

ed location—behind the listeners, radiating sound to the sides.

The rear floor location should appeal to those who want to avoid mounting a pair of speakers on the rear or side walls and running wires to them. Here, at last, is a speaker designed to be placed where most non-audiophiles have always wanted to position them—behind the sofa.

It would be a good idea to pull the sofa out from the wall a couple feet, so the sound can reach the side walls to reflect back.

The KLH V-01 has an attractive trapezoidal shape, with detachable black fabric grilles on the sides and textured black vinyl on the top, front, and back. The back contains the two spring-loaded terminal sets, intended for stripped wires, and a single port, 1.9 inches in diameter.

Measurements

The impedance, which is not given in the instruction sheet, would be rated at 8 ohms for each section. In most cases, two separate wire runs will need to be made to the power amplifier or A/V receiver even

though the Dolby Pro Logic surround signal is mono. Paralleling the speakers would result in a difficult-to-drive, 4-ohm load. (Never parallel the outputs of two power amplifiers to avoid the extra wire run.) A valley in the impedance curve, centered at 46.3 Hz, indicated the cabinet tuning frequency and also the frequency below which cone excursion increased rapidly. No problem here, however, because surround information is attenuated below 80 Hz or so.

The usual anechoic frequency response, measured on the axis of either of the side panels, revealed a fairly smooth and extended curve. However, that does not represent the manner in which this speaker would be used. The frequency response, shown in Fig. 1, was measured in my listening room as it would be heard by a normally seated listener. The V-01 was placed just above the floor, near the center of the 13-foot-wide rear wall, and the microphone was placed at listener height—about 5 feet forward into the room and on the center line. The response shown has been averaged by a third-octave filter; otherwise, dense peaks and dips caused by the room reflections would obscure the trend. We tend to hear the spectral balance of the third-octave measurement, whereas the peaks and dips are heard as room acoustics. The curve shows good bass, a peak at 140 Hz, and a treble roll-off.

The Dolby Pro Logic surround signal cuts off above 8 kHz, and a slight roll-off is desirable anyway for surround sound, so the treble roll-off is okay. When first measured, the peak at 140

Hz was nearly 20 dB! Most of this turned out to be due to interaction with my specific room and listening position. I moved the V-01 slightly off the center line, raised it off the floor by 20 inches,

and moved my microphone forward in the room. The result is the 6-dB peak seen in Fig. 1, which I believe to represent the average of what may be expected in a listening room.

Use and Listening Tests

The KLH V-01 was installed in place of my usual pair of dipole surround speakers

HERE IS A SURROUND
SPEAKER DESIGNED
TO GO WHERE
MOST PEOPLE WANT IT,
BEHIND THE SOFA.

CONRAD-JOHNSON PF2 AND MF2300

Solid-State Components Without Solid-State Sound

Too often, solid-state audio components sound harsh, edgy, grainy and dimensionless. This is so common among solid-state designs that audiophiles readily identify this unmusical sonic signature as "transistor sound". At Conrad-Johnson, we have long believed that these audible distortions are not inherent in solid-state devices. Instead, they are a consequence of circuit design and implementation. Through innovative circuit design and the use of highest quality parts, we have developed a range of Conrad-Johnson solid-state products that prove the point. They do not sound like solid-state. They just sound like music.



For more detailed information on the full range of Conrad-Johnson solid-state products write, phone or fax:
conrad-johnson design, inc.

2733 Marilee Drive • Fairfax, VA 22031 • phone: 703-698-8581 • fax: 703-560-5360

Enter No. 13 on Reader Service Card

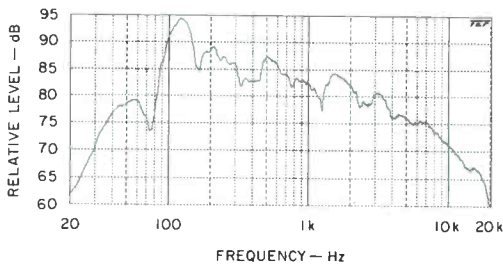

Fig. 1—Frequency response measured in listening room; see text.

in my Dolby Pro Logic audio/video system. LaserDiscs were used for the program material. The test noise function of my audio/video-receiver was used to set the sound levels of left, center, right, and surround speakers to be subjectively equal at my listening position. I noted that the test noise seemed to come from directly behind me when it cycled to surround. The surround delay time was set to 20 mS.

Because I found the amount of perceived surround effect to be lacking on LaserDisc material, I increased the surround gain by 6 dB. The relative loudness and the spectral balance of the surround effects were then quite pleasant, but the surrounding spatial effect was lacking. It sounded as if there was a loudspeaker behind me (and, of course, there was). When I closed my eyes, I could imagine sound sources arrayed in front of me and just behind me, but not to the sides. My dipole speakers, as well as left and right conventional monopole speakers, have done a better job of creating surround.

The KLH V-01 has its place, however, as a solution to a common installation problem. If you cannot accommodate a pair of

COMPARED TO MOST SURROUND SPEAKERS, THE KLH V-01 HAS FAR GREATER SENSITIVITY.

surround speakers well off the floor and to the sides or rear of the listening area, it is worth looking into the V-01. Also on the plus side, the V-01 has far greater sensitivity and sound output capability than most of the small individual surround speakers now on the market. *David L. Clark*

SPECS

Type: Two-way, floor-standing dipole surround speaker.
Drivers: Two 8-in. woofers and two 1-in. dome tweeters.
Frequency Range: 40 Hz to 20 kHz.
Sensitivity: 90 dB SPL at 1 meter for 2.83 V.
Crossover: 1,800 Hz, L-C.
Dimensions: 16½ in. H x 10½ in. D x 6½ in. W at top (41.9 cm x 27 cm x 16.5 cm); 15¼ in. W at base (38.7 cm).
Weight: 21 lbs. each (9.5 kg).
Price: \$200 each.
Company Address: 11131 Dora St., Sun Valley, Cal. 91352.
For literature, circle No. 93

AUDIO/MARCH 1995

74

FEEL THE **REDUCTION**
 OF THE WORLD'S MOST MUSICAL TUBE COMPONENTS

Yakov
 A R O N O V
 MADE IN U. S. A.

YAKOV ARONOV AUDIO LAB, INC. TEL 213.653.3045 FAX 213.937.6905

Enter No. 38 on Reader Service Card



Master Craftsman Jacob Albright



THE LEADER IN SPEAKER TECHNOLOGY™

3021 Sangamon Avenue
Springfield, Illinois 62702

(217) 544-5252 FAX (217) 744-7269
800-283-4644

TOP TEN REASONS NOT TO BUY LEGACY SPEAKERS

10. Our cabinetmakers are too finicky.
9. Neighbors might think you play the violin.
8. You can't pronounce kevlar, titanium and neodymium.
7. Buying direct saves you money. You already have too much money.
6. You won't buy anything with a warranty longer than your first marriage.
5. LEGACY is the critic's choice. What do they know?
4. Your friends may not go home.
3. Feeling Clapton draw a quick breath between licks is *too* realistic.
2. LEGACY customers have that *smug, satisfied* look.
1. Our toll free number is too damn hard to remember.



We know speakers inside and out



Kevlar Sandwich Construction—
The World's finest midrange



Get Real . . .
Get LEGACY

Call 1-800-Audio-Hi
FOR YOUR FREE COLOR BROCHURE



Record Producer Randy Royce

MARK LEVINSON NO. 30.5 D/A CONVERTER AND NO. 31 CD TRANSPORT



The Mark Levinson No. 30.5 D/A converter and No. 31 CD transport are difficult to review, for a number of reasons. First, these products offer more technology and features than can be described in any review of reasonable length. They not only have exceptional features as stand-alone items but offer the ability to directly interface, or "link," with Mark Levinson preamps and

Company Address: c/o Madrigal Audio Laboratories, P.O. Box 781, Middletown, Conn. 06457.

For literature, circle No. 94

amplifiers, allowing one component in the chain to control various features in an entire system. Second, Mark Levinson's great strength—perhaps its sonic signature—lies in its search for neutrality and lack of coloration. Thus, it becomes a challenge for me to write about Mark Levinson equipment.

Describing a product as slightly more neutral or more accurate is scarcely dramatic prose, although it is what the high end is all about.

**THE NOS. 30.5 AND 31
MAKE A STATEMENT
ABOUT JUST HOW GOOD
THE HIGH END CAN GET.**

The No. 30.5 D/A converter costs \$15,950, and the No. 31 CD transport costs \$8,495. It is almost always an expensive trip to go from very good to excellent, but these prices make it clear that it's a *very* expensive trip from excellent to state of the art. If you are to keep things in proportion, you must recognize that you will pay a great deal of this money for small and subtle improvements. The sonic differences in high-end equipment are often described as if the sound improves from bad (mid-fi) to nirvana (the top of the line). In reality, diminishing returns set in relatively early in the high end, as they do in many other hobbies. Sound quality improves from good to state of the art in slow steps, with steadily increasing jumps in price for steadily smaller improvements in performance.

So many competing claims are being made about the technical aspects of digital sound that they tend to recede into the noise level of a review. The firms that are producing the best-performing D/A converters and CD players use very different mixes of digital and analog technologies, and each firm claims that its approach alone provides the most sonic benefits.

It is worth noting that Mark Levinson is one of the few high-end firms that actually designs its digital equipment from the ground up. The extremely high level of technical sophistication is clearly apparent in the Levinson brochures and white papers on the No. 30.5 D/A converter and No. 31 CD transport. These

papers are not filled with generalized claims, and they are all worth reading simply to understand what manufacturers actually have to

do to create state-of-the-art digital equipment. Opening up the 30.5 and 31 is also quite an experience. If you want to see why components

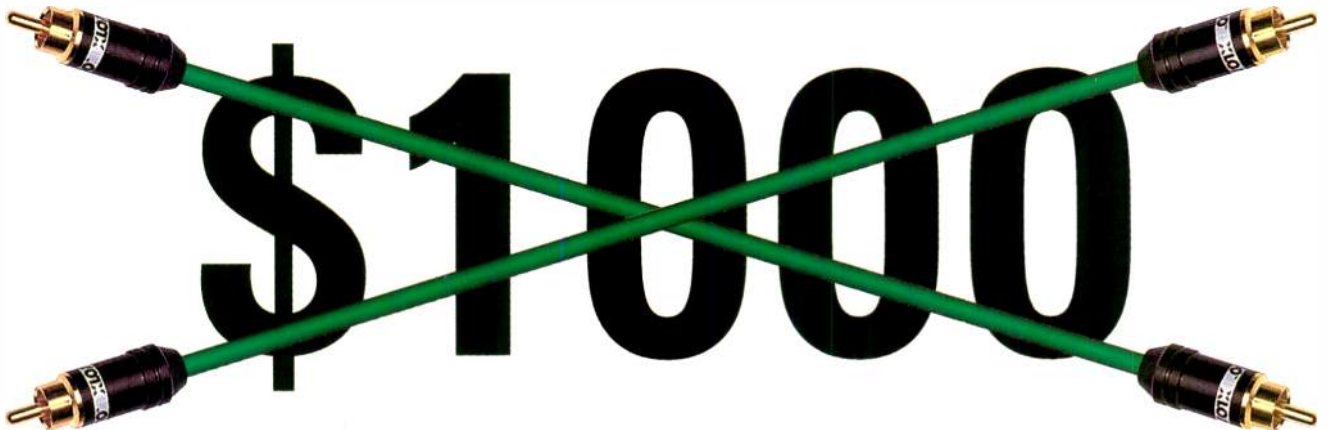

~~\$1000~~

Yours now for just \$49.95!

It's true! The new XLO/PRO Type 150 interconnect, at just \$49.95 for a one meter pair, really *CAN* ADD \$1000 OR MORE worth of better highs, cleaner bass, higher resolution, tighter focus, and broader, deeper, *vaster* soundstage to virtually ANY system.

Try it yourself. Put XLO/PRO 150 up against ANYTHING AT ALL—from "peanut butter and jelly," up to "the high-priced spread." The only cables you'll find that are any better are XLO's own higher priced models.

XLO really *IS* "The Best in the World!"

**Visit your authorized
XLO/PRO dealer today!**

XLO/PRO

9480 Utica Street, Suite 612
Rancho Cucamonga, CA 91730
Phone (909) 466-0382
FAX (909) 466-3662

32 cents FREE!

Mail in this completed coupon, and we'll send you our latest XLO/PRO literature and a GENUINE U.S. GOVERNMENT 32 CENT STAMP!

Name _____

Address _____

Telephone _____

Only one coupon may be redeemed per customer. Offer is not valid outside the continental United States, and expires December 31, 1995.

like these are so expensive, look inside. You'll find electronic luxury, laid out in a form that might easily qualify these units for installation in an art museum.

In terms of key features, the No. 31 transport is a highly automated top-loading device that has virtually all of the programming features known to man, excellent vibration isolation and damping, and outstanding decoding, laser-servo, and power-supply technology. Equally important, it has very advanced output circuitry, providing AES/EBU (XLR), S/P DIF coaxial (RCA), and ST (optical-fiber) outputs. You get full remote control plus the ability to link the No. 31's control and display features to other Mark Levinson components.

The No. 30.5 D/A converter is an upgrade of the No. 30, which has been recognized as one of the three or four best converters at any price. (Leonard Feldman and I reviewed it in the January 1993 issue.) The No. 30.5 preserves the No. 30's outstanding power-supply technology and the discrete audio circuitry in the "towers" on each side of the unit. After extensive comparative listening tests, Mark Levinson also decided to retain the proprietary dual, balanced UltraAnalog 20-bit DACs used in the No. 30.

Most of the digital technology in the center of the No. 30, however, has changed. For \$15,950 (or for only \$3,000 if you have a No. 30 to upgrade), you get one four-layer p.c. board, which replaces three separate digital circuit boards in the previous model. The new circuitry has much shorter routing, and elements that can provide up to 24-bit resolution. The 30.5 has substantially less internal jitter and is much less sensitive to the jitter from an external CD transport or digital tape deck.

The 25-MHz pulse transformers in the No. 30 have been upgraded to 125 MHz, to provide greatly improved time resolution. The record and monitor digital outputs are now driven by low-skew RS-485 chips to improve the symmetry of the leading and trailing edges of a digital signal—which improves compatibility with all types of digital recorders as well as the sound quality of digital tapes made with the 30.5. The selected differential signal is sent to a Crystal digital interface receiver (DIR) for decoding. After decoding, the signal is sent to a microprocessor-controlled NPC5842 dig-

ital filter that has a 24-bit throughput capability, instead of to a filter limited to an 18-bit word length. Regeneration of the sample clock uses far more sophisticated circuitry, based on a DSP-controlled FIFO (first in, first out) data buffer that incorporates custom-made, voltage-controlled oscillators operating at reference frequencies of 256 times the sample frequencies. This feature allows the No. 30.5 to reclock in ways that are far less sensitive to the input from a given CD transport, DAT deck, or LaserDisc player. The No. 30.5 can adjust itself in seconds to the long-term clock rate of given discs, and can suppress incoming jitter to the 20-pS level or better. It is also now far easier to reprogram the name shown on the display for each input.

**TO SEE WHY
THESE COMPONENTS
ARE SO EXPENSIVE,
JUST LOOK INSIDE THEM.**

One of the discoveries I remake often in reviewing high-end equipment is how much the state of the art can advance in even the best equipment. This is definitely the case in comparing the No. 30.5 to its predecessor, the No. 30. When I auditioned the earlier D/A converter, I thought it was superb but that its upper octave clarity and transparency were provided at the cost of a bit of dynamic life, midrange warmth, and lower octave energy. The changes in the No. 30.5's digital circuitry have improved on the strengths of the No. 30 and corrected virtually all of its weaknesses. Low-level definition and upper octave clarity and transparency in the No. 30.5 are even better than they were in the No. 30, which I had regarded as providing the best low-level definition and transparency I'd ever heard. The No. 30.5 is also significantly more dynamic, and this added dynamic life gives its midrange better balance and warmth. Although its deep bass energy may not be quite as strong as that in my reference units, Krell's Reference 64 and Theta Digital's DS Pro Generation V, the No. 30.5's deep bass definition is superb. The deep bass is so good and so musically

natural that even bassaholics are unlikely to register a complaint.

The more I listened to the 30.5, the more I became convinced that it provides more upper octave resolution and detail than any other D/A converter I have ever heard. This purity and transparency were particularly apparent with the No. 31 transport, and some synergy exists between the two units. To be frank, this synergy was limited, and varied from disc to disc. The sound of the No. 30.5 is normally only slightly better when it's used with the No. 31 than when it's used with another transport, such as PS Audio's Lambda (\$1,795). I also was struck by the fact that the Mark Levinson No. 30.5 has the ability to provide this purity and transparency without affecting the life and warmth of the music. Do not misunderstand: This component will not add life or warmth to close-miked recordings, it will not change steel strings into gut, it will not add depth to a shallow soundstage or studio recording, and it will not age a modern concert hall by a century. The No. 30.5, however, does not have the slight trace of leanness that was a problem in the No. 30, and the dynamics are excellent.

You hear sound that makes low-level dynamics seem to rise out of total silence, without a hint of vague electronic haze. The 30.5 then offers similar accuracy at every higher level of musical dynamics, always providing the same natural dynamic energy in the bass and lower midrange that it does in the upper midrange and treble. No converter or converter/transport combination I have yet heard does quite so good a job of convincing you that you are hearing all of the detail on the recording. This is as true with naturally recorded DAT masters as it is with CDs. Further, the 30.5 has a striking ability to open up and sweeten the sound of older CDs and of CDs that seem to have closed or congested sound even on other top-quality converters—and it does this without rolling off or blurring the highs. As a chamber music fan, I am often struck by the fact that some older CDs seem to lack the openness or air of their analog equivalents, and that some current CDs still seem to have problems with groups of string instruments or even small choral voices. As a former (and truly awful) drummer, I am often struck by how

Continued on page 82

Satellite and Subwoofer Speakers: The "Overnight Success" of the '90s.

Overnight, it seems, virtually everyone has discovered the advantages of the satellite-subwoofer speaker concept—*especially* for use in the home theater.

1994 marks M&K Sound's *twentieth year* at the forefront of this technology. After two decades of developing and refining this concept, we are flattered to see satellite and subwoofer speaker systems become

the dominant choice for the multichannel home theater.

M&K speakers have been found in Hollywood screening rooms (the earliest home theaters) since the 1970s.

Long acknowledged as the deep-bass specialists, we've also been pioneers in direct-to-disc and digital audiophile recording with our RealTime Records label—the first U.S. label to release compact discs.



MX-100
Powered Subwoofer

T W E N T I E T H

1 9 7 4 M & K 1 9 9 4

A N N I V E R S A R Y

S-1C Satellite
Speaker



We celebrate our twentieth anniversary by introducing the new M&K S-1C.

This *first Push-Pull Dual-Driver* Satellite speaker exceeds the superb musicality of its legendary predecessors, thanks to M&K's unique Transmission-Line tweeter and several other significant improvements.

Combine the S-1C with an M&K MX-series Deep Bass Powered Subwoofer to cre-

ate a *high-performance, flexible* system that can be optimized for both two-channel music and multichannel film and music reproduction.

With six Satellite and thirteen Powered Subwoofer speaker models, M&K gives you the widest selection in the industry.

Choose M&K and discover what twenty years of cutting-edge expertise can bring to your listening experience.

MILLER & KREISEL
SOUND CORPORATION

10391 Jefferson Boulevard
Culver City, California 90232
310 204-2854, FAX: 202-8782

CAMBRIDGE SOUNDWORKS BY HENRY KLOSS SPEAKER SYSTEM



Cambridge SoundWorks' initial advertisements and promotional materials featured pictures of Henry Kloss, the engineer responsible for the many loudspeaker products offered by the company. I first met Henry years ago, when KLH was introducing the Model Six at the New York Hi-Fi show; I tried to take his picture, and like most engineers, he was very reticent. I'm sure that he still prefers to remain behind the

scenes doing what he does best—creating exceptional loudspeakers. But Henry is a member of the Audio Hall of Fame because of the many classic loudspeaker systems he designed, and he should take a few bows. He engineered the original Acoustic Research AR-1 based on ideas by Edgar Villchur. He co-founded KLH with Malcolm Low and Anton Hoffman, and designed the classic KLH Model Six and other excellent products. Later, at Advent, he designed the Advent Loudspeaker, which is probably the best-selling loudspeaker of all time. Henry has always seemed to be able to get the most out of small, and even tiny,

Company Address: 311
Needham St., Newton, Mass.
02164.
For literature, circle No. 95

loudspeakers. I still have a tiny, full-range loudspeaker driver from a KLH Model 8 FM radio that Henry designed back in the 1960s; it's a classic.

When Henry Kloss designs a loudspeaker system, he is always able to achieve the seemingly impossible; the Cambridge *SoundWorks* by Henry Kloss is no exception. The *SoundWorks* is a three-piece, full-range, self-powered system with two 3½-inch cube satellites and a woofer that measures 8 x 5 x 9½ inches. It is designed to be used with CD and cassette players, computers, and other components that have an output level control.

The 4-inch woofer driver is loaded on one side by a sealed chamber and on the other side by a ported chamber; the bass is produced from the port on one end of the cabinet. The control panel, below the port, has a power switch, a pilot light, a 12-V d.c. input jack, a stereo mini-jack input, a bass level control, and push terminals for the wires that feed the signal to the satellite speakers.

The three power amplifiers, which are inside the woofer cabinet, include equalizers and crossover filters. With music signals, the woofer amplifier is able to produce about 33 watts, and the two satellite amplifiers can produce about 8.5 watts each. The *SoundWorks* system can be operated from a 12-V battery as well as from a normal 120-V a.c. power line. The crossover between the woofer and the satellites is at about 180 Hz.

The nine-page manual has a lot of good information, but it doesn't specify what sound pressure level you can expect for a given input voltage. I made a number of measurements on the *SoundWorks* system, and the sensitivity was about 84 dB SPL at 1 meter with a 100-mV input. This is more than adequate for the intended use of the system. You can adjust the amount of bass with the level control on the woofer control panel; it was never necessary

Photo: Michael Groen

EMOTION

There are many loudspeakers available that do a credible job of reproducing sound. Few, however, are faithful to music's inherent emotional character — to the human qualities of music which make it much more than just an ordered progression of sounds.

The Hales Design Group research and development program extends beyond the plans and specifications of ordinary engineering into another dimension — into the realm of musical expression and human feelings.

As a result, the introduction of the Concept Three has stunned the industry by setting a new standard for musical accuracy.

Visit the finest audio retailer in your area to audition these exceptional new loudspeakers.



...the new reference for sonic realism.

HALES DESIGN GROUP

16812 Gothard Street Huntington Beach, California 92647
Voice: 714 841 6884 Fax: 714 841 2427

© 1994 HALES DESIGN GROUP. ALL RIGHTS RESERVED.

some equations are simple.  KIMBERKABLE

2752 south 1900 west • Ogden UT • 84401 • 801.621.5530



TM

The above logos and combinations are trademarks of K&B Industrial © K&B Industrial 1994

for me to turn it full up during my evaluation of the system.

The maximum output of the woofer is at 75 Hz; I measured about 3% second harmonic distortion at 90 dB SPL with the microphone at 1 meter and the woofer cabinet on a shelf against a wall. You can expect more output when you place the woofer on the floor and near a wall, as the manual recommends.

The manual also suggests that, because of their treble characteristics, you should aim the satellites straight out or even away from your listening position. I agree; I measured a rising high-frequency response with the microphone directly in front of a satellite and an almost flat response at 45° off the axis.

After I finished testing the *SoundWorks* system in my lab, I moved it to my office and used it with a CD player, a portable radio, a TV, and a computer. The satellite speakers are magnetically shielded, so they won't distort a video image. Also, they are so light that they can be attached to the sides of a television or computer screen with Velcro strips. If you use the satellites this way, I suggest that you tilt them up at a 45° angle.

I listened to the *SoundWorks* speaker system with a Turtle Beach sound card in my computer, and it sounded very good. The sounds that had been held prisoner by the speakers inside the portable radio and the television were really amazing. Although I didn't conduct a formal evaluation with a listening panel, as is my usual practice when I report about products, I did ask some people to listen to the *SoundWorks* system while I played *Schemes and Dreams* by Pat Coil (Sheffield Lab 10042-2-F) and *Angelic Voices* by The Daughters of Mary (Renaissance Endeavors CD-102; phone, 800/747-7486). Everyone who listened agreed that the sound was exceptionally good.

Because *SoundWorks* by Henry Kloss is sold directly by Cambridge SoundWorks, it probably should be compared to loudspeaker systems that cost about \$300; even then, it more than adequately holds its own. Considering that it costs only \$199, has a 30-day money-back guarantee, and sounds terrific, I can recommend it highly. Congratulations, Henry, you've done it again!

Edward M. Long

LEVINSON, *continued from page 78*

unnatural the cymbal can be on many CDs; as a Bach fan, I am struck by the continuing problems I hear in harpsichord recordings.

The Mark Levinson 30.5 and 31 do not, of course, perform magic. A bad recording is still usually a bad recording, and no high-end component ever made can salvage a bad performance. Yet the 30.5 does improve many mediocre-sounding CDs that have good or great performances to the point where you can really enjoy them. If you love music (particularly acoustic music) as much as you love sound, and if you really care as much or more about the performance as you do about the recording, then audition the 30.5 not just with good recordings but also with a range of seemingly ordinary or mediocre ones.

Nonetheless, I do not want to exaggerate the extra level of clarity and transparency the Mark Levinson No. 30.5 and No. 31 can provide, or give the impression they do not have competitors. Theta Digital's DS Pro Generation V comes very close to the 30.5, at about one-third the price. Krell's Reference 64, which rivals the 30.5 in price, comes closer still and almost rivals it in terms of sheer detail. The Mark Levinson and Krell are also typical in illustrating the kind of nuances that distinguish top converters. The Krell has a more mid-hall sound than the Levinson, with slightly less dynamic energy but more space and depth.

The answer to "Who's on first?" is something I prefer to leave to Abbott and Costello. I obviously have not heard every top-of-the-line D/A converter, and further improvements will almost certainly have been made in competing transports and converters by the time this review appears. However, if you are truly seeking the best in digital sound and are seeking pure accuracy rather than some particular kind of euphonic coloration, I doubt that you will find a better combination than the Mark Levinson 30.5 and 31. These components make a statement about just how good the high end can get. Yes, you pay a lot to go from mere excellence to the state of the art. Yet if you are a true high-end perfectionist, then you really must audition the Mark Levinson No. 30.5 D/A converter and No. 31 CD transport. They are a true reference standard.

Anthony H. Cordesman

TOM JUNG
ON
WESTLAKE
AUDIO

"BBSM SERIES MONITORS ARE MY REFERENCE"

"For the past 12 years, I have been changing speakers like changing shorts...in search of a sound that is both accurate and relates to the real world. I am now on my fourth pair of BBSM-6's and each new generation of the BBSM series represents a marked improvement in sound from the previous generation. Westlake has expanded on a solid foundation of engineering to offer real world improvements in the sound of their products."

— Tom Jung

"ES. While I still change my shorts every day, I haven't changed speakers in almost a year."

Founded in 1971, Westlake Audio strives to offer the most accurate reproduction of the source recording as currently possible and to research methods of improving this technology for future generations of products. For serious music lovers who value the quality of well recorded music, Westlake Audio offers a number of monitor loudspeakers to suit your individual needs and listening environments.

CHUCK LOEB
simple things

Under the direction of producer/engineer Tom Jung, DMP is the first Jazz label to digitally record music using 20-bit technology. This new advancement produces far more musical accuracy than conventional 16-bit recorders thus creating a compact disc with higher resolution, wider dynamic range, and lower distortion.

Chicago:
The Sound Lab
(708) 776-8888

Synthesis A/V
(312) 644-2142

Los Angeles:
Royal Sound
(213) 733-3400

New York:
Esoteric Sound Systems
(516) 689-7444

San Francisco:
Pro Home Systems
(510) 654-6630

**Westlake
Audio**

CLASSICAL RECORDINGS

bounce

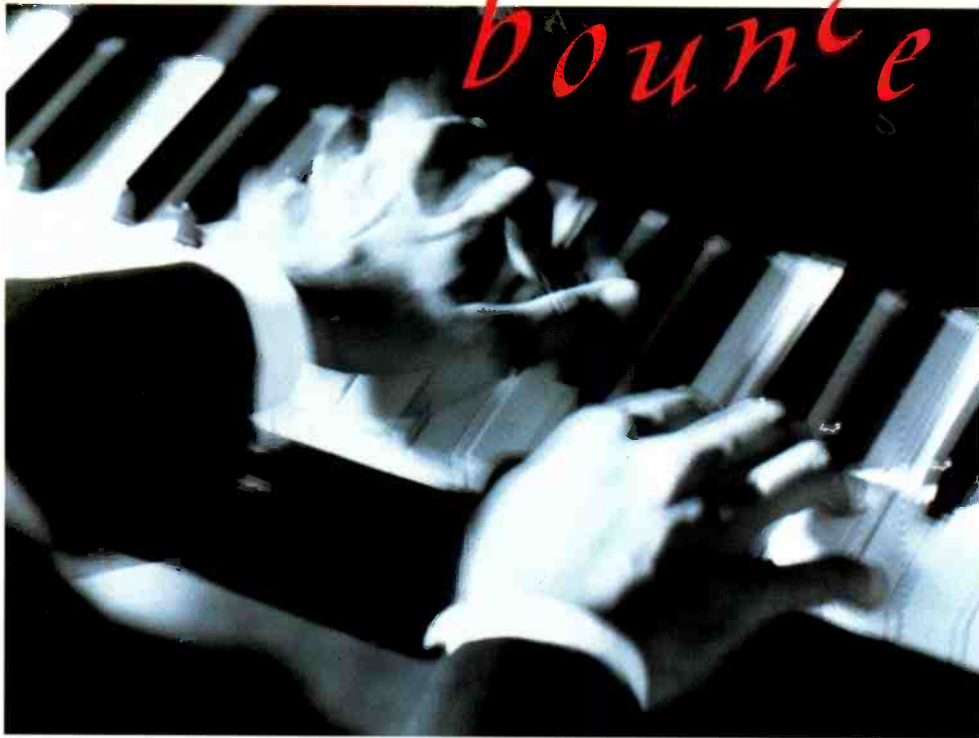

Tod Machover: *Bounce*; *Chansons d'Amour*

Robert Shannon, Yamaha Disklavier,
grand piano, computer,
synthesizers, et al.

BRIDGE BCD 9040, CD; 55:01

Here's an incredibly forceful and dissonant contemporary composer for piano (Machover) and another steely fingered young pianist (Shannon). The Bridge CD label has them galore. I took one look and then made a point of listening straight through without first reading the booklet notes—after all, direct audio impact is still what counts. Let me tell you, it took all my ear tolerance to survive, at least in the extremely loud and dissonant parts. Poor piano! I began with the “Chansons d’Amour,” composed way back in 1982. My CD player, now in respectable middle age, also had trouble with the unbelievably strong sound; it constantly repeated short segments, which didn’t help my understanding at all. But the music is more than interesting; it is overwhelming. On first play, I particularly

liked the long, quiet middle segment, and so did my player—not a single glitch. After an ear rest (for quite a while), I played the same all over again, and this time both the player and I went right through, unscathed. It’s such strong music that it knocks your teeth out.

Only then did I get to the more recent composition, “Bounce,” from 10 years later and full of electronic ad-

vancements. It’s more ingenious, but I like the earlier piece, “Chansons,” better. “Bounce” has too many stunts (designed, as always, to show what can be done), but it has its moments, even so.

Both pieces are played on the Disklavier for this recording. This, as some readers know, is a sophisticated electronic “player piano” system, taking down everything the pianist does, probably a lot more accurately than the systems of the early century. The music is played live, but two interesting quirks may intrigue audio people. First, the “takes” for “Bounce” were edited not from the recording but from the Disklavier playback data on the same piano, with the composer and the pianist present. For “Chansons,” a difficult passage was played into the Disklavier at half speed, played back full speed, recorded, and edited into the whole. These engineers and musicians know what’s what.

“Bounce,” the less serious work, may be a bit affected and contrived, but it’s fun. This one is full of other sounds as well as piano (the same Yamaha plus a second MIDI keyboard and all manner of connected audio generators). I was caught red-handed, for instance, when a long, tinkly high-note passage seemed to me to be faultily recorded, with too much piano-action noise, the tap-tap of the mechanical action. Imagine my surprise when the piano sound stopped but the tapping went right on! Have to watch your step in this kind of review.

Because of all this, I do recommend the CD to just about anybody with some listening enterprise and curiosity—but *don’t* try it for background music.

Edward Tatnall Canby

CHOPIN

Piano Trio, Op. 8; Cello Sonata, Op. 65; Polonaise Brillante, Op. 3

Pamela Frank, violin; Yo-Yo Ma,
cello; Emanuel Ax, piano;
Eva Osinska, piano (on piano-only
version of the Polonaise)

SONY CLASSICAL SK 53 112
CD; 72:26

Anyone who admires the playing of Yo-Yo Ma will want this CD. It is his show from the outset, though the music is not what you’d think of as his repertoire. The trio is

a lovely piece, the sonata perhaps a bit more of a vehicle, and Ma makes the most of every note. But for sheer panache, the Polonaise is the show-stopper. A recently discovered piano-only version of the Polonaise, played by Eva Osinska, is included here for reference; as good as her



playing is, she sounds pallid compared to Ma’s verve and swagger. Sound is up close and personal.

Robert Long

ORIGINAL MASTER RECORDING™



UJCD 617

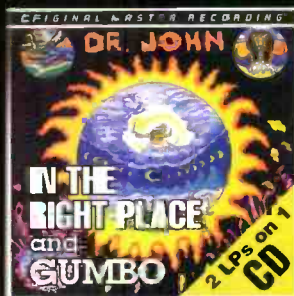

UJCD 619

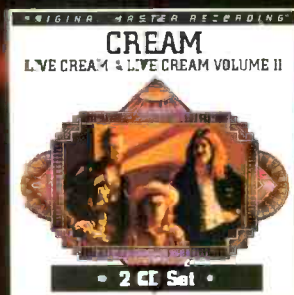

UJCD 2-625

ULTRADISC II™
— The GAIN System —

Nature's Encore

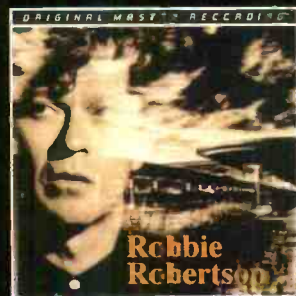

UJCD 618

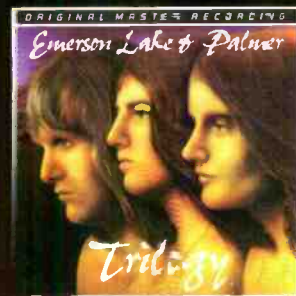

UJCD 621

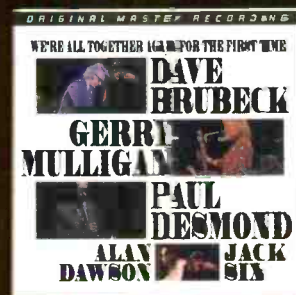

UJCD 627



NEW RELEASE UJCD 620



NEW RELEASE UJCD 623

BETTER SOUNDING MUSIC Your favorite artists sound surprisingly better on Ultradisc II™. Why? Because Mobile Fidelity's mastering technology is a cut above — and you can hear the difference on every CD we produce. As the creators of the 24k gold audiophile CD, we have worked with the most advanced minds in high-end audio on major advances such as The GAIN System™, a proprietary mastering system that utilizes the highest grade of digital technology available. Starting with the original master tapes, we are able to capture every last nuance of the original recording. What does this mean? You'll hear things you never heard before. Upgrade to Ultradisc II™.

Ultradisc II™ — The ORIGINAL 24K Gold Audiophile Compact Disc.
CALL TOLL-FREE (800) 423-5759 FOR A FREE COLOR CATALOG

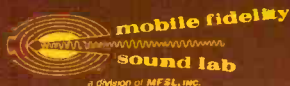

105 Morris Street • Sebastopol, CA 95472 • 800-423-5759
Contact us for in-depth technical information: email: mofi@mofi.ccr.
Internet resource center on WWW/Mosaic

The VT150 Special Edition.



"...I felt I was hearing the music itself."

"This Audio Research is unquestionably the best yet...

It had the classic Audio Research 'High Definition' sound, highly revealing and satisfyingly detailed, all this seemingly achieved without effort...

This is a reference-grade result, and is strengthened by the very fine balance of all the sonic aspects which together determine a musically satisfying performance...

It set a new standard for amplifiers combining the purity and grace of the vacuum tube with the precision and

constancy of the solid state. The VT 150 is a tour de force for William Z. Johnson..."

By Martin Colloms
Reprinted from
HI-FI NEWS & RECORD REVIEW
February 1994

"The VT 150s presented an astonishingly believable and natural rendering of timbre. Instead of hearing a hi-fi representation of the music, I felt I was hearing the music itself..."

The VT 150 is, without question, the best power amplifier I've heard... The VT 150s went far beyond any descriptions of sonic qualities. Instead, they were truly

transcendental, bringing me so much closer to my favorite music than I thought could be achieved by changing power amplifiers...

The bottom line is that I've enjoyed music more through the LS5 and VT 150s than with any other electronics I've had in my system. In fact, nothing else has ever come close. The VT 150s provided the kind of experience that must be experienced firsthand to be believed."

By Robert Hartley
Reprinted from
STEREOPHILE
Vol. 17, No. 18, August 1994

audio research
HIGH DEFINITION®

5740 Green Circle Drive / Minnetonka, Minnesota 55343-4424 / Phone: 612-939-0600 FAX: 612-939-0604

Enter No. 3 on Reader Service Card

**Rachmaninoff: Sonata No. 2
in B Flat Minor, Op. 36;
Concerto No. 3 in D Minor, Op. 30**
*John Lill, piano; BBC National Orchestra
of Wales, Tadaaki Otaka*
NIMBUS NI 5348, CD; DDD; 71:53

Van Cliburn's winning the first prize in Moscow's 1958 inaugural International Tchaikovsky Competition galvanized a horde of young pianists from everywhere, who hoped to emulate that coup. A dozen years later, England's John Lill did just that. He first played this concerto at the age of 18, so he has his conception of it thoroughly worked out.

This CD's appeal derives predominantly from the unusual coupling of these two works, both big, expansive, even sprawling examples of Russian musical Romanticism at its most nakedly emotional. Lill combines blazing virtuosity with musical sensitivity, and in the concerto, Tadaaki Otaka and his band give him excellent support. The unnamed producer has provided needle-sharp sound.

Paul Moor

**Górecki: String Quartets, Nos. 1 and
2; Sonata for Two Violins; Genesis 1**
The Silesian String Quartet
OLYMPIA OCD 375, CD; 74:19

Henryk Górecki catapulted into the consciousness of American music lovers with David Zinman and the London Sinfonietta's recording of the Third Symphony, sung by Dawn Upshaw. But in his native Poland, Górecki had long been considered more or less on a celebrity par with his contemporary and compatriot Krzysztof Penderecki. This disc strides across Górecki's career, sampling as it goes. All of the music it contains is pungent and arresting. Some of it may mystify on first hearing, but if you're willing to surrender yourself to its rhythms and its insistent dissonances, you can easily discover its true eloquence.

The Sonata for Two Violins is a very early piece that, even ignoring the scoring, inevitably suggests the Bartók of the violin duos. "Genesis" is a tripartite piece for strings, also quite early, whose opening section, *Elementi per tre Archi*, is recorded here. It is scored for violin, viola, and cello, and its air-raid-siren glissandos and squeaking-hinge bowings make it the uncanniest work of the lot. The First String Quartet brings us to 1988 and a Górecki involved with rhythm and traditional Polish music (a perennial interest of his). The Second String Quartet, of 1991,

runs a gamut from tenderness to fervor in what is the most beautiful music here.

That brings us to the sound. This is a Polish studio recording with a large amount of what I take to be artificial reverb. The feeling it projects is extremely effective but hardly suggests how any string quartet of my acquaintance sounds in a normal venue for chamber music. At times the effect is that of a string orchestra; at others, Górecki's radical sonorities almost persuade the ear that a synthesizer is at work. Make no mistake: The reverb doesn't so much blur the music as place it in an almost lurid spotlight. The end result is exciting, though in more conventional music I'd question its taste.

How accurately the sound or the playing by the Silesian String Quartet reflects the intentions of Górecki, I'm at a loss to assess. Founded almost 20 years ago, the Silesian is no stranger to international festivals and awards, and its security and virtuosity are much in evidence throughout the recording. Perhaps this superheated hyper-reality is just what Górecki wanted; if so, any live performance of these pieces is bound to disappoint both him and us.

Robert Long

**Grainger: Country Gardens; Bridal
Lullaby; Handel in the Strand;
other piano selections**

Martin Jones, piano
NIMBUS NI 7703, CD; DDD; 78:05

Mother Nature apparently broke the mold after Percy Grainger (1882 to 1961) surfaced in Australia. His virtuoso championship of his Norwegian buddy Edvard Grieg's new piano concerto enabled it, and Grainger, to conquer the world. He frequently arrived at hotels sweaty, dirty, and clad in shorts and boots, having hiked all the way from his preceding gig. He had a passionate love for, and an encyclopedic knowledge of, British folk music, and he made some superb arrangements of it—including several in this nosegay of Graingeriana.

Martin Jones has technique to spare, with the result that it sometimes, in less pretentious numbers, gets in his own way: Old Handel here doesn't stroll down the strand so much as he canters. One unexpected high point: Probably the best piano arrangement ever of what the rest of the world has come to call the Londonderry Air; it's meltingly beautiful, sensitively played, and, like all this assortment, splendidly recorded.

Paul Moor

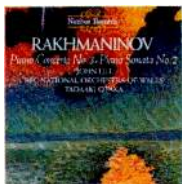



CRUTCHFIELD
FALL 1986
SURROUND SOUND
You Won't Believe
the Difference!
FREE Video Guide to
Home Theater!

Free Expert Advice - Low Discount Prices
Car Stereo • Home Audio • Video • Telephones • Computers

FREE Stereo Catalog

- Convenient shopping — over 100 full-color pages covering hundreds of the latest stereos for your home and car, plus video and telephones
- Quality you can count on — Sony, Kenwood, Pioneer, JVC, Carver, Polk, Advent, Infinity, Bose, NHT, Panasonic, Mitsubishi, and more
- The information you need — including product descriptions, consumer tips, specifications, and our exclusive comparison charts
- There's no other catalog like it! Get yours on its way to you today

Call Now!

1-800-955-9009

8 a.m. to Midnight (Eastern time), 7 days a week
or mail this coupon

Name _____

Address _____ Apt. # _____

City _____

State _____ Zip _____

CRUTCHFIELD
1 Crutchfield Park, Dept. AU, Charlottesville, VA 22906

JAZZ ~ BLUES RECORDINGS

Clapton & Hackett



One young guitarist who early jumped on the British blues bandwagon was Steve Hackett, beginning his career by playing raucous, honking blues harmonica before joining an early incarnation of Genesis and then meandering far down the progressive-rock trail. Both Clapton and Hackett address their own roots on their latest releases.

Clapton's *From the Cradle* marks a riveting return to guitar-hero status. He cuts loose with a vengeance on 16 blues classics, recalling the mighty chops he unleashed nearly 30 years ago on *Blues Breakers*. B.B. King's early recordings (mid-to-late '50s on the Ace, Modern, and Kent labels) are an obvious point of reference on tunes like "Third Degree" and "I'm Tore Down," while on "Someday After a While" he screams and flings around, à la Buddy Guy. "Hoochie Coochie Man" is suitably gruff and ragged, thanks to former Muddy Waters harpist Jerry Portnoy and drummer Jim Keltner's sloppy-loose Chicago shuffle. And on "Five Long Years," Clapton kicks into overdrive with a warm distortion tone that is

work for the Stevie Ray Vaughans and Gary Moores to come.

Clapton Photograph: Ken Settle

From the Cradle Eric Clapton

REPRISE 45735-2, 60:10
Sound: A, Performance: A+

Blues with a Feeling Steve Hackett

PERMANENT CD 27, 46:37
Sound: B+, Performance: B+

Eric Clapton almost single-handedly defined the 1960s British blues movement with his passionate playing on John Mayall's 1966 landmark, *Blues Breakers*. Simultaneously, back in the States, bands like The Paul Butterfield Blues Band, Canned Heat, and The Blues Project were exploring similar territory—emulating the rawness of Southside Chicago blues—with equal conviction. It was the birth of "white boy blues," laying the ground-

Blues Breakers

John Mayall *viva* Eric Clapton
MOBILE FIDELITY UCCD 616, 37:30
Sound: A, Performance: A+

When the authenticity of British blues was called into question—which was often—its saving grace was and remains Eric Clapton. During the movement's mid-1950s heyday, E.C. was the anomalous white English kid who played electric guitar with the soul of a black Chicago bluesman. He was "bitten by the bug," while so many of his counterparts wallowed in "hack" status as chintzy Anglo imitators of everything they absorbed from the great Chess Records catalog.

And on *Blues Breakers*, a record that's considered John Mayall's, it's

Clapton who outshines the other participants. He's clearly a future demigod securing his place in rock guitar, as well as in rock 'n' roll history.

Mobile Fidelity's gold CD reissue of *Blues Breakers* is currently the only complete edition of the album available domestically in any format. While some of this material exists on a Mayall compilation titled *London Blues* (part of PolyGram's Chronicles series), Mo-Fi's release is better if only for its remastering and sonics: Spacious, warm, and clear, where previous issues sound harsh and lacking in detail.

Mike Bieber



The Experience

"I'm particular."

While engineering recordings for many clients, among them the Chicago and St. Louis Symphonies, I heard of Martin-Logan's special electrostatic precision and clarity from several of my colleagues. So, I installed a pair in my studio.

What happened next was amazing. Every change in the recording process became apparent. Details of space in the hall, microphone placement and even converter qualities were instantly perceived. Yet, the superior dispersion of their curvilinear transducer allowed remarkably easy room placement, even in my studio.

After using Martin-Logan products for years, I am excited to introduce the new advanced SL3, shattering industry standards yet again.

What else can I say?

Go to your local dealer and audition the new SL3.

Be prepared for the experience.

SLTM 3

\$3,200.00 US/pr

Following is a sampling of Larry's works:
WFMT Fine Arts Network weekly broadcast of the Chicago Symphony Orchestra, Erato, RCA/BMG, CBS/Sony, Koss Classics, Marco Polo, New World, Crystal, Peregrine, Pro Arte, Summit, Centaur, Orfeo, Musical Heritage Society.



Lawrence L. Rock

MARTIN LOGAN
THE ELECTROSTATIC TECHNOLOGY

p.o. box 707, lawrence, ks 66044, tel (913) 749-0133, fax (913) 749-5320

At Last.

A women's magazine that clears up life's real mysteries.

Like the secret language of mechanics, plumbers and brokers. Why, in some places of business, women still get in trouble for wearing the pants. And how to master the etiquette of interacting on-line.

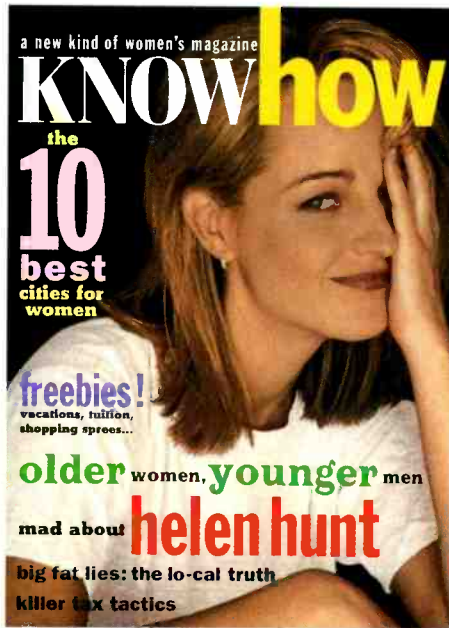

KNOWhow

ON SALE NOW

A new kind of women's magazine.

Copyright ©1994 by Hachette Filipacchi Magazines, Inc.

reminiscent of his work on "Strange Brew" from Cream's seminal *Disraeli Gears*.

Two acoustic numbers, Leroy Carr's "How Long Blues" and Charles Brown's "Driftin'," sound like holdovers from Clapton's *Unplugged* project. And Willie Dixon's "Groaning the Blues" is a guitaristic tour de force for Slowhand.

The sound and overall vibe of *From the Cradle* could be called authentic, although "authentic copy" might be a more accurate description. As convincing and full of emotion as Clapton's hoarse vocals are, some listeners will have a hard time believing that this British millionaire ever had a job in a steel mill "shuckin' steel like a slave." While his guitar playing is often transcendent, his singing, particularly on "Blues Before Sunrise" and "It Hurts Me Too," smacks of affectation rather than authenticity.

Hackett, on the other hand, does not attempt to re-create the phrasing, enunciation, and ambience of classic blues recordings. His interpretations of Little Walter's "Blues with a Feeling," Nick Gravenites' "Born in Chicago," and Freddie King's instrumental "The Stumble," as well as his vocal delivery in general, are more honest than authentic; there's no uncanny mimicry involved here. Rather than wail in Muddy-esque "Got mah mojo woikin' but it jes don' woik on you," Hackett is more likely to express it thusly: "My mojo is in an operable condition, but its efficacy has yet to be demonstrated upon you." His own tunes, notably "Love of Another Kind" and "Way Down South," are imbued with blues feeling yet remain refreshingly original.

On harmonica, the former Genesis guitarist does honk convincingly in a dirty style that recalls Paul Butterfield, though he takes an uncommonly lyrical turn on his minor-key ballad "A Blue Part of Town." As Hackett so ably demonstrates on two biting instrumental showcases, "Footloose" and "The 13th Floor," his guitar playing acknowledges the roots of electric blues while also touching on some of the dazzling technical facility and distortion tones that are a standard part of rock guitar today.

While blues purists will undoubtedly dig Clapton's heartfelt homage to his heroes, they probably won't be able to deal with the hard-rocking nature of Hackett's *Blues with a Feeling*, which has more in common with Gary Moore than vintage B.B. or Muddy.

Bill Milkowski

FACTORY AUTHORIZED

- AD&S • Advent • Audio Control
- Aiwa • AKG • Altec Lansing
- Audio Quest • Acoustic Research
- Audio Source • Atlantic Technology
- B&K • B&O • B&W • Bazooka
- BBE • Beyerdynamics • Bellogetti
- Brother • Canon • Carver • Cerwin Vega • Celestion • Cliff Designs
- Canton • Code Alarm • CWD
- Denon • Dynamat • Grado • Hafler
- Harmon/Kardon • Hitachi • Hughes
- Infinity • Jamo • JBL • JVC
- K40 • Koss • Lexicon • Luxman
- M&K • Mitsubishi • Monitor Audio
- Monster Cable • Niles • OmniMount
- Orion • Panasonic • Philips
- Pinnacle • Pioneer • Panamax
- PDI • Proscan • PS Audio • Rane
- Rockford Fosgate • Runco
- Soundcraftsmen • Soundstream
- Senheiser • Sherwood • Sharp
- Sony • Sonance • SSI • Stewart
- Target • Technics • Terk • Thorens
- Triad & More!

SPECIAL OF THE MONTH

Hafler FACTORY AUTHORIZED CLOSEOUT

<p>Hafler 915 17" Preamplifier Orig \$750 <ul style="list-style-type: none"> • Pure class A all discrete • CMOSFET and relay switching • A high power transformer and extra large filter capacitance • 5 Line inputs and 1 tape input • 4 Switched outlets and one unswitched outlet \$497</p>	<p>Hafler 945 Preamplifier/Tuner Orig \$750 <ul style="list-style-type: none"> • Defeatable tone controls • Remote controlled • Multiplex filters eliminate (19kHz) pilot signal artifacts • Video switching • 3 Switched outlets and one unswitched outlets • Fully double balanced mixer • 5 Line inputs and two tape inputs • 18 Tuner presets \$497</p>
<p>Hafler 9130 Power Amplifier Orig \$480 <ul style="list-style-type: none"> • 85W per channel stereo amplifier • Bridgeable to 150 watts • Self limiting lateral MOSFET output • Front panel level controls • Universal 100-240 volt line transformer \$297</p>	<p>Hafler 9180 MOSFET Stereo Power Amp Orig \$750 <ul style="list-style-type: none"> • 105W per channel stereo amp • Bridgeable to 300W into 8 ohms • Employs 8 self-limiting lateral MOSFET output devices \$477</p>
<p>Hafler 9290 MOSFET Stereo Power Amp Orig \$900 <ul style="list-style-type: none"> • 145 Watts per channel 8 ohms • Bridgeable to 420 watts mono • Front panel gain controls • Mono/stereo switching • Thermal protection \$677</p>	<p>Hafler 9300THX THX MOSFET Power Amp <ul style="list-style-type: none"> • 150W/ch per channel stereo amp • Bridgeable to 450W into 8 ohms • Utilizes 15,000 UF 75V low ESR storage capacitors LIMITED QUANTITIES</p>

The Original **Sound CITY** Since 1986

201-838-9100
 Mail Order Hours: Mon-Fri 9-9 Sat 9-6
 Meadtown Shopping Center
 Rt 23 S. Kinnelon, NJ 07405
 SC#AU395 FREE CATALOG
 1-800-542-7283



AUDIO/MARCH 1995

The Sweet Sound of Vinyl is Back!

- Original Generation Master Tape Source
- Half-Speed Mastered with The GAIN System™
- Specially Plated and Pressed on 200 grams of High Definition Vinyl
- Dust Free - Static Free Rice Paper Inner Sleeves
- Special Protective Board
- Heavy Duty Protective Packaging
- Super-FI Super Stars Limited Edition

LISTEN...



MFSL 1-201



MFSL 1-215

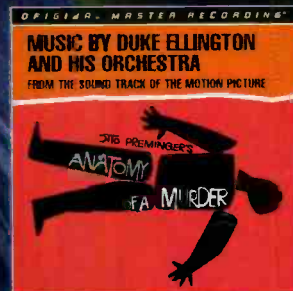

MFSL 1-214

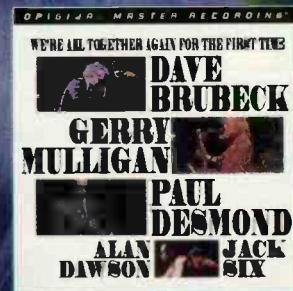

MFSL 1-216



NEW RELEASE MFSL 1-213



NEW RELEASE MFSL 1-217



The Tradition Continues at Mobile Fidelity Sound Lab.

Also available on Anadisq: Jean Michel Jarre • Getz/Gilberto • John Hiatt • MJQ • Alan Parsons • ELP • Pink Floyd • Muddy Waters



105 Morris Street • Sebastopol, CA 95472 • 800-423-5759
e-mail: mofi@mofi.com

Internet resource center on WWW/Mosaic

Enter No. 21 on Reader Service Card

ProGold

ADVANCED CONTACT TREATMENT

- Improves Conductivity
- Reduces Noise & Distortion
- Improves Definition & Clarity
- Extends Dynamic Range
- Seals & Protects Surfaces

The Only Product that Conditions & Protects Plated Surfaces and their Base Metals!

Even the finest equipment cannot guarantee noise and error-free operation. One "dirty" connection anywhere in the signal path can cause unwanted noise, distortion, signal loss and data errors. Considering the hundreds (if not thousands) of connections in electronic equipment today, it is only a matter of time before they begin to fail.



Use what the Manufacturers Use!

Available in Environmentally-Safe Spray, Wipes, Pen, Precision Dispensers & Bulk Containers

How Does ProGold Actually Work?

ProGold outperforms all other contact cleaners, enhancers and lubricants. Due to its unique properties, it deoxidizes and cleans surface contamination, and penetrates plated surfaces and molecularly bonds to the base metals - **NO OTHER PRODUCT DOES THIS.** ProGold fills the gaps in the contact surfaces, increasing the effective surface area and current flow (conductivity). ProGold penetrates the plated surface and molecularly bonds to the base metal to seal and protect it. Conduction through a ProGold coated surface occurs in three ways. First, ProGold is displaced by electrical arc, shock wave or simple mechanical pressure and redistributes itself along the surface when the disturbance is removed. Second, a thin insulating film of ProGold is dispersed by an electrical field. Finally, conduction takes place through very thin films of ProGold by means of a quantum-mechanical phenomenon called "tunneling". Simply stated, electrons travel from one side of a thin film of ProGold to the other without passing through (this is the same effect that gave the tunnel diode its name).



Why Use ProGold?

ProGold increases the performance and reliability of all electrical equipment. It improves conductivity for optimum signal quality, reduces noise & interference, lowers distortion and virtually eliminates intermittents. Unlike other products, it also stabilizes connections between similar and dissimilar metals. ProGold provides long-lasting protection (1-10 years), on gold, silver, rhodium, copper and nickel connections. Use ProGold on all connectors & contacts for maximum performance & protection.

CAIG PRODUCTS... USED BY THOSE WHO DEMAND THE BEST!

Amplex	Federal Express	Honeywell	Switchcraft
Boeing	General Electric	McIntosh Labs	Tektronix
Diebold Inc.	John Fluke Mfg.	Motorola	Texas Inst.
Dolby Lab.	Hewlett Packard	Nakamichi	Xerox Corp.



16744 West Bernardo Drive
San Diego, CA 92127-1904
TEL: (619) 451-1799
FAX: (619) 451-2799

1-800-CAIG-123

Enter No. 6 on Reader Service Card

Hot, Blue & Righteous!

Harry McGonigal

HEAVY HEAT FHB 1994, 57:07

Sound: A, Performance: A

Move over, Slowhand! Flamin' Harry's here. The liner notes say McGonigal's called Flamin' Harry because of his airbrush work and his tattoos. I say it's because of his blaze guitar work. I've heard a lot of flash-guitarists during my 35 years of listening to blues, but no one is any better than Flamin' Harry when he's on. That ol' adrenaline rush, with the hair on the back of my neck stickin' straight up! For those who've not heard him live in the Philadelphia suburbs or at the Jersey Shore, the problem's been getting him down on disc; consider it solved with *Hot, Blue & Righteous!* The recording engineer, Guy Lutze, has gotten a wonderfully immediate sound, particularly from the drums. The acoustics are near those of a club concert, but without the rotten balances and muddy crowd noise that usually accompany venue recordings. The best cut is Harry's version of "I'll Play the Blues for You," an Albert King tune, but he's got an honest dozen on the disc, mostly from his own pen. Of these last, I like "My Baby Bought a Ticket," "Life Under the Gun," and "Rude Shoes," which seems to me like Harry's anthem. Some major ought to sign him. (Heavy Heat, 531 Chestnut St., Perkasio, Pa. 18944; 215/257-1006.)

E.P.

These Blues

Charles Brown

VERVE 314 523 022-2, 59:19

Sound: A, Performance: B+

At age 72, Charles Brown can boast about a career that, at one point, rivalled that of the great Nat King Cole's legendary trio. Also to Brown's credit is his seminal influence on the loosely swinging, low-key genre known as California blues. As with Cole, however, smoothly crooning hits is but one characteristic of Brown's multifaceted talent. It's true that his vocals are as intoxicating as a bottle of fine, mellow wine, but seldom is he credited with the other side of his forte—a wonderfully adept piano style.

Backed by an omni-swinging rhythm section, Brown's sullen voice invariably gives way to heartfelt blues solos on every tune.



Clifford Solomon's raspy tenor sax and Danny Caron's twangy guitar add character to *These Blues*, but the highlight is always Brown's soulful piano—a stylistic mélange drawn from the endearing strides of Art Tatum and Fats Waller.

James Rozzi

Fascination

Michael Shrieve

CMP CD67, 53:22

Sound: A-, Performance: B-

It's hard to imagine Michael Shrieve, former Santana drummer, in an organ trio playing unadorned four-on-the-floor rhythms. For the first quarter of *Fascination*, Wayne Horvitz lays down smoky organ chords while Bill Frisell warps guitar lines that fall like



tinsel around Shrieve's straight-ahead grooves.

Halfway through, however, the intensity shifts. On a storming, time-shifting "One Nation, Invisible," Shrieve begins drawing upon the Tony Williams' Lifetime axis of free-fusion instead of Jack McDuff organ jazz. From there, Shrieve stokes the rhythm fires in free-space-jazz improvisations that bring out Frisell's gift for air sculptures and Horvitz's talent for sonic design. By the time they all get to "Soundings in Fathoms," they're adrift in intuitive space.

John Diliberto

FAST TRACKS

The Billie Holiday Songbook: *Terence Blanchard and His Quartet* (Columbia CK 57793, 57:12). Here, the interpretations of a dozen songs associated with Billie Holiday are enhanced by the presence of singer Jeanie Bryson and an orchestra that, considering Blanchard's muted trumpet, brings to mind the Miles Davis/Gil Evans collaborations. Altogether, this is an elegant tribute. **J.S.**

Live at Maybeck: *Sir Roland Hanna* (Concord CCD-4604, 50:54). Hanna's improvisational skills, which peak here on a three-song Gershwin medley, offer the kind of spontaneity that makes this album a standout. It's Sir Roland's drive, his ability to deliver ragtime-like runs and swing-influenced rhythms, each with a bop-and-beyond sensibility, that help ignite this date. **J.W.P.**



This Month's Specials!

Receivers

Technics SA-GX170 Audio/Video Receiver
•100 watts per channel •Special class H circuit provides greater headroom •AM/FM tuner with 30 presets •Wireless remote

Our Low Price **\$179⁹⁵** (TEC SAGX170)

Sherwood RX-1010 •35 watts/channel, 30 station presets **\$109⁹⁵**

JVC RX-315 •105 watts/channel, remote **\$199⁹⁵**

Technics SA-GX470 •100 watts/channel, surround sound, remote **\$249⁹⁵**

Sherwood RV-6030R •105 watts/channel, Dolby Pro Logic **\$329⁹⁵**

Technics SA-GX770 •125 watts/ch. w/ home theater features **\$399⁹⁵**

High End Audio

PROTON

Proton AP-2000 Preamplifier
•Remote control •Active subwoofer crossover •Separate listen and record controls •Black finish •8 ohms •100 watt capacity

Our Low Price **\$269⁹⁵** (PRT AP2000)

Cassette Decks

JVC TDW-309 Dual Cassette Deck
•Dual auto-reverse •Deck 2 play Deck 2 play & record •Dolby B, C & HX Pro •Pitch control & mic mixing •Full logic silent mechanism •Music scan for up to 99 selections

Our Low Price **\$199⁹⁵** (JVC TDW309)

Teac V-600 •Dolby B/C/HX-Pro, full logic controls **\$149⁹⁵**

Technics RS-TR232 •Dual Deck #2 auto-rev. Dolby B/C/HX-Pro **\$159⁹⁵**

Teac W-750 •Dual auto-reverse, Dolby B/C/HX-Pro **\$174⁹⁵**

Technics RS-TR474 •Dual auto-reverse, Dolby B/C/HX-Pro **\$219⁹⁵**

Teac W-6000R •Dual record/play auto rev. pitch Dolby 3/C/HX-Pro **\$429⁹⁵**

Compact Disc Players

Technics SL-PD867 5 Disc Compact Disc Changer
•Front-loading rotary design allows changing up to 4 discs while 1 is playing •MASH 1-bit D/A converter •32-track programming •Wireless remote control

Our Low Price **\$189⁹⁵** (TEC SLPD867)

RCA CD1051M •16-bit, 20-track programming, remote **\$89⁹⁵**

JVC XLV-114 •2x oversampling, 32-track programming **\$119⁹⁵**

Technics SL-PG440 •MASH 1-bit, 20-track programming, remote **\$139⁹⁵**

Teac PD-D880 •5-Disc Carousel Changer, remote **\$144⁹⁵**

Technics SL-PD967 •5-Disc Changer, MASH 1-bit, pitch control **\$229⁹⁵**

Loudspeakers

JBL 4312 Studio Monitor Loudspeakers
•3-way with 12" low frequency driver, 5" midrange, and dome tweeter •Front panel controls •Black finish •8 ohms •100 watt capacity

Our Low Price **\$499⁹⁵/pair** (JBL 4312BK)

JBL Pro III •2-way Mini Speakers, shielded pair **\$149⁹⁵**

Bose RM2 •Roomate 2 with built-in amp pair **\$249⁹⁵**

Advent Legacy III •floor Standing, 2-way, 10" woofer pair **\$279⁹⁵**

Bose 301-III •Direct/Reflecting, compact, 2-way pair **\$318⁰⁰**

Cerwin Vega Q1 •2-way, 10" woofer, SPECIAL 66% OFF pair **\$499⁹⁵**

Turntables/Cartridges

Thorens 180 3-Speed Belt Drive Turntable
•33, 45, 78 r.p.m. •Automatic shut-off and auto-retract •Synchronous motor •Adjustable anti-skating •External power supply •Includes Stanton cartridge

Our Low Price **\$299⁹⁵** (THN 180)

Teac P-595 •Semi Auto Belt-Drive Turntable w/cartridge **\$89⁹⁵**

Technics SL-BD20 •Semi-Auto Turntable belt drive **\$109⁹⁵**

Technics SL-BD22K •Semi Auto Belt-Drive Turntable pitch **\$129⁹⁵**

Audio Technica AT-331LP •Cartridge: universal mount, linear contact stylus **\$39⁹⁵**

Stanton 680EL •Disc Cartridge w/extra stylus **\$69⁹⁵**

Aiwa Specials

aiwa AD-F850 3 Head Cassette Deck
•Monitor your recordings •2-motor dual capstan drive with leather-touch controls •Dolby B&C •Dolby HX-Pro •Fine bias adjustment •Record calibration •Wireless remote control

Our Low Price **\$299⁹⁵** (AIW ADF850)

Aiwa AD-F450 •Cassette Deck, Dolby B/C/HX-Pro **\$169⁹⁵**

Aiwa AD-WX727 •Dual Cassette Deck auto-rev. Dolby 3/C/HX-Pro **\$199⁹⁵**

Aiwa AD-S950 •Dolby S/B/C/HX-Pro, 3-head, fine bias **\$399⁹⁵**

Aiwa TS-W5 •Powered Subwoofer, 35 watts, shielded **\$149⁹⁵**

Aiwa NSX-2700 •Mini System, CD Player, dual cassette **\$269⁹⁵**

Hi-Fi Stereo VCRs

Mitsubishi HS-U69 Hi-Fi Stereo VHS Recorder
•VCR+ auto programmer with cable box control
•Exceptional picture & sound quality •4-heads
•On-screen programming •4-week/8-event programmable timer •Illuminated remote

Our Low Price **\$649⁹⁵** (MIT HSU69)

Samsung VR8704 •4-heads, 8-event/1-month programmable **\$239⁹⁵**

General Electric VG4235 •4-heads, 8-event/1-yr. programmable **\$259⁹⁵**

Panasonic PV-4451 •4-heads, 1-month/8-event, universal remote **\$279⁹⁵**

JVC HR-J610 •4-heads, 1-year/8-event, remote **\$299⁹⁵**

Sony SLV-720HF •VHS Hi-Fi, 4-heads, VCR Plus+ **\$369⁹⁵**

Maxell Audio/Video Tapes

maxell. R-120DM Digital Audio Tape
Special Purchase

•Metal particle tape with exclusive binder system •Micro-smooth tape surface •High precision housing for greater dependability

Our Low Price **\$599⁹⁵/each** (MAX R120DM)

Maxell UR-120 •Low Noise Cassettes, for general recording 2-pk **\$3²⁹**

Maxell XLII-100 •High Bias Cassettes, for demanding applications 2-pk **\$4⁹⁸**

Maxell P-120GX •8mm Video Tape, for everyday recording each **\$3⁹⁹**

Maxell TC-30HGX •High grade VHS-C 2-pk **\$7⁹⁹**

Maxell T-120 Gold-SPECIAL PACK •2-high grade/1-Hi-Fi VHS tapes for only **\$8⁹⁹**

KOSS Headphone Specials

KOSS ESP/950 Electrostatic Headphones
•High accuracy reference quality for the discerning audiophile •includes amplifier carrying case, and external battery pack •Straight-line response from 8Hz to 35,000-Hz

Our Low Price **\$499⁹⁵** (KOS ESI950)

Koss PortaPro •Lightweight, folding, dual plugs **\$39⁹⁵**

Koss HV/Pro •High velocity element, volume/balance controls **\$49⁹⁵**

Koss TNT/77 •Titanium Semi-open design, dual plugs **\$49⁹⁵**

Koss Pro 4 XTC •Open air, deep bass, dual plugs **\$79⁹⁵**

Koss Pro 4AA •For home or professional use, great isolation **\$89⁹⁵**

Compact Discs

RHINO HEADQUARTERS
RHI 71792

\$11⁹⁹ CD
\$7⁹⁹ CASS

Also Available
Pisces, Aquarius, Capricorn & Jones Ltd.
RHI 71793 **\$11.99CD \$7.99CASS**
Instant Replay
RHI 71796 **\$11.99CD \$7.99CASS**

CALL US TOLL FREE FOR ITEMS NOT LISTED IN THIS AD SE HABLE ESPANOL

SEND MONEY ORDER, CERTIFIED OR CASHIER'S CHECK, MASTERCARD, VISA, AMERICAN EXPRESS OR DISCOVER CARD (include Interbank No., expiration date and signature) To: J&R Music World, Dept. AU0395, 59-50 Queens Midtown Expwy., Maspeth, Queens, NY 11378. Personal and business checks must clear our Authorization Center before processing. Shipping, handling and Insurance Charge (Continental US) is 5% of the total order with a \$4.95 minimum for orders up to \$500; 4% for orders over \$500 to \$1000; and 3% for orders over \$1000. For heavy weight/over-sized items, shipment by air, or to Canada, Hawaii, Alaska, Virgin Islands & Puerto Rico please call for information. DO NOT SEND CASH. Sorry, no C.O.D.'s. NY residents please add sales tax. ORDERS SUBJECT TO VERIFICATION & ACCEPTANCE. NOT RESPONSIBLE FOR TYPOGRAPHICAL OR PICTORIAL ERRORS. ALL MERCHANDISE SHIPPED BRAND NEW, FACTORY FRESH AND 100% GUARANTEED. Some quantities may be limited. Copyright 1995 J&R Music World, City of New York, NY. Dept. of Consumer Affairs License Numbers 0900310/0900615/0900616/0900617

J&R Music World
Call Toll Free To Order
24 Hours A Day
7 Days A Week
1-800-221-8180
To receive our free catalog circle #15 on Reader's Service Card

HONESTY
INTEGRITY VALUE
QUALITY
NEW WEST
innovation ECONOMY
SERVICE

Why New West Electronics?

Well, if the reasons above aren't enough, how about free delivery on all orders over \$100.00, the best customer service available and our non-commission sales staff that really knows what it's all about. Why New West Electronics?

Because you deserve the best!

WE PROUDLY FEATURE:

PANASONIC • SONY • HITACHI • TOSHIBA • JVC
PIONEER • RCA • CANON • SHARP • INFINITY
FOSGATE • CERWIN VEGA • JBL • B&K • KEF
DESIGN ACOUSTICS • CARVER • PREMIERE
HARMAN KARDON • AIWA • GOVIDEO
MONSTER CABLE • ACOUSTIC RESEARCH
KENWOOD • ALTEC LANSING • DENON
AND SEVERAL LINES THAT WE CAN'T
NAME IN PRINT.



CODs AND POS WELCOME

CALL: MON-FRI 6:30A-6:30P SAT 7:00A-6:00P SUN 8:00A-5:00P ALL TIMES PACIFIC STANDARD

800-488-8877

CALIFORNIA

VALUABLE

WE COMBINE EXCEPTIONAL PRODUCTS WITH DESIGN EXPERTISE TO CREATE HIGH PERFORMANCE SYSTEMS OF UNUSUAL VALUE.

Factory Authorized Dealer for:

- Adcom • Apogee • Audible Illusions
- Audiolab • Atlantic • AudioQuest • Audiostatic
- Celestion • DefinitiveTechnology • Denon
- Fosgate • Grado • Hafler • Hitachi • Lexicon
- Linæum • Mc Cormack • Mod Squad • M&K
- NAD • NEAR • Paradigm • Parasound • Power
- Wedge • Rotel • SOTA • Stax • Sumiko • Theta
- Totem • VAC • Van Den Hul • Velodyne
- Vidikron • XLO & more!



(310) 370-8575

Systems Design Group

1310 Kingsdale Ave.
Redondo Bch., CA 90278
Tue-Fri 11am-7pm
Sat 11am-6pm

CALIFORNIA

We don't sell perfect systems.

After 15 years, we've learned no perfect system exists. It has to be built to your specifications, within your budget.

To get started, call us today... **and ask us how.**



310 517-1700
310 517-1732 fax

18214 DALTON AVE. E. DEPT A
GARDENA, CA 90248



CALIFORNIA

WE'RE HERE

Now you can shop with confidence at one of the USA's largest dedicated Home Theater Sales Centers! From basic surround to full blown THX sound, we do it all!



AUTHORIZED DEALER:

- Acurus • AMC • Aragon • Marantz • Alon • Jamo • Counterpoint • Magnum • B&K • Coda • PSB • Energy • Veritas • PS Audio • Fosgate • JBL Synthesis • Proton • Carver • EAD • Audio Alchemy • Stax • Klipsch • Kimber • Grado • Celestion • Quad.

CALIF. TOLL-FREE 1-800-405-HIFI OPEN 7 DAYS

Definition AUDIO VIDEO

2901 West 182nd St.
Redondo Beach
California 90278
CALL (310) 371-0019

ILLINOIS

LEGACY
A · U · D · I · O



Legacy Amplifier and Pre-Amplifier

Call for a free catalog:

800-AUDIO-HI

(800-283-4644)

Fax: 217-744-7269

Authorized Dealer:

- Legacy
- Cary
- Sumo
- Fosgate
- Aparture
- Micromega
- Pioneer Elite
- Counterpoint
- Musical Designs
- Soundcraftsmen
- Kimber Kable
- Beyerdynamic
- Music Metre
- Quicksilver
- Monarchy
- Dynaco
- Hafler
- Coda



The new *Whisper* speaker

Visit our

SPEAKER FACTORY SHOWROOM

at 3021 Sangamon Ave.
Springfield, IL 62702

ILLINOIS

Snell
ACOUSTICS

When Nothing But The Best Will Do!

SNELL'S K/IIV

*Hand Tuned for a Remarkable Performance Standard
Compact Two-Way Bookshelf Design.
Now at MuziCraft.*



- SONY ES
- MARANTZ
- CARVER
- NAD
- SNELL
- JBL-THX
- ONKYO
- PIONEER
- KENWOOD
- VELODYNE

MuziCraft ADVANCED HOME THEATER

PALATINE 1280 E. Dundee Rd. (708) 991-7220
HOMERWOOD 18100 S. Halsted (708) 799-2400

MASSACHUSETTS

OK! SO WE'RE A NAME DROPPER!

Authorized Dealers For...

- JVC
- MITSUBISHI International Corporation ELECTRONICS
- BOSE
- Panasonic
- Canon
- SONY

Pratt WALL BRACKETS

BEACH SALES (Sorry No Catalogs)
80 VFW Parkway
Revere, MA 02151
In Business for 50 Years
1-800-562-9020

MAINE

- Acurus ... Aragon ... Audio Research
- ... Creek ... CWD ... Dahlquist ...
- Denon ... Genesis ... Grado ... Jamo
- ... Lexicon ... Magneplaner ...
- Magnum Dynalab ... Mark Levinson
- ... NAD ... Prometheans ... PSB ...
- Pulsar ... Revolver ... Rotel ... SME ...
- Sota ... Sound Connections ... Stax ...
- Stewart ... Sumiko ... Sumo ...
- Symdex ... Thoren ... Transparent
- Audio ... VPI ... And Much More!

Hi Fi Exchange

FORESIDE MALL • ROUTE ONE
FALMOUTH, ME 04105

(207) 781-2326

MASSACHUSETTS

The Best Values In Hi End Hi-Fi.

audio studio

Authorized sales and service for:

- Audible Illusions, Audioquest, B&K, Beyerdynamic, Cardas, Counterpoint, Dual, Klyne, Maplenoll, Marantz, Mirage, Mission, Monster Cable, Morel, NAD, Nakamichi, Oideion Products, Ortofon, Project, Proton, QUAD, Renaissance Audio, Revox, Sennheiser, SME, Shure, Stax, Straight Wire, Sumiko, Thorens, Velodyne, VPI, and many more.

303 Newbury St., Boston, MA 02115
(617) 267-1001
FAX (617) 277-2415

414 Harvard St., Brookline, MA 02146
(617) 277-0111

INTERNATIONAL BUSINESS ACCEPTED

DEALER SHOWCASE

MINNESOTA

1 (800) 229-0644

RECORD PLAYER NEEDLES AND CARTRIDGES. World's Largest Selection and Lowest Price!!



Proud to promote Audio Technica, Audioquest, Bang & Olufsen, Goldring, Grado, Ortofon, Shure, Signet, Stanton, Nitty Gritty, Last, Discwasher and more!

M-Sat 10-7 Sun 12-5
419 14th Avenue SE
Minneapolis, MN 55414

(612) 378-0543 FAX: (612) 378-9024

**Jerry Reakin's
Needle Doctor**

NEW JERSEY

We at Home Theatre Systems can help you!

AUTHORIZED DEALER FOR

AMPRO	APATURE
APOGEE	CELESTION
DAHLQUIST	DCM
FARUDJA	HARMAN KARDON
JAMO	MITSUBISHI
MONSTER CABLE	NILES
PROTON	SANUS
STEWART	VMPS

44 ROUTE 23N., LITTLE FALLS, NJ 07424

201-890-5959

NEW YORK

SHOP US LAST

WE WILL BEAT ANY PRICE*

ADS • BOSE • CARVER • DENON • INFINITY • MONSTER • MTX • NILES • ONKYO • PIONEER • SONY ES • "Call For Others Not Listed"

*AUTHORIZED DEALERS

The Sound Approach

6067 Jericho Tpke., Commack, NY 11725

800-368-2344

NEW JERSEY

Celebrate the Senses

SAVANT features more systems, with the widest array of design & installation options anywhere...

Accuphase • Acrotec • Air Tangent
Air Tight • Analogue Productions
Apex • Arcam • Arcici • Athena
Atlantic Technologies • Audio Prism
Audiolab • Audiostatic • Basis • Benz
Bitwise • Bright Star • Cardas • Charo
Chesky • Clarity Audio • Clarity Recordings
Creek • Day Sequerra • Delos • Dorian
DWIN • EKSC • Electron Kinetics
Eminent Technology • Ensemble • Epos
Faroudja • Fosgate • Golden String
Goldmund • Goldring • Grado
Harmonia Mundi • Imaging Science Foundation
JPW • Klyne • Last • Mapleshade
Marigo Audio Lab • Merrill • Micromega
Mod Squad • Mogami • Morch • Nestorovic
Neutrik • Nimbus • OmniMount • Opus 3
PAC • Panamax • Pioneer Professional
Power Wedge • Pro Ac • Proprius • QED
Rega • Reference Recordings • Rockusics
Roksan • RoomTune • Sheffield Labs
Simply Physics • Sims • Solidsteel
Sound Anchors • Stax • Stewart Filmscreen
Sumiko • System Line • Target • Tice Audio
Toshiba HD • Townshend Audio • Water Lily
WBT • Wheaton • & More...

Savor these pleasures... Call SAVANT.

800 628 0627 • 609 799 9634

FAX: 609 799 8480

E-Mail: pp000792@interramp.com

Serving The World

SAVANT
A U D I O

NEW YORK

HIGH-END AUDIO... MADE EASIER

Serving the serious music lover since 1985, we have realized that High-End Audio has become a confusing term. Random matching of quality components, will not assure you of a system that can reproduce music. A call or visit to Audio Outlet will. We specialize in products that offer exceptional performance and value. Give us a call, lets talk music. If you just want to know what we sell, call us and ask, or order a copy of our 96 page catalog. It's only \$4.00.

AUDIO OUTLET Inc.

69 S. Moger Ave., Mt. Kisco, NY 10549

914-666-0550 • FAX 914-666-0544



NEW JERSEY

Direct
Audio
Video
Entertainment
Systems

SPEAKERS

Bose, Advent, B&W, Boston, Polk, Atlantic Technology, PSB, Pinnacle, Infinity, JBL

ELECTRONICS

Nad, Adcom, Onkyo, Pioneer, Rotel, Carver, Nakamichi, HK, Kenwood
FOR PRICE SERVICE SELECTION CALL

1.800.308.0354 In NJ NY Call 201.997.7812

MON, TUES, WED 10AM-8PM THURS, FRI 10AM-6PM SAT 10AM-4PM

441 KEARNY AVE.
KEARNY NJ 07032
Visa, Mastercard, Discover

NEW YORK

ALPHA STEREO
Quality Components, Professional Installation & Service



"We are known for the companies we keep"

Adcom, NAD, Rotel, Onkyo, B&W, Ortofon, Audioquest, Monster Cable, M&K, AKG, Stax, Polk Audio, Atlantic Technologies, Audio Alchemy, Beyerdynamics, Sony, PSB, Sennheiser, Alpine, Boston Acoustics.

Northern NY's oldest & most renowned dealer.

57 Smithfield Blvd., Plattsburgh, NY 12901

518-561-2822

Fax: 518-561-2961

Monday-Friday 10am-8pm Saturday 10am-6pm
Mastercard, Visa, Discover, Amex

NEW YORK

audio-technica *twice*

YOUR SEARCH IS OVER!

TIPTOES LAST MONSTER CABLE

DYNVECTOR BANG & OLUFSEN PICKERING

We specialize in hard to find phono cartridges and original replacement styli only!!

(800) 221-0906

CALL TOLL-FREE FOR FREE PRICE QUOTES AND VISA/MC ORDERS N.Y. STATE (518) 599-1112

SEND SELF-ADDRESSED STAMPED ENVELOPE FOR OUR FREE CATALOG.

LYLE CARTRIDGES
115 South Corona Avenue
Valley Stream, N.Y. 11582

Phones Open Mon-Sat 9 am-8 pm

ortofon **SHURE** STANTON

PENNSYLVANIA

PHILADELPHIA
AUDIOPHILES

- | | | |
|-------------------|---------------|----------------|
| Acoustic Energy | Harbeth | Rega Planar |
| Air Tight | Highwire | Roksan |
| Audible Illusions | Jadis | Rotel |
| Audio Alchemy | Kimber Kable | Sci-Fi |
| Audiolab | Kinergetics | Signet |
| Avalon | Klyne | SOTA |
| B&K Components | Koetsu | Soundcraftsmen |
| Cary | Melos | Spendor |
| CEC TL-1 | Meridian | Stax |
| Classe | Micromega | Straight Wire |
| Counterpoint | M&K Sound | Target |
| Creek | Monitor Audio | Totem |
| DPA-Deltec | Muse | Transparent |
| Dynavector | NAD | Unity Audio |
| Eminent Tech. | Oracle | VAC |
| Epos | Parasound | VPI |
| Genesis | PS Audio | Well Tempered |
| Green Mountain | PSB | Wheaton |

DAVID LEWIS AUDIO
At Sound Service Company

8010 Bustleton Ave. Philadelphia, PA 19152
(215) 725-4080 Bank Cards Accepted

VIRGINIA

THE BEST IN HOME GROWN AUDIO.



Hi-Fi Farm

FEATURING:

Accuphase, Acurus, Aragen,
Quad, Alon, OCM, Magnum,
Woodside, Roksan, Spendor,
B&K, Kimber, VMPS, Cargas,
Creek, Epos, Micro-Mega,
and many more.

Also featuring high end used
equipment, fully guaranteed!

2039 Electric Rd., Roanoke, VA 24018

Call for information
1-703-772-4434

Nationwide Toll Free:
1-800-752-4018

All major credit cards accepted

WISCONSIN



the
SoundSeller



For the Musical Difference

Authorized Dealer For:

- | | |
|------------|-----------------------|
| • NAD | • CARVER |
| • GRADO | • LEXICON |
| • PROAC | • ATLANTIC TECHNOLOGY |
| • APATURE | • NAKAMICHI |
| • VELODYNE | • AUDIOCONTROL |
| • CWD | • CELESTION |
| • STAX | • PSB |
| • SANUS | • NILES AUDIO |
| • M & K | • NITTY GRITTY |
| • KEF | • SOUNDSTREAM |
| • ONKYO | • HARMAN KARDON |
| • SONY ES | • MONSTER CABLE |
| • ADCOM | • ALTEC LANSING |
| • THORENS | • ROCKFORD/FOSGATE |
| • TARGET | • POLK AUDIO |

2808 Cahill Road, P.O. Box 224
Marinette, WI 54143
1-800-826-0520 (715) 735-9002

VERMONT

HERE IN VERMONT, PEOPLE DEMAND
VALUE.
WE DON'T WASTE CUSTOMERS MONEY
AND NEITHER DO THESE FOLKS:

ADCOM ATLANTIS AUDIOQUEST B&W
DIGITAL PHASE GRADO MONSTER PSB
ORACLE ROTEL SIGNET
STRAIGHT WIRE SUMICO TANNY
TARGET THORENS YHARFEDALE

5-YR WARRANTIES ON ALL
NEW EQUIPMENT

24% FINANCING AVAILABLE

FOR INSTALLATION AT
ST. RIVER VALLEY, NYC

SCIENTIFIC
STEREO
802 277 5855
128 Main St. — BRATTLEBORO VT 05301

TOLL-FREE
800 456 4434

WISCONSIN

the
HappyMedium

Because you'll play it for keeps

Authorized Dealer For:

ADS	PSB
JVC	TARGET
LEXICON	CLARION
ACURUS	ROCKFORD/FOSGATE
SANUS	SENNHEISER
HUGHES	STEREOSTONE
HAFLER	CELESTION
SONY	SONY ES
MONSTER	BANG & OLUFSEN
NAD	ATLANTIC TECHNOLOGY
M & K	HARMAN KARDON
POLK	LUXMAN
ENERGY	NAKAMICHI
PROAC	P.S. AUDIO
AKC	NILES AUDIO
AVIA	AIWA PORTABLES

430 State St., Madison, WI 53703
608-255-2887

The best place to be seen
is where people are looking.
And each month, both
enthusiasts & dealers read
AUDIO's Classifieds
for information.

AUDIO's Classifieds
- where consumers
shop and dealers buy.

For advertising information...

Call 1 (800) 445-6066

Mon. - Fri. 9-5 pm EST
In Canada: 1 (212) 767-5750

PLEASE NOTE: It is impossible for us to verify all of the claims of advertisers, including product availability and existence of warranties. To confirm that an advertiser is authorized to sell a product, we suggest you contact the manufacturer directly. Please review our *Tips for Mail Order Purchasers* in this section.

AUTHORIZED

AUDIOPHILE & SCHOLAR

UNIVERSITY AUDIO SHOP, MADISON, WI
SPECIAL: Spica SC30 \$299. AUDIO RESEARCH, MARTIN LOGAN, VANDERSTEEN, Totem, Epos, JMLabs, Paradigm, SYMDEX, Spica, NEAR, B&K, AMC, Creek, Aragon, YBA, Boulder, Michael Yee Audio, California Audio Labs, Micromega, Audio Alchemy, Rega, Stax, Magnum Dynalab, Fosgate, Soundstream, Runco, JVC, Grado, & TaraLabs. (608) 284-0001.

SELL FOR CASH OR TRADE AUDIO & VIDEO EQUIPMENT. AUTHORIZED: DENON, H.K. MARANTZ, ACURUS, ARCAM, NAKAMICHI, ROTEL, SUMO CELESTION, DAHLQUIST, ENERGY, KEF, NHT, SIGNET, AUDIO ALCHEMY, AUDIOQUEST, GRADO, ET AL STEREO CLASSICS. 75 CHURCH ST. NEW BRUNSWICK, NJ 08901 (908)220-1144, FAX: (908) 220-1284.

AUDIO UNLIMITED in Colorado offers Accuphase, Acoustic Energy, Acrotec, AirTight, Airtangent, Audio Meca by Pierre Lurne, Audio Note, Basis, Benz-Micro, Bitwiser, Chang, Chario, CODA, dpa Deltec, Day-Sequerra, Dynavector, Ensemble, Graham, Harbeth, Ikeda, JM Labs, Kuzma, Magnum Dynalab, Micromega, Mission-Cyrus, Morch, Musical Design, Music Metre, Muse, NBS, NSM, Onix, Oracle, RoomTunes, Solid Steel, Sound Anchor, SOTA, Spendor, Tice, Totem, Unity Audio, Vimak, Wheaton Triplaner, YBA! and more...PHONE/FAX John Barnes at (303)691-3407. Audio Unlimited, 2341 West Yale Ave., Englewood, CO 80110. VISA and MC accepted.

FOR SALE

STOP! LOOK!! SAVE\$!!
NHT, DENON, POLK, CARVER, NAKAMICHI, KEF, PARASOUND, SNELL, B&K, PSB, NAD, VELODYNE, M&K, ONKYO, ACURUS, FOSGATE, PS AUDIO, AUDIO ALCHEMY, SOUND SHOP 206-692-8201.

HI FI EXCHANGE. Large selection of quality USED hiend components at huge discounts. We buy, sell & trade. Call for inventory list. (718) 423-0400 or visit our showrooms at 251-11 Northern Blvd, Little Neck, NY 11363.

YOU'RE ONLY CHEATING YOURSELF..... IF YOU DON'T TAKE ADVANTAGE OF OUR AUDIOQUEST "F-88" SPEAKER CABLE CLOSEOUT SALE! OVER FOUR HUNDRED PAIR AVAILABLE. SAVINGS 50% TO 70% OFF! "F-88" USES SOLIDCORE HYPERLITZ TECHNOLOGY COMBINED WITH THE OUTRAGEOUSLY SMOOTH AND DETAILED SOUNDING "FDC COPPER" CONDUCTORS. LIST PRICE ON 10' PAIR \$150.00, SALE PRICE ONLY \$55.00! CALL FOR OTHER LENGTHS AND PRICES. PLUS MIDNIGHT, CRYSTAL, INDIGO, RUBY, TOPAZ CLOSE-OUTS. MANY OTHER SALE AND CLEARANCE PRODUCTS INCLUDING AUDIO ALCHEMY, B&K, NAD, KLIPSCH, COUNTERPOINT, POWER WEDGE, VMPS, LEXICON, STRAIGHTWIRE. REQUEST OUR COMPLETE LISTING. HCM AUDIO (800) 222-3465, (916) 345-1341, FAX (916) 345-7269.

RACK AND CHASSIS BOXES for construction of electronic projects. Low cost; quick delivery. Call for free catalog. SESCOM, INC. 1-800-634-3457.

BIG DISCOUNTS!!
SAVE\$!

NAKAMICHI, PSB, CARVER, POLK, NHT, NAD, DENON, SNELL, VELODYNE, KEF, M&K, B&K, PARASOUND, ONKYO, PS AUDIO, FOSGATE, ACURUS, SPICA, SOUND SHOP 206-692-8201.

XXX-TREME DISCOUNTS!!

ONKYO—DENON—CARVER—NAKAMICHI—NAD—PARASOUND—FOSGATE—APATURE—SUMIKO—KEF—SNELL—POLK—M&K—NHT—SPICA—VELODYNE—PSB—CHICAGO STANDS U.S. products. NO GREY! Many closeout deals! STEREO TECH. 414-836-2942

CLASSIFIED ADVERTISING

FOR SALE

SAVE 40% ON HIGH-END home speakers, subwoofers, amplifiers. FREE CATALOG, 3021 Sangamon Avenue, Springfield, IL 62702. 1-800-283-4644.

AUDIO BY VAN ALSTINE INTRODUCES OMEGA III buffered active feedback power amplifiers and buffered hybrid preamplifiers, high powered Fet-Valve hybrid vacuum tube amplifiers, and affordable straight-line tube and hybrid preamplifiers for ultimate faithfulness to the spirit of the music. Now ready — beautiful new 17" wide ultra-dynamic preamplifier featuring switchable tone controls, gold switch contacts, and gold jacks handling 9 sources and 5 loads. AVA ruggedly efficient amplifiers feature striated heatsinks and careful engineering—no output failures in two years! Complete line-only preamplifiers, headphone amplifiers, phase inverters, and more (wired and kits) starting under \$200. Hand crafted in the USA. **ATTENTION VINTAGE DYNACO AND HAFLEL OWNERS.** Economically recycle your equipment for better than new performance. Eliminate old problems with our durable, rugged, musically convincing original designs. Complete PAS, PAT-4, PAT-5, and ST-70 rebuilds (kit or wired) from \$195 include new circuit cards and precision controls. AVA 300V/uS active feedback amplifier circuits for Dyna and Haflel chassis set new standards for transparency, definition, dynamic range, and liquidity. Write, call, or FAX for free illustrated catalog. Audio by Van Alstine, 2202 River Hills Drive, Burnsville, MN 55337. (612) 890-3517, FAX: (612) 894-3675.

AUDIO NEXUS = QUALITY

Featuring legendary **VANDERSTEEN** loudspeakers & **ROTEL** Components.

AMC • Apogee • Audio Alchemy • Audioquest • Audiostatic • B&K • Cardas • Cary • CWD • Dynalab • EAD • Exposure • Fanfare • Forte • Fried • Grado • JM Lab • Kimber • Kinergetics • Magnum • McCormack • Melos • Nakamichi • Power Wedge • PSB • Rotel • Jeff Rowland • Sony ES • Vandersteen • VPI SUMMIT, NJ (908)277-0333

AUDIO RESEARCH SEVERAL USED UNITS AVAILABLE. MCP-33, SP8, CL 60, D 115, ETC. CROWN MACRO REFERENCE AMPS AT HUGE SAVINGS. ALL THE LATEST AUDIO RESEARCH UNITS ON DISPLAY. NAKAMICHI 1000, DUNTECH AND B&W. CALL FOR LISTINGS AND PRICES ON USED EQUIPMENT. IDEAL ACOUSTICS, STARKVILLE, MS. 601-323-4001.

AMPEX 4470 1/4" REEL-TO-REEL. 7.5 & 3.75 IPS. WALNUT CABINET & PORTABLE LUGGAGE CASE WITH STEREO AMP & SPEAKERS. MANUAL. 3 CARTONS TAPES. \$350. (716) 377-8452.

CABLE T.V. CONVERTERS. Jerrold®, Zenith, Pioneer, Oak, Scientific Atlanta, and Many More! 12 Years Experience Gives Us The ADVANTAGE. Visa/MC, Amex, COD. ADVANTAGE ELECTRONICS INC., 1-800-952-3916; 1125 RIVERWOOD DR., BURNSVILLE, MN 55337. Void where prohibited.

DJ & Nightclub Sound & Lighting CATALOG

FREE 72-Page Catalog with a huge selection of name brand professional gear for DJ's, Clubs & Musicians all at discount prices!

Call Today 800-945-9300

Mail Order Center: 11711 Monarch St.
Garden Grove, CA 92641
Retail Super Store: 13110 Magnolia St.
Garden Grove, CA 92644 (714)-530-6700



PRO SOUND & STAGE LIGHTING™ OUR 19th YEAR!

THE FIRST JITTER-FREE TRANSPORT IS AVAILABLE NOW! At \$649. THE REFERENCE ONE TRANSPORT REPRESENTS A BREAKTHROUGH IN TECHNOLOGY AND PRICE. ISOLATED STABLE CLOCK MODULE AND OTL TRANSPORT DRIVER BOARD ALSO AVAILABLE. TURN YOUR CDS INTO MUSIC. G & D TRANSFORMS. (602) 650-1155.

AUDIO CLASSICS, LTD.

Buys-Sells-Trades-Repairs-Modifies.

(AI) = AS IS, (D) = Demo, (EX) = Excellent, (F) = Fair, (G) = Good, (M) = Mint, (N) = New. **AMPLIFIERS:** Accuphase P102(EX) \$1519, P260(EX) \$759, Audio Research CLASSIC-30(EX) \$1519, CLASSIC-120(EX) \$3495, M100(EX) \$2735; B&K ST140(EX) \$265, ST202/BAL(M) \$612, ST2020-BAL(N) \$600; Carver TFM35(D) \$627, TFM55(D) \$811; Chord SPM 1200(N) \$2099; CM Labs 80MRM(AI) \$299; Coda 10(D) \$1761; Conrad-Johnson MF80(N) \$999, MF200(D) \$1499, MV100(EX) \$1769, PREMIER-8(D) \$9995; Counterpoint SA12(EX) \$699, SOLID-2(D) \$1599; Denon POA5000(N) \$922, Dynaco ST400II(D) \$931; Electrocompaniet AW250(G) \$1367; Jadis DEFY-7(D) \$3799; Kinergetics KBA75(N) \$1795; Krell KSA100S \$3995, KSA150(EX) \$2995; Levinson ML11(EX) \$999; Manley EURO-35(D) \$999, STEREO-7575(D) \$1744; Marantz 5(X) \$2500; McIntosh MC30 \$299-499, MC40 \$379-599, MC50(AI) \$106, MC60 \$243-1000, MC225 \$531-899, MC240 \$999-1995, MC250(AI) \$227-309, MC275 \$2819-9995, MC2100 \$227-649, MC2105 \$303-899, MC2155(EX) \$1367; Motif MS100(EX) \$1499; OCM500(D) \$1916; Rotel RB9708X(N) \$360, RB9808X(N) \$569. **CASSETTE DECKS:** Carver TD1770(D) \$442; Denon DRM710(N) \$361, DRS810(N) \$442. **CD PLAYERS:** Accuphase DP70(EX) \$1329; Carver SDA370(D) \$476; DCC3520(D) \$953, DCM320(D) \$265; Kinergetics KCD40(D) \$2115; NAD 5240(AI) \$151; Philips CD40(AI) \$187, CD910PBK(D) \$125, CD920(D) \$135, CDC925(D) \$187; Rotel RCD820(AI) \$227. **CD PROCESSORS:** Aragon D2A-II(M) \$1212; KrellISTEALTH(EX) \$1215, STUDIO-2(M) \$1443; Proceed PDP2(EX) \$455. **CD TRANSPORT:** Krell MD2AC(EX) \$1975; Proceed PDT(EX) \$599-749. **CROSSOVERS:** Accuphase F15L(EX) \$911. **EQUALIZERS:** Audio Control OCTAVE(N) \$143, TEN-II(N) \$199; McIntosh MQ102 \$75-99, MQ104 \$75-\$225, MQ107(EX) \$372. **GUITAR AMPS:** ART 490(EX) \$493; Peavey MARK-IIIP(EX) \$396, SWR BABY-BLUE(EX) \$455. **GUITARS:** Fender TELECASTER(M) \$1215; Gibson CE-CELEBRITY(M) \$987; Fickenbacker 325JL(M) \$987; Sigma CR9(NOS) \$256. **HEADPHONES:** Stax ED1(EX) \$265, LAMBDA-CLASS-MX(D) \$651, LAMBDA-SIG(D) \$1299, SR34-PRO(D) \$162, SR84-PRO(D) \$199, SR-SIGMA(EX) \$227, SRD7-PRO(EX) \$113, SRD7SB \$50-152. **INTEGRATED AMPS:** McIntosh MA5100 \$151-399, MA6100 \$379-549. **MUSICAL ACCESSORIES:** Boss DR550MKII(EX) \$151. **PHONOGRAPHS:** Victor CRENDENZA \$2000-4000, VV-S-215(G) \$375, VVXII(G) \$375. **PRE-PREAMPS:** McIntosh MCP1 \$229-399; Threshold M1-MC(M) \$113. **PRE-AMPLIFIERS:** Accuphase C11(EX) \$227, C202(EX) \$911, C222(EX) \$455; B&K AVP2000(N) \$699; Carver C15V(D) \$587, C20V(N) \$759; Coda 01P(D) \$2089; Counterpoint SA2000(N) \$1395, SA3000(D) \$1642, SA5000(M) \$3246; Denon DAP2500 (EX) \$299; Dynaco PAT4 \$39-99, PAT \$37-99; Electrocompaniet PREAMP-II(EX) \$299; Heathkit WAP2 \$37-99, Krell PAM7(EX) \$607, Levinson NO.25(EX) \$1139, NO.26(EX) \$2887, Luxman SC50(G) \$189; Marantz 7 \$1995-3995; McIntosh C4 \$200-400, C8 \$200-400, C8S \$500, C28 \$299-549, C31V(EX) \$1139, C32 \$299-999, C37 \$1277-2001, CR7 \$167-399; Meitner PA6I(EX) \$759; Precision Fidelity C8-PF(AI) \$303, Rotel RC9808X(D) \$450, Soundcraftsmen PRO-CONTROL-3(EX) \$151. **PROCESSORS:** Audio Pulse 2(G) \$75, Bozak 902(G) \$75, Carver DPL20(EX) \$211, Fosgate DSM3608(EX) \$299, McMartin LR1004(G) \$139. **RECEIVERS:** Fisher 500B(F) \$113, Kyocera R461(D) \$592, Philips FR920(D) \$201, FR930(D) \$299; Tandberg TR2040(B?) \$75. **REMOTE CONTROLS:** McIntosh CR7 \$167-399, CR8 \$129-454, R606(EX) \$78, R624 \$75-133, R626(EX) \$266, R657(EX) \$181. **SPEAKER SWITCHES:** McIntosh P349 \$151-249, SCR2A(EX) \$106, SCR3(EX) \$106-149; Niles MSA6R(N) \$75; Rotel RSS900(N) \$272. **SPEAKERS:** Apogee CENTAUR(EX) \$999, STAGE-Sub(EX) \$1519; BIC REALTA(D) \$683, V52 \$117-149; Carver AL-III(D) \$1062; Dahlquist DQ30(D) \$1337; JM Lab MICRON(D) \$543; KEF Q50(D) \$574; Lineaum LF3-STANDARD(D) \$299; McIntosh ML2C(EX) \$1118, XD715(M) \$433, XR7(EX) \$1063, XR230 \$455-849, XR240 \$683-1199, XR250(EX) \$1499, XRT22HF(M) \$999-1500, XRT22(M) \$4999; Sound Lab PRISTINE(D) \$3199, Velodyne F1200(N) \$878-1095. **TAPE DECKS:** Astromom 407 \$100-400, Concertone 93-4(AI) \$113. **TEST EQUIPMENT:** EFi TV2C(EX) \$406; Hicock 539C(EX) \$607; McIntosh AA2 \$440-749, MI3 \$379-550; Sound Technology 1000A \$873-1799, 1100A(EX) \$499-999, 1200A(EX) \$531, 1701A(EX) \$1215-1799. **TUNER PREAMPS:** Carver CT6(D) \$518, CT7(D) \$429, CT29V(D) \$838; Haller 945(D) \$487; McIntosh MX110 \$265-699, MX117(EX) \$1063; Rotel RTC940AX(N) \$383. **TUNERS:** B&K TS108(N) \$357, Carver TX11B(D) \$671, Magnum-Dynalab F205(N) \$249, FT101A(D) \$705, FT-R \$363-431, Marantz 20B \$299-699; McIntosh MR65 \$299-599, MR65B \$199-799, MR66 \$227-799, MR67 \$227 \$189-899, MR71 \$227-999, MR75(EX) \$1349, MR78 \$607-1399, MR80 \$1215-1519; Perreux TU3(D) \$303; Rotel RT950BX(N) \$284. **TURNTABLES:** Sota COSMOS(N) \$2999. Thorens TD125(EX) \$151; VPI HW19-JR-PLUS(D) \$1375. **PLC(D) \$281. VIDEO DISC PLAYERS:** Denon LA3000(D) \$547. **FREE Catalogue. 8AM-5PM EST Mon.-Fri.,**

**AUDIO CLASSICS, LTD.
607-865-7200**

TIPS FOR MAIL ORDER PURCHASERS

It is impossible for us to verify all of the claims of advertisers, including product availability and existence of warranties. Therefore, the following information is provided for your protection.

1. Confirm price and merchandise information with the seller, including brand, model, color or finish, accessories and rebates included in the price.
2. Understand the seller's return and refund-policy, including the allowable return period, who pays the postage for returned merchandise, and whether there is any "restocking" charge.
3. Understand the product's warranty. Is there a manufacturer's warranty, and if so, is it from a U.S. or foreign manufacturer? Note that many manufacturers assert that, even if the product comes with a U.S. manufacturer's warranty card, if you purchase from an unauthorized dealer, you are not covered by the manufacturer's warranty. If in doubt, contact the manufacturer directly. In addition to, or instead of, the manufacturer's warranty, the seller may offer its own warranty. In either case, what is covered by warranty, how long is the warranty period, where will the product be serviced, what do you have to do, and will the product be repaired or replaced? You may want a copy of the written warranty before placing your order.
4. Keep a copy of all transactions, including cancelled checks, receipts and correspondence. For phone orders, make a note of the order including merchandise ordered, price, order date, expected delivery date and salesperson's name.
5. If the merchandise is not shipped within the promised time or if no time was promised, 30 days of receipt of the order, you generally have the right to cancel the order and get a refund.
6. Merchandise substitution without your express prior consent is not allowed.
7. If you have a problem with your order or the merchandise, write a letter to the seller with all the pertinent information and keep a copy.
8. If you are unable to obtain satisfaction from the seller, contact the consumer protection agency in the seller's state or your local Post Office.

If, after following the above guidelines, you experience a problem with a mail order advertiser that you are unable to resolve, please let us know. WRITE to Susan Ross, Special Marketing, 45th floor, Hachette Filipacchi Magazines, 1633 Broadway, NY, NY 10019. Be sure to include copies of all correspondence.

FOR SALE

ABARGAIN: STAX SIGN/LAMBDA \$1,350: OMEGA SRMT1 \$2,900; PRO/LAMBDA (#1) \$399; SIGN/LAMBDA SRD7 \$499; ED-1 \$550; ALL UNUSED (212)966-1355.

AUDIO POWER AMPLIFIERS. 100-500 WRMS/CH. New amps, custom-built, from only \$188.00 to \$223.00 each. Satisfaction Guaranteed. Call Electronics Hospital (407)952-3838.

WE BEAT PRICES!!

NAKAMICHI, CARVER, POLK, PSB, DENON, NHT, NAD, B&K, SNELL, PARASOUND, KEF, VELODYNE, M&K, ON-KYO, ACURUS, FOSGATE, PS AUDIO, SPICA, SOUND SHOP 206-692-8201.

\$\$\$SAVE!!\$\$

CABLE T.V. CONVERTERS, DESCRAMBLERS. Scientific Atlanta, Zenith, Jerrrod, Pioneer, Oak. Replacements for most models. Quality, Price & Service. Amex/Disc/Visa/MC. Dealer inquiries invited. EAGLE Electronics Inc., 1-800-259-1187, #1, 1301 Railhead Blvd., Naples, FL 33963.

AUDIO INTERFACING ACCESSORIES (over 300) for broadcast, recording, sound reinforcement and live entertainment. Free catalog. SESCO, INC. 1-800-634-3457.

HYPE! HYPE! HYPE!

You get enough elsewhere! We've delivered something different for 15 years—natural, musical results! "Musically exciting" Adcom, B&K and Hafler modifications. Dual-Mono Adcom GFA-555 mods. Smooth, delicate B&K mods. PA-1 driver boards for Hafler amps—budget bliss! Don't be high-end pretenders, be contenders, call us today! MUSICAL CONCEPTS, 5749 WESTWOOD DR., ST. CHARLES, MO 63304. (314) 447-0040.

DBX & ADC HARD-TO-FIND PARTS & SERVICE. CALL WRITE RES, 5462 BUCHANAN PLACE, FREMONT, CA 94538. (510) 490-1622, FAX (510) 656-8878.

STEVE'S CONSIGNMENT SHOP

Hi Fi Farm and Steve's Audio advice now offers consignment opportunities for the used Audio market. Top Dollar Offered. Call for Information. New Equipment also. Call 1-800-752-4018.

B&O • B&W • CARVER • DENON • FOSGATE • H/K • KEF • LEXICON • NAD • NAKAMICHI • ONKYO • POLK • VELODYNE • 24 HOUR AUTOMATED PRICING • MANUFACTURERS WARRANTIES • COURTEOUS ASSISTANCE • AMERICAN THEATER SYSTEMS (904) 321-0100.

SINGERS! REMOVE VOCALS
Unlimited Backgrounds™

From Standard Tapes, Records, & CDs with the Thompson Vocal Eliminator™. Call Now for Free Catalog & Demo Tape. Phone (404)482-4189-Ext 51

LT Sound, Dept AG-15
7988 LT Parkway
Lithonia, GA 30058
24 Hour Demo/Info Request
Line (404)482-2485 - Ext 51
The Thompson Vocal Eliminator™ - Better Than Karaoke!



AUDIO CABLES & MORE



**DON'T PAY EXORBITANT PRICES
! FOR TOP QUALITY !**

We have equaled the high-priced brands. Sonic equivalents at a fraction of their cost. We demystify wire technology. Ask for literature.

AND MORE! DACS, Anti-Jitter Units, CD Players/Transports, Speaker Stands, Speakers, Home Theater, Prologic, Accessories-& MORE. Call 800-321-2108 24hrs./day for free catalog.

L A T INTERNATIONAL
Dept. A 317 Provincetown Road
Cherry Hill, NJ 08034

FOR SALE

FOR TWENTY YEARS WE HAVE BEEN THE SOURCE FOR ALL OF YOUR BLANK AUDIO/VIDEO TAPES AND ACCESSORIES, EVEN REEL-TO-REEL TAPES FOR STUDIOS, AT DISCOUNTED PRICES. CATALOG AVAILABLE. SOUND INVESTMENT CORPORATION, 3586 PIERCE DRIVE, CHAMBLEE, GA 30341. (800) 659-TAPE (8273). IN GA (404) 458-1679. FAX: (404) 458-0276.

AUDIO SOLUTIONS is Atlanta's Hi-End source for Audio Research, Theta, McCormack, Wire World, Cary Audio, Vanders-teen, CODA, Straightwire, Acurus, Snell, Sumiko, SOTA, NHT, Kimber Kable, Magnum Dynalab, Audible Illusions, Rotel, VPI, Paradigm, Dunlavy, Sony ES, Sony Video, Pass Labs, Proac. 5576 Chamblee Dunwoody Rd. (404)804-8977.

Wholesale Connection

Call Toll Free 1-800-226-2800

Receivers • C.D. Players • Tape Decks • Mini Disc Recorders • DAT Recorders • Home Speakers • Mini Systems • Laser Disc Players. JVC • Technics • Kenwood • Pioneer • Harman Kardon • Bose • Infinity • Advent • Pinnacle • Aiwa & More.
Wholesale Connection, 63-48 108th St. Forrest Hills, NY 11375

FRIENDLY PEOPLE & EXPERT ADVICE !

ABC
American Buyer's Club
1-800-354-1324
ABC 130 HIGHWAY 33 • ENGLISHTOWN, NJ 07726

FOR INFO OR CUSTOMER SERVICE CALL 908-780-6600 FAX ORDER 908-294-7480

Wholesale Prices To The Public...

RECEIVERS	CD PLAYERS	VIDEO
YAMAHA RX-V1070 & 870 CALL	YAMAHA CDC-645 CALL	SONY CAMCORDERS CCD TR-400 CALL
CARVER HR-995 CALL	CARVER CDC-745 CALL	CCD TR-700 CALL
DENON AVR2500 & 3000 CALL	HARMAN KARDON TL-8400 CALL	CCD TR-91 CALL
HARMAN KARDON AVR30 & HR-3600 CALL	HD-7525 CALL	CCD TR-70 CALL
JVC FX-915 375	TOP RATED	SONY VCR'S SLVR1000 S-VHS USA
KENWOOD KRV-7060 325	NAKAMICHI MB-2 & MB-3 CALL	BEST SILV-990HF CALL
NAD T100X & 705 CALL	ONKYO DX-C205 CALL	SLV-701HF & 720HF CALL
NAKAMICHI AV-1 799	PIONEER CLD-D503 CALL	EV'S VDS-7200 HI-8 CALL
RECEIVER 2 & 3 CALL	ONKYO PD-M703 CALL	SONY LASER MDP-400 CALL
ONKYO TX-SV-9118X CALL	SONY CDP-C645 CALL	PARASONIC VIDEO CALL PR-2000 CALL
PIONEER VSX-D903S 689	CDP-P745 CALL	NIKON CAMCORDERS VN-760 CALL
SONY STR-D1015S CALL	CDP-CX100 100 CD	JVC VHS-C GRX-5 S-VHS CALL
SPEAKERS	CELESTION ES-1200 HI-8 CALL	GRX-7 COLOR W/RENDER CALL
BIC ALL MODELS CALL	ONKYO NAKAMICHI FOR	JVC VCR'S FOR ALL MODELS CALL
BOSE AMS SII & AM7 CALL	YAMAHA YAMAHA FOR	HRS-6900 CALL
CELESTION MANY MODELS CALL	DENON H. KARDON BEST	HRS-9300 CALL
INFINITY REFERENCE 3 CALL	PIONEER PIONEER PRICE	CANON CAMCORDERS ES-7C 12X ZOOM CALL
REFERENCE 6X CALL	SONY MINI DISC CALL	HITACHI VMH50A-HI-8 COLOR V.F.
KLIPSCH MANY MODELS CALL	SEPARATES	VM-E30A TOP RATED
MIRAGE MANY MODELS CALL	ACURUS FULL LINE CALL	VM-HD7A LATEST HI-8
NHT HDPI & SUPER ZERC CALL	ADCOM GTP-450 CALL	CALL ABC HITACHI VCR'S
PARADIGM TITAN AND TISE II CALL	GFA-555MKII CALL	GO VIDEO CALL ABC VCR'S 499.99/8UP
POLK AUDIO S-8 AND LS-70 NEW	ACE-151 A MUST CALL	RCA 8MM CAMCORDERS
RM-3000 CALL	CARVER TFM-95 CALL	PRO-430 CALL
PSB MANY MODELS CALL	CT-17 CALL	PRO-400, 800, 808
SUBWOOFERS NHT 2700THX CALL	TFM-35 499	USA WARRANTY INCLUDED
NHT SWZP CALL	HAFLER RM-3000 CALL	CAR STEREO CALL 908-780-6600
VELODYNE & BIC IN STOCK CALL	YAMAHA DSP-A2070 CALL	ALPINE AUTOTEK CALL
	DSP-A970 CALL	BOSTON ACOUTICS COLLINS-INFINITY
	CALL ABC FOR SONY HOME AUDIO	JBL • LA. SOUND MT • POLK • SONY

MILLION DOLLAR INVENTORY
5 YEAR WARRANTIES AVAILABLE FOR ALL ITEMS

TEAC X1000R 10 1/2" auto reverse reel deck. \$595 rebuilt with warranty. HALL ELECTRONICS, 706 Rose Hill Drive, Charlottesville, VA 22901. (804)984-4255. FAX: (804)984-3299.

FOR SALE

**AUTHORIZED AUDIO/VIDEO/CAR
1-800-348-7799 FAST DELIVERY
FULL MANUFACTURERS U.S.A. WARRANTY
BRAND NEW, FACTORY COMPLETE**

ADS	CAR	JAMO	AUDIO	PYLE	CAR
ADCOM	AUDIO	JBL	AUDIO	POLK	AUDIO
ADCOM	CAR	JBL	CAR	POLK	CAR
ADVENT	AUDIO	JVC	AUDIO	PARASOUND	AUDIO
ADVENT	CAR	JVC	CAR	"RCA"	L.C.D. T.V.
AIWA	AUDIO	JVC	VIDEO	ROCKFORD	CAR
ALTEC	AUDIO	KEF	AUDIO	SHARP	T.V.
ALTEC	CAR	KENWOOD	AUDIO	SHARP	AUDIO
A. F.	AUDIO	KENWOOD	CAR	SONY	VIDEO
ATL TECH	AUDIO	KICKER	AUDIO	SONY	AUDIO
BAZOOKA	CAR	KLH	AUDIO	SONY ES	AUDIO
BEL	CAR	KLIPBCH	AUDIO	SONY ES	CAR
BOSE	AUDIO	LEXICON	AUDIO	SHERWOOD	AUDIO
B & W	AUDIO	ME QUARTZ	AUDIO	SHERWOOD	CAR
B & O	AUDIO	MAGNAVOX	VIDEO	TAPES	VHS
CELESTION	AUDIO	METRISH	AUDIO	TAPES	BETA
CELESTION	AUDIO	M & K	AUDIO	TAPES	8mm
CLARION	CAR	NAD	AUDIO	TECHNICS	PRO LINE
DENON	AUDIO	NAKAMICHI	AUDIO	TECHNICS	AUDIO
DUAL	AUDIO	ONKYO	AUDIO	THORENS	AUDIO
"G. E"	VIDEO	PARADIGM	AUDIO	TOSHIBA	VIDEO
HAFLEER	CAR	PHILIPS	AUDIO	TOSHIBA	CAR
HITACHI	AUDIO	PIONEER	AUDIO	TROPEZ	PHONES
H. K.	AUDIO	PIONEER	CAR	VELODYNE	AUDIO
INFINITY	AUDIO	PIONEER ELITE	AUDIO	YAMAHA	AUDIO
INFINITY	CAR	PIONEER PREMIER	CAR	YAMAHA	CAR

MasterCard, Visa, welcome. Shipping charges additional, insured. Return Policy 14 day trial period for defects, exchange only. Shipping charges not refundable.
2958 N. University Dr. Suite #35 Coral Springs, FL 33065
*FACTORY AUTHORIZED DISTRIBUTOR AUTHORIZED

BEST \$1,500 LOUDSPEAKERS THX HOME THEATER

Alon - B&W - VMPS - Bang & Olufsen - Adcom - KEF - Harman/Kardon - Mirage - Crown - Celestion - Eminent Technology - McCormick - VTL - Denon - Triad - Polk - Velodyne - Fosgate - Signet - Audible Illu-sions - Snell - Carver - B&K - Unity - Alchemy + 25 More Brands. Honest Advice! TECH ELECTRONICS (904) 376-8080.

MUSICAL CONCEPTS = CD MUSICALITY

Blissful satisfaction with CD sound is possible! ENIGMA, "\$10,000 smoothness" for \$695, EPOCH, "Seductive, Sweet, Natural!" \$995, CDT-4 Transport \$695. All have "Stable Platter!" ENTIRE CD player and CDT-5 Transport "Simply incredible values", \$495/each. Audio Alchemy mods and power supplies, from \$149. We modify Philips-based, Pioneer CD/Laserdisc. We add "COAX" to CD/Laserdisc with "OPTICAL" MUSICAL CONCEPTS, 5749 WESTWOOD DR., ST. CHARLES, MO 63304. 1-314-447-0040.

FREE SHIPPING! PLUS:

EXPERIENCED, FRIENDLY ADVICE! MIRAGE, PS, CWD, KEF, KINERGETICS, PHILIPS, AUDIOQUEST, FRIED, MONSTER, KIMBER KABLE, SPICA, CARY, STRAIGHTWIRE, QUAD, MORE! READ BROTHERS, 593 KING, CHARLESTON, SC 29403. (803) 723-7276.



Greencorp USA, Inc.

*Premium quality cassettes
at wholesale prices*

• Made in Australia •

Call 1-800-972-0707

FOR SALE

Hardbound AUDIO, annual bound volume editions, just like the ones in the Editor-in-Chief's office. Various years available in limited quantities, \$40.00 each. Also available: Hardbound October Annual Equipment Directories. Years 1992, 1991, 1990, & 1987 \$15.95 each, and hardbound May Car Stereo Directories for years 1991, 1990, 1989 and 1985, \$8.00 each. All prices include postage and handling. All orders postpaid. Check or money order only (no credit card orders) payable to AUDIO MAGAZINE. Send orders to AUDIO, 1633 Broadway, New York, N.Y. 10019. Attn: Michael Bieber. Or call 212/767-6301 for further information.

LOUDSPEAKERS

LOUDSPEAKER COMPONENT - KITS. Audio Concepts, Dynaudio, Eclipse, Eton, LPG, Vifa, more! Crossover parts, design books & repairs. Catalog \$2.00. **MENISCUS**, 2575 28th St., S.W., Dept. A, Wyoming, MI 49509. (616) 534-9121.

CUSTOM ACTIVE ELECTRONIC CROSSOVERS. 6 to 36 dB/Oct. Also Snell, Magnepan versions. **DB SYSTEMS**, POB 460, RINDGE, NH 03461. (603) 899-5121.

Speaker Sale: ADS L1290: \$600; AR M4: \$250; Acoustat 1100: \$500; Acoustat 1.1: \$600; Canton Karat 920: \$450; Carver Amazing Silver: \$1200; Celestion 100: \$500; Cerwin Vega AT15: \$500; Dahlquist DQ12: \$700; Dahlquist DQ30i: \$1250; DCM Timewindow 3: \$600; Energy Ref. Con. 22: \$600; Genesis Genre 1: \$800; Harmon Kardon 60's: \$1800; Infinity Kappa 8.1: \$1000; Infinity Ref.6: \$500; Infinity Video 1: \$1000; JBL LX55: \$200; Jamo Indoor/Outdoor: \$100; Klipsch Forte: \$600; Klipsch KG5.2: \$550; Linn Isobarik DMS: \$750; MB Quart 990MCS: \$1200; Merlin Sig.III: \$1500; McIntosh XR-16: \$600; McIntosh XRT-18: \$1150; Mirage SM 2.5: \$100; Near 50M: \$1000; PSB Stratus Gold: \$1500; Pinnacle PN-5: \$100; Polk Monitor 10: \$250; Polk LS50: \$400; Polk 4.6: \$200; Proac Tablette II: \$600; Thiel CS3.5: \$1000; Thiel CS2: \$1400; Unity Audio Sig III: \$995. Call: (217) 544-5252.

1-800-NEW-FOAM. D.I.Y. REFOAM KITS OR WE DO THE WORK. SERVING AMERICA'S SPEAKER NEEDS SINCE 1979. VISA/MC/AMEX/DISC. 1-800-639-3626.

SpectrumAudio

The combination of our coaxial mounting system and our critically aligned phase-coherent directional crossover delivers incredible fidelity.

"A breakthrough in this price range...rivals systems costing many times more."

FROM \$249/PAIR

TO ORDER CALL

800.779.1723

P6W Intl. Corp., 1501 Monroe St. Suite 114, Toledo, OH 43624

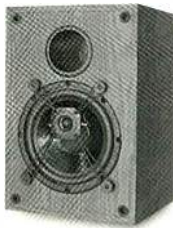

ROTTEN FOAM EDGES?

SIMPLY SPEAKERS does professional foam replacements any size/brand. 7 Year Warranty. We sell DIY Foam Surround Kits for less! Speaker refoaming. MC/VISA/DISCOVER/AMEX: 1-800-767-4041.

SPEAKER CATALOG

Parts Express is a full-line distributor of electronic parts and accessories geared toward the consumer electronics industry and the technical hobbyist. We stock an extensive line of speaker drivers and accessories for home and car. Send for your FREE 188 page catalog today.



Parts Express
340 E. First Street
Dayton, Ohio 45402-1257

1-800-338-0531

LOUDSPEAKERS

HEYBROOK DIRECT! Buy direct from the Importer & save on England's finest value in speakers. Point Fives \$198.00/pr. Solo's \$298.00/pr., HB100's \$398.00/pr., HB150's \$498.00/pr. D'Asign Source 305-743-7130.

LOUDSPEAKER CABINETS Large selection of excellent quality loudspeaker cabinets for custom builders and dealers. Grenier Cabinets, 189 Jennings Road, Horseheads, N.Y. 14845 (607)594-3838.

23 YEARS OF CRITICAL ACCLAIM



FULL ROOM STEREO™

3-D STEREO IMAGE LOUDSPEAKERS

FREE CATALOGUE! 800-231-3458. No matter where you sit you will hear balanced 3-D stereo image with Ohm FRS™ speakers. All Ohm speakers are designed to deliver FULL ROOM STEREO™. American Reco.Js Inc., 409 Plandome Rd., Manhasset, NY 11030. **FACTORY AUTHORIZED SALES/SERVICE.** Discover/Visa/MasterCard/Amex.

HALLADAY ACOUSTICS introduces the ERIN 2.2 full range "Volkmonitor." SANDBAR™ Oak cabinet, VIFA silk dome, 8" PEERLESS woofer, and our TRANSILVER™ silver wired "perfect" crossover yield incredible results. Call or write for the whole story and 1995 catalogue. HALLADAY ACOUSTICS, 713 Spring Street, Suite #8, Saratoga Springs, NY 12866. (518) 581-8095.

OHM SPEAKERS 800-ohm-1254

Upgrades and service plus complete speaker systems from \$200 to \$7000 per pair. Ohm Acoustics, 241 Taaffe Place, Brooklyn, NY 11205.

REPAIR FOAM ROT FOR YOURSELF!

SAT will save you hundreds of dollars! All sizes including AR, Advent, BOSE, JBL Surrounds, adhesive & instructions \$27.95/pr. BOSE 901's \$67.95/pr (incl S/H, No COD'S) Do it yourself with SAT!



STEPP AUDIO TECHNOLOGIES
PO Box 1088, Flat Rock, NC 28731

800-747-3692 MC/VISA
704-697-9001 24 Hr
Incl. make & model w/order

TRUE SUBWOOFER

With phenomenal true deep bass extending below 20Hz with low distortion at a very affordable price.

The new HRSW12V will extend the bass of your stereo or video system for that "air shaking all around you" effect.

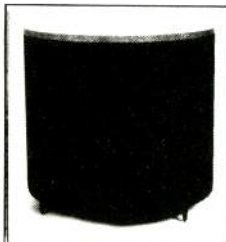

HSU Research HRSW12V

Here's what the experts said of our 100W, 25Hz prototype shown at the Winter CES (production units are 150W, 20Hz):

"...all of the non-boomy, stomach-massaging bass energy was coming from a single 12-inch powered subwoofer..."
Peter Mitchell, *Stereophile* Vol. 17 No. 4, April 1994

"...delivered enough punch to shake the sturdiest shelf..."
Brent Butterworth, *Video Magazine*, April 1994

"One of the most effective subwoofer demonstrations"
Gary Reber, *Widescreen Review* Vol. 3 No. 1, March 1994

Send for complete information on the HRSW12V and our famous HRSW10s.



Write or call:
HSU RESEARCH
20013 Rainbow Way, Cerritos, CA 90701
1-800-554-0150 (Voice)
1-310-924-7550 (Voice/Fax)

Sold factory direct with a 30 day trial - money back guarantee. 5 year manufacturer's defect warranty.

LOUDSPEAKERS

BETTER LOUDSPEAKER TECHNOLOGY

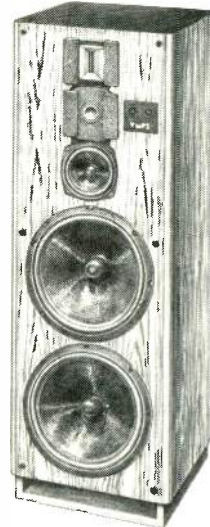

The VMPS Tower II SE 45 x 15 x 16", 109 lbs. \$1476/pr kit. \$1876/pr assem in lt oak, dk oak, or satin black.

The VMPS **Tower II Special Edition**, the deluxe version of an Audio Magazine "Best Buy" system, is now available with exclusive handbuilt, phase-plugged **woven carbon fiber 12"** woofers, the finest dynamic drivers extant.

These high-tech cones are also now standard in our flagship **FF-1 Focused Field Array** (\$6800-\$7200pr), four of which made up the VMPS 1994 WCES Surround Sound display. After auditioning every multichannel/Home Theater display at the Show, the editor of *Widescreen Review* judged the VMPS room best, and by a wide margin. Call or write for copies of the full editorial, or for brochures and test reports on all VMPS systems including our four **Subwoofers** (\$289-\$649ea), the **QSO626** and **Dipole Surround A/V** monitors (\$289-\$349ea), **QSO Series** bookshelf systems, and more. Kit versions of most systems are available, and prices include free shipping in 48 states.

VMPS AUDIO PRODUCTS

div. Itone Audio
3429 Morningside Dr.
El Sobrante, CA 94803
(510) 222-4276 Fax: (510) 232-3837

Hear VMPS at: The Listening Studio, Boston; Sounds Incredible, Brookfield CT; Dynamic Sound, Washington DC; Hifi Farm, Roanoke VA; Home Theater Systems, Little Falls NJ; Mark Curry, Las Vegas, NV; AMUG, Phoenix AZ; Rama Audio, Sun Valley CA; American Audio, Greenville SC; Chattanooga Valley Audio, Rossville GA; Tech Electronics, Gainesville FL; Arthur Morga, Lake Mary FL; DNA Audio, Orange City FL; Sounds Deluxe, Clarendon Hills IL; Audio Exchange, Mishawaka IN; Audio Connection, Terre Haute IN; Ruth Industries, St. Louis MO; Shadow Creek Ltd., Minneapolis MN; Audio by Gil Morrison, Detroit MI; Lookout Electronics, Longview WA; Affordable Audio, Fresno, CA; Exclusively Entertainment, Oceanside, CA; Hal Broda, Escondido CA; Christopher Hansen Ltd., Beverly Hills CA; Audio Haven, Brea CA; Sounds Unique, San Jose CA; Private Line Home Entertainment, Stockton CA; Golden Ear, Chico CA; Itone Audio, El Sobrante CA; James Romeyn, Petaluma CA; The Sound Room, Vancouver BC Canada

LOUDSPEAKERS

VMPS factory assembled speakers. Lowest Prices, shipped direct to you. Free Price sheet, Arthur Morgan, 886 East Charing Cross Cir., Lake Mary, FL 32746.

We set out to build the best three-way loudspeaker system and to offer it at a reasonable price.

The Model 50

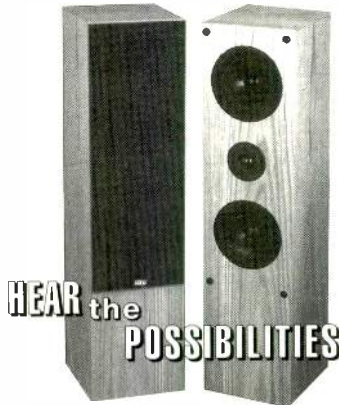

NSM

P.O. Box 326, Garden City, New York 11530-0326
Phone: 516-486-8285 • Fax: 516-538-0933

STATE OF THE ART CROSSOVER NETWORKS. UP-GRADE ANY SPEAKER SYSTEM. DESIGN GUIDE- \$2.00 (REFUNDABLE). ALLPASS TECHNOLOGIES, INC., 2844 CHARMONT DR., APOPKA, FL 32703-5972.

REVOLUTIONARY WORLD CLASS TWEETER: Kryptonite™ RIBBED Dome, 20,000 Gauss, No Basket, no surround. GLASSCONE™, RIBBED Woofers, with PARABOLE™ surround. Zero modal break up. White Electronics, Box 403, Stanford, IN 47463. FAX: (812) 825-3355 SENSATIONAL.

HAL COX (FRIEND OF JIM LANSING), SINCE 1947 BUYS/ SELLS "HARTSFIELD", JBL, ALTEC, EV-PARAGON, OLYMPUS. SPECIAL: JBL 4312 BK MONITORS \$499/PAIR. SHIPS WORLDWIDE. VISAMC, (415) 388-5711. FAX: (415) 388-3359. 164 TAMALPAIS AVENUE, MILL VALLEY, CA 94941. SAN FRANCISCO AREA.

THE GOETZ/VANDERSCHAFF SPEAKER COMPANY BUILDS SPEAKERS FOR THOSE WHO RECOGNIZE THE VERY BEST. WE HAVE BEEN FURNISHING HIGH QUALITY SPEAKER SYSTEMS ON A PERSONAL BASIS FOR 15 YEARS. OUR PRICE RANGE IS \$1200 TO \$4500. CALL US AT (704) 884-9842 (NORTH CAROLINA).

RECORDS

LV/CD/RECORD COLLECTOR'S SUPPLIES. Jewel boxes, record jackets, sleeves, storage boxes, 78 sleeves, dividers, much more! Free brochure: CABCO PRODUCTS, ROOM 663, POB 8212, COLUMBUS, OH 43201. (614) 267-8468.

PRESERVE + MAINTAIN + RESTORE™

LP-78RPM-4CH • Pickering • Stanton • Shure • Nitty Gritty • Vacuum Record Cleaners from \$99.95 • Special Brushes & Fluids • 3-Speed Turntables • Signal Processors • Discounts • Free Catalog! • KAB Electro-Acoustics, P.O. Box 2922, Plainfield, N.J. 07062-0922 (908)754-1479.

HALF MILE VINYL. Quality pre-owned LPs. F/Information, Catalog, SASE: Box 98, East Wareham, MA 02538. (508) 295-2508.

WANTED TO BUY

TOP DOLLAR PAID FOR YOUR USED AUDIO EQUIPMENT. HI FI EXCHANGE (718) 423-0400.

WANT — JBL Hartsfield, EV Patrician, Singles OK, McIntosh, Marantz & other tube equipment. Larry Dupon, 2638 W. Albion, Chicago, IL 60645. (312) 338-1042, evenings.

MARANTZ & ALL VINTAGE EQUIPMENT, HIGH-END. No one pays MORE, working or not! N.Y.S.I. (718) 377-7282, 2-6pm, WEEKDAYS.

US 1st Exporter, David Yo since 1977 always buying: Tube Marantz, McIntosh, ARC, Quad, Leak, Fisher, Dynaco, Vintage speakers, units from Western Electric, Tannoy, EV, JBL, Altec, Jensen, Thorens TD124, Garrard 301, etc. P.O. Box 280802, Northridge, CA 91328-0802. Tel: 818-701-5633.

WANTED TO BUY

AAAALWAYS PAYING TOP \$\$ FOR CLEAN, COLLECTABLE MCINTOSH TUBE AND SOLID STATE, MARANTZ TUBE, WESTERN ELECTRIC, JBL-PARAGON, HARTSFIELDS, ETC. & ALNICO PARTS. EV PATRICIANS, GEORGIANS & MISC. PARTS. M. LEVINSON, KRELL, ARC, SPECTRAL ETC. CALL ME LAST ONLY WHEN YOU'RE READY TO SELL! JOHN: 1-800-628-0266.

TUBE HIFI, CORNER SPEAKERS, THEATER & AUDITORIUM TUBE AMPS, McIntosh, Altec, RCA, Western Electric, Jensen, Marantz, Heath, Dynaco, Craftsman, Eico, Etc. Sonny 405-737-3312.

CASH for USED AUDIO & VIDEO EQUIP. BUYING and SELLING by PHONE. CALL for HIGHEST QUOTE. (215) 886-1650 Since 1984. The Stereo Trading Outlet, 320 Old York Road, Jenkintown, PA 19046.

TOP PAYING FOR MCINTOSH, MARANTZ TUBE AMP McIntosh Solid state, Western, JBL, Altec, Tannoy, EV, Jensen, Speakers & Horn, EMT Turntable, Ortofon Arm Temma—(516) 942-1212, (516) 496-2973.

WANTED: WESTERN ELECTRIC, JBL, MARANTZ OLD EQUIPMENT. SUNLIGHT ENGINEERING COMPANY: 310-320-7020, 22130 SOUTH VERMONT AVENUE, #A, TORRANCE, CA 90502.

Higher offering with CASH for your used Hi-End audio electronic equipment. EASTERN AUDIO, (718) 961-8256. 11AM-7PM, Mon.-Sat. Fax: (718) 961-8315 (NY).

AUDIO CLASSICS BUYS-SELLS-TRADES-REPAIRS High End Audio Components. CALL for a quote. See our ad at the beginning of the classifieds. AUDIO CLASSICS, LTD., POB 176WB, Walton, NY 13856. Phone: 607-865-7200. 8AM-5PM EST Mon.-Fri., FAX: 607-865-7222.

AUDIOPHILE RECORDS

Analogue Productions
Mobile Fidelity - Wilson
Reference Recording - Chesky
Sheffield Lab - Harmonia Mundi
Prophus - RCA Living Stereo - Klavier
Mercury Living Presence - plus many more
in and out of print recordings!

Catalog \$3 in USA, \$5 elsewhere - refundable

ACUSTIC SOUNDS 1-800-525-1630
P.O. BOX 2043 • SALINA, KS 67402-2043
1-913-825-8609 • FAX 1-913-825-0156

Visa
MasterCard

CABLE TV

CABLE T.V. CONVERTERS: JERROLD, ZENITH, OAK, SCIENTIFIC ATLANTIC, ALL BRANDS AVAILABLE. LINK YOURSELF TO THE FUTURE! VISA, MASTERCARD, C.O.D.'S ACCEPTED. CABLELIX, INC.: 1-800-501-0095.

CABLE T.V. CONVERTERS! JERROLD, OAK, ZENITH, SCIENTIFIC ATLANTA, PIONEER...EXCELLENT PRICES! PERSONABLE SERVICE! 30 DAY MONEY BACK GUARANTEE! INNOVATIVE ELECTRONICS INC. 800-493-5474 VISA/MC/C.O.D. ASK FOR JOHN OR BILL!

CABLE TV DESCRAMBLERS/CONVERTERS! WE BUY, SELL, REPAIR ALL MAKES/MODELS! ASK ABOUT OUR INDUSTRY EXCLUSIVE UPGRADE/REFERRAL PROGRAM! MEMBER UNITED STATES BUSINESS BUREAU & NATIONAL CONSUMER CABLE ASSOCIATION! FREE CATALOG: 800-407-4444 OR 305-428-8944!

CABLE TV DESCRAMBLERS. SAVE MONEY, DON'T RENT! NOBODY BEATS OUR PRICE! CALL US LAST FOR THE BEST PRICE!! ALL BRANDS 24 HOUR SHIPPING. VCI 1-800-677-0321.

SERVICES

Inexpensive repairs on amplifiers, preamps, receivers and signal processors. Flat rates on Hafler, Dynaco, and Phase Linear. Fax/Phone Midwest Power: 614-351-0895.

SERVICES

ACCUPHASE

AUTHORIZED SERVICE AND PARTS for all Accuphase products. Contact: ACCUTECH, 206 E. Star of India Lane, Carson, CA 90746. TEL. (310) 324-7406, FAX (310) 324-7422. Hours: 9am-4pm Pacific Time.

Audio Equipment Built, Repaired, Modified and Restored by Richard Modafferi, independent consultant to Audio Classics, Ltd., inventor, and former Senior Engineer at McIntosh. AUDIO CLASSICS, LTD. POB 176RTM, Walton, NY 13856 Phone: 607-865-7200 8AM-5PM EST Mon.-Fri., FAX: 607-865-7222.

SPECIALIST, TUBE EQUIPMENT CUSTOMIZATION Repair Services. Vintage military tubes & parts available. Custom and Vintage tube equipment for sale. Selected Telefunken 12AX7's available. BWS Consulting, 5609 N. 23rd Street, Arlington, VA 22205. (703)536-3910.

MISCELLANEOUS

ANNOUNCING HI-FI '95, THE STEREOPHILE HIGH-END SHOW, in Los Angeles, April 28, 29, 30, 1995. At the Doubletree Hotel, Los Angeles Airport, 5400 West Century Boulevard, (one mile east of LAX), Los Angeles. Our Fourth Show in Southern California. See and hear the best in high-end hi fi, and home theater. Enjoy live concerts. Participate in question-and-answer sessions with STEREOPHILE'S editors and writers. Shop from a wide selection of LPs, CDs, and accessories. Tickets by mail, \$18; at the door \$25. EACH TICKET IS VALID FOR ALL 3 SHOW DAYS. Write or Fax: THE STEREOPHILE High-End Show, 208 Delgado, Santa Fe, NM 87501, Fax (505) 989-8791.

PARTS AND ACCESSORIES

TUBE TRAP

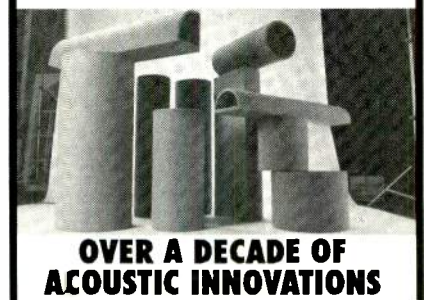

OVER A DECADE OF ACOUSTIC INNOVATIONS

ACOUSTIC SCIENCES CORPORATION offers you the technology & a special economy product line for Home Audio. For recommendations on how to improve your listening space, call 1-800-ASC-TUBE. (1-800-272-8823).

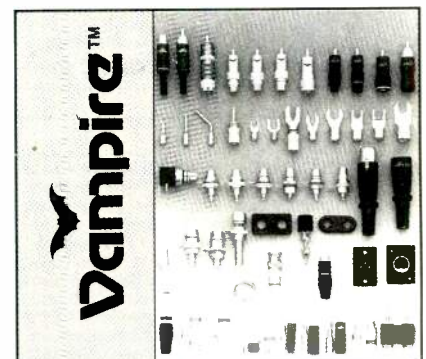

...audible results with the finest
h connecting components!

SOUND CONNECTIONS INTERNATIONAL, INC.
203 Flagship Dr.—Lutz, FL USA 33549
PH: 813-948-2707 Fax: 813-948-2907

PARTS AND ACCESSORIES

Premium Grade Parts

Don't Pay More!

Absolutely the best selection of audiophile grade parts at fair prices! Extensive deep in stock inventory featuring these vendors and many more: **Free** catalog! MIT MultiCap, Wonder Cap, Solen, SCR, Rel-Cap, Nichicon Muse, Black Gate, Caddock, Vishay, Mills, Holco, Resista, TDK, Alps, Noble, EAR, Deflex Panels, Cardas, Kimber, Acrotouch, & pure silver chassis wires, Hexfired diodes, Solo foil inductors, all types of audio connectors, silver contact toggle & rotary switches, stepped attenuator kits, hospital grade plugs, tubes, tools, IC's, super selection of damping materials & feet. International/overseas orders are especially welcome! Phone (415) 669-7181 or fax (415) 669-7558 for a catalog. **Michael Percy, Box 526, Inverness, CA 94937**

N.O.S. PAPER OIL CAPS • SPRAGUE VIT-Q, BLACK BEAUTIES, WESTCAP ETC., N.O.S. ELECTRON TUBES, SOCKETS, HARDWARE, ETC. KURLUFF ENTERPRISES, 4331 MAXSON RD., EL MONTE, CA 91732. 818/444-7079. FAX: 818/444-6863.



Get on our list - to get closer to this list.

- MIT MultiCap • Wonder Cap • Kimber Kap • Solo • Hovland MusCap
- Solen • Siemens • Wima • Holco • Rel-Cap • Draloric • IRC • Allen-Bradley
- Jensen • Resista • Vishay • Caddock • Mills • Matsushita • TKD • Noble
- Cardas • Kimber Kable • van den Hul • Discovery • Audioquest • MIT
- Alps • Bourns • Shalco • Elma • Electros witch • Nichicon • Gold Aero • RAM
- Mallory • Panasonic HFD • Nichicon • Elna • New Old Stock • Ruby Tubes
- UltraAnalog • Burr-Brown • Crystal • Linear Technology • Analog Devices
- Edison Price • International Rectifier • Hitachi • Motorola • UCC
- MagneQuest • Sonic Frontiers • Pearl • Tube Sockets • WBT • Neutrik
- Sound Coat • Curcio Audio Engineering • Assemblage and other kits

And it's growing and growing. To order The Parts Connection 1995 Catalog & Resource Guide, send \$10 and mailing information. You'll also receive a Discount Coupon worth \$10 off a purchase over \$100 or \$25 off a purchase over \$250 as well as *The Breadboard* bulletin to keep you updated on our latest news, information and growth spurts. or credit card information

THE PARTS CONNECTION
A DIVISION OF SONIC FRONTIERS INC.
2790 Brighton Road, Oakville
Ontario, Canada L6H 5T4
Toll Free Order Line
1-800-769-0747
(U.S. & Canada only)
Tel (905) 829-5858
Fax (905) 829-5388

250 PAGE CATALOG AND DESIGN MANUAL: CHECKOUT OUR KITS!!! MOSFET Power Amplifiers, Single-Ended 300B Triode Amps; Passive, Buffered and Class-A Linestages; PhonoDrives, Softstarts, and Active Crossovers. Largest Selection of Parts and Supplies including: Kimber Kap, MIT MultiCap, Solen, WIMA, Wonder Caps, Hovland MusCap, RAM Labs and Golden Dragon Tubes, Kimber Kable, DH Labs, Vampire, Cardas, WBT, Neutrik, Magnequest™ Output Transformers, Caddock, Holco, and Mills Resistors, etc. Plus Lots of Enclosures and Custom Chassis. Send \$12 (U.S./Canada) or \$16 (International). Or call (303) 470-6585, fax (303) 791-5783. Visa/MC Accepted. Welborne Labs, P.O. Box 260198, Littleton, CO 80126-0198.

HELP WANTED

EASY WORK! EXCELLENT PAY! ASSEMBLE PRODUCTS AT HOME. CALL TOLL FREE. 1-800-467-5566. EXT. 11325.

AUDIO/VIDEO STORAGE

CD STORAGE +™



No. A300 (Shown in Solid Brown Oak)

SORICÉ SYSTEMS Include... Video, Cassette, LP, Laserdisc and Component Storage Units.

- ❖ Our A300 Model shown stores 300 CD's.
- ❖ Impeccably crafted in these Premium Solid Hardwoods: Oak, Walnut, Teak or Cherry.
- ❖ Adjustable Shelves store any combination of CD's, Videos & Cassettes - all in One cabinet.
- ❖ Adjustable Solid Brass Bookends keep Discs & Tapes upright and in place.
- ❖ Cabinets can be stacked, wall mounted or left free standing.
- ❖ Optional Wood or Glass Doors are available.
- ❖ Enclosed back provides dust protection.
- ❖ Compact size: 39 1/2"H x 23 1/2"W x 7 1/2"D. Cabinet comes assembled.



PO Box 747-22, Nutley, NJ 07110
Credit Cards, Checks and Money Orders accepted.
30 Day Money Back Guarantee and a Full One Year Warranty on all Models.

For **FREE** Color Literature & Prices on our Full Line of Quality Products
Call: 1-800-432-8005
Fax: 1-201-667-8688

PUBLICATIONS

MUSIC YOU NEED

NEWSLETTER. REVIEWS OF RECORDINGS: ROCK, JAZZ, ETC. ALL WHEAT, NO CHAFF ENHANCE YOUR COLLECTION. \$25 FOR TEN ISSUES. MUSIC YOU NEED, DEPT. A, 655 EIGHT ROD WAY, TIVERTON, RI 02878.

BUILD YOUR OWN LOUDSPEAKERS

Speaker Builder the world's best speaker periodical shows you how. Send today for your first free copy

PO BOX 494, PETERBOROUGH NH 03458

MOVIESOUND NEWSLETTER. The state of film audio tracks in theaters and at home. \$8/year (4-issues). Send \$2 for two sample issues. P.O. Box 7304, Suite269A, No. Hollywood, CA 91603.

BLANK TAPES

1-800-TAPE WORLD or 1-800-245-6000
We'll beat any price! 5.95 SHIPPING • FREE CAT.

SONY	MAXELL	TDK	FUJI
DAT-120 7.49	T120HGX 2.79	T-120HS 1.89	T120HQ 1.99
DAT-120 PRO 9.99	SI-120 6.99	T-120HG 2.49	T-160HQ 2.69
MNI DISC 74 11.99	SI-160 8.99	SI-120 6.99	SVHS-1120 6.69
L750BTHG 3.99	XLI-90 1.79	SA-90 1.69	SVHS-1160 8.99
JVC T120 1.79	XLI-S90 2.29	SAX-90 2.19	HI-8 120 5.99
JVC SI120 6.49	XLI-S100 2.69	SAX-100 2.69	MNI DISC 74 10.99
	DAT-120 7.99	DAT-120 6.99	DR-190 7.99

TAPE WORLD 220 SPRING ST., BUTLER, PA 16003 FAX 412-283-8298
OVER 400 DIFFERENT. SAME DAY SHIPPING. M-F, 8-5

CD CABINETS

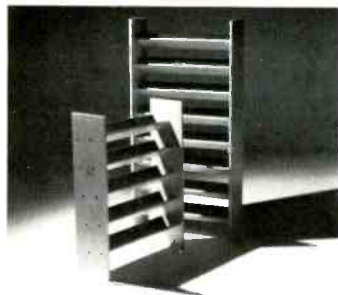

STORADISC™ - See why CD Review picked our Library Series as their "top choice". Fine-furniture quality in a variety of finishes and sizes. Call or write DAVIDSON-WHITEHALL, 555 Whitehall Street, Atlanta, GA 30303. 1-800-848-9811.

BUSINESS OPPORTUNITIES

AUDIO AMERICA is offering an excellent opportunity to start your own audio-video business. With over 25 years experience, we offer expert advice and consultation on all aspects of business planning and operation. For complete information, call **1-703-745-2223.**

Let Us Entertain You!



PARA Home Theater Specialists

When you're buying audio and video components, it's important to understand that it's not enough to buy a good TV and VCR. Components must also be chosen for how they sound together. PARA is a professional association of independent specialty audio/video stores who are committed to the highest standards in retailing.

- ▼ PARA stores will take the time to ask about what you already own and suggest home theater components that will integrate into your current system.
- ▼ PARA home entertainment professionals are educated to explain the newest technologies in clear, friendly language, helping you get the best value for your money.
- ▼ Let us help you choose the system that's just right for you.

CALL 1-800 4-PARA 94 to find the PARA dealer nearest you!



AD INDEX

Firm (Reader Service No.)	Page
Adcom (1)	13
Advent/Crutchfield	24
Advent/Sears Brand Central	33
Audiophile Systems	25
AudioQuest	64, Cover IV
Audio Research (3)	86
B & W Loudspeakers (4)	7
Bacardi	*17
BMG	40 a & b
Brystonvermont (5)	21
Caig Laboratories (6)	92
Cambridge SoundWorks (7, 8)	18 & 19, 20
Carver (9)	60
conrad-johnson (10)	73
Crutchfield (11)	87
Dave's	*17, *27
Digital Phase (12)	65
Golden Strings (13)	33
Hales (40)	81
Infinity (14)	53
J & R Music World (15)	93
Kimber Kable (16)	82
Linn Hi-Fi	25
M & K Sound (17)	79
Martin-Logan	89
McIntosh (18)	29
Mirage (19)	59
Mobile Fidelity (20, 21)	85, 91
Mondial/Aragon (22)	3
NEON (23)	70 & 71
New West Electronics (24)	94
Paradigm (25)	23
Parasound	Cover II & 1
Parasound/Spica	24
Polyfusion Electronics (26)	55
Pontiac/Sunfire (27)	9-11
ProAc (28)	28
PSB Speakers (29)	15
Reel to Real (30)	75
Ruark Acoustics (2)	32
Sanus (31)	*27
Sennheiser (32)	22
Sound City (33)	90
Soundwave (34)	63
Southern Comfort	5
Spica	24
Sunfire Corporation (35)	48 & 49
Vandersteen (36)	57
Velodyne (39)	Cover III
Westlake Audio (37)	83
XLO Electric	77
Yakov Aronov (38)	74
Yamaha	30 & 31

*Regional Ad

AUDIO SUBSCRIBER SERVICE

PLACE LABEL HERE

MOVING? Please give us 8 weeks advance notice. Attach label with your old address, and write in new address below.

NAME _____

ADDRESS _____

CITY _____

STATE _____

ZIP _____

**1 (303) 604-1464
FAX 1 (303) 604-7455**

AUDIO

P.O. Box 52548, Boulder CO 80322

AUDIO, March 1995, Volume 79, Number 3. **AUDIO** (ISSN 0004-752X, Dewey Decimal Number 621.381 or 778.5) is published monthly by Hachette Filipacchi Magazines, Inc., a wholly owned subsidiary of Hachette Filipacchi USA, Inc., at 1633 Broadway, New York, N.Y. 10019. Printed in U.S.A. at Dyersburg, Tenn. Distributed by Warner Publisher Services Inc. Second class postage paid at New York, N.Y. 10019 and additional mailing offices. Subscriptions in the United States, \$24.00 for one year, \$42.00 for two years, \$58.00 for three years; other countries except Canada, add \$8.00 per year; in Canada, \$32.00 for one year (includes 7% GST; Canadian GST registration number 126018209).

AUDIO® is a registered trademark of Hachette Filipacchi Magazines, Inc. ©1995, Hachette Filipacchi Magazines, Inc. All rights reserved. The Editor assumes no responsibility for manuscripts, photos, or artwork. The Publisher, at his sole discretion, reserves the right to reject any ad copy he deems inappropriate.

Subscription Service: Postmaster, please send change of address to **AUDIO**, P.O. Box 52548, Boulder, Colo. 80321-2548. Allow eight weeks for change of address. Include both old and new address and a recent address label. If you have a subscription problem, please write to the above address or call 303/604-1464; fax, 303/604-7455.

Back Issues: For information, write to P.O. Box 7085, Brick, N.J. 08723.

PlayBack

Discwasher

HydroBath CD Cleaning System

The Discwasher HydroBath (\$59.95) is designed to remove surface contaminants, such as greasy fingerprints, from CDs. To clean a disc, you put about 2 ounces of CD6+ fluid into the HydroBath, place the CD on the spindle (label side up), close the lid, and press the start button. A 6-V d.c. motor spins the CD and sprays the fluid on its surface; a replaceable filter screen catches contaminant particles and keeps the fluid clean. The cleaning and drying takes about 45 seconds. A compartment on the bottom holds four AA batteries, but the unit can also be powered by an accessory 6-V d.c. adaptor.

The toughest thing that can happen to a CD, so far as the laser's ability to read the disc is concerned, is for finger grease to get on the bottom surface. I therefore gave this unit a worst-case test by putting some butter on a CD with my finger. Many other cleaners can't handle this, but the HydroBath could after

about six cycles. I repeated the test but

first wiped off most of the butter with a tissue; this time the unit removed the butter film in one cycle.

While I don't recommend mixing CDs and butter, if it does happen, the HydroBath will clean your CDs and restore them to playable condition. It's a very good investment. E.M.L.

For literature, circle No. 125

GRADE: A



DGX AUDIO DDP-1 DIGITAL PREAMP

It was just a matter of time before a product such as this came on the market. The DGX Audio DDP-1 (\$995) is a "digital deconvolution preamplifier" that provides for loudspeaker-specific equalization. Arrangement is made for digital in and out, digital in/analog out, and analog in and out. The unit I received came equalized for the B & W 801 Matrix Series 3 speakers, which I use as a reference; according to the provided equalization curves, there are a number of peaks and dips of a few decibels over most of the audio range, with a substantial bass boost of 8 dB below 56 Hz. To try out the DDP-1, I simply plugged a CD transport into the digital input and connected the audio outputs to my power amp. How did this sound compared to the normal unequalized feed to the speakers? Disturbingly better in some ways, especially the bass. Many sounds had a more natural timbre. There was some tendency toward hardness and irritation, but the more I listened, the more nuances I heard and the more I was impressed. (Construction quality, meanwhile, is adequate; the sheet metal is too thin.) In addition to 801 EQ, the DDP-1 is available with equalization for DGX's own DDL-1 speakers; equalization for other companies' speakers is contemplated.

For literature, circle No. 127

GRADE: A



B.H.K.

"PlayBack" mini-reviews are the result of short, sweet, and sometimes deadly testing by our all-too-experienced editors and writers. These hands-and-ears-only write-ups may look like new product announcements, but the grades and text reflect what the reviewer thought after less than an afternoon's "honeymoon."—E.P.

THIEL CS5i

Monitor Loudspeaker

The original CS5 rapidly became one of the most praised monitors on the market, and I have been using it as one of my references for several years. Thiel has now made the CS5 even better. The CS5i has a new set of woofers that provides better dynamic range in the bass, with substantially less bass distortion.

This not only improves the original speaker's ability to "rock" but also adds a slight

touch of apparent warmth and openness to the soundstage. The Thiel CS5i

costs \$12,300 per pair. If you already own the CS5, you can convert to the CS5i for \$1,200, or—if the serial number is lower than 529—you can get new sets of midrange drivers and woofers for \$1,500.

A.H.C.

For literature, circle No. 126



GRADE: A



*Velodyne VA-X Subwoofers.
Sound So Real You Can Feel It.*

At prices that sound unreal.

Sound moves us most when it's built on powerful waves of bass. Because bass is the heartbeat. That steady, pulsing beat that seems to flow from your home entertainment system right through your body. Touching, soothing, arousing, enhancing your every mood.

When that sound comes from Velodyne's new VA-X Series Subwoofers, it's more than just realistic. It's real. So real you don't simply listen to it. You feel it! And marvel that this high-definition, distortion-free sound could have such brute force and intensity.

Now it's easy to add VA-X Subwoofers to the audio/video home theater of your dreams. At a price that's music to your ears. To audition a Velodyne, call for the dealer nearest you: 1-800-VELODYNE.



Velodyne

Velodyne Acoustics, Inc.
1070 Commercial Street, Suite 101
San Jose, CA 95112
(408) 436-7270

Enter No. 39 on Reader Service Card

“Clearly the best sounding audiophile recordings today.”

The Absolute Sound Vol. 18, Issue 92

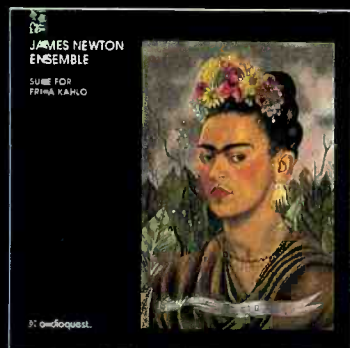

JAMES NEWTON 1023

SUITE FOR FRIDA KAHLO
The award winning flutist and composer celebrates the incredible life and work of Frida Kahlo.

“Brilliant!” -Jazz Times
“My choice for jazz record of the year.” -Stereophile
“**** A gem!” -DownBeat



KEI AKAGI 1028

MIRROR PUZZLE

Pianist and composer Kei Akagi has for many years been one of the most in-demand artists on the jazz and creative music scene. He has recorded and performed with, among others, Miles Davis, Stanley Turrentine and Freddie Hubbard. Kei's working band, featured here, includes fellow Miles Davis alum Rick Margitza on sax, bassist Charles Fambrough and drummer Willie Jones III. Pure musical magic!

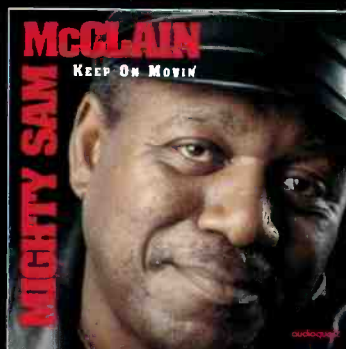

MIGHTY SAM MCCLAIN 1031

KEEP ON MOVIN'

Mighty Sam's first release for AudioQuest Music received a well deserved avalanche of critical praise. Pulse! magazine named it the Blues Album of the Year for '93. Rolling Stone called it "the R&B comeback of the year." How can Mighty Sam possibly top *Give It Up To Love?* Listen for yourself. He did. (Jan. 95 release)



EDWARD SIMON 1025

BEAUTY WITHIN
The rave reviews have been rolling in on this stunning synthesis of Latin music and power jazz.

“A striking statement...the alchemy is audible from the very first track.” -CD Review
“****An inner exploration...a relentless present day groove.” -DownBeat
“Defly straddles Afro-Cuban with hard bop.” -Jazziz

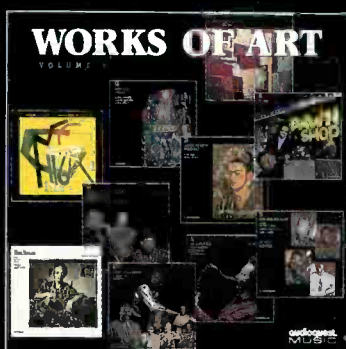

WORKS OF ART VOL. 3 1029

WORKS OF ART VOL. 3
Contains selected tracks from each of the last ten releases on AudioQuest Music. The ultimate demo disc!

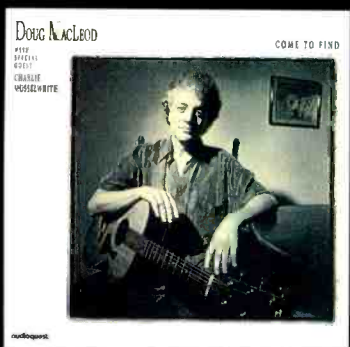

DOUG MACLEOD 1027

COME TO FIND
AudioQuest Music is proud to add one of the brightest singing and song writing talents in blues to its roster. *Come To Find* is the remarkable sound of a consummate bluesman touching the core of his art. He is beautifully supported in an intimate setting by harmonica ace Charlie Musslewhite and the Mighty Flyers' rhythm section, Jimi Bott and Bill Stuve. Don't miss this!

TO ORDER BY
PHONE OR RECEIVE
A FREE CATALOG
CALL 800-474-1977

**audioquest.
MUSIC**

State of the Art Music/State of the Art Sound