

\$3.95

THE TOP 20
OF HIGH-END AUDIO

THE BEST OF

Audio

EDITOR'S CHOICE
OF THE BEST IN
STATE-OF-THE-ART
EQUIPMENT



**COMPLETE REVIEWS
OF HOT GEAR FROM**

**NAKAMICHI,
LEVINSON,
SOTA/SME,
McINTOSH,**

**TANDBERG,
REVOX, ADS,
YAMAHA,
AND MORE...**

mark
levinson
MIDDLETOWN, CONNECTICUT • USA



Display until
Feb. 28, 1987

ML-9
POWER AMPLIFIER

“It is so clearly superior to past amplifiers in the low- to mid-priced range—not to mention most amplifiers two to three times its price— that I can unhesitatingly recommend it for even the most demanding high end system.”

Anthony Cordesman

stereophile

vol. 8, no. 4



**ADCOM GFA-555
POWER AMPLIFIER**
HIGH POWER, HIGH CURRENT

“..it rivals any transistor power amplifier in its power class that I have heard—including high-powered receivers or amps with trick power supplies—at any price.”

The complete review:

A BEST-BUY BREAKTHROUGH OR THE START OF A NEW WAVE?

I am reluctant to call any given transistor power amp a “best buy” or breakthrough. From my talks with designers and other audiophiles, it is clear that the state of the art in power amplifiers is about to change. From where I stand, the Adcom GFA-555 is the first sample of this new wave. It is so clearly superior to past amplifiers in the low- to mid-priced range—not to mention most amplifiers two to three times its price—that I can unhesitatingly recommend it for even the most demanding high end system.

The GFA-555 does everything well, and most things exceptionally well. It provides superb, well-controlled bass with far better speaker load tolerance than most amps. Its midrange and treble are remarkably low in coloration. There is no hint of hardness, and none of the loss of inner detail common to transistor amplifiers.

“The Adcom’s soundstage is sufficiently superior that even those who claim all power amplifiers sound alike might hear the difference.”

With the exception of the Krells, I have never heard a more detailed, natural, and extended upper four octaves in a transistor amp. The Adcom may even be a legitimate rival to the Krell; it’s brighter and more dynamic, and somewhat more open. And, like the Krell, it gives the impression, on really good material, that the amplifier simply isn’t there, on really good material. Nor is the Adcom romantic or sweet, like New York Audio’s new Moscodes. Rather, it offers natural upper octave detail that the latter miss. Other amplifiers have similar upper octave performance, but I unhesitatingly recommend the Adcom over the very stiff competition from Tandberg and Threshold.

The Adcoms’ soundstage is sufficiently superior that even those who claim all power amplifiers sound alike might hear the difference. It comes very close to the better tube power amplifiers in providing detailed, stable, realistic imaging with natural depth. It is not an Audio Research D-250, but is extraordinarily holographic—I suspect almost embarrassingly so. This kind of soundstage has previously cost at least \$2000.

I am also highly impressed with this amplifier’s dynamics. Once again, it is not going to survive a one-on-one with the Audio Research D-250 or Conrad Johnson Premier Fives, but it rivals any transistor power amplifier in its power class that I have heard—including high-powered receivers or amps with trick power supplies—at any price. It provides these dynamics into virtually any load without bloat, restriction of sound, or change in timbre. For all the nonsense published by most manufacturers about driving complex loads, this amplifier actually delivers.

The Adcom does not lose sweetness and detail as its power goes up. I am normally leery of transistor amplifiers rated much above 100 watts; they too often blur detail and harmonic information, and this sonic price tag is far more costly than the added power is worth. This does not happen with the Adcom unless the distortion lights are blinking, and they only blink when the amp is delivering well over its rated 200 watts per channel (8 ohms) or 325 watts (4 ohms). By comparison, once-outstanding high power amplifiers like the Hafler DH-500 now sound annoyingly veiled.

With a minor dealer modification, you can even drive 1 ohm loads like the Scintilla. I can’t measure whether the Adcom delivers its rated 800 watts per channel into 2 ohms, or 20 amps peak, but I can tell you that it does a superb job of driving this superb speaker. Anything in its price range (or even close) generally changes timbre and degenerates when driving the Scintilla at 1 ohm.

“For all the nonsense published by most manufacturers about driving complex loads, this amplifier actually delivers.”

I’m going to have to say a few words about its technology before I give Adcom a swelled head. You’ll be happy to note that the manufacturer claims for the GFA-555 a simple gain path, a 700 watt toroidal transformer, a well-regulated high current power supply, new ultra-stable bias circuitry, direct coupling, no current limiting, and no output inductor. More substantively, its harmonic shape mixes suitable yinyang while avoiding the curse of pyramidology. This, of course, means that it weighs 34 pounds, has simple rack-mount black styling, pilot lights, warning lights (to indicate distortion levels above 1%), and measures exactly $7\frac{1}{16}$ ” by $12\frac{1}{4}$ ” by 19”.

More pragmatically, the technical specifications are significant in that they represent reasonable bandwidth (4-150,000 Hz), damping (150-200), gain (27 dB), and noise (-106 dB). Of these, only the noise specification is outstanding. No attempt is made to beat distortion records: .09% THD at rated power into 8 ohms, and .25% into 4. I have heard so many power amplifiers with infinitely (well, an order of magnitude) better specifications sound so much worse; this may be the amplifier whose sound could convince *Stereo Review*, *High Fidelity*, etc. that their present measurements are virtually worthless.

I suspect that the Adcom is going to force many designers in the \$1000-1500 range to either make radical improvements in their products over the next six months, or look at the possibility of retiring from competition. This is a “must” amplifier to audition before you spring for anything close in

“I suspect that the Adcom is going to force many designers in the \$1000-1500 range to either make radical improvements in their products... or look at the possibility of retiring from competition.”

price. If the Adcom is simply the first of a whole wave of good amplifiers, it will help revitalize the high end for the average audiophile, and force most manufacturers into more reasonable pricing. Now, Adcom, if you can only come up with a preamp as good!

AHC

ADCOM®

11 Elkins Road, East Brunswick, NJ 08816 U.S.A.
Distributed in Canada by: PRO ACOUSTICS INC.
Pointe Claire, Quebec 49R4X5

Manufacturer’s note: Approximate retail prices listed in order of mention in review:

Adcom GFA-555	\$ 680
Krell	2300-7500
NY. Audio Moscode	900-1600
Tandberg	1000-2000
Threshold	1490-3150
Audio Research D-250 (MK II)	6000
Conrad Johnson Premier 5 (pair)	6000
“high powered receivers”	?
“amps with trick power supplies”	?
Hafler DH-500	850

THE BEST OF Audio

EDITOR'S OVERVIEW	Eugene Pitts	4
--------------------------------	--------------------	----------

AMPLIFIERS & PREAMPLIFIERS

BRYSTON 4B AMP	L. L. Greenhill and D. L. Clark	6
CONRAD-JOHNSON PREMIER FIVE AMP	Bascom H. King	12
MARK LEVINSON ML-10A PREAMP AND ML-9 AMP	Bascom H. King	16
McINTOSH MC 2002 AMP	L. L. Greenhill and D. L. Clark	26
TANDBERG 3008A PREAMP AND 3009A AMP	L. L. Greenhill and D. L. Clark	32

TUNERS & RECEIVERS

ONKYO T-9090 TUNER	Leonard Feldman	40
PIONEER F-99X TUNER	Leonard Feldman	44
YAMAHA R-9 RECEIVER	Leonard Feldman	50

TONEARMS, CARTRIDGES & TURNTABLES

SME V TONEARM AND TALISMAN VIRTUOSO DTi CARTRIDGE	Edward M. Long	56
SOTA STAR SAPPHIRE TURNTABLE	Edward M. Long	62
TECHNICS EPC-305MCII CARTRIDGE AND SH-305MC TRANSFORMER	B. V. Pisha	68
TECHNICS SP-10MK3 TURNTABLE	Edward M. Long	72

CASSETTE DECKS

NAKAMICHI CR-7A	Howard A. Roberson	78
REVOX B215	Howard A. Roberson	86
YAMAHA K-1020	Howard A. Roberson	92

COMPACT DISC PLAYERS

ADS CD3	Leonard Feldman	98
DENON DCD-1500	Leonard Feldman	102
PIONEER PD-9010X	Leonard Feldman	106
SONY CDP-650ESD	Leonard Feldman	110

LOUDSPEAKERS

THIEL CS3	Richard C. Heyser	119
------------------------	-------------------------	------------

The Cover Equipment: Nakamichi CR-7A cassette deck and Mark Levinson ML-9 amplifier.
The Cover Photographer: Carl Zapp.
Audio Publishing, Editorial and Advertising Offices, 1515 Broadway, New York, N.Y. 10036.



**BRUCE SPRINGSTEEN
& THE E STREET BAND
LIVE/1975-85**

**THE 3-CD BOXED SET
INCLUDES 40 SONGS, EACH
DIGITALLY MIXED AND MASTERED.
PLUS, A 36-PAGE COLOR BOOKLET
WITH COMPLETE LYRICS AND OVER 70 PHOTOS.
ON COLUMBIA**

Produced by Bruce Springsteen, Jon Landau, Chuck Plotkin.

"Columbia,"  are trademarks of CBS Inc. © 1986 Bruce Springsteen

ALSO AVAILABLE ON LPs AND CASSETTES.



EDITOR'S OVERVIEW

Dear Reader:

Quite often, I am asked "what's best?" in a particular equipment category; usually I try to beg off from such questions, as they are very tough to answer. Recommending, say, a cassette deck, amplifier, or speaker system to someone is like recommending which woman to choose as a wife. Do you like blondes or good cooking? Or what about the choice between a placid disposition and good housekeeping talents? The point here, simply put, is that there is no one scale into which all good or desirable qualities can be forged. (You ladies, further down the masthead, keep your peace or you'll be assigned the task of writing this introduction.)

Audio Magazine generally reviews the better grades of equipment, that is, we test the top of a line of cassette decks, rather than a mid-priced unit. We also review a healthy proportion of what's known as "High End" gear, which a friend says means limited distribution, though not by choice of the maker. How much this "limit" adds to the final price is a moot point, he says.

In any case, we present here a score of reviews, taken from earlier issues, of audio gear that both tested well and sounded good. We have changed to current prices, where necessary, and amended text in a couple of places where some fact had changed in the intervening period. We do not mean this to be an exhaustive report on all high-quality audio equipment; that would require far more editorial pages than we have available.

I feel very good about each unit whose test is presented here; I would be quite happy to have them in my own home system. I think you would be too.

Cordially,



Eugene Pitts, Editor

Audio

Eugene Pitts III
Editor

Art Director: Cathy Cacchione

Technical Editor: Ivan Berger
Managing Editor: Kay Blumenthal
Copy Chief: Elise J. Marton
Associate Art Director: Linda Zerella
Assistant Editor: Andrea Lynne Pieper

Associate Editors:

Edward Tafnail Canby, Bert Whyte, B. V. Pisha

Senior Editors:

Leonard Feldman, Richard C. Heyser,
Howard A. Robertson

Senior Editor/Music Features: Ted Fox
Editor-At-Large: David Lander

Contributing Editors/Artist:

Susan Borey, Herman Burstein, David L. Clark,
Anthony H. Cordesman, Ted Costa, John DiIiberto,
John M. Eargle, Joseph Giovannelli,
Laurence L. Greenhill, Bascom H. King,
Edward M. Long, Peter W. Mitchell,
Jon Sank, Donald Spoto, Michael Tearson,
Jon & Sally Tiven, Pautiette Weiss

Business Services Director: Catherine Hennessey
Production Director: David Rose
Production Manager: Michele Lee
Special Projects Coordinator: Phyllis K. Brady
Ad Coordinator: Susan Oppenheimer

Stephen Goldberg
Publisher

ADVERTISING

Advertising Director: Stephen W. Witholt
(212) 719-6335

Account Managers: Lesa Rader Giberson
(212) 719-6291
Nick Matarazzo
(212) 719-6346

Western Manager: William J. Curtis
Regional Manager: Megean Roberts
(818) 784-0700

Classified Manager: Laura J. LoVecchio
(212) 719-6338

Classified Assistant: Mary Jane M. Adams
(212) 719-6345

CBS MAGAZINES EXECUTIVE STAFF

President: Peter G. Diamandis
V.P., Editorial Director: Carey Winfrey
Sr. V.P., Publishing: Robert F. Spillane
Sr. V.P., Circulation: Robert E. Alexander
Sr. V.P., Operations: Robert J. Granata
V.P., Finance: Arthur Sukei
V.P., Subscription Circulation: Bernard B. Lacy
V.P., Mfg. & Distribution: Murray M. Romer
Pres., CBS Magazine Marketing: Carl Kopf

AUDIO (ISSN 0004-752X, Dewey Decimal Number 621.381 or 778.5) is published monthly, except semi-monthly in November, by CBS Magazines, A Division of CBS Inc., at 1515 Broadway, New York, N.Y. 10036. Printed in U.S.A. at Nashville, Tenn. Distributed by CBS Magazine Marketing. Second class postage paid at New York, N.Y. 10001 and additional mailing offices. Subscriptions in the U.S., \$17.94 for one year, \$32.94 for two years, \$45.94 for three years; other countries, add \$6.00 per year.

AUDIO is a registered trademark of CBS Inc. ©1986, CBS Magazines, A Division of CBS Inc. All rights reserved. **Editorial contributions** are welcomed but should be accompanied by return postage. Submissions will be handled with reasonable care, but the Editor assumes no responsibility for safety or return of manuscripts, photographs, or artwork. The Publisher, in his sole discretion, reserves the right to reject any ad copy he deems inappropriate.

Subscription Service: Forms 3579 and all subscription correspondence must be addressed to **AUDIO**, P.O. Box 5316, Boulder, Colo. 80302. Please allow at least eight weeks for the change of address to become effective. Include both your old and your new address and enclose, if possible, an address label from a recent issue. If you have a subscription problem, please write to the above address or call (800) 525-0643; in Colorado, (303) 447-9330.

AT CELESTION, THE ENJOYMENT OF MUSIC IS THE ONLY STANDARD OF REFERENCE.

Occasionally genuine wisdom about loudspeaker design emerges from the yearly torrent of "speaker-speak." A general consensus regarding the goal of loudspeaker design has finally been achieved: to help recreate the musical sound stage without adding coloration or distortion.

Celestion has been pursuing this same objective for over 60 years. We refine the essential elements in our speakers, drivers and enclosures, so they perform truthfully — nothing more, nothing less. To accomplish this, we rely on exclusive technology like the computerized interferometry mapping system that visually displays the behavior problems of typical tweeters and woofers.

We also employ the most highly evolved of all audio test instruments — educated ears. The end result is sound stage imaging which accurately conveys the dimension of the concert hall.

Undeterred by the steady flow of self-serving buzz words and conflicting absolutes, Celestion continues its pursuit of the music with the new SL 6S. Like other Celestion loudspeakers, its lifelike performance shows that technology is only effective when it serves the demands of the music.

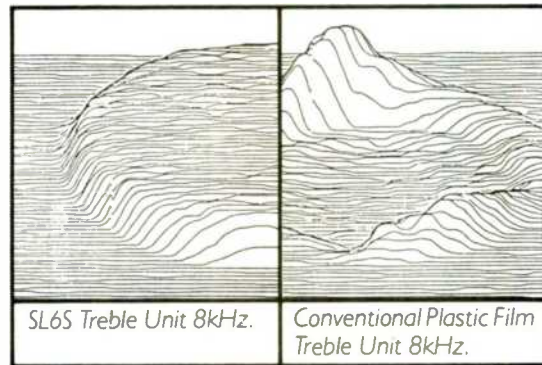

Celestion's computerized laser interferometry mapping system exposes imperfections in driver performances so we can eliminate them.



Our award-winning proprietary one-piece tweeter dome is designed to perform without physical, hence acoustical distortions.



Refinements incorporated in the new SL 6S include a lighter, more efficient aluminum tweeter, a redesigned woofer surround and a new, ultra-rigid bracing system for the low-mass enclosure.

CELESTION

Kuniholm Drive, Box 521
Holliston, MA 01746
(617) 429-6706

1

BRYSTON 4B AMPLIFIER

Manufacturer's Specifications

Power Output: 250 watts rms per channel continuous, 8 ohms, 20 Hz to 20 kHz; 400 watts rms per channel continuous, 4 ohms; 800 watts continuous into 8 ohms in bridged mode.

Rated THD: Less than 0.01% maximum, 250 watts rated power per channel, 20 Hz to 20 kHz.

Frequency Response: 1 Hz to 100 kHz, +0, -3 dB for 1 watt output.

S/N Ratio: Hum and noise, 100 dB below rated output, 90 dB IHF.

IM Distortion: Less than 0.01%, from 10 mW to rated output, for any combination of frequencies from 20 Hz to 20 kHz.

Damping Factor: Greater than 500 at 20 Hz, referred to 8 ohms.

Input Impedance: 50 kilohms unbalanced.

Input Sensitivity: 1.40 V for 250 watts per channel into 8 ohms.

Dimensions: Chassis, 19 in. W x 5¼ in. H x 13½ in. D (48.2 cm x 13.3 cm x 34.3 cm), including connectors; front panel, 16¾ in. W x 7½ in. H (41.1 cm x 18.1 cm).

Weight: 50 lbs. (22.7 kg).

Price: \$1,500.

Company Address: 57 Westmore Dr., Rexdale, Ont., Canada M9V 3Y6. (U.S. office: R.F.D. 4, Berlin, Montpelier, Vt. 05602.)

(Originally published November 1985)



The Canadian-built Bryston 4B is a Class-AB2, solid-state, stereo power amplifier which is rated at 250 watts per channel into 8-ohm loads, 400 watts per channel into 4-ohm loads, and 800 watts, bridged, into 8 ohms. Physically, the unit is rack-mountable and rather small for a Class-AB unit. It has been designed to run cool without an internal fan, which is made possible by using the entire chassis (over 1,500 square inches!) as a finned heat-sink.

The 4B was first produced in 1976. Since then, there have been only a few modifications and a small increase in price, which shows Bryston's product stability. The amplifier's reputation for ruggedness and reliability has resulted in acceptance by recording engineers and touring musicians, while

its reputation for good sonics and an ability to drive difficult speaker loads has made it a hit with audiophiles. Our colleagues in the Audiophile Society (Westchester, N.Y.) favor this amplifier because it sounds good with their Plasmatronics, a somewhat modified pair of Dahlquist DQ-10s, and Snell Type A speakers. Recently, Bryston has designed a new output stage for the 4B, which makes it a good time to review the amplifier.

The Bryston's physical appearance adheres to the traditional military-black, "thermal monolith" design, with heat-radiating fins covering the amplifier's sides and part of its back panel. The heat-sink fins are rounded and have no sharp corners or edges. The front panel features dual-color

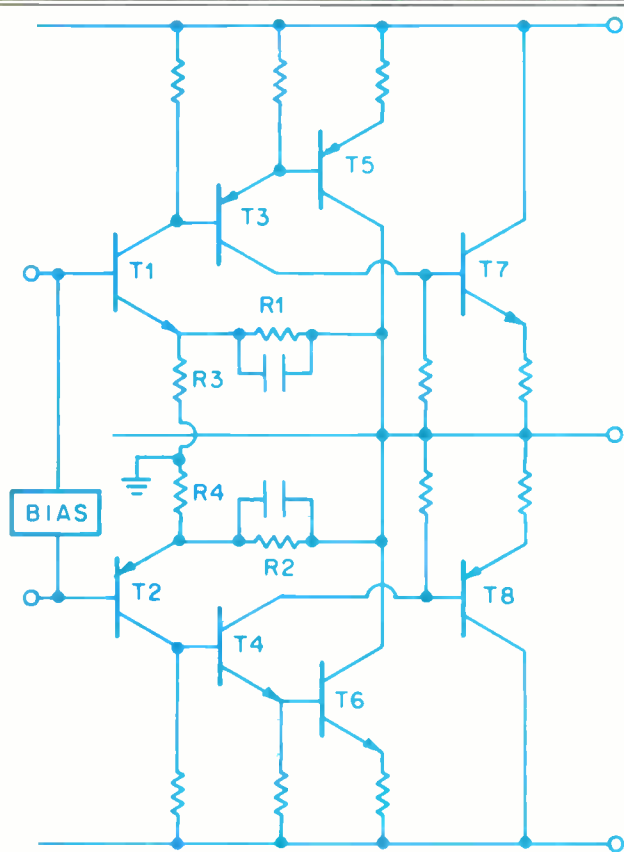

Fig. 1—Circuit diagram, output stage, Bryston 4B amplifier. Note that both polarities of the output transistor are used on each half of the output waveform.

LED pilot lights, one for each channel. These remain green while the unit is powered, and flash red at clipping. The power on-off button is the only front-panel control. The rear panel contains gold-plated signal-input connectors and five-way speaker binding posts, the mono/stereo switch, a ground isolation switch, fuse-holders for two 7-ampere a.c. fuses, and the line cord. The Bryston employs an unusually heavy, nondetachable, coiled line cord.

Construction

The quality of Bryston's chassis construction appeals to us. The front panel is composed of two 1/8-inch sheets of aluminum, sized for a standard rack. Two large power

transformers are located inside, near the front panel, where they are best supported in rack mounting. Chassis aluminum is either 0.048 or 0.125 inch thick, depending on structural needs. The quality of finish, machining, and assembly is up to the best instrument standards. We are delighted to see that Bryston uses threaded steel inserts and Robertson machine screws to attach removable panels instead of the more common (and less expensive) sheet-metal screws. All internal screws and fasteners are treated with locking thread-sealer for structural integrity and vibration resistance. Output transistors and drivers are mounted in vertical groups of three to the sides and back of the chassis. Connections are picked up on the inside by sockets soldered to p.c. boards. One p.c. board in each channel spans two vertical groups and contains the amplifier drive circuitry. The other two "socket boards" are hard-wired to this drive board. Lead lengths are short, desirably, but it struck us that replacing a small circuit-board component would entail the removal of six transistors coated with thermal grease—a messy and time-consuming job. Bryston, however, points out that the amplifier's construction allows the entire board assembly for each channel to be removed for replacement (some dealers even stock these modules), or for low-cost shipping to the factory for service. Should field service be necessary, they say, the boards' plated-through holes allow components to be removed in the field from above the board; this is still hard to do, we've found, on the equipment we have tried servicing that way. In any case, these details of construction reflect Bryston's philosophy of performance first, cost second.

The 4B is a dual-mono design, with separate power supplies for each channel, on a single chassis. Its two completely separate amplifiers are arranged symmetrically to either side of an imaginary front-to-back line. Every part is duplicated, with the exception of a single power cord and a single input/output, bridging-circuit board. Two large E-I core transformers fill the front of the chassis. Four 10,000- μ F filter capacitors (two per channel) stand toward the chassis rear, just in front of the back panel.

Each channel uses an open trimpot, presumably for a one-time adjustment of bias. Airborne contaminants are bound to collect on the resistance track, since the trimpot sits in the updraft between the bottom- and top-panel ventilator slots. Should the bias need future adjustment, the technician in our shop suggested that using a good contact cleaner might be necessary to get a reliable second-time setting.

Even though the unit is small compared to other conventional amps that deliver 200 watts per channel, the inside is neat, with adequate room for cooling and repairs. The driver boards and the input board use gold-plated board-edge connectors. In a wise design move, only power wiring uses the 1/4-inch push-on connectors; signal-bearing lines do not. Soldered and "gas tight" mechanical connections, which we prefer, are used for Bryston's signal circuits. Clip-in, 8-ampere a.c. backup fuses are hidden deep in an area that is not user-serviceable, to prevent damage to the amp from audiophiles who install 30-ampere car fuses in the line sockets to "get more current" out of their amplifiers. Point-to-point wiring is neatly dressed. The circuit boards them-

The amp's newly designed output stage yields 6 dB less distortion than the previous model, and can drive low-impedance loads with less difficulty.

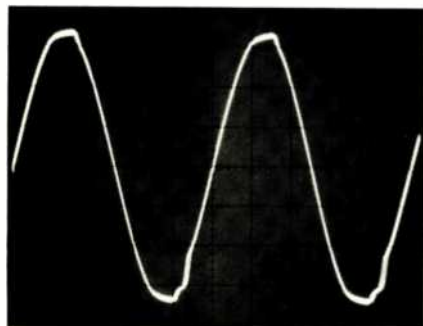

Fig. 2—Response at clipping for large-signal, 20-kHz sine wave and 8-ohm load. Slight "sticking," a source of extra distortion at clipping, can be seen as the trace leaves the flattened peak area.
Scales: Horizontal, 10 μ S/div.; vertical, 20 V/div.

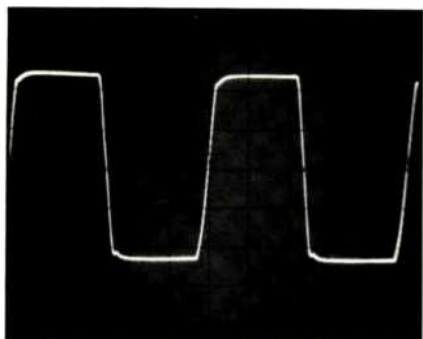

Fig. 3—Response to a 20-kHz square wave, when delivering 250 watts into 8 ohms. Scales same as in Fig. 2.

selves are high-quality epoxy-glass, double-sided with component-designator screening. Parts are well secured and run cool; they are specified for continuous duty, with typical safety margins of 250%. Mean-time-before-failure (MTBF) ratings on the filter capacitors are several times longer than the typical ratings found in home amplifiers, Bryston claims. Factory burn-in consists of a square-wave input signal driving the amplifier into a capacitive load, slightly under clipping, for 100 hours, with a 3-hours-on/1-hour-off cycle. Such procedures "mature" the components inside the amplifier

and uncover any marginal parts that might fail from thermal stress. After these reliability checks, the amplifier is bench-tested, and the results are listed on a sheet packed with the product. These procedures yield an amplifier likely to provide many years of maintenance-free service.

Circuit Description

The circuit of the 4B incorporates much of the design philosophy that Bryston applies in building bipolar, solid-state amplifiers. For example, the double-complementary differential input circuit gives the stage great linearity by negating distortion products with subtractive cancellation. The input stage presents the preamplifier with a high (50-kilohm), linear input impedance. This stage cross-couples the input transistors, which then can supply the bias current for d.c. equilibrium, resulting in a near-zero inherent d.c. offset voltage. This first stage exemplifies Bryston's design goals: To achieve wide-band transient accuracy and open-loop linearity.

Bryston recently introduced a new output-stage configuration which exhibits a number of advantages over the popular complementary bipolar, unity-gain Darlington design. As shown in Fig. 1, the new circuit combines emitter- and collector-output devices for both pull-up and pull-down. It allows the base-drive current from the driver transistors (T3 and T4) to do double duty. Although each pull-up or pull-down pair of output transistors are in parallel insofar as the power-delivery current is concerned, their base terminals are connected in series. This means that the base current supplied to T7 comes from T5 (via T3) and is not merely split between the two bases as it is in the parallel connection. This configuration essentially eliminates any small asymmetry in the zero-crossing region, since both polarities of output transistor are active at all times. Everything else being equal, driver transistors T3 and T4 will be called upon to supply exactly half the base current required in standard configurations, as well as one-fourth the junction-capacitance charging and discharging current. Gain of the output stage is set by the sub-circuit involving resistors R1 through R4. Transistors T5 and T7 comprise the "pull-up" output devices (one of each sex), and T6 and T8 make up the "pull-down" pair.

There are a few easily skirted disadvantages to this new output stage. Placing the base-to-emitter voltage drops of the output transistors in series results in a 1.5-V loss in clipping output voltage; the new 4B has a slightly higher rail voltage to compensate. In addition, this design demands output devices with matched betas, so such parts are hand-selected.

Chris Russell, Bryston's main designer, reports that this new design results in a 6-dB reduction in across-the-band distortion, particularly in the upper harmonics. In addition, the output stage is more tolerant of loading than the previous design, and can drive low-impedance loads with less difficulty. Russell reports that the elimination of all zero-crossing anomalies, particularly notch distortion, means that the new 4B displays a distortion spectrum similar to that obtained with Class-A biasing. Open listening tests, always a part of Bryston's research, reveal for Russell an amp with less veiling than alternative designs.

Speed, huge transient attack, and powerful bass response were our first subjective impressions. This amp has dynamic range to burn.

Measurements

Each power supply uses an oversized transformer, a 25-ampere bridge rectifier, and two 10,000- μ F electrolytic capacitors having 128 joules of energy storage per channel. Potentially noisy fans have been eliminated from the design. Rail voltages are ± 80 V d.c. The power supply, while not electronically regulated, is a "stiff" design. It makes severe demands from the 167-V peak of the 60-Hz, 120-V a.c. sine wave, rather than drawing current over a more substantial percentage of the cycle. This required that we revise our usual testing technique, to maintain peak (rather than rms) line input voltage. No consumer power line is likely to perform in this manner, but then, the consumer is not likely to need (or want) continuous delivery of this level of power to speakers.

The 4B was first run for one hour at 33% of rated power, or about 83 watts per channel into 8-ohm loads with a 1-kHz test signal. The chassis top became warm, but the amplifier didn't thermally shut down.

Voltage gain was found to be 30.1 dB into an 8-ohm load. The IHF sensitivity for 1 watt into 8-ohm loads at 1 kHz was 88.4 mV.

Power output was measured from 20 Hz to 20 kHz into a variety of load conditions, as shown in Table I. At 0.1% THD, minimum continuous power output per channel was 269 watts (46.4 V) into 8 ohms and 286 watts (33.8 V) into 4 ohms. Bridged (mono) operation resulted in a minimum continuous power output of 348 watts (52.8 V).

Bryston does not give distortion or bandwidth limits for power ratings at 4 and 8 ohms in the bridged mode. We arbitrarily selected a very stringent 0.1% distortion limit, and the amplifier came close to its ratings in mid-band. Over the full audio band, and using our distortion limits, the amplifier put out less continuous power at the frequency extremes. Allowing for a little higher distortion, the 4B would have easily met its continuous ratings. The amplifier performed very well at 8 ohms, with ample reserves to handle an occasional impedance dip down to 4 ohms.

As Table II indicates, at rated output power, the maximum total harmonic distortion plus noise (THD + N) was 0.0055% for 8-ohm loads (at 40 V). Measurements at lower levels all indicated lower distortion.

When brought to clipping level at 20 kHz, the waveform flattened on top and bottom, as expected. This happens in all amplifiers when the output transistors have pulled the load up or down to the power-supply voltages or "rails." The Bryston, like most other amplifiers, once brought to the rail voltages, tends to "stick" there for a few microseconds before jumping back to the proper waveform. This effect is shown in Fig. 2, where sticking generates an excess of distortion at clipping. The sticking lasts only a few microseconds per cycle, so its effect is greater at high frequencies, where it occurs for a greater portion of the cycle. A very high current may flow through the output devices during the sticking period. The saturated transistor (the one that pulled the load to its supply rail) does not unsaturate instantly, even though the drive to it is removed. Before it can let go, feedback may tell the opposite transistor to pull the load toward its rail voltage. Thus, for a few microseconds, both output halves can be pulling against each other. At 20 kHz

Table I—Maximum power output (watts) at 0.1% THD + N.

Freq., Hz	8 Ohms		4 Ohms		8 Ohms, Bridged
	Left	Right	Left	Right	
20	284	278	331	359	659
200	294	292	363	402	718
2k	300	298	361	414	707
20k	273	269	210	286	348

Table II—THD + N (%) at rated output, 8 ohms.

Freq., Hz	Left	Right
20	0.0020	0.0025
200	0.0017	0.0019
2k	0.0020	0.0022
20k	0.0048	0.0055

or higher, this simultaneous conduction can suddenly double the current drawn from the power line as the amplifier just begins to clip.

The 4B recovers from clipping very quickly, but traces of sticking can still be seen. Bryston says that a pre-clipper circuit could have been designed into the 4B to prevent output-stage clipping, hence sticking and simultaneous conduction. It was decided, however, that the decreased maximum power output would be a greater sacrifice than the small amount of sticking. After all, if the user operates the amplifier below clipping, there is very little distortion of any kind. The twin clipping indicators on the front panel are most helpful in this regard.

The IHF signal-to-noise ratio (which is A-weighted noise referred to 1 watt output into 8 ohms) measured 87.8 dBA for the right channel and 86.6 dBA for the left channel.

Crosstalk versus frequency was measured by driving one channel and measuring the leakage into the other, with the unused input terminated by a 1-kilohm resistor. Crosstalk was found to be better than -80.5 dB from 20 Hz to 10 kHz, peaking to -73.2 dB at 20 kHz in the left channel. These figures are good, a testimony to the dual-mono design.

Figure 3 illustrates the 4B's square-wave response at rated power, 250 watts per channel into 8 ohms at 20 kHz. The rise-time is 3 μ S. The slew rate measured 24 V/ μ S up, 27 V/ μ S down, asymmetrical. This improved to 30 V/ μ S up, 40 V/ μ S down when the amp was grossly overdriven by a 1-kHz square wave. IHF slew factor into 8 ohms was 3.9 (77.3 kHz). Adding a 1- μ F capacitor caused the expected ringing of the output network, with a 0.2-dB increase in sine-wave output at 20 kHz, but no instability.

Measuring the 1-watt frequency response into 8 ohms showed the amplifier to be within ± 0.1 dB from 20 Hz to 20 kHz. The high-frequency -3 dB point was at 145 kHz, and the low-frequency -3 dB point was at 0.27 Hz. Input impedance for the 4B proved to be somewhat frequency-

**We find the Bryston 4B
to represent good quality,
high reliability, and
elegance of engineering.**

dependent, measuring 48 kilohms at 1 kHz and 36 kilohms at 20 kHz.

The low-frequency damping factor was measured at 460 for 8 ohms, and the wide-band damping factor was measured at 27.6 for 8 ohms. Dynamic headroom measured 1.0 dB (42.3 V, 315 watts) at a pulsed clipping from a steady-state level of 250 watts rated power into 8 ohms. The 4-ohm IHF headroom was 0.36 dB (47 V, 435 watts). The bridged 8-ohm IHF pulsed power output reached 0.66 dB (86.3 V, 930 watts). These figures indicate a power supply with voltage regulation that is tighter than usual.

Our standard test of peak output current utilizes a 20-mS pulse (repeated at a 0.5-S rate) driving one channel of the amplifier into a 0.1-ohm load. Under these conditions, the 4B delivered 17.1 amperes rms for the right channel and 16.3 amperes rms for the left channel, before clipping. This places it in the high-average range, among today's high-powered amps, for instantaneous rms current delivery.

If more than one 4B is used in a system, they should be turned on in sequence rather than simultaneously. This is true for most high-power amplifiers that don't contain turn-on surge-limiting circuitry. The amplifier's heavy turn-on surge can trip household circuit breakers, as co-author Clark found when he turned on his home system, which then contained a Dyna 410 as well as the Bryston 4B.

Use and Listening Tests

Equipment used to evaluate the Bryston 4B included a Linn Sondek turntable with a Magnepan Unitrac 1 arm, Accuphase AC-2 moving-coil and Shure V15 Type V-MR cartridges, Philips Compact Disc players, a Mark Levinson ML-7 reference preamp, Mark Levinson ML-9 and Tandberg 3009A solid-state power amps, and Jung/Randall-modified Dahlquist DQ-10A loudspeakers. Clark auditioned the Bryston in his home system and in his dedicated listening room. The amplifier was interfaced with a number of systems, including Fried Studio IV speakers. An ABX Co. double-blind comparator was used to compare the 4B to a pair of mono Tandberg 3009A amplifiers using the Fried speakers. Hitachi oxygen-free speaker wire was used during testing by both authors.

The 4B was auditioned by co-author Greenhill on the Dahlquist speakers. First subjective impressions with this amp were of speed, tremendous transient attack, and powerful bass response. The amplifier has dynamic range to burn. Greenhill could not believe the 105-dB peaks his Dahlquists delivered re-creating the helicopter landing (in the living room!) during the opening of Pink Floyd's "The Happiest Days of Our Lives" (from *The Wall*). Unlike other amps, the Bryston, its clipping lights flashing, produced enough directional cues so Greenhill could track the gunship coming in from the north, hovering over the right speaker, and finally setting down behind the left Dahlquist! We credit this ability to localize sounds precisely, even at high volume levels, to the 4B's excellent channel separation; Greenhill's favorite big amps, the Levinson ML-3 and Krell KMA-200, are also dual-mono systems. The 4B decoded percussion and voice with uncanny accuracy, bringing an eerie clarity to Stevie Nicks' vocals on "Sisters of the Moon," from Fleetwood Mac's *Tusk*.

The reference Levinson ML-9, though very comparable in the midrange and equally detailed in the highs, could not match the Bryston's field depth. We attribute this to the 4B's dual-mono design. On the other hand, the Levinson outstripped the 4B in deep bass, yielding more solidity and impact on CD bass-drum notes. The front-panel indicators flashed frequently as we subjected the Bryston and a number of other amps to the best bass Telarc CDs could deliver, and the 4B produced the bass pulses with little evidence of audible clipping.

Clark too was impressed by the amplifier's clean power in his open evaluation, but the accurate clipping indicators served as a visual reminder that 250 watts per channel is not always enough. Clark uses the Sheffield Drum Record (Sheffield Lab 14) to check large power amplifiers in his dedicated listening room. This record's closely miked drum kit reaches high peak sound pressure levels (115 to 120 dB at 10 feet) if the proper sonic perspective is maintained. Attempting to reproduce these levels through moderately sensitive Fried Studio IV loudspeakers invariably results in amplifier clipping. With the 4B, the onset of clipping was inaudible, signalled only by the blinking of its clipping indicators. Even when the clipping lights flashed often, the only audible difference was a softening of drum attacks.

Subjectively, Clark found the Bryston's sound cool and analytic. Later, he wondered if his sonic perceptions might be biased by visual reactions to the 4B's styling. Other than the friendly logo silk-screened on the front panel, he found the black, metallic 4B businesslike and rather featureless. Luckily, he was able to test this potential reviewing bias with a pair of Tandberg 3009A mono amplifiers. These amps have sexy Scandinavian styling (rosewood side panels) and easy, sparkling sound to match. After living with the Bryston and Tandberg amplifiers for more than two months, Clark made 16 identification attempts over a 1½-hour listening session, and was correct in 12 out of 16 tries, which we consider significant. Clark tried to replicate this feat, but achieved only seven correct identifications out of 16 trials during his second attempt. Hooked up for a level-matched, double-blind comparison, Clark did not believe he could tell which amplifier was playing.

The Bryston operated smoothly during all bench and listening tests. No turn-on or turn-off thumps were present. The ABX comparator's switching relays caused no problems with the Bryston's protection circuitry.

In summary, we find the Bryston 4B to represent good quality, high reliability, and elegance of engineering design. The front panel's very desirable clipping indicators are essential for preventing audible distortion and speaker damage from intense clipping by this very powerful amplifier. The controlled tests were unable to demonstrate with high significance a sonic difference (below clipping) between the Bryston and the Tandberg 3009A, confirming Clark's belief that most well-designed amplifiers today differ little sonically. Greenhill's subjective impressions of the 4B continued to be highly positive about the amp's channel separation, superb dynamic range, and outstanding midrange detailing—even when these subjective impressions weren't confirmed by Clark's double-blind, A/B/X-controlled procedures.

Laurence L. Greenhill and David L. Clark



Teac.

For over thirty years Teac has been famous for building precision tape recording equipment. But, we're not willing to rest on our reels. So now Teac offers its most comprehensive line ever. From audio and hi-fi video recording equipment, to compact disc players, to graphic equalizers, speakers, and a complete line of audio and video accessories. One thing, however, will never change at Teac—our obsession with creating the most advanced, featured-filled, superbly executed audio and video equipment we can make. So, no matter what Teac you decide to buy, you can be assured of acquiring a piece that has been built to fanatical standards.

HiFi in the extreme.

TEAC®

2

CONRAD-JOHNSON PREMIER FIVE AMPLIFIER

Manufacturer's Specifications

Power: 200 watts continuous into 4, 8, or 16 ohms, 30 Hz to 15 kHz, at 1% THD or IM.

Sensitivity: 1 V for full rated power.

Small-Signal Distortion: 0.05% at mid-band.

Frequency Response: 20 Hz to 20 kHz, +0, -0.5 dB.

Hum and Noise: 96 dB below full rated output.

Input Impedance: 100 kilohms.

Dimensions: 19 in. W x 9 in. H x 20½ in. D (48.3 cm x 22.9 cm x 52 cm).

Weight: 81 lbs. (36.8 kg).

Price: \$3,000 each.

Company Address: 2800R Dorr Ave., Fairfax, Va. 22031.

(Originally published August 1986)



The conrad-johnson Premier Five is a 200-watt, mono, vacuum-tube power amplifier. It is quite large and heavy, and surely will whet the appetite of any tube-electronics lover. I was very pleasantly surprised, a number of months ago, to have a pair of these beauties arrive on my doorstep. I decided that it would be a good idea to review them, as I had spent a good deal of time listening to two other pairs on Infinity RS IB loudspeakers.

Physically, the Premier Five is built more or less like older tube amplifiers, with a main chassis; a large, thick, rack-width front panel; side pieces, and a top cover. However,

instead of using point-to-point wiring between tube sockets and other components, it utilizes a large p.c. board which has most of the interconnections via p.c. traces. The tube sockets are mounted on the p.c. board, and the tubes stick up through holes in the top surface of the chassis. In addition to the holes for the eight output tubes and three front-end tubes, there are holes for a bias pot and a bias-indicator LED for each output tube. The only problem with this construction is that the p.c. board must be partially unwired and swung out if one wishes to replace components on it.



Mounted on the chassis are four large electrolytic capacitors for the power supply, a huge power transformer, and a not-so-huge but still substantial output transformer. On the rear surface of the chassis are a large, four-terminal screw barrier strip appropriate for heavy speaker wire, a plate-current fuse with an LED fuse-out indicator, an RCA signal-input jack, a power-line fuse, and the power cord. The front panel bears a pair of handles and a nonilluminating power switch.

Construction and parts quality on this amp are very good. Reliability is also good, judging from my own experience with the pair under review and with the two pairs owned by Infinity which I had previously auditioned.

Circuit Description

The circuit topology of the Premier Five is similar to that of many older tube designs. The first stage is a grounded-cathode amplifier with two resistors in series from cathode to ground. The signal input is direct-coupled to the grid of the first stage through a 1-kilohm series resistor. Input impedance is set by a 100-kilohm resistor between input and ground. The plate of the first stage is direct-coupled to the grid of the second-stage tube, which is operated as a grounded-plate or cathode follower. The first and second stages use the two halves of a 5751 twin triode tube. Plate-supply voltage to these stages is about 400 V d.c.

The output of the cathode-follower second stage is direct-coupled to the grid of the phase-inverter stage, which is a "long-tailed pair" or differential amplifier. Each tube in the phase-inverter stage is a 6CG7 tube, whose two halves are connected in parallel. The plate outputs of the phase-inverter stage are two equal-amplitude, opposite-phase signals. These are each coupled through four separate capacitors into the grid circuits of four EL34 tubes, which are connected in parallel. Plate-supply voltage for the phase-inverter stage is about 430 V d.c.

This output stage is operated in an ultra-linear connection, with the screen grids of the output tubes fed from taps on the output transformer's primary winding. The B+ for the output stage is about 500 V d.c. Output-stage quiescent current is about 360 to 400 mA.

Output-tube bias is set by a neat arrangement that, to the best of my knowledge, Conrad-Johnson has used on all their tube power amps. Output tube current is sampled across a 20-ohm resistor between each cathode and ground. An op-amp comparator circuit for each output tube compares the cathode voltage to a fixed reference voltage. Each op-amp comparator output is connected, via an indicating LED, to ground. If a particular cathode voltage is higher than the reference, the output of that comparator goes high, turning on the indicator LED. After a suitable warmup of 15 to 30 minutes, biasing procedure requires one to turn the bias pot for each tube until its LED comes on, and then back it off until the LED just goes out. This is simple and neat, though personally, I would rather have a front-panel plate-current meter and switch to select each tube, along with bias pots accessible on the front panel, as on the Audio Research D150 and the older Marantz Model 9.

Overall negative feedback is taken from the output transformer secondary at the 16-ohm tap, through a 5.1-kilohm

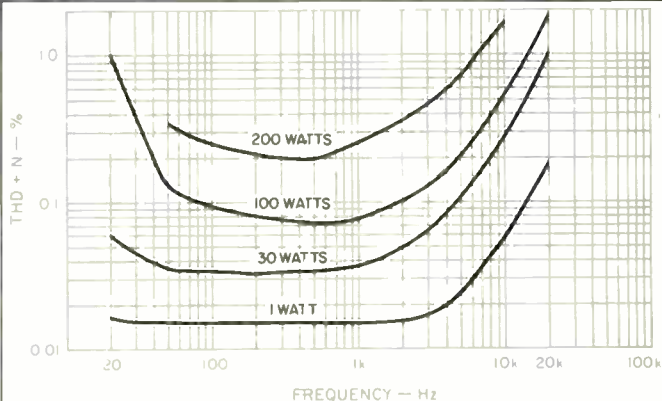

Fig. 1—THD + N vs. frequency for four power levels, with 8-ohm load on 8-ohm tap.

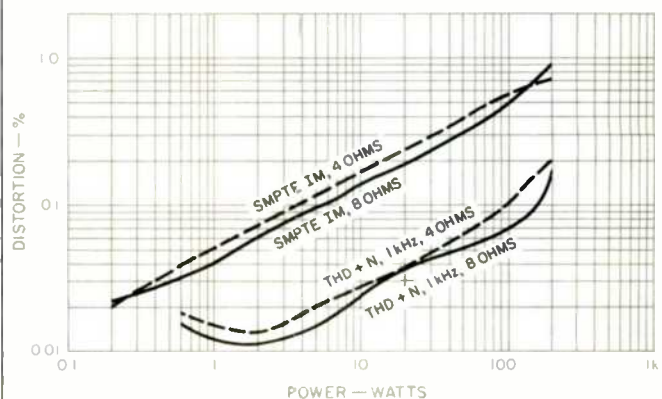

Fig. 2—SMPTE IM (upper curves) and THD + N (lower curves) vs. power for 8-ohm loads on 8-ohm taps and 4-ohm loads on 4-ohm taps. THD + N is for a 1-kHz test signal, with distortion products measured from 400 Hz to 80 kHz.

series resistor, back to the junction point of the first-stage cathode resistors.

In the power supply, the high-voltage secondary is full-wave rectified. A capacitor input filter is formed by two 1,300- μ F, 350-V capacitors placed in series. Across each of these caps is a 100-kilohm, 2-watt resistor. The resistors equalize the d.c. voltage drops across each of the capacitors, and form a bleeder to discharge the capacitors when the power is turned off—definitely dangerous energy storage here. A series inductor, 0.32 henry at 600 mA, couples

In a super system, these amplifiers are stunningly believable. Even in my less lofty setup, I find them ultimately satisfying.

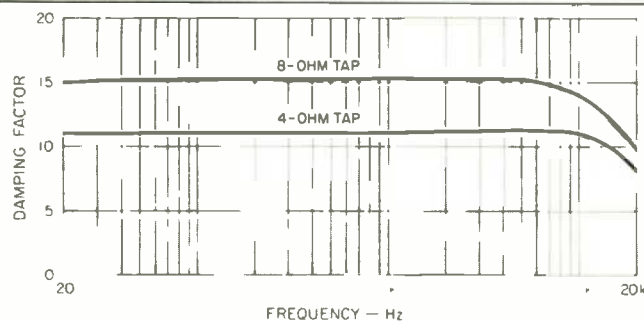

Fig. 3—Damping factor vs. frequency, measured at 8- and 4-ohm taps.

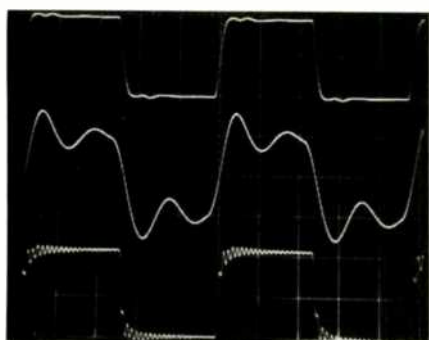

Fig. 4—Response to 10-kHz square wave. Top trace is with 8-ohm resistive load on the 8-ohm tap; middle trace is with 2-μF capacitance across 8-ohm load, and bottom trace is for open circuit (note marginal stability). Scales: Vertical, 5 V/div.; horizontal, 20 μS/div.

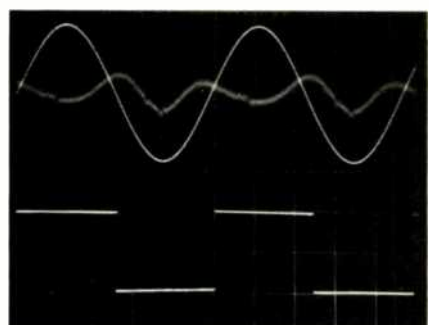

Fig. 5—Top trace: 10-watt, 1-kHz sine wave with distortion products (predominantly even harmonic) shown as residual trace behind it. Bottom trace: 40-Hz square wave, showing excellent low-frequency response. Both signals delivered into 8 ohms. Scales: Vertical, 5 V/div.; horizontal, 5 mS/div.

the peak-rectified d.c. into another capacitor formed by two 3,300-μF, 350-V units in series. Again, 100-kilohm, 2-watt resistors are placed across these capacitors. A parallel combination of two 2-μF, 600-V film capacitors and one 0.15-μF, 630-V film capacitor are placed in parallel with the final electrolytic filter capacitor. The final filtered high voltage is fed to the center tap of the output-transformer primary winding through a 3-ampere fuse that is paralleled by an LED (in series with a limiting resistor) which indicates when the fuse is blown.

The final filtered high voltage also feeds two solid-state zener-follower voltage regulators that supply the regulated voltages of the front-end stages. Across the output of the regulator that feeds the input-amplifier stage are eight 0.15-μF film capacitors. The regulator that feeds the phase-inverter stage is bypassed by a parallel combination of four 1-μF and two 0.15-μF film capacitors.

Another winding on the power transformer is half-wave rectified and filtered, and feeds two separate zener-follower regulators that provide -48 V bias supplies for each half of the output stage. Like the high-voltage supplies, these bias supplies are full of good-quality film bypass capacitors.

A third secondary winding on the power transformer is full-wave bridge rectified and capacitor-filtered to feed smoothed d.c. to the heaters of the front-end tubes. A fourth secondary winding is half-wave rectified to a plus-and-minus supply which provides the supply and reference voltages for the op-amp's bias indicator circuits. A fifth (and final) secondary winding provides 12.6 V a.c. to power the heaters of the output tubes.

To sum up the Premier Five's circuitry: The amplifier circuit itself is fairly straightforward, with the exception of the cathode-follower buffer between the first amplifier stage and the long-tailed-pair phase inverter. The power supply has a lot more filter storage capacitance than older tube-amplifier designs. This, in conjunction with the voltage regulators powering the front-end circuitry, most likely helps keep things more solid—especially under large-signal conditions. The liberal use of low dielectric-absorption, film bypass capacitors throughout the power supply probably helps sonic performance considerably.

Measurements

The first step in measuring the Premier Fives' performance was to rebias the output tubes to the correct idling current at an a.c. line voltage of 120 V. This current, by the way, is 45 to 50 mA. In my house, the line voltage is more like 112 to 114 V with the amps on. Before I rebased the amps, I measured the mid-band power, at the onset of clipping, with 112 V from the power line. This worked out to about 180 watts.

Voltage gain, with an 8-ohm load on the 8-ohm tap, was 36× or 31.1 dB, which is some 5 dB higher than the usual power-amp gain of 26 dB. For the 4-ohm tap, gain was 26.5× or 28 dB. IHF sensitivity for 1 watt out into 8 ohms was 78.5 mV.

Figure 1 shows THD + N versus power and frequency, for 8-ohm loads on the 8-ohm taps. As can be seen, distortion rises above 1 to 2 kHz for all power levels shown. At higher power levels, distortion also rises at low frequencies.

I wish I could quantify why the Premier Fives sound so good, but I can't. So I turn off my rational side and just enjoy the music.

At 20 Hz, the amp could not produce 200 watts output due to output-transformer saturation.

Figure 2 shows THD + N (measured from 400 Hz to 80 kHz, for a 1-kHz test signal) and SMPTE-IM distortion, for 4- and 8-ohm loads on their respective taps. The amp's behavior on the 16-ohm tap is about like that on the 4-ohm tap. For some reason that I can't figure out, the 8-ohm THD at 200 watts shows onset of clipping, but distortion with 8-ohm loading is lower below 200 watts than with either 4- or 16-ohm loading. With either 4- or 16-ohm loading, the THD residue produced at 200 watts output does not exhibit onset of clipping.

Damping factor versus frequency is shown in Fig. 3 for the 4- and 8-ohm taps. Damping factor is higher yet on the 16-ohm tap, because the feedback is taken from this tap on the secondary of the output transformer.

Rise- and fall-times into an 8-ohm load were $3.5 \mu\text{s}$ at ± 5 V output. Oscilloscope photos for various conditions are shown in Figs. 4 and 5. The top trace of Fig. 4 is for a 10-kHz square wave into 8 ohms, driven from the 8-ohm tap. The middle trace is with $2 \mu\text{F}$ of capacitance paralleled with the 8-ohm resistive load. The bottom trace is for an open circuit; stability here is marginal. Square-wave performance on the other taps is similar, but not the same in terms of ringing and overshoot. The top trace of Fig. 5 shows the nature of the harmonic residue, which is predominantly even harmonic, at 10 watts output at 1 kHz. The lower trace shows excellent low-frequency response with a 40-Hz square wave.

Frequency response at 1 watt output, for 8-ohm loading, is shown in Fig. 6. The IHF signal-to-noise ratio was found to be -82 dB. IHF dynamic headroom measured 218 watts or 0.37 dB, and IHF clipping headroom was 205 watts or 0.11 dB; both were measured with 8-ohm loading and 120-V a.c. line input.

Peak current into a 0.1-ohm load on the 4-ohm tap, using the IHF dynamic-headroom test signal of 20 mS on and 480 mS off at 1 kHz, yielded ± 22 amperes before visible distortion occurred.

Summing up on measurements: The Premier Five tube amplifier has higher distortion figures near full power than most solid-state power amplifiers, although at low to medium power levels it is satisfactorily low. High-frequency stability might be a problem with a load that presents a high impedance at ultrasonic frequencies. My only actual experience as evidence of this occurred when driving an Infinity IRS speaker, with its tweeter disconnected temporarily for test purposes. A buzz in the midrange drivers suggested that the amp was oscillating under this abnormal condition.

Use and Listening Tests

A comment on my personal preference or bias is in order here: Some of my reviews may give the impression that I don't care for solid-state gear and that I prefer tube equipment. I would like to clarify this. Good tube equipment, for me, simply re-creates (or creates, if you will) a more believable, emotionally involving musical experience. Where tube equipment gets it more right is in the areas of spaciousness, depth of image in the sound field, and instrument tonality. Thus far, solid-state gear doesn't quite measure up in my opinion, although the gap is narrowing. I do like to use



Fig. 6—Frequency response at 1 watt output into 8-ohm load.

solid-state equipment because of its long-term reliability, stability of characteristics, lower power consumption, etc. With this said, on to my evaluation of the Premier Five amplifiers' sonics.

As previously mentioned, I had the opportunity to hear two other pairs of Premier Fives, in the Infinity Systems sound room, on RS IB and IRS loudspeakers. The Infinity system uses a Mitchell A. Cotter turntable with a Goldmund tonearm and Koetsu Onyx cartridge. The resident preamplifier is an Audio Research SP10. With Premier Fives driving the midrange and tweeter sections of a pair of RS IBs, the sound of this system is very good indeed. I have listened to a good number of transistor amplifiers on this system; in comparison to the Premier Fives, they all sound variously less dimensional, more irritating, and ultimately less musical to my ears.

I have heard the personal system of Arnold Nudell, Infinity's president, a number of times. The signal source in this setup consists of an Otari professional open-reel recorder, playing low-generation copies of master tapes, with or without transformerless Dolby A NR units. The signal from the Otari is fed, via a dual 500-ohm volume control, into the bass amplifier and crossovers of an IRS speaker system. Nudell uses Premier Fives to drive the midrange and tweeter panels. Reproduction is stunningly believable, which tells me that the Premier Fives are incredible amplifiers.

In my less lofty home listening environment (using an Infinity air-bearing turntable, Koetsu's new EMC-1B cartridge, Infinity RS IIB speakers, and Stax SR-X/Mk3 headphones), I have found the Premier Fives to be ultimately satisfying. I keep trying other amplifiers and when I go back to the Fives, my reaction is, "Ahhh, all right!" Even my super-critical associate, Geoff Cook, concedes that they are "pretty good amps." The only other power amplifiers that have satisfied me as these do are the Marantz 9s, which sound a little softer and sweeter in the high end and not quite as solid in the bass. Of course, the 9s are no longer commercially available, whereas the Fives are. I like the Premier Fives very much, and would recommend that anyone who can afford them give them a serious audition.

As a concluding point, I wish I could quantify with some measurements why the Premier Fives sound so good. As a measurer, I don't yet have a clue. This is frustrating, and I hope to ultimately find out why. In the meantime, I have no trouble turning off the rationalist, the language-oriented, measurer part of me, turning on my ears, the ultimate measurer, and enjoying the music.

Bascom H. King

3

MARK LEVINSON AUDIO SYSTEMS ML-10A PREAMP AND ML-9 AMP

Manufacturer's Specifications

ML-10A Preamp

RIAA Equalization Accuracy:
± 0.30 dB.

Gain: Phono, 42, 53, or 63 dB, switch-selectable; line, 22 dB.

Distortion: Phono, 0.014% THD and 0.005% IM at 6 V output, 20 Hz to 20 kHz, 63-dB gain; line, 0.004% THD and 0.004% IM at 6 V output, 20 Hz to 20 kHz.

S/N Ratio: Phono, -72 dB, 20 Hz to 80 kHz, re: 1 mV input at 1 kHz, 63-dB gain; line, 95 dB, unweighted, re: 2 V.

Volume-Control Tracking: ± 0.50 dB in typical usage range.

Line Input Impedance: 15 kilohms.

Recommended Load: Main outputs, 5 kilohms or more; record outputs, 10 kilohms or more.

Dimensions: 2¼ in. H × 19 in. W × 10⅞ in. D (5.7 cm × 48.3 cm × 25.7 cm).

Weight: 8 lbs. (3.6 kg).

Price: \$3,150.

ML-9 Amplifier

Power Output: 100 watts per channel, 8-ohm loads, 20 Hz to 20 kHz; 200 watts per channel, 4-ohm loads.

Distortion: 0.2% THD for 100 watts output, 8 ohms; 0.4% THD for 200 watts output, 4 ohms.

Damping Factor: Switchable, 300, 200, or 100 at 50 Hz, re: 1 watt at 8 ohms.

Input Impedance: 50 kilohms.

Dimensions: 8¾ in. H × 19 in. W × 13⅞ in. D (22.2 cm × 48.3 cm × 34 cm).

Weight: 56 lbs. (25.5 kg).

Price: \$3,250.

Company Address: c/o Madrigal, P.O. Box 781, Middletown, Conn. 06457.

(Originally published August 1985)





The ML-10A preamplifier and ML-9 amplifier stand about midway in the hierarchy of Mark Levinson Audio Systems (MLAS) components. Both are typical MLAS designs, save that the ML-10A breaks with the company's tradition of separate power supplies for preamps, as its power supply has been successfully incorporated into its chassis. Like all MLAS preamps, the ML-10A is a no-frills design, with a minimum of amplifier blocks or switches in the signal path.

Both the amp and preamp are rack width, but are not really designed for rack mounting. The preamp's mounting holes are not spaced to match standard racks; the amp has no mounting holes at all, because the makers recommend placing it near the speakers rather than racking it with the preamp. The ML-10A has a front-panel height of 2¼ inches and a depth of 10½ inches, a very convenient size for a preamp.

The preamp's front-panel controls are sparse, in keeping with the MLAS design philosophy. From left to right, they include a three-position rotary selector switch; toggle switches for tape monitor and "Record/Defeat" (which prevents the possibility of connected but unpowered tape decks nonlinearly loading the selected source—a good idea); two rotary, stepped, output gain switches which provide balance control; toggle switches for "Mono/Stereo" and "High/Low" output gain, and an unstepped volume control.

On the rear panel are the signal, ground, and a.c. connections. The signal connectors are the Camac type used by MLAS in all their equipment, designed to make shield contact before signal contact, thus preventing transients and hum when changing connections. The a.c. connections are through a device called a Corcom, which provides voltage selection for 100-, 120-, 220-, and 240-V a.c. lines, plus line fusing, balanced LC line filtering and a female receptacle for the a.c. line cord.

Internally, the space is completely occupied by a double-sided p.c. board. On the bottom of this board are two solid, quarter-inch-square bars running the full width of the chassis to lend extra mechanical support. Also notable is the beefing-up of critical ground, signal, and power-supply traces by heavy buss wires and copper bars.

Removing the plate which covers the rightmost 3 or 4 inches of the p.c. board reveals the Corcom; a shielded, toroidal power transformer, and the rectifiers and filter capacitors. The plate keeps fingers out of live a.c. line connections and provides additional shielding.

Editor's Note: The particular units reviewed here were produced by the "old" firm, prior to legal difficulties late in 1985. However, the new samples were diligently checked by the reviewer, who tells me that the bench tests show them to be quite "substantially like the units tested last fall." Bascorn further says, "I have also listened to them and find that they sound like the original units. I think that we can run the original review with a few words in postscript to that effect." Our company contact tells us that insofar as they are concerned, the only change is in the ownership of the company, and that they have not changed the units inside or out.—E.P.

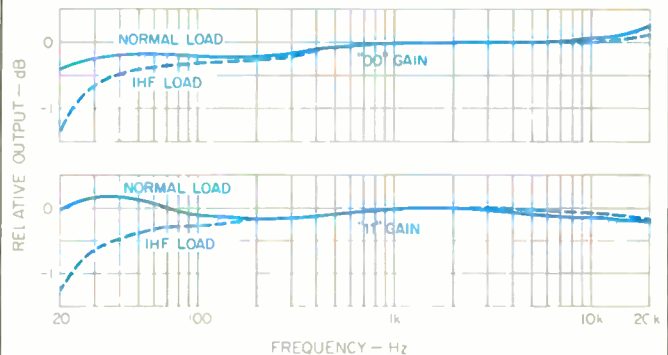

Fig. 1—RIAA phono equalization error for "00" (42-dB) and "11" (63-dB) gain settings, with normal and IHF loads, at tape out.

To the left of this power-supply area are the phono preamps (which take up the whole left half of the p.c. board), the line output amplifiers, and the power-supply regulators.

The volume control is an impressive-looking Penny and Giles unit. Rotary switches are RCL high-conductivity gold-plated units. Connections from the p.c. board to the volume control and toggle switches are via flexible printed circuits. Component quality and construction are first-rate in this unit.

The ML-9 amplifier is rated at 100 watts per channel into 8-ohm loads and, weighing in at 56 pounds, is one of the beefiest 100-watt-per-channel power amps I've seen. (More on the power rating later.) This is a solid, attractive, and well-made piece of audio gear.

On the front panel are a pair of handles and a single rocker-type power switch with an integral red LED indicator. The power switch is, in reality, a circuit breaker switching both sides of the a.c. line. The breaker will trip if the a.c. line current, the heat-sink temperature, or the d.c. offset in the amplifier's output becomes excessive.

On the rear panel are a three-wire, chassis-mounted male socket for the a.c. power cord; fuses for each side of the a.c. line; two Camac signal-input connectors; two pairs of five-way binding posts for output (spaced more than ¾ inch apart to prevent the use of dual-banana plugs); two three-position damping-factor switches, and a second pair of handles to facilitate carrying the amp.

A U-shaped chassis forms the back panel, bottom, and front subpanel. The heat-sink assemblies bolt to the open sides of the U, and a top cover and front panel complete the picture. Within the amplifier enclosure are a number of p.c. boards, including a control board behind the front panel and, inside the rear panel, an output board and two small damping-network boards. The amplifier circuits themselves are mounted on the back of the heat-sinks. A large 1.2-kVA toroidal power transformer and two 36,000-µF/100-V filter capacitors take up most of the interior volume.

The Levinson design philosophy translates into sparse controls, a minimum of amplifier blocks, but many circuit niceties.

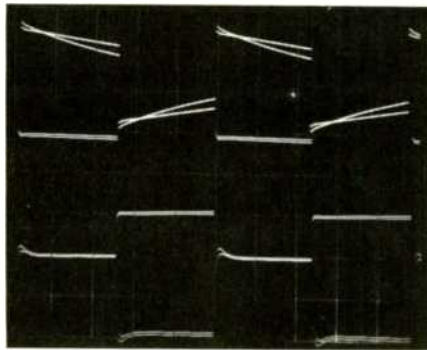

Fig. 2—Phono-preamp square-wave responses at "00" gain setting for 40 Hz (top), 1 kHz (middle), and 10 kHz (bottom). Dual traces show effects of normal and IHF loads.

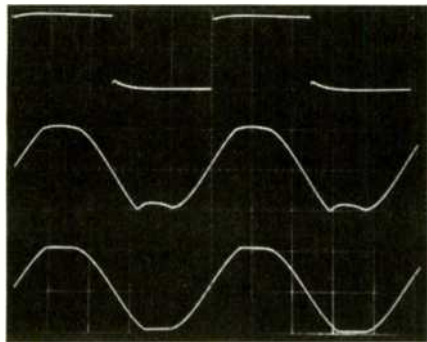

Fig. 3—Additional phono-circuit waveforms. Large-signal square wave (top); sine-wave clipping character at "00" gain setting (middle) and at "11" gain setting (bottom).

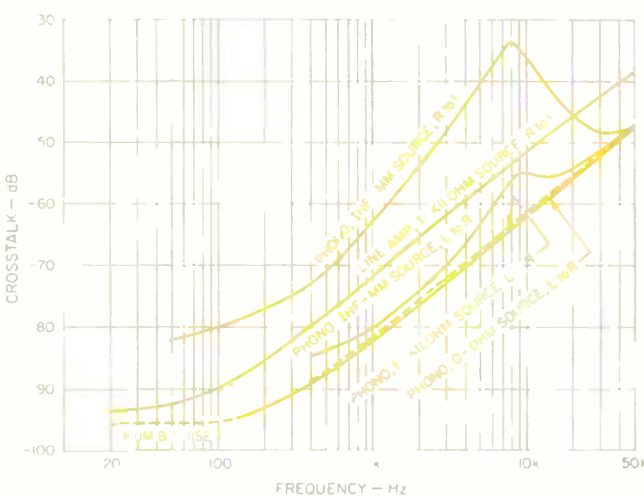

Fig. 4—Crosstalk vs. frequency for line and phono sections. Note that crosstalk is shown in both directions for phono input with IHF-MM source (see text).

Preamplifier Circuitry

The phono preamp circuit starts out with a cascode input stage consisting of a matched pair of bipolar NPN input devices in a common can, whose collectors are connected to the sources of a pair of N-channel junction FETs. A three-device current source feeds the emitters of the input differential pair. The differential output of the first stage is direct-coupled to a pair of NPN emitter-followers whose purpose is to allow high voltage gain in the first stage and provide low output-impedance drive for the output stage. The output stage is a cascode differential amp consisting of PNP devices loaded with an NPN current which converts the differential signal to a push-pull output signal in respect to ground.

An RC feedback network accomplishes RIAA equalization. Two rocker switches on the p.c. board vary the effective value of this stage's shunt feedback resistance to yield three gain levels (42, 53, and 63 dB, at 1 kHz).

Phono input termination is adjusted by a six-rocker, p.c.-mounted switch assembly which allows a normal input impedance of 50 kilohms shunted by 220 pF, an additional 220-pF shunt, a 15-kilohm shunt, an 825-ohm shunt, a parallel combination shunt of 200 ohms and 1,000 pF, a parallel combination of 30 ohms and 0.01 μF, activation of two pairs of plug-in terminals for a user-installed parallel combination, and any parallel combination of the preceding. Flexible input termination, indeed!

For r.f. attenuation, the signal from each phono input connector passes through a 1-ohm resistor with two ferrite beads on its leads.

There are three low-frequency roll-offs in this circuit. The first is an input coupling capacitance consisting of a 2,200-μF electrolytic bypassed with a 0.68-μF film unit. A 66.5-kilohm resistor on the phono input side of the coupling cap and a 200-kilohm resistor on the input-transistor side form a paralleled combination of 49.9 kilohms for the basic value of the input impedance. This input time constant may seem ridiculously long (440 S), but the reason for the large capacitance is to reduce the source impedance to the first stage at low frequencies, in order to get the least possible low-frequency noise. The second low-frequency roll-off is formed by another 2,200-μF capacitor, bypassed by a 0.68-μF film, in series with the shunt feedback resistor. This high value of capacitance is more necessary here to get good response below 20 Hz with the low value of shunt feedback resistance (some 10 ohms or so) at the highest closed-loop gain of 63 dB at 1 kHz. The last roll-off is formed by a 2-μF output coupling capacitor against the nominal line input impedance of 15 kilohms.

The line amplifier circuit is similar to the phono preamp but with a single-case, dual-cascoded J-FET used as the differential amp input stage, here fed from a two-terminal, constant-current source. Output is direct-coupled to the line outputs, as is the input from the volume control. A d.c. balance control in the drain circuit of the first stage allows the output d.c. offset to be zeroed out. A 2.2-μF polypropylene capacitor in the shunt arm of the feedback network causes the d.c. gain of the output amplifier circuit to be unity.

The two rotary "Balance" controls on the front panel each

The ML-9, weighing 56 pounds, is one of the beefiest amps I've seen in its 100-watt-per-channel power class.

adjust one channel's output amplifier gain by ± 5 dB, in 1-dB steps, by varying the value of the shunt feedback resistors. The front-panel "High/Low" switch adjusts both channels at once, placing a resistor in series with the volume control and another in shunt with it, to give 9 dB of attenuation without changing the line input impedance.

The power-supply circuitry in the ML-10A starts with the toroidal power transformer feeding a full-wave bridge rectifier producing about ± 20 V d.c. into 1,000- μ F capacitors. Additional filtering is provided by 2.2-ohm series resistors and two more 1,000- μ F capacitors. This unregulated d.c. is fed into an integrated-circuit dual tracking regulator that provides ± 12 V as power supply for the error op-amps, +12 V as a source for the reference zener diode, and ± 12 V for bias dividers in the actual plus and minus voltage regulators.

The regulator circuitry is unique in my experience, in that it uses a complementary push-pull output amplifier like most transistor power-amplifier output stages. Most voltage regulators use a single-polarity (NPN or PNP) device as a pass element, or use paralleled multiple ones. By virtue of the negative-feedback connection, the pass element tries to keep the output constant as input voltage and load vary. This is fine when the load is increasing: The pass device turns on harder and keeps the voltage up. But imagine what happens when there is some inductance in the load and the load is decreasing: The output voltage would tend to increase beyond the regulated value. All that a single pass element could do here would be to cut off, thereby causing a load-voltage overshoot, a momentary loss of control, and a rise in power-supply output impedance.

Under those same circumstances, with a push-pull pass element as used in the ML-10A, the shunt pass device would turn on, keeping the output voltage from overshooting and keeping the output impedance active and low.

The circuitry itself consists of a complementary compound circuit with two drivers and two output transistors connected between the unregulated input d.c. voltage and ground. The regulated, ± 13 V d.c. voltage is taken from the output-transistor collectors. The error op-amps drive the driver transistors as common-base amplifiers. This is a clever and innovative circuit. Film capacitors are liberally used to bypass electrolytics throughout the power supply. For additional heat dissipation, the top cover bolts to the heat-sink on which the power supply's output and bias transistors are mounted.

Amplifier Circuitry

The ML-9's first stage, like the ML-10A's, consists of a cascode differential amplifier fed from a two-transistor current source. The signal input transistors are a pair of matched NPN devices in a common case. The outputs of these bipolar transistors are direct-coupled to the sources of a pair of N-channel junction FETs whose gates are connected to the corresponding NPN transistor emitters. Degeneration in this composite stage is high, due to 500-ohm emitter degeneration resistors and 3-kilohm FET drain loads. Signal input coupling to the plus input of the input amplifier is via a 15- μ F film capacitor with 100-kilohm resistors to ground on the signal-input and transistor sides of the capacitor, forming a basic, 50-kilohm input resistance at low

Fig. 5—Preamp line-amp square-wave responses for 20 Hz (top), 20 kHz (middle), and 20 kHz at clipping (bottom).

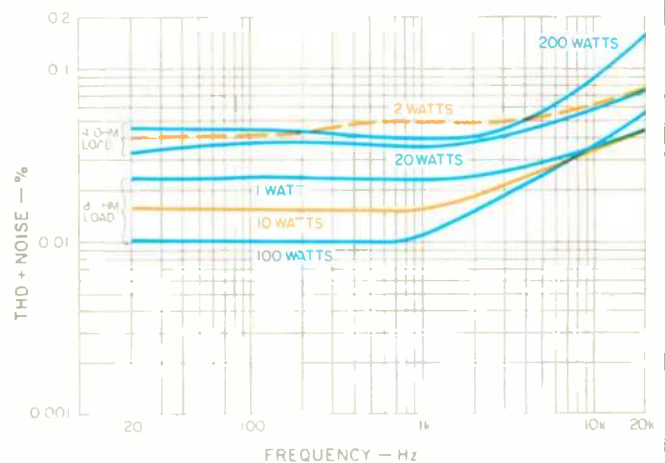
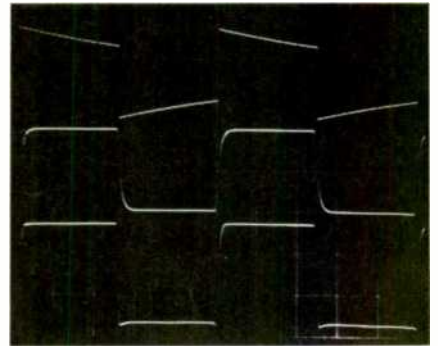

Fig. 6—THD + noise vs. frequency and power, ML-9 amplifier, with 4- and 8-ohm loads.

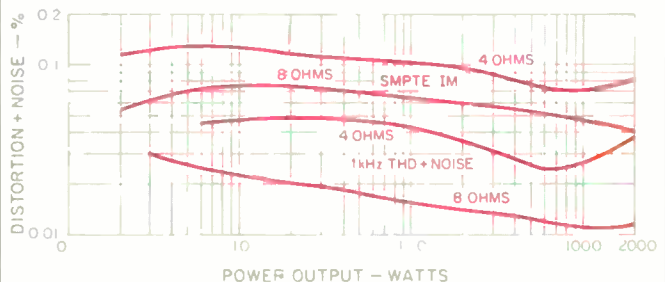

Fig. 7—THD + noise and SMPTE IM vs. power output, ML-9 amplifier.

The preamp's regulator circuitry is unique; it's more like a power amplifier than the usual, simple voltage regulators.

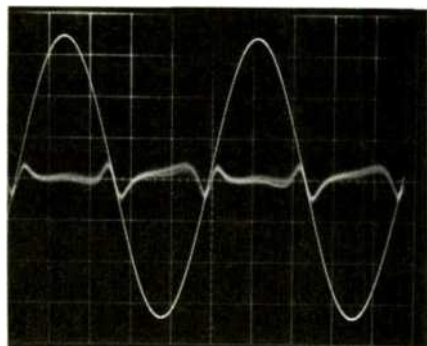

Fig. 8—Harmonic-distortion products.

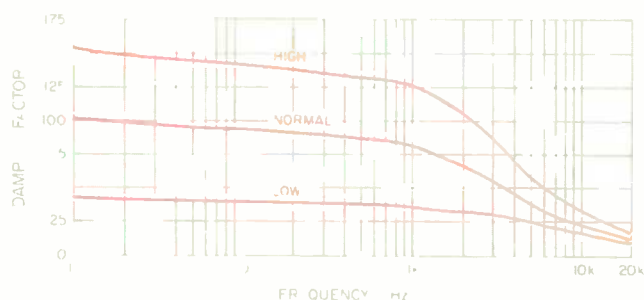

Fig. 9—Damping factor vs. frequency (re: 8 ohms) for three settings of damping switch.

to middle frequencies. A single-pole, low-pass filter having a cutoff frequency of about 80 kHz connects the input coupling capacitor and the plus input of the input stage.

Output of the first stage is direct-coupled to the second stage, which is again a cascode differential amplifier with a current-mirror load. The cascode amplifier part of this circuit uses PNP bipolar transistors, and the current mirror uses NPN bipolars. The net result of this stage is to further amplify the signal and convert the differential output signal to a single-ended output in respect to ground. A bias-spreading network is connected between the output PNP and NPN transistors to provide bias for the output stage (which is a triple complementary emitter-follower arrangement). Four NPN and four PNP TO-3 high-power output devices are used here. The supply voltage for this amplifier is ± 80 V d.c., which makes it a 250 to 300-watt-per-channel amplifier into 8-ohm loads. Further, it is claimed that this circuit can put out ± 29 A into a 2-ohm load. With this in mind, the rating of 100 watts per channel is very conservative, as the unit will deliver at least that much into any conceivable speaker load.

An energy-limiter circuit operates separately on positive and negative half-cycles of the output signal, and it is said to offer output-stage protection without sonic consequences. Considering the basic volt-amp capability of the output stage, the limiter circuit is probably set high enough to come into action only for such extreme conditions as impedances below 1 or 2 ohms.

The distribution of loop feedback is unusual in this amplifier. The usual single shunt-feedback resistor is actually two resistors in series, with one end of the series combination grounded and the other end going through a 10- μ F film capacitor to the inverting input of the input amplifier. Topologically, this is normal and usual. What is different is that most of the loop feedback comes from the output of the second stage to the junction of these two series-connected shunt-feedback resistors. A second loop from the main output comes back through a resistor directly to the inverting input to provide 100% d.c. feedback and some small amount of a.c. feedback.

Even more novel is the variable damping feature. A three-position toggle switch (one per channel) allows for low, normal, and high damping factors to optimally interface with different speakers. The feedback arrangement just described provides the low damping factor; the normal and high damping conditions are provided by an additional feedback network (measuring the drop across the output-buffering RL network) that provides some positive current feedback to lower output impedance even more.

The power supply of the ML-9 shows attention to some unusual details. The a.c. power input immediately goes through a Sprague LC line filter, which filters both sides of the line in respect to the chassis or third-wire power ground. Additional line filtering is provided by a balanced network consisting of a capacitor between hot and neutral, a choke in each side of the line, and another capacitor after the chokes between hot and neutral.

A network consisting of a relay-contact shortable resistance is in series with the transformer primary to reduce inrush current. This relay is operated by a transistor time-delay circuit, which shorts out the series resistance after about 2 S.

A detector circuit on the rear-panel output board monitors the d.c. offset at each channel's output, and it will trip the a.c. line-switch/circuit-breaker if offset becomes excessive. This detector and the time-delay circuit share a small, separate power supply, with its own full-wave bridge rectifier and capacitor filters, which is fed from the switched a.c. line.

Preamplifier Measurements

Circuit gains and IHF sensitivities were measured first and appear in Table I. The three selectable phono gains of 42, 53, and 63 dB are designated as "00," "10," and "11" to correspond with the logical rocker positions of the gain-switch pairs.

Phono noise for different gain settings, weightings and source impedances is shown in Table II. Table III shows IHF S/N ratios; the noise values are quite good for a differential input stage.

Phono THD + noise (Table III) was measured in the "00" gain position, at 6 V rms output, and was less than 0.01%

The amp's power supply makes its rating of 100 watts per channel quite conservative—it will deliver at least that much into any conceivable load.

from 20 Hz to 20 kHz with my normal load (250 pF and 91 kilohms). The IHF loading, at 6 V output, caused clipping distortion at 20 Hz, but at 5 V output, THD + noise was less than 0.01% from 20 Hz to 20 kHz. Measuring distortion at the higher gain settings was frustrated by hum pickup in my measurement setup.

Phono overload versus frequency, for gain settings of "00" (42 dB) and "11" (63 dB), is shown in Table IV. The power-supply voltages of ± 13 V are primarily responsible for the overload values mentioned. Although the 1-kHz, "00"-gain input overload voltage of 60 mV is low compared to some other designs, in practice the ML-10A probably won't be overloaded by low- to medium-output moving-magnet pickups (1 to 5 mV at 1 kHz, at standard level of 5 cm/S lateral or 3.54 cm/S stereo).

Phono RIAA equalization error is shown for several conditions in Fig. 1. Pre-equalized square waves through the phono section are shown in Fig. 2 for normal and IHF loading at "00" gain. The overshoot visible in the 1- and 10-kHz traces is due to a resistor in series with the final RIAA roll-off capacitor, a frequent choice of designers.

The clipping character of the phono preamp is different for "00" and "11" gain settings, as illustrated in Fig. 3. Also shown in Fig. 3 is a large-signal, pre-equalized, 1-kHz square wave, having generally excellent symmetry but with some in-band high-frequency compression. This is a severe test for circuit high-frequency acceptance, since the rise-time of the pre-equalized signal is essentially that of the signal generator (in this case some 50 to 100 nS).

I used to band-limit the square-wave test signal to a 50-kHz equivalent, which is obviously easier on the circuit under test. I have decided lately that a non-band-limited signal with short rise-time, severe and musically unrealistic as it is, is still a meaningful test for evaluating phono preamp circuits.

Channel-to-channel crosstalk in the phono section is shown in Fig. 4. Since I started to measure crosstalk in moving-magnet phono gain stages with an IHF-MM source, I have shown the worse crosstalk direction, i.e., right-to-left or left-to-right. Here, however, I have shown both directions, since the effect depends on which channel is driven. This asymmetry may have some effect on high-frequency imaging symmetry with high-inductance moving-magnet pickups. (For the sake of completeness, I should add that the Audio Research SP10 reviewed in the June 1984 issue had this asymmetrical behavior, whereas the Perreux SM2 reviewed in the July 1984 issue was within a few dB of being symmetrical.) Phono-stage crosstalk for the other two gain settings was about the same as for the "00" setting with source impedances of 0 to 1 kilohm.

Phono input impedance was representable by a parallel combination of 50 kilohms and 250 pF. Phono output impedance was about 600 ohms in series with 2.2 μ F.

The line amplifier section was measured for THD + noise, which was found to be less than 0.01% from 20 Hz to 20 kHz at 7 V rms output with either a normal or IHF load. At 20 kHz with 7 V output, distortion was under 0.01% with up to 6,800 pF of extra capacitance loading. Although not recommended by MLAS, it was found that this line amp would drive 600 ohms at 7 V output with about 0.07% THD in the left channel



Fig. 10—Frequency response, ML-9 amplifier, at 1 watt output.

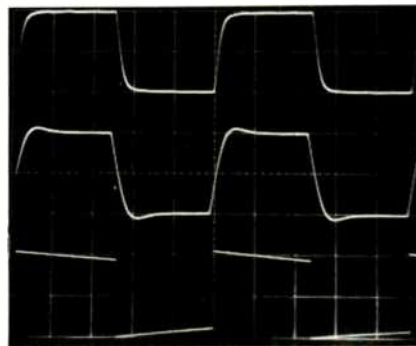

Fig. 11—Square-wave responses, ML-9, for 10 kHz into 8-ohm load (top), 10 kHz into 8 ohms paralleled with 2 μ F (middle), and 40 Hz into 8 ohms (bottom).

and 0.04% in the right. The nature of this distortion was predominantly third harmonic and fairly constant across the audio band. Impressive performance!

Rise and fall times of the output amplifier were 1.8 μ S at ± 10 V output with either a normal or IHF load. Further, the rise and fall times were essentially constant with volume-control attenuation. With either or both balance controls set to +5 dB, the rise and fall times lengthened to 2 μ S. Another attribute of this circuit is that the rise and fall transitions stayed constant and exponential up to clipping. A scope picture of square-wave responses through the output amplifier is shown as Fig. 5. The 20-Hz tilt in the top trace is caused by the 2.2- μ F capacitor in the shunt feedback path. The bottom trace is for a 20-kHz square-wave signal overdriving or clipping the output amplifier.

AUX input impedance measured 14.3 kilohms in parallel with 300 pF. Output resistance was about 85 ohms.

Volume-control tracking was checked by setting the attenuation of the right channel in 5-dB steps and comparing the resultant attenuation in the left channel. Tracking error was within 1 dB to -65 dB, increasing to 2 dB at -70, 5 dB

The ML-9 has a separate power supply for such non-audio circuits as the inrush-current time delay and the d.c. offset sensor.

at -75, and 13 dB at -80, with the left channel always having more attenuation than the right.

Interchannel crosstalk of the line amp is shown in Fig. 4. Incidentally, crosstalk was in-phase for both the phono and line amplifiers.

A final measurement, of the unit's power-supply regulators, showed that correct voltage was maintained down to an a.c. line input of 95 V.

Amplifier Measurements

The ML-9 was first run at 33% of rated power, or 33 watts per channel into 8-ohm loads, for one hour. Even though the heat-sinks got quite hot to the touch, the unit did not thermally cycle off during this test.

Voltage gain was found to be 19x, or 25.6 dB, into 8-ohm loads with normal damping. IHF sensitivity for 1 watt output into 8-ohm loads was 150 mV.

THD + noise was measured for both channels for 4- and 8-ohm loads as a function of frequency and power output, and is shown in Fig. 6. The left channel had higher distortion than the right and is therefore the one plotted. Harmonic and SMPTE-IM distortion versus power output at 1 kHz are shown in Fig. 7. Figure 8 shows the harmonic-distortion products typical of a bipolar output stage with optimum

Table II—Phono noise, referred to input.

Condition and Bandwidth	Source Impedance, Ohms	Referred Input Noise, nV	
		L	R
"00" Gain			
20 Hz to 20 kHz	0	165	350*
400 Hz to 20 kHz	0	95	95
A-Weighted	0	98	100
A-Weighted	100	116	116
A-Weighted	1k	225	230
A-Weighted	IHF MM	690	800
"11" Gain			
20 Hz to 20 kHz	0	135	180
400 Hz to 20 kHz	0	65	65
A-Weighted	0	67	69
A-Weighted	100	90	95
A-Weighted	1k	215	215

* Includes 60-Hz hum

Table I—Gain and IHF sensitivity, ML-10A preamplifier.

Condition	Gain, dB		IHF Sensitivity, mV	
	L	R	L	R
AUX In to Main Out				
Low Gain, Normal Load	7.8	7.8		
Low Gain, IHF Load	7.6	7.6	210.0	210.0
High Gain, Normal Load	17.0	17.1		
High Gain, IHF Load	16.9	17.0	71.5	71.5
AUX In to Tape Out				
Normal Load	0	0		
IHF Load	0	0	500	500
Phono In to Main Out, High Line-Amp Gain				
"00" Gain, Normal Load	58.8	58.8		
"00" Gain, IHF Load	58.8	58.8	0.572	0.572
"10" Gain, Normal Load	70.5	70.5		
"10" Gain, IHF Load	70.4	70.4	0.150	0.150
"11" Gain, Normal Load	80.5	80.5		
"11" Gain, IHF Load	80.4	80.4	0.0475	0.0475
Phono In to Main Out, Low Line-Amp Gain				
"00" Gain, Normal Load	49.5	49.5		
"00" Gain, IHF Load	49.4	49.4	1.68	1.68
"10" Gain, Normal Load	61.2	61.2		
"10" Gain, IHF Load	61.1	61.1	0.435	0.435
"11" Gain, Normal Load	71.1	71.1		
"11" Gain, IHF Load	71.1	71.1	0.139	0.139
Phono In to Tape Out				
"00" Gain, Normal Load	41.7	41.6		
"00" Gain, IHF Load	41.2	41.2	4.3	4.3
"10" Gain, Normal Load	53.4	53.4		
"10" Gain, IHF Load	52.9	52.9	1.14	1.14
"11" Gain, Normal Load	63.3	63.3		
"11" Gain, IHF Load	62.8	62.8	0.362	0.362

bias. Lower bias (idling current) will produce a crossover notch, caused by gain reduction near the origin. Higher bias will produce a notch of the opposite polarity, caused by a gain increase near the origin. The "best" bias produces the dual-peaked "doublet" shape seen in Fig. 8. Distortion is affected by the damping switch, being lowest with the highest damping factor. For example, at 10 watts and 1 kHz, the left channel produced 0.036%, 0.015%, and 0.01% for low, normal, and high damping positions. In measuring distortion in this amp, I noted a thermal drift of bias which manifested itself in distortion dropping with time when power above about 10 watts was being produced. After running at higher power and returning to lower power, distortion would creep up to its former value at that lower power level after 5 to 10 S. I suppose one could term this thermal hysteresis distortion with a long time constant.

Damping factor was looked at as a function of frequency and damping-switch position. The specs for this unit claim damping factors of 100, 200, and 300 at 50 Hz, at a reference level of 1 watt into 8 ohms. I measure this by injecting 1 A rms from one channel into the measured channel. More specifically, one channel is driven to 8 V rms and connected to the measured channel's hot output terminal through an 8-ohm resistor. Then, to a good approximation, mV across the measured channel output becomes milliohms of output impedance. Results of this are plotted in Fig. 9. Using this method with other amplifiers, I generally measure about the same damping factors as claimed. Here, however, I got about half the specified values.

Frequency response at the 1-watt level for 4- and 8-ohm loads is shown in Fig. 10. The slight difference in high-frequency response for different loading is normal with most power amplifiers.

Interchannel crosstalk versus frequency was found to be better than -85 dB up to 10 kHz, rising to -80 dB at 20 kHz and -74 dB at 50 kHz—excellent, indeed.

Rise and fall times were measured at ±5 V output into 8 ohms. As a function of the damping switch, the values were 5.0, 5.5, and 6.0 μS for high, normal, and low positions.

FUEL INJECTION FOR YOUR MUSIC

SHIFT INTO DIGITAL DRIVE WITH RECOTON'S CD ADAPTER

Accelerate into the digital dimension with Recoton's Compact Disc Adapter. Designed by award-winning audio engineer Larry Schatz, this versatile accessory delivers the full impact of digital sound—with no signal loss.

Just plug into the output jack of your portable CD player. Then insert the adapter into your car's cassette unit. No wiring. No permanent installation. Just pure pleasure—to go. Pick one up today and we guarantee you'll never be driven to boredom.

RECOTON®
THE PROVEN PERFORMERS

46-23 CRANE STREET, LONG ISLAND CITY, NY 11101
1-800-RECOTON



I liked the ML-9 amplifier from the moment I first turned it on. It sounds smooth, detailed and spacious, with power and plenty of punch.

Table III—IHF signal-to-noise ratios, phono and AUX inputs.

Condition	Source Impedance, Ohms	IHF S/N, dB	
		L	R
Phono Inputs			
"00" Gain	IHF MM	-76.6	-75.5
"10" Gain	100	-72.7	-72.6
"11" Gain	100	-74.5	-74.0
High-Level Inputs			
High Line-Amp Gain	1k	-91.5	-91.9
Low Line-Amp Gain	1k	-90.5	-91.0

Large-signal square waves near clipping of the output started to slew slightly, in that the transitions became more straight-sloped than exponential. Nevertheless, the amp produced a large-signal rise and fall time at 100 V peak-to-peak into 8 ohms of 6 μ S, for a slew rate of 80 V/6 μ S or 13.33 V/ μ S. A 'scope photo of square waves through the ML-9 appears as Fig. 11: The top trace is 10 kHz into 8 ohms. The middle trace is 10 kHz into 8 ohms paralleled with 2 μ F; notable is the small amount of overshoot and ringing for this capacitive loading. The bottom trace is for 40 Hz.

IHF signal-to-noise ratio, which is A-weighted signal-to-noise below 1 watt into 8 ohms, was -92 dB for the right and -95 dB for the left channel.

Dynamic headroom came out to be 5.3 dB, mainly due to the rated power of 100 watts and the burst power in this test of 340 watts/channel into 8 ohms. Clipping headroom was similarly high, at 4.55 dB, and is related to a continuous output at onset of clipping of 285 watts/channel into 8 ohms.

Use and Listening Tests

Camac connectors, although admittedly superior connectors per se, do cause interconnection problems in audio systems which use the usual RCA connectors. MLAS was kind enough to provide enough adaptors and interconnect cables using their silver wire to allow easy testing and system hookup of the ML-10A and ML-9.

Equipment used to evaluate the MLAS components included the following: Infinity air-bearing turntable and arm with a Koetsu EMC-1B cartridge; Audio Research SP10, Conrad-Johnson PV5 and GC/BHK preamplifiers; Audio Research D70, Dyna ST-35, and Acrosound Stereo 20/20 power amps; Infinity RS IIA speakers, and Stax SR-X/Mk3 headphones.

I received the ML-9 some 4 or 5 months before the ML-10A, so I have had much more exposure to it. I must say that I liked this amplifier from the moment I first turned it on. I find the sound of the ML-9 to be smooth, detailed, and spacious, and without the high-frequency irritation present in most solid-state amplifiers. Surprisingly, it sounds similar to the Dyna ST-35, which is a highly musical-sounding little amp (when its ceramic input-coupling capacitor is eliminated). Compared to the Audio Research D70, the ML-9 is smoother but not quite as revealing of musical texture, detail, and spatiality. Power and punch, it has plenty of—my ears gave up before it did. A critical friend to whom I loaned it thought it was the best solid-state amp he had heard.

Initial listening with the ML-10A was done using the Acrosound tube amplifier driving the Stax phones. Definition was very good, and bass quality and extension were outstanding, although "air" and spatiality were not as good as when the tube preamps were used. There was a noticeable bit of high-frequency edginess present. Subsequent discussion with MLAS indicated that it is really a good idea to warm up the ML-10A for a few days, with the phono inputs shorted or terminated with one's cartridge, before critical listening is attempted. Since the ML-10A is designed to be left on continuously, this warm-up would naturally occur in use. After measuring the unit, I left it on for 5 days before listening again. The sound was definitely better this second time around, with reduced edginess noted.

Using the ML-10A and ML-9 as a combination on the Infinity RS IIAs yielded good definition and spatiality, but I was bothered by an upper mid- to high-frequency irritation. Playing with cartridge loading didn't really help, but turning down the midrange and tweeter controls on the speakers did help a bit. When I would return to the SP10 preamp, for instance, the sound became easier and more musically natural. But then, since musical realism and naturalness in sound reproduction are so much a function of the total combination of elements, it might well be that other combinations of components with the ML-10A would yield superior sound. It really sounded quite good on my headphones.

In summary, the Mark Levinson Audio Systems equipment reviewed here is attractive, solid, and very well-built and should have excellent reliability. As I have said before, the listening comments I have made are essentially my own opinions, and I emphatically recommend that the prospective purchaser go out and audition the equipment in as many circumstances as possible.

Bascom H. King

Table IV—Phono overload vs. frequency, loading, and gain (input values in mV rms, output values in V rms).

Frequency	"00" (42-dB) GAIN			
	Normal Load		IHF Load	
	E In	E Out	E In	E Out
20 Hz	2.45	6.85	2.5	5.9
100 Hz	15.0	7.2	15.0	6.75
400 Hz	39.5	7.2	39.5	6.85
1 kHz	60.0	7.3	60.0	6.9
4 kHz	127.0	7.25	127.0	6.85
7 kHz	203.0	7.2	205.0	6.85
10 kHz	283.0	7.2	282.0	6.8
20 kHz	520.0	7.05	520.0	6.6
Frequency	"11" (63-dB) GAIN			
	Normal Load		IHF Load	
	E In	E Out	E In	E Out
20 Hz	0.18	6.5	0.18	5.35
100 Hz	1.2	7.1	1.24	6.7
400 Hz	3.2	7.05	3.25	6.75
1 kHz	4.85	7.15	4.85	6.8
4 kHz	10.4	7.2	10.4	6.8
7 kHz	16.3	7.15	16.9	6.75
10 kHz	23.7	7.15	23.6	6.7
20 kHz	43.5	7.0	43.5	6.5

Dynamically Different.

THE CARVER M-500t MAGNETIC FIELD POWER AMPLIFIER LEADS AN INDUSTRY TREND TOWARDS MORE USEFUL DYNAMIC POWER FOR MUSIC... AND YET STAYS WELL AHEAD OF ITS INSPIRED IMITATORS.

With its astonishingly high voltage/high output current and exclusive operation features, the M-500t sets standards yet unequalled in the audio community. A conservative FTC sine wave output of 251 watts per channel belies its incredible ability to satisfy peak musical transients demanding far more power. In fact, the M-500t provides more power, more current and more voltage than any comparably priced amplifier ever offered.

POWER EXPRESSED BY THE DEMANDS OF MUSIC. The Carver M-500t responds to musical transients with 600 to 1000 watts of dynamic power, depending on speaker impedance. The gulf between FTC and dynamic power ratings reflects Bob Carver's insistence that amplifier design should fit the problem at hand. The need to reproduce music with instantaneous, stunning impact.

The individual leading edge attack of each musical note lasts less than 1/1000 of a second, yet forms the keen edge of musical reality which must be present if true high fidelity is to be realized. It is especially necessary with the increased dynamic capabilities of Compact Discs and video Hi-Fi. In ordinary amplifier designs, the vast amounts of power required is provided by bulky, expensive power supplies and huge output transformers.

THE MAGNETIC FIELD AMPLIFIER SOLUTION. Rather than increase cost, size and heat output with massive storage circuits, Magnetic

Field Amplification delivers instantaneous high peak and long-term power from a six-pound, four-ounce Magnetic Field Coil. Shown below are the 40-pound toroid coils from a pair of \$7000 esoteric power amplifiers. In front of them is the M-500t's Magnetic Field Coil capable of delivering TWICE the output current (± 100 amperes at 10% regulation!) for exceptionally precise control of voice coil motion



Thus Carver's remarkable, patented design not only lets you enjoy the stunning sonic benefits of simultaneous high current and voltage in a compact, cool-running component, but enables you to afford audiophile-level power as well.

POWER WITH FINESSE. While the M-500t isn't the only amplifier with aggressive output capabilities, it is one of the few that tempers brute power with sophisticated protection circuits beneficial to both the amplifier and your loudspeaker system. These include DC offset, short circuit and power interrupt systems, as well as two special computer-controlled speaker monitor circuits which protect against excessive high frequency tweeter input and overall voice coil thermal overload.

Output is continuously monitored through dual lighted infinite-resolution VU-ballistic meters

which can react to musical transients as brief as 1 millisecond.

In addition, the M-500t's lack of external fan noise is complemented by internal circuitry with the best signal-to-noise ratio of any production amplifier. Better than 120dB. And, unlike any other amplifier in its price or power ranges, the M-500t is capable of handling problematic speaker loads as low as 1 ohm. It may also be used in a bridged mode as a 700 watt RMS per channel mono amplifier without any switching or modification.

MUSIC IS THE FINAL PROOF. Specifications aside, final judgment of any amplifier must be based on musicality.

Bob Carver has carefully designed the M-500t with a completely neutral signal path that is utterly transparent in sonic character, resulting in a total lack of listener fatigue caused by subtle colorations exhibited by many other amplifiers, regardless of their power rating. A veil will be lifted between you and your musical source as the most detailed nuances are revealed and delivered with proper impact.

We invite you to audition the M-500t at your nearest Carver dealer soon. Against any and all competition. We believe that you will be pleasantly surprised at just how affordable this much power, musicality and accuracy can be.

SPECIFICATIONS: POWER, 251 watts/channel into 8 ohms 20Hz to 20kHz, both channels driven with no more than 0.15% THD. Instantaneous Peak power, 1000 watts into 2 ohms; 950 watts into 4 ohms; 600 watts into 8 ohms. Long Term Sustained RMS power, 500 into 2 ohms; 450 into 4 ohms; 300 into 8 ohms. 1000 watts bridged mono into 4 ohms; 900 watts bridged mono into 8 ohms. Bridged Mono RMS Continuous Power, 700 watts continuous into 8 ohms. Noise, 12CdB10Hz A Weighted. Weight, 25 lbs.



CARVER

PO Box 1237 Lynnwood WA 98046

POWERFUL

MUSICAL

ACCURATE

Distributed in Canada by evolution technology

4

McINTOSH MC 2002 AMPLIFIER

Manufacturer's Specifications

Power Output: 200 watts per channel continuous, 8 ohms, 20 Hz to 20 kHz; 300 watts per channel continuous, 4 ohms; 600 watts continuous into 8 ohms in bridged mode.

Rated THD: Less than 0.01% maximum, from 250 mW to rated power per channel, 20 Hz to 20 kHz.

Frequency Response: 10 Hz to 100 kHz, +0, -3 dB, for 1-watt output.

S/N Ratio: Hum and noise, 100 dB below rated output, 90 dB IHF.

IM Distortion: Less than 0.01% from 250 mW to rated output, for any combination of frequencies from 20 Hz to 20 kHz.

Damping Factor: Greater than 100.

Input Impedance: 20 kilohms.

Input Sensitivity: Switchable for either 1.4 or 2.5 V.

Dimensions: Front panel, 16-3/16 in. (41.1 cm) W × 7 1/8 in. (18.1 cm) H; chassis, 14 3/4 in. (37.5 cm) W × 6 1/2 in. (16.5 cm) H × 14 1/2 in. (36.8 cm) D, including connectors.

Weight: 50 lbs. (22.7 kg).

Price: \$1,850.

Company Address: 2 Chambers St., Binghamton, N.Y. 13903.

(Originally published April 1985)





The McIntosh MC 2002 is a Class-AB solid-state stereo power amplifier rated at 200 watts per channel into 8-ohm loads. Physically, the unit is of average size for a Class-AB design, though somewhat lighter than former McIntosh amplifiers of this power rating because it has no potter output transformer or autoformer. McIntosh's massive and expensive bifilar-wound transformers gave them an edge on the competition in the tube designs of the 1950s. When solid-state designs came along, McIntosh used a different device, an autoformer, which used the same core but with a single winding of heavy wire that allowed impedance matching over a broad range.

The front panel sports McIntosh's traditional, rear-illuminated, black-glass construction with gold and black anodization and gold and teal-green nomenclature. The large, square power switch is the only front-panel control, and it glows red when activated. "Power Guard" indicators for each channel monitor clipping quite effectively; between them is a temperature indicator which signals when one or both channels have been shut down because of overheating. Two large, peak-responding power output meters, which use full-wave detection to respond to both positive and negative peaks, occupy the left and center of the panel.

On the rear panel are two RCA signal-input connectors, a screw-clamp barrier strip for the four speaker wires, an unswitched a.c. outlet rated at 100 watts or 1 ampere maximum, a 15-A line fuse, and slide switches for mono/stereo operation and input-sensitivity selection. The line cord is nondetachable.

The chassis construction is an exercise in simplicity. The sides, front, back, top, and bottom are all moderate-gauge (0.048-inch) steel. Four vertical heat-sink extrusions, each containing four TO-3 case output transistors, are bolted to both bottom and top, thus strengthening the assembly. The single, massive power transformer is mounted just behind the front panel, its weight carried by a steel U-section that runs from side to side along the bottom plate. To either side of the transformer are the driver circuit boards. The chassis components are held together by self-tapping screws. The threads in the thin, steel panels were well-formed, but it would be easy to crossthread the bolts on reassembly. The mounting holes in the heat-sinks are pretapped. All in all, this amplifier's mechanical construction is better than average for a home product in its price category.

The quality of the 11 glass-epoxy circuit boards in the McIntosh MC 2002 is very high. Boards are 1/16-inch, single-sided, with milled rather than sheared edges. Solder mask is used but there are no component designators; this should pose no problem, though, because the uncrowded layout allows easy component identification from a chart. Component quality is good to excellent, although no Wonder Caps are used. The correct component types are used throughout, and bias and meter calibration trim pots are sealed from airborne contaminants. Parts are well-secured and run cool. This amplifier, in the McIntosh tradition, should provide 10 to 20 years of maintenance-free service.

Circuit Description

The circuit of the MC 2002 is unusually simple for such a high-performance amplifier. McIntosh's design philosophy

is to achieve high performance with stability and reliability by using a simple topology, with selected components operating in their most linear range.

The input signal passes through an attenuator set at 0 or -5 dB by a rear-panel switch. It is then a.c.-coupled to one input of a differential amplifier stage. Negative feedback from the amplifier output is applied to the other input; output of this stage connects to a positive-drive, cascode-connected pair for further current and voltage amplification. This feeds a push-pull, complementary, triple-Darlington, emitter-follower output stage. The final transistors are four positive and four negative TO-3 case devices per channel, with large (0.5-ohm) emitter resistors.

The power supply uses a single, oversized transformer, a 35-A bridge rectifier, and two 12,000- μ F electrolytic capacitors, which have 77 joules of energy storage. The front-panel power switch actually controls the d.c. supply to a heavy-duty relay; this, in turn, switches on a.c. voltage to the power transformer's primary. The 16 output transistors are convect on-cooled, eliminating potentially noisy fans from the design. Output voltage is ± 80 V d.c.

The metering and protection functions use as much circuitry as the basic amplifier path itself. A 2-S turn-on signal delay is provided by an input-shunting FET. The amplifier

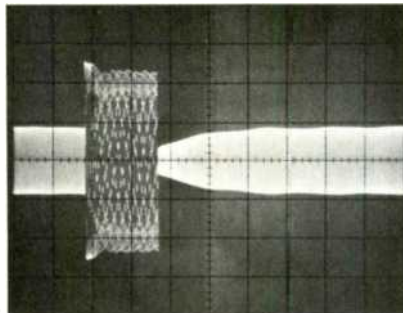

Fig. 1—Characteristics of the Power Guard circuit. (See text.) The continuous signal is 10 kHz, 50 watts into 8 ohms, to which a 1-kHz burst is added so that the resulting signal is +10 dB re: 200 watts. Note that several distinct stages occur. First, there are the horns due to clipping before the circuit acts; next, with the strong signal still present, the gain is reduced to below clipping. Finally, with the 1-kHz overdrive gone, the circuit restores the 10-kHz signal to proper level. (Scales: 20 mS and 15 V per div.)

The MC 2002, in the McIntosh tradition, should provide 10 to 20 years of maintenance-free service to its owner.

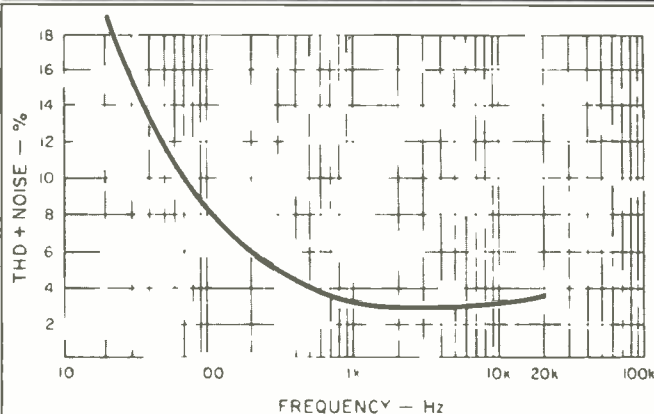

Fig. 2—Total harmonic distortion plus noise vs. frequency at 10 dB over rated output into 8 ohms, steady-state, showing the effect of the Power Guard circuit.

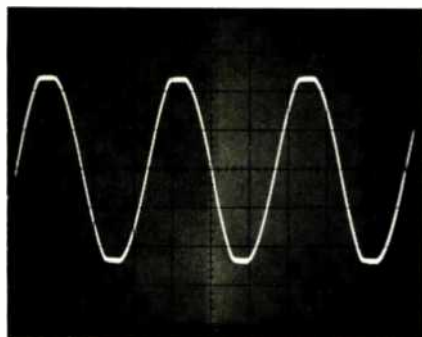

Fig. 3—Response to 300-Hz sine wave at 10 dB over rated 200 watts into 8 ohms. (Scales: 1.0 mS and 20 V per div.)

does not generate a transient, so its output is left free of series relay contacts. If a sustained d.c. offset is detected at the output, an SCR crowbar circuit shorts the power transformer's secondary and causes the line fuse to blow. The amplifier is protected from power-line surges by clamp components in the power supply. If the heat-sink temperature reaches 200° F, thermal cutout switches open and remove the -80 V supply to the driver boards, stopping bias to the entire channel. A volt-clamp limiting circuit also protects the output transistors.

McIntosh's proprietary Power Guard circuitry, a special feature of this amplifier, monitors the summing point at the input differential amplifier. The amplifier input and feedback signals are fed, respectively, into the noninverting and in-

verting inputs of the Power Guard amplifier/comparator. Any voltage difference here means that the overall negative feedback is inadequate to cancel distortion; this might occur from voltage clipping, current limiting, or slew-rate limiting. The sensed voltage is rectified by a bridge rectifier, filtered by a capacitor, and fed to an LED. The front-panel LED indicators, one for each channel, illuminate if distortion is present, causing reduced resistance in a light-dependent resistor. This photoresistor shunts just enough input signal to ground to eliminate the overdrive. In our use with music, only voltage clipping activated the indicators, confirming the high speed and current capacity of the MC 2002. The Power Guard circuit is nondefeatable.

Music waveforms are often "clipped" off because the owner may demand higher sound levels and higher voltages than the system can supply. Still, very few manufacturers offer true clipping indicators on their home amplifiers, though this feature is considered essential for professional audio work. We have tested a number of amplifiers that do not snip off the voltage cleanly and thus cause more distortion than necessary when overdriven. McIntosh does not have this head-in-the-sand attitude about the realities of electronic music reproduction. Even if we nitpick details of McIntosh's Power Guard circuit, it is much appreciated as a first-order solution to a common problem.

Measurements

The McIntosh MC 2002 was first run for 1 hour at 33% of rated power, about 66 watts per channel into 8-ohm loads with a 1-kHz test signal. The chassis top became warm, but the amplifier didn't thermally shut down.

Voltage gain was measured to be 29.0 dB at the 1.4-V switch setting into an 8-ohm load; at the 2.5-V switch setting, gain was 23.8 dB. The IHF sensitivity for 1 watt into 8-ohm loads at 1 kHz was 2.82 V.

Power output was measured into a variety of load conditions, as shown in Tables I, II and III. Using a rating of 0.1% THD, minimum continuous power output per channel was 220 watts (42.0 V) into 8 ohms and 333 watts (36.5 V) into 4 ohms. Bridged operation resulted in a mono signal with a minimum continuous power output of 757 watts (38.9 V). Setting the amp at rated output voltage, THD was 0.0071% for 8-ohm loads (40.0 V), 0.01% for 4-ohm loads (34.64 V), and 0.0044% (38.9 V) in bridged configuration.

The IHF signal-to-noise ratio, A-weighted re: 1-watt output into 8 ohms, measured 90 dBA for the right channel and 92 dBA for the left.

Crosstalk versus frequency was measured by driving one channel and measuring the leakage into the other, with the unused input terminated by a 1-kilohm resistor not connected to external ground. Crosstalk was found to be better than -68 dB from 20 to 500 Hz, rising to -48.4 dB at 10 kHz, and peaking to -42.0 dB at 20 kHz in the left channel. The left-to-right crosstalk is dependent on the load on the left channel; if one removes the load, the crosstalk becomes unmeasurable. This suggests grounding problems or that the long leads to the heat-sinks talk to the other channel.

The characteristics of the MC 2002's Power Guard circuit were measured using a special test setup. A 10-kHz signal was set to drive the amp at -6 dB (20.0 V, 28.28 V peak, 50

When the amp was subjected to the biggest bass-drum whacks Telarc's CDs could deliver, no audible clipping was heard.

watts output). A lower frequency transient at 1 kHz was added such that the combined peak value was 10 dB greater than the rated continuous output (126.4 V, 179 V peak, 2,000 watts). Power Guard attack and release times were then observed from the signal envelope, as shown in the 'scope photo of Fig. 1; they proved to be of the "fast" (5 mS) attack, "slow" (50 mS) release variety. A normal amp would clip heavily, showing "horns" and a brightening outline on the trace for the duration of the 1-kHz added pulse, then would instantly (a good amp can recover quickly) put out the 10-kHz, -6 dB signal. Horns do appear briefly at the beginning of the overdrive pulse block in the 'scope photo, but vanish as the circuit acts quickly. When the overdrive is suddenly cut off, the signal collapses to an area smaller than baseline and gradually expands as the circuit action decays.

Is it better to clean up the clipping and sacrifice a "hole" in the following low-level signals for 50 mS, or to clip and instantly recover to play the low-level signals? Overall, the technique used in McIntosh's Power Guard seems best to us because musical transients do not end abruptly, actually allowing the circuit to recover as they die out. Also, the 5-mS attack time keeps the circuit from acting on extremely short overdrives. A "tick" cannot cause a 50-mS "suckout."

Because of the action of the Power Guard circuitry, gradually increasing the overdrive causes a smooth increase in distortion, not the step function seen with most solid-state amplifiers. Beginning at 0.0018% at rated power (0 dB), the amp's THD rises to 2.2% at 4 dB overdrive, and 3.0% at 10-dB overdrive. Figure 2 shows THD + N for the audio band-pass, with the amplifier driven to 10-dB overdrive into 8-ohm loads. Distortion increases above 3.0% below 1 kHz, reaching a peak of 19% at 20 Hz under these conditions. Figure 3 shows the 'scope appearance of this 10-dB overdrive state at 300 Hz, and the waveform looks much more like a sine wave than would one produced by a conventional amplifier, which might deliver 40% THD + N, quite close to the perfect square waveform seen with 50% THD + N.

Figure 4 illustrates the MC 2002's square-wave response at rated power, 200 watts per channel into 8 ohms at 20 kHz. Power Guard has been switched on, resulting in the tiny overshoot peaks at the leading edges. (These peaks are not seen before the Power Guard cuts in.) Adding a 1.0- μ F capacitor causes minimal ringing of the output network, with a 0.2-dB increase in sine-wave output at 20 kHz, but no instability.

The 1-watt frequency response into 8 ohms showed the amplifier to be within ± 0.1 dB from 20 Hz to 20 kHz. The high-frequency, -3 dB downpoint was at 100 kHz for the 2.5-V input position and at 250 kHz for the normal, 1.4-V input position.

The low-frequency damping factor was measured at 285 for 8 ohms and 143 for 4 ohms. The wide-band damping factor was measured at 53 for 8 ohms and 27 for 4 ohms.

The slew rate measured 23 V/ μ S up and 40 V/ μ S down (asymmetrical). IHF slew factor into 8 ohms was 4.0 (80 kHz); into 4 ohms it was 5.0 (100 kHz).

Dynamic headroom measured 1.4 dB (42.3 V, 223.7 watts) at a pulsed clipping from a steady-state level of 200 watts rated power into 8 ohms; the 4-ohm IHF headroom

Table I—Power output per channel and distortion, 8-ohm loads.

LEFT CHANNEL			
Freq., Hz	V	Power, Watts	THD, %
20	42.0	220.0	0.002
200	44.1	243.0	0.0017
2k	44.8	251.0	0.0019
20k	45.0	253.0	0.0035
RIGHT CHANNEL			
Freq., Hz	V	Power, Watts	THD, %
20	42.0	220.0	0.0030
200	44.0	242.8	0.0022
2k	44.7	250.0	0.0028
20k	45.0	253.0	0.0071

Table II—Power output per channel and distortion, 4-ohm loads.

LEFT CHANNEL			
Freq., Hz	V	Power, Watts	THD, %
20	36.5	333.0	0.0034
200	39.7	394.4	0.0025
2k	39.8	396.0	0.0033
20k	39.7	394.0	0.0043
RIGHT CHANNEL			
Freq., Hz	V	Power, Watts	THD, %
20	36.5	333.0	0.0050
200	39.4	388.0	0.0025
2k	39.8	396.0	0.0033
20k	39.7	394.0	0.0100

Table III—Power output and distortion, mono channel, bridged 8-ohm loads.

Freq., Hz	V	Power, Watts	THD, %
20	39.4	776.0	0.0030
200	39.6	784.0	0.0024
2k	39.7	788.0	0.0030
20k	38.9	757.0	0.0044

was 1.7 dB (47 V, 552.3 watts). These figures indicate a power supply with medium voltage regulation.

Our new test of maximum output current utilizes a 20-mS pulse (repeated at a 0.5-S rate) driving one channel of the amplifier into a 0.1-ohm load. Under these conditions, the McIntosh MC 2002 delivered a 14.8-A rms pulse before clipping, showing itself to be average in terms of current delivery among high-powered amps on the market today. (For an explanation of the authors' test procedure, see "Short-Circuit Current Test" accompanying this issue's review of Sansui equipment.)

The McIntosh's meters proved to have a VU-type action rather than the peak action claimed. A period of 0.4 S is required for the pulse to reach 50% power indication in the

The McIntosh's strong suit was its field depth, soundstage rendition, spatial replication, and instrument localization.

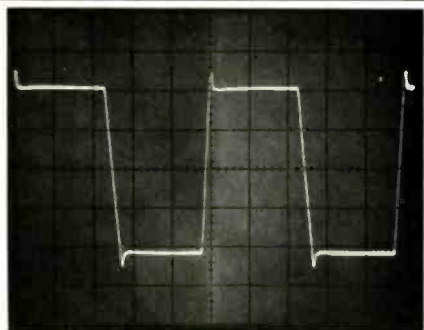

Fig. 4—Response to 20-kHz square wave at 200 watts into 8 ohms, Power Guard circuit activated, with input increased to get 200 watts output. (Scales: 10 μ S and 20 V per div.)

20 Hz to 20 kHz range. At 1 kHz, steady-state signal measurements were accurate at 200 watts, with the error increasing to 127% as power output was decreased to the 2-watt level. With a 1-cycle pulse of 200 watts into an 8-ohm load, the meters read 20 watts at 20 Hz, 15 watts at 200 Hz, 8 watts at 2 kHz, and 0 watts at 20 kHz. In general, the Power Guard indicators served as true clipping monitors, often firing in the presence of minimal meter action.

Use and Listening Tests

Equipment used to evaluate the McIntosh MC 2002 included a Linn Sondek turntable with a Magnepan Unitrac 1 arm, Yamaha MC-1000 and Shure V15 Type V-MR cartridges, Meridian and Philips Compact Disc players, Mark Levinson ML-7 reference preamp, Mark Levinson ML-9 and Crown Micro-Tech 1000 solid-state power amps, and B & W 801F Special and Snell Type A/III loudspeakers. Controlled listening tests also were carried out with an ABX Co. comparator after matching outputs of the McIntosh MC 2002 with the ML-9 to within 0.001 V using the CBS STR-151 test record. New Monster Cable was used, with co-author Greenhill's usual X-Terminators removed so the cable's spade lugs would fit the McIntosh's speaker-connector barrier-terminal strip. (See "Comparator-Controlled Listening Tests," which accompanies this issue's review of Sansui components, for more details on the A/B/X double-blind testing procedure and the equipment used.)

The MC 2002 was auditioned on the Snell Type A/III speakers. First subjective impressions with an amp can be misleading, as was the case here. Greenhill first detected a lack of highs, as well as a grain, glazed midrange and lack of textural detail on low-level sounds. After tightening all the speaker-wire connections, things improved greatly. The veils lifted, detailing improved markedly, and Greenhill became aware that the McIntosh's strong sonic suit was its soundstage rendition, spatial replication, instrument localization, and depth of field. The reference ML-9, though

clearly brighter in the midrange and far more detailed in the highs, could not match the McIntosh's field depth. On the other hand, the Levinson outstripped the MC 2002 in deep bass, yielding more solidity and impact on CD bass-drum notes. The Power Guard lights flashed frequently during these bass tests, in which Greenhill subjected both amps to the biggest bass-drum whacks Telarc's CDs could deliver, but no audible clipping was heard from the MC 2002.

The MC 2002's limiter circuit was auditioned to determine if it would interfere with the amp's sonics by blunting transients or coloring the sound under near-clipping conditions. We enlisted the help of B & W 801F loudspeakers, which feature their own protection circuits. Both the Levinson and Crown could be pushed into audible clipping, producing an awful shredding of the sound, whereupon the B & W's protection circuits cut in and temporarily shut off the speakers. The McIntosh MC 2002's nondefeatable limiter allowed the amp to maintain its aplomb under the same overdriven conditions, and no shredding of sound was heard. The McIntosh's Power Guard prevented the amp from clipping and thus would protect a loudspeaker without the B & W's safeguards. Midrange transients were quick without being overbright or steely, and deep bass transients had plenty of punch.

Below clipping, the MC 2002 again lacked vitality and air in the upper midrange while showing better than average depth of field. Bass definition was good to excellent, holding up well during Power Guard operation, but not going quite as deep as the Levinson. The Crown Micro-Tech 1000 proved to have a faster attack on transients than the 2002, but was brighter and zippier.

The controlled, double-blind A/B/X test failed to support these subjective sonic differences found during uncontrolled listening sessions. Using the B & W 801F speakers, Greenhill was able to identify the randomly selected amp in only 10 out of 16 trials, a rate which reaches only 68% statistical significance rather than the desired 95%.

The McIntosh operated smoothly during all bench and listening tests. A slight turn-off pop could be heard in the speakers, but no turn-on thump was present. The A/B/X switching relays caused no problems with the McIntosh's protection circuitry, as it did with another amp being tested.

In summary, we find the McIntosh MC 2002 amplifier to offer good quality, high reliability and elegant engineering design. Co-author Clark was particularly impressed with the high performance achieved from the MC 2002's simple and relatively cost-effective circuit topology. The Power Guard circuitry, with its very desirable clipping indicators, is a well-thought-out design for preventing audible distortion and speaker damage from intense clipping. The controlled tests, however, reveal no significant sonic differences (below clipping) between the McIntosh and the reference ML-9 amplifier, confirming Clark's belief that well-designed amplifiers today differ little sonically. Greenhill's subjective impressions of the MC 2002, when it was inserted in the audio system described above, continued to be positive about the amp's spatial replication and critical of its midrange clarity—even when he couldn't document his reactions under blind, A/B/X-controlled conditions.

Laurence L. Greenhill and David L. Clark

SPECTACULAR OFFER FROM RCA

Take Any

3 COMPACT DISCS

\$1

For Just

plus shipping & handling with Club membership

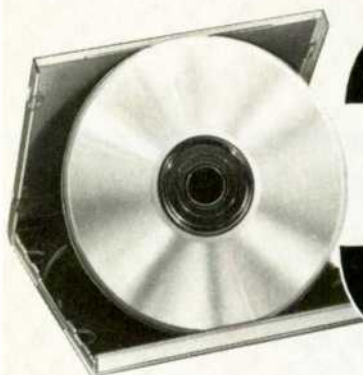

THE ULTIMATE IN SOUND AND SAVINGS!

Yes, take any 3 great CDs here for only \$1 plus shipping/handling. You need buy just two more selections at regular Club prices (usually \$15.98) during the next two years.

HOW THE CLUB OPERATES

As a member, you select from hundreds of exciting Compact Discs described in the Club's exclusive magazine mailed to you 19 times a year. Each issue highlights a Featured Selection in your preferred musical division plus an impressive array of alternate selections. If you'd like the Featured Selection, you need not do a thing; it will be sent to you automatically.

YOU CHOOSE WHAT YOU WANT — WHEN YOU WANT

If you'd prefer an alternate selection, or none at all, just return the card enclosed with each issue of your magazine by the date specified on the card. You will have at least 10 days to decide, or you may return your Featured Selection at our expense. Cancel your membership at any time, after completing your membership agreement, simply by writing to us.

HALF-PRICE BONUS PLAN

You're eligible now! You enjoy big savings right away. With the very first CD you buy at regular Club prices, you receive a bonus certificate. Collect two bonus certificates and take a Compact Disc of your choice for just half the regular member's price, plus shipping & handling.

FREE 10-DAY TRIAL!

Listen to your 3 introductory selections for a full 10 days. If not satisfied, return them with no further obligation. You send no money now, so take advantage of this risk-free offer today!

CD27

CD Club, 6550 E. 30th St
Indianapolis, IN 46219

 114764	 143811	 173469	 134541	 115306	 154570
 110770	 115062	 114734	 115134	 125031	 153740
 154201	 123691	 151758	 154203	 115168	 154381

Chick Corea: Elektric Band
Rumble, Side Walk, Cool
Weasle Boogie, Got A Match?,
etc. GRP DIGITAL 140093

Brahms, 21 Hungarian Dances
Claudio Abbado conducts the
Vienna Philharmonic Orchestra.
DG DIGITAL 115408

Alabama: Greatest Hits • She
And I, Why Lady Why, Feels Sc
Right, Tennessee River, others.
RCA 120247

Pavarotti: Mamma • Title song,
Vieni sul mar, more Arranged &
conducted by Henry Mancini
London DIGITAL 115310

Phil Collins: No Jacket
Required • One More Night,
Sussudio, Don't Lose My
Number, etc. Atlantic 120771

The Glenn Miller Orchestra:
In The Digital Mood • In The
Mood, Chattanooga Choo-Choo,
etc. GRP DIGITAL 143293

Itzhak Perlman: Mozart, Violin
Concertos Nos. 3 & 5 (Turkish)
Vienna Philharmonic Orch /
Levine. DG DIGITAL 115146

Heart • What About Love?
These Eyes, Dreams, It Looks
Could Kill, Nothin' At All, Never,
etc. Capitol 144276

Bach, Organ Works • Daniel
Chorzempa plays the Toccata &
Fugue in D Minor, others.
Philips DIGITAL 115193

Van Halen: 5150 • Why Can't
This Be Love, Dreams, Best Of
Both Worlds, Love Walks In,
more. Warner Bros. 170220

Wagner, Orchestral High-
lights From The Ring • Vienna
Philharmonic Orchestra/Solti
London DIGITAL 115426

ZZ Top: Afterburner • Stages,
Sleeping Bag, Can't Stop
Rockin', Velcro Fly, Rough Boy,
etc. Warner Bros 164042

The Cars: Greatest Hits
Tonight She Comes, Drive, You
Might Think, Shake It Up, others.
Elektra 153702

Tchaikovsky, Symphony No. 6
in B Minor (Pathétique)
James Levine leads the
Chicago Symphony.
RCA DIGITAL '53939

Mozart, Requiem • Schreier
leads the Leipzig Radio Choir &
Dresden State Orch. Philips
DIGITAL 115039

Prince And The Revolution:
Parade • Kiss, Mountains,
Girls & Boys, etc.
Warner/Paisley Park 140234

Sunday In The Park With
George • Bernadette Peters,
Mandy Patinkin & original cast.
RCA DIGITAL 154014

Vivaldi, The Four Seasons
Simon Standage, violin. The
English Concert/Pinnock.
Archiv DIGITAL 115356

Grieg, Peer Gynt Suites Nos. 1
& 2; Sibelius, Pelleas et
Melisande • Berlin
Philharmonic/Karajan DG
DIGITAL 115169

Led Zeppelin IV (Runes) • Stair-
way To Heaven, Black Dog,
Rock And Roll, Four Sticks,
etc. Atlantic 112014



YOUR SAVINGS START HERE

Mail to: Compact Disc Club / P.O. Box 91412 / Indianapolis, IN 46491

YES, please accept my membership in the Compact Disc Club and send me the three CDs I've indicated below for only \$1, under the terms outlined in this ad. I need buy as few as two more CDs at regular Club prices during the next two years... without obligation to buy anything further! (Shipping & handling added to each shipment.)

RUSH ME THESE 3 SELECTIONS:
(Indicate By Number)

D
D
D

I am most interested in the following type of music—but am always free to choose from both categories (check one only)

- 1 CLASSICAL
2 POP/SOFT ROCK

- MR
 MRS. _____
 MISS _____
First Name Initial Last Name (PLEASE PRINT)

Address _____

City _____ State _____ Zip _____

Telephone (____) _____
Area Code

Limited to new members, continental U.S.A. only, one membership per family. We reserve the right to request additional information or reject any application. Local taxes, if any, will be added.

VLS59 (B)



5

TANDBERG 3008A PREAMP AND 3009A AMP

Manufacturer's Specifications Preamplifier

Frequency Response: Line inputs, 20 Hz to 20 kHz, +0, -0.1 dB; 1.6 Hz to 250 kHz, ± 3 dB. MM and MC phono inputs, RIAA 20 Hz to 20 kHz, ± 0.2 dB.

Maximum Output: 10 V at clipping level.

THD (New IHF Standard): 0.004% for MM and MC inputs, 0.003% for "Digital Disc" inputs, 0.007% for line inputs.

Phono Input Sensitivity for 0.5 V Output at 1 kHz: 1.0 mV input for MM, 60 μ V for MC.

Phono Input Overload: 290 mV for MM, 17 mV for MC.

S/N Ratio: 74 dB, A-weighted, for MM input; 78 dBA for MC input; 95 dBA for line inputs.

High-Level Sensitivity: 70 mV.

Phono Input Impedances: Selectable, 33/47/100 kilohms paralleled by 20/120/350 pF for MM cartridges; 150 ohms for MC cartridges.

Dimensions: 17 $\frac{1}{8}$ in. W \times 3 $\frac{1}{4}$ in. H \times 13 $\frac{3}{4}$ in. D (43.5 cm \times 8.3 cm \times 34.9 cm).

Weight: 12.5 lbs. (5.7 kg).

Price: \$995.

Power Amplifier

Power Output: 20 Hz to 20 kHz, 200 watts rms continuous into 8 ohms, 330 watts rms into 4 ohms, 456 watts rms into 2 ohms; 1,512 watts peak (pulse) power into 0.5 ohm.

Rated THD: Less than 0.05%, 1 to 2 ohms; less than 0.01%, 8 ohms.

Frequency Response: 0.07 Hz to 1.5 MHz, +0, -0.2 dB at 1 watt output.

S/N Ratio: 94 dB referred to 1 watt into 8 ohms, A-weighted; 117 dB referred to 200 watts into 8 ohms.

IM Distortion: Less than 0.05% at rated output.

Damping Factor: 250, wide-band.

Input Sensitivity: 150 mV for 1 watt output, 2.12 V for rated output.

Slew Rate: 250 V/ μ S.

Rise-Time: 0.9 μ S.

Dimensions: 17 $\frac{1}{8}$ in. W \times 3 $\frac{1}{4}$ in. H \times 13 $\frac{3}{4}$ in. D (43.5 cm \times 8.3 cm \times 34.9 cm).

Weight: 25 lbs. (11.3 kg).

Price: \$1,195.

Company Address: Labriola Court, Armonk, N.Y. 10504.

(Originally published January 1986)

The 3008A preamplifier and 3009A power amplifier are near the top of Tandberg's line of stereo products. These slim, attractive, Scandinavian-styled components represent the latest in Tandberg's thoughts about audio design. Their circuitry employs discrete components (on ICs), polyester capacitors (with low dielectric absorption) and metal-film resistors in the signal path, and minimal amounts of overall negative feedback—features believed by many audiophiles to be necessary for the best sonics.

The 3009A is rated to deliver 200 watts into 8 ohms and a staggering 1,512 watts (pulsed) into 0.5 ohm. The unit, an adaptation of the firm's 3006A stereo amplifier, is a monaural, high-current design that can deliver very high power into speaker loads, even ones with very low impedances. The low-impedance capability was intended for those who wish to drive several loudspeakers wired in parallel, or speaker systems with an intrinsically low load impedance such as the Apogee Scintilla. (The Scintilla can be configured as a 4- or a 1-ohm speaker, and many audiophiles feel it sounds better in the 1-ohm configuration.)

The black chassis of the Tandberg amp and preamp are of rack width but lack mounting "ears." Each unit stands only 3 $\frac{1}{4}$ inches high, and their 13 $\frac{3}{4}$ -inch chassis depth is convenient for placing these components on shelves or wall units. The 3009A weighs only 25 pounds, unusually light for a 200-watt mono amplifier.

Our samples came with rosewood side panels which allow two monaural amplifiers to be stacked for stereo use (single rosewood panels are also available). We have since learned that Tandberg does not recommend this arrangement for optimum performance, but we found it produced no ill effects.

Control Layouts

The preamp's front panel features a large number of controls. At the far left are the on/off switch and the headphone jack and its volume control. Next come four buttons which control monitoring and two-way dubbing facilities for two tape decks. Near the front panel's center are buttons for the subsonic filter and the tone-control defeat, the bass and treble tone controls, and buttons for stereo/mono and loudness-compensation switching. At the right is a rotary input selector, with positions for "Tuner," "MC" (moving-coil) and "MM" (moving-magnet) phono cartridges, and "Digital Disc." At the far right is a small balance control and a large, detented volume control.

On the preamp's rear panel are the signal, a.c., and ground connections. The high-level signal jacks include inputs and outputs for two tape decks, inputs for a tuner and a CD player, and the main preamp outputs. The phono stage has separate pairs of jacks for the MM and MC inputs. Loading for MM cartridges is controlled by two toggles, one



selecting load impedances of 100, 47 or 33 kilohms, and the other selecting load capacitances of 20, 120 or 350 pF. The back panel also features an unswitched a.c. output rated at 600 watts, and three switched outputs rated at a total of 300 watts. A fuse, a switchable 115- or 230-V a.c. input, and a detachable line cord make up the remainder of this highly functional back panel.

The amplifier's front panel contains only a power switch, an LED power-on pilot light just above the switch, and a second LED mounted at the front panel's right side, which serves as a clipping indicator. The rear panel holds nickel-plated signal input connectors, and five-way speaker binding posts of somewhat nonstandard design. Like the preamp, the amp has a detachable line cord.

Mechanical Construction

The usual approach to audiophile-component construction is to make components that are as heavily built as their professional equivalents, but neater, and to pay little attention to styling beyond the functional. Tandberg took a different course. Instead of the usual, heavy chassis with bolted-on panels, Tandberg built this amp and preamp around light but strong (and attractive) aluminum extrusions. The strongest ones, logically enough, make up the front and rear panels. Lighter extrusions for the sides serve as attachment points for the side covers and for a number of sheet-metal

subchassis that hold internal components in place. These subchassis, and the liberally vented bottoms, are of thin, dull-finished sheet steel. The tops are made of two heavy, slotted extrusions which lock into place, covering the attachment screws. This technique minimizes the number of screw heads visible on the top and side cover panels, thus enhancing the components' appearance, but may lack the strength of a more "unitized" assembly. All chassis components are held together with sheet-metal screws rather than the machine screws which we prefer. While we would not recommend this construction for professional use (and abuse), we find it adequately strong for its intended home applications. The light chassis, dull-steel bottom and internal structures, and cost-effective fasteners make it clear that Tandberg favors external cosmetics over internal overbuilding; audiophiles who worship the innards of their components will not be as pleased. We prefer less slick, more purely functional styling, but all that's a matter of taste.

In the rear two-thirds of the amplifier chassis, vertical, chimney-type heat-sink castings flank and support the large toroidal transformer. The venting of the top and bottom leaves a number of open areas to act as flues for these heat radiators, making a fan unnecessary despite the amplifier's slim design.

The quality of the major circuit boards and the components on them is just what you'd expect for a product in this

Tandberg's light but strong and attractive chassis and their choice of components emphasize practical performance over impressive overbuilding.

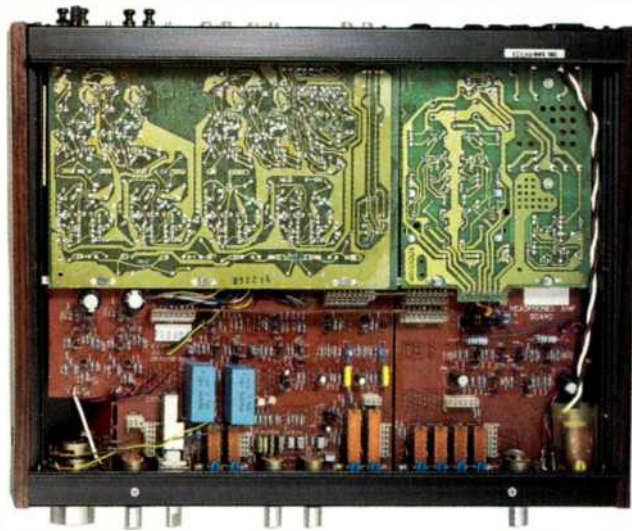

price range. The amplifier's boards are epoxy-glass, with component-designator screening and solder mask, but they lack the clean finish and solid mounting that is important to some enthusiasts. Most resistors are ordinary 5% types, but there are trimpots and 1% devices where needed for precision. The 3009A's capacitors include 85° C stand-up electrolytics, polypropylenes, and a huge 2.2- μ F Wima MKP cap used for input coupling. Interconnection between boards is made via nylon modular plug/socket units with nickel-plated pins and insulation-displacement wire termination.

The amplifier's power supply uses a large toroidal transformer, which not only has a low enough profile to fit in the slim package, but radiates much less 60-Hz magnetic hum than conventional, E-I laminated transformers. When the mono 3009A amplifier was adapted from the stereo Model 3006A, the space vacated by the second channel's driver board was filled with two additional power-supply electrolytic capacitors. The resulting complement of four 15,000- μ F, 80-V electrolytic capacitors stores the full-wave rectified output of the 3009A's transformer. This gives a very high energy storage of 123 joules.

The 3008A preamplifier refines the integration of mechanical structure, user controls, and circuit boards found in the companion power amplifier. Identical decorative and structural extrusions are used in both products, but they suit the preamplifier even better than they do the amplifier. Not only is the lightweight, screwed-together frame perfectly adequate for the preamplifier, but only one crosspiece is required to support the inner edges of the 3008A's four main circuit boards. The front edges of the forward p.c. boards are supported by the front-panel controls and switches. The rear edges of the other two boards have protruding tabs which fit into slots in the vertical, rear-panel boards. We prefer designs in which the circuit boards are firmly screwed down to spacers or chassis mounting bosses; even so, this construction is efficient and provides exceptional service access.

The preamp's circuit boards have clean and open layouts, solder mask, and component designators. The two

front p.c. boards are made from what appears to be brown phenolic material. This material doesn't have the strength and crack resistance of the epoxy-glass used for the other two boards.

Component quality is mixed. Tandberg apparently opted for expensive parts only where they felt there would be sonic merit in doing so. Among the higher quality components are eight very large, 10- μ F capacitors and four 4.7- μ F capacitors, apparently made from carefully selected dielectric materials. There are many other board-mounted polypropylene and chip capacitors, along with 1% resistors. On the less expensive side, one can find eight exposed-track trimmers (subject to problems with dust if they ever need to be readjusted) and push-on modular connectors. Many board-to-board audio runs are made via twisted-pair leads or simply bundled parallel runs. This did not seem too promising for achieving low crosstalk, but our tests showed otherwise.

As with the amplifier, the 3008A's controls have a firm but lightweight action, without the solid, positive feel found in the controls on more expensive preamplifiers. The step-type volume control is an ordinary rotary pot, with a toothed wheel and spring to provide the detents. This action can be defeated easily if need be. All the rotary control elements appear to be the inexpensive, popular, and very satisfactory ones made by Alps.

Preamplifier Circuitry

The preamplifier utilizes two pairs of RIAA amplifiers for each channel. The moving-coil input goes into an MC input amplifier whose gain and noise performance are optimized for low-output, low-impedance moving-coil cartridges. The MM inputs on the rear panel go into MM phono amplifiers that have lower gain and whose inputs are optimized for MM cartridges. Both MM and MC input signals are applied first to flat pre-preamplifiers before being routed to a passive, high-frequency RIAA equalizer. The low-frequency portion of the RIAA equalization is provided by feedback around the second phono-amplifier stage. Input overload from pre-equalized square waves, a common problem in pre-preamplifiers, is avoided here by relatively low gain and very high (± 32 V) rail voltages. (Tandberg was wise to use discrete transistor circuitry; these voltages would not be possible using common low-noise integrated circuits.) To prevent d.c. offset, the phono preamp's output at the selector switch uses capacitive coupling, as opposed to the popular servo-amplifier approach. Four large, rectangular, 4.7- μ F polyester coupling capacitors are firmly mounted on the preamplifier's circuit board.

The discrete transistor circuits in the phono section and in the line output stage are very simple, using only five to seven bipolar devices per gain block. An unusual feature is the single-transistor emitter-follower unity-gain buffer used on all line inputs except CD. These buffers' low output impedance probably is the reason we did not find the crosstalk that the interior wiring led us to expect.

Amplifier Circuitry

As mentioned above, the 3009A design is a mono conversion of Tandberg's highly regarded 3006A stereo amplifier.

We liked the preamp's convenience, the amp's combination of high power and light weight, and the sound of both units.

Like the 3006A, this amplifier uses MOS-FET output transistors. MOS-FETs have several advantages, including a region with a negative thermal characteristic. This means that their internal resistance rises as they become hotter, which tends to turn them off. (Bipolar devices, on the other hand, have a positive thermal characteristic, which necessitates additional circuitry to make them thermally stable.) In addition, MOS-FETs tend to have greater bandwidth than bipolars, and can switch on and off at higher frequencies.

MOS-FETs may not be *inherently* superior to bipolar transistors, but every MOS-FET amplifier we have tested handles very high frequencies, particularly square waves, with much less strain than bipolar amplifiers do. MOS-FET amplifiers usually clip more cleanly, and mutual conduction is generally not evident until very high frequencies (around 100 kHz). MOS-FET amps run hotter at all levels and require higher rail voltages.

The eight MOS-FET output devices that made up the stereo 3006A's two channels are tied in parallel to make up the 3009A's single output. Paralleling the output stages doubles their current-delivery capacity, greatly enhancing their ability to drive low-impedance loads. Paralleling output stages can be done more easily with MOS-FET outputs than with bipolar transistors; paralleling two bipolar output stages would impose heavy current-delivery demands on the driver stage. MOS-FETs, on the other hand, require very little current compared to bipolar devices, even at high frequencies. A single driver stage, carried over from the 3006A, has adequate power to drive the 3009A's two paralleled MOS-FET output stages.

The 3009A incorporates 28 discrete transistor devices and field-effect transistors (FETs) in the amplification channel, not to mention those found in the power supply, servo circuit and clipping indicator. The signal path begins as the input feeds a dual-complementary, single-ended FET input. (It is not a differential input, the kind very commonly found in amp designs these days.) Next, the signal goes to four complementary gain and level-shift stages. These are connected like four independent cascaded amplifiers, each depending on local feedback only. The signal then goes to a driver with three emitter-follower stages, each with extremely low current gain. Associated with that triple emitter-follower are a pair of transistors used to set output-stage bias. This group provides the drive for the paralleled output MOS-FETs (four up and four down) via individual 680-ohm resistors to their gates.

Tandberg's error-correction circuit is a bit unusual. The output signal is linked to the bases of two transistors. In our reading of the schematic, these two transistors form a bias-setting circuit, where the output signal is amplified and applied to the drivers in such a way as to generate negative feedback around the unity-gain output stage. (To have negative feedback around a unity-gain stage requires amplification of the feedback signal itself.) Tandberg, however, describes the two-transistor circuit as a comparator which generates a feed-forward error-correction signal, because the correction signal can be greater than the output of the first emitter follower, and thus the entire circuit can have a negative output. A distortion-nulling pot at this point trims the compared gain for minimum distortion and, Tandberg

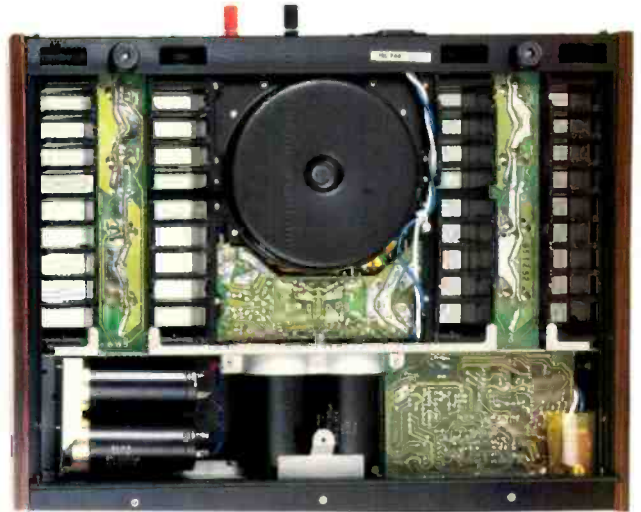

says, for unity gain. Whether feedback or feed-forward is the method, the 3009A's ultra-low output impedance and distortion, plus its ringing on square waves when driving a capacitive load, indicate to us that some form of error correction is in use around the output stages. However one views Tandberg's actual signal-correction method, it functions very well, particularly at high frequencies.

The 3009A's circuitry eliminates d.c. offset by means of a large input-coupling capacitor. The circuit includes a servo amplifier by which the service technician can adjust a trim-pot to null d.c. When fault conditions (including overdrive and short-circuits) are sensed, speaker relays open. These relays employ contacts coated with 24-karat gold. Because gold plating is usually very thin, it disappears after the relays open several times under full power. Coauthor Clark's experience in developing clean relay switching for comparators led him to conclude that gold plating is best applied to low-level circuits, where big arcs that vaporize gold plating don't occur.

The output stage is wired directly to the output terminals, without a conventional output-decoupling network. The main feature of the conventional network is a series inductor which, at supersonic frequencies, isolates the amp from highly capacitive loads which might cause it to oscillate. This series inductor (r.f. choke) circuit can also affect the upper audio frequencies, causing a slight isolation at frequencies as low as 10 to 20 kHz, thus lowering the damping factor in this range.

Tandberg's design avoids the shortcomings of output-decoupling networks, but it is influenced by capacitive output loads despite the lack of overall negative feedback. Since our tests, Tandberg has introduced a modification (now present in all production units) to limit this influence to the ringing we observed, and prevent oscillation without resorting to the more common inductive circuit. The modification places a series-connected resistor and capacitor in parallel across the outputs. This terminates the amplifier at supersonic frequencies, yet does not limit the unit's excellent damping factor.

The amplifier easily meets and exceeds its power ratings. For instance, continuous power into 0.5 ohm is 684 watts, an outstanding figure.

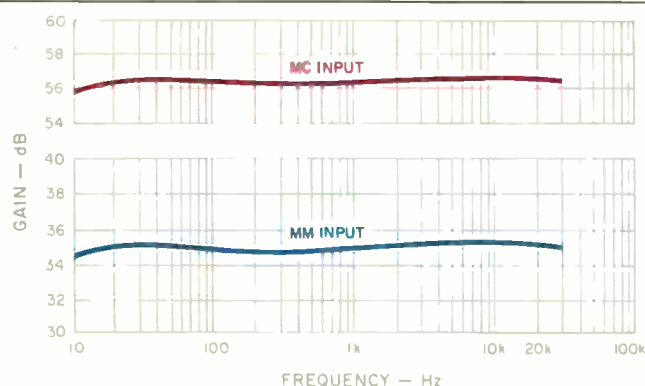

Fig. 1—RIAA response, 3008A preamplifier. Top curve is MC input with 100-ohm load; bottom curve is MM input with 47-kilohm load.

Preamplifier Measurements

Measured from input to main output, using a standard IHF load, the left channel's phono gain was 52.6 dB for the MM input and 73.8 dB for the MC jack. IHF sensitivity, measured from input to main output, was 0.1 mV for the preamplifier's MC input, 1.2 mV for MM phono, and 17.4 mV for all auxiliary line-level inputs.

Signal-to-noise ratios were measured next. The A-weighted measurements included 80.5 dB for the MM phono input and 70.5 dB for the MC phono input—both very good.

Phono overload for the standard 1-kHz input signal was 330 mV at the MM input and 17 mV at the MC input. Overload for the auxiliary stage, measured from auxiliary input to main output, was a high 12.0 V, in keeping with Tandberg's attempt to provide a high overload for the outputs of Compact Disc players. "Line in" input overload in a preamp is only of concern when the selected input is amplified before being applied to the volume control. With direct application to the volume control, the signal is attenuated before it can cause an overload. The 3008A, however, has buffer amplifiers and, if selected, an active subsonic filter ahead of the volume control.

Phono RIAA equalization error initially measured ± 1.0 dB, 20 Hz to 20 kHz, but this was for a very early production unit. Replacing two resistors brought our test unit up to par with current production, with an improvement in this measurement to ± 0.3 dB for the MM input and ± 0.2 dB for the MC input, 20 Hz to 20 kHz, as shown in Fig. 1.

Channel-to-channel crosstalk in the phono section was found to be greater than -49.5 dB in the MC phono section and -49.0 dB in the MM section, both from 20 Hz to 20 kHz. This is a respectable figure for any preamp.

The line amplifier section's THD + N was found to be less than 0.014%, 20 Hz to 20 kHz, at 10 V output using either a normal or IHF load. On the oscilloscope, the distortion

appeared primarily as low-order harmonics and was fairly constant across the audio band.

Amplifier Measurements

The 3009A was first run for one hour at 33% of rated power (about 66.7 watts per channel) into 8-ohm loads with a 1-kHz test signal. The chassis top became warm, but the amplifier didn't thermally shut down.

Voltage gain was found to be 28.9 dB. This requires an input of 1.44 V for full power into an 8-ohm load. The IHF sensitivity for 1 watt into 8-ohm loads at 1 kHz was 102 mV.

Power output from 20 Hz to 20 kHz for a variety of load conditions is shown in Table I. The amplifier easily meets and exceeds the manufacturer's specified continuous power ratings at 8, 4, and 2 ohms. Continuous power into 0.5 ohm is a very strong 684 watts, an outstanding figure. Dynamic headroom measured 1.1 dB (45.2 V, 255.0 watts) relative to 200 watts rated power into 8 ohms. The 4-ohm IHF headroom was 1.3 dB (44.4 V, 449.0 watts). These figures indicate a power supply with tighter-than-usual voltage regulation.

Our standard test of peak output current utilizes a 20-mS pulse (repeated at a 0.5-S rate) driving one channel of the amplifier into a 0.1-ohm load. Under these conditions, the 3009A delivered 7.1 amperes rms (right channel), a low figure for instantaneous rms current delivery among high-powered amps on the market today. Yet, at 0.5 ohm, the Tandberg delivered a staggering 37 amperes rms of current, which is a record for amplifier current delivery on our test bench. Most amplifiers we have tested put more current into a short than any other load. The delivery of 37 amperes rms (52.3 peak amperes) into 0.5-ohm loads basically confirms Tandberg's claim that the 3009A has 55-ampere peak output capability. It is theoretically conceivable that the protection circuitry could mistake a highly reactive, low-impedance load as a short and limit the amplifier's output. This would be a most unusual condition, however, and we did not encounter it in practice.

Operating the amp at rated output power, the maximum total harmonic distortion plus noise (THD + N), 20 Hz to 20 kHz, measured 0.049% for 8-ohm loads (at 40.0 V/200 watts), 0.029% for 4-ohm loads (at 36.3 V/330 watts), and 0.033% for 2-ohm loads (at 30.0 V/450 watts). Measurements at lower levels all indicated lower distortion, as shown in Table II.

The 3009A produces an exemplary 20-kHz, full-power square wave. The lack of an output network allows the 3009A to maintain a high damping factor at supersonic frequencies, resulting in great control of the rise-time and overshoot of the 20-kHz square wave. The low-frequency damping factor measured 264 for 8 ohms and remained at 101 up to 20 kHz for the wide-band damping factor. Figure 2 illustrates the 3009A's 20-kHz square-wave response at rated power, 200 watts per channel, into 8 ohms. Rise-time is less than 1 μ S. The slew rate is asymmetrical, 177 V/ μ S in the positive direction and 160 V/ μ S negative, as measured on a 50-MHz oscilloscope. IHF slew factor into 8 ohms was a very high 10.0 (200 kHz). Adding a 0.1- μ F capacitor in parallel with the 8-ohm output load caused considerable ringing, as shown in Fig. 3. However, capacitors as large as

The Tandberg amp's wide sound stage and its three-dimensional field were remarkable, and the preamp delivered the same spacious sonics.

2.5 μF only lower the ringing frequency, with no significant increase in distortion of a sine-wave output at 20 kHz.

The 1-watt frequency response into 8 ohms shows the amplifier to be well within ± 0.1 dB from 20 Hz to 20 kHz. The -3 dB points are about 400 kHz at the high-frequency end and 0.17 Hz at the low end. Input impedance is somewhat frequency-dependent, measuring 105 kilohms at 1 kHz and 39 kilohms at 20 kHz.

The IHF signal-to-noise ratio, which is A-weighted noise referred to 1 watt output into 8 ohms, measured an excellent 91.9 dBA.

Crosstalk measurements generally do not apply to monophonic amplifiers, but we measured the crosstalk possible when two Tandberg units were mounted together in the optional rosewood frame. Crosstalk versus frequency was measured by driving one amp and measuring the leakage into the other, with the unused input terminated by a 1-kilohm resistor. Even with one amp stacked on top of the other, the separation between the two was greater than 99.6 dB from 20 Hz to 20 kHz!

Use and Listening Tests

Equipment used by coauthor Greenhill to evaluate the Tandberg 3008A preamp and 3009A amplifier included a Linn Sondek turntable with a Magnepan Unitrac 1 arm, Accuphase AC-2 moving-coil and Shure V15 Type V-MR cartridges, a Philips Compact Disc player, a Mark Levinson ML-7 reference preamp, and Mark Levinson ML-9, Onkyo M-510, Classé Audio DR-3 and Bryston 4B solid-state power amps. Apogee Scintilla, Snell Type A-III, and Jung/Randall-modified Dahlquist DQ-10A loudspeakers were used. Tandberg's recently developed speaker wire and interconnect cable were supplied to Greenhill for the listening evaluation; the cable employs a proprietary dielectric insulation material developed by Norwegian chemical and petroleum-product manufacturers.

The 3009A amplifier's speaker terminals do not accommodate heavy audiophile speaker cables or many types of speaker-connector hardware. After some experimentation, we settled on single banana plugs, which made adequate electrical contact even though they could not be pushed in all the way (because each terminal post's inner well is a bit too shallow). Spacing between the terminals is too narrow for double bananas. We feel bare wires don't make optimal contact, either, because the ridge on the knurled plastic clamp that forces the wire against the terminal's metal base deforms before sufficient pressure is generated. Spade-lug wire terminators were tried, but the pressure on the one-sided contact still seemed low to us for the rated 55 peak amperes.

If one or more pairs of Tandberg 3009As are used in a system, they should be turned on in sequence rather than simultaneously. This is true for most high-power amplifiers that don't contain turn-on surge-limiting circuitry.

Subjectively, Clark was struck by the sexy Scandinavian styling of two 3009A amps stacked one atop the other with the rosewood side panels. He also admired the thermal cooling vents and the reworked back panel, which lent the product a sort of modified "hot rod" quality.

Clark auditioned these components in his home system,

and in his special listening room whose design was based on a study by the International Electronics Commission (IEC). The amplifier was interfaced with a number of different kinds of equipment, including Fried Studio IV speakers. Clark found the easy, sparkling sound matched his visual reactions to the product. He also found the 3008A preamp to have fast, detailed sonics that matched the amplifier's. Other audio professionals visited Clark's listening room and drove a pair of 813B Urei monitors with the 3009As. They were very impressed by the amplifier's power, especially considering its small size, and said the 3009A was the most powerful-sounding amp they had yet heard driving these massive speakers!

In Greenhill's evaluation, the two amplifiers were kept six feet apart, short speaker-cable runs were employed, and the units were gain-matched to a number of other fine amplifiers for open testing. Greenhill found the Tandberg amplifier's bass response seemed slightly less defined over his reference Snell Type A-III speakers. The Tandbergs

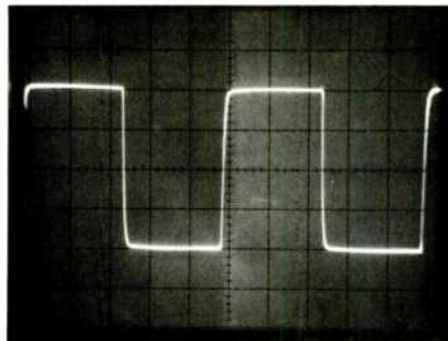

Fig. 2—Response of 3009A amplifier to a 20-kHz square wave, at 200 watts into 8-ohm load. (Scales: Horizontal, 10 $\mu\text{s}/\text{div.}$; vertical, 20 V/div.)

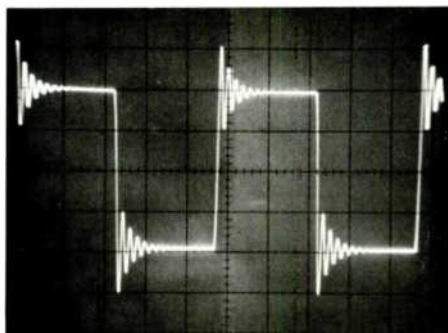

Fig. 3—Same as Fig. 2, but showing effect of a 0.1- μF capacitor across the load.

These new products are two of the best-designed and best-performing components we've tested for *Audio*.

could not deliver the high sound pressure levels of the higher rated (at 8 ohms) Onkyo M-510, nor did they deliver as much depth of imaging as two Classé Audio DR-3s. Yet the Tandbergs excelled in all other areas, showing remarkable sound-stage width and ability to separate singers and instruments in a three-dimensional field. This high definition may be attributable to the dual-mono design, with its absence of crosstalk. The preamp delivered the same spacious sonics, with midrange speed and detailing, while being free of midrange brightness.

The amps were then transported to another system, composed of Quad ESL-63 electrostatic loudspeakers, a Spectral DMC-10 (Gamma version) preamp, Krell KMA100 mono amplifiers, Monster Cable interconnects, and Randall speaker wire. The audiophile who had assembled this system found the Tandbergs' sound accurate, although the Krell amplifiers (which cost more than twice as much as the 3009A pair) just edged out the 3009As by playing with "greater air, more ambience and definition in the highs," whereas the Tandbergs produced "smoother highs with less definition." For him, the Tandberg amps represented an excellent value.

After living with the 3009A amplifiers for more than two months, Clark ran a series of controlled, double-blind listen-

ing tests. He made 16 identification attempts over a 1½-hour listening session, using a Bryston 4B (dual-mono) amplifier for comparison. The results were 12 correct out of 16 trials, a statistically significant score. (We consider a score statistically significant when there is less than one chance in 20 of that score's being due to random guessing.)

In the same room at a later time—and using the same test records, amplifiers, and order of presentation of test trials—Clark tried to replicate this feat. During this second attempt, he achieved only seven correct identifications out of 16 trials, which we consider a statistically nonsignificant result. Because all conditions were held the same for these two tests, he felt it reasonable to combine the test results for a total of 19 correct out of 32 trials, again a result we do not consider significant.

In an attempt to resolve the different outcomes of the two Clark tests, Greenhill ran additional controlled listening sessions with the 3009As. Over a two-week period, he carried out six more tests, consisting of 208 controlled, double-blind A/B/X comparisons, gain-matching the Tandbergs with two other expensive amplifiers—the Levinson ML-9 and the Onkyo M-510.

If one separately analyzes each of the different listening tests we conducted, involving a total of 240 controlled trials, one sees there were no statistically significant sonic differences found between the Tandberg and the other amplifiers, some of which cost twice as much as the 3009As. This finding suggests that increasing the number of listening tests over our usual 16 trials will not necessarily uncover a subtle sonic difference between amplifiers.

On the other hand, our subjective listening sessions left us highly impressed by the sonics of both Tandberg products. Over and over, we used both amp and preamp in our reviewing and for recreational music listening—which is what audio is about, after all! The 3008A preamplifier was more convenient to set up, use, and demonstrate than other, more expensive but perhaps less elaborate preamps. We particularly liked the preamp's headphone controls. As for the amplifier, two 3009As were lighter and easier to set up than many heavy audiophile stereo amplifiers, and were at least as powerful!

The 3009A provided clean, effortless sound. Greenhill found over the months that these amplifiers continued to deliver outstanding transient speed and sound-stage width, with pinpoint instrumental placement, even though the results of the extensive double-blind tests revealed no distinctive sonic "fingerprint" for the amplifier which could be shown with statistical significance.

We feel very positive about these two new products from Tandberg. They are two of the best-designed, best-performing components we have tested for *Audio*. The 3008A preamplifier offers the prospective buyer a clever electronic design and outstanding functionality. The amplifier, which easily qualifies as a serious audiophile product, utilizes a paralleled MOS-FET output stage to deliver exceptional high-current performance, superb high-frequency response, and high power in a lightweight chassis at a reasonable price. We have only praise for the 3009A's sharp design and hot-rod performance.

Laurence L. Greenhill and David L. Clark

TABLE I

Maximum power output at 0.1% THD + N, 20 Hz to 20 kHz, 3009A amplifier.

Load, Ohms	Voltage	Current, Amps rms	Continuous Power, Watts	IHF Dynamic Power, Watts
8	45.2	5.7	255	359
4	44.4	10.6	449	402
2	37.2	18.6	692	414
1	28.6	28.6	818	286
0.5	18.5	37.0	684	
0.1	2.0	7.1	5	

TABLE II

THD + N (%) at rated output, 3009A amplifier.

Freq., Hz	8 Ohms, 200 wpc, 40 V	4 Ohms, 330 wpc, 36.3 V	2 Ohms, 450 wpc, 30 V
20	0.019	0.016	0.023
200	0.019	0.016	0.020
2k	0.020	0.016	0.019
20k	0.049	0.029	0.033

Magnificent Reception.

THE TX-11a COMBINES CARVER'S REVOLUTIONARY ASYMMETRICAL CHARGE COUPLED FM DETECTION CIRCUITS WITH AN AM STEREO SECTION CAPABLE OF FM-QUALITY RECEPTION.

The Carver TX-11a Stereo AM-FM Tuner is the most complete high fidelity broadcast reception component ever offered. It is a technical tour-de-force which further distances Bob Carver's unique products from traditional electronic components. First, by eliminating forms of FM distortion and interference that even the most expensive tuners available can't correct. And second, with a unique additional tuning section capable of making AM stereo sound as good as FM!

THE SILENT TREATMENT. While AM stereo may not yet be available in your area, you can receive FM stereo. Including stations so fraught with interference and distortion that you may be tempted to return to mono AM. That's why the TX-11a includes the first circuitry to remove hiss, "picket fencing" and the myriad other unpredictable noises which often disturb FM listening. Without reducing stereo imaging, frequency response or dynamic range.

Part of the FM signal, the left minus right portion, is extremely prone to "ghosting," or multipath interference caused by hills, buildings and other obstructions. Bob Carver's Asymmetrical Charge Coupled circuitry cancels distortion-causing "dirty mirror" images before they can reach your ears. It filters out noise and restores the part of the signal

needed by our ears and brain to construct stereo imaging. Reintroduced into the mono (L+R) signal matrix, a net reduction of 93% – or better than 20dB of noise reduction – is achieved. All ambient and localizing information is recovered. Only hiss and

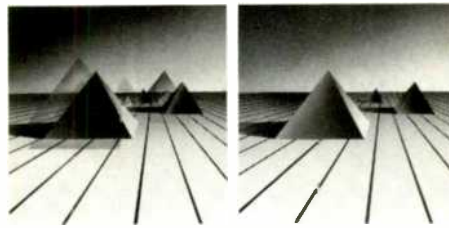

distortion are left behind. Or, as *High Fidelity* magazine put it, "... clean, noise-free sound out of weak or multipath-ridden signals that would have you lunging for the mono switch on any other tuner."

Ovation magazine observed that the circuit, "... may well mean the difference between marginal reception of the station signals you've been yearning to hear and truly noise-free reception of those same signals."

Audio magazine called it, "An FM tuner breakthrough."

THE FIRST AUDIOPHILE AM STEREO CIRCUITRY. Contrary to popular belief, most AM stereo stations have frequency response (20-15kHz), separation (35dB) and signal-to-noise ratios (70dB) audibly indistinguishable from FM stations of equal strength. But only Carver offers the technology to appreciate this hidden performance.

At a press conference in front of America's top stereo writers, Bob Carver unveiled a low powered C-GUAM format AM stereo broadcast transmitter with a Carver Compact Disc Player as a source. The CD source and the TX-11a were also routed directly to a preamplifier and speakers for comparison.

When Bob switched back and forth, most listeners had difficulty distinguishing between the straightwire CD player and the TX-11a's over-the-air AM stereo reception! Many could tell no difference at all!

HUMAN ENGINEERED FEATURES AND CONVENIENCE. The TX-11a is designed to make enjoying FM and AM easy, not dazzle you with flashing light and complex programming. Thirteen presets, wide/narrow band selection, automatic/manual scanning as well as Multipath and Noise Reduction buttons are inset into the burnished anthracite metal face. Full instrumentation including digital display, 6-step signal strength LEDs and other monitor functions are tastefully recessed, visible but not garish. The result is performance without theatricality, access without complication.

CLEAR THE AIR by visiting your nearest Carver dealer. Ask to hear the most expensive tuner they sell (It probably won't be the Carver TX-11a). Tune a multipath-ravaged, hiss-filled FM station on it; then the same station on the TX-11a Stereo AM-FM Tuner. Now press the Carver Multipath and Noise Reduction buttons. You'll hear why *High Fidelity* Magazine called it, "By far the best tuner we have tested..."



CARVER

PO Box 1237, Lynnwood WA 98046

POWERFUL

MUSICAL

ACCURATE

Distributed in Canada by **evolution** technology



6

ONYKO T-9090 TUNER

Manufacturer's Specifications

Usable Sensitivity: Mono, 12.8 dBf; stereo, 17.2 dBf.

50-dB Quieting Sensitivity: Mono, 15.8 dBf; stereo, 37.2 dBf.

S/N: Mono, 95 dBf; stereo, 85 dBf.

THD: Mono, 0.009% (wide i.f.); stereo, 0.02% (wide i.f.).

Frequency Response: 30 Hz to 15 kHz, +0.5, -1.0 dB.

Capture Ratio: 1.0 dB.

AM Suppression: 60 dB.

I.f. Rejection: 100 dB.

Image Rejection: 100 dB.

Selectivity: 80 dB (super-narrow i.f.).

Separation: 55 dB at 1 kHz (wide i.f.); 33 dB, 70 Hz to 10 kHz.

Output Level: 0 to 1.5 V.

Antenna Input Impedance: 75 ohms, unbalanced.

Dimensions: 17 $\frac{3}{4}$ in. (45.1 cm) W x 4 in. (9.9 cm) H x 15 $\frac{3}{8}$ in. (38.8 cm) D.

Weight: 14.5 lbs. (6.6 kg).

Price: \$650.

Company Address: 200 Williams Dr., Ramsey, N.J. 07446.

(Originally published May 1985)





For a tuner manufacturer to affix a \$650 price tag to an FM tuner these days, that manufacturer had better have something out of the ordinary by way of a product. FM tuner technology has advanced very rapidly in recent years, and along with ever more sophisticated and effective circuitry have come lower costs, thanks to the increased use of multi-function, large-scale integrated circuits. Let me state right at the outset of this review that Onkyo's suggested price for their T-9090 tuner is fully justified—and then some. The T-9090 is the kind of tuner that many FM listeners would have gladly paid twice as much for just a few years ago—if it had been available at the time. Think of this tuner as a reception problem-solver.

The tuner's most outstanding feature is its ability to set up operating modes and thus extract the best possible signal available under a wide variety of circumstances. As usual, Onkyo has come up with an acronym for this feature: APR. (Only when I got to the last page of the brief operating manual did I learn that these initials stand for Automatic Precision Reception.) APR is a system that automatically sets the r.f. stage gain (local or distant), i.f. bandwidth (wide, narrow, or super-narrow for extremely high selectivity), stereo/mono mode, and high-blend. Settings are based upon the quality of the incoming signal, including such parameters as field strength, distortion and noise.

Normally, I would object to having a tuner make all these decisions for me (sometimes I want to hear just how noisy a weak-signal stereo station sounds in my location), but not in the case of this one. That's because Onkyo wisely provided a means for overriding the APR system—just for FM masochists like me!

Control Layout

At first glance, the front panel of the T-9090 seemed very "busy," with its profusion of buttons and alphanumeric displays. Upon closer examination, however, I realized that each item on the crowded front panel served a useful purpose, and that the control buttons were quite logically arranged after all. At the extreme left of the panel are a power on/off button, two buttons associated with timer turn-on (an external timer would be required), and a toggle button that turns a built-in "beep" tone on and off. This tone, if left on, will beep every time almost *anything* on the tuner is changed or activated. The owner's manual suggests: "Use this switch to turn off the tone when not needed," and that's just what I did as soon as I was satisfied that it worked as advertised!

The main numeric display is multi-functional. It shows the tuned frequency, signal strength (actually calibrated in dBf), muting- or tuning-level setting (there are three muting levels possible: 17, 27, and 37 dBf), and the number of the preset station currently being listened to. Normally, this display shows tuned-to frequency; the other displays are activated when appropriate pushbuttons are touched. They then appear for 2 S, after which the display returns to the frequency-indicating mode.

To the right of this major display area are indicators which tell you the status of the various operating modes selected manually or by the special APR circuitry. Below these are 20 numbered indicators to tell you which of the 20 preset stations has been selected and is being received. The

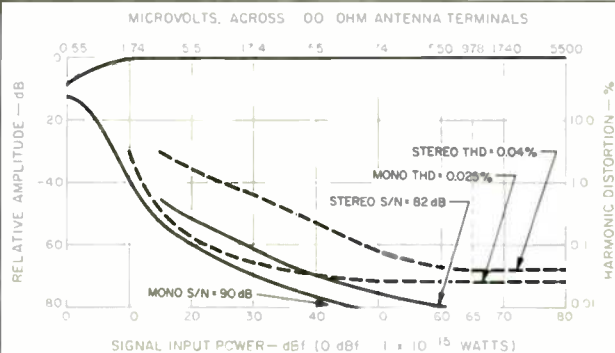

Fig. 1—Mono and stereo quieting and distortion characteristics, FM section, in wide-band i.f. mode.

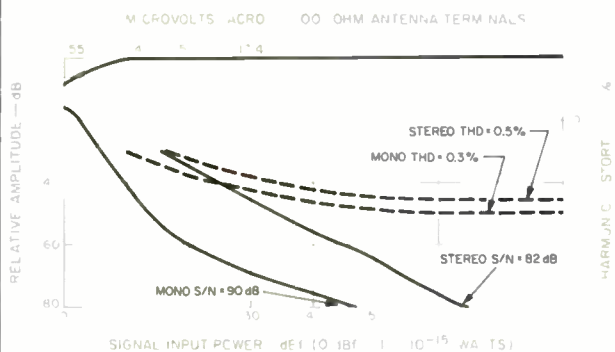

Fig. 2—Mono and stereo quieting and distortion characteristics, FM section, in super-narrow i.f. mode.

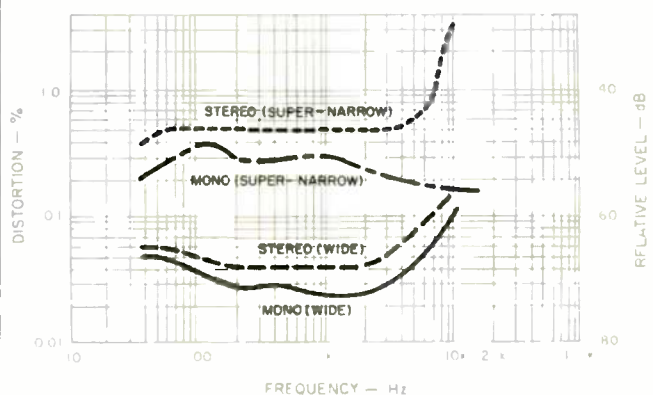
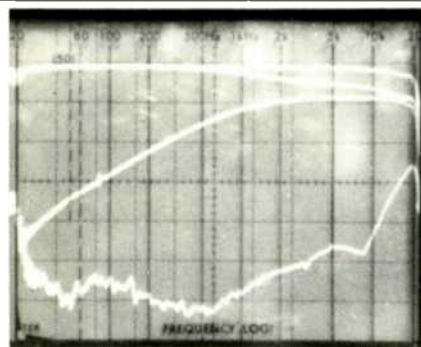
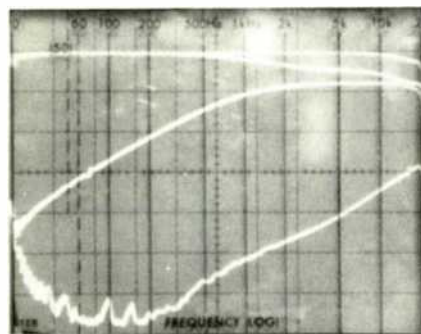

Fig. 3—Harmonic distortion vs. frequency, in super-narrow and wide i.f. modes.

I was never able to honestly disagree with the operation-mode decisions made by this uncannily clever tuner.



A



B

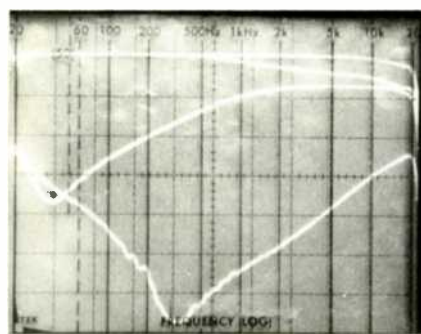

C

Fig. 4—Frequency response and separation vs. frequency, in wide (A), narrow (B), and super-narrow (C) i.f. modes. Top two traces in each photo

show response first without and then with blend; the bottom pair of traces show separation first with and then without blend.

function keys that both assign and select the preset stations are arranged to operate much like keys of a typewriter. There are only 10 of them, but they can select 20 different preset frequencies using an additional shift key (button number 1 becomes 11, 2 becomes 12, etc.). At the upper right of the panel are touch buttons which can be used to override the APR decisions, as well as buttons for selecting "Tuning Mode" (automatic or manual), a button which sets in motion the preset scanning function (the tuner moves sequentially to all of your preset stations, letting you listen to

each for about 5 S), a key for entering preferred stations into the preset memory circuitry, the muting-level key for setting any of the three available muting thresholds, and a key for switching the frequency display over to its signal-strength display function. "Up" and "Down" tuning keys are at the lower right corner of the front panel.

The rear panel of the T-9090 is equipped with only a 75-ohm, coaxial, antenna transmission-line connector. However, Onkyo supplies a small, accessory, 300 to 75-ohm transformer for those who wish to use 300-ohm transmission lines from their antennas to this tuner. Fixed and variable output jacks as well as horizontal and vertical oscilloscope jacks are located near the center of the rear panel (the 'scope jacks are for observation of multipath problems). An output-level control nearby completes the simple rear-panel layout of the T-9090.

Measurements

Most of the measurements I made in the lab had to be done twice, once in the wide-band i.f. mode and then again in the super-narrow mode. I made a few measurements using the intermediate, narrow mode but discovered that distortion and separation figures fell just about midway between those obtained for the two extreme settings.

Figure 1 shows how quieting and harmonic distortion (for a 1-kHz modulating signal) vary with increasing signal strength in the wide-band i.f. mode. Mono usable sensitivity was an impressively low 10 dBf, considerably better than the 12.8 dBf claimed by Onkyo. Even in stereo, usable sensitivity measured only 15 dBf, considerably better than the 17.2 dBf claimed by the manufacturer. In mono, 50-dB quieting was obtained for signal strengths of 12 to 14 dBf (depending upon the i.f. bandwidth setting); for stereo, the signal strength needed to achieve 50 dB of quieting ranged from 19 dBf in the wide i.f. mode to 35 dBf in the super-narrow mode. Figure 2 shows quieting and THD for mono and stereo operation in the super-narrow i.f. mode.

The best signal-to-noise ratio I was able to measure with strong signals was 90 dB for mono and 82 dB for stereo. I won't quibble with Onkyo's claim of 95-dB S/N in mono since, frankly, I don't know for sure whether my test equipment is even capable of measuring signal-to-noise ratios in excess of 90 dB. Suffice it to say that the mono S/N I measured for the T-9090 beats anything I have ever measured for a tuner before.

Test equipment may have been the limiting factor in my measurements of harmonic distortion too. In the wide i.f. mode, I measured a distortion level of only 0.025% for mono and 0.04% for stereo. Admittedly, that's not as low as the 0.009% (mono) and 0.02% (stereo) figures claimed by Onkyo, but when you get down to such low levels of THD, it's hard to say whether the residual distortion is a function of test equipment, minute changes in tuner alignment, or other causes. In any case, these THD levels are obviously not going to be audible. As you might expect, switching to the super-narrow mode for higher selectivity always involves a trade-off against distortion and stereo separation. In the case of the T-9090, THD rose to 0.35% for both mono and stereo operation.

Figure 3 shows how harmonic distortion varies with fre-

This is the kind of tuner that makes you wish for more really conscientious FM broadcasters providing the kind of sound quality the T-9090 can deliver.

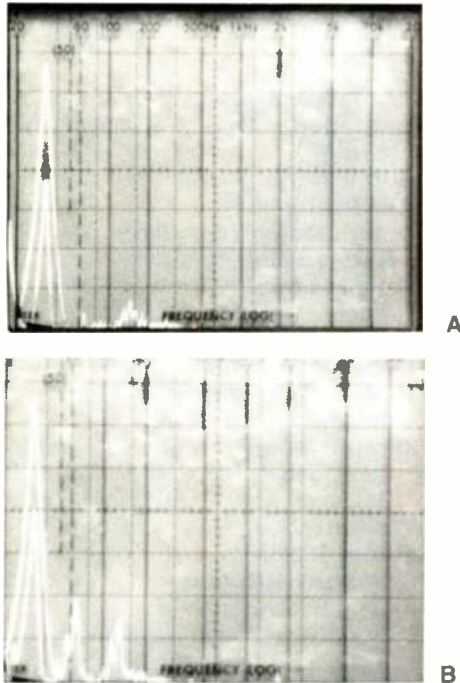

Fig. 5—Crosstalk and distortion products in wide (A) and super-narrow (B) i.f. modes, with a 5-kHz, 100% modulating signal. Sweep is linear from 0 Hz to 50 kHz.

quency for both wide and super-narrow i.f. settings in mono and stereo. The three 'scope photos of Fig. 4 show how frequency response and separation vary with different i.f. settings. In each of these photos, the top two traces represent frequency response (from 20 Hz to 20 kHz) of the modulated channel, first without, then with the blend circuit. The bottom pair of traces in each case shows separation as a function of frequency (the scale is 10 dB per vertical division), with the least separation occurring when the blend circuit is manually activated. Figure 4A was plotted with the tuner set to the wide i.f. mode, in Fig. 4B the narrow mode was used, and in Fig. 4C the super-narrow setting was employed. An unusual, slight attenuation of high frequencies in each upper curve occurred when the high-blend circuit was introduced. In other words, for some reason, when the high-blend circuit is used, not only does separation at high frequencies decrease markedly, but the otherwise flat frequency response of the tuner is somewhat altered at the high end. Without the use of the blend circuit, separation in the wide i.f. position measured 57 dB at 1 kHz, 30 dB at 10 kHz, and 44 dB at 100 Hz. In the super-narrow i.f. setting, separation decreased to a still very satisfactory 42 dB at 1 kHz, 28 dB at 10 kHz, and 41 dB at 100 Hz.

Figures 5A and 5B also dramatically illustrate how i.f.

bandwidth affects distortion of a received audio signal. In these 'scope photos, the spectrum analyzer has been used to display a 5-kHz modulating signal as seen from the desired output (the tall spike at the left of each photo), followed by a second, stored sweep which shows the output of the unmodulated channel under the same conditions. Here the sweeps are linear from 0 Hz to 50 kHz in 5-kHz steps. Notice that in the wide i.f. position (Fig. 5A) there is very little evidence of crosstalk or distortion components at the output of the unmodulated channel (to the right of the main 5-kHz output spike). By contrast, in the super-narrow position (Fig. 5B), though separation is approximately the same (the shorter spike inside the taller one is about 26 dB lower in amplitude than the 5-kHz signal at the desired channel output), there are now several distortion and crosstalk components visible to the right of the 5-kHz signal.

Image and i.f. rejection for this tuner measured more than 100 dB (the limit of my test equipment), while AM suppression was an outstanding 75 dB. Capture ratio measured 1.2 dB, and subcarrier and SCA rejection were both in excess of 71 dB. Alternate-channel selectivity in the narrow position measured approximately 80 dB, increasing to better than 90 dB in the super-narrow i.f. setting.

Use and Listening Tests

I must confess that when it comes to FM, I am always turned on by a top-performing tuner or receiver. The T-9090 is just such a component. It's the kind of tuner that makes you wish there were more really conscientious FM broadcasters out there who were willing to devote the time and effort necessary to provide the kind of sound quality that this model can deliver. Fortunately, I have a couple of stations in my area that do care about good sound, and when you tune them in on a tuner such as this one, you realize just how good a sound—and how quiet a background—FM radio can provide. The T-9090's judgment with respect to modes of operation using the APR circuitry were better than my own. The tuner correctly analyzed a variety of incoming signals and made the right decisions about i.f. bandwidth and local/distant modes (or r.f. gain). In the case of a few really noisy stereo FM signals, it even turned on the blend control to reduce high-frequency hiss. Much as I would like to think that I could make better judgments than the built-in circuits, I have to confess that I was never able to honestly disagree with the decisions made automatically by this uncannily clever tuner.

In my listening area, having as many as 20 presets doesn't seem like overkill, though I know that in some areas there aren't even 20 signals available, let alone that many preferred stations. Using my outdoor antenna and a rotator, I was able to pick up 73 usable signals, some 49 of them in acceptably quiet stereo—including those for which the tuner decided to turn on the blend control. I haven't looked back over the last few years worth of tuner reports, but I suspect that this may be a new record. I have always admired Onkyo's r.f. products, and with the T-9090 they have really outdone themselves. Now, if more FM broadcasters would take their cue from Onkyo and start catching up, the true promise of high-fidelity FM radio would really be fulfilled.

Leonard Feldman



7

PIONEER F-99X TUNER

Manufacturer's Specifications FM Tuner Section

Usable Sensitivity, Narrow-Band: Mono, 10.8 dBf.

50-dB Quieting Sensitivity, Narrow-Band: Mono, 12.8 dBf; stereo, 34.8 dBf.

S/N Ratio: Mono, 94 dB at 80 dBf; stereo, 87 dB at 80 dBf.

Alternate-Channel Selectivity, Narrow-Band: 85 dB.

Capture Ratio, Wide-Band: 0.8 dB.

THD, Wide-Band: Mono, 0.0095% at 1 kHz, 0.015% at 100 Hz, and 0.02% at 6 kHz; stereo, 0.02% at 1 kHz, 0.02% at 100 Hz, and 0.07% at 6 kHz.

THD, Narrow-Band: Mono, 0.09% at 1 kHz; stereo, 0.5% at 1 kHz.

Stereo Separation, Wide-Band: 65 dB at 1 kHz, 55 dB from 20 Hz to 10 kHz.

Frequency Response: 20 Hz to 15 kHz, +0.2 dB, -0.8 dB.

I.f. Rejection: 100 dB.

Image Rejection: 70 dB.

Spurious Response Rejection: 80 dB.

Subcarrier Rejection: 60 dB.

Muting Threshold: 25.2 dBf.

Output Level: 650 mV at 100% modulation.

AM Tuner Section

Sensitivity: 150 μ V/m (with loop antenna).

Selectivity: 18 dB.

S/N Ratio: 50 dB.

Image Rejection: 40 dB.

I.f. Rejection: 60 dB.

Output Level: 150 mV at 30% modulation.

General Specifications

Power Consumption: 120 V a.c., 20 watts.

Dimensions: 18 in. W x 2 1/2 in. H x 12-5/16 in. D (45.7 cm x 6.4 cm x 31.3 cm).

Weight: 9 lbs., 15 oz. (4.5 kg).

Price: \$324.95.

Company Address: P.O. Box 1540, Long Beach, Cal. 90801.
(Originally published November 1985)





Pioneer tuners have always enjoyed a good reputation among devotees of good FM radio. Witness the series of "Super Tuners" that Pioneer pioneered (sorry!) several years ago for car sound systems. The current "Super Tuners" are still considered by many to be the standard by which other car-stereo tuners should be judged. It stands to reason that a company that can do such a good job of designing a tuner for the hostile electrical and physical environment of an automobile should be able to do an equally fine job in designing one for home use. Pioneer has done just that with their F-99X.

One of the chief virtues of the F-99X is its dual i.f. bandwidth, which is switchable from wide to narrow. Many other manufacturers have employed this scheme of trading off selectivity for lower distortion and better separation, but the bandwidths Pioneer has chosen make the most of this idea. The unit, like most recent AM/FM tuners, employs frequency-synthesized tuning, which has also been designed to near perfection. Unlike designs of the earliest synthesized models, the F-99X's use of this crystal-accurate method of tuning has not in any way degraded its signal-to-noise ratio or distortion capabilities. My only quarrel with Pioneer's description of the F-99X is in their use of the word "digital"; I'm not sure what's digital about this fine product, other than the legible frequency display which does, indeed, show tuned-to AM or FM frequencies in numbers—or "digits."

To keep the front panel slim and uncluttered, and yet provide an adequate number of station presets, Pioneer makes use of the now-familiar "shift key" approach. The eight preset buttons, with the aid of a "Station Call" mode key, allow you to program or memorize a total of 16 AM or FM stations. What's more, when you want to recall these stations, it's not necessary to specify whether they are on the AM or FM band. Of course, you can preset AM and FM stations in any order you wish, but if you program the first eight on the FM band with "Station Call" in its out position, and then program the next eight as AM stations with "Station Call" in its depressed position, this key then serves the purpose of switching bands as well as stations. The F-99X will remember the station to which you are tuned when you turn off the power, and will access that frequency when power is turned on again. Even if the power cord is disconnected or there is a power outage (up to three days or so), a charged capacitor inside the tuner will power the memory function so station presets will not be lost.

Control Layout

The "Power" on/off pushbutton, together with its indicator light, is at the upper left corner of the tuner's slim front panel. "FM" and "AM" selector buttons are located below the power switch, and to the right is an LED display area that shows tuned-to frequencies, the selected band (AM or FM), signal strength (by means of three small LEDs), selection of the "Narrow" i.f. mode, and stereo reception.

The "Tuning" rocker bar, to the right of the display, raises or lowers the tuned frequency till the F-99X intercepts the next acceptably strong signal. The same bar can also tune the F-99X up or down the dial in increments of 0.1 MHz (FM) or 10 kHz (AM), if the "Manual Search" button is pressed. Memorizing a station's frequency is accomplished by press-

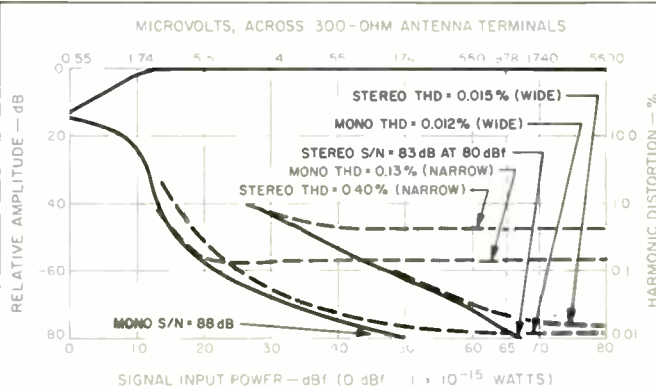

Fig. 1—FM mono and stereo distortion in wide and narrow i.f. modes, and quieting in wide mode only.

ing the "Memory" button, adjacent to the "Tuning" bar, and then pressing one of the numbered preset buttons at the panel's far right. The i.f. mode-selector and "Station Call" buttons are to the right of "Memory" and "Manual Search." An LED above each of these four controls shows when it is activated.

The "Manual Search" button has a second function: Switching to manual tuning also turns the FM muting off. You're more likely to use the manual tuning mode to seek out weak stations, which automatic tuning might skip and muting might make inaudible. So Pioneer's arrangement makes more sense than the more common one of yoking the mono/stereo switch to the muting. The latter practice has, more than once, kept me from listening to a fairly weak station in stereo, even though I was willing to tolerate the extra noise. I dislike having to switch into mono to defeat a muting circuit, especially when its threshold is set too high, as often happens.

I'd like to credit Pioneer with having carefully thought out the most desirable location for the mute defeat switch, but I should note that it may have been the only place they could put it, since this tuner does not have a mono/stereo switch. The omission is not really much of a problem. If you encounter a very noisy stereo station (one strong enough to overcome the stereo threshold of the tuner but not strong enough to be noise-free), you can always switch to mono on your preamplifier or amplifier. Doing so cancels out most of the objectionable noise that is normally out of phase in the left and right channels.

The F-99X's rear panel is equipped with the usual left and right output jacks; a 75-ohm, coaxial FM-antenna connector, and a pair of spring-clip terminals for the separate AM loop antenna, supplied or an outdoor AM antenna. If you want to use a 300-ohm, flat twin-lead for connecting your FM anten-

Muting and stereo thresholds are set at ideal points, so the auto tuning mode delivers only those stereo signals quiet enough to be enjoyed.

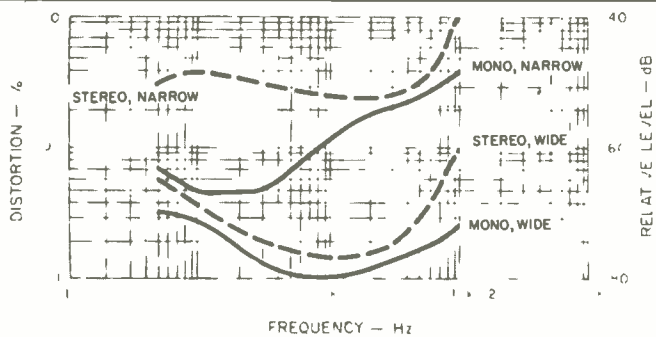

Fig. 2—THD vs. frequency, FM section.

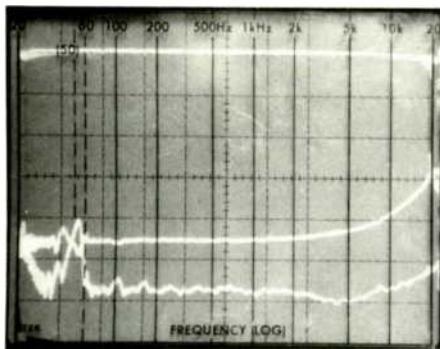

Fig. 3—FM frequency response (top trace) and separation vs. frequency for narrow i.f. mode (middle trace) and wide i.f. mode (bottom trace).

na, you will have to connect it to the 300-ohm/75-ohm transformer that is provided. The version of the F-99X supplied to the United States is also equipped with an output jack labelled "AM Stereo," but no details are given regarding its "tap-in" point. Since I do not have an AM stereo decoder (either for the Kahn-Hazeltine or the Motorola system), I can't say whether this jack serves its purpose.

Measurements

Figure 1 shows the tuner's FM quieting and 1-kHz distortion characteristics and, by implication, its sensitivity. Usable sensitivity was 10.8 dBf in the narrow mode, exactly as claimed, but in the wide i.f. mode, as might be expected, usable sensitivity was slightly poorer, 14 dBf. The 50-dB quieting sensitivity in mono, in the narrow mode, was 13 dBf, actually better than claimed. In stereo, I measured 36 dBf for the 50-dB quieting point, regardless of the i.f. mode. Since quieting characteristics were very nearly the same in either i.f. mode, once signal strengths exceeded the low usable-sensitivity figures, I saw no point in showing quieting for both modes.

In the wide i.f. mode, I measured a maximum signal-to-noise ratio of 88 dB in mono, but I suspect that this result was limited by my test equipment. The same holds true for the wide-mode measurement of THD at 1 kHz in mono, where I obtained a reading of 0.012%. The fact is that the accuracy of my signal generator, as good as it is, is guaranteed only to 0.01% distortion and to a residual-noise figure of around 90 dB. I would therefore not dispute Pioneer's claimed S/N of 94 dB, in mono, or THD of 0.0095%, also in mono. (I just wish I knew how they measured these low figures!)

My tests showed, dramatically, the trade-offs that occur when a tuner has a well-designed wide/narrow i.f. choice. Switching to the narrow mode resulted in a very substantial improvement in selectivity; it measured just over 83 dB in this mode, compared to less than 50 dB in the wide mode. But as you can see in Fig. 1, distortion increased in the narrow mode by more than a whole order of magnitude, measuring 0.13% in mono and 0.4% in stereo for a 1-kHz test signal.

The differences in distortion produced by the tuner in its two i.f. modes are further illustrated by the curves of Fig. 2. Here, I have plotted distortion as a function of frequency, from 50 Hz to 10 kHz, for both mono and stereo operation of each of the two i.f. modes. Stereo separation, shown in Fig. 3, is also affected by the choice of i.f. modes. While in the wide mode, I measured separation of 60 dB (the highest I can measure reliably) at 1 kHz. Separation was very nearly as good at the frequency extremes, with readings of 59 dB at 100 Hz and an incredibly high 53 dB at 10 kHz. Switching to the narrow i.f. mode resulted in separation figures which, although still more than adequate, clearly illustrate what a narrower i.f. bandwidth does to even the most carefully designed and well-aligned multiplex decoder circuitry. Now, separation measured 46 dB at mid-frequencies, decreasing to 44 dB at 100 Hz and 40 dB at 10 kHz.

There are also differences, between the wide and narrow i.f. modes, in separation and crosstalk components created when a 5-kHz signal is used to modulate one channel 100%; this is evident from the spectrum analysis photos of Figs. 4A and 4B. Notice the higher amplitude crosstalk and distortion products that show up to the right of the desired 5-kHz (large) spike in Fig. 4B, compared with those appearing in Fig. 4A.

Overall frequency response was flat within 0.2 dB from 50 Hz to 10 kHz and was down 0.8 dB at 15 kHz, as claimed. Frequency response (in stereo), as well as channel separation for both i.f. operating modes, is shown in the spectrum analysis sweeps of Fig. 3. The frequency sweep is logarithmic from 20 Hz to 20 kHz, and the vertical scale is 10 dB per division.

The muting threshold was set to just under 30 dBf—an ideal point for this tuner, in my opinion. At 30 dBf, the F-99X's stereo signal-to-noise ratio has reached an acceptable level of 44 dB. The stereo switching threshold was set almost to the same point, 27 dBf—again an ideal choice. Therefore, when you are in the automatic tuning mode, the frequency-synthesized tuner will deliver only incoming stereo signals that are quiet enough to be enjoyed. If you want to listen to weaker stereo (or mono) stations, you'll simply

GRP WHERE ARTISTRY MEETS TECHNOLOGY



Diane Schuur/*Timeless*



Kevin Eubanks/*Face to Face*



Lee Ritenour/*Earth Run*

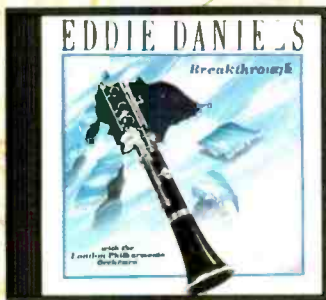

Eddie Daniels/*Breakthrough*



Glenn Miller/*In The Digital Mood*



Dave Valentin/*Light Struck*



Grusin/Ritenour/*Harlequin*



Billy Cobham/*Power Play*



Special EFX/*Slice Of Life*



The Chick Corea Elektric Band

An ongoing commitment to the latest digital recording technology has earned GRP the singular distinction as *The Digital Master Company!*

From *New Age* to *Fusion*, from the *Pioneers* to the *Legends*, GRP proudly presents the hottest names in jazz in the medium they were meant to be heard in.

Music reproduction reflecting the highest state of the art recording technology, from...

GRP, THE DIGITAL MASTER COMPANY.

Also available on Records and Cassettes.

THE DIGITAL MASTER COMPANY



The ultra-low distortion does make a difference, especially when you are listening to stations that habitually overmodulate.

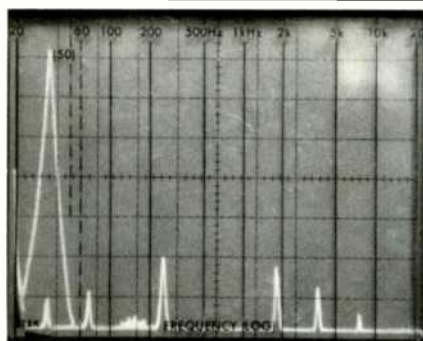

A

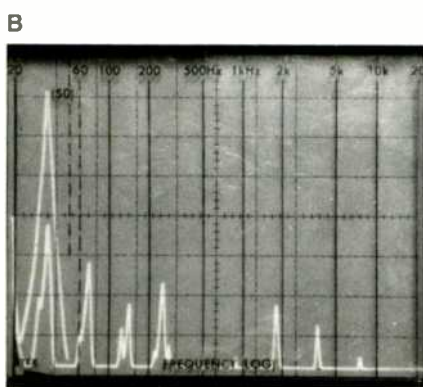

Fig. 4—Separation, crosstalk, and distortion components for 5-kHz left-only modulating signal in wide (A) and narrow (B) i.f. modes, FM section.

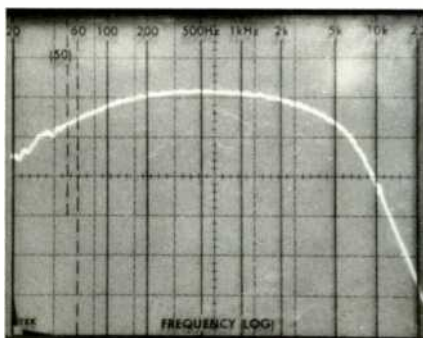

Fig. 5—AM frequency response.

have to tune to those stations manually and thereby defeat the muting circuitry.

Capture ratio, measured in the wide i.f. mode, was 1.0 dB. Subcarrier rejection was 61.5 dB on one channel and 65 dB on the other. SCA rejection was greater than 75 dB, and image rejection measured 71 dB. Spurious response rejection, measured in the wide mode, was greater than 85 dB, and AM suppression measured 67 dB—one of the highest readings I have ever been able to obtain for this important parameter. I.f. rejection was 100 dB or greater (my test setup would have difficulty reading anything over 100 dB).

After plotting AM frequency response (Fig. 5), I didn't spend too much time measuring other characteristics of the AM section. I suppose if you wanted to apply the very liberal tolerance of ± 6.0 dB to the frequency response, you could say that it extended from around 50 Hz to 6 kHz. On the other hand, if you arbitrarily call the 1-kHz output "0 dB," then the -6 dB points would have to be stated as occurring at around 60 Hz and 4 kHz. In either case, the narrow bandwidth of the AM section makes me doubt whether any type of AM stereo adaptor would work successfully when connected to the rear panel's "AM Stereo" jack. I suspect that owners of this excellent tuner won't care one way or the other about AM stereo in any case.

Use and Listening Tests

When connected to my outdoor rotatable antenna, the Pioneer F-99X tuner successfully picked up every FM station that I have ever logged in my listening area. This added up to some 60 usable signals, plus a marginally unacceptable few that were 100 miles or more away. You couldn't ask for much more by way of FM sensitivity in an FM tuner. Even more impressive was the ultra-low distortion. Yes, you can hear the difference, especially when you tune to stations that habitually overmodulate and sound terrible on tuners of lesser quality.

There were a few stations far enough away from the broadcasters in my area to have been assigned adjacent channel frequencies, and these were nicely locked in by switching to the narrow mode. Equally sensitive tuners I have tested were unable to zero in on those stations: Even in their narrow i.f. settings, they just didn't have enough adjacent-channel rejection. Pioneer, as I suspected during the bench tests, has set the narrow and wide i.f. bandwidths where they will do the most good.

I found that I hardly needed to refer to the owner's manual when testing or listening to this tuner. The control layout is very logical and easy to understand. I could argue that the "Memory" pushbutton, required for entering a frequency into one of the preset locations, might have been better positioned near the preset buttons instead of near the "Tuning" rocker, but that's really a minor point.

After I had finished my listening tests, I mounted the two wood-grain side panels that came with the tuner. These panels did indeed dress up what is otherwise a rather stark and plain-looking housing. For the kind of FM reception I was able to get from the F-99X, and considering its very reasonable price, I wouldn't have been too upset even if Pioneer had chosen *not* to throw in those wood side panels.

Leonard Feldman

Reality Realized.

SONIC HOLOGRAPHY TRANSFORMS EXCITING NEW PROGRAM SOURCES AS WELL AS FAMILIAR OLD ONES INTO TRULY LIFELIKE MUSIC EXPERIENCES.

Watch a movie on a 13" black and white TV. Now see it in 70 millimeter Technicolor with Surround Sound.

Listen to your favorite musicians on a portable radio. Now sit three rows back from the stage at a live concert.

The difference is dimension: Width, depth, breadth and detail that turn flat sensory input into breathtaking reality. They're the missing ingredients of live musical performance that Sonic Holography restores to records, compact discs and even hi-fi movie soundtracks.

The most experienced and knowledgeable experts in the audio industry have concurred. Julian Hirsch wrote in *Stereo Review*, "The effect strains credibility — had I not experienced it, I probably would not believe it."

High Fidelity magazine noted that "...it seems to open a curtain and reveal a deployment of musical forces extending behind, between and beyond the speakers." According to another reviewer, "It brings the listener substantially closer to that elusive sonic illusion of being in the presence of a live performance."

All this with your existing speakers and music collection.

HOW SONIC HOLOGRAPHY WORKS. Unfortunately, conventional stereo cannot isolate the output of left and right speakers and send their output only to your left and right ears. Left and right versions of a sound occurrence also cross in the middle of your listening room, confusing your ears with additional extra sound arrivals a split second apart. Stereo imaging and separation suffer because both speakers are heard by both ears, confusing your spatial perception.

The Sonic Hologram Generator in the Carver 4000t Preamplifier, C-1 Preamplifier and Carver Receiver 2000 solve this muddling of sound arrivals

by creating a third set of sound arrivals. These special impulses cancel the objectionable second sound arrival, leaving only the original sound from each loudspeaker.

The result is a vast sound field extending not only wider than your speakers, but higher than your speakers as well. Sounds will occasionally even seem to come from behind you! It is as if a dense fog has lifted and you suddenly find yourself in the midst of the musical experience. Or, as the Senior Editor of a major electronics magazine put it, "When the lights were turned out, we could almost have sworn we were in the presence of a live orchestra."

IMAGINE THE POSSIBILITIES. Thanks to VHS and Beta Hi-Fi stereo soundtracks (found even on rental tapes), and the increasing number of stereo TV broadcasts, Sonic Holography can put you inside the video experience, too.

It's a breathtaking experience. Without the need for additional rear speakers, extra amplifiers or decoders, the visual experience is psychoacoustically expanded by lifelike sound that envelops you, transforming stereo from monochromatic flatness into vibrant three-dimensional reality. Instead of being at arm's length from the action, you are immersed in it.

Then there are the familiar audio sources which Carver innovation has further improved upon, each of which gains character and heightened impact through Sonic Holography.

Compact discs, whose potential is still trapped in the two-dimensionality of conventional stereo, are even more lifelike with Sonic Holography.

Thanks to the Carver Asymmetrical Charge-Coupled FM Detector, FM stereo broadcasts can be received hiss- and interference-free, ready to take on an astonishing presence and dimension through Sonic Holography.

Even AM stereo can actually become a three-dimensional phenomenon with Sonic Holography and the new Carver TX-11a AM/FM tuner which delivers AM stereo broadcasts with the same dynamics and fidelity as FM.

ENHANCE YOUR SPATIAL AWARENESS WITH CARVER COMPONENTS. When considering the purchase of a new preamplifier or receiver, remember how much more you get from the Carver 4000t, C-1 and Receiver 2000. Or add Sonic Holography to your existing system with the C-9 add-on unit.

Each can transcend the limits of your listening (and viewing) experiences by adding the breathtaking, spine-tingling excitement that comes from being transported directly into the midst of audio-video reality.

Visit your nearest Carver dealer soon and expand your range of experiences with Sonic Holography.



CARVER

PO Box 1237, Lynnwood, WA 98046

POWERFUL

MUSICAL

ACCURATE

Distributed in Canada by: evolution technology



8

YAMAHA R-9 RECEIVER

Manufacturer's Specifications

FM Tuner Section

Usable Sensitivity: 8.8 dBf (see text).

50-dB Quieting Sensitivity: Mono, 14.8 dBf; stereo, 37.3 dBf.

S/N Ratio: Mono, 85 dB; stereo, 81 dB.

THD: Mono, 0.05% at 1 kHz, 0.05% at 100 Hz, and 0.1% at 6 kHz; stereo, 0.07% at 1 kHz, 0.07% at 100 Hz, and 0.15% at 6 kHz.

Alternate-Channel Selectivity: 85 dB.

Image Rejection: 40 dB.

I.f. Rejection: 90 dB.

AM Rejection: 55 dB.

Spurious-Response Rejection: 70 dB.

Capture Ratio: "Local," 1.2 dB; "DX," 2.5 dB.

Stereo Separation: 50 dB at 1 kHz, 45 dB at 100 Hz, 45 dB at 10 kHz.

Frequency Response: 30 Hz to 13 kHz, ± 0.5 dB.

Output Level: 500 mV for 100% modulation.

AM Tuner Section

Usable Sensitivity: 250 μ V/m.

Selectivity: 24 dB.

S/N Ratio: 50 dB.

Image Rejection: 40 dB.

Spurious-Response Rejection: 50 dB.

THD: 0.3% at 400 Hz.

Output Level: 150 mV for 30% modulation.

Amplifier Section

Power Output: 125 watts continuous per channel, 20 Hz to 20 kHz, 8-ohm loads; 145 watts continuous per channel, 20 Hz to 20 kHz, 6-ohm loads.

Rated THD: 0.015% at 8 ohms, 0.03% at 6 ohms.

Dynamic Headroom: 1.58 dB.

Damping Factor: 60 at 8 ohms.

Input Sensitivity: MM phono, 0.22 mV; MC phono, 14 μ V; high level, 13.4 mV.

Phono Overload: MM, 110 mV; MC, 8 mV.

Frequency Response: MM phono, RIAA ± 0.3 dB; MC phono, RIAA ± 0.5 dB; high level, 20 Hz to 20 kHz, ± 0 , -0.3 dB.

S/N Ratio: MM phono, 75 dB; MC phono, 74.5 dB; high level, 80 dB.

Residual Noise: 120 μ V.

Subsonic Filter Cutoff: 10 Hz, 12 dB/octave.

Tone Control Range: Bass, ± 10 dB at 50 Hz; treble, ± 10 dB at 20 kHz; midrange, ± 12 dB at 1 kHz.

Loudness Control Range: 40 dB at 1 kHz.

General Specifications

Power Requirements: 120 V, 60 Hz, 500 watts.

Dimensions: 17 $\frac{1}{8}$ in. W \times 5-15/16 in. H \times 16 $\frac{5}{8}$ in. D (43.5 cm \times 15.1 cm \times 42.2 cm).

Weight: 26 lbs., 7 oz. (12 kg).

Price: \$849.

Company Address: 6660 Orange-thorpe Ave., Buena Park, Cal. 90620.

(Originally published December 1985)





Yamaha describes the Model R-9 as an audio/video receiver. I can't deny that it is able to handle and switch signals from two video program sources, including both video and audio (stereo or mono) signals, and to direct those signals to a connected video monitor. Nevertheless, I wish manufacturers would agree on precisely what constitutes an A/V receiver. I've seen some that simply provide a couple of extra inputs for the audio tracks of a VCR or other video program source; at the other extreme are those which switch a variety of video program sources and even have built-in TV audio tuners. The R-9 falls somewhere in between these two extremes.

In terms of its sound capabilities, the R-9 is a superb example of the audio art. Most of the features that have impressed me favorably over the years in earlier Yamaha receivers have been carried over into the R-9. For example, it has a *legitimate* loudness-compensation control; that is, a separate, continuously variable control adjusts the degree of compensation according to the requirements of your actual maximum listening levels, speakers used, etc. Another excellent feature—and one which Yamaha was among the first to introduce—is a separate "Record Out" selector which allows you to record one program source while listening to another. In addition to its high power rating at low distortion levels, its excellent frequency-synthesized tuning system and its 16-station preset capability, the R-9 has a wireless remote control. In some respects, I found that having a remote module for a stereo receiver is even more useful than having one for a TV or a video recorder.

Another interesting innovation, found in the receiver's amplifier section, is its dual mode of operation. At the user's discretion, the amp will operate in true Class A up to around 20 watts per channel, automatically switching to Class AB if signal levels exceed that power output. Of course, in the Class-A mode, power consumption—even with no signal applied—is much higher than in Class B, so you are given the option of having the system operate in Class AB at all times if you feel that the sonic improvement offered by Class A isn't worth the extra power drain.

The tuner has its share of innovative circuitry, too. What Yamaha calls a Computer Servo Lock Tuning System samples incoming signals and determines which of two tuning methods will yield the best and clearest sound. A synthesized, phase-locked-loop tuning circuit is used for weak or noisy stations; for stronger, clearer signals, the R-9 uses an "infinite resolution" FM servo tuning circuit—that is, one which locks onto the station signal rather than the station frequency. "Local" or "DX" settings can be selected manually or automatically, and the new digital fine-tuning arrangement permits you to tune in increments as small as 0.01 MHz in FM or 1 kHz in AM.

Control Layout

The R-9 is a rather tall receiver, its front panel standing nearly 6 inches high, which gives it a somewhat heavy look. But the height is needed, if for no other reason than to accommodate the great number of controls and switches on the front panel. Many of the less often-used controls and switches are hidden behind a hinged flap so that the panel doesn't look quite as cluttered as it otherwise might.

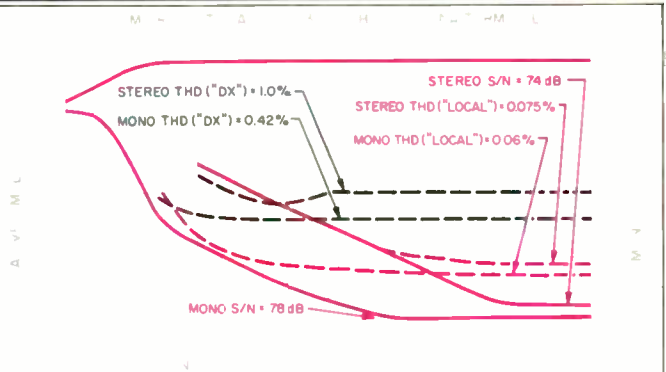

Fig. 1—Mono and stereo quieting characteristics in "Local" (wide-band) mode, and distortion in both "Local" and "DX" (narrow-band) modes, FM section.

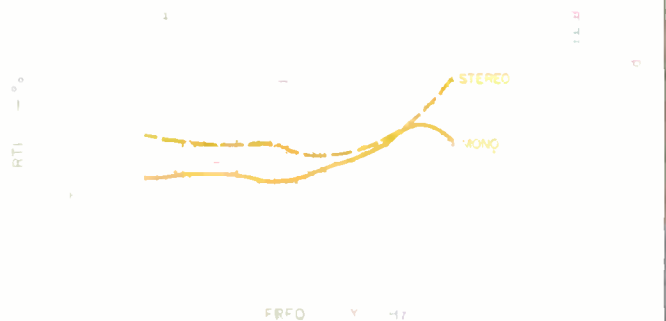

Fig. 2—THD vs. modulating frequency, "Local" mode, FM section.

Most of the controls that are always in view are pushbuttons. There are buttons for on/off switching, audio and video program selection, audio muting, and activation of the automatic Class-A/Class-AB selector. There is also a row of 15 tuner controls. These include eight preset buttons (plus a shift key for selecting any combination of 16 AM or FM stations), and others which activate the preset "Memory" or select the band (AM or FM), the "Receiving Mode" ("Local," "DX," or automatic switching between them), and the "Tuning Mode" (manual or auto scan). Rockers for regular and fine tuning complete this group. The only rotary controls normally visible are the "Volume" knob and the "Loudness" ring surrounding it. The continuously variable loudness control has a full, 40-dB range, as opposed to the 20-dB range on earlier versions of Yamaha's separate loudness control.

Visible at all times, at the upper left of the front panel, is the digital display for AM or FM frequency and a 10-segment "Signal Quality" bar-graph display. Additional indications in this area show the current tuning and receiving modes and which, if any, of the 16 preset stations is current-

With 2.3 dB of dynamic headroom, the R-9 can deliver more than 200 watts per channel, in short bursts, without clipping!

ly selected. Lights to the right of the display show the status of the "DNC" (Dynamic Noise Canceller) and "Simulated Stereo" circuits. In addition, tiny indicator lights illuminate above the program selectors when each is activated.

Opening the hinged flap on the lower section of the R-9's front panel reveals a headphone jack; three speaker-selector pushbuttons; a "Tone Bypass" switch; bass, midrange, and treble rotary tone controls with detented center positions; a balance control; pushbuttons for "DNC" (a single-ended dynamic filter along the lines of the more familiar DNR), "Simulated Stereo," "Stereo/Mono," and "MM/MC" phono, plus a rotary record-out selector.

Functions of the wireless remote control are limited to input selection, power on/off, selection of any one of the 16 preset AM or FM stations, audio muting, and volume adjustment. These functions are the ones you would most likely want to control from the comfort of your listening position.

A diagram in the owner's manual, depicting how various external components would be connected to the R-9, gives some idea of just how much of a "control center" this receiver really is. Shown are a pair of videocassette recorders (one of which could just as easily be a videodisc player), a TV monitor (which must have a video input jack; connection via the antenna input will not do), a Compact Disc player, a turntable equipped with either a moving-magnet or a moving-coil cartridge, two audio tape decks, and three sets of loudspeakers.

Few amplifiers or receivers have three sets of speaker outputs, because the net load impedance could fall dangerously low if all three were connected across the amplifier's outputs at once. Yamaha gets around this by connecting the

"B" and "C" speaker terminals in series, to maintain a reasonably high net impedance across the amplifier output during use with three sets of speakers. Operating speakers in series will, of course, seriously compromise the amplifier's effective damping factor, and should be done only for casual listening in secondary locations. When either the "B" or "C" speakers are used alone or in combination with the "A" speakers, the impedance problem does not arise.

Tuner Measurements

In testing the R-9's FM tuner section, I quickly established that the major difference between the "Local" and "DX" tuning modes was not so much in sensitivity as in selectivity. In other words, the "Local" setting corresponds primarily to a wide i.f. bandwidth setting on other tuners and receivers; the "DX" setting provides higher alternate-channel selectivity, useful for zeroing in on weaker stations that might otherwise be interfered with by strong stations broadcasting at frequencies near the desired signal's.

Figure 1 shows mono and stereo quieting characteristics in the "Local" mode. It also shows harmonic distortion for a 1-kHz modulating signal, in mono and stereo, for both the "Local" and "DX" modes. With the tuning set to "Local" (wide) mode, best S/N ratio in mono was 78 dB; in stereo, it was 74 dB. Usable sensitivity measured 12 dBf, improving somewhat to 10.8 dBf when I switched to the "DX" position. Yamaha's claim of 8.8-dBf usable sensitivity in mono is measured for a 30-dB signal-to-noise ratio. The IHF standard usable-sensitivity measurement is for a 30-dB ratio of signal to noise plus distortion. Hence the apparent discrepancy between my reading and Yamaha's. Our testing methods were obviously the same when it came to 50-dB quieting sensitivity, however. I measured exactly 14.5 dBf in mono and 37.0 dBf in stereo, close enough to Yamaha's published figures.

Figure 1 also shows how distortion rises when tuning is switched to the "DX" (narrow) i.f. mode. In the "Local" mode, harmonic distortion decreased to a low of 0.06% in mono and an almost equally low 0.075% in stereo. Using the "DX" setting, I measured 0.42% THD in mono at all signal levels above about 40 dBf, and stereo THD rose to around 1.0%. Figure 2 shows how THD varied with frequency, for mono and stereo, again in the "Local" or low-distortion mode. Even at 6 kHz, in stereo, THD was only 0.17%.

Tuning mode ("Local" versus "DX") had a great effect upon FM stereo separation, too, as you can see by looking at Figs. 3A and 3B. Both of these spectrum analyses were made for strong-signal conditions and cover the range from 20 Hz to 20 kHz in a logarithmic sweep. The top trace in each case represents desired output from the modulated (left) channel, and therefore constitutes a frequency response plot over the stated frequency range. Deviation from flat response was never greater than 0.3 dB in the "Local" mode (Fig. 3A) and was down 1.5 dB at 15 kHz for the "DX" mode (Fig. 3B). Separation was superb in the "Local" mode (bottom trace of Fig. 3A). It was 58.5 dB at mid-frequencies, nearly 50 dB at 100 Hz, and in excess of 40 dB at 10 kHz. In the "DX" mode, with its higher selectivity but more restricted bandwidth, separation decreased to less than 30 dB across the entire audio spectrum (bottom trace of Fig. 3B)—still

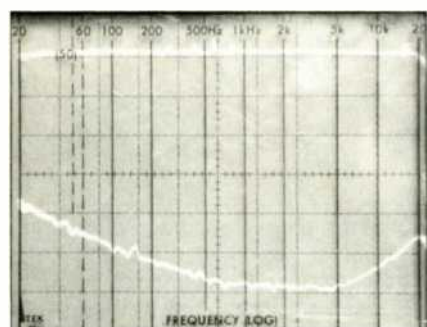

**A Fig. 3—
Frequency
response
(upper traces)
and separation
vs. frequency
(lower traces)
in "Local" (A)
and "DX" (B)
modes, FM
section.**

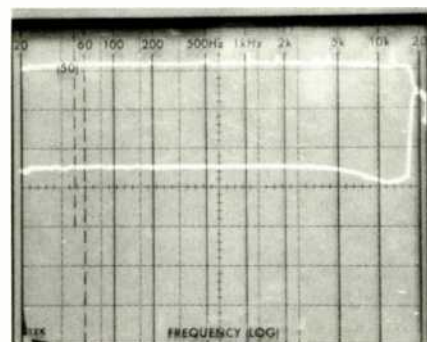

B

The 82-dB S/N ratio on phono would be very good for a separate preamp. When you consider all the possible noise sources in a receiver, it's remarkable.

adequate for good stereo imaging, but nowhere near as high as with the "Local" setting.

Figure 4 shows output products observed from the unmodulated channel's output when the opposite channel is fully modulated by a 5-kHz signal. The sweep extends linearly from 0 Hz to 50 kHz, and the tall spike at the left is the desired 5-kHz signal (the shorter one within it represents the crosstalk at the opposite channel's output). A rather high-amplitude, 19-kHz subcarrier product can be seen to the right of these spikes. Still further to the right is a short spike representing residual 38-kHz output, surrounded by sidebands which are 5 kHz above and below 38 kHz.

I measured a capture ratio of 1.1 dB in the "Local" mode; in the "DX" mode, capture ratio increased to 2.5 dB, as claimed by Yamaha. Both i.f. and spurious-response rejection were 90 dB, AM rejection was 57 dB, and alternate-channel selectivity (measured in the "DX" mode) was 87 dB, a bit higher than the published spec of 85 dB.

AM frequency response, plotted in Fig. 5, extends from around 50 Hz to 4 kHz for the -6 dB points. Best signal-to-noise ratio in AM was exactly 50 dB, as claimed, while harmonic distortion at 30% modulation measured 0.35% for a 1-kHz modulating signal.

Amplifier Measurements

In the "Auto Class A" mode, the R-9's power amplifier section operated in Class A until output power into 8-ohm loads exceeded 20 watts, at which point it smoothly made the transition to Class-AB operation. Maximum output for rated THD was 144 watts per channel into 8-ohm loads for most of the audio spectrum, decreasing to 136 watts per

channel at 20 Hz and 139 watts per channel at 20 kHz. The receiver's rating of 125 watts per channel is, therefore, very conservative. In fact, at rated output of 125 watts per channel, THD at mid-frequencies was a mere 0.0028%, and at the frequency extremes of 20 Hz and 20 kHz, THD measured only 0.009% and 0.007%, respectively. Distortion as a function of power output and frequency is shown in the three-dimensional plot of Fig. 6.

Damping factor of the power amplifier section was 79, referred to 8 ohms, using a standard 50-Hz test signal. Dynamic headroom was very high, measuring 2.3 dB above the rated continuous power level of 125 watts per channel. This means that for short, music-like bursts of signal, the R-9 can deliver in excess of 200 watts per channel without significant clipping! Twin-tone or CCIF distortion was no more than 0.0026% at rated output power.

Phono input sensitivity for 1 watt output was 0.23 mV for the MM phono input and 15 μ V for the MC input; 15 mV of input signal was required for the high-level inputs to produce 1 watt of output. Phono overload measured 145 mV for the MM cartridge input and 14 mV for the MC pre-preamplifier input. Frequency response for the high-level inputs was flat within 1 dB from 20 Hz to 50 kHz. Yamaha has opted to use a nondefeatable, subsonic filter with a nominal cutoff point of 10 Hz. This accounts for the slight drop at the extreme low end, which, in the sample I tested, reached the -3 dB point at 12 Hz. High-frequency cutoff (the -3 dB point) occurred at 100 kHz. All of these measurements were made with the tone-control circuits defeated. The range of the three tone controls is shown in the multiple-sweep spectrum analysis of Fig. 7.

Signal-to-noise ratio for the MM phono inputs was 82 dB, A-weighted, referred to a 5-mV input signal and 1 watt output. That would be a very good S/N ratio even for a separate, high-priced preamplifier. When you consider all of the possible noise- and hum-generating circuits in a receiver as complex and comprehensive as this one, 82 dB seems all the more remarkable. The MC phono input did almost as well, with a measured S/N of 76 dB referred to a 0.5-mV input and 1 watt output. This figure, too, is excellent and compares favorably with results obtained for the very best separate preamplifiers having MC inputs. Signal-to-noise ratio for all of the high-level inputs measured 83 dB, referred to 1 watt output and 0.5 V input. Translated to rated output, this means that if a 2.0-V maximum signal (typical of CD player outputs) were fed to the high-level inputs and the volume-control setting were increased to produce 125 watts, the effective S/N would be about 33 dB higher, or 116 dB. Clearly, this receiver is not going to impose any limitations on the dynamic range or signal-to-noise ratio achieved by even the very best CD players.

RIAA equalization was accurate to within -0.4 dB from 30 Hz to 20 kHz. At 20 Hz, response was off by 1.0 dB, but that can be attributed to the presence of the subsonic filter, which is in-circuit at all times.

Figure 8 shows the action of the separate, continuously variable loudness control at several settings. The control attenuates the midrange, rather than boosting bass and treble. In use, the listener first sets the "Loudness" ring—which surrounds the "Volume" knob—to its maximum (flat)

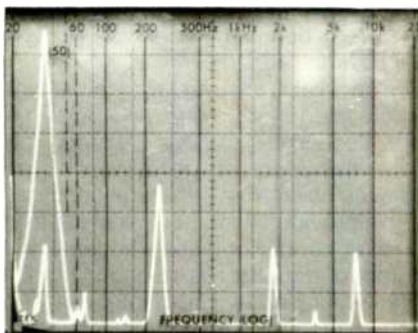

Fig. 4—
Crosstalk
and distortion
components
for a 5-kHz,
FM modulating
signal.

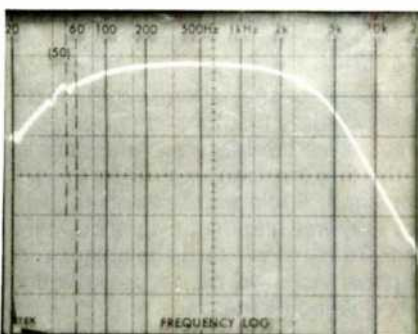

Fig. 5—
AM frequency
response.

The R-9 is, without a doubt, one of the most flexible, well-thought-out central audio components I have encountered.

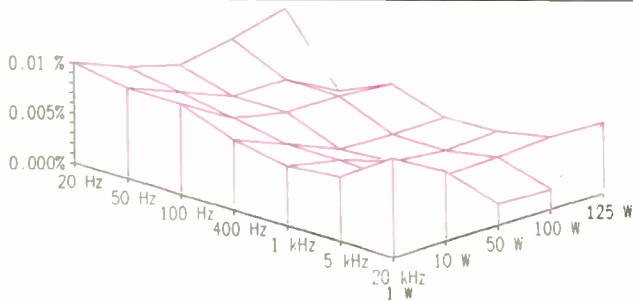

Fig. 6—Power output vs. frequency vs. THD. Perspective exaggerates the corner point representing 125 watts at 20 Hz, where distortion is only 0.009%. The R-9's distortion remains below its rated 0.015% until above 135 watts (see text).

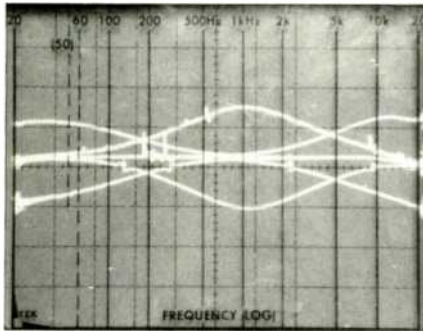

Fig. 7—Tone control range.

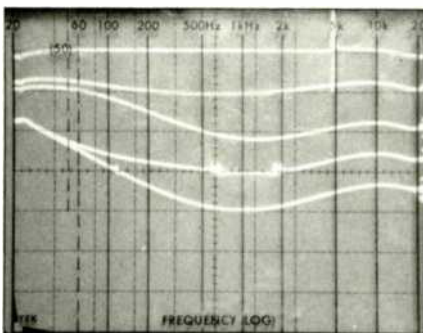

Fig. 8—Loudness contour curves for several settings of the continuously variable loudness control.

setting, adjusts the knob for realistic, live-performance listening levels, and then uses the ring to lower the sound to levels more comfortable for home listening. This calibrates the loudness compensation setting to match the sensitivity of your speakers and the acoustics of your room. At the ring's minimum position, mid-frequency levels are attenuated by around 40 dB regardless of the volume-control setting; this would be suitable for background listening.

Use and Listening Tests

I have already commented on the excellent performance of the R-9's FM tuner section. The choices of tuning and reception modes made by the tuner's microprocessor were almost always the same ones I would have made myself. The tuner section rarely switched into the "DX" mode in my listening location, so I benefited from the extremely low distortion and the excellent stereo separation afforded by the wide-band "Local" mode.

I used a variety of audio and video program sources with the R-9, and found that it served as an excellent multi-media control center. Even when playing CDs selected for their wide dynamic range, the R-9 never ran out of power when driving low-efficiency reference speakers. I did try using the "Auto Class A" mode at lower listening levels and, frankly, could detect no difference between sound quality in Class A and Class AB at those levels. I'd like to think that this speaks well for the low-distortion circuitry of Yamaha's Class-AB amplifier rather than implying a lack of critical perception on my part.

The stereo synthesizer circuit did wonders for some of my video home movies which have only monophonic soundtracks. This circuit, like many others of its type, utilizes a comb filter to convert a monaural signal into simulated stereo. Of course, if you listen carefully, you know that the results are not true stereo, but the spread of sound is pleasing and effective nevertheless.

The Dynamic Noise Canceller circuit is similar in principle to the DNR circuit widely used in car stereos, tape decks, and videodisc players. Essentially, DNC is a sliding low-pass filter which follows the upper-frequency limit of program content and removes noise above that frequency.

The three tone controls provided just about all of the tonal compensation I would ever need. For those who feel that a narrower band multi-control equalizer is needed, the R-9 even has an accessory output loop to which an equalizer or other signal-processing component can be connected. This effectively puts the additional accessory in series with the signals passing through the R-9; the accessory loop acts as a third tape monitor loop but is not switchable.

The Yamaha R-9 is, without a doubt, one of the most flexible and well-thought-out central audio components I have encountered. My only fear is that for some, perhaps, it may actually turn out to be too flexible. People assembling an audio system for the first time may not need all of its features. On the other hand, audio and video enthusiasts who like to plan ahead may well find that, even though they may not use all of the R-9's extensive facilities at first, more and more of the rear-panel jacks will be occupied as their involvement in audio and video increases.

Leonard Feldman

Not Evolutionary, Revolutionary.



Pioneer's Revolutionary CD/LaserVision Player

If there was ever a machine ahead of its time, it's Pioneer's new CLD-909. The most remarkable machine ever invented to play compact discs, music video discs and LaserVision discs.

Its engineering is incredibly sophisticated. Its superior benefits are really quite simple. As a video source, it produces a 60% sharper picture than any VHS machine in existence. As an audio source,

it's one of the best-sounding CD players you can buy. It's also fully programmable, so you can play any audio or video track in any order.

One viewing of Pioneer's CLD-909, and you'll not only be a believer, you'll soon be a possessor of the finest sight and sound machine modern man has ever witnessed. For more information, call 1-800-421-1404.

 **PIONEER**[®]

CATCH THE SPIRIT OF A TRUE PIONEER.

©1986 Pioneer Electronics (USA) Inc., Long Beach, CA



9

SME V TONEARM AND TALISMAN VIRTUOSO DTi CARTRIDGE

Manufacturer's Specifications Tonearm

Type: Tapered magnesium tube with fixed headshell and dynamic balance.

Pivot-to-Spindle Distance: 215.35 mm (8½ in.)

Offset Angle: 23°, 38°.

Overhang: 17.8 mm, adjustable ±9 mm by rack-and-pinion shift.

Tracking Error: 0.012°/mm max.; 0° at 66.04 mm and 120.9 mm from record center.

Vertical Tracking Force: 0 to 3 grams, adjustable by 0.1-gram calibrated knob.

Wiring: Headshell, silver litz, user-replaceable; internal, silver litz; external, monocrystal silver with standard five-pin plug.

Effective Mass: 10 to 11 grams, without cartridge.

Weight: 720 grams (1 lb., 9 oz.).

Price: \$1,750.

Cartridge

Type: High-output moving-coil.

Stylus: Miniature-shaft van den Hul Type I.

Cantilever: Titanium, diamond-coated.

Output: 1.8 mV into 47 kilohms for 5 cm/S at 1 kHz.

Internal Coil Resistance: 105 ohms.

Recommended Tracking Force: 2 grams.

Frequency Response: 10 Hz to 60 kHz.

Separation: 30 dB at 1 kHz.

Compliance: 15×10^{-6} cm/dyne.

Weight: 7.2 grams.

Price: \$1,200; replacement stylus, \$700.

Company Address: c/o Sumiko, P.O. Box 5046, Berkeley, Cal. 94705.

(Originally published June 1986)

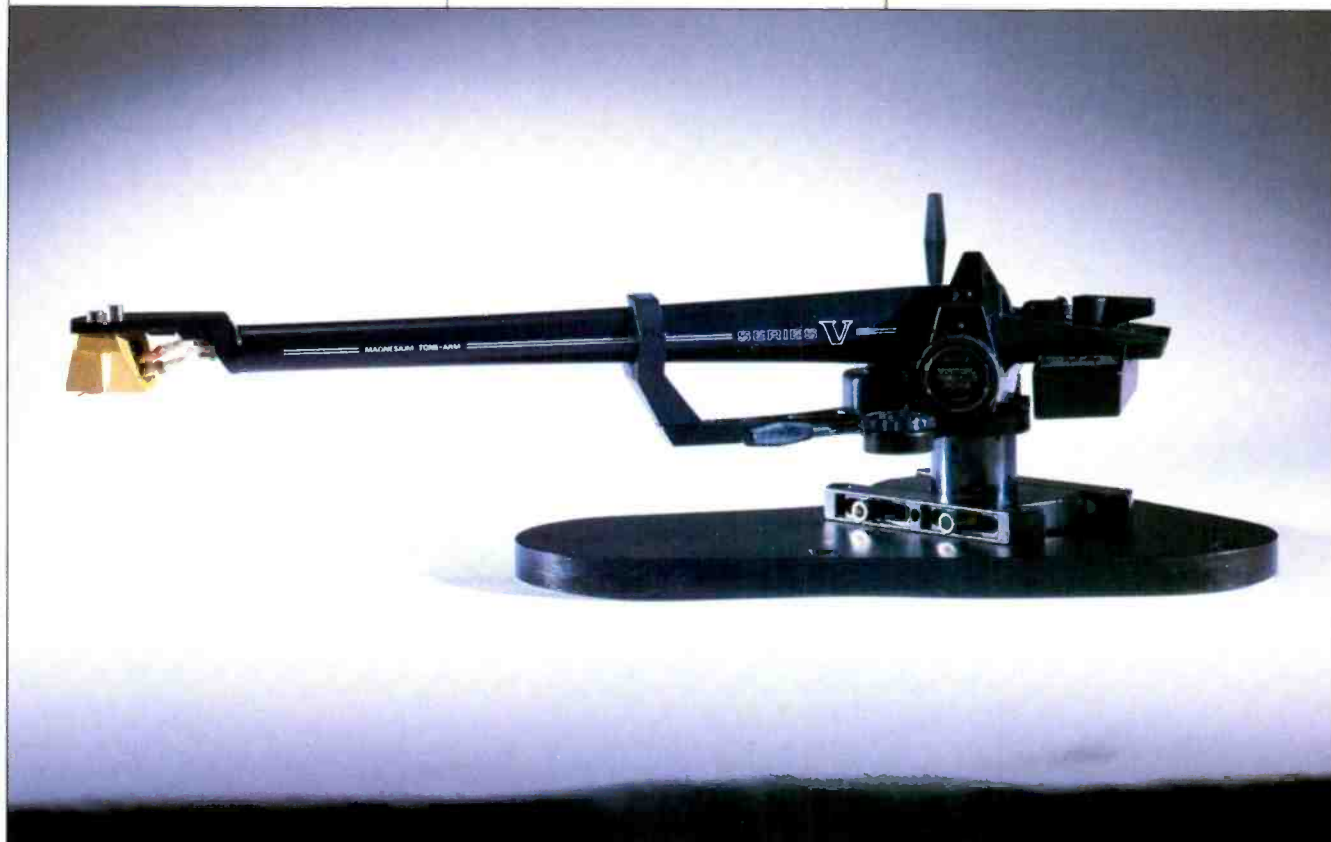

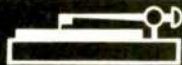

If you are at all interested in, or even curious about, the trend toward perfection of analog record playback equipment, you will be as interested in reading this report as I was in preparing it. I must admit that I consider the SME V tonearm to be a tour de force in design and manufacture. "Well!" you are saying. "Now I don't need to skip to the end of the report and see what Ed Long really thinks about the SME V tonearm." That's true enough, but if you care to know why the SME V works as well as it does and paradoxically why you initially might not like the sound which it helps to produce, read on. Besides, the Talisman Virtuoso cartridge is also a part of this report and is interesting enough on its own to be worth reading about.

It was May 1981 when I reported on the SME 3009 III tonearm in conjunction with the Shure V15 Type IV cartridge. A month later, in June 1981, I reported on the Shure MV30HE cartridge wand, which was designed specifically as a plug-in for the SME III. (The SME III was the model previous to the SME V tonearm; there was no SME IV.) If you are interested in comparing the versions III and V to see the change in direction of design exhibited by the SME V you might want to look at these 1981 reports. A partial comparison between the two is presented here as a "Measured Data" Table.

One thing that has always impressed me, over the years, is the very personal approach exhibited toward the public by SME, a small British company. I think it is due, to a great extent, to SME's Managing Director, Alastair Robertson-Aikman, who is a very personable fellow. He and Reg Eidy, SME's Chief Engineer, have been working on the SME V tonearm for the past five years. At this time SME is represented in the U.S. by Sumiko of Berkeley, Cal. The Technical Director of Sumiko, David Fletcher, also very personable though something of an iconoclast (Indeed!—Ed), seems to have had some input into the design considerations of the SME V. David was the designer of Sumiko's MDC-800 tonearm and is the person most responsible for the technical aspects of the Talisman moving-coil phono cartridges. Since the latest model of the Talisman line—the Virtuoso (or V, for short), seemed like an excellent match for the SME V tonearm, I used it for the technical and listening tests.

The Talisman V is a new moving-coil design and while it shares the Direct Field Focus configuration of the Models A, B and S, it is quite different from them in major respects. The Talisman S cartridge was reported on in the September 1983 issue of *Audio*, and you might want to refer to it to see the direction in which the Talisman line of cartridges is heading.

First Impressions

As can be seen from its photograph, the SME V tonearm is very impressive. It reminds me of one of the scale-model starships which have appeared in recent space-epic movies. The fact that the initials SME stand for Scale Model Engineering is purely coincidental. I'm sure. The construction and finish are of the highest quality and make it obvious that one should expect the highest level of performance. The fit of the bearings is excellent, and no play was evident when I tried my push-pull test by gripping the armtube in one hand and the arm pillar in the other. Tapping the arm-

tube produced a very dull sound, indicating that what resonances might be present were well damped and should not color the sound significantly. The SME V tonearm is a dynamic-balance design. This means that after a counterweight is adjusted to balance the tonearm for the cartridge being used, the vertical tracking force and sidethrust compensation force are set by coiled springs, rather than shifting weights, thus keeping the arm in balance even when it is not perfectly level. Two knobs with 0.1-gram calibrations set the tracking force and sidethrust compensation.

There is no finger lift on the headshell. The tonearm is raised or lowered by a viscous-damped mechanism mounted near the main pillar and operated by a control lever.

The Talisman cartridge has one very distinctive feature which I wish were available on all phono cartridges, threaded mounting holes in the cartridge body. That means no

MEASURED DATA

Parameter	Measurements/Comments	
	SME III	SME V
Year of Report	1981	1986
Shape of Armtube	S	Straight
Armtube Material	Titanium	Magnesium
Armtube Damping	Fibrous lining	Constrained-mode
Effective Mass	5.05 grams	10 to 11 grams
Pivot to Stylus	236 mm (9.3 in.)	233 mm (9.2 in.)
Pivot to Rear of Arm	64 mm (2.5 in.)	73 mm (2.9 in.)
Height Adjustment Range	22.2 mm (0.9 in.)	31.8 mm (1.3 in.)
Tracking-Force Adjustment	0 to 2.5 grams	0 to 3.0 grams
Tracking-Force Calibration	Within 0.05 gram	Within 0.15 gram
Cartridge Weight Range	0 to 12 grams	0 to 14 grams
Counterweights	Six	One
Counterweight Mounting	Locked to armtube	Plastic carrier
Sidethrust Correction	String and weight	Spring
Viscous Pivot Damping	Yes	Yes
Damped Arm-Lift Lever	Yes	Yes
Finger-Lift on Headshell	Yes	No
Headshell Offset	24.5°	23.5°
Arm Mounting Slot Required	Standard SME	Standard SME
Overhang Adjustment	Sliding base	Sliding base
Bearing Alignment	Excellent	Excellent
Bearing Friction	Less than 50 mg	Less than 40 mg
Vertical Bearing Type	Knife edge	Ball race
Horizontal Bearing Type	Ball race	Ball race
Lead Torque	Insignificant	Insignificant
External Lead Length	48 in. (1.2 m)	48 in. (1.2 m)
Arm-Lead Capacity	73 pF	85 pF
Arm-Lead Resistance	1.14 ohms	1.20 ohms
Structural Resonances	250 Hz	1.6 kHz
Price	\$294	\$1,750

Talisman Virtuoso DTI Cartridge

Coil Inductance: 350 μ H
 Coil Resistance: Left, 106 ohms; right, 103 ohms
 Output Voltage (47-Kilohm Load): Left, 0.38 mV/cm/S; right, 0.39 mV/cm/S.
 Cartridge Mass: 7.7 grams
 Microphony: Very low
 Hum Rejection: Excellent
 High-Frequency Resonance: 25 kHz
 Rise-Time: 13 μ S
 Low-Frequency Resonance: 7.5 Hz (in SME V tonearm)
 Low-Frequency Q: 2.5
 Recommended Load Resistance: Greater than 5 kilohms
 Recommended Load Capacitance: Less than 1,000 pF
 Recommended Tracking Force: 2.0 grams
 Polarity: Plus, for CD-4 standard

The SME V tonearm is very impressive. It reminds me of a scale-model starship from a recent space-epic movie.

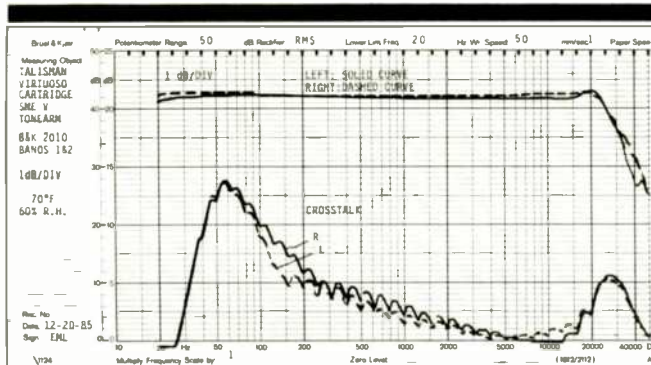

Fig. 1—Frequency response and interchannel crosstalk

of the SME arm and Talisman cartridge using B & K 2010 test record.

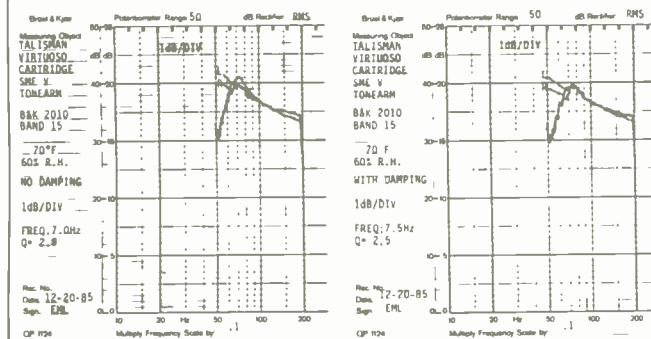

Fig. 2—Low-frequency arm/cartridge resonance is at 7.0 Hz and Q is 2.8 without damping (left);

resonance is at 7.5 Hz and Q is 2.5 with damping (right).

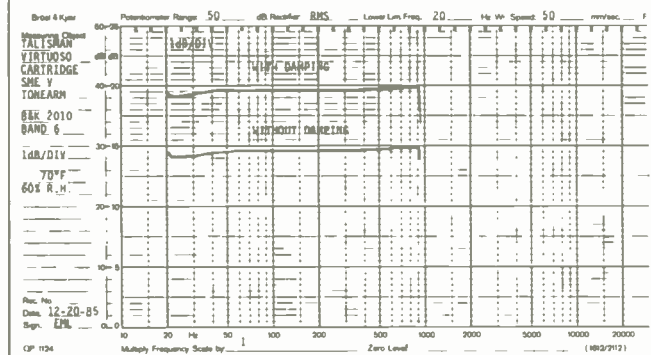

Fig. 3—Slow-sweep check (upper curve) and without resonances, with damping (lower curve).

separate nuts or washers must be held in place while the screws are lined up, started, and tightened, all while holding the cartridge in place. I would like to publicly thank St. Anthony for the many small hardware pieces which he has found for me, over the years, after they had seemingly fallen into some black hole during the intricate cartridge-mounting process.

Features

The armtube of the SME V tonearm is pressure die-cast of magnesium, which has a very good stiffness-to-weight ratio and good inherent damping. The hollow arm tube tapers in both thickness and cross-section along its length, and it extends from the headshell to the counterweight, passing through the pivot bearings without any joints or breaks. The internal damping of the armtube is accomplished by using a technique called constrained-mode damping (more on that later), which has proven very effective in reducing the type of mechanical-energy buildup most prevalent in thin-walled structures.

There are two holes with steel inserts in the headshell for mounting the phono cartridge. Since there are no slots in the headshell, the necessary stylus overhang must be adjusted by moving the whole tonearm in relationship to the turntable's center spindle. This stylus overhang is required for all pivoted tonearms to correct for tracking error across the record surface. The lack of slots does not allow the angle of the cartridge to be adjusted to correct for any misalignment of the stylus on the cantilever. With a "Line Contact" type of stylus, this can be a problem, because it means that the left and right groove walls will not be traced at precisely the same instant. This effect shows up in the phase-versus-frequency plot which I have been showing for a number of years. I am not certain how the interchannel time offset affects the total sound quality, but in the limited experimenting I have done, it seems to have an effect upon the precision of the sound image in the upper frequency range. In any case, the quest to eliminate any odd effects from the reproduced sound should make it a matter of some concern.

The counterweight system has a die-cast casing with weights inside. It is shaped so that it can be placed very close to the pivots, allowing the tonearm to maintain a very low effective mass. Cartridges weighing between 4 and 14 grams can be balanced by rotating a thumbwheel, which adjusts the position of the counterweight. After the cartridge is balanced, the counterweight can be locked in place by turning a lever. The tracking force can be set to as much as 3 grams by turning the calibrated knob.

The vertical tracking angle can be adjusted in one direction while playing a record, by turning the VTA screw, which raises the tonearm pivots. To lower the pivots, the main pillar must be pushed down again. Adjustment of the VTA is also helped by the two white lines which run the length of the armtube and by a special template. The 10-mm diameter horizontal and 17-mm diameter vertical bearings are captive in precision races, and located in the same plane as the record surface, to negate the effects of warp wow. The tonearm can be moved with respect to the center spindle by a rack-and-pinion system which uses a special horizontal

I wish all cartridges had the Talisman's threaded mounting holes, which eliminate the need for tiny nuts and washers.

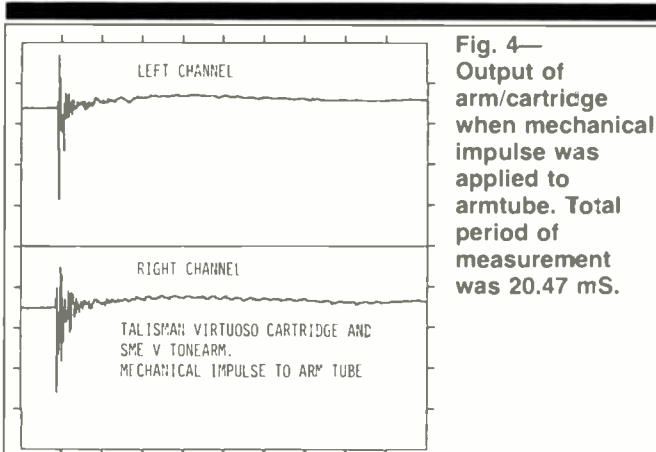

Fig. 4—Output of arm/cartridge when mechanical impulse was applied to armtube. Total period of measurement was 20.47 mS.

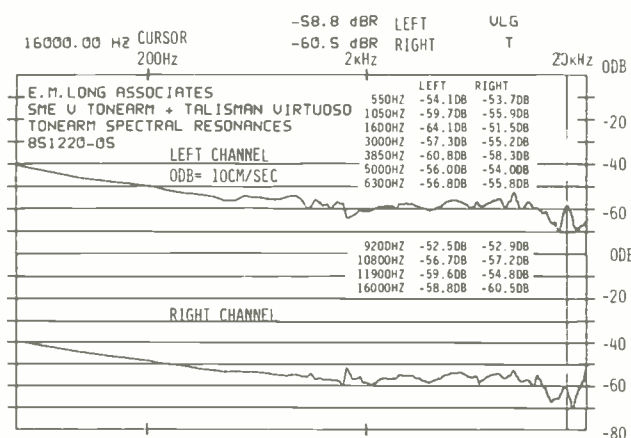

Fig. 5—Output (averaged) of arm/cartridge due to 16 mechanical impulses applied to armtube. This

is an excellent result, indicating good energy damping by the tonearm.



Fig. 6—Interchannel phase difference of arm/cartridge using pink noise from B & K 2011, band 7.

tracking angle key. The HTA key allows the tonearm to be adjusted so that the stylus will overhang the center spindle by the correct amount. SME has used this technique before but never with such an elaborate and precise mechanism.

The tonearm damping system, which consists of a trough of viscous fluid and a paddle, is also a refinement of the previous system used on the SME III tonearm. The amount of damping in the horizontal plane is increased or decreased by lowering or raising the paddle with an adjustment screw. The four color-coded cartridge attachment leads can be changed; the ones supplied were by van den Hul. The internal armtube wiring and the external phono cables are also specially made for SME by van den Hul. The bottom of the arm pillar is fitted with a viscous-damped, right-angle plug which can be rotated almost a full 360°. This allows the phono cables to exit the turntable base wherever it is most convenient and solves the problem of how to anchor them properly.

As a last note about this tonearm's features, I must compliment SME for the quality and comprehensiveness of the instruction manual. It is a gem.

The body of the Talisman V cartridge is machined from a solid piece of aluminum. As mentioned previously, the mounting holes are drilled and tapped right into the body. A high-coercivity neodymium-iron magnet is used in the Talisman's Direct Field Focus system to achieve a very high output voltage. In fact, the output of the Talisman V is about eight times that of the Talisman S, so it needs no step-up device. This means not only lower system cost but that the signal degradation inevitable with a step-up is eliminated. The Talisman V can be operated directly into a 47-kilohm, magnetic phono-cartridge input. In fact, any load impedance above 5 kilohms is acceptable, and input capacitance also has negligible effect. The cantilever of the Talisman Virtuoso which I tested is titanium, with a diamond overlay (as denoted by its DTi designation), which gives it added stiffness. (A Talisman Virtuoso B, with boron cantilever, is also available, for \$800.) The stylus is a van den Hul Type I design, precision-cut from a small cross-section diamond shaft. A damper having very low hysteresis is used in order to maintain good time and amplitude response for better spatial-information recovery.

Measurements and Listening Tests

Figure 1 shows the amplitude versus frequency response and also the crosstalk versus frequency for the SME/Talisman combination; the results are very good. The response at 20 kHz is particularly interesting since it verifies comments by some members of the listening panel that the sound was very open and clear in the upper range. The high-frequency resonance at 25 kHz, due to the interaction of the compliance of the record groove with the effective mass of the stylus tip, is verified by the rise in the crosstalk. The rise in the crosstalk at 60 Hz is an artifact of the B & K 2010 test record; the actual crosstalk for the SME/Talisman combination is much lower.

The low-frequency resonance, caused by the interaction of the tonearm's effective mass and the cartridge's compliance, is shown in Fig. 2, with and without the low-frequency damping system activated. The Q is very low for either

The panel had to learn to appreciate this pair's tightly controlled bass, which was lower but more realistic than with the reference system.

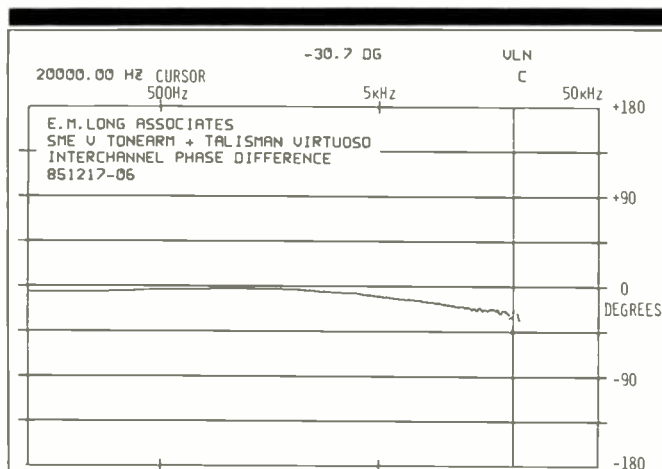
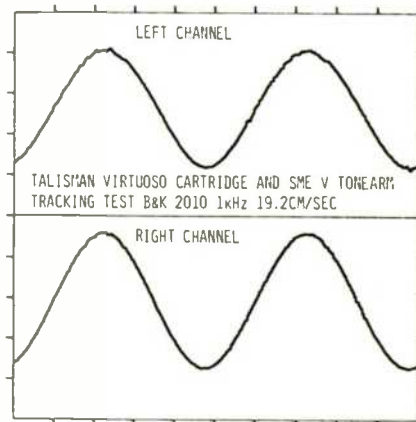

Fig. 7—Interchannel phase difference of arm/cartridge as a function of frequency (B & K 2011, band 7, pink

noise). Phase difference at 20 kHz (cursor position) is 30.7°, equivalent to only 4.3 μS of interchannel delay.

Fig. 8—Tracking of arm/cartridge with a 1-kHz test tone from the B & K 2010 at 19.2 cm/s.



bit. The reference system was preferred by some panel members when reproducing drums and double bass because, as they commented, "the bass sounds fuller." This is another paradox of the SME/Talisman performance, since careful listening to the sound of bass drum on orchestral recordings convinced me that it was more realistic.

The smooth curves of Fig. 3 indicate the control of mechanical resonances in the SME V tonearm. The viscous damping system does not have any visible effect upon the response, but there aren't any major uncontrolled vibrations which would show its effect anyway. This lack of substantial resonances, which might color the sound, can be verified easily by tapping the armtube with a pen or a small screwdriver. I am convinced that it was this very lack of coloration which caused some members of the listening panel to comment that the SME/Talisman combination was more reticent in its quality than the reference system. This is what I meant earlier, when I said that you might not like the sound which the SME V tonearm helps to produce. The lack of coloration in the SME can cause other tonearms to be preferred, at least in short-term listening. I have seen this before, especially in the case of a tonearm which caused a very euphonic coloration due to its very loose pivots!

The results of applying a series of mechanical impulses to the armtube are presented in Figs. 4 and 5, which show the amplitude versus time and the frequency spectrum of the energy of the SME V/Talisman Virtuoso combination. These results indicate the excellent damping of energy by the SME's tapered magnesium armtube and the internal damping system. As I mentioned before, the technique used is called constrained-mode damping. This method places the actual damping material in direct contact with the surface from which the energy is to be removed. The damping material is then covered with, and its movement constrained by, a thin layer of stiff material. The energy is dissipated in the form of heat as it tries to move between the surface to be damped and the constraining layer.

Figure 6 shows the interchannel phase difference, displayed on the screen of a Nicolet Explorer III digital storage oscilloscope. Figure 7 shows the phase versus frequency

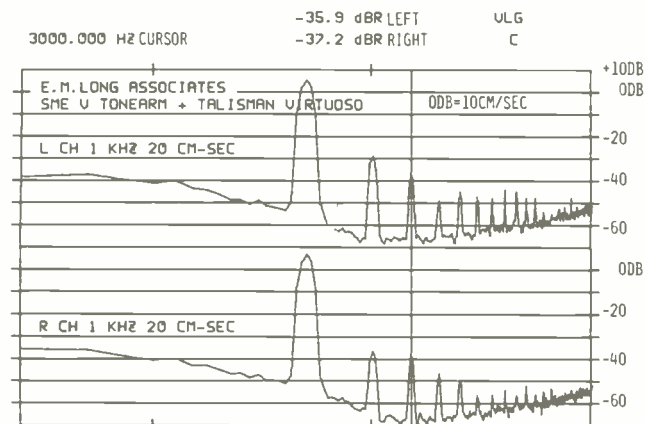

Fig. 9—Spectral analysis of the cartridge output when reproducing the test signal of Fig. 8. The third

harmonic (at the cursor position) is 1.6% in the left channel, 1.4% in the right.

condition, but it must be remembered that I have taken much care in centering the test record, which reduces the side-to-side swaying of the tonearm. The viscous damping system is most effective for this horizontal motion, so it would be even more useful under normal conditions, with the record less carefully centered, than would appear from Fig. 2. The panel's comments about the very tightly controlled character and extension of the bass register were a bit difficult to sort out. Due to better damping of its low-frequency resonance, the SME/Talisman combo had less bass output than the reference system's, though perhaps a bit more extended. This confused some panel members a

Even if you can't afford the SME and Talisman right now, you should audition them to hear how good records can sound.

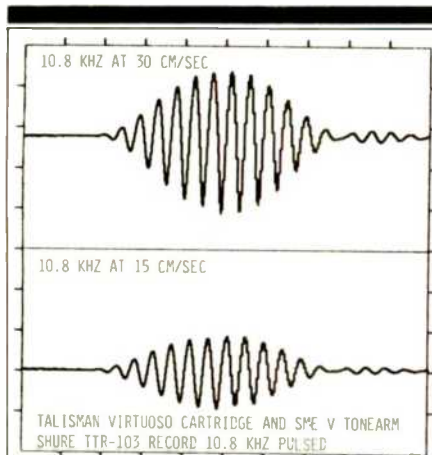

Fig. 10—Output with 30- and 15-cm/S, 10.8-kHz pulse test, Shure TTR-103 test record.

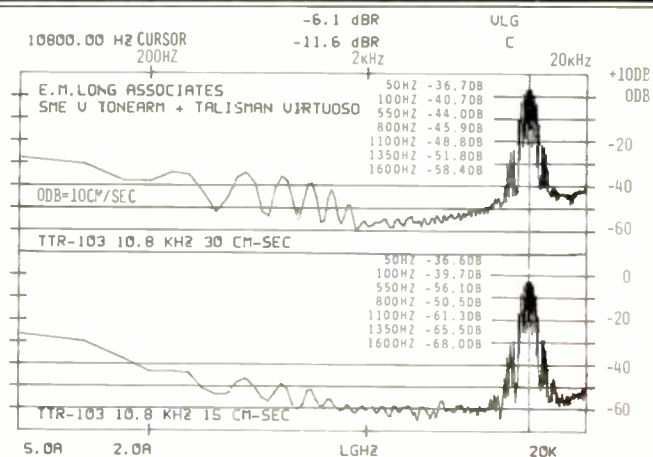

Fig. 11—Spectral analysis of distortion products from signals shown in

Fig. 10. Distortion at 50 Hz is 1.5% for 30-cm/S modulation.

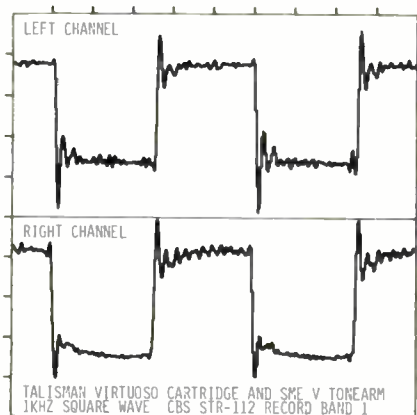

Fig. 12—Cartridge output from 1-kHz square wave, CBS STR-112 test record.

The ability of the SME/Talisman combination to reproduce high frequencies with a seeming effortlessness is verified by the information shown in Figs. 10 and 11. The output of the left channel, while reproducing a 10.8-kHz tone burst at 30 and 15 cm/S, is shown in Fig. 10; its symmetry and lack of compression, even at the higher level, is very good. The aspect of performance most often cited as an area of superiority over the reference system was the way that the SME/Talisman combination reproduced the midrange and high frequencies. The words "transparency" and "clarity" were often used by members of the listening panel to describe the sound.

The responses to 1-kHz square waves, Fig. 12, are excellent and indicate that, while time delay of the high frequencies with respect to low frequencies is present, it is very slight. The relationship of fundamentals and overtones will therefore be correct over a wide range of frequencies.

Conclusions

Both the SME V tonearm and the Talisman Virtuoso cartridge incorporate some very useful and innovative features. Most notable about the SME are its tapered, one-piece magnesium armtube and integral headshell; special van den Hul internal wiring, and the constrained-mode internal damping in the armtube. The Talisman's most remarkable features are, I feel, its solid aluminum body, with integral drilled and tapped mounting holes, and the diamond-coated titanium cantilever. Together, the SME V tonearm and the Talisman Virtuoso cartridge make an excellent combination; anyone who is looking for the finest reproduction of analog discs should try to audition it. Even if you can't afford to buy these components right now, you should listen to them to hear just how good records can sound. *Edward M. Long*

for 64 samples of the same pink noise signal used for Fig. 6. This is a phase transfer function, obtained using a Nicolet 660A-2D Fast Fourier Transform analyzer, and represents the difference in phase between the left and right channels. The very slight phase difference between the channels indicates that the ability to present a very stable stereo image is excellent. The comments of the listening panel confirmed this by indicating that both the SME/Talisman and the reference system presented superb stereo images.

The SME/Talisman combination has excellent tracking ability, as shown by Figs. 8 and 9. Figure 8 shows amplitude versus time of the left- and right-channel outputs while reproducing the second-highest-level 1-kHz band on the B & K 2010 test record. The waveform has only a tiny amount of jitter. The frequency spectrum of this waveform is shown in Fig. 9, and the distortion is very low for this high a level. The eighth and ninth harmonics show an increase; this may account for some of the brightness which was heard when reproducing a trumpet.



10

SOTA STAR SAPPHIRE TURNTABLE

Manufacturer's Specifications

Drive System: Belt.

Wow & Flutter: Less than 0.1%, DIN weighted.

Rumble: Unweighted, -60 dB; weighted, -75 dB.

Speed Stability: $\pm 0.1\%$.

Suspension Resonance: 2.5 Hz.

Dimensions: 20 $\frac{1}{4}$ in. W x 7 $\frac{1}{2}$ in. H x 16 $\frac{1}{2}$ in. D (51.4 cm x 19 cm x 41.9 cm).

Price: \$1,600 (oak finish), \$1,800 (black lacquer); Electronic Flywheel power-line conditioner, \$300.

Company Address: P.O. Box 7075, Berkeley, Cal. 94707.

(Originally published June 1986)



Photograph: Carl Zapp



SOTA, which stands for State Of The Art, is also the name of a small, dedicated company, located in Oakland, California, which manufactures a very high-quality turntable that they claim is "the turntable that Newton would have built." In addition, they make some interesting electronic and accessory products meant to increase the performance of record-playing equipment.

The Star Sapphire is the latest version of a basic turntable which SOTA began manufacturing a few years ago, all designed according to the theory that the supporting mass must exceed the moving platter mass. The major current improvement is the addition of a vacuum record-clamping system; it is also available as a retrofit for the original SOTA Sapphire for about \$600, plus dealer installation. (You might want to look up the report on the SOTA Sapphire turntable in the June 1983 issue of *Audio*, because the new Star Sapphire is very similar but has some important improvements.) The Star Sapphire that I tested was also isolated from the a.c. power line by a new unit which SOTA calls the Electronic Flywheel and describes as a power-line conditioner. This acts as a power reservoir which regulates the voltage and removes noise from the a.c. power line. The Electronic Flywheel is also available separately, for \$300, and may be used not only with the Sapphires, but also with some other d.c. servo turntables. The vacuum clamping system and the Electronic Flywheel are each capable of improving the performance of the turntable, and taken together, they represent a real advance.

This particular Star Sapphire was finished in satin black, even including the wood base. The hinged dust cover is vacuum molded from a soft smoked-brown acrylic plastic. I was able to set the hinges so that the lid would lock in place in a partly opened position. This is handy when the shelf above the turntable doesn't allow the lid to be opened fully.

One thing that you may find strange is that there are no markings on any of the controls! Of course, after you have figured out which knob does what, by reading the instructions, you really won't need the markings anymore. (Besides, think of the power you will have by being the only person who knows where the on/off switch is!) The cover of the control area is different than that of the original Sapphire turntable. It is made of wood, has bevelled edges and a

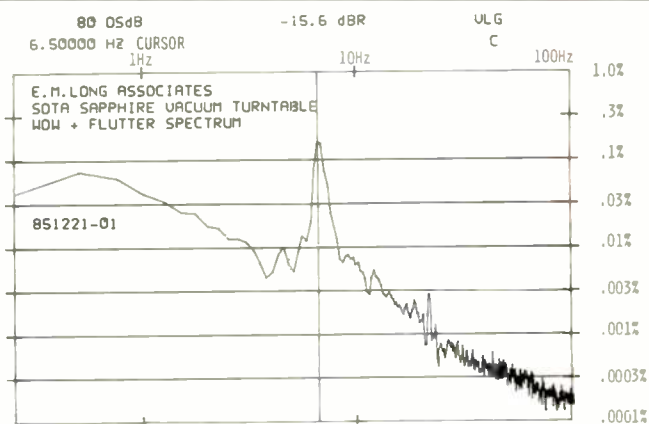

Fig. 1—Computer plot of wow and flutter spectrum, from 0 to 100 Hz. The peak at 6.5 Hz is due to the tonearm/cartridge resonance.

satin black finish, and is held in place by Velcro fasteners. (The original Sapphire has a metal control cover, which is held by screws.) The new cover can be popped on and off easily, although there is really no reason or need to do this; still, I like it and think that it is a clever touch.

I usually have no trouble locating a spot for any turntable I am testing, but this time I also had to find a spot for the vacuum system and the Electronic Flywheel chassis. I put these control units on a separate shelf for some of the tests and on the floor for some others. The noise level of the vacuum system is not very high, but in extremely quiet situations, it would be best to keep it away from your listening position. The vacuum hose is 9½ feet long, so there is some flexibility in where you can locate the vacuum control chassis.

High mass means high inertia and immunity from outside forces, and it is one of the main features of the SOTA turntable design. SOTA engineers believe that the best way to suspend a mass that is spread over a surface, is by not allowing any part of that surface to be outside the area bounded by the suspension. This means that no part of the surface can rotate around an axis formed by two adjacent supports. It follows, then, that the best way to suspend a rectangular surface is by placing four springs at the corners. (This is different from supporting a rigidly suspended mass, such as a turntable base with noncompliant feet, because a four-point rigid support system could allow the mass to rock around an axis formed by opposite corners.) Extra mass, of about 2½ pounds, is added at each of the suspension points. The resonance of the turntable suspension is controlled by using calibrated springs, and by adjusting the amount of this added mass. Since the linear on-axis motion of a coiled spring is accompanied by rotary motion, the Star Sapphire's springs are counterwound pairs

MEASURED DATA

Parameter	Claimed	Measured	Comment
Speed Stability	±0.1%	±0.20%	Very Good
Wow, Unwtd.		0.21%	Very Good
Wow, DIN Wtd.		0.18%	Excellent
Flutter, Unwtd.		0.11%	Excellent
Flutter, DIN Wtd.		0.07%	Excellent
W & F, Unwtd.		0.025%	Very Good
W & F, DIN Wtd.	0.1%	0.18%	Excellent
Long-Term Drift		0.10%	Excellent
Rumble, Unwtd.	-60 dB	-68.3 dB	Excellent
Rumble, Wtd.	-75 dB	-88.2 dB	Excellent
Suspension Resonance	2.5 Hz	3.7 Hz	Very Damped

High mass, for high inertia and immunity from outside forces, is a hallmark of SOTA turntable design.

positioned at opposite corners of the suspended mass. Each spring supports 8 pounds, so the total suspended weight is 32 pounds. A very important difference between the two SOTA Sapphire models and other turntables is that the mass is slung below the springs rather than being perched on top of them. The force of gravity thereby causes the springs to find a stable equilibrium. If the turntable is perched on top of springs, as is often the case with other designs, the force of gravity draws the suspended mass toward an unstable condition.

The mass of the tonearm must be accounted for in balancing the total suspended mass. Since tonearms of various mass must be accounted for, SOTA supplies lead shot in a plastic bag and a spirit level. With the tonearm mounted on the board, the turntable is balanced by pouring the lead

shot into a styrene cup, placed on the tonearm board, while watching the bubble in the spirit level. When the mounting board is level, it can be lifted up, and the lead shot poured into the well under the board. The original SOTA turntables had a hole and plug in the tonearm mounting board into which the lead shot was poured; this proved to be a disadvantage when the turntable had to be transported, because the lead shot could spill out.

The turntable platter is a low-pressure casting, tapered so most of its mass is at its periphery. It is lead lined for high mass and high internal damping, and machined on a CNC (computer numerical controlled) lathe to 0.0002-inch accuracy. Each turntable shaft is matched to a precision, sintered-bronze bearing sleeve and mounted in a surface support block. The shaft and bearing are mounted into a test fixture, and the perpendicularity is checked. If it is within the tolerance allowed, the sapphire thrust bearing is put into position and the combination is rechecked.

The SOTA Star Sapphire turntable has two speeds, 33.3 and 45 rpm, which are selected by a pushbutton. Separate knobs are used to control the exact pitch of each speed. There is no built-in speed indicator, so a strobe disc is supplied. It can be used with ordinary fluorescent lighting to set the exact speeds of 33.3 and 45 rpm by adjusting the appropriate pitch knob until the lines on the strobe disc appear stationary.

The vacuum record hold-down system is the Star Sapphire's single most important improvement over the previous Sapphire turntable. The vacuum pump and the associated control electronics and power supply are mounted in a chassis which is completely separate from the turntable. The vacuum, which is created between the underside of the record and the top of the turntable platter, causes the record to be pressed against the turntable platter surface by the force exerted by the surrounding air pressure. The record isn't actually pressed directly against the platter, because there is an interface, which consists of an acrylic plastic disc and a mat of highly damped rubber. The acrylic disc's internal characteristics are similar to those of a vinyl phonograph record. This allows most of the record's internal kinetic energy to be transferred from the vinyl record to the acrylic plastic disc with very little difficulty, because their impedances are similar. This energy is then dissipated in the highly damped rubber barrier, which is between the acrylic disc and the aluminum turntable platter. The rubber mat also damps out the energy caused by the natural resonance of the turntable platter. Two main attributes of the vacuum system enhance the Star Sapphire's performance: First, since the force pressing the record against the acrylic disc is applied in a very uniform and evenly distributed manner, the mechanical standing-wave energy inside the record can be dissipated in a similarly uniform manner. It also means that more internal energy, which would otherwise color the sound, can be removed from the record.

The other attribute is due directly to the flatness of the record, caused by the vacuum pulling the record flat against the surface of the acrylic disc; a flat record is not warped! (In a previous report, on the Nakamichi Dragon turntable, which had a record-centering system that prevented wow due to eccentricity, I commented that all we

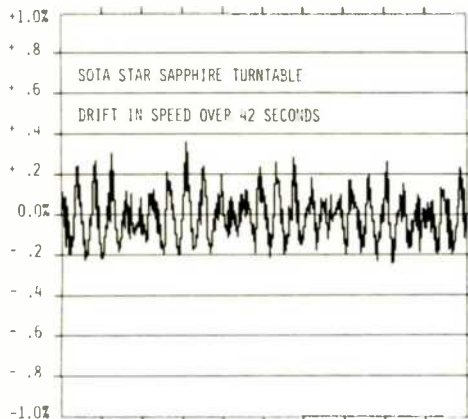

Fig. 2—Speed drift over a 42-S period. The variations are at 1.8 S per cycle (0.56 Hz), related to the 33.3-rpm speed.

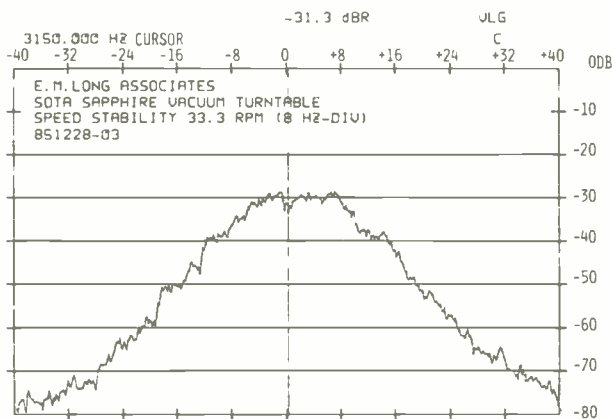

Fig. 3—Speed stability, referenced to 3,150-Hz tone on band 8 of B & K 2010 test record.

The Star Sapphire's vacuum record hold-down system is the single most important improvement over the previous Sapphire.

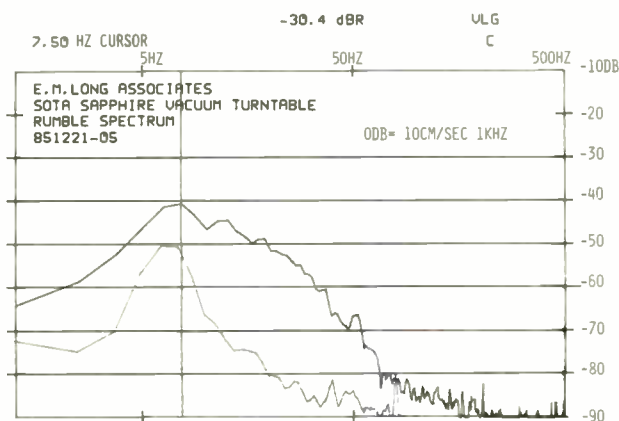

Fig. 4—Rumble spectrum, measured with B & K 2010 test record (upper curve) and with Thorens Rumpelmesskoppler (lower curve). The main factor in the rumble is the tonearm/cartridge resonance.

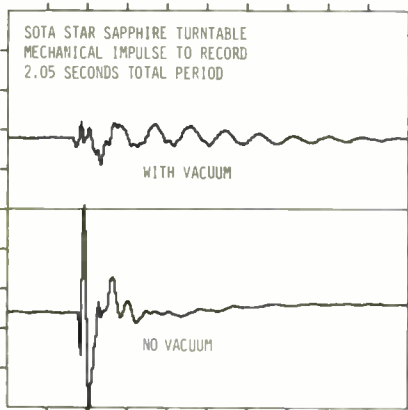

Fig. 5—Output vs. time for mechanical shock applied to edge of record, with stylus resting in groove. Results show effect of vacuum applied (upper trace) and not applied (lower trace). Measurement period is 2.05 S.

needed now was a turntable that would move up and down to remove the effects of warp! I was being facetious, of course, because the obvious solution is to make flat records [there I go again!] or to pull the records flat against the turntable platter by using a vacuum system.) The Star Sapphire's vacuum system reduces the effects of warp wow by removing the vertical component due to warped records. If you are willing to spend a little time centering a record on the Star Sapphire before you sit down to listen, you will be amazed at the difference in the clarity of the sound.

Measurements and Listening Tests

The SME V tonearm and the Talisman Virtuoso moving-coil cartridge were used for the technical measurements and listening tests.

The low-frequency spectrum of the wow and flutter present while reproducing the 3,150-Hz tone on the B & K 2010 test record is shown in Fig. 1. It represents 16 samples of the filtered output of a wow and flutter analyzer (which I also used for drift tests). The increased output at 6.5 Hz is due to the resonance caused by the interaction of the tonearm's effective mass and the compliance of the cartridge stylus suspension. The test record was not perfectly centered during this test because I wanted to show the large effect that the tonearm/cartridge resonance can have on the total energy output of the wow and flutter spectrum. If the wow and flutter were determined by merely observing the fluctuating pointer of a wow and flutter meter, the resulting figure would be higher for a poorly damped tonearm/cartridge combination reproducing a warped and off-center record than for a well-damped tonearm/cartridge combination reproducing a flat, well-centered record. In other words, a turntable could be blamed for having a much worse wow and flutter when it actually could be due, mainly, to the poorly damped low-frequency tonearm/cartridge resonance. The listening panel's comments on the reproduction of piano recordings by the Star Sapphire were very favorable with regard to the stability of sustained tones. I was able to hear an effect, however, while reproducing test tones, which I could associate with the data shown in Fig. 2. This is a cyclical variation which repeats every six rotations of the record. The zero line represents exactly 3,150 Hz, and the graduated lines, plus and minus, represent the percentage of speed increase or decrease from 3,150 Hz. However, like the members of the listening panel, I couldn't hear this effect when the Star Sapphire turntable was reproducing musical recordings. No listening-panel member made any comment which I could definitely correlate with this cyclical phenomenon.

Figure 3 is the spectrum of the frequency variation caused by the wow and flutter and indicates that the variation in speed varies in a rather uniform manner around the 3,150-Hz tone. The data represents the summation of 24 spectrum samples.

The rumble spectrum data which appears in Fig. 4 is a little different from what I've shown in past reports. Usually I have shown only the spectrum of the rumble caused by reproducing the B & K 2010 test record; this is represented here by the upper curve in Fig. 4. The lower curve was made using the Thorens Rumpelmesskoppler (German for

The uniform force of the vacuum flattens out warps and allows uniform dissipation of energy within the record.

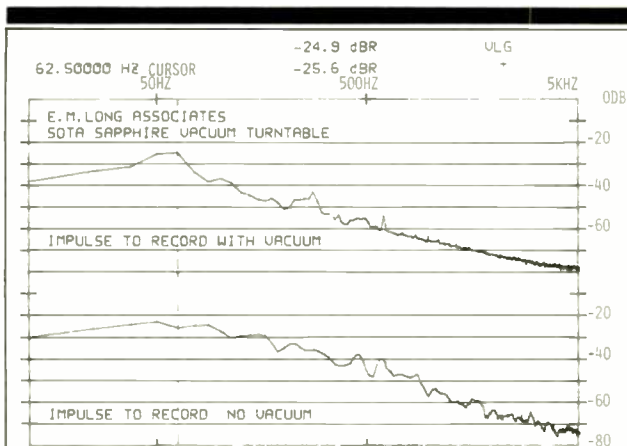

Fig. 6—Spectrum (to 5 kHz) of impulse shown in Fig. 5, with vacuum applied (upper curve) and without (lower curve). The tight contact between the record and the platter's interface disc when vacuum is applied reduces spurious energy. Except at the cursor position (62.5 Hz), energy is reduced by 10 dB or more, the best measured by the reviewer for any record-clamping system.

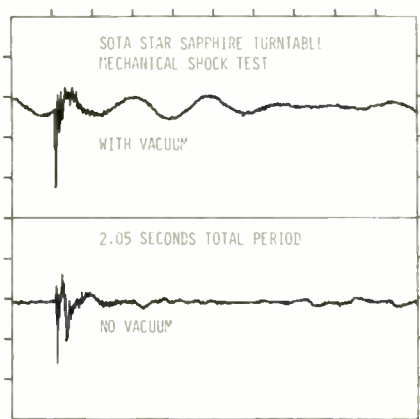

Fig. 7—Output vs. time for mechanical shock to platform upon which the turntable base rested, with vacuum applied (upper curve) and without vacuum (lower curve). Measurement period is 2.05 S.

rumble-measurement coupler), a special device which allows turntable rumble to be measured indirectly, thereby avoiding the artifacts inherent in the test record. Although I am not convinced that using this device is the best way to measure turntable rumble, I did so here because I wanted to show the effect of the tonearm/cartridge resonance on the rumble spectrum. As you can see, both the spectrum produced by the test record and the spectrum produced by the *Rumpelmesskoppler* show that tonearm/cartridge resonance is the major factor in the total rumble output. This is true of almost every modern, high-quality turntable and is certainly true of the turntables I have tested in the recent past. Once again, as in the case of wow and flutter, you can see the large effect that the tonearm/cartridge resonance has upon the measured performance. A poorly damped tonearm/cartridge resonance will cause a turntable to produce worse rumble figures than it justly deserves. In any case, the SOTA Star Sapphire turntable has extremely low rumble, and none of the members of the listening panel made any negative comments in this regard.

The ability of the vacuum record-clamping system to damp the energy in a phonograph record is shown in Figs. 5 and 6. For this test, a mechanical impulse is applied to the edge of a stationary phonograph record while the stylus of the phono cartridge is resting in a groove. The dramatic difference in the output versus time is shown in Fig. 5: The top curve indicates how the energy in the record, due to the first instance of the mechanical shock, is extremely well damped by the vacuum clamping. The lower curve shows the output versus time when the vacuum system is not activated: the initial energy impulse is many times greater than that shown for the vacuum system. Most of the comments of the listening panel about the difference in the quality of reproduction between the SOTA Star Sapphire and the reference system could be correlated to the vacuum system's effect upon the sound. In fact, during one comparison test, the vacuum between the Star Sapphire turntable platter and the phonograph record was released, allowing the tight coupling to be relaxed. This caused listening-panel members to become confused as to which turntable was "A" and which was "B" because these turntables seemed to have reversed their characteristics completely! The effect of the vacuum system on the quality of sound reproduction was clearly evident in comments made by the listening-panel members. Comments about violin and brass indicated that the reference system was "brighter," "sharper," "more forward." The vacuum clamping system made the sound quality of cymbals "duller"—an apparent paradox, which I will explain shortly.

The two spectra of Fig. 6 show how the vacuum clamping system is very effective in reducing the mid- and high-frequency energy from the record caused by a mechanical impulse to the record's edge. Except at low frequencies, such as 62.5 Hz where I set the cursor, the level is somewhere between 10 and 15 dB lower for the vacuum clamping system. When this much energy is removed from the record in the middle and upper frequencies, the quality of the sound is bound to be affected. Because the sound was different from what we were used to hearing, it seemed to be wrong at first. However, upon extended listening, it

The SOTA Star Sapphire's isolation from high-level sound is remarkable, proving its suspension is very effective.

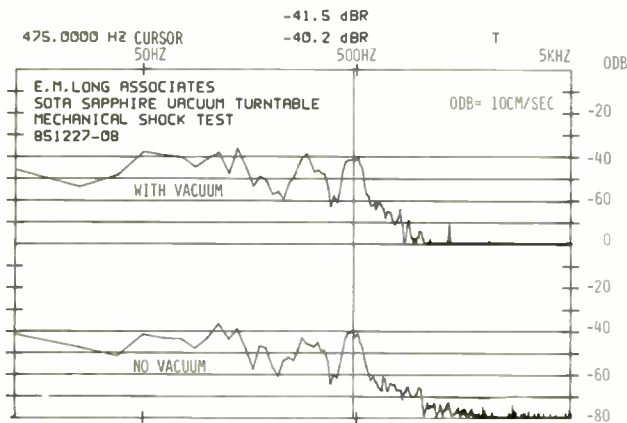

Fig. 8—Spectrum (to 5 kHz) of impulse shown in Fig. 7, with vacuum applied (upper curve) and without (lower curve). Isolation from external vibrations is excellent.

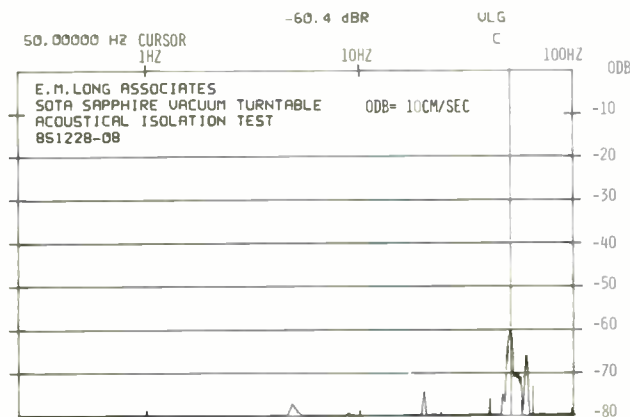

Fig. 9—Spectrum (to 100 Hz) of vibrations from a 100 dB SPL acoustic field at the surface of the record. Stylus was resting in a groove near the middle of the record. Isolation from the acoustic field is extraordinary.

became apparent that the sound from the SOTA with its vacuum was more real than that from the reference system, and in a very convincing way. The reference system has a good record-clamping system which gives good standing-wave energy removal, but it is no match for the SOTA Star Sapphire's vacuum clamping system.

Figure 7 shows output versus time for a mechanical shock applied to the platform upon which the turntable and base rested. The upper curve is with the vacuum system operating, and the bottom curve is with the vacuum turned off. The difference is due to the fact that when the vacuum is released, the record tends to be held away from the turntable platter by the rubber sealing ring which circles the edge of the acrylic damping disc. The spectrum data shown in Fig. 8 is for the same conditions as the time data in Fig. 7. Both with and without vacuum, the energy below 500 Hz is very low in level (shown in Fig. 8) and is quickly dissipated (Fig. 7). The interesting information brought out by these measurements is that the rubber sealing ring must be seated very carefully around the periphery of the record. This will prevent the ring from causing audibly bad effects in the reproduced sound.

Figure 9 is interesting because it shows almost nothing! It is the spectrum of the energy picked up by the stylus, resting in a stationary groove near the middle of a record, while a slow 20 to 100-Hz sweep from an oscillator produced an acoustic level of 100 dB SPL at the surface of the record. The data shown was measured with the turntable's lid open. I also ran the test with the lid closed, to check for any possible cavity resonance effects; the data was essentially identical to that shown. The isolation of the SOTA Star Sapphire from nearby high-level sound is remarkable and indicates that its suspension system and high mass are very effective.

Conclusions

I found that sorting through the listening panel's comments and checking the final scores that were given to the SOTA Star Sapphire and the reference turntables while they reproduced various types of program material were more interesting than usual. This seemed to be due mainly to the difference in sound quality produced by the vacuum clamping system. At first, there were contradictions in some of the comments and in the choice of which system was more satisfactory, but this changed as the tests progressed.

The Electronic Flywheel power-line conditioner was used with the SOTA Star Sapphire, but since the a.c. power line in my lab is generally very stable and free of radio frequency interference, I cannot find any specific correlation with its use. I have no doubt, however, that if you have problems with the purity of the a.c. line, the Electronic Flywheel would be a very good solution.

If you like a bright, forward quality to reproduced sound, you may not take to the SOTA Star Sapphire right away. I am convinced, however, that if you are seeking the most realistic reproduction of sound from analog records, you will like the extra clarity afforded by the vacuum clamping system. Also, the retrofitting of the new vacuum clamping system to already excellent, older SOTA Sapphire turntables is certainly very worth the cost.

Edward M. Long



11

TECHNICS EPC-305MCII CARTRIDGE AND SH-305MC TRANSFORMER

Manufacturer's Specifications Cartridge

Type: Moving-coil, with coreless twin-ring coil.

Cantilever: Tapered pure-boron pipe.

Damper: TTDD (Technics Temperature Defense Damper).

Frequency Response: 10 Hz to approximately 10 kHz, ± 0.5 dB (frequency range, 5 Hz to approximately 100 kHz).

Temperature Characteristics: 5° C to 35° C, ± 1 dB at 10 kHz; standard: 1 kHz.

Output Voltage: 0.18 mV at 1 kHz at 5 cm/S, zero to peak, lateral velocity; 0.5 mV at 1 kHz at 10 cm/S, zero to peak, 45° velocity, DIN 45-500.

Channel Separation: Greater than 25 dB at 1 kHz; greater than 20 dB at 10 kHz.

Channel Balance: Within 1 dB at 1 kHz.

D.c. Resistance: 25 ohms.

Impedance: 25 ohms at 1 kHz (pure resistance).

Compliance: 12×10^{-6} cm/dyne at 100 Hz.

Vertical Tracking Angle: 20°.

Recommended Stylus Pressure Range: 1.00 to 1.50 grams (10.0 to 15.0 mN).

Stylus Tip: 0.2 \times 0.7 mil, elliptical; block diamond.

Weight: 6 grams.

Effective Mass: 0.098 mg.

Mounting Dimensions: 0.5-in. spacing (cartridge already mounted in headshell).

Price: \$300.

Transformer

Type: Step-up, for MC cartridges; amorphous toroidal core.

Recommended Cartridge Impedance: Low, 3-ohm range for load impedances of 10 ohms or less; medium, 15-ohm range for load impedances between 10 and 20 ohms; high, 30-ohm range for load impedances of 20 ohms or more.

Frequency Response: 3 Hz to approximately 300 kHz; 15 Hz to approximately 100 kHz, ± 0.2 dB.

THD: No more than 0.001% at 1 kHz.

Channel Separation: Greater than 90 dB at 1 kHz.

Channel Balance: Within 0.2 dB at 1 kHz.

Shielding: Two layers of Permalloy, cast iron, and outer case.

Recommended Load Impedance: 47 kilohms.

Dimensions: 2 $\frac{3}{8}$ in. W \times 3 $\frac{3}{4}$ in. H \times 8 $\frac{1}{4}$ in. D (6 cm \times 9.6 cm \times 21 cm).

Weight: 9.9 lbs. (4.5 kg).

Price: \$350.

Company Address: One Panasonic Way, Secaucus, N.J. 07094.
(Originally published August 1986)

To overcome the problem of accurately mounting and properly aligning a phono cartridge in a headshell, Technics markets their top-of-the-line cartridges already mounted in one of their headshells, ready for use after vertical tracking force (VTF) and anti-skating force adjustments have been made.

Some of the outstanding features of the EPC-305MCII are the pure-boron tapered cantilever tube that is only a few thousandths of an inch in diameter, which accounts for the low effective mass (0.098 mg); the new damping material (TTDD), which is insensitive to temperature (thus making the cartridge very stable), and the use of a high-energy samarium cobalt magnet in the moving-coil cartridge's design.

Because of the very low output from the EPC-305MCII moving-coil cartridge, it was necessary to design a step-up transformer for it. This special spiral toroidal-core transformer uses amorphous (noncrystalline) magnetic alloy in laminations tens of microns thick. Because of its high saturation characteristics, the spiral toroidal core contributes to wide dynamic range and low distortion in the high range. To achieve a high S/N ratio and prevent hum, the transformer uses four layers of special shielding, which appears to be quite effective since I was unable to induce any hum components in the transformer.

Extreme care must be exercised when mounting the cartridge so as not to bring near it any ferromagnetic (iron,

steel, etc.) objects such as screwdrivers or tweezers. These items may unexpectedly be pulled towards the cartridge's powerful magnets and thereby damage the stylus-cantilever assembly.

Like all Technics phono cartridges, the EPC-305MCII comes mounted in a plastic box which also contains the usual assortment of mounting screws, stylus brush, screwdriver, and removable stylus guard. Also supplied is a printed frequency response curve which appears, at first glance, to be of a generalized nature, but it is actually a true response curve made by the particular cartridge at hand, according to Technics. The plastic box is packaged in a simple cardboard box. The SH-305MC transformer is packaged in a similar manner.

Measurements

The EPC-305MCII, which comes mounted in its own headshell, was inserted into a Technics EPA-A250 (S-shaped) interchangeable tonearm unit attached to a Technics EPA-B500 tonearm base and mounted on a Technics SP-10MKII turntable. The phono cartridge was oriented in the headshell and tonearm with a Dennesen Geometric Soundtracktor.

Where applicable, laboratory measurements of the EPC-305MCII were made using the Technics SH-305MC step-up transformer. The frequency response of the transformer was

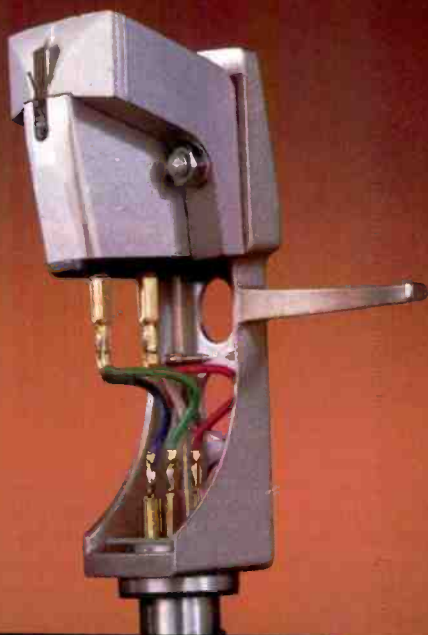

Technics

The 1-kHz square-wave response (Fig. 3) is one of the flattest I have ever seen. The ringing shown was on the test record and was undoubtedly generated by the cutter head when the master was cut. The arm/cartridge low-frequency lateral resonance was 7 kHz. Despite the unusually low lateral resonant frequency, I did not hear any mistracking or distortion at any time.

Using the Dynamic Sound Devices DMA-1 dynamic mass analyzer, I measured the arm/cartridge dynamic mass at 22.5 grams, and the dynamic compliance at 23×10^{-6} cm/dyne at the resonant frequency of 7 Hz. The vertical stylus angle measured 18° for each channel.

Other measured data are: Wt., 6 grams. D.c. resistance, 21.3 ohms. Opt. tracking force, 1.25 grams. Opt. anti-skating force, 1.5 grams. Output, 0.68 mV/cm/S. IM distortion (200/4000 Hz, 4-to-1): Lateral (+9 dB), 1.1%; vertical (+6 dB), 1.8%. Crosstalk (using Shure TTR-109): Left, -32 dB; right, -30 dB. Channel balance, <0.5 dB. Trackability: High-freq. (10.8 kHz, pulsed), 30 cm/S; mid-freq. (1000 and 1500 Hz, lateral cut), 31.5 cm/S; low-freq. (400 and 4000 Hz, lateral cut), 24 cm/S. Increasing the tracking force to 1.5 grams and anti-skating force to 1.7 grams, the low-frequency trackability (400 and 4000 Hz, lateral cut) was 30 cm/S. The Deutsches HiFi No. 2, 300-Hz test band was tracked cleanly to 86 microns (0.0086 cm) lateral at 16.20 cm/S at +9.66 dB and to 55.4 microns (0.00554 cm) vertical at 10.32 cm/S at +5.86 dB.

The Technics EPC-305MCII encountered no difficulty in tracking all the test bands on the Shure Era III and Era IV Obstacle Course musical test records as well as level 6 of the Shure Era V trackability disc. Rarely do commercial analog records have peak recorded velocities exceeding 15 cm/S. Therefore, this cartridge would be able to track any commercially available record, including the well-known audiophile recordings issued by Telarc, Sonic Arts, Sheffield, Reference Recordings, RCA Point 5, and Mobile Fidelity Sound Lab.

Use and Listening Tests

Listening tests are performed both before and after laboratory measurements. All reported listening tests of the Technics EPC-305MCII were made with the Technics SH-EPC-305MC step-up transformer. During the premeasurement listening evaluation, I was quite impressed with the EPC-305MCII's sonic clarity and transparency of sound, as well as the well-defined and tight bass.

The lack of mistracking and distortion at the resonant frequency of 7 Hz is truly remarkable. I attribute this to the superior design of the Technics EPA-A250 tonearm and, in particular, the super-efficient anti-resonance device that is an integral part of it.

When all the laboratory measurements were completed, it was time for the more serious, final musical evaluation of this moving-coil phono cartridge. As we all know, we listen not to laboratory measurements but to music, and that is the final arbiter in determining how faithfully a phono cartridge does its work. Equipment used in the listening evaluation included the aforementioned Technics tonearm and turntable, an Audio-Technica AT666EX vacuum disc stabilizer, an Amber Model FF 17 preamplifier, two VSP Labs Trans-MOS 150

measured in the range from 40 Hz to 50 kHz; it was found to be flat from 40 Hz to 40 kHz, and -0.5 dB at 50 kHz (Fig. 1).

All laboratory tests were conducted at an ambient temperature of 73° F (22.78° C) and a relative humidity of 65%, $\pm 3\%$. The tracking force for all reported tests was set at 1.25 grams, ± 0.25 gram, with an anti-skating force of 1.5 grams. The EPC-305MCII cartridge was used with the Technics SH-305MC step-up transformer set to an input impedance of 30 ohms. However, I am of the opinion that the best sound was heard when the transformer's input impedance was set at 15 ohms rather than the suggested 30 ohms. As is my practice, measurements were made on both channels, but only the left channel is reported (unless there is a significant difference between the two channels, in which case both are reported for a given measurement).

The following test records were used in making the reported measurements: CBS STR-100, STR-112, and STR-170; Shure TTR-103, TTR-109, TTR-110, TTR-115, and TTR-117; Deutsches HiFi No. 2; DIN 45-549; Nippon Columbia Audio Technical Record (PCM) XL-7004; B & K QR-2010; Ortofon 0002 and 0003, and JVC TRS-1005 and TRS-1007.

Frequency response, using the CBS STR-170 test record, is +1.25, -0.0 dB from 40 Hz to 20 kHz. Separation is 41 dB at 1 kHz, 30 dB at 10 kHz, and 26.5 dB at 20 kHz. The data indicates that the EPC-305MCII has excellent response and very good high-frequency separation (Fig. 2).

I was quite impressed by the sonic clarity and transparency of this cartridge as well as the tight bass it reproduced.

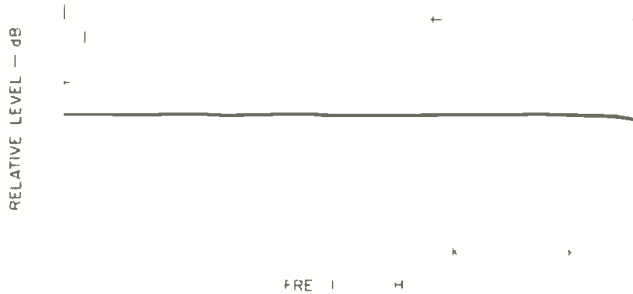

Fig. 1—Frequency response of the Technics SH-305MC step-up transformer.

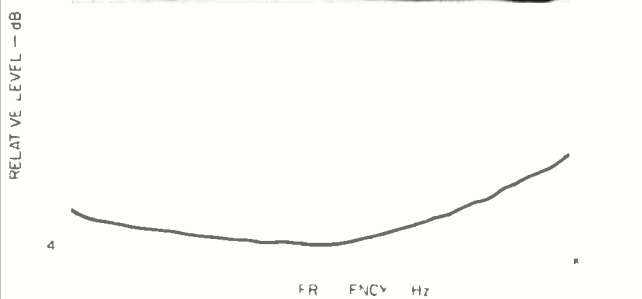

Fig. 2—Frequency response (top curve) and separation (bottom curve) of the EPC-305MCII phono cartridge with SH-305MC transformer.

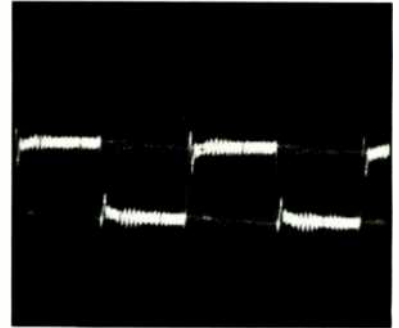

Fig. 3—Response to a 1-kHz square wave.

As in the past, I compared an analog record with its CD version, where both had been derived from the same digital master tape. In this case, it was Mussorgsky's "Pictures at an Exhibition" and "Night on Bald Mountain" (Cleveland Orchestra, Maazel, Telarc DG-10042 on vinyl and CD-80042 on CD). Although the EPC-305MCII reproduced the digital-to-analog vinyl recording very accurately, I feel that there is no contest between the two versions; the CD was superior in every way.

Some of the exceptionally superb recordings I used in auditioning the Technics EPC-305MCII were: *Magnum Opus, Volume 1* (Wilson Audio W-8111); F. I. Tuma's "Stabat Mater" and B. M. Černohorský's "Choral Works" (Prague Madrigal Singers, S. Jányš, Supraphon 1112 3356); Prokofiev's *Excerpts from the Ballet, Romeo and Juliet* (Los Angeles Philharmonic, Leinsdorf, Sheffield Labs 8); Beethoven's "Symphony No. 9" and "Fantasy for Piano, Chorus and Orchestra" (New York Philharmonic, Mehta, RCA Red Seal ARC2-4734, digital); David Foster's *The Best of Me* (Mobile Fidelity Sound Lab MFSL 1-123); *Wild Bill Davison and Eddie Miller Play Hoagy Carmichael* (RealTime Records RT-306, digital); Schubert's *Four Works for Violin and Piano* (Denon OX7141-ND); *Ein Straussfest* (Cincinnati Pops Orchestra, Kunzel, Telarc digital vinyl DG-10098 and Compact Disc CD-80098); and Stravinsky's "L'Histoire du Soldat" and Rimsky-Korsakov's "Capriccio Espagnol" (Chicago Pro Musica, Reference Recordings RR-17).

After evaluating the Technics EPC-305MCII moving-coil phono cartridge and its SH-305MC step-up transformer over a long period of time, I find that the combination compares very favorably to my moving-coil laboratory reference standard, the Ortofon MC 2000, used with the Electrocompaniet MC-2 pre-preamplifier. Accordingly, if you can't afford the rather expensive but superb Ortofon MC 2000, then I suggest that serious consideration be given to its near-equal, the Technics EPC-305MCII, a truly superior moving-coil phono cartridge.

B. V. Pisha

amplifiers (each used in the 300-watt mono mode), speaker and interconnecting cables from Discrete Technology, and a Technics SL-P10 CD player. The speakers, a pair of B & W 801Fs and a pair of Janis W1 subwoofers with their Interphase 1A units, are located in my specially designed, live-end/dead-end listening room.

During the long listening evaluation, I found no coloration present but I did find excellent transient response and tracking ability, and superb applause definition. Stereo imaging and depth were excellent. As was predicted, the EPC-305MCII reproduced the very high-velocity cannon shots on the Telarc "1812 Overture" (matrix II) record with no apparent difficulty. The human singing voice, the cello, and the Bösendorfer piano were reproduced realistically.



Audible Masterpiece

Presenting the multi-room remote controlled audio component system from Revox of Switzerland.

Designed to delight the discriminating eye. And engineered for the utmost in musical fidelity from digital and analog sources. Call or write today for your free color catalog.

Revox. Creating musical enjoyment beyond conventional limits.

STUDER REVOX

1425 Elm Hill Pike, Nashville, TN 37210 (615) 254-5651



12

TECHNICS SP-10MK3 TURNTABLE

Manufacturer's Specifications

Drive: Direct.

Motor: Quartz phase-locked control, ultra-low speed, brushless, d.c.

Platter: Copper alloy and aluminum, diecast, 12.6-in. (32-cm) diameter; weight, 22 lbs. (10 kg); moment of inertia, 1.1 ton-cm (1,100 kg-cm).

Speeds: 33.3, 45, and 78.26 rpm.

Pitch Control: Quartz-locked, $\pm 9.9\%$, in 0.1% steps, at all three speeds.

Starting Torque: 1.2 foot-pounds (16 kg-cm).

Startup Time: 0.25 S to 33 $\frac{1}{3}$ rpm.

Braking Time: 0.3 S from 33 $\frac{1}{3}$ rpm.

Speed Fluctuation Due to Load

Torque: 0% within 0.72 foot-pounds (10 kg-cm).

Speed Accuracy: $\pm 0.001\%$.

Wow & Flutter: 0.015% wtd. rms (per JIS C5521), $\pm 0.021\%$ wtd. peak (per DIN 45-507, IEC 98A weighted).

Rumble: -92 dB DIN B, -60 dB DIN A (both IEC 98A weighted).

Dimensions: Turntable, 14 $\frac{1}{2}$ in. (36.9 cm) W x 4-7/16 in. (11.3 cm) H x 14 $\frac{1}{2}$ in. (36.9 cm) D; power/control unit, 6 $\frac{1}{2}$ in. (16.6 cm) W x 3-

13/16 in. (9.6 cm) H x 16 $\frac{1}{4}$ in. (41 cm) D; optional SH-10B5 base, 22 in. (55.9 cm) W x 18 in. (45.7 cm) D x 6 $\frac{3}{4}$ in. (17.6 cm) H including dust cover.

Weight: Turntable, 40 lbs. (18 kg); power/control unit, 13.2 lbs. (6 kg); optional SH-10B5 base, 42 lbs. (19.1 kg).

Prices: Turntable and power/control unit, \$1,850; SH-10B5 base, \$900.

Company Address: One Panasonic Way, Secaucus, N.J. 07094.

(Originally published February 1985)





The SP-10MK3 is produced by Technics, a division of Matsushita Electric Industrial Co. Ltd., the Japanese company which also owns Panasonic and Quasar. Matsushita is a large, vertically integrated company, which means that it manufactures most of the parts used in the products it produces. Technics makes a full line, including receivers, amplifiers, loudspeakers and tape decks.

There has been a debate, over the years, as to the relative merits of direct-drive, belt-drive and quartz-controlled turntables. Technics makes all three types and therefore is in a unique position to make judgments about which is best. For the SP-10MK3, their top turntable, Technics has chosen to use quartz control and direct drive.

Direct drive allows very tight coupling between the motor and turntable platter, and therefore very precise control. To maintain precise motor speed, and thereby take advantage of such tight coupling, Technics uses quartz control. In this, a quartz crystal is used as a very stable control element in a high-frequency oscillator. The oscillator is then used as a reference to control the drive motor's very low rotational speed. (The exact control method can vary from one design to another.) The advantage of such an approach is in the ability to control the speed and to allow it to be changed in a very precise manner.

One very impressive thing about the SP-10MK3 is its weight. It is by far the heaviest turntable that I have ever tested, and I have had to lift some big ones! The immediate problem was to find a wide and stable platform upon which to place the SP-10MK3. Many of the turntables I have seen lately are so large and heavy as to cause the same problems as those "bookshelf" speakers not designed to fit on normal bookshelves. The Technics SP-10MK3 is much too heavy for any bookshelf I have ever seen. The weight of the SP-10MK3 turntable is 40 pounds, the control unit is 13 pounds and the mounting base is 42 pounds, for a total weight of 95 pounds! Technics obviously feels that the way

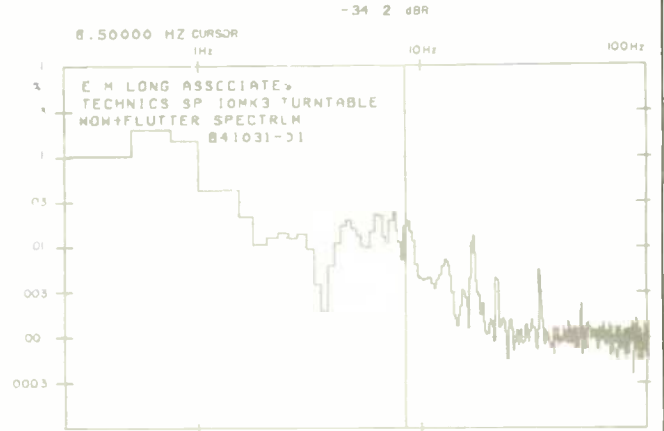

Fig. 1—Wow and flutter spectrum. Note that the vertical percentage scale has been shifted from previous Long turntable reports so that 1% is the maximum level on this scale.

to make a turntable immune to external vibrations is to make it massive. For past reports, I have placed the turntable under test on a special massive platform when I was measuring acoustical and mechanical isolation. With the SP-10MK3, I even made the listening tests with the turntable on this platform.

The electronic speed-control unit is also most interesting. There are eight control buttons plus the a.c. power switch and a large display window. Three of the buttons are for selecting the exact speeds; one is the speed lock, three more are for the plus and minus increments and a "clear" switch. The last control button is "Stop-Start." There is a rather large window on the left side of the control unit through which you can see the speed you have selected, and, if you decide to set the speed fast or slow to change pitch, you can see the percentage change in 0.1% increments as you increase or decrease the speed. If you have an interest in 78-rpm records, which I do, you will like the fact that the SP-10MK3 not only has the usual 33.3 and 45 but 78 rpm as well. The electronic speed adjustment will thus allow you to adjust the pitch of the sound to compensate for the old 78-rpm cutting lathes and tape recorders that did not always run at the correct speed.

The optional SH-10B5 turntable base includes a hinged dust cover of smoked gray plastic. The hinges can be adjusted so that the cover can be held open without raising it to its full height. Four feet are mounted on the bottom of the base, and these can be adjusted to level the turntable. The feet include heavy-duty springs which provide some isolation from external shocks. The black and silver styling of the SP-10MK3 is very clean and functional and gives the immediate impression that it is a very solid, professional turntable.

MEASURED DATA

Parameter	Claimed	Measured	Comment
Speeds	33.3 and 45 rpm	+0.19%	Excellent
Speed Stability	±0.001%	±0.17%	Very Good
Wow, DIN Unwtd.		0.21%	Very Good
Wow, DIN Wtd.		0.08%	Excellent
Flutter, DIN Unwtd.		0.12%	Very Good
Flutter, DIN Wtd.		0.02%	Excellent
W & F, DIN Unwtd.		0.28%	Very Good
W & F, DIN Wtd.	0.021%	0.08%	Excellent
Long-Term Drift		0.40%	Good
Rumble, Unwtd.	-60 dB	-68 dB	Excellent
Rumble, Wtd.	-92 dB	-90 dB	Excellent
Suspension Resonance		5.3 Hz	Well Damped

The Technics SP-10MK3 uses quartz control and direct drive to achieve very tight coupling between the motor and platter.

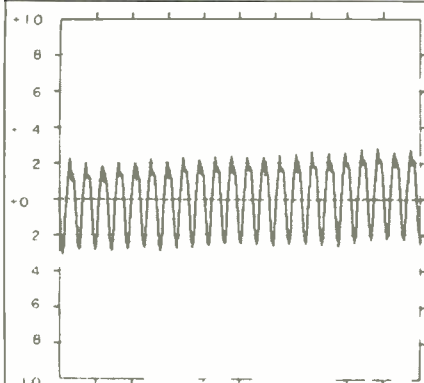

Fig. 2—Speed drift over a 41-S period. The 1.8-S cycle is 5.6 Hz and related to a single revolution at 33.3 rpm. Drift varies between +0.24% and -0.25%.

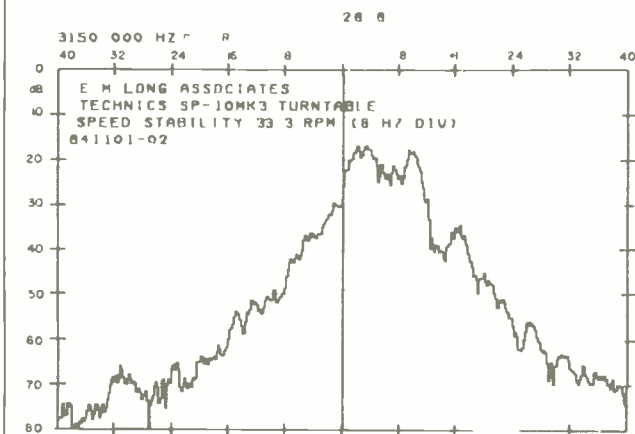

Fig. 3—Speed stability. The 0-Hz reference is to the 3,150-Hz tone on the

B & K 2010 test record. Note that speed tends to be fast.

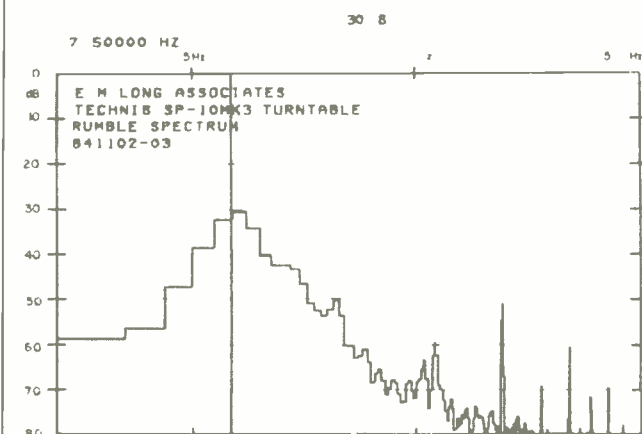

Fig. 4—Rumble spectrum, with main output at the 7.5-Hz tonearm/cartridge resonance.

Features

As mentioned before, the SP-10MK3 uses a direct-drive motor, which means that the motor drives the platter without going through any belts or gears. In the case of the SP-10MK3, the motor is part of the platter. The magnetic rotor is mounted on the underside of the platter and is driven by the electric current in the stator coils mounted on the base plate. The platter is made of copper alloy and weighs 22 pounds. Even though it must drive such a heavy turntable, the motor is capable of a starting torque of 16 kg per cm and a moment of inertia of 1.1 ton/sq. cm—quite remarkable. With such torque available, it is no surprise that Technics claims that the platter can reach stable speed within one quarter of a second. By looking at the strobe, I could see that the turntable locked in at 33.3 rpm within one-half turn of the platter. Since the platter makes one complete revolution in 0.56 S at this speed, it appears that the SP-10MK3 meets the specification.

A technique called slip cueing is often used in radio stations to start records exactly. To do this, the record is held stationary while the turntable is rotated. At the desired moment, the record is released, and, since the turntable was already running, the start of the sound can be determined very accurately. The SP-10MK3 can do the same thing *from a standing start*. The stopping time of the turntable is also amazing, considering the mass of the platter, since it comes to a complete halt within 0.3 S after running at 33.3 rpm. The braking is both electrical and mechanical.

The speed can be locked to the standard speeds of 33.3, 45, and 78.26 rpm or it can be adjusted to $\pm 9.9\%$ of each of these speeds in 0.1% increments. The increment is chosen by holding down either the "+" or "-" button on the control unit. Technics includes a chart which will allow you to determine the percentage of change in frequency or the change of pitch in percentage points. As an example, a change of speed from 33.3 rpm by +5.9% will cause a pitch change of a half-tone sharp, and a change of -5.6% will cause a pitch change of a half-tone flat. Adjusting the speed this way allows a recording to be set to the exact pitch originally intended and also allows one to play along in tune with the recording. A "clear" key allows the speed to be reset immediately to the exact rated speed. If you place the control unit next to the turntable, you will need a surface about 29 inches wide and 21 inches deep, and there should be a clearance of about 17 inches above the turntable to allow the cover to be opened.

Mounting a tonearm to the SP-10MK3 is facilitated by the fact that separate mounting platforms are provided with the SH-10B5 mounting base. One of the two that I received had a hole for mounting the Technics EPA-100MK2 tonearm; the other was blank. After the tonearm was fastened to the mounting platform, it was secured to the turntable base by four hex-head bolts. This allows different tonearms to be preset and then changed easily.

Measurements and Listening Tests

As I mentioned earlier, all the measurements and listening tests were conducted with the Technics SP-10MK3 turntable mounted to the SH-10B5 base and with the combination placed on a very heavy and stable platform.

The total weight here is 95 pounds! Technics feels this is the best way to make the table immune to external vibrations.

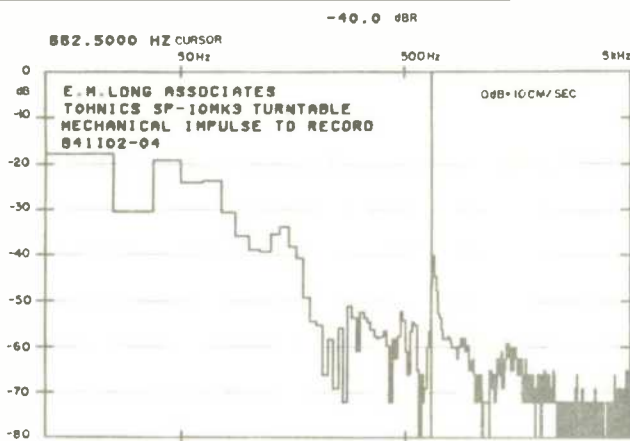

Fig. 5—Spectrum to 5 kHz due to a mechanical impulse applied to the edge of a stationary record with the stylus in a quiet groove. The cursor is at 662.5 Hz, which is the main ringing frequency of the platter and where the output is -40.0 dB below 10 cm/sec.

Fig. 6—Output vs. time of the impulse used to obtain the spectrum in Fig. 5. Total period is 0.205 S.

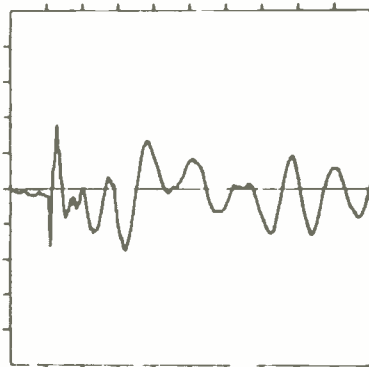

Fig. 7—Spectrum to 5 kHz due to mechanical shock applied to the massive platform upon which the turntable and base rested during tests. Resistance to such shock was very good.

The wow and flutter was measured with a W&F meter and also by recording the component spectrum using the Nicolet 660-2D Fast Fourier Transform (FFT) Analyzer. Figure 1 shows the spectrum of the wow and flutter from the FFT. Most of the components are below 0.03%, and the cursor indicates -34.2 dB, which is 0.02%, at 8.5 Hz. The main component of the wow and flutter spectrum is at about 0.5 Hz. When the record groove is not perfectly centered, the stylus will read the signal at 0.56 Hz, which is the frequency of rotation at 33.3 rpm. This causes the wow modulation seen in Fig. 1, and the accuracy of centering the record has a definite effect upon the amount of wow. The "Measured Data" table shows that the unweighted wow and flutter is 0.28%, while the weighted wow and flutter is only 0.08%. Since the weighting has the effect of reducing the effect of wow and flutter below 20 Hz, this corroborates the data presented in Fig. 1.

The drift in speed over a 40-S period is shown in Fig. 2, a digital storage oscilloscope plot. There is an indication of a little "hunting" by the servo when the speed increases above +0.2%. This might be the reason for the components which appear at frequencies above 10 Hz in Fig. 1. Drift, displayed in Fig. 2, is minor and indicates that overall rotational speed is slightly fast. During the listening sessions, there were no comments regarding the sound that could be directly linked to lack of stability in tone when compared to the reference system. It is rather difficult, however, to be absolutely certain that a record is perfectly centered during listening tests, at least to the degree possible during the technical measurements. I did try a separate experiment to check this. I offset the record slightly on one turntable while I carefully centered a duplicate on the other. When I did this, there was one comment from a panel member about a difference in clarity. I heard a difference also, but I discount my own conclusions to a great extent because I was aware of the test conditions. This might be a clue to explain a phenomenon reported by reputable persons that they have heard an effect upon clarity when the record is rotated to a different position relative to the platter.

Figure 3 shows the spectrum due to playing a recorded 3,150-Hz tone and indicates that the SP-10MK3 is running slightly fast in the 33.3 rpm quartz-locked mode. This is shown as +0.19% in "Measured Data." What this means is that a record which should be exactly 60 minutes when played at 33.3 rpm, will take 59 minutes and 53.2 seconds. This is excellent long-term stability and could be made almost perfect by setting the speed back two clicks to -0.2%. Precise control of speed is very important for timing broadcasts, but it is also handy when copying a record to tape because it can be used to avoid running out of tape at the end of a piece of music. The cyclical variation in speed, shown in Fig. 3, is not the best I have measured, but it is more a function of record eccentricity than of actual speed variations in the turntable itself. Still, the performance here is very good and translates to the $\pm 0.17\%$ shown for speed stability in "Measured Data." The claimed spec of $\pm 0.001\%$ may be a typographical error since it is easy to mix decimal points and percentages. I know, because I tend to fall into this trap myself!

The rumble spectrum is shown in Fig. 4. Most of the

The Technics SP-10MK3 is certainly among the best turntables presently offered by anyone. It's a rugged, heavy-duty unit for daily use.

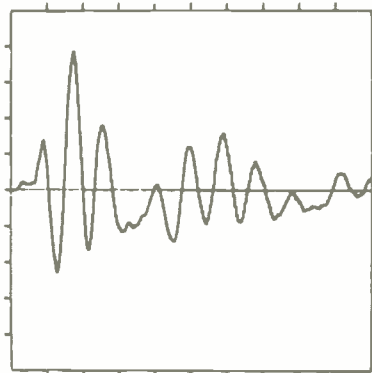

Fig. 8— Output vs. time of the impulse used to obtain the spectrum of Fig. 7. Total period is 0.205 S.

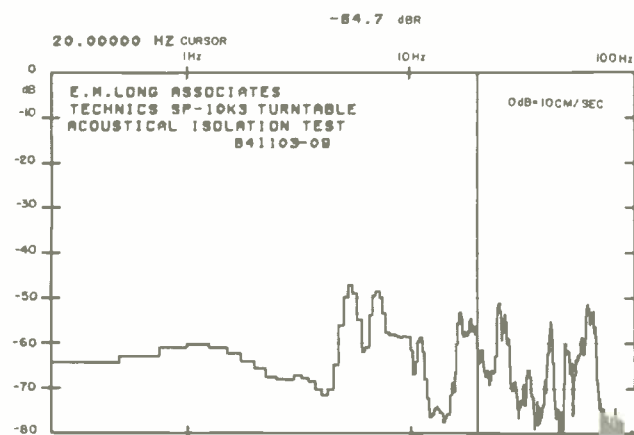

Fig. 9— Spectrum to 100 Hz due to a 100 dB SPL acoustic field at the record surface with the stylus in a quiet groove

near the middle of a stationary record. The acoustic isolation is excellent.

rumble is at the 7.5-Hz tonearm/cartridge resonance frequency. The unweighted and weighted rumble specs are shown in "Measured Data" as being -68 and -90 dB, respectively; Technics claims values of -60 and -92 dB. The rumble is so low that only the most sophisticated equipment and techniques will allow it to be measured with any accuracy, and it has to be rated excellent.

Figure 5 shows the averaged spectrum produced by a series of mechanical impulses. These impulses were applied to the edge of a stationary record while the stylus was resting in a quiet groove near the middle of the record. Figure 6 shows the output versus time caused by one of the mechanical impulses picked up by the stylus. Technics doesn't supply any type of record clamping device, so I didn't use one on the SP-10MK3 for these measurements. During the listening tests, no clamping device was used on either the SP-10MK3 or the reference turntable. The stock platter mat doesn't appear to be anything special, but it is effective in suppressing the ringing of the metal platter at 662.5 Hz. During the listening tests, comments were made about differences in tonal balance between the SP-10MK3 and the reference turntable. It was felt that these differences might be related to differences in the spectrum of the energy in the record. For example, the sound of acoustical guitar seemed a bit fuller from the SP-10MK3, which shows more energy in the range below 200 Hz than the reference turntable.

The isolation of the SP-10MK3 from external shock is indicated by the spectrum shown in Fig. 7. The cursor is at 450 Hz, and the energy rise at this frequency is down -47.2 dB. The greatest amount of energy is concentrated below 100 Hz. The suspension resonance of the SH-10B5 is at 5.3 Hz and very damped, but the great mass of the system can be energized by external shock. Therefore, care was taken during the listening sessions to avoid any mechanical coupling between the loudspeakers and the turntables. Figure 8 shows the output versus time for the mechanical shock which produced the spectrum shown in Fig. 7.

Figure 9 shows the spectrum of the electrical output of the cartridge with the stylus resting in a quiet groove while an acoustical signal produces a level of 100 dB at the surface of the record. This signal is a very slow sweep from 20 to 100 Hz. The system's degree of isolation from this acoustical signal is excellent.

Conclusions

The SP-10MK3 is offered by Technics as being the best turntable that they make; it is certainly among the best turntables presently offered by anyone. If you are in the market for a rugged, heavy-duty turntable which will hold up well in day-after-day use and has broadcast-type professional features, you should check it out. The overall sound quality is only slightly below that of a few top audiophile turntables, and the SP-10MK3 is as good as the best of them with regard to acoustical isolation. In order to achieve this performance, you will have to place the turntable and its base on a very solid platform. The precise control of speed and the ability to change tonearms easily are great features which should interest both musicians and audiophiles.

Edward M. Long

The separate control unit is used to select speeds and vary the pitch, with speed change shown in 0.1% increments.



Sansui's AU-G77XII amplifier is rated superior for CD reproduction.

Sansui X-cels in digital performance. Our new AU-G77XII amplifier reproduces digital signals more accurately because our X-balanced circuitry delivers more headroom—without clipping. With ordinary amplifiers you need massive amounts of power to react to the pulse-like transients produced by digital discs. But with Sansui's X-balanced circuitry, our AU-G77XII handles digital peaks and low impedance loads with no problem.

It features virtually distortion-free power* (0.008 THD) and dynamic power is 160 watts-per-channel into 8 ohms; 220 watts-per-channel into 4 ohms; and 260 watts-per-channel into 2 ohms.

The AU-G77XII also features input for phono MM/MC (selectable), CD, tuner, tape 1 and tape 2, line 1 and line 2. Plus a special adapter input/output loop for EQ or processor for added dubbing capabilities. When it comes to optimum performance with digital music sources, Sansui's AU-G77XII is an amplifier that's past digital ready. Hear it today and you'll know we're not distorting the truth.

*110 watts-per-channel minimum RMS, both channels driven into 8 ohms from 20–20,000 Hz.

*We've X'd out distortion
in digital reproduction.*

Sansui Electronics Corp., Lyndhurst, NJ 07071, Carson, CA 90746



Sansui

Putting More Pleasure in Sound.



13

NAKAMICHI CR-7A CASSETTE DECK

Manufacturer's Specifications

Frequency Response: 18 Hz to 21 kHz, ± 3 dB.

Harmonic Distortion: 0.8%.

Signal/Noise Ratio: 66 dBA with Dolby B NR, 72 dBA with Dolby C NR.

Separation: 37 dB.

Crosstalk: -60 dB.

Erase: 60 dB at 100 Hz.

Input Sensitivity: 50 mV.

Output Level: Line, 1.0 V; head-phone, 12 mW into 8 ohms.

Flutter: 0.027% wtd. rms, $\pm 0.048\%$ wtd. peak.

Fast-Wind Time: 80 S for C-60 cassette.

Dimensions: 17 $\frac{1}{8}$ in. W x 5 $\frac{5}{16}$ in. H x 12 in. D (435 mm x 135 mm x 306 mm).

Weight: 19.8 lbs. (9 kg).

Price: \$1,495.

Company Address: 19701 South Vermont Ave., Torrance, Cal. 90502. (Originally published August 1986)





The CR-7A cassette deck introduces Nakamichi's latest automatic calibration system and offers other Nakamichi firsts as well. The microprocessor-controlled auto-calibration process includes the expected record-sensitivity and bias adjustments, but adds an important element to achieve superior results: The playback-head azimuth is first automatically aligned to the record head to eliminate misalignment as a source of drooping high-end response. Then, the bias adjustments can correct for true response deviations. In conjunction with accurate sensitivity adjustments, the best possible Dolby NR tracking is secured.

The azimuth correction is based upon the detected phase (time) difference between the left and right playback channels with a 400-Hz test tone. Time differences between tracks are the same whatever the frequency, and with squaring circuits, the interchannel time error (ICTE) is easily measured. The ICTE is, of course, directly related to the misalignment, and the system's servo drives to reduce the error to zero (in steps of about a minute of arc). I liked the approach and looked forward to seeing how it would fare in the tests. Nakamichi states that their response corrections have a criterion of ± 0.3 dB and that sounded very good to me, even considering the numerous checks and rechecks of sensitivity and bias during the calibration process. At the conclusion of the procedure, bias and sensitivity data are automatically stored in the CR-7A's memory for that particular tape type, the test oscillator is turned off, user-preferred settings are restored, and the deck rewinds to "0000" and enters record/pause mode, ready to record.

The CR-7A uses Nakamichi's asymmetrical, dual-capstan, diffused-resonance, direct-drive transport for lower audibility of flutter and greater clarity of sound. To gain "smoother tape travel" and "more transparent sound," the capstan drive shafts have a special matte finish and the head assembly includes a pressure-pad lifter. Nakamichi was one of the first manufacturers to use a motor-driven cam to control a number of transport functions, and the three switch cams of the CR-7A inform the microprocessor of system status and tell it how to respond to operator instructions. Automatic slack take-up helps to minimize the chance of damage to tapes.

Quality electronics include direct-coupled recording, line, and headphone amplifiers; a fully discrete playback amplifier with direct coupling from the head; independent power supplies to each circuit, and matched Dolby NR ICs to keep tracking error within ± 0.25 dB.

The CR-7A is the first Nakamichi deck to include a real-time counter, which I'm really glad to see—I had almost given up waiting. I think that every deck directed at the serious recordist should include at least one real-time counter mode. The CR-7A offers the desirable nicety of both elapsed- and remaining-time display modes. The counter is not a true clock, because it calculates tape time from tape motion rather than measuring time directly. As a result, however, it has the more important attribute of staying calibrated even during fast winding. Time calibration takes about 8 S, which is quite speedy, and recalibration will take place if needed after a fast wind. Calibration is lost if a cassette is removed, but since recalibration is fast, this is of little import. The remaining-time calibration is purposely set

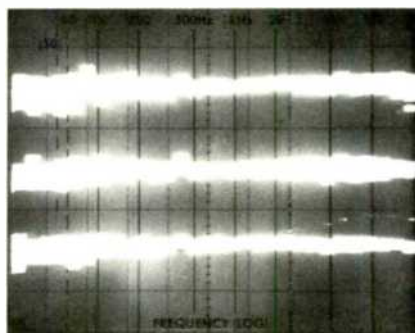

Fig. 1—Record/playback responses for "PN/Music" signal, recorded at -20 dB with Dolby C NR, showing overlaid results from 14 Type I tapes (top), 13 Type II tapes

(middle), and 13 Type IV tapes (bottom). See text. (Vertical scale: 5 dB/div.)

so that it reaches "00:00" 5 to 30 S before getting to the actual end of the tape. This helps to avoid the very end of the tape, where faint tape wrinkles caused by the hub clamps reduce recording quality. Also, the zero reading is a reference point for "Auto Fade." With this switched on, a recording will be automatically faded out at the tape end ("00:00") regardless of the actual counter mode. This is a handy feature, especially for those who can't stand the abruptness of a tape run-out.

Control Layout

A look at the front panel reveals other features of interest. The "Power" button is flush with the panel at the upper left; it would be difficult to turn off inadvertently, and that's good. The eject button, some distance below, initiates a smooth opening of the cassette-compartment door. The "Timer" ("Play/Off/Rec") slide switch is below the eject button and above the headphone jack. The compartment door is just to the right of these controls. With the door removed, access to the head and drive assemblies is excellent. Some cleaning tasks are aided by the fact that the unit can be put in play mode without a tape in place, but caution is needed.

Dominating the top middle and right of the front panel is the multi-function display. At the left is the four-digit, three-mode counter display that indicates tape motion, elapsed time, and remaining time. For automatic time calibration, the correct tape length (C-46, C-60, or C-90) must be selected. Little "M" and "S" annunciators under the counter's figures remind the user of the minute/second nature of the readout; there are annunciators for tape length as well, showing the choice that has been made.

To the right of the counter are horizontal, two-channel, peak-responding bar-graph meters, each with 24 segments. All of the segments and some of the scale markings are light tan; "0" up to " + 0" are red. The large number of segments and the 5-inch length of the bars make for easy interpretation of levels. Below the meter scales is "Auto

The CR-7A is the first Nakamichi deck to offer a real-time counter, for both time elapsed and time remaining, and I'm very glad to see it.

Calibration," which is always illuminated. When that process takes place, "Azimuth," "Level," "Bias," and "Ready" illuminate in order, just below, showing the status of the calibration procedure. "Ready" stays illuminated at the end of the process, and remains so unless the cassette is ejected or the deck's power is turned off.

Next to these indicators, below the middle part of the meters, is "Tape" with "EX," "SX," or "ZX" illuminated to show the tape type (I, II, or IV) selected manually or in automatic calibration. To the right of these is the EQ read-out, indicating 120 or 70 μ S. Normally, EQ would be selected automatically along with the tape type, but the CR-7A allows one to switch EQ for particular high-frequency recording needs: 120 μ S for more headroom, 70 μ S for lower noise.

The NR system choices are shown with "B" or "C" indicators, as well as "MPX Filter." "Subsonic Filter" lights up to show if that is being used. Further to the right are the "Source" and "Tape" annunciators, turned on in accordance with the monitor choice made.

Below the display panel, at the left, are the "Counter Reset" button (which does not affect time modes), the three-position memory switch ("Memory Stop/Off/Auto Repeat"), and the "Counter Mode" button. "Memory Stop" obtains a stop at "0000" with a fast wind in either direction. (Holding in the wind button will get a wind through zero, a desirable configuration.) "Auto Repeat" will get a repeated playing of the entire side of a tape.

Below are nine angled transport-control buttons, each with its own status light, arrayed in three rows. The top three buttons, from left to right, control rewind, play, and fast forward; all have light-green indicators. The second three control pause, stop, and record. The first two have light-green indicators, and record has a red one. The bottom row consists of "Fader" (with a down-pointing arrow), "Rec Mute," and "Fader" (with an up-pointing arrow). All of these have red indicators.

When the record button is pushed, the deck goes into record/pause mode ("Rec Mute" also lights up), and a push of the play button initiates recording. A push of the down fader reduces the record level to zero, and "Rec Mute" turns on again when this is complete. Pushing the up fader returns the record level to where it was. During fading, the intensities of the two fader indicators show the status of the fading. Holding in a fader button gets a faster fade than a single tap. "Rec Mute" mutes the signal while held in, but it does not get an automatic stop, as is obtained on some decks.

Below the middle and right side of the display are small buttons for selecting "EX(I)," "SX(II)," and "ZX(IV)" tape types, as well as "EQ," "Dolby NR," and "Peak Hold." As mentioned earlier, the tape-type and EQ switches are used only when manual choices are desired. The "Peak Hold" circuit gives a 2-S display of peaks at any signal level—even very low levels. This low-level capability is more important than it might seem, for it helps the user to judge all levels similarly. When it is on, "Hold" illuminates just below "Peak" at the left end of the meters.

Below the manual tape switches are the "Tape Length" selector button and the manual "Playback Azimuth" control.

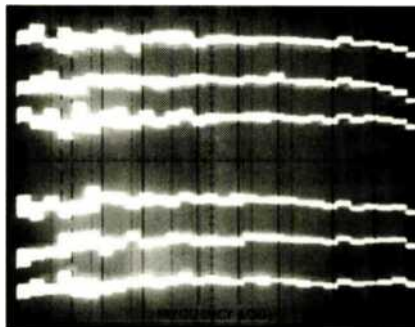

Fig. 2—Record/playback responses to high-level signals with Dolby C NR. Top three traces show response for wide-band pink-noise test signal at "+10" on the CR-7A's meter for Nakamichi EXII, SX and ZX tapes, respectively. Bottom three traces are for record/play of "PN/Music" signal at "+8" on the meter for the same three tapes. See text. (Vertical scale: 5 dB/div.)

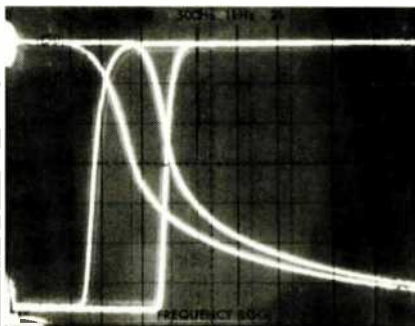

Fig. 3—Action of automatic fader circuits, showing fade-outs (traces descending from left to right) and fade-ins (traces rising from left to right). Left-hand trace of each pair shows action in slow mode; fast-mode fades are to the right. See text. (Scales: Vertical, 10 dB/div.; horizontal, 2 S/div.)

When you do something this well
you can't do it for everyone.

Look closely. This is an audio cabinet unlike any other. Handcrafted from solid wood and gleaming marble. Accented by the glint of solid brass hardware and beveled glass. Hand rubbed to a deep gloss. Elegant. Timeless. A Talwar cabinet. Individually crafted to your exacting specifications.

Now look inside. At joints reinforced for rigidity. A shelf support system that provides proper air flow on all sides. Features such as an 8-outlet power strip, concealed wire management system, heavy duty casters, and removable back. Plus sophisticated options. Like equipment cooling, vibration isolation, power filtering, electrostatic control, time delay power-up, and grounding bus bar.



Talwar cabinetry. An elegant home for your equipment. An elegant addition to your home.

For more information, write the Talwar Company, 311 West Point Terrace, West Hartford, CT 06107. (203) 521-2263.

TALWAR
Music to your eyes.

I was struck at once by the outstanding flatness of the record/playback responses, particularly with Dolby C noise reduction.

When recording on the CR-7A, auto-calibration would be the normal route, and azimuth calibration would be part of that process. In playing back a tape recorded on another deck or a prerecorded tape, the front-panel azimuth control allows adjusting the playback head's azimuth to match the actual flux on the tape, setting it for maximum high-frequency output. This control is duplicated on the supplied infrared remote control so that the head alignment can be peaked from the listening position. As soon as the control (front-panel or remote) is turned or pushed to get a change, the meter scales blank out and the topmost meter becomes an azimuth-position indicator with a center arrow. Each step made in adjustment is about 2.5 minutes of arc—acceptably accurate in theory and a great convenience in practice.

To the right are the "Auto Calibration" push bar and its "Reset" button, for use in case of error, and the "Monitor" selector bar for source or tape. Along the bottom right of the front panel are four on/off buttons for "Manual Tape/EQ," "Auto Fade," "Subsonic Filter," and "MPX Filter." The "Tape/EQ" switch has an adjacent red indicator; all of the others have annunciators in the display area.

Along the right-hand end of the front panel, from top to bottom, are level-control knobs: "Master," "Left," "Right," and "Output." The "Master" knob is of medium size, and the other three are small. None have knurling, and the friction is slightly too high for easy turning of the small knobs.

The stereo in/out line jacks on the rear panel are gold plated, which is a nice touch. Two "System Remote" jacks—a DIN socket for transport functions and a mini-jack for the azimuth control—can be used to tie this deck into Nakamichi's CA-7 control amplifier.

I removed the top and side cover to examine the internal construction. After some hours of use, the shielded power transformer was noticeably warm to the touch, but still not hot. There are three soldered-in fuses on the power-supply p.c. board, which also contains the bias oscillator. The large logic p.c. board covers almost two-thirds of the chassis area. Below it is a medium-size p.c. board, and at the bottom is another large card which is close to half-chassis size. The soldering is excellent, but there was some flux noted at hand-wired spots. The logic card is well supported, in general, but there was some springiness noted. The overall chassis construction is rugged and very rigid, with large center and side rails from front to back. The transport was quiet in operation, especially in play.

Measurements

Playback responses with TDK and BASF test tapes were within 1 dB at most points, but there was a greater rise (1.6 to 3.0 dB) at the four highest frequencies of the 70- μ S tape. A number of premium decks have shown a rise in this region, although this deck's rise is about 1 dB greater than most others. This comes from Nakamichi's use of playback heads which correspond more closely to the ideal defined in the IEC Standards than to the IEC calibration heads most tape manufacturers use.

Record/playback responses of the CR-7A were checked using "PN/Music" (pink noise rolled off 6 dB/octave at 2 kHz) and a $\frac{1}{3}$ -octave RTA. I was struck immediately by the outstanding flatness of the responses, particularly with

Table I—Record/playback responses (–3 dB limits).

Tape	With Dolby C NR				Without NR			
	Dolby Lvl		–20 dB		Dolby Lvl		–20 dB	
	Hz	kHz	Hz	kHz	Hz	kHz	Hz	kHz
Nakamichi EXII	10.6	20.0	10.6	21.8	10.6	13.0	10.6	22.3
Nakamichi SX	10.7	13.0	10.7	21.1	10.7	10.2	10.7	22.0
Nakamichi ZX	10.6	21.0	10.6	22.0	10.6	15.0	10.6	22.4

Table II—Miscellaneous record/playback characteristics.

Erasure At 100 Hz	Sep. At 1 kHz	Crosstalk At 1 kHz	10-kHz Phase		MPX Filter At 19.00 kHz
			Error	Jitter	
67 dB	60 dB	–100 dB	10°	15°	–31.9 dB

Table III—400-Hz HDL₃ (%) vs. output level (0 dB = 200 nWb/m).

Tape	NR	Output Level						HDL ₃ = 3%
		–10	–8	–4	0	+4	+8	
Nakamichi EXII	Dolby C	0.12	0.17	0.28	0.47	1.3		+6.0 dB
Nakamichi SX	Dolby C	0.07	0.12	0.26	0.76	2.2		+5.1 dB
Nakamichi ZX	Dolby C	0.04	0.07	0.13	0.33	0.81	2.0	+9.2 dB

Dolby C NR. Figure 1 shows the –20 dB responses for Type I, II, and IV tapes (top to bottom). Each trace is actually the stored collection of responses for many tapes having a wide range of performance. The Type I tapes included BASF LH-MI, Denon DX1, Fuji GT-I, Konica GM-I, Magnex Studio 1, Maxell XLI-S, Memorex dB, Nakamichi EXII, PDMagnetics FERRO, Scotch XSI, Sony HF-S, TDK D and AD-X, and Yamaha NR—a total of 14 widely different formulations. The Type II tapes included BASF CR-MII, Denon HD6 and HD8, Loran High Bias, Maxell UDS-II and XLII-S, Memorex CDXII, Nakamichi SX, Realistic Supertape Hi-Bias, Sony UCX, TDK SA and HX-S, and Yamaha CR-X—a total of 13 "noncompatible" tapes. The Type IV tapes were BASF Metal IV, Denon DXM, Fuji FR Metal, JVC ME-P, Konica Metal, Maxell MX, Nakamichi ZX, PDMagnetics 1100 Metal HG, Scotch XSMIV, Sony Metal-ES, TDK MA and MA-R, and Yamaha MR—a total of 13 tapes that are not as similar as some have been led to believe.

I find the results truly marvelous for flatness and consistency, and outstanding for record-sensitivity matching. The vertical spreading of the traces includes statistical effects of the pink noise, any differences in Dolby record-level calibration, any response deviations, and any Dolby C NR mis-tracking. All of the 13 to 14 responses for each tape type were completely acceptable, but the Nakamichi tapes supplied with the CR-7A (EXII, SX, and ZX) were used for the tests that followed.

I checked the record/playback responses with PN/Music at an rms level equivalent to Dolby level (" +8" meter). They looked so flat (Fig. 2, bottom three traces) that I next fed in, at maximum meter level (" +10"), pink noise that was *not*

The peak-responding meters are just that, except the decay time was short, making "Peak Hold" essential for good metering.

Table IV—HDL₃ (%) vs. frequency using Dolby C NR.

Tape	Level	Frequency (Hz)						
		50	100	400	1k	2k	4k	6k
Nakamichi ZX	-10	0.06	0.13	0.04	0.05	0.05	0.06	0.08
	0	0.36	0.47	0.40	0.42	0.40	1.0	1.8

Table V—Signal/noise ratios with IEC A and CCIR/ARM weightings.

Tape	IEC A Wtd. (dBA)				CCIR/ARM (dB)			
	W/Dolby C NR		Without NR		W/Dolby C NR		Without NR	
	α DL	HD=3%	α DL	HD=3%	α DL	HD=3%	α DL	HD=3%
Nakamichi EXII	68.2	74.2	51.3	57.3	68.2	74.2	48.7	54.7
Nakamichi SX	71.3	76.4	54.8	59.9	71.9	77.0	52.7	57.8
Nakamichi ZX	70.3	79.5	53.6	62.8	71.2	80.4	51.5	60.7

Table VI—Input and output characteristics at 1 kHz.

Input	Level		Imp., Kilohms	Output	Level		Imp., Ohms	Clip (Re: Meter 0)
	Sens.	Overload			Open Ckt.	Loaded		
Line	43 mV	>31 V	38	Line	923 mV	770 mV	2.4k	+17.3 dB
				Hdphn.	842 mV	618 mV	18	

rolled off. The results, the top three traces of Fig. 2, show how little roll-off there is even at this very high level. This characteristic is reflected in the excellent figures contained in Table I, showing the -3 dB limits with a sine-wave test tone. The low-frequency response is well extended and very consistent, at both levels and for all three tapes.

Dolby play level indication was high, about 1 dB above the meter-zero level. A number of checks were run to see how well auto calibration aligned the playback head to the recorded flux. Using a 10-kHz test tone for the recheck, there was a consistent 10° phase error between tracks with one tape, which translates to a misalignment error of only 0.3 minute of arc. I used the manual control to try to zero the error with the 10-kHz tone and found that the steps were about 50° of phase in this mode. Nonetheless, I got to within 5° of phase, about 0.15 minute of arc—excellent alignment. The total auto-calibration time was always 15 S or less, with azimuth alignment followed by multiple checking and re-checking of 400-Hz level (for Dolby calibration) versus 15-kHz level (for bias and response). The only time I got an error (indicated by a flashing readout) was when I mistakenly tried to calibrate the Type I tape with manual inputs for Type IV and "70 μS."

The subsonic filter response was 3 dB down at 20 Hz, 20 dB down at 11 Hz, and 30 dB down at 9.8 Hz. The response came back up below this point but was 13 dB down at 7 Hz. The bias in the output during recording was very low. Table II lists a number of other record/playback characteristics. Worthy of note are the excellent 67-dB erasure at 100 Hz and the high separation and crosstalk figures—to say nothing of the low phase error and jitter after auto calibration.

The third-harmonic distortion figures were excellent for all three tapes, and, as Table III shows, those for ZX tape were outstanding. The scan with the spectrum analyzer also showed that distortion was primarily HDL₃, with little evidence of other harmonics. The low level of the distortion made it difficult to measure HDL₃ across the band, and Table IV lists the superior results. Even at Dolby level, distortion was well controlled up to 4 kHz, where tape-saturation effects caused a sharp increase in nonlinearity. Table V provides evidence of how the high maximum output levels of Table III lead to outstanding signal/noise ratios.

Miscellaneous input/output characteristics are shown in Table VI. The line input impedance given is actually a minimum, obtained with all input pots at maximum rotation. With the three pots at a more normal setting, the measured impedance was 83 kilohms—good for minimum loading of other equipment. On the other hand, the line output impedance of 2.4 kilohms is on the high side, particularly if the load is 10 kilohms. A 20-kilohm load would not be a problem. The headphone output drove all phones I tried to very high levels; the output attenuator was needed.

The two sections of the master input-level pot tracked each other within a dB for 60 dB of attenuation, which is excellent. The action of the automatic fader was checked with a 1-kHz tone (Fig. 3) for the two fading speeds, for both fade-in and fade-out. The slow fades are to the left in Fig. 3, and the fast fades are to the right. Although a big contrast exists between the speed of the down-fades and of the much faster up-fades, there is some logic to this approach: The unit fades in fast to be fully up when the music starts, and fades out slowly so the music or applause will trail away to silence. The two sections of the output-level pot tracked within a dB for 40 dB, fairly good. Output polarity was the same as the input in both source and tape modes.

The peak-responding meters met the standards for such meters, with the exception that the 0.7-S decay time was too short. The use of "Peak Hold" appeared essential for good metering. I was not able to verify the accuracy of all the meter-segment thresholds, because they are not tied to specific level figures. Still, the spacing and the results obtained would indicate good dynamic metering. The meter responses were 3 dB down at 10.6 Hz and 20.2 kHz.

There was substantially no measurable change in tape play speed over a range of line power from 110 to 130 V. Over short periods of time, speed variations were on the order of ±0.01%. With selected cassettes, I got flutter values of 0.035% wtd. rms and ±0.055% wtd. peak, very close to the specified values. More typically, I got 0.05% wtd. rms and 0.065% wtd. peak. These are good results but not impressive—and they are noticeably higher than specifications. The fast-wind time for a C-60 cassette was 61 S. There was loose-loop take-up with cassette insertion. Changes in modes and run-outs to stop were all about 1 S.

Use and Listening Tests

The CR-7A owner's manual is clearly written and has helpful illustrations, but some additional detail would aid many users. (I should note, however, that Nakamichi also sent a lengthy technical memo to members of the press, in the form of a news release.)

Sonically, the CR-7A outperformed my reference deck, and the CR-7A's best performance was certainly easier to achieve.

All of the controls and switches were completely reliable during testing and listening. As mentioned earlier, the only problem with auto calibration was a mistake on my part. I really appreciated the wide use of annunciators to show switch status; I had been frustrated so many times in the past with Nakamichi's small, black pushbutton switches—were they in or were they out?

The record, pause, and stop functions all produced light clicks that were down into tape noise with Dolby C NR. I somehow felt personally rewarded with the inclusion of the counter time modes; Nakamichi must have listened to those of us who had pleaded for them. The remote control worked reliably up to at least 20 feet. I put in some prerecorded tapes to try adjusting playback azimuth from my favored listening position, and though about half the tapes were best with the nominal zero setting, others offered a definite opportunity for improvement. Results with the latter demonstrated the value of the Nakamichi approach: There is no other way to match the correction gained by accurate playback alignment.

I have mulled over the question of whether adjusting the playback head, as is done in the CR-7A, is essential to get proper alignment with the flux recorded on the tape. Any deck's heads are aligned at the factory, of course—the playback head is adjusted to match a good alignment tape, and the record-head adjustment is made with a no-skew blank tape. The ability to re-adjust the playback head, however, ensures the best possible playback of any tape, from any machine, with whatever skew; it must also be recognized that record-head adjustments can do nothing about correct playback of recordings made on decks that suffer from azimuth errors. I conclude that this feature is very worthwhile, one which I would like to see on more decks.

During recording of various sources, I confirmed my earlier conclusion that "Peak Hold" was essential for the best

level metering. I made certain that the peak level went no higher than just below the 3% limits measured during the bench tests. Sources included a number of favorite albums, such as Respighi's *Feste Romane* with Lorin Maazel and the Cleveland Orchestra (Mobile Fidelity MFSL 1-507) and *Buddy Spicher and Friends: Yesterday and Today* (Direct Disk DD102). I did find that with the CR-7A's excellent low-end response, use of the subsonic filter was required with some of the records.

It took me a very short time to decide that the match between the CR-7A's responses with and without Dolby C NR was definitely the best that I have ever heard; I felt similarly about the source/tape comparisons. The frequency response and level matchings accomplished by the auto-calibration system left me nothing to point to as "too much" or "too little." I was very impressed with the CR-7A's ability to retain all of the low bass contained in some of the source material—even at the highest levels. I had found in tests that the flutter was above the stringent specification, but I did not hear any detrimental effects that I could attribute to this. In comparisons with my reference deck, a Nakamichi 582, I judged the CR-7A's sound to be slightly better and its best level of performance certainly a lot easier to achieve.

Overall, the auto-calibration system worked very well indeed and achieved impressive sonic results. The record/playback responses were the best I have measured with Dolby C NR, and in/out and source/tape matchings were outstanding. I wish that the deck had punch-in recording and that the output impedance was lower for some uses, but I'm glad that this unit has counter time modes, manual tape selections, subsonic filter, and manual playback-azimuth control. The price is high, but the Nakamichi CR-7A provides a superlative combination of wide, flat response, low noise and distortion, and a superior auto-calibration system.

Howard A. Roberson

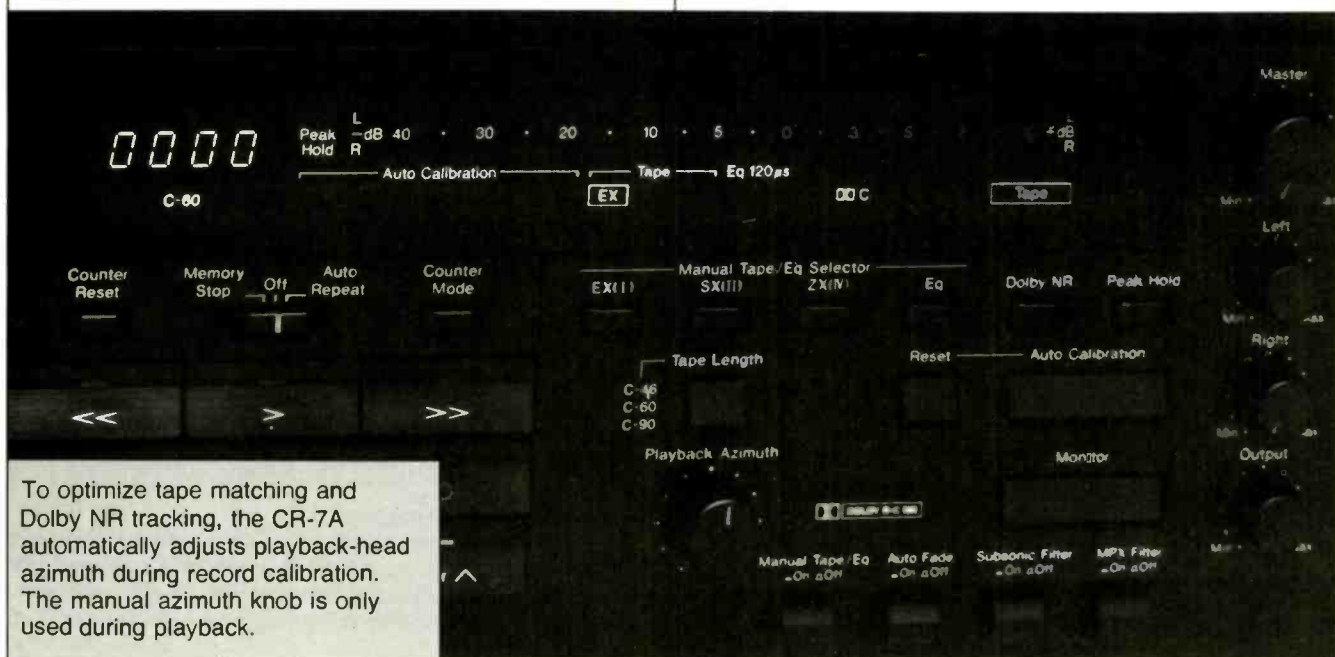

To optimize tape matching and Dolby NR tracking, the CR-7A automatically adjusts playback-head azimuth during record calibration. The manual azimuth knob is only used during playback.

Wingate Not for beginners.

The discriminating sensibilities of the true audiophile are developed gradually as an acquired taste. Naturally, then, we realize that the Wingate 2000A is an extraordinary feat of engineering that far exceeds the understanding or appreciation of the novice. Instead we suggest this incomparable Pure Class A amplifier only for the audio connoisseur whose trained ear will recognize absolute purity of sound.



Wingate Audio Corporation
P.O. Box 9121, 423 4th St., SW
Hickory, NC 28603
704-324-0334

100 w/ch dual-mono power MOSFET Pure Class A amplifier with zero-negative feedback design for unprecedented signal transparency and resolution.



Pure Class A





14

REVOX B215 CASSETTE DECK

Manufacturer's Specifications

Frequency Response: 30 Hz to 18 kHz; to 20 kHz with CrO₂ and metal tapes.

Harmonic Distortion: 0.8%.

Signal/Noise Ratio: 72 dBA with Dolby C NR.

Separation: 40 dB.

Erasure: 70 dB.

Input Sensitivity: 50 mV.

Output Level: Line, 775 mV; head-phone, 2.8 V.

Flutter: ±0.1% wtd. peak.

Fast-Wind Time: 75 S for C-90 cassette.

Dimensions: 17.7 in. W x 6 in. H x 13.1 in. D (45 cm x 15 cm x 33 cm).

Weight: 20.4 lbs. (9.2 kg).

Price: \$1,590; B205 remote-control transmitter, \$125.

Company Address: 1425 Elm Hill Pike, Nashville, Tenn. 37210.
(Originally published July 1985)

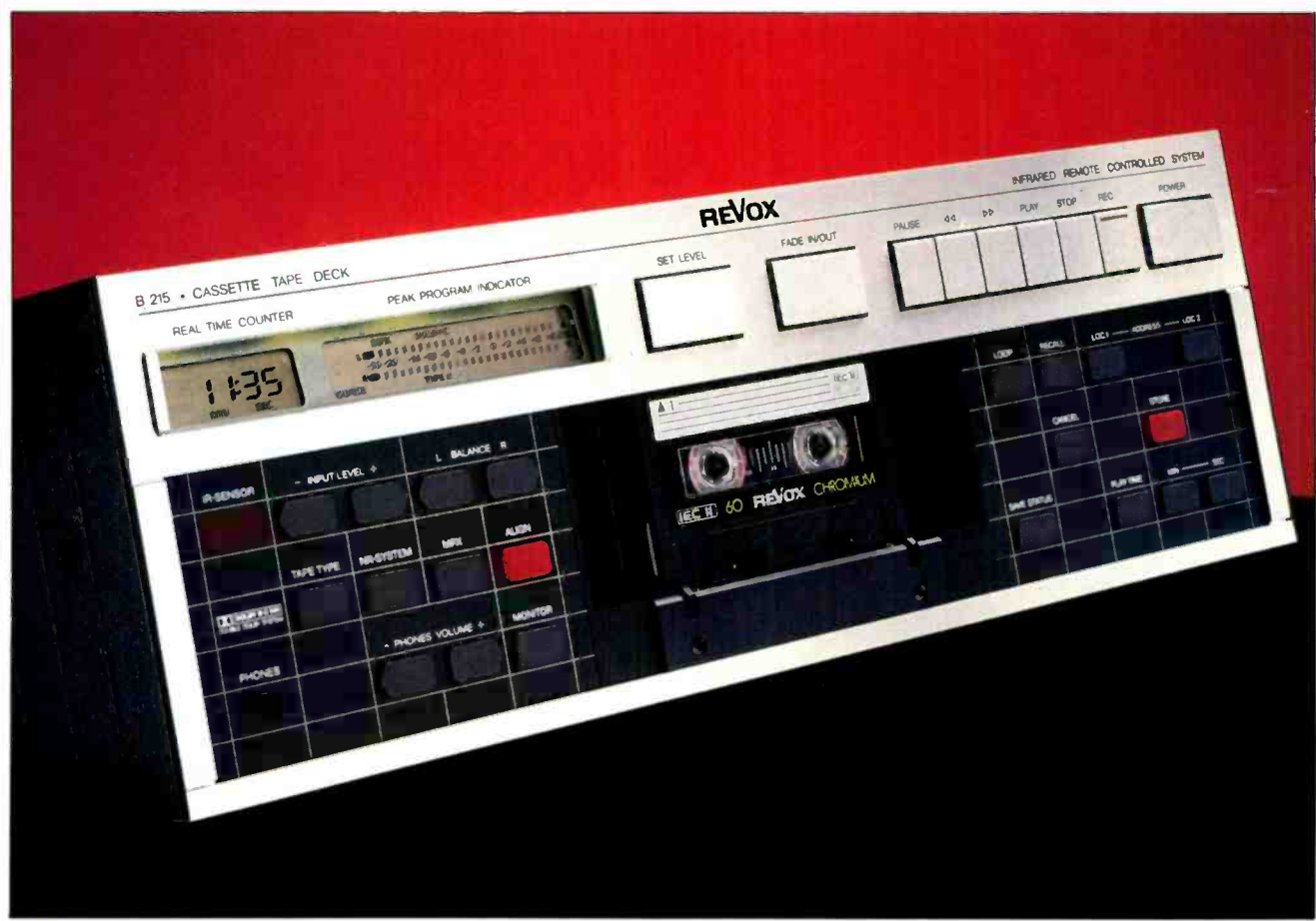

Photograph: ©Bill Kourinis



The Revox B215 cassette deck uses sophisticated micro-processing for many internal functions. There are actually three microprocessors: One for the time counter, another for the automatic tape-matching system, and the third for housekeeping and for control interfacing with other components in Revox's B200 series.

All units in this series can be operated from the same optional remote-control unit. But they can also connect, via rear-panel serial ports, to a separate interface box which can then be connected to a home computer (for programmed control) or to infrared remote-control receivers in other rooms. With the Revox units interconnected in this way, one could simultaneously start the B215 tape deck and switch the receiver to "Tape" mode by pressing "Play" on the remote transmitter—whether the transmitter is pointed at the receiver, the B215, the interface unit, or an infrared receiver in another room.

The most important use for the on-board microprocessing is the automatic alignment to match the characteristics of any tape used. In just 20 S, adjustments are made automatically to bias, record sensitivity and equalization to ensure flat response, good Dolby NR tracking and low distortion. Information on the internal settings can be stored for two Type I tapes, three Type IIs, and one Type IV. The B215 also incorporates the Dolby HX Professional system, which varies bias during recording in accordance with the spectral makeup of the signal for lowest distortion overall.

The microprocessor-controlled time counter yields elapsed-time indications after only a few seconds of play, no matter where the cassette is started. A selected elapsed time can be entered, and a fast-wind made to that point. Two time addresses can be stored for one-button fast-wind returns, or for looping (continuous play) between them.

Another helpful feature of the B215 is a system which automatically sets recording levels. Automatic fade-in and fade-out during recording is an additional nicety.

The tape drive uses four motors, two for the direct-drive capstans and two for spooling the tape. An optical end-of-tape sensor stops the transport at the start of the clear leader, instead of at its end. This positions the tape exactly where recording can be restarted as soon as the cassette is flipped; time is not lost while the leader passes the heads once in each direction.

Control Layout

The B215 deck is large, but it has a friendly look, with brushed aluminum as the top of the front panel and dark gray for the lower part. The black designations on top and the white ones below are very easy to read over a wide range of lighting levels, making the B215 one of the best units in this regard. The very large, aluminum pushbuttons and the large, medium-gray and red ones all stand out clearly from the panel and require just a light touch for actuation.

After the deck is plugged in but before it is turned on, a red standby indicator illuminates in the "IR-Sensor" window at the upper left end of the gray panel. The deck can be turned on in either of two ways, with the B205 remote control or with the "Power" pushbutton at the upper right of the front panel. With turn-on, the red indicator goes off, and the "Real

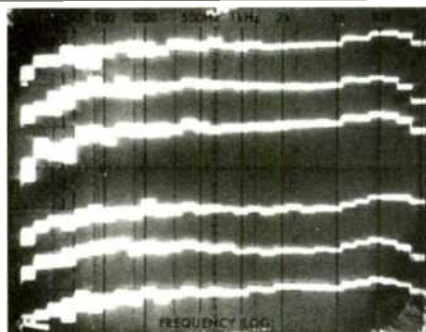

Fig. 1—Record/playback responses using Dolby C NR. Top three traces made with Maxell UD-XL I (Type I), TDK HX-S (Type II) and TDK MA-R (Type IV), all at Dolby level. Bottom three traces with the same tapes but at -20 dB. (Scale: 5 dB/div.)

Time Counter" and "Peak Program Indicator" LCDs appear. The counter display shows "--:--" over "Min" and "Sec" to remind the user that calibration has not been done for an elapsed-time indication. The "Peak Program Indicator" has "L" and "R" horizontal meter scales and calibrations from "-30" to "+8" in between. Just to the right of the meters is "Bal" with an arrow above it, pointing up (next to the "L" scale), and an arrow below it, pointing down (next to the "R" scale). At the lower left of the same display area, "Source" announces that the incoming signal is being monitored. Additional details of these displays will be given while discussing the use of the pushbuttons.

To the right of the displays are the "Set Level" and "Fade In/Out" pushbuttons. "Set Level" automatically sets the digitally controlled input-level attenuator while you play the loudest portion of a disc, so that the highest recording levels will be just below the point where unacceptable distortion would occur. Automatic setting continues as long as the button is held in, so the actual time taken is determined by the user.

With the "Fade In/Out" button, the signal can be faded between full off and the preset attenuator level, whenever desired. You cannot, however, vary the fade speed or interrupt the fade halfway. Fades can be made any time during recording without stopping the transport.

Fading is also invoked by the "Pause" control, which is grouped, with the other transport-control buttons, to the fade button's right. There is an automatic fade-in if recording is started from record-pause mode (rather than "Stop"), and an automatic fade-out if you interrupt recording with the "Pause" instead of the "Stop" button. Pressing "Pause" also automatically switches the monitoring back to "Source," in anticipation of continued recording—a convenient feature.

It is possible to switch among modes as desired, and punch-in recording is possible by holding "Rec" and "Play"

A helpful feature automatically sets the recording level so the highest peaks are just below the distortion point.

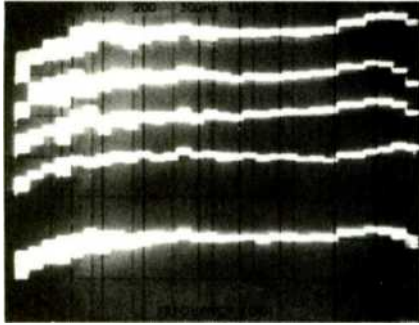

Fig. 2—Record/playback responses. Upper four traces, all made with Dolby C NR, are: +6 dB on Maxell UD-XL I, +4 dB on TDK HX-S, +6 dB on TDK MA-R, and +10 dB on Maxell UD-XL I. Bottom trace shows overlaid responses with Dolby B and C NR and without NR, all made on UD-XL I tape at -14 dB. (Scale: 5 dB/div.)

at the same time. The above constitute a nice collection of features for the serious recordist.

In "Rec/Pause," the meter display shows "Source" and, above, a flashing "Record." Pushing "Pause" again initiates recording, with the display indicating the change in monitor status from "Source" to "Tape."

Below the transport buttons are nine gray pushbuttons plus the "Store" button, which is red. The top row consists of "Loop," "Recall," and two "Address" buttons, "Loc 1" and "Loc 2." The next row is for "Cancel" and the aforementioned "Store." The bottom row has "Save Status," "Play Time," "Min," and "Sec."

When a cassette is first inserted, "Real Time Counter" is blank, as mentioned earlier. With a push of "Play Time," a standard tape length (whichever you used last) will be displayed; successive pushes will step the indicated length from "C 46" to "C 60" to "C 90" to "C 120," and back to the start again. After the selection of the correct length, a few seconds of playing or recording will get a calibrated, elapsed-time reading in the counter display. After calibration has been completed, a start of recording will automatically store the "Min/Sec" address (tape location) in "Loc 1." By use of the "Min," "Sec" and "Store" buttons, and then "Loc 1" or "Loc 2," any location on the tape can be put in memory. Except when in record mode, a push of "Loc 1" or "Loc 2" will initiate a fast-wind to that exact point on the tape. The counter display shows "Loc" and "1" and/or "2" above it when there is an entry or two to indicate. When both

locations are used, a push of "Loop" will initiate continuous play and rewind cycling between the two points, even fast-winding to the start point from any location on the tape. Arrows appear between the tops and bottoms of the "1" and "2" in the display, reminding the user that the deck is in "Loop" mode. "Recall" and a location button will get a display of the corresponding tape-time location. "Cancel" will, of course, clear the memory of whichever button is pushed.

"Save Status" is used to store all recorder settings including level, NR system, balance, etc., in a nonvolatile memory for use with a timer (which, of course, shuts off all power to the recorder for a period of time).

Under the counter and meter displays are 11 pushbuttons, 10 gray and one red. The top row, just to the right of the infrared sensor mentioned earlier, has two buttons for input level ("-" and "+") and two for balance ("L" and "R"). When an input-level button is held in, a relative level from "-∞" to "+10" appears in place of the "Min/Sec" readout. A brief push will get single steps up or down, and a hold will obtain continuous stepping which increases in speed as the button is held in. The arrows above and below "Bal" show when there is electrical balance, but the level indication must be used to find the best setting.

The second row of buttons under the displays consists of "Tape Type," "NR System," "MPX," and the red "Align." When a cassette is first inserted into the holder, tape type is automatically sensed and displayed, provided that the cassette has the sensing holes which indicate this information. "Tape Type" allows manual setting for "Type I," "Type II," "Type II—120 μS," and "Type IV." All are self-explanatory with the exception of "Type II—120 μS." This is an unusual and useful feature for the serious recordist: If there is a more-than-average amount of energy in the higher frequencies, the results with a Type II tape may be better with 120-μS EQ instead of the usual 70 μS. The selected tape type is announced along the bottom of the meter display, Type I to Type IV, left to right.

The selection of "MPX," "Dolby B," or "Dolby C" is similarly indicated along the top of the meter display. "MPX" is an on/off selection, and "NR System" steps the choice from off to "Dolby B" to "Dolby C" NR.

Alignment, in the case of the Revox B215, means electronic adjustment of the recording function and not the mechanical adjustment of a record or playback head. A push of "Align" with the deck in record/pause mode starts the process that adjusts bias, record sensitivity and equalization for the best responses with low distortion, both with and without Dolby NR. It's a 20-S procedure, and while it's functioning, "Align" appears at the lower right in the meter display. There are a total of six memory locations for alignment information: Two for Type I tapes (A1 and A2), three for Type II (A1, A2, A3), and one for Type IV (A1). With the use of "Align," the settings are automatically put into memory, normally A1 location. To save the settings for another tape formulation without disturbing the information in memory A1, push "Align" and then the "Pause" button to step to the next memory location. Overall, this is a very good way to handle tape matching, with the convenience of storing the matching-condition information for the tapes most used. These

The drive, which had a look of long-term durability, ran very quietly—perhaps the best of any I've yet tested.

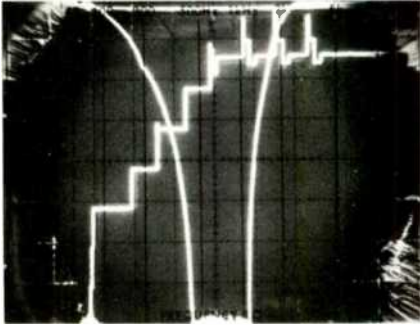

Fig. 3—Tests of two gain-adjustment functions. Curved trace shows fade-out from 0 dB to maximum attenuation, and fade-in from maximum attenuation to 0 dB. Stepped trace shows action of "Set Level" function as input is increased in 10-dB steps from -70 to 0 dB (see text). (Vertical scale: 10 dB/div.; horizontal scales, 1 S/div. for fader, 5 S/div. for "Set Level" test.)

memories are also nonvolatile, holding their contents even if the recorder's power is disconnected.

Along the bottom row of buttons below the display are the headphone jack, all the way to the left, two "Phones Volume" buttons (" - / + ") and the "Monitor" selector (causing "Source" or "Tape" to appear in the meter display). The headphone level can be set to one of eight steps. My immediate reaction to this design was a bit of skepticism, but I reserved judgment until I actually tried listening.

The shallow, vertical well for the cassette has a very open design, which gives outstanding access for any sort of cleaning or demagnetizing. Inserting a cassette was a simple process of putting the top in first, then pushing in the bottom. I liked the finish and the ruggedness of the drive elements, particularly the large diameter of the capstan shafts.

On the B215's back panel are the expected stereo pairs of in/out phono jacks. There is also a DIN-type socket for the serial interconnection link with other Revox equipment. The power cord is detachable.

Removing the steel top and back covers allowed examination of the interior. The chassis has a rigid, box-girder construction, providing excellent support for the transport system and the circuit cards. The large flywheels were very evident, and the rest of the drive was judged to be very well-constructed, with a definite look of long-term reliability. The drive was very quiet, even in play mode—perhaps the quietest of any deck I've tested to date. The soldering on the

cards was excellent, with slight flux at a few hand-soldered points. There were a total of four fuses, all in clips.

Measurements

The playback responses of the Revox B215 were the best I have measured to date, with many points within ± 0.3 dB of the reference level. Playback of a standard flux level was indicated correctly, and tape play speed was 0.2% fast, at the most.

For record/playback measurements, I used "Align" to match the deck to a large number of tapes having a wide range of bias and sensitivity characteristics. For the test signal, I used what I call "PN/Music"—pink noise rolled off at 2 kHz—to ensure accurate assessment of the performance with Dolby C NR. (Testing with sine-wave signals with Dolby C NR.) The record/playback responses were at least very good with every tape tried, and excellent with most. Maxell UD-XL I, and TDK HX-S and MA-R, were judged to be the best overall and were therefore used for the detailed tests that followed. Excellent results were also obtained with these Type I tapes: BASF Pro I Super, Fuji FR-I, Maxell XL I-S, PDMagnetics Tri-Oxide Ferro HG, Sony AHF, TDK AD and AD-X, and Yamaha NR-X. Type II tapes with excellent results included BASF Pro II Chrome, Fuji FR-II, Maxell UD-XL II and XL II-S, PDMagnetics 500 Crolyn HG, Sony UCX and UCX-S, TDK SA-X, and Yamaha CR. Among Type IV tapes, Maxell MX, Memorex Metal IV, Sony Metallic, TDK MA, and Yamaha MR were excellent. I was further impressed by the fact that the B215 got very good responses with BASF Metal IV in the C-120 length, much better than other decks I have tried.

Revox did not provide detailed information on the alignment process, but a little detective work with the aid of my Hewlett-Packard computing counter got these clues: There is a sequence of four tones—17.4 kHz, 477 Hz, 17.4 kHz, and 3.7 kHz—with many stepped-level changes in the first three tones and a relatively small and smooth change in the level of the final tone. The deck's output was muted during "Align," but it was possible to observe the sequence with playback later. There were many changes during the 20-S process, and I could see that there were many comparisons made between 477-Hz and 17.4-kHz outputs at a number of absolute levels. It appeared more than likely that settings for bias and record sensitivity were very accurately set for good responses and low distortion. The 3.7-kHz level adjustment was judged to be the final touch-up for the flattest responses across the band.

Figure 1 shows record/playback responses, with Dolby C NR, for the three selected tapes, both at Dolby level and 20 dB below that. All of the responses are very flat, including those at 0 dB. (I should point out that with the PN/Music test signal, there will be less high-end roll-off in the playback because the rolled-off test signal causes much less tape saturation.) Having made that parenthetical note, I call attention to Table I, which lists the -3 dB limits for all three tapes, with and without Dolby C NR. These tests were made with sine-wave test tones which were *not* rolled off at the higher frequencies. The results were outstanding at Dolby level: The low-end responses dipped down 3 dB at 22 to 24

The B215 had the best playback responses I've yet measured. Record/play response was at least good with every tape, excellent with most.



Because it also controls other Revox components, the B205 remote unit has more buttons than the B215 tape deck.

Hz, came back up somewhat, and finally rolled off at 9.4 to 10.4 Hz. Figure 2 shows record/playback responses with PN/Music at higher levels. The outstanding Dolby NR tracking is illustrated in the bottom trace, where the results at -14 dB for no NR, Dolby B and Dolby C NR are all overlaid, making just one trace.

Table II lists a number of measured record/playback characteristics, all excellent. The measurement for 10-kHz phase error and jitter between channels was one of the best I have ever seen, and the multiplex filter was positioned exactly. The level of bias in the output during recording was very low.

The level of the third-harmonic distortion (HDL_3) was mea-

sured, with Dolby C NR, as a function of level for the three tapes, and as a function of frequency at -10 dB with TDK HX-S tape. Table III lists the distortion in the output from -10 dB to the points where HDL_3 equals 3%. The distortion-limit levels are somewhat low, but the distortion figures for 0 dB correspond very closely to specifications. The mid-band distortion was not as low as some other decks' (Table IV), but 0.24% at the frequency extremes is very good.

Signal/noise ratios were measured with and without Dolby C NR, with both IEC A and CCIR/ARM weightings. The results in Table V are a close match to other high-performance decks at Dolby level, but are somewhat low with reference to the 3% limit point. This does, of course, correlate to the somewhat low 3% points measured earlier. Perhaps we should recall the deck's outstanding frequency responses to remind us of the trade-offs involved in recorder design.

Table VI shows measurements obtained for a number of input/output properties. Everything seemed quite in order, but the overload level of 2.65 V calls for caution on the part of users who might feed the deck from equipment whose output capability is greater than this.

Figure 3 shows time and level plots of "Fade In/Out" and "Set Level." The sweep rate for the fades is 1 S/div. The fade-out takes about 2.4 S and the fade-in a little over 1 S, both acceptable times.

To test the "Set Level" function, I first attenuated the output from my test generator by 70 dB and set the B215's input level control to "-∞" to challenge the automatic function with an extremely low-level test signal. The B215 automatically and rapidly readjusted its input attenuator to its maximum setting, "+10," but, as Fig. 3 shows, the resulting record level was still only -35 dB.

I then increased the test generator's output in 10-dB steps. For the changes from -70 to -40 dB of generator output, the B215's attenuator remained at "+10," and recording level rose in accordance with the input-level changes. When the generator's output reached -30 dB, recorded level shot past its final limit, dropped briefly, then settled at the desired recording level, and the B215's attenuator reset itself to "+8." The action on subsequent 10-dB jumps in generator output was the same—a sharp rise, two sharp drops, and a final adjustment. The attenuator readout reflected these changes: "-2," "-12," and "-22." The B215 set its recording level below the distortion limit on these final four input-level steps. Because of its obvious stepping, "Set Level" should not be used during actual final recording, but it is a great convenience for setting up.

The input-level pushbuttons were used to make the deck's input attenuator step from maximum (+10) down to -∞. There were 1-dB steps from +10 to -44, followed by -46, -48, -51, -54, -60, and finally -∞. Each of the steps was substantially without error, and the tracking between sections was within 0.1 dB from +10 down to -54. These results are much superior to anything else that I have checked in the past.

There are eight positions for balance on either side of zero. The first "L" step, for example, increases "L" level by 1 dB; the second "L" step decreases the "R" level by 1 dB; the third step increases the "L" level by another dB, etc.,

Table I—Record/playback responses (-3 dB limits).

Tape Type	With Dolby C NR				Without NR			
	Dolby Lvl		-20 dB		Dolby Lvl		-20 dB	
	Hz	kHz	Hz	kHz	Hz	kHz	Hz	kHz
Maxell UD-XL I	22	21.1	8.2	23.1	23	14.1	8.5	24.6
TDK HX-S	22	22.7	8.3	24.5	23	16.0	8.6	25.5
TDK MA-R	24	23.4	8.4	23.1	24	17.0	8.8	23.9

Table II—Miscellaneous record/playback characteristics.

Erase	Sep.	Crosstalk	10-kHz A/B Phase		MPX Filter
At 100 Hz	At 1 kHz	At 1 kHz	Error	Jitter	At 19.00 kHz
66 dB	59 dB	-93 dB	25°	7°	-32.7 dB

Table III—400-Hz HDL_3 (%) vs. output level (0 dB = 200 nWb/m).

Tape Type	NR	Output Level					$HDL_3 = 3\%$
		-10	-8	-4	0	+4	
Maxell UD-XL I	Dolby C	0.10	0.14	0.27	1.0		+3.1 dB
TDK HX-S	Dolby C	0.14	0.22	0.46	1.1	2.7	+4.2 dB
TDK MA-R	Dolby C	0.17	0.22	0.50	1.2	3.0	+4.0 dB

Flutter was marvelously low, a consistent 0.10% weighted throughout a C-90 tape—the best I have measured to date.

until, with the eighth step, "L" has been increased by 4 dB and "R" has been decreased 4 dB. It is an interesting way of balancing, and it could be the best way, at that.

The headphone volume adjustments were measured as: Maximum (0 dB), -4.1, -9.2, -14.2, -20.2, -28.1, -38.6 dB, and off. My first reaction was that the steps were too coarse, but trials revealed that the changes seemed quite right for whatever the user might desire—"a little softer," for example. I tried a number of headphones and found there was enough gain to drive any of them to very high levels.

Tracking between channels was outstanding, so there was no need for balance trimming. The deck's output polarity was inverted in "Tape" but not in "Source" output mode.

Each of the horizontal bar-graph meter sections has 24 separate segments, although the bottom one in each meter is always on. Scaling extends from "-30" to "+8," with the lowest figures somewhat out of calibration. Accuracy was good from "-18" to "-6," however, and the single-dB steps from "-5" to "+8" were all within 0.1 dB—superb over this important recording-level range. The dynamic responses of the meters met the requirements of the standard for peak program meters, with response to -1 dB with a 10-mS tone burst and a 1.4-S decay time. There were slightly higher meter indications with the tone-burst offset, but there should have been more of a change. The frequency response of the meters was down 3 dB at 7.0 Hz and 169 kHz; the latter appears to be unnecessarily high.

Substantially no changes in tape play speed were detected with changes in line power from 110 to 130 V. Short-term variations in play speed were less than $\pm 0.01\%$, excellent

indeed. The flutter was marvelously low and very consistent throughout the length of a C-90, 0.010% wtd. rms and $\pm 0.023\%$ wtd. peak. After checking the effect of changing modes and loading and unloading the tape, I concluded that the B215 showed the best overall flutter performance I have measured to date.

The fast-wind speed was high, just 73 S for a C-90, but the stops were smooth and gentle. Times required for changing modes were very short, really too short to measure with a stopwatch. Cueing with fast-forward or rewind and "Stop" worked well, and seemed quite natural after a few trials. Calibration of the elapsed-time counter took about 7 S. With calibration made at the start of a cassette, errors built up during the playing, totalling a minute or so halfway through a C-90. Recalibration at that point reduced the error to several seconds, which is very acceptable. This is a good feature, but I would expect better accuracy. In case of any question, it would appear best to recalibrate the counter halfway through.

Use and Listening Tests

The owner's manual has a very good (albeit undetailed) text, well organized, with helpful illustrations. Technical freaks would probably like more information on "Align" and the use of the microprocessors. The manual does not mention that punch-in recording is possible. Brief use pointed out to me that a cassette had to be advanced at least a short distance for "Align" to work; that was easy to do, and the benefits were great.

No record clicks could be detected by ear or meter, even when using Dolby C NR. There were very soft pause and stop "clunks" down in the tape noise (no indication on the monitoring meter). I found that with "Stop," and more so with "Pause," very short sections of the tape being used were not erased completely—leaving little beeps from my earlier tests. A very short rewind would be in order to prevent such distractions if a tape is being reused and has not been bulk erased.

For record/playback listening tests, I used pink noise for tracking tests and dbx-encoded disc versions of digitally recorded originals: *Wolftracks* with John Kay and Steppenwolf (Nautilus NR-53/dbx PS-1084), music of Rodrigo (Varese Sarabande VCDM 1000.150/dbx PS-1032), and others. The results were excellent, aided, I am sure, by the peak-responding meters, which were easy to read over a fairly wide range of illumination levels. With recording levels set quite high, I did prefer the Type II results over Type I, and the Type IV results over Type II; in each of these successive comparisons, the bass became less muddy and the music better detailed. Once again, I concluded that, with listening at high levels, the maximum recording level was best kept to that for a distortion of about 1%—about 0 dB on the B215.

The Revox B215 utilizes its microprocessors for many important and helpful things. "Align" performed very well, and the responses were among the best seen to date. Flutter performance was superlative, and the construction of the transport was judged to offer long-term reliability. The B215 is large, so it won't fit just anyplace, but it should have considerable attraction for those who seek performance and advanced features.

Howard A. Roberson

Table IV—HDL₃ (%) vs. frequency at 10 dB below Dolby level.

Tape Type	NR	Frequency (Hz)						
		50	100	400	1k	2k	4k	6k
TDK HX-S	Dolby C	0.24	0.17	0.14	0.16	0.08	0.10	0.24

Table V—Signal/noise ratios with IEC A and CCIR/ARM weightings.

Tape Type	IEC A Wtd. (dBA)				CCIR/ARM (dB)			
	W/Dolby C NR		Without NR		W/Dolby C NR		Without NR	
	@ DL	HD=3%	@ DL	HD=3%	@ DL	HD=3%	@ DL	HD=3%
Maxell UD-XL I	67.5	70.6	52.0	55.1	68.6	71.9	49.4	52.5
TDK HX-S	69.0	73.2	53.1	57.3	69.8	74.0	50.6	54.8
TDK MA-R	69.1	73.1	53.3	57.3	69.9	73.9	50.7	54.7

Table VI—Input and output characteristics at 1 kHz.

Input	Level		Imp., Kilohms	Output	Level		Imp., Ohms	Clip (Re: Meter 0)
	Sens.	Overload			Open Ckt.	Loaded		
Line	47 mV	2.65 V	96	Line Hdphn.	779 mV 2.8 V	690 mV 0.52 V	1.5k 219	+16.0 dB



15

YAMAHA K-1020 CASSETTE DECK

Manufacturer's Specifications

Frequency Response: 20 Hz to 18 kHz; to 20 kHz with CrO₂ tape; to 23 kHz with metal tape.

Harmonic Distortion: 0.5%.

Signal/Noise Ratio: 59 dB; 75 dB with Dolby C NR, 95 dB with dbx NR.

Separation: 40 dB.

Crosstalk: 60 dB.

Input Sensitivity: Line, 40 mV.

Output Level: Line, 360 mV; head-phone, 3.6 mW into 8 ohms.

Flutter: 0.03% wtd. rms, ±0.06% wtd. peak.

Fast-Wind Time: 70 S for C-60 cassette; 45 S in high-speed mode.

Dimensions: 17½ in. W x 5¼ in. H x 15 in. D (435 mm x 133 mm x 381 mm).

Weight: 16.8 lbs. (7.6 kg).

Price: \$649.

Company Address: 6660 Orange-thorpe Ave., Buena Park, Cal. 90620.

(Originally published March 1986)





Sitting at the top of Yamaha's line of cassette decks is the K-1020, which has three heads for superior record/playback performance and a dual-capstan drive in a closed-loop configuration for stable, low-flutter tape transport. The record and play heads are made of pure Sendust, and the erase head is made of ion-plated ferrite.

The Yamaha deck is one of relatively few with Dolby HX Pro, which ensures the best possible headroom extension by dynamically controlling bias in response to the signal's spectral content. [See the article on HX Pro in August 1984 *Audio*, by Jensen and Pramanik, for more data.] This is not a noise-reduction system; however, the K-1020 does provide Dolby B and C NR as well as dbx NR, which gives it great flexibility in making recordings, and enables it to play back any prerecorded material. The K-1020 also has the unique ORBiT (Optimum Record Bias Tuning) system, which combines manual bias adjustment with a readout which shows when the bias is best for the tape being used.

The counter reads elapsed time from wherever it is reset. This is not a mere clock, which functions only in record and play modes; instead, it reads even in fast-wind modes, converting tape position into minutes and seconds via a computer chip. Such time indications are very useful when making recordings. The deck also offers memory and auto-play modes in conjunction with the counter. One handy feature is that the recorder will rewind and stop exactly where recording started if rewind is pushed during recording. This location is stored automatically, and the counter does not have to be reset first. Pressing and releasing the fast-forward or rewind button initiates normal fast winding, but holding down either fast-wind button raises the winding speed an additional 35%. This speed bonus is also available—and especially helpful—in auto-search mode, which finds the beginning or end of the piece being played. Fast-winding automatically slows near the tape's ends to prevent tape breakage.

The K-1020 features a fluorescent, peak-responding, wide-range stereo meter. Surrounding annunciators indicate monitor, memory and auto-mode status, tape type, whether recording is being done, NR system, multiplex filter, and bias-test status. These all make operation more convenient and help to minimize mistakes.

Control Layout

The K-1020's front panel helps make the deck easy to operate in most lighting conditions, not only because of its good displays but because its designations stand out in white against the black background. At the upper left of the panel is the large "Power" on/off switch. The "Eject" button, just below, is similar in shape, but because it's smaller and its surface is knurled, and because this layout is now common, users probably won't confuse them. There is a useful "Output Level" control further down, just above the "Phones" jack.

The cassette carrier tilts out briskly with a push of "Eject," but the stop is fairly gentle. Access for cleaning and demagnetizing is quite good, and with the door cover snapped off, it is excellent—among the best I've seen. The transport will not go into play mode without a cassette in place, so the deck won't rotate the pinch roller for you while you're clean-

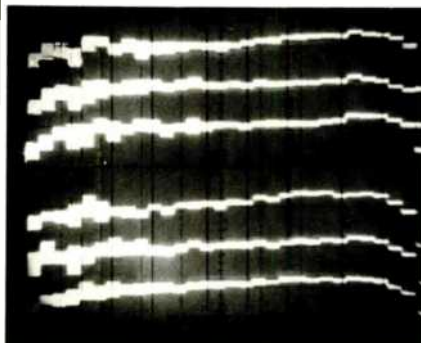

Fig. 1—Record/playback responses using Dolby NR, at Dolby level (top three traces) and at -20 dB (bottom three traces), for Yamaha NR (Type I), Sony UCX-S (Type II) and Maxell MX (Type IV) tapes (top to bottom in each set). Vertical scale: 5 dB/civ.

ing it. I would prefer to have the roller driven during cleaning, but it is true that, if it did rotate, a cotton swab could get wrapped around the capstan if you weren't careful. With a tape in place, tape slack is automatically taken up when the door is closed, and also when power is first turned on.

To the right of the cassette compartment is the "Master Fader," which is used only during recording. Yamaha recommends that this control be used just for fades from full-off to full-on, and for fade-outs; otherwise, they recommend leaving this vertical slider all the way up, at "0." A scale along the slider's left shows, in dB, how much the fader attenuates the stereo signal at various positions. (The controls which adjust individual-channel recording levels will be discussed a bit later.)

Across the top right side of the K-1020 is the display panel with the meters, counter and annunciators referred to earlier. At the left of this display is the four-digit elapsed-time counter, which has red LED numerals and a minus sign that lights if the tape is rewound past counter zero. The counter can be reset at any time, but it should, of course, be reset at the very beginning of a tape if you need to keep track of the total time (position) to any point on the tape. This counter has two valuable characteristics: It keeps its basic time calibration even with fast winding, and it maintains its reading (unless purposely reset) even when a cassette is ejected, so the user can note the time from the counter and write it on the cassette label.

The annunciators below the counter are "Rec" (which glows during record and record/pause modes and flickers when the auto rec mute is operating), "Test" (which lights when the ORBiT circuit is in use and flickers when ORBiT is in standby), and the "Tape/Source" indicator.

To the right is the memory-mode annunciator panel, with lights to indicate when the memory is in use and when either

This deck is one of the few with Dolby HX Pro, which ensures the best headroom extension by dynamically controlling bias.

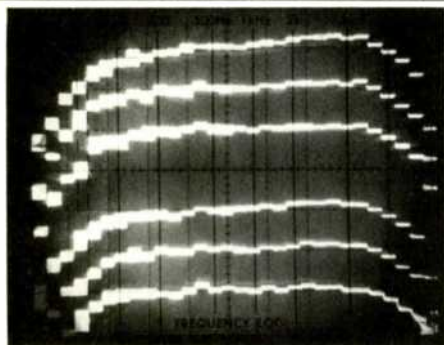

Fig. 2—Record/playback responses using dbx NR, with bias set with ORBiT circuit, at Dolby level (top three traces) and at -20 dB (bottom three traces), for same tapes as in Fig. 1. Vertical scale: 5 dB/div.

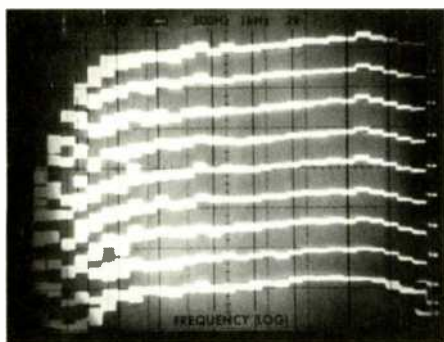

Fig. 3—Record/playback responses using dbx NR, with bias decreased slightly from amount set with ORBiT circuit, for Maxell MX (Type IV) tape. Dolby-level response is centered vertically, with responses measured from -16 to $+16$ dB. Vertical scale: 5 dB/div.

of the two repeat modes is active. One of these two modes, "0-M Repeat" (zero-to-memory repeat), plays the section of the tape between counter zero and any point the user enters into memory, up to eight times. The second, "Full Repeat," plays the entire side of the tape, then rewinds and replays it, also up to eight times. (That eight-time limit seems like more than enough to me!)

The recording-level meters are horizontal, fluorescent bar-graphs with a bluish-white center scale that extends from -30 to $+20$. Little dot lights above and below these scale numbers serve as guidelines for maximum re-

cord levels; the dots extend to $+6$ for normal and chrome tape, and to $+8$ for metal tape—except when dbx NR is used, in which case the dots extend to $+16$ for all tape types. These guidelines are a good idea and are easy to read from any distance which would leave you within reach of the controls.

Segments light to show up to 18 different recording levels within the meter's range. (There are actually 19 segments, but the first, just to the left of -30 , is on all the time.) The meter segments covering the range up through 0 are bluish white, and the ones from 0 to $+20$ are red. The meters are classified as peak-responding, but confirmation of that was left to the actual testing. I found it slightly irksome that the single-digit scale numbers are just to the right of the corresponding scale segments, rather than centered on them. But in actual recording, where levels change rapidly, this objection proved trivial.

Below the bar-graphs, from left to right, are these annunciators: "Bias," with adjustment-direction arrows; "Filter"; symbols for Dolby B, Dolby C and dbx noise reduction, and indicators for "I/Normal," "II/CrO₂" and "IV/Metal" tape types. All of these annunciators are bluish white, except for "dbx," which is red in color.

Below the left portion of the display area, just to the right of the "Master Fader," are the transport control switches, all with good-sized, rectangular pushbuttons. Along the bottom, from left to right, are "Rec/Pause," "Stop" and "Mute/Search." Just above, from left to right, are rewind, "Play" and fast forward. Above these buttons are narrow-bar pushbuttons for "Reset," "Memory" and "Monitor." The functions of most of these are self-explanatory or have been mentioned before, but some additional comments are in order: Pushing "Rec/Pause" once readies the deck for recording, and recording is initiated by pushing "Play." A push of "Mute/Search" during recording will gain an automatic 4-S blank interval and a stop in "Rec/Pause." Holding the button in will get a longer blank time.

Holding in either of the fast-wind buttons gets a faster-than-normal winding. Pushing "Mute/Search" along with the wind button will get a fast rewind and a stop at the beginning of the present song; pushing "Mute/Search" with fast forward takes you quickly to the start of the next song. There are no status lights associated with any of the transport control buttons, but there is the red "Rec" annunciator that appears under the counter. A few simple checks showed that punch-in recording was possible from any mode as long as "Rec/Pause" and "Play" were both held in at the same time. This is a good feature, and I didn't see it mentioned in the manual.

To the right of the transport switches is a collection of controls, hidden behind a small swing-down panel. At the top, from left to right, are six pushbuttons, interlocked as needed, for "NR-Off," "Dolby B," "Dolby C," "dbx," "MPX Fil" and "Bias Test." All of the buttons are black, with the exception of "Bias Test," which is red. The designations above the buttons are hard to see when the deck is below eye level, but Yamaha comes to the rescue by printing a legend—quite easily seen—near the edge of the swing-down panel. As mentioned earlier, these buttons have associated annunciators in the display area.

Playback responses for both equalizations were excellent, with most points accurate to within a fraction of a dB.

When "Bias Test" is pressed, the "Test" annunciator below the counter begins flashing; it lights steadily when "Rec/Pause" and "Play" are pressed to initiate recording of the test signal. When testing begins, the "Bias" annunciator below the record-level meter lights, with arrows showing which way to turn the "Bias Adjust" knob (just below the test switch) to set correct bias for the tape in use. When both the right- and left-pointing arrows are illuminated equally, bias is set correctly. When the "Bias Test" button is released, the tape is automatically rewound to the point where the test started. Overall, this is a simple and effective operation.

To the left of the "Bias Adjust" knob are the left and right "Preset Rec Level" pots with small, finely knurled knobs. Friction was not high, and adjustments were made easily. Further to the left is the "Auto Mode" rotary switch with positions for full repeat, zero-to-memory repeat, off, timer play, and timer record.

On the rear panel are the stereo input/output phono jacks, which are gold-plated, a nice touch. Also on the back is a DIN-type socket for the optional remote control.

Removing the top and side cover revealed a neat and well laid-out combination of p.c. boards. The main circuit board occupied more than half the chassis, and served as a motherboard for the smaller p.c. boards containing the Dolby and dbx NR circuitry. The power supply was on a separate board. The soldering was excellent; interconnections were made with multi-pin plugs. Adjustments were very clearly labelled, both with functions and with part numbers. The shielded, separately mounted transformer was just warm in operation. The transport looked good and was very quiet in operation. Overall, it was an impressive scene.

Measurements

Playback responses for both equalizations were excellent, with most points accurate to within a fraction of a dB. Meter indications for playback of a standard level were very close, within the limitations of segment resolution. Tape-play speed was just 0.1% fast. Record/playback responses were checked for a large number of tapes using pink noise, rolled off at 6 dB/octave above 2 kHz to make it more music-like. The adjustable bias permitted good matches to a large number of tapes. ORBiT (Optimum Record Bias Tuning) was very speedy in use and acceptably accurate, in general. (More on this later.)

Based upon the overall response curves obtained with the use of ORBiT, Yamaha NR (Type I), Sony UCX-S (Type II) and Maxell MX (Type IV) tapes were selected for the detailed tests to follow. Other very good performers were Fuji GT-I, Maxell XL I, and TDK AD for Type I; Denon HD7 and HD8, Fuji GT-II, Maxell XL II, Memorex CDX II, TDK HX-S, and Yamaha CR-X for Type II, and Scotch XSM, Sony Metal-ES, and TDK MA and MA-R for Type IV.

Figure 1 shows the record/playback responses for the three selected tapes at Dolby level and 20 dB lower, all with Dolby C NR. All of the responses are very good, even with the high-end roll-off at -20 dB and the slightly elevated responses from 2 to 10 kHz with Yamaha NR tape. Table I lists the -3 dB limits obtained using a sine-wave tone. Particularly noteworthy is the Dolby-level high-end limit of 20.2 kHz with Maxell MX and Dolby C NR. A slight decrease

Table I—Record/playback responses (-3 dB limits).

Tape Type	With Dolby C NR				Without NR			
	Dolby Lvl		-20 dB		Dolby Lvl		-20 dB	
	Hz	kHz	Hz	kHz	Hz	kHz	Hz	kHz
Yamaha NR	16.3	10.2	15.5	16.5	16.2	8.7	15.5	18.6
Sony UCX-S	16.3	10.6	16.3	18.8	16.3	9.1	15.5	20.3
Maxell MX	17.1	20.2	17.4	19.8	17.2	14.2	16.0	22.2

Table II—Miscellaneous record/playback characteristics.

NR Type	Erase At 100 Hz	Sep. At 1 kHz	Crosstalk At 1 kHz	10-kHz A/B Phase Error	Jitter	MPX Filter At 19.00 kHz
Dolby C	62 dB	60 dB	-94 dB	50°	10°	-35.2 dB
dbx	87 dB	56 dB	-108 dB			

Table III—400-Hz HDL₃ (%) vs. output level (0 dB = 200 nWb/m).

Tape Type	NR	Output Level						HDL ₃ = 3%
		-10	-8	-4	0	+4	+8	
Yamaha NR	Dolby C	0.09	0.11	0.20	0.63	2.3		+4.7 dB
	dbx	0.07	0.09	0.10	0.14	0.22	0.45	+17.1 dB
Sony UCX-S	Dolby C	0.14	0.20	0.40	1.0	3.0		+4.0 dB
	dbx	0.16	0.19	0.24	0.34	0.45	0.75	+17.3 dB
Maxell MX	Dolby C	0.16	0.21	0.38	0.79	1.7		+6.4 dB
	dbx	0.15	0.19	0.24	0.32	0.42	0.60	+17.9 dB

in bias, below that which was set with ORBiT, raised the high-end limits but also added another 1 or 2 dB to the slight elevation which already existed in the 2- to 10-kHz region.

Figure 2 shows the record/playback responses for the same three tapes, using dbx NR and with the bias set using ORBiT. Results were disappointing, and a slight decrease in bias was made to reduce the high-end roll-off. (The low-end roll-off is characteristic of dbx NR, not restricted to the K-1020.) The reduction in roll-off was accompanied by some elevation in response from 2 to 10 kHz; some users might like this, others might not. The assessment: ORBiT did an excellent job of getting responses very close to the best possible, but minor bias trimming might be in order for the very most critical listening.

Table II lists record/playback test results, using both Dolby C and dbx NR. All of the figures are excellent, among the best ones I've seen to date. Note that use of dbx NR improves erasure and reduces crosstalk, albeit with some reduction in separation. There was some low-level bias in the output during recording.

Third-harmonic distortion of a 400-Hz tone was measured for the three tapes, both with Dolby C and with dbx NR. For these tests, the level was gradually increased from 10 dB below Dolby level to the point where HDL₃ reached 3%. The data in Table III shows low distortion at the lower levels for both NR systems, and also shows that a much higher maximum level is possible with dbx NR. Table IV lists the HDL₃ figures obtained with Maxell MX at -10 dB with Dolby C and dbx NR from 50 Hz to 5 kHz. The rise in distortion at the lower frequencies is much greater for dbx NR than it is for Dolby C NR. The distortion at the higher frequencies is

I found ORBiT and the excellent metering and displays to be my favorite features, particularly when switching tapes.

Table IV—HDL₃ (%) vs. frequency at 10 dB below Dolby level.

Tape Type	NR	Frequency (Hz)						
		50	100	400	1k	2k	4k	5k
Maxell MX	Dolby C	0.32	0.36	0.16	0.15	0.14	0.27	0.29
	dbx	2.7	1.2	0.15	0.18	0.15	0.16	0.15

Table V—Signal/noise ratios with IEC A and CCIR/ARM weightings.

Tape Type	IEC A Wtd. (dBA)				CCIR/ARM (dB)			
	W/Dolby C NR		With dbx NR		W/Dolby C NR		With dbx NR	
	@ DL	HD=3%	@ DL	HD=3%	@ DL	HD=3%	@ DL	HD=3%
Yamaha NR	69.0	73.7	74.1	91.2	67.7	72.2	70.2	87.3
Sony UCX-S	72.0	76.0	78.7	96.0	71.9	75.9	74.5	91.8
Maxell MX	70.8	77.2	77.0	94.9	69.9	76.3	73.2	91.1

Table VI—Input and output characteristics at 1 kHz.

Input	Level		Imp., Kilohms	Output	Level		Imp., Ohms	Clip (Re: Meter 0)
	Sens.	Overload			Open Ckt.	Loaded		
Line	42 mV	>31 V	23	Line Hdphn.	340 mV 3.0 V	299 mV 0.67 V	1.6k 203	+21.8 dB

lower with dbx NR, but it is also low with Dolby C NR; all of the figures show the benefit of HX Pro, which is incorporated in this deck.

Signal-to-noise ratios were measured for the three tapes with Dolby C and dbx NR systems, using both IEC A and CCIR/ARM weightings. The results, shown in Table V, are all excellent, with Type II (UCX-S) figures superior to those for Type IV (MX) most of the time.

The input and output characteristics listed in Table VI are in general agreement with Yamaha's specifications, with some minor disparities. The headphone output, with an 8-ohm impedance instead of the more usual 50 ohms, delivered 2.1 mW per side. This was a bit less than specified, but maximum listening level at 0 dB was very high with all of the headphones tried, proving the value of the K-1020's output-level control.

The two sections of the master fader tracked each other within a dB at settings from full to 60 dB of attenuation, and most of the scale markings were accurate within a dB. This is excellent performance, and would enable you to make exact level shifts for both channels at once. The output-level control had more deviation between its sections—just over 1 dB at 20 dB of attenuation, and 2 dB at 40 dB down. The output polarity was the same as the input in "Source" mode, but was reversed in "Tape."

The frequency response of the bar-graph meters was approximately 3 dB down at 22 Hz and 21 kHz. The great majority of the meter scale calibrations were accurate to within a dB, including "-30" (-31 actual). From "-10" to "+4," errors were 0.6 dB at most. The meters' response time met the requirements for those classified as peak-responding, but the decay time of 0.87 S was short compared to the standard minimum of 1.4 S. Adding either a

positive or negative d.c. offset to the test tone burst did not raise the meter indication, which is as it should be for true peak-reading meters.

The average tape-play speed did not vary with changes in line voltage from 110 to 130 V. There were fairly regular short-term speed changes up to $\pm 0.015\%$ or so. Flutter was somewhat dependent upon the cassette used: It measured 0.045% wtd. rms and $\pm 0.065\%$ wtd. peak on the average, but just 0.025% wtd. rms and $\pm 0.045\%$ wtd. peak with the Yamaha NR tape. The fast-wind time for one side of a C-60 cassette was 68 S for normal fast wind, but only 48 S with the button held in for the higher speed. The time to change modes was 1 S or less.

Use and Listening Tests

The owner's manual presents considerable detail and good technical exposition on the K-1020's features, especially HX Pro and the Dolby and dbx NR systems. There are good illustrations and an excellent block schematic, helping to make it one of the better user manuals I've seen.

All of the controls and switches were completely reliable throughout the testing. The resistance to movement of the master fader's slider was high for fast fading, but the control's action was very smooth nonetheless. The right record-level pot knob was not snug on its shaft, but it never did come off.

I found ORBiT and the excellent metering and displays to be my favorite features, particularly when switching from tape to tape. I also found that I used the higher winding speed more than I thought I would. Timer start, mute, memory, and repeat modes all worked as they should. Going into record mode caused only a small click on the tape, down at the tape-noise level heard with Dolby C NR; I detected no sounds created by entering pause or stop modes.

Most of the listening tests were conducted using dbx-encoded discs from digital recordings, such as Rachmaninoff's Symphony No. 2 with the Scottish National Orchestra, Alexander Gibson conducting (Chandos ABRD 1021/dbx PS-1074). Switching to Dolby C NR made an obvious improvement in the noise level, but with Yamaha NR tape there was then too much added presence. With Sony UCX-S tape there was only a little additional presence, which was much more to my liking. Maxell MX was best of the tapes at the highest levels. With all three tapes, reducing bias slightly when using dbx NR improved the sound, to my ears. I still missed the deep bass of a number of LP sources, but there was no doubt about the K-1020's ability to record at very high levels with dbx NR. The elapsed-time readout was quite accurate, within 30 S over a 90-minute period.

The Yamaha K-1020 does not have a long list of special features, such as music programming, but it does have conveniences that are useful all of the time: Elapsed-time counter, ORBiT, wide-range metering, Dolby and dbx NR, master fader, output-level control, and extra-high-speed winding on demand. The internal construction is definitely above average, and its arrangement should minimize any required service time. The K-1020 offers a nice combination of features and performance for its price, and should compare favorably with other decks in its range.

Howard A. Roberson

Digital Discrimination.

BECAUSE ALL CD'S ARE NOT CREATED EQUAL, THE NEW CARVER DTL-200 COMPACT DISC PLAYER IS INTRIGUINGLY DIFFERENT.

The Carver DTL-200 answers the audiophile's demand for a CD Player which provides not only the greater dynamic range and richer bass expected from compact disc technology, but also the musicality, spectral balance and spatial qualities of well executed analog high fidelity recordings.

The new remote control Carver DTL-200 represents the next logical evolutionary step towards marrying the awesome technology of digital playback with Bob Carver's commitment to the re-creation of the live performance. It embodies the latest digital/analog conversion circuitry with oversampling, sophisticated laser system and a wealth of operating features. And it possesses unique Carver circuitry that solves real-world sonic problems associated with commercial CDs.

TIME DOMAIN CORRECTION. The Carver DTL-200 incorporates an important new computer logic innovation that monitors the incoming digital signal for imperfections and "glitches" caused in recording and production. Such errors are immune to conventional error-correction processes because they are actually data anomalies. Yet they can add overall harmonic distortion and cause audible changes in sound quality.

The DTL-200's Time Domain Correction circuit constantly performs a complex, 25-bit digital calculation on passing data. This high-speed error correction algorithm, in conjunction with a 121-pole digital filter, terminates distortion-causing high harmonics as they occur in the bit stream. The result is frequency response within 1/1000 of a dB of the original, with significant reduction of distortion to less than 0.007%.

PLUS THE DIGITAL TIME LENS. On top of this unerring ability to produce natural, real-sounding music from the CDs' digital bits, the Carver DTL-200 has the remarkable Digital Time Lens circuit to insure your listening enjoyment.

When Bob Carver obtained his first compact disc player, he was surprised at the sound derived from most of the compact discs he purchased. The three-dimensional musical perspective which his analog system provided in lush abundance on phono discs evaporated into a flat, brittle wasteland. After exten-

sive testing, Bob uncovered two fundamental flaws in almost all compact discs: 1) An unpleasant, harsh spectral energy balance. The overall octave-to-octave energy balance was shifted on the CD towards more midrange above 400 Hz. 2) The amount of L-R signal (which carries the spacial detail of the music) on the CD was inexplicably, but substantially, reduced when compared with the amount of L-R signal found on the corresponding analog disc. The difference is obvious in these two oscilloscope photos.

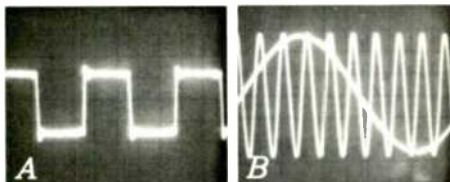

A Lissajous pattern showing spatial detail (L-R) (L + R) ratio from an LP record.

B The same instant of music but taken from the CD version. Note the decreased (L-R) content, as shown by the narrowed trace.

Carver's circuitry corrects the ratio of L-R to L + R by performing one extra, but important mathematical operation on the signal stream that all other CD players fail to perform. This final operation makes all the difference.

The result is a natural sound with more of the three-dimensional information that places us in the same space with performers. You won't need the Digital Time Lens on all CDs. But it is there when you need it.

In the beginning, Carver hoped, indeed he expected, that once recording artists and engineers became more experienced with CD technology

fewer and fewer CDs would require the Digital Time Lens. But both laboratory and listening tests reveal that the majority of even the most recently released CDs benefit significantly from the Digital Time Lens.

PACKED WITH USEFUL FEATURES. The Carver DTL-200 makes enjoying Compact Discs a simple exercise in button pushing from your favorite listening chair. You can program any combination of up to twelve tracks from a single CD, repeat a specific track or a whole Compact Disc for uninterrupted enjoyment.

Along with the ability to skip forward or backwards song-by-song, a touch of a key allows you to audibly review a disc backwards or forwards at many times normal speed. An A-B Specific Phrase Repeat lets you carefully analyze one section of a performance or simply provide a point of reference in a long, un-indexed symphonic movement.

All functions are displayed on an easy-to-read but subtle LCD display including programming sequence, current selection number, individual and total playing times plus indexing cues.

HEAR THE CARVER DIGITAL DIFFERENCE.

Just as all CDs are not created equal, neither are Compact Disc Players. Of all the models currently available, only the new DTL-200 (and DTL-50) have the innovative and exacting Bob Carver touches that can substantially enhance your enjoyment of the digital medium.

Audition the new DTL-200 today at your Carver dealer, using a variety of discs. You will be surprised at how audibly it can improve on what is already the best playback medium ever offered.

SPECIFICATIONS. Frequency Response: 5Hz-20kHz \pm 0dB \pm 0.2dB Total Harmonic Distortion: 0.007% S/N: 100dB Channel Separation: 90dB @ 1kHz Dynamic Range: 96dB Wow & Flutter: unmeasurable Programming: 12 track remote and manual



CARVER

PO Box 1237 Lynnwood WA 98046

POWERFUL

MUSICAL

ACCURATE

Distributed in Canada by evolution technology



16

ADS CD3 COMPACT DISC PLAYER

Manufacturer's Specifications

Frequency Response: 20 Hz to 20 kHz, ± 0.25 dB.

S/N Ratio: Greater than 100 dBA re: 0 dB.

THD: Less than 0.01%, 20 Hz to 20 kHz, at 0 dB; less than 0.1%, 20 Hz to 20 kHz, at -20 dB.

Channel Separation: Greater than 86 dB, 20 Hz to 20 kHz.

Phase Shift: Less than 5° , 20 Hz to 20 kHz, between or within channels.

Output Level: Fixed, 2.0 V rms at 0 dB, ± 0.5 dB; variable, 0 to 2.0 V rms; headphone, 0 to 3.0 V rms into 30 ohms.

Dimensions: 17.5 in. (44.5 cm) W \times 2.8 in. (7 cm) H \times 14.8 in. (37.7 cm) D.

Weight: 17½ lbs. (7.9 kg).

Price: \$1,250; optional RC1 remote-control unit, \$100.

Company Address: One Progress Way, Wilmington, Mass. 01887.
(Originally published June 1985)



ADS obviously intends this, their first Compact Disc player, to be part of their highly regarded Atelier series of audio components. Not only is the styling of the CD3 consistent with that of the other components in that series, but its performance and features clearly identify it as a top-of-the-line product. As was pointed out to me by Richard Moore of ADS, the CD3 is the company's second fully digital product. Some of you may remember the ADS10 Acoustic Dimension Synthesizer, a digital time-delay unit which used A/D and D/A adaptive delta-modulation conversion techniques developed by DeltaLab. The CD3 is an international product, in the best sense of the phrase, with the developmental engineering work done on a cooperative basis by engineers from ADS and its sister firm, Braun Electronic GmbH, of West Germany, while a highly regarded Japanese company does the actual assembly work in that country.

The CD3 can handle and play discs with up to 99 tracks, and as many as 30 selections can be programmed in random sequence. Using the optional remote control, any 30 of the 99 tracks can be programmed, with any selection accessible immediately; using the front panel controls, only the first 30 tracks are programmable.

The controls have been grouped in a most logical fashion, with the more often-used basic controls placed together on the front panel in full view. The more specialized and less often-used controls are on a push-to-release, pivoting panel below the disc drawer. These controls allow the more sophisticated user to perform such functions as toggling between display of elapsed and remaining time, toggling between track and index numbers, programming selections, and choosing any portion of the disc for repeat play.

I have often been asked what differentiates a really superior CD player from an "adequate" one. The ADS CD3 may help to answer the question, for it is definitely in the superior

class, as evidenced by some of its mechanical innovations as well as by its electronic and sonic performance. The smoothly operating, motor-driven loading drawer, for example, cradles the CD on soft cushions to prevent any damage to the disc itself. The slider responds quickly, smoothly, and noiselessly. Like other ADS Atelier components, the CD3 uses steel top and bottom covers for mechanical strength and shielding. The spindle motor is an extremely quiet, d.c., brushless type.

I found the laser tracking-servo system to be quite resistant to external shock and vibration applied to the sides of

Fig. 1—Frequency response, left (top) and right channels.

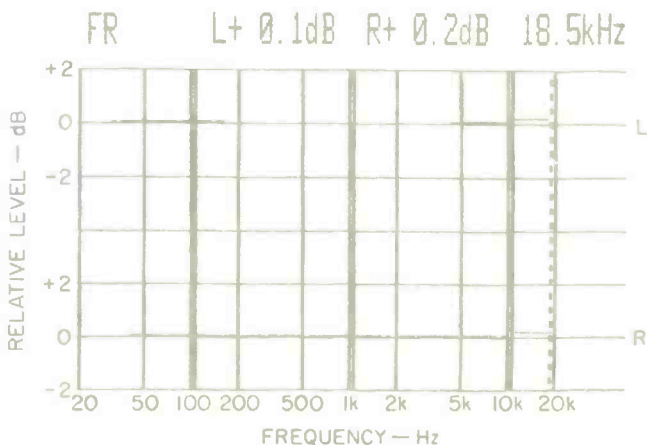



the unit. The sample I tested showed some sensitivity to mechanical shock applied vertically, but I am told by ADS that a cure is being worked out by shock-mounting the transport. In any case, vertical shock is the least likely type of mechanical vibration to occur in actual use.

Circuit Highlights

The CD3 employs two-times oversampling (88.2 kHz) with digital filtering. Separate digital-to-analog converters are used in each channel, with full 16-bit linear conversion. Hypersonic, multiple-pole, analog filters with cutoffs above 35 kHz are used for improved spurious-response rejection. These filters exhibit extremely flat frequency and phase response in the audio band and, according to ADS, have less than 5° of phase shift at 20 kHz. I found that the extremely quiet and low-distortion analog stages placed no dynamic-range limitations on this player.

The CD3 employs advanced digital circuitry for tracking and control functions and for signal processing. This VLSI circuitry is under the control of two internal, eight-bit microcomputers which operate together for rapid control of tracking and error-correction circuits, and for rapid response to front-panel or remote-control command inputs.

Control Layout

The controls on the CD3 are, above all, designed to perform complex functions while remaining extremely simple to use. For example, pushing the power button, with a disc in place, will place the mechanism in the pause mode and give a readout of the total number of tracks on the disc and the total playing time. Loading of the disc drawer can be done by pressing the "Start" button or touching the "Slider" button. A "Pause" button functions as its name suggests, while the "Skip" button moves the pickup to the beginning of the next track if play is in progress. If "Skip" is depressed for longer than 0.5 S, the track or index number increases by one every half-second. Releasing the button advances the pickup to the track or index number shown at the time of release. Fast-forward and fast-reverse operate at three times normal speed when these buttons are first pressed, and at 20 times normal speed if the buttons are held down for more than 5 S. The return button sends the pickup back to its rest position and switches the disc-drive motor off.

The display area above the slider drawer incorporates a four-digit, seven-segment display for indicating elapsed or remaining time, and a two-digit, seven-segment display for showing the selected track or index number.

The only other features visible on the front panel are a headphone jack and pop-out headphone level control, both at the far right, and an indication of where to push on the

Fig. 2—THD vs. frequency at three signal levels.

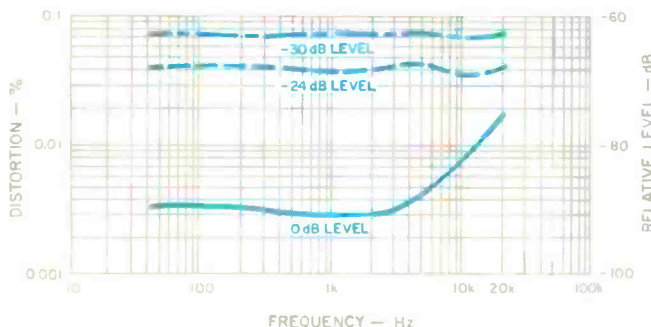

The CD3 is definitely in the superior class, as evidenced by some of its mechanical innovations as well as its electronic and sonic performance.

swing-down slider drawer to expose the programming and display controls. These handle elapsed- or remaining-time display, track or index selection and display, memory clear, and A-B play (automatic repeat between any user-selected start and end point). The CD3's rear panel has fixed and variable output jacks, with a level control for the latter.

The optional RC1 wireless remote control is designed to operate all ADS Atelier remote-controllable components, not just the CD3. It operates like a flip-up telephone/address selector, with seven overlays which show key designations for each of the components it can control. I did not have the remote-control unit on hand when I tested the CD3, but am told that the CD player will be the first ADS component controlled by this hand-held remote unit, with other components to follow.

Measurements

Frequency response, measured for both the left and right channels, was flat to within 0.2 dB from 20 Hz to 20 kHz (see Fig. 1). Output was extremely linear at all recorded levels, deviating from perfect linearity by no more than 0.2 dB over the range from maximum recorded level (0-dB reference level) to -80 dB.

Harmonic distortion at 0-dB recorded level was about as low as I have measured for any CD player: 0.003% at mid-frequencies and no more than 0.18% at 19 and 20 kHz, where many earlier generation CD players exhibited much higher distortion. SMPTE-IM distortion measurements were also extremely low, with readings no higher than 0.002% at maximum recorded levels. Twin-tone IM measurements resulted in readings of 0.0025% at 0-dB level and 0.008% at -10 dB. Figure 2 shows harmonic distortion as a function of frequency for test signals at three recorded levels. As with all digital audio systems, harmonic distortion increased linearly as signal level decreased, reaching about 0.075% at -30 dB. As for undesired "beats" within or without the audio spectrum, they were practically nonexistent in this unit—a direct result of the oversampling, digital filtering and full 16-bit linear D/A conversion techniques used in the CD3.

Signal-to-noise ratios for the CD3 were outstandingly high, measuring more than 98 dB, unweighted, and between 102 and 104 dB, A-weighted. The spectral distribution of residual noise is shown in the S/N analysis graphs of Figs. 3A and 3B.

At low and mid-frequencies, separation (Fig. 4) ranged from just over 83 to 84 dB. At higher frequencies, separation decreased slightly—more so in R to L than L to R. At 20 kHz, separation in both channels was still 74 dB, far more than is required for a very satisfactory stereo presentation. Output from the fixed-level jacks measured 2.04 V, while maximum level from the variable outputs was 3.24 V.

Figure 5 shows the CD3's reproduction of a 1-kHz, square-wave signal. The shape of the square wave confirms the fact that this player employs the now-preferred digital-filter approach. The very low level of ripple observed on the top and bottom of the waveform is not so much the result of phase shift (virtually none in this unit) as it is the absence of higher order odd harmonics (above 20 kHz) which are not present in the reproduced square wave. The digitally generated unit-pulse signal on my Philips test disc was repro-

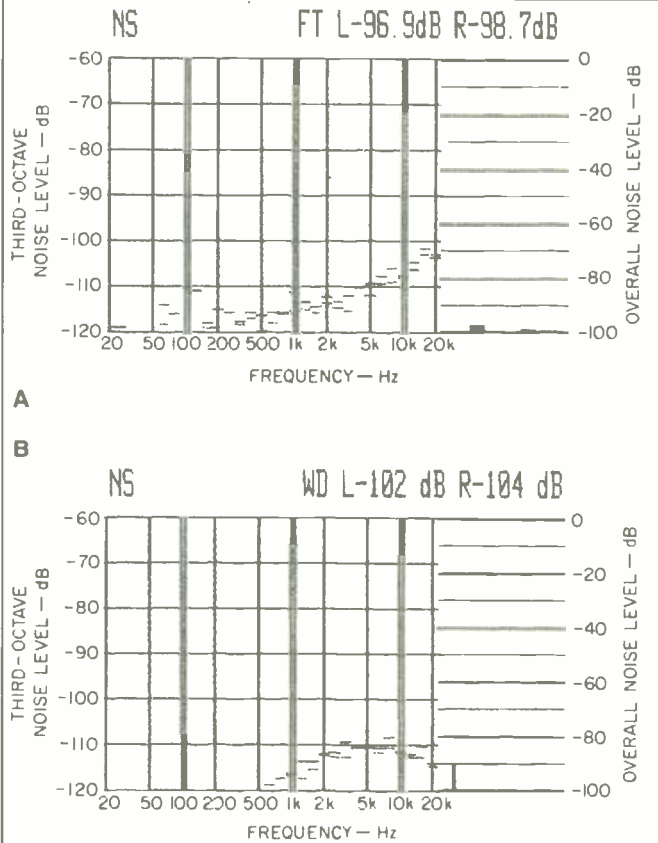

Fig. 3—S/N analysis, both unweighted (A) and A-weighted (B).

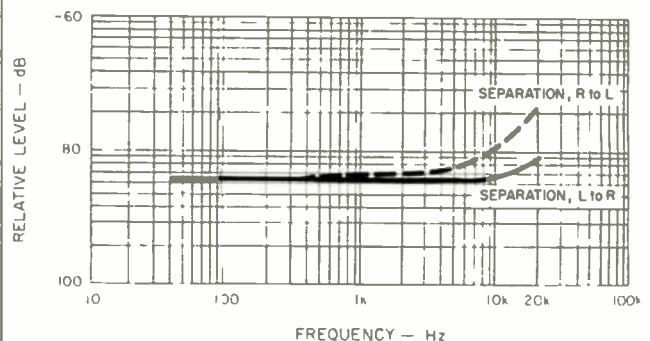

Fig. 4—Separation vs. frequency.

More and more CD players, including this one, zip right through my defects disc without missing a beat. I'll have to find a more severe test!

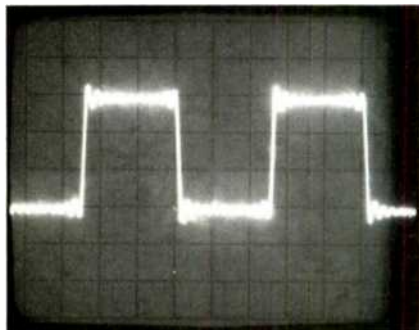

Fig. 5—Square-wave reproduction, 1 kHz.

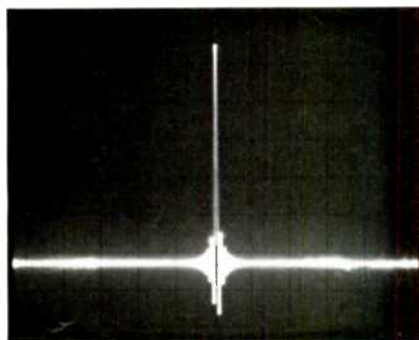

Fig. 6—Single-pulse test.

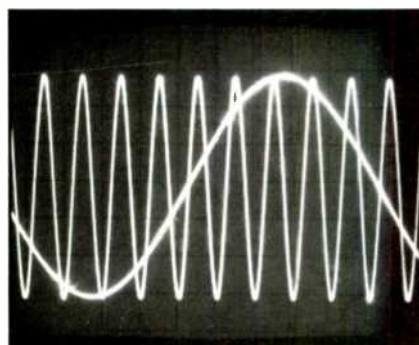

Fig. 7—Phase-error check using tones of 200 Hz and 2 kHz.

duced with the waveshape shown in Fig. 6; again, a result that is typical of CD players which employ this advanced type of digital filtering and oversampling.

While I lack the means to check out ADS's claim of minimal phase shift between channels or within a channel, the 'scope photo of Fig. 7 does show that there was no measurable phase shift between a 200-Hz signal recorded on the left channel and a 2-kHz signal output from the right. The simultaneous zero-axis crossing in the positive direction of both signals confirms this.

More than two years ago, when I subjected the earliest CD players to my special "defects" test disc (a disc with an increasingly wide opaque wedge, a series of black dots meant to simulate dust particles, and a simulated fingerprint smudge), it was a rare event when a player's optical tracking system and error-correction system could play through these imperfections without mistracking or muting. Now, more and more current-generation players, including the ADS CD3, zip right through this problem disc without missing a beat. The maximum width of the opaque wedge on the test disc is 900 microns. ADS tells me that their CD3 could easily handle a width as great as 1.5 mm (1,500 microns). It looks as though I am going to have to come up with a more severe tracking test for CD players! Lateral vibration and shock of more than mild severity also resulted in no mistracking, but, as mentioned earlier, downward (vertical) external shock on the top surface of the unit did result in momentary muting and, in extreme cases, mistracking.

Use and Listening Tests

The ADS CD3 ranks among the best-sounding CD players I have tested thus far; it reproduces well-engineered CDs with smoothness and clarity. I was particularly impressed with its sound quality during very soft musical passages, where earlier CD players have sometimes been less than outstanding.

Ergonomically, the ADS CD3 is a gem. At the time I tested the unit, the owner's manual was not yet available, yet I had no trouble figuring out what the controls did and how they were to be used. If you do most of your listening to CDs from start to finish, or want to select tracks of a disc as you listen (skipping those you don't want to hear all the way through), you may not even have to refer to the owner's manual. The display area includes a transparent window which, with its rear illumination and mirror optics, allows you to watch a CD spin while it plays. I find this not only desirable but comforting, since it assures me that all is well inside the drawer and that my favorite CDs have not been swallowed up.

If there is one aspect of the ADS CD3 that bothered me just a little, it was the fact that the remote control is not included as part of the standard package. I understand that this particular remote is intended to be used with several ADS Atelier components, and therefore it is probably a costlier item to produce. Still, adding an extra \$100 to what is already a fairly expensive CD player may discourage some people from considering this particular CD player. On the other hand, given an opportunity to audition this player and operate its elegant controls, others may well feel that price is of secondary importance when such a magnificently crafted instrument is involved.

Leonard Feldman



17

DENON DCD-1500 COMPACT DISC PLAYER

Manufacturer's Specifications

Frequency Response: 5 Hz to 20 kHz, ± 0.3 dB.

Dynamic Range: 96 dB.

S/N Ratio: 96 dB, A-weighted.

THD: 0.0025% at 1 kHz.

Channel Separation: 95 dB.

Number of Programmable Selections: 20.

Output Level: Fixed, 2.0 V rms; variable, 0 to 2.0 V rms.

Dimensions: 17½ in. W x 3½ in. H x 14 in. D (44.5 cm x 8.9 cm x 35.6 cm).

Weight: 13.2 lbs. (6 kg).

Price: \$650; wood side panels, \$30 per pair.

Company Address: 27 Law Dr., Fairfield, N.J. 07006.

(Originally published June 1986)





With so many low-cost CD players now available, I think a lot of us tend to forget that there are several companies which still offer a wide variety of CD players in many price categories. The higher priced units often deliver more than just increased programmability, remote control, and other convenience features; some actually provide better sound when compared with their lower priced counterparts. Denon's DCD-1500 is such a CD player. It does indeed offer a wireless remote control (which operates virtually all of the front-panel functions, plus volume) as well as full random programming of up to 20 selections. Certainly it provides several repeat-play modes and a display area that tells you just about everything you need to know about the player's operation. Still, my own enthusiasm for the DCD-1500 stems more from its circuitry and sonic performance than from its admittedly advanced and easy-to-use operating features. More about the sound quality of this excellent machine shortly; first, let's take a look at its superb ergonomics.

Control Layout

A slide-out drawer with its "Open/Close" pushbutton is at the upper left of the front panel; below the drawer is a "Power" on/off button. A large, well-illuminated, and easy-to-read display area to the right of the disc drawer indicates track and index numbers, time elapsed (or remaining time), presence or absence of a disc, and programmed track numbers (from 1 through 20). Below the display are separate pairs of pushbuttons for track skipping (forward and reverse) and for audible search in either direction.

A pushbutton labelled "Index" and another called "Program & Direct" are used, together with 10 numbered keys, to call up specific tracks or indexed passages for immediate play, or to enter up to 20 tracks for programmed play. A pushbutton labelled "+10" facilitates accessing track numbers above 10; if you wanted to play track 28, for instance, you would touch the "+10" button twice, then the "8" button, and then either the "Play" button or (if you were storing the command in the program memory) the programming button. A large "Play" button, along with "Pause" and "Stop," are to the right of the number keys. Still further to the right are buttons which activate the various repeat-play modes (track, entire program, or entire disc), clear a program from memory, recall previously programmed information, and switch from an elapsed-time to a remaining-time display. A timer-start switch, also at the right of the panel, allows the DCD-1500 to be turned on or off by an external timer.

At the lower right corner of the panel are a stereo phone jack and a level control for the phone output signal. The rear panel is equipped with the usual left and right output jacks as well as a subcode output jack for use with video-graphics adaptors when they become available to consumers, sometime in the near future.

Measurements

Frequency response for the Denon DCD-1500 (Fig. 1) was extremely flat, deviating from perfect flatness by no more than +0.2 and -0.4 dB from 20 Hz to 20 kHz. Total harmonic distortion at 1 kHz for a 0-dB (maximum recorded level) test signal was 0.004%. What's remarkable about the

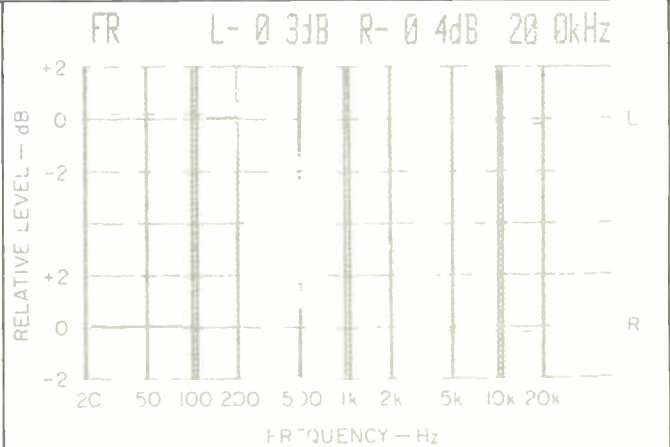

Fig. 1—Frequency response, left (top) and right channels.

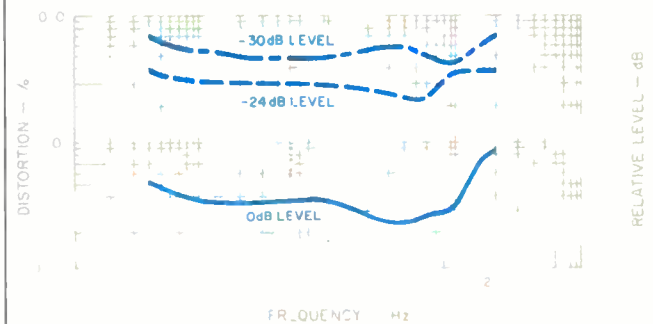

Fig. 2—Distortion vs. frequency at three recorded levels.

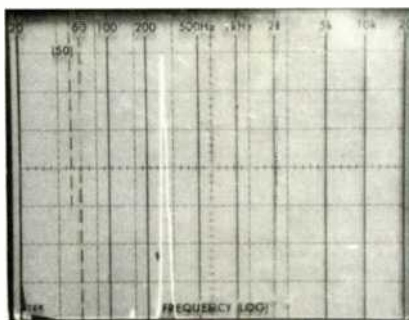

Fig. 3—Spectrum analysis of 20-kHz test signal shows no out-of-band components other than a minute "beat" at 16 kHz.

The outstanding separation indicates careful layout of analog output stages and complete independence of left- and right-channel D/A conversion systems.

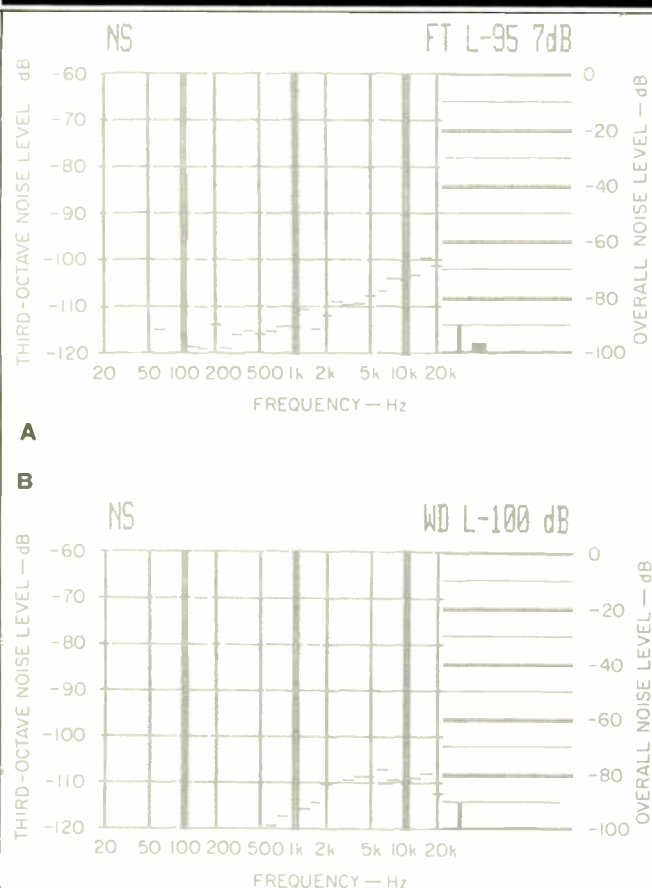

Fig. 4—S/N analysis, unweighted (A) and A-weighted (B).

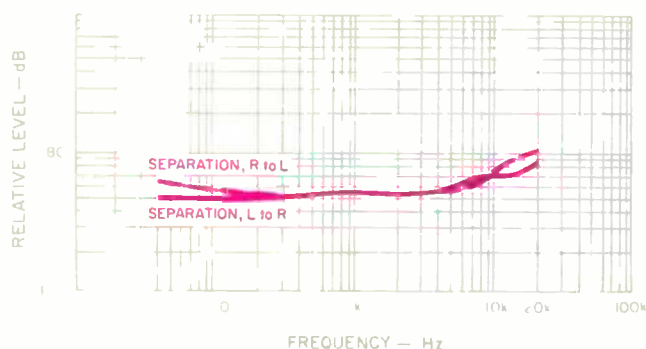

Fig. 5—Separation vs. frequency.

distortion characteristics of this player is that even at the high-frequency extreme, where I normally have to introduce a low-pass filter to obtain meaningful THD measurements, the readings on my distortion analyzer remained unusually low (see Fig. 2). The significance of this can best be appreciated if you refer to Fig. 3. In this 'scope photo of a spectrum-analyzer sweep (which is linear, from 0 Hz to 50 kHz), you can see a reproduced 20-kHz signal, but that's all you see, aside from a very minute "beat" at around 16 kHz. There were absolutely no out-of-band components visible outside the audio spectrum. It's been a long time since I obtained such a clean sweep (pardon the pun) when making this test on CD players; the last two players I tested that exhibited this kind of clean, spurious-noise-free out-of-band output were the Pioneer PD-9010X and the Sony CDP-620ES. Most other players usually produce an out-of-band beat at around 24 kHz when reproducing the high-level 20-kHz signal. I'm not saying that the absence of such out-of-band beats results in improved sound quality, but I'm beginning to wonder whether there isn't some sort of subtle correlation. The fact is that the Denon DCD-1500 did sound remarkably smooth and clean during my listening tests, but I'll get to that presently.

Figure 4A shows an analysis of unweighted signal-to-noise ratio; it measured 95.7 dB, almost as good as the weighted S/N claimed by Denon. When an A-weighting network was added to the measurement, as shown in Fig. 4B, S/N improved to an even 100 dB, several dB better than claimed by the manufacturer.

Stereo separation was outstanding too. Notice, in Fig. 5, how it remains almost as good at the high-frequency extreme as it is at mid- and low frequencies. Most CD players I've tested recently tend to offer much-reduced separation at high frequencies. In the case of the DCD-1500, separation remained above 80 dB even at 20 kHz. Maintaining this kind of separation involves careful layout of the player's analog output stages as well as complete independence of the digital-to-analog conversion system for left and right audio channels.

Output linearity was excellent, remaining accurate to within 0.5 dB all the way from maximum recorded level down to 80 dB below that level. SMPTE-IM distortion measured a mere 0.002% at maximum recorded level, increasing to 0.01% at -20 dB recorded level. CCIF-IM distortion was an insignificant 0.003% at maximum recorded level and an even lower 0.0017% at -10 dB. That's as low as I've ever measured, and provides further proof of the nearly complete absence of any intermodulation distortion products generated by the combination of sampling frequency and program content.

As I might have guessed, wow and flutter was too low to be measured by my test instruments, and any pitch error that might be present was also too low to be measured by my frequency counter. De-emphasis networks, automatically switched in when pre-emphasized CDs are played, were accurate to within 0.3 dB. The only parameter that fell short of published specs was dynamic range, which, when measured in accordance with the recently approved EIAJ Standards, was 91 dB as against 96 dB claimed by Denon. It's entirely possible that Denon is measuring this specification

With sound as good as any CD player I've tested so far, and a price a good deal lower than many, this unit is a winner in my book on every count.

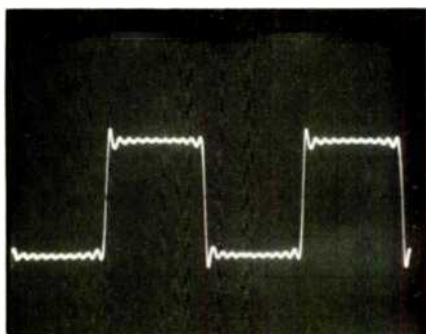

Fig. 6—Reproduction of a 1-kHz square wave.

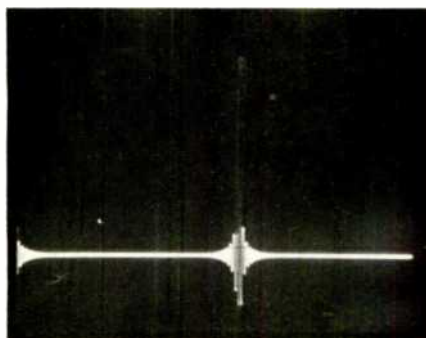

Fig. 7—Unit-pulse test.

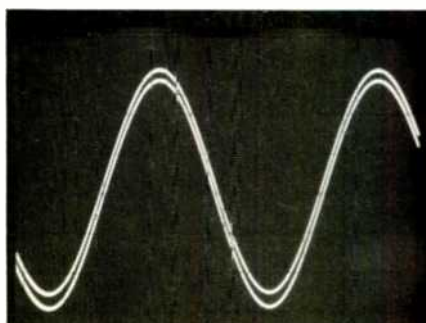

Fig. 8—Interchannel phase match when playing 20-kHz test tone shows that separate D/A converters are used in each channel.

in some other way. In any case, a dynamic-range capability of 91 dB is certainly nothing to be ashamed of, by anyone's standards.

Output level for the DCD-1500 measured 2.06 V on one channel and 2.08 V on the other, for a difference of 0.02 V. Denon employs 88.2-kHz oversampling and digital filtering prior to D/A conversion. This technique results in the extraordinarily clean and accurate 1-kHz square-wave reproduction shown in Fig. 6. What appears to be a minor amount of "ringing" along the top and bottom of the reproduced square wave is not ringing at all, but simply the absence of higher order harmonic components (above 20 kHz) that would be needed in order to yield a perfectly straight horizontal line here.

Figure 7 shows a reproduced unit pulse; its symmetry is consistent with what I have come to expect from CD players employing the type of filtration and oversampling used by the DCD-1500. As for the sine waves shown in Fig. 8, they are perfectly in phase with each other, indicating that Denon is using two separate D/A converters (one for each channel). This technique avoids the usual 11.3- μ S delay which occurs between channels when a single D/A converter is "multiplexed" to recover separate left and right signals.

I would have been very surprised if this superb player had not been able to play through my defects disc without any skipping or muting. In fact, it did play through the maximum width of the opaque wedge, the maximum-diameter dust simulation, and the simulated fingerprint smudge without so much as a hint that there was anything wrong with the test disc. It also successfully tracked a damaged disc that I keep around in the laboratory for just such rigorous testing—a disc that has been rejected by more than one CD player in the past.

Use and Listening Tests

I suspect that I am sometimes influenced by what I measure or the test bench when it comes time to judge a product's sound-reproduction qualities. I'm convinced that we can "psych" ourselves into hearing subtle qualities that we want to hear, or that we expect to hear. To me, the sound of the DCD-1500 seemed a shade better than what I have been hearing of late from several CD players whose measurements haven't been quite as good as this one's. I wanted to be sure that the measurements weren't prejudicing me, so I called in two friends who own CD players and asked them to bring their players along to my listening room. Without knowing when they were listening to their own players and when they were listening to the Denon, both of these friends preferred the sound of the DCD-1500 over that of their own.

I've always wanted to believe that, ultimately, there is a correlation between measured results and audible results—providing the right measurements are made. Happily, that contention held true in the case of the DCD-1500. It not only performed well on the bench and was easy to use via its remote control or via its front-panel controls, but it sounded as good as any CD player I have tested so far. What's more, its price is a good deal lower than that of some of my other favorite CD players. It is a winner in my book on every count.

Leonard Feldman



18

PIONEER PD-9010X COMPACT DISC PLAYER

Manufacturer's Specifications

Frequency Response: 2 Hz to 20 kHz, ± 0.3 dB.

THD: 0.001% at 1 kHz.

THD + Noise: 0.0022% at 1 kHz.

Dynamic Range: 96 dB.

S/N Ratio: 98 dB, A-weighted.

Number of Program Selections:

32, for tracks numbered up to 99.

Channel Separation: 95 dB at 1 kHz.

Line Output Level: 2.0 V.

Power Consumption: 120 V, 60 Hz, 18 watts.

Dimensions: 18 in. W x 3.7 in. H x 12.2 in. D (45.6 cm x 9.5 cm x 31 cm).

Weight: 12 lbs., 8 oz. (5.7 kg).

Price: \$539.95.

Company Address: P.O. Box 1540, Long Beach, Cal. 90801.

(Originally published February 1986)





Pioneer's top CD player is also its most versatile and feature-laden. Supplied with a wireless, 13-function remote control, the PD-9010X can be programmed from the comfort of your armchair for up to 32 randomly accessed tracks on a disc—and the track numbers programmed can extend up to 99! In addition to the usual line output, this player is equipped with a stereo headphone jack and a headphone level control, both conveniently located on the front panel. To keep the panel simple and uncluttered, Pioneer has elected to place the programming number keys on the remote control only. In other words, you cannot program the unit from the front panel. You can, however, play discs in the normal fashion using front-panel buttons and controls. Fast search and fast advance or reverse of the pickup from track to track is possible, and you can access a given point on a disc by its index number—if the disc is so coded—from both the front panel and the remote-control unit. Index numbers cannot be included in any random programming, however.

Control Layout

The "Power" on/off switch, headphone level control, and stereo phone jack are located at the left of the front panel. The slide-out disc tray to their right can be opened and closed using the "Open/Close" pushbutton just to its right; the compartment can also be closed by gently pushing the front of the tray when a disc is in place. Two small indicator lights below the drawer show when a disc has been loaded and when a remote-control command has been received by the remote sensor on the front panel.

The elaborate fluorescent display area is immediately to the right of the disc tray and its "Open/Close" switch; it provides no fewer than 11 separate status indications. These include track and index numbers; minutes and seconds of total time, time remaining or elapsed time; play, pause, and repeat-play modes; indication of whether a disc has been properly loaded, and acknowledgment of commands from the remote control.

In addition to the large numerals that display the current track being played, there are 15 small numerals arranged in a row below the main display. These illuminate to show total number of tracks on the disc. If a disc contains more than 15 tracks, an arrow pointing to the right illuminates to indicate that fact.

Near the right-hand end of the panel are "Play" and "Pause" buttons. Along the panel's lower edge are a "Time" key (which toggles the time display), a "Repeat" key, forward and reverse "Index Search" keys, forward and reverse "Manual Search" keys, a pair of track-advance and track-reverse keys, and a "Stop/Clear" key to discontinue play as well as to clear the memory of programmed instructions.

The hand-held remote-control unit supplied with the PD-9010X duplicates most of the function keys described above. It is also equipped with the "0" to "9" number keys and the "Program" key needed for random-access programming.

Measurements

Frequency response of the PD-9010X is shown in Fig. 1. Response was very slightly attenuated at 20 kHz, measuring

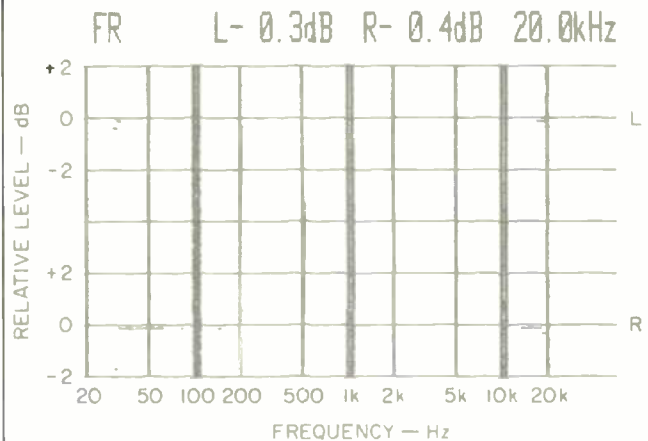

Fig. 1—Frequency response, left (top) and right channels.

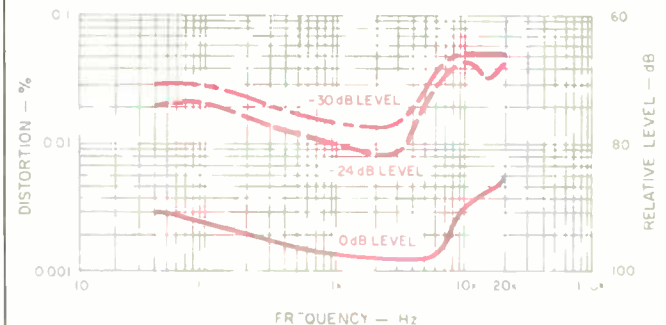

Fig. 2—Distortion vs. frequency at three recorded levels.

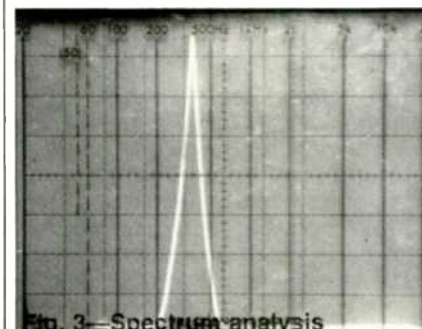

Fig. 3—Spectrum analysis of 20-kHz test signal shows no out-of-band components other than a minute "beat" at 16 kHz.

The harmonic distortion produced by this unit was truly negligible, and its output at 20 kHz was totally clean.

-0.3 dB for the left channel and -0.4 dB for the right channel. As usual, in order to plot frequency response deviations in greater detail, the vertical scale in Fig. 1 is only 2 dB per division.

The harmonic distortion produced by this well-designed unit was truly negligible. Unlike almost every other CD player I have tested in the past two years, this one did not produce any significant "beats" at out-of-band frequencies. As a result, it was not necessary to introduce a band-pass filter when making the measurements. The values plotted in Fig. 2 are the actual values read by my distortion analyzer in its wide-band mode, and the three curves are valid all the way up to 20 kHz. Cutoff of the analyzer, when used in the wide-band mode, is at 80 kHz, so if there were any out-of-band components of significance, they would have contributed to and increased the readings. Under these test conditions, THD at 1 kHz was an incredibly low 0.0015%, well below Pioneer's claimed 0.0022% for THD + noise.

Figure 3 confirms the fact that no out-of-band beats were present when the PD-9010X reproduced high frequencies. The tall spike in this spectrum analysis represents a 20-kHz test signal; as you can see, there are no other components visible. The only other CD player I ever tested that exhibited such totally clean output at 20 kHz was Sony's top-of-the-line CDP-650ESD, which has a suggested price more than twice that of the Pioneer PD-9010X.

Unweighted signal-to-noise ratio measured 98.1 dB; the A-weighted measurement was a very high 102 dB, 4.0 dB higher than claimed by Pioneer (see Figs. 4A and 4B). SMPTE IM measured 0.003% at maximum recorded level, increasing to 0.025% at -20 dB recorded level. CCIF IM (twin-tone, using 19- and 20-kHz tones at the equivalent of highest recorded level) was an extremely low 0.0037% at maximum recorded level and an even lower 0.0028% at -10 dB recorded level.

Stereo separation, plotted in Fig. 5 as a function of frequency, ranged from 73.0 dB at the high-frequency extreme to 90.0 dB at mid-frequencies.

Reproduction of a 1-kHz square wave is shown in Fig. 6. The reproduced wave shape is typical of that produced by CD players which employ oversampling and digital filtering. The unit pulse in Fig. 7, as reproduced from a Philips test disc, is also consistent with what I have obtained with other players that employ this type of filtering and oversampling. The apparent inversion of the waveform is not our photo editor's mistake. Evidently, phase inversion occurs somewhere in this player's signal chain, as it has in a few other units I have tested. So long as this inversion is the same in both left and right channels, there is no problem.

In checking for phase error, I detected no difference in the positioning of a pair of low- and mid-frequency test tones (200 Hz and 2 kHz) on opposite channels compared with the positioning of a pair of mid- and high-frequency signals (2 and 20 kHz). I concluded, therefore, that in addition to its many other sonic virtues, the Pioneer PD-9010X is virtually free of any phase or time-delay errors commonly associated with analog output filters.

As I expected, the Philips defects disc was unable to trip up the excellent tracking and error-correction capabilities of this CD player. As has been true of nearly all of the third-

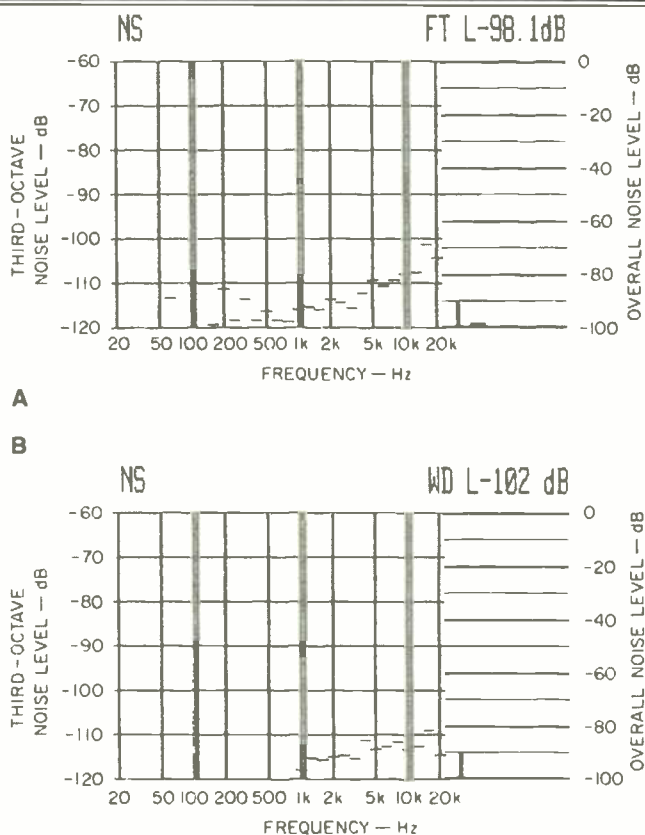

Fig. 4—S/N analysis, unweighted (A) and A-weighted (B).

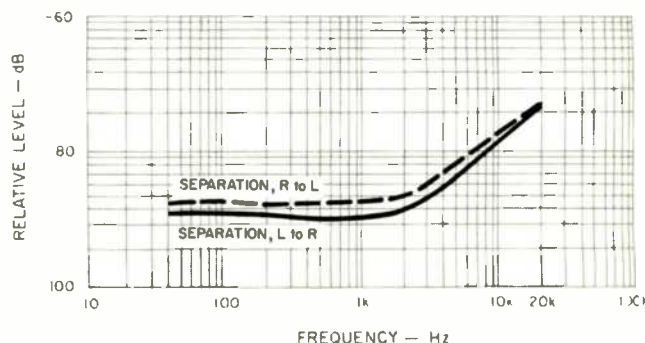

Fig. 5—Separation vs. frequency.

I can't think of any programming or display features that have not been included on this superb-sounding player.

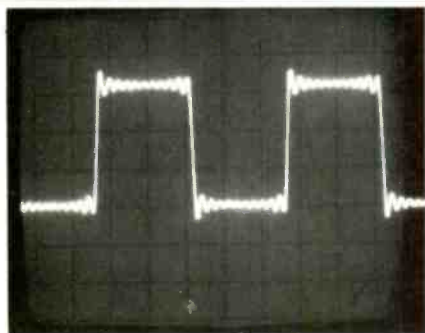

Fig. 6—
Reproduction of
a 1-kHz square
wave.

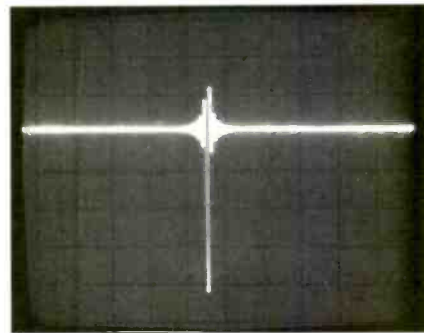

Fig. 7—
Unit-pulse test.

generation units I have been evaluating lately, this one had no trouble playing right through the simulated scratch (up to 900 microns in width), the simulated dust circles (up to 800 microns in diameter) and the simulated fingerprint smudge which extends over two complete musical tracks of the test disc. Resistance to mild vibration and external shock was especially good. The PD-9010X continued to play with no audible interruptions, skipping, or disc rejection while I repeatedly subjected it to less-than-gentle tapping along its top and sides. The folks at Pioneer have advised me that part of this stability comes from the player's unique internal suspension system. Pioneer has apparently gone to great pains to make certain that the PD-9010X will play through discs under a variety of difficult conditions.

Another example of the care Pioneer has taken is the special disc-retaining surface which engages CDs when the machine is in the play mode. Most disc-retaining surfaces simply grab the disc near its center hole. In the PD-9010X, nearly three-quarters of the surface of a disc is supported while being played. You can imagine how much this will help when trying to track moderately warped CDs!

Use and Listening Tests

My initial reaction to the PD-9010X was to object to the fact that I could not program the player at its front panel but had to use the remote control. I felt this way even though I

realized that Pioneer achieved two worthwhile objectives with this approach: Lower cost (since they didn't have to duplicate the number keypad and its associated circuitry on the panel) and a less cluttered appearance. After using the player for a few days, my initial objections simply disappeared. More often than not, I found myself loading a disc and then, with the remote in hand, sitting down across the room to program what I wanted to hear—with the disc's "jewel box" package and album booklet alongside my chair. I realized, too, that if I desired to program the machine at its front panel, there would be nothing to stop me from simply keeping the full-function remote control alongside or on top of the player.

Such minor considerations aside, let me get to the important things. In a word, the Pioneer PD-9010X is one of the most value-laden CD players it has been my pleasure to evaluate so far. I can't think of any programming or display features which have been omitted that a user might require. All of those convenience features wouldn't be worth much, however, if the player lacked good sound-reproduction capability. Not only is this player a superb-sounding instrument, but Pioneer has somehow managed to put all of these desirable qualities together in a unit that sells for a price that more music lovers than ever will be able to afford. I'll bet the competition is tearing apart several PD-9010Xs right now trying to find out how Pioneer did it! *Leonard Feldman*

The elaborate display of the PD-9010X has eleven status indications, but Pioneer kept the unit's front panel simple by placing all programming controls on the remote transmitter.

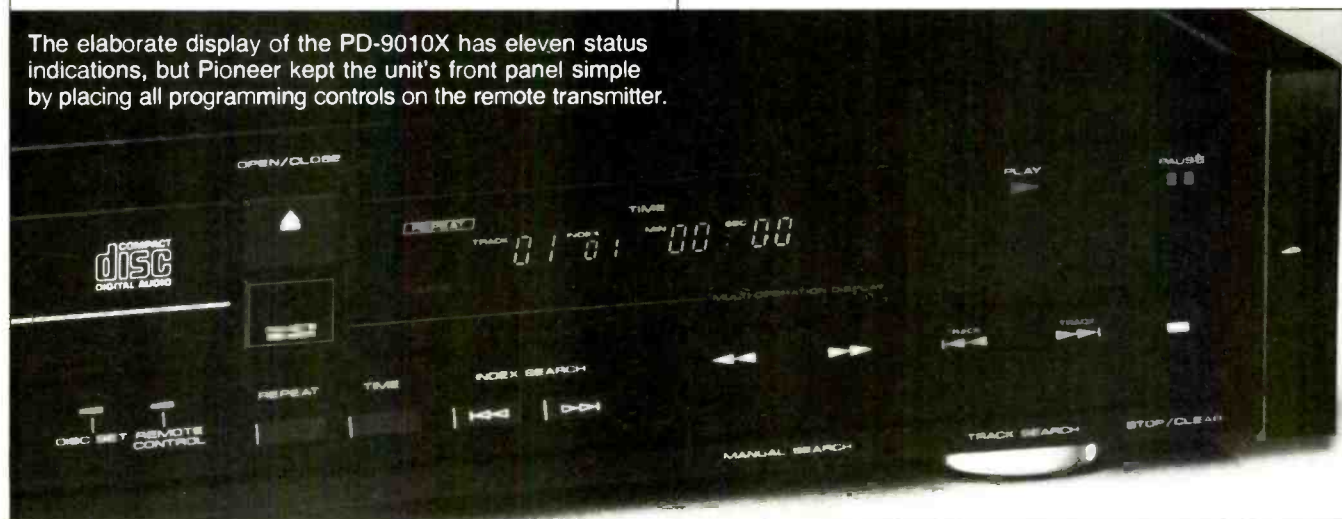



19

SONY CDP-650ESD COMPACT DISC PLAYER

Manufacturer's Specifications

Frequency Response: 2 Hz to 20 kHz, ± 0.3 dB.

Harmonic Distortion: 0.0025% at 1 kHz.

Dynamic Range: Greater than 96 dB.

Channel Separation: Greater than 95 dB.

Number of Programmable Selections: 20.

Output Level: 2.0 V, fixed and variable.

Phone Output Level: 28 mW into 32 ohms.

Power Consumption: 16 watts.

Dimensions: 16-15/16 in. W \times 3 1/8 in. H \times 13-3/16 in. D (43 cm \times 8 cm \times 33.5 cm).

Weight: 19 lbs., 6 oz. (8.8 kg).

Price: \$1,300.

Company Address: Sony Dr., Park Ridge, N.J. 07656.

(Originally published July 1985)





Digital Compact Disc technology is moving along at a rapid clip. Sony, one of the "founding fathers" of CD, measures its progress by, among other things, the generation number of its players. The CDP-650ESD is Sony's third-generation, top-of-the-line player; as such, it incorporates a host of technical advances, both internally and externally, which are worth mentioning at the outset.

Most important, perhaps, is the fact that Sony has, at long last, swung over to digital filtering and oversampling—a technique first espoused by Philips, their partner in the development of the CD system. Moreover, Sony's use of oversampling and digital filtering goes a step further than anyone else's in that it employs a single master clock to synchronize all decoding and digital-to-analog conversion operations. The very significant benefits of this technology became apparent to me when I tested the unit and listened to it, but more about that later.

Much of the advanced circuit integration developed by Sony for their miniaturized car CD players and their acclaimed Model D-5 portable CD player is also found in the CDP-650ESD, including the incredibly dense VLSI chip that replaces the function of three ICs used in earlier-generation players. The tracking, servo and laser pickup mechanism is the same lightweight, lower-mass assembly used in the aforementioned D-5 and car players; the motor which guides the laser pickup and keeps it on track is a brand-new, linear unit which replaces the bulky, worm-gear motor used on earlier models. This new motor enables the player to access any point on a CD in 1 S or less—even track 99 of a 99-track disc, if any such were ever produced (besides test discs)!

Random-access programmability has been increased to 20 selections, including programmed access to index points on those discs which are index-configured. (More and more such discs are appearing lately.) In addition to specific, programmed play, Sony has incorporated a new playing mode which they call "Shuffle Play." In this mode, the selected tracks or index segments are played back in random order. I wondered what possible use this might be to consumers; when I inquired, I was told that it might be handy to have when playing a multi-track disc for background music or for dancing. The disc could be repeated over and over, but the order of selections would be different each time so that listeners wouldn't become bored. I rather think that this function won't be used by too many people, but if nothing else, it does display the power of the micro-processor used in this machine. Another novel convenience is the "Auto Delay" function, which allows you to delay the playback of each chosen selection by 2 S. Repeat play and AMS (Automatic Music Sensor, for rapid selection of a given track) are pretty much the same as they were on earlier Sony players.

Control Layout

The front panel of the CDP-650ESD has a completely new look, especially in the display area. The disc-compartment drawer remains basically as it was on earlier machines. The compartment drawer is opened by touching an "Open/Close" key just to its right, and is closed by touching the front of the drawer itself, by touching the "Open/Close" key

or by initiating "Play" of a disc. Numbered keys from 0 through 20, plus a key labelled "+ 10," are located near the panel's center and are used to call up desired tracks either for immediate play or for programming. With the aid of the "+ 10" key, it becomes easy to call up or program track numbers higher than 20; for example, to call up track 44 (assuming there were that many tracks on a disc) you would punch the "+ 10" button four times and then touch the "4" button. The "Play," "Pause," "AMS" (automatic track advance and track retard), and play-mode keys ("Continue," "Single," and "Program") are to the right of the numeric keyboard, while "Check" and "Clear" keys (for verifying programmed instructions or clearing them from memory) are just below the numeric keys. The "Stop" key and a pair of manual-search keys are near the lower right corner of the panel; the latter allow fast search in either direction while listening to a disc.

At the lower left corner are the switches to turn the player on and off, either manually or by an optional external timer. Five more buttons are beneath the display: "Repeat" (which

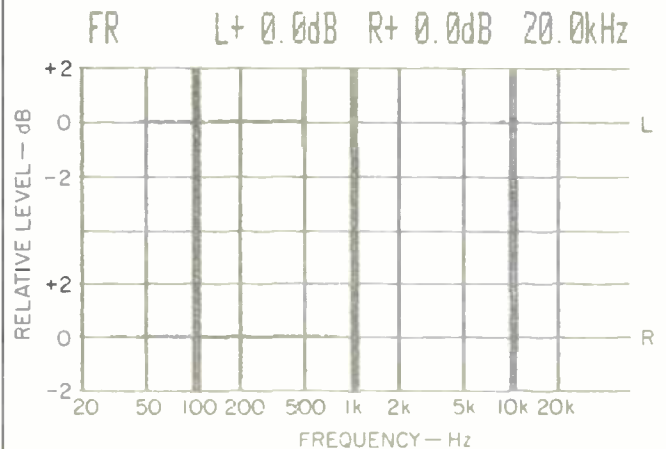

Fig. 1—Frequency response, left (top) and right channels.

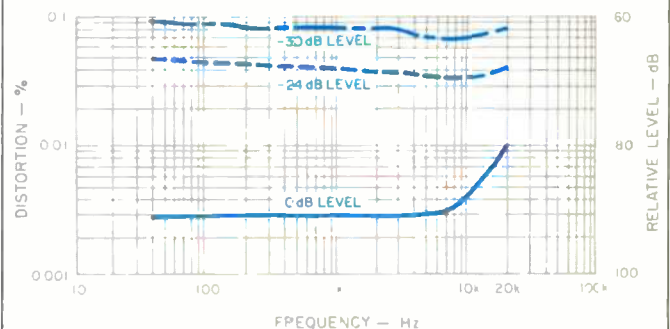

Fig. 2—THD vs. frequency at three signal levels.

Sony has, at last, gone to digital filtering and oversampling, using a single master clock to synchronize all D/A conversion operations.

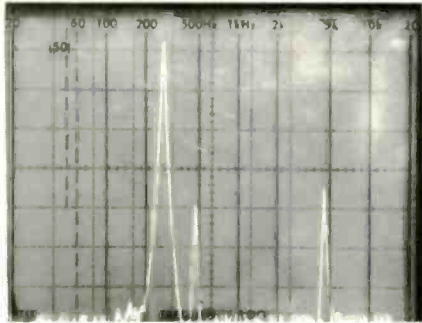

Fig. 3— Spectrum analysis done on early CD player, showing desired tone (tall spike) and spurious beat tones.

repeats a selection program or the passage between two user-selected points), "A↔B" (which sets those points in memory), "Time" (to select elapsed- or remaining-time display), "Auto Delay," and "Shuffle Play." At the lower right corner are an output-level control (which varies both headphone output level and the level at the rear-panel variable output jacks) and a stereo phone jack.

The display area on the front panel provides a variety of useful data concerning the status of the player and the disc being played. A "Disc" indicator lights up when a disc has been inserted properly. When a disc is first inserted, a "Track" indicator shows the total number of tracks contained on the disc for a few seconds, then displays the

SONY'S DAS-702ES: GILDING THE DIGITAL LILY?



Along with the remarkable Sony CDP-650ESD Compact Disc player tested for the accompanying report, I also evaluated another new product from Sony, the DAS-702ES external D/A converter. In essence, this unit duplicates functions which must be incorporated into any CD player, the translation of the digital code extracted from a digital program source (such as a Compact Disc) into the closest possible replica of the original analog audio signal. In fact, it's only usable with signal sources having digital outputs, like the CDP-650ESD, but no other CD players that I know of so far. Thus, my first

reaction to this additional component was to ask why anyone would want or need it, since full decoding is performed by the D/A circuitry already contained in every CD player (including the Sony CDP-650ESD, which is intended to serve as a companion piece for the DAS-702ES).

The people at Sony suggested that this separate D/A decoder (or converter) is a state-of-the-art device which, if connected to the CDP-650ESD, would yield sound superior even to that of the top-of-the-line CD player itself. Furthermore, I learned that the DAS-702ES offers greater digital-to-analog decoding flexibility

and might well be needed in the future for certain other D/A decoding chores. For example, the digital input applied to this decoder need not be confined to a sampling rate of 44.1 kHz (the standard CD sampling frequency). The unit can also handle a sampling rate of 32 kHz (the standard sampling rate for digital-audio broadcasting in Europe and elsewhere) and the 48 kHz used in professional digital recording with equal ease.

I was curious to learn whether I would be able to measure or hear any difference between the sounds produced by the superb CDP-650ESD operating on its own, and the sounds produced by hooking up that player (via its digital-output jack) to the DAS-702ES. To satisfy my curiosity, I repeated virtually every measurement that I had made on the CDP-650ESD alone, on the combination of the CD player plus the separate D/A unit. I resolved to do a blind listening test between the two setups as well, using my associate to set up the test in a random switching sequence and instructing him not to tell me when he was switching setups from one to the other. But I'm getting a bit ahead of myself.

On the DAS-702ES, the digital input jacks are paralleled by a pair of jacks identified as "Digital Outputs." These provide a convenient feed-through to pass the undecoded digital program material to other devices which might require data in digital format (such as, for example, some future type of dedicated, digital tape-recording mechanism, or even the

The brand-new, linear pickup motor enables the player to access any point on a CD in 1 S or less.

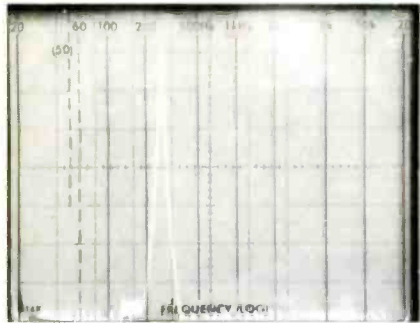

Fig. 4— Same test as in Fig. 3, done on the Sony CDP-650ESD. Note absence of unwanted beat frequencies above the residual noise floor.

number of the track actually being played. A time counter displays the total amount of playing time on a disc when the disc is first inserted, after which it reverts to displaying the elapsed time of the track being played or the total time remaining on the disc. A "PGM" (ProGraM) indicator illuminates when the player is in the standby mode for programming. An "Index" indicator shows the index number of the selection being played (or, during the "check" sequence, of index numbers programmed for future play). Lights on a 1 to 20 numeric grid show how many selections you've programmed. If you program more than 20, the word "Over" lights up, along with the grid.

The rear panel of the CDP-650ESD is equipped with fixed-

black box that will someday be used to generate the video graphics signals encoded in certain CDs).

The only front-panel controls on the DAS-702ES are a power "On/Off" switch, a "Digital Input" switch (for selecting between the two sets of digital input signals which may be connected to the unit), a headphone jack for monitoring decoded output using stereo phones, and an output-level control which regulates both headphone and variable line-output levels. The rear panel is equipped with the aforementioned pairs of digital input and output jacks, as well as pairs of fixed- and variable-level analog (decoded) output jacks.

Measurements

Many of the published specifications supplied for the DAS-702ES, though excellent in their own right, are actually somewhat poorer than the specs supplied by Sony for the CDP-650ESD operating by itself! For example, frequency response claimed for the separate decoder/converter, though extending from 5 Hz to 20 kHz, carries a tolerance of ± 0.5 dB, as opposed to ± 0.3 dB and a range of 2 Hz to 20 kHz for the player. Rated distortion for a 1-kHz signal at maximum recorded level (using a 44.1-kHz sampling rate) is listed as 0.004%, as opposed to 0.0025% for the CDP-650ESD. Dynamic range is marginally lower than that of the player alone, as well. And so on.

Sony maintains that when you get down to the published specs that are

involved in the digital domain, such minute differences are not what determine which unit will sound better. I certainly couldn't take issue with that, but I did want to make some measurement comparisons for my own satisfaction.

In Fig. B1 you will find a graph of frequency response plotted in the

same way as Fig. 1 of the CDP-650ESD report. Note that at 18.5 kHz there is already some attenuation of response. Figure B2, plotting distortion versus frequency, confirms what Sony admits: The separate D/A converter actually has slightly higher distortion at the three output levels I use to measure THD. Signal-to-noise ratio

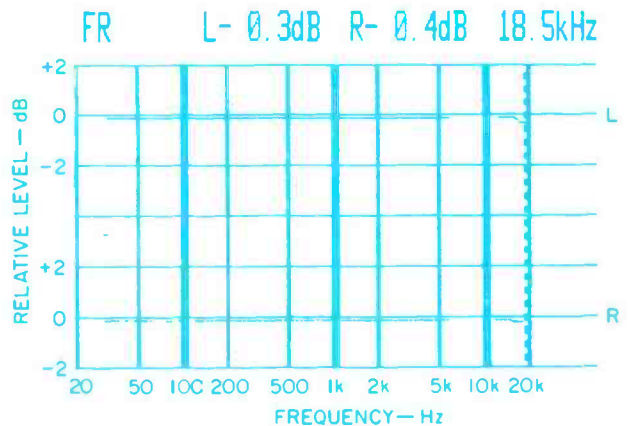

Fig. B1— Frequency response, left (top) and right channels, DAS-702ES D/A converter.

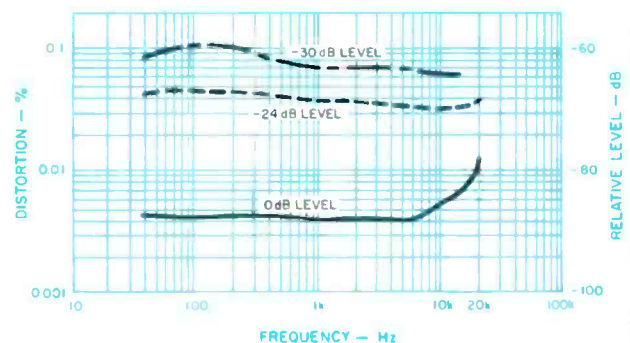

Fig. B2— THD vs. frequency at three signal levels, DAS-702ES.

The CDP-650ESD exhibited the flattest frequency response of any player I've ever tested. Deviation from absolutely flat never exceeded 0.1 dB.

and variable-level output jacks. There is also a multiple-pin accessory connector which, the owner's manual cryptically tells us, is to be used "to connect optional equipment which will be available in the future." By this time, I suspect, many of us know that the "optional equipment" will be a black-box accessory which will allow access to the video graphics that will soon be available on Compact Discs. The addition of this accessory will allow such digitally generated graphics

to be displayed on your TV screen while you listen to the audio content of the same CD.

The rear panel also has a "Play Mode" initializing switch. This switch sets the turn-on play mode, determining whether the CDP-650ESD will set itself for continuous, single-selection, or programmed play when first turned on. The rear-panel switch would therefore be set to the mode you want most often, while the front-panel mode keys are used to

(unweighted, at least) was also a bit poorer on the DAS-702ES, 94.9 dB as against 97 dB for the CDP-650ESD (see Fig. B3). About the only parameter that measured better with this decoder than with the CDP-650ESD alone was separation, which, at mid-frequencies, reached levels as high as 86 dB and remained higher than 82 dB at 20 kHz.

Using the same test disc, I photographed the usual square-wave, unit-pulse and phase-shift signals as they appear on an oscilloscope in order to compare them with the photos obtained for the CDP-650ESD unit. Try as I might, I couldn't see the slightest bit of difference between Figs. B5, B6, and B7 and the corresponding photos taken for the CD player alone. Can you?

Listening Tests

Next, I was ready for the "moment of truth." Dutifully blindfolded, I asked my assistant to play some of my favorite CD tracks through both setups: The CDP-650ESD outputs feeding my reference system directly, and the player's digital output hooked up to the DAS-702ES, whose analog outputs were, in turn, hooked up to another pair of inputs on the reference amplification system. Happily, there was no problem adjusting for precisely equal outputs; when you deal with Compact Disc players, output levels are easily controlled and referenced to maximum recorded level. In this case, maximum recorded level provided an output of exactly 2.0 V rms for both setups.

After extensive listening, I have to tell you that I could not, at any time, distinguish between the sound of the two systems. They were both marvel-

Fig. B3—S/N analysis, unweighted, DAS-702ES.

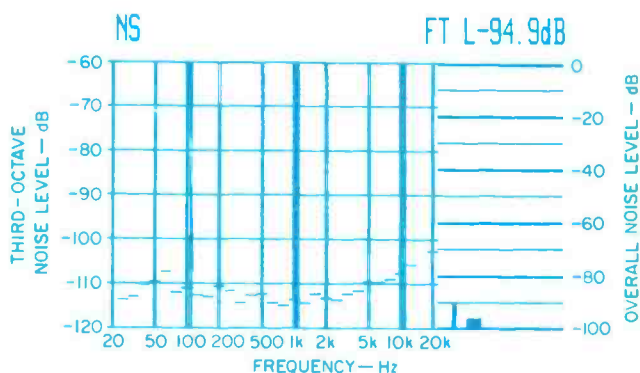
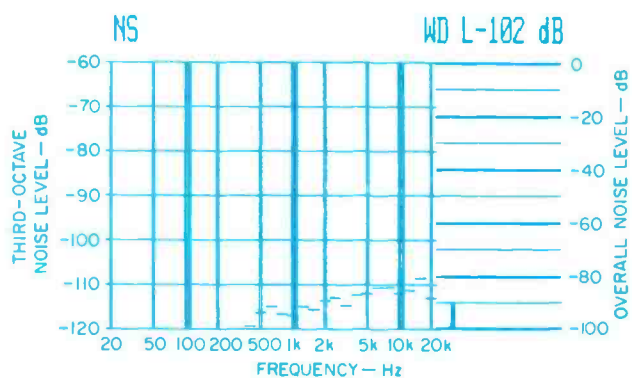

Fig. B4—S/N analysis, A-weighted, DAS-702ES.



ous, of course, but until I have a need for a decoder that will handle digital information using a sampling rate of either 32 or 48 kHz, I myself see no reason to invest in this separate decoder, however more sophisticated its circuitry may be.

Dealing in this rather controversial area of esoterica (which is not my usual habitat, I might add), I don't want to let the matter stand there. I have a feeling that I am going to be deluged by a sack of mail from readers who will tell me that *of course* they

can hear an obvious improvement when the separate (and costly) D/A converter box is used to do the digital-to-analog decoding. In order to forestall such a deluge of mail, I'm going to strongly urge Editor Eugene Pitts to allow other ears to conduct similar testing. If those ears disagree with my conclusion, I will not be upset or the least bit insulted. I will, in fact, conclude that perhaps Sony had very good reasons after all for introducing, as a consumer product, a component part of a Compact Disc player which

This feature-laden player has just about every convenience I would want. They're easy to use and are augmented by the wireless remote control.

change from that play mode. Finally, the rear panel houses a special digital-output jack—a first for any CD player, as far as I have been able to determine. At this jack, you can access the full digital code picked up from a CD by the laser pickup, before it is converted to an analog signal by the player's own D/A conversion circuitry. Aside from the obvious ability to dub CDs onto a digital recorder while the musical information is in the digital domain, this special

output lets you connect an external digital converter component, such as Sony's DAS-702ES (see sidebar).

The 41-button remote control duplicates virtually every control on the front panel, right down to the volume control.

Measurements

To begin with, let me state that the CDP-650ESD exhibited the flattest frequency response of any CD player I have yet

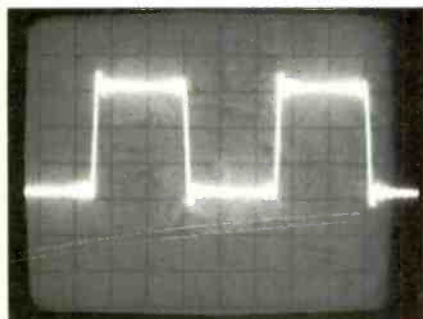

Fig. B5—Square-wave reproduction, 1 kHz, DAS-702ES.

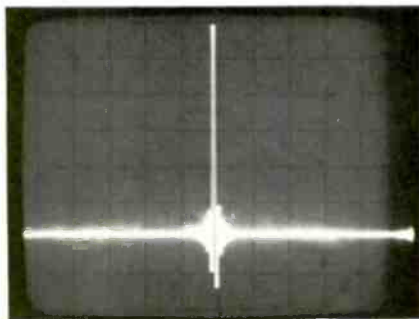

Fig. B6—Single-pulse test, DAS-702ES.

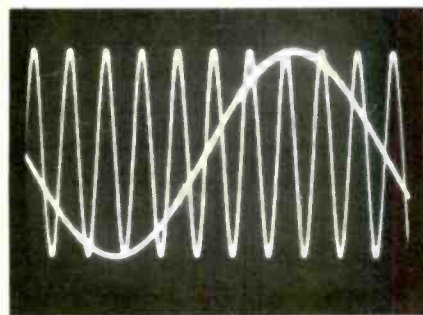

Fig. B7—Two-tone phase-test signal (200 Hz and 2 kHz), DAS-702ES.

casual, nonaudiophile listeners made the same sort of comments when I was independently demonstrating the unit's disc handling to them. They were not prompted to give any sort of comment on the sound; they volunteered the remarks. My conclusion is that I like to listen to the new Sony in preference to the old player, whether or not there is any hard data from a blind A/B test backing up statements on its sonic superiority.

The sound of the CDP-650ESD when combined with the DAS-702ES was, however, a different story—probably because I had troubles with the converter right from the start. I sent the unit home, via UPS, since I do my most serious listening there. The switch controlling the digital output arrived broken, because of its being located as the most vulnerable component during boxed carrying and because Sony uses the very worst sort of packaging—crushable, coffee-cup foam. I fixed the switch once, and Sony fixed it (very quickly, thank you) after two more trips. Neither fix would have been needed had that switch not been placed at the furthest possible point from the handle for the carry home and if not for that awful foam. Neither is worthy of a top-of-the-line product.

Anyway, I thought that the sound of the combined Sonys was less good than the sound of the 650 alone, but still better than the first-generation player. I do not have sufficient switching facilities to be able to check this sort of a three-way comparison, and I think that my difficulties in getting the 702 working probably influenced my judgment about its character. I'd buy a 650, but in the absence of another use, I'd pass up the 702. *E.P.*

sells (at \$1,500) for more than the best complete player they now have available. I look forward eagerly to further tests by others, since without them I will remain rather puzzled by this D/A converter—feeling all the while that perhaps I'm missing the point somewhere. . . . *L.F.*

I have done some fairly extensive A/B tests, with very close mid-band level adjustment, as well as many, many hours of open subjective listening to the CDP-650ESD in comparison with the first-generation player

that had perhaps the most highly respected sonics. In the open listening, there was a smoother, less-shrill character to the Sony that sounded as if all frequencies from about 4 kHz and up had been shelved down about a quarter or a half dB. There was an edge to the sound of the other machine, as if a bit of interstation FM noise had been added, noise which was whistley, whiny, and scrapey in character. These differences tended to go away for me when I was doing the A/B tests. However, three other

Sound quality of the CDP-650ESD is absolutely magnificent, far better than Sony's first generation of players.

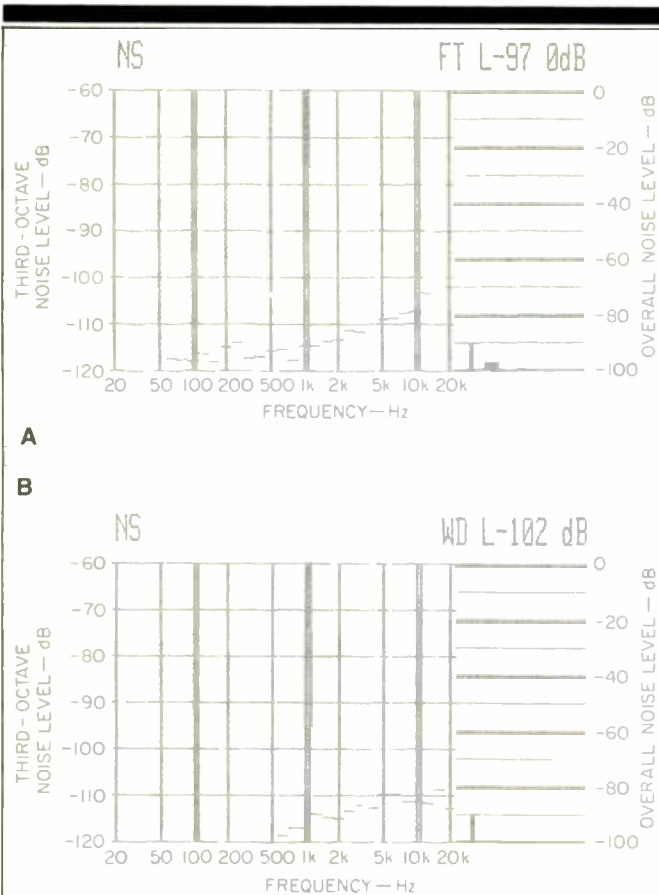

Fig. 5—S/N analysis, unweighted (A) and A-weighted (B).

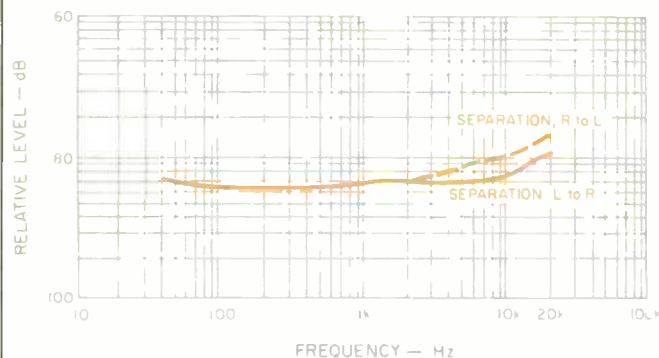

Fig. 6—Separation vs. frequency.

tested. As you examine Fig. 1, a plot of frequency response for the left- and right-channel outputs, you are not going to see very much because the plot of output, for the most part, fell smack on the 0-dB line of the graph. Maximum deviation from absolutely flat response was never more than 0.1 dB, and, as you can see from the notations on the graph, at the highest test frequency (20 kHz), deviation from flat response was 0 dB.

Harmonic distortion at mid-frequencies for a maximum recorded level signal measured under 0.003%. I have tested other players with such low distortion, but I have never run across a player that exhibited such a low distortion figure at high frequencies (0.01% at 20 kHz). Part of the explanation lies in the fact that Sony has swung over to a combination of oversampling and digital filtering—but that's not the whole answer, since many other manufacturers have employed these circuit techniques before. Another factor is the use of a single master clock (as opposed to several nonsynchronized clocks) to synchronize the decoding operations to the 44.1-kHz sampling rate of Compact Discs. Figure 2 shows how harmonic distortion varied with frequency for recorded levels of 0, -24, and -30 dB.

Figures 3 and 4 are perhaps of even greater interest. Figure 3 shows what happens when a test signal is recovered by an earlier generation CD player. The tall spike represents the desired output signal, while shorter, spurious components to the right represent undesired output resulting from nonlinearities in the system and from the use of multiple digital clocks in the decoding system. The same signal, reproduced by the Sony CDP-650ESD, was scanned by a spectrum analyzer in the same way, and the output over a wide spectrum of frequencies is shown in Fig. 4. All that you can see now is the desired output at the left and the random, residual noise floor. There are no unwanted "beat" frequencies at any other point in the display!

Unweighted signal-to-noise ratio measured a very high 97.0 dB, increasing to 102 dB when an A-weighting network was used (see Figs. 5A and 5B). SMPTE IM measured only 0.002% at maximum recorded level and 0.015% at -20 dB recorded level. IHF IM (twin-tone) measured only 0.0021% at 0-dB level and 0.0021% at -10 dB level. Stereo separation, plotted as a function of frequency in Fig. 6, ranged from 82 dB at mid-frequencies to around 76 dB at high frequencies.

This player's reproduction of a 1-kHz square wave is shown in Fig. 7. Notice how much closer this waveform is to a true square wave than were the waveforms other players reproduced from this signal in earlier tests. It's not just that the "ringing" on the leading edge of the square wave, associated with the use of steep, multi-pole analog filters, is absent. There's also much less of the low-level ripple normally seen on the horizontal portions of the square wave with players using digital filtering and oversampling. This suggests very minimal phase shift for the square wave's higher order (high-frequency) components. The virtual absence of any phase shift indicated by the comparison of 200-Hz and 2-kHz signals on opposite channels in Fig. 9 confirms this. In Fig. 9, both the low-frequency (200-Hz) and higher frequency (2-kHz) sine waves cross the zero axis in the same direction, at precisely the same time.

Teac Compact Disc. HiFi in the extreme.

Teac is not in the habit of building audio equipment for the undiscerning. Rather, we commit ourselves to those few individuals discontented with anything less than the finest recording and sound reproduction equipment money can buy.

Before you stands the remarkable Teac ZD-5000. Perhaps the purest embodiment the compact disc player has yet experienced. A machine with a list of features and specifications so numerous, so advanced as to impress the most jaded audiophile. A machine so refined its output jacks are plated with 24k gold. And when it comes to remote controlled functions, nobody comes remotely close.

The Teac ZD-5000 compact disc player. "Fi" just doesn't get any higher.



This player is likely to convert those few diehards who are not yet convinced that the CD is the best thing to happen to home audio in many a decade.

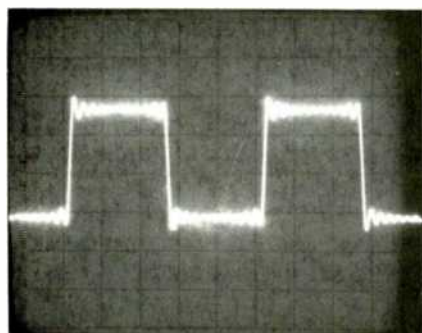

Fig. 7—Square-wave reproduction, 1 kHz.

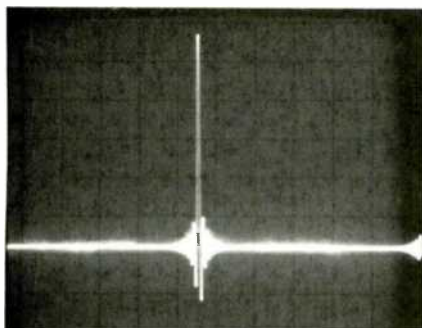

Fig. 8—Single-pulse test.

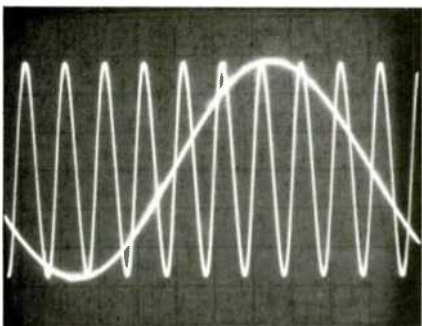

Fig. 9—Two-tone phase-test signal (200 Hz and 2 kHz).

Use and Listening Tests

This feature-laden player has just about every convenience I would want in a CD player. Furthermore, the features are easy to use and are all augmented by the multi-function, wireless remote-control unit which is supplied with the CDP-650ESD. About the only possible feature that Sony has left out is access to a given point on a disc according to time (minutes and seconds into a given track). Sony says that their own opinion surveys of CD-player owners indicated that this feature is rarely used (and seldom requested), while accessing by index (which this player does offer) is increasingly desired.

When I first read that the CDP-650ESD could access any point on a disc within 1 S or less, I presumed that this was a bit of promotional exaggeration, but I felt that no one would really quibble if, in fact, the laser pickup took 2 or even 3 S to reach its destination. Much to my amazement, the claim is no idle exaggeration. I have a special test disc with 99 tracks on it designed to check accuracy of access and other qualities relating to a player's tracking ability. This unit found track 98 in no more than 1 S! I realize that this feat, in and of itself, doesn't really mean that much. But to my mind, it tells me a great deal about the lightweight laser pickup and about the accuracy, speed, and reliability of the new linear motor used in this player. These assemblies and this kind of pickup travel suggest that there will not be much mistracking with this machine: All of its built-in, error-correction circuitry will be available for correcting or concealing errors in discs, with none of it "spent" to compensate for disc-reading errors caused by the player's poor tracking.

Sound quality of the CDP-650ESD is absolutely magnificent. It is far better than the sound quality of Sony's first-generation players, and, with really good software in place, it is also distinctly better sounding than their excellent second-generation players—about which I had nothing but praise last year. I realize that I have used superlatives to describe earlier CD players from Sony, as well as from other manufacturers. It's important to point out that I am talking about relatively minor sonic differences here. Of course, the first players offered great sound—given decent CDs to use with them—and I still maintain that the sound produced by those first- and second-generation players, when playing properly produced CDs, was better, by far, than anything I had heard from LPs or analog tapes. What I am saying now is that the slight problems that I (and others) attributed to some of those early players seem to have been eliminated in this third-generation unit from Sony. I can't tell you if it's their new VLSI chip that's doing the trick or if it's the single master clock, the lighter laser pickup, or the new linear motor. Possibly it's all these things added together, plus the experience gained by Sony's design engineers after nearly three years of intense activity in Compact Disc design. All I know is that the CDP-650ESD is a magnificent-sounding machine that, when heard playing well-made CDs, is likely to convert those few remaining diehards (yes, there are still a few) who aren't yet convinced that the Compact Disc is the best thing that's happened to audio and home sound reproduction in many a decade. Until I can be shown that a better sounding CD player exists, I'm going to consider this model my new standard of reference. *Leonard Feldman*



20

THIEL CS3 SPEAKER

Manufacturer's Specifications

System Type: Three-way.

Drivers: 10-in. (25-cm) woofer, 4 $\frac{3}{8}$ -in. (11-cm) midrange, and 1 $\frac{1}{8}$ -in. (2.8-cm) soft-dome tweeter.

Nominal Impedance: 4 ohms.

Bandwidth: 22 Hz to 22 kHz, -3 dB

Phase Response: $\pm 10^\circ$, minimum.

Sensitivity: 89 dB SPL at 1 meter for 1 watt input.

Recommended Amplifier Power: 40 to 250 watts.

Dimensions: 13 in. W \times 13 in. D \times 41 in. H (33 cm \times 33 cm \times 104 cm).

Weight: 75 lbs. (34 kg).

Price: \$1,950 per pair.

Company Address: 1042 Nandino Blvd., Lexington, Ky. 40511.

(Originally published November 1985)

(Editor's Note: The CS3.5, at \$2,450 per pair, has replaced the CS3, but I believe it will be very similar in audible and measured traits.—E.P.)



Standing slightly over a meter tall, the Thiel CS3 is a loudspeaker system whose driver positions and internal crossover circuitry are designed to produce the effect of a single, coherent source of sound. The three drivers are mounted on a sloping panel, the intention being for the sound from each driver to arrive simultaneously at the listening position. This coherence is assisted by a special crossover design which produces a very gradual, 6-dB/octave crossover slope, rather than more conventional, higher slope crossovers. The 6-dB crossovers provide simultaneous amplitude and phase compensation, and Thiel claims they have been designed to complement the characteristics of the drivers in their enclosures.

This care in acoustic design is carried forth in the front panel, which is rounded so as to minimize the sonic edge reflections which plague conventional, sharp-edged enclosures. In my opinion, most of the right steps seem to have been taken to produce a sonically improved design.

A black-cloth grille assembly covers the drivers and the curved panel on which they are mounted. Unfortunately, the frame of this grille projects in front of the acoustically designed panel and provides a reflecting object at just the wrong place. My listening tests and acoustic measurements indicate that the grille does more acoustic harm than is justified by its cosmetic function. The grille does, however, provide some protection for the drivers against accidental finger-pokes by toddlers, so this should also be taken into account.

An electronic equalizer, to be used between the preamplifier and the power amplifier, is provided. The equalizer is a separate unit which is powered by the a.c. line; it supplies appropriate bass boost to provide more uniform low-frequency response.

Thiel provides a short but excellent information manual which tells most of the things an owner needs to know about proper setup and operation. One thing the manual doesn't

Thiel's care in acoustic design is carried forth in the rounded front panel, designed to minimize sonic edge reflections.

say is that, because of this tower speaker's small supporting base, the CS3 should be placed on a firm surface. If the speaker were placed on carpet, its top-heaviness would allow it to be tipped over backwards by a toddler's not-too-hard nudge. Thiel provides stabilizing pins, which fit pre-drilled holes in the bottom of the cabinet, to deal with this problem. However, since my samples came without them—possibly because the speakers had been unpacked for preliminary listening elsewhere—I was unable to test their effect. Thiel's manual discusses these pins only in terms of their potential effect on the sound (reducing small speaker motions which could compromise clarity), not in terms of safety.

The speaker is fused for protection, and it has separate tweeter connections to allow bi-amplification. The tweeter and low/mid terminals are normally shorted together with conductive straps (supplied), for use with a single, full-range amplifier. The speakers come with a 90-day warranty, but a 10-year warranty is available, free, to owners who return the warranty card.

Measurements

The CS3 is rated at a nominal impedance of 4 ohms. The measured magnitude of impedance, shown in Fig. 1, verifies that the system remains near this nominal value over most of the audio range. The measured complex impedance is given in Fig. 2. As a complex load, the CS3 has very little reactive impedance above 200 Hz, indicating that this speaker is a rather benign load for most power amplifiers. The admittance, at a constant-voltage drive corresponding to an average power of 1 watt into 4 ohms, is presented in Fig. 3. This admittance measurement gives the actual amplifier drive requirement, in amps per volt, under conditions that represent the way we listen to the speaker, rather than under the constant-current laboratory-test conditions of impedance measurements. A careful comparison of this curve with the complex impedance curve also shows something else: The speaker's drive requirements do not substantially change with power level, except for frequencies above 10 kHz. Even there, demands on the amplifier remain in the safe, principally resistive region.

The CS3 system incorporates an active bass equalizer in order to achieve deeper bass. Figure 4 shows the measured transfer gain of this equalizer in the range from 1 Hz to 1 kHz. The bass boost is quite substantial, amounting to 12.3 dB at 25 Hz. Caution should be exercised in driving this system to higher sound levels with program content containing high levels of low bass. A 30-watt drive level in mid-range, well within this system's capability, can escalate to 120 watts at 25 Hz, with possible damage to the woofer. The equalizer does drop back down to reasonable levels at the normal flutter-modulation range around 5 Hz; thus, record warp and general surface irregularities on analog discs should not cause audible modulation effects due to substantial excursions of the bass driver.

Figure 5 shows the measured difference in gain between the left and right equalizer channels. These are exceptionally well balanced over the whole range, with a worst-case offset of about 0.3 dB at the resonance peak of 25 Hz.

Figures 6 and 7 show the axial, anechoic frequency

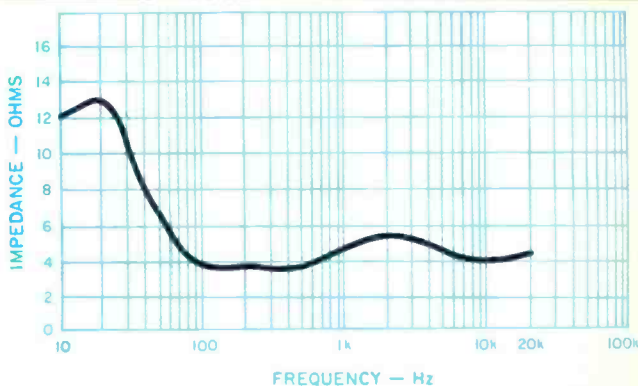

Fig. 1—Impedance.

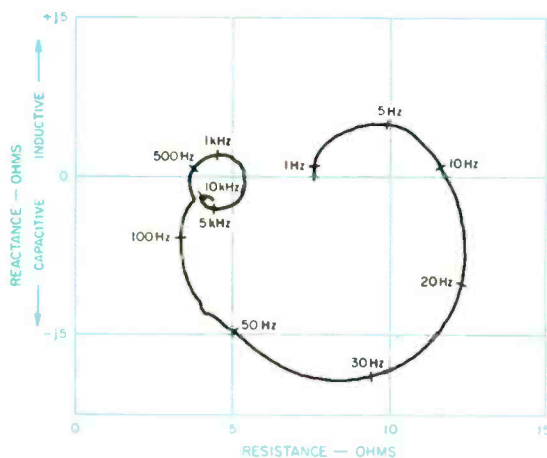

Fig. 2—Complex impedance.

response for a constant voltage drive corresponding to 1 average watt into 4 ohms. The measurements were made at an actual distance of 1.6 meters, directly in front of the midrange driver, and the SPL is corrected for a 1-meter path length. Measurement was made with the electronic equalizer in place. I could not verify either the high- or low-frequency claims made by Thiel; however, the differences between my measurements and the specifications are not large. I measured the response extremes at 29 Hz and 16 kHz as being 3 dB down from the mean mid-band average. Through the majority of the audio range, the CS3 is quite smooth in its response.

The phase response of Fig. 7 is corrected for two air-path length delays. At a physical path length of 1.6 meters, the bass response is corrected for a time delay of 4,660 μ S, while the air-path delay required to bring the 15-kHz range up to 0° is 4,697 μ S. The tweeter arrival is within 37 μ S of the midrange arrival. The corrected phase shift is near 0° over the majority of the audio range, which means that a positive-

The boost provided by the bass equalizer is quite substantial, so one should be cautious in driving this system to high sound levels.

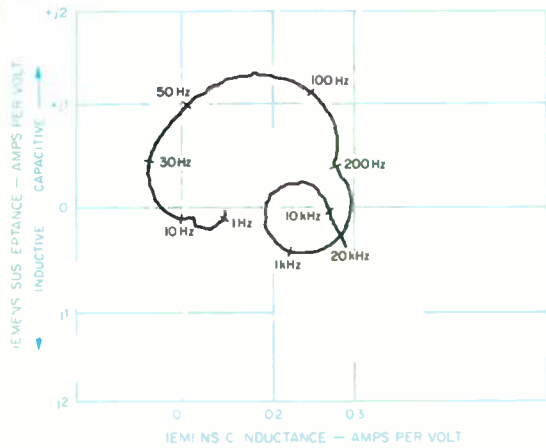

Fig. 3—Complex admittance for 2 V rms drive.

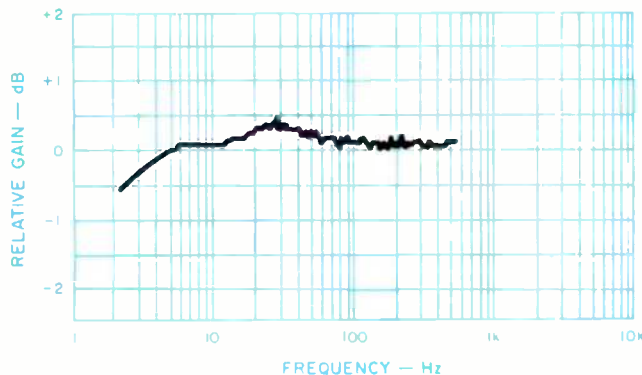

Fig. 5—Difference in gain between left and right equalizer channels.

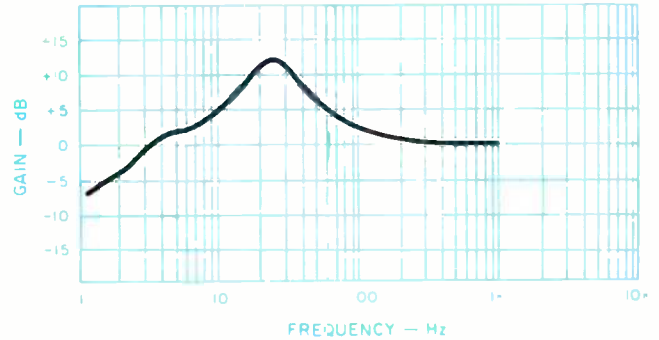

Fig. 4—Transfer gain of bass equalizer, which was measured as flat to 31 kHz

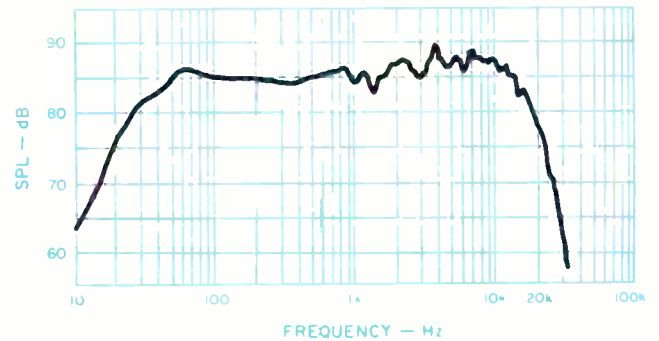

Fig. 6—On-axis sound output level with a constant drive of 2 V rms, measured at 1.6 meters and corrected for 1-meter path length.

going voltage drive produces an in-polarity, positive pressure increase at the listening location.

It was clear right from the beginning that the grille is a source of problems. Figures 8 and 9 show the *change* in sound (relative to Figs. 6 and 7) which is produced when the grille is removed. A peak-to-peak amplitude variation of 4 dB in mid-band and a mid-band phase variation of 25° is enough to make me suggest that a musically sensitive owner should remove the grille in order to achieve better sonic accuracy.

The 3-meter room test is shown in Fig. 10. Although the speaker's anechoic frequency response (shown in Fig. 6) is quite smooth, the room measurement is quite unsmooth. This measurement was made with the speaker placed 30 cm in front of a wall. The microphone was in a nominal listening location, 3 meters from the speaker and 1 meter

above a carpeted floor. The frequency spectrum of the first 13 ms of sound which arrived at the listening location was measured, and no article of furniture was placed where a substantial sound reflection could occur within this time window. The top measurement was made directly on-axis. The lower one was made with the microphone positioned so that the speaker was in a normal left-channel stereo position, 30° off the center line of the speaker. Because of the substantial variation, the two curves are displaced 15 dB for clarity of presentation; normally, I use a 10-dB offset.

Energy-time curve (ETC) measurements verified that the substantial ripples in response above about 1 kHz are due to ceiling reflections which arrive about 3.5 ms after the direct sound. The culprit, if that be the word, is the very large vertical dispersion pattern of the midrange and tweeter. Figure 11 is the ETC of the first 4.5 ms of sound, where

Horizontal dispersion of energy is very smooth, indicating exceptionally good stereo lateralization.

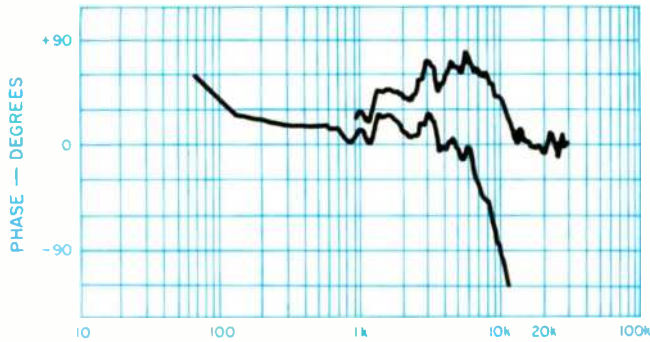

Fig. 7—On-axis phase response, measured at 1.6 meters and corrected for two time delays to correspond to 1-meter

measurements. Time offsets are 4,697 μ S (top curve) and 4,660 μ S (bottom curve).

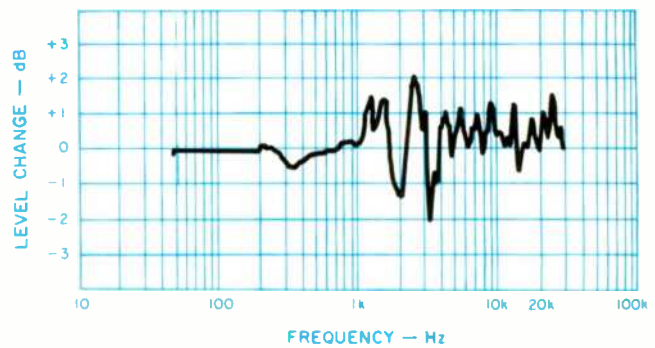

Fig. 8—Change in sound output produced by removing grille.

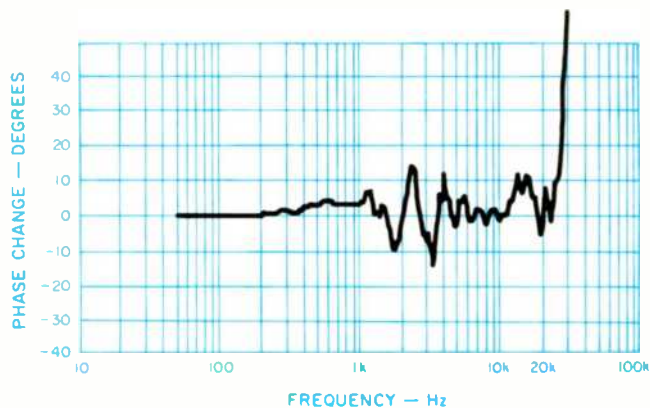

Fig. 9—Change in direct-sound phase response produced by removing grille.

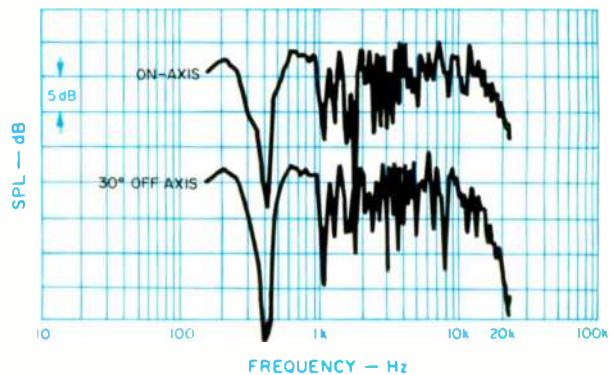

Fig. 10—Three-meter room response.

the principal problem lies. The first peak, at 9.5 mS, is the direct sound. The next peak, at 11.1 mS, is the floor reflection, and the third peak, at 12.8 mS, is the ceiling reflection. The energy level of the ceiling reflection, in the d.c. to 20-kHz band, is only 8 dB less than that of the direct sound.

Figure 12 is a measurement I make on each speaker but normally do not include in my reviews. This is the impulse response which corresponds to the ETC of Fig. 11. The ETC is the true log magnitude of the impulse response, so no new information is provided with regard to signal energy, but the impulse response clearly verifies the CS3's claim of being a coherent-source loudspeaker. The actual sound pressure of the first arrival, the floor arrival, and the damaging ceiling reflection are extremely good pulse shapes. These 3-meter sound measurements, Figs. 11 and 12, show that the CS3 should definitely not be placed directly under any overhanging shelf or near an object which can reflect

sound into the listening area. They also reveal why the CS3 sounds good on transient material, even though the normal 3-meter room measurement is quite irregular: The ear hears three rapid, coherent arrivals occurring at times related to the room geometry, instead of hearing a time-stretched smear of sound.

Figures 13 and 14 show the measured horizontal and vertical polar energy patterns. (These measurements are the normalized integral of the squared magnitude of the power spectral density, integrated over the range from d.c. to 20 kHz.) The horizontal dispersion of energy is exceptionally smooth, and remains within 3 dB over the full stereo stage. This indicates exceptionally good stereo lateralization. The vertical response is also good, showing only a small dip at 5° above the normal listening axis. It is the untamed vertical dispersion that may cause early sound interferences in some rooms. Both dispersion curves indi-

The system can handle power, but it begins to show distress at very high levels, with the bass going first. At normal levels there's no problem.

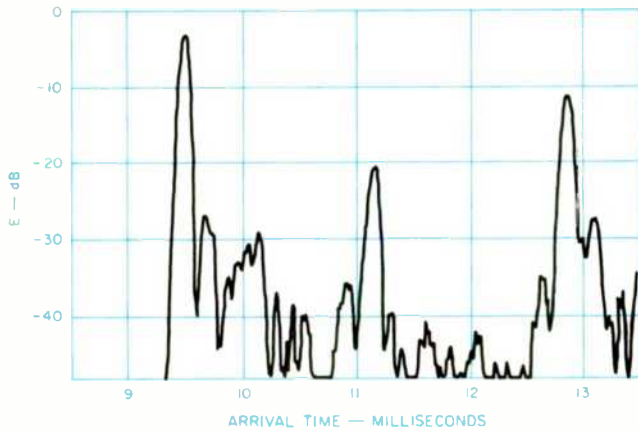

Fig. 11—Energy-time curve for 3-meter room response.

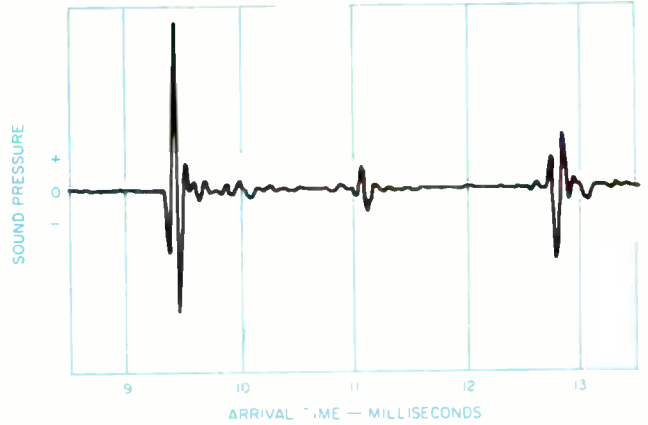

Fig. 12—Impulse response for first-signal arrivals in 3-meter room test.

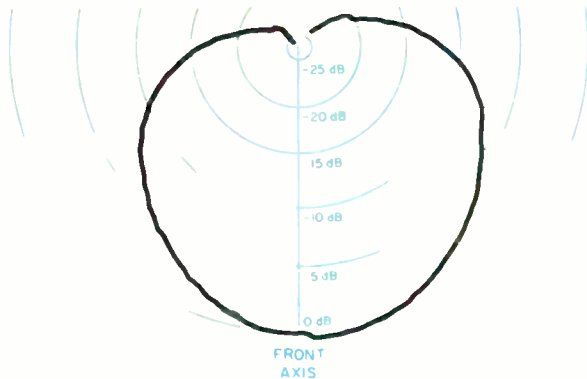

Fig. 13—Horizontal polar-energy response.

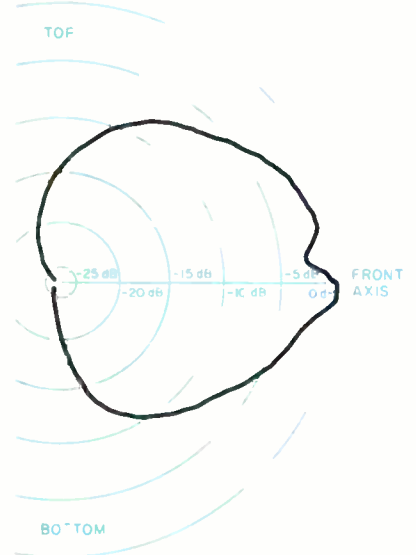

Fig. 14—Vertical polar-energy response.

cate that no acoustically reflecting object, such as a chair or bookcase, should be placed near the CS3.

Harmonic distortion for the tones E_1 , A_2 , and A_4 (41.2, 110, and 440 Hz) are plotted in Fig. 15. Distortion is quite low for A_2 and A_4 , but the low bass has higher distortion than I would like to see in a speaker of this otherwise high quality. As with the frequency measurements, the bass equalizer is incorporated in this distortion measurement. Deep bass is achieved with a penalty in the CS3; the woofer is driven rather hard—some 7.5 dB harder than mid-band, in the case of E_1 (41.2 Hz). The result is that the woofer runs out of steam when the midbass and midrange drivers are still 10 dB below their power-handling limit. In all deference to Thiel's excellent design, I recommend that a subwoofer be considered where the user desires robust sound levels—not for deeper bass, but for cleaner bass.

The measured intermodulation of 440 Hz by 41.2 Hz is

shown in Fig. 16. In this measurement, as in the previous one, the electronic equalizer causes the speaker to be driven harder at 41.2 Hz than at 440 Hz. The woofer clearly shows that it is the Achilles' heel with regard to distortion. The IM rises constantly with increasing power level. The nature of this distortion is principally amplitude modulation of 440 Hz by 41.2 Hz. At 1 average watt, the incidental 440-Hz phase modulation is 1° peak-to-peak. At 10 average watts, it is still only 2° peak-to-peak, the remainder of the distortion being amplitude modulation. This measurement indicates that high-level program dynamics may become muddled by bass modulation.

Figure 17 shows the axial ETC with the grille in place, and Fig. 18 shows the ETC with the grille removed. This is an exceptionally fine impulse response in either case, but the grille does contribute to some early scatter of sound arrival. Measurements made off-axis (not presented here) show

I was quite impressed by the overall accuracy of reproduction. The CS3 does a good job with voice and piano, and percussion is sharp and well defined.

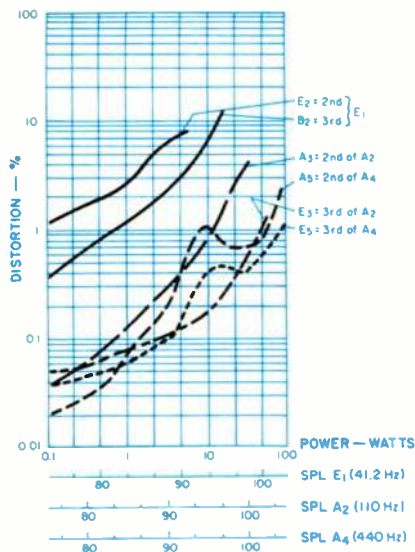

Fig. 15—Harmonic distortion for the tones E_1 (41.2 Hz), A_2 (110 Hz), and A_4 (440 Hz).

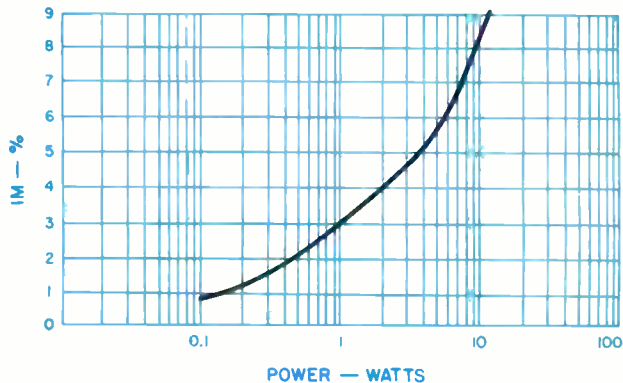

Fig. 16—IM distortion on 440 Hz (A_4) produced by 41.2 Hz (E_1) when mixed in one-to-one proportion.

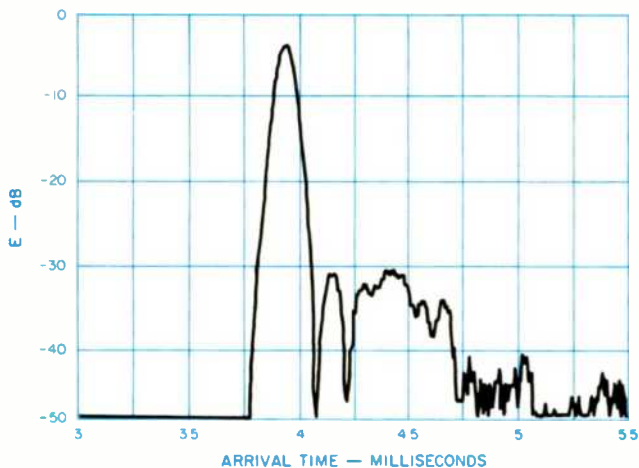

Fig. 17—Energy-time curve with grille in place.

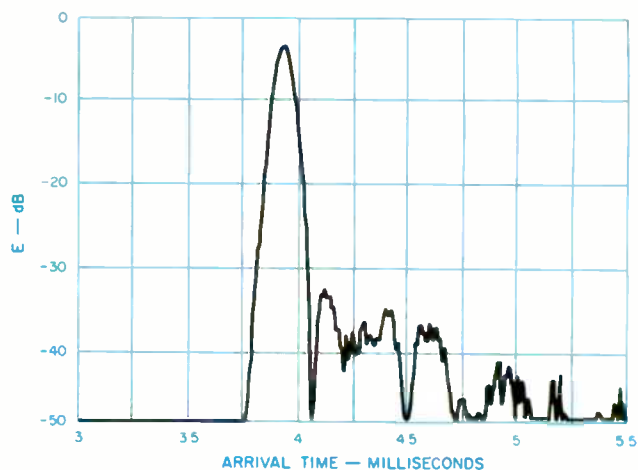

Fig. 18—Energy-time curve with grille removed.

that the effect of the grille is even more dominant at those positions. I recommend removing the grille if this is compatible with listening-room decor.

Use and Listening Tests

I was favorably impressed with the Thiel CS3's overall accuracy of reproduction. Although a bit tizzy on the top, this is one of the very few home systems I have heard which does a good job of reproducing both piano and female vocals.

To my ears, the most accurate reproduction was achieved with these loudspeakers placed about 50 cm in front of an acoustically absorbing wall and subtending a 60° angle at the listening location. I preferred the sound I got when the Thiel CS3 speakers were pointed straight ahead, putting me 30° off the front axis, and with the grille assembly removed.

The entire system is capable of handling relatively high power, but it does begin to show audible distress at very high sound levels. The bass goes first, becoming a bit muddy on really hard-driving beats. The midrange, in the octave above middle C, tends to go harsh at very high drive levels, but the tweeter hangs in there at all levels. All of this occurs at very high levels, and I had no quarrel with cleanliness of reproduction at my normal listening levels.

Low bass is there, but it is not overwhelming. Midrange is smooth, and free of obvious peakiness, to my ears. The extreme top end has a sizzle which can be tamed by pulling down the high treble on bright program material such as brass.

Stereo imaging is excellent, both in depth and lateralization. Percussive sound is sharp and well defined but a bit bright, and tends to pull forward in the stereo image.

As I said, I liked the sound.

Richard C. Heyser

AMAZING? ISN'T IT

The amount of nonsense that gets thrown around in the audio world. If you are sick of being treated like a 5-year-old child by shoe salesmen masquerading as audio experts, you owe it to yourself to give us a call. Our opinions are based on a solid foundation of experience with the components we sell as well as those sold by our competitors. Most importantly we don't simply sell the finest audio equipment available, we arrange it in complementary systems designed to extract the greatest benefit from your audio dollars chosen from among the following lines we represent:

ACOUSTAT • ADCOM • AKROYD • APOGEE • AUDIO-QUEST • AUDIO NOTE • AUDIO RESEARCH • BERNING • CWD • DYNAVECTOR • GRACE • GRADO • HEYBROOK • HI-PHONIC • KISEIKI • KOETSU • KRELL • KYOCERA • LINN SONDEK • LIVEWIRE • MONSTER CABLE • NITTY GRITTY • NYAL (MOSCODE) • ONIX • ORACLE • PROAC • PROTON • PS AUDIO • RANDALL RESEARCH • RAUNA • REGA • REVOX • ROBERTSON • SILTECH • SME V • SNELL ACOUSTICS • STAX • SYMDEX • SYRINX • TALISMAN • TARGET • VANDERSTEEN

SOUND BY SINGER

165 E. 33RD STREET
New York, NY 10016
(212) 683-0925
WE SHIP ANYWHERE

JUST LISTEN!

"The Mod Squad Compact Disc Damper is an inexpensive device that gives better sonic results than any \$25 device has a right to. If it will fit in your CD player, it comes with my highest recommendation."

Allen Edelstein
Stereophile, vol. 9, no. 2

"We know of no other audio accessory that provides so much sonic improvement for so little cost. A must, if application dictates, for any system having compact discs as a program source."

Earl C. Hudson,
Audiogram 21



YOU'LL HEAR WHAT THEY'RE TALKING ABOUT

Available from Mod Squad dealers everywhere

The Mod Squad offers a unique portfolio of products and services. For a complete catalog, send \$2 (refundable with order) to The Mod Squad, Department A, 542 Coast Highway 101, Leucadia, CA 92024.

The Mod Squad

542 Coast Highway 101
Leucadia, CA 92024
(619) 436-7666

In Australia: Sound Centre Hi-Fi, Brisbane
In Canada: May Audio Marketing, Longueuil
In France: Audio Quartet, Nice
In Hong Kong: Sound Chamber
In Italy: P.F.A., Pisa
In Netherlands: Audio Quartet, Nice
In South Africa: Phonovox, Johannesburg
In Switzerland: The Critical Ear, Basel
In United Kingdom: Parabolic Sales, Devon

How you can afford tubes...

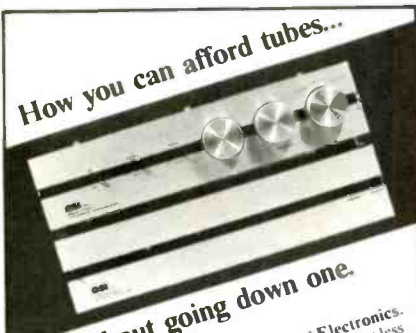

without going down one.

Affordable excellence from GSI Musical Electronics. Start with the 5tp High Gain Vacuum Tube Preamp at less than \$1200. Complement with the A1 250-watt Tube/Hexfet Power Amp for tube sound with solid-state power and reliability. Experience the GSI system as well as these other top performers:
ASC (Tube trap) • Athena (Polyphasers)
Audible Illusions • Classe • Convergent Audio Technology
Euphonic Technology (CD player) • Eminent Technology
Roy Grant • Klyne • Lazarus • Melos
MIT (MI-750 Shotgun) • Oracle • Quad • Quicksilver
Straight Wire • Superphon • Sumiko • Syrinx • Target
Van Den Hul • Vandersteen • VPI • Well Tempered
Phone the number shown for your private appointment.

HOURS: By Appointment. Also available for Sunday appointments.
920 Sherman Ave., Thornwood, NY 10594
Day Phone: 203-869-0745
Eve: 914-747-3375

Definitive Hi-Fi

Companions.

conrad-johnson
model PV-5
pre-amplifier.

conrad-johnson
model MV-50
amp ifier.

the conrad-johnson group
280CR Dorr Ave.
Fairfax, Virginia 22031



LINE DRIVE



Less Signal Processing = More Natural Music

LINE DRIVE—a system control center designed specifically for your line level components: CD players, tape decks, tuners, VCR audio.

LINE DRIVE—the flexibility of a preamplifier without the inherent colorations. Compare it with the best preamplifier you can find and be thrilled with how clean and accurate the Line Drive sounds.

Available from Mod Squad Dealers everywhere. Or direct from The Mod Squad, Dept. A, 542 Coast Highway 101, Leucadia, CA 92024, (619) 436-7666. For a complete catalog send \$2 (refundable with order). Ask about our 2-week money-back guarantee.

*The
Mod Squad
Inc.*

AUDIO NEXUS: STEREO COMPONENTS THAT HONOR MUSIC. ALPHASON, AUDIOQUEST, BEL, B&K, COUNTERPOINT, DAYTON WRIGHT, EMINENT TECHNOLOGY, FRIED, JSE, KLYNE, MELOS, MERIDIAN, MONSTER CABLE, PREMIER, PS-AUDIO, ROTEL, ROWLAND, SHURE ULTRA, SOTA, SPECTRUM, SYSTEM-DEK, TALISMAN, VAN-DEN-HUL. NJ (201) 464-8238.

DIGITAL SUBWOOFER?!

Digital technology has become a major force in the audio world, with its ability for high dynamics, accuracy, low noise and outstanding clarity.

After two years of research and development, ACOUSTIC ELECTRONICS CORPORATION, is pleased to announce the integration of digital technology into its new AQ-200D DIGITAL SUBWOOFER SYSTEM. THAT'S RIGHT!! A digital subwoofer with a (200K) sampling rate. This marks an unprecedented first in the audio industry!

No other subwoofer is capable of the accuracy that the AQ-200D delivers! This is possible, in part, by the fact that all bass information is relayed entirely through our new innovative fiber optic system! (NO WIRES!!) Many other new and exciting ideas are utilized in this latest design from ACOUSTIC ELECTRONICS CORPORATION.

Whether you own dynamics, ribbons, or electrostatic loudspeakers, this is the only subwoofer to use. Choose either the AQ-200D DIGITAL SUBWOOFER; the AIR 3.3 MONO BLOCK AMPS, or the renowned AIR 2.2 STEREO AMP from ACOUSTIC ELECTRONICS CORPORATION and you will be assured of the finest sound reproduction quality at any price!

For further info and dealer listing write:
ACOUSTIC ELECTRONICS CORPORATION
BOX 13
HIGHLANDS, NJ 07732

ABSOLUTELY UNPARALLELED IN EXCELLENCE!

Audition these remarkable, patented JSE Infinite Slope loudspeakers in your own home on our 7 Day—**NO RISK AUDITIONING** Policy. We'll pay shipping and offer a **FREE 1 YEAR** subscription to Audio. Authorized JSE, Fried, Spectrum, Haller, Thorens, Apature dealers. **SOUND UNLIMITED**, 178 Main St., Bristol, Conn. 06010. Est 1959. (203) 584-0131.

MC VISA AMEXP ACCEPTED

SINCE THE NEW GARROTT P-77'S DEBUT in March of this year, this cartridge has become an absolute favorite for many music lovers and analog enthusiasts. It has rightly been called a "Dynamic Coil" cartridge because it incorporates for the first time the advantages of moving coil, variable magnetic reluctance and moving magnet types. Fatigue-free, a marvelous tracker and a groove preserver, this instrument is not only musical but also within reach expense-wise. For your area dealer call Audio Advancements: 201-857-1422.

ALABAMA-WEST GEORGIA

Audioquest, Belles, Creek, Dynavector, Futterman, Garrott, Grado, KEF, Klipsch, McLaren, Meridian, MIT Cables, Monster Cable, MOSCODE, NAD, Oracle, Premier, Promethean Green, Quad, Rauna, Signet, Spectrum, Soundstream, Souther, Thorens, Transparent Audio, Tube Traps, VPI, Zapco and more. **ACCURATE AUDIO** 110 E. Samford Ave, Auburn, AL 36830. 205-826-1960.

Going Portable!

Go with...

CD/MATE™

The Original Portable Compact Disc Carrier



Sug. Retail
\$9.95

- ATTACHES TO PORTABLE CD PLAYERS WITH VELCRO TABS (Incl.)
- PLUSH INTERIOR HOLDS SIX CD'S WITHOUT JEWEL BOXES

CD/MATE™

P.O. BOX 1480 BURBANK, CA 91507
818-846-0765

DIMENSIONAL PURITY

VANDERSTEEN AUDIO



Vandersteen Audio was founded in 1977 with the commitment to offer always the finest in music reproduction for the dollar. Toward this goal there will always be a high degree of pride, love, and personal satisfaction involved in each piece before it leaves our facilities. Your Vandersteen dealer shares in this commitment, and has been carefully selected for his ability to deal with the complex task of assembling a musically satisfying system. Although sometimes hard to find, he is well worth seeking out.

Write or call for a brochure and the name of your nearest dealer.

VANDERSTEEN AUDIO
116 WEST FOURTH STREET
HANFORD, CALIFORNIA 93230 USA
(209) 582-0324

MODEL 2C

AUDIO CONNECTION
in Northern New Jersey

TURNTABLES: Basis, Goldmund, Heybrook, Merrill, The Well Tempered Lab
TOEARMS: Eminent Tech., Goldmund, Well Tempered
CARTRIDGES: Decca, Garrott P-77, Grado, vdHul MC10
ELECTRONICS: (solid state) Belles, British Fidelity, FM Acoustics, Jordan, Leach, Magnum, Dynalab (tube) Audible Illusions, Melos, MFA Systems, Music Reference (RAM), Quicksilver
CD PLAYERS: Melos Audio, Harman Kardon
SPEAKERS: Kindel, Princeton Acoustics, Heybrook, Rauna, Spondor, Vandersteen
ACCESSORIES: AudioQuest, Chicago Sp. Stand Goldmund, Livewire, Kimber Kable, MIT, Peterson, Sims Vibration, Sonex, Tiptoes, ToruFluid, ASC Tube Traps, Tweek

1-201-239-1799

615 Bloomfield Ave., Verona NJ 07044

AUDIO CONNECTION also has for sale: occasional close-outs, used equipment. **HOURS:** Mon, Tues, Fri 12-7, Thurs 12-9, Sat 11-6. Closed: Sun, Weds. **PLEASE, CALL FOR AN APPOINTMENT!**

Improve the sound of any speaker.



Yes, your speakers can sound as if they cost twice as much. Chicago Speaker Stands are rigid and spiked to prevent the movement that causes smearing and blurring of the musical event. Chicago Speaker Stands must be heard. Over 25 Models. Prices start at under \$40 per pair.

Chicago Speaker Stand

American quality and technology made in the USA
312-745-5500 800-882-2256

C.K. AUDIO

WELCOMES WASH. D.C. AUDIOPHILES

We carry products that truthfully honor the music. Our component selections are based on the following—Musicality, Value & Reliability. We believe in providing you with the most music for your investment. This goal is accomplished in the following lines we represent: Counterpoint, Convergent Audio Tech., Nova, Superphon, Music Reference, Bedini, Spectrascan, Dimensional Optics, Micro Seiki, Alphason, Koetsu, High-phonics, Kliseki, Audioquest, Promethean, Ram Tubes, Randall Research, Kimber Kable, Symdex, Non-speakers, MAS, Angstrom.
Please call or write for free newsletter. C.K. Audio, 11605 Basswood Drive, Laurel MD 20708, 301-498-5709. Visa/MC/Free Shipping.

**When we say
it's good...it is!**

Adcom + Apogee + AR + B&K + Carnegie + CJ
Eminent Technology + Grado + HK + Infinity RS1b
Krell + Kyocera + Meridian + NEC + Pro Ac + SME 5
Spondor + Spica + Souther + Sumiko + VPI + MORE

and now, JADIS!

**AUDIO
VISION**

1060 Massachusetts Avenue
Arlington, MA 02174
617 648-HIFI

INFORMATIVE

For over 11 years Audio Odyssey has provided their many loyal customers with concise and accurate product information. Why? Because at Audio Odyssey, they understand a better informed customer is a more satisfied customer.

Write or call today for information. All inquiries will be promptly answered!

REPRESENTING:

Adcom, Bang & Olufsen, Boston Acoustics, B&W, CWD, Conrad Johnson, Denon, Dual, Kilpsch, Monster Cable, NAD, Nakamichi, PS Audio, Thiel; Sony and NEC Video.

Audio Odyssey

1718 E. Kimberly Road, Davenport, IA. 52807
(319) 355-6565

Philadelphia Audiophiles

We proudly represent:

Acoustic Research	Infinite Slope	Quicksilver
Adcom	Kimber Kable	Rega Planar
Akroyd	Kindel	Revolver
Apt	Kinergetics	Rogers
Ariston	Linn Sondeck	Scott
Audible Illusions	Merlin	Sherwood
Beard	Micro Seiki	Sonographe
B&K Components	NAD	Soundcraftsman
Celestion	Naim	Spica
Conrad Johnson	Nitty Gritty	Stax
Creek	Nobis	Straightwire
Eagle Amps	Parasound	Superphon
Electrocompaniet	Pioneer Elite	Triad
ESB	PS Audio	Ultra by Shure
Golding	QED/Target	Wharfedale

Plus 15 brands of cartridges and more!

SOUND SERVICE CO.

8010 Bustleton Ave. Philadelphia, PA 19152
(215) 725-1177-78 Bank Cards Accepted

As reviewed in

talisman
virtuoso DTi

stereophile

Vol. 9 No. 4



"The sound emerges from a near-silent, black velvet background... This, combined with an accurate high-frequency balance (yes, that's right—the DTi doesn't have the HF rise that plagues most MC cartridges), gives the DTi the cleanest, most natural top end I've heard in a cartridge.

'Musicality' means different things to different people. Unfortunately, for many it has acquired a negative connotation, implying a warm or bloated lower midrange accompanied by a moderate amount of low even-order harmonics. The DTi's musicality, on the other hand, stems from its excellent tonal and harmonic accuracy. To put it simply, it gets the notes and the relationship between them right.

I have no doubt that it is the best high-output MC on the market, and one of the best cartridges available regardless of type or price."

—STEVE W. WATKINSON

By SUMIKO, INC.,
P.O. Box 5046
Berkeley, CA 94705

The best CD Player is a matter of opinion.

Many opinions.

AT
 NE 1986 • \$2.00

precision probably give outstanding service for a long time.
 •Finally, the Denon DCD-1500 tops my list. It's the player I recommend most highly. It has oversampling, dual D/A converters, remote controller, formidable specifications, full features, and Denon sound. The Denon engineers who created it should be honored in public.

Test: CD-Spieler Denon DCD-1500

Feuer und Flamme

Welt wollte Denon
 ine Palastrevolution.

DENON DCD-1500
 typically £399

The current range of Denon players covers the ground from true budget to audiophile models. The DCD-1500 fits bang in the middle of the range as far as price is concerned and could best be described as being a full-feature domestic machine that is built with audiophile attention to detail.

Rather like the second generation of Sony players, the Denon uses separate converters for the two stereo channels rather than time-sharing the one. The therefore escapes phase problems of the approach. The twice oversampled filters but back board correction is chosen by Burr Brown. The circuit at each stage is powered by digital

fürwicklungen die Mechanik, den Gangsver-



Rich, atmospheric sounding player

- Construction
- Ease of use
- Sound quality
- Value for money

The Real Deal
 This Denon DCD-1500 is well designed throughout. For where you look you'll see signs of careful engineering and evidence of the willingness to spend the extra time and money to do the job right. The Denon engineers who created the DCD-1500 have done a superb job.

The DCD-1500 is an outstanding player at any price, and a phenomenon at its retail price. In my opinion, it's the best deal in today's CD-player market.

Ken Perlman is a contributing editor to Digital Audio.

Use and I suspect the sure on the product's sound we can "psych" we want to hear, of the DCD-1500's hearing of late surements haven't wanted to be sure ing me, so I called asked them to bring room. Without knowing players and when they these friends preferred of their own.
 I've always wanted correlation between providing the right contention held true in the performed well on the remote control or via its as good as any CD player its price is a good deal favorite CD players. It is a winner in

correction once or twice highest information layer test. The equivalent level surface mark and fingerprint tests were cleared without problems.
 Hayden Labs, importer of Denon, has said that current production of the DCD-1500 is being changed to incorporate better RF screening — no problems were encountered with our sample during the review.

Hayden Labs Ltd
 Hayden House
 Chiltern Hill
 Chalfont St Peter
 Bucks SL9 9UG
 ☎ (0753) 888447

Beispielsweise speist der Klötzchen Baukasten mit vier einzelnen

Audio

**MASS TEST
49 CASSETTES**

IS THIS
HEARM?

Rating: ★ ★ ★ ★ ★
In several measurements, the DCD-1500 out-performed any other player.

SAPPHIRE
TABLE
DENON DCD-1500
CD PLAYER

Listening Tests
I am sometimes influenced by what I measure on a bench when it comes time to judge a reproduction quality. I'm convinced that what we expect to hear. To me, the sound is a shade better than what I have heard from several CD players whose measurements were as good as this one's. I have friends who own CD players and use them along to my listening and they were listening to their own copy of the Denon, both of which I have listened to the DCD-1500 over that one that, ultimately, there is a difference in results and audible results—these are made. Happily, that of the DCD-1500. It not only was easy to use via its controls, but it sounded great so far. What's more, it is one of some of my other CD players on every count.
Leonard Feldman

Denon DCD-1500



Preis: um 1600 DM
Garantie: 12 Monate
Abmessungen: 43,4 x 8,9 x 25 cm (BxHxT)
Denon Electronics GmbH
Halskestraße 32
4030 Ratingen 1

Pro und Kontra
++ Klang
++ Ausstattung
++ Verarbeitung
+ Fernbedienung

Preisbezogene Wertungen
Klang: sehr gut
Fehlerkorrektur: gut bis sehr gut
Ausstattung: sehr gut
Verarbeitung: sehr gut

HIFI VISION-Urteil
Preisbezogenes Gesamturteil: sehr gut
Absolute Einstufung: Referenzklasse

The audio critics of the world hardly ever agree on anything. But when it comes to superlative CD players, Ken Pohlmann, Len Feldman, Masamitsu Fukuda, Ulrich Smyrek, David Praker, Yoshiyuki Ishida, Artur Jung, and Hideki Kaneko recommend one model with amazing consistency: the Denon DCD-1500.

How did Denon achieve this exalted status? Not by offering useless buttons, switches and fluorescent displays. But by developing better digital circuitry, building to higher standards, and using better parts. Our proprietary Super Linear Converter is the only one that actually corrects D/A transfer distortion. Each circuit gets its own separate power supply. And our filters are computer-analyzed for linear phase. So you hear sound that rewards the most critical listening.

In a player as reasonably priced as the DCD-1500, these refinements are enough to make even a hard-boiled critic stand up and cheer. And now there's more cause for celebration: three new Denon CD Players. They're built on the same principles as the DCD-1500, and they're even more affordable.

So if you want to hear the best that the Compact Disc format has to offer, get yourself to a Denon dealer. And don't forget to tell him who sent you: Ken, Len, Masamitsu, Ulrich...

DENON
DESIGN INTEGRITY

AUDIO/JUNE 1986



DCD-1500: Dual Super Linear Converters; Oversampling Digital Filters; CALP Analog Filters; Programming; Remote Control.



DCD-1300: Super Linear Converter; Oversampling Digital Filters; Real-Time Phase Correction; Programming; Remote Control.



DCD-700: Super Linear Converter; Real-Time Phase Correction; Programming; Remote Control; Headphone Jack with Level Control.



DCD-500: Super Linear Converter; Real-Time Phase Correction; Programming; Emphasis Display; Headphone Jack.

Audio 4/1986

Audio 4/1986

offers...
price...
sampling, dual...
error correction...
DCD-1500's audio quality...
of some players...

A V I E W F R O M T H E T O P

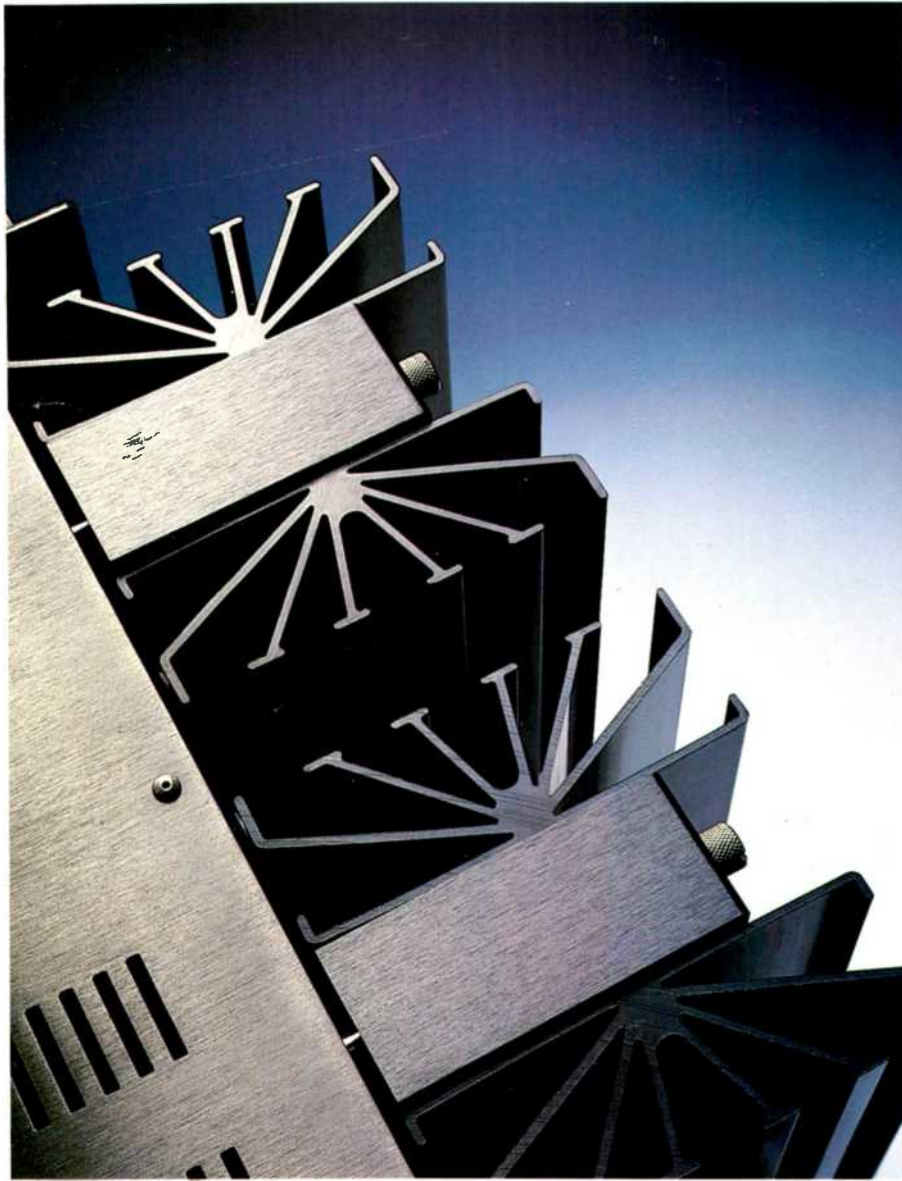

HEATSINK—July 1986

Spend some time with a Mark Levinson® component. As every work of art is unique, so it is with Mark Levinson products. The complete range of amplifiers and preamplifiers is crafted for music lovers who appreciate the subtleties within reproduced music and also demand a precise execution of the designer's imagination.

Experience a level of craftsmanship that sets the standard for technical artistry and stands the test of time.

mark
levinson