

Audio

MASS TEST
49 CASSETTES

JUNE 1986 • \$2.00

EXCLUSIVE REVIEW:
SME'S SERIES V—IS THIS
THE ULTIMATE TONEARM?

COMPARISON TEST:
FOUR CD CHANGERS

TESTED:
SOTA STAR SAPPHIRE
TURNTABLE

DENON DCD-1500
CD PLAYER



0 66030



Attention Magazine Retailer:
Important notice on first Classified Ad page

**Lots of new companies make speakers for cars.
AR has made speakers since this car was new.**



In 1954, the Dodgers were in Brooklyn, Brando was on the waterfront, and Elvis was in Sun Studios. In September 1954, a classic two-seater called the Ford Thunderbird went into production.

That same year, Acoustic Research invented the Acoustic Suspension principle and used it to create another classic: the first high fidelity bookshelf speaker. Soon, AR products became the most revered, most sought-after, most imitated speakers in history.



Now, Acoustic Research puts its years of loudspeaker experience on the road. With the sophisticated new GCS Speakers. Most car speakers aim their tweeters at your rear window, not at your ears. AR's GCS-100 system has separate component woofers, midranges and tweeters. So you can mount the tweeters up front, where you can hear them. And the GCS-300, a classic 6 x 9, tilts the tweeter towards the front. While many car speakers have no crossover at all, these AR speakers have true electronic crossovers for minimum IM distortion. And while others use flimsy paper cones, AR uses ultra-rigid polypropylene.

Ultimately, making car speakers is easy. The hard part is making speakers sound good. And that's precisely what AR has been doing for 32 years.



AR
ACOUSTIC
RESEARCH

We speak from experience.

Enter No. 2 on Reader Service Card



See page 88

FEATURES

CHANGE FOR THE BETTER: FOUR MULTI-DISC CD PLAYERS	Leonard Feldman	62
CASSETTE TEST UPDATE: 49 FORMULATIONS	Howard A. Roberson	74

EQUIPMENT PROFILES

SME V TONEARM AND TALISMAN VIRTUOSO DTi CARTRIDGE	Edward M. Long	88
SOTA STAR SAPPHIRE TURNTABLE	Edward M. Long	98
MAGNUM DYNALAB FT-101 TUNER	Leonard Feldman	108
DENON DCD-1500 COMPACT DISC PLAYER	Leonard Feldman	116
SHURE SM91 MICROPHONE	Jon R. Sank	122
AURICLE: ORACLE DELPHI II TURNTABLE	Anthony H. Cordesman	130

MUSIC REVIEWS

FITTING REVIVALS: THE MOSAIC REISSUES	Frank Driggs	136
COMPACT DISCS		140
ROCK/POP RECORDINGS	Michael Tearson, Jon & Sally Tiven	146
CLASSICAL RECORDINGS	Edward Tatnall Canby	152
JAZZ & BLUES		160

DEPARTMENTS

SIGNALS & NOISE		6
AUDIOCLINIC	Joseph Giovanelli	10
TAPE GUIDE	Herman Burstein	14
BEHIND THE SCENES	Bert Whyte	18
DIGITAL DOMAIN	Ken Pohlmann	27
SPECTRUM		33
ROADSIGNS	Ivan Berger	39
AUDIO ETC	Edward Tatnall Canby	46
THE BOOKSHELF		53

The Cover Equipment: SME V tonearm, Talisman Virtuoso DTi cartridge, and SOTA Star Sapphire turntable.

The Cover Photographer: Carl Zapp.

Audio Publishing, Editorial and Advertising Offices,
1515 Broadway, New York, N.Y. 10036.

Subscription Inquiries, (800) 525-0643; in Colorado, (303) 447-9330.



See page 136

THE BALANCE OF POWER



The need for power is undeniable. But raw power is no measure of a great amplifier. At Sumo, we recognized the need but approached the problem in a new way. The result is a differential amplifier employing a unique full wave balanced bridge output circuit. This provides impressive statistics as well as awesome performance.

The power is 200 watts RMS per channel into 8 ohms at 0.05% THD. There is no current limiting. As a consequence Andromeda is capable of delivering 80 amp peaks at 1 ohm instantaneously.

Music has definition and detail. Sonic texture is smooth and transparent. Bass is tight, m.d-range natural, and highs clean. Instrumental timbre is accurate through the top two octaves. Soundstage is wide, instrument placement consistent. The reviews are consistent too. Your Sumo dealer will show them to you.

Among the select group of dealers showing the Sumo Andromeda are:

MUSICAL IMAGES OF KENTUCKY
11027 Buckeye Trace
Goshen, KY 40026
Tel. 502 228-3200

SPEAKER CRAFT, INC.
7505 Big Bend Blvd.
Webster Groves, MO 63119
Tel. 314 968-2170

AUDIBLE DIFFERENCE AUDIO
556 Halcombe Ave.
Mobile, AL 36606
Tel. 205 479-7195

andromeda by
SUMO

21300 Superior St. • Chatsworth, CA 91311 • 818/407-2427

VARIATIONS ON A THEME



Fine furniture from CWD is handmade of select natural hardwoods, hand finished with care, outfitted with precision hardware. And CWD cabinets are good investments. Our modular concept lets you select cabinets and accessories to create your own unique system of cabinetry... a system you can add to and rearrange as you enhance your audio and video systems.

The theme: the finest in furniture. The variations: with CWD's modular designs, they're up to you. See for yourself, call toll free 1-800-323-2159 or the dealer nearest you. (In Illinois, call 312) 563-1745.)

In Dark Oak, Natural Oak and Natural American Walnut

HIGH PERFORMANCE MODULAR FURNITURE THAT KEEPS PACE WITH YOUR ELECTRONIC SYSTEM

CUSTOM WOODWORK & DESIGN INC.

CWD®

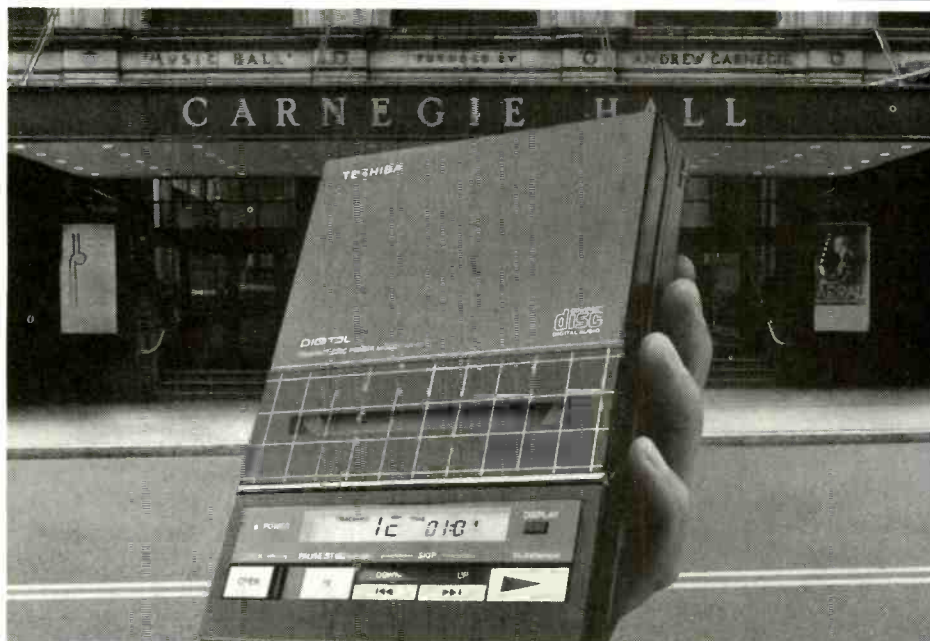

The best sound you can hear next to Carnegie Hall.

Toshiba's new CD player makes concert quality sound portable. Yet, hooked up to your stereo system it's a top of the line home CD player. Offering 16 program random memory, 3 beam laser pick up, even a wireless remote. Toshiba's XR-P9 is the complete, portable CD player. Outside of a concert hall nothing sounds better.

In Touch with Tomorrow

TOSHIBA

Toshiba America, Inc., 82 Totowa Road, Wayne, NJ 07470

Enter No. 51 on Reader Service Card

Audio

Eugene Pitts III
Editor

Art Director: Cathy Cacchione

Technical Editor: Ivan Berger
Managing Editor: Kay Blumenthal
Copy Chief: Elise J. Marton
Associate Art Director: Linda Zerella
Assistant Editor: Andrea Lynne Piecer

Associate Editors:

Edward Tatnall Canby, Bert Whyte, B. V. Pisha

Senior Editors:

Leonard Feldman, Richard C. Heysler,
Howard A. Roberson

Senior Editor/Music Features: Ted Fox
Editor-At-Large: David Lander

Contributing Editors/Artist:

Susan Borey, Herman Burstein, David L. Clark,
Anthony H. Cordesman, Ted Costa, John DiIiberto,
John M. Eargle, Joseph Giovanelli,
Laurence L. Greenhill, Bascom H. King,
Edward M. Long, C. G. McProud,
Peter W. Mitchell, Jon Sank, Donald Spoto,
Michael Tearson, Jon & Sally Tiven, Paulette Weiss

Business Services Director: Catherine Hennessey

Production Director: David Rose

Production Manager: Patti Burns

Special Projects Coordinator: Phyllis K. Brady
Ad Coordinator: Susan Oppenheimer

Stephen Goldberg
Publisher

ADVERTISING

Advertising Director: Stephen W. Witthoft
(212) 719-6335

Account Managers: Lesa Rader Giberson
(212) 719-6291
Nick Matarazzo
(212) 719-6346

Western Manager: William J. Curtis
Regional Manager: Megean Roberts
(818) 784-0700

Classified Manager: Laura J. LoVecchio
(212) 719-6338

Classified Assistant: Mary Jane M. Adams
(212) 719-6345

CBS MAGAZINES EXECUTIVE STAFF

President: Peter G. Diamandis
V.P., Editorial Director: Carey Winfrey
Sr. V.P., Publishing: Robert F. Spillane
Sr. V.P., Circulation: Robert E. Alexander
Sr. V.P., Operations: Robert J. Granata
V.P., Finance: Arthur Sukul
V.P., Subscription Circulation: Bernard B. Lacy
V.P., Mfg. & Distribution: Murray M. Romer
Pres.: CBS Magazine Marketing: Carl Kopf

AUDIO (ISSN 0004-752X, Dewey Decimal Number 621.381 or 778.5) is published monthly by CBS Magazines, A Division of CBS Inc., at 1515 Broadway, New York, N.Y. 10036. Printed in U.S.A. at Nashville, Tenn. Distributed by CBS Magazine Marketing. Second class postage paid at New York, N.Y. 10001 and additional mailing offices. Subscriptions in the U.S., \$17.94 for one year, \$32.94 for two years, \$45.94 for three years; other countries, add \$6.00 per year. **AUDIO** is a registered trademark of CBS Inc. ©1986. CBS Magazines, A Division of CBS Inc. All rights reserved. **Editorial contributions** are welcomed but should be accompanied by return postage. Submissions will be handled with reasonable care, but the Editor assumes no responsibility for safety or return of manuscripts, photographs, or artwork. The Publisher, in his sole discretion, reserves the right to reject any ad copy he deems inappropriate. **Subscription Service:** Forms 3579 and all subscription correspondence must be addressed to **AUDIO**, P.O. Box 5316, Boulder, Colo. 80302. Please allow at least eight weeks for the change of address to become effective. Include both your old and your new address and enclose, if possible, an address label from a recent issue. If you have a subscription problem, please write to the above address or call (800) 525-0643; in Colorado, (303) 447-9330

Special Introductory Offer From RCA

FREE COMPACT DISC!

with Club membership plus shipping & handling



YES, TAKE ANY COMPACT DISC HERE.

Three Dozen To Choose From!



115441



143765



115356



114734



154381



115168



142320



115062



164042

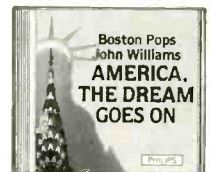

115134



115169



144512



151758



144101



115146



154203

Ella Fitzgerald: The Johnny Mercer Songbook • Too Marvelous For Words, Skylark, Dream, etc. Verve 163610

Brahms, 21 Hungarian Dances Claudio Abbado conducts the Vienna Philharmonic Orchestra. DG DIGITAL 115408

Alabama: Greatest Hits • She And I, Why Lady Why, Feels So Right, Tennessee River, others. RCA 120247

Carmen (Highlights) • Film soundtrack. Migenes-Johnson, Domingo. Maazel conducts. Erato DIGITAL 154105

Phil Collins: No Jacket Required • One More Night, Susudio, Don't Lose My Number, etc. Atlantic 120771

Stars And Stripes Forever • The Philip Jones Ensemble plays 15 Sousa greats. London DIGITAL 115051

Mozart, Symphonies Nos. 40 & 41 (Jupiter) • James Levine with the Chicago Symphony. RCA DIGITAL 104810

Tears For Fears: Songs From The Big Chair • Everybody Wants To Rule The World, Shout, etc. Mercury 143666

Bach, Organ Works • Daniel Chorzempa plays the Toccata & Fugue in D Minor, others. Philips DIGITAL 115193

Daryl Hall & John Oates: Live At The Apollo • Apollo Medley, Everytime You Go Away, others. RCA 140625

Wagner, Orchestral Highlights From The Ring • Vienna Philharmonic Orchestra/Solti. London DIGITAL 115426

Kenny Rogers: The Heart Of The Matter • Morning Desire, Tomb Of The Unknown Love, title cut, etc. RCA 153995

The Cars: Greatest Hits Tonight She Comes, Drive, You Might Think, Shake It Up, others. Elektra 153702

The Canadian Brass: High, Bright, Light & Clear • Baroque gems for brass ensemble. RCA DIGITAL 144529

Mozart, Requiem • Schreier leads the Leipzig Radio Choir & Dresden State Orch. Philips DIGITAL 115039

Pavarotti: Mamma • 16 great Italian songs, arranged & conducted by Henry Mancini. London DIGITAL 115310

Sunday In The Park With George • Bernadette Peters, Mandy Patinkin & original cast. RCA DIGITAL 154014

Bach, Brandenburg Concertos Nos. 4-6 • The English Concert led by Trevor Pinnock. Archiv DIGITAL 125417

Rimsky-Korsakov, Scheherazade • Andre Previn conducts the Vienna Philharmonic. Philips DIGITAL 115415

Prince: Around The World In A Day • Pop Life, Raspberry Beret, America, Temptation, etc. Warner/Paisley Park 124370

THE ULTIMATE IN SOUND AND SAVINGS!

Yes, any Compact Disc here is yours FREE—when you become a member of the Compact Disc Club. You pay only shipping and handling—then need buy just one more selection at regular Club prices (usually \$15.98) during the next year.

HOW THE CLUB OPERATES

As a member, you select from hundreds of exciting Compact Discs described in the Club's exclusive bulletin mailed to you 13 times a year. Each issue highlights a Featured Selection in your preferred musical division plus an impressive array of alternate selections. If you'd like the Featured Selection, you need not do a thing; it will be sent to you automatically. If you'd prefer a different Compact Disc, or none at all, just return the Notification Card enclosed with each issue of **CD Discovery** by the date specified on the card. You will have at least 10 days to decide, or you may return your Featured Selection at our expense. And you may cancel your membership at any time, after completing your membership agreement, simply by writing to us.

HALF-PRICE BONUS PLAN!

As a member of the Compact Disc Club, you enjoy big savings. With every Compact Disc you purchase at regular Club prices, you receive a bonus certificate. Collect two bonus certificates and take a Compact Disc of your choice for just half the regular member's price, plus shipping/handling.



A Service of RCA

DON'T MISS THIS OPPORTUNITY.

Simply complete the coupon and mail it today for your FREE Compact Disc and membership in the Compact Disc Club.

YOUR SAVINGS START HERE...

Mail to: Compact Disc Club / P.O. Box 91412 / Indianapolis, IN 46291

YES, please enroll me as a member of the Compact Disc Club and send me the Compact Disc I have indicated below free. I need buy just one more CD at regular Club prices in the next year... *without obligation to buy anything further!* (Shipping/handling added to each shipment.)

WRITE THE NUMBER OF YOUR FREE MEMBERSHIP CD HERE:

I am most interested in the following type of music—but am always free to choose from both categories (check one only):

1 CLASSICAL 2 POP/SOFT ROCK

First Name _____ Initial _____ Last Name _____ (Please Print)

Address _____ Apt _____

City _____ State _____ Zip _____

Telephone (_____) _____ Area Code _____

Limited to new members; continental U.S.A. Only one membership per family. We reserve the right to request additional information or reject any application. Local taxes, if any, will be added.

VCS72

AT

Proof of the Pudding

Dear Editor:

I want to compliment you on your "Equipment Profile" of the Fried Studio IV Speaker which appeared in the February 1986 issue. That company never seems to advertise, so the fact that you reviewed one of their products is sure proof that you are not letting your technical opinions be swayed by advertising dollars. I like your willingness to present graphs and, in general, to give detailed, factual reviews of equipment. One of your competitors presents equipment reviews that annoy me greatly by their wishy-washy character and lack of quantitative data. I'm letting my subscription to that magazine lapse.

Francis B. Shaffer
Newport, R.I.

Repair Needed

Dear Editor:

I am looking for someone to repair an old Grundig Majestic table radio from the 1950s, Model 3035. Is there anyone in the New York/New Jersey area who can help me out?

R. E. Olsen
Madison, N.J.

Editor's Note: We will be glad to forward any responses to our correspondent.—A.P.

Enough Already

Dear Editor:

Come on guys! The first Lirpa items were clever and amusing. The constant follow-ons ruined last year's Annual Equipment Directory (not just one entry but one in each category), and now you continue to waste editorial space with this tiresome routine.

For this type of humor I buy *Mad* and *National Lampoon*. I buy *Audio* for information of a different kind.

Hector O. Myerston
Milpitas, Cal.

Brewed or Instant?

Dear Editor:

With regards to the article about the Lirpa Turbo Steamtable (April 1986), I don't think I'm willing to trade hum for whistle. I'll bet it makes a great cup of tea, though.

William R. Hitchens
Mountain View, Cal.

No More April Fools

Dear Editor,

I am writing in regards to the April issue of *Audio*. Up until now, I have always considered your magazine a happy medium between the mags for the masses and the high-end publications. You have provided me with reviews of good equipment in my price range as well as a look at esoteric gear. I feel that the April issue was a sad and wasteful departure from this practice. An entire issue devoted to auto sound equipment is a definite step into the realm of low fidelity. Furthermore, I found the inclusion of products from Prof. I. Lirpa a gross misuse of page space as well as a waste of my money. If I want stupid journalism, I'll buy the *National Enquirer*. In future issues, please try to bring the quality of your magazine up to the level that it should be.

Robert T. Shaw
Bremerton, Wash.

Subjective Impressions

Dear Editor:

Bravo! I applaud your steps to find a middle ground between the slick audio periodicals and the underground high-end journals. The "Auricle" column is a welcome departure from traditional product reviews; three cheers for Anthony Cordesman!

In the November 1985 issue, I was pleased that reviewers Laurence L. Greenhill and David L. Clark described the associated equipment used in their tests of the Bryston 4B amplifier, but unfortunately Mr. Heyser made no mention of what amp was driving the Thiel CS3 speakers during his listening sessions. I encourage you to include the listening setup for all product reviews, and perhaps even give a description of the listening room.

Again, my compliments to all of you. You are breaking new ground, and I suspect the going may be tough at times. Press on with a clear conscience—a little subjectivity never hurt.

Robert E. Suminsby, Jr.
Clovis, N.M.

Editor's Note: Subjectivity? Is that where "One man's meat is another man's poison"? Or is it where "What's sauce for the goose is sauce for the gander"?—E.P.

To Err Is Human

Dear Editor:

This communication will take some kind of record for insignificance.

In the first paragraph of my interview with John Charles Cox (*Audio*, January 1985), I date the Joseph Henry experiment as 1854. The date should be 1849. I wish all my mistakes were this small.

F. Alton Everest
Whittier, Cal.

Pickup on South Street

Dear Editor:

I have recently been hearing about inquiries from owners of B-I-C turntables, and other B-I-C audio equipment going back as far as the Garrard days, who have been having a difficult time locating parts and service, and have heard that B-I-C is out of business.

B-I-C's policy was always to support its products with a strong service organization. A company called South Street Service has taken over all of the service and parts for B-I-C equipment. The owner, Adam Ruthkowski (former national service manager at B-I-C), confirms that virtually all parts are still available through his company. In fact, they have remanufactured many parts that previously were not available, such as speaker grilles, turntable motors, headshells, etc. The company's address is 202 South St., Oyster Bay, N.Y. 11771, and their telephone number is (516) 922-0358.

Arthur Gasman
Port Washington, N.Y.

FM A-OK

Dear Editor:

You have used much ink bad-mouthing FM lately; I thought you might be amused to hear from someone who likes things as they are.

First, the facts of life: Commercial broadcasting is designed to serve the needs of the advertiser. "Processing" is a good thing. Take so much garbage and run it through a processor—nothing is lost. The signal is louder. The advertisers are happy. Nothing else matters. The consumer does not care about quality, but wants mindless noise to fill the background as he goes about his daily routine.

I do not listen to such broadcasts. From my remote location, I can receive

Boston Acoustics component speaker systems.

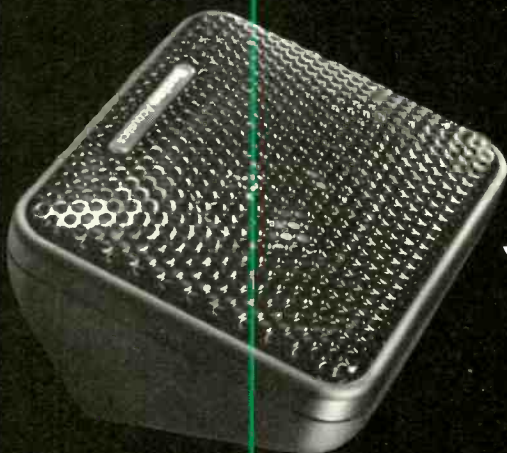

**Your car could become
your favorite listening room.**

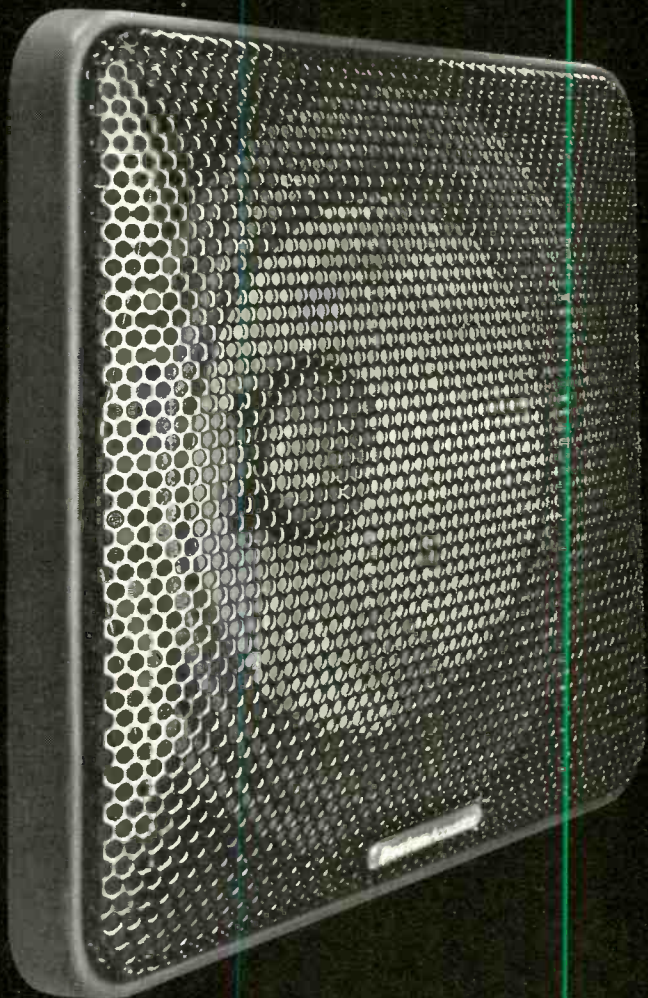

Now, you can enjoy world-renowned Boston Acoustics music reproduction in your car. Our component approach makes it possible. Each portion of the audio range is accurately reproduced by a separate driver, just as in our highly regarded home systems. Each component speaker can be unobtrusively mounted where it fits best. And sounds best.

We've designed five different Boston component speaker systems, so you can choose one that's just right for you and your car. From our most compact two-way system, to our finest three-way system that lets you hear the full ten octaves of music. All five use our exclusive Varimour™ CFT dome tweeter, which you can aim for optimum stereo imaging.

For a detailed brochure and the name of your nearest dealer, send your name and address to: Boston Acoustics, Inc., Department 7A, 247 Lynnfield Street, Peabody, MA 01960. (617) 532-2111.

You just may get into the habit of picking up your car keys when you want to do some really serious listening.

Boston Acoustics

Nothing will destroy
a good tuner's performance
like a wide-band TV-signal
preamp in the antenna line.

40 noncommercial stations. I choose from jazz, classical, rock and religious music, 24 hours a day. Noncommercial broadcasters serve the listener's needs. They do not assault their listeners with mind-numbing advertising. They are delighted to hear from listeners, and seek their advice in program-

ming and scheduling. If you think they are doing something wrong, they will let you show them how it is supposed to be done. Many (most?) people associated with public broadcasting are unpaid volunteers. Do you care enough to get involved? They need your time. They need your donation.

There's simply no other moving coil cartridge quite like it.

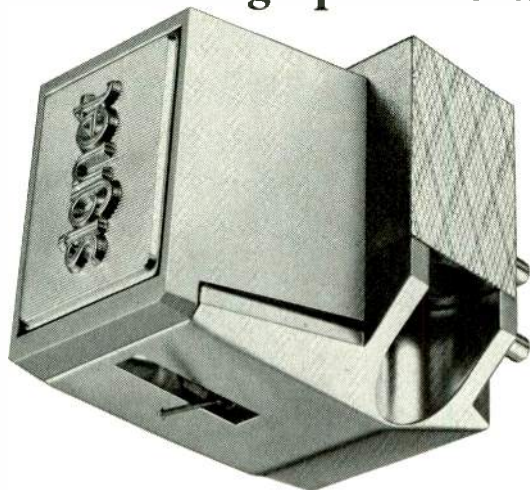

MK440ml Dual Moving MicroCoil™ Stereo Phono Cartridge with MicroLine™ Stylus

Start with the precision Dual Moving MicroCoils at the heart of the MK440ml. They are wound from Linear-Crystal Oxygen-Free Copper (LC-OFC) wire. The result is phase coherency and low distortion impossible with ordinary wire. And an unmatched ability to reproduce transients and the highest frequencies with superb clarity.

The MK440ml MicroLine stylus is equally outstanding. Mounted on a tiny beryllium rod, gold plated to reduce resonances. It has the minimum possible scanning radius for perfect tracing, yet an uncommonly long support radius for best tracking. This "contact ridge" maintains its unique shape throughout its useful life. Unlike all other stylus shapes, it exhibits no gradual increase in distortion, record wear, or erosion of frequency response. The Signet MicroLine stylus is indeed the most advanced stylus shape ever created.

The MK440ml is bench-crafted to remarkable standards of precision and uniformity in the finest Signet tradition. Until you've seen and heard this outstanding component, you can only guess how good your records can sound. At your helpful Signet dealer. Write or call today for the one nearest you.

signet

4701 Hudson Dr., Stow, OH 44224 • (216) 688-9400

As to reception, how many audiophiles do you know of who spend \$1,000 for a tuner and use a ribbon-wire dipole or some active indoor antenna? The same people, I'll wager, who are so upset about processing. Signal-to-noise ratio is the name of the game; you can't move your antenna closer to the station, but you can move it farther from the noise, by moving it outdoors. The most rudimentary outdoor antenna will be more successful than any antenna in your living room, where the walls shield it from the desired signal, and your home's power lines and electrical equipment bathe it in wide-band electronic noise.

Since the FM band is located just above TV channel 6, most low-band TV antennas will do a good job on FM. (An FM-only antenna is preferred, though, as it will reject out-of-band signals and noise.) Omnidirectional antennas are the cheapest and easiest to install, but directional antennas have gain; because signals and noise from undesired directions are rejected, the desired signal seems stronger. Often, best results are obtained by nulling an undesired signal, rather than pointing the antenna directly at the desired signal's transmitter.

But nothing will destroy a good tuner's performance like a wide-band TV-signal preamp in the antenna line. You do not want to cram every signal in the VHF spectrum down your tuner's throat. Furthermore, a noisy preamp will mask weak signals, and a preamp that overloads will cross-modulate, and cause each station to appear at several points on the dial. An antenna preamp should have only enough gain to cover the loss in the down-lead, usually a few dB. But most preamps have much more gain, enough to reduce the tuner's overall dynamic range, upset its AGC and muting circuits, and possibly cause it to overload. Try a preamp only after you have put up the best possible antenna—and don't be surprised if the preamp makes your reception worse.

For more information about FM and VHF in general, get a copy of the *VHF Handbook*, available for \$17.50 from the American Radio Relay League, 225 Main St., Newington, Conn. 06111.

Kerry Stiff
Otis, Kans.

"Great and important"

—Julian Hirsch,
Stereo Review

"Tour de force"

—Hans Fantel,
New York Times

"Glorious"

—David Ranada,
Stereo Review

"Breakthrough"

—Peter Mitchell,
Boston Phoenix

ONE revolutionary speaker technology—and the unique musical experience it evokes—has inspired unprecedented critical acclaim.

But with all their superlatives, the audio reviewers have not succeeded in putting that musical phenomenon into words. You must experience it. You must hear

T H E d b x O N E

"Incredible," Len Feldman exclaimed in *Ovation*.

The acoustic achievement that aroused such enthusiasm is patented Soundfield™ technology. It takes you beyond stereo.

Into the dbx zone.

Into an era in which every listener is freed forever from the "stereo sweet spot" in front of a pair of conventional speakers.

dbx One speakers deliver a musically accurate, balanced stereo image throughout the room.

Wherever you go. Even within a foot of either speaker.

Hans Fantel said, "Always the sound was everywhere... but with every detail just where it ought to be." Precisely so.

The dbx One takes you beyond stereo. Beyond what other kinds of speakers—even the recent imitators—promise, much less deliver.

And now there's the more affordable dbx Ten.

"Does it produce a stable

stereo image throughout the listening area?" asked Julian Hirsch. "The answer is yes, definitely."

About the overall sound Hirsch wrote, "We cannot recall ever measuring as flat a high-frequency room response... it is a sound I can listen to for hours on end"

If you are serious about music, you must hear them. For the location of the dbx speaker dealer nearest you, call us directly, at (617) 964-3210.

dbx®

Beyond stereo



A division of BSR North America Ltd.

© 1986 dbx

71 Chapel Street

Newton, Massachusetts 02195

(617) 964-3210

Enter No. 18 on Reader Service Card

Equalization with LPs and CDs

Q. When I bought my CD player, I was a bit disappointed with the sound on some of my discs. The frequency response was not what I could obtain with LP versions of the same records. To my ears, the CD versions had a peaky midrange (3 kHz) with loss of warmth. I then remembered an article in Audio that suggested a boost of 3 dB in the 120-Hz range along with a cut of 3 dB in the 2- to 4-kHz range for CDs with this problem.

The other day I was searching through my record collection, and found a record with the label "Digital." This LP never sounded right because of too much warmth and lack of midrange. It was then that I thought of using the mirror image of the CD-correction curve. That did the trick!—Marc Ferland, Montreal, Que., Canada

A. As with any other program source, you will like the sound of some CDs and dislike that of others. As you have found, you can, with a slight adjustment of some equalizer controls, make a given program source sound better. Using an equalizer in this way is more important, to me, than using it merely as a tool for producing an overall flat frequency response for a given listening position.

Static Solutions

Q. In your December '85 column, reader Andrew Hinds raised the issue of static. Your answer merely scratched the surface with regard to solutions. Having spent the last 20 years in the computer industry fighting this stuff, I would like to offer the following suggestions:

1. Check if your wall outlet is grounded. If you are not the technical type, get a qualified person to do this for you. Should the outlet not have a ground, get one installed. It may be expensive, but it's worth it.

2. Ground all your equipment. Because most audio equipment has only a two-wire wall plug, you will need to run extra wires from your components to the wall outlet/receptacle.

3. Install a grounded anti-static mat in front of your equipment. This means wiring the ground to the mat. Most computer stores carry these or will direct you to a source.

4. Use anti-static spray on your car-

pet. Commercial sprays, although good, smell horrible, do not last long, and are expensive. I prefer a 50/50 mixture of fabric softener and water. Apply in a fine spray. Not only is this cheap and long-lasting, but it will also make your carpet smell nice.

The presence of static has wounded many computer systems, causing untold damage. In audio components, static, at its worst, can lead to premature equipment failure. At best, it can reduce one's listening pleasure.—Lutz E. Moeckel, Costa Mesa, Cal.

Groove Skipping and Compliance

Q. I recently switched from a cartridge of relatively high tracking force to one requiring somewhat less force; the compliance of the new cartridge is higher than that of the old one. For some reason, my new cartridge often skips over the opening grooves, whereas the first one did not. Why aren't cartridges uniform as far as compliance and tracking force are concerned?—Henry C. Moski, Branford, Conn.

A. The most likely cause of your groove-skipping problem is a mismatch between your new cartridge and your old arm. Every arm/cartridge combination has a resonant frequency, which is a factor of the cartridge's compliance and the total effective mass of the cartridge and arm. By raising the compliance without lowering the mass, you have moved the system's resonance down, probably below the desirable 8- to 12-Hz range. As a result, record warps (which are most pronounced at the record's outer edge) and, perhaps, vibration caused by footfalls in your room can now excite this resonance. Possible solutions include switching to an arm with lower mass (difficult and expensive), and switching to a cartridge with lower compliance. Your cartridge's manufacturer might possibly offer a stylus for your cartridge with lower compliance than the one you have now, but it may not have as desirable a tip design.

As to why tracking force and compliance are not standardized: All else being equal, a cartridge with high compliance and requiring a minimum tracking force will tend to have better transient response than cartridges of lower compliance which require a greater

tracking force. Obviously, given the same stylus tip configuration, cartridges which require less tracking force will also produce less record wear than those requiring higher tracking force. Cartridges with high compliance are more expensive to produce and are sometimes unsuited for some discs. Further, these cartridges are more readily damaged.

In order for a cartridge to have high compliance and to track at as low a force as practical, some trade-offs must be made, often in terms of reduced output voltage. Thus, high-compliance cartridges may prove unsatisfactory when used with preamplifiers or receivers having insufficient voltage gain and/or signal-to-noise ratio to accommodate them.

Signal Loss at Low Volume

Q. At low volume, regardless of program source, both channels of my receiver cut in and out—with lots of static. The receiver will operate normally for about 5 to 10 minutes before the onset of this condition. I can temporarily restore the receiver to normal operation by quickly turning the volume control way up and then turning it down to its original setting. I then can listen for another 5 to 10 minutes before the cycle starts again. The receiver works properly at volumes above background-music level.

I have had this receiver in the shop several times. Each time, the technician believed that the receiver was merely dirty. All the controls were cleaned, but these "repairs" had no effect.—Jon T. Satterwhite, Rossville, Ill.

A. The condition you have described could be the result of so many different factors that I cannot pinpoint any one as the likely cause. The interesting thing is that the condition occurs on both channels. This tends to support the idea that there is a defect in the power supply, which is certainly common to both channels. But I cannot explain how the quick rotation of the volume control could shock-excite the power supply into proper operation.

If you have a problem or question about audio, write to Mr. Joseph Giovanelli at AUDIO Magazine, 1515 Broadway, New York, N.Y. 10036. All letters are answered. Please enclose a stamped, self-addressed envelope.

H I D E A W A Y S

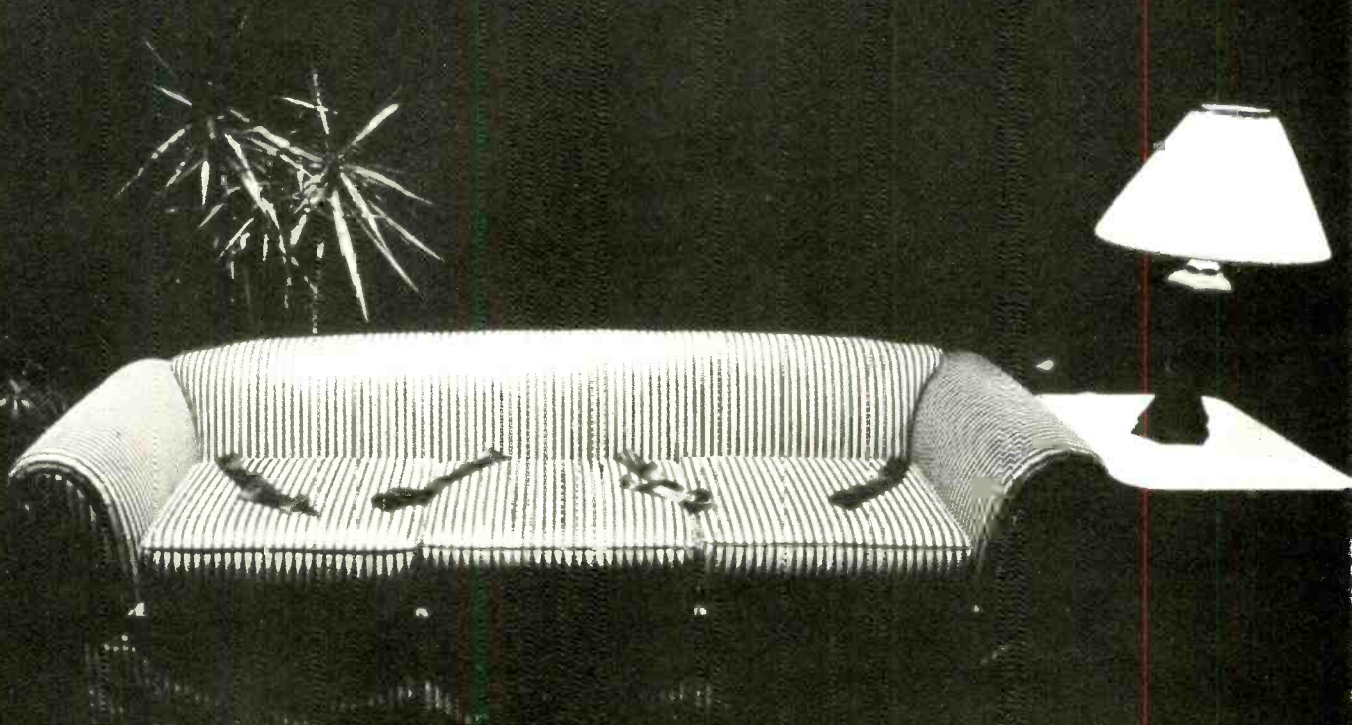

IS YOUR COUCH EQUIPPED . . .

for Stillwater Designs® new behind-the-couch surround sound speakers? The HIDEWAYS® — another original innovation from the makers of KICKERS®.

SHOWING IN ROOM D-42 AT CES Enter No. 46 on Reader Service Card

Bridging a stereo amp for mono use can increase total power or damage the amp. Better check with the amp's manufacturer before you try it.

Can it possibly be that there is an IC (other than a voltage regulator in the power supply) common to both channels? You will need a schematic of your equipment to determine this.

In any event, you need to trace the signal through your receiver. Hopefully, you will locate the earliest stage which exhibits volume loss. Even here, the effects of feedback could obscure the true nature of the problem. Use a second amplifier to trace the signal. You will likely need a service manual so you can follow the path of the signal through the receiver. Obviously, you must monitor your receiver as well as the "test" amplifier so you can hear the reduction in volume—maybe in both amplifiers and maybe not, depending on whether you have connected the test amplifier to a stage of the receiver which exhibits this volume drop.

Of course, you can also watch for changes in any of the various power-supply voltages.

Another possibility is that the system becomes unstable and breaks into oscillation. The frequency of such oscillation may be too high to hear, but it should be detectable on a 'scope or by noting an unexpected a.c. voltage. A defective filter capacitor may lead to unwanted coupling among various audio stages. This, in turn, can produce oscillation.

If you are unable to perform these tests, find a competent service shop. Perhaps a factory service center has found your problem to be a common one, with your make and model of receiver, and it may well have a cure.

Bridging a Power Amplifier

Q. I am confused about how to bridge a stereo power amplifier for monophonic use. Can you enlighten me on the subject?—Edgar A. Gorspe, San Diego, Cal.

A. To bridge an amplifier in this fashion, a monophonic signal must be fed to each of the amplifier's input channels, with one channel receiving the signal out of phase with respect to the other. This out-of-phase condition causes one channel's "hot" output terminal to go positive while that of the other channel goes negative, producing a greater voltage swing than either channel could manage on its own. To do this, essentially places the two out-

put circuits in series, just as you would place two batteries in series in order to increase their output voltage. The speaker is connected between the two hot terminals rather than between one hot terminal and ground (as is done for normal stereo use). Some amplifiers incorporate the necessary bridging (phase-reversing) circuit, thus requiring only one input cable. Others require external bridging circuits, while still others cannot be bridged without damage.

Results vary. Most commonly, bridging the amplifier will cause it to deliver exactly twice the rated power of either channel when used normally. But some amplifiers can deliver more than twice their single-channel rated power when bridged, while others may deliver a bit less.

Consult your amplifier's manufacturer about the advisability of bridging, and to find out what output power may result and what impedance restrictions, if any, may be imposed for bridged operation.

About CDs and Players

Q. Before I buy a CD player, I need to know more about the product. If CDs are better than conventional records and tapes, why? Would a reasonably discriminating listener really be able to notice this improvement? Why is the term "digital" used? How is a disc made? Is there more than one size? What features should I look for in a CD player? Is there a version which can both record and play? Finally, are CDs recorded directly from the music source or are they copied from records and tapes?—P. Y. Williams, Marble Falls, Tex.

A. No matter what I tell you about CDs and the machines used to play them, the only way you will know if you like the music they produce is to listen to them. As with anything related to music listening, our perception of CDs is subjective. However, I can say that most listeners do hear a distinct improvement, while some critical audiophiles feel that LP records, despite the measurable advantages of CD, sound better in some respects.

There are some objective facts I can mention. It is possible to record more low frequencies on CD than is possible either on tape or on phonograph rec-

ords. The signal-to-noise ratio on CDs is better than on phonograph records or cassettes. Wow and flutter are virtually unmeasurable. Given all of this, you can see that the dynamic range of music on CD can be extremely wide.

The term "digital" refers to the fact that music is encoded on the disc as a series of binary numbers (ones and zeros) representing its amplitude measured every 0.0000226 second. These binary digits (1.4 million per second) are represented by tiny pits, too small to be seen by the naked eye, which are read by the finely focused beam of a small laser. The original recording from which the CD is made may have been either digital or analog; if the latter, it is converted to digital form for the CD.

The discs come in only one size, 4.7 inches (12 cm) in diameter. The manufacturing process is complex, involving the creation of a master from which the tiny pits are molded, the molding of the disc, and the coating of the disc with a reflective aluminum layer and then a protective lacquer on which the label information is stamped. Only the lower side of the disc is read by the laser, but the disc can still hold up to 74 minutes of music. The present Standard specifies that these discs be recorded only on one side.

Most CD-player features relate to convenience rather than sound, helping you locate and access specific points on the disc and set up programs of tracks you wish to play. Have a dealer demonstrate these to you so you can determine for yourself which ones you want. Machines which can record other types of optical discs are still comparatively rare and quite expensive. It is anticipated that CD player/recorders for the home will be available in a few years.

Compact Discs are made from the record companies' master tapes, and therefore have higher fidelity than if they were copied from the records and tapes released for sale. (There are exceptions: CDs of historic performances made before studios began using tape recorders. Even these are probably made from tape dubs of the original master discs, with ticks and pops edited out and possibly other enhancements made.) Since CDs cannot be edited (among other reasons), they are not used for studio recording. 

BRYSTON



Model .5B preamplifier

Bryston's name has for decades meant the absolute best in electronics.

Bryston has never considered price to be an important criterion in the design of a product, only the best possible audible performance. The cost was simply a result of the components required to accomplish that end.

Bryston reasoned there is a large number of audiophiles, no less demanding in their expectation of component (and sonic) quality, who have decided to remain

with a basic, though highly competent, sound system using only a few of the finest signal sources. For you, if you are among this uncompromising group, there is now the Point-Five-B.

The .5B utilizes the finest components including a laser-trimmed volume control, hand tested and selected transistors in all amplification functions, metal film resistors and polystyrene capacitors matched to less than 1%. The preamplifier undergoes extremely close inspection and a

100-hour burn-in prior to shipping.

The .5B is a "final purchase" preamplifier, (i.e. its performance may be favourably compared even to the most costly "exotics", and it is unlikely to be surpassed in the near future), but is meant to be used in a sound system employing only a few quality components.

We invite you to experience the Bryston .5B preamplifier, one of the easiest-listening, most musical preamplifiers available.

In the United States:

BRYSTON VERMONT LTD.

RFD #4, Box 2255, Montpelier, Vermont 05602
(802) 223-6159

In Canada:

BRYSTON MARKETING LTD.

57 Westmore Dr., Rexdale, Ontario, Canada M9V 3Y6
(416) 746-0300

A Tape for All Players

Q. My primary tape deck has both Dolby B and C noise-reduction systems, while the tape players in my cars have DNR (Dynamic Noise Reduction) but not Dolby B or C NR. I also have a personal stereo player with Dolby B NR. Using my primary deck, I want to make a single tape that can play back satisfactorily on all my decks. How can I best do this?—Robert A. Nuernberg, Mequon, Wisc.

A. I suggest that you make your recordings with Dolby B NR. When played back without Dolby decoding, they will sound a bit bright but not unreasonably so; this added brightness may even be desirable in the environment of a moving car. If the brightness is undesirable, a mild downward turn of the treble control will help. Another strategy is to use Type I (ferric oxide) record EQ and play back with Type II EQ; this will provide a moderate treble cut.

Checking Dolby Alignment

Q. I own a home cassette deck with Dolby C NR, which I use to make recordings that I play on my Sony Walkman, which also has Dolby C NR. The first time I made recordings and played them back on the Sony or several other cassette decks, they sounded muffled and lacking in highs. There was also audible pumping of the sound as the Dolby C NR switched the playback levels at obviously incorrect points. Recordings made and played back on the home deck sounded fine. On the other hand, professionally recorded tapes with Dolby C NR sounded fine on other equipment, but not on the deck in question.

I have made test recordings on the deck, using Dolby B NR and no NR, and these recordings are compatible with other equipment. This eliminated azimuth misalignment as the cause of my problem. I believe that the fault lies with the deck's Dolby NR calibration, so I sent the unit back to the manufacturer. The deck was returned to me—improved, but still not totally compatible with other equipment. Is there any way that I can determine if my cassette deck is adjusted correctly, once and for all?—Robert A. Ward, Cleveland Heights, Ohio

A. To check your deck's Dolby NR

alignment, you need a test tape containing a 400-Hz tone at Dolby level (200 nWb/m) and a signal generator that produces a 400-Hz tone. First, play the test tape; the meter of your deck should indicate Dolby level. Next, record a 400-Hz tone on your own tape at a level that drives the indicator to the Dolby mark; when playing this tape, the indicator should again come to the Dolby mark. If playback of the test tape does not produce a Dolby-level reading, or if recording at the Dolby mark does not produce a Dolby-level reading in playback, your deck is misaligned.

High-quality Dolby-level test tapes are expensive. If you have access to a cassette deck that you trust to be properly calibrated, you can make your own Dolby test tape with probably sufficient accuracy to be useful. Record a tape at Dolby level as indicated by this deck's meter, using a 400-Hz tone from a signal generator or perhaps from a test phono disc. When this tape is played on your own deck, your deck's meter should read Dolby level.

Deck Incompatibility

Q. I own two cassette decks, a JVC KD-V200J and a Technics RS-B14. When I record on the JVC with high-quality tape, using Dolby C NR, the playback on the JVC sounds superb. But when I play this cassette on the Technics, the high end sounds muffled. Also when I record on the JVC and play the tape on the Technics, the right meter is about 2 or 3 dB down relative to the left meter, and the right channel seems to have more bass than treble.—Eric Gagne, South Hadley, Mass.

A. Apparently you have an azimuth alignment problem. That is, either the JVC or the Technics record/playback head, or both, are not correctly aligned. You may also have a Dolby NR tracking problem, which often results in treble loss. Again, one or other of the two decks, or both, may be at fault. The difference in response between the left and right channels may relate to the azimuth problem or the Dolby tracking problem, or both.

If the JVC plays its own tapes well enough, the fault is more likely to lie with the Technics. But you do not say what happens when you record and

play tapes on the Technics, or when you record tapes on the Technics and play them on the JVC. Analysis of those results might point more surely at the source of the problem.

Going Into Reverse

Q. In my auto-reverse tape deck, when the tape changes direction only the drive motor reverses; the head stays stationary. Why isn't this design used in all auto-reverse decks? Wouldn't this overcome the problem of azimuth alignment in decks that use a swivel-head design? Surely it must be cheaper, as it doesn't require an extra motor to turn the head.—Daniel Cohen, Verona, N.J.

A. One of the problems in designing and constructing a high-quality tape head is to keep the gaps co-linear, that is, in exactly the same vertical line so that azimuth is the same for both gaps. The problem is compounded by the fact that physical co-linearity does not assure magnetic co-linearity. In the case of a reversible cassette deck which does not use a swivel head, the head must have four gaps, two for each direction of tape travel. To keep all gaps co-linear is a good deal more difficult for a head with four gaps than for a head with two. Hence a number of manufacturers have elected to go the route of swivel heads. Swivel-head decks usually have separate azimuth adjustments for each direction of tape travel.

VCR Dropouts

Q. I am considering the purchase of a hi-fi VCR solely for audio recording, because five or six hours of audio can be recorded on a single tape with sound quality superior to that of most open-reel or cassette decks. If I record only at the slower LP and EP speeds, will audible dropouts be more prevalent than at normal speed, as some audio experts contend?—Frederick Goldsby, Pitman, N.H.

A. In theory, these experts are correct. That is, the slower the VCR speed, the more noticeable the drop-

If you have a problem or question on tape recording, write to Mr. Herman Burstein at AUDIO, 1515 Broadway, New York, N.Y. 10036. All letters are answered. Please enclose a stamped, self-addressed envelope.

outs will be. However, much depends on the quality of the tape employed. A good tape will have fewer and briefer dead spots. Hence you have a good chance of obtaining satisfactory results at the slower VCR speeds.

Dubbing: Three to Two Or Two to Three?

Q. My stereo system includes a three-head cassette deck with a rated frequency response of 20 Hz to 24 kHz and a 75-dB signal-to-noise ratio. I am planning to buy a two-head deck for dubbing; its specs are 20 Hz to 20 kHz frequency response and 74-dB signal-to-noise ratio. My problem is that I have been told by an audio salesman that it is much better to dub from one three-head deck to another three-head deck. Please advise.—John DeRosa, Mattapan, Mass.

A. The two-head deck you plan to buy should serve quite adequately for dubbing. Apart from not being able to monitor the tape as you record, the chief drawback of a two-head deck as compared with a three-head deck is less extended treble response in playback. This drawback can be inconsequential, particularly with a two-head deck that maintains playback response substantially to 20 kHz. After all, does your program material go out to 20 kHz or beyond? Does your hearing extend that far?

It is usually best to play a tape on the same deck that was used to record it. Therefore, in dubbing, you would play the original tape on the three-head deck (assuming that's the deck it was made on) and record the copy on the two-head deck.

(Editor's Note: Playing a tape on the same deck that recorded it has two advantages. First, if the recording deck's tape speed was too fast or slow, playing it back at the same speed would cancel the effects of this error, since pitch and tempo change only when a tape is recorded at one speed and played back at another. Second, if the playback and record head were aligned at the same factory, as is the case with three-head decks, the odds of azimuth mismatches would be reduced. If the same head is used for both functions, as is the case with two-head decks, it entirely eliminates the possibility of such mismatches.

However, this presumes that the recording deck's speed and playback azimuth have not changed since the recording was made, and that you're not dubbing tapes made on some other recorder altogether. If these presumptions are not true, you'd do best to experiment to see which dubbing arrangement—three-head to two-head or vice versa—gives you the best results.—I.B.)

Tape Type and Print-Through

Q. Are Type II cassettes less susceptible to print-through than Type I tapes?—Victor G. Alter, Amherst, N.Y.

A. High-coercivity tapes—that is, tapes with high resistance to demagnetization—are less subject to print-through than low-coercivity tapes. Inasmuch as Type II has higher coercivity than Type I, Type II is less subject to this phenomenon.

Protecting Magnetic Recordings

In the January 1986 issue, reader K. P. Moylan told of his problem with tapes going through U.S. Customs; they were being damaged by inspection devices. Mr. John Carr, of John Carr & Associates, Flossmoor, Ill., writes of his experience:

"I frequently use the U.S. mails and various carriers, namely U.P.S., Federal Express, and Express Mail, to ship magnetic computer disks. We have experienced almost 100% failure rates (unreadable data) after shipment through Customs. In the past two years, we have experienced an increasing error rate in disks shipped via U.S. mail, even when the shipping cartons are clearly marked with colored warning stickers. We've had no problems yet with U.P.S. or Federal Express. We avoid problems by: (1) Shipping in stiff cardboard cartons secured with plastic tape and marked with colored warning stickers; (2) wrapping the disk in a single layer of aluminum foil (lead-lined photographic film pouches offer greater protection, but at higher cost); (3) cushioning the disk with air-cell material—there are special plastic packing materials for cushioning and radiation protection, available from electronics-supply houses; and (4) avoiding those carriers which have a record of damaged disks."

Steven Pecsek of Riverbank, Cal.,

writes: "Regarding the effects of Postal Service X-ray machines on recorded tapes I recall reading that although X-rays have no effect on magnetic tape, the large electromagnets in the machines can erase some of the signal [with the high frequencies being most vulnerable—H.B.]. I have operated an open-reel mail-order tape service for the past 10 years and shipped perhaps 100 tapes overseas, but have never had any complaints of damage due to X-ray machines or any other causes. However, I do write on the boxes, "Do Not X-ray—Magnetic Tape."

Mr. Pecsek has brought to my attention a *3M Sound Talk* bulletin on the subject, dated Volume III, No. 1, 1970. Following are some excerpts: "Laboratory-conducted tests have determined what would constitute adequate protection from stray magnetic fields of a magnitude which may possibly be encountered in transit. It was found that field strengths within the tape of 50 oersteds or less caused no discernible erasure . . . Sources of magnetic energy to which tape being shipped might be subjected would be motors, generators, transformers, etc. These devices are designed to contain their magnetic fields to accomplish some kind of work. With this in mind, it is safe to assume that field strengths of more than 1,500 oersteds would not be encountered in ordinary shipping situations.

"Because field intensity decreases rapidly with distance from the source, the 50-oersted point . . . is reached at a distance of 2.7 inches from a 1,500-oersted source. From this it can be seen that the easiest and least costly method of obtaining erasure protection is by insuring a degree of physical spacing from the magnetic source. It is suggested that tape being prepared for shipment be packed with bulk spacing material such as wood or cardboard between the tape boxes and the outer shipping container.

"Three inches of bulk spacing should give adequate protection and virtually eliminate any potential for erasure. This magnetically protective spacing can also be justified because of the excellent protection gained against physical damage to the contents"



Soundcraftsmen

S-E-P-A-R-A-T-E-S...

WORLD'S MOST VERSATILE PREAMPLIFIERS

Unique Equalizer/Preamplifiers and Straight-Line Preamplifiers featuring -97dB Phono S/N, Adjustable Phono Capacitance and impedance. Moving Coil Inputs, Phono Input Level Controls. Exclusive AutoBridge™ circuit for Mono Operation of Stereo Amplifiers @ **TRIPLE POWER OUTPUT**, versatile Push-Button Patch bay with External Processor Loops, Digital and Video/Audio Inputs, Precision Passive Coil EQ Circuitry and **0.1 dB Readout Differential/Comparator®** Unity Gain Controls for Highest Gain, Lowest Distortion and No "Clipping" of Wide Dynamic-Range Material. Computone Charts and 12" LP Frequency Analysis Test Record included with Preamp-EQ's...

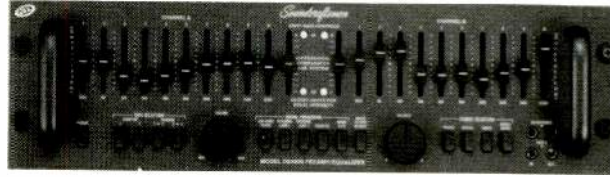

WORLD'S MOST ACCURATE REAL-TIME ANALYZERS AND EQUALIZERS

REVOLUTIONARY Differential/Comparator circuitry makes possible **0.1dB Readout Accuracy!** Automatic or Manual Octave Scanning for Fast, Accurate Analyzing and Equalizing. Precision Passive Coil Filters for Highest Gain. Lowest Distortion, Scan-Analyzer Models. With and Without Built-in Equalizers. No Calibrated Microphone necessary. Computone Charts and 12" LP Frequency Analysis Test Record included with EQ's...

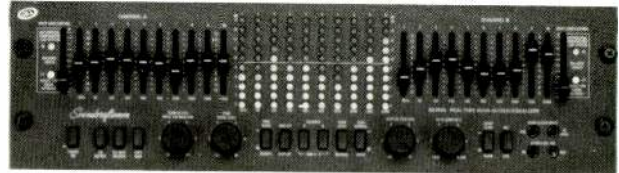

REVOLUTIONARY CLASS "H" AND MOSFET HIGH CURRENT AMPLIFIERS

The most advanced Stereo and Professional Amplifiers featuring Class H Dual Signal-Tracking Power Supply. Auto-Buffer™ for Continuous 2-Ohm Operation, No-Current-Limiting, Auto Crowbar Output Protection, Power MOSFET circuitry for High Reliability, Calibrated LED meters, A-B Speaker Switching, 125 to 600 w/p/c @ 8 ohms, 20-20kHz

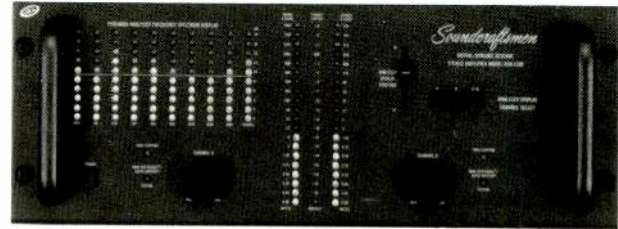

FOR A DEMONSTRATION, VISIT NEAREST DEALER LISTED BELOW

However, many additional Dealers—too numerous to list here—are located throughout the U.S. with many models on display. If no dealer is shown near you, or you encounter any difficulty, please phone us at 714-556-6191, ask for our "Dealer Locator Operator"

ALASKA

Wrangel
WRANGEL DRUG
ARIZONA
Phoenix
AUDIO ASSOCIATES
Tucson
B&A ELECTRONICS
Yuma
WAREHOUSE STEREO
NO. CALIFORNIA

Concord
SOUND DISTINCTION
Goleta
HOUSE OF AUDIO
Palo Alto
WESTERN AUDIO
Sacramento
LISTEN HERE
San Francisco
LISTENING POST
Santa Barbara
HOUSE OF AUDIO
SO. CALIFORNIA
Phone 714-556-6191, ask for "Dealer Locator Operator" (insufficient space to list all Dealers in this area)

COLORADO

Colorado Springs
THE SOUND SHOP
Denver, Arvada, Aurora
STEREO PLUS
Englewood
GOLD SOUND
Gunnison
WILDWOOD MUSIC
CONNECTICUT
Avon
TUNXIS ELECTRONICS
Bristol
TUNXIS ELECTRONICS
Danbury
CARSTON STUDIOS
Middletown
TUNXIS ELECTRONICS
Newington
TUNXIS ELECTRONICS
Southington
TUNXIS ELECTRONICS
West Hartford
TUNXIS ELECTRONICS

FLORIDA

Fort Lauderdale
SPEAKER WAREHOUSE
Fort Walton Beach
AUDIO INTERNATIONAL
Hollywood + Hialeah
SPEAKER WAREHOUSE
Lakeland
THE SOUND FACTORY
Merritt Island
AUDIO MART ELECTRONICS
Miami
AUDIO PLUS
LA MIRAGE
LAS FABRICAS
Orlando
AUDIO MART ELECTRONICS
MARKETPLACE ELECTRONICS
GEORGIA
Atlanta
AUDIO UNLIMITED
STEREO CITY
STEREO DESIGNS
Augusta
THE STEREO SHDP
Columbus
WORLD-WIDE ELECTRONICS
Warner Robbins
WORLD HIFI
Savannah
AUDIO WAREHOUSE

HAWAII

Hilo
YAFUSO T.V. APPLIANCE
Honolulu
VIDEO LIFE
Lihue, Kauai
JACK WADA ELECTRONICS
Waialuku, Maui
ADRIAN'S ELECTRONICS
IDAHO
Idaho Falls
PHASE 4 STEREO
ILLINOIS
Chicago
MARTROY ELECTRONICS
MUSICRAFT
Dekalb
AUDIO PLUS
Gurnee
OPUS EQUIPMENT
Peoria
ELECTRONICS DIVERSIFIED

INDIANA

Burton
ANDERSON ELECTRONICS
Indianapolis
STERED IMAGE
Michigan City
AUDIO CONNECTION
New Haven
HJS SOUND
South Bend
TWILIGHT ZONE
West Lafayette
VON'S ELECTRONICS
KANSAS
Overland Park
AUDIO ELECTRONICS
Salina
DEL'S TV
Wichita
AUDIO PLUS
KENTUCKY
Lexington
THE STEREO SHOPPE
Louisville
HI-FIDELITY, INC
LOUISIANA
Baton Rouge
NEW GENERATION
Houma
LANNY'S MUSIC
LaFayette
NEW GENERATION
Metairie
SOUND TREK
New Orleans
SOUTHERN RADIO SUPPLY
TULANE STEREO

MARYLAND

Annapolis
MID SHIPMEN'S STORE
Baltimore
STANSBURY STEREO
Gaithersburg
AUDIO BUYS
MASSACHUSETTS
Boston
ENCORE AUDIO
Dartmouth
MIKE ROSE ENT.
Sunderland
SCIENTIFIC STEREO

MICHIGAN

Burton
STEREO VILLAGE
Detroit
PECAR ELECTRONICS
Marquette
AMERICAN TV
MINNESOTA
Bloomington
MINNESOTA SOUND VALUE
Duluth
TEAM ELECTRONICS
Litchfield
QUALITY STEREO
MISSISSIPPI
Gulfport
TIPPIT'S MUSIC
MISSOURI
Chesterfield/St. Louis
INSTANT REPLAY
Kansas City
SOUND DYNAMICS
NEBRASKA
Lincoln
LIGHT & SOUNDS FANTASTIC

NEVADA

Las Vegas
UNIVERSITY PRO AUDIO
NEW HAMPSHIRE
New London
NORTH STAR ELECTRONICS
NEW JERSEY, SO.
Cherry Hill
WIDE WORLD ELECTRONICS
Wildwood
SEASHORE STEREO
NEW YORK CITY, NORTHERN N.J.
Phone 201-947-9300, ask for "Dealer Locator Operator" (insufficient space to list all Dealers in this area)

NEW YORK —UPSTATE

Buffalo
PURCHASE RADIO
Plattsburg
GREAT NORTHERN STEREO
Syracuse
MORRIS ELECTRONICS
SUPERIOR SOUND

NORTH CAROLINA

Fayetteville
QUALITY SOUND
Greensboro, High Point, Winston-Salem,
AUDIO-VIDEO CONCEPTS
Hendersonville
PRO SOUND & ELECTRONICS
Hickory
MC LAUGHLIN'S TV
Morehead City
Newbern
ANDERSON AUDIO
Raleigh
CREATIVE ACOUSTICS
NORTH DAKOTA
Dickinson
MUSIC HUT

OHIO

Akron
OHIO SOUND
Boardman
ELECTRONICS LTD.
Bowling Green
HART AUDIO
Canton
OHIO SOUND
Canton
METRODYNE
Cleveland
B&B APPLIANCE
OHIO SOUND
Lima
HART AUDIO
Middleburg Hts.
B&B APPLIANCE
Parma
DESIERO ENT.
Warren
ELECTRONICS LTD.
OKLAHOMA
Oklahoma City
JOHNSON TV & SOUND
OREGON
Eugene
BRADFORD'S HIGH FIDELITY
Klamath Falls
HIGH COUNTRY RECORDS
Portland
HAWTHORNE STEREO

PENNSYLVANIA

Bloomsburg
HAPPY EAR STEREO
WEBBER'S PRO AUDIO
Chambersburg
SUNRISE ELECTRONICS
Hermitage
CUSTOM SOUND CO.
McKeesport
HI FI CENTER
Philadelphia
SOUND OF MARKET
SOUND SERVICE
Pittsburgh
AUDIO JUNCTION
Reading, Shillington
PHOENIX HI FI
Sharon
ELECTRONICS LTD.
Willow Grove
SOUNDEX
PUERTO RICO
Sanjurjo
R. F. ELECTRONICS
SOUTH CAROLINA
Columbia
NORTON STEREO
Greenville
DOON JONES STEREO
Newberry
THE ELECTRONIC SHOP
Spartanburg
DOON JONES CUSTOM STEREO

TENNESSEE

Nashville
AUDIO SYSTEMS
TEXAS
Arlington
SOUND IDEA
Beaumont
BRDCK AUDIO
Corpus Christi
SOUND VIBRATIONS
El Paso
SOUND ROOM
Fort Worth
SOUND IDEA
Houston
HOME ENTERTAINMENT
Hurst
SOUND IDEA

MIDLAND FOLGER'S ENTERTAINMENT

UTAH
Bountiful
INKLEY'S
Midvale
INKLEY'S
Salt Lake City
INKLEY'S
St. George
ARROW AUDIO
VERMONT
Brattleboro
SCIENTIFIC STEREO
VIRGIN ISLANDS
St. Thomas, U.S. and British Virgin Islands
ELECTRONICS UNLIMITED
VIRGINIA
Arlington
AMERICAN AUDIO
Falls Church
AUDIO BUYS
Richmond
GARY'S
WASHINGTON
Olympia
DESCO ELECTRONICS
Yakima
STEREO FIRST
WASHINGTON D.C.
AUDIO KRAFTERS
WEST VIRGINIA
Morgantown
THE SOUND POST
Princeton
THE SOUND POST
WISCONSIN
Appleton
AMERICAN TV
Glendale
SOUNDSTAGE
Madison
AMERICAN TV
Oshkosh
AUDIO PLUS
Sheboygan
GENE'S CAMERA & SOUND
Waukesha
AMERICAN TV
CANADA
Ontario M2H2S5
Tri-Tel Assoc.



the Soundcraftsmen STORY

Soundcraftsmen Celebrates it's 17th Year of Manufacturing Audio Components for the Discriminating Audiophile... Right Here in Santa Ana, California

From the introduction of our first Equalizer in 1969, through to our present-day product line of 26 models of U.S. Made Amplifiers, Pre-amps, Equalizers, and Analyzers, all made right here in Santa Ana, our goal has been to Design and Manufacture very affordable State-of-the Art "SEPARATES," with all of the unique and necessary features that audiophiles demand...and to assure the highest level of performance, 35% of Soundcraftsmen's Production Staff is involved in Quality Control procedures...100% Quality Control is seen on EVERY unit manufactured, and EVERY transistor and EVERY circuit board is put through an individual test.

More Importantly, EVERY completed unit is final Q-C Tested 3 TIMES!...First, EVERY unit is electronically tested for specification accuracy...and Second, EVERY unit is connected to a High Fidelity system and listened to—just like you would at home...and Third, if your unit meets or exceeds the critical standards set forth on these tests, it is then hooked up and tested again on the final packing line, before it is packaged for shipment. EVERY unit, absolutely no exceptions, is FINAL-TESTED 3 SEPARATE TIMES, in 3 SEPARATE DEPARTMENTS, to assure you unsurpassed Reliability as well as superb Performance.

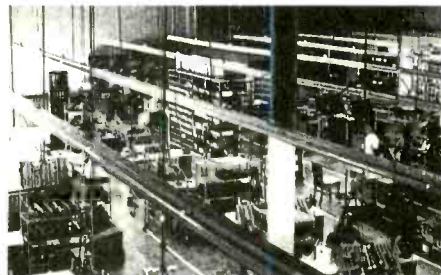

PRODUCTION AREA, MAIN PLANT

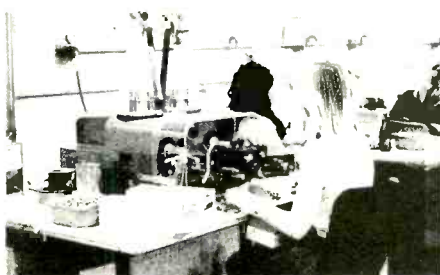

PRECISION COIL-WINDING



HAND-CRAFTED COMPONENTS



CIRCUIT BOARD LAYOUT

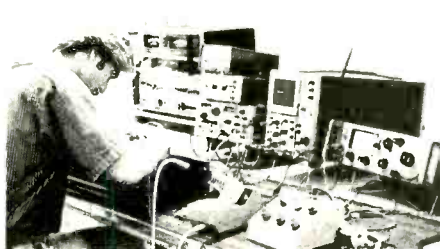

ENGINEERING AND DESIGN

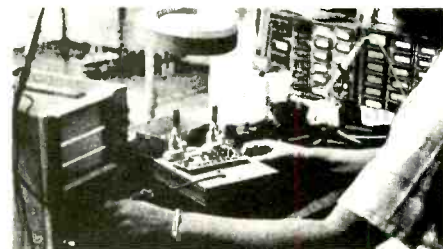

QUALITY CONTROL #1



Meet Paul Rolfes, Chief Engineer, V.P., and inventor of Soundcraftsmen's many "FIRSTS" in amplifier technology...

His inventions in electronic power circuitry have resulted in more than a dozen original patents, plus all of the following Audio industry "FIRSTS":

- FIRST—with signal-tracking multiple-rail power supplies.
- FIRST—with fully electronic automatic resetting crowbar circuitry.
- FIRST—with Phase-Control-Regulation power supplies.
- FIRST—with automatic low-impedance power supply selection.

The Audio Industry's Most Complete line of Power Amplifiers— 16 Models of Power Mosfet and Class H Amplifiers, from 125 Watts p/c to 375 Watts p/c @ 8 ohms, 20-20kHz, < 0.05% THD.

Our newest Power Mosfet Amplifier is the PM840, a phenomenal value in High-Current and High-Power... 205 watts per channel output at 8 ohms, 20Hz to 20kHz with less than 0.05% THD, and with a Performance/Value ratio that is unmatched... a total of 410 watts RMS at 8 ohms, over 600 watts RMS at 4 ohms, and over 900 watts RMS at 2 ohms... \$499.

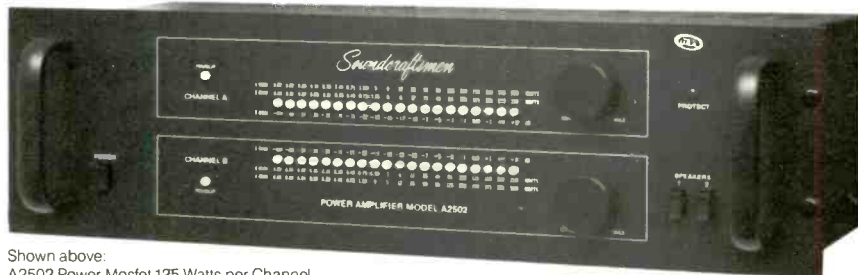

Shown above: A2502 Power Mosfet 125 Watts per Channel



Yes, rush me the name of my nearest dealer, 1986 Buyer's Guide, and info on FREE 16-page color Brochure and 12" LP Test Record System Evaluation Kit. Mail to Soundcraftsmen, 2200 S. Ritchey, Santa Ana, CA 92705.

Name _____
 Address _____
 City _____
 State _____ Zip _____

FREE!

16-PAGE FULL COLOR BROCHURE, AND \$19.95 SYSTEM EVALUATION KIT: 1-12" LP Spectrum Analysis Test Record, 2-sets of Computone Charts, 1-Connector Cable for comparison test, 1-instruction folder for use with your present stereo system. Send coupon for FREE SPECIAL OFFER DETAILS.



BERT WHYTE

MARKING TIME



If the 104,163 industry people who attended the 1986 Winter CES in Las Vegas were expecting any major advances in technology or the introduction of exciting new product categories, they were sorely disappointed. The general consensus seemed to be that most manufacturers were marking time, merely showing updated and face-lifted versions of existing products. It was apparent that they had decided to make their major new product introductions at the Chicago Summer CES.

At both the summer and winter shows, I spend most of my time where the high-end components are demonstrated. At this WCES, high-end audio components were shown at the Sahara Hotel, and I must say I felt very sorry for the manufacturers who had to exhibit there. These companies spent a lot of time and money trying to present worthwhile demonstrations of their products, but even the most conscientious of them could not cope with the Sahara's abominable exhibit rooms. Not only were they relatively small, converted guest rooms, but their raised platforms upon which beds are normally placed could not be removed. The sounds from loudspeakers made many of these large, undamped platforms vibrate and resonate, superimposing a most degrading coloration on the reproduced sound. This made any accurate assessment of quality well nigh impossible. Surely, audio components deserve better than this sort of treatment.

As is usual these days at Consumer Electronics Shows, CD players held the spotlight. Though virtually every major component manufacturer offers CD players for home use (most made by several OEM suppliers), new configurations continue to proliferate.

There is a trend towards changer-type CD players. For the car, Sony has their unique "DiscJockey," with a 10-disc changer remotely mounted in the car trunk. CD changers for the home are represented by such units as the original six-disc Pioneer PD-M6 and a five-disc Mitsubishi model. One of the problems with the various CD changers, for home or car, is that they all use different magazines or disc caddies for holding discs such that none of them are compatible with each other. (See the feature article on CD changers in this issue.—Ed.)

Many of the mid-priced and high-end CD players are much improved. Some incorporate third-generation technology which affords remarkably high-quality reproduction. More CD players are being designed with extra refinements and convenience features in an effort to make them seem different and more desirable.

Onkyo was showing what was billed as the first CD player to use fiber-optics technology. Six fiber-optic cables interconnect various stages carrying only digital information such as L/R, word and bit clock signals, audio data, de-emphasis actuate, etc. All this is supposed to help achieve lower noise and distortion. A U.S. version, the DX-320, should be available this spring.

Tandberg introduced the TCP-3015A Compact Disc player. This \$1,295 unit apparently will be one of the first to employ the new Philips 16-bit, four-times oversampling, 176.4-kHz system. Dual D/A converters are used, along with digital and analog filtering. The analog circuitry is direct coupled, is totally discrete (no ICs), and has zero negative feedback. Wireless remote control is provided, along with a full complement of time-display and programming features.

Yamaha introduced no less than 10 new CD players, ranging in price from \$249 to just under \$1,000. The CD-2000 and CD-2000M are the flagship models, with the latter featuring XLR balanced-line inputs and special r.f. shielding for broadcast and studio use. Both units use Yamaha's third-generation digital filter (which has a 90-dB cutoff slope); new fifth-order active analog filters are also used. An important feature is a new vibration-damping assembly for the analog audio circuit board. Newly designed VLSI chips are used, 88.2-kHz oversampling is employed, and an S/N ratio of 105 dB is claimed.

The Magnavox CDB 650 uses Philips' new 16-bit/176.4-kHz oversampling system, has a new laser pickup, and features access time of less than 1 S. Uniquely, 785 tracks from different CDs can be programmed into the unit! The price is \$410.

Much to the horror and chagrin of the anti-digital brigade, there are people (many of whom are newly minted audio enthusiasts) who don't care one whit about vinyl phonograph records and don't even own a turntable! For these people, and for those who want a really high-quality preamplifier for CD playback, the clever folks at Mod Squad have introduced their Active Line Drive. This neat, compact unit has an outboard power-supply transformer and has high-level inputs for CD, tuner and video equipment, plus two auxiliary inputs. A tape-monitor loop is provided. Front-panel rotary controls include an input selector, balance control, 31-step volume control, and a source/mute/tape switch. According to Mod Squad specs, the Active Line Drive provides 18 dB of gain, with an S/N ratio of 90 dB and very low harmonic and IM distortion. The output

Illustration: Rita Pocock

ANNOUNCING THE CBS COMPACT DISC CLUB

ANY 2 COMPACT DISCS FOR \$1.00 WITH MEMBERSHIP



340323



336222



Barbra Streisand The Broadway Album

342097



343624



334391

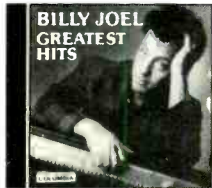

336396-396390 (2CDs)



316604

CHOOSE STATE-OF-THE-ART SOUND IN THE LATEST CD RELEASES.



336669



343715



263293

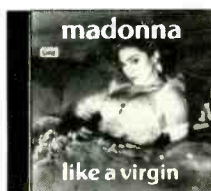

331645



337402



324822

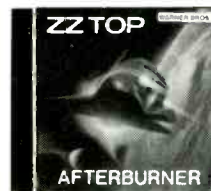

340414



339226



337519



326629



333112

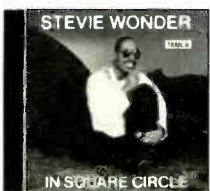

339200



321570

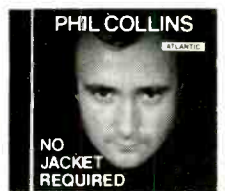

333286

338616. Miami Vice—Music From The Television Series. G. Frey. #1 You Belong To The City; many more. (MCA)
339903. The Cars—Greatest Hits. Tonight She Comes, Drive, more. (Elektra)
341263. Enach Light & The Light Brigade—Big Bands Of The Thirties. Begin The Beguine; more. (Project 3)
322008. Linda Ronstadt & The Nelson Riddle Orch.—What's New. (Asylum)

323261. Lionel Richie—Can't Slow Down. All Night Long; Sluck On You; Hello, etc. (Motown)
340182. Philip Glass—Mishima. Original music from the film. (Nonesuch)
335547. Berlioz: Symphonie Fantastique. Barenboim, Berlin Phil. (Digital—CBS Masterworks)
331264. Bryan Adams—Reckless. #1 hit: Heaven; Run To You; etc. (A&M)

343160. Beethoven: Symphony No. 9 (Choral). Bruno Walter, Columbia Sym. (CBS Masterworks)
318089. Michael Jackson—Thriller. Billy Jean; The Girl Is Mine, etc. (Epic)
273409. Beethoven: Piano Sonatas. Vladimir Horowitz plays. Appassionata; Moonlight; Pathetique. (Columbia)
320499. The Police—Synchronicity. Winner of three Grammy Awards! (A&M)

341073. Steely Dan—A Decade of Steely Dan. Reeling In The Years; Hey Nineteen; more. (MCA)
337279. Placido Domingo—Save Your Nights For Me. Love songs. (CBS)
288670-398677 Barry Manilow—Greatest Hits. It's A Miracle; Mandy; etc. (Counts as 2—Arista)
322024. Huey Lewis & The News—Sports. Bad Is Good; Heart & Soul; etc. (Chrysalis)

336578-396572. Bach: Flute Sonatas—Rampal, flute; Pinnock, harpsichord, etc. (Counts as 2—Digital—CBS Masterworks)
314443. Neil Diamond's 12 Greatest Hits, Vol. 2. You Don't Bring Me Flowers (with Barbra Streisand); etc. (Columbia)
340760. Stevie Nicks—Rock A Little. Top 10 Talk To Me; I Can't Wait; title cut; etc. (Modern)

328740. Mozart: Piano Concerto No. 26 (Caranation); Rondos. Murray Perahia and English Chamber Orchestra. (Digital—CBS Masterworks)
219477. Siman & Garfunkel's Greatest Hits. El Condor Pasa; Bridge Over Troubled Waters; etc. (Columbia)

COMPACT disc DIGITAL AUDIO

The age of CD sound is here—and you have a practical new way to find the CDs you want. As your introduction to the CBS Compact Disc Club, you can choose any 2 CDs listed in this ad for just \$1.00. Fill in and mail the application—we'll send you CDs and bill you for \$1. You simply agree to buy 2 more CDs (at regular Club prices) in the next year—and you may then cancel your membership anytime after doing so.

How the Club works. About every four weeks (13 times a year) you'll receive the Club's music magazine, which describes the Selection of the Month for your musical interest... plus many exciting alternates.

If you wish to receive the Selection of the Month, you need do nothing—it will be shipped automatically. If you prefer an alternate selection, or none at all, fill in the response card always provided and mail it by the date specified. You will always

Selections with two numbers contain 2 CDs and count as 2—so write in both numbers.

have at least 10 days in which to make your decision. If you ever receive any Selection without having 10 days to decide, you may return it at our expense.

The CDs you order during your membership will be billed at regular Club prices, which currently are \$14.98 to \$15.98—plus shipping and handling. (Multiple-unit sets may be somewhat higher.) After completing your enrollment agreement you may cancel membership at any time; if you decide to continue as a member, you'll be eligible for our money-saving bonus plan. It lets you buy one CD at half price for each CD you buy at regular Club prices.

10-Day Free Trial: We'll send details of the Club's operation with your introductory shipment. If you are not satisfied for any reason whatsoever, just return everything within 10 days and you will have no further obligation. So why not choose 2 CDs for \$1 right now.

CBS COMPACT DISC CLUB • Terre Haute, IN 47811

CBS COMPACT DISC CLUB
P.O. Box 1130, Terre Haute, Indiana 47811

Please accept my membership application under the terms outlined in this advertisement. Send me the 2 Compact Discs listed here and bill me only \$1.00 for both. I agree to buy two more selections at regular Club prices in the coming year—and may cancel my membership at any time after doing so.

Send me these 2 CDs

My main musical interest is (check one):

(But I may always choose from either category)

ROCK/POP CLASSICAL

Mr.
Mrs.
Miss

Print First Name Initial Last Name

Address _____ Apt. _____

City _____

State _____ Zip _____

Do you have a VCR? (Check one.) Yes No 708/F86

Do you have a credit card? (Check one.) Yes No

This offer is not available in APO, FPO, Alaska, Hawaii, Puerto Rico. Please write for details of alternative offer.

Note: All applications are subject to review. The CBS Compact

Disc Club reserves the right to reject any application.

1TF/NZ

Most Japanese firms have been keeping prototypes of DAT recorders under wraps, apparently to avoid any negative effect on the booming CD market.



Tandberg 3015A CD player

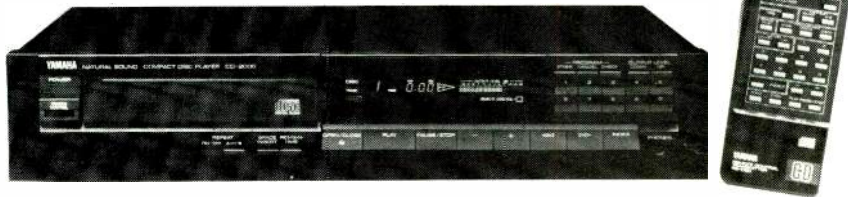

Yamaha CD-2000 CD player

impedance is 100 ohms, maximum output is 13.5 V rms, and the unit will safely drive virtually any power amp.

At \$500, the Active Line Drive is a good companion for upscale CD players. I have used this unit with a number of high-quality amplifiers, and it has proven to be an excellent performer. Its sound is very neutral and clean, with an open, transparent quality, a nice preservation of depth, and good, stable imaging. The unit is extremely quiet and does not degrade the S/N ratio of even the most expensive CD player. Eliminating the cost of high-quality phono circuitry enabled the Mod Squad to provide the Active Line Drive with high-quality parts and to achieve a level of performance as good as many higher priced preamps.

Although a number of Japanese manufacturers are known to have fully developed models of digital audio tape recorders, they have been keeping them under wraps, apparently by mutual agreement. However, Onkyo evidently believed the CD market was so strong that there was really no compelling reason for further delay. Thus, they showed a prototype of their DT-1000 DAT recorder, although price and delivery schedule were not announced. The DT-1000 is equipped with a real-time music counter and music program system, allowing access to any part of a program by index or time.

As you may know, the Japanese have developed both stationary-head and rotary-head DAT system versions. To make matters more complicated, the EIAJ (Electronic Industries Association of Japan) has adopted *both* formats as standards.

However, there seems to be a general favoring of the rotary-head (R-DAT) format, and this is what Onkyo has employed in the DT-1000. The R-DAT cassette is approximately two-

thirds the size of a standard audio cassette. It moves at a snail's pace of 8.15 or 12.225 mm per second, which respectively affords 120 and 80 minutes of recording. There are two channels, and with a 30-mm recording drum operating at 2,000 rpm, the writing speed of 3.13 meters per second is equivalent to a linear speed of over 10 feet per second! Quantization is 16-bit linear, and the sampling rates are 48, 44.1 and 32 kHz. You may note that the 48-kHz rate is the same as used in the professional digital formats; theoretically, this means that a DAT cassette might exhibit higher resolution than a CD! Error correction is similar to CD, with double-encoded Reed-Solomon code employed.

A remarkable system, this DAT. One can only speculate on its uses. Of course, to be competitive with CD there will have to be prerecorded DAT music cassettes. Even when duplication becomes fast and cost-effective, however, a comparison of wear characteristics would still favor the CD. Though many playbacks could be made with little degradation, eventually there would be wear on the magnetic coating of the tape (even with evaporated metal), and edge-frilling of the tape could also be, ultimately, a degrading and limiting factor. Nonetheless, the DAT provides fascinating new recording technology. **A**

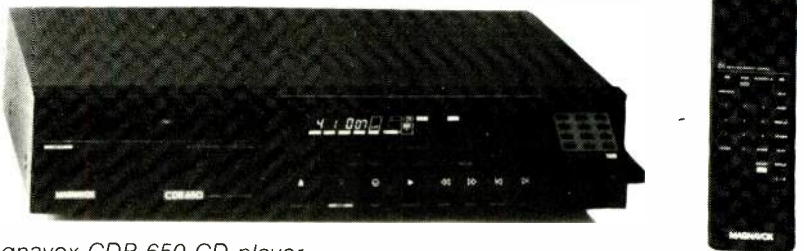

Magnavox CDB 650 CD player



Prototype of the Onkyo DT-1000 digital audio tape recorder

THE 800 SERIES MASTER MONITORS



LISTEN AND YOU'LL SEE

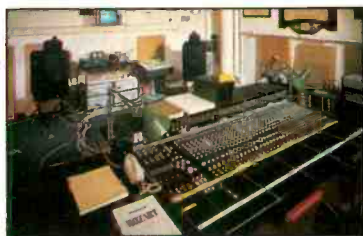

801's at a Deutsche Grammophon digital recording session in the Kingsway Hall, London.



801's pictured here in the Decca digital suite, London.



801's in the celebrated EMI Abbey Road studios, London.

Top-of-the-line models 801F, 802F, 808 and the new MPA810 power amplifier: at the fore-front of sound reproduction technology. Used by digital recording studios worldwide and soon, we hope, by you.

1966  1986

B&W CELEBRATES 20 YEARS OF THE QUEST FOR PERFECTION

The inspiration behind B&W was, and still is, that of John Bowers — creator, engineer, music-lover and perfectionist. B&W is a personal dream that became an internationally respected company.

Twice the winner of the Queen's Award to industry and designer of numerous award-winning and trend-setting loudspeaker models, B&W still remains committed to the goal which was the impetus for its founding: the most faithful re-creation of music possible. For while John Bowers and his B&W team enjoy the great respect of the audio industry, they have as many admirers and friends among the world's top professional musicians, conductors and recording engineers. That, perhaps better than any other accolade, attests to the quality of every B&W design.

Today the B&W sound quality is legendary, and extends from the professional monitor models 801F and 808 to a range of products to suit virtually every application. The affordable 100-series of Digital Monitors, the Video Acoustical Monitors, Professional Amplifiers, Active loudspeakers and a complete range of Automobile loudspeakers, all reflecting the "Quest for Perfection" which motivated B&W's beginnings 20 years ago.



"My own critical standards when listening to music have always been exacting. I have never expected those of B&W customers to be less so." John Bowers
 Founder and Managing Director, B&W Loudspeakers

The world's audio press tells the story:

Model P2 (1966) "... for this loudspeaker with its broad and balanced polar response, its linear and extended frequency response is approaching the ideal everyone is seeking — perfection."

John Gilbert, Gramophone (U.K.)

Model 801 (1979) "In simplest possible terms, the 801 is among the handful of great loudspeakers available."

High Fidelity (U.S.A.)

Model DM6 (1975) "... the overall impression left after many weeks of listening is predominantly one of satisfying, untiring natural sound, without any distracting feature which could be termed a flaw."

Trevor Atwell, Hi-Fi News (U.K.)

Model 808 (1984) "It is difficult to describe how one gets caught up in the music, how the climaxes of a Mahler symphony, for instance, afford an emotional impact that can truly be described as uplifting... There is no doubt that the B&W 808 is a major achievement in advanced speaker design."

Bert Whyte, Audio (U.S.A.)

Active 1 (1985) "The John Bowers Active 1 certainly measured like a fine speaker, and we are happy to report that it sounds as good as its measurements imply—beautifully balanced and uncolored... The bass output from the two 6-inch drivers... compares very well with the output from good 12-inch woofers in cabinets at least twice the size of the Active 1."

Julian Hirsch, Stereo Review (U.S.A.)



B&W Hi-Fi Leaves Home... And Takes to the Road

The beginning of this decade saw the logical extension of home hi-fi into the automobile, with sophisticated audiophiles seeking performance standards on a par with those of their high-end domestic systems.

B&W responded to the challenge in 1982 by introducing their LM1 series of Leisure Monitors. For many LM1 provided for the first time an opportunity to have quality hi-fi in the automobile.

The enthusiasm with which LM1 was received led to the introduction of MASS — B&W's Modular Automobile Sound System — in 1985. Comprising 8 interlinking modules, MASS combines B&W's world-famous sound quality with system flexibility, high sensitivity and a wide range of installation options.

MASS provides a refined solution to the problems of critical in-car listening, maintaining the highest performance standards while overcoming installation limitations, off-axis listening positions and adverse climatic conditions. Such refinements as B&W's APOC (Audio Powered Overload Circuit) to protect the drive units and the unique dual-action swivel mount of the LT40 tweeter (based on the famous TXS26 high-frequency driver used in studio monitor 801F) are just some of the technological advances made with MASS.

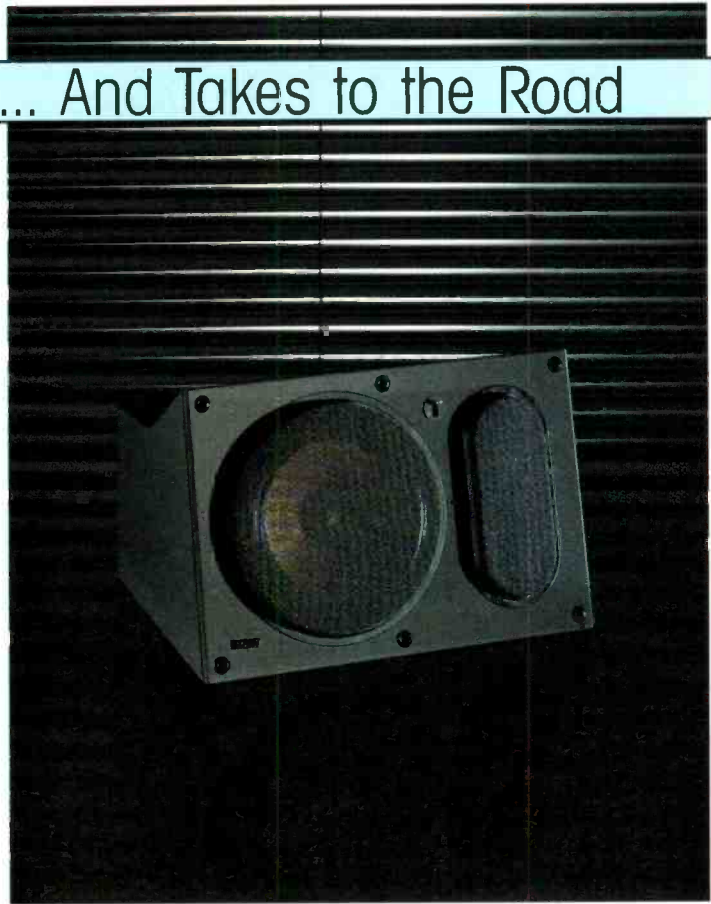

Leisure Monitor LM1



Eight associated modules form MASS

The Kevlar Cone

Kevlar — DuPont's aromatic polyamide fibre — is vastly superior to conventional loudspeaker materials and particularly suited to automobile loudspeaker applications. Kevlar's combination of high stiffness and low mass had proved its sonic superiority through use in the all-important midrange driver of the 801F. Its extremely low mass is particularly critical for automobile applications where high sensitivity is an important criterion given the lower power output of most car audio amplifiers.

Easily capable of withstanding temperature extremes and high humidity, Kevlar will not be affected by the adverse conditions inherent in the automobile environment. Initially developed for bullet-proof vests Kevlar is used today for racing cars, yachts, and many other high-performance products where the weight-to-strength ratio is critical, such as the Porsche 959 which must be a prime example of today's technology ahead of its time.



Kevlar cone & Porsche 959

Two Decades of Creative Innovation

In his heart John Bowers is an engineer and designer, and his engineering creativity has directed B&W's policy from the very beginnings of the Company. This dedication has made B&W one of the most research-oriented companies in the audio industry, and their Steyning Research Establishment is among the most advanced acoustical laboratories in Europe.



Steyning Research Establishment

Although equipped with some of the most modern and sophisticated tools available, it is the Steyning Research Establishment's engineering team which is B&W's greatest asset. Their creativity over the last twenty years has pioneered a number of industry milestones:

- a calibration certificate included with every production loudspeaker
- digital testing for quality control in production
- incorporation of electronic overload protection circuits
- first to use Kevlar for loudspeaker cone construction
- first in Europe with a linear-phase loudspeaker — DM6
- first with computer optimisation for crossover design
- first to use composite enclosure techniques employing Fibrecrete bonded to structural foam
- first to employ laser interferometry to study the vibrational behaviour of loudspeaker drivers.

... and in 1986...

MATRIX — a significant advance in loudspeaker enclosure technology.

It is a source of considerable pride to everyone at B&W that every model in the range employs only components of B&W's own design and manufacture. All drivers and crossover networks are manufactured at B&W's facilities in Worthing, Sussex, under the most stringent quality control systems.

Styling has always been recognised as an important feature of B&W loudspeakers and Kenneth Grange of Pentagram Design has consistently created enclosure designs which complement the technical excellence of the loudspeakers.



Dr. Glyn Adams, head of B&W's research department, pioneered a technique for monitoring the vibrational behaviour of loudspeakers using lasers.

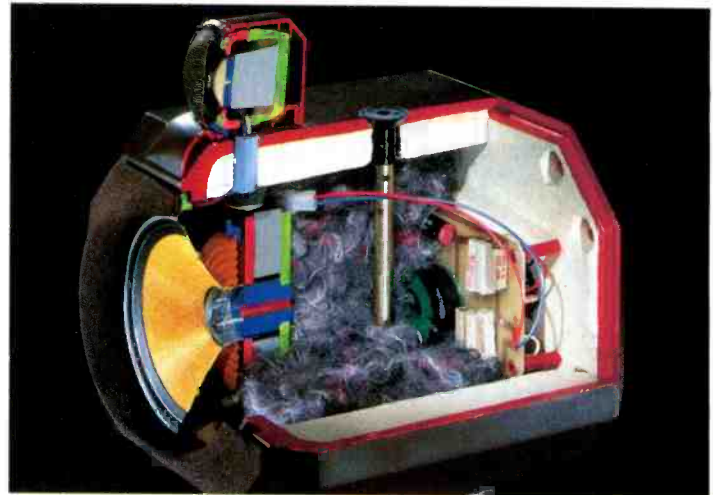

The Fibrecrete lining of its midrange head assembly is one of the important reasons for B&W 801F's superior performance.



B&W's automated tweeter assembly. Technology in the service of music.

MATRIX — The Modern Art of Sound

In loudspeaker design, as in other technologies, the frontiers of what can be accomplished are pushed back gradually in an evolutionary process of development. Occasionally, however, a breakthrough of major proportions is made. B&W MATRIX* is just such a breakthrough.

Whilst steady progress has been made in the development of new and better drive units, until recent years little attention has been paid to the actual enclosure housing these drive units. Because of its importance to loudspeaker performance, B&W instigated a research programme on enclosure design three years ago, embracing a wide range of materials including the so-called Aerospace materials, "Sandwich" construction and even concrete. Despite the extravagant claims made for these materials, B&W's research showed that in some respects they were inferior to a conventional enclosure. B&W therefore invented MATRIX.

The MATRIX enclosure comprises an inner honeycomb structure bonded to the outer skin of the cabinet and filled with sound absorbing foam. The enormous stiffening provided by this structure virtually eliminates enclosure radiation at low and mid frequencies, with the additional damping providing a similar effect at high frequencies. The cellular foam configuration almost completely absorbs rear radiation by the driver.

Of equal importance is the "Time History" — the time required for the sound to decay. MATRIX scores equally well on this count, minimizing "hang-over" inherent in less sophisticated loudspeaker enclosures.

The B&W MATRIX series of Digital Monitors has been designed for the age of the compact disc, with all the additional requirements this source material places on the loudspeaker system: increased dynamic range, increased transient information and a lower noise floor.

Having designed a near-perfect enclosure B&W developed totally new and improved components to complement their invention. Homopolymer Polypropylene cones (almost twice as stiff as Copolymer Polypropylene

used by other manufacturers), a totally new Ferrofluid cooled tweeter giving 8dB increased dynamic headroom at high frequencies and a crossover network providing a new standard for low distortion and resistive amplifier loading.

B&W have published a complete "Design Story" on the MATRIX series of Digital Monitors, including research results from the three-year design programme. Write to us for your copy, or visit your local authorized B&W dealer.

*B&W MATRIX is a trademark of B&W Loudspeakers Ltd.

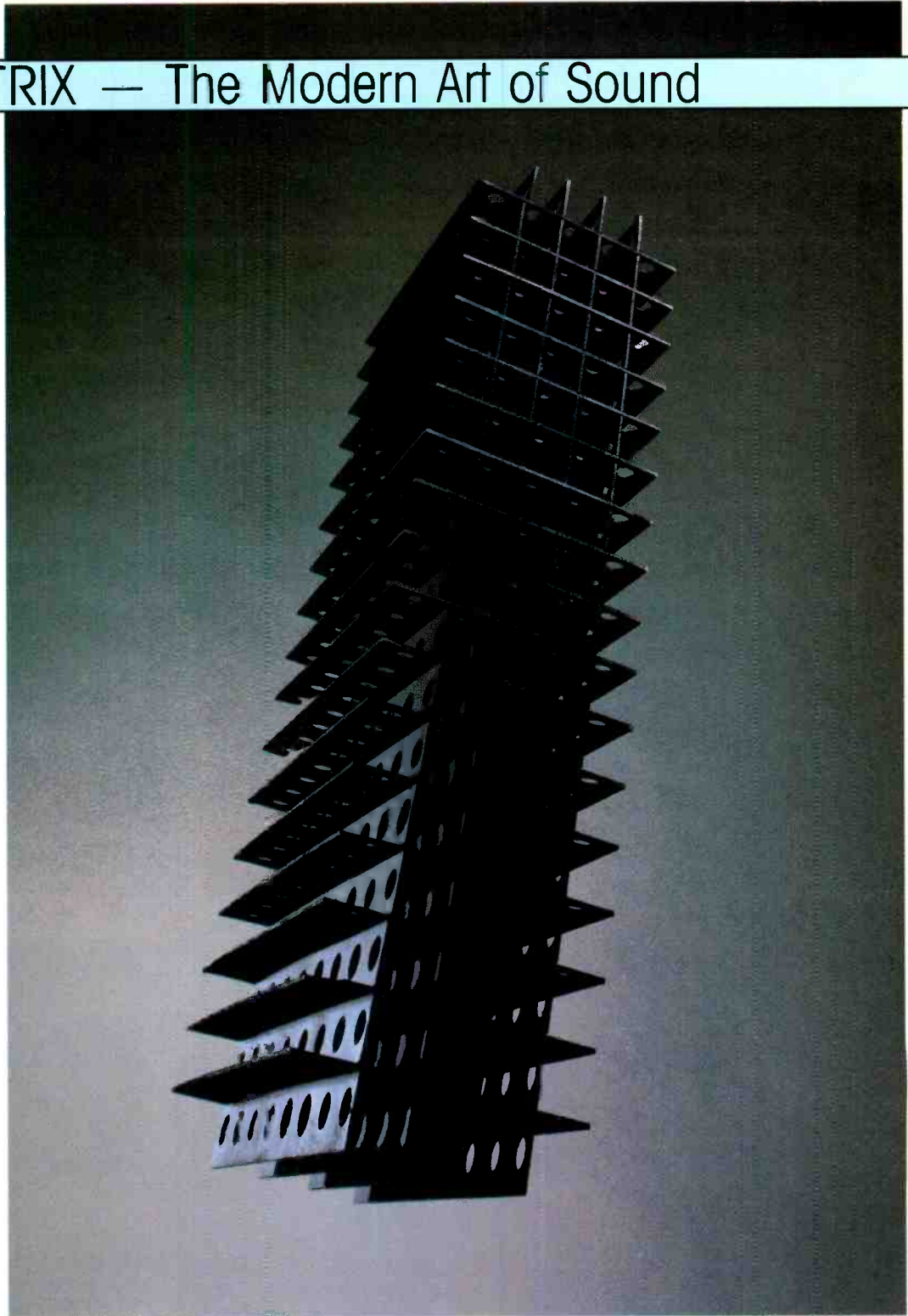

1966 **B&W** 1986

MILESTONES



1967 P2H "Approaching the ideal everyone is seeking - perfection."
JOHN GILBERT, GRAMOPHONE

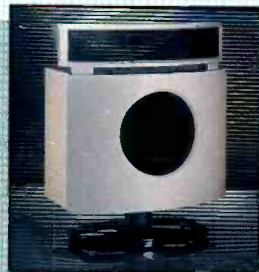

1970 DM70 When launched Funk-Technik (Germany) said: "... a milestone of development for the next decade." Time proved them correct.



1972 DM4 Increased B&W's export tenfold in five years winning a second Queen's Award.

1975 DM6 Europe's first linear phase system and the first to use Kevlar in cone construction.

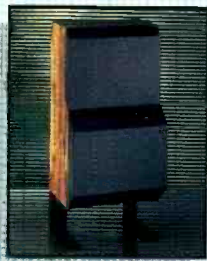

1983 DM10 Pop, jazz, rock, classical - total spectrum capability from this popular and 'affordable' Digital Monitor.



1979 801 B&W's first professional monitor loudspeaker. Now selected worldwide as classical music monitor by all major recording labels.

1984 ACTIVE 1 B&W's first electronic loudspeaker system. Originated, designed and produced completely in-house.



1984 808 Reproduction to full reference standards - perfection to 120dB.



1986 MATRIX This unique system concept incorporates a revolutionary enclosure design. Find out more from your B&W stockist.



Two decades of creative innovation, of setting the standards in advanced loudspeaker design. Constantly pushing at the frontiers of sound technology. The B&W quest for perfection continues.

20 Years Of Sound Technology

ANGLO AMERICAN AUDIO, P.O. BOX 653, BUFFALO, NY 14240 416-297-0595



UNSPRINTABLE OPTIONS

The ink had barely dried on my critical examination of DAT (in the February and March issues) when the letters started arriving. Of course, every in-house journalist knows that crank mail typically far outweighs fan mail, but I was still surprised at the growing imbalance of opinion. Letters of encouragement from analog fans, desperate to put the hex on the next digital technology? No.irate letters from digital supporters, displeased at criticism of their conquering hero? Nope. The reactionary correspondence came in business envelopes, on letterhead, from Japanese audio companies.

When big companies take issue with an individual, some very tangential things can be said, especially when the companies involved are bona fide, aboveboard, maximum-integrity outfits which fully understand the power of the audio press. An exceedingly polite message is conveyed; no mention of a disagreement is made. Rather, points are argued with copious amounts of information. The tacit message is: "As you can see, at great cost we have figured out the technology; it's great, the public will agree, and we shall recoup our investment."

Backed by the weight of technical evidence, that's a hard argument to counter. All the numbers and diagrams certainly inspire confidence, as well as some expectation. And it is clearly high technology, hence it *must* be desirable. As I sifted through the pages of documentation, I wondered whether I had been foolish in shooting off my mouth against DAT. Were my objections to the soon-to-be format founded on defensible hypotheses, or was it only a case of intolerance based on lack of information and awareness?

I decided to take a closer look at the technology of the DAT system. Coincidentally, a recent Electronic Industries Association of Japan (EIAJ) committee meeting has resulted in new guidelines for the design of the system, affording us a greater understanding of things to come. This EIAJ committee was formed in 1983 to guide development of DAT, and now consists of 81 manufacturers (60 of them Japanese). Within the committee, there are R-DAT and S-DAT subcommittees. It firmly controls the destiny of DAT.

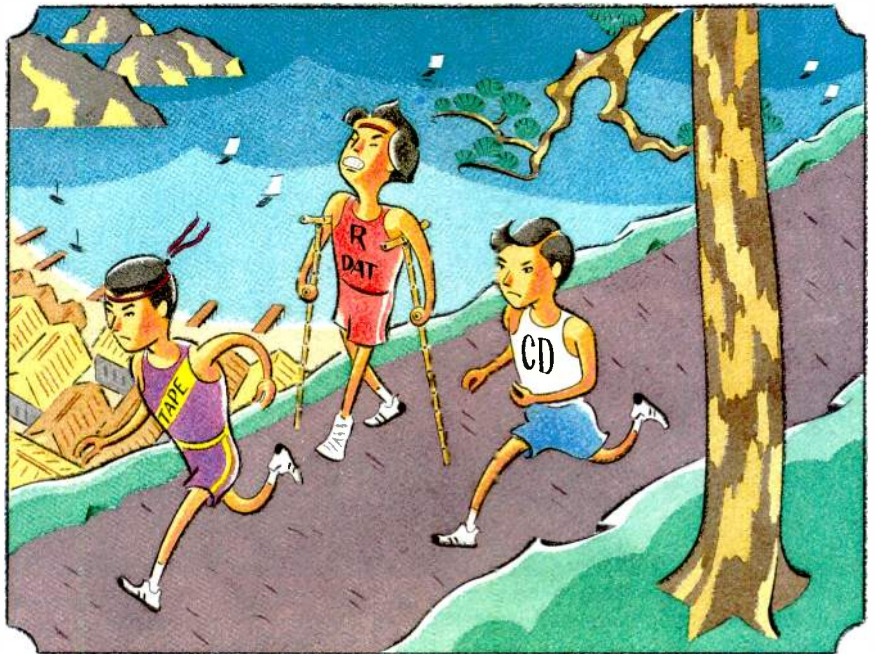

Illustration: Philip Anderson

At this time, S-DAT appears to be on the back burner, due to technical obstacles such as head technology and tape formulation. On the other hand, R-DAT is forging ahead, borrowing from video head and videotape technologies which already offer wide recording bandwidths. Because R-DAT can adapt existing technology, it appears to have the shortest road to commercial realization and thus the best prospects for near-term success.

One of the benefits of digital technology is the flexibility of design parameters; the EIAJ committee has used this flexibility to expand DAT's capabilities—or abused it to the point of confusion, depending on your point of view. Table I shows the format specifications for R-DAT. There are no fewer than four record/playback modes and two playback-only modes. Every R-DAT machine will have at least the Standard record/playback mode and both playback-only modes (called Normal and Wide). The other three modes are options for specific applications.

The Standard record/playback mode offers 16-bit quantization and a 48-kHz sampling rate. Full digital inputs and outputs will permit digital recording and playback of data; however, that capability is crippled by the committee's choice of sampling rate.

By design, 48 kHz is incompatible with the Compact Disc's 44.1-kHz sampling rate. Thus, you will not be able to digitally transfer CD material to tape even with a CD player that has digital outputs; intermediate conversion to analog will be required.

Though you won't be able to record digitally at the 44.1-kHz sampling rate, you will be able to play back tapes made at that rate—pre-recorded tapes made by the record companies from the same masters they use for CDs. In addition, every recorder will have a feature which prevents operation if any digital source has been copy-guarded. While all of this puts the whammy on piracy, it also has the effect of creating a digital recorder with little or nothing digital to record. I suggest that the R-DAT logo depict a sprinter who has just shot himself in the foot.

The only record/playback modes with potential digital source material to record are the optional modes, which all use 32-kHz sampling rates. Option 1 provides two hours of recording time and Option 2 provides four hours. Option 3 allows two hours of four-channel recording and playback. What kind of digital source material is available for full digital recordings? There is direct-broadcast satellite material, beamed at 32 kHz, in Japan and parts of Eu-

Full digital inputs and outputs would permit digital recording and playback, but that ability is crippled by R-DAT's 48-kHz sampling rate.

Table 1—Specifications for R-DAT operating systems.

	RECORDING AND PLAYBACK MODES				PLAYBACK MODES	
	Std.	Opt. 1	Opt. 2	Opt. 3	Normal	Wide
Number of Channels	2	2	2	4	2	2
Sampling Frequency (kHz)	48	32	32	32	44.1	44.1
Quantization Bit	16L*	16L*	12NL*	12NL*	16L*	16L*
Rec. Line Density (kB/in.)	61.0	61.0	61.0	61.0	61.0	61.1
Rec. Sq. Density (MB/sq. in.)	114	114	114	114	114	76
Subcode Capacity (kB/S)	273.1	273.1	136.5	273.1	273.1	273.1
Cassette Size	← 73 x 54 x 10.5 mm →					
Rec. Time (minutes)	120	120	240	120	120	80
Tape Width	← 3.81 mm →					
Tape Material	← Metal Particle → Ferric					
Tape Thickness	← 13 microns, ± 1 →					
Tape Speed (mm/S)	8.15	8.15	4.075	8.15	8.15	12.225
Tape Pitch (microns)	13.591	13.591	13.591	13.591	13.591	20.41
Drum Size	← 30 mm; 90° Wrap Angle →					
Drum Rotating Speed (rpm)	2,000	2,000	1,000	2,000	2,000	2,000
Writing Speed (meter/S)	3.133	3.133	1.567	3.133	3.133	3.129
Head Azimuth, Alt. Tracks	← ± 20° →					

*L = Linear; NL = Nonlinear

rope—but it's not available in the U.S. I think the sprinter actually shot himself in both feet.

Okay, okay, you've just sunk \$2,000 into an R-DAT recorder. You'll never use it for digital recording because you don't live in Japan or Europe. You can't make digital-to-digital copies of your Compact Discs (unless someone markets a black-box sampling-frequency converter, but on the other hand, why record a CD to tape anyway?) and you can't make digital-to-digital copies of prerecorded R-DAT tapes. And how often will you use it for live microphone recordings of, for example, your mother-in-law singing opera arias?

Well, what will you use your R-DAT for? You can do what all analog cassette recorders already do—record from analog sources or from digital sources converted to analog. Or you can play back prerecorded digital tapes. Tapes for the Normal playback mode will be mass-recorded in real time; as with the record/playback modes, metal-particle tape will be used. Tapes made for the Wide playback mode can be prerecorded at a higher speed using the same sort of "contact print" techniques that are used to duplicate videotapes: A blank tape is fast forwarded (200 times normal speed) in contact with a master tape; a focused magnetic field at the point of contact causes the blank tape to assume the magnetic characteristics of the master.

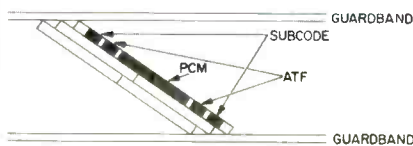

Fig. 1—R-DAT data fields, showing tracking correction blocks.

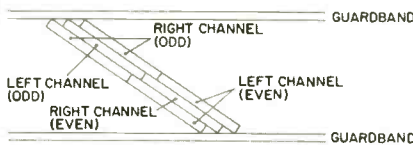

Fig. 2—Distribution of the R-DAT data for error correction.

Because the signal level resulting from contact duplication is significantly lower than that of normal-speed dubbing, the Wide mode requires a wider track than the other formats to compensate for the decrease in output level. This is accomplished by running the tape 50% faster. Playing time is reduced to 80 minutes; however, since the recording square density is lower, regular ferric oxide tape may be used instead of metal tape.

All R-DAT modes use a common head and tracking system. The rotating drum has two heads 180° apart, with a tape wrap of only 90°. Because of the low wrap, tracking stability is said to be better than M-wrap and U-wrap video systems. This should facilitate design

of portable and car players. To help ensure accurate tracking, a dedicated tracking correction system is employed. As shown in Fig. 1, part of each data track contains correction data (labelled ATF). As each track is read, the head overscans the track width to read a small part of the adjacent tracks. Then, the intensity of the ATF data is compared to that on adjacent tracks; a difference causes the tracking correction system to adjust the head accordingly.

Other data blocks are used for subcode. As on the Compact Disc, this data is used for tape time, indexing, music selection, etc. The audio is contained in 196 blocks of PCM data. As with any video-based system, time compression must be used to divide the continuous signal into fields, with enough time left between the fields to accommodate the recorder's head-switches. The fields are rejoined in playback.

Each track is split into halves, for left and right channels, as shown in Fig. 2. To facilitate error correction, data for each channel is additionally split into even and odd data blocks, one for each head. If one head reads bad data (because of dirt on the tape or a tape defect), the other head's received data can be used to interpolate the missing information. All of the data is encoded with the Reed-Solomon error-correction code, as on CDs.

Technically, the R-DAT has apparently arrived. Pending critical first-hand listening tests, I can only speculate that it will sound better than analog cassette recorders. In the same way that the Compact Disc conquered the analog disc, digital audio tape might conquer the analog cassette. Like the CD, it should provide higher fidelity, longer playing time, and conveniences such as programmability and indexing. It will also further open the door to future-generation audio systems in which digital outputs from sources such as the CD and DAT are digitally processed and amplified.

But I'm still not a believer. The purposely incompatible sampling rates largely negate the supreme advantage of DAT—direct digital recording of digital sources such as CD and DAT. Why design lameness into a product? That's a technological tragedy. **A**



ONKYO
Grand Integra M-510
Power Amplifier

Artistry in Sound

ONKYO®



The ONKYO Grand Integra M-510 Power Amplifier combines transparency, musicality, and accurate spatial imaging together with sufficient power to drive any high quality loudspeaker system, regardless of efficiency or load impedance.

Conservatively rated at 300 watts per channel, the M-510 features Onkyo's unique Real Phase power

supply design, which prevents sonic degradation due to amplifier/speaker interaction.

Loudspeakers represent complex electrical loads, compared to the rather simple resistive loads used by engineers who design power amplifiers. Recently, many designers have examined the loudspeaker's impedance characteristics, and quality

amplifiers now feature the ability to provide increased power output into lower impedance loads. This low impedance drive capability is necessary due to the changing impedance of a real loudspeaker, as well as to properly drive the growing number of low impedance rated speaker systems.

However, these designs still fail to take into account the reactive nature of the speaker load. The ONKYO Grand Integra M-510 Power Amplifier combines for the first time the Real Phase power supply design, with Onkyo's True Low Impedance Drive Capability.

Impedance Characteristics for IHF Reactive Speaker Test Load

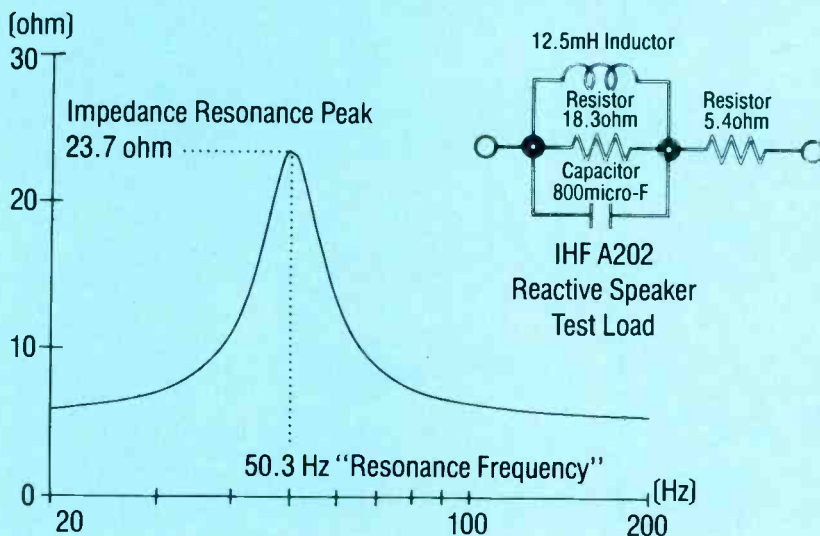

Loudspeakers present complex, reactive loads to the amplifier. This is the impedance curve from a loudspeaker load test model, showing a peak of 23.7 ohms at the 50.3 Hz resonance peak.

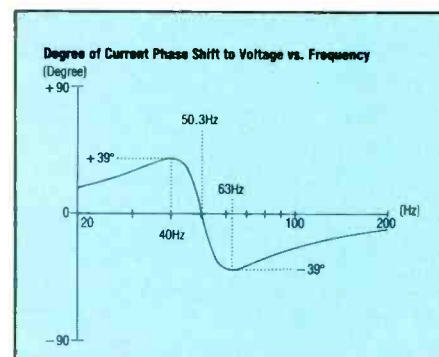

The graph shows the amount of phase shift between current and voltage relative to frequency, with a phase shift of +39 degrees below the resonance point and -39 degrees above the resonance point.

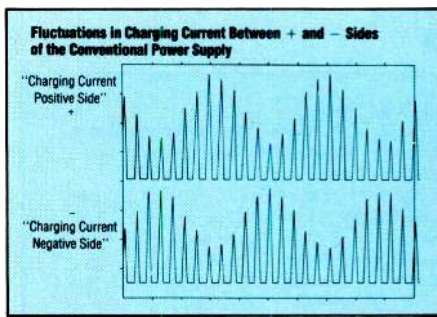

Fluctuations in the power supply charging current between the '+' and '-' sides of a conventional supply; these fluctuations cause a loss of image specificity, "smearing" the stereo image.

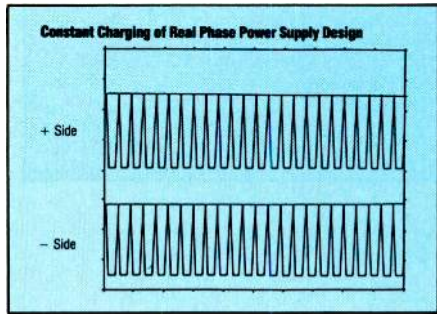

The ONKYO Real Phase power supply design eliminates these fluctuations, providing stable power on demand, resulting in precise stereo imaging, with no loss of detail even during the most dynamic passages.

Power Supply:

The M-510 features three separate power supply systems. Essentially, the amplifier is a Dual Mono type; that is, the left and right channels are separate all the way back to the power switch and AC cord. Each of the two main power supplies features two power transformers; one, a large toroidal unit, features tremendous power handling capacity; the second, a Real Phase transformer about half the size of the main unit, smooths out fluctuations in charging current due to amplifier/speaker interaction. AC from the transformers is converted to DC by high current rectifiers, and each channel features two massive 33,000 microFarad 100 Volt filter/storage capacitors.

Input Controls:

Two sets of inputs are provided on the rear panel. The set labeled "Direct" bypasses the front panel attenuators. The other set of inputs allow attenuation via the two precision potentiometers hidden behind the flip down front panel door. Both sets of inputs are direct coupled.

ONKYO's exclusive Super Servo circuit cancels DC and extremely low frequency AC (below 3 Hz) without the use of coupling capacitors.

Meters and Relays:

The third power supply system provides separate DC energy for the front panel lights, the protection circuitry, and the speaker relays. This ensures that large peak outputs can not affect these important stages in any way. Two sets of speakers can be hooked up to the M-510, and the switchable relays allow System A, System B, or System A + B operation. The four output relays wired in parallel per channel provide extremely high current handling capability, with very low contact resistance so that damping remains high.

The front panel meters are peak reading, with fast attack and slow decay for maximum effectiveness. Each meter draws from a separate power supply, so the activities of one channel cannot affect the meter indication of the other. The meters are calibrated using 8 ohm loads, and are very accurate. Meter sensitivity can be changed from normal to -10db by a pushbutton; in the -10db mode full scale (0db) deflection indicates 30 watts into 8 ohms load. Approximate power output into 4 ohm loads can be calculated by doubling the meter readings. Approximate power output into 2 ohm loads can be calculated by quadrupling the meter readings.

Protection Systems:

The amplifier must protect both itself and the loudspeaker systems from damage in the event of component failure and/or severe overdrive conditions, but these systems must not interfere with musical integrity under normal conditions. Short term power available from the M-510, depending upon load impedance, can be over 2.5 kilowatts per channel, which can cause severe thermal damage to even the most rugged loudspeaker system.

The M-510 protection circuits will disrupt operation in the presence of the following conditions:

1. Overheated output stage(s)
2. Excessive DC at the input terminals
3. Amplifier output stage component failure producing DC
4. Excessive current flow

at the speaker terminals in the presence of extremely low impedance loads at full power, including short circuit.

The protection circuits monitor the various conditions, but are totally isolated from the audio circuits by photoelectric opto-couplers. The protection systems are powered by the third main power supply and are thereby unaffected by high power consumption during peak audio signal conditions.

Start-up Sequence:

The start up sequence of the amplifier's various stages is carefully controlled, in order to prevent excessive inrush current from the house AC line. Due to the massive storage capability of the power supply systems, the amount of current required during turn on of all three supplies at the same time would trip the house AC circuit breaker(s) or blow the fuse. Also, excessive turn on currents can damage circuit components, so the M-510 switches on in a gradual, controlled manner.

Start up of the M-510 energizes the three power supplies in sequence, and after the DC storage is stabilized, the four audio stages are energized in sequence. Meter lighting is gradually increased to normal or low intensity, depending on the lighting switch selector, and after all stages are settled, the output relays close. The process takes about ten seconds. The front panel "Waiting Monitor" indicates the sequential turn-on of the four stages.

Pre-conditioning:

The input and driver stages of the M-510 amplifier are biased in true Class A constant current fashion. The output stage consists of fourteen high current transistors per channel, with a dissipation capability of 2800 watts continuous. The output transistors are biased partially on all the time (Class AB) using Onkyo's exclusive Linear Switching system to eliminate switching distortion. When the amplifier is first turned on, a special pre-heat system increases the output stage bias, until the correct output stage temperatures are reached. The front panel "Waiting Monitor" indicates correct output stage temperatures when all the LED's are lit. The amplifier will operate from approximately

ten seconds after initial turn-on; however, distortion is higher when the output stage is cool, so we recommend the unit remain idle until the Waiting Monitor indicates correct output stage temperature. Idle current from the AC line is approximately 250 watts when cold, settling down to about 160 watts when correct output stage temperatures are reached.

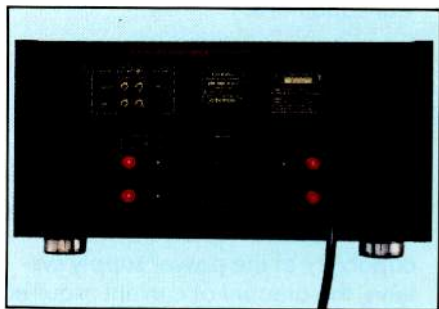

PERFORMANCE SPECIFICATIONS

Power Output:

300 watts per channel, RMS into 8 ohms
500 watts per channel, RMS into 4 ohms
800 watts per channel, RMS into 2 ohms

IHF Dynamic Power Output:

>400 watts per channel, 8 ohms
>750 watts per channel, 4 ohms
>1.3 kilowatts per channel, 2 ohms
>2.1 kilowatts per channel, 1 ohm

Harmonic Distortion:

<.005%

Intermodulation Distortion:

<.003%

Power Bandwidth (IHF):

5 Hz to 100 kHz, -3 db, THD .2%

Gain:

33.8 db

Frequency Response:

1 Hz - 100 kHz, +0, -1.5 db

Input Sensitivity:

1 Volt for full output

Input Impedance:

20 kOhm (direct inputs)

S/N, A weighted:

120 db

Load Impedance:

1 ohm to 16 ohms, nominal speaker impedance
4 ohms to 16 ohms, EIAJ specification

Damping Factor:

>300; 8 ohms at 50 Hz

Meter Range:

44 db

Meter Accuracy:

0 db indicated: + or - 1 db
- 10 db indicated: + or - 2 db
- 20 db indicated: + or - 3 db

Meter Rise Time:

Minimum to 0 db - 100 microseconds

Decay Time:

0 db to -20 db - 1 second

Power Requirement:

120 Volts, 60 Hz (USA model)

Power Consumption:

720 watts EIAJ specification
160 watts idle, no signal

Dimensions:

507mm wide x 264mm high x 512mm deep

Weight (Shipping):

72 Kg 160 lbs.

As reviewed in

stereophile

“The lab concluded that “so far, this appears to be the best amp evaluated on our test bench.””

“Here we have a very powerful amplifier with outstanding sonics across the board—power with delicacy. Low-impedance panel systems like the Apogee Scintillas will do their best with this amplifier.”

“Most important, the Grand Integra costs over \$4000, putting it up against the Krells, the Levinsons, and the best of Audio Research. Although this is very strong competition, today I find the M-510 unmatched in its soundstage width and transient fidelity; in other respects it is at least very good. I would advise Onkyo to continue pushing back the frontiers of audio engineering; their American competition certainly will be.”

Laurence Greenhill

stereophile

Vol. 8 No. 8

Artistry in Sound

ONKYO®

200 Williams Drive, Ramsey, N.J. 07446 201-825-7950

DRESSED-UP DISCS

Fumble-Proof Packaging

I rather like a new Compact Disc packaging format—the Digi-Pak from AGI—that appears to me to offer a reasonable alternative to the Jewel Box. Now, while the Jewel Box is part of the CD Standard, there are Standards and there are standards. For example, the original Standard for the Compact Cassette, also a Philips development, specified the cassette box, and of course there are now a variety of other styles of boxes available, both in the aftermarket and as original packaging. This new Digi-Pak is to be used by the record companies on an OEM basis, and it appears to offer certain advantages.

I don't know how many times you've dropped a Jewel Box and broken a hinge, but I've got about 15% of my collection of CDs suffering from this seemingly congenital malady—*fumblitis Editorius*. I think, however, that the ear on the lid or front of the box just isn't strongly enough made to stand up to the wear and tear it will take in the normal course of its life. I've asked several of my CD-maker contacts about replacement lids, and a couple of them have promised me a handful.

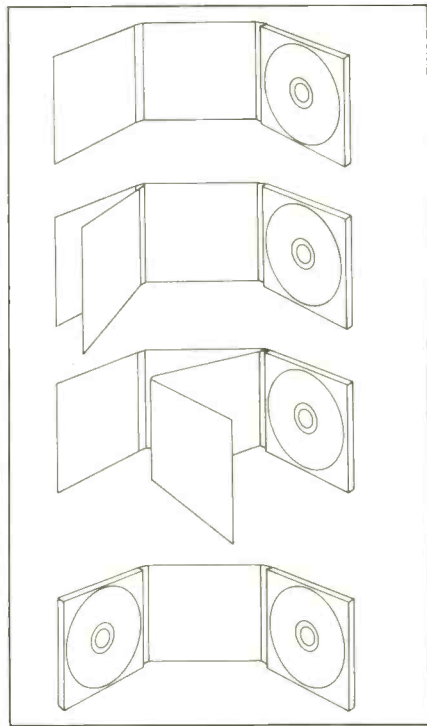

I'm still waiting. I'd even *buy* a few dozen at, say, 50¢ each, but I can't find anyone who sells them—mail order or otherwise. If anyone decides to go into this business, I'll take a bunch of lids as my fee for use of the idea.

Anyway, the Digi-Pak does away with this problem. Basically, it's made up of a revised center insert, of plastic, shaped much like the one inside the Jewel Box, with a wraparound of cardboard to carry the graphics. The insert is not *exactly* like the Jewel Box's. For one thing, it's easier to get the CD off the center spindle of the Digi-Pak because its four corners have ramps arranged so that it is easy to get a finger under the CD. Pressure at two points—up at the ramp, and down at the spindle—pops the CD out of the Digi-Pak.

It's also easier to get to the CD. I need two hands to open the Jewel Box; I can open the Digi-Pak with one. Who cares? Someone trying to get at a CD to play it while driving a car, for instance.

You can see in the drawings that there are several configurations AGI can supply; we've seen only the

simpler, single-disc styles so far, a few from Island Records and one from A&M. The half-dozen I've had my hands on look better to me than the Jewel Box. Which is to say, in university terms, that their graphical achievement quotient is relatively superior. ("What?") Also, to look at the album-cover graphics, you don't have to peer through the plastic lid of the Jewel Box.

My contact at AGI is chary about answering my "How much?" question directly, and I think he's right to point out that the two forms of packaging aren't directly comparable. And he needs an answer to "For how many?" before he can answer my question on price. The different formats cost different prices too. The upshot of this is that using a Digi-Pak won't cause a CD manufacturer to suddenly have to raise prices by \$5—or enable him to lower prices by that much.

My guess is that you'll be seeing more of these in the record stores, from several more labels than Island, A&M, Capitol, and American Gramophone, the only firms said to be testing the packaging at this time. *E.P.*

We use CDs instead of LPs for listening checks because the last pass is as clean as the first, provided our ears are still reacting cleanly.

Demos de Mode

We editors use specific recordings, other than the ones we normally listen to for pleasure, to wring out loudspeaker systems during our travails at shows and press functions. At *Audio*, we also use these discs to separate the sleepers from the goats amongst the speakers herded in for review. This latter hurdle is a go/no go or pass/fail test where units submitted for potential review get two chances to sound acceptably good. We presently use CDs, rather than LPs, because of their ease of handling and repeatedly clean signal—the last pass is as good as the first, providing our ears are up to it. I might add that we are still searching for a truly good piano run, preferably at high level, but with enough notes to have fundamentals in the ranges of all three drivers in a three-way system. If anyone knows of such, please write to us in care of the magazine.

Though we would not pretend that the following are the only discs which might be employed for these purposes, here are some we do use:

Opus 3 Test Record 1, *Depth of Image* (CD 7900). "Labyrinth" has a very nice male vocal, "Zamponas" switches from large panpipes to conversation and produces a startling sense of space, and Bach's "Invention No. 14" has four guitars arranged in a semicircle (at least on the better speakers). We're still getting to know Test Record 3, *Dynamics*, but it promises to be useful.

RCA's *Transformer* by Lou Reed (PCD14807) is a good example of how the transcription of old masters to CD can be worthwhile. The cut we use is "Walk on the Wild Side," specifically, the part where the girls come across the studio toward the open mikes. With some speakers, it sounds as if the distance they travel is upwards of 20 feet; with others, it sounds like only about five. On one system, they seem to jump at listeners from about 10 feet out, right up to the mikes. Thanks are due Randy Patton, now of Sumo; he played me this cut on the Ti series speakers from JBL, for whom he worked at the time.

Verve's *We Get Requests* by the

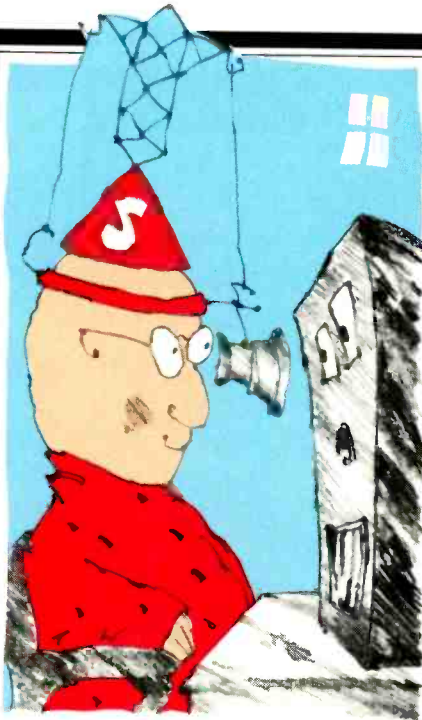

Oscar Peterson Trio (810 047-2) is another example of how some of the older recordings do well in the transfer. We use the bowed and plucked bass on "You Look Good to Me" to check the low-end reproduction. It's recorded at a higher level than the piano, but it's naturally high, even though many speakers reproduce it at a lower level. One speaker seemed to fall off a cliff when bassist Ray Brown got halfway down his fingerboard.

GRP's *Mountain Dance* by Dave Grusin (GRP-D-9507) is something I first ran into on a JVC prerecorded metal tape. The master used for the CD has, I believe, had its balances altered from the running master used for the tape, but the title cut has a cymbal imaged so well I can almost count the rivets. There are some extreme transients here too, from the piano, which is very closely miked. Indeed, some say it is *too* closely miked; I can only reply that I've heard some few speakers not go CrUnCh with this input. Also, "Thanksong" has my nomination for Sweetest Piano Ever Recorded and is rivaled, in my estimation, only by the "Three Cowboy Songs" cut on Sheffield's *Discovered Again*, also by Grusin.

Female vocals are tough for speakers to reproduce without

coloration, and it amazes me how two different speakers—both good—can be so different in how they handle the ladies. The CD we use most often is Sheffield Lab's *West of Oz* by Amanda McBroom (CD-15), and then usually the "Dorothy" track. (Why *did* Dorothy leave Oz?) Two other discs of this same genre are *Silver Linings: Songs by Jerome Kern* sung by Joan Morris (Arabesque Z6515) and *Blue Skies*, with Kiri Te Kanawa and Nelson Riddle and his orchestra (London 414 666-2). These are relatively new additions to our library, but at present I think they will be permanent.

Male vocals, for some reason, are usually less difficult for speakers to reproduce, at least in my experience. We use two CDs: *Trouble in Paradise* by Randy Newman (Warner Bros. 9 23755-2), with "The Blues" being the most played track, and "Der Doppelgänger" sung by Shura Gehrman, with Nina Walker playing piano, on a Nimbus sampler (NIM 5001 1). There is a very wide dynamic range to Mr. Gehrman's voice on this recording, and some speakers go buzzy as a result.

One recording which received much attention in its LP version also deserves mention in CD: *Cantate Domino* on Proprius/AudioSource (CDP 7762), which we use less often than the others, mostly because of my musical tastes, but which is sweet and clean nonetheless.

The last disc, which fits into the The CD to Take When You Can Only Take One to the Show category, is the Denon Audio Technical CD (38C39-7147). The 99 tracks on this disc may be divided into two basic categories, music and test signals, with the latter further divided into general audio signals and special ones for CD players. There is a good variety of music, from jazz and rock to classical, with the emphasis on instrumental classical. The test signals in the basic section include tracks for channel identification, balance, and phase checks; there are white and pink noise tracks for measurement and setup. The signals in the CD test section are pretty specialized and are generally intended for measurements.

E.P.

Audible Elegance

Audio Components of Uncompromising Quality

Exclusively from Revox of Switzerland



From Switzerland, A Harmonious Blend of Elegant Styling



Only Revox can offer complete systems designed and engineered to please both the demanding audiophile and the discriminating, convenience-conscious homeowner. The front faceplates on Revox components do not trumpet unnecessary "high tech" ostentation. Such gimmickry is not needed. A few moments of listening to a Revox system will let you know that, indeed, advanced technology is at work.

Pioneering Revox technology goes beyond impeccable sonic performance. For example, advanced digital control systems developed by Revox extend remote control convenience to rooms throughout the home. The luxury of superior music reproduction with fingertip control need no longer be confined to the living room.

This leaflet gives a brief description of the Revox component line. Should you desire more information, please visit your Revox dealer and request a free copy of our 48-page full color catalog.

Revox B285 AM/FM Receiver

A symphony of sophistication and simplicity, the full-featured B285 is surprisingly easy to operate. The secret lies in the B285's two on-board microprocessors. You program the B285 to respond to your listening habits and your room environment. Set it once and, from then on, the B285 remembers all the adjustments for you.

Features include:

- Programmable input sensitivity for all input signals
- 29 AM/FM station presets
- Programmable output levels for A & B speaker terminals
- Multimode LC display
- Advanced digital synthesizer tuner section
- Infrared remote control of 9 functions
- Bi-directional data port for multi-room remote capability
- Power amplifier section with class AB output stage
- Rise time of 3 μ s and slew rate of 100 V/ μ s for superb transient response
- Exceptionally low noise for optimum CD reproduction. *B286 Tuner/Preamplifier*. No power amplifier stage; otherwise identical to the B285.

Agora B Speaker Systems

Digital sound recording challenges the limits of conventional loudspeaker design, and Revox meets this challenge with the new Agora B active speaker systems. Each Agora B enclosure contains three separate power amplifiers—one each for the bass, mid-range, and high-frequency drivers. This triamplified design delivers deep, tight bass and breathtaking high frequency transparency. • *Agora B speakers also feature:* • Active filter network instead of passive crossovers • Two bass drivers, one mounted on top of the enclosure and facing inward to eliminate even-order harmonic distortion • Feedback sensing circuit to compensate for back EMF from bass driver • High rigidity titanium dome tweeter • Bass, treble and bass blend adjustment controls.

B215 Cassette Deck

Revox has designed a cassette deck to please the most performance-conscious audio enthusiast. Yet this same cassette deck also allows a non-technical music lover to make professional-quality recordings consistently and effortlessly.

A unique microprocessor controlled system, developed by Revox engineers, automatically calibrates the B215's internal bias and equalization for the best possible performance on any tape selected.

Other B215 features include:

- Automatic or manual input level setting
- 3 heads • 4 direct drive motors • Dual capstans driven by quartz-locked Hall-effect motors
- Microprocessor spooling motor control for constant speed winding and jerk-free stops
- Azimuth stable pivoting headblock
- Dolby** B and C NR • Dolby** HX Pro headroom extension
- Elapsed time counter
- Address locate • Automatic start-of-record locate • Loop function • Automatic fade-in/fade-out
- Bi-directional serial data bus.



and Advanced Technology

B225 Compact Disc Player

Overwhelmingly acclaimed by audio critics as the reference standard CD player, the B225 makes no compromises in sonic performance or user convenience.

B225 features include:

- Oversampling (176.4 kHz) and digital filtering for superior sound resolution and optimum phase response
- Cueing time of less than 3 seconds to any point on the disc
- Pre-programming of nearly every conceivable combination of repeat, skip, pause, loop, and autostop functions
- Programming steps may use track

(selection) or time as boundaries • Dual mode LCD shows total tracks on disc, disc index, track playing, time of track, program step, as well as status of pause, loop, and autostop functions • May be operated using same infrared remote transmitter as other Revox system components.

B791 Tangential Tracking Turntable

With its patented Linatrack tonearm, the B791 provides exceptional sonic performance while rendering record damage of any kind virtually impossible.

B791 features include:

- Servo controlled linear tracking system
- Tonearm less than 1 3/4" long from pivot to stylus tip
- Hall commutated direct drive motor with quartz-locked speed control
- Variable speed control • LED display shows nominal speed and percentage of deviation in variable speed mode.

Revox Infrared Remote Control with Multi-Room Capability

Your entire Revox audio system may be controlled by a single, lightweight, palm-sized infrared remote transmitter.

With over 30 different commands at your fingertips, you can orchestrate the operation of your AM/FM receiver (or integrated amplifier and tuner), turntable, compact disc player, cassette deck, and open reel recorder.

What's more, thanks to advanced digital technology, you may now extend the convenience of remote control beyond your main listening room to the other rooms of your home. Simply place a pair of extension speakers and a B206 Remote Receiver wherever you wish to enjoy full-fidelity music. All transmitter functions are relayed instantaneously



Revox B205 Remote Transmitter

through the B206 to your Revox system. Revox multi-room remote lets you match the music to your mood, in bed or bath, by patio or pool.

Revox multi-room remote control is available in a variety of different configurations for easy installation in any home. Inquire at your Revox dealer for more information.

**Remote transmitter and receiver units optional. Some Revox components may require optional individual receiver modules.*

***Dolby and Dolby HX Pro are trademarks of Dolby Licensing Corporation.*

Our commitment to music begins here.



Producer/engineer Bob Clearmountain at the Power Station studios, New York. Clearmountain uses these 24-track Studer recorders in his work with Bruce Springsteen, Bryan Adams, Hall & Oates, and Huey Lewis and the News, among others.

When you purchase Revox audio components, you are investing in more than buttons and lights in a box. Your Revox system is the culmination of a 30 year commitment to quality music reproduction that stretches across the entire spectrum of professional and consumer audio.

Our Studer professional recorders dominate the world-class recording studio market. And Studer engineers have been prime movers in development of digital audio systems.

Our recorders and mixing consoles carry this commitment into television and radio studios. From NBC in Washington to CBS in Hollywood to KUFM in Missoula, Montana, broadcasters count on Studer Revox for reliability and superior performance.

It continues here.



On-air studio at WFMT, Chicago's classical music "superstation."

We apply the same strict standards of engineering excellence to every Revox home audio component. Because we know what it takes for quality music reproduction. After all, we were there every step of the way.

And finishes here.



Revox system with B285 Receiver, B225 Compact Disc Player, B215 Cassette Deck, Agora B Powered Speakers, B791 Turntable, and multi-room remote capability.

STUDER REVOX

Studer Revox America

1425 Elm Hill Pike/Nashville, TN 37212/(615) 254-5651

FORDING AHEAD



The Ford/JBL system



The Ford Premium system

Motown Sound

When I provided a technical description of the Ford/JBL sound system back in November of last year, I didn't say too much about the sound because I hadn't yet had a chance to hear it on the road. Now I've had that chance, and a chance to compare it to another Ford sound system, called the Premium.

First, the human-engineering aspects: On the Ford/JBL system, which I tested in a Lincoln Continental, the tuning controls cover all the bases, but the number of presets (Detroit's standard four AM plus four FM) struck me as skimpy, especially for a luxury car. The bass, treble, balance, and fader controls have pointers so you can read their positions by touch, but they and the volume control are too close together and too similar in size. It would have been better if the volume knob were a bit larger and spaced off slightly from the others, and if the bass and treble knobs were somewhat farther from the fader and balance controls. The control legends are offset to the right of each knob—except for one legend, "Speakers," which bridges the gap between the fader and balance knobs.

An LED shows when the AMS (Automatic Music Sensor) is on, and an indicator on the dial display lights up when you switch on the Dolby B NR circuit. However, there's no indication of when DNR is on or off—and DNR does audibly affect the treble of wide-range material. Tape equalization is selected automatically, which I like in car systems. The night illumination is basically good.

The Ford Premium system I used was in a new Ford Taurus. The

Premium has more speakers than Ford's standard sound systems (not just in the doors and rear deck, but also in the dash), and it has a separate amplifier. It lacks two features I liked on the Ford/JBL system (DNR and scan tuning) but adds a local/distant switch and has more presets (six AM, 12 FM), a better placed tuning knob, and even better night illumination.

Neither head units have automatic tape ejection when the ignition or their power switches are turned off, turns on automatically when a tape is inserted, nor has separate memory switches. To memorize a station, you push the button down for a few seconds, until the sound cuts out, and then back in again. On the Ford Premium system, I had to hold the station preset buttons nearly as long to recall a memorized station as to memorize a new one.

The Continental has a power antenna, controlled by a separate switch some distance from the radio. On a car bristling with automatic circuits, the omission of an automatic antenna switch keyed to the radio struck me as absurd. The Ford Taurus has a fixed antenna.

Both systems performed well. The Ford/JBL in the Continental had only so-so multipath resistance but exhibited no wow and flutter on rough roads. There was some picket fencing; the transition between mono and stereo was too abrupt and perhaps was set at too high a signal level.

The Ford/JBL's upper bass can get loud enough to make most rock fans happy, and the lower bass goes down low enough to induce some mild (and pleasant) gut flutter on

organ pedal tones, but that low bass becomes less audible on the road, where low-frequency road noise competes with it. The very lowest string-bass tones on my test tape could not be heard at all—it would take a subwoofer to make them audible. Our Editor, Eugene Pitts, thought he heard a dip somewhere in the region of 80 to 150 Hz.

At the high end, the Ford/JBL system made triangles ring with a pleasant metallic character, though I've heard them sound a hair more silvery. Voices, especially familiar ones, were noticeably but not objectionably altered, making the words clearer but the sound a bit less musical.

Because of the overall bass boost, I had to turn the bass down slightly and the treble up a bit for most program material, to about the 11 o'clock and one o'clock positions, respectively. But on other material, I had to set the controls back to flat. Both Gene Pitts and I felt that the tone-control hinge points might have been set at the wrong frequencies.

Imaging was reasonably good for a car-stereo system, though some cuts (such as the "Bach Invention" dubbed from Opus 3's Test Record No. 1, *Depth of Image*) were noticeably flattened, with instruments pushed into the speaker locations. To get a good stereo blend, I had to fade in a bit of the rear speakers (I set the controls at 75% front, 25% rear); this very occasionally caused some high-frequency sounds to originate from behind the listener.

The Ford Premium system had less bass and a different overall balance—I sometimes found myself moving the bass setting up to one o'clock and the treble down to 11 o'clock, instead of the other way 'round, but I mostly left the controls flat. Stereo imaging was not as good as the Ford/JBL's, but still far better than I usually hear in cars; I heard stereo which seemed to originate from dead ahead of me rather than from the middle of the car, but I had to dial in a bit more rear speaker to get it.

On AM, the Ford/JBL system had an over-plummy sound, like a telephone with bass boost. The Ford Premium may have had more treble,

The reverse charge from misconnected booster cables brought violent death to one of my car's amplifiers and damaged the voltage regulator.

and certainly it had less bass, for a more natural balance.

My wife, who is rapidly becoming an audiophile, volunteered that the Ford/JBL had a "very pleasant, full sound, but not a really authentic one. It always seems like you're listening to a sound system." Of the Ford Premium, she said, "It sounds even more like a sound system—not as rich, not as spacious. But still good."

The Ford Premium system in the Taurus costs \$295 more than the radio that normally comes with the car; if you order a Taurus without any radio, you save \$196, making \$491 the real price of the Premium system in the Taurus. You can't buy a Continental without stereo; it normally comes with a Premium system somewhat like the Taurus', and the Ford/JBL system costs an additional \$506. If the Premium systems in the two cars have the same real cost, then the actual price of the Ford/JBL system is about \$1,000. All these prices include installation, which makes them pretty competitive with custom systems of equal quality.

You can do better than even the Ford/JBL system, of course, but you'd have to spend more money to do it. I hope to have an example for you in a month or two.

Reverse Samaritan

My car stalled in traffic recently—dead battery (since replaced). Most drivers honked impatiently as if I'd done it on purpose, then swerved around me with no particular interest in helping a fellow motorist in distress. But once the next red light had clotted up the traffic again, the owner of a battered van (note how new-car owners never stop and help?) responded to my wildly waving booster cables by pulling up next to me, opening his hood, and clipping my cables to his battery.

I popped back into my car for a quick re-start. Then I noticed sparks from under his hood—he'd hooked up his end backwards. I flew out of the car, grabbed and reversed the cables, and got my car started again.

Since my battery was low, I didn't play my stereo that day, and didn't use the car for a few weeks. So it was quite a while before I noticed that only one end of my car was making music. One amplifier had died—and it was a violent death, which surprised Tony Igel, who's now working on my sound system. "I've seen cracked resistors before, but the ones in that amp *popped*, until nothing was left but the lead-in wires," he said. At first, he couldn't account for it. Then I

remembered the reverse charge; it came to mind when I found my voltage regulator damaged too.

When I'm not flustered by a sea of honking horns, I always handle—or at least oversee—my booster cables for myself. Had I done that, I'd probably have avoided the mistake my Samaritan made, and would certainly have taken the cables off quicker if I *had* made it. (In all fairness, some yoyo had wired the van so both its cables were red!)

I'd also have hooked up the cables in the proper order. Safety experts say you should first hook up the hot (+) lead to the car being charged, then connect both leads to the car doing the charging, then hook the negative (-) lead to the car being charged—and not to the battery but to some grounded point a slight distance away. This lowers the chance of the connection spark setting off hydrogen fumes.

In the present case, I'd run a small risk of a fire or explosion, and blown my regulator and an amp (not to mention losing my cable), all because I was spooked by embarrassment and by concern for the maddened motorists behind me. Their horn blasts showed how much concern they had for me.

Perfectly Clear

The metal case that normally surrounds Audio Control's EQX car equalizer is deliberately bland and uninteresting to discourage tinkering by those without the instruments and facilities to set it up right.

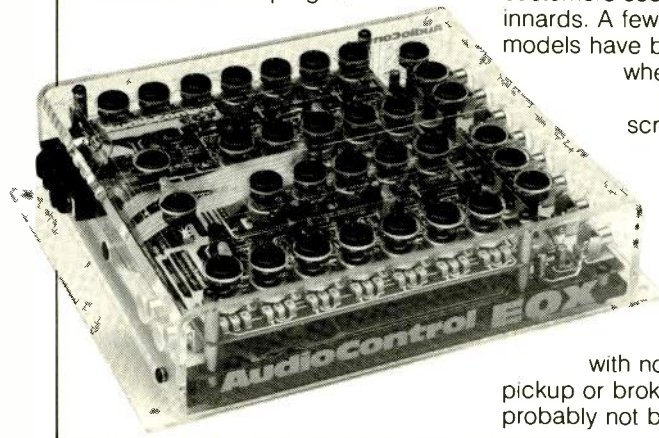

This, alas, makes it rather dull to look at on the sales floor. To give the product visual sex appeal, the company made up a few samples with transparent plastic covers for showroom use, thus letting customers see and admire the EQX's innards. A few of the plexi-cased models have been used in show cars, where looks count for more than plastic's inability to screen out electrical noise.

You guessed it:

Now some car stereophiles are trying to get transparent EQXs for their cars too.

They can—but for about \$100 extra, with no warranty against noise pickup or broken cases. Showoffs will probably not be deterred.

Double Threat

Dual cassette drives have found their way into double-well decks, rack systems, portable systems, and even pocket-sized tape players. So why not into the car as well? The Nippon CAR6060 has an analog AM/FM tuner plus a dual-cassette system, one side of which can record as well as play tapes. Using a hand-held microphone (included), you can dictate into the latter as you roll along, or use both drives together to dub as you drive. This little wonder was apparently made to sell for \$299, but for some reason failed to sell at that price. So it's now available from COMB, a liquidation house, for \$99. Ordinarily, I don't include dealer information in a "Roadsigns" item, but since you're not likely to find this in your neighborhood, COMB's number is (800) 328-0609.

DESIGNED BETTER TO SOUND BETTER



THE CR TICS AGREE:

HI FI CHOICE "Best Buys"
RA820, RA820BX, RA870,
RE870

WHAT HI FI? Awards winner
1985, RA840BX

WHAT HI FI? (RA820BX)
"Rotel have provided hi-fi
enthusiasts and the casual
buyer alike with an amplifier
to take your breath away. A
very deserving award winner
(best amplifier, 1986)."

HI FI FOR PLEASURE calls
RA820BX "a remarkable
little amplifier which shows
the competition a clean pair
of heels. It's a gem that can
only further enhance Rotel's
reputation." Their verdict on
the RP850 turntable? "Rotel
has pulled the rug from
under the competition with a
good sounding turntable-
arm combination offering
splendid value for the
money."

STEREO REVIEW sums up
their test of RA870/FB870
(branded): "We cannot recall
seeing any other integrated
amplifier that can match its
distinctly above-average
power-output capacity."

AUDIO MAGAZINE:
"Anyone, even the most
judgemental of golden-ears,
should find the sound
reproduction quality of the
RC870 (Pre-amp) to be
beyond reproach."

GFAND PRIX AWARD 1986
Hi-Fi Product Of The Year:
RA820BX Amplifier
WHAT HI-FI? Magazine

Find out what the
excitement is about. It's as
easy as visiting your local
Rotel dealer for a
demonstration.

ROTEL *hi-fi*

ROTEL *hi-fi*

The Smart Choice in High-Performance High Fidelity

Rotel hi-fi is an overnight success which was twenty five years in the making. Founded in 1961 as an OEM manufacturer building hi-fi equipment for many of the big names of the day, Rotel has today taken its rightful place among those respected brand names with a top-quality line of high-performance audio components designed for the serious audio enthusiast.

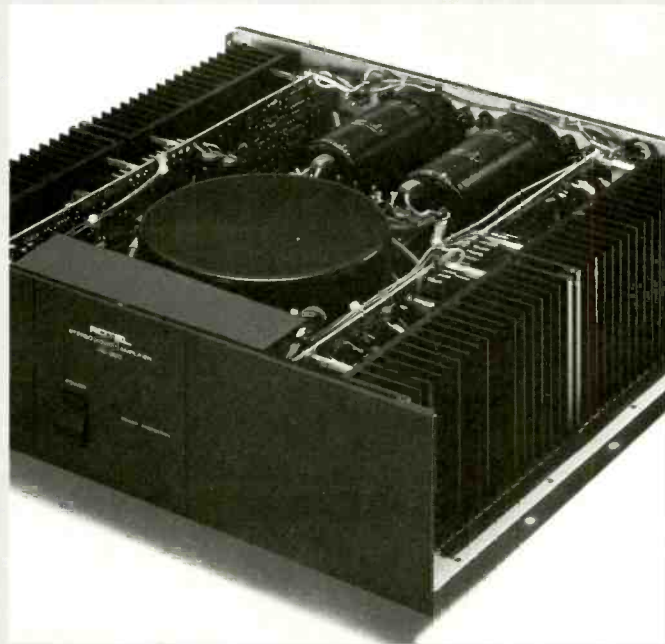

"After our experience with the RB880, we can better appreciate why Rotel products enjoy favour among demanding high-end audiophiles. If the RB880 is a typical example of the company's products, the reputation is well deserved."

Stereo Review April, 1986

Twenty-five years' experience manufacturing audio components shows: since its introduction, the Rotel hi-fi line has won an overwhelming number of awards and accolades from the international audio press, culminating in the selection of the RA820BX amplifier as Hi-Fi Product of the Year (1986) in the prestigious **What Hi-Fi** Awards.

Such immediate acclaim and impact on the marketplace is virtually unheard-of. It is an indication that Rotel's performance-oriented design philosophy is precisely right for today's discerning audio enthusiast.

The Rotel line is designed in Britain to suit that very demanding, purist market. The United Kingdom has spawned some of the audio industry's most famous names — product lines which have led the way in advancing the state of the audio engineering art and science. Today Rotel hi-fi is one of the most successful, sought-after and valued names in the British audio market, and has earned the respect of knowledgeable audio enthusiasts in Europe and America as well.

Critically-Acclaimed Amplifiers

The first components designed to Rotel's very high performance standards were the superb amplifiers. Rotel amplifiers are available in a variety of configurations: power amplifiers (bridgeable for triple the power in monaural mode), pre-amps of the highest quality and refined performance, and integrated amplifiers combining the technology of the separates onto a single chassis for great cost-efficiency.

Each model has since come to be regarded as a performance leader in its price range, easily out-performing even amplifiers costing considerably more.

Technically Speaking

At the heart of each Rotel amplifier is the high-voltage, high-current design. In simplest possible terms, this means Rotel amplifiers will sound much more powerful when driving real loudspeakers than conventional amplifiers of comparable rated power.

Amplifier power ratings are measured under strictly-controlled laboratory conditions, with the amplifier driving a steady-state 8-ohm resistor at a continuous power level. Once connected to loudspeakers and reproducing music, however, the amplifier faces a completely different set of performance conditions:

All loudspeakers are reactive, presenting the amplifier with an impedance which fluctuates as frequency changes, requiring up to twice the power for the same volume level. Similarly, musical transients (short-term "peaks" such as a kick-drum note) may double or triple the power demand for a short period of time. High-voltage and high-current capability are required to cope with these conditions.

Rotel amplifiers are designed to easily handle these real-world demands. Such technical refinements as large power supplies and doubled or tripled output devices give Rotel amplifiers huge power reserves, great control on complex musical passages, and the ability to drive even difficult loudspeaker loads. The difference in performance quality will be truly appreciated with today's advanced digital recordings whose extended dynamic range puts tremendous demand on the amplifier.

MODEL	POWER OUTPUT			PEAK CURRENT
	8 Ohms	4 Ohms	2 Ohms	
RA820BX Integrated Amp (rated 25 W/channel)	52 watts	92 watts	156 watts	20 amps
RA840BX Integrated Amp (rated 40 W/channel)	95 watts	171 watts	256 watts	29 amps
RA870 Integrated Amp RB870 Power Amp (rated 60 W/channel)	100 watts	180 watts	292 watts	30 amps
RB880 Power Amp (rated 100 W/channel)	144 watts	262 watts	362 watts	60 amps
Conventional Amp (rated 60 W/channel)	84 watts	49 watts	25 watts	3.6 amps

Specially-Selected Components

Early in the design process it was determined that design and manufacturing dollars would be spent on those components which directly affect sound quality. For that reason, all electrical components such as resistors, capacitors and transistors are sourced from Europe's finest suppliers and hand-selected to a 1% tolerance for critical circuits (20% tolerances — that is, deviations from stated electrical values — are not uncommon in audio components manufacture). Such attention to close tolerances ensures that all circuits will perform precisely as intended by the design engineer. In addition, components are selected for the lowest possible noise levels, ensuring extremely quiet operation.

Straight-Line Design

Even the world's finest components are necessarily imperfect conductors. As a result, all Rotel amplifiers, tuners and receivers typify a straight-line design approach, eliminating all components from the signal path which are not strictly necessary for performance. This straight-line design is seen most graphically in the removal of "features" and controls which make no contribution to sound quality. It is also evident in direct loudspeaker connections and the absence of conventional protection circuits.

In strictly technical terms, this straight-line design eliminates the potential for phase shift, distortion and signal-loss. In terms of your listening enjoyment, it means a very low noise threshold, improved resolution of low-level details and the most natural, accurate sound reproduction.

System-Building with Rotel hi-fi



"Put simply, the Rotel sounded full, clear, detailed and very dynamic. More than any of the others, the RPE30 sounds like an expensive deck."

What Hi-Fi? Turntable Super-test.

Rotel hi-fi is a complete line, including tuners, receivers, compact disc players, cassette decks and turntables, all designed and manufactured to the very

high standards set by the Rotel amplifiers. The emphasis on pure, performance-oriented engineering has been the guiding principle in the design of every component in the line. Whether you choose to build a complete Rotel system or upgrade your current system with one or two Rotel components, you are assured of truly outstanding sound reproduction quality.

Rotel's quiet, accurate and supremely musical turntables, for example, illustrate the exhaustive attention to detail which is an integral part of every Rotel design: details like an arm-mount pillar precision machined from a solid piece of aluminum refined specifically to Rotel's high standards; details like a platter mat made of energy-absorbing Norselex, and details like silicone-filled feet to isolate the turntable from external vibrations.

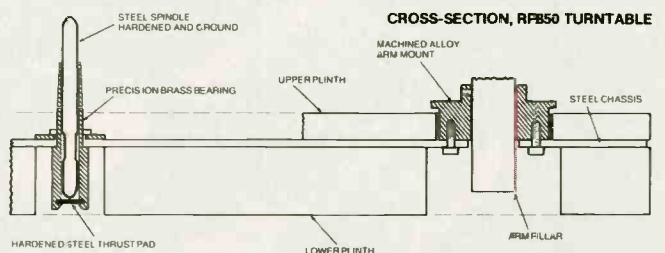

The Balanced Design Concept

In the design of a high fidelity sound system, as in the selection of a high fidelity sound system, it is ultimately the weakest link in the chain, not the strongest, which sets the limit to the performance achieved.

In recognition of this fact, no single aspect of a Rotel component's design is considered paramount. Instead, each model is engineered for performance quality which is consistently high in all its aspects.

Similarly, all Rotel components are designed to complement each other in terms of sound quality and performance. This consistency has been repeatedly recognised in the selection of complete Rotel systems as top performers in their field by the British audio press. With Rotel hi-fi, the weak links simply do not exist.

Bringing You Back to What It's All About: MUSIC

In the final analysis, of course, the only criterion which truly matters in the design and selection of any audio component is its ability to reproduce music naturally, accurately and convincingly. While some "hi-fi" companies appear to have lost sight of this fact, we remember that you purchase audio components to enjoy your music to the fullest, not to read specifications. This is why the listening room remains our most important laboratory.

We invite you to put Rotel high fidelity components to the test. Visit your local Rotel authorized retailer with your favourite records or compact discs and listen to the music. A simple listening test is the best way to find out why Rotel hi-fi is the smart choice in high-performance high fidelity.

Designed in Britain, Enjoyed World-Wide

Perreaux: The art of reproducing art.

Perreaux audio components are handcrafted to serve the art of music. Their reproduction of music is the finest available. The meticulous attention to detail—from the hand selection and matching of transistors to the corrosion proof and high

conductivity 24 karat gold plated circuit board—preserves every detail of the original musical event. The creation of each limited production Perreaux audio component is an art in itself. A tribute to the senses of sight and feel.

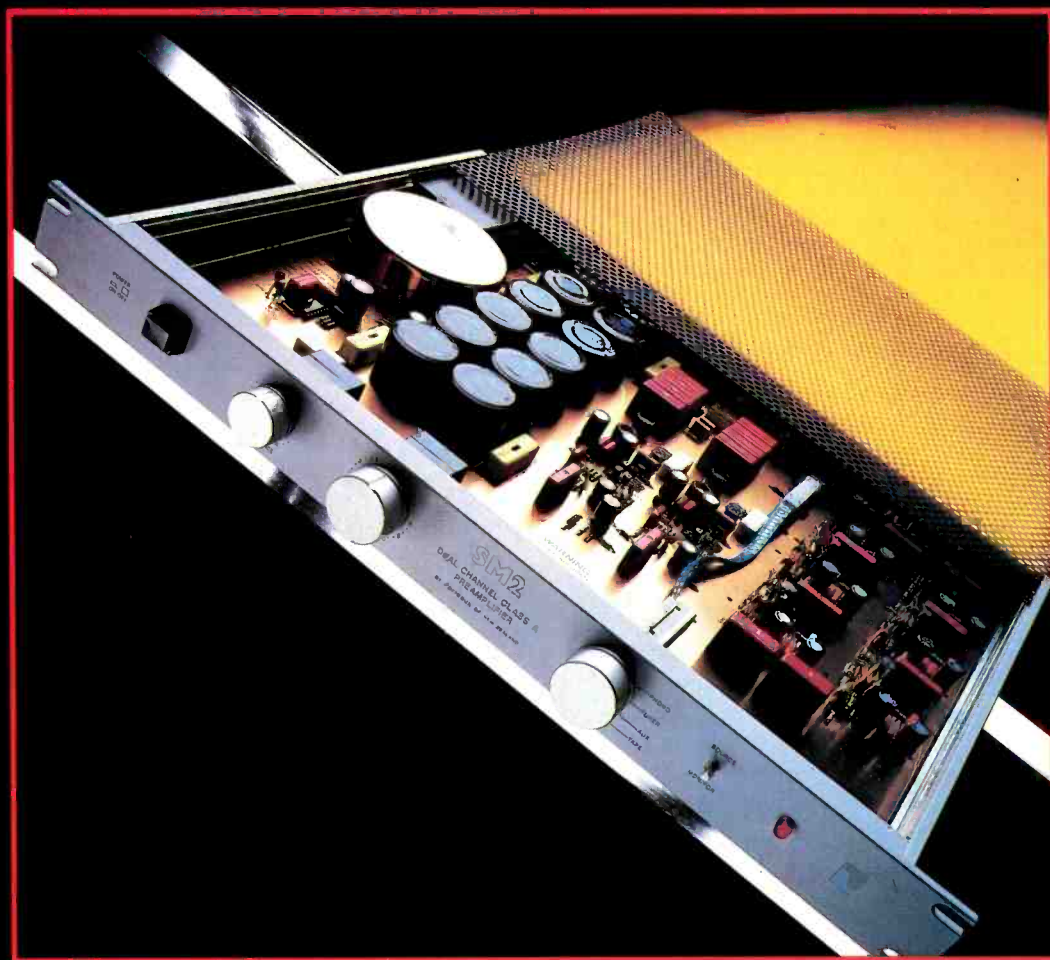

In a vote of audio critics and retailers, Perreaux was awarded the Hi Fi Grand Prix for "its Mercedes-like construction."

Audio/Video Magazine, USA

"The Perreaux has the talent for making music become a physical entity within the room."

Hi Fi For Pleasure Magazine, England

"... the synthesis of all you could demand, perfectly accomplished."

Stereo Magazine, Germany

"Peter Perreaux's masterpiece is as smooth and velvety in sound as its graceful front panel is in finish."

Hi Fi & Elektronik Magazine, Denmark

"Perreaux electronics have all the appearance and finish of the finest Swiss machinery."

Revue du Son Magazine, France

"... due to Perreaux's verifiable quality, it is likely to be the best value purchase in audio."

Son Hi Fi Magazine, Canada

The best audio investment in the world... Perreaux amplifiers have a built in 80% trade-in value.*

An interview with Anthony Federici,
Director of Perreaux International

Q. Why do Perreaux components have such a high trade-in value?

The trade-in value of Perreaux components have always been far higher than average. This is probably due to several factors: Engineering that is at the leading edge of technology... hand crafted, limited production... simple, elegant, non-trendy styling...

and exceptional value when new. To further increase trade-in value, Perreaux is now giving a one-year limited parts and labor warranty on pre-owned Series 2 that is traded toward Series 3.

Q. How long do you anticipate that Perreaux will retain this exceptional trade-in value?

Probably indefinitely, because the resale value is intrinsic to the product. Given Perreaux's reliability and longevity, a 1-year warranty on pre-owned equipment is not an expensive commitment for the

factory. In other words, the trade-in "deal" simply reflects the real world value of Perreaux. I would expect both new and used Perreaux's to continue to retain the world's highest trade-in value.

Q. Why do you believe people will pay as much or more for a used Perreaux as for a new product from another manufacturer?

Because they are already doing so with Perreaux. A used Porsche or Mercedes costs more than many

new cars. However, because essentially there are no mechanical parts, it won't deteriorate like a car.

Q. Will this lead the way for audio components other than Perreaux to increase their trade-in value?

I hope so. Because it will allow more people to enjoy quality audio. As an example: The new Perreaux Series 1 system, consisting of a tuner, preamp and power amp, retails for about \$2000. I would expect it to retain about a \$1500 trade-in

value toward a new Perreaux. This means that the consumer will have been enjoying Perreaux quality and performance for about \$500. That's only the cost of a moderate receiver.

Amplifiers
Preamplifiers
Tuners



Techport Ltd.
Westbury, NY
1-800-TECPORT
or 516-683-3000

**At participating dealers up to 80% of original amplifier purchase price and 70% of original preamplifier purchase price will be offered for trade up of Series 2 toward Series 3.*

Enter No. 33 on Reader Service Card

PARENTS OF THE LOST ARK



After only three months, I must hastily return to my whiskered friend who bought a camcorder to make home videos and invited me to his party the day after he acquired it (see "Audio ETC," March '86).

This man is not young, but he has the energy of a man of 20. Since I last wrote, that big camcorder has already been hauled all over New York City and, believe it or no, to Mexico. I have seen—and heard—some of the results. I am glad to report that the video aspect of these new home movies continues to blossom and my friend to exploit it with ever more ingenuity. He is canny. I think he has a sense, at least in the video area, as to what is good, just as some of us do with our still cameras. He is learning, as predicted. But it is sad to note that, with one big exception, the audio as I hear it (or do not hear it) is getting nowhere fast. I saw lots of pretty Mexico; I heard nothing but faint, distant, unintelligible voices off somewhere. And so it goes—with that one exception. So much superb audio equipment at hand here, in the newer cameras, in the new VCRs, and *what* are we doing with it? Not much. We just let the sound roll, as it will, and take pretty pictures.

The one enormous exception to an audio that mostly does nothing at all came in a classic, ever-expanding area that is as inexhaustible as the human species—babies! And parents. Millions and millions of baby pictures in full color, fuzzy in print form, better (but less popular) in slides, are taken every day. Minus sound. And quite a few home audio tapes are made too, on every sort and size of cassette recorder. Minus picture. The *combination* of these two in video format is, shall I say, potentially explosive. That's what I think, after having seen it, again via my busy friend, who did all the work.

He is not, really, an amateur-at-large, though he was surely a beginner in the use of a camcorder as described in March. How could he be otherwise? But he knows what he wants. Days after he bought that equipment, he put out an ad offering his studio (that is, his apartment) for video pictures at \$50 an hour, videocassette included. It's my guess that what he *really* wanted was something to take pictures of, to experiment on—some subject matter. And I think he had a good idea of what might show up. Presto, a young couple with baby, plus a couple of ancillary hangers-on,

came right downstairs from higher up in his building and signed for a video hour, sound *and* sight. Young, and photogenic too. How could he do better? I have to admire the guy.

Gently mix a bland liquid, glycerine, with nitric acid and sulphuric acid, and you have another liquid, looking just as innocent, which will blow up if you so much as tickle it. Nitroglycerine, the basis of dynamite. That's what we have here in audio/video terms. Just combine the ingredients.

On the one hand, you have baby's first visibly toothless grin and drool, or maybe those epochal first steps, with visibly delighted adults beaming all around. Just lovely for those who are near and dear, but sometimes too much of a muchness if you are not quite *that* close. I speak, of course, firsthand. I am subject not merely to vast quantities of family photos but those of most of my older friends, whose grandchildren populate the world. I've seen 'em all. (I am not totally hard-boiled: Two lovely pictures of my Irish niece with baby, and her English husband with their second baby, are thumbtacked to my wall. Very nice.)

On the other hand, babies (and parents) in audio, minus pictures, are of very limited value, hi-fi or not. I should know. In palmier days I once made a long, super hi-fi audio tape of my first nephew. It went on and on—the great new feature at the time—via an Ampex or such, in impeccably first-class sound. Pioneer baby recording! I was proud of it. Babies are cute to look at, but, really, their audio is not of the best. Years later I played that tape to the same nephew, now grown up. What an anticlimax. He was merely embarrassed and disgusted. One does not play baby tapes to the same baby until he or she is at least 65 years of age. Baby's first argh-gargle-gargle is the way I put it. That's what you hear. Plus the ecstatic cooings and coochy-coochy sounds of the fond parents. Good sound only makes things worse. When my brother walked into the room, on the above playing, he merely said, "What's *that*?" and walked out again. He didn't notice that the grown-up voice doing all the cooing was his own. (He can't recognize his own mother in a recording I made, either, nor his father.) Isn't audio wonderful? So there's

Illustration: Bob Scott



To hear why George Benson records on Sony Digital equipment, play him back on a Sony Compact Disc Player.

When it comes to capturing the experience of live music, no audio equipment delivers the performance of digital audio.

That's why George Benson, creator of *Breezin'*, the best-selling jazz recording in history, has decided to invest in digital equipment.

And the name this leader in jazz/pop fusion chooses, interestingly enough, is the leader in digital audio: Sony.

Not only has Sony led the way in professional digital recording equipment, we also invented the digital system for playback—the compact disc player. Sony introduced the first home, car and portable CD players. And Sony sells more types of compact disc players than anyone else in the world.

But whichever Sony Compact Disc Player you choose, each allows you to hear the music the way the artist originally intended.

So why not do what George Benson does? Play back the top-selling compact discs the same way they were mastered. On Sony Digital equipment. You'll find that when it comes to bringing you close to the music, nothing else even comes close.

Presenting the Sony Discman™, the world's smallest portable compact disc player.

Hardly larger than the disc itself, the fully programmable Discman* D-7DX comes complete with carrying case, headphones and a rechargeable battery. Everything you need for digital audio on the go.

SONY
THE LEADER IN DIGITAL AUDIO™



Two groups, one a live audience and the other recorded but very real, can happily merge in a useful if limited way.

the fate of baby's first audio, minus the picture. Throw it out, and the sooner the better.

When I saw my friend's baby videotape, or, say, around half of it (I think they went on into a second hour), things went *bang*. Nitroglycerine. I was astonished, entertained, pleased—even though these were total strangers. It was quite charming, even if it went on and on, and definitely something I had never imagined before in recording and reproduction of sound or sight.

Unrehearsed? Of course. Amateurs? Of course, though the mother might have been a model and all the other young folks were good looking too. As the minutes wore on—and on—I found that for the first time the endless expanse of recording was a positive thing and wholly new. These people just sat, or stood. No special arrangement, no script, no nothing. For a few moments, things were self-conscious and a bit uncomfortable, and the baby tended to hide behind Mama with a finger in her mouth. But time does march on, and after a while everybody began to relax; how long can you be uncomfortable? Not *that* long. Desultory conversation sprang up, not of any importance, not always intelligible, but natural enough. There were long silences, not at all uncomfortable. Baby began to come forward. The mother was on one side, father on the other; that calls for action among babies. Papa played games with baby on his shoulder, swinging her around casually, the familiar way of good papas. Then baby reached toward Mama, and crawled across. Delighted chirps and gurgles, much better than on any old "blind" tape. And finally, after about a dozen crossings back and forth (do babies ever get tired of such things?), the miracle happened. Right on camera, that baby took its first unaided steps. Wow! You don't get that in old-time short movies. Not the first, of course, but about 15 minutes worth of further first steps. Baby caught on, fast. By that time, honestly, I was one of that family, whose names I did not even know.

If the recording parameters are *right*—right for the picture, right for the audio—this kind of a long, long scene is practically self-generating. Just let it

go. And go some more. Not that a large audience would want to view at such length! This is still the old, traditional baby scene, for parents and others they can bulldoze into paying attention, not to mention aunts and uncles and neighbors. But for a while, maybe 10 or 15 minutes, almost anybody could find it pleasing. And if the audience starts its own desultory conversations while the video plays (they will, they will), then—again, if the thing is rightly done—the two groups, "live" and on videotape, will shortly seem to merge, and the celebrated baby is not in the least disturbed. Quite a fine thought; my imagination soars. How to combine two family gatherings at a distance, like the remotes that allow conversation between TV newscasters far apart? No, you can't do a give-and-take of that sort. But two groups, one a live audience, the other recorded but very real, can indeed happily merge in a useful if limited way.

So you see why I think the baby boom, plus all other and similar family affairs, babies or no, is about to come upon us in home-video terms. I do regret the (temporary) disappearance of the outdoor scenic picture, in favor of all this indoor stuff, but I bow to the inevitable. Me, I'll be out there taking stereo color slides again, of landscapes, mind you, and cats and dogs and horses as often as babies. (I got one marvelous, accidental 3-D shot of a baleful, yellow-eyed cat glaring at me from underneath a parked car in France. I never even noticed it as I took the picture.) The rest of you will be safely indoors wielding your video, and more audio/video power to you. Especially audio.

But how did this videotape get taken, in that same big apartment as described in March? The differences between this and my friend's first efforts are instructive. First, instead of a large, noisy crowd of party people, shouting over their eats and drinks, plus loud background music from the hi-fi speakers, there was this time only a handful of people, including baby, and no background noise in the apartment nor from outside (maybe it was Sunday morning). And the camera was now moved way forward, there being no impeding bodies, carrying its built-in

Polk Audio

The Speaker Specialists®

Where to buy Polk Speakers?

AUTHORIZED DEALER LIST

- ALABAMA Auburn: Audio Warehouse • Birmingham (Homewood): Audion • Huntsville: Campbell's Audio Video • Mobile: Fidler Hi-Fi • Montgomery: The Record Shop • Tuscaloosa: Gayler's ALASKA Anchorage: Shimek's • Fairbanks: North Music
- ARIZONA Flagstaff: Sound Pro • Mesa: Hi-Fi Sales • Tucson: Audio Emporium, Sounds Great
- ARIZONA Little Rock: Leisure Electronics • Searcy: Sound Room
- CALIFORNIA Arcata: Arcata Audio • Bakersfield: Sound Advice • Berkeley: Sounding Board • Campbell: Sound Goods • Chico: Sounds By Dave • Davis: World Electronics • Fairfield: C & M Stereo Unlimited • Fresno: Valley Stereo • Los Angeles: Beverly Stereo • Mill Valley: World of Sound • Orange: Absolute Audio • Penngrove: California Stereo • Sacramento: World Electronics • San Diego: Sound Company • San Francisco: Stereo Store, World of Sound • San Gabriel: Audio Concepts • Santa Barbara: Creative Stereo • Santa Cruz: Stereo Solution • Santa Maria: Creative Stereo • Santa Monica: Shelley's Stereo • Thousand Oaks: Creative Stereo • Ventura: Creative Stereo • Visalia: Metro Stereo • Walnut Creek: High Fidelity Shoppe • Woodland Hills: Shelley's Stereo
- CALIFORNIA Cal Evolution Technology, Toronto for nearest dealer: 416-335-4422
- COLORADO Arvada: Soundtrack • Aurora: Soundtrack • Boulder: Soundtrack • Denver: Colorado Springs: Sunshine Audio • Denver: Soundtrack • Littleton: Soundtrack • Pueblo: Sunshine Audio
- CONNECTICUT Avon: Hi-Fi Stereo House • Danbury: Sounds Incredible • Fairfield: Audio Design • Greenwich: Al Franklin's Musical World • Grafton: Robert's The Musical World • Hartford: Al Franklin's Musical World • Havertown: Audio King • Newington: Hi-Fi Stereo House • New London: Robert's The Music People • Norwalk: Audiotronics DISTRICT OF COLUMBIA Myer Emco
- FLORIDA Altamonte Springs: Audio Spectrum • Boca Raton: Cap Video • Clearwater: Pyramid Audio • Daytona Beach: Stereotypes • Ft. Lauderdale: Cap Video • Gainesville: Stereo Garage • Ft. Pierce: Sound Shack • Ft. Walton Beach: Audio International • Jacksonville: Audio Tech • Lakewood: Sound Shack • Merritt Island: Audio Video • Miami: Audio By Capasa • Cap Video • Sympathetic Ear • Naples: Stereo Garage • Orange Park: Audio Tech • Orlando: Audio Spectrum • Pensacola: Fidler Hi-Fi • Tallahassee: Stereo Stereo • Tampa: Audio Vision • W. Palm Beach: Electronic Connection
- GEORGIA Atlanta: Stereo Village • Augusta: Stereo City • Duluth: Stereo Village • Morrow: Stereo Village • Savannah: Audio Warehouse • Smyrna: Stereo Village • Tucker: Stereo Village
- HAWAII Honolulu: Stereo Station
- IDAHO Boise: Stereo Shoppe • Pocatello: Stokes Brothers • Sandpoint: Electracraft • Twin Falls: Audio Warehouse
- ILLINOIS Aurora: Stereo Systems • Bloomington: Alan's Creative Stereo • Buffalo Grove: Columbia Audio Video • Champaign: Glenn Poo's • DeKalb: Audio Plus • Hoffman Estates: Simpy Stereo • Highland Park: Columbia Audio Video • Lansing: Audio Clinic • Mt. Prospect: Simpy Stereo • Normal: Glenn Poo's • Northbrook: Alan's Creative Stereo • Peoria: Iam Electronics • Riverdale: Stereo Designs • Rockford: Columbia Audio Video • Schaumburg: Alan's Creative Stereo • Hi-Fi Hunch • Springfield: Sundown One • Sterling: Midwest Hi-Fi • Vernon Hills: Alpha Creative Stereo • Villa Park: Hi-Fi Hunch • Waukegan: Alan's Creative Stereo
- INDIANA Bloomington: Hooser Electronics • Bluffton: Ely TV & Stereo • Greenwood: Hi-Fi Buys • Indianapolis: Hi-Fi Buys • Lafayette: Hi-Fi Buys • Marion: Classic Stereo • Muncie: Hi-Fi Buys • South Bend: Classic Stereo • Tera Hauls: Hooser Electronics
- IOWA Des Moines: Audio Labs • Fairfield: Golden Ear Audio Video • Sioux City: Audio Emporium
- KANSAS Emporia: Nelson's • Junction City: Audio Junction • Overland Park: Audio Electronics • Wichita: Audio Visions • Topeka: Nelson's
- KENTUCKY Lexington: Stereo Shoppe • Louisville: Hi-Fi Buys • Owensboro: FM High Fidelity
- LOUISIANA Baton Rouge: Stereo Village • Gretna: Stereo Village • Lafayette: Sound Electronics • Metairie: Stereo Village • New Orleans: Stereo Village • Opelousas: Sound Electronics • Shreveport: Audio Fidelity • West Monroe: Audio West
- MAINE Bangor: Sound Source • Camden: Harbor Audio Video
- MARYLAND Annapolis: Spaceways Sound • Baltimore: Soundscape • Frederick: Evergreen Audio • Rockville: Myer Emco MASSACHUSETTS Gloucester: Glass Sails • N. Dartmouth: Creative Sound Systems • Waltham (Boston): Waltham Camera & Stereo • Worcester: O'Cons
- MICHIGAN Ann Arbor: Absolute Sound • Birmingham: Almas Hi-Fi • Dearborn: Almas Hi-Fi • East Lansing: Stereo Shoppe • Farmington Hills: Almas Hi-Fi • Grand Rapids: Sound Room • Iron Mountain: Stereo • Minneapolis: Creative Sound Shoppe • Portage: Sound Room • Royal Oak: Absolute Sound • Saginaw: Audio Shoppe, Court Street Listening Room • Traverse City: Stereo Shoppe
- MINNESOTA Brooklyn Center: Audio King • Burnsville: Audio King • Duluth: Mels TV & Audio • Edina: Audio King • Mankato: Sound World • Minneapolis: Audio King • Minnetonka: Audio King • Rochester: Sound World • Roseville: Audio King
- MISSISSIPPI Gulfport: Empress • Jackson: Walters Audio • Pascagoula: Empress
- MISSOURI Cape Girardeau: Stereo One • Columbia: D & M Sound • Lebanon: Sight & Sound • St. Louis: Sound Central MONTANA Bozeman: Thrifty Ear • Great Falls: Rocky Mountain Hi-Fi
- NEBRASKA Lincoln: Stereo West • Omaha: Stereo West
- NEVADA Las Vegas: Upper Ear • Reno: The New Hampshire Concord: Audio of New England • Lacuna: Audio of New England • New London: North Star Electronics • New York: Jersey East Brunswick: Atlantic Stereo • Franklin Lakes: Stereo • Maple Shade: Bryn Mawr Stereo • Montclair: Perdue Radio • Harrison: ARC Audio & Video • Ridgewood: Sounding Board • Shrewsbury: Monmouth Stereo • Toms River: Rands Camera • West Caldwell: Perdue Radio
- NEW MEXICO Albuquerque: Real Time Audio • Carlsbad: Besons
- NEW YORK Albany: Clark Music • Batavia: Unicorn Audio • Buffalo: Speaker Shop • Canastota: Chemung Electronics • Elmira: Chemung Electronics • Fredonia: Studio One • Glens Falls: Audio Genesis • Huntington: Audio Breakthroughs • Ithaca: Chemung Electronics • Jamestown: Audio Breakthroughs • Manhasset: Audio Breakthroughs • Newburgh: Ranzin's Electronics • New York City: Audio Breakthroughs, Electronic Workshop • North Tonawanda: JB Electronics • Olean: Listening Room • Syracuse: Clark Music • Vestal: Hart Electronics • Wappinger Falls: Ranzin's Electronics
- OHIO Akron: Ashville: Mr. Toad's Stereo Video • Chapel Hill: Stereo Sound • Charlotte: Stereo Video • Greenboro: Stereo Sound • Jacksonville: Southeastern Electronics • Lima: Stereo Video • Raleigh: Audio Buys, Stereo Video • Wilmington: Southeastern Electronics • Winona-Salmon: Stereo Sound
- OKLAHOMA Lawton: Pacific Sound • Minot: Midwest Audio
- OHIO Cleveland: Audio Craft • Cincinnati: Stereo Lab • Columbus: Stereo Lab • Dayton: Audio Center • Center • Fairlawn: Audio Craft • Findlay: Audio Craft • Lima: Stereo Video • Mayfield Heights: Audio Craft • Toledo: Audio Craft • Westlake: Audio Craft
- OKLAHOMA Lawton: Hi-Fi Shop • Tulsa: Audio
- OREGON Beaverton: Stereo Superstores • Eugene: Radiator's High Fidelity • Klamath Falls: Sound Chamber • Pendleton: Royal Mobile Sound • Portland: Stereo Superstores
- PENNSYLVANIA Allentown: Bryn Mawr Stereo • Altoona: Sound Concepts • Binkley: Hart Electronics • Bryn Mawr: Bryn Mawr Stereo • Camp Hill: Bryn Mawr Stereo • Erie: Studio One • Frazer: Bryn Mawr Stereo • Indiana: Sound Concepts • Jenkintown: Bryn Mawr Stereo • Kingston: Hart Electronics • Lancaster: Bryn Mawr Stereo • Reading: Stereo Land • Philadelphia: Bryn Mawr Stereo • Pittsburgh: Audio Junction • Quakertown: Bryn Mawr Stereo • Reading: G-T Stereo • Selinsgrove: Stereo Shop • Williamsport: Robert M. Sides • Windber: Pro Audio
- RHODE ISLAND N. Providence: Eastern Audio
- SOUTH CAROLINA Charleston: Audio Warehouse • Columbia: Stereo Shop • Greenville: Stereo Shop • Spartanburg: Stereo Shop
- SOUTH DAKOTA Rapid City: Team Electronics • Sioux Falls: Sound World • Rapid City: Linder-Walsh • Rapid City: Hi-Fi • Cookeville: Network Entertainment • Johnson City: Mr. Toad's Stereo Video • Kingsport: Mr. Toad's Stereo Video • Rockwell: Network Entertainment • Memphis: Opus II • Nashville: Hi-Fi Buys
- Texas Austin: Audio Video • Beaumont: Brock Audio • Dallas: Dallas: Audio Video • Dallas: Arnold & Morgan • El Paso: Soundquest • Galveston: Island Audio • Garland: Arnold & Morgan • Houston: Sheffield Audio • Longview: Audio Techniques • Lubbock: Ultra Electronics • Odessa: Harold's Electronics • San Angelo: Walker Audio • Temple: Audio Tech • Texarkana: Sound Town • Waco: Audio Tech • Wichita Falls: Hamilton Bryan
- UTAH Logan store only: Stokes Brothers • Salt Lake City: Broadway Music • Vernal: Dirk Labrum Co.
- VERMONT Burlington: Audio Den
- VIRGINIA Bristol: Mr. Toad's Stereo Video • Charlottesville: Sound Machine • Falls Church: Myer Emco • Franklin: Audio Video Showroom • Leesburg: Evergreen Audio • Richmond: Gary's Stereo, Lindsey Ward • Roanoke: Audio Concepts • Virginia Beach: Digital Sound
- WASHINGTON Bellevue: Northwest Audio Video • Bellingham: OC Stereo • Lynnwood: Northwest Audio Video • Oak Harbor: OC Stereo • Everett • Richland: Tri-Ear Stereo • Seattle: Definitive Audio, Northwest Audio Video • Spokane: Audio Craft (Hals) • Tukwila: Northwest Audio Video
- WEST VIRGINIA Barboursville: Pied Piper • Beckley: Pied Piper • Huntington: Pied Piper • Morgantown: Sound Post • Piedmont: Sound Gallery
- WISCONSIN Appleton: Sound World • Green Bay: Stereo • Lacrosse: Sound World • Madison: Happy Medium • Marinette: Sound Saver • Milwaukee: Audio Emporium • Rhineland: Audio Broker • Wausau: Sound World
- WYOMING Cheyenne: Team Electronics • Riverton: Sound Room



SDA 2
\$695.00 ea

SDA SRS
\$395.00 ea

SDA 1A
\$875.00 ea

SDA CRS
\$395.00 ea

Compact Disc Ready

"The experts agree: Matthew Polk's revolutionary TRUE STEREO SDAs always sound dramatically better than conventional loudspeakers."

"The Genius of Matthew Polk Brings You the Breathtaking Sound of the SDAs"

Matthew Polk's critically acclaimed Audio Video Grand Prix Award-winning TRUE STEREO SDA Technology is the most important fundamental advance in loudspeaker technology since stereo itself. "They truly represent a breakthrough."

Rolling Stone Magazine

The SDAs' patented* design makes them the world's only true stereo speakers. A conventional mono speaker is designed to be heard by 2 ears at once while True Stereo loudspeakers should each be heard by only one ear piece (like headphones) in order to preserve full stereo separation. Polk's revolutionary TRUE STEREO SDAs are the first speakers engineered to accomplish this and realize the astonishingly lifelike, three-dimensional imaging capabilities of stereo.

The Experts Agree:

"Breathtaking... a new world of hi-fi listening."
Stereo Buyers Guide

"Mindboggling powers of sonic persuasion."
High Fidelity Magazine

"Literally a new dimension in sound."
Stereo Review Magazine

"An amazing experience."

High Fidelity Magazine

Listeners are always amazed when they hear the huge, lifelike, high definition, three-dimensional sonic image produced by Polk's revolutionary TRUE STEREO SDA Loudspeakers. The nation's top audio experts agree that Polk SDA Loudspeakers always sound dramatically better than conventional loudspeakers. When you hear the dramatic difference you'll agree too.

*U.S. Patent Nos. 4,489,432 and 4,497,064. Other Patents Pending, U.S. and foreign.

Distributed in Canada by Evolution Technology, Toronto.

polk audio
The Speaker Specialists®

1915 Annapolis Rd. Baltimore, Md. 21230

What improved this video over the cameraman's first effort? There wasn't any background noise, and the camera with built-in mike was close up.

mike (which I have found is *not* removable, a terrible mistake) right up front, relatively close. The sound was still a bit off-mike, but the pictures made up for it as in professional TV (where the voices, minus picture, often sound surprisingly tinny). Thus the sound was good and natural as one watched—

including the baby. Indeed, it was a fine 50/50 proposition, a balance between audio and video such as we *must* have for good results.

If you want good sound, any sound at all, *do not* use the camera zoom to bring things up close! Not, at least, until someone takes up my idea of a

built-in and synchronized sound-zoom microphone which can change the sound pickup as the zoom changes the picture, automatically. Then you can zoom close and your sound will also be close. (Not only the mike pick-up pattern but the volume level would have to be synchronized, come to think of it, before feeding the overall automatic gain ride. Unless, of course, the gain ride could cope with the differences on its own. More R&D—we would have to find out.)

A few words, in contrast, about my friend's videos of Mexico. On a raw winter evening in New York, the big monitor suddenly spread out the blue, blue Mexican sea, all gentle wavelets (with, alas, color fringes) and piled-up white clouds above (the same). Such an idyllic scene! We gasped with pleasure—for about four minutes. We heard extremely faint occasional sounds of distant voices in the background, otherwise no audio. Just wavelets and a moderately distant shoreline, with white buildings discernible. We were anchored in a hired motor launch, a ways off shore. Ten minutes later, the same. Fifteen minutes, still the same. Ugh. Blue waves ad infinitum? Not very good video.

Then suddenly the cameraman (same old Mr. Whiskers) bethought himself and jumped into action. We had been sitting, motionless, in a hired boat, the bored local launchman ensconced in the rear at the tiller. Now we were seen to move in towards shore, at speed. The buildings loomed up closer, and the camera roved back and forth for some interesting views—houses, hotels, beach establishments, tropical foliage in green. We dashed sidewise along the shore at full speed, then turned and dashed back again. A fine picture! Lots to look at, even people along the beach and docks. But the sound? Nothing changed. What about the launch motor, which must have been pretty loud? It was silent. Yet the traces of audio were still there, distant voices and such.

You see, audibly we had never moved an inch. The motor did not stir. All that traveling was done with the zoom lens from a motionless deck. Clever, but the whole thing might as well have been a silent film. Give me babies, *audible* babies, any day. **A**



Deutsche Grammophon presents the culmination of a lifetime devoted to the Beethoven Symphonies...

**HERBERT VON KARAJAN
Berlin Philharmonic
BEETHOVEN ·
THE NINE SYMPHONIES**



Now complete in a deluxe boxed set or on individual Compact Discs, LPs and Chrome-Cassettes.



Symphonies Nos. 3 & 8 with overtures debut simultaneously in the complete set and singly, completing the cycle.

© 1986 DG / PolyGram Classics, Inc.

FEEL THE THUNDER WITH **MTX**
ROAD THUNDER SPEAKERS

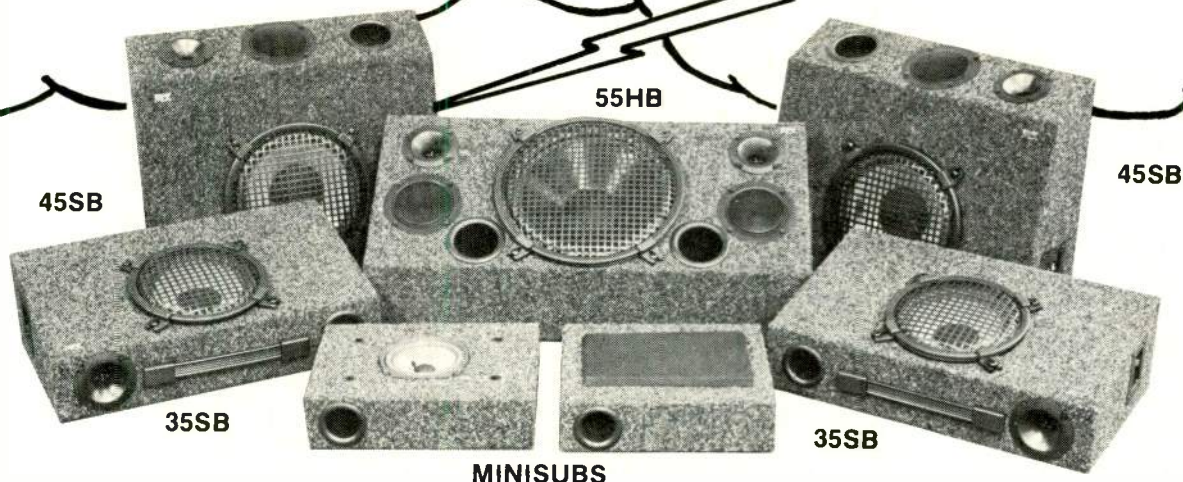

• **Thunderous Bass**

Polypropylene drivers and a Thiele/Small-aligned vented cabinet design combine to give thunderous, vibrating bass. What's more, these speakers easily handle the wide dynamic range of digital audio.

• **Carpeted Enclosures**

Heavy-duty carpeting can be dyed to match color of vehicle interior.

• **Install In Minutes
—without cutting holes**

Simply place them vertically behind truck bench seats or lay them flat in the cargo area of vans and hatchbacks. Carpeted cabinets stay put without scratching car interiors.

• **Convenient Handles**

MTX 35SB, 45SB, and 55HB can easily be used as extension speakers at many outdoor (and indoor) events. Just install with extra wire—convenient handles make it easy to move these rugged speaker systems to where the action is happening.

- **High Efficiency—loud volume without a large amplifier**
- **Exceptional 10-Year Limited Warranty**
- **Made in U.S.A.**
- **Fit all Trucks, Vans, Hatchbacks, RVs**

**Powerful Mobile Speaker Systems
making Big Sounds on and off the Road**

MTX 55HB

A 3-Way Stereo Enclosure Full Range System that's designed to fit perfectly in rear well of all late-model Firebirds and Camaros. Also fits all hatchbacks and vans. Ideally suited for use in RVs.

Sensitivity: 97dB Power Handling: 5-150 watts
 Freq. Resp.: 40HZ-22 KHz Sugg. Retail: \$349

MTX 35SB

An 8" 2-Way Full Range System that fits behind the seats of most mini-sized domestic and import trucks. Can also be placed in cargo area of all hatchbacks and vans.

Sensitivity: 94dB Power Handling: 5-100 watts
 Freq. Resp.: 60Hz-22 KHz Sugg. Retail: \$299 pair

MTX 45SB

A 10" 3-Way Full Range System that fits behind the seats of most full-size pickups. Also fits most compact hatchbacks as well as all full-size hatchbacks and vans.

Sensitivity: 97dB Power Handling: 5-150 watts
 Freq. Resp.: 55Hz-22KHz Sugg. Retail: \$399 pair

MTX Minisubs

A 5 1/4" Compact Subwoofer System that is designed to fit underneath seats to provide direct low frequency coupling to the listener.

Sensitivity: 91.5 dB Power Handling: 5-75 watts
 Freq. Resp.: 65 Hz-3 KHz Sugg. Retail: \$200 pair

MTX Loudspeakers One Mitek Plaza Winslow, IL 61089

Phone (815) 367-3811

Enter No. 29 on Reader Service Card

**100 WATTS.
HIGH CURRENT.
GFA-555 TECHNOLOGY.**

**The new
ADCOM GFA-545.**

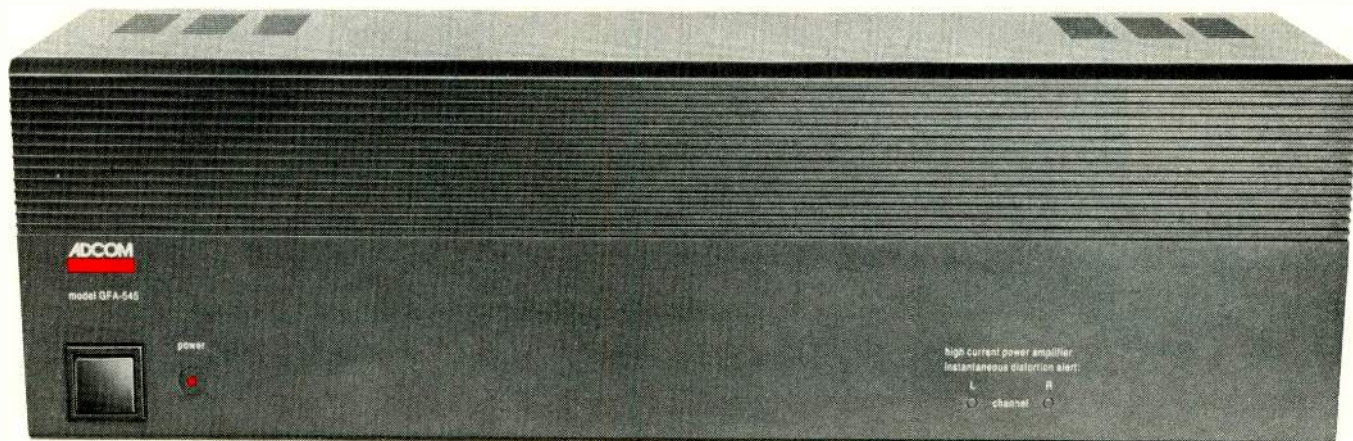

This new power amplifier from Adcom offers the same circuit topology as our GFA-555. And that's the amplifier independent test reports have found clearly superior to others priced two to three times higher.

The essential differences: 100 watts per channel for the GFA-545 vs. 200 watts for the GFA-555. And a correspondingly lower price.

However, nothing at all is sacrificed when it comes to interfacing accurately and easily with virtually any speaker system available today.

Which one for you? If your listening room and other requirements don't really call for the amount of power the GFA-555 delivers, the GFA-545 is probably all the amplifier your speakers will ever need.

The only way to really appreciate the superlative quality of the new GFA-545 is to compare its sonic performance with any other amplifier, regardless of power or price.

You'll find there's just no comparison.

Power ratings are continuous, both channels driven into 8 ohms, 20 Hz-20 kHz, with no more than 0.09% THD.

ADCOM[®]

11 Elkins Road, East Brunswick, NJ 08816 USA 201-390-1130

Distributed in Canada by PRO ACOUSTICS INC.
Pointe Claire, Quebec H9R4X5

Enter No. 3 on Reader Service Card

A NOVICE APPROACH



The New Sound of Stereo by Ivan Berger and Hans Fantel. New American Library, paperback, 265 pp., \$12.95.

In *The New Sound of Stereo*, Ivan Berger and Hans Fantel have gathered together all of the knowledge that first-time hi-fi buyers need. Armed with such wisdom, beginners should be able to go bravely forth into the shops, avoid most of the pitfalls, take home a good-sounding system and perhaps even save some money. But the book goes farther than that, covering topics such as how to place speakers in a listening room, how to plan for future upgrades, and how to shop later for additional components that will extend the basic system. Berger and Fantel also discuss how to integrate video sound into an audio system.

No, you won't find detailed explanations of Thiele/Small parameters, nor probing surveys of exotic speaker cables. What's here is just the basics, straight from the shoulder. Still, even experienced audiophiles might find some of the information useful. Have you forgotten what a dBW or a femtowatt is, or how to trouble-shoot a system to find the component that needs repair?

This book truly delivers on its promise to be jargon-free. To explain the technical concepts behind audio in clear, easy-to-understand English is

not always easy to do, but Berger and Fantel succeed wonderfully. A glossary would be a nice addition to the second edition. However, terms are well defined in the text, and the well-organized index points to them clearly.

Another strong point is the book's emphasis on listening. Understanding technology is one thing, but knowing what it means in actual sound is quite another. Berger and Fantel encourage readers to trust what their ears are telling them, and offer guidelines about listening to hi-fi gear. Frequently, they raise the beginner's objection: "My ears are untrained, so my perceptions are not worthwhile," and beat it back by saying that you'll learn to recognize your new system's virtues *and* its vices after you buy it, so why not acquire some listening skills first, to minimize those vices?

Always, their advice is tempered with common sense. In discussing how to listen to speakers, the authors urge you to listen to the bass, but also point out that too much bass reveals a defect in the design. A powerful amplifier is desirable, but too much power can be a waste of money; of course, too little power leads to other kinds of problems. They quickly debunk the beginner's notion that a speaker with more drivers in the cabinet is always better than one with fewer drivers—even to the point of extolling the virtues of the theoretically ideal one-way system. Unfortunately, despite giving much attention to left-right speaker imaging, they neglect depth of image, which is one of the really interesting ways speakers differ from each other.

In the chapter on cartridges, Berger and Fantel cover all the principal topics, including stylus geometries, tracking, and groove structure. With dry humor, while discussing compliance, they appear to explain the units of measurement, but actually do not: "Compliance is usually expressed by a measurement such as 10^{-6} dynes/centimeter" (or pascals per millinewton, which amounts to the same thing)." In other words, don't worry about the strange units of measurement; what a beginner needs to know is whether a low or a high number is better, and why. Berger and Fantel don't explain why cartridges affect the sound of a system as much as speak-

ers do. Early in the book they allude to the idea that transducers have the greatest effect on the sound of a system. But they don't nail it down and advise the consumer to shop for a cartridge as carefully as for a speaker.

The authors observe that open-reel tape recorders are better than cassette recorders. Clearly, this is more or less true, but I've seen too many consumers who were misled by this oversimplification. A low-end open-reel machine is not necessarily capable of making better sounding tapes than a sophisticated cassette deck at the same price. They talk extensively about transports, but don't describe how they affect the sound quality. However, I like their orderly discussion of tape types and noise-reduction systems.

Probably, not many readers of *Audio* will think they need this book. After all, it's "just" basic hi-fi information. But we all have friends who pester us with questions. For them, we should keep a copy of *The New Sound of Stereo* handy. Then we can peek at it in the middle of the night to answer our own questions. Don't let its simple, straightforward language fool you; the book is a handy reference that belongs on every audiophile's shelf. *Steve Birchall*

San Francisco Nights by Gene Sculatti and Davin Seay. St. Martin's Press, paperback, 192 pp., \$12.95.

In the mid-'60s, as a few brave souls began trading in their acoustic guitars for electrics, something strange was happening in the already progressive San Francisco Bay area. A new sound, an amalgam of folk, bluegrass, raga, Bach and jug band music, was incubating in garages, back rooms and basements of Victorian houses. It would soon rush headlong into a realm ruled at the time by spike-heeled girl groups, squeaky-clean folk duos and trios, bleached-blond surf stylists and a handful of toned-down black singers.

The authors of *San Francisco Nights* set the stage for the psychedelic explosion by briefly reviewing the city's early days as a gold-rush boomtown and beatnik haven. They then plunge into the swirling musical waters. While raising the idea that the psychedelic era was ushered in when the pent-up energy of the '50s was dosed with

San Francisco Nights traces the commercial, personal, and spiritual aspects of the city's psychedelic era with a charming exuberance.

mind-altering drugs, the authors maintain that the scene was created by people who had nothing better to do. Boardwalks, rather than board rooms, sheltered the creative energy which blossomed in the four years covered by the book.

In a style of reportage that lacks chronological cohesiveness, but compensates with a charming exuberance of tone, the authors trace the histories of prototypical groups such as The Beau Brummels and The Charlatans, survivors like The Grateful Dead and Jefferson Airplane, and transplants such as Janis Joplin and Steve Miller. There are also various flashes in the pan, and groups who—like Only Alternative and His Other Possibilities—were too unstable even to record a whole album. Profusely illustrated with publicity photos and snapshots of the era's movers and shakers, *SF Nights* also provides a scenic side trip into the advertising world of the time. Many concert posters are reproduced, as well as laughable attempts by record companies to promote their psychedelic artists with band-member look-alike contests and ads lamed by stereotypical jargon.

Concert promotion, however, in the early days of the Fillmore and Avalon ballrooms, was more like throwing a big party. Hardheaded opportunism was blotted out by sheer romance—promoters such as the Family Dog organization exhausted their budgets on framable posters, light shows, party favors, fruit, and prizes such as talking mynah birds. To ensure good attendance at their shows in the spring of 1966, the Fillmore promoters would phone every one of hundreds of people in their personal phone books to get the word out.

The authors report that most artists and organizers shied away from the machinery of capitalism. With lines firmly drawn at that time between the establishment and the counterculture, record companies, by making money from art, seemed particularly evil. But eventually, the practicalities of big

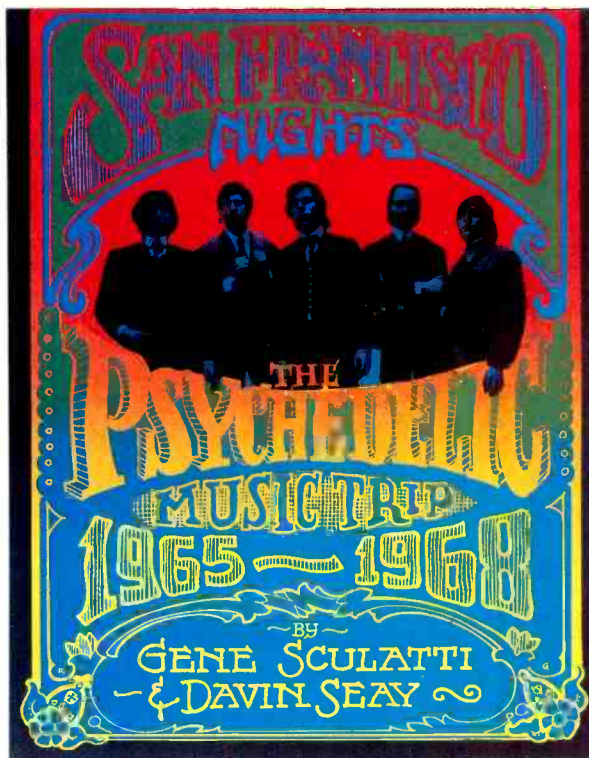

business swept through the scene like a green tidal wave. The idealistic either sank or rode its crest. The original Family Dog members gravitated to Mexico in a yellow school bus, one of them with the entire working capital for a show that was already booked. The intimate ballroom "happenings," with their intricate trappings, quickly gave way to civic theater concerts and extravaganzas in sports stadiums. Attention to unromantic details such as contracts, insurance, upscale advertising and security police replaced concern over party favors. Jefferson Airplane had risked their counterculture status by "collaborating with known commercial interests" and signing with RCA for an unprecedented \$25,000 advance. Other San Francisco groups, encouraged by the Airplane's success and the control they maintained over their product, became less hesitant to cross the line. The Grateful Dead, who thought they were doing fine as a dance band with steady ballroom gigs, eventually signed up with Warner Bros., late in the game, for an experimental lark. During 1967's Summer of Love, Joe Smith of Warner Bros. was commuting to the Dead's house in the

Haight to conduct a flurry of scouting and signing.

By 1968, the San Francisco image was being imitated worldwide. *SF Nights* tours the complementary music scenes in New York, Los Angeles, Boston, Detroit, Chicago and Texas. Even England's psychedelic scene, the authors maintain, was essentially a graft of San Francisco, which took root in a London basement dancehall where patrons grooved to the house band, Pink Floyd, from dusk until dawn.

Up until 1967, record sales to the youth market were mostly of 45s; in assembling an LP, artists might pad out a few three-minute hits with filler and sound-alikes. With longer songs (in part developed to accommodate ballroom audiences) and expanded musical concepts, psychedelic music brought about the rise of albums. Almost overnight,

there was an onslaught of LPs packed with extended musical messages and bearing a \$5.98 price tag. And the new album market gave credibility to the wide-open formats of underground radio, which would slip, by the mid-'70s, into a predictably formulaic AOR programming format.

Although it covers the commercial angles of the psychedelic era with insight, *San Francisco Nights* doesn't fail to portray the personal dramas, spiritual underpinnings and naive good will which were its cornerstones. It's an armchair tour that will induce nostalgia in those who were engulfed by it. Held up against the less-than-best elements of today's music scene, it may evoke regret that the psychedelic era dissolved to leave us among a host of pretentious, vapid and soulless contenders.

Susan Borey

Principles of Digital Audio by Ken Pohlmann. Howard W. Sams & Co., paperback, 285 pp., \$19.95.

Every knowledgeable audiophile will want to have a copy of Ken Pohlmann's *Principles of Digital Audio*. This book, written in an easy, conversation-



TDK BRINGS OUT THE RECORDING ARTIST IN YOU.

Backspin on your volleys is great. Backspin on your music is not. That's why TDK developed a series of high-bias audio cassettes that give you a power-serve of pure lifetime performance.

TDK SA delivers an unmatched high end with extra sensitivity for all of your most sophisticated musical favorites.

For music that's all over the court, we've developed an improved TDK SA-X, which is now the world's lowest-noise tape. It reaches high and low to deliver crisp, clear sound without distortion.

And for error-free follow-through in recording from compact discs, we offer TDK HX-S. It captures all the dynamic purity of the original digital sound like no other.

TDK high-bias audio cassettes. They'll sure improve the way you play—your music.

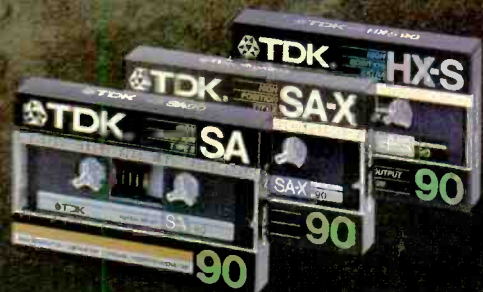

TDK also manufactures a quality line of video cassettes and floppy disc products.

TDK. THE ART OF PERFORMANCE.

Enter No. 48 on Reader Service Card

TO FIND OUT WHAT NORMAL HANDLING COULD DO TO YOUR CDs,

SCRATCH HERE:

You may not see anything wrong, but you'll quickly hear it. Even ordinary handling can result in scratches on the "print" surface of your compact discs, producing dropouts which cause skipping—rendering them unplayable. But there's a way out of this scrape.

No other cleaner in the world beats Recoton's CD-11 Compact Disc Radial Cleaner—winner of the 1985 Audio/Video International Grand Prix Award for Design and Engineering. It cleans your compact discs the way manufacturers recommend: in a straight line—across the radius—from the center of the disc to the outer edge.

By removing dirt, dust and film across the surface with an ultrasoft chamois pad, Recoton's true radial cleaning action significantly reduces the causes of distortion and dropouts. The results are pure sound and error-free reading of digitally encoded music information.

And to ensure longer lasting pleasure from your compact discs, ask your dealer about the complete line of Recoton accessories. Like our superb non-corrosive cleaning solution and unique surface restoring scratch filler solution. Plus protective shields for permanent safeguarding of your compact discs.

Before you get into a real scrape with ordinary compact disc cleaners, get the award winning performance of Recoton.



RECOTON®

46-23 CRANE STREET, LONG ISLAND CITY, NY 11101.

Enter No. 39 on Reader Service Card

Pete Best's narrative is superficial, and the only time you get a feel for his personality is when he recounts being sacked from The Beatles.

al style, explains nearly every facet of the subject. Pohlmann covers the familiar territory of digital encoding, but he goes much farther than most writers on the subject, exploring such topics as the decoding process, error protection, magnetic and optical storage media, and digital transmission methods. The chapter on the Compact Disc alone is worth the price of the entire book, particularly because of the section on the inner workings of a CD player. There are also hundreds of diagrams to illustrate and clarify the points under discussion.

This is not the sort of book you would read straight through while curled up in front of the fireplace, but rather the kind you keep handy to answer your questions. To make topics easy to find, Pohlmann has arranged them in a logical progression; the table of contents is a good general outline, and the index is genuinely helpful. The bibliography includes most of the standard works on digital audio and will be valuable to readers seeking more detailed information.

Despite the straightforward, conversational style of Pohlmann's writing, some readers will find that he has assumed a level of technical knowledge that they don't have. Occasionally, unusual terms such as "birefringence" (a measurement to check the flatness of a CD) or "syndrome" (not a disease contracted by bad data) go past without definition or explanation, so you might need to consult a technical dictionary from time to time. For the second edition, a glossary would be a nice addition. However, you can infer enough meaning from the context to get through it if you are persistent. I suspect that Pohlmann, being a college professor, is accustomed to the live interaction of a classroom, where students can ask about terms they don't understand. In a book, specialized language needs to be explained, especially in a relatively new field.

Sams' editors evidently need some courses in basic English grammar. They repeatedly fail to make subject and verb agree in number, and seem defenseless against the run-on sentence. Readers should keep a bucket of periods and upper-case letters handy. These are not matters of style and preference, but are shocking ex-

amples of incompetence. All I can say is, grit your teeth and plow through it, because what Pohlmann has to say is worth reading.

The design of the book is crisp and clean, and the boldface subheadings help you find topics quickly and easily. But the failure to coordinate the illustrations with the text is annoying. Why are the drawings *always* one page ahead of the text? With just a little more thought and care, the production team could have placed most of the diagrams on the same page as the text.

Books on technical subjects can be extremely dry, but this author's subtle sense of humor helps relieve any oppressively technical feeling. For instance, he warns readers not to experiment with ultra-fast sampling rates, because the energy required might create a black hole. In another place, he uses a budget for a motorcycle trip as a metaphor. The budget contains only three items: Beer, gas, and motels.

The section on rotary-head and stationary-head digital recorders is filled with good information. In the chapter on the Compact Disc, the description of how a CD is mastered and pressed should be fascinating reading to anyone who owns a CD player. A section on recordable optical discs will become more valuable in the future, as the various types of discs (DRAW, WORM, OROM, and who knows what else) start to enter the marketplace.

Principles of Digital Audio is packed with information, and it's worth reading. Don't hesitate to buy it and keep it handy for reference, but let the publisher know how you feel about the text editing. *Steve Birchall*

Beatle! The Pete Best Story by Pete Best and Patrick Doncastle. Dell Publishing, paperback, 192 pp., \$7.95.

In the years since John Lennon was assassinated, every childhood friend of Lennon's and every "fifth Beatle" has put pen to paper to let the world know the real story. Pete Best was The Beatles' drummer before Ringo was shuttled in, and one can sympathize with the fellow who sweated out the early days in the German clubs, before audiences were screaming for the Fab Four. (In fact, much of the time Best was with the group, they were the Fab

Five, with Stu Sutcliffe on bass. Sutcliffe had a row with McCartney on one of the German gigs and left the group, dying shortly thereafter of a brain hemorrhage.) Many of the facts included here have been documented in one book or another, as well as in Dick Clark's television special, *Birth of The Beatles*, for which Best served as a research consultant.

Beatlemaniacs keenly devoted to every aspect of the group's career might find this volume of interest, but it provides only a few insights into the group's history. Best's narrative isn't exactly inspired, and most of the time he deals with superficial incidentals—how George refused to clean up the evidence of his post-drunken sickness and managed to live with it in his room for quite some time, how the German girls were ever so eager to comfort the Fab Four, etc. The only time you get a feeling for the Best personality is when he recounts being sacked from the group. In a mire of pitiful anecdotes, he belabors the question, "If I wasn't a good enough drummer, why did they put up with me for the years of paying dues and then give me the elbow right after receiving a record contract?"

True, Pete Best got the shaft, but how many times should one try to make milk from sour grapes?

Jon & Sally Tiven

Bookcassettes

The success of radio drama was due to skilled writing, skilled acting, and skillful use of sound. Radio drama "worked" not just because of what was said, but because of what was left out and, hence, left to the imagination.

Similarly, a good novel relies solely on skillful writing, leaving the reader to fill in the blanks.

Now, the Brilliance Corp. of Grand Haven, Mich. has produced a combination of the novel and the spoken drama. On its *Bookcassettes*, complete books are recorded on cassette, read by excellent actors. The narrative passages are read as one might expect. What is unusual is that dialog is read by actors who can be considered as taking the parts of the characters whose lines they speak.

The dialog is in no way changed, nor are the narrative portions. Nothing is

Bookcassettes use digital speech compression for rapid narration, and are recorded monophonically using all four tracks of a stereo cassette.

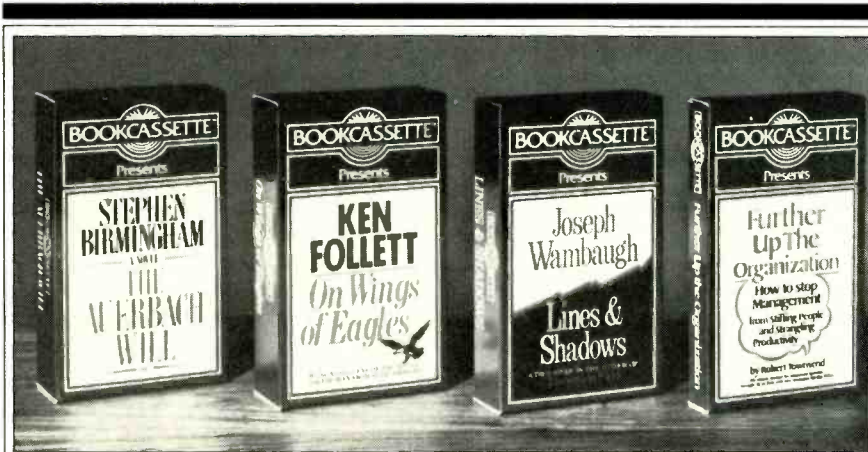

omitted. Likewise, nothing is added, not even sound effects. If the book describes a high-speed car chase, you must supply the sound of the motor, the sound of shots, the smell of gasoline, etc. The only liberties which are sometimes taken involve such touches as adding a bit of reverberation if the action takes place inside a church, applying some filtering if we are eavesdropping on a telephone conversation, etc.

The reading is often done at high speed, and this can be a bit disconcerting at first. I found, however, that after listening a while, I became used to it. Further, this brisk pace adds to the tension in adventure novels.

A book can take several hours to read aloud, and if suitable steps were not taken, *Bookcassettes* would have to be recorded on many cassettes. To solve this problem, *Bookcassettes* are recorded monophonically, using all four tracks on the cassette. In order to play them, you need a stereophonic player. Begin by setting the balance control so that the left channel is heard. Play the first side of the cassette; turn it over and play the second side. Next, turn the cassette over once more, but now adjust the balance control so that output is obtained from the right channel only, and proceed as before, listening to the third and fourth tracks of the cassette.

Program material of this kind would likely be enjoyed by users of personal portable equipment. Even where such players are equipped with a balance control, it is often disconcerting to have the sound produced in just one channel of a headphone. To solve this, the Brilliance Corp. can supply an adaptor

to be placed between the player and the headphones. This device has switching which can send a signal from either the left or right channel into both sides of a headphone.

Another interesting technical note is that the folks at Brilliance use digital speech compression to achieve the reading speed, rather than having the actors wear themselves out attempting to maintain such a pace. This writer has considerable experience with speech compression and can usually detect it; I was not able to do so when listening to *Bookcassettes*.

The *Bookcassette* packaging is designed to look like a book, and the price is the same as that of the hardcover printed version. The headphone adaptor costs approximately \$2.

These products are available at fine bookstores. For a catalog and additional information, write to: Brilliance Corp., Box 114, Grand Haven, Mich. 49417. The phone number is (616) 846-5256 in Michigan, (800) 222-3225 elsewhere. *Joseph Giovannelli*

In One Lifetime: The Life of William Grant Still by Verna Arvey. The University of Arkansas Press; cloth, \$16; paperback, \$9.95.

William Grant Still was born in 1895 in the deepest South, descended from a slave woman and a Scots plantation supervisor named Still. He was, without a doubt, the first Negro (the term preferred in this book, and common through most of Still's life) to rise in the music world into the "classical" area by virtue of thorough training, and to compose on a professional symphonic scale and conduct major orchestras.

This in itself makes him an important figure in American musical life. Though he long outlived Gershwin, three years his junior, the two lives make an interesting parallel, running virtually side by side in the heady New York of the 1920s—though in Arvey's biography Gershwin's name is never mentioned, among hundreds of well-known musical personalities.

William Grant Still, like Gershwin, immersed himself in the show-biz excitement of post-WWI New York, both as a brilliant arranger/composer/conductor and as a performer on almost any instrument that came along. But oddly, Still's commitment to the classical took him technically far beyond Gershwin, who never really mastered either the required expertise in orchestration or, more important, the structural organization of larger classical forms. Still was a tune-writer of genius, with a marvelous sense of piquant harmonies and rhythms. His larger works are essentially strings of these tunes glued together with ingenious breaks.

As a teenager Still was already studying the basic classical disciplines—counterpoint, harmony and reading—through the scores of Beethoven and even Richard Wagner. Astonishing, one might think, in a Negro youth brought up at the beginning of this century in deepest Louisiana and in Little Rock (of more recent fame in black liberation). But from the very start, Still pursued a classical education, thorough and conservative, even including a stretch at that Midwestern bastion of "serious" music, Oberlin College.

Where Gershwin's genius kept him in the living theater, right on through *Porgy and Bess*, William Grant Still (who also wrote operas) was thus able to diversify into a surprising variety of musical entertainment, from Eubie Blake's traveling *Shuffle Along*, full of future black stars, to much success in radio, arranging for big-time network shows, and on to major symphony orchestras and worldwide recognition. This last did not imply a rejection of black values—far from it. Still went the opposite way, to bring classical dignity and craftsmanship to music with Negro themes. It was a notable aim, and often shocking to those who expected the "primitive" sort of black art.

The gold standard for golden ears only.

Here's your invitation to experience a full spectrum of audio delights made for your ears alone.

It's **AUDIOPHILE AUDITION**, the one truly state-of-the-art radio program brought to you for a full hour each Sunday on over 100 participating national public radio stations and selected commercial concert music stations by **AUDIO Magazine** and **Telarc Records**.

It's fun, it's innovative. And it's hosted by John Sunier, one of the country's leading record reviewers, author of numerous audio articles and books, including "The Story of Stereo," and FM broadcasting specialist for three decades.

Heard at 2 pm Eastern Standard Time Sundays on most stations, or check your local public radio listings for exact times in your area. Be sure you're tuned in to hear:

- Digital mastered satellite-transmitted broadcasts of the very best jazz and classical music.
- A unique opportunity to aurally sample the finest CD's, direct discs, half-speed mastered, 45 rpm, dbx and other high-technology records.
- Audiophile cassettes, reel tapes, and digital tapes plus binaural sound and other special features.
- Interviews with noted audio and music personalities.
- Hints on how to enjoy your stereo system more.
- Comparisons of different recording technologies.
- Audio jargon made understandable for the layman.

AUDIOPHILE AUDITION **THE PUBLIC RADIO PROGRAM FOR AUDIO BUFFS** **WITH JOHN SUNIER**

See page 180 for local stations in your area.
If your local station doesn't yet carry Audiophile
Audition, call or write and suggest they schedule it.
Audiophile Audition is provided at no charge.



Though this account is far from totally objective, events in the life of William Grant Still make for a powerful biography.

All of which makes for a powerful range in the subject matter of this biography, in spite of many predictable weaknesses: The author, Verna Arvey, was Still's second wife, a brilliant and well-educated white pianist, writer and interviewer who began working with him when he came to the West Coast around 1934. They were not married until 1939, but their increasing interdependence is clear enough. She could put vast energy into an increasingly complex interracial social life and a growing involvement in music worldwide; she also became Still's literary partner, devising texts, fitting words to the shape of melodic lines, concocting entire plots of his operas directly with him. In this book, it is "we" and "our" throughout the second part, and no slightest disrespect or criticism of "Billy" can be tolerated by this strong-minded helpmate. A far from totally objective account, understandably.

The theme of racial tolerance, rather than belligerence, runs through the

book and can only be praised; it was an ideal for both Still and Arvey. Their case for the dignity of Negro accomplishments is even more persuasive. But the impetuous Verna is not a good judge; those many great names, and small ones too, who were sympathetic and helpful tend to be made into plaster saints; on the other side, she relates scurrilous plots, real enough, yet tending to blame the ominous "they" and, alas, leaning toward an intolerance that is not too pleasant.

The famous Still benefactors are invariably "foremost composers" and the like, but though they surely were kindly, most of them are anything but foremost in many minds. They all belong to a very conservative, old-fashioned type, which seems to have been where the Stills moved. Atonal music, in contrast, is made by "tin pan clangers," and "modernists" in general are given very short shrift. "Modern music"—a term long outmoded—is senseless jangle and nothing more.

Some will agree, others definitely not.

The first half of the story, before the name-dropping (legitimate but, in the end, boring), is the salvation of this work and explains the rest. The picture of a group of highly intelligent 19th-century black families, well educated and well mannered, most of them quite literate and often schoolteachers, is quite fascinating, a side of the old Deep South life that seldom reaches us these days. It does, in truth, explain the later William Grant Still in rather moving terms, in spite of the tendency towards plaster sainthood, and is thus a contribution towards both musical and black history.

Incidentally, the entire world of audio electronics and recording of music is virtually ignored here. This is strictly a live-music world, straight through to the 1970s! Not atypical of the professional musician's viewpoint. Broadcasting, yes—but only as though it were another show, or a concert.

Edward Tatnall Canby

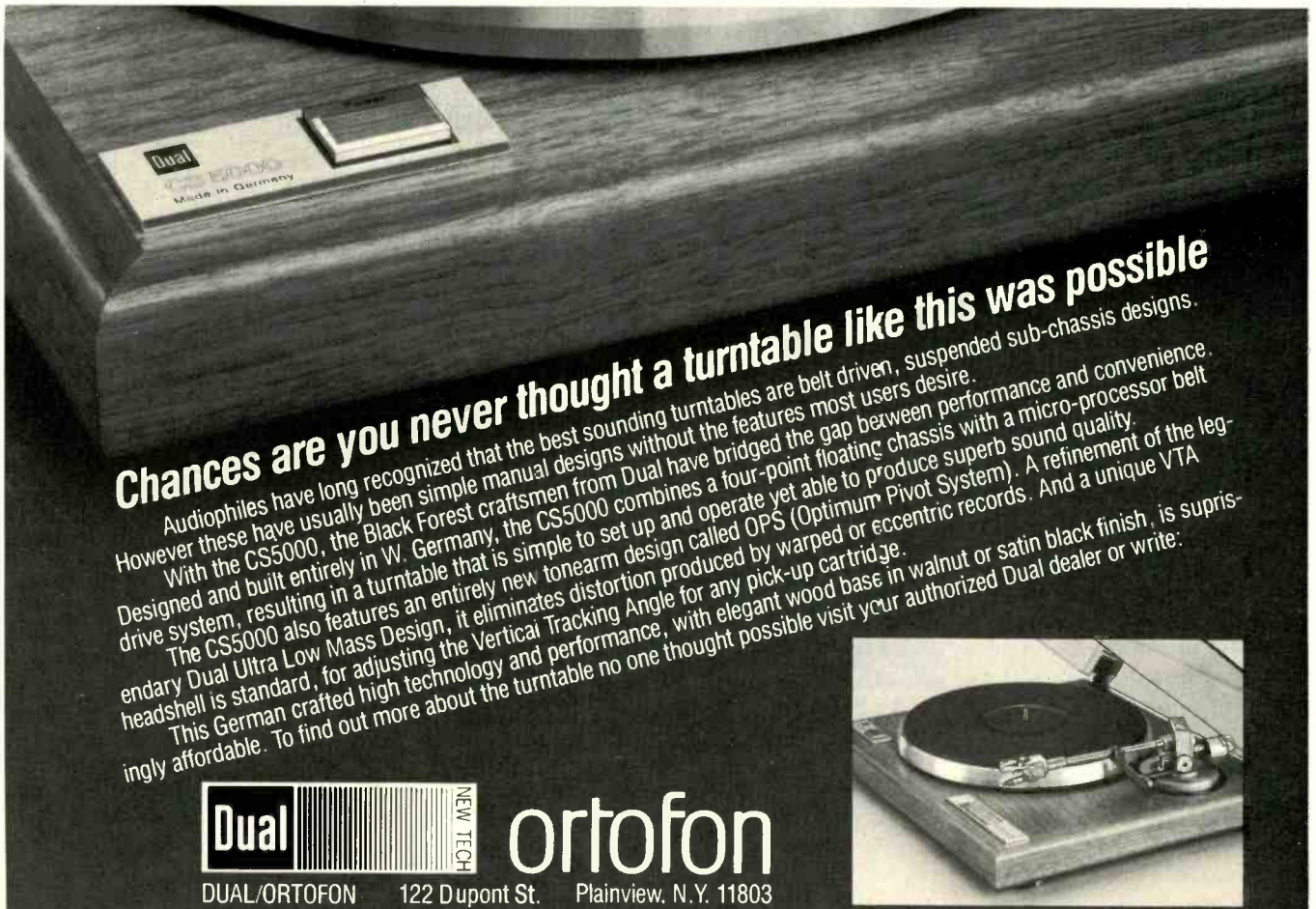

Chances are you never thought a turntable like this was possible

Audiophiles have long recognized that the best sounding turntables are belt driven, suspended sub-chassis designs. However these have usually been simple manual designs without the features most users desire.

With the CS5000, the Black Forest craftsmen from Dual have bridged the gap between performance and convenience. Designed and built entirely in W. Germany, the CS5000 combines a four-point floating chassis with a micro-processor belt drive system, resulting in a turntable that is simple to set up and operate yet able to produce superb sound quality.

The CS5000 also features an entirely new tonearm design called OPS (Optimum Pivot System). A refinement of the legendary Dual Ultra Low Mass Design, it eliminates distortion produced by warped or eccentric records. And a unique VTA headshell is standard, for adjusting the Vertical Tracking Angle for any pick-up cartridge.

This German crafted high technology and performance, with elegant wood base in walnut or satin black finish, is suprisingly affordable. To find out more about the turntable no one thought possible visit your authorized Dual dealer or write:

Dual  **NEW TECH** **ortofon**

DUAL/ORTOFON 122 Dupont St. Plainview, N.Y. 11803



I N T R O D U C I N G

TWO NEW MIDDLEWEIGHT CONTENDERS



From the corner of Zeff Advanced Products Co. come two healthy new performers, the M-80 and S-80 auto amplifiers.

The **M-80** is a subwoofer amplifier delivering an unyielding 80 watts of power. An integral phase-accurate electronic crossover provides a stereo high pass output. The low distortion and brute output drive potential of this amplifier reproduces the most demanding bass passages into even 2 ohm loads with ease and precision.

The **S-80** is an 80 watt stereo ampli-

SPECIFICATIONS	M-80	S-80
POWER	80 watts	80 watts
THD	.03%	.03%
SLEW RATE	30V/ μ S	40V/ μ S
MIN. LOAD	2 ohms	2 ohms
S/N	100 dB	100dB

Two-year limited warranty, parts and labor

fier which can be used as stand-alone or in conjunction with the M-80 as a 160 watt bi-amplified system. High current capabilities and ultra fast circuitry result in clean, fast transience, making this amplifier a perfect medium-power choice for use with today's and tomorrow's music sources.

Having remained at the forefront of technology, Zeff Advanced Products has



Made in U.S.A.

provided the audio performance standard for over ten years. From this background our new amplifiers join a line of proven, high quality audio components made entirely in the U.S.A., including our Parametric EQ/electronic crossover (THD < .004%, S/N > 102dB) and our 200 watt power amplifier (THD < .003%, slew rate > 50V/ μ S).

For a full line brochure or technical support write or call (209) 577-4268. In California call toll free: 1 (800) 25-POWER.

For power, performance, quality and reliability . . . it's ZAPCO . . . by unanimous decision!



Zeff Advanced Products Company

2549 Yosemite Boulevard, Suite E, Modesto, California 95354.

Enter No. 52 on Reader Service Card

CHANGE FOR



Leonard Feldman

The world is full of CD players, thanks to the standardization of the Compact Disc format. A recent innovation is that you no longer have to load and play discs one at a time: If you want to play several discs sequentially (or play random selections from several discs), you'll find that suddenly there are several CD changers around. If you go shopping for one, you'll also discover, as I did in the course of testing four of them, that while the CD format has been standardized, the way CD changers handle multiple discs is, in fact, anything but standard.

THE BETTER:

Four Multi-Disc CD Players



In fact, of the four units tested for this report, no two even handle the same *number* of discs. Pioneer, the first company to surprise the world with a CD changer, uses a disc "magazine" that can house six discs. Nikko's mammoth NCD-600 comes close to being a CD jukebox, as it can store 60 discs in a huge disc tray. Sony's innovative DiscJockey car CD player puts most of the mechanism (including the CD magazine) in a sealed container that hides in the trunk of your car; it can hold and handle up to 10 discs. Finally, the very recently introduced Mitsubishi home CD player, similar in many ways to the Pioneer unit, uses a magazine that holds

five discs. So much for CD changer standardization! Features and programmability of these four CD players vary widely too, so let's take a look at them, one by one.

Pioneer PD-M6: Features and Controls

The Pioneer CD changer plays as many as six discs, loaded in a special magazine. Random-access programming of up to 32 tracks is possible on any of the discs, and direct access to any track on any disc is also easily accomplished. Repeat functions are available for repeat-play of all six discs,



Pioneer PD-M6

one track of one disc, or all programmed tracks of all six discs. Audible scan of program material is possible at two speeds. The PD-M6 has a headphone output with an independent level control. A wireless remote control allows you to operate the player's functions at a distance and even permits full programming of the player. Since "black boxes" to interface TV sets with CD players (for digitally generated still-frame pictures encoded on CDs) are expected to be available soon, the Pioneer PD-M6 is also equipped with a subcode output connector for such adaptors.

Because the PD-M6 accepts a six-disc magazine in its loading slot, it is necessary to use the supplied single-disc magazine when you want to play a single disc. The loading slot, about as wide as a VCR's cassette slot, is positioned below a multi-function display area on the front panel. To the left of the slot and display are the usual "Power" on/off button, the headphone level control, and the stereo headphone output jack. The fluorescent display has indications for "Repeat" play, "Program" memorization, program step (or time in minutes), disc number (or time in seconds), track number, and, finally, a series of one to six symbols showing which disc is being played. Six numbered buttons to the right of the display select the disc, while 10 numbered buttons just below are used to select tracks to be played or programmed. Below these are larger, light-touch pushbuttons to "Eject" the disc magazine and to actuate "Repeat" play, program memorization, and track advance or reverse.

A small "Display" key below this bank of buttons changes the information shown in a portion of the display. Depending on how many times you

push the button, this display section will show either the current track number and elapsed time within the track, or total playback time and the number of tracks on the disc, or the disc and track numbers of the selection being played. If the "Display" button is pressed a fourth time, the display changes back to its original mode. A "Check" key lets you review the contents of a previously entered program, item by item, while a nearby "Clear" key allows you to erase previously entered program commands.

The "Random Play" pushbutton is another nice touch. Push this button when you've loaded six discs into the player, and the unit will continuously

play tracks on all the discs, in random order, until you stop the machine. "Play" and "Pause" buttons are located at the right end of the front panel, and below them are the two-speed forward and backward audible search buttons. These, if pressed for more than 2 S, increase the speed of the audible search. A "Stop" pushbutton is at the lower right of the front panel.

The rear panel of the Pioneer PD-M6 is equipped with the usual left- and right-channel output jacks, an unswitched a.c. convenience outlet, and the subcode output terminal.

**Nikko NCD-600:
Features and Controls**

Nikko says that this 60-disc changer was essentially designed as a professional or commercial-grade unit; nonetheless, it is finding its way into all sorts of places, including radio stations, discos, and even the homes of some audiophiles. The NCD-600 can play any number of discs in sequence, furnishing at least 45 hours of continuous music if it's ordered to play all 60 discs in its tray. However—and this is an unexpected drawback—the number of randomly selected tracks you can pro-



Nikko NCD-600

All four CD changers showed the familiar, ultrasonic beat tones, but only two had even weak beats within the audible frequency range.

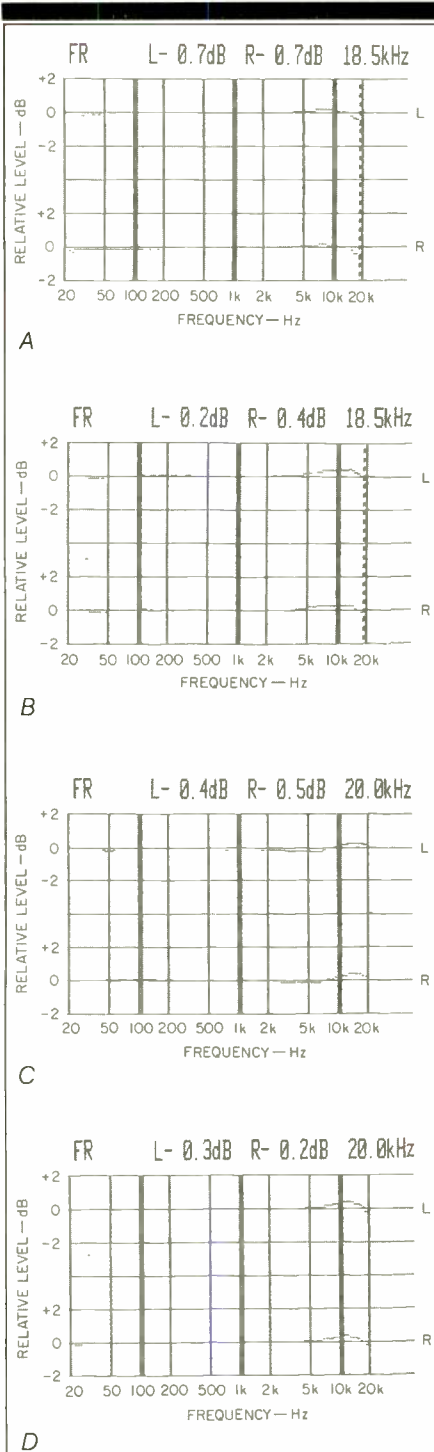

Fig. 1—Frequency response, left (top) and right channels, of Pioneer PD-M6 (A), Nikko NCD-600 (B), Sony CDX-A10 (C), and Mitsubishi DP-409R (D).

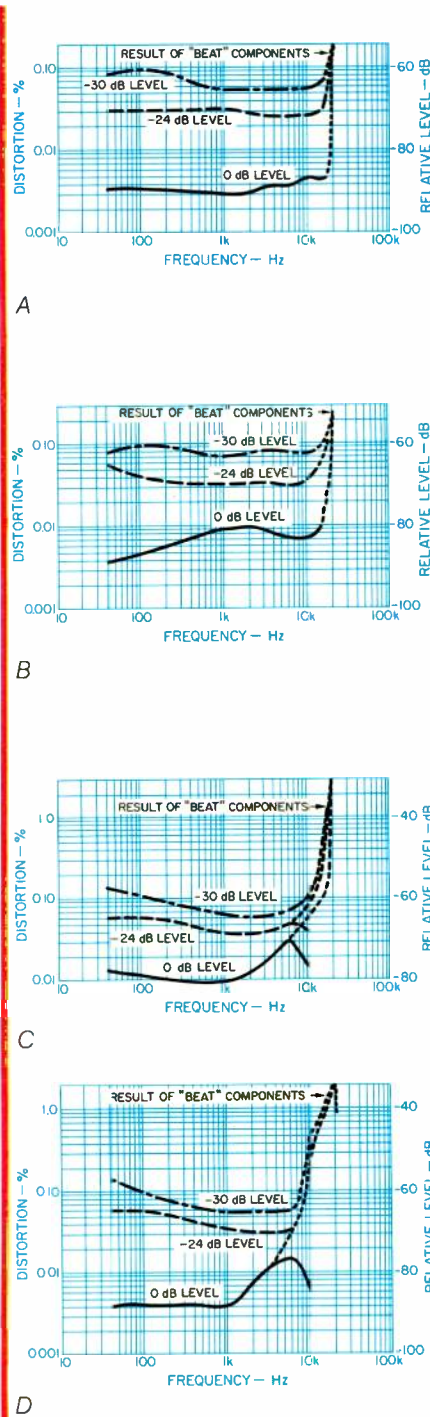

Fig. 2—THD vs. frequency, at three signal levels, for Pioneer PD-M6 (A), Nikko NCD-600 (B), Sony CDX-A10 (C), and Mitsubishi DP-409R (D). Note change in scales for (C).

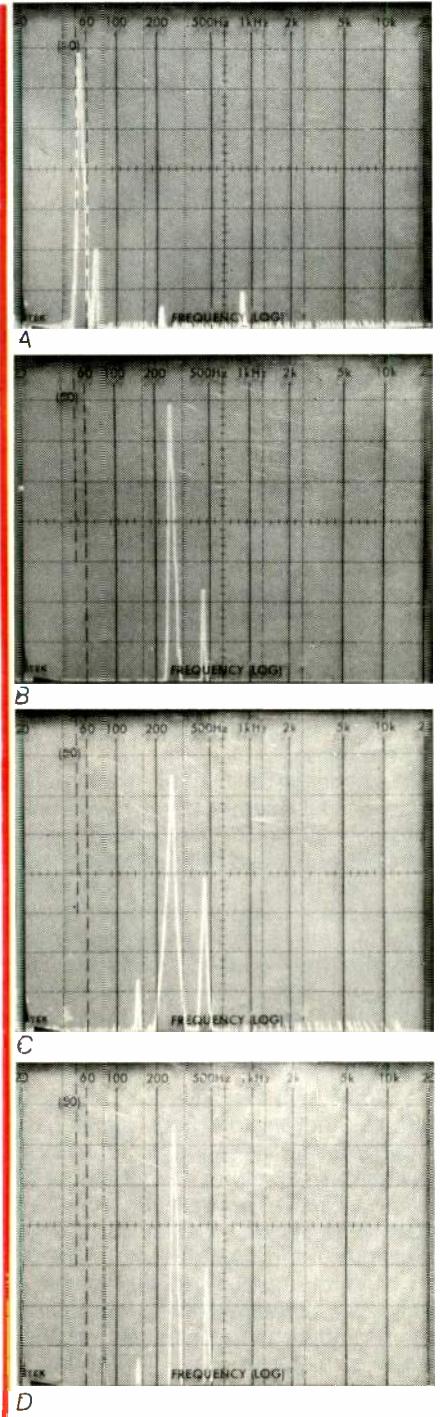

Fig. 3—Out-of-band components reproduced when playing a 20-kHz test tone for Pioneer PD-M6 (A), Nikko NCD-600 (B), Sony CDX-A10 (C), and Mitsubishi DP-409R (D).



Sony CDX-A10

gram is limited to five (though those tracks can come from any of the discs). You can, on the other hand, have the programmed selections repeated over and over.

Two unusual innovations found only in the NCD-600 are independent pitch and rhythm (or tempo) adjustments. In other words, you can adjust pitch up or down and, if you choose, readjust tempo so that it doesn't increase or decrease when you change pitch. Try doing that with a turntable, all you analog die-hards.

Mounting discs into this machine is not a casual operation. It involves unscrewing four hex-head screws from the front panel and then releasing the wide disc tray for loading. I wouldn't want to have to repeat this tricky operation too often, so, if you're going to load this tray to its full capacity, I'd suggest you carefully choose the discs you want to load and keep an accurate list of which disc is loaded into which numbered slot!

In addition to the usual control push-buttons, the Nikko's front panel has rocker bars for adjusting pitch (up to a half-octave in either direction) and tempo ($\pm 5\%$). Two multi-function displays plus an LED display for stereo output level are near the upper left of the control panel. The first display shows the currently playing disc number and track number as well as the player's status ("Play," "Standby," "Search," or "Error"). The second display shows the numbers of the preselected or programmed discs as well as the numbers of the preset tracks on those discs; it also indicates whether or not these discs and tracks have been correctly entered into the system's memory.

An output-level control on the rear panel controls both the headphone output jack on the front panel and the line-level output on the rear. There's also provision for connecting an alternate program source (such as a tuner or tape deck) to the NCD-600. A rear-panel slide switch selects either the player's output or the signal from the alternate source for output through the player's rear-panel jacks. If you can reach the rear-panel selector switch and output-level control, and feel no need for a preamp's tone controls, you could use the NCD-600 as the control center for a two-source audio system, feeding the output directly to a power amplifier.

If 60 CDs aren't enough for you, this unit can be linked by fiber optics to additional NCD-600s (at \$4,395.95 a pop), expanding program access to as many as 240 discs. An optional modification to later production runs (which will be made available for installation in existing NCD-600s) will also add unlimited programmability, nonvolatile memory to store programs for reuse, programmable pitch and rhythm control, and RS-232 serial interfaces for control by computer systems, which would expand the programming possibilities even further.

Sony CDX-A10: Features and Controls

Billed as the world's first Compact Disc changer specifically designed for the requirements of a car, the Sony DiscJockey is offered either as a changer only or with a fully integrated AM/FM synthesized tuner module (the Model XT-10, \$129.95). It can be used with power amplifiers alone or can be linked (via the optional XA-39 switch-

ing unit, \$29.95) to a previously installed head unit.

The only part of the CDX-A10 you need to have up front, where the driver can access it, is a tiny control unit which Sony has dubbed the DiscJockey Remote Commander. This unit has the same height and width as DIN-sized head units, so it can be mounted in standard radio slots. However, since it's only an inch thick, many more mounting choices are possible: The Commander can be mounted in an optional, gooseneck control pod (handy if the radio slot is already filled), can be attached with Velcro strips to the dash or any other convenient surface, or can be hung from a small hanger. The latter two options let you remove the Commander and pass it to other passengers. The unit can even be stored under the front seat when it's not being used, so passersby will have no clue that there's a stereo present.

The heart of the DiscJockey is its 10-disc magazine changer, which is installed in a vehicle's trunk. The mechanism floats freely on a sub-suspension to resist shock and road vibration. The changer's outer casing is built of dust-resistant, high-impact material. The changer provides rapid access to any selection on any disc, and can send up to six different operating-status messages directly to the control Commander's displays.

When you activate play mode on the Commander, the CDX-A10 checks to see which of the magazine's slots are filled; playback begins from the first filled slot, regardless of its position in the magazine. If all 10 discs are present, you can have more than 10 hours of continuous music without having to replace the magazine in the changer.

The unit has two modes of programmed operation. One, called the Random Music Sensor, lets you program up to five selections from any of the discs, but this memory clears whenever the system is turned off. In addition, the Program Play feature allows programming 10 selections, with memory status maintained even if you change listening sources (such as switching to the tuner) or if you turn the unit off. You can also begin play from anywhere within the program, not just from the first programmed selection. In effect, you can program a total of 15

In most of the players, stereo separation declined at high frequencies, but at worst it was still twice as good as a phono cartridge's.

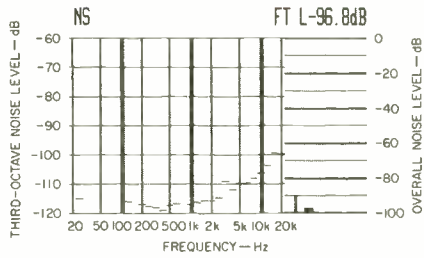

Fig. 4A—Unweighted SIN analysis, Pioneer PD-M6.

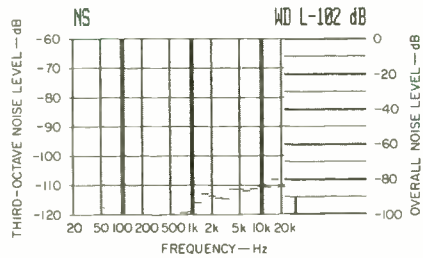

Fig. 4B—A-weighted SIN analysis, Pioneer PD-M6.

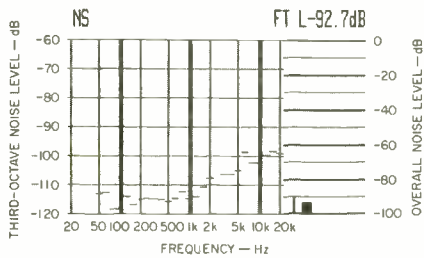

Fig. 4C—Unweighted SIN analysis, Nikko NCD-600.

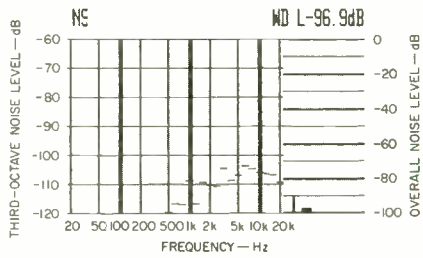

Fig. 4D—A-weighted SIN analysis, Nikko NCD-600.

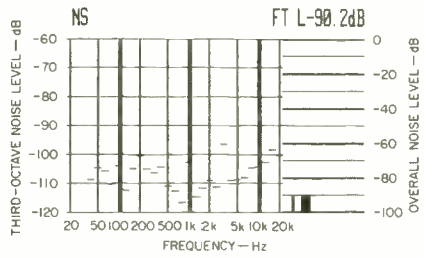

Fig. 4E—Unweighted SIN analysis, Sony CDX-A10.

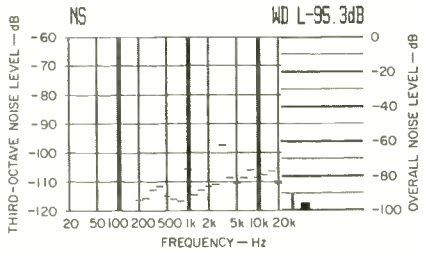

Fig. 4F—A-weighted SIN analysis, Sony CDX-A10.

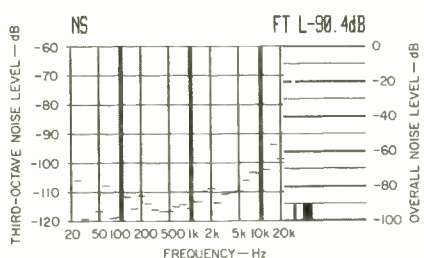

Fig. 4G—Unweighted SIN analysis, Mitsubishi DP-409R.

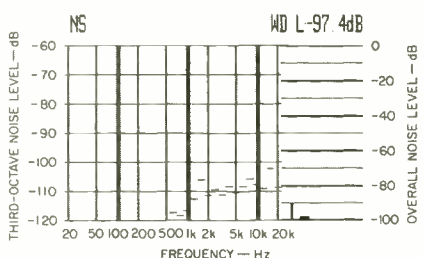
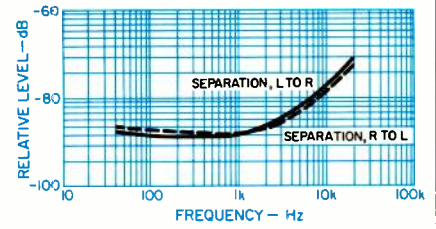
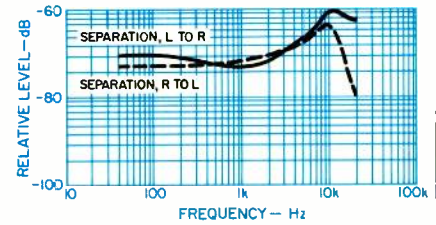

Fig. 4H—A-weighted SIN analysis, Mitsubishi DP-409R.



A



B

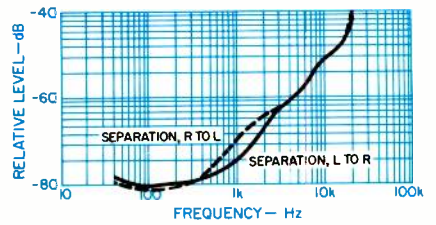

C

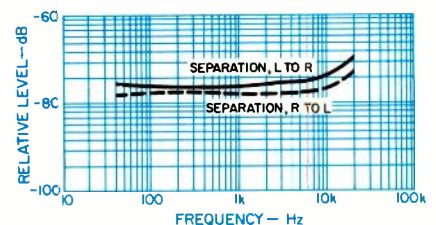

D

Fig. 5—Separation vs. frequency for Pioneer PD-M6 (A), Nikko NCD-600 (B), Sony CDX-A10 (C), and Mitsubishi DP-409R (D). Note change in scale for (C).

selections using the two memory systems, though you must press separate buttons to begin each of the two sequences. Other playback options include direct selection by disc and track number, skipping from one selection to another in either direction, and audible music search for sampling the music at 10 times normal speed in either forward or reverse.

The optional XT-10 tuner module (see sidebar) has no controls whatever. It simply plugs into a receptacle on the back of the changer module, and connections are provided for the antenna input and a power-antenna control. With the tuner module installed, when you switch to radio mode, the Commander's button functions change appropriately. The XT-10 offers 20 station presets (10 AM and 10 FM), automatic scan tuning, manual tuning, and a local/distant/mono switch.

Back in early 1983, when I was introduced to the intricacies of Compact Disc hardware and software manufacture during a visit to Philips and Polygram in Europe, one of the engineers at Philips predicted that it wouldn't be long before we'd all be listening to CDs in our cars. At the same time, he suggested it would be a good idea if car CD players were equipped with optional compressor circuits so that the wide dynamic range recorded on many CDs could be fully appreciated under actual driving conditions. The first car CD players, introduced almost two years ago, ignored this suggestion, but now Sony has practiced what the Philips engineer first preached. The CDX-A10 is equipped with a two-position compressor (or Dynamic Range Suppressor, as they call it). Sony has also tossed in a defeatable surround-sound circuit for arbitrary-matrix decoding to feed ambience to the rear speakers while regular stereo emanates from the front; since this is on the same button as DRS, you can't use surround and compression at the same time.

To keep the size of the Commander module as small as it is (just over 7 inches wide by 2 inches high by 1 inch thick), Sony wisely assigned multiple functions to its controls. The volume button, for example, also serves to alter tone-control settings, channel balance and even front-rear fader settings; its function is determined by a

small associated "Select" key. As this key is depressed successively, indicator lights tell you what function the up/down button is performing; a few seconds after any adjustment is completed, the control and display revert to volume-adjust mode. The usual controls found on any CD player's front panel are also found on this tiny Commander module, including numbered keys for programming desired track selections.

If you have connected the optional XT-10 tuner pack, pressing a key at the lower right of the CDX-A10's Commander switches you over to radio mode. As if by magic, the displays and buttons which previously governed the CD player suddenly assume new roles. The controls for CD fast search and track advance become manual and automatic radio tuning keys. Numbered buttons are now used to call up preset AM and FM stations, and the large display window tells you the frequency to which you are tuned, whether reception is mono or stereo, what preset number you have selected and whether you are in the local or distant reception mode.

Mind you, all that's connecting the Commander module back to the main unit in the trunk (and the tuner pack, if you've installed it) is a thin multi-conductor cable. This cable is easily hidden beneath the carpeting of your car, and requires only a small hole through the rear wall of the car's interior to the trunk space.

Extra magazines which hold 10 discs can be purchased at a suggested price of \$19.95 each. Because a multi-disc magazine generally takes up less space than the corresponding number of CD jewel-box cases, the 10-disc Sony, six-disc Pioneer and five-disc Mitsubishi magazines can all be used as handy CD storage devices in

the home. If you're wondering what to do with the booklets that normally accompany each CD, Sony has an answer to that too: With each of their 10-disc magazines, the company supplies a transparent folder (similar to a billfold credit-card holder) whose 10 pockets are just the right size for these booklets.

Mitsubishi DP-409R: Features and Controls

The Mitsubishi Compact Disc changer allows more selections to be programmed than any of the other changers tested here: A total of 30 selections from any of up to five discs can be loaded into its disc magazine. If you own a VHS VCR and have a cabinet with compartments for storing videocassettes, you'll find that you can store the Mitsubishi CD magazines in those same compartments. In fact, the slot on the front of this player looked so much like that of a front-loading VCR, for a moment I thought they had sent me the wrong component to test!

In addition to manual playback of an entire disc in sequence, the DP-409R allows you to program disc and track selections very easily. The player also has two repeat-play modes, for playback of programmed selections or of its entire five-disc magazine. Other features include the usual track-skip, fast-forward and -reverse (audible) scan, and scanning of the next disc. The unit does not have a headphone jack or an output-level control, but it does include a wireless remote control which duplicates most of the front panel's functions. This player is also offered without the remote control, as the Model DP-309, for a lower price.

The moment you insert the disc magazine into the loading slot, a series of bars lights up in the display to the slot's right; these bars tell you which



Mitsubishi DP-409R

You can tell from the 'scope photos that all these units use analog filtration and single, multiplexed digital-to-analog converters.

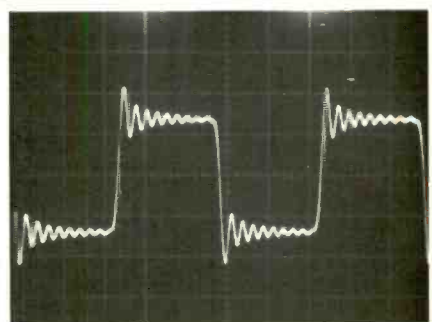

A

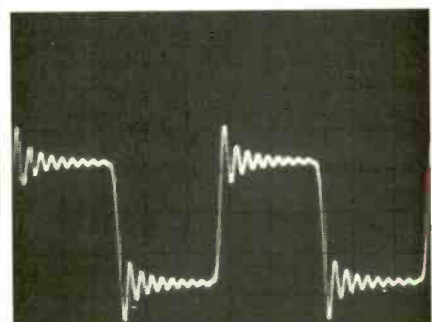

B

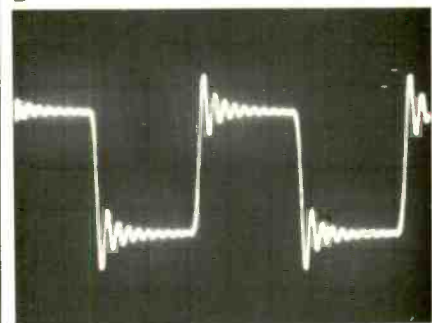

C

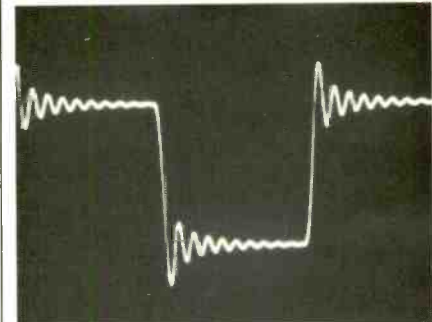

D

Fig. 6—Reproduction of a 1-kHz square wave by Pioneer PD-M6 (A), Nikko NCD-600 (B), Sony CDX-A10 (C), and Mitsubishi DP-409R (D).

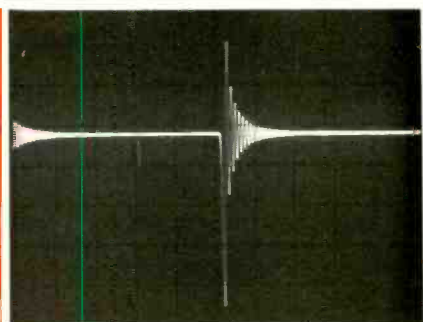

A

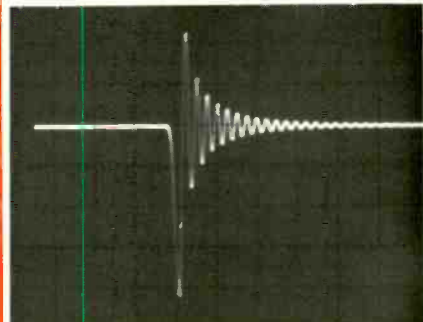

B

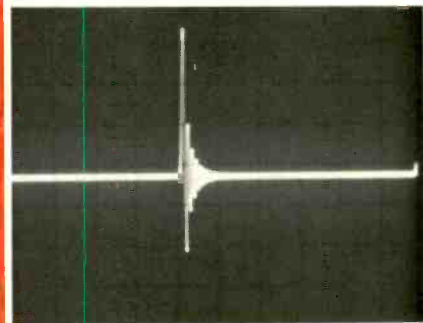

C

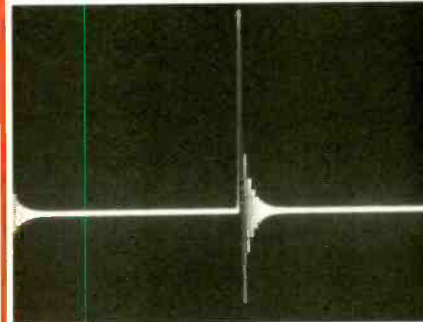

D

Fig. 7—Unit-pulse reproduction by Pioneer PD-M6 (A), Nikko NCD-600 (B), Sony CDX-A10 (C), and Mitsubishi DP-409R (D).

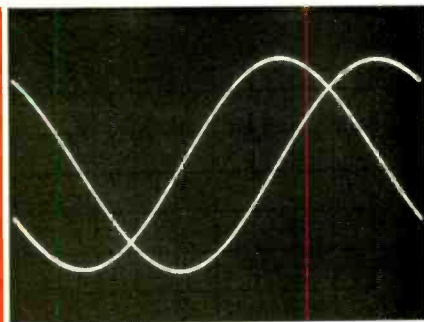

A

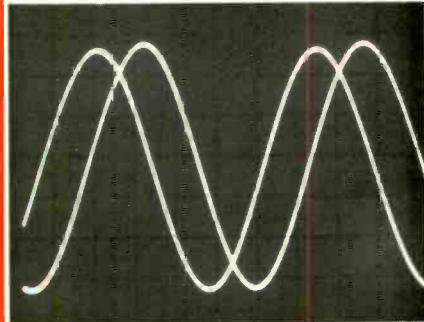

B

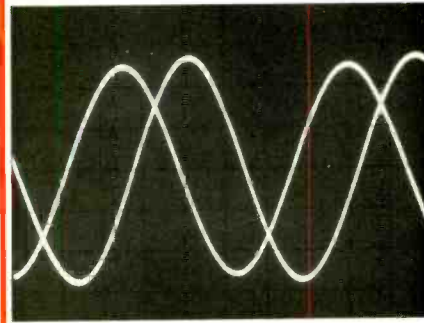

C

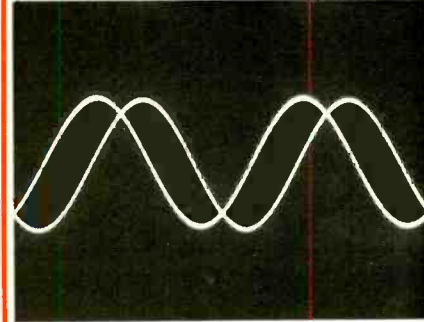

D

Fig. 8—Interchannel phase difference when reproducing a 20-kHz test tone for Pioneer PD-M6 (A), Nikko NCD-600 (B), Sony CDX-A10 (C), and Mitsubishi DP-409R (D). Horizontal scale: 5 μ S/div. for Pioneer only, 10 μ S/div. for all others.

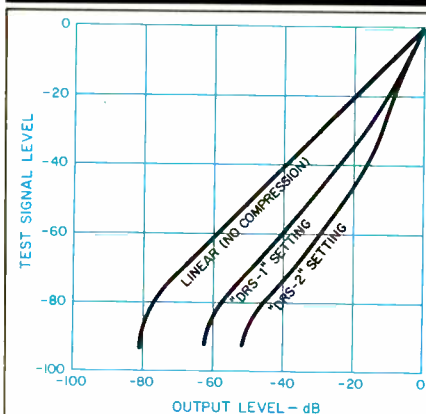

Fig. 9—Input vs. output characteristics for Sony CDX-A10, without compression and with each "DRS" compression setting.

disc trays have been filled. (Both the trays and the illuminated display bars are numbered 1 through 5.) The rest of the display area provides the kind of information we've all gotten used to on CD players, such as track number, disc number and elapsed time. During programming operations, the program number (1 through 30) is displayed instead of the elapsed time. Illuminated words also tell you if you are in the program mode or in a repeat-play mode.

Separate sets of forward and reverse keys are used for audible music search and for track advance or reverse. A button labelled "Next" advances play from one disc to the next, and the usual array of numbered keys and program buttons is used to memorize up to 30 desired selections from any of the five discs in any random order. When entering selections either for immediate play or for programming, the first button pressed will register as the disc number desired; the subsequent numbers pressed will automatically be entered as the desired track numbers of that disc. These steps make using the DP-409R very simple and straightforward.

Measurements: The Quartet of Changers

As you can well imagine, I did not measure these four CD changers at the same time—or even in the same month. I saved up my data, one model at a time, until I could do a side-by-

side analysis of measured results. I also kept an accurate set of notes concerning the musical listening tests that I conducted for the three home players. I had an opportunity to listen to the Sony car CD changer at this past Winter Consumer Electronics Show in Las Vegas. Since it's pretty hard to do a serious listening test at such an event, I had hoped that Technical Editor Ivan Berger would get a chance to road-test the unit. Unfortunately, that was not possible.

Rather than spell out the test results for each player, I've summarized the results in Table II and have presented most of my usual plots and spectrum-analysis photos. My comments will be limited to how the players' measurements compared with each other.

I found it interesting that all four of these CD changers exhibited the familiar out-of-band spurious components that I've been seeing from other players. These "beat" components have occurred when I've reproduced a 20-kHz test tone and examined the output spectrum from 0 Hz to 50 kHz, as I did for Figs. 3A, 3B, 3C, and 3D. Notice, though, that while all four players produced an output above 20 kHz (caused by an IM beat between the 44.1-kHz sampling rate and the 20-kHz test tone itself), only two of the players produced low-level, "in-band" beat signals (at around 16 kHz). To be sure, the level of these in-band beats is so low, and normal high-frequency program content is so far below the maximum 0-dB level at which this test was made, that this form of spurious signal will certainly not be audible under real-world listening conditions. Still, the difference in results between the Sony and Mitsubishi units versus the Nikko and Pioneer units suggests that each pair of companies is using a different type of chip for their D/A conversion.

I have the feeling, too, that the manufacturers' spec sheets do not reflect the new EIAJ-approved method of measuring dynamic range. As you can see from Tables I and II, my results are much better than the published specs of dynamic range for all four units. I doubt if it's a case of conservative specification writing; rather, the specs were likely written before the new EIAJ Standard was issued. In any case, dynamic range is no problem with any of

these CD changers, and here Sony's car unit is the winner, with a possible dynamic range of 114 dB. That's ironic, because you don't really need (and can't possibly appreciate) this amount of dynamic range in an automobile environment—unless, of course, the car is standing still.

All of the units had more than adequate stereo separation at mid-frequencies, but all but the Mitsubishi unit exhibited rather rapid reductions in separation as higher and higher test frequencies were reproduced from a single channel. Check this out for yourself by looking at Figs. 5A, 5B, 5C, and 5D. Still, even the worst case of decreased separation at 10 kHz (about 50 dB) is more than twice as much as I ever measured for a phono cartridge at that high frequency.

From looking at Figs. 6A, 6B, 6C and 6D, it was evident to me that all of these units have steep, multi-pole analog output filters rather than digital filtration. I'm told that the most commonly available (and least expensive) multi-function chips that are used in small portable CD players and in lower cost units are designed to be used with analog filters. To keep costs reasonable, what with the complexity of changer mechanisms and all of the added memorization circuitry involved in programming multiple discs, these manufacturers have probably elected to use such chips instead of those that provide digital filtration prior to D/A conversion.

It's also evident to me, from Figs. 8A, 8B, 8C and 8D, that each player employs only a single D/A converter. Left- and right-channel digital-to-analog processing is done by time multiplexing, which results in a time delay of just under 12 μ S between signals. However, if the time delay in Fig. 8A seems as though it's greater for the Pioneer unit than it is for the other three, this is my fault: I used a different horizontal sweep rate (5 μ S instead of 10 μ S per division) when testing the Pioneer. In fact, all four units exhibited the same time-delay error for the 20-kHz signals on opposite channels.

All of the units were able to track all of the built-in "defects" on a special test disc. This is especially important for the Sony car unit, which is going to have to track perfectly, even under

The dynamic range specifications claimed for these players are conservative and apparently were written before the EIAJ Standard for this spec.

TABLE I—MANUFACTURERS' SPECIFICATIONS

Parameter	Pioneer PD-M6	Nikko NCD-600	Sony CDX-A10	Mitsubishi DP-409R
Frequency Response	4 Hz to 20 kHz, +0.5, -1 dB	10 Hz to 20 kHz, ±0.5 dB	5 Hz to 20 kHz, ±1.0 dB	5 Hz to 20 kHz, ±0.5 dB
THD	Less than 0.005%	0.007%	0.015%	0.003%
Dynamic Range	Greater than 94 dB	85 dB	85 dB	94 dB
S/N	Greater than 98 dB	Unmeasurable	85 dB	98 dB
No. of Discs Handled	6	60	10	5
Programmability	32 Selections	5 Selections	15 Selections	30 Selections
Channel Separation	Greater than 92 dB	N/A	75 dB	98 dB
Line Output Level	1.5 to 2.5 V rms	0 to 5.0 V rms	N/A	2.0 V rms
Power Requirements	23 watts	37 watts	800 mA (at 12 V d.c.)	17 watts
Dimensions (W x H x D), Inches	16 ³ / ₁₆ x 3 ³ / ₁₆ x 12 ⁷ / ₁₆	18.4 x 13.9 x 14.7	12 ³ / ₄ x 5 ¹ / ₄ x 8 ³ / ₄ (Trunk-mounted)	16 ³ / ₄ x 4 ¹ / ₈ x 13 ³ / ₈
Weight	13 lbs. (5.9 kg)	59.4 lbs. (27 kg)	12 lbs., 6 oz. (5.6 kg)	16 lbs., 9 oz. (7.5 kg)
Price	\$499.95	\$4,395.95	\$999.95	\$500
Company Address	P.O. Box 1720, Long Beach, Cal. 90801 For literature, circle No. 10C	5830 S. Triangle Dr., Commerce, Cal. 90040 For literature, circle No. 10I	Sony Corp., Park Ridge, N.J. 07656 For literature, circle No. 10J	P.O. Box 6007, Cypress, Cal. 90630 For literature, circle No. 10K

TABLE II—MEASURED DATA

Parameter	Pioneer PD-M6	Nikko NCD-600	Sony CDX-A10	Mitsubishi DP-409R
Frequency Response	20 Hz to 20 kHz, ±0.7 dB (See Fig. 1A)	20 Hz to 20 kHz, ±0.4 dB (See Fig. 1B)	20 Hz to 20 kHz, ±0.5 dB (See Fig. 1C)	20 Hz to 20 kHz, ±0.3 dB (See Fig. 1D)
THD at 1 kHz (0-dB Level)	0.003% (See Figs. 2A & 3A)	0.009% (See Figs. 2B & 3B)	0.009% (See Figs. 2C & 3C)	0.004% (See Figs. 2D & 3D)
S/N (Unwtd./A-wtd.)	96.8/102.0 dB (See Figs. 4A & 4B)	92.7/96.9 dB (See Figs. 4C & 4D)	90.2/95.3 dB (See Figs. 4E & 4F)	90.4/97.4 dB (See Figs. 4G & 4H)
SMPT E IM (At 0 dB)	0.0047%	0.005%	0.01%	0.003%
SMPT E IM (At -20 dB)	0.03%	0.015%	0.03%	0.025%
CCIF IM (At 0 dB)	0.98%	0.0039%	0.018%	0.002%
CCIF IM (At -10 dB)	0.09%	0.0049%	0.02%	0.0023%
Separation at 1 kHz	88 dB (See Fig. 5A)	72 dB (See Fig. 5B)	73 dB (See Fig. 5C)	76 dB (See Fig. 5D)
Dynamic Range	100 dB	103 dB	114 dB	106 dB
Square-Wave Response	(See Fig. 6A)	(See Fig. 6B)	(See Fig. 6C)	(See Fig. 6D)
Unit-Pulse Response	(See Fig. 7A)	(See Fig. 7B)	(See Fig. 7C)	(See Fig. 7D)
Intrachnnl. Phase Delay	(See Fig. 8A)	(See Fig. 8B)	(See Fig. 8C)	(See Fig. 8D)
Maximum Output Level	2.0 V rms	4.7 V rms (See text)	3.68 V rms	2.3 V rms
Short Access	2.0 S	1.0 S	0.75 S	1.5 S
Long Access (Disc to Disc)	6.0 S	15.0 S (Varies)	12 S	13 S
Wow and Flutter	Unmeasurable	Unmeasurable	Unmeasurable	Unmeasurable
Tracks 900-μ "Scratch"	Okay	Okay	Okay	Okay
Tracks 800-μ "Dust"	Okay	Okay	Okay	Okay
Tracks "Fingerprint"	Okay	Okay	Okay	Okay

conditions of extreme vibration and external shock. When you add the problem of imperfect discs with opaque or scratched areas to the problem of external shock and vibration, it is almost miraculous that units such as the Sony car CD changer perform as well as they do.

The Nikko unit delivered a whopping 4.7 V of output for 0-dB recorded level

when its rear-panel level control was turned fully up. I don't believe the designers should have allowed for such a high level, especially since, if you allow the unit to operate at that level, the Nikko's own analog output stages are overloaded and distort audibly.

While all of the units exhibited extremely fast short-term access time (the time it takes for the laser pickup to

get from one track to an adjacent track), the Pioneer PD-M6 was the clear winner when it came to long-term access time (getting from one disc to another), performing this feat in 6 S. The slowest, in this regard, was the Nikko, at 15 S, but it's certainly understandable when you consider the number of discs and the size of the disc tray that has to be traversed.

Each of these changers offers a different combination of features, but all offer sound quality which could not be faulted.

SONY'S XT-10 TUNER MODULE:

An evaluation

Adding an AM/FM tuner module to Sony's 10-disc CD changer doesn't take up any more interior space inside a car or other vehicle: The tuner module itself is just another "black box" (actually silver colored) that can be hidden in the trunk and plugged into a receptacle on the main CD changer unit also located there. Once the connection is made, the Remote Commander in the car's passenger compartment becomes the control panel for tuner functions as well as for CD playing tasks.

Since anyone purchasing the CDX-A10 CD changer may want to add the XT-10 tuner module initially, or at some time in the future, I thought it would be only fair to evaluate the tuner module's performance in terms of the total system. The accompanying Table compares Sony's pub-

lished specifications with those I measured in my lab. Figure B1 shows how signal-to-noise ratios and 1-kHz distortion levels vary with increasing signal strength in both mono and stereo modes. As is true of most car FM tuners, the left and right channels are deliberately blended at low signal strengths, reducing background noise considerably to make the signal usable, but at the expense of some stereo separation. This action is the cause of the by-now-familiar dip in the stereo S/N curve shown in

Parameter	Published Value	Measured Value
Usable Sensitivity	9.3 dBf	12.0 dBf
50-dB Quieting,		
Mono	15.3 dBf	18.0 dBf
Selectivity	75 dB	75 dB
S/N Ratio		
Mono	70 dB	73 dB
Stereo	67 dB	71 dB
THD, 1 kHz		
Mono	0.15%	0.2%
Stereo	0.3%	0.55%
Separation, 1 kHz	42 dB	43 dB
FM Frequency Response	30 Hz to 15 kHz, ± 3 dB	30 Hz to 15 kHz, +1.4, -3.0 dB

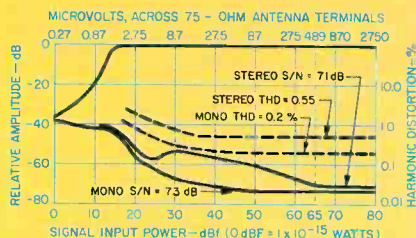

Fig. B1—Mono and stereo quieting and distortion characteristics, Sony XT-10 FM tuner module used with Sony CDX-A10 car CD changer.

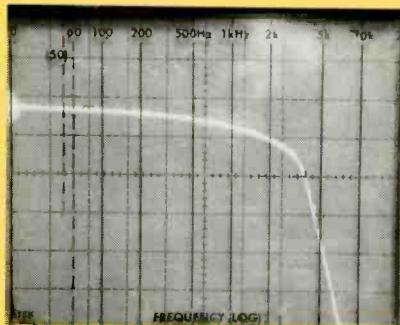

Fig. B2—AM frequency response, Sony XT-10 tuner module used with Sony CDX-A10 car CD changer.

Fig. B1, where S/N actually improves a bit as signal strength falls from 30 to 25 dBf. The tuner also has an impulse-noise suppression circuit, which may be contributing to the S/N performance. Frequency response for AM reception is shown in Fig. B2.

I found the station presets easy to program, and station seeking and scanning worked well on the test bench. My overall assessment of the Sony XT-10's performance is that, when used in conjunction with the CDX-A10 changer, it compared very favorably with some of the better separate car-stereo tuners I have measured over the past few months. L.F.

The action of the Sony CDX-A10's compressor circuits was checked both in listening tests and on the bench. Figure 9 shows how output level varied with input level for the three settings of the compressor: No compression (linear response), the moderate "DRS-1" setting, and the more extreme "DRS-2" setting.

Use and Listening Tests

As indicated earlier, I wasn't able to test all of these CD changers at the same lab session, nor was I able to listen to them in side-by-side comparisons. As a result, I should not offer a definitive answer as to which model sounds best.

I found the Pioneer, Sony, and Mitsubishi units easy to load and use. I would reserve the Nikko unit for applications in which you really want to load up to 60 discs and, because of the difficulties of installing the tray, don't expect to change the complement of discs too often.

According to the notes I kept of my listening sessions, none of these units delivered sound quality that I can fault in any major way. In fact, since all of the players employ pretty much the same kind of digital circuitry, any differences that I would be likely to hear would arise from the analog output stages used in these four machines and from any minor deviations from perfectly flat response.

If I had to vote for the combination of best sound quality and best human engineering of the three home units, I'd pick the Mitsubishi DP-409R. The Pioneer PD-M6 would be a close runner-up, and the Nikko unit would place third. The Sony unit's ease of use was impressive on the test bench; its sound quality was also impressive in the listening room. I suspect that the two compression settings will be a most welcome feature for those car-audio buffs who have been hoping for a way to listen to CDs without either rupturing the cones of their car speakers or turning down levels so low as to miss the quieter passages of music. I found the "DRS-1" compression setting to be extremely effective and ideally set for my taste, but it would take a road test to fully qualify this feature, and the unit as a whole, in this "sweepstakes" of CD changers.

BECAUSE TOO MUCH PERFORMANCE IS NEVER ENOUGH

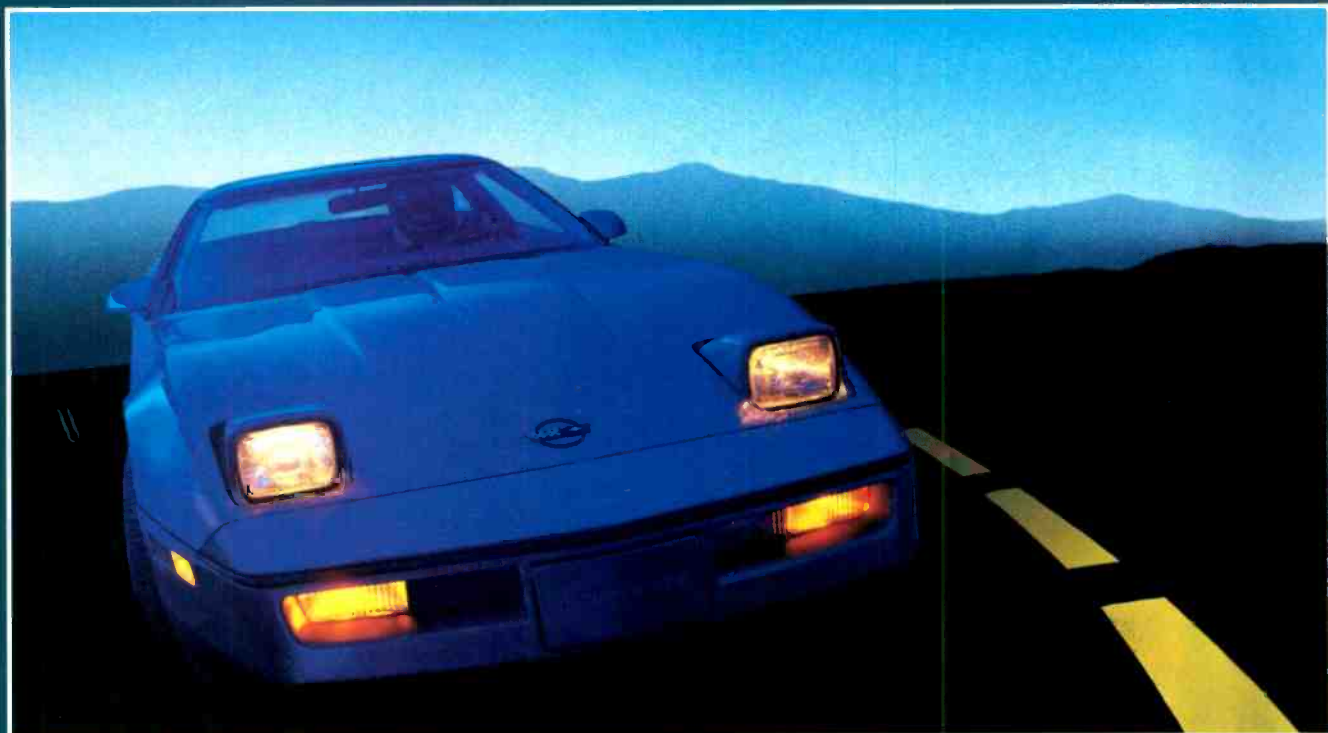

Harman Kardon's drive for sonic excellence has elevated the standards of high fidelity for over 30 years. Our striving for the ideal is often considered "too much" by our competitors. Now the pleasure of "too much performance" is brought to the automotive environment.

Our competitors must feel that 20-20,000Hz ± 3 dB is "too much performance" to expect from an in-dash cassette/tuner, or they would offer it. We believe it the minimum necessary for true high fidelity reproduction. Even our least expensive model offers this and other "over design" distinctions: Dolby[®], dual gate MOSFET front ends, superior tuning sections, hand selected tape heads and heavy duty transports.



Shown: The new CH161 DIN-mount in-dash cassette/tuner, and CA260 automotive amplifier.

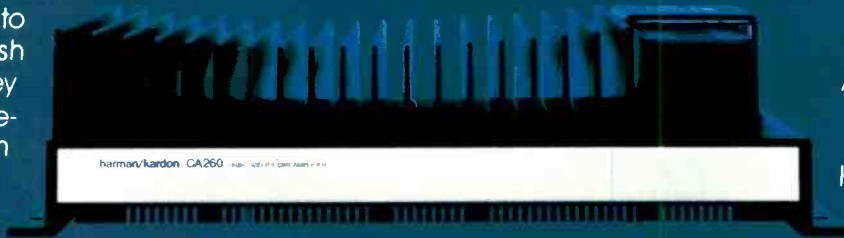

Our competitors must feel that High instantaneous Current Capability, Low Negative Feedback and discrete componentry constitute "too much performance" in automotive amplifiers. All of our mobile amps, from the 3.5 Watt/channel CA205 to the 60 Watt/channel CA260, are "over designed" to include these superior design criteria.

Automotive high fidelity performance from Harman Kardon. It's too much.

For more information and your nearest dealer call toll free 1-800-633-2252 Ext. 250 or write 240 Crossways Park West, Woodbury, New York 11797.

harman / kardon

A Harman International Company

High Performance Necessities for the Mobile Audiophile.



TYPE III HD6/90

FUJI CASSETTE
POSITION-METAL

GTI
90

Metaxial
60

POSITION-METAL

STEREO
NOISE RED
BASF CR-M
IEC II

Photo: David Hamsley

Sheet music score with various instrument parts including Tuba (Tb), Timpani (Timp.), Viola (Vla.), and Violin (Vcl.).

Cassette Test Update: 49 FORMULATIONS

Howard A. Roberson

In September 1984, we published a "Cassette Test Update" covering 12 formulations; this, in turn, was an update of the September 1983 review of 77 cassettes. The fact that this present article covers 49 new and updated products illustrates the continuing improvement made by all manufacturers. Included here are 20 Type I tapes, 23 Type IIs, and six Type IVs. There are three formulations from BASF, six from

Denon, three from Fuji, eight from Maxell, four from Memtek Products (Memorex), five from PDMagnetics, three from RAKS, four from Scotch, five from Sony, five from TDK, and three from Triad. I may have missed some improved tapes, at least since our previous coverage, but I have relied on the manufacturers' announcements and responses to queries. (Editor's Note: As we were fact-checking this article prior

to sending it for typesetting, we were told by a PDMagnetics technical services representative that the firm had ceased operations in the United States. Since goodly stocks will remain on dealer shelves and the firm will continue to do business in Canada, we felt the most reasonable course was to include the data Mr. Roberson had taken.—E.P.)

BASF emphasizes that their LH Maxima I and Chromdioxid Extra II are the IEC Standard Reference Tapes for Types I and II, respectively. The company's new Type II tape is Chromdioxid Maxima II. The names sound impressive, albeit a little complicated. The boxes and tapes show abbreviations: LH-MI, CR-EII, and CR-MII—much easier to handle. All formulations have new shells and packaging.

Denon's tape line is new, with the exception of DX-1, which remains to the line. The "HD" in each of the new formulations stands for "high density." In their literature, Denon emphasizes the "over-sized window, the higher-grade pressure-pad spring, the transparent H-shaped slip sheets and the DB (dynamic balance) hubs." Denon's best tape for high (Type II) bias is HD8, which uses New High Technoroom—a mixture of cobalt-coated ferrite and metal.



Cassette manufacturers have worked hard to improve formulas, so that competition for the title of "Best Tape" is tough.

Fuji has improved their FR-II with new, fine-grain Beridox magnetic particles, applied with advanced coating technology for greater density and uniformity. The FR tapes' cassette mechanism has been improved with honeycomb slip sheets, a loop-prevention guide, a tension stabilizer guide, and other features. Fuji's GT-I and GT-II cassette tapes are close, magnetically, to their FR-I and FR-II counterparts. The GT shells and mechanisms, however, are made to operate at higher temperatures and under conditions of vibration such as exist in car tape-player service.

Maxell made general improvements across the line and made changes to the line, as well. LN is gone, replaced by UR. UDS-I and UDS-II are new products specifically targeted for distribution through chain stores and other mass merchandisers. UD drops out of the line, with UDS-I in a sense its replacement. UDXL-I and UDXL-II, in case you haven't noticed, are simplified to XLI and XLII, respectively. XLI-S and XLII-S remain in the line. Experience with the particles used in these cassettes supported the technology used for the coating on UDS-II. A new ferric crystal magnetic particle was developed for UDS-I.

Memtek Products has updated the Memorex MRX I and HBII formulations, but two new additions to the line are of greater interest. HBXII is a high-remnance formula designed to provide higher MOLs (maximum output levels), greater sensitivity, and increased frequency response compared to standard high-bias tape. The new CDXII is a late addition to the still-limited category of metal-particle cassettes for Type II bias. Memtek wants the "CD" in the name to emphasize the tape's ability to record wide dynamic ranges, such as on Compact Discs and digitally mastered LPs.

PDMagnetics has updated most of the formulations in both its standard and HG (high-grade) lines. The improvements include new shell designs for better tape visibility and better mechanical performance. As a fair percentage of our readers may know, PDMagnetics is a joint venture between Philips (whence cometh the "P") in the Netherlands and DuPont (providing the "D") in the United States.

RAKS has not been represented in any of our previous surveys, and it appeared worthwhile to include their three formulations. The RAKS tapes are products of Turkey, and the supplied literature did not provide much information.

Scotch has made improvements across the entire line, including new packaging. I had never tested Scotch's CX formulation before, so a report was considered to be in order at this time.

Sony calls its line of newly designed audio cassettes "high tech," and they're not just using buzzwords. Bias noise levels are reduced with the use of new Super Crystal Gamma ultrafine magnetic particles, which are said to be distributed more evenly and densely, with an improved binding system for stronger adhesion. The improved Super Protection (SP) II mechanism, parallel-ribbed liners, and stepped hubs all help to ensure more even tape winding. The shells now have a wide-window design for greatly improved viewing. The line consists of HF and HF-S Type Is, UCX and UCX-S Type IIs, and the Type IV Metal-ES.

TDK has improved the D and AD Type Is, as well as the SA, SA-X and HX-S Type IIs. The D formulation has been updated to bring a new level of premium performance to "value-conscious consumers." The improved AD combines ultrafine Linear Ferric Oxide particles with a better binding process, improving both the distribution and orientation of the particles. TDK has resisted the name-changing strategy used by some others. They have, however, made further improvements in their SA formulation and have changed their Laboratory Standard cassette mechanism to reduce mechanical resonance during recording and playback. SA-X offers high sensitivity with low noise, claimed to be "lowest in its category." Because my first report on HX-S (September 1984) used early, limited-production samples, I decided to do a complete re-check to verify the conclusions made at that time.

Test Methods

Each manufacturer supplied three samples of each formulation evaluated. I examined the packaging and unwrapped the samples, noting any tab

instructions. Every sample was fast-wound once in each direction before any other tests.

I used a Nakamichi 582 deck for the great majority of these record/playback tests. I also used a Nakamichi CR-7A and Aiwa and Akai recorders for some follow-up tests.

Bias and sensitivity figures for all tapes tested were measured with reference to the standard IEC Type I, Type II, and Type IV reference tapes. Bias was measured at an internal point in the deck, using a Heath SM-5238 audio voltmeter in its dB mode and recording the meter's dB output on a calibrated stripchart recorder for easy reading to 0.1 dB. Sensitivity was calibrated using the 582's built-in 400-Hz tone and setting a Fluke 8050A true-rms meter, in dB mode, to read "0.00" during playback of the IEC reference tape. Relative sensitivities for all other tapes were then read directly from the meter.

Bias was set using pink noise, band-limited to 20 Hz to 20 kHz, as the source, with adjustment made for the best response at 20 dB below Dolby level. The record-head alignment was always trimmed before the bias adjustment to ensure the absence of skew effects. Because the bias could be set to make all of the -20 dB responses nearly alike, no plots were made at this level nor was there any effort to measure the minor differences in the -3 dB points. Swept-sinusoid plots and -3 dB checks were made at Dolby level, however, as this data was indicative of high-frequency saturation limits.

In a change from previous tests, the maximum 3% distortion points are *output* levels, referred to Dolby level (200 nWb/m at 400 Hz). The Fluke 8050A was set to read "0.00" dB for playback of a Dolby-level calibration tape, and all maximum output level figures were then read from the 8050A's display. The MOL figures for 100, 400, and 1,000 Hz show the signal levels at which third-harmonic distortion reached the standard 3% level. The MOL figures for higher frequencies show the signal levels at which twin-tone IM (TTIM) distortion reached 3%. For this test, I used tone pairs of 2.0 and 2.5 kHz for the 2-kHz MOL data, 5 and 6 kHz for the 5-kHz data, 7 and 8 kHz for the 7-kHz data (not shown in

TABLE I—MEASURED DATA

	Maximum Output Level (dB, re: 400-Hz Dolby Level)						Response At -3 dB For 0-dB Mod.					
	HDL ₃ = 3%			TTIM = 3%			S/N Ratio (dBA)	Level (kHz)	Mod. Noise (dB)	Bias (dB)	Sens. (dB)	
	100	400	1k	2k	5k	10k						
TYPE I	Tape											
	BASF LH-MI	+4.0	+4.8	+5.6	+0.8	-2.4	-8.8	58.3	10.6	-45.7	+0.4	-0.3
	Denon DX3	+5.4	+5.6	+5.5	+0.5	-2.4	-9.4	57.9	10.5	-43.2	+0.5	-0.5
	Denon DX4	+4.7	+5.5	+5.6	+0.7	-2.5	-8.9	57.7	10.2	-44.4	+0.4	+1.3
	Fuji GT-I	+4.0	+4.6	+4.7	+0.3	-2.7	-9.5	57.5	9.6	-43.7	0.0	-0.4
	Maxell UR	+3.9	+4.3	+4.4	+0.5	-2.5	-9.0	57.0	9.8	-43.8	-0.5	0.0
	Maxell UDS-I	+5.4	+5.9	+5.7	+1.0	-2.0	-8.2	59.2	10.2	-45.6	-0.4	+0.9
	Maxell XLI	+6.5	+6.8	+6.8	+0.8	-2.0	-8.5	58.8	10.0	-46.3	+0.1	+0.9
	Maxell XLI-S	+6.2	+6.8	+5.3	0.0	-3.0	-9.0	60.3	9.7	-45.7	+0.2	+1.4
	Memorex MRX I	+4.9	+5.3	+5.1	-0.3	-3.4	-10.3	59.1	9.3	-46.4	-0.7	+0.1
	PDMagnetics FERRO	+3.5	+3.9	+4.0	-0.5	-3.5	-10.0	55.5	9.3	-41.3	-0.5	+0.5
	PDMagnetics FERRO HG	+3.0	+3.6	+4.3	+0.5	-2.4	-9.0	57.9	9.9	-46.2	0.0	-0.3
	RAKS High Dynamic	-0.2	0.0	+0.8	-1.9	-5.0	-11.5	55.3	8.0	-37.6	-1.4	-1.8
	RAKS High Dynamic I	+0.8	+0.9	+0.8	-1.2	-4.3	-9.7	54.8	8.5	-35.8	-0.8	-1.2
	Scotch CX	+3.8	+4.2	+4.3	-0.6	-3.7	-10.7	55.1	9.4	-45.7	-0.9	0.0
	Scotch XSI	+3.2	+3.8	+4.2	-0.3	-3.4	-9.7	56.6	9.0	-45.3	-0.4	0.0
	Sony HF	+2.0	+2.4	+2.5	-0.9	-4.1	-10.3	54.3	8.9	-36.1	-0.9	-1.0
	Sony HF-S	+5.3	+5.7	+5.6	+1.0	-1.0	-8.4	59.5	10.0	-45.2	0.0	+0.3
	TDK D	+2.6	+3.5	+4.5	0.0	-3.1	-9.6	55.5	9.3	-45.4	-0.1	-1.0
	TDK AD	+3.8	+6.2	+6.2	+1.3	-1.7	-8.2	60.3	9.9	-44.3	+0.5	-0.3
Triad F-X	+5.2	+6.0	+6.1	+1.5	-2.1	-8.8	59.7	10.0	-43.7	+0.9	+0.2	
TYPE II	BASF CR-EII	+2.1	+2.7	+3.4	-4.3	-8.0	-12.0	60.0	7.7	-51.2	+0.4	-0.9
	BASF CR-MII	+4.8	+5.4	+4.0	-4.0	-8.3	-12.8	63.0	7.3	-51.0	+1.0	+1.0
	Denon HD6	+2.5	+3.3	+3.1	-3.6	-7.3	-12.7	59.6	8.3	-47.3	+0.5	-0.2
	Denon HD7	+3.5	+4.6	+4.6	-3.0	-7.0	-12.4	60.4	8.5	-46.7	+0.2	+1.6
	Denon HD8	+4.1	+5.2	+5.8	-1.2	-4.1	-7.9	59.0	11.3	-44.9	+0.6	+2.4
	Fuji FR-II	+4.5	+5.4	+5.4	-1.0	-5.1	-10.7	60.6	9.2	-49.4	+0.2	+1.4
	Fuji GT-II	+4.6	+5.6	+5.8	-1.0	-4.9	-10.4	62.1	9.3	-50.2	+0.4	+1.1
	Maxell UDS-II	+2.8	+3.5	+3.4	-2.6	-6.5	-11.4	59.4	8.7	-48.3	0.0	+0.7
	Maxell XLII	+4.4	+5.2	+5.1	-2.1	-5.6	-10.6	60.4	9.2	-48.0	-0.1	+1.7
	Maxell XLII-S	+5.5	+6.1	+4.1	-3.3	-7.3	-11.6	62.1	7.6	-43.8	+0.6	+2.8
	Memorex HBII	+3.0	+4.0	+4.8	-2.8	-6.2	-11.5	59.8	10.2	-48.0	+0.2	+1.0
	Memorex HBXII	+5.4	+6.1	+5.8	-1.0	-4.6	-9.9	61.4	10.1	-52.8	+0.1	+1.8
	Memorex CDXII	+5.7	+6.3	+6.1	-0.4	-3.1	-6.9	61.2	11.9	-47.4	+1.3	+2.9
	PDMagnetics 500 Crolyn	+3.5	+3.8	+2.7	-5.7	-8.7	-13.1	60.2	7.4	-50.5	+0.2	0.0
	PDMagnetics 500 Crolyn HG	+2.9	+3.5	+2.6	-5.1	-8.5	-12.8	61.5	7.1	-38.7	0.0	-0.1
	RAKS High Dynamic II	+0.4	+1.2	+1.5	-4.5	-8.3	-12.8	57.2	7.3	-41.2	-0.2	-0.1
	Scotch XSI	+4.0	+4.6	+3.6	-3.8	-7.4	-12.1	59.4	7.7	-46.2	+0.3	+0.7
	Sony UCX	+4.8	+5.7	+5.8	-1.5	-5.4	-10.9	60.6	9.2	-47.8	-0.2	+2.5
	Sony UCX-S	+4.1	+5.0	+5.2	-2.1	-5.4	-10.8	60.0	9.3	-48.6	+0.4	+1.7
	TDK SA	+3.4	+4.4	+4.9	-1.9	-5.7	-11.2	60.9	8.9	-47.2	+0.1	+1.1
TDK SA-X	+3.7	+4.4	+3.6	-2.8	-7.3	-11.5	63.2	7.8	-47.8	+1.0	+1.6	
TDK HX-S	+6.9	+7.5	+7.0	+0.3	-2.5	-6.6	60.6	12.2	-47.8	+1.2	+3.3	
Triad EM-X	+3.6	+4.2	+3.9	-1.0	-3.8	-7.0	60.2	11.7	-48.0	+0.5	+2.6	
TYPE IV	Denon HDM	+5.9	+7.2	+7.2	0.0	-3.4	-7.7	62.0	11.7	-48.0	+1.4	-0.8
	Maxell MX	+8.0	+9.1	+9.5	+2.3	-1.9	-6.8	62.7	12.5	-50.4	+0.1	+0.8
	PDMagnetics 1100 Metal HG	+7.7	+8.5	+7.9	+1.2	-2.4	-6.8	62.3	11.7	-45.7	-0.2	+0.5
	Scotch XSMIV	+5.8	+6.5	+6.2	-0.3	-3.4	-7.6	59.7	11.4	-47.2	-0.5	-0.1
	Sony Metal-ES	+8.8	+10.2	+10.3	+2.1	-2.4	-7.1	66.0	12.5	-50.8	+0.6	+2.0
Triad MG-X	+6.3	+7.3	+7.2	+0.9	-2.9	-7.5	61.9	11.7	-47.7	+1.0	-0.1	

Table I but used in plotting the figures for all formulations), and 10 and 11 kHz for the 10-kHz MOL data.

The signal-to-noise ratio was referenced to the signal level that produced 3% distortion at 400 Hz, measured with IEC A weighting. (For those who wish to compare these results with figures obtained with CCIR/ARM weighting, subtracting 2.6 from the dBA figure will provide a fairly accurate conversion.)

A 3-kHz tone was recorded and played back to assess flutter. I should point out that these results are just general indications: The deck which one uses has a considerable effect on the measured figure for any tape. Even relative rankings may shift when the same tapes are measured on a different cassette deck, especially if those rankings are close to begin with. The same 3-kHz tone was also used to test

for dropouts and to determine the degree of level stability at this moderately high frequency.

I measured modulation noise differently this time than I have in the past. Formerly, I used a simple 1-kHz notch filter to remove the recorded high-level tone, measuring the distortion products (and noise) remaining. However, the "notch" of such a filter is not perfectly square-sided, but tapers enough

This year we also checked the external plastic wraps, which may seem trivial, but they can be a source of great frustration.

to filter out some of the distortion products, too. This time, to minimize the notching needed, I recorded the high-level tone on both channels, reversed the polarity on one channel in playback, and trimmed levels and head alignment until the test signals from the two channels (when mixed together) nulled each other out as far as possible. I then used a filter to notch out only the residual tone left after nulling. This method works because the 1-kHz test tone is coherent and correlated channel-to-channel, but the modulation noise is not. Therefore, summing the two channels, with one out of phase, cancels the tone, while the noise power from the two signals adds; with a little level compensation, the method works out just fine.

Use Tests

The first tests involved removing the external plastic wrapping and then fast-winding the samples in each direction. I had been frustrated in the past when trying to get a cassette's wrapper off. Even after using the pull tab, it is often a struggle. I have found that by purposely pulling the tab toward the other end of the box and then, perhaps, toward the "short" end at the last moment, I can remove most wraps very easily. So, how well did this work on these samples?

BASF: Removal of the wrap was easy with the across-the-box pull. A couple of the boxes hung up a little when opening. All samples wound smoothly.

Denon: These tapes have a little curved arrow on the wrap, giving the essential clue for easy removal. I liked the high-quality boxes. All winds were smooth.

Fuji: Wrap removal was easy with the across-the-box pull. I liked the GT-I and GT-II shells with their tactile clues on A and B sides. Not only are these good for users of car players, but blind people will also find them helpful. All winds were smooth.

Maxell: There is a diagonal arrow at the tab, but I found it was better to pull straight for a short distance before going diagonally. All of the samples wound smoothly.

Memorex: The pull tab was not very obvious, but it worked very well with the swooping pull. The new Memorex boxes are not as well sealed against

dust as the previous ones, but the cassettes can still be inserted either way for storage. All samples wound smoothly.

PDMagnetics: The packages opened easily with an across-the-box pull (which I prefer). Some boxes hung up very slightly when opened or closed, but general quality was high. All samples were smooth and quiet in winding.

RAKS: Most samples opened easily with the tab. Several of the boxes were rather grabby on opening. Most of the cassettes made little squeals or burbles during fast winding.

Scotch: All samples opened easily—even CX, where the pull tab is closer to the center of the box. All cassettes wound smoothly.

Sony: The wrapper for each of this company's formulations has an obvious pull tab; right next to the tab is the instruction to "Pull Diagonally." This was the best combination for wrap removal I found in the collection. Some of the samples were notably quieter in winding than the average.

TDK: In general, removing the wrap was very easy. As a group, the TDK samples were the quietest during fast winding.

Triad: All samples opened easily with the tab, and all were quiet during the fast winding. The triangular window is different, but it limited the visibility of the tape packs between the hubs.

Measurements

Table I lists the results of the evaluation of the 49 formulations, using the Nakamichi 582 deck. The arrangement is different from most of our surveys in the past, although it is quite similar to the Table in our September 1984 report. I remind all readers that the present tests are based upon tests of maximum output level for 3% distortion rather than maximum recording level for that distortion point. Please also note that the 2-kHz data is now obtained from TTIM rather than HDL₃ tests. I have also provided plots showing frequency response at 0-dB output level (solid line) and MOL for 3% distortion (dashed line) for each tape formulation. Note that distortion at the 0-dB level is less than 3% wherever the solid curve is below the dashed one, and more than 3% wherever the dashed curve falls below the solid one.

Therefore, the MOL curve will probably be of more help in understanding the limits on record/playback levels for each tape.

The brief comments on each of the tapes are arranged alphabetically by brand within tape type. Most of these tapes showed little or no skew, had consistent bias requirements and sensitivity, had quite good 3-kHz output-level stability, and showed average flutter. I have therefore not mentioned these areas unless something was poor—or especially good.

TYPE I TAPES

For all tape types, high MOLs are a fundamental requirement for high performance. Since most of the Type I tapes have about the same absolute noise level, the higher a tape's 400-Hz MOL, the higher its signal-to-noise ratio. Type I tapes show neither high MOLs at 10 kHz nor really extended response at 0 dB, but they are generally better than Type II tapes in these regards. The basic reason for this is not an innate superiority of Type I tape but a difference in equalization: The smaller high-frequency boost used in recording Type I tapes causes less saturation. At the same time, however, the difference between Type I and Type II playback equalization is the main reason why Type I tapes have generally lower S/N ratios than Type IIs. Nevertheless, the best-performing Type I tapes, with 400-Hz MOLs of +6 dB or more, have S/N ratios that are a match for many Type II tapes.

BASF LH Maxima I (LH-MI): An above-average tape, with good MOLs, low noise and extended response at 0 dB. In fact, it had the widest response of any Type I tape tested here.

Denon DX3: This is an above-average tape, with good MOLs, fairly low noise and extended response at 0 dB. Bias requirements and sensitivity were very consistent.

Denon DX4: Because this formulation's measurements were so very close to those for DX3, I rechecked some tests. I got the same results—but no matter, this is an above-average tape for the same reasons as given for DX3.

Fuji GT-I: This is a slightly above-average tape. The MOLs were fairly good, but the response at 0 dB was not par-

TYPE I

ticularly impressive. Bias requirements were very consistent. As stated earlier, the shell design is excellent for easy use when the user isn't able to see the cassette.

Maxell UR: This LN replacement gets a somewhat above-average rating for its combination of fairly good MOLs and high-end response close to 10 kHz. Flutter was lower than average.

Maxell UDS-I: This is a good addition to the tapes available—one of the better Type I formulations. MOLs were high across the entire band, noise was low, and 0-dB response was quite well extended. Bias requirements and sensitivity were very consistent, and flutter was slightly lower than average.

Maxell XLI: This is one of the best Type Is, offering high MOLs, low noise, and fairly well-extended response. Bias requirements and sensitivity were both very consistent. Flutter was lower than average.

Maxell XLI-S: Overall, this is one of the best Type I tapes. It had high MOLs and low noise, but some areas were not a match for XLI. Bias requirements were very consistent, but sensitivity had a 0.6-dB spread among the two sides of the three samples. The 3-kHz output stability was very good, and flutter was lower than average.

Memorex MRX I: This formulation had good MOLs for the lower frequencies, but less so for the higher ones. The 0-dB response was about average, which corresponds to the results obtained for high-frequency MOLs. The bias requirements were very consistent, and the flutter was lower than average. Overall, this is an above-average tape.

PDMagnetics FERRO: This is an average Type I tape in all respects.

PDMagnetics Tri-Oxide FERRO HG: Compared to FERRO, the higher MOLs overall, the lower noise and the more-extended response get this tape a slightly above-average rating, aided by consistent bias requirements and lower-than-average flutter.

RAKS High Dynamic: This is a lower-than-average tape; in fact, it measured the poorest of the lot. MOLs were very low, the modulation noise was high, and the response was the least extended of the Type Is. Bias requirements and sensitivity were not consistent, and dirt deposits from two of the

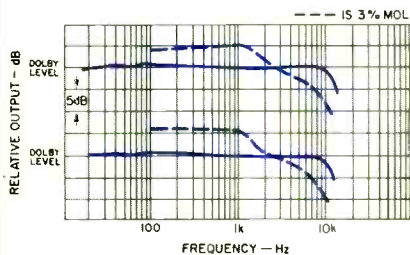

BASF LH-MI (top) and Denon DX3

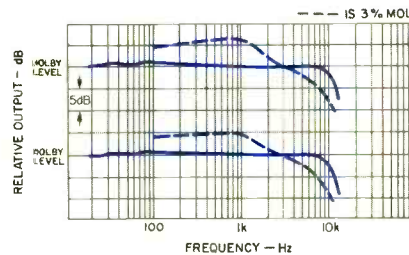

Denon DX4 (top) and Fuji GT-1

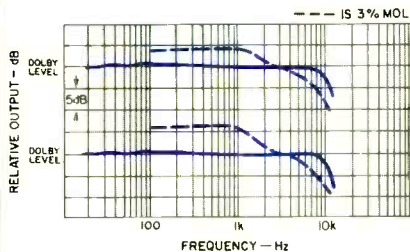

Maxell UR (top) and UDS-I

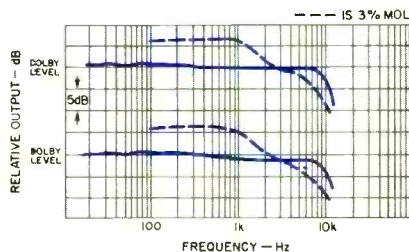

Maxell XLI (top) and XLI-S

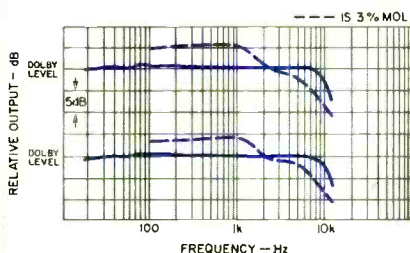

Memorex MRX I (top) and PDMagnetics FERRO

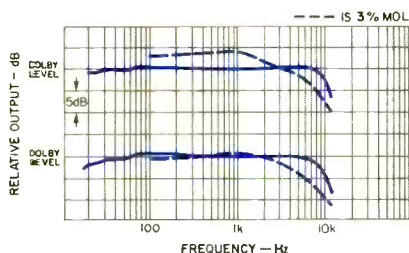

PDMagnetics Tri-Oxide FERRO HG (top) and RAKS High Dynamic

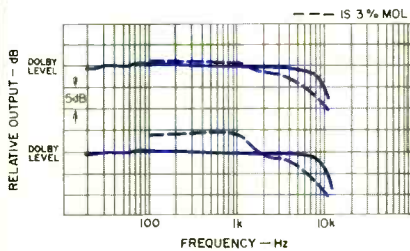

RAKS High Dynamic I (top) and Scotch CX

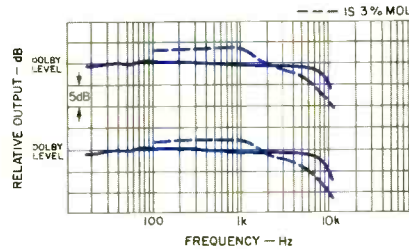

Scotch XSI (top) and Sony HF

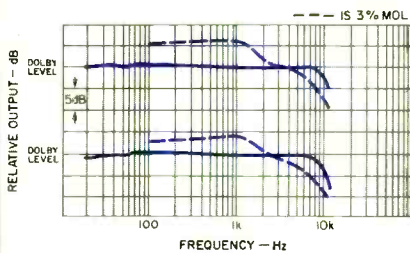

Sony HF-S (top) and TDK D

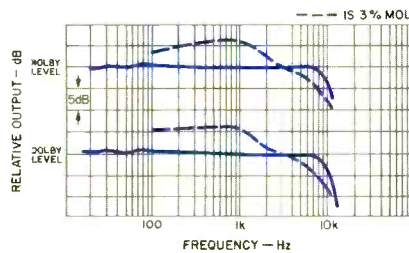

TDK AD (top) and Triad F-X

New to the marketplace, since our last test, is the metal-particle Type II cassette, which exhibits superior performance.

three samples confused the taking of data. In addition, flutter was poorer than average.

RAKS High Dynamic I: Overall, this was a slightly better performer than the other RAKS Type I, but it showed other problems. Dropout performance was poor enough to be audible, and one sample jammed in record mode.

Scotch CX: Overall, this is a formulation of average performance in most respects. Bias requirements were very consistent, and dropout performance was better than average. Flutter was noticeably better than the average—one of the best in this regard.

Scotch XSI: In most areas, XSI seemed a lot like CX during the testing, and the general results were also average. Dropout performance was better than average, as was the flutter.

Sony HF: This is a below-average Type I tape, with rather low MOLs, high noise, and restricted response at 0 dB. Flutter was lower than average.

Sony HF-S: This is definitely one of the better Type I tapes. MOLs were good across the band, noise was low, and response was good at 0 dB. Bias requirements and sensitivity were very consistent. The flutter was slightly better than average.

TDK D: Overall, this formulation fits into the group of average-performing tapes. Bias requirements and sensitivity were very consistent.

TDK AD: A good combination of high MOLs, low noise, and a fairly well-extended response. Bias requirements were completely consistent, and flutter was slightly better than average. Add it all up: This is one of the better/best Type I tapes.

Triad FX: This is definitely one of the better Type I tapes, with good MOLs across the band, low noise, good response and high consistency in all respects. The flutter was lower than average.

TYPE II TAPES

Different criteria must be applied when evaluating Type II tapes. The basic need for a high-quality recording medium remains, of course, but a few differences from Type I tapes appear. For example, most Type II tapes have low MOLs at the higher frequencies, but they usually have higher signal-to-

noise ratios than Type I formulations. A good part of this is the result of record and playback with Type II (70- μ S) equalization. The record-EQ difference also affects 0-dB response at the higher frequencies, where Type I tapes beat most of the Type IIs. (If the same EQ were used for both Type I and Type II tapes, the performance of the two groups would be more similar, and some Type II tapes would then show better high-frequency MOL than Type I tapes.)

Take particular note of the results for Denon HD8, Memorex HBXII and CDXII, TDK HX-S, and Triad EM-X. These tapes stand as worthy competitors to the Type IV metal-particle tapes, at least in some areas of measurement, and generally demonstrate superior performance. Excepting HBXII, incidentally, all these tapes are metal-particle formulations, and they could be the best choice for tape decks that don't perform particularly well with Type IV tapes.

BASF Chromdioxid Extra II (CR-EII): The MOLs were lower than most of the other tapes in this report, and the signal/noise ratio and 0-dB response were average. Bias requirements were completely consistent from sample to sample. The 3-kHz output-level stability was better than the average Type II. Overall, about average.

BASF Chromdioxid Maxima II (CR-MII): The low-frequency MOLs were quite good, but the high-frequency ones were on the low side. The signal-to-noise ratio of 63.0 dBA was one of the very best for all Type IIs and Type IVs. The 0-dB response rolled off at 7.3 kHz, quite obvious in the plot. Bias requirements and sensitivity were very consistent. The 3-kHz output-level stability was excellent, and the dropout check showed good smoothness even at the fast scan rate. The flutter was lower than average. Overall, this is one of the better Type II tapes; for recording material which does not have considerable high-frequency content, it is one of the best.

Denon HD6: The MOLs were mostly on the low side, and other results were average. Bias requirements were completely consistent, and flutter was slightly better than average. In toto, somewhat below average.

Denon HD7: The increase in MOLs

over HD6, and other improvements, were desirable differences. Bias requirements and sensitivity were completely consistent. The fast scan for dropouts was quite smooth—one of the better performances. Flutter was better than average. Overall, a good, average Type II tape.

Denon HD8: This is one of the metal-particle Type II tapes, and it evidenced quite high MOLs across the band and a 0-dB response that was much more extended than most Type IIs. Do note that the signal/noise ratio was actually lower than average. If noise reduction is used, however, this may have little significance. Bias requirements were completely consistent, and the 3-kHz output-level stability was better than average. Adding it all up, this is one of the better-to-best Type II tapes.

Fuji FR-II: This formulation showed good MOLs and reasonable 0-dB response. Bias needs were very consistent. The 3-kHz output was smooth and stable, one of the best for all tape types. Flutter was low, also one of the best. Definitely one of the better Type II tapes.

Fuji GT-II: Although the manufacturer targets this tape for the car market, its high MOLs, low noise and good 0-dB response make it good for any use. Bias requirements were very consistent. The 3-kHz output was stable and smooth—the best overall for all tapes tested. Flutter was better than average. One of the best Type IIs.

Maxell UDS-II: With so-so MOLs along with a mediocre signal-to-noise ratio, this is a below-average tape. Consistent bias needs were a plus.

Maxell XLII: The MOLs were quite good, the very consistent bias and sensitivity were nice, the 3-kHz output-level stability was excellent, and flutter was better than average. This is a better-than-average Type II.

Maxell XLII-S: I expected this tape to outperform XLII but was puzzled to see that, overall, it did not. Its S/N and its MOLs (at frequencies below 5 kHz) were the only areas in which it outperformed XLII. Overall, this is one of the better Type II formulations, but it would perform best when recording material that didn't have very much high-frequency energy.

Memorex HBII: The MOLs were just average overall, but the 0-dB response

TYPE II

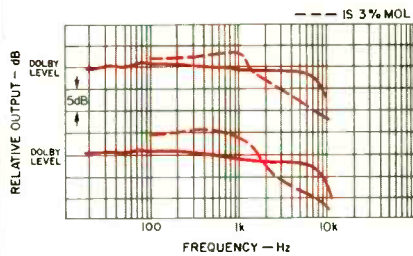

BASF CR-EII (top) and CR-MII

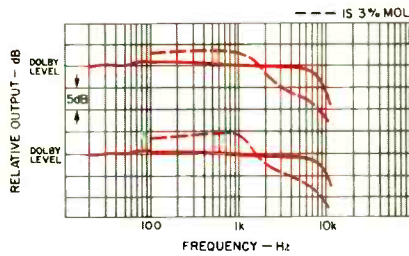

Denon HD6 (top) and HD7

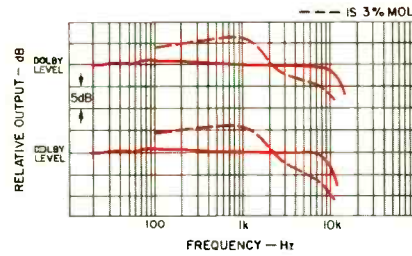

Denon HD8 (top) and Fuji FR-II

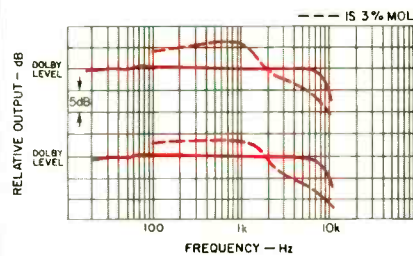

Fuji GT-II (top) and Maxell UDS-II

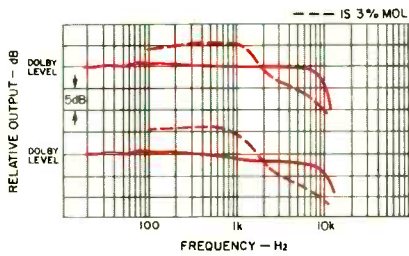

Maxell XLII (top) and XLII-S

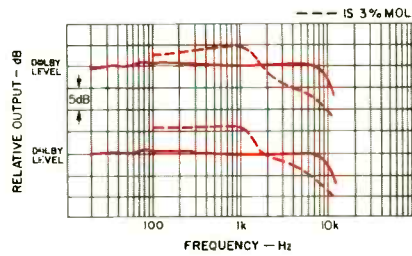

Memorex HBII (top) and HBXII

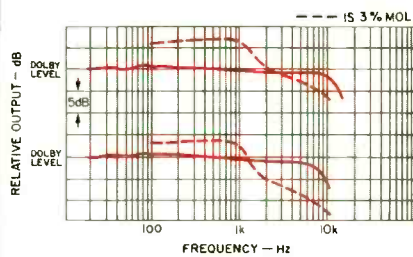

Memorex CDXII (top) and PDMagnetics 500 Crolyn

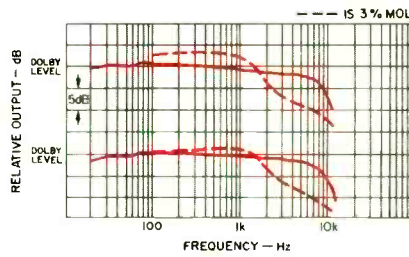

PDMagnetics 500 Crolyn HG (top) and RAKS High Dynamic II

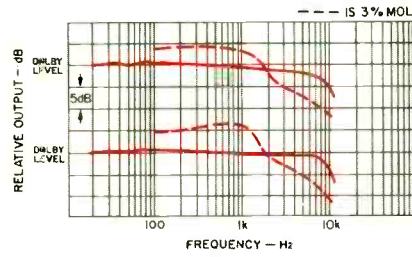

Scotch XSII (top) and Sony UCX

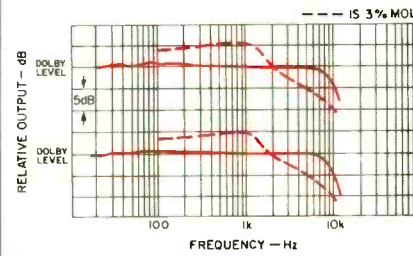

Sony UCX-S (top) and TDK SA

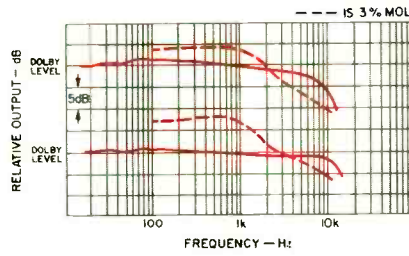

TDK SA-X (top) and HX-S

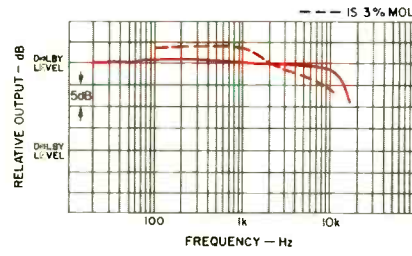

Triad EM-X

was impressive: In fact, it was the best for the nonmetal-particle Type IIs. Bias needs were very consistent. Flutter was slightly lower than average. The sum total makes for a better-than-average Type II tape.

Memorex HBXII: The high MOLs, the good 0-dB response, and the low noise make an impressive combina-

tion. Bias requirements were very consistent. The 3-kHz output-level stability was better than most, and the flutter was one of the lowest. HBXII is one of the better-to-best Type II tapes.

Memorex CDXII: This is Memtek Products' entry into the Type II metal-particle derby. (They have dropped their Type IV formulation.) The MOLs were

very high for a Type II, the noise was fairly low, and the 0-dB response was well extended. The flutter was noticeably better than average. This is one of the best Type II tapes, and it is a match for some of the Type IVs.

PDMagnetics 500 Crolyn: The MOLs were on the low side across the band, and the 0-dB response was quite re-

stricted. Bias needs were completely consistent, but this is a below-average Type II formulation.

PDMagnetics 500 Crolyn HG: This tape's designation indicates better performance than its stablemate, but alas, the tests don't show it. The S/N ratio was slightly better than that for 500 Crolyn, but the modulation noise was considerably poorer. With MOLs and 0-dB response on the poor side, this is a below-average tape.

RAKS High Dynamic II: With the lowest MOLs, the lowest S/N ratio and one of the poorer 0-dB responses, this is the poorest Type II in this report.

Scotch XSII: This tape had average MOLs overall, and the 0-dB response was rather limited. Bias needs and sensitivity were very consistent. The 3-kHz output-level stability was one of the better ones, considering all tape types, and the flutter was lower than average. This is an average Type II formulation.

Sony UCX: The MOLs were generally high, and the 0-dB response was better than average. Bias and sensitivity were very consistent. Flutter was much lower than average—one of the best. UCX is one of the better Type IIs.

Sony UCX-S: I had expected to get somewhat higher MOLs with this formulation than with UCX; instead, I got slightly lower figures. Nonetheless, UCX-S is also one of the better Type IIs. Bias needs were very consistent, the 3-kHz output level was very stable, and there was nothing to see in the dropout check—one of the best tapes in this respect.

TDK SA: Fairly good MOLs, a reasonable 0-dB response, and excellent output-level stability make SA one of the better Type II tapes.

TDK SA-X: This is nominally one of the "hot" tapes, recommended by its maker for challenging applications. Formerly, such tapes had very high MOLs at higher frequencies, but most manufacturers have changed their formulations to yield lower noise instead. Typical of such tapes, SA-X actually had average high-frequency MOLs. It did have the best signal-to-noise ratio of all Type IIs tested (albeit just barely), a figure exceeded by just one Type IV formulation. It is one of the better tapes for recording material with limited high-frequency energy.

TDK HX-S: The fact that this tape had the highest MOLs across the band, and the most extended 0-dB response, makes this the best-performing tape of all Type IIs. It is even a match for some Type IVs. The formulation evidenced very consistent bias needs and sensitivity. The 3-kHz output-level stability was one of the best for all tapes, and the scan for dropouts was one of the smoothest.

Triad EM-X: This recent addition to the metal-particle Type IIs had average low-frequency MOLs, but the high-frequency MOLs were impressive. The 0-dB response was well extended, matching the other similar-formulation Type IIs. Overall, one of the better Type IIs.

TYPE IV TAPES

The better metal-particle Type IV tapes still stand as the best performers, primarily because of their very high MOLs and reduced high-frequency saturation, gaining greater response extension at 0 dB. It has also been generally true that the metal-particle tapes are relatively noisy, and the net result of this is that the signal/noise ratios for Type IV tapes have been little or no better than some of the Type IIs. However, I found a refreshing exception to this tendency, as the comments below reveal.

Denon HDM: This is an average metal-particle tape which offers high MOLs, low noise, and very good 0-dB response. Bias and sensitivity were very consistent, and the output level was very stable. Flutter was lower than average.

Maxell MX: The MOLs were very high, the S/N ratio was high, and the 0-dB response was very good—what else does one need? Well, MX does have very consistent bias needs and sensitivity, smooth 3-kHz output with high-speed scan, and lower flutter than average. One of the best Type IVs.

PDMagnetics 1100 Metal HG: This is a typical metal-particle tape with very good MOLs, a very good S/N ratio, and a well-extended 0-dB response. Bias needs were very consistent, and the 3-kHz output-level stability was one of the best for all tapes. Flutter was better than average.

TYPE IV

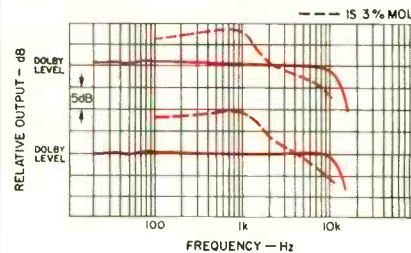

Denon HDM (top) and Maxell MX

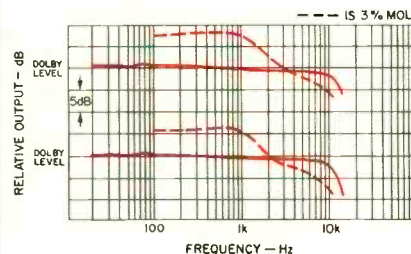

PDMagnetics 1100 Metal HG (top) and Scotch XSMIV

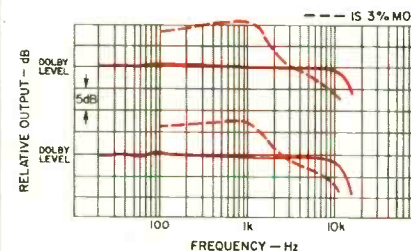

Sony Metal-ES (top) and Triad MG-X

Scotch XSMIV: The MOLs were the lowest for this group of Type IV tapes, and the formulation was matched or surpassed by two of the Type II metal-particle tapes in a number of respects. Bias requirements and sensitivity were very consistent. This is a very good tape, but the Type IV competition is tough.

Sony Metal-ES: This tape had the highest MOLs of the group, produced the highest S/N ratio by over 3 dB, and matched the widest 0-dB response. Bias needs were very consistent. Sony Metal-ES had the highest performance of all 49 tapes tested.

Triad MG-X: This is a typical metal-particle tape, showing high MOLs across the band and an extended 0-dB response. The samples were very consistent in most respects, but there was a regular ± 0.2 dB sensitivity change every 0.5 S. Flutter was higher than average.

Most people would improve the sound of their tapes if they paid more attention to getting a better tape-to-deck match.

Further Checks

While checking the 3-kHz output-level stability during playback, several formulations showed noticeable level variations that came and went for no apparent reason. The variations were almost always greater in the right channel than they were in the left, and a short rewind was associated with higher variations. These conditions were noted with the Nakamichi 582 test deck, but when the same tapes were given the same basic test on an Aiwa AD-M700 and an Akai GX-R99, the level variations were very much smaller—even nonexistent, in some cases. My tentative conclusion is that there was some sort of interaction between the particular tapes and their shells and the tape handling of the Nakamichi 582.

I don't know the exact mechanism involved here, but I do suggest to recordists that there may be subtle sonic effects that relate to particular deck/tape combinations. The variations were usually less than 1.0 dB total and occurred over a period of 2.5 to 3.0 S, so noticing any effects while playing music would be difficult.

Although I run all my tests on C-90 cassettes, I wondered how well other lengths match C-90s for bias and sensitivity. If other lengths are used, what will happen? Another facet of the same question is this: If the deck is set up with C-60s, then how well does it perform with C-90s? This is particularly pertinent when seeking the best Dolby NR tracking.

To test this, I used a variety of old and new formulations of Type I, Type II, and Type IV tape from Fuji, Maxell, PDMagnetics, RAKS, Scotch, and TDK—in as many lengths as I had available. For Types I and II, there was very close agreement among C-90s, C-60s and C-46s in each formulation. (I did not have C-46s for half of the brands tested.) The Maxell LN and UD C-120s, however, required noticeably more bias, particularly the LN tapes. Most of the Type I and II formulations showed agreement in sensitivity among all lengths. The exceptions were that the C-60 version of UDXLI was 1.7 dB less sensitive than the C-90, and the RAKS High Dynamic C-60 was 1.4 dB more sensitive than its C-90 version.

Each Type IV had its own story. The

Fuji FR Metal C-60 required 0.7 dB less bias than the C-90 and had 0.5 dB more sensitivity than its longer counterpart. The average figures for the Maxell MX C-60 matched the C-90 results, but there was some spread in both bias and sensitivity of the samples checked. With some older samples of TDK MA, the C-60s required less bias and were less sensitive, but with newer tapes, the C-60s required *more* bias and were somewhat *more* sensitive. With MA-R tapes, the C-60s and C-90s matched closely enough in both bias and sensitivity, but they produced different figures than those obtained for the MA formulation.

With recent Type I and II tapes, the bias requirements and sensitivity for most lengths agree pretty well. You would have only minimal problems in interchanging C-90, C-60, and C-46 versions of a given tape. The use of a C-120, however, could introduce some noise-reduction tracking problems, to say nothing about tape saturation and transport problems.

The discrepancies are larger for the relatively few Type IV tapes. The consistency from batch to batch, let alone from length to length, that is so common in Type I and Type II tapes is not yet shared by metal-particle Type IV cassettes. (I haven't seen enough Type II metal-particle tapes to comment on them.) However, the differences in bias needs that show up in my tests with a Nakamichi 582 might not show up on the many cassette decks, especially inexpensive ones, which lack the headroom or bias capacity to take full advantage of Type IV tapes capabilities.

To give an idea of how wide a range of bias and sensitivity variations one might encounter, I combined the bias and sensitivity data for the 49 formulations reported here with earlier data or 36 other tapes. The results are presented in Figs. 1 and 2; these show the number of formulations with which particular bias and sensitivity values occur. For these figures, I divided bias requirements and sensitivities into ranges ± 0.2 dB wide and 0.5 dB apart (center-to-center). Hence the "0.0" bar includes all tapes falling within a range of ± 0.2 dB, the "+1.0" bar includes tapes that have values of 0.8 to 1.2 dB, and so on.

Note that the most common bias-requirement values, for all three tape types, was just about 0.0 dB, the IEC Standard, but that tapes meeting the IEC Standard for bias were least common among the Type IV formulations. There was less agreement with the IEC Standards for sensitivity—especially among Type II tapes (where the most common value was +1.0 dB) and Type IVs (where it was -0.5 dB). The high-sensitivity Type II tapes are the "hot" ones referred to earlier, such as TDK SA-X and the new metal-particle Type IIs.

If you switch tape formulations without readjusting bias or record sensitivity, you can minimize possible Dolby-tracking problems by choosing a tape whose requirements are close to those of your original tape. Your new tape should therefore be one whose sensitivity is within 1.0 dB, and whose bias requirement is within 0.5 dB, of your original tape. (Bias affects tracking because a tape that requires more bias, but doesn't get it, will have a boosted high-frequency response.) The following list shows some combinations whose bias requirements and sensitivity meet the above criteria; note that the bias groupings do not correspond exactly to those of Fig. 1.

Type I: Among lower bias tapes, Konica ML, Memorex dB, and Realistic Supertape Gold have reasonably well-matched requirements. Medium-low bias: Maxell UR, Memorex MRX-I, PDMagnetics FERRO, and Scotch CX and XSI. Slightly low bias: Denon DX1 and Maxell UDS-I. Tapes requiring nominal IEC-zero bias fall into three sensitivity groups: Fuji GT-I, Loran Normal, PDMagnetics Tri-Oxide FERRO HG, and TDK D; Fuji ER, JVC DA3, Magnex Studio 1, Nakamichi EXII, and Sony HF-S; and Maxell XLI and TDK AD-X. For somewhat high bias, there are also three groups: BASF LH-MI, Fuji DR, and Konica GM-I; BASF LH-MI, Konica GM-I, and Yamaha NR; and Denon DX-4 and Maxell XLI-S. Finally, for high bias: BASF LH-MI, Denon DX-3, TDK AD, Triad F-X, and Yamaha NR-X. As this listing shows, BASF LH-MI fits in well with a number of other tapes; it's a possible choice in three combinations. On the other hand, some Type I tapes are not listed at all, because their combinations of bias

Cassette mechanisms have received a good deal of attention, as makers realize how much shells can influence play.

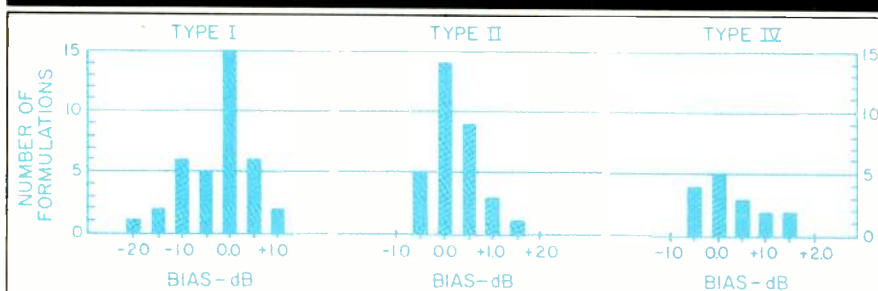

Fig. 1—Bias requirements for 85 tape formulations.

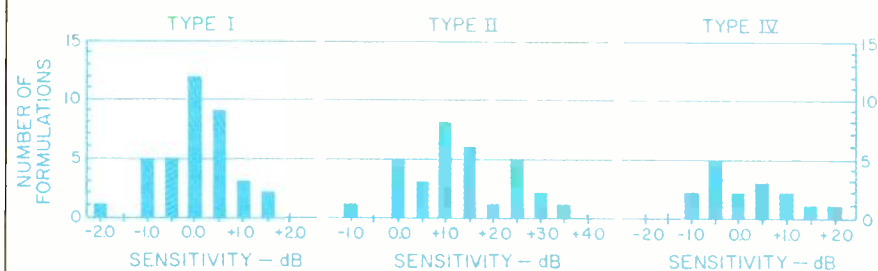

Fig. 2—Sensitivity of 85 tape formulations.

and sensitivity match no other Type I formulations.

Type II: Low bias: Konica GM-II, Nakamichi SX, and Yamaha CR. For nominal zero bias, again three groups: JVC DA7, Maxell XLII and UDS-II, Memorex HBXII, and TDK SA; Denon HD7, Fuji FR-II, Memorex HBII, and Realistic Supertape Hi-Bias (which match especially well among themselves); and the group of Nakamichi SX-II, Sony UCX, and Yamaha CR-X. I picked out two groups for somewhat high bias: Fuji GT-II, Maxell UDS-II, Scotch XSII, and TDK SA; and Denon HD8, Maxell XLII-S, Sony UCX-S, TDK SA-X, Triad EM-X, and Yamaha CR-X. The high-bias combinations are: BASF CR-MII and Loran High Bias, and Memorex CDXII and TDK HX-S. Denon HD8 and Maxell XLII-S are possible additions to the last pair of tapes.

Type IV: For low bias: BASF Metal IV, Konica Metal, Magnex Studio 4, Scotch XSMIV, and TDK MA-R. I picked two groups close to IEC-zero bias: JVC ME, Magnex Studio 4, and Nakamichi ZX are in one group; Maxell MX, PDMagnetics 1100 Metal, and Realistic Supertape Metal are in the other. For somewhat high bias there are also two groups: Fuji FR Metal, Triad MG-X, and Yamaha MR; and Sony Metal-ES

and TDK MA. For high Type IV bias, there are just two tapes: Denon HDM and Triad MG-X. Note that the bias and sensitivity combinations of the Magnex and Triad formulations allow them to be used with either of two adjacent groups.

All of these groupings should be considered as general guidelines for use when interchanging tapes without making bias or sensitivity adjustments. Users who do make such adjustments can interchange tapes more freely, without consulting these guides. In any case, the user should always listen carefully to assess the sonic effects when changing tape formulations.

Measuring Modulation Noise

Although the test for measuring modulation noise was described and the results were listed, additional comment is in order. There is no common measuring practice, and no standards for the band-limiting or notch filters, so there is no way to ensure that different testers will get comparable results. Quite a few people believe that modulation noise should be measured at something like 10 kHz, but others say this should be called "scrape flutter." I'm hoping to find alternative ways of configuring my cancellation/filtering

setup for more assurance of stable, reliable data. With the increasing availability of source material having very wide dynamic ranges, such as Compact Discs, cassette recordings with Dolby C or dbx NR will be more revealing of modulation noise if it occurs. In general, with normal use, dbx NR helps to prevent modulation noise, which is directly related to the recorded level on the tape. Perhaps the improved and improving cassette formulations will ensure that modulation noise will not be a problem, but I will be keeping my eyes and ears open.

Present and Future Formats

Formulations of all types have improved continuously. Even in the last few years, there have been significant changes, such as metal-particle Type IV tapes and, more recently, their Type II counterparts. Shells have also improved, providing better visibility, greater resistance to heat, greater reliability, and lower skew. But we are constrained by the analog format, are we not? Actually, relatively few people are as restricted as they think they are: Many of them would greatly improve the sound of their tapes if they paid more attention to getting the best tape/deck match, followed better recording practices, and used higher quality sources. (Retiring their old decks for improved units might help, too.) There is much that can be done with the tools at hand, and the convenience and low cost of the many varieties of cassette recorders/players will continue to have great appeal for many years to come.

We will see digital audio tape (DAT) in one or two formats, and it is likely that we'll be seeing prototype recordable Compact Discs in the next year. Because the technology of the DAT medium is very sophisticated, it is logical to expect that initial prices will be high for both the tape and the recorder(s). The portable Compact Disc players indicate the possibilities as far as sophistication in a small package is concerned. The actual selling price of deck-type DAT recorder/players, and the cost of DATs, will determine how much of the large analog cassette-format market shifts to digital. In the meantime, enjoy all of the marvelous things there are to record, play and listen to. **A**

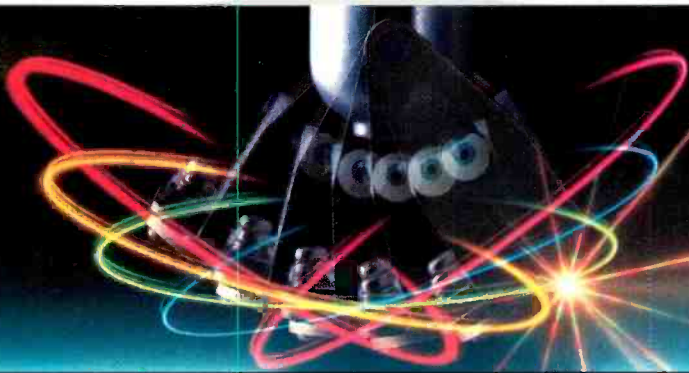

FINALLY, A SECURITY SYSTEM THAT WON'T SOUND OFF FOR ALL THE WRONG REASONS.

Our secret is something the engineers call a Computer Servo Motion Sensor.

This remarkable piece of technology (pictured above) rotates like a gyroscope, correcting the things that make an alarm sound when you don't want it to—a nosy cat, a steep incline, even a gust of wind.

But the relief from false alarms is nothing compared to the relief you feel when you're protected by Alpine.

When you leave your vehicle, you push an electronic touch pad on your key ring, and all the doors lock.

Then a red warning light flashes on your door or dash. Sensors that are built into the trunk, hood and doors feed information constantly to an

on-board computer. And no one, not even you with your own key, can start the engine until the touch pad is touched again.

We make five mobile security systems, with varying degrees of protection. All are superb examples of the applied technology

you expect from Alpine.



To find the dealer nearest you, just give us a call at 1-800-ALPINE-1.

And remember, we also make brilliantly engineered car audio systems and cellular telephones.

All, we are proud to say, are standard equipment on Lamborghini.

Enough said.

ALPINE
mobile electronics systems

Enter No. 53 on Reader Service Card

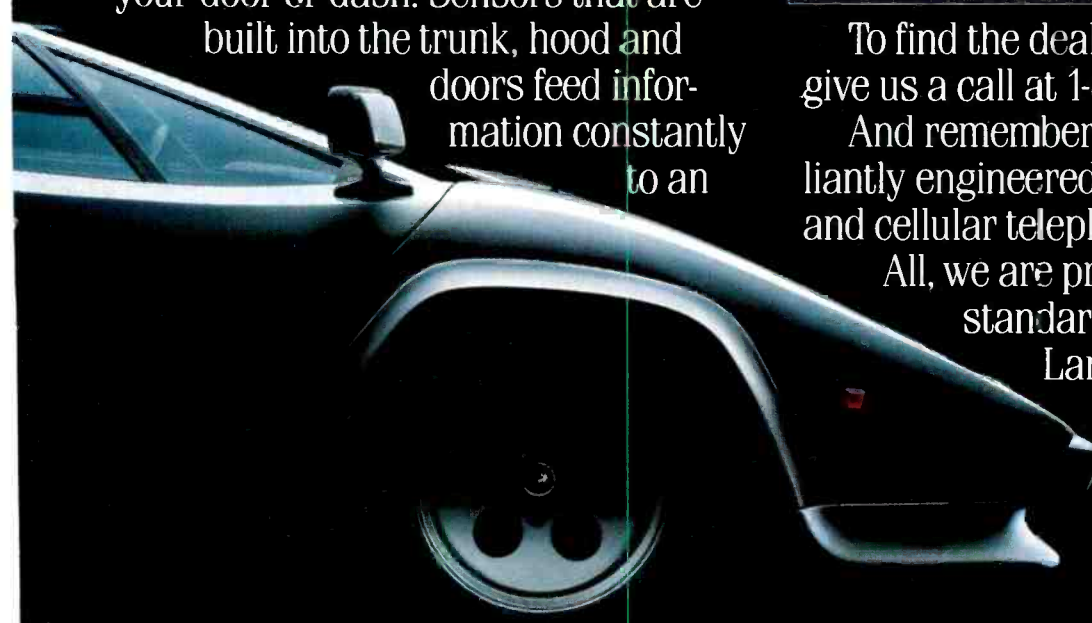

Choice:

No matter what Canton speaker you choose, quality German craftsmanship comes from within.

Whether it be our mini-speakers to our floorstanding speakers, our home or automotive speakers, satellite/subwoofer combinations or active and passive speakers—Canton offers choice.

Choice in size, finish and technology. ..The only choice we don't offer is choice in quality—Canton speakers are offered only in uncompromising "top quality."

To help you choose the right Canton speaker, visit better audio/video retailers across the country. Come. Discover.

Explore the vast array of quality audio components Canton has to offer.

"Choice" Hi-Fi. From Canton.

Canton North America, Inc.
254 First Avenue North · Minneapolis, MN 55401
612/333-1150



CANTON

High Fidelity Made in W. Germany.



Enter No. 13 on Reader Service Card

1

SME V TONEARM AND TALISMAN VIRTUOSO DTi CARTRIDGE

Manufacturer's Specifications Tonearm

Type: Tapered magnesium tube with fixed headshell and dynamic balance.

Pivot-to-Spindle Distance: 215.35 mm (8½ in.).

Offset Angle: 23°, 38'.

Overhang: 17.8 mm, adjustable ±9 mm by rack-and-pinion shift.

Tracking Error: 0.012°/mm max.; 0° at 66.04 mm and 120.9 mm from record center.

Vertical Tracking Force: 0 to 3 grams, adjustable by 0.1-gram calibrated knob.

Wiring: Headshell, silver litz, user-replaceable; internal, silver litz; external, monocrystal silver with standard five-pin plug.

Effective Mass: 10 to 11 grams, without cartridge.

Weight: 720 grams (1 lb., 9 oz.).

Price: \$1,750.

For literature, circle No. 90

Cartridge

Type: High-output moving-coil.

Stylus: Miniature-shaft van den Hul Type I.

Cantilever: Titanium, diamond-coated.

Output: 1.8 mV into 47 kilohms for 5 cm/S at 1 kHz.

Internal Coil Resistance: 105 ohms.

Recommended Tracking Force: 2 grams.

Frequency Response: 10 Hz to 60 kHz.

Separation: 30 dB at 1 kHz.

Compliance: 15×10^{-6} cm/dyne.

Weight: 7.2 grams.

Price: \$1,200.

For literature, circle No. 91

Company Address: c/o Sumiko, P.O. Box 5046, Berkeley, Cal. 94705.



If you are at all interested in, or even curious about, the trend toward perfection of analog record playback equipment, you will be as interested in reading this report as I was in preparing it. I must admit that I consider the SME V tonearm to be a tour de force in design and manufacture. "Well!" you are saying, "Now I don't need to skip to the end of the report and see what Ed Long really thinks about the SME V tonearm." That's true enough, but if you care to know why the SME V works as well as it does and, paradoxically, why you initially might not like the sound which it helps to produce, read on. Besides, the Talisman Virtuoso cartridge is also a part of this report and is interesting enough on its own to be worth reading about.

It was May 1981 when I reported on the SME 3009 III tonearm in conjunction with the Shure V15 Type IV cartridge. A month later, in June 1981, I reported on the Shure MV30HE cartridge wand, which was designed specifically as a plug-in for the SME III. (The SME III was the model previous to the SME V tonearm; there was no SME IV.) If you are interested in comparing the versions III and V to see the change in direction of design exhibited by the SME V, you might want to look at these 1981 reports. A partial comparison between the two is presented here as a "Measured Data" Table.

One thing that has always impressed me, over the years, is the very personal approach exhibited toward the public by SME, a small British company. I think it is due, to a great extent, to SME's Managing Director, Alastair Robertson-Aikman, who is a very personable fellow. He and Reg Eidy, SME's Chief Engineer, have been working on the SME V tonearm for the past five years. At this time, SME is represented in the U.S. by Sumiko of Berkeley, Cal. The Technical Director of Sumiko, David Fletcher, also very personable though something of an iconoclast (Indeed!—Ed.), seems to have had some input into the design considerations of the SME V. David was the designer of Sumiko's MDC-800 tonearm and is the person most responsible for the technical aspects of the Talisman moving-coil phono cartridges. Since the latest model of the Talisman line, the Virtuoso (or V, for short), seemed like an excellent match for the SME V tonearm, I used it for the technical and listening tests.

The Talisman V is a new moving-coil design, and while it shares the Direct Field Focus configuration of the Models A, B and S, it is quite different from them in major respects. The Talisman S cartridge was reported on in the September 1983 issue of *Audio*, and you might want to refer to it to see the direction in which the Talisman line of cartridges is heading.

First Impressions

As can be seen from its photograph, the SME V tonearm is very impressive. It reminds me of one of the scale-model starships which have appeared in recent space-epic movies. The fact that the initials SME stand for Scale Model Engineering is purely coincidental, I'm sure. The construction and finish are of the highest quality and make it obvious that one should expect the highest level of performance. The fit of the bearings is excellent, and no play was evident when I tried my push-pull test by gripping the armtube in one hand and the arm pillar in the other. Tapping the arm-

tube produced a very dull sound, indicating that what resonances might be present were well damped and should not color the sound significantly. The SME V tonearm is a dynamic-balance design. This means that after a counterweight is adjusted to balance the tonearm for the cartridge being used, the vertical tracking force and sidethrust compensation force are set by coiled springs, rather than shifting weights, thus keeping the arm in balance even when it is not perfectly level. Two knobs with 0.1-gram calibrations set the tracking force and sidethrust compensation.

There is no finger lift on the headshell. The tonearm is raised or lowered by a viscous-damped mechanism mounted near the main pillar and operated by a control lever.

The Talisman cartridge has one very distinctive feature which I wish were available on all phono cartridges, threaded mounting holes in the cartridge body. That means no

MEASURED DATA

Parameter	Measurements/Comments	
	SME III	SME V
Year of Report	1981	1986
Shape of Armtube	S	Straight
Armtube Material	Titanium	Magnesium
Armtube Damping	Fibrous lining	Constrained-mode
Effective Mass	5.05 grams	10 to 11 grams
Pivot to Stylus	236 mm (9.3 in.)	233 mm (9.2 in.)
Pivot to Rear of Arm	64 mm (2.5 in.)	73 mm (2.9 in.)
Height Adjustment Range	22.2 mm (0.9 in.)	31.8 mm (1.3 in.)
Tracking-Force Adjustment	0 to 2.5 grams	0 to 3.0 grams
Tracking-Force Calibration	Within 0.05 gram	Within 0.15 gram
Cartridge Weight Range	0 to 12 grams	0 to 14 grams
Counterweights	Six	One
Counterweight Mounting	Locked to armtube	Plastic carrier
Sidethrust Correction	String and weight	Spring
Viscous Pivot Damping	Yes	Yes
Damped Arm-Lift Lever	Yes	Yes
Finger-Lift on Headshell	Yes	No
Headshell Offset	24.5°	23.5°
Arm Mounting Slot Required	Standard SME	Standard SME
Overhang Adjustment	Sliding base	Sliding base
Bearing Alignment	Excellent	Excellent
Bearing Friction	Less than 50 mg	Less than 40 mg
Vertical Bearing Type	Knife edge	Ball race
Horizontal Bearing Type	Ball race	Ball race
Lead Torque	Insignificant	Insignificant
External Lead Length	48 in. (1.2 m)	48 in. (1.2 m)
Arm-Lead Capacity	73 pF	85 pF
Arm-Lead Resistance	1.14 ohms	1.20 ohms
Structural Resonances	250 Hz	1.6 kHz
Price	\$294	\$1,750

Talisman Virtuoso DTi Cartridge

Coil Inductance: 350 μ H
 Coil Resistance: Left, *06 ohms; right, 103 ohms
 Output Voltage (47-Kilohm Load): Left, 0.38 mV/cm/S; right, 0.39 mV/cm/S
 Cartridge Mass: 7.7 grams
 Microphony: Very low
 Hum Rejection: Excellent
 High-Frequency Resonance: 25 kHz
 Rise-Time: 13 μ S
 Low-Frequency Resonance: 7.5 Hz (in SME V tonearm)
 Low-Frequency Q: 2.5
 Recommended Load Resistance: Greater than 5 kilohms
 Recommended Load Capacitance: Less than 1,000 pF
 Recommended Tracking Force: 2.0 grams
 Polarity: Plus, for CD-4 standard.

The SME V tonearm is very impressive. It reminds me of a scale-model starship from a recent space-epic movie.

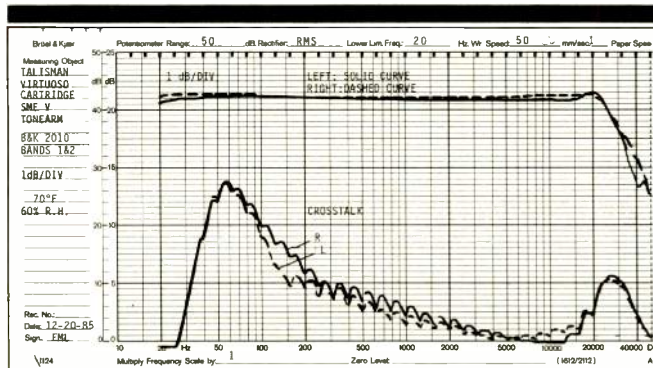

Fig. 1—Frequency response and interchannel crosstalk

of the SME arm and Talisman cartridge using B & K 2010 test record.

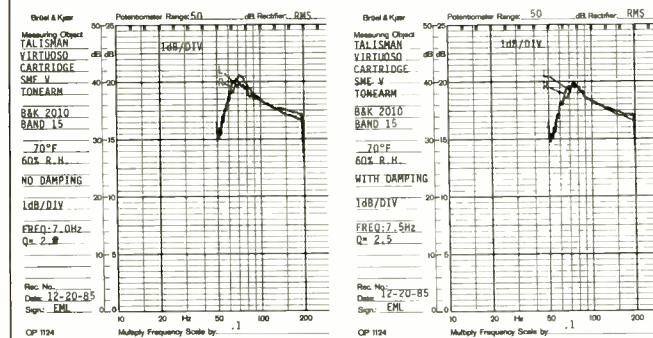

Fig. 2—Low-frequency arm/cartridge resonance is at 7.0 Hz and Q is 2.8 without damping (left);

resonance is at 7.5 Hz and Q is 2.5 with damping (right).

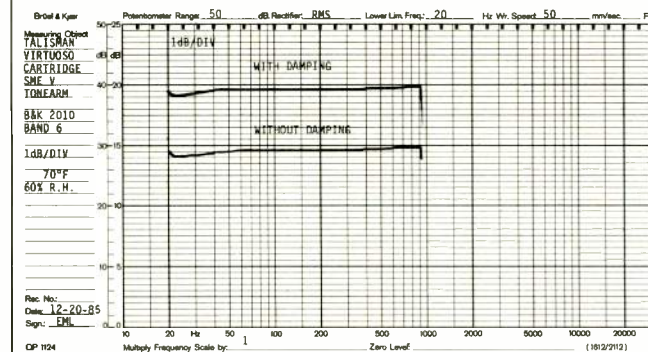

Fig. 3—Slow-sweep check (20 to 900 Hz) for tonearm resonances, with damping (upper curve) and without (lower curve).

separate nuts or washers must be held in place while the screws are lined up, started, and tightened, all while holding the cartridge in place. I would like to publicly thank St. Anthony for the many small hardware pieces which he has found for me, over the years, after they had seemingly fallen into some black hole during the intricate cartridge-mounting process.

Features

The armtube of the SME V tonearm is pressure die-cast of magnesium, which has a very good stiffness-to-weight ratio and good inherent damping. The hollow arm tube tapers in both thickness and cross-section along its length, and it extends from the headshell to the counterweight, passing through the pivot bearings without any joints or breaks. The internal damping of the armtube is accomplished by using a technique called constrained-mode damping (more on that later), which has proven very effective in reducing the type of mechanical-energy buildup most prevalent in thin-walled structures.

There are two holes with steel inserts in the headshell for mounting the phono cartridge. Since there are no slots in the headshell, the necessary stylus overhang must be adjusted by moving the whole tonearm in relationship to the turntable's center spindle. This stylus overhang is required for all pivoted tonearms to correct for tracking error across the record surface. The lack of slots does not allow the angle of the cartridge to be adjusted to correct for any misalignment of the stylus on the cantilever. With a "Line Contact" type of stylus, this can be a problem, because it means that the left and right groove walls will not be traced at precisely the same instant. This effect shows up in the phase-versus-frequency plot which I have been showing for a number of years. I am not certain how the interchannel time offset affects the total sound quality, but in the limited experimenting I have done, it seems to have an effect upon the precision of the sound image in the upper frequency range. In any case, the quest to eliminate any odd effects from the reproduced sound should make it a matter of some concern.

The counterweight system has a die-cast casing with weights inside. It is shaped so that it can be placed very close to the pivots, allowing the tonearm to maintain a very low effective mass. Cartridges weighing between 4 and 14 grams can be balanced by rotating a thumbwheel, which adjusts the position of the counterweight. After the cartridge is balanced, the counterweight can be locked in place by turning a lever. The tracking force can be set to as much as 3 grams by turning the calibrated knob.

The vertical tracking angle can be adjusted in one direction while playing a record, by turning the VTA screw, which raises the tonearm pivots. To lower the pivots, the main pillar must be pushed down again. Adjustment of the VTA is also helped by the two white lines which run the length of the armtube and by a special template. The 10-mm diameter horizontal and 17-mm diameter vertical bearings are captive in precision races, and located in the same plane as the record surface, to negate the effects of warp wow. The tonearm can be moved with respect to the center spindle by a rack-and-pinion system which uses a special horizontal

Of all the top compact disc players, only dbx gives you:



control.

Only dbx puts solutions at your fingertips for the most common shortcomings of today's CDs.

Take their wide dynamic range. It's great—until you use CDs for background music or make cassette copies for your car. When you adjust the volumes to keep loud passages under control, you miss

the quiet parts completely. Adjust for the quiet, and the next loud passage hits you like a sonic boom.

Problem Two: CDs made from analog or overly processed tapes may suffer from "limiting" during the original recording or loss of transient peaks during mixdown. The impact and excitement of the live per-

formances become muffled and lack lustre.

And consider the tremendous channel separation on CDs. Sometimes it leaves no "center" and makes the music sound dry and two-dimensional.

Only DX3 from dbx gives you the answers to those

problems. Besides giving you the tracking, filtering, and programming features you'd expect in a top-line machine.

You've waited for the *right* CD player. Now it is waiting for you. At your dbx dealer's.

Go beyond stereo, into the dbx zone.

dbx[®]
Beyond stereo



A division of BSR North America Ltd.
© 1986 dbx
71 Chapel Street
Newton, Massachusetts 02195
(617) 964-3210

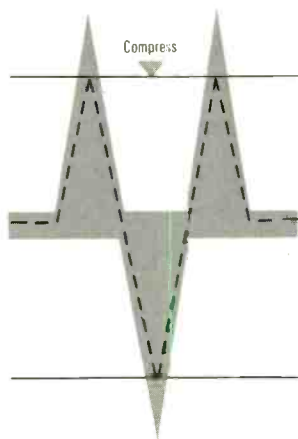

Compress lets you control the dynamic range (between loudest and softest passages).

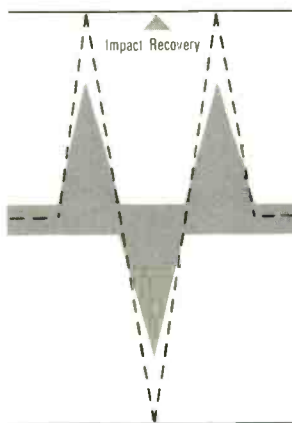

DAIR[™] (Digital Audio Impact Recovery) restores full "punch" to musical peaks that were limited during recording or lost during processing.

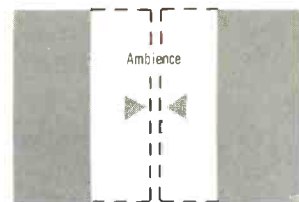

Ambience control lets you adjust the difference between channels, to narrow the stereo image (accentuating "centeredness") or widen it (adding ambience, or spaciousness, to the music).

I wish all cartridges had the Talisman's threaded mounting holes, which eliminate the need for tiny nuts and washers.

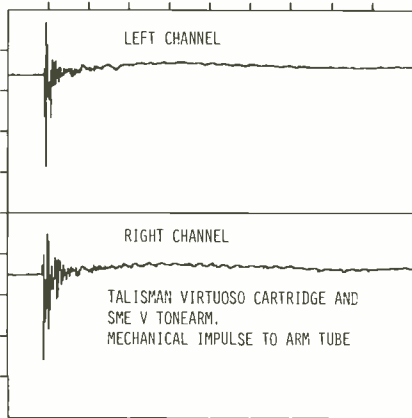

Fig. 4—Output of arm/cartridge when mechanical impulse was applied to armtube. Total period of measurement was 20.47 mS.

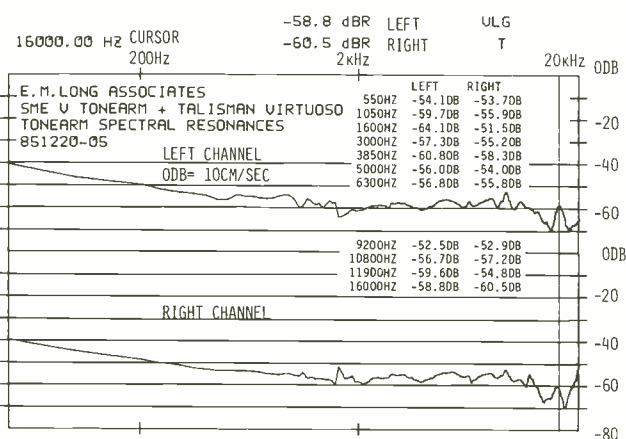

Fig. 5—Output (averaged) of arm/cartridge due to 16 mechanical impulses applied to armtube. This

is an excellent result, indicating good energy damping by the tonearm.

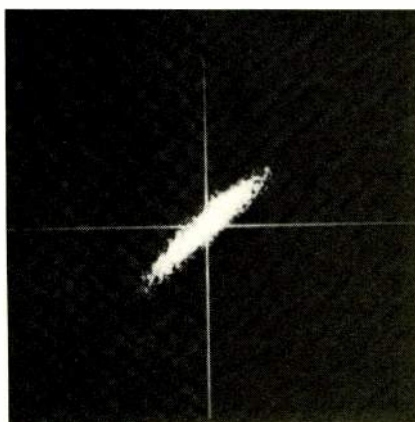

Fig. 6—Interchannel phase difference of arm/cartridge using pink noise from B & K 2011, band 7.

tracking angle key. The HTA key allows the tonearm to be adjusted so that the stylus will overhang the center spindle by the correct amount. SME has used this technique before but never with such an elaborate and precise mechanism.

The tonearm damping system, which consists of a trough of viscous fluid and a paddle, is also a refinement of the previous system used on the SME III tonearm. The amount of damping in the horizontal plane is increased or decreased by lowering or raising the paddle with an adjustment screw. The four color-coded cartridge attachment leads can be changed; the ones supplied were by van den Hul. The internal armtube wiring and the external phono cables are also specially made for SME by van den Hul. The bottom of the arm pillar is fitted with a viscous-damped, right-angle plug which can be rotated almost a full 360°. This allows the phono cables to exit the turntable base wherever it is most convenient and solves the problem of how to anchor them properly.

As a last note about this tonearm's features, I must compliment SME for the quality and comprehensiveness of the instruction manual. It is a gem.

The body of the Talisman V cartridge is machined from a solid piece of aluminum. As mentioned previously, the mounting holes are drilled and tapped right into the body. A high-coercivity neodymium-iron magnet is used in the Talisman's Direct Field Focus system to achieve a very high output voltage. In fact, the output of the Talisman V is about eight times that of the Talisman S, so it needs no step-up device. This means not only lower system cost but that the signal degradation inevitable with a step-up is eliminated. The Talisman V can be operated directly into a 47-kilohm, magnetic phono-cartridge input. In fact, any load impedance above 5 kilohms is acceptable, and input capacitance also has negligible effect. The cantilever of the Talisman Virtuoso which I tested is titanium, with a diamond overlay (as denoted by its DTi designation), which gives it added stiffness. (A Talisman Virtuoso B, with boron cantilever, is also available, for \$800.) The stylus is a van den Hul Type I design, precision-cut from a small cross-section diamond shaft. A damper having very low hysteresis is used in order to maintain good time and amplitude response for better spatial-information recovery.

Measurements and Listening Tests

Figure 1 shows the amplitude versus frequency response and also the crosstalk versus frequency for the SME/Talisman combination; the results are very good. The response at 20 kHz is particularly interesting since it verifies comments by some members of the listening panel that the sound was very open and clear in the upper range. The high-frequency resonance at 25 kHz, due to the interaction of the compliance of the record groove with the effective mass of the stylus tip, is verified by the rise in the crosstalk. The rise in the crosstalk at 60 Hz is an artifact of the B & K 2010 test record; the actual crosstalk for the SME/Talisman combination is much lower.

The low-frequency resonance, caused by the interaction of the tonearm's effective mass and the cartridge's compliance, is shown in Fig. 2, with and without the low-frequency damping system activated. The Q is very low for either

WHY IS THIS MAN SMILING?

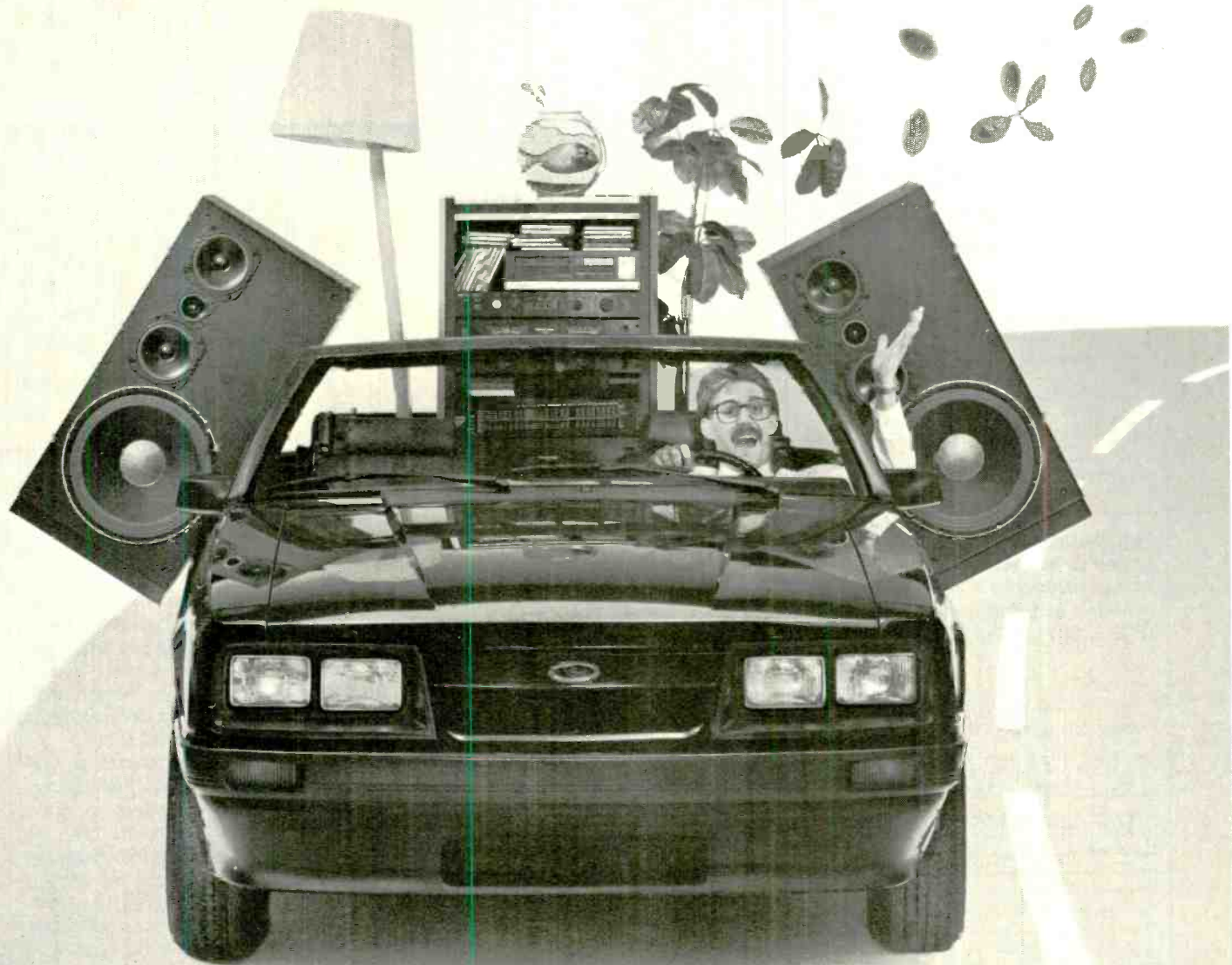

Because at last he's getting the full-dimensional sound of home stereo in his car. But if you don't drive a convertible, and you can't distinguish the kettle drums from the potholes, here's good news for you—

Cerwin-Vega's complete line of car speakers delivers stunning dynamic range. Reproducing bass as low as 20Hz, our broad assortment of subwoofers offers both 6x9 and round formats in an unparalleled selection of sizes—each compatible with analog and digital source material.

Maserati or Mercury. Mendelssohn or Metheny. Whatever your taste, we've got what you're listening for. Cerwin-Vega!



For more information, please write or call:

Cerwin-Vega!
The Loud Speaker Company

12250 Montague St. Arleta, CA 91331 (818) 896-0777

The panel had to learn to appreciate this pair's tightly controlled bass, which was lower but more realistic than with the reference system.

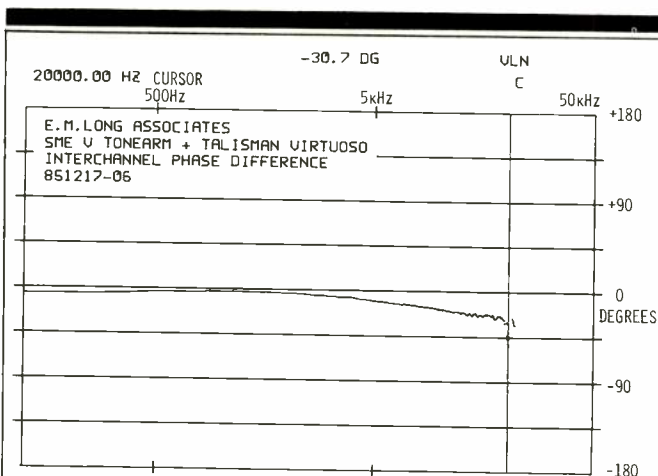

Fig. 7—Interchannel phase difference of arm/cartridge as a function of frequency (B & K 2011, band 7, pink noise). Phase difference at 20 kHz (cursor position) is 30.7°, equivalent to only 4.3 μ S of interchannel delay.

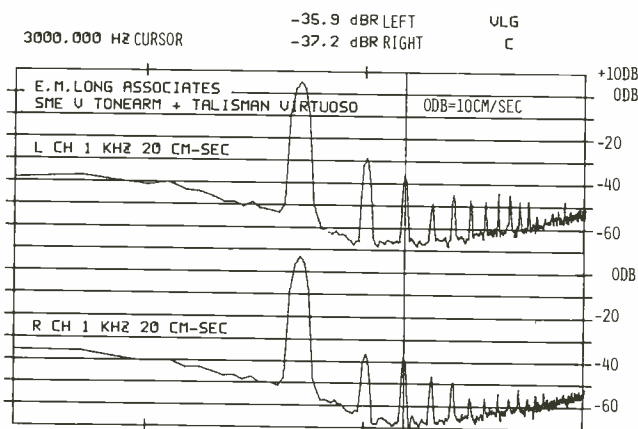
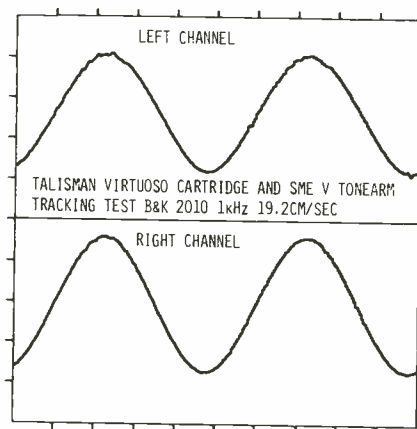

Fig. 9—Spectral analysis of the cartridge output when reproducing the test signal of Fig. 8. The third harmonic (at the cursor position) is 1.6% in the left channel, 1.4% in the right.

condition, but it must be remembered that I have taken much care in centering the test record, which reduces the side-to-side swaying of the tonearm. The viscous damping system is most effective for this horizontal motion, so it would be even more useful under normal conditions, with the record less carefully centered, than would appear from Fig. 2. The panel's comments about the very tightly controlled character and extension of the bass register were a bit difficult to sort out. Due to better damping of its low-frequency resonance, the SME/Talisman combo had less bass output than the reference system's, though perhaps a bit more extended. This confused some panel members a

Fig. 8—Tracking of arm/cartridge with a 1-kHz test tone from the B & K 2010 at 19.2 cm/S.



bit. The reference system was preferred by some panel members when reproducing drums and double bass because, as they commented, "the bass sounds fuller." This is another paradox of the SME/Talisman performance, since careful listening to the sound of bass drum on orchestral recordings convinced me that it was more realistic.

The smooth curves of Fig. 3 indicate the control of mechanical resonances in the SME V tonearm. The viscous damping system does not have any visible effect upon the response, but there aren't any major uncontrolled vibrations which would show its effect anyway. This lack of substantial resonances, which might color the sound, can be verified easily by tapping the armtube with a pen or a small screwdriver. I am convinced that it was this very lack of coloration which caused some members of the listening panel to comment that the SME/Talisman combination was more reticent in its quality than the reference system. This is what I meant earlier, when I said that you might not like the sound which the SME V tonearm helps to produce. The lack of coloration in the SME can cause other tonearms to be preferred, at least in short-term listening. I have seen this before, especially in the case of a tonearm which caused a very euphonic coloration due to its very loose pivots!

The results of applying a series of mechanical impulses to the armtube are presented in Figs. 4 and 5, which show the amplitude versus time and the frequency spectrum of the energy of the SME V/Talisman Virtuoso combination. These results indicate the excellent damping of energy by the SME's tapered magnesium armtube and the internal damping system. As I mentioned before, the technique used is called constrained-mode damping. This method places the actual damping material in direct contact with the surface from which the energy is to be removed. The damping material is then covered with, and its movement constrained by, a thin layer of stiff material. The energy is dissipated in the form of heat as it tries to move between the surface to be damped and the constraining layer.

Figure 6 shows the interchannel phase difference, displayed on the screen of a Nicolet Explorer III digital storage oscilloscope. Figure 7 shows the phase versus frequency

AMPLIFICATION FOR THE CONNOISSEUR

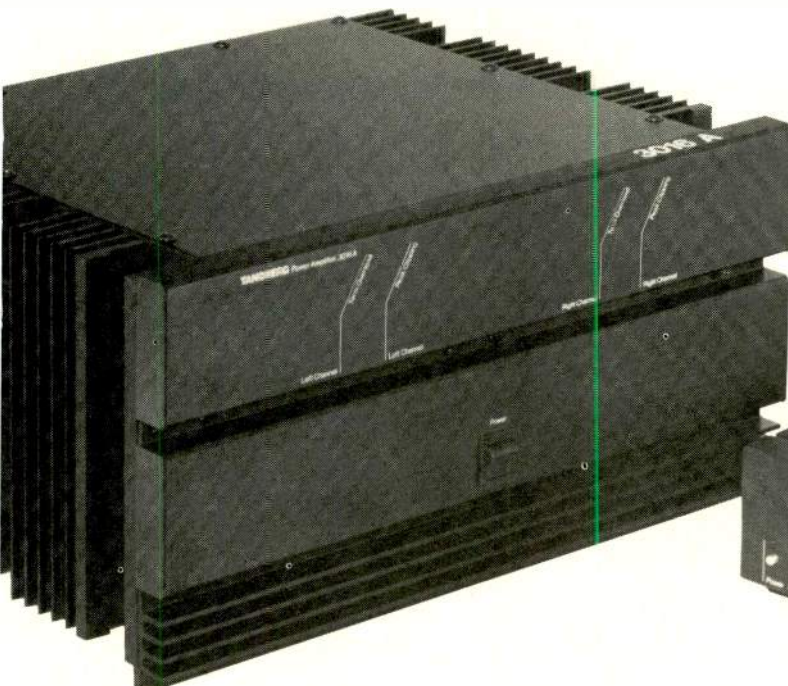

Carefully selected polypropylene capacitors, metal film resistors, finely-tuned discrete circuitry and zero-feedback design...are some of the design aspects that take Tandberg's equipment out of the mainstream and place it in the world of the audio connoisseur.

Tandberg now establishes the reference for sonic clarity, openness and overall musicality with the TPA 3016A Power Amplifier and the TCA 3018A Preamplifier. Never before has the selection of quality components, complete absence of IC's, high current capability and elimination of signal degrading negative feedback design been executed with such dramatic results.

The high-current, dual-mono MOSFET amplifier, rated at 220 watts per channel with no more than 0.05% total harmonic or IM distortion, and peak power capability of 1,500 watts into 0.5 ohms, confirms the TPA 3016A Power Amplifier's extraordinary ability to handle a wide range and variety of low impedance speakers. An engineer, heating up load resistors at his test bench, will be quite satisfied... as would a professional musician listening to the reproduction of music.



A newly-developed moving coil input stage that sets new standards for musicality, clarity and low noise, with both the MC and MM inputs fed into a passive RIAA network that truly demonstrates the advantages of zero feedback design, makes the TCA 3018A "direct-path" Preamplifier the perfect complement to the TPA 3016A Power Amplifier.

How does Tandberg's advanced engineering translate into a new standard of listening pleasure for the audio connoisseur? Visit your local Tandberg dealer and decide for yourself.

TANDBERG

One Labriola Court
Armonk, NY 10504
(914) 273-9150

Audio Components for the Connoisseur

Even if you can't afford the SME and Talisman right now, you should audition them to hear how good records can sound.

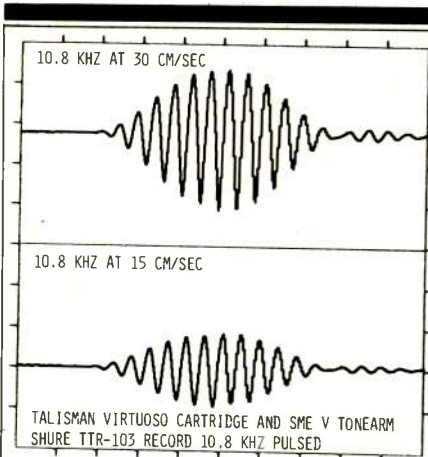

Fig. 10— Output with 30- and 15-cm/S, 10.8-kHz pulse test, Shure TTR-103 test record.

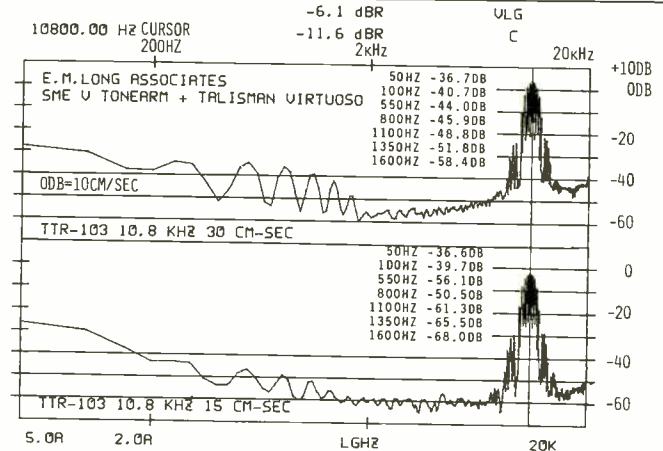

Fig. 11—Spectral analysis of distortion products from signals shown in

Fig. 10. Distortion at 50 Hz is 1.5% for 30-cm/S modulation.

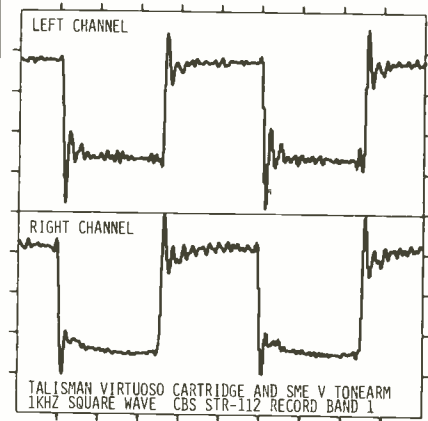

Fig. 12— Cartridge output from 1-kHz square wave, CBS STR-112 test record.

The ability of the SME/Talisman combination to reproduce high frequencies with a seeming effortlessness is verified by the information shown in Figs. 10 and 11. The output of the left channel, while reproducing a 10.8-kHz tone burst at 30 and 15 cm/S, is shown in Fig. 10; its symmetry and lack of compression, even at the higher level, is very good. The aspect of performance most often cited as an area of superiority over the reference system was the way that the SME/Talisman combination reproduced the midrange and high frequencies. The words "transparency" and "clarity" were often used by members of the listening panel to describe the sound.

The responses to 1-kHz square waves, Fig. 12, are excellent and indicate that, while time delay of the high frequencies with respect to low frequencies is present, it is very slight. The relationship of fundamentals and overtones will therefore be correct over a wide range of frequencies.

Conclusions

Both the SME V tonearm and the Talisman Virtuoso cartridge incorporate some very useful and innovative features. Most notable about the SME are its tapered, one-piece magnesium armtube and integral headshell; special van den Hul internal wiring, and the constrained-mode internal damping in the armtube. The Talisman's most remarkable features are, I feel, its solid aluminum body, with integral drilled and tapped mounting holes, and the diamond-coated titanium cantilever. Together, the SME V tonearm and the Talisman Virtuoso cartridge make an excellent combination; anyone who is looking for the finest reproduction of analog discs should try to audition it. Even if you can't afford to buy these components right now, you should listen to them to hear just how good records can sound. *Edward M. Long*

for 64 samples of the same pink noise signal used for Fig. 6. This is a phase transfer function, obtained using a Nicolet 660A-2D Fast Fourier Transform analyzer, and represents the difference in phase between the left and right channels. The very slight phase difference between the channels indicates that the ability to present a very stable stereo image is excellent. The comments of the listening panel confirmed this by indicating that both the SME/Talisman and the reference system presented superb stereo images.

The SME/Talisman combination has excellent tracking ability, as shown by Figs. 8 and 9. Figure 8 shows amplitude versus time of the left- and right-channel outputs while reproducing the second-highest-level 1-kHz band on the B & K 2010 test record. The waveform has only a tiny amount of jitter. The frequency spectrum of this waveform is shown in Fig. 9, and the distortion is very low for this high a level. The eighth and ninth harmonics show an increase; this may account for some of the brightness which was heard when reproducing a trumpet.

SURGEON GENERAL'S WARNING: Smoking
By Pregnant Womer May Result in Fetal
Injury, Premature Birth, And Low Birth Weight.

Winston America's Best.

Excellence.
The best live up to it.



2

SOTA STAR SAPPHIRE TURNTABLE

Manufacturer's Specifications

Drive System: Belt.

Wow & Flutter: Less than 0.1%, DIN weighted.

Rumble: Unweighted, -60 dB; weighted, -75 dB.

Speed Stability: $\pm 0.1\%$.

Suspension Resonance: 2.5 Hz.

Dimensions: 20¼ in. W x 7½ in. H x 16½ in. D (51.4 cm x 19 cm x 41.9 cm).

Price: \$1,600 (oak finish), \$1,800 (black lacquer); Electronic Flywheel power-line conditioner, \$300.

Company Address: P.O. Box 7075, Berkeley, Cal. 94707.

For literature, circle No. 92



Photograph: Carl Zapp

SOTA, which stands for State Of The Art, is also the name of a small, dedicated company, located in Oakland, California, which manufactures a very high-quality turntable that they claim is "the turntable that Newton would have built." In addition, they make some interesting electronic and accessory products meant to increase the performance of record-playing equipment.

The Star Sapphire is the latest version of a basic turntable which SOTA began manufacturing a few years ago, all designed according to the theory that the supporting mass must exceed the moving platter mass. The major current improvement is the addition of a vacuum record-clamping system; it is also available as a retrofit for the original SOTA Sapphire for about \$600, plus dealer installation. (You might want to look up the report on the SOTA Sapphire turntable in the June 1983 issue of *Audio*, because the new Star Sapphire is very similar but has some important improvements.) The Star Sapphire that I tested was also isolated from the a.c. power line by a new unit which SOTA calls the Electronic Flywheel and describes as a power-line conditioner. This acts as a power reservoir which regulates the voltage and removes noise from the a.c. power line. The Electronic Flywheel is also available separately, for \$300, and may be used not only with the Sapphires, but also with some other d.c. servo turntables. The vacuum clamping system and the Electronic Flywheel are each capable of improving the performance of the turntable, and taken together, they represent a real advance.

This particular Star Sapphire was finished in satin black, even including the wood base. The hinged dust cover is vacuum molded from a soft smoked-brown acrylic plastic. I was able to set the hinges so that the lid would lock in place in a partly opened position. This is handy when the shelf above the turntable doesn't allow the lid to be opened fully.

One thing that you may find strange is that there are no markings on any of the controls! Of course, after you have figured out which knob does what, by reading the instructions, you really won't need the markings anymore. (Besides, think of the power you will have by being the only person who knows where the on/off switch is!) The cover of the control area is different than that of the original Sapphire turntable. It is made of wood, has bevelled edges and a

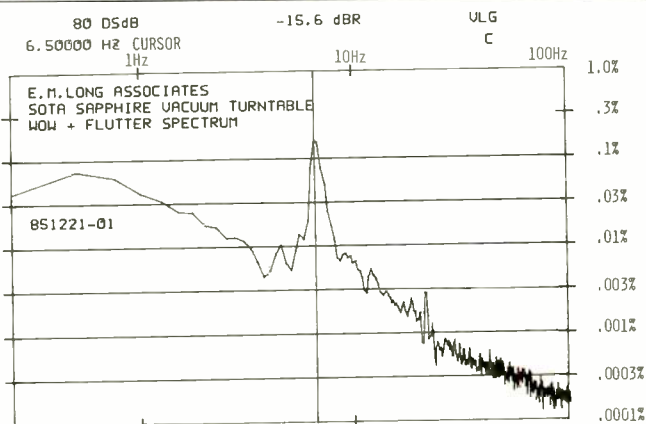

Fig. 1—Computer plot of wow and flutter spectrum, from 0 to 100 Hz. The peak at 6.5 Hz is due to the tonearm/cartridge resonance.

satin black finish, and is held in place by Velcro fasteners. (The original Sapphire has a metal control cover, which is held by screws.) The new cover can be popped on and off easily, although there is really no reason or need to do this; still, I like it and think that it is a clever touch.

I usually have no trouble locating a spot for any turntable I am testing, but this time I also had to find a spot for the vacuum system and the Electronic Flywheel chassis. I put these control units on a separate shelf for some of the tests and on the floor for some others. The noise level of the vacuum system is not very high, but in extremely quiet situations, it would be best to keep it away from your listening position. The vacuum hose is 9½ feet long, so there is some flexibility in where you can locate the vacuum control chassis.

High mass means high inertia and immunity from outside forces, and it is one of the main features of the SOTA turntable design. SOTA engineers believe that the best way to suspend a mass that is spread over a surface, is by not allowing any part of that surface to be outside the area bounded by the suspension. This means that no part of the surface can rotate around an axis formed by two adjacent supports. It follows, then, that the best way to suspend a rectangular surface is by placing four springs at the corners. (This is different from supporting a rigidly suspended mass, such as a turntable base with noncompliant feet, because a four-point rigid support system could allow the mass to rock around an axis formed by opposite corners.) Extra mass, of about 2½ pounds, is added at each of the suspension points. The resonance of the turntable suspension is controlled by using calibrated springs, and by adjusting the amount of this added mass. Since the linear on-axis motion of a coiled spring is accompanied by rotary motion, the Star Sapphire's springs are counterwound pairs

MEASURED DATA

Parameter	Claimed	Measured	Comment
Speed Stability	±0.1%	±0.20%	Very Good
Wow, Unwtd.		0.21%	Very Good
Wow, DIN Wtd.		0.18%	Excellent
Flutter, Unwtd.		0.11%	Excellent
Flutter, DIN Wtd.		0.07%	Excellent
W & F, Unwtd.		0.025%	Very Good
W & F, DIN Wtd.	0.1%	0.18%	Excellent
Long-Term Drift		0.10%	Excellent
Rumble, Unwtd.	-60 dB	-68.3 dB	Excellent
Rumble, Wtd.	-75 dB	-88.2 dB	Excellent
Suspension Resonance	2.5 Hz	3.7 Hz	Very Damped

High mass, for high inertia and immunity from outside forces, is a hallmark of SOTA turntable design.

positioned at opposite corners of the suspended mass. Each spring supports 8 pounds, so the total suspended weight is 32 pounds. A very important difference between the two SOTA Sapphire models and other turntables is that the mass is slung below the springs rather than being perched on top of them. The force of gravity thereby causes the springs to find a stable equilibrium. If the turntable is perched on top of springs, as is often the case with other designs, the force of gravity draws the suspended mass toward an unstable condition.

The mass of the tonearm must be accounted for in balancing the total suspended mass. Since tonearms of various mass must be accounted for, SOTA supplies lead shot in a plastic bag and a spirit level. With the tonearm mounted on the board, the turntable is balanced by pouring the lead

shot into a styrene cup, placed on the tonearm board, while watching the bubble in the spirit level. When the mounting board is level, it can be lifted up, and the lead shot poured into the well under the board. The original SOTA turntables had a hole and plug in the tonearm mounting board into which the lead shot was poured; this proved to be a disadvantage when the turntable had to be transported, because the lead shot could spill out.

The turntable platter is a low-pressure casting, tapered so most of its mass is at its periphery. It is lead lined for high mass and high internal damping, and machined on a CNC (computer numerical controlled) lathe to 0.0002-inch accuracy. Each turntable shaft is matched to a precision, sintered-bronze bearing sleeve and mounted in a surface support block. The shaft and bearing are mounted into a test fixture, and the perpendicularity is checked. If it is within the tolerance allowed, the sapphire thrust bearing is put into position and the combination is rechecked.

The SOTA Star Sapphire turntable has two speeds, 33.3 and 45 rpm, which are selected by a pushbutton. Separate knobs are used to control the exact pitch of each speed. There is no built-in speed indicator, so a strobe disc is supplied. It can be used with ordinary fluorescent lighting to set the exact speeds of 33.3 and 45 rpm by adjusting the appropriate pitch knob until the lines on the strobe disc appear stationary.

The vacuum record hold-down system is the Star Sapphire's single most important improvement over the previous Sapphire turntable. The vacuum pump and the associated control electronics and power supply are mounted in a chassis which is completely separate from the turntable. The vacuum, which is created between the underside of the record and the top of the turntable platter, causes the record to be pressed against the turntable platter surface by the force exerted by the surrounding air pressure. The record isn't actually pressed directly against the platter, because there is an interface, which consists of an acrylic plastic disc and a mat of highly damped rubber. The acrylic disc's internal characteristics are similar to those of a vinyl phonograph record. This allows most of the record's internal kinetic energy to be transferred from the vinyl record to the acrylic plastic disc with very little difficulty, because their impedances are similar. This energy is then dissipated in the highly damped rubber barrier, which is between the acrylic disc and the aluminum turntable platter. The rubber mat also damps out the energy caused by the natural resonance of the turntable platter. Two main attributes of the vacuum system enhance the Star Sapphire's performance: First, since the force pressing the record against the acrylic disc is applied in a very uniform and evenly distributed manner, the mechanical standing-wave energy inside the record can be dissipated in a similarly uniform manner. It also means that more internal energy, which would otherwise color the sound, can be removed from the record.

The other attribute is due directly to the flatness of the record, caused by the vacuum pulling the record flat against the surface of the acrylic disc; a flat record is not warped! (In a previous report, on the Nakamichi Dragon turntable, which had a record-centering system that prevented wow due to eccentricity, I commented that all we

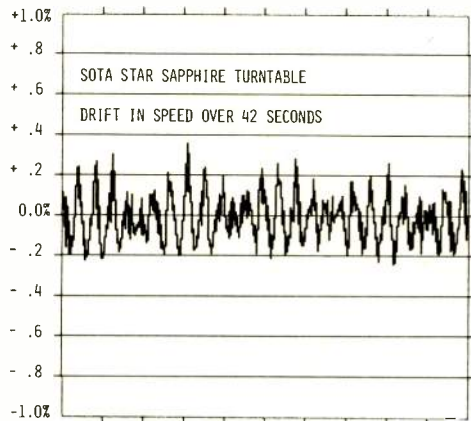

Fig. 2—Speed drift over a 42-S period. The variations are at 1.8 S per cycle (0.56 Hz), related to the 33.3-rpm speed.

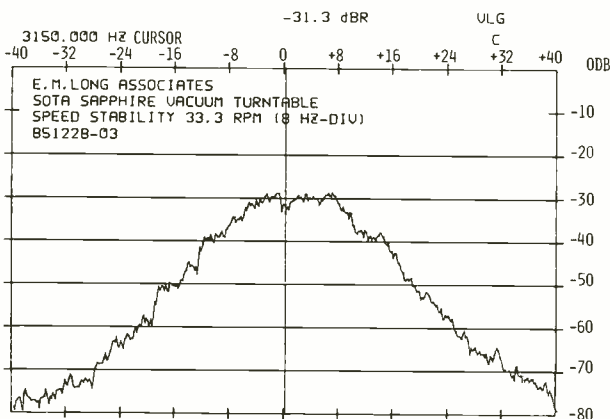

Fig. 3—Speed stability, referenced to 3,150-Hz tone on band 8 of B & K 2010 test record.

BEYOND CONVENTIONAL AUDIO

The DX-320 is divided into two sections, with coupling between the digital and analog stages of the player via Opto-Coupling Modules. In addition, power supply interference is prevented by using separate power supplies for the analog and digital sections, as well as for the transport mechanism.

Three high speed ONKYO Opto-Coupling Modules allow transfer of ultra high frequency digital audio data, word clock and bit clock signals which range in frequency from 17.64 kilohertz up to 4.32 megahertz. The module incorporates an optical fiber, between a precision LED light source and focusing lens, and a receiving photo-diode and lens assembly. Three additional opto-isolators are utilized for transfer of left/right clock, de-emphasis and muting signals. Together, these special components eliminate DSI.

OPTO-COUPLING FOR ACCURATE DIGITAL REPRODUCTION

In addition to the digital audio data signals that must be converted into analog, CD players must also process non-audio digital data. During this conversion, Digital Signal Interference (DSI) occurs due to noise transfer between the various digital and analog stages, through printed circuit board wiring and common ground lines. These non-audio data signals can actually interfere with the digital to analog conversion, resulting in Digital Signal Interference. This noise contributes to the harsh sound characteristics often attributed to digital reproduction.

In order to prevent DSI from appearing at the player's outputs along with the music signal, we found that it was necessary to completely isolate the digital and analog blocks of circuitry from each other electrically. This was made possible by the development of ONKYO's exclusive Opto-Coupling Module.

This new technology prevents DSI by utilizing specially designed high speed fiber optics that convert the digital data signals into beams of light. This eliminates the transfer of noise between the digital and analog stages. The result is honest, accurate musical reproduction with none of the harsh characteristics often attributed to conventional CD players.

Artistry In Sound
ONKYO

200 Williams Drive, Ramsey, NJ 07446

The Star Sapphire's vacuum record hold-down system is the single most important improvement over the previous Sapphire.

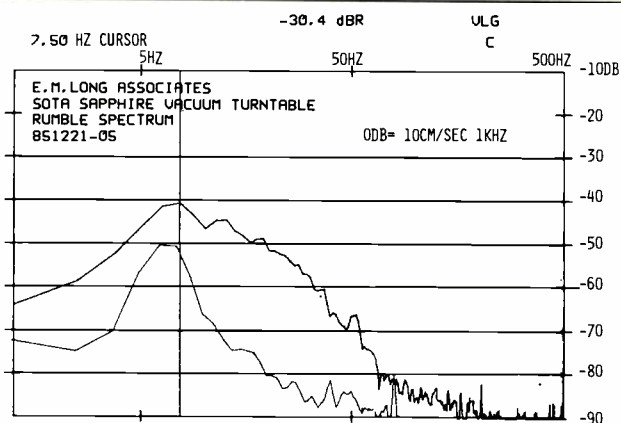

Fig. 4—Rumble spectrum, measured with B & K 2010 test record (upper curve) and with Thorens Rumpelmesskoppler (lower curve). The main factor in the rumble is the tonearm/cartridge resonance.

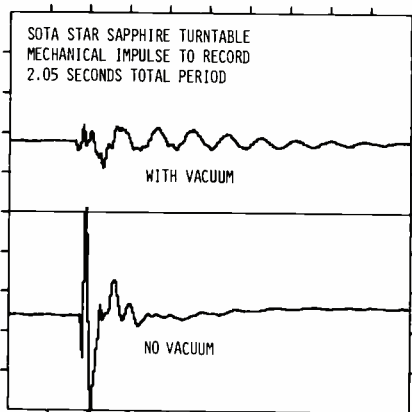

Fig. 5—Output vs. time for mechanical shock applied to edge of record, with stylus resting in groove. Results show effect of vacuum applied (upper trace) and not applied (lower trace). Measurement period is 2.05 S.

needed now was a turntable that would move up and down to remove the effects of warp! I was being facetious, of course, because the obvious solution is to make flat records [there I go again!] or to pull the records flat against the turntable platter by using a vacuum system.) The Star Sapphire's vacuum system reduces the effects of warp wow by removing the vertical component due to warped records. If you are willing to spend a little time centering a record on the Star Sapphire before you sit down to listen, you will be amazed at the difference in the clarity of the sound.

Measurements and Listening Tests

The SME V tonearm and the Talisman Virtuoso moving-coil cartridge were used for the technical measurements and listening tests.

The low-frequency spectrum of the wow and flutter present while reproducing the 3,150-Hz tone on the B & K 2010 test record is shown in Fig. 1. It represents 16 samples of the filtered output of a wow and flutter analyzer (which I also used for drift tests). The increased output at 6.5 Hz is due to the resonance caused by the interaction of the tonearm's effective mass and the compliance of the cartridge stylus suspension. The test record was not perfectly centered during this test because I wanted to show the large effect that the tonearm/cartridge resonance can have on the total energy output of the wow and flutter spectrum. If the wow and flutter were determined by merely observing the fluctuating pointer of a wow and flutter meter, the resulting figure would be higher for a poorly damped tonearm/cartridge combination reproducing a warped and off-center record than for a well-damped tonearm/cartridge combination reproducing a flat, well-centered record. In other words, a turntable could be blamed for having a much worse wow and flutter when it actually could be due, mainly, to the poorly damped low-frequency tonearm/cartridge resonance. The listening panel's comments on the reproduction of piano recordings by the Star Sapphire were very favorable with regard to the stability of sustained tones. I was able to hear an effect, however, while reproducing test tones, which I could associate with the data shown in Fig. 2. This is a cyclical variation which repeats every six rotations of the record. The zero line represents exactly 3,150 Hz, and the graduated lines, plus and minus, represent the percentage of speed increase or decrease from 3,150 Hz. However, like the members of the listening panel, I couldn't hear this effect when the Star Sapphire turntable was reproducing musical recordings. No listening-panel member made any comment which I could definitely correlate with this cyclical phenomenon.

Figure 3 is the spectrum of the frequency variation caused by the wow and flutter and indicates that the variation in speed varies in a rather uniform manner around the 3,150-Hz tone. The data represents the summation of 24 spectrum samples.

The rumble spectrum data which appears in Fig. 4 is a little different from what I've shown in past reports. Usually I have shown only the spectrum of the rumble caused by reproducing the B & K 2010 test record; this is represented here by the upper curve in Fig. 4. The lower curve was made using the Thorens *Rumpelmesskoppler* (German for

BEYOND CONVENTIONAL AUDIO



THE ONKYO INTEGRA DX-32C WITH OPTO-COUPLING THE SOUND IS NO ILLUSION

The Integra DX-320 Compact Disc player is the first of ONKYO's new generation of CD players to incorporate our unique Opto-Coupling digital signal processing system. Conventional CD players transmit digital data internally via printed circuit board wiring, which interacts with analog audio signals to produce Digital Signal Interference (DSI), resulting in an audible "harshness" in the music.

Specially designed high speed Opto-Coupling modules in the DX-320 transfer the digital audio and other data signals to the analog output stage via fiber optics, preventing DSI. The result is noise-free, life-like reproduction with none of the harsh sound characteristics often attributed to other CD players. This remarkable new technology can only be found in the ONKYO DX-320.

Double oversampling and digital filtering greatly improve phase and harmonic accuracy. A fully programmable wireless remote control includes memory selection, phrase capability, and indexing for maximum convenience.

Our unique transport design incorporates ONKYO's exclusive Poly-Sorb, a rubber-like compound that improves isolation by absorbing extraneous vibrations, eliminating skipping and mistracking.

The Integra DX-320 Compact Disc player fulfills the promise of digital audio, with sound quality that's as close to the original as anything you've ever heard. Audition the DX-320 at your authorized ONKYO dealer today.

Artistry In Sound

ONKYO®

200 Williams Drive, Ramsey, N.J. 07446

The uniform force of the vacuum flattens out warps and allows uniform dissipation of energy within the record.

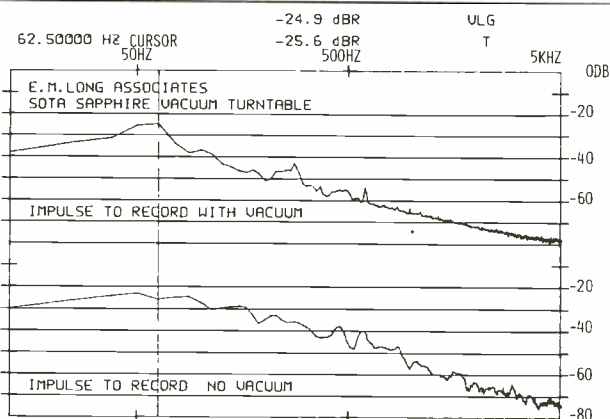

Fig. 6—Spectrum (to 5 kHz) of impulse shown in Fig. 5, with vacuum applied (upper curve) and without (lower curve). The tight contact between the record and the platter's interface disc when vacuum is applied reduces spurious energy. Except at the cursor position (62.5 Hz), energy is reduced by 10 dB or more, the best measured by the reviewer for any record-clamping system.

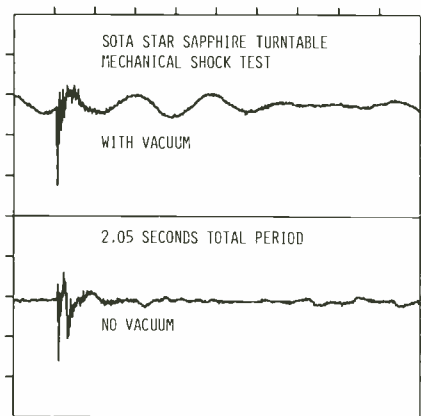

Fig. 7—Output vs. time for mechanical shock to platform upon which the turntable base rested, with vacuum applied (upper curve) and without vacuum (lower curve). Measurement period is 2.05 S.

rumble-measurement coupler), a special device which allows turntable rumble to be measured indirectly, thereby avoiding the artifacts inherent in the test record. Although I am not convinced that using this device is the best way to measure turntable rumble, I did so here because I wanted to show the effect of the tonearm/cartridge resonance on the rumble spectrum. As you can see, both the spectrum produced by the test record and the spectrum produced by the *Rumpelmesskoppler* show that tonearm/cartridge resonance is the major factor in the total rumble output. This is true of almost every modern, high-quality turntable and is certainly true of the turntables I have tested in the recent past. Once again, as in the case of wow and flutter, you can see the large effect that the tonearm/cartridge resonance has upon the measured performance. A poorly damped tonearm/cartridge resonance will cause a turntable to produce worse rumble figures than it justly deserves. In any case, the SOTA Star Sapphire turntable has extremely low rumble, and none of the members of the listening panel made any negative comments in this regard.

The ability of the vacuum record-clamping system to damp the energy in a phonograph record is shown in Figs. 5 and 6. For this test, a mechanical impulse is applied to the edge of a stationary phonograph record while the stylus of the phono cartridge is resting in a groove. The dramatic difference in the output versus time is shown in Fig. 5: The top curve indicates how the energy in the record, due to the first instance of the mechanical shock, is extremely well damped by the vacuum clamping. The lower curve shows the output versus time when the vacuum system is not activated; the initial energy impulse is many times greater than that shown for the vacuum system. Most of the comments of the listening panel about the difference in the quality of reproduction between the SOTA Star Sapphire and the reference system could be correlated to the vacuum system's effect upon the sound. In fact, during one comparison test, the vacuum between the Star Sapphire turntable platter and the phonograph record was released, allowing the tight coupling to be relaxed. This caused listening-panel members to become confused as to which turntable was "A" and which was "B" because these turntables seemed to have reversed their characteristics completely! The effect of the vacuum system on the quality of sound reproduction was clearly evident in comments made by the listening-panel members. Comments about violin and brass indicated that the reference system was "brighter," "sharper," "more forward." The vacuum clamping system made the sound quality of cymbals "duller"—an apparent paradox, which I will explain shortly.

The two spectra of Fig. 6 show how the vacuum clamping system is very effective in reducing the mid- and high-frequency energy from the record caused by a mechanical impulse to the record's edge. Except at low frequencies, such as 62.5 Hz where I set the cursor, the level is somewhere between 10 and 15 dB lower for the vacuum clamping system. When this much energy is removed from the record in the middle and upper frequencies, the quality of the sound is bound to be affected. Because the sound was different from what we were used to hearing, it seemed to be wrong at first. However, upon extended listening, it

AN AMERICAN HERO

America's new LeBaron GTS outperforms Germany's BMW 528e and Mercedes 190E.

For a long time, the legendary BMW and Mercedes had no competition in America.

Now they've got more than they can handle:

	0 TO 50	SLALOM	CORNERING	BRAKING
LEBARON GTS	5.63 secs.	6.20 secs.	.861 G's	136.25 ft.
MERCEDES 190E	6.83 secs.	6.35 secs.	.829 G's	137.87 ft.
BMW 528e	7.14 secs.	6.56 secs.	.814 G's	140.18 ft.

Chrysler LeBaron GTS overwhelms the German cars when you equip it with turbo, sports handling suspension and fifteen-inch wheels.*

The GTS accelerates convincingly faster, corners comfortably better, handles the slalom

significantly quicker and stops reassuringly shorter than both the Mercedes Benz 190E and the BMW 528e. (Results of United States Auto Club tests.)

There's one more event the GTS dominates: the bottom line. GTS is priced under \$12,000.** And for good measure, it's backed by the Chrysler 5-year or 50,000-mile Protection Plan.†

If you've been holding out for an American hero, it's here.

Buy or lease at your Chrysler-Plymouth dealer. Buckle up for safety.

LEBARON **GTS**



Division of
Chrysler Corporation

THE COMPETITION IS GOOD. WE HAD TO BE BETTER.



*Overall results of USAC tests vs. standard equipped competitive test models. **Sticker price as shown. Title, taxes extra. Limited warranty. Restrictions apply. Excludes leases. See copy at dealer.

The SOTA Star Sapphire's isolation from high-level sound is remarkable, proving its suspension is very effective.

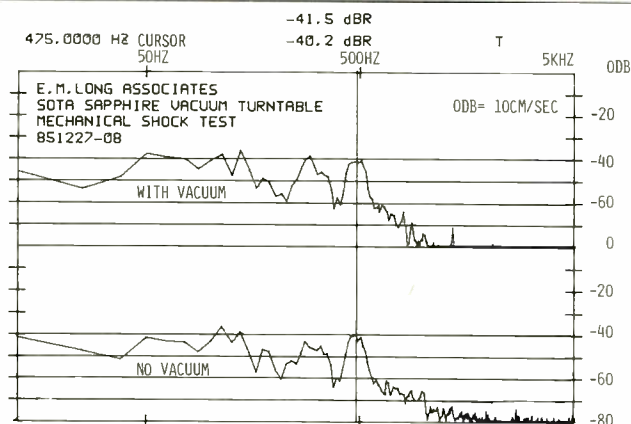

Fig. 8—Spectrum (to 5 kHz) of impulse shown in Fig. 7, with vacuum applied (upper curve) and without (lower curve). Isolation from external vibrations is excellent.

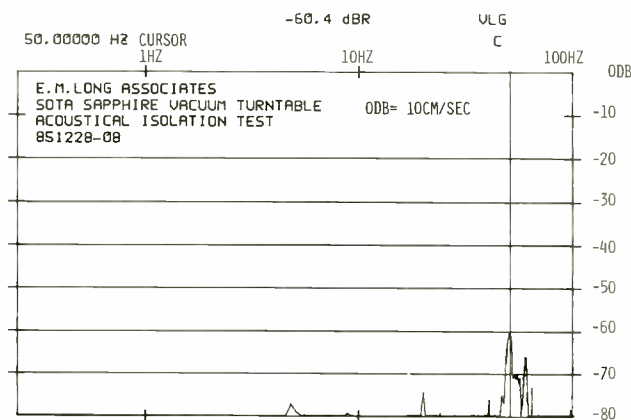

Fig. 9—Spectrum (to 100 Hz) of vibrations from a 100 dB SPL acoustic field at the surface of the record. Stylus was resting in a groove near the middle of the record. Isolation from the acoustic field is extraordinary.

became apparent that the sound from the SOTA with its vacuum was more real than that from the reference system, and in a very convincing way. The reference system has a good record-clamping system which gives good standing-wave energy removal, but it is no match for the SOTA Star Sapphire's vacuum clamping system.

Figure 7 shows output versus time for a mechanical shock applied to the platform upon which the turntable and base rested. The upper curve is with the vacuum system operating, and the bottom curve is with the vacuum turned off. The difference is due to the fact that when the vacuum is released, the record tends to be held away from the turntable platter by the rubber sealing ring which circles the edge of the acrylic damping disc. The spectrum data shown in Fig. 8 is for the same conditions as the time data in Fig. 7. Both with and without vacuum, the energy below 500 Hz is very low in level (shown in Fig. 8) and is quickly dissipated (Fig. 7). The interesting information brought out by these measurements is that the rubber sealing ring must be seated very carefully around the periphery of the record. This will prevent the ring from causing audibly bad effects in the reproduced sound.

Figure 9 is interesting because it shows almost nothing! It is the spectrum of the energy picked up by the stylus, resting in a stationary groove near the middle of a record, while a slow 20 to 100-Hz sweep from an oscillator produced an acoustic level of 100 dB SPL at the surface of the record. The data shown was measured with the turntable's lid open. I also ran the test with the lid closed, to check for any possible cavity resonance effects; the data was essentially identical to that shown. The isolation of the SOTA Star Sapphire from nearby high-level sound is remarkable and indicates that its suspension system and high mass are very effective.

Conclusions

I found that sorting through the listening panel's comments and checking the final scores that were given to the SOTA Star Sapphire and the reference turntables while they reproduced various types of program material were more interesting than usual. This seemed to be due mainly to the difference in sound quality produced by the vacuum clamping system. At first, there were contradictions in some of the comments and in the choice of which system was more satisfactory, but this changed as the tests progressed.

The Electronic Flywheel power-line conditioner was used with the SOTA Star Sapphire, but since the a.c. power line in my lab is generally very stable and free of radio frequency interference, I cannot find any specific correlation with its use. I have no doubt, however, that if you have problems with the purity of the a.c. line, the Electronic Flywheel would be a very good solution.

If you like a bright, forward quality to reproduced sound, you may not take to the SOTA Star Sapphire right away. I am convinced, however, that if you are seeking the most realistic reproduction of sound from analog records, you will like the extra clarity afforded by the vacuum clamping system. Also, the retrofitting of the new vacuum clamping system to already excellent, older SOTA Sapphire turntables is certainly very worth the cost.

Edward M. Long

NEC's digital
experience here...



brings you a better
digital experience here.



When you put a satellite in orbit, you want every possible assurance that it will perform. That's why corporations and governments all over the world ask NEC to build their satellites.

Even if you don't launch objects into outer space, it's comforting to know that NEC puts much of our satellite PCM digital technology into our Compact Disc players for the home.

While most high fidelity companies have only two or three years of experience with PCM digital audio, NEC has been at it since 1965. So it comes as no surprise that other manufacturers are now imitating the digital filtration and high-speed switching our CD players have had from the beginning. And it's no surprise that independent critics in America, Europe and Japan have awarded NEC's players top ratings.

You see, building satellites is not enough for NEC. We feel obligated to take the world's most advanced technology one step further. Into your home.

NEC

3

MAGNUM DYNALAB FT-101 TUNER

Manufacturer's Specifications

Usable Sensitivity: Mono, 10.3 dBf; stereo, 11.2 dBf.

50-dB Quieting: Mono, 13.2 dBf; stereo, 34.0 dBf.

Frequency Response: 20 Hz to 16 kHz, -3.0 dB.

S/N: Mono, 80 dB.

Alternate-Channel Selectivity: Wide-band, 55 dB; narrow-band, 75 dB.

Adjacent-Channel Selectivity: Wide-band, 6 dB; narrow-band, 20 dB.

Image Rejection: 75 dB.

Capture Ratio: 1.5 dB.

AM Suppression: 70 dB.

Wide-Band THD: Mono, 0.1%; stereo, 0.18%.

Wide-Band Separation: 60 dB at 1 kHz.

Antenna Input: 75 ohms.

Power Requirements: 120 V a.c., 75 watts.

Dimensions: 19 in. W x 3 $\frac{3}{4}$ in. H x 13 in. D (48.3 cm x 9.5 cm x 33 cm).

Weight: 12 lbs. (5.4 kg).

Price: \$549.

Company Address: c/o Castle Marketing, P.O. Box 219, Alexandria Bay, N.Y. 13607.

For literature, circle No. 93



As a long-time devotee of FM, I must say right up front that the Magnum Dynalab FT-101 tuner gave me a delightful couple of days of experimenting, measuring, and listening. After all the gadgets—the countless models with more and more presets, frequency synthesis, remote control, and anything else that imaginative marketers have dreamed up—it was nice to encounter a tuner whose main function is to receive FM stations reliably and with good sound quality.

Finding such features as a center-tune meter, a multipath meter, and a well-calibrated signal-strength meter (one that doesn't hit the peg at the top of the scale when a signal of

50 μ V or more is received) was, as one of my associates put it, like a breath of fresh air. Add to this the almost unheard-of gift accessory of a legitimate indoor antenna that comes with each FT-101 (instead of the usual limp piece of 300-ohm transmission line shaped into a T-bar), and I began to feel that here was a little company that really cares about their customers—and about high-quality FM. All of this is so commendable that I am ready to forgive the fact that this fine tuner did not meet some of its published specifications.

Analog tuning is not so common these days, but there are several good reasons for using it. Magnum Dynalab points

“Light my Lucky.”



SURGEON GENERAL'S WARNING: Cigarette
Smoke Contains Carbon Monoxide.

Lights: 8 mg. "tar", 0.7 mg.
nicotine av. per cigarette by FTC method.

Analog tuning is not all that common these days, but there are some good reasons why Magnum has used it in the FT-101.

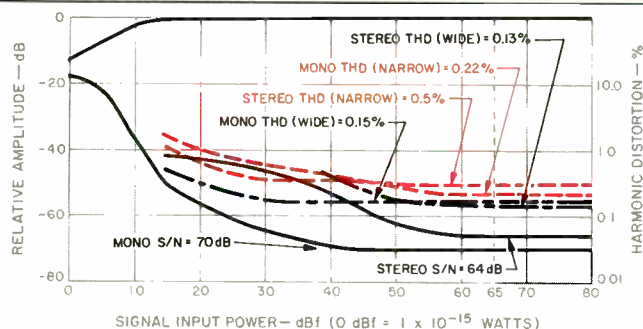

Fig. 1—Mono and stereo quieting and distortion characteristics.

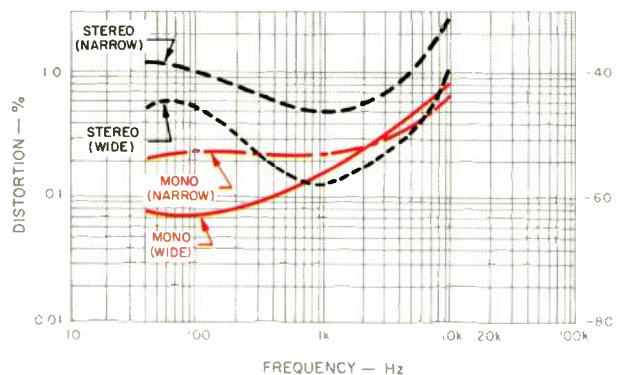

Fig. 2—THD vs. modulating frequency.

ing able to tune continuously, instead of in 200- or even 100-kHz increments, is a definite advantage in such instances.

Some minor errors in the six-page owner's manual are easily counterbalanced by the obviously sincere motives and dedication of the people at Magnum. I got the feeling that these people care more about delivering an honest product than about their quarterly or annual financial report. Long may they survive!

Control Layout

The 19-inch front panel of the FT-101 tuner is notably devoid of needless pushbuttons, lights, knobs, and fluorescent displays. At the left of the panel are five small toggle switches: A power switch, all by itself, and four others arranged in a vertical row. These handle mono/stereo selection, wide and narrow i.f. modes, a.f.c., and muting. A center-tune meter is fittingly positioned dead-center on the panel; it is flanked by a multipath meter at the left and a signal-strength meter at the right. The one concession to the "digital" age is a four-digit frequency display located below the center-tune meter. Just to the right of the display, below the signal-strength meter, is a "Stereo" indicator which lights up when a stereo signal is received. The only remaining control is a rotary (yes, I said rotary) tuning knob coupled to a nice flywheel for that old-fashioned, smooth tuning feel, albeit without the old traveling dial pointer. There is, incidentally, an FT-101R version that is rack-mountable.

The FT-101's digital frequency display is simply derived from the continuously variable local-oscillator frequency. A three-stage r.f. MOS-FET front-end is employed, and separate i.f. configurations are used for the narrow and wide i.f. modes. With their regular owner's manual, Magnum sent along an interesting bulletin which recommends that users keep the a.f.c. switch off if they live in an area with signal "congestion." As Magnum sees it, a.f.c. does not "lock onto" signals but rather indirectly broadens the pass-band of the tuner. I agree with them up to that point, but then they go on to say that keeping the a.f.c. off "will allow a distant station that is drifting slightly due to atmospheric to be received without unnecessarily bothering the FM-stereo 'blend' or the 'mute' circuitry." Well, that's the first time I've ever heard of "atmospherics" causing a station to drift! What they're apparently referring to is fading or fluctuation in signal strength when the signal is received by ground wave.

A word about the indoor FM antenna packed with each FT-101: In a way, it's almost as interesting as the tuner that it augments. Cleverly constructed of a flexible metal band similar to the metal strip used in those familiar pocket tape measures, the antenna is so assembled that you can pull up on the center of the metal band and thereby reduce the lengths of its two "dipole" rods. The business ends of the metal band remain rigid and extended, and the entire assembly can be rotated for best reception of a desired station signal. The "DX Silver Ribbon" antenna is not manufactured by Magnum but is imported by them for distribution in Canada and the U.S. (They sell it separately as well as supplying it with the tuner.) Since the FT-101 is equipped only with a 75-ohm input, Magnum provides a 300/75-ohm transformer for use with their indoor antenna or with any other 300-ohm antenna system.

out that a slight off-station adjustment can sometimes reduce interference (from adjacent-channel signals) and still leave the listener reasonably clean reception. An early spec sheet (since revised) discussed the problem of stations transmitting off their assigned broadcast frequency, a problem which, I gather from the company, may be more common in Canada than in the U.S. Here, where FM broadcast stations are required to be right on frequency (within a few Hz), many cable TV companies use FM-band carriers for stereo soundtracks to accompany their video programs. These carriers are often on nonstandard frequencies, which frequency-synthesized tuners cannot receive properly. Be-

AKAI FOR LIFE'S GREAT PERFORMANCES.™



The most beautiful music in the world begins with three simple words: To. Without. And.

These three simple commands make the new AKAI CD-A70 the most easily programmed CD player you can buy. At any price.

AKAI calls it Natural Logic Operation. And here's how it works.

To hear, for example, tracks 1 thru 9, while skipping 3 and 5, you simply enter the following: 1 To 9 Without 3 And 5.

It's fast, simple and foolproof. And the full-function wireless remote control lets you manage the CD-A70's talents from a more comfy command center. Like your couch.

Best of all, the performance

is flawless. Thanks to an advanced 3-beam laser pick-up. 16-track memory. A Random Play System. Digital filter. Subcode terminal.

Plus an insulated floating mechanism and special cabinet to eliminate resonance.

The AKAI CD-A70.

Nobody makes great performances easier to enjoy.

Visit your AKAI dealer soon for an audition. Or write to: AKAI America, P.O. Box 6010, Compton, CA 90224-6010. Enter No. 5 on Reader Service Card

The measured performance of Magnum's FT-101 tuner is respectable, even though it did not meet all its published specs.

Fig. 3—Frequency response (top traces), separation with weak-signal input (middle traces), and separation with strong-signal input (bottom traces), for wide-band (A) and narrow-band (B) i.f. settings.

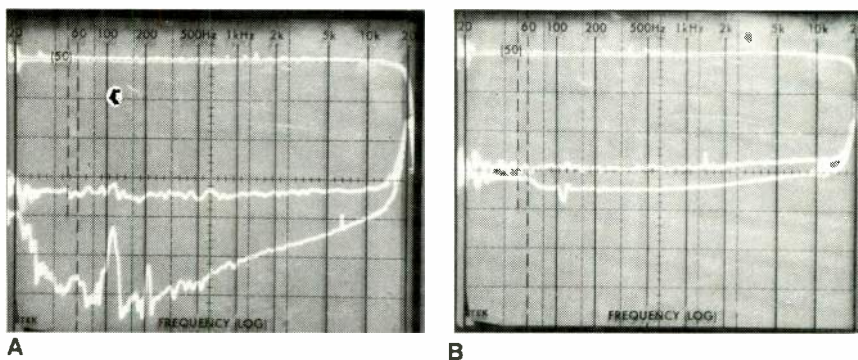
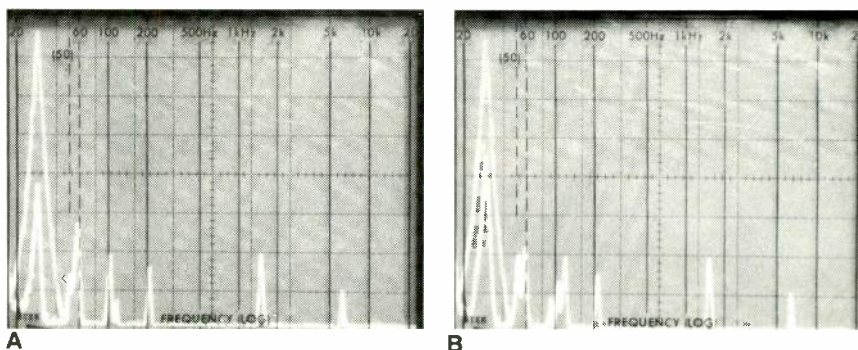

Fig. 4—FM stereo crosstalk and distortion components for a 5-kHz modulating signal in wide-band (A) and narrow-band (B) modes. Sweep is linear, 5 kHz/div.; ignore frequency notations on 'scope face.



Measurements

Though the tuner's performance was respectable, it fell short of meeting some of the manufacturer's published specs. Frankly, I have yet to test *any* tuner whose sensitivity actually measures 8.8 dBf, the figure on the FT-101's earlier spec sheet. The fact is that 8.8 dBf is approximately equivalent to 1.5 μ V across 300 ohms. If Magnum Dynalab had measured 1.5 μ V across the tuner's 75-ohm input, it would translate to 14.7 dBf, in which case the 12 dBf I measured on each of two samples tested would have been better than specified. (Incidentally, most measured data given here is for the second unit; the first seemed to be acting up and, we think, not representative of the breed.)

In any case, the revised specifications list only dBf figures, and I base my comparisons on these. Usable sensitivity in mono, rated at 10.3 dBf, measured 12.0 dBf. The stereo figure, specified at 11.2 dBf, measured 12 dBf. Sensitivity for 50-dB quieting in mono, specified as 13.2 dBf, measured 15 dBf. In stereo, it was rated at 34.0 dBf and was measured as 38 dBf.

Figure 1 shows mono and stereo quieting and distortion characteristics as a function of signal strength for both the narrow and wide i.f. modes. Note that the FT-101 deals with weak-signal stereo transmissions much as many car-stereo tuners do, blending the stereo channels together as the signals grow weaker to reduce background noise levels. This accounts for both the rather odd shape of the stereo noise curve in Fig. 1 and the surprisingly good figure I

obtained in stereo for usable sensitivity; at the very low signal levels involved in measuring this parameter, the stereo has been blended almost back to mono. The FT-101 is the first home tuner I have encountered which uses this design approach.

With strong signals, mono and stereo S/N were pretty much as expected and did not vary that much when I switched from wide to narrow i.f. modes. Distortion in wide-band, mono mode was 0.15%, close to the specified value (and better than the old specification). In stereo, also wide-band, distortion measured 0.13%. The fact that the stereo THD figure was a bit lower than the mono reading is not that unusual, but the first FT-101 I tested had lower distortion (0.2% mono, 0.18% stereo) in the narrow i.f. mode than in the wide mode (0.3% mono, 0.25% stereo). This is the opposite of what I would have expected, and I suspect that the first sample's alignment might have been slightly off. This may well have been the case, as the second unit's distortion did increase as expected in narrow-band mode (to 0.22% mono and 0.5% stereo), and its THD measurements were closer to Magnum's specifications. Figure 2 shows how harmonic distortion varies with frequency for both wide and narrow i.f. settings in mono and in stereo.

Figures 3A and 3B show frequency response and stereo separation. The plots in Fig. 3A were made with the tuner in the wide-band mode; in Fig. 3B, the narrow-band setting was used. In both cases, separation was measured with strong-signal inputs (bottom traces) and then at weaker

AKAI FOR LIFE'S GREAT PERFORMANCES.™

Only one thing justifies the price of admission. The performance.

The path to first-rate performance is paved with plenty of imposters. Which can be readily found on any corner.

First-rate performance can't.

Because like anything else of real value, it takes a little looking. With both eyes, and ears, wide open.

Which is how most audio/videophiles discover AKAI equipment.

And what they

soon discover is superb performance: In stereo-ready monitor/tv's. And innovative VHS Hi-Fi VCR's.

For the audio buff, high-speed MOS-FET amps and quartz-locked tuners. Sophisticated receivers. Fully-programmable CD-players with AKAI's Natural Logic Operation. Cassette decks

featuring AKAI's patented GX-heads guaranteed for over 17 years. Even complete audio/video home entertainment centers.

In short, a comprehensive line of components, systems and portables.

So write for a list of AKAI dealers. Because once you've found an AKAI dealer, you've found someone who truly values performance and quality as much as you do.

And that, all by itself, may well be worth the price of admission.



For more information and a list of AKAI dealers, write to: AKAI America, P.O. Box 6010, Dept. 1, Compton, CA 90224-6010.
Enter No. 6 on Reader Service Card

This home tuner is the first I've tested which uses the car-stereo technique of blending channels when the signal grows weak.

signal levels of around 40 dBf (middle traces) to demonstrate the "blending" effect used by Magnum. The blending is much more pronounced in the wide-band mode, simply because separation in this mode, with strong-signal inputs, is much greater to begin with. Stereo separation was one characteristic that did exhibit the expected pattern when switching from narrow-band to wide-band i.f. modes. Frequency response (top traces) was exceptionally good, varying by no more than ± 0.2 dB from 30 Hz to 15 kHz.

Figures 4A and 4B show distortion and crosstalk products that appear at the unmodulated channel's output when a 5-kHz signal modulates an r.f. carrier to 100%. These photos confirm my earlier findings—that distortion was actually worse in the wide-band mode than it was in the narrow, and that separation was somewhat better in the wide-band mode, as one would expect.

Muting threshold measured 11 dBf, and, although there was no clear stereo threshold because of the blending system, the stereo indicator light turned on for signal inputs as low as 5 dBf.

Alternate-channel selectivity in the narrow- and wide-band modes was almost precisely as claimed, and I was particularly impressed by Magnum's ability to achieve 30-dB adjacent-channel selectivity while maintaining adequate bandwidth for relatively low-distortion reception in the narrow i.f. mode. AM suppression measured 58 dB, as against

the 70 dB claimed, and image rejection was close to 80 dB, as opposed to 75 dB claimed. Capture ratio measured 1.5 dB, as claimed, and was substantially the same in both narrow and wide i.f. modes.

Use and Listening Tests

Despite its failure to meet certain published specifications, the Magnum Dynalab FT-101 sounds good and is easy to use. The center-tune meter moved to dead center when signals were tuned precisely to lowest distortion reception. The multipath meter, unlike many such indicators, did move to a minimum reading when my outdoor antenna was oriented for minimum audible multipath effects. As I indicated earlier, the FT-101's signal-strength meter is calibrated so that a listener can get a meaningful idea of actual signal strengths.

The FT-101 will not appeal to everyone. To some, the very simplicity of its front panel might imply a lack of sophistication on the inside. Indeed, if you were to open the top cover of the tuner (as I did), you might be put off by the fact that much of the space inside is empty. Nevertheless, on the basis of its sound and engineering, I do not feel that the price of the FT-101 is particularly out of line. All of which proves that purist audio products don't have to be priced so high that the very people who appreciate them most can't afford them.

Leonard Feldman

KRAV-FM cleans its valuable library of compact discs with Discwasher.[®] They must know something.



Charlie Derek, Station KRAV-FM.

With one of the largest compact disc collections in the country, Radio Station KRAV knows it has to clean CDs because it can't afford playback tracking problems. And a dirty compact disc will distort the sound by blocking or scattering the CD player's laser beam.

Station KRAV also knows that the new Discwasher Compact Disc Cleaner provides *true radial cleaning*—the only right way to clean a CD according to manufacturers. You'd expect a superior product from Discwasher, the leader in audio care.

To keep the near perfect sound of your CDs, take your cue from the experts: clean them with the Discwasher Compact Disc Cleaner. Get Discwasher's Guide to Compact Disc Care from your dealer or by writing to Discwasher.



New discwasher[®] Compact Disc Cleaner

The only right way to clean a compact disc.

© 1985 Discwasher
A DIVISION OF INTERNATIONAL JENSEN INC.

4309 Transworld Road, Schiller Park, IL 60176

"Knew you'd be a vision in white
How'd you get those pants so tight?
Don't know what you're doin'
But you must be livin' right
We got some places to see
I brought all the maps with me
So jump right in...Ain't no sin
Take a ride in my machine
City traffic movin' way too slow
Drop the pedal and go...go...go
Goin' ridin' on the freeway of love
Wind's ag'in' your back
Goin' ridin' on the freeway of love
In my pink Cadillac"

FREEWAY OF LOVE
Aretha Franklin

MAXELL. THE TAPE THAT LASTS AS LONG AS THE LEGEND.

She's traveled the highway from gospel singing sister to the reigning Queen of Soul. Fueled by a big powerful voice and a big joyous heart. Maxell audio tapes are created so that you can have a permanent record of that long journey, now and in the years to come. At Maxell every tape is manufactured to standards 60% higher than the industry calls for. So even after 500 plays the genius that is Aretha will thrill you just like it did when you first heard it, tooling down your very own freeway of love. **maxell**



4

DENON DCD-1500 COMPACT DISC PLAYER

Manufacturer's Specifications

Frequency Response: 5 Hz to 20 kHz, ± 0.3 dB.

Dynamic Range: 96 dB.

S/N Ratio: 96 dB, A-weighted.

THD: 0.0025% at 1 kHz.

Channel Separation: 95 dB.

Number of Programmable Selections: 20.

Output Level: Fixed, 2.0 V rms; variable, 0 to 2.0 V rms.

Dimensions: 17½ in. W x 3½ in. H x 14 in. D (44.5 cm x 8.9 cm x 35.6 cm).

Weight: 13.2 lbs. (6 kg).

Price: \$629.95; wood side panels, \$30 per pair.

Company Address: 27 Law Dr., Fairfield, N.J. 07006.

For literature, circle No. 94



With so many low-cost CD players now available, I think a lot of us tend to forget that there are several companies which still offer a wide variety of CD players in *many* price categories. The higher priced units often deliver more than just increased programmability, remote control, and other convenience features; some actually provide better sound when compared with their lower priced counterparts. Denon's DCD-1500 is such a CD player. It does indeed offer a wireless remote control (which operates virtually all of the front-panel functions, plus volume) as well as full random programming of up to 20 selections. Certainly it provides several repeat-play modes and a display area that tells you just about everything you need to know about the player's operation. Still, my own enthusiasm for the DCD-1500 stems more from its circuitry and sonic performance than from its admittedly advanced and easy-to-use operating features. More about the sound quality of this excellent machine shortly; first, let's take a look at its superb ergonomics.

Control Layout

A slide-out drawer with its "Open/Close" pushbutton is at the upper left of the front panel; below the drawer is a "Power" on/off button. A large, well-illuminated, and easy-to-read display area to the right of the disc drawer indicates track and index numbers, time elapsed (or remaining time), presence or absence of a disc, and programmed track numbers (from 1 through 20). Below the display are separate pairs of pushbuttons for track skipping (forward and reverse) and for audible search in either direction.

A pushbutton labelled "Index" and another called "Program & Direct" are used, together with 10 numbered keys, to call up specific tracks or indexed passages for immediate play, or to enter up to 20 tracks for programmed play. A pushbutton labelled "+10" facilitates accessing track numbers above 10; if you wanted to play track 28, for instance, you would touch the "+10" button twice, then the "8" button, and then either the "Play" button or (if you were storing the command in the program memory) the programming button. A large "Play" button, along with "Pause" and "Stop," are to the right of the number keys. Still further to the right are buttons which activate the various repeat-play modes (track, entire program, or entire disc), clear a program from memory, recall previously programmed information, and switch from an elapsed-time to a remaining-time display. A timer-start switch, also at the right of the panel, allows the DCD-1500 to be turned on or off by an external timer.

At the lower right corner of the panel are a stereo phone jack and a level control for the phone output signal. The rear panel is equipped with the usual left and right output jacks as well as a subcode output jack for use with video-graphics adaptors when they become available to consumers, sometime in the near future.

Measurements

Frequency response for the Denon DCD-1500 (Fig. 1) was extremely flat, deviating from perfect flatness by no more than +0.2 and -0.4 dB from 20 Hz to 20 kHz. Total harmonic distortion at 1 kHz for a 0-dB (maximum recorded level) test signal was 0.004%. What's remarkable about the

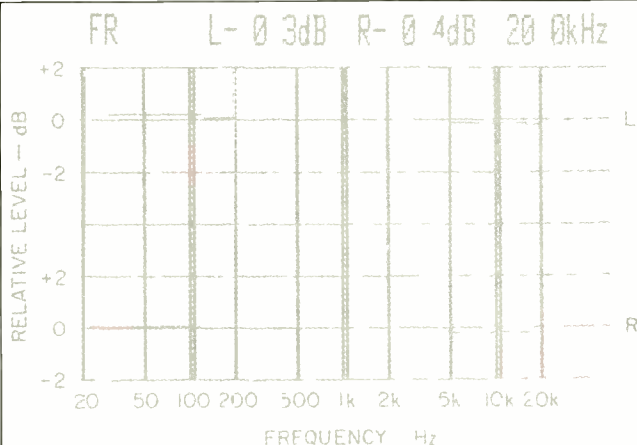

Fig. 1—Frequency response, left (top) and right channels.

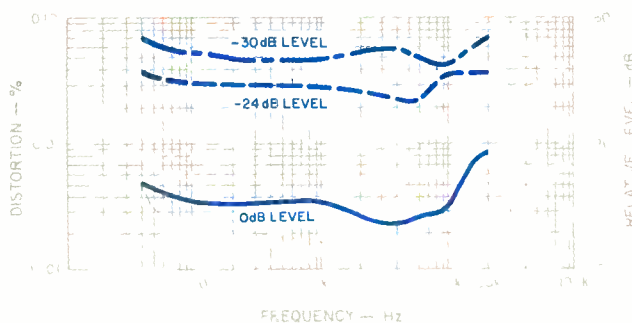

Fig. 2—Distortion vs. frequency at three recorded levels.

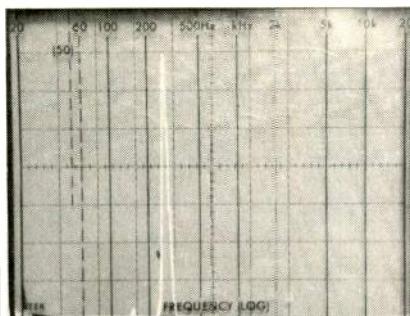

Fig. 3—Spectrum analysis of 20-kHz test signal shows no out-of-band components other than a minute "beat" at 16 kHz.

The outstanding separation indicates careful layout of analog output stages and complete independence of left- and right-channel D/A conversion systems.

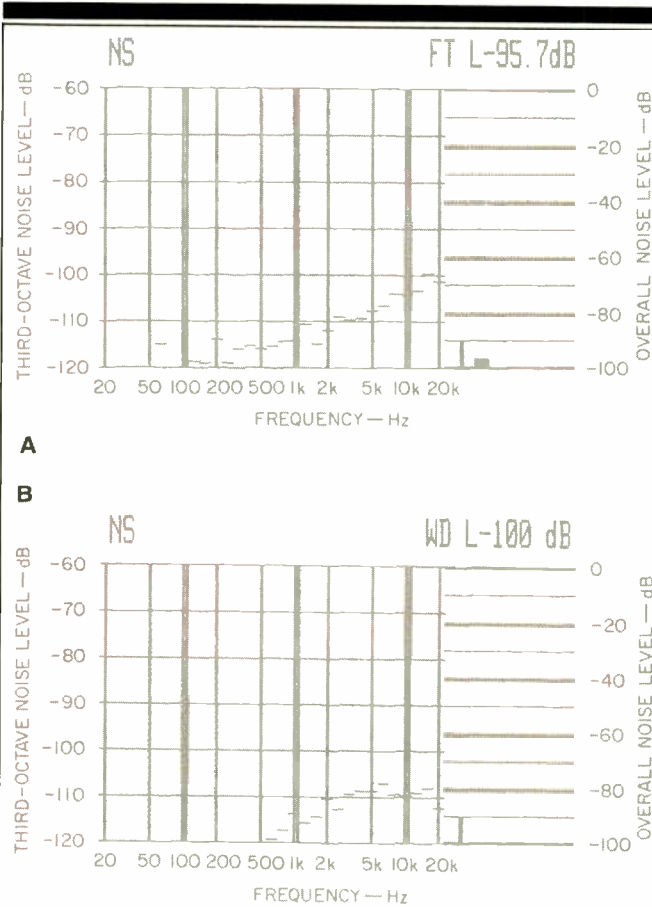

Fig. 4—S/N analysis, unweighted (A) and A-weighted (B).

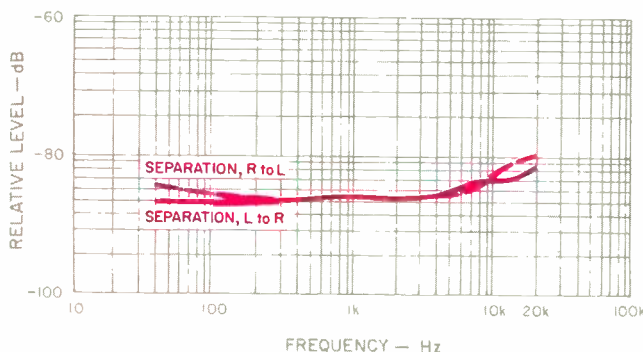

Fig. 5—Separation vs. frequency.

distortion characteristics of this player is that even at the high-frequency extreme, where I normally have to introduce a low-pass filter to obtain meaningful THD measurements, the readings on my distortion analyzer remained unusually low (see Fig. 2). The significance of this can best be appreciated if you refer to Fig. 3. In this 'scope photo of a spectrum-analyzer sweep (which is linear, from 0 Hz to 50 kHz), you can see a reproduced 20-kHz signal, but that's all you see, aside from a very minute "beat" at around 16 kHz. There were absolutely no out-of-band components visible outside the audio spectrum. It's been a long time since I obtained such a clean sweep (pardon the pun) when making this test on CD players; the last two players I tested that exhibited this kind of clean, spurious-noise-free out-of-band output were the Pioneer PD-9010X and the Sony CDP-620ES. Most other players usually produce an out-of-band beat at around 24 kHz when reproducing the high-level 20-kHz signal. I'm not saying that the absence of such out-of-band beats results in improved sound quality, but I'm beginning to wonder whether there isn't some sort of subtle correlation. The fact is that the Denon DCD-1500 did sound remarkably smooth and clean during my listening tests, but I'll get to that presently.

Figure 4A shows an analysis of unweighted signal-to-noise ratio; it measured 95.7 dB, almost as good as the weighted S/N claimed by Denon. When an A-weighting network was added to the measurement, as shown in Fig. 4B, S/N improved to an even 100 dB, several dB better than claimed by the manufacturer.

Stereo separation was outstanding too. Notice, in Fig. 5, how it remains almost as good at the high-frequency extreme as it is at mid- and low frequencies. Most CD players I've tested recently tend to offer much-reduced separation at high frequencies. In the case of the DCD-1500, separation remained above 80 dB even at 20 kHz. Maintaining this kind of separation involves careful layout of the player's analog output stages as well as complete independence of the digital-to-analog conversion system for left and right audio channels.

Output linearity was excellent, remaining accurate to within 0.5 dB all the way from maximum recorded level down to 80 dB below that level. SMPTE-IM distortion measured a mere 0.002% at maximum recorded level, increasing to 0.01% at -20 dB recorded level. CCIF-IM distortion was an insignificant 0.003% at maximum recorded level and an even lower 0.0017% at -10 dB. That's as low as I've ever measured, and provides further proof of the nearly complete absence of any intermodulation distortion products generated by the combination of sampling frequency and program content.

As I might have guessed, wow and flutter was too low to be measured by my test instruments, and any pitch error that might be present was also too low to be measured by my frequency counter. De-emphasis networks, automatically switched in when pre-emphasized CDs are played, were accurate to within 0.3 dB. The only parameter that fell short of published specs was dynamic range, which, when measured in accordance with the recently approved EIAJ Standards, was 91 dB as against 96 dB claimed by Denon. It's entirely possible that Denon is measuring this specification

ANYTHING ELSE IS JUST UN-PROFESSIONAL



From Live Aid to Lincoln Center, top ten artists to top studio producers, JBL has been the #1 choice in professional loudspeakers for more than 40 years. Now the JBL "T" and "TL" series promise to make the star of stage, screen and studio, the star of car audio, too.

Rugged, reliable, automotive versions of JBL's professional equipment, the "T" and "TL" series are designed by the same acoustical engineers with the same attention to quality and performance.

"T" series loudspeakers feature high and mid-high frequency transducers made of pure titanium—the same titanium domes that are used in JBL's professional studio monitors. Titanium's high strength-to-weight ratio ensures clear, powerful highs without listener fatigue. And now, for the first time, you can get the benefits of titanium at a lower cost with the "TL" series' titanium laminated domes.

High polymer laminated and mineral filled polypropylene low frequency transducers, in the "T" and "TL" respectively, deliver smooth, uncolored, powerful bass response. They're remarkably resistant to the automobile's acoustically hostile environment. You'll get that smooth JBL response on the bumpiest roads, too. Cast aluminum mountings and die-cast frames resist twisting and buckling, even when mounted on uneven surfaces. Cones and voice coils are tightly aligned for consistently accurate musical reproduction and high power handling. The JBL "T" and "TL" series automotive loudspeakers. Once you've heard the professionals, you won't want anything else.

For more information and your nearest dealer call toll free 1-800-633-2252 Ext. 150 or write JBL, 240 Crossways Park West, Woodbury, New York 11797.



Pictured above, left to right are: The T95, T55, T65, and, the TL900, TL500, TL600.



A Harman International Company

With sound as good as any CD player I've tested so far, and a price a good deal lower than many, this unit is a winner in my book on every count.

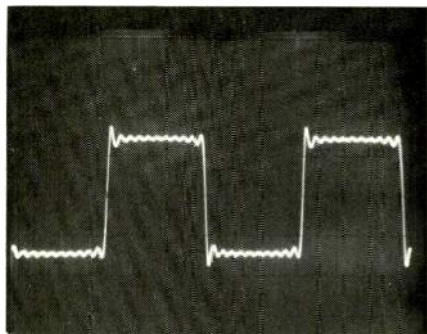

Fig. 6—Reproduction of a 1-kHz square wave.

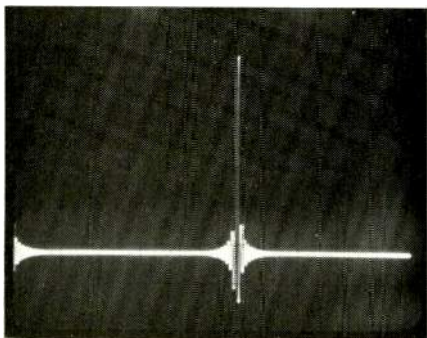

Fig. 7—Unit-pulse test.

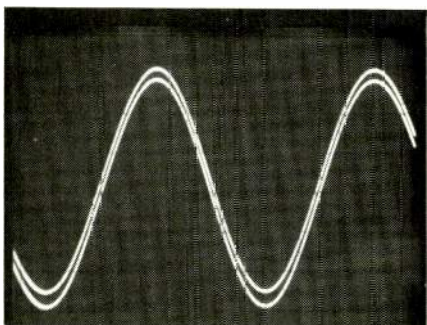

Fig. 8—Interchannel phase match when playing 20-kHz test tone shows that separate D/A converters are used in each channel.

in some other way. In any case, a dynamic-range capability of 91 dB is certainly nothing to be ashamed of, by anyone's standards.

Output level for the DCD-1500 measured 2.06 V on one channel and 2.08 V on the other, for a difference of 0.02 V. Denon employs 88.2-kHz oversampling and digital filtering prior to D/A conversion. This technique results in the extraordinarily clean and accurate 1-kHz square-wave reproduction shown in Fig. 6. What appears to be a minor amount of "ringing" along the top and bottom of the reproduced square wave is not ringing at all, but simply the absence of higher order harmonic components (above 20 kHz) that would be needed in order to yield a perfectly straight horizontal line here.

Figure 7 shows a reproduced unit pulse; its symmetry is consistent with what I have come to expect from CD players employing the type of filtration and oversampling used by the DCD-1500. As for the sine waves shown in Fig. 8, they are perfectly in phase with each other, indicating that Denon is using two separate D/A converters (one for each channel). This technique avoids the usual 11.3- μ S delay which occurs between channels when a single D/A converter is "multiplexed" to recover separate left and right signals.

I would have been very surprised if this superb player had not been able to play through my defects disc without any skipping or muting. In fact, it did play through the maximum width of the opaque wedge, the maximum-diameter dust simulation, and the simulated fingerprint smudge without so much as a hint that there was anything wrong with the test disc. It also successfully tracked a damaged disc that I keep around in the laboratory for just such rigorous testing—a disc that has been rejected by more than one CD player in the past.

Use and Listening Tests

I suspect that I am sometimes influenced by what I measure on the test bench when it comes time to judge a product's sound-reproduction qualities. I'm convinced that we can "psych" ourselves into hearing subtle qualities that we want to hear, or that we expect to hear. To me, the sound of the DCD-1500 seemed a shade better than what I have been hearing of late from several CD players whose measurements haven't been quite as good as this one's. I wanted to be sure that the measurements weren't prejudicing me, so I called in two friends who own CD players and asked them to bring their players along to my listening room. Without knowing when they were listening to their own players and when they were listening to the Denon, both of these friends preferred the sound of the DCD-1500 over that of their own.

I've always wanted to believe that, ultimately, there is a correlation between measured results and audible results—providing the right measurements are made. Happily, that contention held true in the case of the DCD-1500. It not only performed well on the bench and was easy to use via its remote control or via its front-panel controls, but it sounded as good as any CD player I have tested so far. What's more, its price is a good deal lower than that of some of my other favorite CD players. It is a winner in my book on every count.

Leonard Feldman

COMPUTERS HAVE TAKEN SOMETHING FROM YOUR MUSIC.



THE NOISE.

Computers have allowed EPI engineers to evaluate new aspects of speaker performance and push noise/distortion to an all-time low. The new computer-tested EPI Time/Energy Series speakers separate the instruments so you can hear the parts as well as the sum.



Their sound is crystal clear, uncolored and more natural than ever.

COMPUTERS DISCOVER THE MISSING LINK. Using computers,

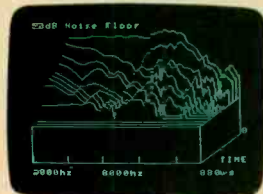

EPI engineers discovered that conventional speakers don't reproduce short signals cleanly. Since this

type of signal is particularly relevant to the ear's ability to recognize sound it was a profound discovery.

A NEW SOURCE OF DISTORTION. When conventional high quality speakers were tested with very short signals the computer showed they

continued to produce sound long after the signal had ended. We call this Time/Energy distortion.



CLOSER THAN EVER TO PURE SOUND. One discovery led to another and it didn't stop until EPI engineers had developed tweeter diaphragms and woofer cones made of new materials formed into new shapes. EPI engineers even developed a special bonding process and special tools and fixtures to laminate together the cone layers with an ideal combination of stiffness and damping. The result is



drivers that stop producing sound almost immediately after the signal from the amplifier ends. The benefits are distortion-free sound from solo instruments, and superb detail and a sense of separation from groups of instruments.

The EPI Time/Energy Series represents the most



dramatic improvement in the fundamental fidelity of our speakers in the entire history of EPI. Now we know what computers are good for.

EPI[®]
TIME/ENERGY SERIES

Epicure Products, Inc., Newburyport, MA 01950
(800) 225-7932 In MA (800) 892-0565
A Penril Company

5

SHURE SM91 MICROPHONE

Manufacturer's Specifications

Type: Unidirectional, surface-mounted electret condenser.

Frequency Response: 20 Hz to 20 kHz, at 30° incidence to infinite surface.

Polar Pattern: Half-cardioid (cardioid in hemisphere above mounting surface).

Output Impedance: Nominal, 150 ohms; actual, 90 ohms.

Output Level: -69.0 dB (0.35 mV) at 1 kHz (0 dB = 1 V/μbar, measured with sound source at 30° incidence to infinite surface).

Maximum SPL: 144 dB at 1 kHz, sound source at 30° incidence, 800-ohm load.

Hum Pickup: 16 dB equivalent SPL in 1-mOe field (60 Hz).

Output Noise: 23 dB SPL, A-weighted.

Phasing: Positive voltage at pin 2 with positive pressure on diaphragm.

Power: Two 9-V alkaline batteries (NEMA 1604A) for 300 hours continuous use, or 11 to 52 V d.c. simplex voltage (operational to 9 V d.c.); current drain, 1.8 mA.

Filter Response: In low-cut position, -12 dB/octave below 80 Hz; in flat position, -6 dB/octave below 30 Hz.

Cable: 7.6 meters (25 ft.), two-conductor, shielded, small diameter, between microphone and preamp; extendable to 75 feet with accessory cables.

Cases: Microphone, matte black enamelled die-cast base and perforated steel grille with replaceable or cleanable fine-mesh screen and foam-pad wind/dirt barrier; preamplifier, matte black enamelled die-cast aluminum.

Dimensions: Microphone, 3 $\frac{3}{8}$ in. W × 5 $\frac{1}{8}$ in. D × $\frac{5}{8}$ in. H (9.5 cm × 13 cm × 1.6 cm); preamplifier, 2 $\frac{3}{8}$ in.

W × 4 $\frac{3}{8}$ in. D × 1-1/16 in. H (6 cm × 11.1 cm × 2.7 cm).

Weight: Microphone, 9.3 oz. (263 grams), not including cable; preamplifier, 11.3 oz. (320 grams), including batteries.

Price: \$300.

Company Address: 222 Hartrey Ave., Evanston, Ill. 60204.

For literature, circle No. 95



This is my third review of a surface-mounted boundary microphone. The previous reviews (March 1983 and March 1985) described the Crown Pressure Zone Microphones (PZMs), which consist of a tiny, omnidirectional electret condenser capsule placed upside down, 1 mm from a metal plate. This assembly must be used on a large baffle surface for optimum results—at least 24 inches in diameter to obtain reasonably flat low-frequency response.

Since "PZM" is a trade name, competitors have used the terms "boundary" or "surface-mounted" to describe their own versions. It is not necessary for the transducer element of a boundary mike to be positioned upside down, as long as the input port or diaphragm is located within a few millimeters of the surface. The element should be small, about 10 mm in diameter. These dimensions pertain to music applications where uniform frequency response and polar pattern is required up to 15 kHz. For speech applications, the upper limit need be only 6 kHz, so these dimensions may be larger. Shure designed a boundary microphone for speech reinforcement applications long before the introduction of the PZM. It consisted of a cardioid element enclosed in a foam block, which was placed on a desk or table near the talker.

The boundary microphone is most convenient to use in applications where it can be placed on a natural boundary, such as a wall, floor, ceiling, or piano lid. If you need a stand-mounted mike, it makes more sense to use a conventional unit than to mount a large baffle on a stand with a boundary mike. An exception, in my opinion, is a "bipolar pair" stereo array (described in the March 1985 Crown review), which is a low-cost alternative to an expensive stereo microphone.

The omnidirectional boundary microphone has uniform pickup over a hemisphere, and therefore does not discriminate against ambient noise, particularly noises originating behind the microphone, i.e., in the direction opposite to the sound source. To provide discrimination, Shure has developed a directional boundary microphone, the SM91. The sound pickup pattern is a half-cardioid. To achieve uniform characteristics to 15 kHz, the SM91 uses a new electret condenser capsule only 10 mm in diameter. This capsule is mounted on its side rather than upside down. It is positioned close to the backing plate and protected by a foam and stainless-steel screen. Since floor-mounted mikes may get dirty, Shure has thoughtfully provided for easy disassembly and cleaning of the screens.

The microphone capsule includes an FET impedance converter. Up to 75 feet of cable may be used between microphone and preamplifier, including the 25 feet furnished plus a 50-foot extension. These cables are terminated with Switchcraft TA3F miniature three-pin connectors, which are readily available from electronic parts suppliers. The preamp input circuitry appears to be balanced and designed to reject stray r.f. picked up in the cable. This is a desirable feature for use in urban locations.

The SM91 is powered by the batteries in the preamp box or remotely from equipment having phantom power available. Battery power will satisfy most audiophiles, but response to earlier reviews indicates that some readers will want to use remote powering. As previously explained, two

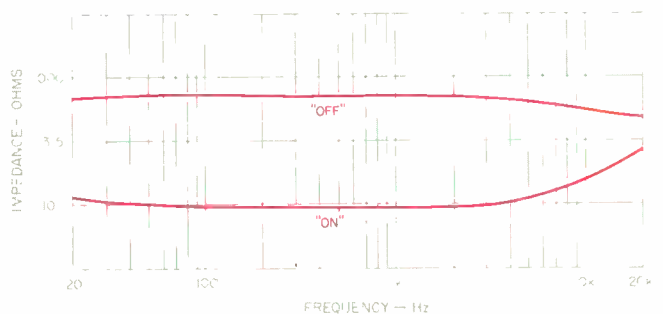

Fig. 1—Impedance vs. frequency, with battery power supply on (lower curve) and off (upper curve). Mid-frequency impedance with power on is 94 ohms; with power off, it is 680 ohms, still low enough to properly load preamp or mixer inputs. Note that the impedance scale is logarithmic.

kinds of remote power schemes, phantom and A-B, are in use today. The SM91 uses phantom power, though Shure's Technical Data Sheet refers to it throughout as "simplex" power ("phantom" is used parenthetically in one place). Shure says this is a telephone-company term, but in communications usage (and in my dictionaries of electronic terms), "simplex" refers to radio transmission and reception on a single frequency. One term should not have two usages within the field of electronics, I believe.

I have described electret condenser and boundary microphones in the *Journal of the Audio Engineering Society* (July-August 1985) and have previously reviewed two Shure electret microphones in *Audio* (the SM81 in August 1980 and the SM85 in May 1982).

Measurements

Figure 1 shows the measured impedance characteristics. The impedance with power on, 94 ohms at 1 kHz, agrees with specifications. (The mike's 680-ohm impedance with power off is still a suitable termination for microphone input circuits.) The inductive rise at 20 kHz with power on raises some questions as to optimum load impedance for best transient response, lowest noise, and minimum sensitivity to stray r.f. pickup. For my simple tests, I used an "unloaded" 150-ohm input of a professional-grade preamp. Shure specifies a minimum load of 800 ohms, so some experimentation with loads might be in order for critical applications.

The acoustical testing geometry for boundary microphones is not standardized, and as explained in previous reviews, I have devised my own methods which I think come close to conforming with EIA Standards for testing conven-



The Best of Both Worlds.

You can have it all: sophisticated, state-of-the-art speaker technology and the finest handcrafted European styled enclosures. Best of all, speaker designs of uncompromising performance and beauty are now available at a price anyone can afford.

DALI'S commitment to excellence begins with a computer-conceived theoretical model. Real world engineering takes over from there, following an intensive process of driver complement optimization, crossover design, and critical evaluation, sparing no expense until we've obtained the best possible system.

Each DALI speaker is also painstakingly finished in select, handrubbed hardwood veneers in the best tradition of Danish furniture craftsmanship. The result is a speaker line that looks as dramatic as it sounds.

For a DALI demo and presentation, or for more information on all DALI products please contact the **DALI Representative** in your area, or call toll-free **1-800-251-DALI** (in California **305-252-7203**).

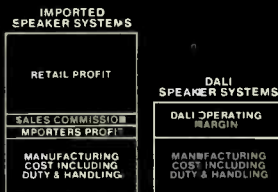

DALI RETAIL PRICES

CALIFORNIA

Doug DeGroot
(415) 494-3612

John Filippone
(213) 414-0144

Rimas Butkys
(818)288-2403

Tu Nghiem
(408) 248-7266

John Schreck
(408) 942-8133

Tom Tiseo
(213) 393-2956

Andrew C. Victor
(619) 375-2375

CONNECTICUT

Mark Dicorpio
(203) 756-8164

FLORIDA

John Cudrik
(904) 371-6587

Rene Lima
(305) 266-1897

GEORGIA

Mark Mancinelli
(404) 925-2704

ILLINOIS

Dave Brownell
(312) 964-7160

INDIANA

Dave Jacobs
(317) 846-1922

Kampol
Surapiboonchai
(309) 454-8291

Randy Toth
(317) 257-3494

IOWA

John A. Everett
(515) 752-3899

LOUISIANA

Clint D. Hamilton
(504) 272-1468

Louis Huth
(504) 242-5441

MICHIGAN

Jeffrey S. Buhl
(313) 666-4080

MISSISSIPPI

Jerold B. Sit
(601) 924-3950

MISSOURI

Stanley Curtis
(314) 426-6856

NORTH CAROLINA

Ron Hunter
(704) 438-4509

NEW JERSEY

Frank Cicetti, Jr.
(201) 348-7384

Robert M. Kearns
(201) 794-6634

Roy Locke
(201) 794-6634

NEW MEXICO

James Brogan
(505) 988-5674

Al Cannon
(612) 433-2898

NEW YORK

Chris Christiansen
(516) 775-3848

Curtis Hucks
(718) 624-6602

Rosen Matthew
(212) 926-3621

James F. Peters
(607) 535-4007

OHIO

Wael Elsakka
(216) 321-5379

OREGON

Bobbie Lo
(503) 344-9819

PENNSYLVANIA

John C. Vilsack
(412) 327-1179

Barry Hecht
(215) 923-2226

SOUTH CAROLINA

Jeff Byess
(803) 781-4152

Harlan Goerman
(803) 293-3338

TENNESSEE

Harlan Richter
(615) 847-8394

VIRGINIA

Bryan Jackson
(804) 422-5904

WISCONSIN

Gerald R. Kitchin
(414) 744-6496

DALI

Danish American Ltd., Inc.
P.O. Box 55386
Valencia, CA 91355

Name _____
Address _____
City _____
State _____ Zip _____
Phone (_____) _____

The SM91 is a directional boundary mike, which discriminates against ambient noise better than omnidirectional PZMs.

tional mikes. The geometry I used for testing the frequency response of the SM91 with various directions of sound incidence is shown in Fig. 2. You must visualize the polar pattern of any microphone as a three-dimensional "figure of revolution." In the case of the SM91, imagine that the two-dimensional cardioid shown in Fig. 2A is revolved 360° about its axis. Then, the plane surface of the wood baffle cuts the 3-D cardioid in half. I measure the responses of a conventional, cylindrical mike with a circular diaphragm in only one plane, the horizontal. Because of symmetry, the mike can presumably be rotated in its mounting without changing these responses. My acoustic tests consist of measuring frequency response at various angles of incidence. If these stripcharts were recorded at many angles, one could plot polar diagrams at selected frequencies. A boundary mike requires response tests in one or more half-planes orthogonal (perpendicular) to the boundary plane.

The omnidirectional mikes previously reviewed were tested in only one half-plane for angles from 0° to 90°. The 0° axis was perpendicular to the baffle. Because of symmetry, three curves (0°, 45°, and 90°) were adequate to describe the performance.

Figure 2 shows that the SM91 requires tests in two orthogonal vertical planes. For clarity, I refer to one plane as "longitudinal" because it is aligned with the principal axis of pickup (Fig. 2A). The other (Fig. 2B) is called "transverse" because it is at right angles to the principal axis. Shure defines the angle or direction at which frequency response is measured as being theta and being 30°. If the SM91 is visualized as being on a stage apron, then an included theta angle of 0° to 90° would include all of the upstage-downstage sound sources. The audience noise and reverberant sound sources would lie at an included angle of 90° to 180°, and presumably would be attenuated. If the mike is connected to a sound-reinforcement system, these angles would include reflected amplified sound, which should be attenuated to minimize feedback.

The transverse plane includes sources to stage left and right. Note that this plane intersects the longitudinal plane where theta equals 90°. An inclined transverse plane intersecting where theta equalled 30° or 45° might have been a better choice for my tests, but this would have been too difficult to set up because the heavy-duty pipe stand required to support the massive baffle had no means to rotate the baffle about a horizontal axis, but only allowed rotation about a vertical axis. In all tests, the sound source remained in a fixed position while the baffle and mike were rotated.

I used angular increments of 45° for theta and alpha. Values of theta were: 0°, 45°, 90°, 135°, and 180°. Values of alpha were: 0° (same as theta being equal to 90°), 45°, and 90°, in one quadrant only because of symmetry. Shure defines theta being equal to 30° as the principal axis for response testing. It is of little concern that I omitted 30°, because the 0° and 45° response curves which I measured are smooth, parallel, and not too different from Shure's 30° curve.

The previous reviews of boundary mikes showed that my sensitivity data were 6 dB higher than the manufacturer's because of a difference in calibration procedure. They calibrated the SPL at the baffle surface, but I calibrated free-

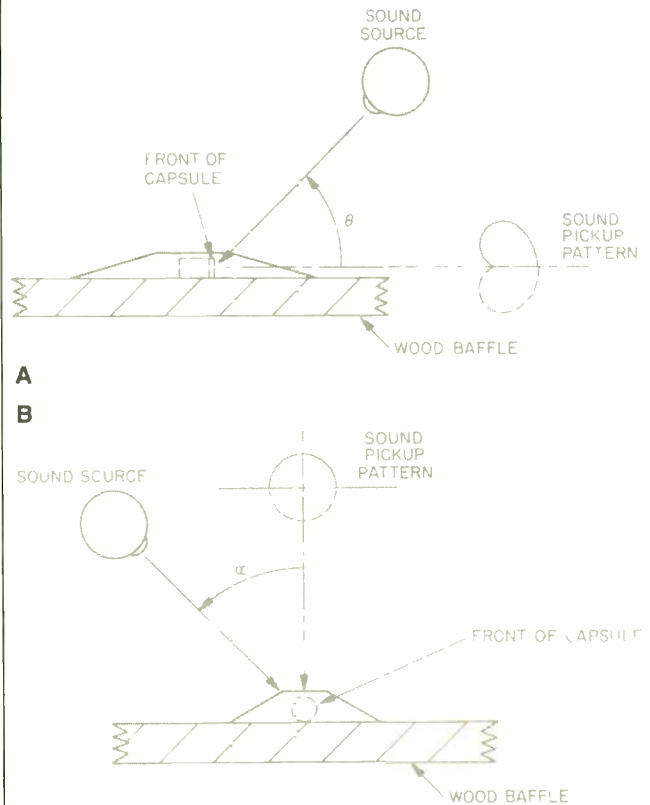

Fig. 2—Geometry of sound tests for a directional boundary microphone in longitudinal (A) and transverse (B) vertical planes.

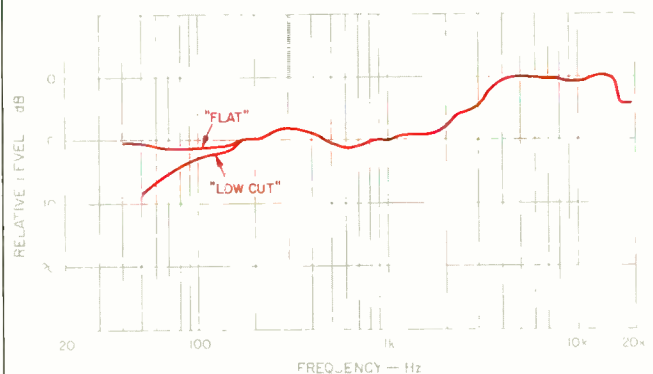

Fig. 3—Frequency response on pseudo-infinite baffle (0 dB equals -61 dBV/Pa).

There is no bass boost due to proximity effect; the response at 6 inches is much like the curves I obtained at 6 feet.

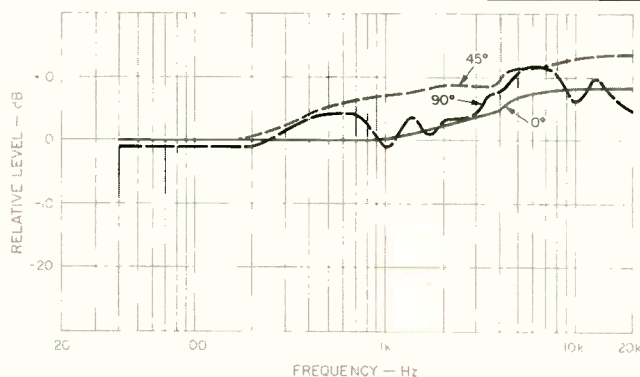

Fig. 4—Front-hemisphere frequency response for three longitudinal vertical angles, with microphone outdoors on 24-inch baffle at 6-foot distance (0 dB equals -61 dBV/Pa).

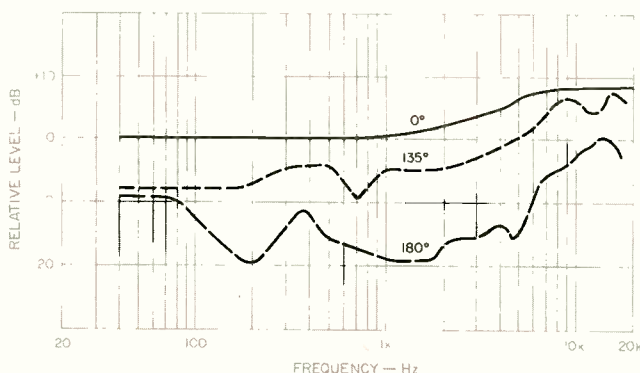

Fig. 5—Rear-hemisphere frequency response for three longitudinal vertical angles, under same conditions as Fig. 4.

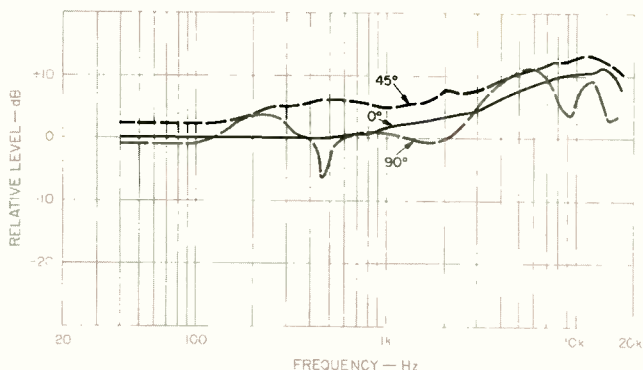

Fig. 6—Same as Fig. 4, but with microphone on 48-inch baffle.

space SPL prior to the introduction of the baffle. In addition to being easier to do, my procedure, I believe, follows EIA Standards.

The first response tests were conducted indoors, using a 2-inch-diameter precision sound source, with the mike and 24-inch square baffle only 6 inches away and oriented so theta was 90°. In previous reviews, I found that this produces the smoothest response curve for boundary mikes because it minimizes the wiggles due to reflections at the baffle edges. The reason is that, in the case of a 24-inch baffle, the reflected sound path is greater than 2 feet, compared to the 6-inch direct sound path. The results are similar to what one would expect from a large surface such as a floor or wall; hence the term "pseudo-infinite baffle response." The PZM microphone manufacturer conducted a similar test by using Time-Delay Spectrometry (TDS) to minimize reflections. The TDS method, unfortunately, had a lower limit frequency of 200 Hz in that test. My conventional test method, made possible by the very small sound source, works down to 30 to 40 Hz. In all tests, the microphone was mounted about 1 inch from the center of the baffle.

Figure 3 shows my pseudo-infinite baffle curve for the SM91. Sound is incident where theta equals 90°. If the mike were an ideal cardioid in free space, the 90° response would be 6 dB below the 0° response. However, this is not true for a boundary mike, as shall be seen. The SM91 shows an essentially flat curve to 2 kHz, then rises to +9.5 dB at 5 kHz. The manufacturer's curve for theta equalling 30° shows a rising response which, from 50 Hz to 5 kHz, increases 6 or 7 dB. Previous reviews showed that a rising response is desirable for boundary microphones. The astute reader will wonder why there is no bass boost due to proximity effect. The response at 6 inches is much like the curves (to be discussed) at 6 feet. I can think of two reasons for this. First, Fig. 3 shows the response where theta equals 90°, and a cardioid has no proximity effect at 90°. Second, the particle velocity is zero at a boundary, which should cause proximity effect to vanish. In most applications, the microphone will be too far from the source for proximity effect to be a factor.

I tried to measure directional responses indoors, at 12 and 24 inches, with the small source and 24-inch baffle, but results were poor. Then I resorted to outdoor testing with my large, spherical source (an 8-inch cone speaker in an 18-inch sphere, as compared to my small source's 2-inch aluminum piston in an 8-inch sphere). This was calibrated with a laboratory ribbon velocity mike prior to introducing the baffle. (See *Audio*, September 1978 and March 1983). The baffle/mike system was mounted 6 feet from the source so that a semblance of accuracy could be maintained with a 48-inch baffle rotated to the various angles of theta or alpha. To change from longitudinal to transverse planes, I simply turned the mike 90°.

First, I mounted the SM91 on a 24-inch baffle. Figure 4 shows the front-hemisphere responses for theta angles of 0°, 45°, and 90°. The lumps in the 90° response probably are due to edge reflection, because otherwise the curve should resemble Fig. 3. The 0° and 45° curves do not show these wiggles. The 45° curve is several dB above the 90° curve, as with a cardioid in free space. The 0° curve is 6 dB down, similar to the 90° curve, but for a different reason: At 0°

Frequency response, on a large surface, is uniform at all angles and smooth from 40 Hz to 20 kHz.

incidence, the pressure doubling vanishes. I set the 0-dB reference at -61 dBV/Pa because it looked best for the 0° and 90° curves. A better measure of axial sensitivity is the 1-kHz level of the 45° response, which averages about -55 dBV/Pa. Rated output at 30° and 1 Pa (94 dB SPL) is -49 dBV. Thus, these measurements are 6 dB low compared to Shure's value, just opposite to the outcome of the PZM tests. I trust that this disparity is likewise attributable to calibration techniques. Alternatively, it may just be a worst-case sum of production tolerances, lab differences, and the difference between sensitivity at theta angles of 30° and 45° . This caused a problem with noise-level calculation, which will be discussed later. The output level, -55 dBV/Pa, is acceptable for a 94-ohm mike; my *JAES* paper establishes -60 dBV/Pa as a minimum for a 250-ohm (passive) mike.

The frequency response curve for 45° rises about 12 dB, compared to 8 dB for the 0° measurement. Shure's value of 6 to 7 dB at 30° is significantly less than my 45° rise. The response curves are very smooth from 40 Hz to 20 kHz, so that if extra "brightness" is perceived, it may be equalized to suit the application.

Figure 5 shows responses for the rear hemisphere. If I had plotted the 45° curve as a reference, the discrimination at 135° at 1 kHz would be 10 dB, and at 180° would be 24 dB. This is excellent performance indeed.

Figures 6 and 7 show front- and rear-hemisphere responses with a 48-inch baffle. The rise of the 45° curve is the same as 0° : 10 dB, more in line with Shure's curve for 30° . Again, these curves are smooth, but the 90° curve is lumpy at frequencies about one octave lower than the curve in Fig. 4. This corresponds to the difference in baffle sizes. It may be concluded that only the 90° response of the SM91 is sensitive to baffle-edge reflections. Discrimination at 135° and 180° compares favorably to Fig. 5.

It was mentioned in the PZM reviews that the pressure-doubling effect (+6 dB) vanishes at a frequency related to baffle size, thus causing a step-down in bass response. (Frequencies are listed in the March 1983 review.) This effect is only very slightly seen in Fig. 6, as a 3-dB rise in the 45° bass response as compared to Fig. 4.

Figure 8 shows the transverse-plane response with the 48-inch baffle. The 0° curve is similar to the theta equals 90° curve. The 45° response picks up some edge reflections, but the 90° curve is smooth.

I conclude that the frequency response of the SM91, when the unit is placed on a large surface, is uniform for frontal angles of both theta and alpha equalling 0° and 90° and probably all angles in between. It is smooth from 40 Hz to 20 kHz, rising about 8 to 10 dB, which is appropriate for a boundary mike. Response where theta equals 180° is essentially a perfect null.

Measured noise level versus frequency is shown in Fig. 9. Battery power was used in this test. The measured levels in dBV are shown because the conversion to equivalent SPL is subject to interpretation. If I use my measured 45° value of acoustic sensitivity, -55 dBV/Pa at 1 kHz, the A-weighted overall noise level is 30 dB equivalent SPL. Rated noise level is 24 dB, but to obtain this value I would have to use the rated sensitivity figure. The noise level of the PZM I used for comparison measured -118 dBV A-weighted, which

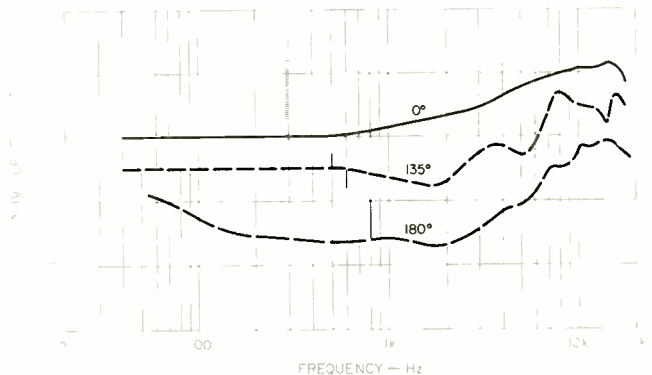

Fig. 7—Same as Fig. 5, but with microphone on 48-inch baffle.

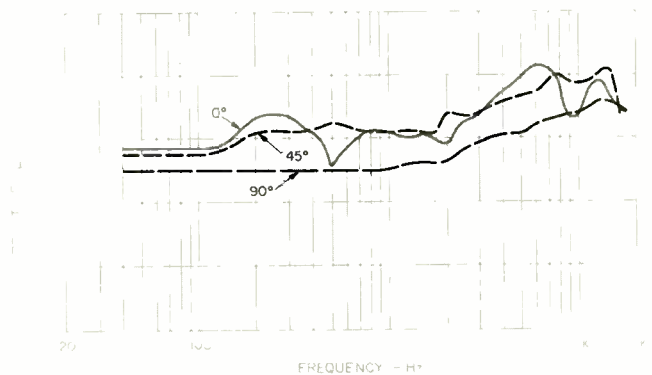

Fig. 8—Frequency response for three transverse vertical angles, with microphone outdoors on 48-inch baffle at 6-foot distance (0 dB equals -61 dBV/Pa).

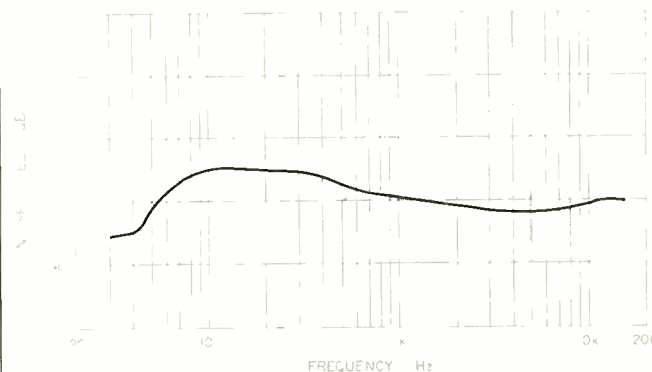

Fig. 9—Noise spectrum ($1/3$ -octave bands). Overall noise levels are -114 dBV, unweighted, and -119 dBV, A-weighted.

The SM91 makes clean tapes in noisy rooms and sounds lively. If I could have only one pair of boundary mikes, I'd choose Shure SM91s.

equalled 24 dB SPL, based on its -48 dBV/Pa measured sensitivity. (The PZM's 680-ohm impedance accounted for the higher output voltage level.)

Phasing was as specified, and agrees with EIA Standards. Clipping level exceeded 0.4 V peak output on speech (-11 dBV rms). Conversion to SPL depends on the acoustic sensitivity figure: Using -55 dBV, I obtain 138 dB, and -49 dBV results in 132 dB. Remembering that clipping exceeds these figures, the results compare favorably to the 144 dB specified.

Use and Listening Tests

The PZM or boundary has now been established as a legitimate high-quality microphone for both audiophile and professional applications, so it is a suitable reference for comparison to the SM91. I did not have any Crown units on hand, but I did have a Realistic, which was purchased from Radio Shack for \$39.95. I found that the frequency response and noise level of this mike compare very favorably to the Crown units, so I elected to use it as a reference.

The outdoor tests of the SM91 were frequently disrupted by wind gusts, which produced large excursions of the chart recorder pen. The gusts did not exceed 10 knots, which is an acceptable value for outdoor sound testing. I could not use the integral low-frequency filter while I was making my tests.

Indoors, I found that I could "pop" the SM91 with "Peter Piper picked . . ." spoken at 12 inches, and the mike was silent for a second following each pop. The Realistic would pop at 6 inches (with windscreen) and would not go silent after the pop impulse. The low-frequency filter in the SM91's preamp reduces but does not eliminate this effect. Popping should not be a problem, however, because the SM91 would rarely be used for close speech pickup.

Vibration noise caused by tapping my desk produced slightly more noise from the SM91 than from the Realistic.

The SM91 mike and preamp have negligible magnetic hum pickup compared to the Realistic. When testing with speech at 12 inches from the mikes on my desk, I found that the SM91 had more high and low frequencies than the Realistic and less room-noise pickup. The SM91 made a superior speech tape in a room with a noisy air conditioner.

The SM91 and the Realistic were placed side by side on the carpeted center aisle of a church (which seats 900 and has a ceiling 40 feet high). They were used to record a concert by a chorus of 25 young persons about 15 feet distant, with a piano between them and the mikes, plus a set of drums to the right of the piano. A two-track cassette tape using the two boundary mikes was made on an inexpensive Sanyo recorder, while an Aiwa AD-F990B recorder (with Dolby HX Pro) was recording the concert simultaneously using a permanently flown AKG C422 stereo mike 20 feet above the boundary mikes. Comparisons of the boundary-mike tracks on a monaural A/B basis showed that the SM91 had more vocal presence than the Realistic and more cymbal sound. Bass drum and piano sounded similar on both tracks. Overall, the SM91 sounded clearer and more pleasing. The audience was quiet, so no difference in ambient noise level could be detected. Reverberation was not heard in either mike, because the sources were relatively close and the room acoustics were not very live. Comparison to the Aiwa tape on a stereo basis is, of course, unfair. The HX Pro feature of the Aiwa, plus the very flat response of the AKG C422, means that high frequencies were very accurately recorded. I thought that the SM91's highs, by comparison, were a little excessive in relation to its low-frequency response. Surprisingly, the stereo perspective from the pair of dissimilar boundary microphones was not grossly different from that of the C422, and rather pleasing, I thought. I suspect that a pair of SM91s placed side by side and perhaps angled outwards might be excellent for stereo recordings.

I did not hear any noise (hiss) from either the Realistic or the SM91, but the sound level was consistently high at the mikes. No trouble was encountered with wind noise, of course, in this indoor application.

The cable of the SM91 is too stiff and kinky. It would not lie flat on the floor, which is essential for a surface-mounted microphone.

The recorder gain settings for the Realistic and SM91 were much different. The gain setting for the Realistic was normal, but the SM91 required a much higher setting because of its low impedance and output voltage. I think that a 150-to-600 ohm transformer should be used if the SM91 is connected to the mike input of a cassette recorder. (Jensen makes excellent transformers for this purpose.)

The minor problems evidenced in the measurements did not show up in the listening tests. These tests were limited in scope, due to lack of another concert to record and the fact that the single mike supplied for review precluded stereo recording. I conclude from these tests that the SM91 can make a cleaner speech tape in a noisy room, and a livelier sounding choral recording, than an omnidirectional boundary mike. If I were permitted only one pair of boundary mikes in my recording suitcase, I would choose the SM91.

Jon R. Sank

Top view of the Shure SM91. Note the steel grille, useful protection for a mike that will often be used on floors.





**THE ONE HIGH-END AUDIO SYSTEM
GOOD ENOUGH TO PLAY IN EVERY ROOM.**

The finer your audio system, the more you should enjoy it. So why confine your listening pleasure to just one room?

Now Kyocera's Full System Remote components let one system drive up to three sets of speakers in different rooms — and let you control everything from any room!

With up to three remote sensors and a wireless controller, you can adjust volume, choose tracks on the Compact Disc player, tune AM or FM stations, even record cassettes without ever leaving your chair. Just as important, Kyocera Full System Remote components are greatly improved versions of the same Receivers, Cassette Decks, and CD Player that earned Kyocera its high-end reputation.

So don't settle for an audiophile system that only plays in one room when you can own the one audiophile system that plays in three.



 **KYOCERA**

Enter No. 26 on Reader Service Card

Built right from the ground up.

ORACLE DELPHI II TURNTABLE

Company Address: 505 Boul. Industriel, Sherbrooke, Que., Canada J1L 1X7.

For literature, circle No. 96

The first version of the Oracle Delphi turntable appeared on the market in 1979, establishing a level of styling that made it a candidate for the Museum of Modern Art's design collection. Few high-fidelity products have been as visually attractive or provided so many new features. The new Delphi II retains all of these physical attributes and features, and, adding a number of important sonic ones, now definitely has high-end sound quality. At \$1,250 it may be expensive, but it is a serious contender for the title of the best sounding turntable currently.

The original Delphi had a good suspension and a very good ability to reject acoustic vibration and problems from movement of the floor and furniture. It was also one of the first turntables to provide a precise adjustment for tuning the suspension to different tonearm weights, as well as having a mechanism for securing the record to the turntable mat, thereby minimizing any resonance or coloration caused by the lack of a firm record/turntable interface. Setup procedures, however, were complex and poorly explained, and improvement was needed in some other areas too. For example, the original a.c. motor, noisy and a source of quality-control problems, was replaced in 1980 with a new, quieter d.c. motor. This didn't produce the smooth sound or stability of some of the top competition, and the unit had audible wow. Further, the spring suspension did not reject low bass and midrange energy from external sources well enough.

The Delphi II provides all the necessary improvements to correct these problems, and more. The d.c. motor now is a Pabst unit, first used on the \$2,500 Oracle Premiere. Its drive is smoothed electrically by a large capacitor bank, and mechanically by a built-in, 1-pound flywheel. The flywheel is dynamically balanced at the factory



at three times the normal operating speed. Potentiometers at the back of the turntable allow precise speed adjustment. A new molybdenum-disulphide oil, said to provide extended wear capabilities, is used in the main bearing assembly.

The base of the Delphi II is $\frac{5}{8}$ inch thick, rather than the $\frac{1}{2}$ inch of the previous Delphi, and its new spring suspension system does a far better job of rejecting external vibrations. Aluminum tonearm plates are optional, priced at \$66 if pre-cut to match your arm and \$38 if blank. Extra springs are supplied to tune the turntable suspension to match different arm weights; audiophiles who do their own setup or want to change tonearms will find this (and the now very well-written setup instructions) to be of major help. They will be equally pleased by the com-

bined stroboscope (for setting turntable speed) and cartridge-alignment protractor which Oracle has included with the Delphi II.

Most important, these improvements have clear sonic results. My extensive listening comparisons with other top-ranking turntables showed that the Delphi II provides an exceptionally neutral and musical sound. The speed-regulation and stability problems common to many belt-driven turntables were minimal to nonexistent, and the Delphi II consistently provided more musical data and low-level transient information, from the midrange up, than most competing designs.

The sound stage and imaging were stable and musically very convincing. The sound had excellent dynamics and musical life without a trace of hardness or the extra record noise

“... the **McIntosh**® has the best sound yet of any
COMPACT DISC PLAYER...”

McIntosh has earned world renown for its technological contributions for improved sound. When you buy a McIntosh you buy not only HIGH TECHNOLOGY that leads to superior sound reproduction, you buy technological integrity proven by time. The McIntosh Compact Disc Player is the newest evidence of McIntosh technological integrity.

For more information on the McIntosh MCD 7000 Compact Disc Player and other industry-leading McIntosh products write:

McINTOSH LABORATORY INC.
P.O. Box 96 EAST SIDE STATION, A 105
BINGHAMTON, NY 13904-0096



COMPACT
disc
DIGITAL AUDIO

Handcrafted with pride in the United States by dedicated, highly trained craftspeople.

Enter No. 28 on Reader Service Card

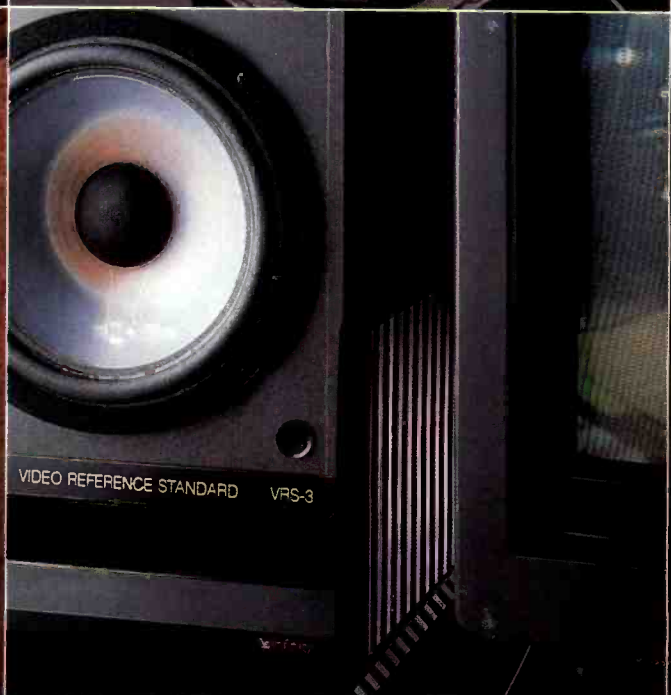
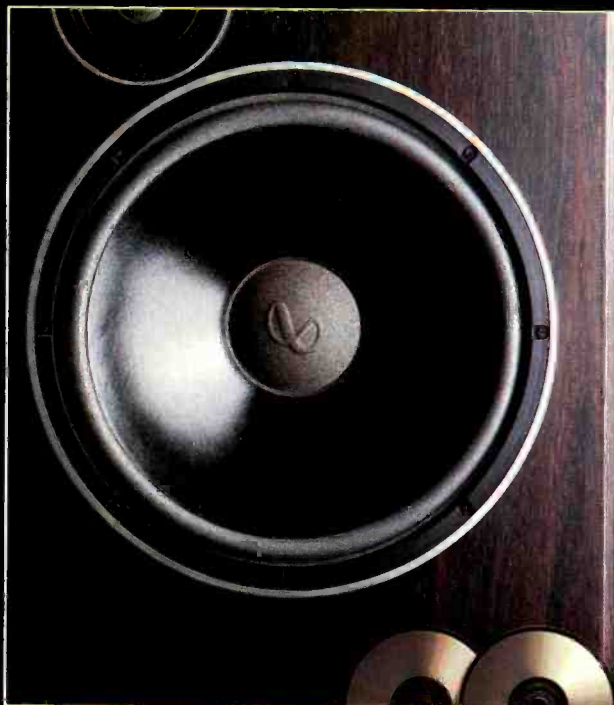

Scientific Illusions

Reviewers of loudspeakers sometimes speak of black magic, the hidden ingredient that makes a speaker sing after science has had its say. For us at Infinity, there's no magic in designing a loudspeaker, though there is intuition, and art, and a lot of applied science. Yet we traffic in illusion and we bend our science to create the imponderable reality that occurs when a living performance emerges from our loudspeakers. This year the illusion becomes more potent through these product innovations:

- A re-engineered and re-configured RS Series, with low diffraction cabinets, floating grills, new drivers, and startlingly realistic Chatsworth Oak cabinetry. A new standard for bookshelf loudspeakers.

- A Studio Monitor Series that achieves an uncommon blend of ultra high efficiency, linearity and style. Polypropylene coated cones, front-mounted controls and High Output Polycell tweeters are housed in handsome, contoured rosewood cabinets.

- A Series II automotive speaker line that offers all new drivers and cosmetics. New Polycell midranges and tweeters do wonders for the human voice and anything else within its frequency band.

- A Video Reference Standard Series with height-adjustable cabinets, shielded drivers, contemporary styling and the sheer musicality on which we've built our reputation.



Enter No. 25 on Reader Service Card **Infinity — The illusion of being there.**

Infinity Systems, Inc. • 9409 Owensmouth Avenue • Chatsworth, CA 91131 • (818) 709-9400

The Delphi II provides an exceptionally neutral and musical sound that has excellent dynamics and life without any hardness.

common on many compromise designs. "Sweet" is overworked as an adjective for audio systems that communicate the character of the music, rather than imposing their own coloration on the sound, but it is appropriate for the Delphi II. Midrange coherence—the ability to provide a consistently musical and convincing sound over very long periods of time—rivals that of any turntable at any price.

If the new Oracle Delphi II does have a special sound character or coloration, it lies in the deep bass. Like most free-floating or suspension turntables, the Oracle tends to reduce bass energy in comparison with other designs. This can be minimized by using the manufacturer's optional metal tonearm mounting plate rather than the standard acrylic plate, and clamping it as tightly as possible to the turntable frame. A 1/8- to 1/4-inch rope of Mortite placed between the mounting plate and the turntable frame will help damp it. Without such damping, the metal plate tends to rob the sound of some of the sweetness found with the acrylic tonearm mounting plate, which cannot be rigidly clamped to the turntable frame.

A further improvement in the bass is possible by replacing the standard feet with spiked or metal-cone feet to "fix" the turntable firmly to the mounting cabinet or shelf. This seems to consistently improve the clarity and life of the bass and lower midrange. The Delphi II also works synergistically with the new air-bearing arms. The Eminent Technology Two, for example, provided outstanding performance and has a special mounting kit for the Oracle. The Alphason, Syrinx, and other top-quality pivoting arms also provided excellent overall performance, but with a little less bass data.

In summary, the Oracle Delphi II is the kind of turntable that makes many audiophiles feel that the analog disc is still the most pleasurable source of music in the home. The unit apparently does trade off some lower bass energy for exceptional sweetness in the upper midrange and higher octaves, but no competing product is free of such trade-offs. It is a superb audio product and one that can contribute years of musical pleasure and excitement.

Anthony H. Cordesman

TELARC
THE HIGHEST STATE OF THE NEWEST ART



BEETHOVEN PIANO SONATAS
"MOONLIGHT" · PATHÉTIQUE · APPASSIONATA
JOHN O'CONNOR



COMPACT DISC (CD-80118) · LP RECORD (DG-10118)

Enter No. 50 on Reader Service Card

TELARC
THE HIGHEST STATE OF THE NEWEST ART



DEBUSSY · Quartet in G
RAVEL · Quartet in F
CLEVELAND QUARTET



COMPACT DISC (CD-80111) · LP RECORD (DG-10111)

Enter No. 50 on Reader Service Card

REDEFINITION.

THE CARVER RECEIVER

Redefines your expectations of receiver performance with the power you need for Digital Audio Discs plus virtually noise-free stereo FM reception. A receiver with astonishing performance incorporating two highly significant technological breakthroughs: Bob Carver's Magnetic Field Power Amplifier and his Asymmetrical Charge Coupled FM Detector.

ESSENTIAL POWER: Your system needs an abundance of power to reproduce, without distortion, the dynamic range of music on Digital Audio Discs and fine analog recordings.

The Magnetic Field Amplifier in the CARVER Receiver gives you 130 watts per channel* of pure, clean power with superbly defined, high fidelity reproduction.

The Magnetic Field Amplifier produces large amounts of power (absolutely necessary for the accurate reproduction of music at realistic listening levels) without the need for heavy heat sinks, massive transformers, and enormous power capacitors required by conventional amplifier design.

Unlike conventional amplifiers which produce a constant, high voltage level at all times, irrespective of the demands of the ever-changing audio signal (Even when there is no audio signal in the circuit at all!), the Magnetic Field Amplifier's power supply is signal responsive. Highly efficient, it produces exactly and only the power needed to carry the signal with complete accuracy and fidelity.

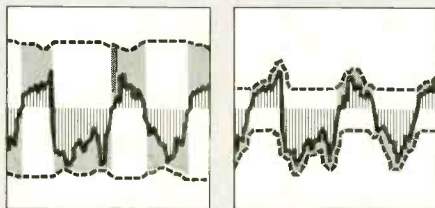

Solid line: audio output signal. Broken line: power supply voltage. Shaded area: wasted power. Vertical lines: power to speakers.

The 130 watts-per-channel* CARVER Receiver is about the same size and weight of conventional receivers having merely 30 watts per channel!

NOISE-FREE RECEPTION: The AM-FM CARVER Receiver gives you FM stereo performance unmatched by that of any other receiver.

As it is transmitted from the station, the stereo FM signal is extremely vulnerable to distortion, noise, hiss and multipath interference.

However, when you engage CARVER's Asymmetrical Charge Coupled FM Detector circuit, the stereo signal arrives at your ears virtually noise-free. You hear fully separated stereo with space, depth and ambience!

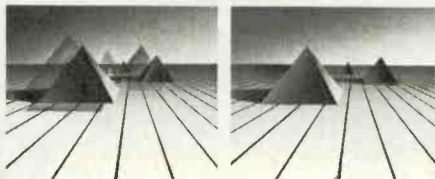

Reflected multi-path signals cause audible distortion.

Asymmetrical Charge Coupled FM Detector gives your ears a true sonic image.

The Asymmetrical Charge Coupled FM Detector was first introduced in CARVER's TX-11 Stereo Tuner, receiving unparalleled critical acclaim:

"A major advance... its noise reduction for stereo reception ranged from appreciable to tremendous. It makes the majority of stereo signals sound virtually as quiet as mono signals, yet it does not dilute the stereo effect."

Julian D. Hirsch, STEREO REVIEW (December, 1982)

"Separation was still there; only the background noise had been diminished, and with it, much of the sibilance and hissy edginess so characteristic of multipath interference."

Leonard Feldman, AUDIO (December, 1982)

"What distinguishes the TX-11 is its ability to pull clean, noise-free sound out of weak or multipath ridden signals that would have you lunging for the mono switch on any other tuner we know of."

HIGH FIDELITY (January, 1983)

"The Carver Receiver is, without question, one of the finest products of its kind I have ever tested and used."

Leonard Feldman, AUDIO (June, 1984)

The CARVER Receiver has been designed for fidelity, accuracy and musicality. You will want to visit your CARVER dealer for a personal audition of this remarkable instrument.

*130 watts per channel RMS into 8 ohms, 20 Hz to 20 kHz with no more than 0.05% total harmonic distortion.



CARVER Powerful Musical Accurate

Carver Corporation P.O. Box 1237 Lynnwood, WA 98036

Distributed in Canada by Evolution Audio, Ltd.

Enter No. 14 on Reader Service Card

MOBILE MUSICALITY.

THE CARVER CAR AMPLIFIER introduces Magnetic Field Amplifier technology to automotive high fidelity. Finally, the traditional weak link between car stereo decks and modern speaker design has been replaced with Carver technology. Into 1/10th of a cubic foot, Bob Carver has engineered a complete 120 watts RMS per channel amplification system with the fidelity, accuracy and musicality demanded by the most critical reviewers and audiophiles.

ESSENTIAL POWER. Even before the exciting advent of car Compact Disc players, an abundance of power has been necessary to reproduce, without distortion, the frequency and dynamic range produced by modern decks.

Unfortunately, conventional amplifier technology is particularly unsuited to delivering this needed power to the specialized car interior environment. Like their home stereo counterparts, traditional car designs produce a constant high voltage level at all times, irrespective of the demands of the ever-changing audio signal—even those times when there is no audio signal at all! Because automotive amplifiers must, obviously, derive their power from the host vehicle, such an approach results in substantial drain to delicately balanced automobile electrical systems.

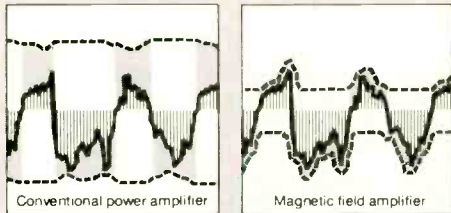

Solid line: audio output signal. Broken line: power supply voltage. Shaded area: wasted power. Vertical lines: power to speakers.

The Carver Magnetic Field Car Amplifier is signal responsive. Highly efficient, it produces only the exact amount of power needed to deliver each musical impulse with complete accuracy and fidelity. Thus the Carver Car Amplifier not only reduces overall long-term power demands, but produces the large amount of power necessary for reproduction of music at realistic listening levels without the need for oversize power supply components. Important considerations in the minuscule spaces which quality car design allocates to add-on electronics.

INTELLIGENT POWER. A hallmark of all Carver amplifiers is the careful integration of sophisticated speaker and amplifier protection circuitry. The Carver Car Amplifier is no exception.

Speakers are protected with a DC offset internal fault protection design which turns off the power supply at first hint of overload. An overcurrent detector mutes audio within microseconds of a short circuit, as does an output short circuit monitoring circuit. Together, these three circuits eliminate the potential need to replace fuses, revisit your autosound installer, or worse yet, replace expensive speakers due to a moment's indiscretion with your deck's volume control.

ASSIGNABLE POWER. Integrated bi-amplification and bridging circuits, along with The Carver Car Amplifier's compact configuration make it ideal for multiple-amplifier installations.

The built-in 18dB/octave electronic crossover allows use of two amplifiers in a pure bi-amplification mode without addition of extra electronics. Or, at the touch of a button, one Carver Car Amplifier can become a mono amplifier for subwoofers while the other Carver Amplifier handles full range. Or, for astonishing dynamic and frequency response, two Carver Car Amplifiers may be operated in mono mode into 8 ohms for a 240 watt per channel car system which will truly do justice to digital without taxing your car's electrical generation system.

INNOVATIVE POWER. Can 1/10th of a cubic foot of space hold yet more innovations? Yes.

Carver has addressed the ongoing problem of head-end/power amplifier level matching: Output of current car decks varies widely from brand to brand and model to model. The result can be a less than perfect match. The Carver Car Amplifier incorporates circuitry which compensates for variations in head-end output, reducing noise and optimizing signal-to-noise ratio. In addition, Carver has added a subsonic

filter which removes inaudible power-robbing infrasonics before they can tax the amplifier and speakers. Finally, a delayed turn-on circuit activates the Carver Car Amplifier after your head-end unit has powered up, to eliminate starting pops and thumps.

ACCURATE POWER. It goes almost without saying that a product Bob Carver designs for the road carries the same superb electronic specifications that his home audio products are known for.

The Carver Car Amplifier is flat from 20Hz to 20kHz, down -3dB at 16Hz and 30kHz. Not coincidentally, the usual specifications given for Compact Discs. A signal-to-noise ratio of over 100dB means that, in even the most quiet luxury sedan, you will never be annoyed by hiss. The other specifications are equally as impeccable. You may peruse them in our literature or in independent reviews soon to appear.

ACQUIRABLE POWER. The remarkable Carver Car Amplifier is currently available for audition at Carver dealers across the country.

It is worth the journey. Whether you have a car system in need of the sonic excitement possible with abundant power, or are in search of the perfect complement to a new high-performance automobile, you owe it to yourself to experience the logical extension of Carver technology—the Carver Car Amplifier M-240.

Power Output Stereo Mode: (continuous RMS power output per channel, both channels driven, at 13.8 VDC input), 120 W into 4 ohms, 20 Hz to 20 kHz with no more than 0.15% THD.

Power Output Bridged Mono Mode: (Referenced to 13.8 VDC input) 240 W into 8 ohms, 20 Hz to 20kHz with no more than .15% THD.

Input Sensitivity: Variable 250mV to 4V

Signal to Noise Ratio: (Referenced to 120 W, A weighted into 4 ohms) Greater than 100 db

Crossover 115 Hz, 18 dB/octave

Weight: 4.7 lb.

The Carver Car Amplifier



CARVER

POWERFUL

MUSICAL

ACCURATE

Carver Corporation, P.O. Box 1237, Lynnwood, WA 98036

Distributed in Canada by Evolution Audio

Enter No. 15 on Reader Service Card

GERRY MULLIGAN



Mosaic Records is bringing back to life a great deal of wonderful jazz that has not been available for quite a long time. Founders Charles Lourie and Michael Cuscuna—two seasoned marketing and production men with lots of experience in big and small record companies—have long-term leases on the old Blue Note and World Pacific catalogs; they also plan to lease significant contemporary material from a variety of sources.

The Connecticut-based company, founded in California in 1983, is packaging this music the way it should be: Reissued material is arranged in chronological sequence, along with alternate takes and previously unissued tunes used in toto, wherever and whenever possible. The packaging, liner notes, discographies, mastering, and pressing represent the state of the art for this kind of material. The only flaw I can find in their superb presentations is one I had to overcome more than 20 years ago, when I produced a somewhat similar series of packages at Columbia Records: There is no listing of contents on the backs of the boxes; this may prove to be a serious drawback for those who may not know the material well.

Still, the series is a remarkable accomplishment and an extremely valuable one. Mosaic has set a standard for the industry to follow, and we can look forward to more marvelous music in the months and years to come.

(Editor's Note: The following reviews are of Mosaic's first seven releases; several additional packages are available. All may be ordered from Mosaic Records, 197 Strawberry Hill Ave., Stamford, Conn. 06902; 203-327-7111. Prices quoted do not include shipping and handling.)



The Complete Blue Note Thelonious Monk (MR4-101, four-record set, \$34), a limited edition of 7,500 pressings, contains all the known recordings—as well as a considerable number of previously unissued alternate takes—which Monk made as a leader for Blue Note from 1947 through 1952. One of the great originals of jazz, Thelonious Sphere Monk had a sound so unique that he carved out his own niche while being wrongly regarded as a be-bopper. Generally, the sessions with just Monk and rhythm come off best, because horn players seem to have inordinate difficulty getting his rhythms in place. Not that there is any really bad

Photographs: Frank Driggs Collection

FITTING REVIVALS

THE MOSAIC REISSUES

FRANK DRIGGS

the very best Lee Konitz alto saxophone work to be found on record. "Bernie's Tune," "Walkin' Shoes," "Freeway," and so many other completely realized improvisations are all here, and sound to this listener's ears completely fresh and just as exciting as they were when originally released. Fourteen previously unissued performances also help make this Mosaic package absolutely essential.



The Complete Blue Note Albert Ammons and Meade Lux Lewis (MR3-103, three-record set, \$25.50) may well have less appeal than most of Mosaic's other releases. This would be a great shame, because solo boogie-woogie piano as played by Ammons

MEADE "LUX" LEWIS (LEFT) AND ALBERT AMMONS

playing, but Monk is such a whole, in and of himself, that horns are almost (to me, anyway) an intrusion upon his creations. There is some fine playing by Sahib Shihab on alto, Billy Smith on tenor, Milt Jackson on vibes, Lou Donaldson on alto saxophone, Lucky Thompson on tenor sax, Kenny Dorham on trumpet, and finally, by Sonny Rollins on his own date in 1957, with Monk as a sideman. There is wonderful accompaniment throughout, particularly by Art Blakey and a little-known bassist named Bob Paige.



The Original Gerry Mulligan Quartet with Chet Baker (MR5-102, five-record set, \$42.50) contains all the justifiably famous recordings which Mulligan's pianoless group made with Baker in 1952 and 1953. These records, as Pete Welding's extremely thorough and fascinating notes tell us, made Mulligan a media celebrity, made Chet Baker a major trumpet star at a time when Miles Davis was in eclipse, and pretty much launched Pacific Jazz as a record label. Their music was, for better or worse, also dubbed West Coast jazz. The hard-swinging and gifted Mulligan took great exception to this description, having performed superbly in a wide variety of contexts on both coasts before and after these history-making sessions, some of which were originally recorded for Capitol, others for Pacific Jazz. The last three sessions (including one live from The Haig, a Los Angeles club where the group made its initial impact) include some of





CLIFFORD BROWN

and Lewis, two of the genre's very best practitioners, is really no longer being performed. Yes, Sammy Price is still around, and quite capable in this style, but this was a specialty of both these players, in a time when boogie-woogie, believe it or not, achieved a national reputation of a sort. Although Ammons and Lewis recorded for many other companies in the 1940s, it was for Alfred Lion at Blue Note that they did their best work. Lion had them make extended recordings on 12-inch 78s—very expensive, in a time when few collectors knew or understood anything about boogie-woogie or Ammons and Lewis.

Ammons specialized in hard-driving, medium and up-tempo pieces. Lewis was adept at songs of all tempos, but none more so than the slow, introspective "Blues Parts I Through V," the last part of which was not released until this Mosaic package was produced. The complexity of Lewis' playing and the sheer joy and drive of Ammons' work really come across. It's the real thing, not the imitation done by every big band and then every R&B and rock group of the past 30 years. This set is essential to anyone wanting to know the beauty and joy of this very special branch of jazz and blues.



The Complete Blue Note and Pacific Jazz Recordings of Clifford Brown (MR5-104, five-record set, \$42.50) lets the listener know right from the start that a particularly gifted player had arrived on the scene. Clifford Brown was, at 23, the most promising of all modern jazz men to come up since the advent of the LP. He had it all—speed, articulation, ideas, a fine glowing tone, and tremendous punch to his playing. His



CHET BAKER

death at age 25 in an auto accident was a tragic loss to music. He is heard here at length in the company of proven talents like Lou Donaldson, Elmo Hope, J. J. Johnson, Horace Silver and Jimmy Heath, with stellar rhythm sections headed by Kenny Clarke, Art Blakey and Philly Joe Jones. There is no question of the value of this music and of Clifford Brown's unique talent.

ART PEPPER



The Complete Pacific Jazz Small Group Recordings of Art Pepper (MR3-105, three-record set, \$25.50). Much of Art Pepper's life was lived in the shadows, as he tried to deal with drug addiction, long incarceration and a general inability to come to grips with the world away from jazz. Luckily for us, he left a large legacy of beautiful music behind. Mosaic's beautifully packaged, mastered, and annotated set will very definitely stand as *the* tribute to Art Pepper's highly individualistic alto-saxophone solos. Recorded in 1956, with one date in 1957, the set starts off deceptively low-key, with Chet Baker and Richie Kamuca and some of the antsiest piano I've ever heard from Pete Jolly. Later things improve considerably, with Baker playing some of his very strongest solos and Phil Urso contributing some good tenor. Pepper shares the last dates with Bill Perkins and Bill Holman on tenor (both of whom play very well), with some good trumpet by Don Fagerquist, tuba by Red Callender and baritone by Bud Shank. And there is some excellent drumming throughout the set by Stan Levey, Lawrence Marable, Mel Lewis, and Shelly Manne.



The Complete Blue Note Forties Recordings of Ike Quebec and John Hardee (MR4-107, four-record set, \$34). Quebec and Hardee were two of swing's noncommissioned officers, jazz *soldati* of a high order. Their talents were put to the test time and time again during and after World War II, and the two enjoyed a measure of success in the '40s, only to be shot down in the overwhelming tide of public indifference to their consummate skills toward the end of the decade. It was an exciting time for modern jazz, but a very bad time for those in other genres, including many artists who had been major stars.

Both saxophonists were born in 1918. Quebec, from Newark, N.J., scored first because of his proximity to New York, where all the action was; he worked with a dozen big and small bands before settling in with Cab Calloway's band in 1944. He signed

with Blue Note that year and immediately had a major Harlem jukebox hit with "Blue Harlem," both takes of which were originally released. As long as Quebec remained with Calloway, he had a steady paycheck, but he most certainly deserved personal stardom, although he never achieved it on his own. John Hardee, from Corsicana, Tex., served his apprenticeship in local and territory bands before going into the service in World War II. He surfaced in Tiny Grimes' group on 52nd Street in New York and was added to Blue Note's roster in 1946. His first record, "Tired" backed with "Blue Skies," sold very well throughout the New York area, and in 1948 Hardee formed his own quartet. After a year, there was just not enough work to keep going, and late in 1949, at his wife's urging, he went back to Dallas and became a music teacher.



J. C. HIGGINBOTHAM



FRANKIE NEWTON

Both men have left a fine legacy of big-toned, warm, and swinging saxophone solos that Blue Note captured in the 1944-46 period. All are very much recommended as outstanding examples of the kind of playing that, for inexplicable reasons, fell into disfavor in the late '40s. Besides the two saxists, Jonah Jones, Tyree Glenn, Buck Clayton, Tiny Grimes, Ram Ramirez, Sid Catlett and J. C. Heard all have prominent roles to play here, in some of swing's last and finest moments on record.

which may well be taken for granted now; in 1939 it was highly unusual and quite daring, and was Blue Note's first major hit.

Because these were the first combo records made by Blue Note, they have a slightly tentative quality to them. Newton, Higgy, and Bechet are clearly the stars and the principal reason one would want to own this record. **A**

IKE QUEBEC



JOHN HARDEE



The Complete Recordings of the Port of Harlem Jazzmen (MR1-108, \$8.50) gathers Blue Note's first two 1939 sessions built around Frankie Newton and J. C. Higginbotham, with Sidney Bechet added on the second session. Piano is by Albert Ammons on the first and Meade Lux Lewis on the second and a rhythm team of Teddy Bunn, Johnny Williams and Sid Catlett round out the picture. There is fine playing, particularly by Frankie Newton, a trumpeter of real ability whose lengthy illnesses prevented him from realizing himself on records the way he might have. J. C. Higginbotham had been a major force on trombone since his days with Luis Russell in 1929, and he is still near the top of his form on "Basin Street Blues" and "Wearyland Blues," included here. Newton is at his peak on "Blues for Tommy," dedicated to the great New Orleans trumpeter Tommy Ladnier, who had passed away four days before the session, and who, according to Stanley Dance's lucid notes, may well have been producer Alfred Lion's first choice to make this date. Sidney Bechet stars on "Summertime" in a classic performance



SUBLIME FROM THE RIDICULOUS



At one point, the fictionalized Salieri is describing the third movement of the "Serenade for Winds." "On the page, just a pulse, like a rusty old squeeze box, and then, suddenly, high above it, an oboe—a single note hanging there unwavering, until a clarinet took it over, sweetening it into a phrase of such delight, filled with such unfulfillable longing. It seemed that I was hearing the voice of God." That describes Mozart's essential musical gift: His ability to mold the simplest gesture into a sophisticated musical expression of incredible beauty. *Steve Birchall*

Richard Strauss: A Hero's Life. The Dresden State Orchestra, Herbert Blomstedt.
Denon 33C37-7561.

Strauss' autobiographical tone poem, "A Hero's Life (Ein Heldenleben)," romps hilariously through his musical world. He pokes fun at his critics and music in general with subtle good humor. But many listeners, distracted by the late 19th-century, larger-than-life style of the piece, may overlook the humor.

Strauss' gigantic sonata/allegro form is so large a forest that it disappears; all we see are the trees. He compounds that joke in many ways. At the end of the first theme's exposition, he throws the gauntlet down to his critics with a loud, pompously pyramided dominant seventh chord. But he leaves it hanging, unresolved, until after a brief silence, when the critics answer with the chattering chaos of the second theme.

In the expanded coda, a poke at the "Eroica" symphony, Strauss quotes from his own works, including, with sly humor, "Don Juan." Later, in track 6, the critics' voices once again rise, and Strauss quotes the "Jousting with Windmills" passage from "Don Quixote." Wryly, he tosses in some "bleating sheep" (muted trumpets) and an imitation of the wind machine (cymbal roll) as well.

In 1944, Strauss recorded "A Hero's Life" with the Vienna Philharmonic (now available on the Vanguard LP set SRV 325/29). His tempos were a bit brisker than what we are used to hearing now, and he tended to separate phrases rather than to connect them

Amadeus, Original Soundtrack Recording. The Academy of St. Martin-in-the-Fields, Neville Marriner.
Fantasy FCD 900-1791-2.

A genius can be just as imaginative in his social life as in his artistic expression. Thus, although in Mozart's music we hear a world of exquisite good taste, polish, and perfection, the Mozart we see in the film *Amadeus*—based on known facts about the composer's personality—is superficial, shallow, and lewd.

In some ways, the musical selections found here reflect the side of Mozart that the movie depicts. For instance, the Rondo theme of the "Piano Concerto" is an absurdly air-headed tune—what a composer might whistle while walking to the post office. But Mozart molded that trivial tune into a masterpiece. He plays games with your expectations, especially at phrase endings, teasing you into believing the music will go in one direction when actually he's about to merrily go off in another. That precarious balance between the silly and the sublime is a basic aspect of his personality.

This recording sounds clean and spacious. However, wispy clouds of analog distortion are evident, and the choral selections suffer the most. Quiet and medium-level passages sound fine, but when the sopranos start to

soar, that familiar hollow, pinched, analog distortion appears. A digital recording by the same performers of the "Symphonie Concertante" (Philips 411 134-2) is especially revealing. When you come back to *Amadeus*, its fuzzy edges are obvious.

But this is still an especially good analog recording, and the production complements the music. In the "Symphonie Concertante" producer John Strauss keeps the solo violin and viola slightly separated spatially. Their similar but distinctive timbres are so accurate that we can follow them independently, just as if we were watching a live performance or reading the score.

Ambience changes from track to track because the acoustics of various rooms are integral parts of the way the film tells its story. A good example is the rehearsal of "The Marriage of Figaro" attended by the Emperor. This is the sound of an empty theater, not a full house.

Neville Marriner and the Academy of St. Martin-in-the-Fields made new recordings especially for the film, and they are among the best Mozart performances available. For those who don't know Mozart's music, the album is an excellent introduction. For those who do, listening to these superbly performed selections is a joyous experience. A second album already has been issued, both on LP and CD.

Illustration: Philip Anderson

smoothly. Perhaps the most interesting difference is the way he treated his melodies. Instead of long lines with convoluted contours, his melodies often turned out to be rather simple, with added ornamentation—more like Mozart, in a certain sense. Clearly Strauss wanted that quasi-Classical approach to the piece. Blomstedt and the Dresden State Orchestra come fairly close to realizing Strauss' point of view.

Although I like Denon's use of track designations to mark the various sections, the booklet notes are confusing, and wrong on what takes place in tracks 4 and 5. The location of the recapitulation is unmistakable; Strauss wrote it in large, bold brush strokes. The booklet says it starts at the beginning of track 5, but on the disc it actually occurs at 6:04 in track 4, and track 5 starts at an irrelevant point later on.

This disc's most immediately attractive characteristic is the resplendently reverberant hall sound. Not only is it a properly big, spacious sound, but the quality and character of that sound are excellent. At times, in the loudest passages, I would like to hear more of the inner voices. The offstage trumpets in track 4 sound distant but not muffled.

The Dresden brass play with awesome strength and power, especially in the "Battle Scene." In quiet passages, the horns have a wonderfully dark tone and a flowing legato. You'll hear some unusual colors in the woodwinds, particularly the double reeds. Peter Mirring's solo violin tone is extremely bright, enabling him to stand out from the darker massed strings while still playing softly.

Blomstedt leads the Dresden Orchestra in an exciting, well-controlled performance. From the fury of the "Battle Scene" to the tenderness of the "Hero's Helpmate" to the quiet contentment of the closing passages, this is an outstanding recording.

Steve Birchall

Lush Life: Linda Ronstadt with Nelson Riddle and His Orchestra
Asylum 9 60387-2.

Lush Life is a rich, extravagant aural delight, a Compact Disc of the very first rank technically. Artistically, the real star is arranger/conductor Nelson Riddle, not vocalist Linda Ronstadt.

The late Riddle exhibited sheer genius in his arrangements for the singing voice. No one knew better how to cradle, support, and highlight a singer, how to weave a totally appropriate orchestral framework that lived and breathed in tandem with each vocal shading. His work with Frank Sinatra is legendary.

All 12 classic pop songs on this generous Compact Disc are touched by Riddle's magic wand. Working with concertmaster David Frisina's four-piece combo, Riddle eases his orchestra, glistening with strings, mellow with horns and bass, through the slow torchers "It Never Entered My Mind," "When Your Lover Has Gone," and "I'm a Fool to Want You." He kicks it into high gear, with brasses blaring and feisty, for the uptempo "You Took Advantage of Me" and "Can't We Be Friends." The magic of Riddle's touch is apparent in the brilliant instrumental accents and underpinnings for Ronstadt's voice throughout—the exquisite solo acoustic guitar drifting behind her in the intro to "When I Fall in Love," the melancholy muted trumpet woven into "Mean to Me," the honey-gold harmonica flowing through "Skylark," the classic blast of massed horns in "You Took Advantage of Me." And the strings, those magical strings! Under Riddle's guidance they soar sweetly above orchestral clouds, twinkle in CD-silent space, or form calm, sonorous rivers of supportive sound.

Linda Ronstadt makes an admirable attempt to handle this splendid material. Her voice is sweet and clear with remarkable range and savvy. Unfortunately, the savvy is based on rock technique, and these selections are of another musical dimension. Despite Ronstadt's lengthy career and serious vocal training, the sweetness of her voice evokes an aura of innocence, but this material requires a worldly-wise voice, a voice with a psychologically ragged edge. Ronstadt may one day achieve the stature of the female greats of the genre like Billie Holiday, Julie Wilson, Carmen McRae, or Ella Fitzgerald, but right now she too often goes for the big belt instead of the smoky understatement. She does best on uptempo cuts, but simply lacks the resources for the rest. "Sophisticated Lady" and "Lush Life," two of the finest



DIGITAL DISCOVERIES 91

BE
THERE
WITH
BARBRA
ON
BROADWAY.



THIS IS IT. THE
BEST POP CD SO FAR,
BAR NONE.
'THE BROADWAY ALBUM' . . .

—DIGITAL AUDIO

IF YOU HAVEN'T HEARD THE CD,
YOU HAVEN'T HEARD THE ALBUM. . .

—STEREO REVIEW

CBS Compact Discs use the latest digital recording and mastering equipment to deliver the best in CD sound. Barbra Streisand's "The Broadway Album" is just one example of our dedication to the science—and the art—of the Compact Disc.



CBS COMPACT DISCS.
STATE-OF-THE-ART SOUND.

"CBS" is a trademark of CBS Inc. © 1986 CBS Inc.

This is the kind of disc that justifies the CD revolution. What clarity from the orchestra, and what art from Eva Marton!



and most difficult songs in the popular catalog, are utterly beyond her grasp.

Technically, this disc is CD dream stuff. Ronstadt's voice, lightly dusted with reverb and placed front and center, floats up from the disc with sparkling clarity and real intimacy. Solo instrumentals are cleanly placed one step back, and another step beyond lies Riddle's fabulous orchestra. Aural space is brilliantly defined by producer Peter Asher, and the dynamic range is astounding. The silence between cuts and passages is the *raison d'être* of digital recording.

Don't wait for Ronstadt to grow into this material. Give her an A+ for effort, and consider this CD a triumph in the pop domain. *Paulette Weiss*

Richard Strauss: Excerpts from Salome and from Die Liebe der Danae; Four Last Songs; Malven. The Toronto Symphony, Andrew Davis; Eva Marton, soprano.
CBS MK 42019.

This is the kind of Compact Disc recording (digital in every phase of production and, although recorded at a live concert, painstakingly thought out as to placement, separation and so forth) that justifies the CD revolution. What a glorious concert! What orchestral clarity! And what art from Eva Marton, whose American reputation has risen so swiftly!

The selections begin with the "Dance of the Seven Veils," that 9½-minute orchestral accompaniment to

Salome's legendary writhing. The castanets and xylophone, which Strauss did not include for mere grace notes, shimmer here as they never did on LP or cassette. The flutes' lethal playfulness and the high pizzicato on the violins are stunning—in fact, the ineluctable movement of this piece, from apparently friendly waltz tempo to the final frenzy, is almost overwhelming. This is powerful music whose effect has to be respected. You wouldn't want to live too long within it.

Then comes Miss Marton, to sing the quarter-hour final scene. Her Salome is no puppet: Caught between Herod's politics and lust and her mother's jealousy, she shares both the psychosexual obsession of one and the single-mindedness of the other. "*Ich lebe noch, aber du bist tot, und dein Kopf gehört mir*" has never sounded so frighteningly Pyrrhic a victory.

Davis and his orchestra, and the CBS production crew, have come up with a masterwork of a disc. "Your voice was a censor," Salome sings to the severed head of the Baptist, "and when I looked at you, I heard a strange music." On those last words, Strauss reverts to the notes of John's first prophetic announcement, from prison, at the opera's beginning. Marton conveys the whole terrifying arc of the story. I shuddered at the blasting finale.

An orchestral interlude follows: The restful, lush, symphonic fragment of the seldom heard "Love of Danae." Then Marton returns for the "Four Last Songs," in the third of which ("Time to



**THIS MONTH'S
BIG EVENTS
ON CBS
COMPACT DISCS.**

JUNE

5

**CHET ATKINS, C.G.P.
STREET DREAMS**

7

8

**RAISED
ON
RADIO**

JOURNEY

**THE COSTELLO SHOW
FEATURING ELVIS COSTELLO**



KING OF AMERICA

HANDEL

MUSIC FOR THE ROYAL FIREWORKS
CONCERTO A DUE CORINI NO. 2
(F MAJOR / F-DUR / FA MAJEUR)
ARIODANTE: OUVERTURE

LA GRANDE ÉCARTÉE / LA CHAMBRE DU ROY
JEAN-CLAUDE MALGOIRE

15

BERNSTEIN

MAHLER

Symphony No. 1 "Titan"
New York Philharmonic

Leonard Bernstein

20 JUST RELEASED!

MAHAMSHNU ORCHESTRA "Birds Of Fire"
"19 Hot Country Requests, Vol. II"
"JANE FONCA'S Workout Record New And Improved"
JUDAS PRIEST "Turbo"
ORIGINAL BROADWAY CAST "A Chorus Line"
Nine releases of MAHLER Symphonies and Song Cycles conducted by Leonard Bernstein
Ten "Great Performances" releases, including MENDELSSOHN/TCHAIKOVSKY:
Violin Concertos featuring Isaac Stern with The Philadelphia Orchestra and Eugene Ormandy

BONNIE TYLER

**SECRET DREAMS
AND FORBIDDEN FIRE**

22

**COMPACT
disc
DIGITAL AUDIO**

Enjoy today's revolution in sound with CBS Compact Discs. Our rapidly-growing catalog features over 500 titles by superstar artists in all categories of music; and our new state-of-the-art digital mixing and mastering equipment assures you of the finest possible sound. "CBS" is a trademark of CBS Inc. © 1986 CBS Inc.



Edo De Waart achieves a wide range of dynamic expression and a fine balance between organ and orchestra in this peerless Saint-Saëns recording.

Sleep") her voice caresses us like a welcome dream. Davis plays piano for her 90-second delivery of the "Zueignung," as he does for the final cut—the "Malven," which was discovered just over a year ago, after the death of soprano Maria Jeritza. The short song was written and sent by Strauss to Jeritza just before his death in 1949, and when she left us in late 1984, we had to revise our Strauss list. At 84, Papa Strauss was still in control of his genius. I think Madame Jeritza would be pleased—delighted, even—with Marton's canny artistry. You will be.

Donald Spoto

Saint-Saëns: Symphony No. 3. The San Francisco Symphony, Edo De Waart; Jean Guillou, organ. **Philips 412 619-2.**

The Saint-Saëns Third Symphony, a big, bravura display piece for organ and orchestra, has long been a favorite of audiophiles. The organ is a very important part of this score, and in my opinion a truly successful recording of this symphony demands the use of a real pipe organ. Unfortunately, many recording halls do not have pipe organ installations. In those cases, the producer may elect to substitute an electronic organ or may decide to record the organ parts on a pipe organ in another location, be it a hall or a church, and then dub in those parts with a recording of the rest of the orchestra to make a composite.

This latter procedure is fraught with peril, because the acoustic character of the pipe organ's location is usually quite different from the acoustics of the orchestral hall. While a few composite recordings have skillfully integrated organ and orchestra, most of them are quite unsatisfactory and some verge on being ludicrous.

The music on this Philips CD was recorded in the new Davies Hall in San

Francisco, which appears to be an ideal venue for this Saint-Saëns symphony. The magnificent new Ruffatti organ installed in Davies Hall is said to be the largest concert organ in North America. It certainly has the immense power, tonal resources, and huge, 32-foot pedals necessary to give grandeur and majesty to the symphony's organ parts. Moreover, the approximately two-second reverberation period of Davies Hall gives the organ great clarity and articulation, allowing the organ sound to be completely integrated with that of the orchestra.

Edo De Waart's performance mirrors the sound, being a model of clarity. He achieves a fine balance between organ and orchestra, a very lyrical exposition of the second movement, and a wide range of dynamic expression. Throughout the third movement, De Waart maintains a brisk momentum. The finale is appropriately grandiose, with De Waart providing an exciting and propulsive thrust to the music which culminates in tumultuous and triumphant outbursts from organ, brass, and percussion.

Sonically, this recording has no peer. If you have a really good subwoofer, you will find the thunder of the bass pedals truly awesome. At the beginning of the second movement, the pulsating throbs of the mighty 32-foot pedals reach the most subterranean level of musical sonority. Of the five recordings of the Saint-Saëns Third Symphony currently on CD, this clearly is the one of choice. *Bert Whyte*

Tchaikovsky: Romeo and Juliet, Francesca da Rimini. The Cleveland Orchestra, Riccardo Chailly. **London 414 159-2.**

Here is a blockbuster CD that will challenge the capabilities of even the biggest, most elaborate and expensive of audio component systems. Engineer Colin Moorfoot has provided a recording of enormous dynamic expression, without sacrificing clarity or upsetting orchestral balances.

The "Romeo and Juliet" on this CD is of more than usual interest, because the same music, with the same Cleveland Orchestra in the same Masonic Auditorium, was also recorded by Telarc. Both are fine recordings with sur-

prisingly small differences. Here, the engineers opted for a slightly more distant acoustic perspective, so there is a bit more air around the instruments in this recording. In the opening passages of the work, the contrabassi in this version are somewhat darker and have more weight, and the bass drum is of lower pitch and has even more impact than the famous Telarc drum! The performances, though, are fairly similar, with Maazel on Telarc taking the piece at slightly faster tempi than Chailly.

However, the gem is Tchaikovsky's infrequently performed "Francesca da Rimini." If you like the music of Tchaikovsky but are not familiar with this particular work, you'll probably find it overwhelming!

For "Francesca da Rimini," Tchaikovsky wrote some of his most flamboyant music. In its unabashedly heart-on-sleeve romanticism, it becomes a searing emotional experience. Tchaikovsky's depiction of hell is a marvel of orchestration, with heavy use of brass and percussion. The love theme that follows is one of the most exquisite melodies Tchaikovsky ever composed. The finale is simply shattering, with huge brass fanfares and a barrage of bass drums, accented by explosive tympani strokes and the crash of cymbals and tam-tam. The final moments are cataclysmic, with the entire orchestra playing furioso and triple fortissimo.

The Cleveland Orchestra plays all these fireworks with their usual precision and élan. Musically and sonically, this is one of the best and most exciting CDs currently available. *Bert Whyte*

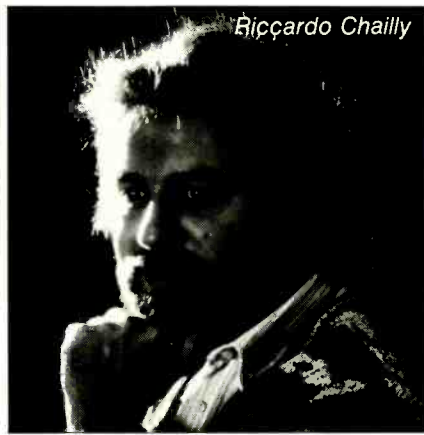

Riccardo Chailly

At this level, even the slightest refinement is an achievement.

We'd like to introduce you to our new line of separates. They build on the renowned reputation of the previous line by incorporating refinements which, though small, are by no means insignificant.

The new M-85 power amplifier, for instance, offers greater dynamic power for increased headroom as well as more continuous power output.* And newly designed circuitry allows it to safely drive loads as low as 2 ohms.

But it also offers something which can't be measured in specs. And that is a more natural, open, transparent sound, using musical signals, not electrical ones, as the means of measurement. Modifications in the voltage amplifier circuitry, as well as Yamaha's unique Extended Rolloff Equalizer, help contribute to this refined musicality.

The M-85 continues to employ Yamaha's Auto Class A Power and Zero Distortion Rule circuitry for the most musical, distortion-free reproduction possible.

As does the new C-85 control preamplifier. But we've added an Extended Rolloff Equalizer, DC servo

circuitry and current noise suppression to the C-85. This improves the signal-to-noise ratio and allows for a purer sound with a wider variety of phono cartridges. And the new easy-to-see LEDs clearly indicate which of the C-85's inputs you've selected.

Our new T-85 tuner uses two separate reception modes and four IF modes, all automatically selected for optimum signal quality. And with its five-digit tuning, the T-85 adds that extra measure of fine-tuning capability lacking in all other synthesized tuners.

These are just a few examples of the refinements we've made to our top-line separates. The rest of the new separates component series also offers refinements over their predecessors. Which, when you consider how good they are, is quite an achievement.

Yamaha Electronics Corporation, USA, P.O. Box 6660, Buena Park, CA 90622
*260 watts RMS per channel, both channels driven into 8 ohms, 20 to 20,000 Hz at no more than 0.003% Total Harmonic Distortion.



ROCK/POP RECORDINGS

MICHAEL TEARSON
JON & SALLY TIVEN

COMING CLEAN



King of America: Elvis Costello
Columbia 40173.

Sound: C Performance: B+

The problem with Elvis Costello has always been the same—credibility. How do you believe a guy who seems more to be playing with words than to be saying something he really feels? How do you believe a guy whose chords and chord progressions have gotten so runny, vague, and noncommittal that you suspect they'd be just as effective played backwards? How do you believe a guy whose singing style is distinguished by its ironic mock sincerity?

In that it reveals the artist's own struggle with these questions, *King of America* marks an important departure for Costello, whose real name, Declan MacManus, is used in the album credits. Based closely on a small variety of traditional genres such as folk, blues, and country & western, the music is harmonically clearer and cleaner than that of Costello's last few albums. Thankfully, the glitzy, ambiguous chords are fewer. The best thing about the music is the production by T-Bone Burnett, which is spare, simple, and

direct, in stark contrast to the busy, murky, funhouse hurly-burly into which The Attractions, Costello's backup band, had degenerated. Solid, understated playing by former Elvis Presley sidemen serves to clarify, rather than to obscure, the impulse behind each song.

Costello's struggle to come clean, and the partial extent of his success, is most apparent in his singing, which had gradually turned into a monstrous parody of the oozing, smarmy lounge crooners of yesteryear. Now, through his new resolve to be himself, he has managed at least to keep this parody at bay long enough to turn in two or three of the most genuinely moving performances of his career.

Susan Borey

Red to Blue: Leon Redbone
August AS 8888, \$8.98.

Sound: D+ Performance: B+

It's difficult for me to think of Leon Redbone as a serious musician or musical ethnographer when he insists on treating himself as a novelty. Musicians, though, seem to have little trouble with the eclectic white bluesman's

posing; on *Red to Blue*, Redbone's first non-bootleg album since 1981's *From Branch to Branch*, he gigs with David Bromberg (playing dobro), folk trio The Roches, Hank Williams Jr., and, on several cuts, blues pianist Mac "Dr. John" Rebennack. Redbone himself is a talented, imagistic guitar player—his intro to "Somebody Stole My Gal" might have made Pine Top Smith or Cow Cow Davenport honk and shout about how fine the man plays. Still, I wish somebody would tell me what Leon Redbone means.

Whether I ever find out or not, he and one hell of a pickup ensemble give a kiss to such old standards and obscurities as "Someday Sweetheart" and "Whose Honey Are You?" that brings them back to life—contemporary without being campy. And on the newer stuff especially, such as Bob Dylan's "Living the Blues" and Redbone's own "Steal Away Blues," his delivery is carefree but never throwaway.

Yet, as much of a delight as it is, *Red to Blue*—on Redbone's home-town label—is a little too faithful to the spirits of 78: Scratchy static and frequent small pops provided an unwelcome, almost-continuous accompaniment on my copy of the album. Redbone may be too quirky for mass tastes, but I'm astonished he can't or won't find some space on a blues specialty label that might show an aficionado's care in the pressing.

Frank Lovece





THE LEGEND CONTINUES.

Altec Lansing, the standard of high fidelity for everyone from the Academy of Motion Picture Arts and Sciences to the 1984 XXIII Winter Olympic Games, has just pioneered nine new breakthroughs in loudspeaker technology. For the Altec Lansing dealer nearest you, call 1-800-ALTEC88, (in Pennsylvania 1-717-296-HIFI).
Altec Lansing Consumer Products Milford, Pennsylvania 18337.

Though Mark O'Connor plays everything except drums here, the lovely, clear and warm sound of his new album belies its overdubbed nature.

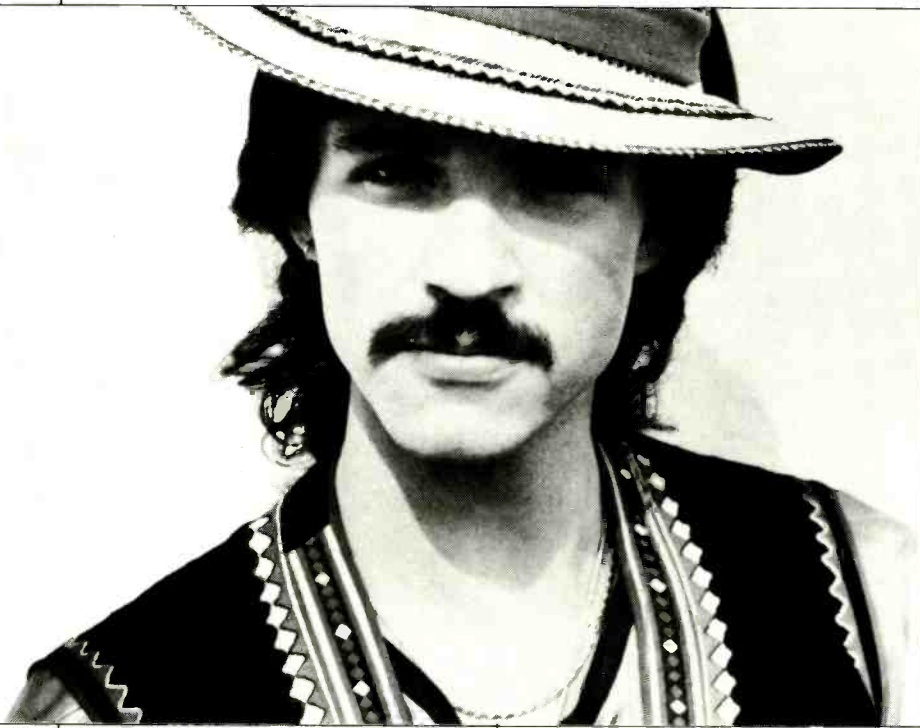

and excellent stereo deployment. Engineer Buford Jones has achieved a really warm sound, with a genuine ensemble feel to O'Connor's playing that belies the overdubbed nature of the recording.

Artistically, *Meanings Of* is a breakthrough album for Mark O'Connor. No longer may he be fairly called a country artist or even country oriented. He is one whale of a total musician as both composer and player, and his music defies all labels except wonderful.

Michael Tearson

Lives in the Balance:

Jackson Browne

Asylum 60457-1-E, \$8.98.

Sound: C

Performance: C

Three years in the making, *Lives in the Balance* offers proof that Jackson Browne hasn't been asleep at the wheel—he's just been taking time to turn a corner. Headmaster of the "sensitive" school of songwriting, Browne had a loyal following hanging on every poignant, cynical, or visionary observation up until 1983's widely misunderstood *Lawyers in Love*, whose title track failed to convey his intended irony and left fans bewildered.

There's nothing confusing about *Lives in the Balance*. Haunted by the spectre of war, Browne has clearly shifted his attention to politics, which he evaluates with the same intensity he formerly used to expose the dark side of romance. The more serious he gets, the less poetic he waxes; his willingness to trade in his trademark strengthens his new image as a concerned patriot. He's left room for just one love song; it's the only place you'll find lines about "the shallows and reefs . . . in the shape of a heart."

With synthesizers, hard-edged guitar, and horn, Browne has beefed up his accompaniments to fit his agitated mood, and to escape association with this decade's lightweight rock contingent. It doesn't always work; the title tune, for example, loses balance from its excess of drama. When it does work, however (as on "Soldier of Plenty," whose urgent tone and stinging chorus are about as mellow as whip-lash), this fresh approach yields some of Browne's best bits of music to date.

Susan Borey

Meanings Of: Mark O'Connor
Warner Bros. 25353, \$8.98.

Sound: B+

Performance: A

Barely into his 20s, Mark O'Connor is already making undeniably excellent music that absolutely defies pigeonholing. His pedigree is most impressive: He won national awards for both fiddling and flat-picking guitar before he was in his teens (he has won the fiddle title eight times). He has recorded half a dozen solo albums for Rounder and played on countless Nashville sessions. He's been a recording and touring member of David Grisman's superlative bluegrass/jazz fusion group as well as that seminal jazz/rock fusion group The Dixie Dregs.

Meanings Of is O'Connor's major league debut album, his first for Warner Bros. Its nine selections cover a wide variety of sounds and styles far removed from country music. Most amazing is that Mark has played everything except drums. This includes violin, viola, guitars, mandolins, electric bass, dulcimer, piano, percussion, and assorted synthesizers. His command is invigorating, but technical prowess alone is not what the album is about.

What it is about is O'Connor's compositions. Eight are totally original, and their bright attitudes, exuberance and diversity are the album's strongest assets. The ninth is a guitar medley dedicated to Mark's friend, the late Merle Watson. This medley includes "Amazing Grace," "Will the Circle Be Unbroken," "OMAC Blues," and "Taps," creating a lovely and heartfelt eulogy.

The recorded sound of *Meanings Of* is absolutely lovely, with great clarity

Jackson Browne



ELITE COMPONENTS. AT LAST AUDIOPHILE QUALITY AT AN AFFORDOPHILE PRICE.

Elite Components are incredibly rich. Rich with sound, quality, and value. So rich we could easily charge a whole lot more. But we'll leave that job to the competition.

Pioneer's never had a sound this good. Designed by Pioneer's Professional Products Division, these components can hold their own against anyone.

The sound from Elite Components is so nearly perfect, there's no need for complicated controls. Their achieved design goal: ultimate sound quality made simple, at a very affordable price.

The A-88X(BK) amplifier: "...it can hold its own sonically against just about any competitor, including audiophile specialist models that can boast much greater mystique—and cost."
High Fidelity Magazine

The PD-9010X(BK) Compact Disc Player: "The Pioneer PD-9010X is one of the most value-laden CD players it has been my pleasure to evaluate so far. I'll bet the competition is tearing apart several PD-9010X's right now, trying to figure out how Pioneer did it." Leonard Feldman, *Audio Magazine*

The CT-A9X(BK) cassette deck: "To say that we were impressed with the Pioneer CT-A9X would be an understatement. Outstanding as its measured performance was, it did just as well in actual use." Julian Hirsch, *Stereo Review Magazine*

The F-99X(BK) FM/AM tuner: "The 1986 Grand Prix Award Winner, Pioneer's F-99X(BK) is one of the high-performance components in the company's Elite series, a system of ambitious scope." *AudioVideo International*

Elite speakers are equally impressive. Designed and developed to maximize the superior sound Elite Components deliver, these speakers guarantee optimum sound reproduction for demanding digital applications.

The Pioneer Elite series clearly illustrates just how far Pioneer has gone to make audiophile components truly affordable. For more information regarding your nearest Elite dealer, call Pioneer's Customer Service Division at 1-(800)-421-1404.

©1986 Pioneer Electronics (USA) Inc.
Pioneer Electronics (USA) Inc., Long Beach, CA
Pioneer Electronics of Canada, Inc., Ontario, Canada



PIONEER®

CATCH THE SPIRIT OF A TRUE PIONEER.

Enter No. 34 on Reader Service Card



Album: Public Image Ltd.
Elektra 9 60438-1, \$8.98.

Sound: B+ Performance: B

John Lydon, a.k.a. Johnny Rotten, a.k.a. PiL, a.k.a. Public Image Ltd., is not a singer or a musician per se but a personality who makes records. The discs he issues are not so much songs as rants put to music, and given that his melodies are never particularly gripping, the strength of his records is dependent upon the talents of whoever is laying down the music tracks.

In the beginning, Johnny's music was provided by The Sex Pistols, who laid a solid foundation for his banter. PiL, the group Lydon formed after the demise of The Pistols, was far more grating, as its initial incarnation featured musicians only slightly more musically inclined than Lydon himself. Personnel changes have since mutated the group to the point where PiL is now a creation of the producer (in this case Bill Laswell) more than any kind of rock group.

Ironically enough, with this album PiL sounds more like a coherent group than ever before. Although there is a tip of the hat to the studio experimentation that has dominated the previous

The Fabulous Thunderbirds



John Lydon's ensemble sounds more coherent than ever. They experiment, but also try to play backing tracks that might get on the radio.

PiL records, there is a conscious effort to come up with backing tracks that sound like they might almost get on the radio.

No credits are given on the album for players or songwriters. But our spies inform us that the personnel includes drummers Ginger Baker and Tony Williams, cellist Shankar (currently playing on the new Pretenders/Chrissie Kerr record), Laswell himself on bass, and guitarist Steve Vai (formerly with Frank Zappa).

One doubts that this turn of the worm will produce veritable hits for PiL, but at least Lydon has a chance of connecting with a larger share of the young music-buying marketplace, which could make all our lives more interesting. Amen. *Jon & Sally Tiven*

Tuff Enuff: The Fabulous Thunderbirds
Epic BFZ 40304.

Sound: B- Performance: B

The Fabulous Thunderbirds have been kicking around Texas for ages, playing terrific rhythm and blues with a heavy accent on the latter. Along the way they've made several albums too. However, *Tuff Enuff*, produced by Dave Edmunds, is their finest—no doubt about it.

The four-piece band is fronted by harmonica-playing, smoky-voiced Kim Wilson. Jimmie Vaughan, Stevie Ray's big brother, is the guitarist, and Preston Hubbard and Fran Christina make up the rhythm section. This is a great-chops kind of band.

Wilson writes most of the original material The Thunderbirds do, and he has come up with a couple of real winners this time, including the title cut, which has enough sizzle to make ZZ Top jealous, and the deadly clever "Amnesia." Another highlight is a hot cover of "Wrap It Up."

Edmunds' production does not fool around. It focuses on the band unit and their solid performance. For fill, Edmunds brings in keyboards alternately played by Al Copley, Geraint Watkins, and Chuck Leavell. On the light shuffle "Two Time My Lovin," Cesar Rojas and David Hidalgo of Los Lobos add voices.

Looking for something in the way of a house-rocking party album? *Tuff En-*

uff has all the ingredients—hot tunes, hot chops, lively sound. Put it on, turn it up, and check out how good it'll make you feel.
Michael Tearson



Different Light: The Bangles
Columbia BFC 40039.

Sound: C+ Performance: B

The four women who make up The Bangles have delivered a sweet album here, their second full-length. While there is nothing too blazingly original, it's a snappy set of sharp songs delivered with a brightness and simplicity reminiscent of late-'60s recordings.

In the best of The Bangles' songs is a feeling of vulnerability that is really quite appealing. The band does write some choice material, but the best songs here are a pair of covers. "Manic Monday," written pseudonymously by self-professed Bangles fan Prince, is a sweet/sad groan about facing the start of yet another week. Jules Shear's "If She Knew What She Wants" comes off as a charming slice of girl talk about a friend both pitied and envied.

Vocals are a focal point, and lots of soaring harmony is used. Each Bangle gets her shots at lead voice, but Susanna Hoffs emerges as the band's strongest singer. David Kahne's pleasantly uncluttered production is very right, as he doesn't let frills get in the way of the good material.

If *Different Light* isn't a world shaker, it is still quite a nice album. I expect it is making The Bangles a lot of new friends.
Michael Tearson

Fountain pen, ballpoint, pencil, or phone. Pick up any one of them and you will soon hear all the sound you've never heard.

A marriage made in hell.

The sad truth of the matter is that your amp and speakers were never made for each other. No matter how hard manufacturers have tried to match them, their differences have remained irreconcilable.

As in all bad marriages, it's a communication problem. They just don't talk to one another. The amp cannot anticipate requirements of the speaker, nor can the speaker tell the amp what it needs. The result is phase and amplitude distortion not measurable in the indi-

"For my own personal system, it was the answer to problems that I had been trying to solve with a graphic equalizer. The system has never sounded so good!" - Jim Thomas, MIX Magazine

And your system will produce sound much closer to true "live" sound than you've ever heard from it or any other system before. Which means you'll be able to increase your enjoyment of everything you listen to through your stereo system—your albums, cassettes, videos, television, radio and even your compact discs—all as they

humble or magnificent. Every application is an improvement. In short, it makes any speaker sound better.

The BBE 2002 also has the virtue of being able to fit into any audio system. It measures only 16" x 7 1/2" x 3". And all you need to make it work is to plug it into a regular wall socket, and plug it into your standard tape loop. Then sit back and get comfortable, because from now on, you're going to be using your system a lot more. And enjoying it more.

What price glory?

\$250.

We believe in the BBE 2002 so strongly that we're

Revolutionize your sound system in one stroke.

vidual components. So whether you're listening to Mozart or Twisted Sister, something is always lost in the translation.

What your amp and speakers need to live in harmony is something that understands them.

Not just another black box.

Though the BBE™ 2002 may make some pretty familiar promises, it goes about fulfilling them in a very different way.

Everyone wants their sound as close to "live" as possible. At Barcus Berry Electronics, Inc. we're no different. We consider ourselves very knowledgeable in the area of live sound since we've been making the world's most popular musical instrument transducer microphones for the past 20 years.

But over the past 10 years, we've also been perfecting a brand new technology that will finally let you get as close to true "live" sound as man-made components will allow.

So, ten years and 42 patent claims applied for and granted later, we've come up with something close to a miracle. We call it the BBE 2002.

The BBE 2002 has a "brain" that knows how speakers work. It continually compares the original sound program or signal

were really meant to be heard.

But be forewarned. It's an extraordinary sensation at first, because you're hearing your sound system deliver better sound than you've ever heard before. It's the best thing this side of live. It's as if



you always listened to your speakers with old army blankets over them and suddenly took them off. And it'll spoil you for anything less.

Even engineers and producers need BBE.

The BBE 2002 employs the same circuit utilized in our professional model which is being used in recording studios, radio stations, movie theatres and concert halls throughout the world. This professional model has exceeded the expectations of the most demanding engineers, producers and performers.

What the BBE 2002 represents is the solution to the amp/speaker interface problem. Try as they might with the most advanced acoustic technologies, component manufacturers have never been able to make all their equipment work together efficiently.

And the BBE 2002 works wonders with any system you connect it to, however

giving you an iron-clad 30-day, your \$250 back, no questions asked, guarantee. And we'll even give you a full year's warranty on all parts and labor.

The phone is mightier than the pen.

There are several ways you can fix your sound system. You can call us toll free at 1-800-453-5700. In Utah, 1-800-662-2500. We've got those famous operators standing by 7 days a week, 24 hours a day. Or you can fill out our coupon with the

"I can't imagine working on another album without BBE."

- Steve Levine, producer of Culture Club, The Beach Boys, and 1984 BPI Producer of the Year.

writing instrument of your choice and order your BBE 2002. Credit cards, money orders, bank checks, certified checks and wire transfers will be processed immediately. Personal checks require 18 days to clear. And, if you're in a particular hurry and order by credit card, you can get your BBE rushed to you for a small additional charge.

You can also write or call us for a free brochure to learn more about the BBE 2002.



But that will only delay the inevitable. Sooner or later, you're going to have your own BBE 2002. Be the first on your block. You always have been. Haven't you?

"Everything we heard from it sounded good, and it had no discernable flaws. Not too many products we test can justify the same conclusion."

- Julian Hirsch, Stereo Review

with the likely output at the speakers—all the while anticipating the myriad problems caused by the inherent imperfections of the speaker/amp interface.

A true musical genius.

The BBE 2002 is not only smart, it's fast. It corrects the signal, as needed, more than 50,000 times a second.

The results are dramatic to say the least. Some say they're revolutionary. The highs have greater clarity. There's a remarkable increase in presence. Separation is extraordinary. Harshness is diminished so you'll experience less "ear fatigue."

1-800
453-5700
In Utah, 1-800-662-2500

I want my BBE.

Send me ___ BBE 2002 unit(s) at \$250 each. (CA residents add applicable tax. U.S. currency only. Additional charge for rush shipping determined by destination. Canadian residents should write for additional information.) (Please allow 4-6 weeks for delivery.)

BBE All the sound you've never heard.
Barcus-Berry Electronics, Inc.
5500 Bolsa Ave. Suite 245 Huntington Beach, CA 92649

Enclosed is a check for \$_____ Or please charge to my:

Visa MasterCard American Express

Card # ---- Exp. date

Signature _____ Telephone (____) _____

Name (print) _____

Address _____

City/State/Zip _____

A-6

© 1986 Barcus-Berry Electronics, Inc.

EDWARD TATNALL CANBY

NO UGLY DUCKLING

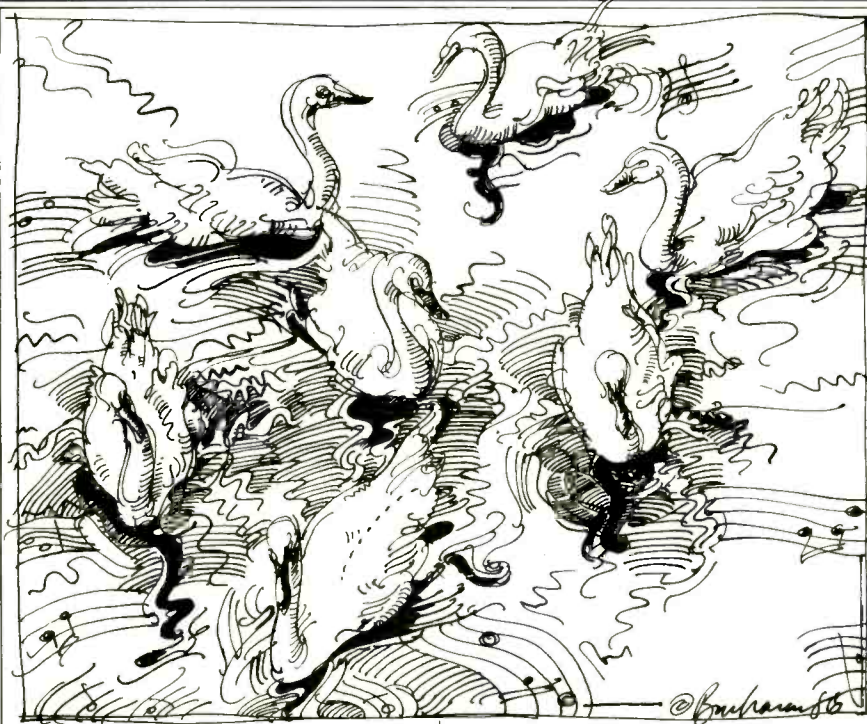

Heinrich Schütz: Der Schwanengesang (Opus Ultimum). The Hilliard Ensemble, The London Baroque, The Knabenchor Hannover; Heinz Hennig, conductor.

EMI 27 0275, digital, two-record set (import).

Even among the most dedicated Schütz lovers, of which there are plenty in the U.S., there are probably quite a few who have not heard of this work, "The Swans' Song." It was composed around 1670, 11 sizable pieces plus two extras, but probably was not much performed and soon faded away. Only one segment, the final "German Magnificat," has been around and is familiar. Schütz, in his 80s when this music was composed, was the greatest pioneer of German church music for the Protestant faith—but what can you do when your boss and king, the Elector of Saxony, converts to Catholicism? Start all over again in Latin?

What we have here, now that the actual music has at last been assembled completely enough to work out a performance (appearing in unexpected finds from 1900 to as recently as 1970), is a "scholarly edition" according to newer ideas as to how Schütz must be brought into sound: Very

much amplified from the original notes. Schütz was conservative for that late time. He didn't say much of anything, but expected a lot—an organ and a very considerable collection of instruments, plus solo voices to contrast with the double chorus, all added ad lib. Today, we have to realize all this as best we can, a tough and controversial job for anyone who tries. There can be no definitive version.

All the more remarkable to hear what grand, big music this can be. For German music it is strikingly like Monteverdi, who wrote a generation earlier, and quite unlike the more familiar late Baroque of Vivaldi, Bach, Handel, and (er) Pachelbel. The older manner prevails, many short segments at different speeds, joined together in quick contrasts. None of the long stretches based on one or a few ideas that we hear especially in Bach. Instead of Bach chorales we hear their antecedents, Gregorian chants and the similar (and related) early Lutheran hymns.

Two choirs of voices, and choirs of contrasting instruments (added), bring plenty of drama and complex sound to the words of Psalm 119, a very long one, taken verse by verse in the exuberant German text. Solos and combinations of a few voices—boy sopra-

nos, countertenor, and bass—alternate with the mostly joyful chorus. It is a wide stereo expanse, big and live, and, when your ear adjusts, it can grow impressive.

I would rate these 13 motets (the technical designation for each of the separate movements) as still somewhat transitional in the performance, not entirely jelled into one style and manner. The diction is superb and un-failingly clear, the accuracy and verve are terrific, the speed—thank the Lord—is "up to time," at a *speaking* tempo in respect to the words themselves. The instruments are of an authentic type from recorders to trombones (no strings—the high voices and recorder take care of that). But the various voices are too dissimilar; some sing minus vibrato, some with quite a lot, some are throaty, some reedy and edgy. Not too good a blend and often a bit distracting. A more integrated sound would have been better, but this is not easy to achieve, today, when singing styles are changing so fast.

Schütz in digital! This British-made LP is not part of EMI America's catalog, but imports are often around, or can be ordered. Try.

Lost in the Stars—The Music of Kurt Weill: Various Artists
A&M SP-9-5104, \$9.98.

Sound: B— Performance: A+

Lost in the Stars is a celebration of the dramatic music of Kurt Weill, who is best known for *The Threepenny Opera* and his other collaborations with Bertolt Brecht. A wildly diverse collection of artists performs on this album, the third in a series that Hal Willner, coordinator of live music for *Saturday Night Live*, has assembled. The previous two honored Nino Rota and Thelonious Monk. All three are albums of startling performances by artists doing things you'd never expect them to, and there is brilliance throughout. *Lost in the Stars* is the best yet.

Sting offers a stark reading of "The Ballad of Mack the Knife" in a different translation from the German—more brutal and violent than the ones made famous by Bobby Darin and Louis Armstrong. Marianne Faithfull is appropriately jaunty, rough-hewn and melodramatic, by turns, doing the chilling

Illustration: Yvonne Buchanan

If you can't afford it, spare yourself the heartache of listening to it.

We are all aware that, money aside, it is an easy matter to upscale our quality of life, but difficult to lower it. In this regard, ignorance is bliss, and strict abstinence is sometimes better than a taste of something finer that we can't have. So it is with the Concord HPL-550 Tuner/Amplifier/Tape Deck. One listen could ruin you.

Concord's performance engineering over the years has resulted in a list of mesmerizing characteristics that, as you become aware of them, will change your perceptions of car radios.

For instance:

A sound most critics claim is the best they've ever heard in a car radio.

Superb stereo imaging, wide band frequency response, and very low distortion levels are just some of the qualities of Concord's exclusive Matched Phase Amorphous Core Tape Head.

A cleaner sounding FM than you ever believed possible, thanks to the exclusive Concord FNR FM noise reduction system.

The Tuner/
Tape Switch

enables the listener to hear radio broadcasts when tape is in the rewind, fast forward or play mode.

Hot AM Stereo that receives Motorola C-QUAM broadcast signals.

Electronic DC Servo Tape Drive for extended life and accurate control of tape speed.

High powered inboard amplifiers—rated at 25 watts per channel.

Dolby B, C, + DBX: Tape noise reduction systems.

Lighted panel switches,
electronic memory
with 24 preset

stations, signal processor circuitry, a two-way/four-way amplifier, automatic Music Search Scanner, and a Bass EQ Switch.

One listen to all of this and you will be exhilarated. But then, if you can't afford it, you will be depressed. What will it be? Exhilaration and depression, the full human gamut? Or blissful ignorance? The trouble is, if you have read this far you are no longer blissfully ignorant.



CONCORD®
Anything else is a compromise.

Concord Systems, Inc.
6025 Yolanda Avenue
Tarzana, CA 91356-0010
A Penril Company

Enter No. 16 on Reader Service Card



Lost in the Stars is uncommonly intense, a challenging thrill-ride through some very dark and dangerous places evoked by Kurt Weill.

"Ballad of the Soldier's Wife." The presentation of "Alabama Song" alternates vocals by Richard Butler of The Psychedelic Furs, pop singer Ellen Shipley, and jazz singer Bob Dorough over Ralph Schuckett's wonderfully clanging chart. Tom Waits is brilliantly cast to sing the cynical and violent "What Keeps Mankind Alive?" as is former Wall of Voodoo vocalist Stanard Ridgway (remember "Mexican Radio"?) for the black wit of "The Cannon Song."

Dagmar Krause conjures up images of smoky, late-night movie scenes in the famous "Surabaya Johnny," with a spectacular rendition that segues to the dirge-like "Oh Heavenly Salvation" featuring the great New Orleans voices of Johnny Adams and Aaron Neville. Todd Rundgren's contribution is a surprisingly effective modern treatment of "Call from the Grave." The album's only real clinker is Lou Reed's "September Song," on which his coy monotone conveys neither sarcasm nor romance—whichever of the two he was trying to express.

Carla Bley and Phil Woods offer a dreamy instrumental version of the title song. (It would have been nice to have Maxwell Anderson's lyrics printed with the album notes, since we don't hear them, but you can't have everything.) Charlie Haden and Sharon Freeman do equally well with "Speak Low." Other contributors include the inimitable Van Dyke Parks, Steve Weisberg, John Zorn, and the Armadillo String Quartet.

This is an uncommonly intense album to listen to. Selections are ordered intelligently and often provocatively to

heighten irony. It becomes a challenging thrill-ride through some very dark and dangerous places.

The album was recorded in nearly as many locales as there are contributors, but it is still consistently wrought. For atmosphere, many selections have tricky little dramatic effects involving voices heard through filters (such as the radio voice echoing the lyrics late in "Alabama Song"). Throughout the album, horns are given warm and loving treatment. *Lost in the Stars* is a very classy recording. The only problem is that the generous length of the sides, 30 and 30½ minutes, leads to difficulty in maintaining levels—a problem that doesn't crop up on cassette. (Of course, with the cassette package you don't get the detailed annotation that comes with the album; all you get is two biographical paragraphs about Kurt Weill.) The Compact Disc release of *Lost in the Stars* is even longer than the LP, with the addition of "Meatball Song" by Elliot Sharp and "The Great Hall" by Henry Threadgill. It also sports extended versions of "Oh Heavenly Salvation" and "Johnny Johnson" by Van Dyke Parks.

Lost in the Stars is truly extraordinary. It throws a lot of light on a composer whose music grows more vivid with time, and reveals unsuspected facets of several very well-known artists. Best of all, it is a riveting listening experience, both on musical and dramatic levels. It is a milestone of an album.

Michael Tearson

Janáček: Lachian Dances, Idyll. The Rotterdam Philharmonic, James Conlon.

RCA Erato 75191, digital, \$10.98.

Leos Janáček—from the name, he is obviously out of the land of Dvořák and Smetana, once collectively called Bohemia as a part of the Austrian Empire. Janáček is a good 19th-century composer who lived on well into the 20th, incongruously continuing to compose in the "modern music" era. His late operas are really getting around now, and for good reason; he is, we might say, more modern than old Richard Strauss—roughly a contemporary—but old-fashioned enough to appeal to a lot of ears.

However, this music is something else again. The "Lachian Dances" date from 1890 and purport to be folk music. But in those days "folk" meant crude and, of course, subject to cleaning up as "art" music, which is what you will hear. Indeed, this thickly scored work goes along with everything from Brahms and Dvořák and Smetana to Grieg, as a pleasing and juicy dance suite. But both Grieg and Dvořák sound more modern than this bland yet tuneful Janáček.

The "Idyll" is even earlier, one of those lovely, strings-only suites that were so popular, again from the same familiar composers. This one was composed when Janáček was 24, in 1878—it is early "late-Romantic" and far, far from the 20th century. Though



James Conlon



READ LIPS, NOT ADS.

We bet this isn't the first time you've heard the Aiwa name, even if it is the first time you've read an Aiwa ad. Because what's on people's minds is soon on their lips. Like the name Aiwa. And Aiwa's new high-performance DX-1500 Compact Disc Player. Its advanced 3-beam laser pickup assures positive, precise tracking. Two sub-beams constantly check, and instantaneously correct, the main laser beam as it tracks each digital signal. If that sounds a bit too technical, wait until you hear how good it makes your compact discs actually sound. Just listen to your favorite album. In any order you like! The DX-1500 has single-touch memory. This allows you to program up to 16 tracks for playback in any order you wish. And the repeat function can be programmed for the whole disc, your random program or just one track. While the music is playing you just sit back with the wireless remote control and enjoy the sounds. That's the Aiwa advantage: all the technology you expect from the compact disc now comes with the incredible ease you get only from Aiwa. Now that you know all about Aiwa's high-performance DX-1500 Compact Disc Player, try to keep your lips sealed. Go on, just try. Really try.



YOU'RE INVITED TO THE WORLD OF DIGITAL AUDIO

The digital revolution continues...
And once again, Sony and Audio Magazine are sponsoring seminars to tell you all about it.

In fact, digital audio, already the driving force in high fidelity, is rapidly expanding to include Digital Signal Processing components, Digital Audio Tape cassettes, plus an extraordinary array of new applications for the Compact Disc.

Len Feldman, author, audio critic and Senior Editor of Audio Magazine, will be your guide at this seminar.

But there's more. Dramatic sound demonstrations. Door prizes. Compact Discs, given away at each event.

And it's all *free!* Just contact the sponsoring dealer nearest you for exact time and location.

Seattle, WA	Apr. 14	Definitive Audio
San Francisco, CA	Apr. 15	Digital Sonics
Los Angeles, CA	Apr. 16	Paris Audio
Denver, CO	Apr. 17	Listen Up
Odessa, TX	Apr. 21	Electronic Service Center
New Orleans, LA	Apr. 22	Alterman Audio
New York, NY	Apr. 29	Lyric HiFi
Philadelphia, PA	Apr. 30	Chestnut Hill Audio
Baltimore, MD	May 1	Gramophone Ltd.
Washington, DC	May 2	Audio Associates
Minneapolis, MN	May 6	Audio King
Chicago, IL	May 7	United Audio
Detroit, MI	May 8	Pointe Electronics
Cleveland, OH	May 9	Ohio Sound
Miami, FL	May 12	Sound Advice
Atlanta, GA	May 13	Hifi Buys
Nashville, TN	May 14	Audio Systems
Portland, ME	May 19	New England Music
Wellesley, MA	May 20	Music Box
Paramus, NJ	May 21	Harvey's Electronics

A cooperative effort of

Audio

SONY

THE LEADER IN DIGITAL AUDIO.

Compare the new two-wheel drive Jeep Comanche to Ford Ranger and Chevy S-10, and you'll find Comanche has the lowest price tag. And in 4x4's, Comanche is the lowest-priced long-bed pickup you can buy.*

Up front, a gutsy 117 horsepower 2.5 litre electronic fuel-injected engine is standard. It's more powerful than the base engine of any other pickup in its class.

Comanche's 119.9 inch wheel-base is longer than any other long-bed pickup in its class.

Comanche is the only 4x4 pickup built with a choice of two "shift-on-the-fly" four-wheel drive systems.

You'll find big 15-inch wheels and all-weather radials standard on Comanche, optional on two-wheel drive Ford Ranger and Chevy S-10.

Four Wheeler of the Year.

Safety belts save lives.

*Based on manufacturers' suggested retail prices for base long-bed vehicles. Excluding taxes, license, destination charges and optional equipment. Prices may change without notice.



Easy to be a truck. Hard to be a Jeep.



New Jeep Comanche 
Available in 2WD and 4WD



This album of foamy little dance pieces, led by Erich Kunzel, features some sound effects that are sure to exercise your hi-fi system.

harmonically more conventional than the "Dances," the "Idyll" is a strong and youthful work which seems perhaps more timeless than the composer's later music.

A resonant and rather distant recording here, not good for the somewhat thick "Lachian Dances," which are blurred and smeared in a golden acoustic haze. Nor did I much enjoy the peripatetic James Conlon's direction of the Dutch orchestra. It is technically correct but smoothly dull, and too often sloppy around the edges. Maybe he was just off the plane, and perhaps the orchestra had only a few run-throughs before facing the digital recorder. It happens. On the other hand,

the all-strings "Idyll" takes fire, is much more expressive and is more accurately played too. Moreover, the string orchestra is more at home in its acoustics than the full orchestra of the first LP side. Aha! One notes that the first side was recorded in June, the second side in October, and the sound engineers were different! That could explain a great deal. Curious art, this jet-style recording we do today.

Ein Strausfest. The Cincinnati Pops Orchestra, Erich Kunzel.

Telarc DG 10098, digital, \$12.98.

Telarc is busy on its "pops" series, using its home-town (well, almost home-town) orchestral forces. *Ein Strausfest* features music of the Waltz Strausses, led by big brother Johann Jr. Oddly enough, there is only one waltz on the first side and one on the second—the rest are the less familiar but more energetic polkas, galops and so on.

There's more. Telarc interestingly goes into a zany "sound effects" tradition that dates back acoustically to the days of Mozart and Haydn—echoes of which you will know in such items as the Haydn "Military" symphony, the many "Turkish" cymbal-like effects in works of the time (and through Beethoven), and, of course, the preposterous "Toy" symphony, apparently by Leopold Mozart, Wolfgang's papa. The fad for all sorts of incongruous noises reached right into the 19th century, but by the time of the waltzes and polkas from the Strauss family, it was more of a conscious reminiscence, just for the fun of it.

I won't go into a studious list of Telarc sound effects in these foamy little dance pieces, but needless to say, they are very well designed to exercise your home fi. As on the CD version, there is a warning about very loud (and very soft) sounds and potential danger to equipment! Rightly so. Have fun—and be careful.

When you're
through compromising...

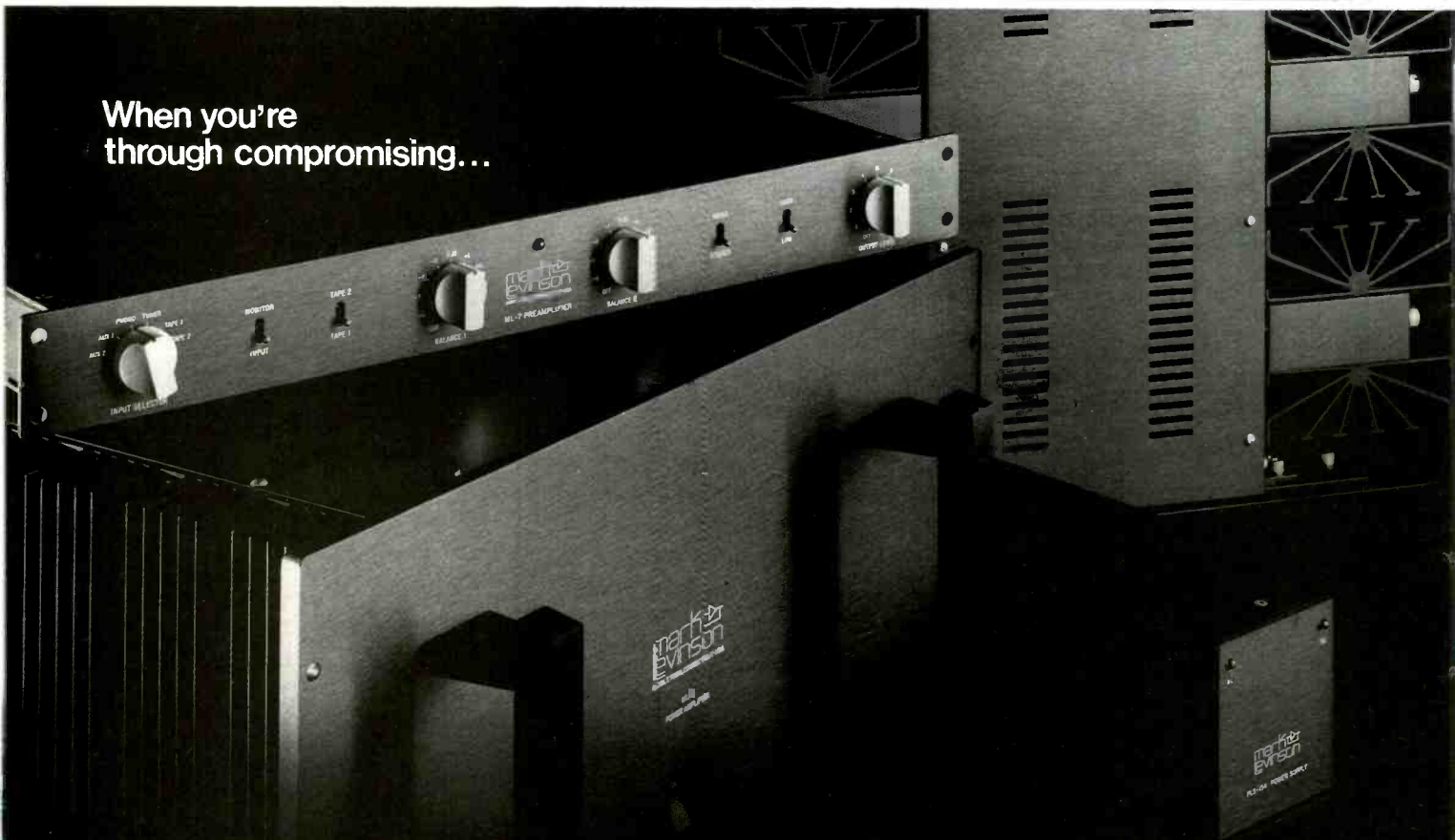

M A R K L E V I N S O N

Manufactured and distributed by **MADRIGAL LTD.**, PO Box 781, Middletown, CT 06457 ITT Telex 4942158

Who buys Pyle Driver[®] Car Stereo?



almost everybody!



Over two million car owners have installed the great sound of Pyle Driver[®] speakers.

The Quality Continues! Introducing Car Stereo Components Powerful Enough to be Pyle.

New Pyle Driver[®] Pounders

Powerful new speaker systems for pickups, hatchbacks, sports cars, vans and 4x4's. Pound for pound, the most dynamic speaker systems on or off the road.

New Pyle Digital Demand Amplifiers

Power packed and distortion free for pure explosive sound. Pyle Digital Demand amplifiers, preamp/EQ and electronic crossover are American made and fine tuned by 30 years experience. Perfectly Pyle!

Enter No. 37 on Reader Service Card



PYLE

For the name of the Pyle dealer nearest you write:
Pyle Industries, Inc. • 501 Center St. • Huntington, IN 46750

MOUNT MCKINLEY



The Chess Box: Muddy Waters
Chess PLP 6040-6050, 11-disc set,
 \$95 plus shipping. (Available from
 Down Home Music, 10341 San Pablo
 Ave., El Cerrito, Cal. 94530.)

In a Chicago bar named Big John's, north of North Avenue, when it still was Old Town and not a sinecure for old geeks; before they pulled down Big John's, and Lee Schmidt's Second Chance next door, and the fluorescent Irish pub beyond, and while Vieux Carré was still a neighborhood bar, I lost a pool game, badly, on a tiny bumper-table just four feet in length. I'd gotten on the table by putting my paper match, split like a miniature dousing stick, at the end of the row, and waiting five games. When my turn came, the King of the Table broke the rack hard, put down nothing, and scratched, the cue bouncing off the table. I ran six solids, missed, he missed, and I knocked the last two off the slate.

The next guy up was a skinny little wimp with half a moustache spread over the two sides of his face. He couldn't shoot no pool, 'less the ball was shorter than six inches, straight in, out of the pocket. But he didn't need to, 'cause that's the kind of leaves he

got, both off his shots and the two I left him. I wasn't totally wiped—got one ball—but there wasn't no way but that I got run off that table.

Now, sittin' up on one of the shoe-shine chairs they had along the side for watching pool, like a king on a throne, with his hair up on the front of his head in a big do, was Mr. McKinley Morganfield. I knew who he was; I'd been listening to him earlier that night. Now, boys get to feeling bad when they get whupped worse than they ought to be. I looked up at Muddy and shrugged; he gave me one of his patented partial smiles where only the right lower quarter of his face moved. It didn't make me feel *no* better.

The story goes, Muddy was driving his uncle's coal truck when he heard from a friend that Leonard Chess wanted him at the studios. Leonard has said that Morganfield just walked in off the street; Arnold Shaw writes in his classic book, *Honkers and Shouters*, that Muddy was sponsored by another Delta bluesman, Sunnyland Slim, and that a Chess talent scout spotted him in a local club.

This 11-disc boxed set, which bills itself as a "P-Vine Special" on the bellyband, has a 20-page, 12 x 12-inch booklet mostly in Japanese, with a lot

of pictures this blues freak has never seen before. On page 3 are the enticing credit lines, "Originally produced by Leonard and Phil Chess. Manufactured and distributed by Blues Interactions, Inc., under license from Chess Records."

The recordings cover 20 years, beginning with "Gypsy Woman," from 1947, when Muddy was 32. This cut is one of 25 from Aristocrat in the box; the balance comes from Chess 45s and LPs. Included are "Rollin' Stone," "Hoochie Coochie Man," "Mannish Boy," "Crawling Kingsnake," "Messin' with the Man," and about 150 others. Now, I consider myself a blues record collector, which means that I have a few hundred blues LPs. P-Vine or Blues Interactions, whichever, has a much stronger idea of what it means to be a blues record freak than I do; I freely admit it. I just wish I could read the Japanese, because there's a wad of information in the booklet. Aside from the period photos, which had to be hard enough to dig up, it shows early record labels and jackets, clippings, a *Cashbox* regional Hot 10 chart from 1954, an interview with Mr. Morganfield together with a pic of him on some TV screen, and a 20-album Chess/Checker/Cadet-Concept discography. Taking up a page is a drawing of roots and influences showing Muddy's musical associations with literally dozens of important musicians from Son House and Robert Johnson, through the original Sonny Boy, Little Walter, Junior Wells, Otis Spann, Willie Dixon, Wolf, James Cotton, Chuck Berry, Buddy Guy, Otis Rush, and Carey Bell, to Paul Butterfield, Mike Bloomfield, Johnny Winter, and The Band.

All of which is to ignore the music—ah me, yes, the music—the present inside all this fancy wrapping. It's Big Muddy, up front, in the center, that's the attraction, and he's man enough to carry the show for all 11 discs. For a blues fan like me, it was enough to keep me listening straight through four or six discs, with a detour back through three or four of the stronger cuts. The subject's loving, always, and always Muddy's the man—present, strong, virile; intent, and not to be messed with. His voice is full of power, raw and hurting, and never uncontrolled. There are times when he's gen-

Rogers

LEGENDARY ACCLAIM

RAVE REVIEWS: Year after year, in audio journals and magazines throughout the world, Rogers loudspeakers get consistently positive reviews. Why? Because something overwhelming happens when you connect with the emotional heart of the music. Make the connection . . . Rogers, Legendary Acclaim.



- "LS-2 vocals were remarkably clear and open, with no trace of edginess or hardness." *HIFI Heretic*, 1985 (U.S.)
- "The LS-6 was found to be very well balanced with a transparent, informative mid, and an open, airy nature." *HIFI Choice*, 1985 (UK)
- "The LS 3/5A is a real monitor speaker, the sound is just amazing. The stereo image is just wonderful." *New HIFI Sound*, 1985 (UK)
- "The Rogers Studio 1 was awarded just as many points as our reference system which is over 7 times the price." *Electronic Sound*, 1981 (Germany)
- "The LS7 in its latest form is a really excellent speaker which seems virtually transparent in its reproduction of music." *HIFI for Pleasure*, 1984 (UK)

FOR MORE INFORMATION CONTACT

naiao

BOX 1840 BRANTFORD ONTARIO CANADA N3T 5W4
BOX 1250 FALLS STA NIAGARA FALLS NY USA 14303-0260
(519) 756-4860

Enter No. 40 on Reader Service Card

tle, fully using an intricate technique; other tunes are heavy celebrations of what it means to be a man in Muddy's world.

On the early cuts there's melodic guitar work, with simpler groups; on several, Muddy was in country mode, soaring like Lonnie Johnson. The later pieces are more settled, in the Chicago style Muddy did so much to define, with a more solid, professional backing of piano, sax and slide guitar. The sound quality, regrettably, is at best only fair and generally poor—even though some caring soul has done a lot of cleaning up and quieting down to try to make this a quality reissue. It probably isn't possible to do anything better.

Now, I don't carry around \$95 in my pocket most days, but I have to say this collection represents a bargain at that price to this blues freak. *E.P.*

Soul Man—Live in Japan: Otis Clay **Rooster Blues R7609**, two-disc set, \$10 plus postage. (Available from Rooster Blues, 2615 North Wilton Ave., Chicago, Ill. 60614.)

Sound: B+ Performance: A-

The concert stage is the ultimate proving ground for a bluesman. Rock acts may hide behind elaborate theatrics, but blues and soul performers,

once away from the technical wonders of the modern recording studio, are forced to rely on that rarest of commodities, raw talent. And as his fans have long claimed, raw talent is precisely what soul man extraordinaire Otis Clay has in abundance.

Time and again during this two-disc live set, I was tempted to play parts of a track over and over again, much the way that you might repeatedly watch a perfectly executed sports play on videotape. Clay's vocals are a luxurious blend of technique, talent, and soul. Vocal mannerisms and nuances that lesser figures would nurse into trademarks, Clay casually tosses off without a second thought. He can do it all, but this veteran refrains from overpowering his material with his ability.

"Ellie" is the highlight of an album without a bad track. The Southern-born Clay started his career as a gospel singer, and his voice still drips with emotion in a spectacular performance that blurs the line between gospel and secular traditions. Clay's eight-piece band sensitively follows his vocals, sometimes almost disappearing into silence while Clay alternately pleads with and confesses to his enthralled audience.

Archivists take note: This set was cut in 1983 in Japan, but has been remixed for its domestic debut. Clay's stirring vocals are always in the forefront, his wonderful band is crisply recorded, and the set's live ambience augments the performances. Highly recommended, and here's hoping that Clay's now-deleted albums for American labels find their way back into record stores. *Roy Greenberg*

Out of the Blue: Didier Lockwood **Gramavision 18-8504-1**, digital.

Sound: B Performance: B-

Didier Lockwood is a French violinist who has been the designated heir to Jean-Luc Ponty—who was the designated heir to Stephane Grappelli—for several years now. Unlike Ponty, who's abandoned his jazz heritage for electrified music, Lockwood dips his bow into fusion as well as modern forms of acoustic jazz. His electric albums, including the recent *Didier Lockwood Group*, have been uneven, while his acoustic discs have been too even.

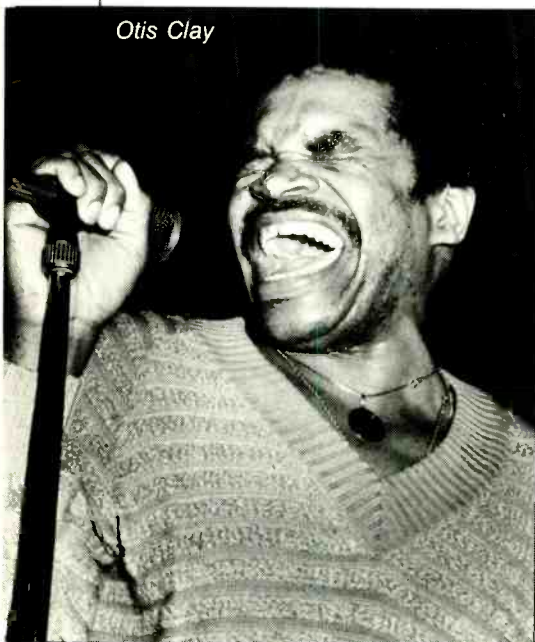

Otis Clay

Audio

SUBSCRIBER SERVICE

Place label here

MOVING?

Please give us 8 weeks advance notice. Attach label with your old address, and write in new address below.

Name _____

Address _____

City _____

State _____ Zip _____

AUDIO
1255 Portland Place
P.O. Box 5318
Boulder, CO 80322

Didier Lockwood is an exceptional violinist, and his instrument has a nice cutting edge on this digital recording.

Here, Lockwood has selected one of the best contemporary jazz rhythm sections in bassist Cecil McBee and drummer Billy Hart. Their churning, inventive rhythms power *Out of the Blue* even through its most tepid moments. Much of this album is simple jamming, with great musicians playing unin-

spired tunes with little depth. "Cello Britten," "November Song" and "Train Blues" have moments, particularly some enlivened McBee solo spots, but they are not entirely memorable.

On the other hand, "Legs," the opener, promises an album of spirited duels and reckless charges as the en-



semble locks into a shifting rhythm under Lockwood's pyrotechnics. Pianist Gordon Beck turns in his best work, recalling pianist Don Pullen with a combination of speed and nuance. The title cut is a storm of tumbling rhythms, as Lockwood deftly leaps, twists, turns and slides through the maelstrom created by Hart and McBee. Thelonious Monk's "'Round Midnight" is introduced with a fiery obbligato and a more impassioned reading than is normally given this dark, cool classic.

Lockwood's violin has a nice cutting edge on this digital recording, and the rhythm section has more depth than any of his previous acoustic discs did. The ensemble has presence without the false equalization and reverberation that mar many contemporary jazz recordings.

Didier Lockwood is an exceptional violinist who has yet to make the definitive statement of his mastery. *Out of the Blue* shows all the markings of a musical genius who hasn't reached his first destination. *John Diliberto*

Le Parc: Tangerine Dream
Relativity EMC 8043, \$8.98.

Sound: C Performance: D+

Because they cleared the brush 20 years ago for our bumper crop of synth bands, any criticism of Tangerine Dream should be tempered with respect. Helping to haul the synthesizer from the lab to the pop arena is not enough, however, to excuse the band's creative stagnation, so embarrassingly evident on *Le Parc*.

After the initial infatuation with novel electronic sounds wore off, most musicians expanded their application of the

FOR THE SHEER LOVE OF MUSIC

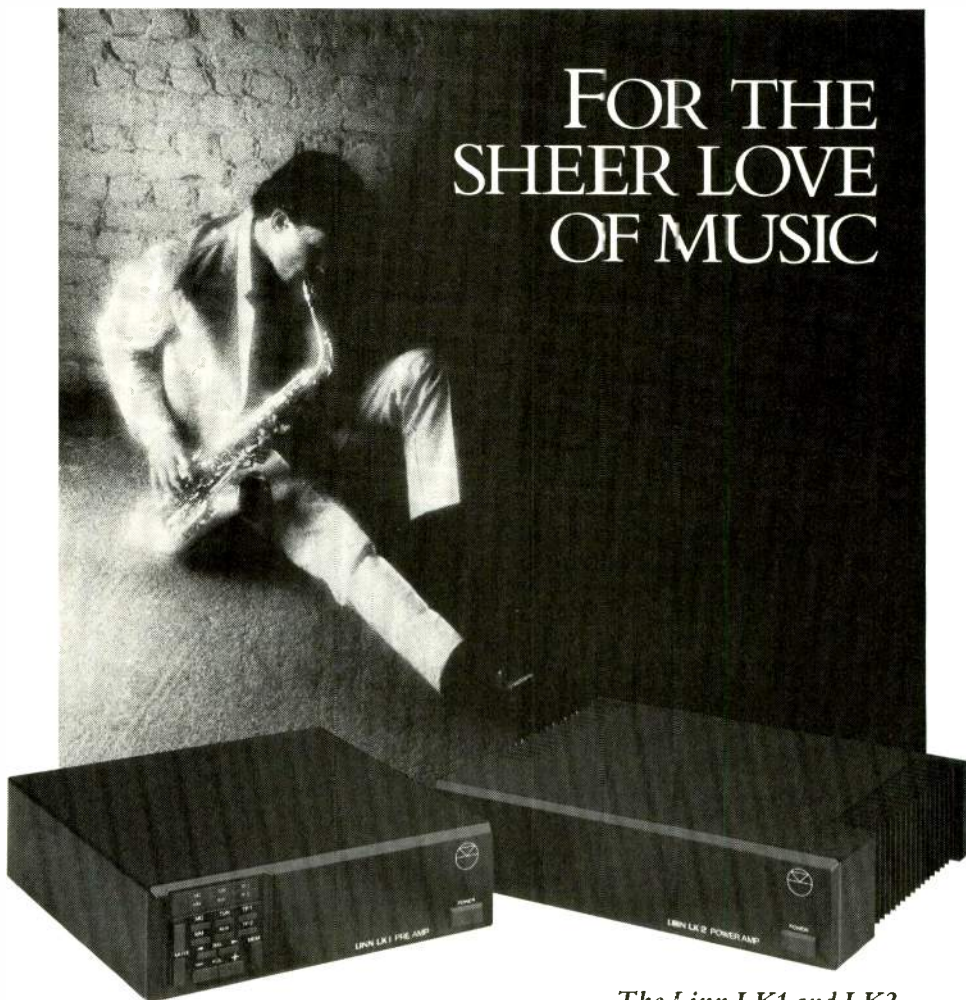

The Linn LK1 and LK2

The most advanced preamp and poweramp in the world—incorporating microprocessor controlled analog switching, full remote control and simple modular construction. The LK1 and LK2 set new standards in design, manufacture and quality control. Unprecedented musical performance at a price that will astound you.



The Linn LK1 and LK2.
They must be heard.

For further information contact: Audiophile Systems Ltd. • 8709 Castle Park Dr. • Indianapolis, IN 46256
Aldburn Electronics • 127 Portland Street • Toronto, Ontario • Canada M5R2N4

The Sound of Perfection.



The Secret is BASF Chrome.

Pure Chrome! It's the secret! Pure Chrome! It's the reason! Pure Chrome BASF Chromdioxid Maxima II. It's producing the sound that every other tape in the world wants to sound just like. Because it's the only tape in the world that delivers pure sound in all its brilliance. The only tape in the world made of perfectly shaped chromium dioxide particles in an exclusive formulation that delivers extremely low background noise.

It all adds up to unbelievable sound reproduction. Unbelievable sensitivity in the critical high frequency range. In fact, it's the improved formulation of Chromdioxid Extra II, the official world standard for Type II high bias tapes.

Now that you've heard the reasons why it's the sound of perfection, hear the sound of perfection. BASF Chromdioxid Maxima II.

 **BASF**
 Chrome Audio & Video Tapes
 The quality never fades.

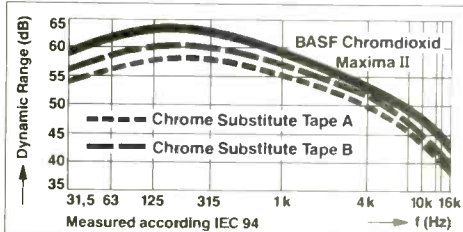



Tangerine Dream

Creative stagnation is evident on *Le Parc*, an album with little warmth and a lot of unnervingly plastic sound.

In the right context, the pings and drones could be evocative, or at least amusing. Here, weak arrangements and insipid, poppish melodies make the album sound like video-game sound effects on a very grand scale.

A certain amount of blame can be laid on the percussion. On many songs, it's relentlessly constant, with rare variations, and usually pushed forward in the mix. In these cases a more subtle placement and a few fills and breaks might have given the music a much needed edge.

The songs on *Le Parc* are dubbed as "aural portraits" of various parks around the world, but not much distinguishes the different parks surveyed. With its evasive impressionism and narrow vision of the synthesizer's potential, *Le Parc* is, unfortunately, like a primer of what to avoid in electronic music. It's sad that trailblazers such as Tangerine Dream should be stranded on such an artistic plateau.

Susan Borey

synthesizer. It became a tool of convenience when used for simulation, an enhancing accessory when used for atmospheric sheen, a source of rhythmic focus when used to accentuate the beat. Tangerine Dream, however, has chosen to continue working with the most ineffectual, limp, and downright annoying attributes of synthesizers on *Le Parc*. Many of the sounds are so purely plastic that they're unnerving—

there's very little warmth against which the electronic sounds can serve as synthetic highlights. There are several remarkable tones on the album, bobbing like buoys on the sea of muck; these include the delicate, feathery tones that tickle the ear on "Hyde Park" and the expansively breathy tones on "Zen Garden" which sound like they've come from a giant chrome voicebox.

Two new expressions of quality from Japan

The E-302 integrated amplifier combines a very conservatively rated 120-watt per channel power amplifier with a sophisticated and refined preamplifier in a single chassis to offer you a convenient, attractive, and cost effective alternative to separate components.

Accuphase has a heritage of producing some of the finest sounding tuners available. The T-107 tuner, the long awaited

FM only version of the highly acclaimed T-106, offers a new level of performance and value which none can match.

Both units are part of the Accuphase tradition of offering the highest level of performance achievable with the finest available parts and workmanship that has made the Accuphase name synonymous with quality the world over.



Accuphase

Exclusive U.S. Distributor **MADRIGAL LTD.** P.O. Box 781, Middletown, CT 06457 ITT TLX 4942158

Enter No. 1 on Reader Service Card

CLASSIFIED ADVERTISING RATES

BUSINESS ADS—\$1.60 per word, MINIMUM charge PER AD, PER INSERTION \$40. All centered or spaced lines \$14.

NON BUSINESS ADS—\$1.10 per word, MINIMUM charge PER AD, PER INSERTION \$25. All centered or spaced lines at \$11.

ALL LINE ADS—First line set in bold face type at no extra charge. Additional words set in bold face at \$1.90 extra per word. One point ruled box is \$14.

CLASSIFIED LINE ADS ARE PAYABLE IN ADVANCE BY CHECK OR MONEY ORDER ONLY. (Sorry, we cannot accept credit cards or bill for line advertising.) **ALL LINE ORDERS** should be mailed to:

AUDIO/CBS Magazines
P.O. Box 9125
Dept. 346V
Stamford, CT 06925

ORDERS WILL NOT BE PROCESSED WITHOUT ACCOMPANYING CHECK OR MONEY ORDER FOR FULL AMOUNT.

CLOSING DATE—First of month two months preceding the cover date. If the first of the month falls on a weekend or holiday, the closing date is the last business day preceding the first. **ADS RECEIVED AFTER THE CLOSING DATE WILL BE HELD FOR THE NEXT ISSUE UNLESS OTHERWISE STATED.**

FREQUENCY DISCOUNTS—3 times less 5%, 6 times less 15%, 12 times less 20%. These discounts apply to line ads only. Ads submitted for a three-time frequency are unchangeable. Frequency discounts not fulfilled will be short-rated accordingly. Agency discounts do not apply to line advertising.

BLIND ADS—Audio box numbers may be used at \$8 extra for handling and postage.

GENERAL INFORMATION—Ad copy must be type-written or printed legibly. The publisher in his sole discretion reserves the right to reject any ad copy he deems inappropriate. **ALL ADVERTISERS MUST SUPPLY:** Complete name, Company name, Full street address (P.O. Box numbers are insufficient) and telephone number. Classified **LINE ADS** are not acknowledged and do not carry Reader Service Card Numbers. **AGENCY DISCOUNTS** do not apply to line advertising. **FREQUENCY DISCOUNTS** not fulfilled will be short rated accordingly. Only those advertisers who have prepaid for their entire contract time will be **RATE PROTECTED** for the duration of that contract, in the event of a rate increase.

CLASSIFIED DISPLAY RATES

1 col x 1 inch	\$295
1 col x 2 inches	\$465
1 col x 3 inches	\$666
2 cols. x 1 inch	\$530
2 cols. x 2 inches	\$895

One column width is 2 1/8". Two columns wide is 4 1/4". For larger display ad rates and 6, 12, 18 and 24 times frequency rates call (212) 719-6338.

DISPLAY ADVERTISERS should make space reservation on or before the closing date. Ad material (film or velox) may follow by the tenth. **DISPLAY ADVERTISERS MUST SUPPLY COMPLETE FILM NEGATIVE READY FOR PRINTING OR VELOX. PRODUCTION CHARGES WILL BE ASSESSED ON ANY AD REQUIRING ADDITIONAL PREPARATION.**

ALL DISPLAY CORRESPONDENCE should be sent to:

Laura J. Lo Vecchio, AUDIO MAGAZINE,
1515 Broadway, New York, NY 10036

FOR ADDITIONAL INFORMATION: CLASSIFIED LINE ADS: Mary Jane Adams—(212) 719-6345. **CLASSIFIED DISPLAY ADS:** Laura J. Lo Vecchio—(212) 719-6338

BENNETT SOUND CORPORATION

SW 100 Amplified Subwoofers
Below 20 HZ — Below \$700.

P.O. BOX 565
RESEDA, CA 91335
(818) 345-1608



RETAIL DISPLAY ALLOWANCE

ATTENTION ALL MAGAZINE RETAILERS: CBS Magazines, the Consumer Publishing Division of CBS Inc., is pleased to announce a Retail Display Allowance available to all retailers interested in earning a display allowance on **AUDIO**. The display allowance will be paid upon your fulfillment of the terms and conditions of the formal agreement which will be sent to you upon request. To obtain full details and a copy of the formal agreement, please write to CBS Magazine Marketing, CBS Magazines, the Consumer Publishing Division of CBS Inc., One Fawcett Place, Greenwich Connecticut 06830. This plan will become effective with all issues of **AUDIO** delivered to you subsequent to the date your formal Retail Display Agreement is received and accepted by our company.

ATTENTION CREEK DEALERS

THE FULL CREEK LINE, NOW AVAILABLE FROM MUSIC HALL
108 STATION ROAD, GREAT NECK
NY 11023 (516) 487-3663
WILL BE ON VIEW AT CES
RM 529 AMERICANA CONGRESS

FOR SALE

CARVER, NAKAMICHI, BANG & OLUFSEN, A.D.S., CROWN, REVOX, HAFNER, ADCOM, MISSION, MERIDIAN, N.A.D., HARMAN/KARDON, KYOCERA, YAMAHA, LUXMAN, DENON, KLIPSCH, B & W, POLK, KEF, D.C.M., E-V, J.B.L., INFINITY, D.B.X., AKG, AND OTHER QUALITY COMPONENTS. BEST PRICES—PROFESSIONAL CONSULTATION. ALL PRODUCTS COVERED BY MANUFACTURERS' U.S.A. WARRANTY. AMERISOUND SALES, INC., JACKSONVILLE, FLORIDA 32241. EAST: (904) 262-4000 WEST: (818) 243-1168.

ACOUSTAT AND PS AUDIO—SUPERB!

Free shipping! Fast service! Also Sota, Thorens, Talisman, Audire, Hafler, Klipsch, Adcom, Quad, SAE, Compact Digital Player. READ BROTHERS STEREO, 593 King Street, Charleston, South Carolina 29403. (803) 723-7276

Monster Speaker Cable: Technology that Improves the Sound of Your Music

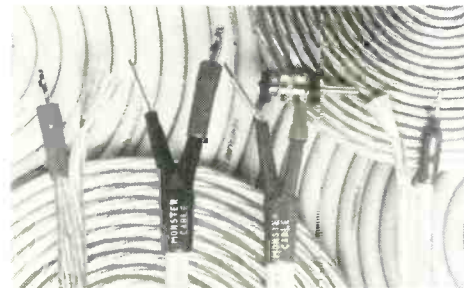

Monster Cable®

Speaker cable standard of the audio industry.

Used by more audiophiles worldwide than any other speaker cable, Monster Cable is considered "standard equipment" for any good audio system. The Monster is also the *industry* standard and is used in labs and listening rooms of the world's most respected audio manufacturers. Great bass, extended highs, superb imaging and increased dynamic range are Monster Cable qualities that have satisfied the most demanding audiophiles. Also, our rugged Duraflex jacket keeps Monster Cable looking great even after years of use.

Superflex™

The balance between budget and performance.

Superflex puts Monster performance into a lower priced package, and lets your ears hear the difference in sound while your wallet benefits from the difference in price. Using the same high purity copper, fine stranding and special winding configurations found in all Monster cables, Superflex simply uses fewer

strands per conductor and performs at a level that can't be matched by ordinary "zip cord". Because it's flat, Superflex is simple to install under carpets, and its large center "web" allows for easy tacking along walls and baseboards. And of course, true to its name, it's superflexible.

Powerline 2® and Powerline 3®

An advanced new wire technology.

Considered by audiophiles and critics as the finest speaker cable ever built, Powerline 2 utilizes our latest cable design to control the audio signals' electromagnetic field. Powerline 2 "time aligns" music signals and lets them travel coherently to your speakers. All musical sounds reach your ears at the same time and are reproduced with accuracy and uncanny three dimensional quality. Powerline 3 provides nearly the same performance as Powerline 2, but in a smaller size package for a lower price. Both cables produce a quality of music that is unobtainable through any other technology.

Monster Cable® Products, Inc.
101 Townsend, San Francisco, CA 94107
Tel: 415 777-1355 Telex: 470584 MCSYUI

MONSTER CABLE®



*New image
from Castle*



DURHAM LOUDSPEAKER

"The appearance of the Durham is stunning... with excellent sound staging and imaging" — *Stereophile Magazine* Vol. 9 No. 1.

Finished in real wood veneer in wide range of finishes such as natural oak, walnut, teak, mahogany and black ash.

For your free copy of our catalogue contact:

MAY AUDIO MARKETING LTD.

P.O. Box 1048
Champlain, N.Y. 12919 Tel.: (514) 651-5707

Transparent Audio Marketing PRESENTS

— The Audio System That Faithfully Reveals The Source —

WELL TEMPERED TABLE • WELL TEMPERED ARM • VAN DEN HUL MC-10 MOVING COIL • MIT MI-330 INTERCONNECT • ROWLAND RESEARCH COHERENCE ONE PREAMP • ROWLAND RESEARCH MODEL 5 STEREO AMP OR MODEL 7 MONOS • MIT MH-750 SPEAKER WIRE • RESPONS SPEAKERS

For more information and a local dealer list:

Transparent Audio Marketing, Inc.

Box 117, Rt. 202

Hollis, ME 04042

(207) 929-4553

FOR SALE

ABSOLUTELY THE FINEST IN THE NORTHEAST. Audible Illusions, B&K, Eagle 2, Fullerman OTL, Lazarus, Magnum/Dynalab, Melos, NYAL-Moscode, Quicksilver, Rotel, Superphon, Rega, SOTA, Systemek, Eminent Technology, Grado, Premier, Profile, Souther, SME, Sumiko, Well Tempered, Talisman, Grace, Supex, Andante, Audioquest, Kiseki, Dayton Wright, Fried, Spectrum, Spica, Vandersteen, Wharfedale, Arcici, Chicago Speaker Stand, Peterson, FMS, Livenwire, Straight Wire, Mod Squad, Tweek. FREE NEWSLETTER, FREE SHIPPING, TRADES, VISA MC. OCEAN STATE AUDIO, 985 Cranston St., Cranston, RI 02920. (401) 943-2580.

ACOUSTAT MODEL II-\$850/PR.; AUDIO RESEARCH SP3-D76-D51; DCM TIMEWINDOWS-\$590PR.; ELECTROCOMPANET AMP-\$850; NEW GRACE F9E RUBY-\$170; LEVINSON ML10-\$1600, ML6A'S, ML2'S; NAIM 135-\$2495/PR., 110-\$500, NAIT-\$300; NEW SIGNET TK10ML-\$175; SNELL TYPE C-\$1200; SOTA HEADAMP-\$100; CALL TERRY (402) 391-3842.



A MAJOR BREAKTHROUGH IN PHONO REPRODUCTION!

THE V.P.I. - DIGITAL
MICROPROCESSOR POWER
SUPPLY - P.L.C.™



- Makes every turntable sound significantly cleaner and quieter!
- Turntables with A.C. synchronous motors can now have electronic speed control!

V.P.I. Ind. Inc.

P.O. Box 159 Ozone Park N.Y. 11417
718-845-0103

FOR SALE

ACCESS TO MUSIC SAN FRANCISCO

Offering guidance based on a practical understanding of the fundamental role of music in contemporary life. Linn, Naim, Rega, Creek, Revolver, Wharfedale, Dual, Sound Organization, Watts. Single Speaker Demonstrations Exclusively. Call for details. (415) TO MUSIC.

AFFORDABLE AUDIO IN COLORADO—ADCOM, HARMAN-KARDON, JBL, SOUNDCRAFTSMAN, PLUS SPEAKER & SUBWOOFER KITS. GOLD SOUND. BOX 141A, ENGLEWOOD, CO 80151.

ALABAMA—WEST GEORGIA

High end stereo at affordable prices. Audioquest, Belles, Creek, Dynavector, EPI, Grado, KEF, Klipsch, LiveWire, McLaren, Monster Cable, MOSCODE, NAD, Premier, Rauna, Signet, Soundstream, Thorens, VPI, Zapco, and more. Accurate Audio: 110 E. Samford Ave, Auburn, Ala 36830. (205) 826-1960.

ALCHEMIST & TALISMAN MOVING COIL CARTRIDGES. MOST MODELS IN STOCK. CALL TOLL-FREE 1-800-222-3465 FOR ORDERING & PRICES. WE CAN'T BE BEAT! HCM AUDIO, (916) 345-1341. VISA/MC/AMEX.

ALTEC, JBL, ELECTRO-VOICE speaker components and systems, JBL studio monitors. Aitec 19's, 604-8K's. Reel recorders: Revox, Tandberg, UHER, Otari Tascam. Low prices, free flyer. Rick Marder, AHCo. (201) 561-8123.

AMPLIFIER SALE! FAMOUS TRANSISTORIZED DYNACO kits: ST410, 200/200W, \$299 (\$12.75 UPS); ST150, 75/75W, \$149 (\$9 UPS), Warranty, Sound Values, Box 551AM, Dublin, OH 43017. Visa/MC ordering: 1-800-443-4548.

AN INVITATION FROM SELECT SOUND. Visit us in historic Roslyn Village and experience our personal friendly service and outstanding audio values—ROTEL-CHAPMAN-SUPERPHON-RAUNA-REGA-HEYBROOK-GOLD-RING. . . . Appointments recommended. (516) 484-9299. 1345 Old Northern Blvd., NY.

APOGEE IN DETROIT! Experience the Amazing Apogee Loudspeakers. Also available: Krell, Rowland Research, Melos, Electron Kinetics, Rauna, Audioquest, Koetsu, Syrinx, Straightwire, and more. PERFORMANCE SYSTEMS (313) 542-8114 or (313) 342-2475.

ARGENT, ARISTON, B&K, BEL, CLEARAUDIO, Dayton Wright, Morrison, Souther, Straight Wire and VPI. Hear these and other fine components at Audio Abode, Dallas, Texas, where music and technology live in harmony. In home auditions available. (214) 369-2092.

ARISTON TURNTABLE BLOW-OUT SALE! SAVE 50% TO 60% ON THESE TOP-QUALITY BELT-DRIVE TURNTABLES. STARTING INVENTORY OF 250 UNITS WILL BE SOLD "FIRST-COME, FIRST-SERVED." COMPARABLE QUALITY TO THORENS, AR, & REGA. PRICES START AT UNDER \$100! CALL TOLL-FREE 1-800-222-3465 FOR ORDERING & PRICES. CALL (916) 345-1341 FOR ALL OTHER INFORMATION! HCM AUDIO. VISA/MC/AMEX. DEALERS WELCOME.

AUDIO ELITE IN WISCONSIN!!!

DENON, CONRAD-JOHNSON, HAFLER, BELLES, VANDERSTEEN, ACOUSTAT, SOTA, PS AUDIO, BOSTON ACOUSTICS, MIRAGE, PROTON, JBL and any others you desire. 414-725-4431. Menasha, WISCONSIN.

FOR SALE

APPALLING? ISN'T IT?

How many esoteric audio products look and feel as if they were made by orangutans with screwdrivers. If you are fed up with sacrificing reliability, aesthetics and quality of construction to obtain purer sound, don't despair!

There are many high-end audio components built by small yet solid professional companies which not only express the utmost in musicality but also reflect the high level of design integrity, craftsmanship and quality control. At Sound By Singer we select and blend only such components into systems designed to extract the most music from your audio dollars.

ACOUSTAT • ADCOM • AKROYD • APOGEE • AUDIOQUEST • AUDIO NOTE • AUDIO RESEARCH • AUDIO VOIS • B&K • BERNING • BEVERIDGE • COUNTERPOINT • CWD • DYNAVECTOR • FUSELIER • GRACE • GRADO • HI-PHONIC • KISEIKI • KLOSS • KOETSU • KRELL • KYOCERA • LINN SONDEK • LIVEWIRE • MONSTER CABLE • NITTY GRITTY • NYAL (MOS-CODE) • PRECISION FIDELITY • PROAC • PROTON • RANDALL RESEARCH • RAUNA • REGA • REVOX • ROBERTSON • SME V • SNELL ACOUSTICS • STAX • SYMDEX • SYRINX • TALISMAN • VANDERSTEEN

SOUND BY SINGER

165 E. 33RD STREET
New York, NY 10016
(212) 683-0925
WE SHIP ANYWHERE

AR, PROAC, SOTA, PERREAUX, CJ, BEYER, STAX, CARVER, CONCORD, DENON, ENERGY, HK, KEF, NAD, NAKAMICHI HOME & AUTO, NITTY GRITTY, NILES, ORTOFON, PARSEC, POLK, PROTON, SOUND-CRAFTSMEN, SUMIKO, GRACE, THORENS, VPI, CWD, AND MORE. PROFESSIONAL CONSULTATION AND INSTALLATION. THE LISTENING ROOM, 1305 COURT ST, SAGINAW, MICHIGAN 48602. (517) 792-3816.

ATHENA POLYPHASORS

Exceptional music reproduction systems are created from the best individual components and the best interface technology. Athena PolyPhasors are a part of that interface technology. For a reprint of the review from IAR Hotline #40, send a SASE to ATHENA, PO Box 210465, San Francisco, CA 94121. Audition PolyPhasors at:

HIGH C STEREO	LEESBURGH, VA
LYRIC	NEW YORK, NY
CHRISTOPHER HANSEN LTD	LOS ANGELES, CA
MUSIC BY DESIGN	SAUSALITO, CA
MUSIC BY THE SEA	LEUCADIA, CA
HOUSTON AUDIO CONCEPTS	HOUSTON, TX
AUDIO PERFECTION	MINNEAPOLIS, MN

AUDIBLE ILLUSIONS & ADCOM-555 @ HIGH END AUDIO WEST, California. SUPERPHON, MOSCODE, B&K, PS, MUSIC REFERENCE, VIP, SYSTEMDECK, MMT, GRADO, WTA, TALISMAN, MONSTER, AUDIOQUEST, RANDALL, STRAIGHTWIRE, RAUNA, SPICA, SPEC-TRUM. SOUND LAB. (714) 861-5413.

AUDIO ADVANCEMENTS ANNOUNCES: The new GARROTT P-77 cartridge is finally available. It is genuinely musical, smooth, detailed, and an excellent tracker, utilizing the very high quality new GARROTT MICRO-TRACER diamond. The combination of capturing the spirit of the music and its affordability (\$265) makes it the most unique and outstanding product to be found anywhere. P.O. Box 15, Verona, NJ 07044. 201-857-1422. Dealer inquiries welcome!

BEST TRADES OFFERED. Acoustat, Adcom, Allison, Alpha, Alphason, Apt, AR, Audioquest, B&K, BEL, Berning, British Fidelity, Celestion, Classe, Creek, Distech, Duntech, Dual, Fried, Futterman, Goetz, Grace, Grado, GSI, Gyrodec, Hafler, Heybrook, JSE, Kiseki, Koetsu, Lazarus, Logic, M&K, McLaren, MCM, Melos, Micro Seiki, Mordant-Short, Meridian, Merlin, Monster Cable, Nitty Gritty, PS Audio, OHM, Quicksilver, Premier, Rauna, Revox, Robertson, Rogers, Rotel, SAEC, SME, Snell, SOTA, Spondor, Spica, STAX, Straightwire, Superphon, Souther, Symdex, Talisman, Tannoy, VPI, VSP, Rowland Research, and more. Free newsletter. AUDIO DOCTOR, 1518 W. Commercial, Box 380, Buffalo, MO 65622. (417) 345-7245. Hours: 9-6 M-Th., 9-4 Fri-Sat.

THE SOUTHER JUNIOR
ANNOUNCING FOR '86
THE SLA-3 IMPROVED REPLACED BY THE NEW TRIQUARTZ \$550
SUPERIOR SOUND SAME PRICE \$850
THE CLEARAUDIO IMPORTER
THE LEADER IN LINEAR PHONO TRACKING
SOUTHER ENGINEERING CORPORATION
429 YORK STREET CANTON MASSACHUSETTS 02021
617 828-5050/TELEX SOUTHER 940 536BOS TELEX

FOR SALE

AUDIO ADVISOR INC. Get LOW PRICES on ALL types of audio equipment—including high-end and even esoteric products not normally discounted! Now we can save you money on the equipment you REALLY WANT. Extensive selection—no need to settle for second choice. Thousands of satisfied customers nationwide. Call us for price quotes or friendly, expert advice. Catalog \$1. 616-451-3868. VISA/MC/AMEX. THE AUDIO ADVISOR, INC., 225 OAKES SW, GRAND RAPIDS, MI 49503.

AUDIO DIMENSIONS SPRING CLEARANCE. Counterpoint SA-4 mono tube amps \$2995/pr. w/warranty. Audio Research D-52B \$395, B&K EX 140 list \$700 demo \$449, Kloss model 1 10ft projection TV list \$4000 demo \$2500, NYAL Moscode 300 (used) \$495, Amber series 70 (used) \$250—Audio Dimensions: (405) 722-9332. Naim 135 mono amps \$1995/pr.

AUDIO NEXUS ADORES THE BEL 1001 CLASS-A AMPLIFIER. And we're pretty finicky. NJ, (201) 464-8238, (201) 730-2409.

In New England...

Known by the company we keep.

MAJOR AUDIO	Grado	Stax
Acoustat	Signature	Sumiko
ADS	Livewire	Talisman
Alpha	Magnepan	Tandberg
Audio	Martin-Logan	Thiel
Interface	Meitner	Threshold
Audio Pro	Meridian	Vandersteen
Audioquest	Mission	Velodyne
Boston	Mod Squad	VPI
Acoustics	MIT	Yamaha
Bryston	NAD	Yamaha
Carver	Nakamichi	Audiophile
CWD	Nelson Reed	
DCM	Oracle	VIDEO
Denon	Robertson	NAD
Dynavector	Signet	NEC
Eagle	Snell	Pioneer
Eminent	SOTA	Proton
Technology	Spica	Sony

Modern Demo Facility, Specialty Records, Accessories and CDs, In-store Service, Custom Cabinetry, No Mail Orders Please

5 TAKE AUDIO

105 Whitney Ave., New Haven, CT (203) 777-1750
Mon., Tue., Wed., Fri., 10-6, Thurs., 10-8, Sat., 10-5,
MC/VISA/AMEX/TAKE 5 Charge

They're Here



SME

SERIES V

By SUMIKO, INC.
P.O. Box 5046
Berkeley, CA 94705
415-843-4500

For the name of your nearest dealer, see page 176

"THE QUAD FOUNDATION SPEAKER BASE"

By

Chicago Speaker Stand

The Quad Foundation Speaker Base is engineered and is aesthetically designed to be an integral part of the Quad ESL-63, and not merely an add-on device which elevates the speaker off the floor. The "QFSB" is an engineering marvel, it is the only speaker base which brings the QUAD to the theoretical ideal of mounting a speaker rigidly in free space. To achieve this, the ESL-63 mounts directly into, and is securely fastened to the "QFSB". It is also very massive (150 lbs. each), **VIRTUALLY** non-resonant and spiked to eliminate undesirable speaker movement.

The Quad Foundation Speaker Base is molded to the exact width and curvature of the ESL-63 and looks like part of the speaker. To further complement the ESL-63 the "QFSB" is available in gloss black or brown.

1-800-882-2256

In Illinois 312-745-5500

FOR SALE

AUDIOPHILES: BETTER STEREO SOUND

Whatever your components or room characteristics, SONEX can give you better—and truer—home sound. Use this patented acoustic foam to FINE-TUNE YOUR ROOM'S ACOUSTICS. You'll notice a difference in reduced standing waves and smoother frequency response. The pros have used SONEX for years in studio and broadcast booths. And now a home-sized version of this patented, professional acoustic foam is yours for the asking. Two boxes cover 32 square feet. Send a check for \$99 (includes shipping & handling) for this special two-box offer to: Illbruck, 3800 Washington Ave. N., Dept. AJ, Minneapolis, MN 55412.

VPI
made in u.s.a.

INTRODUCING THE HW-19 MK II



- 1— Lead lined acrylic platter
- 2— Tiptoes between suspension and chassis
- 3— Reflex type screw on clamp
- 4— Tungsten carbide bearing
- 5— The explosive dynamic range of digital with the resolution and musicality of analog

V.P.I. Ind. Inc.

P.O. Box 159, Ozone Park, N.Y. 11417
(718) 845-0103

FOR SALE

B&W LOUDSPEAKERS-THE FINEST IN THE WORLD! MOST MODELS IN STOCK. WE SELL ONLY U.S.A. MODELS WITH U.S.A. WARRANTIES. CALL TOLL-FREE 1-800-222-3465 FOR AVAILABILITY AND SHIPPING INFORMATION. HCM AUDIO: (916) 345-1341. VISA/MC/AMEX.

BEAT THE PRICE FIXERS WITH low discount prices and full U.S.A. manufacturers warranties on: Nakamichi, Revox, Carver, Bang & Olufsen, ADS, Kyocera, HK, Crown, Hafler, B&W, NAD, Tandberg, Polk, Island Audio, Inc., 1122 Riverside Drive, Holly Hill, FL 32017. (904) 253-3456.

AT LAST, HIGH DEMAND HARD TO FIND APT PRODUCTS

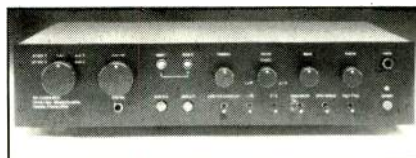

Now you can order top-line, APT Holman Classics direct from the factory (where dealers aren't available). Be first for NEW Series 1 and 2 amps and pre-amps, including NEW innovative tuners, coming this summer. Call APT direct (617) 458-7675: 9 to 5 EST. Dealer enquiries encouraged.

apt[®]

Apt Corporation 176 Walker Street, Lowell, MA 01854

FOR SALE

AUDIO CONNECTION

in Northern New Jersey

TURNABLES: Goldmund, Heybrook, Merrill, VPI, Well Tempered

TONEARMS: ET, Grado, Lurné, Well Tempered
CARTRIDGES: AudioQuest, Decca, Garrott P-77, Grado, Promethean

ELECTRONICS: (TUBE) Audible Illusions, Melos, MFA Systems, Music Reference, Quicksilver (SOLID STATE) Belles, Electrocomp., FMA, Jordan, Leach, Magnum, British Fidelity

CD PLAYERS: Melos Audio, Harman Kardon
SPEAKERS: Kindel, Princeton Acoustics, Rauna, Sendor, Vandersteen, Merlin

ACCESSORIES: AudioQuest, Chicago Sp. Stands, Goldmund, Last, LiveWire, Kimber, Kinergetics, MIT, Nitty Gritty, Peterson, Sims Vibration Dynamics, Sonex, Tiptoes, Torumat, Tweek, vdHul, VPI

1-201-239-1799

615 Bloomfield Ave., Verona NJ 07044

AUDIO CONNECTION also has for sale: occasional close-outs, some used equipment and display pieces. Single speaker demonstration; record cleaning; audiophile discs. HOURS: Mon, Tues, Fri 12 to 7, Thurs 12 to 9, Sat 11 to 6. Closed: Sun, Weds. PLEASE, CALL FOR AN APPOINTMENT!

B&W BUMPS & BRUISES SALE! WE HAVE HUNDREDS OF B&W LOUDSPEAKERS WITH SCRATCHES, DENTS, DINGS AND OTHER COSMETIC BLEMISHES AT SAVINGS UP TO 50%! ALL SPEAKERS HAVE BEEN PERFORMANCE TESTED BY B&W AND CARRY THEIR 5-YEAR U.S.A. WARRANTY. CALL TOLL-FREE 1-800-222-3465 FOR PRICES & AVAILABILITY. HCM AUDIO: (916) 345-1341. VISA/MC/AMEX.

CALL TOLL FREE! 1-800-826-0520 FOR: Hafler, Denon, Dahlquist, Tandberg, dbx, 3D, Proton, Nitty-Gritty, B&W, VSP, Thorens, Grace, CWD, Monster, M&K, Grado, Belles, Oracle, Talisman, Duntech, STAX, Astatic, DCM, Pro-Ac, Tip-Toes, Audioquest, Dynavector, Fried, Moscode, Snell. Sound Seller, 1706 Main, Marinette, WI 54143. (715) 735-9002.

CASH for all types of USED STEREO EQUIPMENT. We BUY by PHONE. STEREO TRADING OUTLET, 320 Old York Rd., Jenkintown, Pa 19046. 215-886-1650.

COMPONENTS FOR THE CONNOISSEUR

Audio Research, Audible Illusion, APT, B&K, Discrete Technology, Eagle, Quicksilver, Moscode, Melos, Streets, Superphone, Lazarus, Martin-Logan, Vandersteen, Infinite Slope, Merlin, Micro, VPI, Merrill, Rega, Systemdek, Grado, Well-Tempered. Sacrifice following: Magneplanar 111s, Thiel CS3, O3A, Raven Ribbons, Clements RT7, Perkins Monitors, Rauna Leiras, MCM 7s, Daybreaks, Meitner PreAmps, Robertson 4010, Sumo Amps & Pre, Mission 7000, many others. PAUL HEATH AUDIO, 217 Alexander, Rochester, NY. (716) 262-4310.

A SINGER'S DREAM!



REMOVES VOCALS FROM RECORDS!

Now You can sing with the world's best bands! The Thompson Vocal Eliminator can remove most or virtually all of a lead vocal from a standard stereo record and leave most of the background untouched! Record with your voice or perform live with the backgrounds. Used in Professional Performance yet connects easily to a home component stereo system. Not an equalizer! We can prove it works over the phone. Write or call for a Free Brochure and Demo Record.

LT Sound, Dept. AU, P.O. Box 338,
Stone Mountain, GA 30086 (404) 493-1258
24 HOUR PHONE DEMO LINE: (404) 493-6879

FOR SALE

CONNECTICUT HIGH-END: Conrad-Johnson, NYAL Moscode, Adcom VPI, Sonographe, Grado, Souther, Sumiko, Acoustal, Rauna, Duntech, The Stereo Lab, 140 Bank St., New London, CT 06320. (203) 447-9802.

DEFINITIVE HI-FI

920 Sherman Ave.
Thornwood, N.Y.
10594

Available for Audition,

- VAN DEN HUL MC-10
- WELL-TEMPERED LAB WTA
- V.P.I. HW19 MK II
- GSI 5TP pre-amplifier
- A-1 250 watt tube/Heflet
- SYMDEX Epsilon speaker

PLEASE TELEPHONE FOR APPOINTMENT
Day: (203) 869-0745, Eve: (914) 747-3375

DEMONSTRATORS—ACOUSTAL TNP \$450; Counterpoint SA-7 \$300; Hafler DH220 \$260; DH100 \$100; VSP Labs TM-150 \$450; Thorens TD160 Super \$250; Used—Linn Sondeck LP-12, Ittok, Asak \$750; Magnaplanar 1U Factory Modified \$625; Bass Panels \$525; New—Sprica, ATC, JSE, SOTA, VPI, Eminent Technology, Moscode, Magnum, B&K, Wharfedale, Chicago, and more. Audio Ecstasy: (716) 865-9938.

DEMONSTRATORS WITH WARRANTY—Acoustal TNP \$485; Acoustal TN-120 \$520; Acoustal TN-200 \$835; Ariston RD-40/w Profile II \$315; Berning TF-10HA \$1465; Berning EA-2100 \$1885; Classe Audio DR-2 \$1200; Counterpoint SA-2 \$565; Counterpoint SA-3.1 \$695; Counterpoint SA-5.1 \$1255; Counterpoint SA-6 \$275; Counterpoint SA-7 \$415; Counterpoint SA-8 \$1555; Counterpoint SA-12 \$695; Electrocompaniet Preamplifier I \$1255; Electrocompaniet Amplifier IIa \$1045; Electron Kenetics Eagle II \$695; Esoteric Audio 509/pr \$1220; NEC CD-803E \$500; Precision Fidelity M7a \$590; Rega Planar III \$350; VPI HW-19 MKII/w Dynavector DV-501 \$975.

NEW WITH WARRANTY—Accuphase AC-2 \$255; Adcom GFP-1A \$245; Audio Interface CST-80 \$175; Dynavector DV23RMR \$160; Grace F-9ER \$155; Grace 707/747 VTA \$55; Hafler DH-110K \$205; Hafler DH-330K \$240; Hafler DH-500A \$500; Kiseki Blue \$315; Ortofon MC-200 \$170; Profile II \$110; Stax CDY/EC-1 \$375; Supex SDX-2000 \$250; Van Den Hull II \$220.

USED—EUMIG FM/T-1000 \$250; Mark Levinson ML-1/A-3 \$750; STAX UA-7CF \$150.

GREENFIELD EQUIPMENT, 7805 Greenfield Street, River Forest, IL 60305, 312/771-4660, MC/VISA. Auditions by appointment—shipping & export facilities.

Audio Exposure has the smoothest, cleanest, most musical power amp anywhere near its price. The **McLaren Audio 702** stereo power amp has 100 watts a side of clear power, is built like a tank, looks beautiful, is stable into any load and only costs \$995. Also Model 902, 250 watt monoblock, \$1990/pr.

629 Camino de las Mares #305, San Clemente, CA 92672 (714) 240-0742

FOR SALE

DR. MORIKAWA 845'S, MANUFACTURED BY Audio Professor Inc., 50 watt triode class A amplifiers utilizing transmitter tubes, complete LC/OFC wire throughout including transformer windings. \$2800 each. Photos available. (716) 473-2571, (718) 261-2388.

DRAMATICALLY IMPROVE YOUR "NEW" AR TURNTABLE We guarantee the following products to improve your AR's transparency, detail and smoothness or we will refund the purchase price.

- 1). AudioQuest Sorbothene Mat \$35
- 2). Predrilled Aluminum Armboards
MMT, Linn, or AR arms \$30
- 3). Hum-shielding for AR Platters:
Platter shield \$39

The Audio Advisor, Inc. 225 Oakes SW, Grand Rapids, MI 49503 (616) 451-3868. Shipping \$3/item.

CARVER, NAKAMICHI, BANG & OLUFSEN, A.D.S., CROWN, REVCX, HAFLER, ADCOM, MISSION, MERIDIAN, N.A.D., HARMAN/KARDON, KYOCERA, YAMAHA, LUXMAN, DENON, KLIPSCH, B & W, POLK, KEF, D.C.M., E-V, J.B.L., INFINITY, D.B.X., AKG, AND OTHER QUALITY COMPONENTS. BEST PRICES—PROFESSIONAL CONSULTATION. ALL PRODUCTS COVERED BY MANUFACTURERS' U.S.A. WARRANTY. AMERISOUND SALES, INC., JACKSONVILLE, FLORIDA 32241. EAST: (904) 262-4000 WEST: (818) 243-1168.

ELECTRACRAFT: AUTHORIZED DEALER FOR Bang & Olufsen, Dahlquist, DCM, Denon, Entec, Grado, Hafler, KEF, Klipsch, M&K, Monster Cable, P.S. Audio, Revox, Signet, Sota, Tandberg, and many more high-end audio products, including mobile sound. M/C, Visa, Amex. ELECTRACRAFT, 400 Cedar Street, Sandpoint, Idaho 83864. 208-263-9516.

ELECTRONIC CROSSOVERS: 6, 12, 18 DB/OCTAVE. Kits from \$120. Transient-Perfect Crossover, \$175. Subsonic, Bandpass Filters from \$25. Free flyer w/reviews. ACE AUDIO CO., 532-5th Street, East Northport, NY 11731-2399. (516) 757-8990.

Now in Greenwich: the Total End in High End Audio.

Visit our Demonstration Studio, fully equipped with the latest high-technology, Hi-Fi audio equipment from such dedicated manufacturers as ...

Apogee • Belles • Duntech • Esoteric Wire • Gale
Jorcan Amplification • Krell • Kyocera • J.A. Mitchell • Perreux
Pioneer Video • Princeton Acoustics • Proton Video
Quicksilver • Souther • Straight Wire • Sumiko • Symdex
Thomson Video • Triad • VPI • Well Tempered Arm • Zeta

... a relaxed place. Where you can hear what can be done with today's newest equipment. Where you can compare...unimpaired. Where you can discuss your needs with the experienced, knowledgeable Aud-Vid people who can turn personal preferences into reality. Phone...or just stop in...Mondays through Saturdays.

79 E. Putnam Av. (Rte. US 1)
Greenwich, CT 06830
(203) 869-0666

YOUR COMPLETE AUDIO ENTERTAINMENT CENTER

QED HiFi

The Audible Difference

A240CD/SA Integrated Amplifier



The A240CD/SA 40 Watt per channel integrated amplifier. A truly unique amplifier that can be optimised for C.D. or analogue sources.



NOW IT'S OFFICIAL!
The best Budget Amplifier available.

It's the QED A240CD that gets my final vote though. It is a more ambitious design than the rest, and in upgraded form it delivers on the promises in convincing fashion.

WHAT HI-FI April '86

MADE IN ENGLAND

For full information contact
Exclusive QED Distributor,

May Audio Marketing Ltd.
P.O. BOX 1048,
Champlain, NY 12919.
TEL. (514) 651-5707

VANDERSTEEN AUDIO DIMENSIONAL PURITY

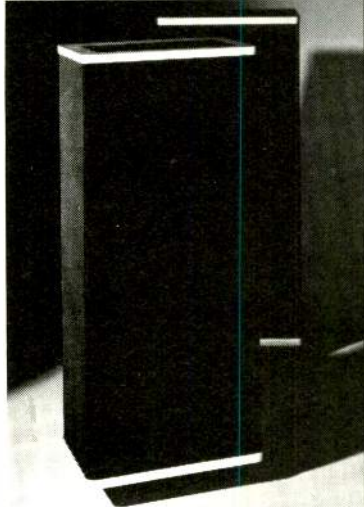

MODEL 2C

Vandersteen Audio was founded in 1977 with the commitment to offer always the finest in music reproduction for the dollar. Toward this goal there will always be a high degree of pride, love, and personal satisfaction involved in each piece before it leaves our facilities. Your Vandersteen dealer shares in this commitment, and has been carefully selected for his ability to deal with the complex task of assembling a musically satisfying system. Although sometimes hard to find, he is well worth seeking out.

Write or call for a brochure and the name of your nearest dealer.

VANDERSTEEN AUDIO
116 WEST FOURTH STREET
HANFORD, CALIFORNIA 93230 USA
(209) 832-0324

FACTORY DIRECT SALE

Esoteric amplifiers and preamplifiers from **VSP LABS** are now available **FACTORY DIRECT** at **MANUFACTURER'S PRICES** and **NO SALES TAXES**.

TransMos Amp (150 W/CH)
Gold Edition Amp (200 W/CH)
Straightwire II Preamp
HPF-102 Subsonic Filter

These amps and preamps had twelve great reviews since 1983.

Available for a limited time only.

C.O.D., VISA and MasterCard orders accepted. For prices and information call 313-769-5522, or write VSP LABS, 670 Airport Boulevard, Ann Arbor, MI 48104.

All units are covered by a one (1) year factory warranty
Availability outside VSP area dealers.

CSA Audio knows how to tune you in

- Acoustat • Acoustic Electronics • Acoustic Research • Audio Research • Boston Acoustics • Counterpoint • Dahlquist • DCM • Denon • Dayton-Wright • Duntech • ESB • Electron Kinetics • Hafler • Jensen Video • Koetsu • Klyne • Kyocera • Linn Sondek • Mission • Monster • Pioneer Video • Proac • PS Audio • Shinon • Sota • Tandberg • Thiel •

193 Bellevue Ave, Upper Montclair, NJ 201/744-0600



FOR SALE

ELECTRON TUBE SALES 6DJ8 6AN8A 6CA7 6L6GC 6550A EL34 KT77 KT88 EF86 Same day shipping from stock Industrial Tube Distributors since 1947. 4000 Types in stock. A R S Electronics, 7110 DeCielis Place, Van Nuys, Ca. 91406. 1-800-422-4250.

END YOUR HUM PROBLEMS WITH THE AR-XE.

The Merrill motor rebuild and hum shield combination will end the hum problems. Reduces the hum by a factor of 10DB. Also improves the motor's mechanical quietness and removes the existing end play in the motor. UNDERGROUND SOUND, 2125 CENTRAL AVE, MEMPHIS, TN 38104 (901) 272-1275.

ENHANCE YOUR LISTENING PLEASURE THRU music appreciation. Free information. The Other Stave, Box 773397, Dept. A, Houston, Texas, 77215-3397.

FREE UPS SHIPPING!

Carver, Nakamichi, conrad/johnson, Apogee, Superphon, Acoustat, Fanfare, harman/kardon, AR Sapphire turntable, Clements, Hafler, VSP, VPI, NEC videc. Trade-ins welcome! Demo special—Acoustat TNP preamp \$399, Hafler DH-220A \$379, DH-160A \$259, DH-110A \$335. NEW Hafler kit specials—one each to sell—DH160K \$189, DH100K \$135. THRESHOLD AUDIO, 409 South 22nd St. Newark-Heath, Ohio 43056. 614-522-3520.

FOR SALE

EXCEPTIONAL AUDIO REPRODUCTION SYSTEMS AD-COM, AR, ARCAM, AUDIOQUEST, AUDIOSOURCE, AU-DIRE, BRITISH (MUSICAL) FIDELITY, CHICAGO, CREEK, DUAL, GRACE, GRADO & SIGNATURE, GOLDRING, FRIED, HEYBROOK, KENWOOD BASIC, KYOCERA, LINN, LOGIC, MAS, MORDAUNT-SHORT, NITTY GRITTY, PREMIER, PROMETHEAN, QED, RATA, REGA, ROTEL, ROYD, SHINON, SPECTRUM, SUPERPHON, SUPEX, TALISMAN, TARGET along with LAST, LIVEWIRE and others. EARS, P.O. BOX 658-U, W. COVINA, CA 91790 818-961-6158 EVENINGS, WEEKENDS. MC/VISA. MANY MONTHLY SPECIALS, PREPAID SHIPPING-SEND STAMP!!

FRIED SPEAKERS & KITS

State-of-the-art sound. Try our prices! Free shipping. Also Sota, Hafler, SAE, Audire, Thorens, Adcom, Klipsch, CD players. READ BROTHERS STEREO, 593 King Street, Charleston, South Carolina 29403. (803) 723-7276.

GENE RUBIN AUDIO—LOS ANGELES: Linn, Naim, Rega, Thorens, Hafler, Creek, Rotel, Energy, Conrad-Johnson, British-Fidelity, Spondor, Superphon, Mordaunt-Short & more. (818) 571-1299, (213) 283-0001.

GREAT PREOWNED EQUIPMENT! Electrocompaniet Preamplifier One, \$1095 Signature Amplifier, \$1095, both \$2075. SOTA Star (Koa) with Acrylicmat, \$1149. Sumiko MDC-800 with tools and weights, \$950. Electrocompaniet Amplifier 2A, \$695. 512-494-3551.

HAFLER AMP MOD

Oversized **TOROIDAL TRANSFORMER** for DH200, DH220. Improved bass, more power, less heat. Easy Installation. \$79.95 (\$4 UPS). BANNER, (704) 487-7012, P.O. Box 1803, Shelby, NC 28150.

HAFLER—HIGH QUALITY, LOW COST

We stock all of the following components: DH-100K \$175, DH-100A \$225, DH-110K \$360, DH-110A \$440, DH-120K \$260, DH-120A \$320, DH-160K \$275, DH-160A \$375, DH-220K \$400, DH-220KE \$410, DH-220A \$500, DH-220AE \$510, DH-330K \$385, DH-330A \$460, DH-500K \$675, DH-500KE \$695, DH-500A \$850, DH-500AE \$870. Accessories too! Three year warranty on assembled units. Visa and MasterCard. Free delivery to ALL zip codes (PR and APO/FPO too). **WORLDWIDE EXPORTING. OXFORD AUDIO CONSULTANTS, INC.,** Box 145, Oxford, OH 45056-0145, 513-523-3333, TLX427791.

HAFLER IN THE SOUTH!

In stock, the superb Hafler pre-amps, amplifiers, tuner and equalizer. Immediate **FREE** shipping. Also Acoustat, Adcom, Audire, CWD, Fried, Klipsch, Mirage, Monster Cable, PS, SAE, Superphon, Talisman, Thorens, CD players. READ BROTHERS STEREO, 593 King Street, Charleston, South Carolina 29403. (803) 723-7276.

—APOGEE ACOUSTICS, INC.

Designers and Manufacturers of the World's
Only Full Range Ribbon Speaker Systems

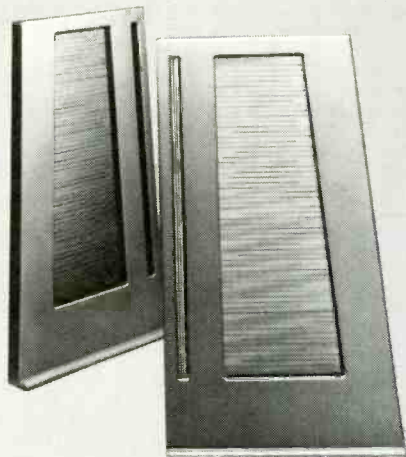

48" x 24" x 2"

"CALIPER"

The New Measure of Sound
World Debut, June 1986 CES

Raphael Hotel • 201 Delaware Place • Chicago 943-5000

—APOGEE ACOUSTICS, INC.

35 York Industrial Park • Randolph, MA 02368

Telex: 928121 APOGEE RAND

Singles or Systems

For eyes and ears,

always the highest fidelity you can afford.

Adcom • Apature • Apogee • AR • Audioquest • B&K
Conrad Johnson • CWD • Eminent Technology • FMS
Grado • GS • Harman/Kardon • Infinity RS1b • JSE • Krell
Kyocera • Magnum • Melos • MIT • Mission • Motif • NEC
Nitty Gritty • PRO AC • Rotel • Shinon • Souther • Spica
Spondor • Stax • Sumiko • Superphon • Thorens
Vandersteen • Veritas • VPI and many, many more!

**OPEN: TUE, WED, FRI: 11-7, THURS: 11-8
SAT: 11-5; OR BY APPOINTMENT.**

**AUDIO
VISION**

1060 Massachusetts Avenue
Arlington, MA 02174

617-648-HIFI

FOR SALE

HAFLER OWNERS REJOICE! MUSICAL CONCEPTS has improved our classic amplifier modifications! All Hafler amplifier modifications have undergone significant topological changes resulting in dramatically superior sound. "Tubelike," "great depth," "dramatic focus," "pure tonality" are among the descriptions offered by our customers. Still available: M-110SN (Hafler DH-110), highly regarded by both The Absolute Sound and Audiogram (best solid state preamp!), toroid transformers for all Hafler amps, dual mono conversions and too many other services to mention, including our pacesetter CD player mods. Write for brochure/review packet. Musical Concepts, #1 Patterson Plaza, Florissant, MO 63031, 314-831-1822, 1-5PM central.

HAFLER PREAMPS, POWER-AMPS, & TUNERS. MOST MODELS IN STOCK. CALL TOLL-FREE 1-800-222-3465 FOR ORDERING & PRICES. WE CAN'T BE BEAT! HCM AUDIO, (916) 345-1341. VISA/MC/AMEX.

IOWA AUDIOPHILES: WE CARRY ADCOM, Aiwa, Concord, Dual, Fried, Hafler, Last, MTX, Parasound, Spectrum, Superphon and others. Hawkeye Audio, 311 E. Washington St., Iowa City, IA 52240. (319) 337-4878.

LAST RECORD & CD CARE PRODUCTS! LOWEST DISCOUNT PRICES ANYWHERE! ALSO STYLUS CARE, VIDEO CLEANERS, AND CASSETTE CLEANERS. ORDER TOLL-FREE 1-(800)222-3465 (except California) 916-345-1341. MC/VISA/AMEX.

CARVER, NAKAMICHI, BANG & OLUFSEN, A.D.S., CROWN, REVOX, HAFLER, ADCOM, MISSION, MERIDIAN, N.A.D., HARMAN/KARDON, KYOCERA, YAMAHA, LUXMAN, DENON, KLIPSCH, B & W, POLK, KEF, D.C.M., E-V, J.B.L., INFINITY, D.B.X., AKG, AND OTHER QUALITY COMPONENTS. BEST PRICES—PROFESSIONAL CONSULTATION. ALL PRODUCTS COVERED BY MANUFACTURERS' U.S.A. WARRANTY. AMERISOUND SALES, INC., JACKSONVILLE, FLORIDA 32241. EAST: (904) 262-4000 WEST: (818) 243-1168.

LEVINSON LNC2 W/PLS151, 100/7000HZ & case \$1100. IVIE 10A/20A Spectrum Analyzer-NEW-\$400. QUAD ESL63 w/stands, original \$1350. COTTER PREAMP CM2/PSC2 MK2L transformer \$500. NAKAMICHI RX202 \$350. UHER CR134 stereorecorder w/SENNHEISER MKE2002 Binaural Microphones \$350. SOUNDTRACTOR & PIVOTRAM(Alum) \$85pr. (315) 437-3357 Central NYST.

LINN & NAIM—NEW PRODUCTS

Visit our SINGLE SPEAKER DEMONSTRATION ROOM and hear these remarkable new Linn products: Index Speaker \$350/pr., K-9 mm cartridge \$150, Preamp, Power-amp, Visa and MasterCard. Free delivery to ALL zip codes. WORLDWIDE EXPORTING. OXFORD AUDIO CONSULTANTS, INC., Box 145, Oxford, OH 45056-0145, 513-523-3333, TLX427791.

MCINTOSH MCINTOSH MCINTOSH MCINTOSH I pay retail for your used McIntosh Call or write for quotes AUDIO RESOURCE #1 Metairie Ct. Met, La. 70001 504-833-6942.

SOTA's Reflex Clamp is Here!



Ready to Hear LP Perfection?

SOTA's new record clamp combines simplicity of use, elegance, and unequalled performance. True Reflex action. Rigid, massive, yet decoupled during play. The ideal match for the SOTA Supermat.

Capture part of the SOTA achievement. Experience how perfect an LP can sound! Warning: Both may be addictive!

SOTA
industries

P.O. Box 7075, Berkeley, CA 94707

FOR SALE

LOWEST POSSIBLE PRICES ANYWHERE! FULL WARRANTY—Most Audio Brands!! C.D. Players—Car Products—Computers (Hardware—Software)—Most Video Brands!! ELECTRIFIED DISCOUNTERS, 996 ORANGE AVE., WEST HAVEN, CT, 06516, MC/VISA. (203) 937-0106.

LOW PRICES-HIGH END EQUIPMENT!!!

DENON, CONRAD-JOHNSON, KEF, HAFLER BELLES, ADCOM, VANDERSTEEN, BCM, ACOUSTAT, SOTA, PS AUDIO, CARVER, BOSTON ACOUSTICS, MIRAGE, PROTON, JBL and any others you desire. AUDIO ELITE, 414-725-4431. Menasha, WISCONSIN.

OUR PRICES CAN'T BE BEAT!!!

MCINTOSH

(ALL TYPES)

MARANTZ (TUBE) AND OTHER PRECISION AUDIO COMPONENTS, SPEAKERS & PARTS, BOUGHT-SOLD-TRADED-MODIFIED. FREE CATALOGUE. 8AM-5PM EST MON-FRI. AUDIO CLASSICS, POB 176AFS, WALTON, NY 13856, 607-865-7200. AUDIO ADVERTISER SINCE 1979.

OUR SPECS SPEAK FOR THEMSELVES.

INTEGRA-1 MKII

Integrated 2-way 6" / Dome Tweeter (Adapted for bi-amp)

Power Handling Capacity	100 Watts RMS
Frequency Response	45-25000 Hz
Woofer Type	6" Dia., 3" Aluminum voice coil
Tweeter Type	Soft dome, Aluminum voice coil
Ferrofluid Cooling/Damping	Yes
Impedance	4 ohms
Sensitivity 1W/1M	91 db
Magnetic Structure Weight	2.3 lbs./1.05 Kgs.
Dimensions	160mm/6 1/4" Dia., 67mm/2 3/4" Depth
Mounting Depth	53mm/2 1/8"
Net Weight	2.85 lbs./1.3 Kgs.
Front Grill	Integral metal grill

INTEGRA-2 MKII

Integrated 2-way 8" / Dome Tweeter (Adapted for bi-amp)

Power Handling Capacity	120 Watts RMS
Frequency Response	35-25000 Hz
Woofer Type	8" Dia., 3" Aluminum voice coil
Tweeter Type	Soft dome, Aluminum voice coil
Ferrofluid Cooling/Damping	Yes
Impedance	4 ohms
Sensitivity 1W/1M	92 db
Magnetic Structure Weight	2.3 lbs./1.05 Kgs.
Dimensions	220mm/8 5/8" Dia., 75mm/3" Depth
Mounting Depth	57mm/2 1/4"
Net Weight	3.3 lbs./1.5 Kgs.
Front Grill	Integral metal grill

What they tell you is that *Morel's Integra Auto Fidelity loudspeakers* are head and shoulders above conventional coaxial systems. The Integra concept utilizes two magnets—both for the woofer and one for the dome tweeter—integrated on a single axis. The result: adroit high-power handling and sumptuous sound. And Integra loudspeakers are rugged enough for use in any vehicle.

Morel also offers separate woofers, tweeters, midranges and crossovers for your car. Please call or write for further details.

INTEGRA

Morel Acoustics USA

414 Harvard Street, Brookline, MA 02146
tel. (617) 277-6663 telex 650-2499475

Morel (U.K.) Ltd.

11 Foxtail Road, Ransomes Indus. Estate
Ipswich IP3 9RT, England
tel. (0473) 719212 telex 987601 Morel G

Morel Acoustics Ltd.

Industrial Area B, P.O. Box 140, Ness Ziona
70 451 Israel



*the highly acclaimed DR-3 power amplifier,
the new DR-7 preamplifier...*

technology reflected in music

*Debut of the new DR-7
at Chicago CES*



Plasse Audio Inc.

227-G BRUNSWICK BLVD., POINTE CLAIRE, QUEBEC H9R 4X5 • TEL.: (514)694-6561

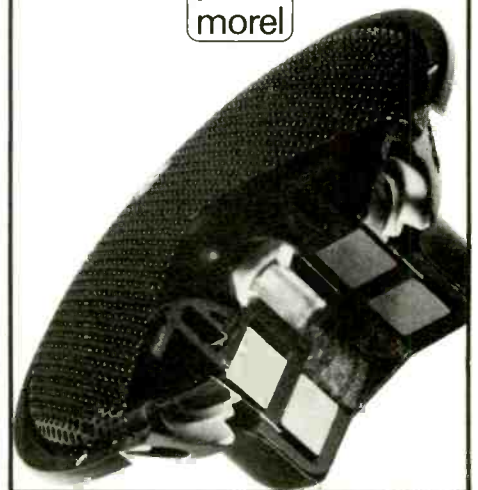

MOVING, LEGENDARY SOUND.

Chestnut Hill Audio is moving around the corner to expanded facilities. Our legends go with us: Accuphase, Acoustic Electronics, Amber, Apature, Apogee, Audio Pro, Audioguest, B&K, Berning, Cabasse, CWD, Counterpoint, DB, Distech, Duntech, Entec, Euphonic, Fourier, Grace, Hafler, ITC, Janis, Koetsu, Kyocera, LAST, Linn Sondex, Live Wire, Logic, Levinson, Meridian, Miyabi, Michell, Mordaunt Short, Music Reference, Nitty Gritty, NAIM, NYAL, Oracle, Origin, Pyramid, P.S. Audio, Quad, Rauna, RGR, Signet, Sony, Souther, Spectral, Spondor, Symdex, Talisman, Tandberg, Thorens, 3-D Acoustics, VPI, VSP Labs, Vandersteen, Zeta

149 North Third Street, Philadelphia, PA 19106 (215) 923-3035

CHESTNUT HILL AUDIO LTD.

Shown: Audio Control Richter Scale Series III

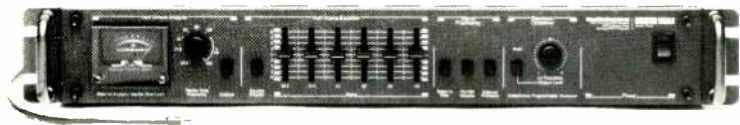

The New Richter Scale™ Series III More Features Give You More Bass Control

When we introduced the world's first half-octave bass equalizer with warble-tone analyzer, laboratory-grade measurement microphone and built-in electronic crossover, it shook up the audiophile world. Finally, speaker performance and room anomalies below 250Hz could be effectively analyzed using warble tone, a high resolution dB meter and a 4-micron diaphragm back-electret measurement microphone on a convenient 20' cord.

Well, now there is even more performance. The new Richter Scale Series III has six half-octave EQ bands (at 22.5, 31.5, 45, 63, 90 and 125Hz). Its extremely sharp 24 dB/octave programmable electronic crossover employs Linkwitz-Reilly alignment, a hitherto esoteric and incredibly expensive design which provides flat amplitude

response with zero phase differences (lobing error). Plug-in modules allow easy adjustment from 20Hz on up. Specs are astonishing: 0.005% THD and -120dB S/N.

You get a built-in 18dB/octave subsonic filter, rumble reduction circuit, amplifier bridging and mono bass output. And our famous measurement microphone and warble tone generator. And gold plated jacks no less. All built in the USA and backed with a gutsy 5-year warranty for \$349. Write us for complete information, a technical paper on Linkwitz-Riley, and the location of your nearest dealer.

AudioControl™

6250-212th St. S.W. • Lynnwood, WA 98036
Phone (206) 775-8461

"...THE MOST SUCCESSFUL DESIGN OF ALL"

J. Gordon Holt *Stereophile* July, 1985.

Mr. Holt elaborates further: "of all the speakers in this price class that I have heard, I would say that Siefert's Maxim is probably the most successful design of all...The system is beautifully balanced and almost perfectly neutral...the low end from these is just amazing!...these little speakers will play LOUD! Unlike most small systems...they have the most accurate middle range I have heard from any speaker...the high end sounds as if it goes out almost indefinitely... I would gladly take this high end in preference to that of most over-\$2000 speaker systems I have auditioned in recent years...The Maxim reproduce massed violin sound superbly— with not a trace of steeliness, yet with all the resinous sheen of the real thing...I have never heard strings on good CDs sound more natural...the imaging and soundstage presentation from these are excellent. They do not sound small...It can make most audiophiles (and practically all music lovers) quite happy for an indefinite period of time. RECOMMENDED."

The Maxim IIIs, whose 40-Hz resonance is unmatched anywhere for a ported system only 13 H x 11 D x 9 W, are optimized for lowest-possible group delay and intermodulation distortion. Hardwood finishes are walnut, oak, or black. Now, join hundreds of satisfied purchasers who testify that J. Gordon Holt's claims are not overstated. Then, add a biamped subwoofer for still-greater performance heights.

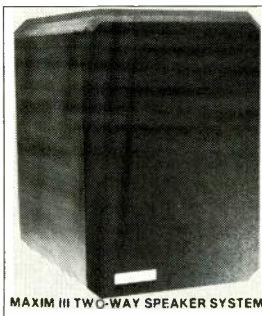

MAXIM III TWO-WAY SPEAKER SYSTEM

Send for a reprint of the entire review along with complete specifications of this 2-way bookshelf-size system. Save \$100 from the \$499/pr. dealer-selling price. Buy the Maxim III's factory-direct for \$399, plus \$14 shipping. 30-day, satisfaction-guaranteed return privilege.

SIEFERT RESEARCH

VISA/MC Orders (213) 457-4239

31212-A Bailard Rd., Malibu, CA 90265

FOR SALE

MARANTZ, MCINTOSH, TANNOY, J.B.L., ALTEC, Beveridge and other old equipment bought and traded. Selling: Beveridge III \$1500, Infinity 4.5 w/x/over \$1400. Double pairs KLH9 \$1495. Paragon 12a \$485. Tympani 1D \$675 pr. R.G. signature Xpander \$285. Benchmark ambience \$750. Rappaport class A amp \$750. Tech SL-P10 CD \$325. Nak. 700II from factory o'haul \$425. Hafler 500 \$300. Gyrodeck black/gold \$675, w/Well Tempered amp \$885. Final Audio Res. \$3m table \$1000, w/Triplanar arm \$1850. Series 20 D23 X'over \$475. Apex PR10 hi speed port. O'hauled \$325. Levinson ML1 \$725. Shahinian woofer interface \$400. Counterpoint SA2 \$275. Marantz 10B fact. specs \$795, model 20 that Marantz felt bettered the 10 \$375. 2130 the last fine scope tuner by Marantz as new \$375. Marantz 7, 9's, 10b, as original rackmounts + beautiful, not cheap. MC 1900 rec. w/cab. \$475. N.Y.S.I. Noon to 3P.M. 718-377-7282.

MARANTZ 9'S \$2,500 PR., 10B \$700, #3 crossovers \$600pr., #1 preamps \$500pr., #16 \$250. Gold Aero premium tubes stocked, shipped fast! McIntosh MC-75's \$775pr., MC-60's \$650pr., MC-2100 \$450, MC-225 \$300, MI-75 \$500, MR-71 \$350, MR-67 \$200, 1700 \$300, 1900 \$500, MX-110's \$300-425, MX-115 \$450, C-24 \$99, C-26 \$300. Kilowatt isolation transformer 140dB noise rejection for AC \$700 great for audio, video. Denon demos: POA-1500 poweramp \$400, PRA-1000 preamp \$275, TU-767 tuner \$200, DR-M33 cassette \$325. Mercury Living Presence, R.C.A. shaded dogs request list. R.C.A. ribbon microphones: 77DX \$475, BK-11A \$190. Handpicked tubes from 1970 many numbers. S.A.E. MKV1 tuner w/cabinet \$325, MK1B preamp w/cabinet \$200, MK1VDM poweramp \$225. Nakamichi 680ZX \$700, NR-200 \$300, Ni-Cad (I sell C cells) \$1.50. Tandberg 6021X halftrack \$225. Boothroyd-Stuart Meridian system \$550. Crown DL phono modules 1/2 price. Sansui 9090DB receiver \$300. OHM F driver(s) \$225. Deltalabs DL-5, DL-4, ADM-512 demos 70% off. Onkyo sealed TX-25 \$140, TX-35 \$185. Marantz 7T preamp \$165. Phase Linear 700B \$475. Sony LC90-FeCr \$11, LC60-FeCr \$6, LC90-SLH \$9, LC60-SLH \$4.50 elcaset tape. Teac AL-700 elcaset machines factory sealed originally \$1,100 now \$299, RX-10DBX for elcaset sealed \$225, 234 Syncast new \$600. Technics RS-7500 elcaset mint \$500. Panasonic SH-3433 4 channel scope \$300. Mitsubishi demos: LT-30 \$325, DA-M30 meter \$100, DA-F30 \$200, DA-R8 \$150, Lux L-110 integrated \$525. EV 7445 quad encoder \$475. Revox A700 \$1,200, G36MK3 \$250. Many Teac remote controls \$50. Pioneer RTU44 quad recorder w/remote \$1,250. Sony TC854-4S quad w/sel sync, remote \$1,200. DBX 224 \$225, 400 \$200, 128 \$250. Ortofon STM-72 transformer \$25. 600 pre-recorded r/tr \$7, 1/2track \$18. Want collections pre-recorded r/tr, McIntosh, Marantz (tube) units, Sony, Teac, Advent Dolby units, oddball pieces, accessories. Want high quality units for consignment. Everything money back guaranty. Shipping worldwide Martin Gasman: 779 Worcester Street, Wellesley, Mass. 02181 phone: 617-CEL-TICS, 617-235-8427.

MCINTOSH, MARANTZ, AUDIO RESEARCH, LEVINSON, KRELL, TANNOY, ALTEC, JBL, WESTERN ELECTRIC, BERNING, DYNACO, BUY-SELL-TRADE, MAURY 713-728-4343, 11122 ATWELL, HOUSTON, TEXAS 77096.

MCINTOSH MC60'S, MC225, MC240, MC275, C-26, C-34V, MC2205, MC2105, MC2002, MCD7000, MI3, over 60 pieces in stock. ONE YEAR TRADE-UP POLICY. NO MINIMUM ON USED GEAR! Call, write for quotes. AUDIO RESOURCE, #1 Metairie Court, Metairie, LA 70001. 504-833-6942.

MCINTOSH SOLID STATE COMPONENTS, J.B.L. used Alnico components, and systems. Bought, sold and traded. 313-229-5191, 7-11PM EST.

MERRILL AR MODIFICATIONS— MERRILL TURNTABLE

UNDERGROUND SOUND, 2125 CENTRAL AVE.,
MEMPHIS, TENN. 38104
(901) 272-1275.

MOSCODE MINUET & APT H-P PREAMPS, Kinergetics tuner, Infinite Slope Mod. 2 and ADS 4590 series 2 speakers. NEC N561U-4 head VHS VCR. (215) 567-4626, PA.

MUSICAL CONCEPTS MC-1 PREAMP

Finally ready in kit form, this dual mono preamp on one board offers truly outstanding performance for the Hafler DH-101, Dyna PAT-4/5, and scratch built units. Audiogram says this is the best solid state preamp period! Write for details. Musical Concepts, #1 Patterson Plaza, Florissant, MO 63031, 314-831-1822, 1-4PM Central.

FOR SALE

MOUNT YOUR TONEARM ON A SOTA turntable and smile, smile, smile. Expert setups and installations. Audio Nexus, NJ. (201) 464-8238 or (201) 730-2409.

NITTY GRITTY RECORD CLEANING MACHINES & SUPPLIES IN STOCK. IF YOU'RE USING ANY OTHER METHOD OF RECORD CLEANING YOUR RECORDS ARE STILL DIRTY! SAVE YOUR RECORDS! INVEST IN A NITTY GRITTY. NITTY GRITTY MACHINES ARE QUALITY CONSTRUCTED AND EASY TO USE. WE ALSO STOCK REPLACEMENT PARTS AND THE NEW CD CLEANING MACHINE. CALL TOLL-FREE 1-800-222-3465 FOR ORDERING & PRICES. WE CAN'T BE BEAT! HCM AUDIO, (916) 345-1341. VISA/MC/AMEX.

ORDER TOLL-FREE 1-800-222-3465. ACOUSTAT • AL-CHEMIST • AR • ARISTON • AJDIOQUEST • B & W • BOSE • BOSTON • GRACE • GRADO • HARMAN/KARDON • HAFNER • JVC • KENWOOD • LAST • LIVEWIRE • MONSTER CABLE • NITTY GRITTY • PETERSON • PREMIER • SONY • SOTA • SPICA • STAX • STRAIGHTWIRE • SUPERPHON • THORENS • TALISMAN • VAN DEN HUL. CALL FOR LOW PRICES. MOST ITEMS IN STOCK. HCM AUDIO, (916) 345-1341. VISA/MC/AMEX.

PREMIER TONEARMS & ACCESSORIES BY SUMIKO. MOST ITEMS IN STOCK. CALL TOLL-FREE 1-800-222-3465 FOR ORDERING AND PRICES. WE CAN'T BE BEAT! HCM AUDIO, (916) 345-1341. VISA/MC/AMEX.

PRO. DIGITAL AUDIO PROCESSORS JVC VP101 MicLine mixing, external sync. \$950, free shipping. Visa/MC PRODIGITAL, 3400 Pendleton Dr., Wheaton, Md. 20902 202-635-5588 Full Audio Services—digital Editing.

PS AUDIO: GOURMET SOUND. SAVOR their delicious, new products. AUDIO NEXUS, NJ (201)464-8238, (201)730-2409.

QUAD 63 SPEAKERS, SPECTRAL MODIFICATION, Entec sub-woofers, Spectral DMC-10 preamp, DMA-100 amp, almost new. (201) 746-2794.

AudioQuest Solves The Energy Crisis!

Usually people worry about how to get enough energy. AudioQuest has been working on how to get unwanted energy out of your audio system. The answer is by using **Sorbothane**, an amazing material that is like a black hole for unwanted vibration.

- aq Sorbothane Record Mat
- aq Sorbothane Isolation Feet
- aq Sorbothane Record Clamp
- aq Sorbothane Self Adhesive Sheets
- aq Sorbothane Vacuum Tube Dampers

audioquest

629 Camino de los Mares #306
San Clemente, CA 92672
714-240-0604

FOR SALE

PROTECT YOUR VALUABLE COMPONENTS from voltage spikes, noise, and the damage that results, with a Waber surge suppressor six outlet strip. Single stage protection DG115S \$57.50. Triple stage protection DG315S \$135. Inexpensive insurance for all audio, video, and computer systems. Brochures available Visa and MasterCard. Free delivery. OXFORD AUDIO CONSULTANTS, INC., Box 145, Oxford, OH 45056-0145. 513-523-3333, TLX427791.

RARE BRB AMPLIFIERS—BELOW WHOLESALE. Limited quantities. New, Model 200-\$395, Model 120-\$295, Model 1B-\$40. Bruce Rosenthal, 1300 Terra Bella Ave., Mountain View, CA 94039-7267. (408) 245-9864.

CARVER, NAKAMICHI, BANG & OLUFSEN, A.D.S., CROWN, REVOX, HAFNER, ADCOM, MISSION, MERIDIAN, N.A.D., HARMAN/KARDON, KYOCERA, YAMAHA, LUXMAN, DENON, KLIPSCH, B & W, POLK, KEF, D.C.M., E-V, J.B.L., INFINITY, D.B.X., AKG, AND OTHER QUALITY COMPONENTS. BEST PRICES—PROFESSIONAL CONSULTATION. ALL PRODUCTS COVERED BY MANUFACTURERS U.S.A. WARRANTY. AMERISOUND SALES, INC., JACKSONVILLE, FLORIDA 32241. EAST: (904) 262-4000 WEST: (818) 243-1168.

SIDEREALKAP

NOT JUST ANOTHER GENERIC CAPACITOR WITH A WONDERFUL NAME, THE SIDEREALKAP WAS DESIGNED FROM ITS INCEPTION TO BE THE FINEST SOUNDING CAPACITOR AVAILABLE FOR AUDIO TODAY. FIND OUT WHAT THE MUSIC LOVER'S CAPACITOR DOESN'T SOUND LIKE. CALL (619) 722-7707, OR WRITE TO: SIDEREAL AKUSTIC, 1969 OUTRIGGER WAY, OCEANSIDE, CA 92054. FREE LITERATURE AND PRICE INFORMATION UPON REQUEST. DEALER INQUIRIES INVITED.

Definitive Stereo—Southern Style!

- Apogee
 - Audionics
 - Audio Research
 - Bang & Olufsen
 - Cello
 - Duntech
 - Entec
 - Goldmund
 - Janis
 - KEF
 - Linn
 - McIntosh
 - Magneplanar
 - Mark Levinson
 - Meridian
 - N.A.D.
 - Nakamichi
 - Nitty Gritty
 - Phase Technology
 - Polk Audio
 - Quad
 - Rega
 - Signet
 - Spectral
 - Stax
 - Yamaha
- Factory Authorized Service
 - Consultation, Design and Installation
 - Quality Stereo and Video Cabinetry
 - On-Location Master Recording Service

audition

2829 18th Street South
Birmingham, Alabama 35209
(205) 870-3554

Tues., Thurs.: 10-8; Wed., Fri., Sat.: 10-6

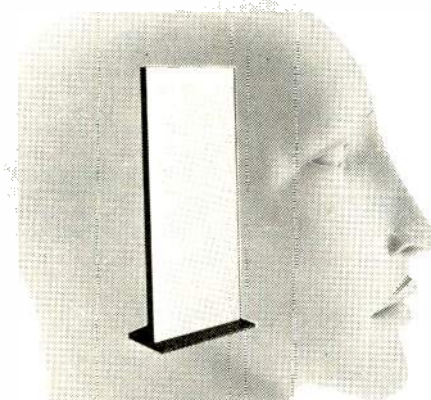

Acoustat speakers were designed to work the way your ear was designed to hear.

Perfectly.

Acoustat speakers utilize a unique full-range electrostatic element — one that operates in much the same way as the recording microphone and the human ear. Because of this, they are capable of reproducing music exactly as it was recorded with all the sonic brilliance and realism you hear at a live concert.

Acoustat speakers provide musical enjoyment that is unequalled by any other loudspeaker system regardless of price. We'd like you to hear the full story of Acoustat speakers and electronics.

Call or write for the name of the Acoustat dealer nearest you — then give your ears the music they deserve.

ACOUSTAT
SPEAKERS • ELECTRONICS

Revolutionary by Design

3101 Southwest First Terrace / Fort Lauderdale, Florida 33315
Telephone 305/462-6700

audio-technica

GRAVITY

DIAMONDS ARE NOT FOREVER!

When was the last time you changed your stylus? If you can't remember, then it may already be too late!!

We specialize in phono cartridges, factory original replacement styli, headphones & record care items only!!

(800) 221-0906

CALL TOLL-FREE FOR FREE PRICE QUOTES VISA/MC/C.O.D. ORDERS N.Y. State (516) 599-1112

SEND SELF ADDRESSED STAMPED ENVELOPE FOR OUR FREE CATALOG

LYLE CARTRIDGES

Dept. A Box 158
Valley Stream, N.Y. 11582

Phones Open Mon. - Sat. 9am - 8pm

ortofon SHURE STANTON

TIPTOES LAST MONSTER-CABLE

Dynavector Bang & Olufsen PICKERING

Western Mass. Quality Components Qualified Sales and Service

Acoustat Boston Acoustics B&W Carver Castle Celestion C.W.D. Fried Haller Onkyo Ortofon

Rego Cambur Revok Rotel Signet Sony S O T A Soundstream Spica Sumiko Thorens

Sound & Music
92 King St. Northampton, MA 013-584-9647

FOR SALE

SME TYPE V—The finest tonearm in the world. For the most demanding professional and commercial applications—radio stations, libraries, mastering studios, etc. For order information call or write to: **TOPOLOGY**, P.O. Box 1452, Palo Alto CA 94302, (408) 723-7404. Due to limited availability orders will be filled on a first come basis.

SONY P.S.X7 FULLY AUTOMATIC DIRECT drive turntable system Quartz lock Carbon fiber tonearm with Empire 4000D3 cartridge. Mint condition. Mark Dishotsky, 2190 Brigham St., Brooklyn, NY. (718) 934-4553. Call for price.

SOTA TURNTABLES: BEAUTIFULLY CRAFTED, unsurpassed sonics. Hear the Sapphire, Star, Superstar. **AUDIO NEXUS**, NJ. (201) 464-8238, (201) 730-2409.

STRAIGHT WIRE

HOW CAN A SPEAKER CABLE THAT SELLS FOR \$1—\$3/FT. SOUND MORE LIKE A DIRECT CONNECTION THAN OTHER CABLES SELLING FOR MANY TIMES ITS PRICE?

MUSIC RIBBON

THE SPEAKER CABLE OF TOMORROW, TODAY Offering greater impedance linearity resulting in lower phase shift. **FLAT** geometry (.05" thin)—**BEST CABLE FOR CUSTOM INSTALLATIONS UNDER CARPETING.** OFC/Polypropylene Jacket; superior mechanical stability minimizes I.M.

MR-24 (10ga.) \$3/ft • MR-16 (12ga.) \$2/ft
MR-12 (14ga.) \$1.50/ft • MR-8 (15ga.) \$1/ft

THE ONLY TUNABLE SPEAKER CABLE AVAILABLE CALL OR WRITE FOR SPECIFICATIONS. PRICE LIST AND DEALER INFO ON MUSIC RIBBON and other STRAIGHT WIRE PRODUCTS:
LSI • FLEXCONNECT • TEFLON-12
P.O. Box 78, Hollywood, FL 33022. (305) 925-2470.

THE DESIGN CENTER FEATURES: Superior components, expeditions, courteous, service facilities; complete consultation, delivery, installation. For delicious sound: 418 Front Street, Santa Cruz, CA 95060. (408) 425-5141.

You may be damaging every record you play...

...if you haven't replaced your stylus (needle) in the past year.

Finding the proper Shure replacement styli is easy. Call toll-free **1-800-257-4873** (Illinois residents call **1-800-624-8522**) for the location of your nearest Shure Stylus Replacement Center. Your dealer will show you a stylus that's precision designed to maximize the sound of your system.

Call today. Don't let a great record collection go to ruin.

SHURE®

A JANIS BASS SYSTEM

FOR MANY YEARS A REFERENCE STANDARD FOR SUBWOOFER PERFORMANCE ITS THE CHOICE WHEN ONLY THE BEST WILL DO

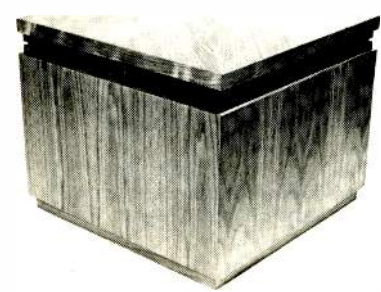

ASK FOR OUR COMPLETE LITERATURE THE JANIS BASS SYSTEM

JOHN MAROVSKIS AUDIO SYSTEMS, INC.
2839 Roebeling Avenue, Bronx, New York 10461 (212) 892-7419

FOR SALE

THE BEST EQUIPMENT, EXPERT ADVICE and outstanding prices! SOTA, Vandersteen, Klyne, Eminent Technology, Electrocompaniet, Koetsu, Electron Kinetics, SME, Sumiko, Straightwire, Peterson, Lazarus, Precision Fidelity, Superphon—much more! Specials on new and used equipment. Newsletter available. Galen Carol Audio: 512-494-3551.

FOR SALE

THORENS TURNTABLES. MOST MODELS IN STOCK. CALL TOLL-FREE 1-800-222-3465 FOR ORDERING & PRICES. WE CAN'T BE BEAT! HCM AUDIO, (916) 345-1341. VISA/MC/AMEX.

UHER, Sennheiser, Sony, AKG, (Shure), Electro-Voice, Audio-Technica, Beyer, Bose, etc. Portable Recorders, Microphones, Mixers, Line, A.V. Carpenter (GHP), P.O. Box 1321, Meadville, Pa. 16335-0821

LOUDSPEAKERS

ABSOLUTELY REAL

"Leading edge" best describes the technology and quality of the **GOLD 3.0**. Drivers and complete systems. Audio Concepts, your ribbon headquarters. Free brochure, **GOLD 3.0** manual \$10. 1631 Caledonia St., LaCrosse WI. 54603. 608-781-2110

ACCURATE & AFFORDABLE, OVER 30 PROVEN DESIGNS for audiophiles, speaker kits for home, car, subwoofer & pro. **JBL, AUDAX, SEAS,** polypropylene drivers & crossovers. \$2 Gold Sound, Box 141A, Englewood, CO 80151.

A.D.S. STUDIO MONITOR SPEAKERS 2030'S. Will handle 1200 watts (overload protection). Can biamp, walnut, mint, w/C2000 crossover. awesome sound. (313) 772-2634.

START WITH SEPARATES SYSTEM 1
(UNDER \$2700)

- Turntable: Linn Sondek LP-12
- Tonearm/Cartridge: Linn Basik + /Adcom GFC-1E
- Preamp: Adcom GFP-1A
- Tuner: Adcom GFT1-A
- Amplifier: Adcom GFA-2
- Speakers: Snell Type E II
- Compact Disc Player: Adcom GCD-300

SOUND BY SINGER
165 E. 33rd Street
New York, NY 10016
(212) 683-0925
We ship anywhere

KIMBER KABLE

HIGH PERFORMANCE SPEAKER WIRE

ASK YOUR DEALER OR CALL FOR DIRECT SALE

KIMBER KABLE
2058 Harrison Blvd.
Ogden, Utah 84401
(801) 621-5530

LOUDSPEAKERS

ALPHA ELECTRONICS ACTIVE CROSSOVERS: 24dB/Octave, amplitude, phase correct. Two through six way, perfect for subwoofers. Boards \$29.95, kits \$129, upgradeable cardrack \$399.95. Alpha Electronics, Box 15026, Detroit, Michigan 48215.

ARE THE BEST SPEAKER SYSTEMS really available only by mail? Send \$1 for our 60 page color catalog. Acoustic Interface, POB 6632, Santa Barbara, CA 93160.

A&S SPEAKERS IS PROUD TO announce that we are now carrying complete, audiophile loudspeakers systems from VMPs, Scan-Speak, Euphonic Audio, and Nelson-Reed. Also available is the widest selection of speaker components from Focal, Audax, Dynaudio, Peerless, Becker, Jordan and others. Free catalog. A&S SPEAKERS, Box 7462A, Denver, CO 80207. (303) 399-8609.

ATTENTION AUDIOPHILES: JSE INFINITE SLOPE Loudspeakers are available from us. Inquire about our 7 Day—**NO RISK** auditioning program. Authorized Hafier and Thorens dealers. We pay shipping. Sound Unlimited, 178 Main St., Bristol, Conn. 06010. Est. 1959. (203) 584-0131.

MC VISA AMEXP ACCEPTED

ATTENTION MAGNEPAN OWNERS—For your Magnepan MG-11B speakers: the **TOPOLOGY MIM-11B**, a plug-in module that will transform your 11B's into speakers that will amaze you. For information call or write to: **TOPOLOGY**, P.O. Box 1452, Palo Alto CA 94302, (408) 723-7404. Coming soon: The **TOPOLOGY MIM-11IA** for your MG-111's.

ATTENTION: SYSTEMS AND COMPONENTS WANTED. JBL, Hartsfields, Paragons—E.V. Patricians, Tannoy autographs, GRF, etc. Charlie Dripps, 4331 Maxson Rd., El Monte, CA 91732. (818) 444-7079.

LOUDSPEAKER COMPONENTS-KITS. Audax, Dynaudio, Eclipse, Focal, Peerless, Morel, Vifa, and more! 1µf-80µf polypropylene capacitors. Catalog 50c. Meniscus, 3275W Gladiola, Wyoming, Michigan 49509. (616) 534-9121.

Epi
made in u.s.a.

CLEAN RECORDS . . .
CLEAN SOUND!



The HW-16 and HW-16.5 Record Cleaners will wash and dry your records so well; the sound of Analog Recording will amaze you! The HW-16 or HW-16.5 will be the most important addition you can make to your music system.

V.P.I. Ind. Inc.
P.O. Box 159, Ozone Park, N.Y. 11417
718-845-0103



Building on Success

Developed from the legendary MS20, the new **MORDAUNT-SHORT MS25Ti** is an advanced high efficiency two-way system, with 8" bass unit, Titanium tweeter, and overload protection.

At \$250 the pair, the **MORDAUNT-SHORT MS25Ti** is available in Black Ash or Walnut laminate.

Mordaunt-Short

RCS Audio International, Inc.
1055 Thomas Jefferson St. N.W.
Washington, DC 20007
(202) 342-0400

U.S. distributors for British Fidelity, Mordaunt-Short, Sendor, and Logic.

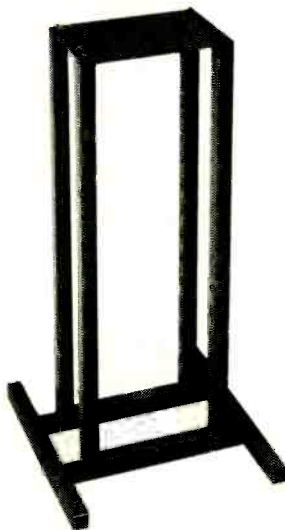

THE HERCULES EDGE

- Adjustable spikes on base, for maximum stability and coupling.
- Adjustable cone-point set screws on plate provide optimum coupling of the speaker to the stand.
- Rigid, non-flex design.
- Lead-sand filling capacity adds weight and dampens resonance.
- Superbly finished.
- Four models to match a wide range of loudspeakers.

**YES, YOU CAN UPGRADE
SPEAKER STANDS!**

Chicago Speaker Stand

THE AUDIOPHILES CHOICE

1-800-882-2256
In Illinois call 312-745-5500

WHAT MAKES THE NEW SYRINX LE-2 TONEARM SPECIAL?

- A cigar profile non-resonant arm tube.
- VTA, azimuth and alignment are fully adjustable.
- The detachable headshell is more rigid and more adjustable than a bayonet mount.
- The calibrated arm pillar for repeatable VTA settings.
- The graduated bias is linear across the record surface for improved tracking and transparency.
- The calibrated, locking counterweight couples over a wide bandwidth for better energy transfer
- High quality, specially-purified internal wiring.
- A suggested retail of only \$400.

Syrinx

Distributed by
ASSEMBLAGE

P. O. Box 815, Branford, CT 06405 (203) 488-8099
Meitner Audio Miyabi Koetsu

SME Series V Authorized Dealers

Note: Because of deadline factors, this list may not be complete. Call 415-843-4500 for up-to-date information.

Esoteric Audio
Scottsdale, AZ

Absolute Audio
Orange, CA

Audible Difference
Palo Alto, CA

Audio Excellence
San Francisco, CA

C&M Stereo Unlimited
Fairfield, CA

db Audio
Berkeley, CA

Garland Audio
San Jose, CA

Newport Audio
Newport Beach, CA

Optimal Enchantment
Santa Monica, CA

Paul Seydor Audio
Los Angeles, CA

Listen Up
Denver, CO

Take 5 Audio
New Haven, CT

Audio by Caruso
Miami, FL

Sound Components
Coral Gables, FL

The Stereo Shop
Lilburn, GA

Campus Audio Services
Honolulu, HI

Paul Heath Audio
Chicago, IL

Victor's Stereo
Chicago, IL

Natural Sound
Framingham, MA

OEM Audio Cnsltns.
Rockville, MD

HiFi Exchange
Falmouth, ME

Audio Advice
Raleigh, NC

CSA Audio Design
Upper Montclair, NJ

Woodbridge Stereo
Woodbridge, NJ

Audio Visions
West Babylon, NY

Lyric Hi Fi
New York, NY

Sounds by Singer
New York, NY

Corner Audio Store
Beaverton, OR

Better Sound Concepts
Pittsburgh, PA

Sassafras Audio
Jenkintown, PA

Soundex
Willow Grove, PA

Opus Two
Memphis, TN

Galen Carol Audio
San Antonio, TX

Audio Den
S. Burlington, VT

Audio Analyst
Madison, WI

Salon I
Wisconsin Rapids, WI

Sound Investments
Milwaukee, WI

SUMIKO, INC. P.O. Box 5046, Berkeley, CA 94705

LOUDSPEAKERS

CARVER, NAKAMICHI, BANG & OLUFSEN, A.D.S., CROWN, REVOX, HAFLE, ADCOM, MISSION, MERIDIAN, N.A.D., HARMAN/KARDON, KYOCERA, YAMAHA, LUXMAN, DENON, KLIPSCH, B & W, POLK, KEF, D.C.M., E-V, J.B.L., INFINITY, D.B.X., AKG, AND OTHER QUALITY COMPONENTS. BEST PRICES—PROFESSIONAL CONSULTATION. ALL PRODUCTS COVERED BY MANUFACTURERS' U.S.A. WARRANTY. AMERISOUND SALES, INC., JACKSONVILLE, FLORIDA 32241. EAST: (904) 262-4000 WEST: (818) 243-1168.

DEMONSTRATORS WITH WARRANTY—Acoustat model one \$980; Acoustat one + one \$1190; Beveridge system V \$2080; ITC Model one \$505; JSE model one \$680; Side-real Acoustic IV \$800; Stax ESL-F81 \$1600; Triad system 70 \$250.

GREENFIELD EQUIPMENT, 7805 Greenfield Street, River Forest, IL 60305. 312/771-4660. MC/VISA. Auditions by appointment—shipping & export facilities.

EPIK TRANSMISSION LINE MONITOR SPEAKERS \$495; Pro-Ac Studio 3 speakers in walnut with stands \$1650; Martin Logan Monolith Electrostats \$2800. Mike Saunders: 209-477-6428.

FRIED LOUDSPEAKERS: LEGENDARY, FANTASTIC. Audition all models at AUDIO NEXUS, NJ (201)464-8238, (201)730-2409.

GUSS SPEAKERS

From \$3000. For a copy of review ("The loudspeaker equivalent of the Holy Grail") and demonstration at our Madison Avenue showroom, call (212) 888-3339.

PROAC STUDIO 1—AMAZING NEW SPEAKER that S.M. Gerdson of Hi Fi Listening calls, "The best loudspeaker under \$1000 a pair. The studio 1 have a powerful realistic sound with silky highs." Call 303-449-1440. Modern Audio, 2888 Bluff, Suite 210C, Boulder, Colo. 80301.

LOUDSPEAKERS

PROAC SUPER EBT Loudspeaker sets new standards of excellence in transparency, detailing and dynamic range for only \$775 pr. We recommend Super EBT as the perfect upgrade from LS-3/5A or Spica. Bradford's Hi-Fidelity, 150 W. Broadway, Eugene, OR 97401. (503) 344-7349.

SNELL A TYPE II Walnut cabinets. Absolutely perfect condition. One of the most accurate speakers available at any price. Two years old. \$2,300 pair. 513-751-6611 or 751-0168.

SPEAKER BUILDERS SAVE 50-70%. Esoteric kits including compound subwoofers, ribbon systems. Dynaudio, Strathern, Seas, IAR Wondercaps, Chateauroux polypropylene, Phase and amplitude correct active crossover kits by Shadow. AC foam for cost effective room treatment. The finest in stock, guaranteed lowest prices, helpful service! All new 1986 Catalog \$2 refundable. Audio Concepts, 1631 Caledonia St., La Crosse WI. 54602. 608-781-2110.

SPECTRUM LOUDSPEAKERS: HIGHEND SOUND at budget prices. AUDIO NEXUS, NJ, (201) 464-8238, (201) 730-2409.

SPICA SPEAKERS & CHICAGO STANDS—SIMPLY THE BEST. Authorized dealer, personalized service. Call for appointment or prices. MOBILE RECORDING COMPANY, Carmel, IN (317) 846-5308 Eves.

TURNTABLES

MICRO SEIKI 1500VG AND FVG TURNTABLES definitely, absolutely, and positively blow away ALL the over-advertised competition. They are unequivocally the best. We will prove it to you by mail. Send for complete literature and ordering information. Anaioq Excellence, 12021 Wilshire Blvd. #131, Los Angeles, CA 90025. 213-652-3336.

PARTS & ACCESSORIES

BRISSON MI-330 INTERCONNECTS, IAR class 1aa! Specialists in difficult terminations, flexible section tonearm sets, camacs for Goldmund and Levinson. Brisson hook-up wire for audio constructors. Customized ATHENA Poly-Phasors with hardwired MI-330 cables. ASC Tube Traps to control reflections in your listening room. Custom threaded Tiptoes for any audio product. Michael Percy, Box 526, Inverness, CA 94937. (415) 669-7181.

DB-5 TONE CONTROL—For people who hate tone controls. Corrects tonal balance of imperfect recordings. Less than 0.0008% THD, five year warranty. DB SYSTEMS, Rindge, New Hampshire 03461 (603) 899-5121.

WATCH THIS SPACE!

We tried to think of what would interest readers of AUDIO magazine at the beginning of spring. Car stereo might do, but we don't sell any. Personal stereo, walkperson devices, but we don't have those either. In fact, we don't sell anything that could be used out-of-doors. However, for those who still enjoy music in their homes during the summer, we offer the following:

ACOUSTAT	JBL T1	JANIS	MAGNAVOX
FRIED	SOUTHER	ITC	SOTA
HAFLE	SUMIKO	SONY	A R
P.S. AUDIO	PLC	THORENS	DBX

This month we'll be at the Consumer Electronics Show in Chicago, investigating more new and exciting products to display in this space

Manufacturer's
Inquiries
Invited.



95 vassar st.
cambridge, ma
02139



617
547-2727

DISC CLEANING PERFECTED!

We live in a world of dust, grease and static electricity — all enemies of the phonograph record and compact disc.

Each form of pollution creates its own kind of havoc with the reproduction of music. Each interrupts the most critical junction in the audio chain. And until each is eliminated, your musical enjoyment will not be optimized.

Nitty Gritty Record Care Products manufactures unique cleaning systems that are 100% effective in eliminating dust, grease and static electricity from records and compact discs. Records and cd's that have been cleaned by a Nitty Gritty sound more like live music. They have extended high frequency response, improved imaging, more acoustical space, and less noise. Everyone can hear the obvious improvement that a Nitty Gritty cleaning makes.

Recommended by AUDIO, AUDIO AMATEUR, AUDIO VIDEO INT'L, DIGITAL AUDIO, FANFARE, HOME ENTERTAINMENT, INT'L AUDIO REVIEW, SENSIBLE SOUND, SON HI FI, STEREOPHILE, and STEREO REVIEW.

FREE info upon request:

NITTY GRITTY

RECORD CARE PRODUCTS, INC.

4650 Arrow Hwy #F4, Montclair, CA 91763
(714) 625-5525



CLEAN RECORDS . . . CLEAN SOUND



THE BEST THERE IS!

The HW-17 Pro Record Cleaner is a true "State of the Art" device.

- Self contained fluid pump
- Stainless Steel catch basin
- Self adjusting velvet coated pickup nozzle
- Bi-directional cleaning
- Quiet operation!

V.P.I. Ind. Inc.
P.O. Box 159
Ozone Park, N.Y. 11417
718-845-0103

PARTS & ACCESSORIES

MCINTOSH COMPONENTS, PARTS & ACCESSORIES BOUGHT-SOLD-TRADED. THOUSANDS OF PARTS IN STOCK. CALL OR WRITE FOR YOUR FREE CATALOGUE. 8AM-5PM EST MON-FRI. AUDIO CLASSICS, POB 176PA, WALTON, NY 13856. 607-865-7200. AUDIO ADVERTISER SINCE 1979.

TUBES & ACCESSORIES WITH ADVICE on tubes, mods., system design, new & used components. Amperex, EE, GE, Gold Lion, Mullard, Sylvania, Tungram. Exclusive US rep. Siemens/Telefunken. Great prices. Consultant/supplier to manufacturers, dealers, clubs, individuals. Douglas Kent Smith Consulting, 240 W. Pike St., Canonsburg, PA 15317-1163. (412) 746-1210.

CD PLAYERS

ANALOG READY

Almost all CD players share one common problem, poor design of the Analog Audio stages. Owners of Philips based players, i.e., Magnovox, Sylvania, Mission, Meridian, Revox, Nakamichi, etc. Can now enjoy a performance level unattained by any other player. Two performance levels available: Level I \$180, Level II \$280, both installed. Write for brochure. Musical Concepts, #1 Patterson Plaza, Florissant, MO 63031. (314) 831-1822, 1-5 PM CST.

CARVER, NAKAMICHI, BANG & OLUFSEN, A.D.S., CROWN, REVOX, HAFLER, ADCOM, MISSION, MERIDIAN, N.A.D., HARMAN/KARDON, KYOCERA, YAMAHA, LUXMAN, DENON, KLIPSCH, B & W, POLK, KEF, D.C.M., E-V, J.B.L., INFINITY, D.B.X., AKG, AND OTHER QUALITY COMPONENTS. BEST PRICES—PROFESSIONAL CONSULTATION. ALL PRODUCTS COVERED BY MANUFACTURERS' U.S.A. WARRANTY. AMERISOUND SALES, INC., JACKSONVILLE, FLORIDA 32241. EAST: (904) 262-4000 WEST: (818) 243-1168.

CD PLAYERS

COMPACT DIGITAL PLAYERS!

In stock! Fast, FREE shipping. Also: Adcom, Klipsch, Acoustat, PS, Quad, Spica, Fried, and more. (See our Halter ad.) READ BROTHERS STEREO, 593 King Street, Charleston, South Carolina 29403. (803) 723-7276.

J.S. AUDIO OFFERS A LARGE selection of CD players at competitive prices. For more information Mon. thru Sat. please call 301-890-3232. J.S. Audio, One Childress Court, Laurel, MD 20707. We honor Visa & M/C.

SONY READY

Musical Concepts is now accepting the current generation Sony CD players for modification. Our mods offer outstanding clarity neutrality and sweetness. Level I \$180, Level II \$280. We now accept MasterCard and Visa. Musical Concepts, #1 Patterson Plaza, Florissant, MO 63031, 314-831-1822; 1-5PM CST.

TAPE RECORDERS

CARVER, NAKAMICHI, BANG & OLUFSEN, A.D.S., CROWN, REVOX, HAFLER, ADCOM, MISSION, MERIDIAN, N.A.D., HARMAN/KARDON, KYOCERA, YAMAHA, LUXMAN, DENON, KLIPSCH, B & W, POLK, KEF, D.C.M., E-V, J.B.L., INFINITY, D.B.X., AKG, AND OTHER QUALITY COMPONENTS. BEST PRICES—PROFESSIONAL CONSULTATION. ALL PRODUCTS COVERED BY MANUFACTURERS' U.S.A. WARRANTY. AMERISOUND SALES, INC., JACKSONVILLE, FLORIDA 32241. EAST: (904) 262-4000 WEST: (818) 243-1168.

Chicago Speaker Stand
THE AUDIOPHILES CHOICE



Rd-2

In order to capture the increased fidelity afforded by today's digital and high quality analogue recordings, audiophiles realize that they must place great attention on proper speaker mounting. Improperly mounted speakers fail to project the advantages of new recording technology as increased dynamics are lost in carpets, furnishings and other environmental factors.

For more musical enjoyment from your audio-video system, elevate your speakers on Chicago Speaker Stands.

CALL TODAY!!

1-800-882-2256

312-745-5500

The Most Knowledgeable Audio Dealership

Many audiophiles who want high quality audio systems are misled by well meaning—but misinformed salesmen, magazines, and friends whose understanding of sound reproduction is superficial or incomplete. As a result, many expensive "mistakes" are made.

During the past 10 years, Gala Sound has distinguished itself as the preeminent high-quality audio dealership in the United States. Founded by pianist/acoustician James Gala, audiophiles, musicians, orchestra conductors, and recording engineers throughout the U.S. and Europe rely on Gala Sound for state-of-the-art audio systems tailored to their specific needs, listening environments and budgets. These systems are second to none.

If you're serious about sound, you can own the finest: a definitive audio system from Gala Sound. Phone (do not write) Jim Gala at (716) 461-3000.

KEF • B&W • MAGNEPLANAR • ACOUSTAT • MERIDIAN • MARK LEVINSON • THRESHOLD
MCINTOSH • CONRAD-JOHNSON • BRYSTON • BELLES RESEARCH • REVOX

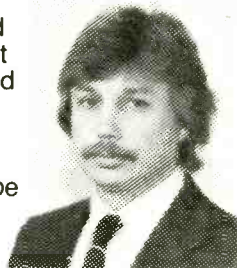

GALA SOUND

3122 Monroe Avenue, Rochester, New York 14618 • (716) 461-3000

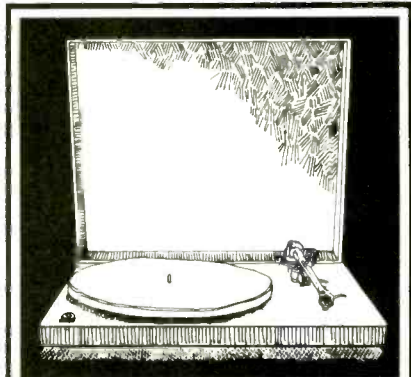

regal

REGA products reflect a splendidly simple British design philosophy: use only what is necessary & make it of the highest quality. The result is a handsome source of beautiful music, at a proper price.

REGA dealers will encourage you to listen to your favorite recordings and judge for yourself. For information:

import audio

3149 shenandoah, st. louis, mo. 63104 • 314-773-1211

LOWEST LOUDSPEAKER DISTORTION

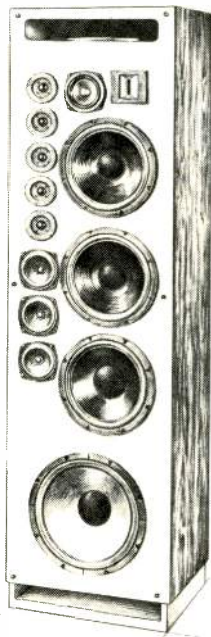

The VMPS Super Tower IIa/R, \$1,099ea black kit, \$1,299ea oak or walnut kit, \$1,499-1,699ea assem. 76x21 1/2x17" 300lbs

The VMPS Super Tower IIa/R is a very large floor-standing, ultra-low distortion, high efficiency speaker system designed for audiophiles seeking high output levels and dynamic range, extremely low levels of coloration, and the most extended bass response available in production loudspeakers.

Outstanding performance specifications include 100dB/1W/1m sensitivity, -3dB points at 17Hz and 50kHz, THD not exceeding 0.25% (22Hz-30kHz/1W drive), 132dB/1m undistorted output capability, and an in-phase, linear-phase design with **QSO HoloSonic** image-enhancement circuitry for dramatic three-dimensional imaging. Recent press comment on the STIIa/R includes: "World Class" (**High Fidelity**, Ap 85); "Awesome...left bruises on my abdomen" (**Hifi News & Record Review**, England, Ap 85); "The acoustic footprints (of different halls) were unmistakably clear and as easy to differentiate as if you were there in person." (**Digital Audio**, Ap 85).

Other VMPS models include the **MiniTower II** (\$329ea kit, \$439ea assem), **Super Tower/R** (\$699ea kit, \$969ea assem), our three highly-acclaimed **Subwoofers** (Smaller, \$229ea kit, \$299ea assem; Original, \$279ea kit, \$375ea assem; Larger, \$439ea kit, \$549ea assem), and the **QSO Series** of bookshelf speaker systems. Hear them at the dealers listed below, in our exhibit suite at Summer CES (Americana Hotel 443), or write for brochures and test reports. Prices include free shipping in USA and kits are supplied with fully assembled cabinets.

VMPS AUDIO PRODUCTS

div Itone Audio
3412 Eric Ct El Sobrante Ca 94803
(415) 222-4276

Hear VMPS at: The Listening Studio, Boston; The Long Ear, Coeur d'Alene Id; Sound Stage, Syracuse Ut; Arthur Morgan, Altamonte Springs Fl; ANH Video Audio, Houston Tx; Shadow Creek Ltd, Minneapolis Mn; Efficient Stereo, Torrance Ca; Sounds Unique, San Jose Ca; Digital Sonics, Foster City Ca; Just Speakers, San Francisco Ca; Eclectic Audio, Livermore Ca; Itone Audio, El Sobrante Ca; Walker Audio, San Angelo Tx; Mountaineer Telephone, Beckley W Va.

ACTIVE ELECTRONIC CROSSOVERS

NEW DESIGN! MODEL 120
NOW AVAILABLE

Made to order in bi-amp, tri-amp, and quad-amp configurations with optional level controls, subsonic filters, or summers. Filters, regulated power supplies, equalizers, also available.

Free catalog and price sheet

DeCoursey Eng. Lab.

11828 Jefferson Bl. Culver City, CA 90230
PHONE (213) 397-9668

AUTO SOUND

CARVER, NAKAMICHI, BANG & OLUFSEN, A.D.S., CROWN, REVOX, HAFLER, ADCOM, MISSION, MERIDIAN, N.A.D., HARMAN/KARDON, KYOCERA, YAMAHA, LUXMAN, DENON, KLIPSCH, B & W, POLK, KEF, D.C.M., E-V, J.B.L., INFINITY, D.B.X., AKG, AND OTHER QUALITY COMPONENTS. BEST PRICES—PROFESSIONAL CONSULTATION. ALL PRODUCTS COVERED BY MANUFACTURERS' U.S.A. WARRANTY. AMERISOUND SALES, INC., JACKSONVILLE, FLORIDA 32241. EAST: (904) 262-4000 WEST: (818) 243-1168.

CARTRIDGES & TONEARMS

A MOVING COIL CARTRIDGE SOUNDS BEST. However don't waste \$500 for cartridge or tonearm. GRAMOPHONE says "MKIV tonearm \$79 + MC-2V \$59 + T-24 transformer \$89 reproduced test sequence of records with unusual accuracy & tonal naturalness." High output MC-3L/2 'Vital' stylus \$59. Visa/MC. Reviews \$1 bill. Mayware, POB. 58, Edgware, Middlesex, England.

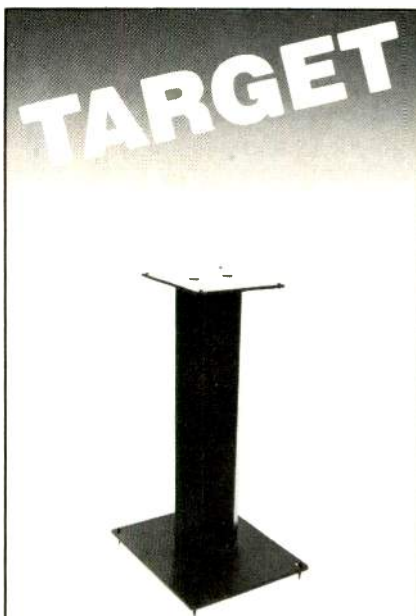

HJ SERIES

A new range of super heavy rigid speaker stands. Constructed from heavy gauge tube and plate complete with spiked feet and pointed studs under speaker.

For your free copy of our catalogue contact:
MAY AUDIO MARKETING LTD.
P.O. Box 1048
Champlain, N.Y. 12919 Tel.: (514) 651-5707

CARTRIDGES & TONEARMS

ABSOLUTELY BEST BUY MAYWARE MOVING COIL cartridges High output MC-3L/2 or MC-2V \$55 with 'Vital' super-polished nude diamond styli. MKIV tonearms \$69. Visa/MC. Reviews \$1 Bill. Mayware, POB 58, Edgware, Middlesex, HA8 7UE, England.

AUDIOPHILE RECORDS

FLABBERGASTED BY COMPACT DISCS? Before you banish your 'record-player' compare **AUDIOPHILE** albums from **MOBILE FIDELITY, SHEFFIELD LAB, NAUTILUS** and prepare for another surprise! **SOUND ADVICE** (816) 361-2713. Some **BEATLES** Collections, many **OUT-OF-PRINTS** available. **UHQRS**. Sale prices.

MOBILE FIDELITY ITEMS: Little Feat Waiting for Columbus. UHQRS: Beatles, Supertramp, Pink Floyd. Test Pressings: Abbey Road, Dark Side, Sheffield S10 The Missing Link. Call, Write for price. David Moretto: 1128 Confederate Cres., Virginia Beach, VA 23456. 804-467-0583.

ORIGINAL MASTER RECORDINGS! From Mobile Fidelity now only \$11.99. Many out-of-print and box sets available. Quick delivery, personal service. Free catalog. Ultrasound, 1319 Highland Ave., Dayton, OH 45410. 513-256-9714 (evenings).

OUT-OF-PRINT MOBILE FIDELITY over 60 titles from \$9. Also UHQ's, Super Disks, Direct-To-Disc's. Running out of titles fast! Chad, (913) 825-8609. 213 South 2nd, Saina, KS 67401.

REFERENCE RECORDINGS

For the discriminating few, we announce the release of a new Prof. Johnson PURE ANALOGUE Recording: "MARNI NIXON SINGS GERSHWIN." To stylish accompaniment by LINCOLN MAYORGA, Miss Nixon embellishes her already legendary reputation as one of America's most beloved singers in a program of rare and classic Gershwin songs. "Summertime," "Embraceable You," "Someone To Watch Over Me," "The Man I Love" and many more are given spine-tingling, definitive treatments by these two consummate artists. Such performances, captured in RR's patented sonic purity on imported JVC surfaces (at 33-1/3 rpm, note), **ESSENTIAL VINYL**. See rave review in Winter issue. The Absolute Sound. RR-19 now available at many audio and record stores, or direct from **REFERENCE RECORDINGS** (a \$16.98 postpaid, Box 77225X, San Francisco CA 94107. (415-355-1892). Visa/MC welcome. Free catalogue/reviews. Dealer inquiries invited! (P.S. All-digital compact disc in preparation.)

The Best Price on Sound Advice



At **SOUND STAGE** you can talk to a knowledgeable salesperson who will advise you on the best audio or video equipment that meets your needs and budget. From our large selection you can compare performance specifications and prices

- ALL **SOUND STAGE** equipment includes:
- 30-day best price protection
 - free 3-year warranty with parts & labor
 - free delivery

PLEASE, NO MAIL ORDER

NEC	ALPINE	ENERGY	TALISMAN	THE UNGO BOX
ADS	SIGNET	LUXMAN	AUDIO-PRO	AUDIOCONTROL
DCM	HAFLER	ALLISON	CJ WALKER	BEYER DYNAMIC
STAX	GRACE	PROTON	NITTY GRITTY	DBX SOUNDFIELD
KLOSS	FOSTEX	DUNTECH	JENSEN VIDEO	BANG & OLUFSEN
AMBER	DENON	CLIFFORD	3D ACOUSTICS	SURROUND SOUND

Call for store hours
(718) 961-9888

173 Broadway
N.Y.C. NY 10007
(NW corner of
B'way & Cortlandt
Enter on Cortlandt
One flight up)

OR
184 10 Horace Harding Expwy
Fresh Meadows NY 11365 (Exit 25 L E)



COMPACT DISCS



COMPACT DISCS AND ACCESSORIES

Call for FREE catalog.
Requests welcome
24 hours a day.
Retailer prices available

ALL DISC MUSIC, INC.

CT call
1-452-0203

1-800-ALL DISC

41 Monroe Turnpike, Trumbull, CT 06611

COMPACT DISCS—CLASSICAL, JAZZ, POP/AUDIO-PHILE, EUROPEAN & JAPANESE IMPORTS. Special orders welcomed. Send \$3 for comprehensive catalogue. Players available. NYCD, P.O. Box 20232, London Terrace Station, New York, NY 10011

COMPACT DISCS—MOST TITLES \$11.99—\$13.99. 3,000 plus titles in stock. Free catalog plus monthly updates. Oz Records, 5246A Memorial Drive, Stone Mountain, GA 30083, (404) 292-5452.

IMPORT DISCS ONLY: Classics, Jazz, Rock, International etc., from Europe and Japan. Catalog \$1 (Specify type of music). Chicago Digital: (312-383-5810), 905 S. Oak Park Ave, Oak Park, IL 60304.

NEW! A UNIQUE CD PROGRAMMING SYSTEM TO EVALUATE CD'S. DETAILED INSTRUCTIONS AND MANY EXAMPLES MAKE EVALUATIONS EASY. NOW LISTENER CAN HAVE VALUABLE INFORMATION ON EACH DISC/SONG. 140 CUSTOMIZED LABELS IN SEVEN BRIGHT COLORS INCLUDED. ONLY \$4.95 CALIFORNIA RESIDENTS ADD 6% SALES TAX. THE CD PROGRAM, 12591 HARBOR BLVD, SUITE 311, GARDEN GROVE, CALIFORNIA 92640.

Classical, Opera & Jazz Lovers

are invited to revel in our COMPACT DISC Catalogue completely detailing the more than 1700 titles we have IN STOCK.

Now in our fourth year.

Mail \$5.00 Annual Subscription Fee (refundable with 1st order) to:

Ethel Enterprises

P.O. Box 3301, Dept. A.
Falls Church, VA 22043

OVER 70 CD REVIEWS. The CD Critic reviews Pop, Jazz, and Classical on a quarterly basis. Premier issue. \$4. P.O. Box 3426 Huntington Beach, Ca. 92605.

USED DISCS WANTED! Top dollar paid—or trade two used for one new. CHICAGO DIGITAL: (312) 383-5810, 905 S. OAK PARK AVE, OAK PARK, IL 60304.

WE'RE MUSIC TO YOUR EARS

- Free Catalog of CD's.
- Same day shipping if you order before 12 noon EDT.
- \$1.00 DISCOUNT per disc on orders of 10 or more.
- \$2.50 for UPS Cont. U.S. shipments.

Call Toll Free to order:
USA 1-800-232-3687
NYS 1-800-537-7303

P.O. Box 616, Clifton Park, NY 12065
518-664-2550



Audio Exposure carries the definitive value in top quality phono cartridges. The **AudioQuest 404B** is a very smooth, high definition moving coil. It is available in three output levels (2.2mV, 1.1mV, .22mV) so there is an **AudioQuest 404B** that is perfect for your system, \$225.

629 Camino de los Mares #305, San Clemente, CA 92672 (714) 240-0742

BLANK TAPE

TAPES		T/120/1750		MG		1-800-245-6000		MAXELL	
MAR-90	5.55	TDK	4.59	3.99	SONY UCX-90	1.85	MAX-90	3.75	
MA-90	3.79	TDK HDPRO	—	6.79	SONY HF-90	99	XLII-90	2.39	
HIS-90	3.89	MAXELL	4.69	5.89	FUJI FR11-90	1.69	XLII-90	1.89	
SAX-90	2.39	MAXELL GOLD	—	7.89	FUJI METAL 90	3.39	XLI-90	1.79	
ADK-90	2.90	FUJISONY	4.69	5.99	BASE METAL 1204-89	—	UDSII-90	1.69	
SA-90	1.65				UR-120	1.88			
SA-90	1.40				UR-90	1.09			
AD-90	1.55				UR-90	.99			
D-90	.85				XL125-90B	6.49			
D-90	.85				UD35-90	4.99			
SONY ES-90	4.69				KONICA T120	4.69			

WE WILL BEAT ANY PRICE OF THE TOTAL ORDER INCLUDING ALL SHIPPING & HANDLING CHARGES BY 11:30 AM. M.F. 8:30-5:00
3% SHIPPING ANY SIZE ORDER C.O.D. ADD 1.95 412-283-8621
ALL TAPES HAVE U.S. WARRANTIES BUTLER, PA 16001
220 SPRING ST.
COMPLETE LINE OF TDK AND MAXELL IN STOCK

RECORDS

RECORD COLLECTORS SUPPLIES. REPLACEMENT JACKETS, VARIOUS SLEEVES, MULTIPLE BOXES, 78 RPM SLEEVES, LASER DISK CASES, CABCO PRODUCTS, BOX 8212, ROOM 661, COLUMBUS, OHIO 43201. MC VISA/AM/EX. By phone (614) 299-0476.

SERVICES

OVERSEAS VIDEOTAPES CONVERTED AMERICAN, VICEVERSA. Two system videorecorders, Televisions, Monitors discounted. Toll Free 1-800-626-8775 or (718) 507-5800, APPLE AUDIO, 74-18 37th Avenue, Jackson Heights, New York, 11372.

AUDIO PULSE SERVICE. Factory trained technicians. Write us about Model One update kits, White Labs, 10528 Lower Azusa Rd., Suite 192A, El Monte, CA 91731. (818) 446-5346.

Counterpoint

The New Generation of Tube/MOSFET Technology

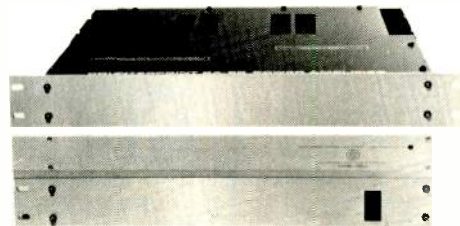

SA-20

Stereo Hybrid
Amplifier
\$1995.00 each

SA-20/20

Mono Hybrid
Amplifier
\$3990.00/pair

- * 1,000 Joule Power Supply
- * Massive 1KVA Custom Transformer
- * Custom Gold Plated/Teflon Connectors
- * Vacuum Tube Rectification
- * Hand Selected Tubes/MOSFET Output
- * 200 W/Channel/8Ω; 1000 W (Peak)/2Ω
- * Bridgeable To Nearly Twice The Power

Audition The SA-20 and SA-20/20 at your Counterpoint Authorized Dealer.

Counterpoint Electronic Systems, Inc.
P.O. Box 12472 Dept. S, La Jolla, CA. 92037
Telephone (619) 453-9090 Telex 284902 CPT UR

STATIONS NOW CARRYING

AUDIOPHILE AUDITION

THE PUBLIC RADIO PROGRAM FOR AUDIO BUFFS

Majority carry live at 2 PM EST Sundays
Times are given for those who tape delay

*** = Commercial concert music stations
tr = translators

ALABAMA	Dothan Huntsville Mobile Montgomery/Troy	WRWA WLPH WHL 9 PM Sun WTSU	COLUMBUS	tr
CALIFORNIA	San Bernardino Ridgecrest San Diego*** San Mateo/ San Fran. Crescent City Weed Yreka	KVCR tr KFSD 10 PM Sun KCSM 10 AM Sun KSOR (Ashland) tr KSOR (Ashland) tr	NEBRASKA	Lincoln Omaha
COLORADO	Greeley/Boulder Eates Park Gypsum/Eagle Valley Sterling	KUNC tr tr	NEVADA	Reno
CONNECTICUT	Bridgeport	WSHU	NEW MEXICO	Las Cruces Lordsburg Silver City Maljamar Portales
FLORIDA	Fort Pierce Jacksonville Miami Orlando Panama City Panama City Pensacola	WQCS WJCT 5 PM Sun WLRN WMEF 6 PM Sun WKGC-AM WKGC-FM WUWF 5 PM Sun	NEW YORK	New York City Rochester Schenectady Syracuse Troy
GEORGIA	Columbus Columbus Atlanta Augusta Macon	WJSP WTJB WABE WAGC WDCO	NORTH CAROLINA	New Bern
IDAHO	Rexburg Pocatello	KRIC 11 PM Mon and repeated 1 PM Fri tr	OHIO	Cincinnati Cleveland Columbus Lima Toledo Youngstown
ILLINOIS	Chicago Rock Island	WBEZ 10 30 AM Thur WKVR	OKLAHOMA	Edmond (Ok. City) Norman Tulsa***
INDIANA	Elkhart Fort Wayne Muncie	WVPE WBNI 10 30 PM Mon WBST	OREGON	Ashland Chemult Chiloquin Coos Bay Gold Beach Lakeview Roseburg Eugene
IOWA	Cedar Falls Council Bluffs	KHKE 11 AM Sat KIWR	PENNSYLVANIA	Erie Pittsburg
KENTUCKY	Hazard Louisville Louisville Richmond	WEKH WFPK WUOL 6 PM Sun WEKU	SOUTH CAROLINA	Beaufort Charleston Columbia Conway Greenville Rock Hill Sumter
LOUISIANA	Hammond Lafayette New Orleans Shreveport	KSLU KRVS 5 PM Sun WWNO KDDO 5 PM Sun	SOUTH DAKOTA	Aberdeen/Pierpont Brookings Pierre/Reliance Rapid City Sioux Falls Vermillion Vermillion Edgemont Lead Pringle Spearfish
MICHIGAN	Alpena Detroit** Flint Interlochen Mt. Pleasant Twain Lake	KCML WDRS WFBZ WIAA WJMU WBLV 9 AM Wed	TENNESSEE	Chattanooga Johnson City Memphis Nashville
MINNESOTA	Mankato Albert Lea Blue Earth Fairmont Minneapolis	KMSJ tr tr tr KBEM & repeated Midnite Tues	TEXAS	Beaumont College Station (Austin) Corpus Christi Dallas*** El Paso
MISSOURI	Columbia Kansas City Pl. Lookout Rolla St. Louis Springfield Warrensburg	KBIA KCUR KSOZ KUMR KUMW WSMU KCMW	VIRGINIA	Richmond Roanoke
MONTANA	Billings Absarokee Bozeman Colstrip	KEMC tr tr tr	WASHINGTON	Seattle***
			WISCONSIN	Kanosh WYOMING
			WYOMING	Cody Sheridan

FOR THE BEST NEW YORK PRICES CALL BOSTON!!

THE LOWEST DISTRIBUTOR PRICES ON ALL THE TOP BRANDS OF HOME ELECTRONICS ARE AS CLOSE AS YOUR PHONE! PUT OUR NATIONAL BUYING POWER TO WORK FOR YOU. NOW! VIDEO, TV, AUDIO, PORTABLE STEREO, COMPACT DISC PLAYERS, TAPE, COMPUTERS, FLOPPY DISKS, COMPUTER PAPER, ACCESSORIES, PRINTERS, MONITORS... WE HAVE IT ALL. TREMENDOUS

1-800-225-8656
ORDERS ONLY 9-6 M-F

SELECTION, ALL THE MAJOR MANUFACTURERS AND THE LOWEST PRICE ARE ALWAYS JUST ONE CALL AWAY!!

Parasonic ZENITH JVC SHARP SANYO TEAC RCA

WORLD WIDE ELECTRONICS DISTRIBUTORS
5 Commonwealth Ave., Woburn, MA 01801

MAIL ORDER: For rapid service, send certified check or money order. All prices reflect cash discount. No cash discount on MC/VISA! Personal checks require approx. 14 days for clearing. Add \$7 shipping & handling for orders under \$100. 7% for orders over \$100. NO C.O.D. MASS residents add 5% sales tax. Mass. Orders (617) 933-1440

WANTED TO BUY

ALWAYS PAYING TOP \$\$ FOR MCINTOSH solid state components, JBL loudspeakers (the older the better), McIntosh MC 3500 or MC 350 for personal use. 313-229-5191, 7-11PM EST.

ATTENTION: WANTED: MCINTOSH, MARANTZ, AUDIO RESEARCH, LEVINSON, TANNY, WESTERN ELECTRIC, TUBE & SOLID STATE, 713-728-4343, MAURY, 11122 ATWELL, HOUSTON, TX, 77096.

MCINTOSH, MARANTZ TUBE, MCINTOSH S.S. equipment, Thorens, Western Electric, Tubes, Speakers, etc. TOP CASH. Scott Dowling, 9908 Daines Drive, Temple City, CA 91780. (818) 286-9122, evenings/weekends.

MCINTOSH, MARANTZ TUBE COMPONENTS, Western Electric, Altac, JBL, John Conrad, 1178 Blackbird St., El Cajon, CA 92020. (619) 449-9155.

MCINTOSH, MARANTZ TUBE AMPS. Classical speaker systems, raw units of Jensen, JBL, Altac, Trosnic, Tannoy, Western Electric Tubes, Amps, Speakers, Drivers, Horns. Tel: 818/576-2642. David Yo, P.O. Box 832, Monterey Park, CA 91754.

TUBE AMPS BY MARANTZ, MCINTOSH, Fisher, Altac, Regency needed. Also want speakers: Tannoy, Beveridge, Altac, J.B.L. Paragon etc., E.V. Patrician, Regency, W.E. and other old field coil drivers. Please get my price before you sell. Ed: (718) 377-7282.



**UNBEATABLE PRICES • PROFESSIONAL SERVICE
FLEXIBLE PAYMENT PLANS • IMMEDIATE DELIVERY**

<p>CAR STEREO IN-DASH RADIO CASSETTE</p> <table border="1"> <tr><td>ALPINE</td><td>7272</td><td>\$ 296.00</td></tr> <tr><td>KENWOOD</td><td>KRC999</td><td>\$ 879.00</td></tr> <tr><td>SONY</td><td>XRT40</td><td>\$ 179.00</td></tr> <tr><td>YAMAHA</td><td>YCT450</td><td>\$ 288.00</td></tr> <tr><td>DENON</td><td>DCR7600</td><td>\$ 468.00</td></tr> <tr><td>NAKAMICHI</td><td>TD700</td><td>\$ 634.00</td></tr> <tr><td>PIIONEER</td><td>KE8181</td><td>\$ 219.00</td></tr> <tr><td>JVC</td><td>KSRX250</td><td>\$ 189.00</td></tr> <tr><td>SHERWOOD</td><td>CRD185</td><td>\$ 108.00</td></tr> <tr><td>BLAUPUNKT</td><td>ASPEN</td><td>\$ 229.00</td></tr> <tr><td>CONCORD</td><td>HPL520</td><td>\$ 259.00</td></tr> </table>	ALPINE	7272	\$ 296.00	KENWOOD	KRC999	\$ 879.00	SONY	XRT40	\$ 179.00	YAMAHA	YCT450	\$ 288.00	DENON	DCR7600	\$ 468.00	NAKAMICHI	TD700	\$ 634.00	PIIONEER	KE8181	\$ 219.00	JVC	KSRX250	\$ 189.00	SHERWOOD	CRD185	\$ 108.00	BLAUPUNKT	ASPEN	\$ 229.00	CONCORD	HPL520	\$ 259.00	<p>CAR AMPLIFIERS/EQ'S</p> <table border="1"> <tr><td>CARVER</td><td>M240</td><td>\$ 275.00</td></tr> <tr><td>DENON</td><td>OCA3250</td><td>\$ 188.00</td></tr> <tr><td>KENWOOD</td><td>KAC8200</td><td>\$ 229.00</td></tr> <tr><td>NAKAMICHI</td><td>PA150</td><td>\$ 153.00</td></tr> <tr><td>ALPINE</td><td>3519</td><td>\$ 149.00</td></tr> </table>	CARVER	M240	\$ 275.00	DENON	OCA3250	\$ 188.00	KENWOOD	KAC8200	\$ 229.00	NAKAMICHI	PA150	\$ 153.00	ALPINE	3519	\$ 149.00	<p>HIFI/STEREO</p> <table border="1"> <tr><td>MONSTER</td><td>INTERLINK 1 mtr</td><td>\$ 29.00</td></tr> <tr><td>CANTON</td><td>KARAT 200</td><td>\$ 266.00</td></tr> <tr><td>CELESTION</td><td>DLB</td><td>\$ 387.00 pr.</td></tr> <tr><td>BMW</td><td>DW130</td><td>\$ 493.00 pr.</td></tr> <tr><td>TECHNICS</td><td>SA956</td><td>\$ 328.00</td></tr> <tr><td>YAMAHA</td><td>R7</td><td>\$ 399.00</td></tr> <tr><td>ONKYO</td><td>TA2056</td><td>\$ 278.00</td></tr> <tr><td>AIWA</td><td>ADW20</td><td>\$ 409.00</td></tr> <tr><td>DBX</td><td>3BX11</td><td>\$ 425.00</td></tr> <tr><td>JVC</td><td>RX3304VB</td><td>\$ 189.00</td></tr> <tr><td>DENON</td><td>DRM44HX</td><td>\$ 499.00</td></tr> </table>	MONSTER	INTERLINK 1 mtr	\$ 29.00	CANTON	KARAT 200	\$ 266.00	CELESTION	DLB	\$ 387.00 pr.	BMW	DW130	\$ 493.00 pr.	TECHNICS	SA956	\$ 328.00	YAMAHA	R7	\$ 399.00	ONKYO	TA2056	\$ 278.00	AIWA	ADW20	\$ 409.00	DBX	3BX11	\$ 425.00	JVC	RX3304VB	\$ 189.00	DENON	DRM44HX	\$ 499.00
ALPINE	7272	\$ 296.00																																																																																	
KENWOOD	KRC999	\$ 879.00																																																																																	
SONY	XRT40	\$ 179.00																																																																																	
YAMAHA	YCT450	\$ 288.00																																																																																	
DENON	DCR7600	\$ 468.00																																																																																	
NAKAMICHI	TD700	\$ 634.00																																																																																	
PIIONEER	KE8181	\$ 219.00																																																																																	
JVC	KSRX250	\$ 189.00																																																																																	
SHERWOOD	CRD185	\$ 108.00																																																																																	
BLAUPUNKT	ASPEN	\$ 229.00																																																																																	
CONCORD	HPL520	\$ 259.00																																																																																	
CARVER	M240	\$ 275.00																																																																																	
DENON	OCA3250	\$ 188.00																																																																																	
KENWOOD	KAC8200	\$ 229.00																																																																																	
NAKAMICHI	PA150	\$ 153.00																																																																																	
ALPINE	3519	\$ 149.00																																																																																	
MONSTER	INTERLINK 1 mtr	\$ 29.00																																																																																	
CANTON	KARAT 200	\$ 266.00																																																																																	
CELESTION	DLB	\$ 387.00 pr.																																																																																	
BMW	DW130	\$ 493.00 pr.																																																																																	
TECHNICS	SA956	\$ 328.00																																																																																	
YAMAHA	R7	\$ 399.00																																																																																	
ONKYO	TA2056	\$ 278.00																																																																																	
AIWA	ADW20	\$ 409.00																																																																																	
DBX	3BX11	\$ 425.00																																																																																	
JVC	RX3304VB	\$ 189.00																																																																																	
DENON	DRM44HX	\$ 499.00																																																																																	
<p>CAR SPEAKERS PER PR.</p> <table border="1"> <tr><td>JENSEN</td><td>6x9 TRIAXIAL</td><td>\$ 59.00</td></tr> <tr><td>PLYLE</td><td>8229</td><td>\$ 118.00</td></tr> <tr><td>NAKAMICHI</td><td>SP300</td><td>\$ 295.00</td></tr> <tr><td>ALPINE</td><td>6393</td><td>\$ 135.00</td></tr> <tr><td>BOSTON ACOUSTICS</td><td>C700</td><td>\$ 139.00</td></tr> <tr><td>INFINITY</td><td>RSAS2</td><td>\$ 79.00</td></tr> <tr><td>JBL</td><td>T545</td><td>\$ 169.00</td></tr> </table>	JENSEN	6x9 TRIAXIAL	\$ 59.00	PLYLE	8229	\$ 118.00	NAKAMICHI	SP300	\$ 295.00	ALPINE	6393	\$ 135.00	BOSTON ACOUSTICS	C700	\$ 139.00	INFINITY	RSAS2	\$ 79.00	JBL	T545	\$ 169.00	<p>VIDEO/TV.</p> <table border="1"> <tr><td>PANASONIC</td><td>PV1545</td><td>\$ 569.00</td></tr> <tr><td>JVC</td><td>HRD566</td><td>\$ 699.00</td></tr> <tr><td>RCA</td><td>VLT600HF</td><td>\$ 539.00</td></tr> <tr><td>SONY</td><td>SLHF550</td><td>\$ 529.00</td></tr> <tr><td>SHARP</td><td>VHS-Hi-Fi</td><td>\$ 419.00</td></tr> <tr><td>FISHER</td><td>FVH960</td><td>\$ 581.00</td></tr> <tr><td>SONY</td><td>20XR</td><td>\$ 699.00</td></tr> </table> <p>All camcorders in stock - VHS. Beta & 8 mm Call for best price</p>	PANASONIC	PV1545	\$ 569.00	JVC	HRD566	\$ 699.00	RCA	VLT600HF	\$ 539.00	SONY	SLHF550	\$ 529.00	SHARP	VHS-Hi-Fi	\$ 419.00	FISHER	FVH960	\$ 581.00	SONY	20XR	\$ 699.00	<p>SPECIAL SALE</p> <table border="1"> <tr><td>DENON</td><td>DCD1000</td><td>\$ 299.00</td></tr> <tr><td>DENON</td><td>DP59F</td><td>\$ 399.00</td></tr> <tr><td>DENON</td><td>PRA1000</td><td>\$ 399.00</td></tr> <tr><td>DENON</td><td>POA1500</td><td>\$ 459.00</td></tr> <tr><td>DENON</td><td>DR4755B</td><td>\$ 429.00</td></tr> <tr><td>C-40</td><td></td><td>\$ 239.00</td></tr> <tr><td>YAMAHA</td><td>M40</td><td>\$ 288.00</td></tr> <tr><td>YAMAHA</td><td>M60</td><td>\$ 349.00</td></tr> <tr><td>YAMAHA</td><td>T320</td><td>\$ 99.00</td></tr> <tr><td>YAMAHA</td><td>T520</td><td>\$ 159.00</td></tr> <tr><td>YAMAHA</td><td>T720</td><td>\$ 189.00</td></tr> <tr><td>YAMAHA</td><td>K320</td><td>\$ 159.00</td></tr> <tr><td>YAMAHA</td><td>PF1000</td><td>\$ 388.00</td></tr> </table>	DENON	DCD1000	\$ 299.00	DENON	DP59F	\$ 399.00	DENON	PRA1000	\$ 399.00	DENON	POA1500	\$ 459.00	DENON	DR4755B	\$ 429.00	C-40		\$ 239.00	YAMAHA	M40	\$ 288.00	YAMAHA	M60	\$ 349.00	YAMAHA	T320	\$ 99.00	YAMAHA	T520	\$ 159.00	YAMAHA	T720	\$ 189.00	YAMAHA	K320	\$ 159.00	YAMAHA	PF1000	\$ 388.00
JENSEN	6x9 TRIAXIAL	\$ 59.00																																																																																	
PLYLE	8229	\$ 118.00																																																																																	
NAKAMICHI	SP300	\$ 295.00																																																																																	
ALPINE	6393	\$ 135.00																																																																																	
BOSTON ACOUSTICS	C700	\$ 139.00																																																																																	
INFINITY	RSAS2	\$ 79.00																																																																																	
JBL	T545	\$ 169.00																																																																																	
PANASONIC	PV1545	\$ 569.00																																																																																	
JVC	HRD566	\$ 699.00																																																																																	
RCA	VLT600HF	\$ 539.00																																																																																	
SONY	SLHF550	\$ 529.00																																																																																	
SHARP	VHS-Hi-Fi	\$ 419.00																																																																																	
FISHER	FVH960	\$ 581.00																																																																																	
SONY	20XR	\$ 699.00																																																																																	
DENON	DCD1000	\$ 299.00																																																																																	
DENON	DP59F	\$ 399.00																																																																																	
DENON	PRA1000	\$ 399.00																																																																																	
DENON	POA1500	\$ 459.00																																																																																	
DENON	DR4755B	\$ 429.00																																																																																	
C-40		\$ 239.00																																																																																	
YAMAHA	M40	\$ 288.00																																																																																	
YAMAHA	M60	\$ 349.00																																																																																	
YAMAHA	T320	\$ 99.00																																																																																	
YAMAHA	T520	\$ 159.00																																																																																	
YAMAHA	T720	\$ 189.00																																																																																	
YAMAHA	K320	\$ 159.00																																																																																	
YAMAHA	PF1000	\$ 388.00																																																																																	
<p>RADAR DETECTORS</p> <table border="1"> <tr><td>UNIDEN</td><td>RD9</td><td>\$ 186.00</td></tr> <tr><td>BEL</td><td>880</td><td>\$ 119.00</td></tr> <tr><td>WHISTLER</td><td>SPECTRUM</td><td>\$ 129.00</td></tr> <tr><td>FOX</td><td>VIXEN II</td><td>\$ 159.00</td></tr> <tr><td>COBRA</td><td>TRAPSHOOTER II</td><td>\$ 149.00</td></tr> </table>	UNIDEN	RD9	\$ 186.00	BEL	880	\$ 119.00	WHISTLER	SPECTRUM	\$ 129.00	FOX	VIXEN II	\$ 159.00	COBRA	TRAPSHOOTER II	\$ 149.00	<p>WALKMANS/ PORTABLE STEREO & TV</p> <table border="1"> <tr><td>AIWA</td><td>HSJ500</td><td>\$ 129.00</td></tr> <tr><td>SONY</td><td>WMF100</td><td>\$ 124.00</td></tr> <tr><td>SONY</td><td>WMDC6</td><td>\$ 239.00</td></tr> <tr><td>PANASONIC</td><td>RF71</td><td>\$ 98.00</td></tr> <tr><td>SONY</td><td>FD2A</td><td>\$ 111.00</td></tr> </table>	AIWA	HSJ500	\$ 129.00	SONY	WMF100	\$ 124.00	SONY	WMDC6	\$ 239.00	PANASONIC	RF71	\$ 98.00	SONY	FD2A	\$ 111.00	<p>REAR DETECTORS</p> <table border="1"> <tr><td>UNIDEN</td><td>RD9</td><td>\$ 186.00</td></tr> <tr><td>BEL</td><td>880</td><td>\$ 119.00</td></tr> <tr><td>WHISTLER</td><td>SPECTRUM</td><td>\$ 129.00</td></tr> <tr><td>FOX</td><td>VIXEN II</td><td>\$ 159.00</td></tr> <tr><td>COBRA</td><td>TRAPSHOOTER II</td><td>\$ 149.00</td></tr> </table>	UNIDEN	RD9	\$ 186.00	BEL	880	\$ 119.00	WHISTLER	SPECTRUM	\$ 129.00	FOX	VIXEN II	\$ 159.00	COBRA	TRAPSHOOTER II	\$ 149.00																																				
UNIDEN	RD9	\$ 186.00																																																																																	
BEL	880	\$ 119.00																																																																																	
WHISTLER	SPECTRUM	\$ 129.00																																																																																	
FOX	VIXEN II	\$ 159.00																																																																																	
COBRA	TRAPSHOOTER II	\$ 149.00																																																																																	
AIWA	HSJ500	\$ 129.00																																																																																	
SONY	WMF100	\$ 124.00																																																																																	
SONY	WMDC6	\$ 239.00																																																																																	
PANASONIC	RF71	\$ 98.00																																																																																	
SONY	FD2A	\$ 111.00																																																																																	
UNIDEN	RD9	\$ 186.00																																																																																	
BEL	880	\$ 119.00																																																																																	
WHISTLER	SPECTRUM	\$ 129.00																																																																																	
FOX	VIXEN II	\$ 159.00																																																																																	
COBRA	TRAPSHOOTER II	\$ 149.00																																																																																	

NO MEMBERSHIP FEE REQUIRED!
• Friendly, knowledgeable sales people
• All products brand new and carry U.S.A. warranties

FOR FASTEST SERVICE CALL (212) 684-6363 HOURS: 9AM-7PM EST. Monday-Saturday
or Write Direct: 2 PARK AVENUE, DEPT. 11, New York, N.Y. 10016

Prices subject to change without notice. We reserve the right to limit quantities. Offer may be withdrawn anytime.

WANTED TO BUY

QUADRAPHONIC OPEN REEL TAPES, RECORDS (whole collections), select equipment. Michael Robin, 120 Atlanta Place, Pittsburgh, Pennsylvania 15228. (412) 341-1686.

WHAT! NOT ANOTHER AD FOR that old tube gear and speakers? You got it! Send for my pricing schedule. I buy most anything. Charlie Dripps, 4331 Maxson Rd., El Monte, CA 91732. (818) 444-7079.

WOLLENSAK 8080 OR 8075 8-track cartridge recorder, with very little use. Will pay \$150. John, P.O. Box 34773, Los Angeles, CA. 90034, 213/202-8648.

BUSINESS OPPORTUNITIES

COMPUTERS PC XT AND AT COMPATIBLES: High Quality, Low Prices, Assembled, Kits, Monitors, Printers, Software, Etc. Dealer Info. MicroMagic, Box 18009, Seattle, WA. 98118. East: 202 723-7404, West: 206/325-7601.

ELECTRONIC REPRESENTATIVES NEEDED!! UNLIMITED PROFIT POTENTIAL! LOWEST POSSIBLE PRICES!! OVER 100 BRANDS! AUDIO — VIDEO — CAR STEREO — COMPUTERS & PERIPHERALS! — ELECTRONIC EXPERTS, 1000 ORANGE AVE., WEST HAVEN, CT 06516.

PUBLICATIONS

HIFI HERETIC ASKS:

Are you ready for an audio review journal that doesn't pull its punches? Ready for a magazine that evaluates audio equipment with the emphasis on both sound quality and value? We offer straightforward, no-nonsense reviews of high-quality equipment you can actually afford. Send \$16 for a one-year (four issue) subscription to: HIFI HERETIC, P.O. Box 1549, Gloucester, Virginia 23061, and receive a copy of Issue One ABSOLUTELY FREE!

MISCELLANEOUS

INVENTIONS, IDEAS, NEW PRODUCTS WANTED for presentation to industry/exhibition at national innovation exposition. Call free 1-800-528-6050. In Canada, 1-800-528-6060. X831.

NEW IDEA? American Patent in Washington, D.C. will assist you through Research and Development! Free Kit—1-800-257-7880.

MAIL ORDER

AMERICAN, BRITISH, AND JAPANESE HIGH END: SHAMEFULLY LOW PRICES, Nakamichi, Mission, B&W, KEF, Revox, Sumo, NAD, Denon. Plus Over 100 Other Brands. Information SASE Required. VISA/MC, COD. Serious Buyers Only. East 1-202/723-7404, West 1-206/325-7601. AudioWorkShop, Box 18009, Seattle, WA 98118.

Audio Video Car Stereo

Lowest Prices on All Major Brands
of Audio, Video & Car Stereo

FULLY WARRANTED

GET IT FREE!

Free Delivery Anywhere in the U.S.
Major Credit Cards Accepted

The SOUND Approach
6067 Jericho Tpke., Commack, NY 11725
"Call Us" (516) 499-7680

Truth and Nothing But . . .

If you're the kind of human being who can't live without music, then you ought to know about *The Absolute Sound*, the journal of High End audio. It takes home music systems utterly seriously and uses the real thing—unamplified music in a real space—as the ultimate standard against which to judge audio components and recordings. Its writers tell the truth, without fear or favor, in a magazine where cussed independence is still the style.

Issue 41 Is Out

Believe it or not, there's a \$14,900 turntable that makes vinyl discs, digital or analogue, the exact equivalent of the master tape . . . Our critics discuss their pick of the best recordings in rock, baroque, jazz, dance, and film music . . . We find the very first musical-sounding CD player, one that makes CDs listenable . . . We also tell you how the Top Ten popular recordings of 1985 really sound (wanna peel the wall paint?) . . . And guess which affordable 50-watt amplifier has our reviewers stretching adjectives.

The Search Ends Here

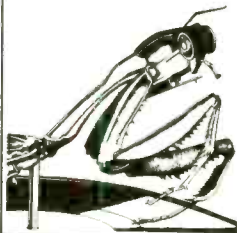

To subscribe (six issues), send \$33 (\$55 in US funds for readers outside North America). You can also call our business office at (516) 671-6342 and order *The Absolute Sound* with your Visa, Mastercard, or American Express. To sample a single issue, send us your check for \$7.50.

the absolute sound

Return to:
Box 3000
Dept. CC 1A64
Denville, NJ
07834

motif mc seven

A dual-
monaural f.e.t.
preamplifier
designed and
manufactured by
conrad-johnson
design, inc.

For information,
write:

conrad-johnson
design, inc.
2800R Dorr Ave.
Fairfax, VA
22031

703-698-8581



AD INDEX

Firm (Reader Service No.)	Page
Accuphase (1)	164
Acoustic Research (2)	Cover II & 1
Adcom (3)	52
Aiwa (4)	155
Akai (5, 6)	111, 113
Alpine (53)	85
Altec Lansing (54)	147
AMC Jeep Comanche	157
Audiophile Systems (7)	162
Audiophile Audition	59
BASF (8)	163
B & W Loudspeakers (9)	21-26
Barcus Berry (10)	151
Boston Acoustics	7
Brystonvermont (11)	13
CBS Records (12)	142, 143
Canton (13)	86 & 87
Carver (14, 15)	134 & 135
Cerwin-Vega (21)	93
Chrysler Le Baron	105
Columbia House	19
Concord (16)	153
Custom Woodwork & Design	4
DALI	124
dbx (18, 19)	9, 91
Denon (20)	Cover III & 184
Discwasher (23)	114
EPI (24)	121
Harman/Kardon	73
Infinity (25)	132
JBL	119
Kyocera (26)	129
Levinson	158
Lucky Strike	109
Maxell (27)	115
McIntosh (28)	131
Mitek (29)	51
NEC (31)	107
Onkyo	29-32, 101, 103
Ortofon (32)	60
Perreux (33)	44 & 45
Pioneer (34)	149
Polk (35)	48 & 49
Polygram (36)	50
Pyle (37)	159
RCA	5
Recoton (39)	56
Rogers (40)	161
Rotel (41)	41-43
SUMO	3
Signet (43)	8
Sony (44)	47
Sony Digital (45)	156
Soundcraftsmen (30)	16 & 17
Stillwater Design (46)	11
Studer Revox (47)	35-38
Tandberg (22)	95
TDK (48)	58
Technics (49)	Cover IV
Telarc (50)	133
Toshiba (51)	4
Winston	97
Yamaha	145
Zapco (52)	61

Eliminate Your "Patchcord Headaches"

If you have more components than places to hook them up, we have a switching system for you. For complete information on switch boxes for your tape decks, signal processors, and speakers, WRITE OR CALL TODAY.



niles **audio**

Dept. A, P.O. Box 160818
Miami, Florida 33116 (305) 238-4373
DEALERS: SEE US AT BTH 323* MCCORMICK CTR.

MAIL ORDER

UP TO 40% SAVINGS-WORLDS BEST AUDIO Equipment: Specify Make, Model. Send SASE. AudioWorkShop, Box 18009, Seattle, WA 98118, East 202/723-7404, West 206/325-7601.

YAMAHA: R9 \$699 R8 \$529, R7 \$419, R100 \$549, R5 \$269, R3 \$199, GE60 \$299, CDX3 \$349, CD1000 \$649, DX7 Synthesizer \$1599.
NAKAMICHI: RX202 \$529, BX300 \$599, RX505 \$949, Dragon \$1499, OMS 5 \$799, OMS 7 \$1099.
DENON: DRA 555 \$349, DRA 755 \$429, DRM 44HX \$499, POA1500 \$569, DP61 \$399, Sony TCD5M \$549, Tascam M30 \$899, 38 \$2499. Full USA warranty. VISA/MC/AMEX/DINERS, COD. Prices subject to change. International model available. 206-221-2977, 206-361-2455. TASKAMICHI AUDIO: POB 25583, 11555 27th N.E., Seattle, WA 98125.

NEW!

CD UPGRADES

Dramatic Improvements in your digital sound

Compact Disc Damper—improves imaging and tightens bass by stabilizing the disc during play

CD Player Modifications—better tonal balance, sweeter trebles, and improved dynamics result from upgrading parts, power supplies and connectors

Line Drive—a sophisticated system control center for your CD player, tuner, tape deck and video sound

Available at Mod Squad dealers everywhere, or direct from The Mod Squad. For a complete catalog send \$2 postage/handling (refundable with order) to

The Mod Squad Inc.

542 Coast Hwy. 101, Department A
Leucadia, CA 92024 • (619) 436-7666

“I am thoroughly impressed by the synthesis LM20 monitor. At only \$600 a pair, they literally fill a room with music. A remarkable speaker.”

Bobby Taylor
President
Excalibur Audio

synthesis
2817M Dorr Avenue • Fairfax, Virginia 22031
703-698-7905

Some people
don't know
the first
thing
about
digital audio.



With new companies entering the Compact Disc market every month, it's not surprising that many people haven't the faintest idea how digital audio was developed. Or by whom.

The theory of digital recording was worked out in the 1920's. But it took almost 50 years for someone to build the first digital audio recorder good enough for commercial record production. That someone was Denon.

How did it happen to be Denon? Perhaps because Denon is Japan's oldest record company, with a single-minded commitment to recorded music. Or possibly because Denon is Japan's oldest audio company, with a 75-year tradition of advancing the state of the audio art.

In any case, Denon engineers quickly put their digital invention to use—releasing the world's first digitally-recorded LP and compiling the world's largest library of digital master tapes.

Soon we were making digital-grade amplifiers, digital-grade recording tape, digital Compact Discs, and CD players regarded by many reviewers as the world's finest.

Consider the DCD-1500 Compact Disc Player. *Digital Audio* gave it the highest rating of any CD player under \$1,000. Not bad, considering it retails for \$629.95*.

And then there's Denon HD8 cassette tape. Our exclusive "High Technoroum" magnetic coating makes it simply the best Type II tape for recording digital sources. And don't miss Denon's PMA-900V Integrated Amplifier, with the new Pure Current Power Supply for prodigious dynamic range.

So when it comes to getting the latest and best in high-performance digital audio, you have two choices. You can wait for other companies to catch up. Or you can be there first. With Denon.

DENON
The first name in digital audio.

Enter No. 20 on Reader Service Card

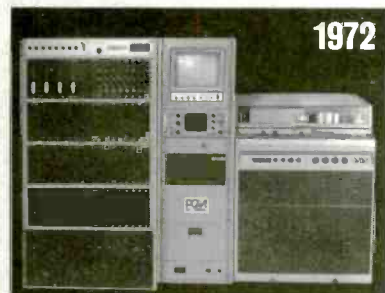

The first PCM digital audio recorder used in commercial record production, the Denon DN-023R.



Denon's Broadcast Compact Disc Player, the DN-3000F, cues to an accuracy of 13.3 milliseconds.



Denon introduces the finest high-bias cassette for recording digital sources: HD8.



With the highest ranking of any CD player under \$1,000, the Denon DCD-1500 lists for only \$629.95*.



*Suggested retail price.

IN THE PURSUIT OF PERFECTION, TECHNICS MOVES TWO STEPS CLOSER.

A high-performance digital filter. A fine-focus single-beam laser. Both in the new Technics compact disc players.

Musical perfection. It's the promise of the compact disc. To fulfill that promise the new Technics SL-P300 incorporates two significant advances.

A high-performance digital filter to deliver unsurpassed sound. An improved FF1 fine-focus single-beam laser system. It has the strength and accuracy to "read" through most fingerprints, scratches and even imperfections in the disc itself.

For programming convenience, the FF1 laser can move across a disc in less than a second. And, of course, the SL-P300 also has an infrared, wireless remote control. To play any selection. In any order. From almost anywhere in the room.

Result: the new Technics compact disc players have moved two steps closer to musical perfection. And now, so have you.

Technics
The science of sound



Enter No. 49 on Reader Service Card