

# Audio

FEBRUARY 1984 • \$1.75

**PERFORMANCE-  
CHECK YOUR AMP  
AND PREAMP**

## **TESTED:**

**dbx 4BX EXPANDER**  
**EASILY WORTH ITS PRICE**

**MARANTZ COMPACT  
DISC PLAYER**  
**SUPER PERFORMER**

**HAFLER 220 AMP**  
**RUGGED DESIGN**



**NAD's FLOPPY TONEARM**

\*\*\*\*\*5-DIGIT 20707  
460350 MXU 67126099 14 6 SEP84  
MR. FRED B. MAXWELL  
16712 GOLDSBOROUGH  
LAUREL MD 20707

02UH

00309





# HARMAN KARDON INTRODUCES THE MOST ADVANCED STATE-OF-THE-MIND RECEIVER



Thirty years ago Harman Kardon introduced the world's first high fidelity receiver. It was built on the philosophy that quality audio must evolve from creative, quality thinking.

That quality of thought has served as the foundation of all Harman Kardon audio products.

In 1958 Harman Kardon introduced the world's first stereo receiver.

In 1963 Harman Kardon introduced Ultrawideband Frequency Response and in 1970 Harman Kardon became the first company to use Dolby<sup>1</sup> in a cassette deck.

Today, Harman Kardon audio products continue to be so technologically advanced that "state-of-the-art" falls short of describing them. They have become "state-of-the-mind," the highest level at which the mind can create.

A distinct example of Harman Kardon's state-of-the-mind technology is the hk690i receiver, which leads their line of quality receivers and possesses their most important state-of-the-mind concept to date: High instantaneous Current Capability.

Harman Kardon has consistently used High instantaneous Current Capability (HCC) in all of their amplifier sections. HCC provides the instantaneous power that is vital to precisely drive and control nearly any loudspeaker system.

With its HCC of 45 amps, the hk690i will develop far more power under peak loads than its rated 60 Watts per channel<sup>2</sup> while

maintaining the low distortion and widebandwidth required for accurate sonic reproduction. This means that the hk690i gives you louder, clearer sound than any other 60 Watt<sup>2</sup> receiver.

The digital synthesized quartz-locked hk690i has an Ultrawideband Frequency Response of 0.2Hz to 150kHz, as well as low negative feedback for extremely fast and accurate transient response. The result is the virtual elimination of TIM distortion.

The phono section of the hk690i has a unique dual RIAA equalization circuitry which maintains a constant low level of negative feedback throughout the audio frequency range. An exclusive sample-and-hold MPX decoder decreases high frequency switching noise while eliminating the need for much of the filtering normally required in FM processing.

Among performance features included are: Provisions for two tape decks (with tape copy capability), switchable bass and treble turnover frequencies, a Moving Coil head amplifier, and subsonic and high cut filters.

The hk690i provides the combination of pure power and sonic excellence that the true audiophile demands.

So, while other manufacturers continue to pile on unnecessary features and gimmicks, Harman Kardon continues to develop fundamentally advanced audio equipment.

1. Dolby is the registered trademark of Dolby Laboratories, Inc.

2. 60 Watts RMS per channel into 8 Ohms, 20Hz-20kHz with less than 0.6% THD.

## harman/kardon

Our state-of-the-mind is tomorrow's state-of-the-art.

# Buff Stuff from TDK.



You, the audiophile, are the toughest critic we know when it comes to sound performance. You're very selective in deciding the perfect equipment for your recording and listening needs.

And you're just as selective in choosing your recording tape. TDK knows that. So we developed a line of high performance audio cassettes that meet your critical requirements.

We call it the TDK Professional Reference Series.

You're probably using TDK SA-X high bias cassettes now because of their superior performance characteristics. In addition, TDK has developed normal bias AD-X which uses TDK's famous Avilyn particle formulation and delivers a wider dynamic range with far less distortion than ever before. Plus, TDK's unique metal bias MA-R cassette which features high-energy performance in a one-of-a-kind unibody

die-cast metal frame.

The TDK Professional Reference Series...it'll sound impressive to your ears. So share the pleasure with your friends; they'll appreciate it.

**TDK**  
THE MACHINE FOR YOUR MACHINE<sup>®</sup>



# Audio

FEBRUARY 1984

VOL. 68, NO. 2



See page 34.

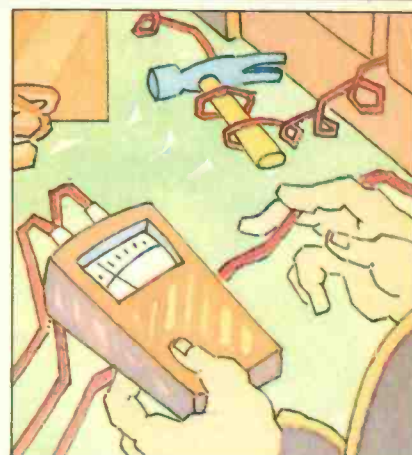

See page 42.

## FEATURES

NAD's FLOPPY TONEARM .....	B.-E. Edvardsen, P. W. Mitchell, and J. Janda .....	34
PERFORMANCE-CHECK YOUR AMP AND PREAMP: PART I .....	M. J. Salvati .....	42

## EQUIPMENT PROFILES

DBX 4BX DYNAMIC-RANGE EXPANDER .....	Howard A. Roberson .....	50
HAFLER DH-220 POWER AMPLIFIER .....	Leonard Feldman .....	54
NAD 5120 TURNTABLE .....	Edward M. Long .....	58
BOSTON ACOUSTICS MC-1vdH PHONO CARTRIDGE .....	B. V. Pisha .....	61
MARANTZ CD-73 COMPACT DISC PLAYER .....	Leonard Feldman .....	66

## MUSIC REVIEWS

ROCK/POP RECORDINGS .....	Michael Tearson, Jon & Sally Tiven .....	78
CLASSICAL RECORDINGS .....	Edward Tatnall Canby .....	86
COMPACT DISCS .....	Bert Whyte, John M. Eargle, C. Victor Campos .....	90

## DEPARTMENTS

SIGNALS & NOISE .....	6	
WHAT'S NEW .....	8	
BEHIND THE SCENES .....	Bert Whyte .....	13
AUDIO ETC .....	Edward Tatnall Canby .....	16
TAPE GUIDE .....	Herman Burstein .....	25
AUDIOCLINIC .....	Joseph Giovannelli .....	28
SPECTRUM .....	Ivan Berger .....	30

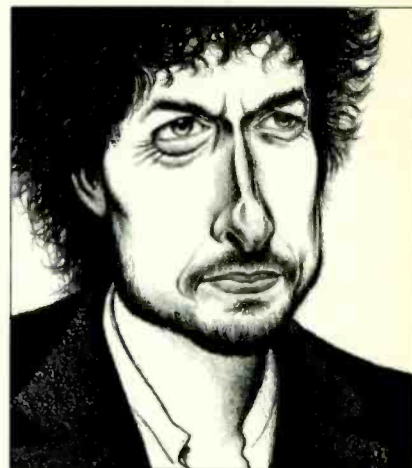

See page 78.

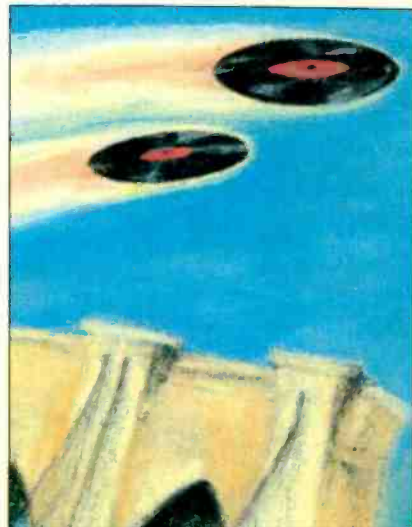

See page 16.

The Cover Equipment: NAD "floppy" tonearm and 5120 turntable.  
The Cover Photographer: Carl Zapp.



Audio Publishing, Editorial and Advertising Production Offices,  
1515 Broadway, New York, N.Y. 10036.

Subscription Inquiries, (800) 525-9511; in Colorado (303) 447-9330.



Today's Chevrolet

# Hotter than Texas chili.

**Camaro Z28.** "Hot." A three-letter word that's synonymous with Z28 in the vernacular of the enthusiast.

**What's so hot about Z28?** Everything. Styling. Performance. Comfort.

Powered by a track-proven small-block V8,\* Z28 delivers throaty bursts of power when you need it. And the optional High Output Package gives Z28 even hotter credentials.

It goes around corners, too. Thanks to a refined torque-arm rear suspension and new, precise front geometry with special upper and lower control arms, Z28 has recorded a lateral acceleration figure of .85g on the GM Proving Grounds.

**Simmering shape.** Z28 looks as quick as it goes. Sleek, curving lines and a 62-degree raked windshield help provide a low drag coefficient of .339. And Z28's deep front air dam helps reduce nose lift, while aiding steering response.

**Take it to your next cookout.** So if you've got a taste for something hot, get a Z28. You'll find it's hotter than Texas chili.

Today's Chevrolet. Bringing you the cars and trucks you want and need. That's what Taking Charge is all about.

\*Some Chevrolets are equipped with engines produced by other GM divisions, subsidiaries, or affiliated companies worldwide. See your dealer for details.



Let's get it together... buckle up.

OFFICIAL U.S.  
CARS AND TRUCKS  
OF THE XIV  
OLYMPIC WINTER  
GAMES



Sarajevo '84

© 1982 GM Corp. Sarajevo '84



CHEVROLET   
taking charge

# The leader in equalizers still stacks up best with improved specs, more features and a new look.

ADC's new line of Sound Shapers® prove that the best just got better. Again. Our stereo frequency equalizers incorporate the superb electronics, reliability, and high performance technology that have made ADC famous. Plus we've improved them with new refinements that offer you more control and a new design that makes them look as good as they function.

Our top-of-the-line SS-315 offers a unity gain of  $\pm 1$  dB and the best signal-to-noise ratio in the industry. For the utmost in versatility, the range of each frequency control is an extra wide  $\pm 15$  dB, far more than the 12 dB of lesser equalizers. Tape monitoring and two-way dubbing capabilities for two decks are available. LED indicators for each control let you see the selected frequency curve at a glance. The SS-315 includes a built-in real-time spectrum analyzer, pink noise generator and calibrated electret microphone enabling you to attain flat response in minutes. Other features include external noise reduction and sound processor loops to accommodate time delay, subharmonic synthesizer, dynamic range expander or reverb units. There's also a subsonic filter that gets rid of damaging, power-robbing subsonic frequencies.

The other models in our Sound Shaper line offer the same fine ADC quality, with similar features geared to your equalization and budget needs.

If you've been waiting for the right stereo frequency equalizer for your system, don't wait any longer. With ADC Sound Shapers, the odds are stacked in your favor. (And if you're into video, be sure to see and hear what our new ADC Video Sound Shapers can do to improve your video performance.)

*Sound  
Shaper*  
Frequency  
Equalizers

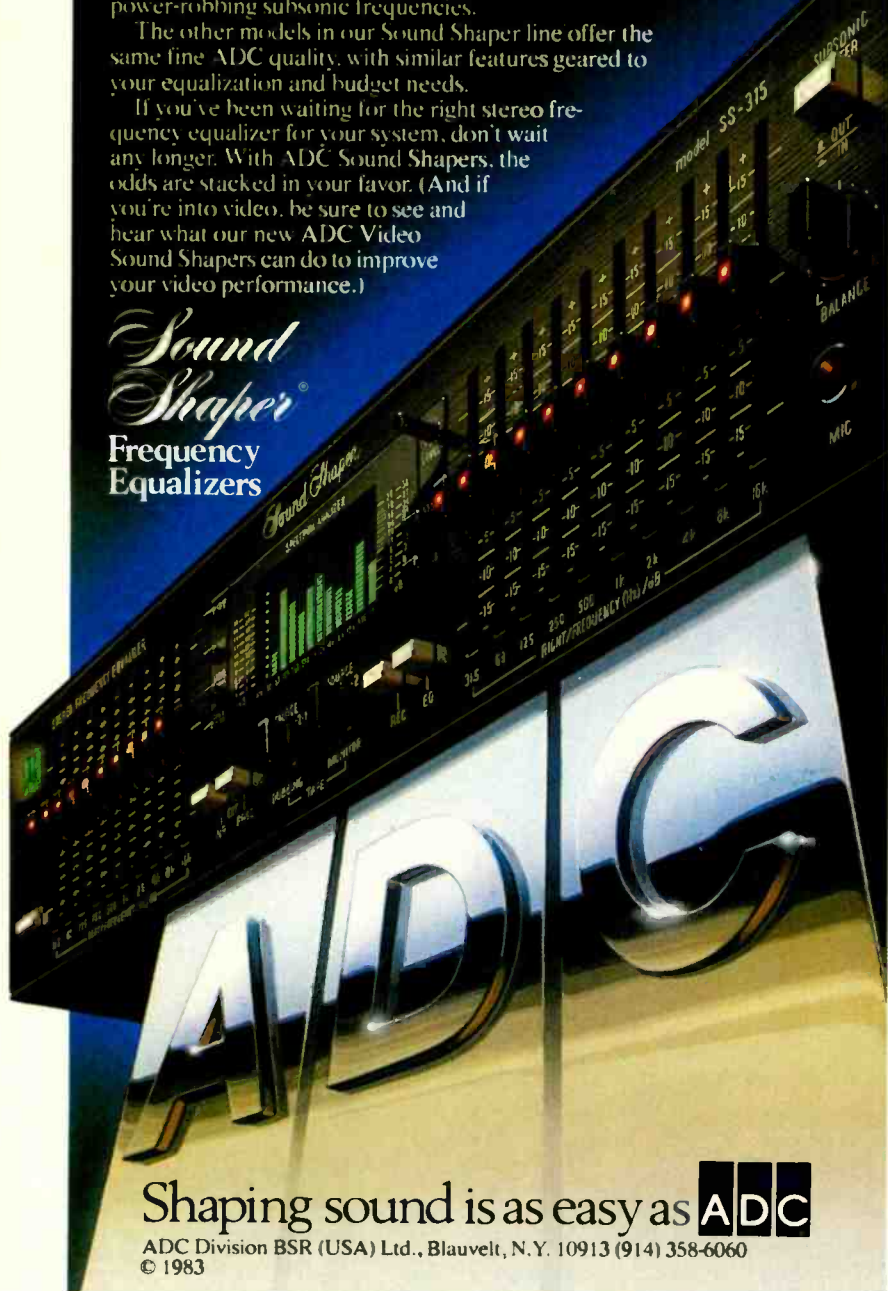

Shaping sound is as easy as **ADC**

ADC Division BSR (USA) Ltd., Blauvelt, N.Y. 10913 (914) 358-6060  
© 1983

Enter No. 2 on Reader Service Card

## Audio

Eugene Pitts III  
Editor

Art Director: Cathy Cacchione  
Assistant Art Director: Linda Zerella

Technical Editor: Ivan Berger  
Managing Editor: Kay Blumenthal  
Assistant Editor: Andrea Lynne Hecker

Associate Editors:  
Edward Tatnall Canby, Bert Whyte, B. V. Pisha  
Senior Editors:  
Leonard Feldman, Richard C. Heysler,  
Howard A. Roberson

Contributing Editors/Artist:  
Herman Burstein, Ted Costa, John DiIiberto,  
John M. Eargle, Joseph Giovannelli, Bascom H. King,  
David Lander, Edward M. Long, C. G. McProud,  
Jon Sank, Donald Spoto, Michael Tearson,  
Jon & Sally Tiven

General Manager: Mary Anne Holley  
Production Manager: Elaine S. Geiger  
Asst. to the Publisher: Susan L. Newkirk

Roman Beyer  
Publisher

### ADVERTISING

Advertising Director: Stephen Goldberg  
(212) 719-6335  
Eastern Ad Manager: Stephen W. Witthoft  
(212) 719-6337  
Account Manager: Steve Moser  
(213) 487-5880  
Classified Ad Manager: Laura J. LoVecchio  
(212) 719-6338

### OPERATIONS

Circulation Director: Norma Darragh  
Marketing Services Director: Perry Grayson  
Production Director: David Rose

### CBS MAGAZINES EXECUTIVE STAFF

President: Peter G. Diamandis  
Sr. V.P.: George H. Allen  
V.P., Finance & Admin.: Robert J. Granata  
V.P., Circulation: Robert F. Spillane  
V.P., Mfg. & Distribution: Murray Romer

Thomas O. Ryder  
V.P., Group Publisher

**AUDIO** (ISSN 0004-752X, Dewey Decimal Number 621.381 or 778.5) is published monthly by CBS Magazines, A Division of CBS Inc., at 1515 Broadway, New York, N.Y. 10036. Printed in U.S.A. at Nashville, Tenn. Distributed by CBS Magazine Marketing. Second class postage paid at New York, N.Y. 10001 and additional mailing offices. Subscriptions in the U.S., \$15.94 for one year, \$27.94 for two years, \$37.94 for three years; other countries, add \$6.00 per year.

**AUDIO** is a registered trademark of CBS Inc. ©1984, CBS Magazines, A Division of CBS Inc. All rights reserved.

Editorial contributions are welcomed but should be accompanied by return postage. Submissions will be handled with reasonable care, but the Editor assumes no responsibility for safety or return of manuscripts, photographs, or artwork. The Publisher, in his sole discretion, reserves the right to reject any ad copy he deems inappropriate.

**AUDIO** Publishing, Editorial and Advertising Production offices, 1515 Broadway, New York, N.Y. 10036. Subscription offices, P.O. Box 5318, 1255 Portland Place, Boulder, Colo. 80322; (800) 525-9511, (303) 447-9330 in Colorado. Postmaster: Send change of address to P.O. Box 5316, 1255 Portland Place, Boulder, Colo. 80322.





Acoustic Research  
puts its best drivers on the road.



Acoustic Research isn't just our name. It's the reason we exist. After nearly three decades of dedication to pure acoustic research and the development of world-acclaimed home loudspeaker systems, AR is finally on the road. We devoted years of research to the problem of automotive acoustics: temperatures, surfaces and road noise conditions. Then we designed car speakers good enough to bear our name. We started with the same driver designs found in our home systems, and custom designed their response for maximum performance in the automotive environment. Introducing the AR1MS, 1cs and 3cs. Don't hit the road until you hear them.

**AR** Hear what you've been missing.

For additional details and dealer locations, please write: Teledyne Acoustic Research, 10 American Drive, Norwood, MA 02062, USA.

## CD Phase Relationships

Dear Editor:

I have enjoyed Leonard Feldman's concise equipment reviews in *Audio* and *Ovation* for some time. Mr. Burstein and Mr. Giovanelli have helped me with technical problems, also. There are very few really knowledgeable people working in most of the audio houses here, and I've gotten 10 different solutions to the same question at 10 different shops!

I have the Sony CDP-101 machine and haven't had any problems as yet—just two discs that skipped or stuck, which was the disc manufacturer's fault, not the player's. Mr. Turok's CD reviews, which appear in *Ovation*, mentioned a muting problem in three out of four of the discs he reviewed, which made me very leery of buying these discs. However, every CD that I bought which muted on his machine, did not mute on my Sony. (He is using the Sharp player.) My Sony dealer tells me that the machine is in reverse

phase and the speaker wires should be reversed. I have tried this and cannot perceive any difference in the bass or performance. In switching the speaker wires normally, doesn't this put the speakers out of phase and reduce bass? If this technician is correct and the Sony is reverse phase, reversing the speaker leads should increase the bass, shouldn't it? Sony doesn't say anything in their manual about reversing speaker leads.

Frank Fabian  
San Francisco, Cal.

*Leonard Feldman Replies:* Thank you for your letter concerning phase relationships in your Sony CDP-101 player. I'm afraid that the salesman is either confused himself or has confused you in describing what he perceives as a problem. First of all, the two outputs of this player are *not* out of phase *with respect to each other*. They may well both be out of phase with respect to the *input* signals. That being the case,

what the salesman probably is suggesting is that you reverse the connections to *both* speakers. That is, connect the "hot" wire from each of your amplifier's output channels (usually marked "+" or colored red) to the "cold" or "ground" terminal on each speaker, and the "cold" wire (marked "-", "Com," or "Ground") from each channel of the amplifier to the "hot" terminal on each speaker.

Doing this will hardly ever result in a major audible difference, though some critical listeners maintain that such absolute phase relationships are important and that they do hear a difference when both speakers are out of phase with respect to the way the microphones picked up the sound waves of the music in the first place. I would say that there's no harm in reversing the phase of both speakers, as described, and if you feel that you hear an improvement (however subtle), it's perfectly all right to leave the connections that way.

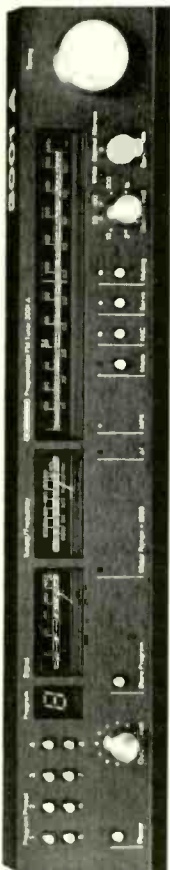

**TANDBERG  
DESIGNS  
THE FINEST  
AUDIO  
EQUIPMENT.**

**FOR THOSE  
WHO BUY  
ONLY  
THE FINEST  
EQUIPMENT.**

Tandberg's world-famous European superiority in designing the finest audio equipment may not be appreciated by everyone. However, for those discriminating individuals whose high performance requirements cannot be met by a mass production approach—be it an automobile or audio gear—Tandberg is their logical choice.

The Series 3000A stereo components shown here are the finest Tandberg has ever produced in its 50 years of audio experience.

The mass production of Integrated Circuits (ICs) has made "impressive specs" easy & inexpensive to achieve. As a result, the vast majority of high fidelity products have been designed for the least costly production techniques & "printed" specifications in mind... and not necessarily the accurate reproduction of music.

For example, our research showed that conventional electrolytic capacitors used by virtually all other manufacturers typically exhibit 5% or more dielectric absorption. This means that 5% of the musical signal is "memorized" and superimposed on the following signals, producing audible distortion. To prevent this, Tandberg engineers replaced electrolytic capacitors with more expensive polystyrene & polypropylene units, reducing

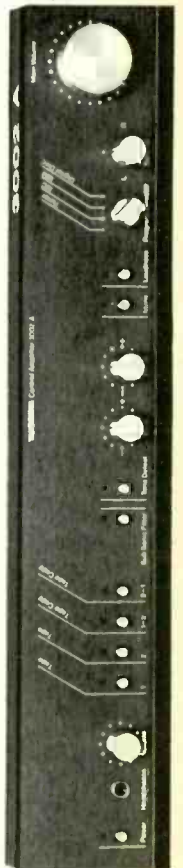



All of the above is not to be confused with the situation where one speaker is out of phase with respect to the other speaker. When that happens (inadvertently or otherwise), there is a clear loss of bass response in the system, and placement of instruments takes on a vagueness that is clearly perceived by just about any listener.

Thanks again for the kind words about my work in *Audio* magazine and elsewhere.—L.F.

#### Audio Once Again

Dear Editor:

Bravo, bravo, oh bravo! I applaud what appears to be the return from the grave of the "old" *Audio* magazine that I so sorely missed!

Congratulations on your July and August 1983 issues, the construction articles therein and much other meaty content. I had all but given up, but will now gladly renew my subscription.

You are to be especially commended for your continuing in-depth cover-

age of the Compact Disc equipment, which is the greatest innovation in the audio field in at least 25 years. Also, of extremely great value is the reviewing of the CD software by Bert Whyte, who has the courage and integrity to call a spade a spade (as well as a dog). You are currently the only publication with the courage, honesty and integrity to honestly evaluate such things rather than the Delphic and Pollyanna-ish stance taken by the other rags. Keep up the outstanding work!

Paul T. Kelly  
Fort Wayne, Ind.

#### Separate But Equal

Dear Editor:

I really appreciate your reviews of Compact Discs under a separate heading. I am a new subscriber to *Audio* and a new owner of a Compact Disc player. I subscribed primarily due to your Compact Disc reviews; my small CD library is based heavily on them. CDs are expensive and I want

the best buy for my money. I live in a small town and I must often buy "blind and deaf" except as guided by you. Your guidance has been excellent so far; please continue.

Having Compact Discs as a separate magazine department is good because CDs seem to require a different method of recording and mixing, and thus separate reviews from analog recordings. It necessitates listening to the CD, and not just saying, "We reviewed this work four years ago and the CD ought to sound the same."

Telarc seems dominant in top-quality CDs. There is apparently a magic touch in making CDs that Telarc has in abundance. I hope you continue with reviews of mainly good CDs (like Telarc's). It's more important now, when choices are few, to know what to look for rather than what to avoid.

I do enjoy the rest of *Audio*. Keep up the good work.

Ron Charlton  
Paducah, Ky.

dielectric absorption losses to only 0.05%...an improvement on the order of 100 to 1!

In addition, ceramic capacitors commonly used in most audio circuits change value with the voltage applied to them, creating phase shift in the higher frequencies, as well as a harsh or metallic sound character. Tandberg engineers replaced the traditional ceramic capacitors in all signal-carrying stages with higher quality polyester units, eliminating phase shift and sound problems entirely.

This advanced engineering has resulted in upgrading of literally hundreds of electrical components in the outstanding Series 3000A. The new TPT 3001A Programable Tuner offers a significant audible improvement over the original TPT 3001, which itself had been considered *the* finest FM tuner in the world. The TCA 3002A Preamplifier offer a superb balance of practical flexibility and the same sonic improvements, and includes a "true" Digital input that allows up to 20 volts of signal without overload for use with the most demanding of tomorrow's source material. The TPA 3003A Power Amplifier, offering 150 watts RMS per channel (both channels driven into 8 ohms, 20 Hz to 20 kHz, with less than 0.02% THD), is a high current design, offering minimum negative feedback and high speed



in an efficient package no larger than its matching Preamplifier and Programable Tuner.

With Tandberg's Series 3000A, compromise in any link of the audio electronics chain becomes a problem of the past.

If your musical requirements cannot be satisfied with mass production, only Tandberg has the high fidelity products, nationwide dealer support & service network to satisfy today's discretionary consumer...that individual who expects outstanding performance, quality and stable value.

For the name & address of your nearest authorized Tandberg dealer, call or write:  
**Tandberg of America**  
Labriola Court, Armonk, NY 10504  
(914) 273-9150

# TANDBERG



### Dual Turntable

The Dual CS 630Q is isolated from external shock and vibration by four computer-designed shock absorbers, plus a platter mat of highly inert material. The Dual ULM tonearm and cartridge have only 7 grams total effective mass, with the arm centered by a

gimbal. The controls are front-mounted, soft-touch buttons. The direct-drive motor's speed is displayed on the front of the unit. Wow and flutter is specified as  $\pm 0.02\%$  wtd. rms, and weighted rumble is  $-80$  dB (DIN B). Price: \$249.95. For literature, circle No. 100



### Koss Portable Headphones

Looking a bit larger than most headphones for portable use, the Koss Porta Pro phones are still light (2.5 ounces) and feature an adjustable temple pad to vary the earcup pressure and hold the phone in place even during strenuous activity.

### Hafler FM Tuner

The Hafler DH330 FM tuner features an "AutoFilter" interference-reduction design, an automatic high-blend circuit designed to work without pumping or breathing. The

quartz-synthesis unit can be tuned in several ways: Manually, in 50-kHz increments; automatic scan of all stations up or down the dial, or automatic scan of the five stations stored in its nonvolatile, batteryless

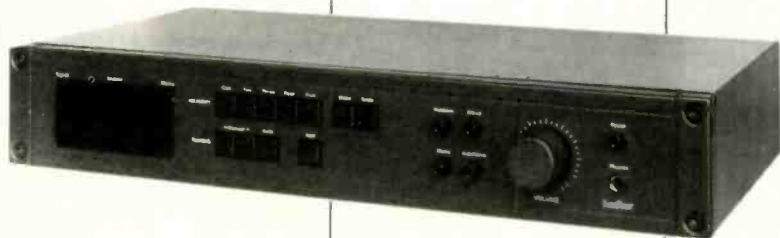

### Danefurn Cabinet

A vertical drawer on one side of the DFAV-6 cabinet can be used to hold cassettes or small accessories. The cabinet is veneered in walnut, has glass doors, moves on castors, and measures 28 inches W x 42 inches H x 20 inches D. Price: \$492.00.

For literature, circle No. 101

Rated performance is frequency response of 15 Hz to 25 kHz, less than 0.2% distortion at 100 dB SPL, and an impedance of 60 ohms. The phones come with a screw-on, quarter-inch plug adaptor, a mute switch, and provision for microphone mounting. Price: \$59.95.

For literature, circle No. 102

memory. Controls include mute on/off and sensitivity, an "AutoStereo/Mono" switch, volume control, and a headphone jack. Price: Assembled, \$449.95; kit, \$374.95.

For literature, circle No. 103

### B & W Loudspeakers

The bass/midrange drivers in the B & W DM3000 are designed to act as if they diminish in size with increasing frequency; a passive radiator augments the low bass. The tweeter is a 1-inch dome type. Fourth-order Butterworth filters are used in the crossover, to minimize losses and phase shift. The cabinet is roughly pentagonal in plan, to reduce standing waves and reflections from the cabinet rear. Price: \$895.00 each. For literature, circle No. 104





# Soundcraftsmen SUPER SYSTEM



**Choose  
Your  
Power**

One A2801 equals 140\* WATTS/CHANNEL...  
Two A2801's equal 410\* WATTS/CHANNEL...

## Power!

410\* WATTS/CHANNEL of continuous, clean power, with huge reserves. Two new A2801 Power MOSFET Amplifiers, operating in AutoBridge® mono mode are perfect for effortless reproduction of

the magnificent dynamics of the revolutionary DIGITAL AUDIO DISC. One of five new Class H and POWER MOSFET Digital Reserve amplifiers..... starting at \$449.

## Control!

The world's most versatile Stereo Preamplifier now incorporates exclusive AutoBridge®, permitting instant connection of two stereo amplifiers in bridged mono mode, tripling power output! Quiet, distortionless 10-band Octave Equalizer, superb Phono Preamp with

exclusive CartriMatch® impedance/capacitance/level adjustments, elaborate tape dubbing capabilities and Electronic Patch Bay make the DX4200 truly the ultimate Stereo Control Center ..... Soundcraftsmen preamps start at \$399.

## Performance!

The T6002 AM-FM Stereo Tuner combines outstanding reception with all the features and controls needed for enjoyable listening:

Quartz Phase-Locked Loop front-end, 14-station memory, auto-scanning to name just a few ..... Soundcraftsmen T6002 \$299.

\*POWER @ 8 OHMS, 20HZ TO 20KHZ, WITH NO MORE THAN .05% THD.

The World's Finest Stereo Components  
Are Still... **MADE IN U.S.A.!**

*Soundcraftsmen*



**FREE!**

\$19.95 EQ-EVALUATION KIT, includes 1-12" LP Frequency Spectrum Analysis Test Record, 2-sets of Computone Charts, 1-Connector Cable for comparison test, 1-instruction folder. **WRITE TO US FOR FAST ACTION, OR CIRCLE READER SERVICE CARD #30,** and we'll send you **FREE SPECIAL OFFER DETAILS.**





### ADS Loudspeaker

Smallest in ADS' new seven-speaker line, the L470 uses a high-compliance 7-inch woofer of "StiffLite" construction and a 1-inch soft-dome tweeter. Rated frequency response is 50 Hz to 20 kHz,  $\pm 3$  dB, with a crossover at 2 kHz. The speaker is rated at 75 watts maximum power, with 15 watts the recommended minimum. It is available in walnut or matte-black plastic laminate, and a matching floor stand is available. Price: \$159.50 each.

For literature, circle No. 106

### Nakamichi Auto-Reverse Cassette Deck

The "bay window" is a necessary aspect of the

unique auto-reverse system in Nakamichi's RX-202 deck. When one side of the tape is done, the cassette



### Yamaha CD Player

Yamaha's second-generation Compact Disc player, the CD-X1, uses a unique digital filtering system which oversamples at 88.2 kHz to minimize phase distortion, plus a three-beam laser pickup for better tracking. The deck can be set to play as soon as its disc tray closes, or to start play on timer command. Up to 23

selections can be programmed in numerical sequence. Repeat can be programmed between any two points, and the disc can be fast-scanned forward or back, with  $-20$  dB muting. The display shows elapsed time of each selection, total disc time, selection number, and remaining time. Price: \$599.00.

For literature, circle No. 108

is moved out and twirled 180° to play the other—in less than 2 seconds. This UDAR (UniDirectional Auto-Reverse) system is claimed to prevent the azimuth misalignment caused by a regular deck's auto-reverse bidirectional playback. Other features include an "Auto Rec Standby" system (which rewinds the tape to the beginning of the side, records 6 seconds of silence, then enters record standby mode), plus Dolby B and C NR. Price: \$650.00.

For literature, circle No. 107



### Micro-Acoustics Cartridge

The 830 CSA direct-coupled electret phono cartridge features a new stylus shape, called the Cutting Stylus Analogue, designed in conjunction with Micro-Point, a maker of recording styli. The new stylus is said to track the groove more precisely, for higher resolution and less record wear. Each cartridge is individually tuned and damped to eliminate microphonics and spurious resonances, and each is supplied with a response curve. Price: \$335.00.

For literature, circle No. 109



### Toshiba CD Player

Toshiba's second CD player, the XR-Z70, is a front-loading unit with 16-program memory function and variable headphone output control. The display shows total elapsed time, elapsed time for the current track, and remaining time.

Wireless remote control is optional. Price: \$799.95.

For literature, circle No. 105





9 mg. "tar", 0.7 mg. nicotine av. per cigarette by FTC method.

© 1983 R.J. REYNOLDS TOBACCO CO.

# Winston. America's Best.



Join the first team.  
Reach for Winston.

Warning: The Surgeon General Has Determined  
That Cigarette Smoking Is Dangerous to Your Health.



**HEAR ALL OF THE MUSIC AND NONE OF THE TAPE**



# **SWITCH TO BASF CHROME AUDIO TAPE**

## **THE WORLD'S QUIETEST TAPE**

If you won't settle for anything less than pure music, accept nothing less than BASF Pure Chrome audio tape. Unlike ferric oxide tapes, BASF Pure Chrome is made of perfectly shaped chromium dioxide particles. And the exclusive Chrome formulation delivers the lowest background noise of any tape in the world, as well as outstanding sensitivity in the critical high frequency range. And this extraordinary tape is designed especially for the Type II Chrome Bias position. So make sure you're hearing all of the music and none of the tape. Make the switch today to the world's quietest tape. BASF Chrome.

 **BASF**  
Chrome Audio & Video Tapes



## DASHED HOPES

Last month, in my report on the 74th AES Convention in New York, I discussed the new DASH digital format. You may recall that this is a joint proposal by Studer, Sony/MCI, and Matsushita for a digital recording format standard.

Unfortunately, opposition to the DASH format has appeared at this early stage. Spokesmen for JVC, 3M, and Mitsubishi, all manufacturers of digital recording equipment, indicated they thought there are some inadequacies in the error-correction systems of DASH and that the DASH format would have little influence on their digital activities. Ampex, who has not yet introduced a digital recorder, indicated they expect to market this type of equipment within the next two years and emphasized that it would not be compatible with DASH.

It would appear that these attitudes are not likely to lead to an industry-wide adoption of DASH, at least for the present. Thus, about the only thing the manufacturers of digital recorders have been able to jointly approve is the use of 48- and 44.1-kHz sampling rates.

In spite of the opposition to DASH, no one is likely to deny the marketing clout of the DASH proponents. Sony announced that their 24-channel digital recorder, the PCM 3324, is now equipped for the DASH format and that earlier versions of this model can be retrofitted for DASH operation. Down the line, when new, thin-film heads are available, this will make double density recording possible and permit up to 48 channels of digital audio.

To illustrate the possibilities of the DASH format, the Technics arm of Mat-

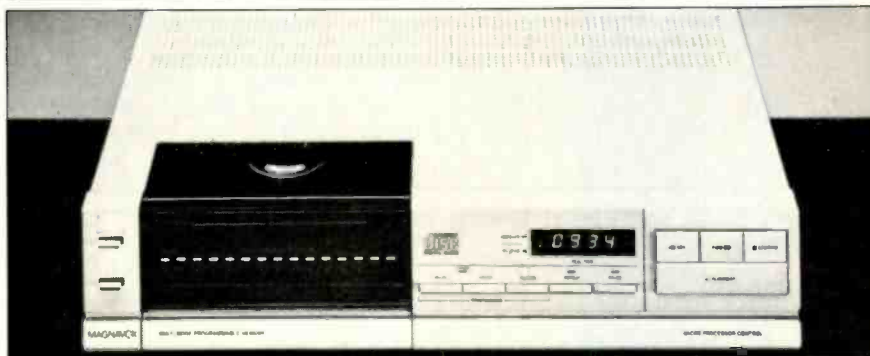

The Magnavox FD 3030SL CD player was shown at the AES Convention.

sushita showed a prototype DASH digital recorder at the AES Convention. This unit features high-density recording and reproducing on thin-film magnetic heads, permitting 16 digital audio channels on quarter-inch tape. The transport features isolated loop tape drive, similar to that found on Technics 1520 analog tape machines. The recorder is mounted in a console, with a full-function remote control mounted on a pedestal with castors. No prices were quoted, and Matsushita spokesmen emphasized that this recorder is a "look what we can do" project and may not be marketed in this country.

Studer has shown an 8-channel digital recorder, but this is very likely an interim model, with little chance of being marketed.

Into the midst of all this infighting steps dbx. You may recall I reported on their Model 700 CPDM (Companded Predictive Delta Modulation) digital recorder in the January 1983 issue of *Audio*. dbx announced they will make available CPDM cards and associated digital hardware on an OEM basis to

the manufacturers of professional tape recorders. They contend that since they will be supplying the digital hardware and specifying track formats, a typical tape recorder manufacturer needs only to integrate this circuitry into their own units. The result will be a fixed-head digital tape recorder with a dynamic range claimed to be 20 dB greater than is currently available from PCM recorders. Further, dbx claims these machines will be cost competitive with analog recorders of comparable track format. Finally, since dbx controls the digital hardware and specified track formats, there will be full compatibility between tape recorders produced by manufacturers using the CPDM technology. No prices for the CPDM hardware have been announced yet, but it is a most interesting development, conjuring up images of relatively inexpensive CPDM recorders from the likes of such analog tape machine manufacturers as Otari, TEAC/Tascam, Technics, Fostex, etc.

It goes without saying that whatever kind of digital tape recorder is employed, the machines are no better than their input signals. The sad fact is that many digital recordings are degraded because the signals they receive are from analog mixing consoles, which in varying degrees add noise and distortion to the program signals. It has been anticipated for some time that a pure digital mixing console would appear on the market. That time is now, and Rupert Neve of England, well-known for their line of sophisticated mixing consoles, introduced a pure digital DSP (Digital Signal Processing) console via an audio/visual presentation. The DSP console, developed with

The CDP-200 is Sony's first step toward a less expensive CD player.

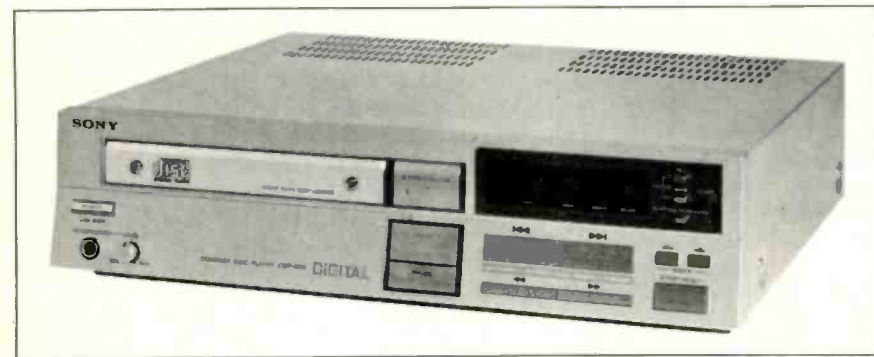

**AKG introduced a *tube* microphone which features specially selected 6072 tubes.**



*The Tube, from AKG, is a modern version of the C-12 microphone introduced in the early '50s.*

the help of the BBC (one of the first customers for the unit), is totally automated, with special remote control via fiber optic cables, all sorts of memory functions, and assignable controls. There are said to be several other studios in England which have ordered DSP consoles. According to *The Daily* (the first AES Convention newspaper, and a welcome service similar to the daily papers at the CES), negotiations are currently underway with an American studio for a DSP console. Anticipated price of the DSP is a rather breathtaking \$600,000.

There is no question that the DSP console is a giant step forward in digital technology, soon to be followed by similar units. Needless to say, the DSP is a big console, and I am bound to say that, with all its multiple input facilities, it properly belongs in a studio. There, ironically, it will be used to record a great deal of pop/rock music that has limited dynamic range and a number of distortion-producing instruments (such as the "fuzz box"). What price a super-quiet, ultra-low-distortion digital console?

As a recording engineer mainly involved with classical music, my plaint is, "Hey, Rupert Neve, how about a

portable, pure digital input mixer that I can use to record classical music on location in a concert hall?" I use purist mike techniques, i.e. Blumlein coincident mikes, M/S, simple two- or three-channel spaced arrays, etc., so your portable digital mixer need not be very elaborate. Give me eight to ten mike inputs, pan pot facilities, four outputs. Peak reading and peak-hold bargraph metering (à la the Sony PCM-F1) will also do nicely. I don't need echo send or return, and I abhor EQ controls. As you see, all quite simple, but desperately needed! If you can make one of these digital mini-mixers for about 8,000 quid, give me a call, quick!

There were various bits and pieces of digital equipment shown at the AES Convention. Sony took the first step towards less expensive CD players with the new CDP-200. This \$700 unit features Sony's horizontal, front-loading "Linear Skate Drawer" mechanism, with feather-touch front-panel controls. For the first time, a consumer Sony CD player has an "Index" function that enables the user to find subcoded sections within movements of a classical recording, or to zero in on sections of episodic-type music, such as the "Nutcracker Suite," or "Pictures at an Exhibition." There are displays for track and index number, elapsed time, and remaining time. Sony very considerably continues to provide headphone jacks with level control, a facility found on very few CD players.

On a more professional level, Sony introduced the CDP-3000, a special player designed for broadcast work, with extremely rapid and analyzer/performance check facilities.

Philips, through its North American Philips Magnavox division, introduced two new CD players. The \$850 FD 2020SL is a top-loading unit, with much more rapid access to the tracks on a disc than in previous Magnavox players. There is also a display showing elapsed time for the entire disc or for individual tracks. The FD 3030SL is a more elaborate model; it features front loading and is priced at \$950. Philips also showed a professional CD player for the broadcast market. This is a two-piece system comprising a CD drive unit and a CD drive-control unit. Ultra-fast access time and many spe-

cialized timing information program functions are provided.

Here we are at the cutting edge of digital technology, so would you believe a new *tube* microphone was introduced at the convention? Yes, AKG showed their new condenser microphone, simply named The Tube. This mike is a modern version of the much-admired C-12 of the early '50s. I often used a pair of these mikes in those days, and especially liked their warm, very natural and musical sound. It is these qualities which resulted in a resurrection of this microphone type. The Tube features specially selected 6072 tubes. There is a remote power supply, a 9-position polar-pattern selector and a three-position bass roll-off switch. The Tube comes complete with shock mount, windscreen, and cables in a heavy-duty flight case; the price is \$1,700. The people at Sheffield Lab have been using tube mikes in their recordings for years, so they should be especially happy about this new AKG model.

John Meyer finally has his Model 833 studio reference monitor loudspeaker in production. The 833 is amplitude and phase-domain regulated. Frequency response is stated to be  $\pm 3$  dB from 35 Hz to 18 kHz. Maximum SPL is a phenomenal 120 dB continuous, with a peak of 130 dB. John claims his Model 833 is "bulletproof," what with its extremely rugged drive units and Speaker Sense protection system, which employs an rms limiter. However, unlike other limiter circuits, this one is out of the circuit, protecting sonic purity until the overload threshold is reached. John hints that a consumer version of this 833 loudspeaker may be forthcoming. To say it would be digital ready is putting it mildly.

Preprints of papers presented during the AES Convention which should interest you include "A Subjective Comparison of Five Analog and Digital Tape Recorders" (No. 2033, H-8) and "Subjective Measurements of Loudspeakers—A Comparison of Stereo and Mono Listening" (No. 2023, H-5). Both papers were written by Floyd Toole and are fascinating reading! They are available from the Audio Engineering Society (60 East 42nd St., New York, N.Y. 10165) for \$3.00 per preprint.





# When was the last time this many publications agreed on anything?

"The performance . . . was astounding . . . I can't imagine anyone (buying) one of these cars . . . without the music system."  
High Fidelity

"... the one option no one should go without..."  
Motor Trend

"... this sonic paradise..."  
"... a truly outstanding advance in automotive sound."  
Stereo Review

"My friends there kept hopping in and out of the car, shaking their heads in delighted astonishment."  
New York Times

"... a car stereo the quality of which is, in a word, stunning."  
Home Electronics & Entertainment

"Believe every rave you've read, and then some."  
AutoWeek

"... one of the sweeter bargains of the year."  
Road and Track

"Best Sound System: Delco-Bose"  
Car and Driver

"The results are fantastic."  
Popular Science

The most highly acclaimed automotive option. Available only on GM cars.

Will you have the same reaction as the press? Our recent experience has convinced us that, regardless of your interest in music, you will require less than one minute of listening to know that you want the Delco-GM/Bose Music System in your next car.

Hear it now in selected models of General Motors automobiles.

Sound so real it will change how you feel about driving.



Our computerized listener enables us to match the Music System to the individual acoustics of each model automobile.



Available on selected models of Cadillac, Buick, Oldsmobile and Chevrolet.





EDWARD TATNALL CANBY

## CLASSIC PARALLEL SPAN

**H**as classical music reached perihelion? That's the feisty question I'm about to address. I've put this thought out of mind many times—it keeps coming back.

Halley's comet has to do with it. So does the Brooklyn Bridge. Cycles, phases, ellipses! The great Bridge completed a cycle this year and looks good for another century. Halley's does it faster; it went around in 1910 and is due again a couple of years from now. Audio itself—originally entitled the phonograph—was born while the sensation of the day, the Brooklyn Bridge, was being built. You think that early audio was any less spectacular? Not by much. "My God—it talks!" exclaimed the Emperor of Brazil through his enormous beard, and he hit the nose on the head, as I like to say: Audio still talks. It communicates. That's the very idea.

Classical music, I would have you understand, is a very strange phenomenon and not very old. A short life. The idea of classical music was just beginning to glimmer when the Brooklyn Bridge was opened. You can date it along with Halley's; it wasn't until well after the turn of the century that our present classical music began to be noticed in the world—even though most of the music we call classical had been written long before. Nor did classical's now well-known sidekick, popular music, exist in those older days.

All this music was there, of course, going back many centuries, in one form or another. But it wasn't classical—not as we think of it. Nor even pop, the same. Classical before the Brooklyn Bridge, I suppose, could have been called contemporary, because that's what it generally was—but why bother? There were popular categories such as light opera, folk music, dance music, military and marching music, beer hall music: Of course they were popular, since people liked them. Concert music, too, was popular, and even such useful music as the sound that went with church services. But absolutely none of this was *classical*. In the long haul, that concept didn't turn up until the day before yesterday. To date, you can't really call it more than temporary, a brief and unusual thought, here for awhile, then maybe—who knows?—gone.



Illustration: Harriet Kaplan

For century after century in the West (if not the East), there was virtually no old music in active service. All music was new, or pretty nearly new, as a matter of course. If you tried a revival, as Handel often did in England, you reworked your old stuff to suit new conditions. After 10 or 15 years it might be a bit out of date. Exactly the way engineers today rework a Model 310 amplifier into the 310A. I think I can say that in all these earlier periods, before the Brooklyn Bridge, music was always normal, i.e., of the time, contemporary, much like anything else in Western society from pots and pans to Shakespeare. (He, too, was often updated, and we do it still.)

Not so this present body of music that we collectively call classical. It's a category that is absolutely new to us—or was when it first blossomed and burgeoned, some years ago. And that is within my lifetime, when you come down to it. Crazy!

There are those who tell us that our present climate on earth is actually a brief flash of abnormal warmth before we go back to the glaciers, the norm. I'm thinking that this is the nature, too, of our classical music. And the necessary opposite to go with it, popular music.

So what has this all to do with audio? Only too much. Sonic engineering, in particular, recording, first appeared right along with our new concept of classical music, post-Brooklyn Bridge. It is not too much to say that the two are *one*—everything we know about this classical music relates directly to the very history of audio, and by no coincidence. Another of those symbioses, a give-and-take, a living together, which exactly encompasses our own history.

Where do today's classical recordings come from? Straight out of those elegant old opera records of the turn of the century—the beginnings of classical music. And pop? Out of the less fancy (10-inch) entertainment discs that started with humorous skits, Irish ditties, sentimental songs, went on to early "jass" and ragtime and so straight to our pop, so huge a biz.

Do you remember that the people at Victor Talking Machine put out their fancy opera on red-label shellacs, the famous "red seals"? To this day, the successor, RCA, releases classical music on its Red Seal label. An unbroken continuity, musical and business. Just to be different, back at the turn of the century, Columbia put out its fancy music on royal blue. The newest classi-



# AUDIOPHILE FILE™ XL-S

## COMPACT DISC COMPATIBLE

Maxell introduces the new XL-S audio cassettes; a series of ferric oxide tapes which deliver a level of performance that can capture the sound nuances found on Compact Discs more faithfully than other ferric oxide cassettes on the market.

There are a number of areas where this achievement is apparent.

### GREATER DYNAMIC RANGE.

Through a new formulation of our magnetic particles, we were able to reduce the perceived residual AC bias noise level by 1 dB in the critical 2 kHz to 10 kHz mid-frequency range. And simultaneously increase sensitivity and maximum output levels by as much as 2 dB.

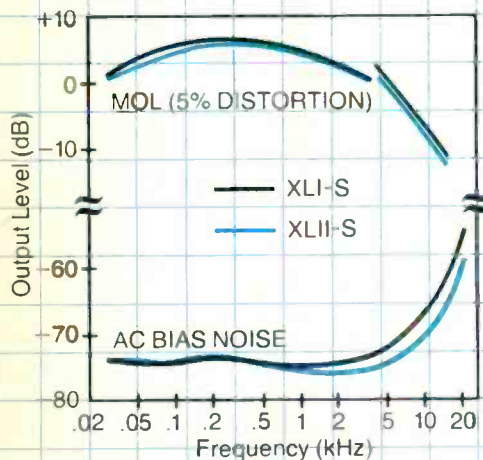

As a result, the dynamic range of each tape has been significantly expanded. So you get a

better signal to noise ratio and a fuller impact of the dynamic transients exclusively inherent to digital CD recordings.

### LOWER DISTORTION.

The newly formulated particles also contribute considerably to XL-S's low output fluctuation, as well as its virtual distortion-free reproduction, especially in the critical mid-range frequencies. This, in turn, accounts for our XL-S tape's enhanced sound clarity.

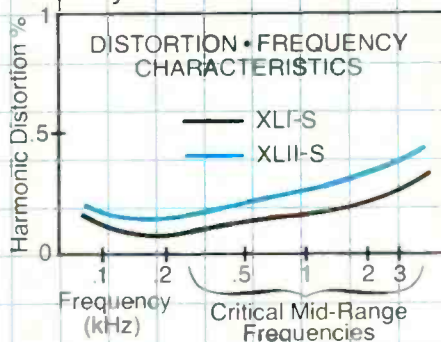

### IMPROVED MAGNETIC PARTICLES.

Our refined particle crystallization process is the basis for all of these accomplishments. Maxell engineers are now able to produce a more compact needle-shaped Epitaxial magnetic particle of extremely high uniformity.

This allows us to create a greater ratio of total surface area to unit weight of magnetic particles.

As a result, our XL-S

tapes now have the ability to record more information per unit area than ever before.

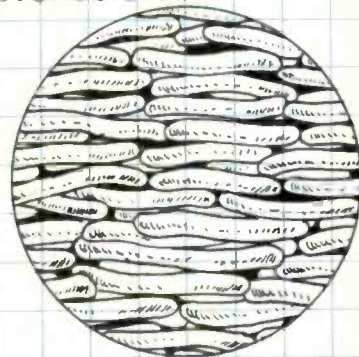

PACKING DENSITY OF UNIFORM PARTICLES.

Which is why Maxell high bias XLII-S and normal bias XLI-S are unsurpassed at reproducing the sound qualities found on today's finest recordings. Regardless of whether your frame of reference is analog or digital audio discs.

For technical specifications on the XL-S series, write to: Audiophile File, Maxell Corp. of America, 60 Oxford Drive, Moonachie, New Jersey 07074.



## IT'S WORTH IT.

©1984 Maxell Corporation of America, 60 Oxford Drive, Moonachie, N.J. 07074



Audio, originally called the phonograph, was born while the sensation of the day, the Brooklyn Bridge, was being built.

cals from CBS are still blue, though rather more somber, possibly reflecting some unintended pessimism as to the classical future. You can see that the very life of audio in its entire musical aspect coincides with the span, to date, of classical vs. popular. And that span, both ways, runs only since the

turn of the century. There was no audio before the Bridge. Nor classical music. They have grown up together.

I'm not saying that they will die together! But they most assuredly will *change together*, perforce. It could not be otherwise.

We take classical and popular, the

Great Division, so much for granted that by now our entire huge industry, producing our music "softgear," is structured on the split, which goes right down our corporate middle, and has since we began. The selling volume and the cash is on the pop side, but classical, as we all know, has enormous influence, and it is in classical, for whatever reasons of innovative thinking or simply prestige, that we find much of our cutting edge. Again, we always have. The Great Divide persists. We are absolutely tied into it.

Eighty years, a century, seems a very long time for industry, almost like forever. But in music itself it is perilously short. Things are undoubtedly changing fast. Can we be surprised that the classical segments of audio have been in turmoil these last few years?

You understand that I have spent a long life, myself, with this classical music idea, and I am a part of it. I have worked with it, in teaching music, in record reviews and hi-fi writing, in choral conducting, and 25 years of "classical" broadcast commentary. I've written notes for hundreds of classical albums and put out a couple of my own. So classical continuity is not only ours, it is mine, personally. But from the very start I have had my doubts. I taught music appreciation (the educational branch of the classical music idea) for no less than seven years, and what I didn't learn then I will never know. Right now, I know that life is ephemeral and so is classical. It was a fine idea in its time—say, the mid-'30s. But that time is now drawing to an end. Like Halley's comet, the very idea of classical music (and pop) is going to sail off into the blue yonder and just fade away for a century or so. Who cares what happens after that?

Not the music itself. Isn't Mozart turning up in movie soundtracks and in beautiful music and even commercials these days? Just the idea of classical.

What in the Lord's name is that idea? We all believe in it and take it for granted. Have you ever doubted that there is such a thing? If not, then try to define it. Well, er, that's music that, umm, you know, it's *classical*, not popular. It defines itself, which is a pretty lame definition. I fear that the only way to get hold of classical is to take a few jabs at

## Most of your present record library will never reappear as digital discs.

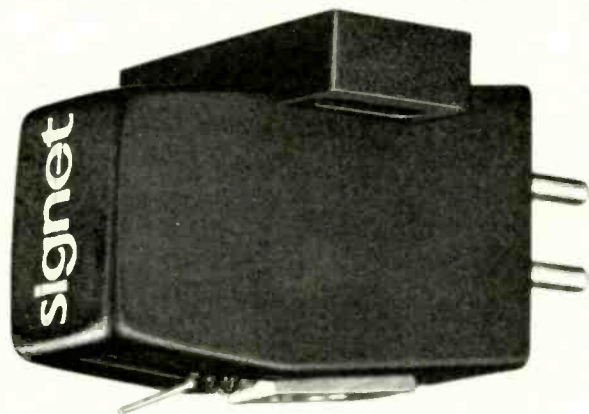

### With the Signet TK10ML you probably won't care!

Until you hear the Signet TK10ML, you may not fully appreciate how superb today's analog recordings can be. And how little may be gained by going all-digital.

The single most significant advance in the Signet TK10ML is its unique new *MicroLine™* stylus... with the longest, narrowest "footprint" ever achieved! Its scanning radius is a mere 2.5 microns, half that of the best ellipticals, while its vertical contact footprint is *three times longer* than the elliptical. The Signet *MicroLine* stylus tracks very high frequencies better—at lower groove pressure—than any other design.

Even with repeated playings, the *MicroLine* stylus maintains its shape, without "spreading" like all other tips.

So grooves sound new, long after other styli are threatening irreparable damage to your record collection.

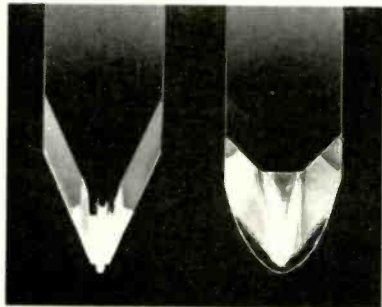

Each Signet TK10ML *MicroLine* stylus is created from a whole, natural octahedral diamond, oriented for longest life, and with a square shank to precisely fit the laser-cut hole in our unique, ultra-rigid low-mass boron cantilever. You get perfect alignment. Period.

But the proof of quality is in the playing. With the new Signet TK10ML, older records literally come back to life. New records transcend the limits of ordinary technology. Your entire system gets a new lease on life.

Visit your Signet dealer. Peek into his microscope to see this fantastic stylus. Then get the *real* proof. Listen.

  
signet

SIGNET, 4701 HUDSON DRIVE, STOW, OHIO 44224

Enter No. 7 on Reader Service Card



## JBL Automotive Loudspeakers.

When you understand how well they're put together, the argument for buying anything else simply falls apart.



A unique flat-wire voice coil (Patent applied for) helps JBL Automotive Loudspeakers achieve both high efficiency and high power capacity.



Each speaker features a die-cast aluminum frame to ensure complete freedom from warping or corrosion.



The loudspeaker's magnetic structure produces a symmetrical magnetic field around the voice coil gap of the low frequency driver. This design provides a dramatic reduction in distortion.

You're looking at the inner workings of a remarkable automotive product. It's manufactured to tolerances so precise that they actually rival those found in critical engine components. It incorporates some of today's most advanced metalworking and chemical engineering techniques. And its performance is unsurpassed.

The product is JBL's T545, 3-way automotive loudspeaker. Part of a full line of new JBL speakers designed with innovative features you can see as well as hear. Each model, for example, utilizes a rugged die-cast aluminum frame to ensure tight tolerances and complete freedom from warping and corrosion. The loudspeakers also feature large, long-excursion, flat-wire voice coils. This design uses the magnetic field in the voice coil gap more efficiently so the speakers need less power to operate.

And that's only part of the story. Through the use of large-diameter, high-temperature voice coil formers and the latest in high-temperature adhesive technology, power capacity has also been improved. Combined with the loudspeakers' high efficiency, this provides outstanding dynamic range and significantly higher maximum sound output.

Other features include a massive, barium ferrite magnetic structure, powerful high frequency and ultra-high frequency drivers, and bi-amplification capability on 6 x 9-inch models.

Of course, the best way to appreciate their advanced engineering is to audition them for yourself. So ask the audio specialists at your JBL dealer for a complete demonstration of JBL Automotive Loudspeakers. Once you hear them, the argument for

buying anything else will simply fall apart.



First with the pros.

JBL/harman international

If noise, hum and distortion turn you off, turn on Sansui's new AU-D77X\* integrated amplifier for pure, true sound.

Only Sansui offers a trio of exclusive noise-eliminating innovations.

First, the unique Super Feed-forward DC power amplifier system routs virtually all types of distortion at all frequencies in the power amplifier.

Then, DD/DC circuitry, another Sansui breakthrough, produces high speed response and unmeasurable TIM in the predriver stage of the power amp.

And finally, Sansui's latest contribution to silent performance, the newly developed Ground Free circuit that substantially reduces Interface Hum Distortion (IHM) in the output, driver and pre-amp stages of the amplifier.

The result is clean, uncluttered music—virtually free of noise, hum and



Sansui's new GF amplifiers depart from the conventional to assure inaudible distortion even at the highest level of sound.

distortion. (You also get this impeccable performance with Sansui's 130-watt\* top-of-the-line AU-D11 MK II integrated amp.)

One outstanding performer deserves another. The TU-S77X tuner adds a new dimension to the state-of-the-art. Its new FM multiplex decoder improves channel separation and reduces distortion significantly. Also available is the TU-S77AMX tuner which automatically receives a rd switches to every approved AM stereo broadcast system.

The AU-D77X and TU-S77X make the perfect tuner/amp combination for people who appreciate great technology as much as they enjoy the silence in great sound. Get the "Silent Treatment" at your Sansui audio specialist, or write.

SANSUI ELECTRONICS CORPORATION  
Lyndhurst, NJ 07071; Carson, CA 90746  
Sansui Electric Co., Ltd., Tokyo, Japan

# THE SILENT TREATMENT



*Putting More Pleasure in Sound*

**Sansui**

\*AU-D77X—110 watts, 0.0028% THD; AU-D11 MK II—130 watts, 0.0025% THD. Minimum RMS, both channels driven into 8 ohms, from 10-20kHz.

Enter No. 8 on Reader Service Card



For centuries in the West (if not in the East), there was virtually no old music in active service. All music was new, or pretty new, as a matter of course.

it, which, much as I love the stuff and live with it, I'm always ready to do.

So I looked up classical music in my big music dictionary, 1938 edition newly revised. Ha! That's right at the apogee of the whole classical thing. There it was, all too familiar, a definition I've heard a thousand times: *Classical music is music that has stood the test of time.*

Now, friends, that sounds pretty good, doesn't it. Like a political speech or maybe a sermon. But, I tell you, that definition is sounding brass, to quote the Bible. It's full of holes.

Of course it has stood the test of time—time has passed and it is still around. So are the potholes in the old road that goes by my house. Classical potholes, I suppose?

And what if maybe some classical music didn't stand up so well and, in fact, had to be dug out of its grave—how do you fit that in? Vivaldi's popular "Four Seasons," for instance. It didn't stand the test of time at all. They exhumed the corpse (from the library) only a few decades ago.

That fine definition also means, you realize, that nobody's music is classical until it's aged awhile, like so much cheese. Not Mozart's or Beethoven's or anybody else's. It has to stand that time test before it can qualify. Most of our classical music was successful in its own day—a lot of it really flourished—but it wasn't classical. It was *contemporary*. The composers were still alive. Their stuff went straight into production. And consumption. Not all of it went over big the first time—things often don't, like Broadway shows today. But if something flops, you either withdraw it or try to revise it, or turn to something that works better. When Handel, writing brand-new operas in England, one after the other, lost his shirt in the venture, he turned to other things and recouped his losses just like any normal business man. *Oratorio*, for instance—it sold. It was popular. And he kept revising, cutting, changing, adding, again like a Broadway show today, with precisely the same intent. Strictly commercial, definitely popular—even "Messiah." But never, never classical. Music was strictly normal, then, very much like other activities of mankind. That was no problem! Some of the best, you

could say virtually all of the best, was of this normal sort and for centuries before Handel and after him as well. Until audio and the Bridge came along.

That Test of Time isn't entirely wrong, of course. There is a healthy process of elimination that gets rid of an enormous amount of data, including music,

as time rolls onward. Just as well. The quantity of old music that is still waiting to be exhumed is horrendous. We can't resurrect all of it and, what's more, we won't want to. The Test of Time has nothing to do with it. There's junk and there's good stuff (as we think now, at least) all mixed together. I don't think

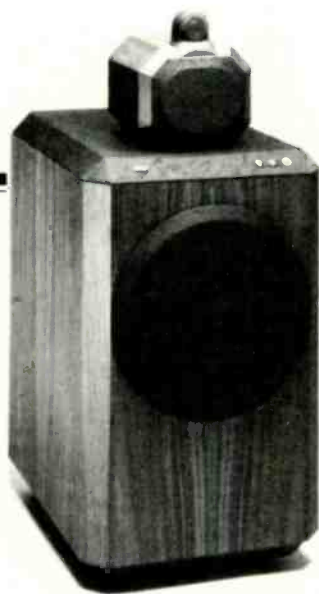

The sound engineers at most of the world's great classical recording studios\* have at least one thing in common.

\*Decca, Deutsche Grammophon, CBS, Capitol, EMI, Polygram

They all choose B&W 801F loudspeakers to monitor the fidelity of their recordings.

You, too, can choose this same digital technology to monitor your recordings in your own home. B&W has just released the all new DM110 at only \$298.00 per pair and the DM220 at \$498.00 per pair.

These speakers are engineered for high acoustical output, high sensitivity (not less than 90db) and a linear and extended frequency response.

Complete your studio with a pair of B&W's.



**the Best in the World**

Distributed in United States and Canada by  
Anglo American Audio Co. Inc., Box 653, Buffalo, NY, 14240. (416) 438-1012  
Member of Misobanke International Group

# MUSICAL

## The CARVER C-1 Sonic Holography Preamplifier: Appreciated for Musicality

Acclaimed for superlative performance, meticulous engineering, high reliability and finest sonic quality, the C-1 fulfills the requirements of the most demanding audiophile. And more...

The C-1 provides a very affordable way to experience the sheer musical pleasure of SONIC HOLOGRAPHY, a recreation of the three-dimensional sound field of the original, live performance.

Sonic Holography has been acclaimed as a scientific and artistic achievement of significant merit. Solving the problems of sonic imagery inherent in conventional stereophonic reproduction, Sonic Holography presents timing and phase information that exists in stereo program material but is normally inaudible.

With Sonic Holography, this information emerges in three-dimensional space around the listener who is thus able to establish the precise location of the instruments and voices.

The Carver C-1 is a quality instrument replete with precision gold-band laser-trimmed resistors, life-time lubricated sealed switches, G-10 glass epoxy boards and machined solid metal parts. The C-1 provides moving coil input, soft touch controls, an in-resonance filter, a headphone amplifier, dual tape monitors, variable turnover tone controls, silent muting, and an external processor loop.

Its straight-wire engineering assures that a watt of input leaves with just 0.000000251 watts of distortion. Or less.

If you seek new levels of detail, openness and three-dimensionality in an audiophile preamplifier, we invite you to audition the CARVER C-1.



C-1

# CARVER

CORPORATION 19210 33rd Avenue West, Lynnwood, WA 98036

POWERFUL

MUSICAL

ACCURATE

Distributed in Canada by EVOLUTION AUDIO, LTD.

The core of classical repertory, to my dismay, really hasn't changed. It's just about the same now as it was when I was in school.

very much of time as a judge of artistic worth. Times change. So do we. Today's dud is tomorrow's success, or, more often, the opposite.

The most bizarre thing about our classical music is that it is so completely detached from the normal reality of give and take. Yes—we put everything we have into selling performers, those great geniuses of the world of PR. But the music itself is something else. The core of classical repertory, to my dismay, really hasn't changed. It's just about the same right now as it was when I was in school. We still play the famous "Fifty Pieces" of Virgil Thomson, who said it all (though he was writing about live concert music) a half-century ago. That inner core is small and warm; we all enjoy the music when we don't hear it too often. But the concert biz and the big record companies, hand in hand, are out to drive the stuff through our heads until we shriek. Too much!

I do like the new part of classical—that is, the music that didn't stand the Test of Time but was happily revived again into sound and now resides on an absolutely astronomical scale in the present LP catalogs. This is by far the most heartening, the most constructive aspect of classical music today. It is truly new to us, this music, a fresh contemporary experience. And it has already changed the face of music, concert and recorded alike. Out of the grave—long may it wave.

Not so the classical inner core, the big familiar works, spectacular as they are in terms of size and virtuoso performance. The fi may be hi, but the music is tired. It just repeats and repeats—I should know. We're not going anywhere with this stuff. We're whipping a dead horse.

I'm not a pessimist! I just feel that things are moving much too fast now for the old concept of classical to survive. Merger is in the air. We are bursting with energy—video coming up, digital, the CD. Contemporary music is moving out, classical pieces turn popular, live music is taking on all sorts of new names—and forms. We're building conglomerates. But can our industry cope?

Yes—when it abolishes that Great Divide between classical and popular. Out of date! It just gets in the way. **A**



# The BX-100 and BX-150 Surprisingly Affordable... Unquestionably Nakamichi!



The BX-10C and BX-150 are available in black or silver to coordinate with any decor.

Think you can't afford a Nakamichi? Think again! The BX-100 and BX-150 are proofs positive that quality needn't be expensive. Compare their sound with *any* competitively priced deck (even more expensive ones) and judge for yourself. You'll find cheaper decks. You'll find similarly priced decks with more "features." But if *music* is as important to you as it is to us, you'll not find one to match the BX-100 or BX-150.

The BX-100/BX-150 emphasize essentials, not frills. No other single-capstan transport matches their microprocessor-controlled "Silent Mechanism" for the smooth, vibration-free motion that lets you hear every musical nuance. Ordinary single-capstan decks shroud music in a veil of high-frequency flutter and modulation noise that specs don't reveal. One listen to the BX-100 or BX-150 will tell you what you've been missing!

Magnetics and electronics—two other areas of particular Nakamichi expertise. Our RP-2D record/playback head not only

outperforms conventional combination heads but most "sandwich" types used on 3-head decks. Response is flat from 20 Hz to 20 kHz so you hear every musical overtone. And, on metal tape, response holds up at -20 dB and at -10 dB and (with the BX-150's Dolby\*-C circuit) at 0 dB—clear proof of superior heads and electronics.

The final essential—calibration. Inexpensive decks usually have few setup controls so performance is a matter of luck. The BX-100 and BX-150 have *two dozen* internal adjustments and undergo a 30-step alignment procedure. *Every* deck is individually calibrated on *each* track on *three* tapes before it leaves

the factory to assure you of Nakamichi Sound.

Nakamichi Sound is unique. Measurements and specs only hint at the sound we demand of our recorders so we apply the acid test—direct comparison of live and recorded music. Our ultimate test instrument is our Concert Hall! Hear what we've been hearing! Audition a BX-100 or BX-150 at your Nakamichi dealer now.



Nakamichi Sound Research Center Concert Hall

\* \*\* Dolby Laboratories Licensing Corporation

 **Nakamichi**

Enter No. 11 on Reader Service Card

For more information, write Nakamichi U.S.A. Corporation, 1101 Colorado Avenue, Santa Monica, CA 90401.



© 1983 R.J. REYNOLDS TOBACCO CO.

LIGHTS: 10 mg. "tar", 0.8 mg. nicotine, KING: 17 mg. "tar",  
.3 mg. nicotine, av. per cigarette by FTC method.



*You've got what it takes.*

# Salem Spirit

*Share the spirit.  
Share the refreshment.*



Warning: The Surgeon General Has Determined  
That Cigarette Smoking Is Dangerous to Your Health.

SMOOTH AND REFRESHING

REFRESHING



## Squeak

*Q. My open-reel deck has worked satisfactorily for seven years, but lately it sometimes makes a squeaking noise which comes from the area of the left reel. This occurs only during normal operation, and not in fast forward or rewind mode. If the squeak occurs when recording, the sound is extremely distorted at this point in playback. What's wrong? I tried spraying the belts with a silicone spray, but this had no effect.—Phil Mougis, Middle Village, N.Y.*

A. While a belt may be slipping, I doubt that silicone spray is the proper substance to apply. Special liquids are sold to remove glaze from rubber materials and enable them to grab more solidly. You might try one of these. However, the belt (if this indeed is where the problem lies) could be beyond salvation and need replacement.

Check whether the tape is rubbing against the flanges of the supply (left) reel, whether the left reel hub is making contact with the chassis, and whether the reel is doing so.

If your problem still persists, you will have to rely on a competent service technician, preferably one authorized by the deck manufacturer to service its product.

## Multiplex Filter Use

*Q. I use my tape deck for recording from discs and FM. The problem I have is understanding the use of the multiplex filter in my deck. The deck manufacturer recommends using the filter only for FM. Should it also be used for discs, as some articles have recommended?—Herbert A. Polson, Montreal, Que., Canada*

A. The purpose of the multiplex filter is to eliminate the 19-kHz pilot tone which appears in an FM broadcast. This tone may interact with the Dolby circuitry, producing mistracking, or its harmonics may interact with the oscillator frequency, causing beat frequencies to appear. Some tuners have effective multiplex filters, while others do not. Therefore, cassette decks often include a multiplex filter. This filter will sharply reduce frequencies in the region of 19 kHz and above, usually with negligible effect on frequencies within the hearing range of most of us—say, below 17 kHz or so.

Ordinarily the filter should be engaged only when recording from FM. However, it is possible that use of the filter might add to one's listening pleasure when recording from phono by removing more noise than desired audio signal. Why not try recording both ways and decide for yourself?

## Head Cleaners

*Q. What is the best solvent for cleaning cassette tape heads, capstans, etc.?—Glen R. Carnrick, Sandy Hook, Conn.*

A. The two items most frequently recommended for cleaning are isopropyl alcohol (91%) and fluorocarbons, in particular trichlorotrifluoroethane. Probably the best course is to follow the recommendations of your deck manufacturer. Whatever the solvent, it should be one that is safe to use on tape heads, capstans, pressure rollers, and, quoting from one maker of a solvent, "plastics, rubber, metals, painted surfaces, and elastomer parts." (*Editor's Note:* For a more detailed discussion of this subject, refer to Howard A. Roberson's article, "Tape Recorder Maintenance," which appeared in our April 1982 issue.)

## Playback Level Indications

*Q. Why do the LED level indicators on my cassette deck always show a lower level (about 2 to 3 dB) during playback than the level at which I recorded? Also, why would the right-channel level be consistently higher than the left during playback, even though both were equal when recording?—Jeff Pagels, Largo, Fla.*

A. The level indication in playback will depend on the sensitivity of the tape you are using. Some tapes, for a given signal input, deliver more signal than do other tapes. It may be that the deck manufacturer calibrated the playback indication for a more sensitive tape than the one you are using.

Higher level of the right channel relative to the left channel may be due to miscalibration in either recording or playback. In playback, the right indicator may read higher for equal signals in the left and right channels. Or, in recording, the right indicator may read lower for equal signals so that more signal has to be fed to the right channel for equal readings when recording.

## VU or Not VU

*Q. My four-year-old cassette deck has very clear and well-lit VU meters plus a light that turns red when maximum permissible record level (MPRL) is reached. This combination seems to be the best solution for properly setting the record level. I will probably have to buy a new deck within two years, but feel threatened by the ever-changing technology. There appears to be a trend to eliminate VU meters in favor of LED displays. By far I prefer the simple and reliable VU meter, despite salesman's attempts to convince me that the new devices are ultra-superior. There seems to be greater chance of malfunction with an array of lights than with a simple meter. My question is whether tape decks in the near future will phase out VU meters altogether, or whether the industry will give the consumer a choice.—Marshall Saiger, Long Beach, Cal.*

A. I really can't guess what the home tape deck industry will do in its quest for new gadgets to promote sales. Nor can I guess which existing or future gadgets will prove superior to the devices they supplant. Nonetheless, I am inclined to feel, much as you do, that a VU meter plus a lamp that lights on MPRL—or else a peak-reading meter—affords an excellent way of steering between the Scylla of distortion produced by too high a recording level and the Charybdis of noise resulting from too low a level.

In the beginning, most home tape decks used an "electronic eye," a fluorescent tube with a V-shaped shadow that closed at MPRL. This was very easy to use, reliable, and conducive to good results in recording. Its drawback, felt probably by only a minority of home recordists, was that it did not provide a numeric indication of relative levels in dB below (or above) MPRL.

To give a professional look, home decks then introduced so-called VU meters. In many cases—quite likely most—the chief characteristic of these meters was that they wiggled; seldom did they have the response and decay-

**If you have a problem or question on tape recording, write to Mr. Herman Burstein at AUDIO, 1515 Broadway, New York, N.Y. 10036. All letters are answered. Please enclose a stamped, self-addressed envelope.**

Displays for signal level are to a great extent simply faddish; what's popular now may not be in fashion next year.

time characteristics, and the frequency response, of true VU meters. But as time went by, the situation improved; true VU meters or meters with traits quite similar to them appeared more frequently.

Then there was a return to peak-reading devices, such as the electron-

ic eye, but in different forms. One way was to substitute a peak-reading meter for an average-reading (true) VU meter. Another was to make the meter switchable between average-reading and peak-reading. Still another was to add an LED or other device that would light up when MPRL was reached.

(About here it is appropriate to slip in a note that European professionals have long used peak-reading meters, in contrast to American professionals, who have long used average-reading meters.)

The most recent stage has been to use a succession of LEDs or a fluorescent bar (bar graph); these devices have the virtues of accurately following signal peaks and of indicating relative level. As to their reliability—freedom from failure—compared with the meter, as yet I have no information. I suspect that the indicator comprising a string of LEDs is apt to be the first to go.

Where do we go from here? I dunno. Anything is possible, including voice announcements, a flag that rises and falls with record level setting, smoke signals, etc. We might even return to meters.

#### Azimuth Problem

*Q. I trade tapes, and nearly all the ones I receive are out of phase due to being recorded and played back on different decks. My equipment is checked regularly, so there is nothing wrong on my end. Is there an outboard device I can buy to adjust the phase of such tapes for better frequency response?—David White, San Jose, Cal.*

*A. Your problem is one of azimuth, which of course introduces phase shift and treble loss. Correct azimuth alignment of a tape head requires that its gap be at a right angle to the long dimension of the tape. An azimuth error in recording can be compensated by an identical error in playback. Thus, if a deck uses the same head for recording and playback, or if it has separate heads but with equal azimuth errors, there will be no treble loss due to azimuth misalignment. In your case, it is not necessarily true that your head or heads are in correct azimuth alignment; you may simply have matching errors. On the other hand, your heads may be correctly aligned, with the fault lying in the decks of others.*

*I know of no device such as you are seeking. The closest thing is Nakamichi's expensive Dragon tape deck, which automatically adjusts azimuth in playback for maximum treble response. It does so by comparing phase at the top and bottom of a track; adjustment is continuous during playback.* A

# ALLISON

## FIRST IN TECHNOLOGY

*Allison has earned an international reputation for accuracy in reproducing the sound of live music.*

*Superior technology is one reason for this recognition. Much of the technology stems from our own fundamental research; we hold the basic patents on Room-Matched® design.*

*For example, we've learned that the response of every speaker changes dramatically with its position in the room.*

*For flat response in your room, therefore, the speaker must be designed for use where you intend to place it. We offer several different Room-Matched models, each optimized for one general location.*

*We also make available three distinctly different cabinet styles: The Traditional Series, the Designer Series (shown), and the low-cost Series 100. For information write or call Allison Acoustics: Toll free 1-800-225-4791.*

*In Massachusetts 617-237-2670. Allison Acoustics Inc. Seven Tech Circle, Natick, MA 01760.*



NAME \_\_\_\_\_

STREET \_\_\_\_\_

CITY \_\_\_\_\_

STATE \_\_\_\_\_

ZIP \_\_\_\_\_



# McINTOSH . . . TIMELESS

## Like a Stradivarius

Antonio Stradivari (1644-1737) invested his violins with all the historic and contemporary technical knowledge of his day, applied his own research, intelligence and master craftsmanship to produce an instrument that still leads the musical world in performance capability, technology and value. Almost 250 years later, his violins are still . . . the best.

Since its beginning in 1949, McIntosh has been the technological performance and value leader for this industry. Continuous research and development at McIntosh explores the virgin terrain of new performance and value that lies beyond the boundaries of the technological map described by others. This pioneering effort constantly pushes the boundaries of existing knowledge. Over the years, the United States Patent Office has granted thirty patents that certify the results of this innovative and exploratory research. Each patent has exposed new areas of technology which leads to the superior performance of a McIntosh and exposed new areas of effort and thought that is unmatched by any other research group in this industry, in the world. McIntosh is truly the technological leader and McIntosh is dedicated to continuing that leadership. McIntosh still . . . the BEST.



C33 Professional Stereo Preamplifier \$2299.00  
Suggested retail price cabinet extra

For more information:

McIntosh Laboratory Inc. A 24  
East Side Station, P.O. Box 96  
Binghamton, N.Y. 13904-0096

NAME \_\_\_\_\_

ADDRESS \_\_\_\_\_

CITY \_\_\_\_\_ STATE \_\_\_\_\_ ZIP \_\_\_\_\_

Enter No. 13 on Reader Service Card



## Welcome to 1984

Writing this at the end of 1983, I want to take just a line or two to wish all of you the best for 1984.

I wish, too, to thank the many of you who have taken the time to write just to tell me that my answers to your letters were of help. You are really quite a nice bunch of people. I get far more letters of this sort than I do the kind telling me to leave town.

I have received a couple of letters from those who are concerned that perhaps they really do not get personal attention. I guess this is because I use a word processor to answer my mail these days. I have no staff, so I must do all of the typing, and I'm not a really good typist. I look better, though, with the chance to fix things before the hammers hit the paper; it's the only reason that I have done this. I still read each letter and study it to see how I can be of help. None of that has changed.

Because of the subjective nature of questions dealing with specific products, I find it best not to handle them. I do not believe it is proper for me to foist my personal, subjective opinions on you.

Given all of this, I look forward to working with all of you again this year.—J.G.

## MM Cartridge with MC Input

*Q. I own an integrated amplifier which has provisions for using a moving-coil cartridge. My moving-magnet cartridge has a 3.5-mV output. If the MC arrangement is just a stepup transformer, why does my sound level drop when I switch from MM to MC?—Ron Webb, Tempe, Ariz.*

*A.* In one way or another, the moving-coil circuitry in a receiver adds gain to the phono circuitry to make up for the tiny voltage produced by moving-coil cartridges. The input impedance of such a circuit is usually low, and, hence, the output from your MM cartridge will be shorted out by this low impedance. This would result in a lower signal than you had expected when attempting to use your MM cartridge with your MC circuitry.

I have never tried such an arrangement and cannot say for certain what will happen in every case. I believe that the actual degradation of perfor-

mance will depend on the details of the MC circuit in any given instance.

There is always the possibility, too, that something is amiss with the MC circuitry. You'll never know this unless you obtain a moving-coil cartridge.

## Record Timing

*Q. Am I correct in assuming that there is no standard for noting times of individual "cuts" or for complete record album sides? Do such times include music only or also the silent time between the cuts?—Rudi Schmid, Kensington, Cal.*

*A.* When timing a single selection on a record album, the timing starts at the instant that the first note plays and ends at the instant that the last note finishes. The silence before or after that selection is not included.

When timing a complete album side, the timing begins at the instant that the first note begins and concludes the instant the last note ceases. This, of necessity, includes all music and all silences between selections.

## "Wide" Stereo

*Q. A couple of years ago, I bought my mother an AM/FM stereo and cassette unit which possesses a feature I had never seen before. There is a button which, when pressed, turns the regular stereo into "wide" stereo. It was amazing to hear the improvement. Please explain how this "wide-range" stereo button works.—Bruce DeQuasie, Parkersburg, W. Va.*

*A.* There are a number of variations on the idea of enhancing the spatial qualities of stereophonic program sources. Essentially, what is done is to take some right-channel signal, change its phase, and introduce a small portion of that signal into the left channel. Similarly, the left-channel signal is introduced into the right channel. (Some more elaborate schemes introduce time delay before feeding signals into their corresponding, opposite channels.)

## Amplifier Overload with Bass and Treble Boost

*Q. I have read that, when incorporating a mixer with bass and treble controls into a sound system, excessive boost may cause the power amplifier to "clip," depending on the pow-*

*er of the amplifier. If the mixer has the capabilities of a 12-dB boost in both bass and treble, would these boosts require more power from the amplifier, perhaps resulting in overload?—Michael P. Conner, St. Louis, Mo.*

*A.* The same factors apply to boosting frequencies with a mixer as apply to boosting them with an equalizer or with an amplifier's tone controls.

Treble frequencies require so little power to reproduce that they will probably never be boosted enough to overdrive the amplifier. [They can, however, be boosted enough to burn out tweeters, if the material being reproduced is rich in high frequencies or harmonic distortion.—J.B.]

Bass, however, requires much more power. The low frequencies already account for most of the power being delivered by the power amplifier. Even so, the possibility of overdriving the power amplifier depends upon how close the system was to being overdriven before the boost was added. If the program being fed into the system was deficient in bass, chances are that the added boost would not result in the amplifier's being driven to the point of clipping.

If the amplifier has lots of reserve power, it is possible that even when the program has lots of bass, boost still won't be sufficient to cause problems.

## Too Much Signal

*In your June 1983 column, you replied to a reader whose tuners received one station with a loud hiss when in the basement, but received it without hiss upstairs. Your reply appears to have missed the point.*

*The reader is obviously plagued by an excess, rather than a lack of signal, as shown by the three clues he cites—signal strength meter well above normal, worse hiss when an FM distribution amplifier is used, and drastically diminished hiss when a knife switch in the antenna lead-in is opened.*

*The phenomenon here is well known to manufacturers of CAFM processing equipment for CATV systems. Exces-*

**If you have a problem or question about audio, write to Mr. Joseph Giovanelli at AUDIO Magazine, 1515 Broadway, New York, N.Y. 10036. All letters are answered. Please enclose a stamped, self-addressed envelope.**



sive signal level from a grouping of FM stations will cause intermodulation distortion at the sensitive front-ends and front mixers of FM tuners. The multiple products produced ( $nF_1 \pm nF_2 \pm nF_3 \dots$ ) effectively appear as a raised r.f. noise floor.

The problem becomes worse on some of the newer synthesized tuners, because the preselect filtering formerly available from multiple-gang tuning capacitors is no longer available. (Some better quartz tuners, however, do use stages of varactor preselection).

There are several solutions to the reader's problems. First, do not use a distribution amplifier or preamp. (In any case, you are unlikely to find one with a lower noise figure than the first r.f. amplifier of your tuner.) Second, use coax all the way; if the antenna is a 300-ohm type, use an outdoor 300/75-ohm transformer with it.

Use a 75-ohm splitter between the two floors, and always keep both lines

terminated by the 75-ohm inputs on the tuners. Last, try a resistive 75-ohm attenuator between the antenna lead and the "noisy" tuner. Use only as much attenuation as necessary to get good performance. (This creates the same effect as the reader's partially opened knife switch, but in a predictable form).

These problems can occur when a sensitive tuner is hooked up to a CATV FM feed, and receives 30 to 40 FM channels at once, all at substantially higher levels than off-air signals. Again, an attenuator (e.g., 20 dB) right at the tuner input can help.—Gilles Vrignaud, Quante Corp., Santa Clara, Cal.

#### Amplifier Linearity

**Q.** If a power amplifier is to be linear, should not its output be proportional to its input? I was looking at a test report for a power amplifier, and something was wrong. If 100 mV produces 1-watt output, why is not the

input required to produce the rated 200-watt output 200 times that input voltage, or 2.0 volts—rather than the 1.4 volts shown in the test report? Would not a linear input/output curve be preferable?—Robert Malanchuk, Columbus, Ohio

**A.** You are certainly correct that a linearity should exist between the change in output power and the change in input voltage which produced it. But that linearity is not a one-to-one equivalence, as we are comparing two different units. Power consists of voltage and current. If voltage alone is considered, we see from Ohm's Law ( $P = E^2/R$ ) that power varies as the square of the voltage across a fixed resistance. Put another way, to increase power output 200 times, we must multiply the voltage input by the square root of 200, which is approximately 14. Multiplying  $14 \times 100$  mV, we get 1.4 V, the figure quoted in the amp specs you were discussing.  $\Delta$

You knew they were coming.

## HEYBROOK HB1 LOUDSPEAKERS

We've all been waiting for an affordable speaker system that will accurately reproduce all aspects of the musical performance when used with quality, budget equipment. Yet, for upgrading considerations, the speaker must be capable of reproducing the dynamics and subtle detail revealed by equipment of the very highest quality. The Heybrooks impressively meet these demanding requirements.

At \$339.00 a pair, the HB1's are *Made for Music.*

Imported and distributed by

**D'Ascanio Audio**

11450 Overseas Highway, Marathon, FL 33050 • (305) 743-7130

## TIME FOR A CHANGER

Illustrations: Philip Anderson

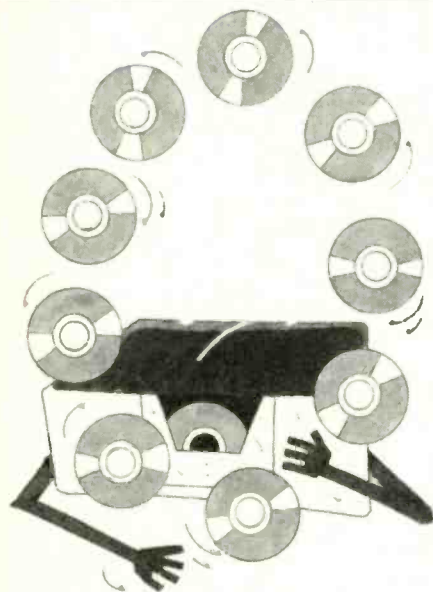

### Return of the Changer?

Multiple-play turntables—record changers, if you prefer—have apparently disappeared from all but the cheapest systems. They had their sonic drawbacks, but they were certainly a convenience.

And they may be coming back—though not for phonograph records. At one time, Benjamin imported a 10-cassette changer from Lenco. Now Sony (who once had a changer for open-reel tapes!) is introducing a new model, the MTL-10 Cassette Bank, also holding 10 cassettes.

Compact Disc changers are also likely to arrive in a few years. Philips is admittedly looking into changer design, and they're not alone. The mechanism will have to be completely different from a phono changer's, as it may be impractical to put the laser assembly on an arm that can swing in

between the top and bottom disc stacks during play, and swing out again to let the next one drop. (You'd have to play the CDs label-side down, then, too). More likely, it will work something like the old Thorens multiple-play model, shifting records one at a time from a stack to the platter and on to a second stack.

It will also eliminate the record-producer's old dilemma of how to sequence the sides of a multiple-disc album. Sequenced for manual play, each disc would bear two consecutive sides (1-2, 3-4, 5-6, etc.); in changer sequence, the sides would be arranged for easy stacking (1-6, 2-5, 3-4). Since CDs only have one side, no problem.

How long will we have to wait? Perhaps not very. Two days after penning these speculations, I learned that Aiwa, Hitachi and Marantz showed prototype CD changers at the Japan Audio Fair last October. The Marantz model held 10 discs, Hitachi's held 31, and the Aiwa held 99 discs; let's hope the latter two, at least, have random-access changing, so that one could play only selected discs without having to remove and reshuffle them. They probably do: Denon's 100-disc prototype, also shown in Tokyo, can be programmed to play any 15 selections in its store, no matter which discs or tracks they're on.

Don't look for the Aiwa or Denon to show up in many homes; they're presumably for commercial use of various types. Ten-disc models like the Marantz are certain to show up as home equipment, and something the Hitachi's size just might as well, though it will also probably sell better in commercial/institutional markets.

### Space-Age Microphones?

*High Technology* ran a piece a while back (July/August 1982) on the use of optical fibers as sensing devices—including their use as acoustic sensors.

Microphones? Phono cartridges? Well, probably not, at least not in the near future. The techniques described in the article involved long lengths of fiber to produce only subtly measurable effects, such as optical phase interference. And the effects produced, all purely optical, must be converted to electrical signals before use in a sound system. Possibly the fibers could be used to modulate a laser beam, but that would work only for analog recording; so far, all the laser sound recording I've seen has been digital. If an *Audio* reader can prove me wrong, and come up with a good fiber-optic microphone or cartridge, I'd like to see and hear the result. The same holds true for the use of fiber optics as magnetic sensors: Tape heads, anyone?

Years ago, I think in *Analog*, I read of another interesting space-age microphone design: A thin, mildly radioactive rod at the center of a cylinder lined with radiation-sensing material. As sound waves changed the air's pressure (and hence density) in the space between the radiation source and sensor, the sensor's output would change, yielding an electrical signal. Seems to me the idea would work if the cylinder were small enough and the sensor fast enough. But I bet the output signal would be awfully noisy. Radiation hazards would have to be considered, too, though I doubt they'd be any worse than a smoke detector's. Any readers know more?

### Digital Peace Parley

The digital revolution has generated as much heat as laser light. At one pole stand those who feel that digital is the best thing yet to happen to sound; at the other stand those who feel that it's the worst. And in between are those who feel that digital has a distance still to go—to reach perfection, say some; to reach acceptability, say others.

And so SPARS (the Society of

Professional Audio Recording Studios) will hold a conference from Thursday, March 8 to Saturday, March 10, called "The Digital Revolution: In Search of a Peace Treaty." It will feature eight seminars, including one by *Audio's* Len Feldman ("CD or Not CD, Was That the Question?"), a concert ("Ear Training"), and a debate (in the form of a mock trial) between Doug Sax and John Eargle. Participants are also

invited to prepare their own position papers for distribution to others at the conference.

Registration is \$325, with discounts for early registration, SPARS membership, and student observer status. For information, write to SPARS, P.O. Box 11333, Beverly Hills, Cal. 90213, or phone: Gary Helmers (213/651-4944, California), Dave Teig (212/355-1008, New York) or John Woram (516/764-8900, New York).



### Music Hath Charms

"Superstitious" folk beliefs have often been precursors of real scientific breakthroughs. Which is why W. Wilson Mayne, writing in the English scientific weekly *New Scientist* last summer, was perplexed. He'd heard, in his travels through the Orient, that ground-up phonograph records are an antidote for snakebite. That struck him as nonsense at first, but when he heard the same thing in another country, thousands of miles away, he began to wonder if there might be something in it.

Turns out there was, according to a later letter from a reader in Sweden: "The old records are made of Bakelite, a phenol/formaldehyde resin which releases small amounts of formaldehyde . . . when pulverized.

"Formaldehyde is known to deactivate proteins and peptides, and the snake venoms contain active components of peptidic character. . . .

"It would probably be quite easy to

develop an efficient antidote against snakebite using a substance that releases formaldehyde in a controlled way. . . ."

So there you are—only weren't the old records made from shellac rather than Bakelite? So I suspect the mystery is still unsolved—or it is really a superstition after all? Today's LPs won't work, in any case. CDs either.

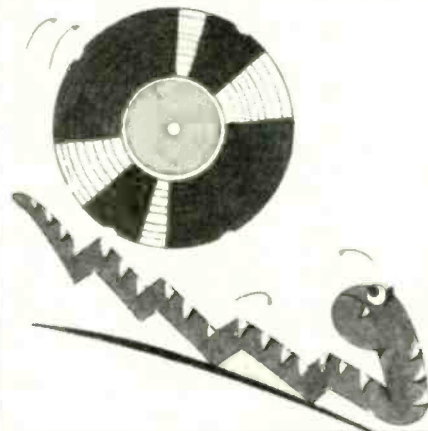

### "K" vs. "k"

As long as there has been an *Audio* (and longer), the quantity 1,000 has been abbreviated by a lower-case "k," as in "15k resistor" (sometimes spelled out as "15-kilohm resistor"). That's still true, but sharp-eyed readers will have begun to spot occasional instances of capital "K" when digital matters are discussed.

The capital "K" stands for 1,024—two to the tenth power, sometimes called a "binary thousand." Digital matters, being based on two-valued logic (yes/no, on/off . . .), work out more naturally to powers of 2 than powers of 10, and  $2^{10}$  comes up often enough to be called after its decimal cousin,  $10^3$ .

This, by the way, is why the same computer memory may be referred to as either "64K" or "65K"—64K is 65,536. Perhaps it would be more logical to equate 64K with 65k, but who said computer people were logical?

# Don't buy this tuner.

(Until you've heard others at twice the price.)



Sonic performance is the best reason for selecting any audio component. And when it comes to tuners, performance is relatively easy to evaluate.

A tuner either brings stations in clearly, or it doesn't. Especially the weak and distant stations that on some tuners come in noisily or not at all.

The music, of course, must sound clean and accurate. And two (or more) tuners should be auditioned under identical conditions.

Then you want to compare features: such as the tuning system, programming flexibility, signal displays and signal-enhancement controls.

Now, it's time to consider price. Our new GFT-2 is less than \$250. But we suggest you ask your dealer to compare it with other tuners priced up to \$500 or more.

When you've done all that, you'll no longer need our advice. You'll know exactly which tuner to buy.

The new Adcom GFT-2.

- Quartz-referenced digitally-synthesized tuning (accuracy: 0.000025%)
- Dual-gate MOSFET RF amplifier
- Double-tuned quadrature detector
- Storage for seven AM and seven FM stations
- 5-stage LED signal-quality display
- Manual and automatic scan.

For further information or the location of the ADCOM dealer nearest you, please write to:

## ADCOM®

11 Elkins Road, East Brunswick, NJ 08816

Not all tape news involves cassettes. There are also digital tapes available in Beta and VHS formats, and 15-ips, half-track tapes.

#### Prerecorded Progress

Prerecorded cassettes have traditionally sounded pretty bad, with more limitations on high-frequency response than on noise, and distortion creeping in more often than on disc releases. You paid more for the recording, but had less to show for it. The tape used was often the cheapest possible, and the flimsy cassette shells tended to jam—especially the ones whose tape-viewing windows had no transparent covers to keep out the dust. On the other hand, as long as everyone was listening through limited-fidelity portables, it didn't matter much.

While such portables still exist, more and more listeners have cassette systems of reasonably high fidelity—at home, in their cars, or in their pockets—and the record industry is finally starting to catch on:

- BASF has been pushing their premium ferric and chrome tapes to duplicators, and some labels (such as A&M and Sine Qua Non) are beginning to use the latter. However, neither label's chrome cassettes have the Type II recognition notch, so decks with only automatic playback-equalization setting will play them with the wrong (120- $\mu$ S) EQ.

- Last year, Electro Sound introduced cassette duplicating equipment which used the Dolby HX Professional system; this year, Warner (including Elektra/Asylum, Atlantic, and presumably Nonesuch)

announced that they'll use HX Pro for all their prerecorded cassettes. Capitol (which makes tapes for other labels as well) and other duplicators are reportedly on the verge.

The HX Pro system (developed by Bang & Olufsen as an improvement on Dolby's original HX system) increases tape headroom in recording. It does so by adjusting bias instantaneously, cutting it when the signal is rich in high frequencies (which have a biasing effect), to avoid saturation due to overbiasing, then restoring it to normal when the treble content goes down again. Both B & O and Harman/Kardon home decks have the system.

- In October, WNCN, a New York classical FM station, began a 13-week series of programs produced entirely from cassettes. The *Sine Qua Non Seven Star Series* was, naturally, sponsored by Sine Qua Non, which produces and distributes cassettes from the Varese Sarabande, Orion, Northeastern and Crystal Clear labels.

- Since mid-1981, In Sync Laboratories, of New York, has been offering its tapes in Dolby C as well as Dolby B formats, both duplicated in real-time (rather than at high speed) on Nakamichi 582 decks, using TDK SA-X tape. The tapes are sold in stores, and also by mail from the company, at 2211 Broadway, New York, N.Y. 10024. The catalog offers 108 titles, 99 of which are available in both formats—the other nine were

dubbed from 78-rpm discs, so the extra few dB of noise reduction won't matter much. Dolby C tapes are also available from Delos and Direct-to-Tape Labs, and, on special order, from Mobile Fidelity.

- The dbx tape catalog now contains 56 titles, from 20 record labels, at \$14.95 apiece. As the number of dbx-equipped home and car decks rises, and with the availability of dbx decoders for Walkman-type personal tape players, that number should rise. At least one other source (Direct-to-Tape Labs, again) offers dbx-compatible tapes, and I wouldn't be surprised to see more sources emerge.

Not all the tape news involves compact cassettes. Mobile Fidelity now has PCM digital cassettes (Beta or VHS format). And Sonic Arts, of San Francisco, is offering its recordings on 15-ips, half-track tapes (two 10½-inch metal reels for \$198) as well as on PCM digital cassettes for \$75 apiece. The Sonic Arts tapes are not actually sold, but leased, subject to licensing agreements which forbid the user to make reproductions in any form. Digital copies of the PCM tapes will be traceable, as the cassettes have digitally encoded serial numbers. On the other hand, each 15-ips tape comes with a copy of the LP made from the same master tape, so one can check one's turntable and cartridge against the tape.

#### Digital Diagnostics

In my front hall is a neat pile of comatose audio equipment, ready for its run to the repair shop. I'm handy enough with a soldering iron to fix whatever's wrong, but I lack much of the knowledge and all of the time to diagnose just what needs fixing.

Come digital, this may no longer be a problem. It's not that digital circuits will be easier to fix, at least by those of us brought up on analog. But it is possible, and probably not too expensive, to build self-diagnostic facilities into almost anything which already has a microprocessor (which includes a good many analog components now), and probably even

easier to build them into components which are digital almost all the way through.

There's a precedent: Larry Schotz's Micro/CPU-100 tuner, first sold by Sherwood and also later by Draco Labs, could be fitted with a diagnostics board which found bad circuits or components and named them on the station display. The board was plugged in at the dealer's, but as digital prices come down, similar functions might be built in.

I can hardly wait. Preamps will still be a nuisance to fix (all those cables to unplug and keep straight), but it will save lugging heavy power amps across town to the shop.

#### Styli Saved by Dr. Scholl

With my last tonearm, I lost a few styli by accidentally letting the arm fall to the metal surface of my turntable base. My new arm doesn't let that happen, but before I got it, I found a solution at my neighborhood drugstore: Moleskin, from the foot-care department. Cut a piece to cover the area where the stylus might fall, dye it the color of your choice, then just peel off the backing and stick it onto the top of the turntable base.

Sorry I can't show a picture of this. I took the moleskin off again when I got my new arm, which doesn't let the stylus fall that far.



# CAMEL LIGHTS

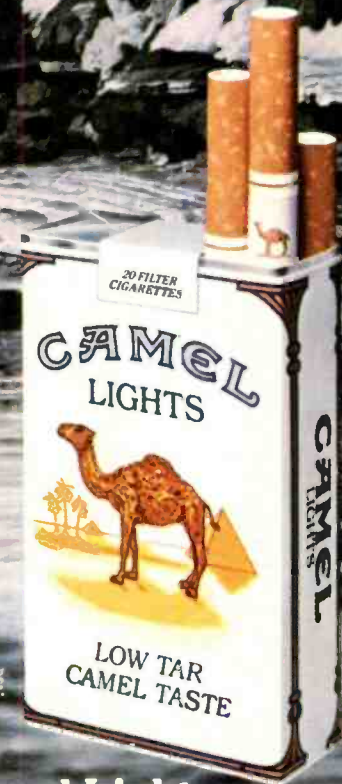

9 mg. "tar", 0.8 mg. nicotine av. per cigarette by FTC method.

9 mg tar.

Warning: The Surgeon General Has Determined That Cigarette Smoking Is Dangerous to Your Health.

Camel Lights.  
Low tar. Camel taste.



# NAD's FLOPI

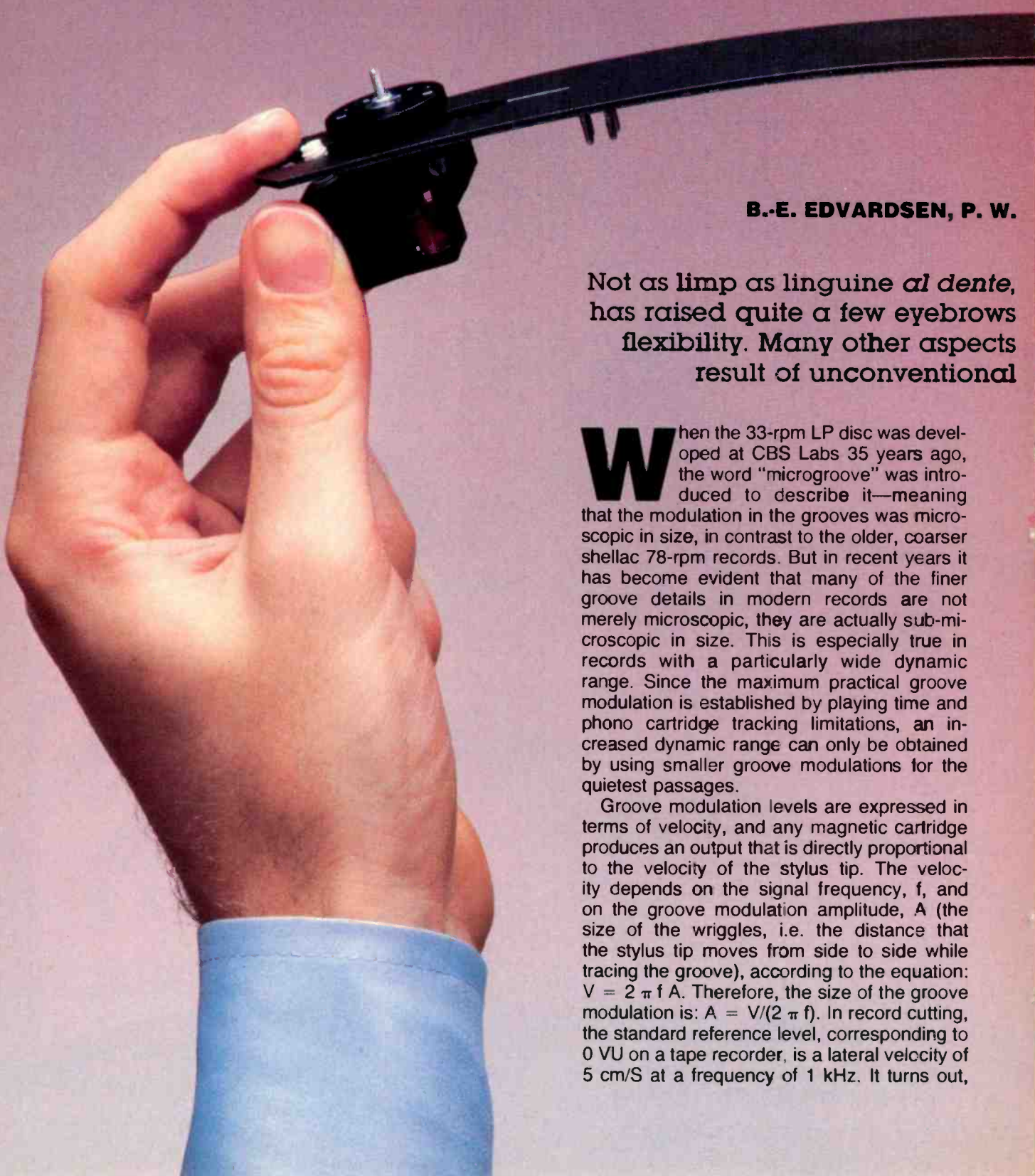

**B.-E. EDVARSEN, P. W.**

Not as limp as *linguine al dente*, has raised quite a few eyebrows flexibility. Many other aspects result of unconventional

**W**hen the 33-rpm LP disc was developed at CBS Labs 35 years ago, the word "microgroove" was introduced to describe it—meaning that the modulation in the grooves was microscopic in size, in contrast to the older, coarser shellac 78-rpm records. But in recent years it has become evident that many of the finer groove details in modern records are not merely microscopic, they are actually sub-microscopic in size. This is especially true in records with a particularly wide dynamic range. Since the maximum practical groove modulation is established by playing time and phono cartridge tracking limitations, an increased dynamic range can only be obtained by using smaller groove modulations for the quietest passages.

Groove modulation levels are expressed in terms of velocity, and any magnetic cartridge produces an output that is directly proportional to the velocity of the stylus tip. The velocity depends on the signal frequency,  $f$ , and on the groove modulation amplitude,  $A$  (the size of the wiggles, i.e. the distance that the stylus tip moves from side to side while tracing the groove), according to the equation:  $V = 2 \pi f A$ . Therefore, the size of the groove modulation is:  $A = V/(2 \pi f)$ . In record cutting, the standard reference level, corresponding to 0 VU on a tape recorder, is a lateral velocity of 5 cm/S at a frequency of 1 kHz. It turns out,



# OPY TONEARM

MITCHELL, and J. JANDA

the arm on NAD's 5120 still because of its highly unusual of the turntable are also the design approaches

therefore, that the groove modulation for this standard 0 VU level is only:

$$A = \frac{5 \text{ cm/S}}{6.3 \times 1000 \text{ Hz}} \\ = 0.0008 \text{ cm, or } 8 \text{ } \mu\text{m,}$$

where 1  $\mu\text{m}$  is a millionth of a meter. The highest modulation velocities on a record, corresponding to the loudest peaks in music, are typically 15 dB above this 5-cm/S reference level [1]. The quietest passages can be more than 50 dB below the reference [2], for a total dynamic range of 65 dB, but this is an exceptional case. A more typical figure for the smallest modulations is -40 dB, which corresponds to a velocity (and amplitude) that is 1/100th of the reference level, i.e. 0.08  $\mu\text{m}$ . Sub-microscopic indeed!

Visible light has a wavelength of approximately 0.5  $\mu\text{m}$ , so this means that quiet passages in an LP record can have groove modulation amplitudes even smaller than a wavelength of light. Using an optical microscope, it is physically impossible to resolve anything shorter than the wavelength of the light being used, so it is easy to understand why the first really detailed photographs of record grooves were not obtained until the scanning electron microscope became available.

Obviously, in order to reproduce the quietest passages in modern LPs, the record playing system must be sensitive to extremely



Photograph: Bill Kourimis

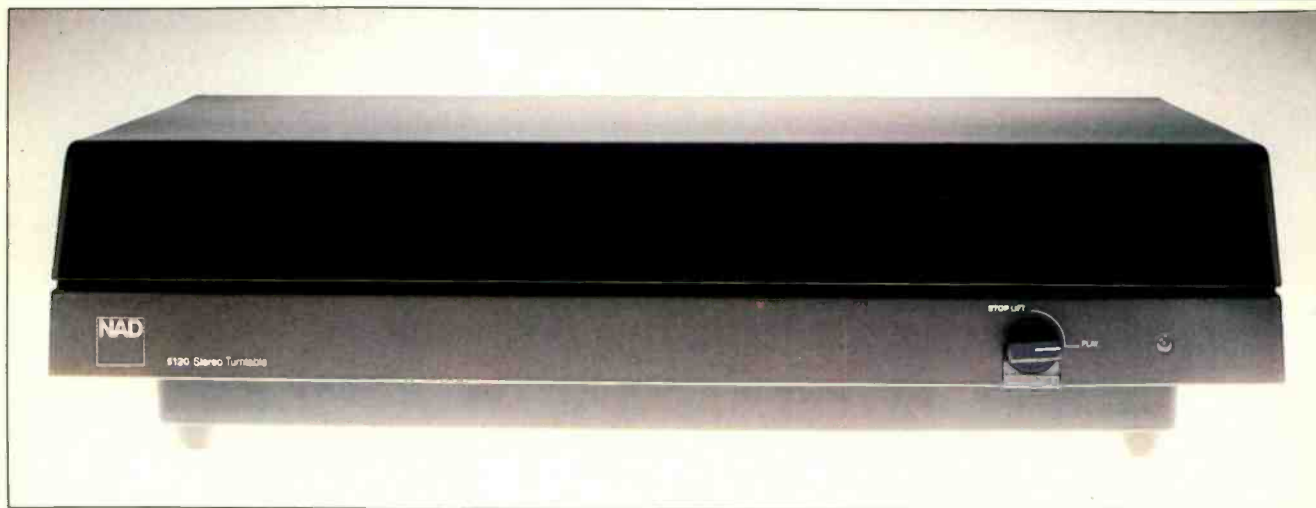

**The potential ringing in metal arms has led to the assumption that all arm flexure must be minimized. But, unlike metal, the fiberglass arm has high internal damping at the midrange.**



*Bjørn-Erik Edvardsen is Director of Research at the London headquarters of NAD International. Jiří Janda, responsible for the conception and development of the "floppy" tonearm, is a consultant to the Tesla Research Institute in Prague, Czechoslovakia. Peter W. Mitchell is an American technical writer and a consultant to NAD in Massachusetts.*

small stylus motions. But that means that the system will have virtually seismographic sensitivity to *any* vibration reaching the stylus. In addition to playing the music encoded in the groove, the "phonograph as seismograph" also "plays" the vibration spectrum of its environment, including the resonant vibrations generated in the player itself. Therefore, the fundamental problem in turntable design is the control of unwanted vibrations, whatever their source or path of propagation.

If the comparison to a seismograph seems inappropriate, recall that the record-playing system is a motion detector (the phono cartridge) whose low-frequency output is amplified by a factor of approximately 10,000 (for moving-magnet cartridges) or 100,000 (for moving-coil cartridges). This is the typical voltage gain from phono input to loudspeaker terminals, including RIAA equalization of +17 dB at 50 Hz and assuming a volume control setting 15 dB below maximum.

#### **Arm-Cartridge Resonance**

In every tonearm there is a characteristic infrasonic resonance produced by the interaction between the compliance of the stylus assembly and the effective tonearm-cartridge mass. The resonance typically produces a peak of 8 to 15 dB in the frequency response of the system, somewhere between 6 and 15 Hz [3]. The amplitude of the peak indicates how much the cartridge and arm are overreacting, acting as a mechanical amplifier for

any stimulus; a 12-dB peak means that the amplitude of the arm-cartridge motion is four times greater than the amplitude of the stimulus. Of course, normal musical signals on records are not low enough in frequency to stimulate this arm-cartridge resonance, but other stimuli are common: Warps and ripples in the surface of the record, and all of the external vibrations that pass through the turntable's suspension to the platter and tonearm.

Recall that the stylus is held in the groove by the vertical tracking force, which bears down against the upward restoring force supplied by the springlike compliance of the stylus assembly. Thus—in theory—the arm-cartridge mass is suspended at a constant distance above the record surface by a delicate balance of force and counterforce. In fact, this precise balance is constantly disturbed by external vibration and by the undulations of the imperfectly flat disc surface. These cause the deflection of the cantilever to change, altering the balance of forces, and, once set in motion, the suspended mass will resonate up and down on its springy supporting compliance. Thus, at a microscopic level (and sometimes at a plainly visible level), the arm/cartridge system is perpetually shaking up and down at its resonant frequency.

The effects of this resonance have been widely documented, notably by P. Ladegaard at Bruel & Kjaer [4]. Note that, while the arm and the cartridge body are vibrating up and down, the



## The fundamental problem in turntable design is the control of unwanted vibrations, whatever their source or path of propagation.

stylus tip normally stays in the groove. So, as the height of the cartridge body above the disc surface varies, the vertical tracking angle and stylus rake angle change—and this is an immediate source of distortion.

Next, as the cantilever's deflection varies, the effective tracking force on the stylus is rapidly changing; it alternately digs into the groove with too much tracking force (creating the possibility of accelerated record wear) and nearly flies free with insufficient tracking force to hold the stylus in contact with the groove—and the result is mis-tracking, with high distortion on musical transients and peaks. This rapid variation in effective tracking force, due to resonant arm/cartridge oscillation on a warped disc, is seen in Fig. 1 (reproduced from [4]).

Since no cartridge is a perfectly linear transducer, any strong infrasonic vibration of the stylus will intermodulate with the musical signals in the audio frequency range, muddying the sound and producing further intermodulation in the loudspeaker if not filtered out. This is a common cause of muddy bass sound.

Finally, any up-and-down motion of the cartridge relative to the record surface produces a back-and-forth "scrubbing" motion of the stylus along the groove, causing frequency modulation of the recorded signal [5]. With a vertical tracking angle of 22° (typical of today's pickups), the scrubbing motion of the stylus along the groove is 40% as large as the vertical vibration. The audible result is flutter, and it occurs most strongly at a frequency of 10 Hz or less, where the ear is most sensitive to flutter.

Minimizing the influence of the infrasonic arm/cartridge resonance is, obviously, a desirable objective that has received inadequate attention from turntable designers. Of course, the severity of this resonance will be reduced if cartridge manufacturers include damping in their cantilever suspensions, but that can be done only to a limited degree, as it tends to degrade the tracking ability of the cartridge [6]. The "dynamic stabilizer" brush which is affixed to many of the Shure Brothers pickups provides effective damping, but a solution is still needed for other cartridges.

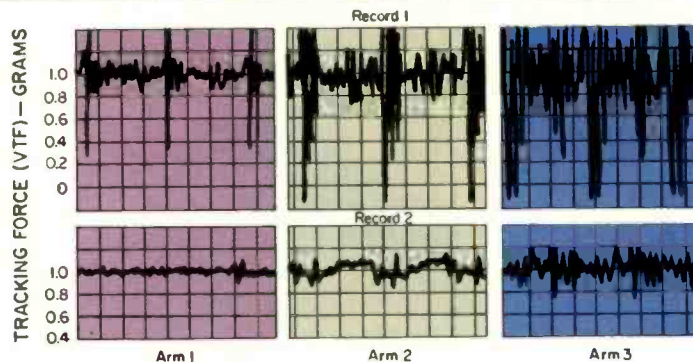

Fig. 1—Dynamic variation of the effective vertical tracking force during two revolutions of a warped record (upper curves) and of a visibly flat disc (lower curves), with three

tonearms differing in effective mass. After Poul Ladegaard's "Audible Effects of Mechanical Resonances in Turntables."

### The Floppy Tonearm

A tonearm must be a stable carrier for the cartridge, must hold it in a level position tangential to the groove (as nearly as possible), should be low in mass, should be reasonably free of resonances, and must have wiring to carry the signal. The usual design solution involves a low-mass plug-in headshell; a rigid, precision-tooled tube of anodized aluminum, carbon fiber, or more exotic materials; an even more precisely machined set of pivots and bearings, and some flexible wires.

The most novel element in NAD's new tonearm is its construction. Not tubular, it is a flat arm made of the copper-clad fiberglass material used for printed circuit boards. The wiring from the cartridge to the pivot is etched on the underside of the arm, and the wide copper-clad area surrounding the signal wiring forms a ground plane that provides electrostatic shielding against hum pickup. The 1-inch width of the flat arm makes it extremely rigid in the lateral plane, more rigid than a thin-walled metal tube can be. However, since it is only 1.5 millimeters thick, the fiberglass arm is relatively flexible in the vertical plane, a characteristic which is both interesting and controversial.

All tonearms have some flexure. With tubular metal arms, the primary flexure mode typically occurs at upper-bass and lower-midrange frequencies, and if the material of the arm is not well damped, the energy absorbed in the flexure mode may emerge as resonant

ringing. It is this potential ringing in metal tonearms which has led to the common assumption that all tonearm flexure must be minimized. The vertical flexure of this floppy arm is therefore likely to prove controversial. But unlike metal, the fiberglass material has high internal damping at midrange frequencies.

Tonearm flexure produces a notch in the frequency response of the cartridge. Because of the new arm's flexibility in the vertical plane, the primary notch occurs not in the midrange but in the deep bass—around 25 Hz in the early prototype arms, in which the counterweight was fairly rigidly coupled to the rear of the arm. A mathematical analysis by James V. White (formerly of CBS Labs) showed that this low-frequency flexure mode could be put to good use. By making the mount for the counterweight more compliant (actually suspending the counterweight on a spring), the notch was moved down to around 10 Hz, where it coincides with—and tends to cancel—the resonant peak in the arm-cartridge response.

In other words, the flexure of the arm-counterweight system provides a new way to control the problematic resonance of the arm-cartridge system. The flexible tonearm and spring-loaded counterweight function as a "dynamic vibration absorber" (DVA). Mechanically, what happens is that unwanted vibrational energy from the arm-cartridge resonance propagates up the length of the flexible arm, where



**The flexure of the arm-counterweight system provides a new way to control the problematic resonance of the arm-cartridge system.**



it is transformed back into kinetic energy, setting the counterweight into vibration at the same frequency.

In essence, energy from the resonance is subtracted from the front of the arm (where it produces unwanted cantilever flexing and other difficulties) and is transferred to the back of the arm, where it is relatively innocuous.

Another beneficial effect is that the arm's vertical flexure partially decouples the front end of the arm (with the cartridge) from the remainder of the arm and the counterweight, thus lowering the effective inertial mass of the arm. A cartridge mounted in the flexible arm will therefore resonate at a higher infrasonic frequency than in a conventional rigid arm of the same static inertial mass.

Fundamentally, this is not a new idea. A counterweight often is mounted via a rubber decoupling sleeve, rather than being bolted rigidly to a tonearm, and the compliance of the sleeve produces DVA properties in the counter-

weight at some frequency. However, this phenomenon usually occurs in the 30 to 100 Hz range, where it cannot be of any benefit.

The DVA system designed for the flexible tonearm is illustrated in Fig. 2. The counterweight is pivoted from a hinge point at its front end. The main mass of the counterweight (its rear portion) is free to move vertically, suspended on a coil spring whose stiffness is adjustable. Its resonance frequency is tunable in the 7 to 14 Hz range by means of a screw attached to the top of the spring, aligning with a frequency scale on the counterweight. Thus, the DVA is tunable by the user to match the frequency of the arm-cartridge resonance. The large infrasonic resonance peak that occurs in a rigid tonearm becomes a pair of smaller peaks which straddle the notch produced by the flexible arm and tuned counterweight assembly.

To stabilize the infrasonic behavior of the system still further, a viscous damping mechanism has been incorporated into the counterweight assembly, consisting of a vial of silicone oil and a threaded rod. The damper is essential, since it absorbs the vibration of the counterweight and thus dissipates the energy that was subtracted from the arm-cartridge resonance by the floppy arm and DVA. The damping effect is adjusted by varying the depth of the rod in the oil, turning it until its tip aligns with scale gradations from 0 to 3 on the side of the counterweight, representing the range from no damping to heavy damping.

The damping blends the DVA notch and the resonance peaks into the smooth, controlled response illustrated in Fig. 3. In the vertical direction, where disc warps occur (upper curves), the result is a weakened resonance. In the 45° direction of the stereo groove modulation axes (lower curves), the resonance virtually disappears!

Incidentally, in the 45° curves a 1-dB dip in response can be seen in the response of the floppy arm at about 140 Hz. This is present only in the right channel, and it is due to *torsional* flexure of the arm, caused by the fact that the center of gravity of the cartridge is not on the arm's central axis. This minor flexure mode could be eliminated, but it is not clear that the cost of doing



## A cartridge mounted in the flexible arm will resonate at a higher infrasonic frequency than in a conventional arm of the same static inertial mass.

so would bring any sonic benefit. As noted above, the fiberglass arm does not ring the way a metal arm does.

The tonearm for the new turntable is assembled from commonly available materials and easily manufactured parts. To obtain an effective arm mass of less than 8 grams, no headshell is provided. The entire arm is a plug-in unit, with its hardware located at the pivot where it contributes nothing to the effective mass of the system. In fact, the entire vertical pivot assembly is just a standard DIN socket, mounted in a sleeve on a pair of screws whose conical tips, precisely machined and hardened, function as low-friction cone bearings. Four metal pins on the tonearm fit the DIN socket, providing at once both the electrical connection and the mechanical installation of the arm. An audiophile who uses multiple cartridges can install each pickup in its own arm and can preset the tracking force and other adjustments; swapping cartridges is as simple as unplugging one arm and plugging another in.

### Suspension as Filter

The human ear is extremely sensitive at mid-treble frequencies, with hearing thresholds approaching 0 dB SPL. But at low frequencies the ear is very in-

sensitive; at 30 Hz the threshold of audibility is about 60 dB SPL, and at still lower frequencies only large vibrations are either heard or felt.

The shelf or cabinet that the turntable rests on is a sounding board. At a microscopic level it is continually stimulated by structure-borne vibrations from street and rail traffic, furnace blowers, refrigerator and air-conditioner compressors, and even loudspeaker-cabinet vibration. But since human hearing is completely oblivious to this perpetual low-frequency rumble, we can easily forget how sensitive the record-playing system is to such vibration, and how important it is to prevent it from reaching the record and stylus.

There are two ways to minimize the influence of structure-borne vibration on a turntable. One is to assemble the entire turntable as a rigid unit; make it heavy (so that it will resist being set into vibration), employ nonresonant materials wherever possible, and mount the assembly on compliant feet (made of springs and soft rubber) for isolation. The other approach is to mount the platter and tonearm together on a subchassis that floats on compliant springs, isolated from everything—including the exterior parts of the turntable itself.

In either case, it is the compliance of the system that determines how well isolated the record and stylus are from structure-borne vibration. Any suspension or compliant support has a resonance frequency, related to its compliance and to the mass it is supporting. Above its frequency of resonance, the suspension is an effective mechanical filter, preventing the transmission of vibration. Vibrations below the resonance frequency will pass freely through the suspension, shaking the record and stylus. Logically, then, the suspension resonance ought to be placed at the lowest practical frequency in order to narrow the range of the vibrations that can possibly reach the stylus.

Depending on the amount of damping employed, the suspension resonance may actually increase the amplitude of vibrations at or near the resonant frequency. For this reason the suspension resonance should not be located at or near the frequency of the stylus-tonearm resonance (usually between 7 and 15 Hz), where any unwanted vibration will be doubly amplified. If these resonances do coincide or overlap, the user is likely to experience frequent problems with acoustic feedback or resonance-induced flutter,

Fig. 2—A counterweight assembly that functions as a dynamic vibration absorber. The counterweight is mounted on a hinged bracket, with its weight supported on a spring whose tension is user-adjustable to set the resonant frequency. The tip of a threaded rod is inserted into a vial of silicone fluid to provide viscous damping.

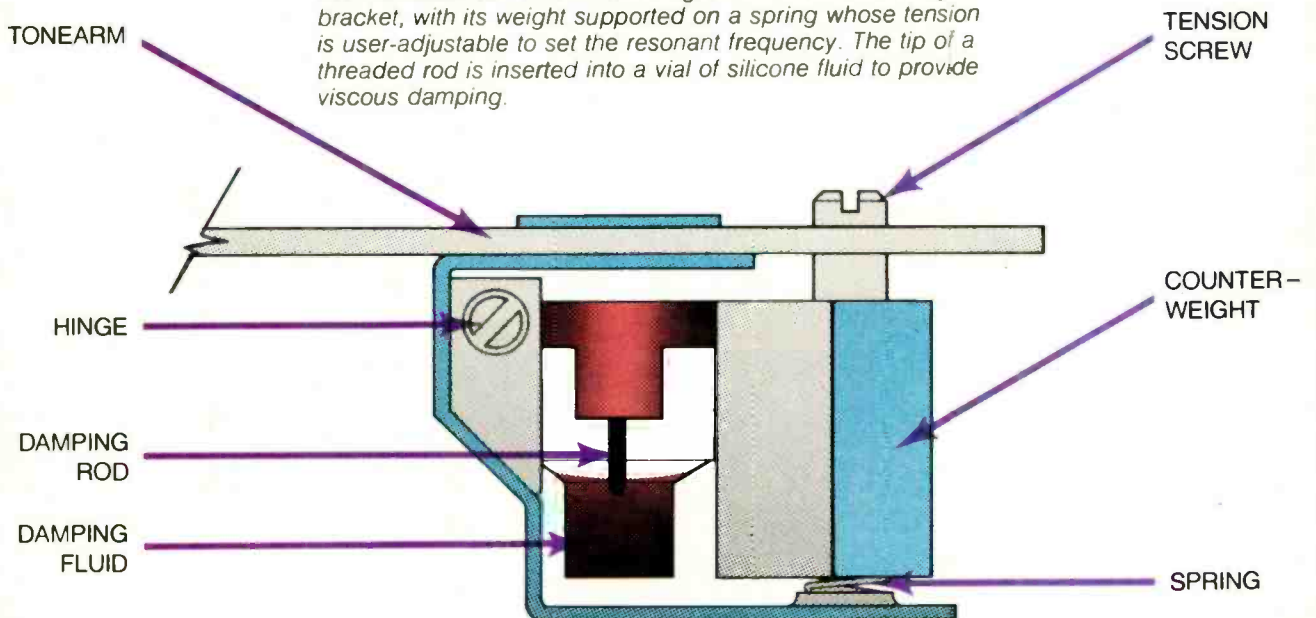

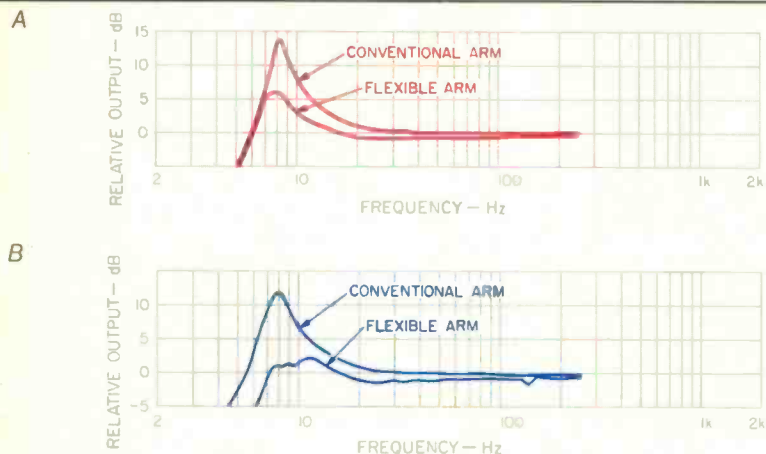

Fig. 3—The infrasonic response of a cartridge in a straight low-mass tubular tonearm, and the same cartridge measured in the floppy tonearm. The upper graph (A) shows the response to vertical modulation; the lower graph (B) shows pure left- or right-channel modulation.

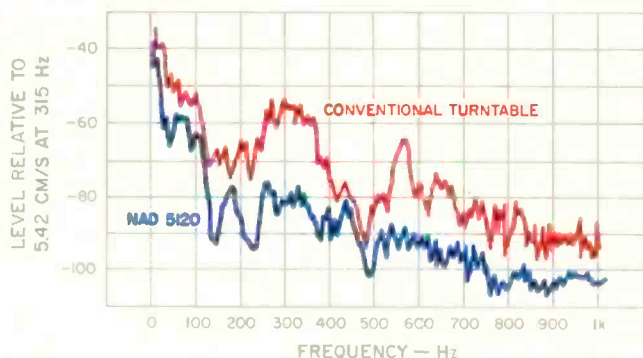

Fig. 4—The "microphonic" response of two turntables, which were measured by placing the stylus in the groove of a non-rotating record and exposing the turntables to a sound field of 95 dB SPL white noise. The NAD 5120, whose platter and tonearm are isolated on a floating subchassis, is 10 to 20 dB less sensitive to acoustic feedback than the conventional turntable, the NAD 5025, which relies on compliant feet for isolation.

**One immediate advantage of the floating subchassis approach is that it isolates the stylus from the base and dust cover.**



and may be forced to install additional vibration absorbing or damping materials beneath the turntable.

Turntables that employ compliant feet for isolation usually have a resonant frequency of 10 Hz or higher, because a more compliant suspension would make the entire turntable too unsteady—rocking or bouncing when any of the operating controls were touched. In a floating subchassis design, however, there is no obstacle to placing the suspension frequency below 4 Hz, and this is the approach taken in the AR, Linn Sondek, and Oracle turntables, as well as the new NAD turntable discussed here. The platter and tonearm are mounted together on a rigid platform so that if any infrasonic disturbance does get through the suspension, the platter and stylus will tend to move *together*, minimizing the unwanted stylus deflection [7]. The platform is supported on three springs whose compliance allows the platter to move freely in any direction by at least 3 millimeters before encountering significant resistance.

There is, however, one disadvantage to a very low suspension frequency. Wooden floors often have a springy resonance at a similarly low frequency, so that footfalls or dancing may cause groove-jumping. As annoying as this may be, it has the advantage (unlike other suspension-induced problems) of being an obvious flaw that the user can take steps to correct.

One immediate advantage of the floating subchassis approach is that it isolates the stylus from the base and dust cover. Every turntable is "microphonic" to some degree—responding directly to sounds in the room (including the output from the loudspeakers). The dust cover, being a large but thin and stiff object, is especially efficient at intercepting airborne vibrations and coupling them into the platter.

The importance of this is easy to demonstrate. Place the stylus tip in a record groove with the platter stationary, and play pink noise through a loudspeaker located several feet away. Set the volume so that the sound level measured near the turntable is about 90 dB SPL (measured on the "C" scale, i.e., without A-weighting), and connect the output of the cartridge to an oscilloscope or spectrum analyzer-



## Turntables with compliant feet for isolation usually resonate at 10 Hz or higher, since a more compliant suspension would make the table too unsteady.

er. Typically, in a turntable without a floating subchassis the microphonic pickup will be only 30 to 40 dB below normal musical signal levels. This coloration can be reduced by 10 dB or better, simply by placing a pillow on the dust cover to deaden it or by completely removing the cover.

Figure 4 illustrates the acoustic sensitivity of two turntables, measured as described above. Over a broad frequency range the NAD 5120 turntable, with its floating subchassis, is 10 to 20 dB less microphonic than a conventional turntable (the NAD 5025) that relies on compliant feet for its isolation.

### Motor and Platter Vibration

Of course, the vibration of the drive motor is an important problem in any turntable. In principle, excellent performance can be obtained with either a direct-drive or a belt-drive system, but only a belt drive fits our requirements for low cost, easy manufacturability, and compatibility with a floating subchassis suspension. This choice avoids both the cogging (torque pulsations) of inexpensive direct-drive systems and the complexity (which translates into high cost) of the more refined, high-performance direct-drive mechanisms. An inexpensive, a.c. synchronous motor provides accurate speed and is bolted to the turntable's base, where its slight vibration is inconsequential. Its torque is coupled to the floating platter via a thin neoprene belt that is taut enough to carry power to the platter at its desired rotational frequencies (0.55 and 0.75 Hz, i.e., 33 and 45 rpm), but is far too flexible to transmit higher frequency vibrations with any great efficiency. A suitable belt/platter resonance frequency is therefore around 2 Hz.

The floating suspension is so compliant that even the slight tension of the drive belt was enough to pull the platter off-center, toward the left-rear corner of the turntable where the motor is located. A spring was added in the right-front quarter to keep the floating subchassis in the correct centered position.

It has become traditional in turntable design to use the flywheel inertia of a massive metal platter as a mechanical flutter filter, in order to minimize the influence of bearing irregularities,

torque pulsations in the drive, etc. There are well-known disadvantages to this approach, however. One is the need, in many cases, for dynamic balancing of the platter after it is cast, in order to avoid an eccentric mass distribution that would increase wow and bearing wear. Another is the bell-like resonance of the metal platter itself; the greater the platter's mass, the more mechanical energy it can store when stimulated into vibration, and the more difficult it becomes to damp this ringing with a vibration-absorbing rubber platter mat. The importance of this problem is testified to by the widespread marketing of specialized platter mats.

These problems can be eliminated at their source. With a belt drive to filter out motor-induced flutter and rumble, and with the smooth platter rotation provided by a highly polished, hardened steel spindle shaft rotating in a close-fitting, self-lubricating sleeve bearing, there simply is no need for the flywheel effect of a metal platter. Instead, the new turntable employs a rubber platter, 7 millimeters thick.

In addition to having no resonance of its own, the rubber platter damps the vibrations which arise in the LP record itself. LPs are large, thin, and rigid, and so they are naturally microphonic, picking up sound from the air and coupling it to the stylus. Additional vibration is induced in the disc by the inertia of the stylus vibrating in the groove, as a consequence of Newton's Third Law of Motion (action produces reaction). Critical listeners may wish to obtain maximum damping of disc vibration by purchasing a spindle clamp to press the disc down, forcing discs with slight dish warp into uniform contact with the rubber platter.

To guarantee a flat contact surface for the LP, the rubber mat is supported by a lightweight aluminum disc that is curved up at the rim for stiffness. That disc has its own potential for resonance, of course, so the rubber platter increases to 9 millimeters thick near its rim and wraps around the edge of the disc, helping prevent any ringing.

In the course of developing the 5120 turntable, new solutions were found for the vibration-control problems that every turntable manufacturer must face. One of these solutions (the stiffened

rubber platter) effectively eliminates the minor but common problem of metallic platter resonance. Another—the use of a flexible tonearm and a tunable, spring-suspended, viscous-damped counterweight functioning as an adjustable dynamic vibration absorber—effectively tames the infrasonic arm-cartridge resonance, which has been a major unresolved problem in real-world turntable performance. In addition, the traditional floating subchassis suspension proved to be an economical and effective barrier to both structure-borne and airborne vibration.

As analog LP discs continue to improve in quality, thanks to better mastering and pressing techniques, it becomes increasingly important to eliminate subtle flaws in turntable performance. We hope that the ideas described here are a useful step in that direction. A

### References

1. Anderson, Roger, et al., "Phonograph Reproduction—1978," *Audio*, Vol. 62, No. 5, May 1978.
2. Pruitt, Robert L., "Macro Microgroove Model," CAS '80 Conference (Discwasher Inc.).
3. Happ, L. and F. Karlov, "Record Warps and System Playback Performance," *Journal of the Audio Engineering Society*, Vol. 24, No. 8, Oct. 1976.
4. Ladegaard, Poul, "Audible Effects of Mechanical Resonances in Turntables," B & K Applications Note 17-233, 1978.
5. Anderson, Roger, "A Vibration Stabilizer System for Phonograph Reproduction," AES Preprint No. 1356, May 1978.
6. Lipshitz, Stanley, "Impulse Response of the Pickup Arm-Cartridge System," *JAES*, Vol. 26, No. 1/2, Jan./Feb. 1978.
7. Villchur, Edgar, "A New Turntable-Arm Design," *Audio*, "Part 1," Vol. 46, No. 9, Sept. 1962; "Part 2," Vol. 46, No. 10, Oct. 1962.

*Editor's Note:* An "Equipment Profile" on the NAD 5120 turntable appears in this issue. In his abbreviated report, Edward M. Long paid particular attention to the tracking and isolation qualities of the turntable—E.P.





# Performance-Check Your Amp and Preamp

M. J. SALVATI

## PART I—FREQUENCY RESPONSE, SIGNAL-TO-NOISE RATIO, AND SENSITIVITY

**M**easuring the performance of state-of-the-art equipment, fully and with commensurate accuracy, normally requires about \$20,000 worth of lab-grade test equipment. Fortunately, you can make a number of performance checks on amplifiers and preamps with just a few pieces of low-cost test equipment.

The key to this apparent minor miracle is the phrase "performance check." The procedures described here, *adapted* from IHF test procedures, will not always be sufficiently accurate to qualify as valid specification measurements, but they will be accurate enough to tell you if something is wrong and, in many cases, will come close to lab-grade accuracy. By not reaching for maximum accuracy in every measurement or verifying every spec, you can make most of these measurements with just a decent a.c. voltmeter, an audio generator, load resistors, and a few homemade accessories. (Some measurements described in Part II of this article will call for an oscilloscope, but there is a way around that, as you will see.)

### Frequency Response

Frequency response is actually the amplitude response of a circuit or device with regard to frequency. In most cases we want a flat response (i.e., no amplitude variation) over the audio-frequency range. In some cases (noise filters and loudness controls, for example), we *do* want a certain type of amplitude variation to achieve a particular improvement in perceived sound. Frequency response as measured is the ratio of output amplitude over a range of frequencies to output amplitude at a reference frequency (generally 1 kHz). This ratio is usually expressed in dB, and specified as the worst-case variation(s) over a certain frequency range, e.g., "10 Hz to 50 kHz,  $\pm 0.5$  dB." Though the dB variation is sometimes omitted, it will not be in a truly accurate spec.

*Equipment Needed.* Basically, a frequency-response measurement is made by applying a constant-amplitude input signal to an amplifier or other device, and measuring the output voltage as the input signal's frequency is varied. The equipment needed is

simple: Just a signal source and a.c. voltmeter covering the appropriate frequency range, and load resistors. The minimum frequency range over which the signal source and voltmeter must have a perfectly flat response is 20 Hz to 20 kHz, although 10 Hz to 100 kHz is needed in many cases. Fortunately, there are many low-cost signal sources available, called function generators, which have extremely flat output (less than 0.3-dB variation) and sufficiently low sine-wave distortion (less than 1%) over the 10 Hz to 100 kHz frequency range. The B & K 3010 and 3015, Global Specialties 2001, OK Industries FG-201, and Exact 119 are a few examples. Of course, if you have an audio oscillator of lab-grade standard (such as the Krohn-Hite 4200), you need not resort to a function generator for flat output.

The one "problem" with simple function generators is that they generally do not have step attenuators in their output circuits. This makes it nearly impossible to set the 5-mV reference input level for the phono input, and the even lower levels needed for some of

If even the modest equipment outlined is beyond your reach, don't despair. There is an alternate technique.

Fig. 1—Decade attenuator circuits. Multi-output precision attenuator (A) and simple attenuator for phono inputs (B).

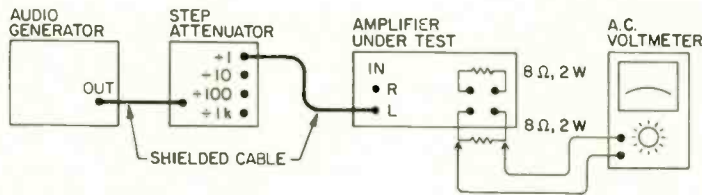
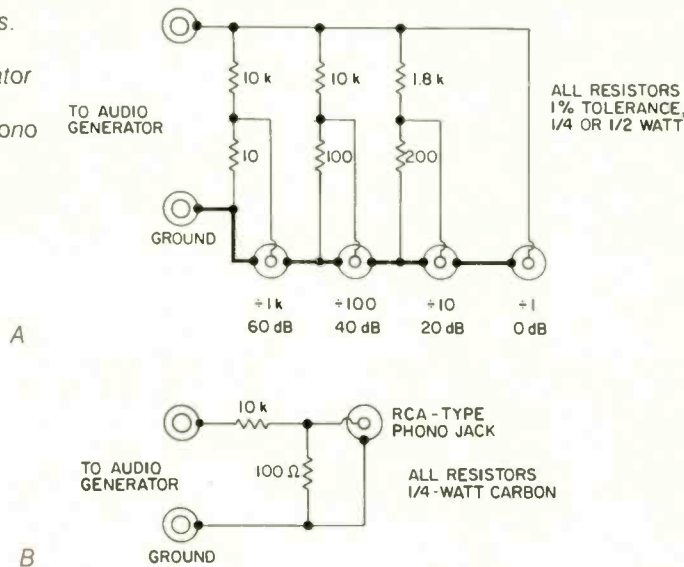

Fig. 2—Basic equipment setup for performance measurements. Configuration shown is for measuring amplifier or receiver power-output stages; for preamplifier

measurements, substitute a 10-kilohm, 1/4-watt resistor paralleled by a 1,000-pF capacitor for each of the 8-ohm, 2-watt resistances shown.

If even the modest equipment requirements outlined thus far are beyond your reach, don't despair. There is an alternate measurement technique, described after the basic procedures, which allows accurate frequency-response measurements with really bad test equipment—albeit at the cost of extra time and effort.

The load resistors needed are a pair of 16-ohm, 5%, 1-watt carbon resistors connected in parallel for each power-amplifier output, and a 10-kilohm, 5%, 1/4-watt carbon resistor paralleled by a 1,000-pF capacitor for preamp outputs.

**Basic Measurement Procedure.** If your signal generator and voltmeter both have sufficiently flat frequency response, measure frequency response as follows:

1. Turn on all equipment (Fig. 2), and allow an appropriate warmup time, about 5 minutes for semiconductor equipment and 15 minutes for vacuum-tube equipment.
2. Set any filters, equalizers, and tone, boost, or loudness controls to their flat-response positions, unless you specifically want to measure the effect of one such control on frequency response. Set the amplifier's volume or gain control to minimum, and its balance control for equal output.

3. Connect the appropriate attenuator output (if used) to the input jack of the amplifier being measured. For devices with multiple inputs (such as preamps and receivers), connect to a general-purpose high-level input (AUX, for example), unless you wish to make a specialized frequency plot. Do not use the phono inputs for a general frequency-response measurement. Set the amplifier's mode or function switch to match the input used.

4. Connect the appropriate load(s) to the amplifier's output terminal(s). Connect the a.c. voltmeter across the load resistor of the channel under test.

5. Set the a.c. voltmeter range switch to accommodate the reference output level. The IHF mandates 0.5 V for preamps, and the voltage corresponding to 1-watt output for power amplifiers (2.82 V at 8 ohms, 2.0 V at 4 ohms). However, you can get the same results and save yourself a lot of conversion calculations by using voltage values which correspond to your me-

the following measurement procedures. Fortunately, there is a way around this, too—an attenuator like those shown in Fig. 1. You can use the 0-dB output for AUX, tuner, or tape inputs, the -40 dB output for moving-magnet phono, mike, or tape head inputs, and the -60 dB output for moving-coil phono inputs.

An a.c. voltmeter's flatness is generally included in its accuracy spec. Look for no worse than 2% to 3% accuracy over the 10 Hz to 100 kHz frequency range. If you must use a digital voltmeter (DVM), be certain to check

its frequency-response spec in the instruction manual. Many DVMs have poor frequency response above 10 kHz, and some low-cost instruments are not accurate or even usable beyond 1 kHz! For this reason, and also because few DVMs have the much-needed dB indication, an old-fashioned analog voltmeter, specifically designed to measure audio voltage, is generally used for frequency-response measurements. Sensitivity is of little importance, since frequency-response measurements are generally made at output levels of 0.5 to 3 V.



If your test equipment's frequency response isn't flat, your response plots will look like designs for a roller coaster.

ter's 0-dB mark. On most a.c. voltmeters, these correspond to 0.775 V (on the meter's 0-dB range), suitable for preamps, and 2.45 V (+10 dB range), suitable for power amps. If you have one of the few a.c. voltmeters using the 0 dB = 1.0 V system, use 0.316 V (-10 dB range) for preamps, and 3.16 V (+10 dB range) for power amplifiers and receivers.

6. If measuring anything other than a separate power amplifier, set the generator frequency to 1 kHz and adjust its output level to 0.5 V. Turn up the amplifier's gain or volume control until the voltmeter pointer is on the 0-dB meter-scale calibration. Thereafter, do not touch the amplifier's gain or volume controls. If measuring a separate power amplifier, set its level control (if any) to maximum, and use the audio generator's output control to set the 0-dB meter-scale indication at 1 kHz.

7. Set the generator to other frequencies in turn, and record the voltmeter indication in terms of plus and minus variations from 0 dB for each frequency. Make extra measurements around frequencies where the output voltage undergoes rapid change so the "knees" in the response curve can be accurately drawn.

8. Plot the meter readings obtained in Step 7 on semilog graph paper, as shown in Fig. 3. Good-quality audio equipment will produce a flat response that rolls off smoothly at each frequency extreme.

*Using Non-Flat Test Equipment.* If your audio generator and/or a.c. voltmeter have such poor output flatness and frequency response that they make the plotted response curve look like a design for a roller coaster, redo the measurement with the following modification. Each time you change frequency in Step 7, disconnect the voltmeter from the amplifier output, and remeasure the generator output voltage. Adjust the generator output-level control for the output level selected in Step 6, then reconnect the voltmeter to the amplifier output and record the output level. This technique, though time-consuming, cancels out flatness problems in the test equipment. Note, however, that you *must* use the same voltmeter to measure the amplifier's input voltage that you use to measure its output voltage.

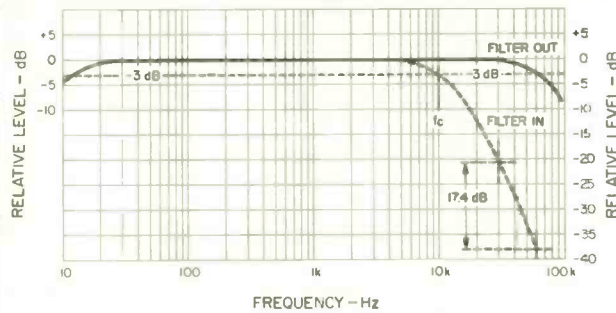

Fig. 3—Frequency-response plot for a typical amplifier. Note the 3-dB down points and the filter slope (dashed curve).

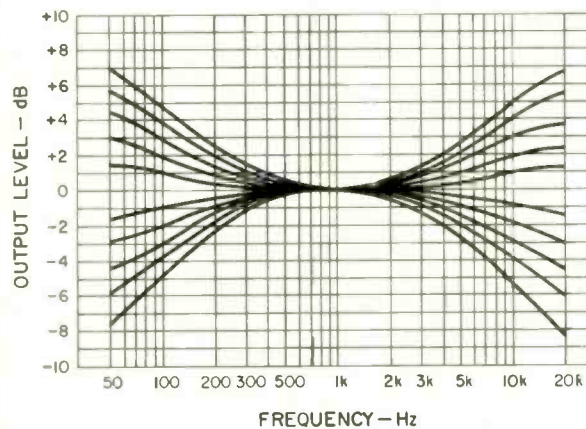
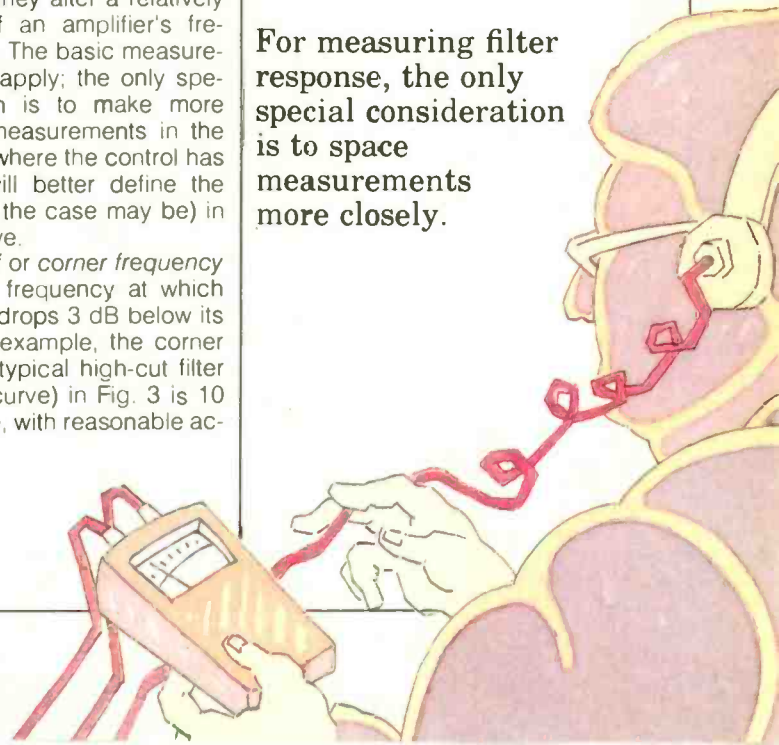

Fig. 4—Typical tone-control frequency-response plots.

*Filters, Equalizers and Tone Controls.* When filters and graphic equalizers are inserted, they alter a relatively limited portion of an amplifier's frequency response. The basic measurement techniques apply; the only special consideration is to make more closely spaced measurements in the frequency range where the control has its effect. This will better define the knee or peak (as the case may be) in the response curve.

The rated *cutoff* or *corner frequency* of a filter is that frequency at which output amplitude drops 3 dB below its 1-kHz value. For example, the corner frequency of the typical high-cut filter plotted (dashed curve) in Fig. 3 is 10 kHz. To determine, with reasonable ac-

For measuring filter response, the only special consideration is to space measurements more closely.



Ideally, an amp should have no output when no input is applied. In reality, noise appears in the output of every amplifier.

accuracy, the roll-off or attenuation rate of a filter, you must make measurements at frequencies where the output is 30 to 40 dB down. In our Fig. 3 example, the response is down 20.6 dB at 30 kHz, and is 38 dB down at twice that frequency (one octave higher). The measured difference of 17.4 dB is close to the 18 dB/octave theoretical attenuation rate of a three-pole filter.

Conventional tone controls, be they stepped or continuous, affect a relatively large portion of an amplifier's response curve. To fully characterize their action, make frequency-response measurements over the range of 50 Hz to 20 kHz (according to the Basic Measurement Procedure) at each step or panel marking. (If you wish, you can go beyond this frequency range, but then the results may be affected by the amplifier's low- and high-end roll-off.) Plot the results on semilog graph paper, as in Fig. 4.

**Phono Inputs.** Measured directly, the frequency response of an amplifier's phono input will look like a severely tilted curve. This is due to the high-frequency attenuation and low-frequency boost characteristics of the RIAA equalization in the phono circuitry. You should therefore plot the difference between the measured response and the playback equalization values given in Table I. (Note that the values in this table must be algebraically subtracted to get the proper sign for the remainder.) For example, suppose you measure  $-8$  dB at 5 kHz. Since the 5-kHz response is supposed to be  $-8.2$  dB, the actual error is only  $+0.2$  dB.

### Signal-to-Noise Ratio

Ideally, an amplifier should have no output signal whatsoever when there is no input applied. In reality, noise of some sort (hum, thermal, popcorn, etc.) appears in the output of every amplifier. Signal-to-noise ratio is the strength of the hum and noise appear-

A

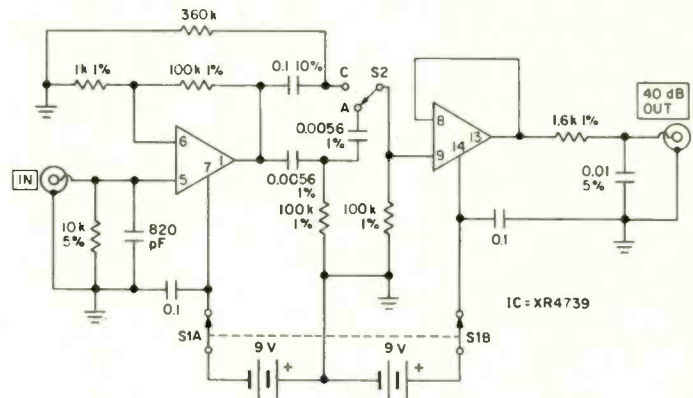

B

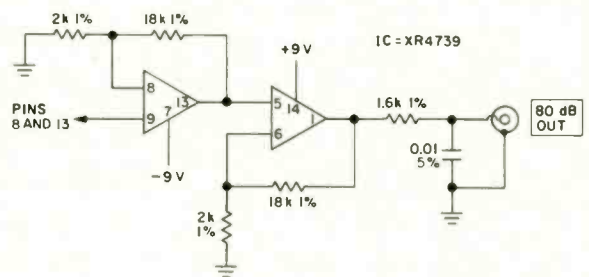

Fig. 5—Simple filter/amplifier (A), with A- and C-weighting networks, for use with a.c. voltmeters having sensitivities of at least  $-60$  dB (1 mV, full scale). For less sensitive meters, add the extra gain stage (B).

ing in the amplifier's output signal relative to the amplifier's rated output level. This ratio is normally expressed in dB, and constitutes the S/N ratio spec of most older amplifiers. The S/N ratio of newer amplifiers is the ratio of hum and noise to a standard reference output level, with standardized gain in most cases. Since most amplifiers are rated for output levels higher than the IHF reference levels, the new method results in lower numbers, particularly for high-power amplifiers.

However, another difference between old and new standards is weighting (i.e., filtering that restricts the bandwidth of the noise being measured.) Most old-standard measurements were made with B- or C-weight-

ed filters, which pass a wider noise bandwidth than the A filter mandated by the current IHF spec. As a result of measuring less of the noise present in an amplifier's output, the S/N ratio is higher for any equivalent noise and reference levels. Because of these differences, there are few valid comparisons possible between S/N ratios made under the old and new measurement procedures.

**Equipment Needed.** Basically, S/N measurements are made by shorting an amplifier's input terminals and measuring the noise voltage present at the amplifier's output terminals. However, the noise output of modern audio equipment is so low that only a few, expensive a.c. voltmeters can give a

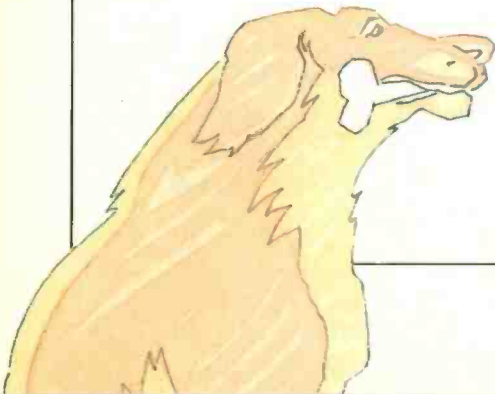



An amplifier's AUX, tuner and tape inputs generally use the same circuitry, and will produce identical results.

readable indication. Therefore, it is customary to amplify the noise with an amplifier whose own noise level is very low. The circuit shown in Fig. 5A is a low-cost, low-noise amplifier having 40-dB voltage gain (100X), and containing the filters for A and C weighting. All capacitor values are in microfarads, and the resistors are 1/4-watt carbon film. The preferred tolerances are specified on the schematic, but ordinary 5%-tolerance resistors and 10% capacitors will provide enough accuracy for practical purposes. The low-cost XR4739 is available from several mail-order houses, but a Precision Monolithics OP-227 (different pin connections) will provide even lower noise performance.

When preceded by the preamplification described, nearly any a.c. voltmeter having a dB scale and range markings can be used. The most sensitive range should be -60 dB (1 mV, full scale) if you expect to work on high-quality audio equipment, where the S/N ratios may exceed 110 dB. If you have a low-cost a.c. voltmeter such as the old but popular Heathkit AV-3 (-40 dB, 10 mV, full scale), you might need amplification in addition to that of the basic filter/amp. Another XR4739 (Fig. 5B) can be added to pin 7 of the first XR4739. This will provide an 80-dB gain output in addition to the 40-dB gain output of the basic filter/amp. Furthermore, if the voltmeter's dB scale has its zero referenced to 0.775 V (1 mW into 600 ohms), no dB conversions or difficult calculations will be needed in the following procedures.

The IHF recommends input terminations via 1-kilohm resistors for most inputs (AUX, tuner, tape, line, moving-magnet phono, etc.) and 100 ohms for moving-coil phono inputs. For our pur-

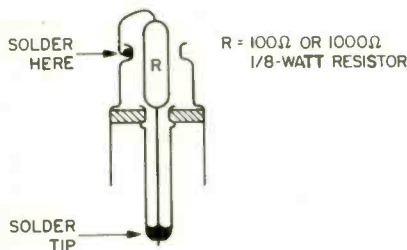

Fig. 6—Input-terminating plug for S/N measurements.

poses you can use the shorting plugs (usually) supplied with your audio equipment for most measurements. However, input termination is important with some ultra-low-level moving-coil preamps, so you should build a couple of 100-ohm shorting plugs as shown in Fig. 6. Use as small a carbon- or metal-film resistor as you can obtain; do not use carbon-composition resistors. Keep the leads extremely short on these plugs.

The load resistors needed are a pair of 16-ohm, 5%, 1-watt carbon resistors connected in parallel for each power-amplifier output. The input impedance of the filter/amp will provide the proper load for preamp outputs.

Receiver, preamp, and integrated amplifier S/N ratio measurements made to the current IHF procedure also require an audio generator supplying 0.5 to 3 V at 1 kHz, and a decade attenuator (Fig. 1).

**Basic Measurement Procedure.** To measure S/N ratio relative to rated output (or to reference output, for discrete power amplifiers), proceed as follows:

1. Turn on all equipment (Fig. 7) and allow an appropriate warmup time (about 5 minutes for semiconductor equipment and 15 minutes for vacuum-tube equipment).
2. Insert shorting plugs or terminations into the input connectors of the desired amplifier function (e.g., tuner).
3. Set any filters, equalizers, and tone, boost or loudness controls on the amplifier to their flat-response position. Set the function or mode selector of the amplifier under test to match the input terminated in Step 2. Set its volume or gain control at maximum, and its balance control for equal output.
4. Connect the filter/amp 40-dB out connector to the input connector of your a.c. voltmeter, and select the weighting network (A or C) called for by the specification you are checking.
5. If the unit under test is a preamp, connect its output jack (for the channel being measured) directly to the input connector of the filter/amp. If the unit under test is a power amplifier or receiver, connect 8-ohm load resistors across each channel's speaker terminals, then connect the filter/amp input across the load resistor of the channel being measured.
6. Set the voltmeter's range selector

for maximum on-scale reading. The measured S/N ratio is the sum of four dB figures: The meter scale, meter range, filter/amp gain, and the output adjustment factor. For our calculations, use the plus or minus signs of the meter scale and range switch as marked. Consider the filter/amp gain as a negative quantity, output levels above 0.775 V as negative, and output levels below 0.775 V as positive. For example, if we were measuring the tuner input of a preamp with 0.5-V rated output, the meter scale might indicate -5.5 dB when the voltmeter range switch is set to its -50 dB position. Since the output level of 0.5 V is below 0.775 V (0 dBm), we add the 3.8-dB adjustment factor (Table I) as a positive quantity to get S/N ratio at rated output:

$$(-5.5) + (-50) + (-40) + (3.8) = -91.7 \text{ dB.}$$

If a power amplifier were being measured, the adjustment factor (for reference or rated output) would certainly be a negative quantity. Adjustment factors for the standard 1-watt refer-

Don't plot the tilted curve representing phono-input frequency response—plot the difference between RIAA equalization and your measured results.

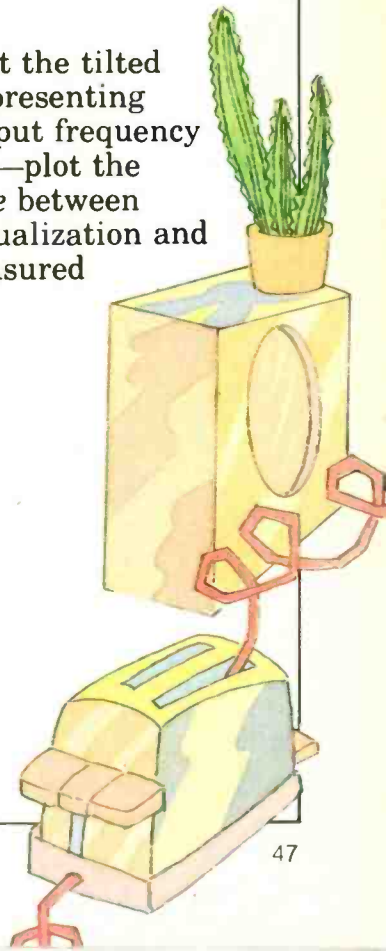

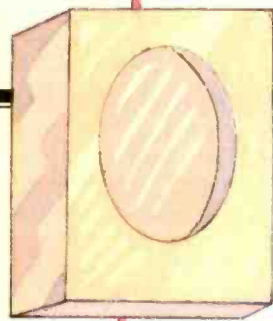

Sensitivity used to be defined in terms of *rated output*. Now it's defined in terms of a *reference output level*.

ence output and for various rated power output levels are given in Table II.

7. Switch the input of the filter/amp to the other channel's output, and repeat Step 6.

8. Repeat Steps 2, 3, 6, and 7 for every other pair of inputs on the amplifier. Note, however, that the AUX, tuner, and tape inputs of an amplifier generally use the same circuitry and will produce identical results. Inputs with different circuitry include high-level phono, low-level phono, mike, and tape head.

*S/N Ratio Relative to Reference Output.* This is similar to the current IHF

Table I—Phono correction factors.

Hz	dB	kHz	dB
20	+19.3	1	0
30	+18.6	2	-2.6
50	+17.0	3	-4.8
70	+15.3	4	-6.6
100	+13.1	5	-8.2
200	+8.2	7	-10.9
300	+5.3	10	-13.8
400	+3.8	12	-15.3
700	+1.2	15	-17.2
1000	0	20	-19.6

procedure for receivers, integrated amplifiers, preamplifiers, and any type of amplifier *other than* discrete power amplifiers. It is much more complicated than the Basic Measurement Procedure, because the amplifier's gain

must be standardized before the actual S/N measurement can be made. To make this measurement, proceed as follows:

1. Set up the equipment as shown in Fig. 2, selecting the attenuator output jack appropriate for the input being measured (0 dB for AUX, tuner or tape, 40 dB for MM phono and mike, 60 dB for MC phono).

2. Turn on all equipment and allow an appropriate warmup time, about 5 minutes for semiconductor equipment and 15 minutes for vacuum-tube equipment.

3. Set any filters, equalizers, and tone, boost or loudness controls on the amplifier to their flat-response position. Set the amplifier's volume or gain control at minimum and its function or mode selector to match the input being tested. Set its balance control for equal output.

4. Set the audio generator frequency at 1 kHz and its output level at 0.5 V.

5. Turn up the amplifier's volume or gain control until the a.c. voltmeter indicates reference output (0.5 V for preamps, 2.82 V for receivers and integrated amplifiers). After this point, *do not touch* the amplifier's volume or gain control.

6. Disconnect the attenuator cable from the amplifier input, and insert a shorting plug or terminating resistor into the same input connector.

7. Install the filter/amp between the a.c. voltmeter and output of the amplifier under test (see Fig. 7). Select the A-weighting network.

8. Set the voltmeter range switch for maximum on-scale indication. The measured S/N ratio, relative to reference output, is the sum of four dB figures: The meter scale, meter range, filter/amp gain, and output adjustment factor. For our calculations, use the plus or minus signs of the meter scale and range switch as marked. Consider the filter/amp gain as a negative quantity. The preamp adjustment factor is +3.8 dB; the power amplifier and receiver adjustment factor is -11.2 dB for 8-ohm loads.

9. Switch the input of the filter/amp to the other channel's output, and repeat Step 8.

10. Repeat Steps 1 to 9 for every other pair of inputs you wish to measure. Note, however, that the AUX, tun-

Table II—Power, voltage, and dB conversions.

Power (8-Ohm Load)	Power (4-Ohm Load)	Voltage	dB Voltage Factor*
500	1000	63.2	-38.2
450	900	60.0	-37.8
400	800	56.6	-37.2
350	700	52.9	-36.7
300	600	49.0	-36.0
250	500	44.7	-35.2
220	440	42.0	-34.7
200	400	40.0	-34.2
180	360	37.9	-33.8
160	320	35.8	-33.3
150	300	34.6	-33.0
140	280	33.5	-32.7
130	260	32.2	-32.4
120	240	31.0	-32.0
110	220	29.7	-31.7
100	200	28.2	-31.2
90	180	26.8	-30.8
80	160	25.5	-30.3
75	150	24.5	-30.0
70	140	23.7	-29.7
65	130	22.8	-29.4
60	120	21.9	-29.0
55	110	21.0	-28.7
50	100	20.0	-28.2
45	90	19.0	-27.8
40	80	17.9	-27.3
35	70	16.7	-26.7
30	60	15.5	-26.0
25	50	14.1	-25.2
20	40	12.7	-24.3
15	30	11.0	-23.0
12	24	9.8	-22.0
10	20	8.95	-21.3
8	16	8.00	-20.3
-	-	5.00	-16.2
-	-	3.00	-11.8
1	-	2.82	-11.2
-	1	2.00	-8.2
-	-	1.00	-2.2
-	-	0.5	+3.8

\*0 dB = 0.775 V (1 mW into 600 ohms)

$$\text{Voltage} = \sqrt{\text{Power} \times \text{Resistance}}$$

$$\text{dB} = 20 \log \frac{\text{Voltage}}{0.775}$$

er, and tape inputs of an amplifier generally use the same circuitry and will produce identical results. Inputs with different circuitry include high-level phono, low-level phono, mike, and tape head.



To measure amplifier sensitivity at rated power output, your load resistors must be able to dissipate huge amounts of power.

### Sensitivity

This specification, too, has undergone a significant change in recent years. In the old days, sensitivity was defined as the minimum input voltage needed to develop *rated* amplifier output (either voltage or power) when applied to a certain input connector. The current IHF standard defines sensitivity as the minimum input voltage needed to produce the appropriate *reference* output level. There isn't much difference between the two standards for preamps, since the typical rated output voltage for preamps was only about twice the current 0.5-V reference level. However, most power amplifiers and receivers have rated outputs in the 30 to 200 watt range, many times the 1-watt reference output level now used for power amps. The result is that their sensitivity figures now look much better (lower), especially in the case of high-power amplifiers and receivers.

**Equipment Needed.** Sensitivity measurements require a sine-wave signal source (audio oscillator or function generator) at 1 kHz with output amplitude controllable over a range from 0.1 mV to 1 V, and an a.c. voltmeter capable of measuring those levels at 1 kHz. Though low-cost function generators do not have output-level controls capable of easy operation below a few hundred millivolts, and low-cost a.c. voltmeters cannot measure levels below a few millivolts with any degree of accuracy, very low-level sensitivity measurements are still possible. By inserting an attenuator of known division ratio between the generator and amplifier, you can set the generator's output at easily controlled levels 10 to 1,000 times higher than the levels actually fed to the amplifier. The attenuator shown in Fig. 1A provides up to 3 decades of precision attenuation, with outputs ranging from 0.1 mV to 2 V, all from an input voltage that need be controlled at the generator only over a range from 100 mV to 2 V. Of course, if your generator does have a wide-range output attenuator, you might need only a single 40-dB attenuator (Fig. 1B) for very low-level phono inputs. In general, though, you might use the 0-dB output for low-power amplifiers and receivers, the -20 dB output for high-power amplifiers and the AUX, tuner, and tape inputs of preamps, the

Fig. 7—Equipment setup for S/N measurements on power-output stages. For preamp measurements, change output loads as in Fig. 2.

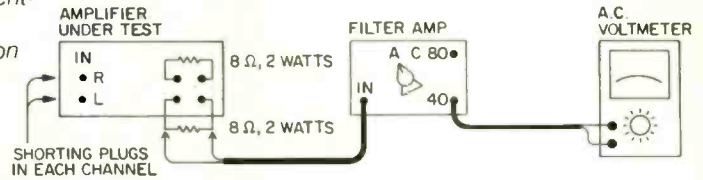

-40 dB output for low-level inputs (phono, mike, tape head), and the -60 dB output for very low-level moving-coil phono inputs.

Load resistors for reference-output sensitivity measurements are the same as used for frequency-response measurements because of the low power levels involved. However, if you are going to measure power amplifier or receiver sensitivity at *rated* power output, the load resistors must be capable of dissipating possibly huge amounts of power. This means large wire-wound resistors mounted on large sheet-aluminum heat-sinks. You will need at least one 8-ohm, 5% tolerance resistor. If any of your power amplifiers or receivers is specified at 4 ohms, obtain two 8-ohm resistors. These can be connected in parallel to make a 4-ohm resistor, or used separately for other measurements where both channels must be driven.

**Measurement Procedure.** To measure the sensitivity in a particular input mode, proceed as follows:

1. Turn on all equipment (Fig. 2) and allow an appropriate warmup time, about 5 minutes for semiconductor equipment and 15 minutes for vacuum-tube equipment.
2. Set any filters, equalizers, and tone, boost or loudness controls on the amplifier to their flat-response position. Set the amplifier's volume or gain control at maximum, and its balance control for equal output in each channel.
3. Set the audio-generator output-level control for minimum output.
4. Connect the generator output to the attenuator input, and the appropriate attenuator output jack to the desired input jack of the amplifier being measured. Set the amplifier's function or mode selector to match the input being used.
5. Connect the appropriate load(s)

across the amplifier output terminals. Connect the voltmeter input terminals across the load resistor of the channel being measured.

6. Set the a.c. voltmeter range selector to the position covering the appropriate reference level (0.5 V for preamps and 2.82 V for power amps and receivers). However, if you are measuring sensitivity at *rated* output, set the range selector to a position covering the rated output voltage (preamps) or the voltage level corresponding to rated power output (power amps and receivers). The conversion chart in Table II will be helpful in this case.

7. Set the audio generator frequency at 1 kHz, then increase its output level until the voltmeter indicates reference or rated output. (You may have to change the amount of attenuation to do this.)

8. Disconnect the a.c. voltmeter from the load resistor and measure the *generator* output voltage. Divide this voltage by the attenuator's division ratio to get the sensitivity figure for that input. (Now you see why we needed 1% resistors.) For example, if we measure 1.2 V and are using the 20-dB (divide-by-10) attenuator, the input sensitivity is 0.12 V (120 mV).

9. Repeat Steps 3 to 8 for the other channel.

10. Repeat Steps 3 to 9 for the other inputs. Note, however, that the AUX, tuner, and tape inputs of a preamp or integrated amplifier generally use the same circuitry and will produce identical results. Inputs with different circuitry include high-level phono, low-level phono, mike, and tape head.

In Part II, I'll describe how to measure damping factor and maximum output. I'll also show how to build a simple indicator which can substitute for an oscilloscope for certain tests.  $\Delta$

1

## DBX 4BX DYNAMIC- RANGE EXPANDER

### Manufacturer's Specifications

**Expansion:** 0 to 50% (in dB), for each of three bands (1:1.5 maximum).

**Impact-Restoration Gain:** 0 to +12 dB, each band.

**Transition-Level Range:** 30 to 300 mV, mid-band.

**Volume-Control Range:** -40 to +10 dB.

**Frequency Response:** 20 Hz to 20 kHz,  $\pm 0.5$  dB, with no expansion.

**Noise:** -90 dBA re: 1 V.

**Harmonic Distortion:** Less than 0.15% without expansion.

**Maximum Input/Output Level:** 6 V at unity gain.

**Impedance:** Input, 1 megohm; output, 200 ohms.

**Dimensions:** 17-15/16 in. (456 mm) W  $\times$  3 1/2 in. (89 mm) H  $\times$  12 1/4 in. (311 mm) D.

**Weight:** 11 lbs. (5 kg).

**Price:** \$799.00.

**Company Address:** 71 Chapel St., Newton, Mass. 02195.  
For literature, circle No. 90



The Model 4BX is the latest and most sophisticated in dbx's series of expanders designed to recapture the dynamics lost in recording or broadcasting. There are three bands of processing in the 4BX, to minimize such unwanted effects as "pumping" of the high frequencies in response to dynamic variations in the bass. The three bands cover frequencies from 150 Hz down ("LF"), from 150 Hz to 6 kHz ("MF"), and from 6 kHz up ("HF"). Gain change in each band is indicated by a horizontal row of LEDs—six yellow LEDs to the left indicate up to 20 dB of downward expansion, and upward expansion is indicated with six red LEDs

to the right (+12 dB maximum). Below this array is a row of 12 red LEDs that illuminate, from left to right, to show the amount of instantaneous impact restoration, again to a maximum of 12 dB.

The "Volume," "Expansion," "Transition Level" and "Impact Restoration" controls all have separate momentary-contact increase and decrease buttons. Above each set of buttons is a five-bar red-LED ladder. For "Volume," the "rungs" indicate gain, in 10-dB steps from -30 to +10 dB. The "Expansion" indications are in steps of 10%, from 10% (1.1:1) to 50% (1.5:1). The "Transition Level" indicators have





a minus sign at their bottom bars, a reference arrow in the middle, and a plus sign at the top. There are no designations along the "Impact Restoration" ladder, but with increasing action, more LEDs turn on. In all cases, the actual control is much finer than the resolution of the LED steps, indicated to some extent by the intensity of the top-most lit LED. The "Volume" (gain) can be immediately muted by 40 dB with the light-touch "Power On/Mute" button. Another touch returns the volume to its previous setting.

There are also light-touch buttons with status lights for "Off," for "Source" and for "Tape" (the latter two electrically

interlocked), as well as for "Pre" and "Post" (with similar interlocking). At the very right of the front panel is a vertical slider for setting the brightness of all of the LED displays, anywhere from completely off to "easily seen in a bright room." The one exception is the red LED above "Off" to show that the unit is, in fact, still on. When "Bypass" is used, the gain-change LEDs are extinguished, but other indications remain on. The "Pre" and "Post" switches offer the choice of processing either the signal fed to a tape recorder or the playback signal. All functions except "Source/Tape" and "Pre/Post" switching are duplicated on the infrared remote control supplied; a green LED next to the receptor on the front panel acknowledges receipt of remote commands. A good feature is that continuous, smooth level changes can be made by holding down the appropriate button on the panel or on the remote control; it is not necessary to make a series of small steps, though small steps can be made with short taps of the button.

The back panel has stereo pairs for line in/out and tape recorder in/out. There is also a screw-type fuse-holder, not supplied by most manufacturers these days. Two trim pots, one for the "HF/Transition Level" and the other for the "Impact Restoration" release rate, are both set at the factory and best left alone by casual diddlers. More on these later.

Removal of the steel top and side cover revealed a nearly chassis-size p.c. board with another board above it on standoffs. There was also a small, vertical p.c. board for the remote-control receptor preamp. The soldering was excellent, parts quality was high, and parts were identified. Interconnections between boards, including the full-size front-panel one, were with multi-pin cabling.

### Measurements

Figure 1 shows the swept-frequency responses for a number of conditions. First, the input level was adjusted for 1-kHz unity gain, even with expansion introduced. Then, responses were taken in "Bypass" and with 1.5:1 expansion switched in, and for four settings of the back-panel "HF/Transition Level" control. The response is very flat in "Bypass," but note that, with the expansion switched in, there is some elevation of the low-frequency band. The level of the high-frequency band varied greatly over the range of the control, from  $-3.5$  to  $+19$  dB for the same input level. The  $+3$  dB setting was used for the next responses, with the input level increased 5 dB and for expansions of 1.3:1 and 1.5:1. Similar plots were made with the input level reduced 10 dB. All of the expansions are quite accurate (with the unity-gain offsets factored in), and the curve shapes are consistent for the same expansion.

The responses without expansion were within 0.3 dB from 20 Hz to 20 kHz (within 0.2 dB in "Bypass"), and the  $-3$  dB points were at 6.0 Hz and 90 kHz, for both cases. With some expansion, the responses indicated the filter crossovers—around 150 Hz between the low- and mid-frequency bands, and from just below 2 kHz to a bit above 6 kHz between the mid- and high-frequency ones, depending on the setting of "HF/Transition Level." For most of the tests, the crossover was between 4 and 6 kHz. Others checks demonstrated that the filter roll-off rates were fairly high, judged to be completely satisfactory for the needed isolation between bands.

The 4BX made great improvements in what was received from all the pop/rock stations. This was less certain with the classical.

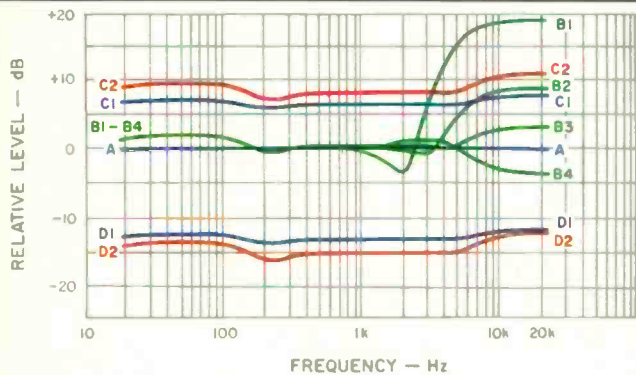

Fig. 1—Swept-frequency response for various control settings: "Bypass" position (curve A), and with 1.5:1 expansion switched in, at four settings of the rear-panel "HF/Transition Level" pot (curves B1 through B4). With input level raised 5 dB, mid-frequency level rises 6.5 dB with 1.3:1

expansion (curve C1) and 7.5 dB with 1.5:1 expansion (curve C2). With input level lowered 10 dB, mid-frequency level falls 13 dB with 1.3:1 expansion (curve D1) and 15 dB with 1.5:1 expansion (curve D2). All C and D curves were made with "HF/Transition Level" set at +3 dB.

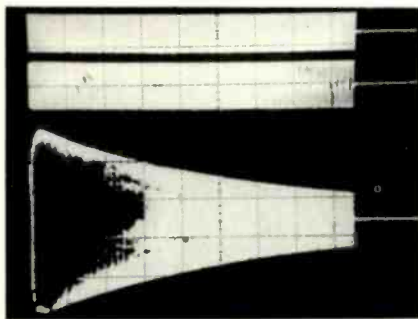

Fig. 2—Response to 500-Hz tone burst of 425-mS duration: Input (top), output with 1.3:1 expansion (center), and output with 1.3:1

expansion plus maximum "Impact Restoration" (bottom). Scales: Vertical, 2 V/div.; horizontal, 50 mS/div.

The input level for unity gain, with "Transition Level" set to its minimum, was 860 mV at 1 kHz. The level was 11 mV for the maximum setting, and 78 mV with "Transition Level" set for the middle indication. For those who think of it in terms of adjusting a threshold, this probably seems a bit backwards; if, however, the "Transition Level" adjustment is thought of in terms of effect, it becomes quite logical—lowering the threshold on an expander will increase the output level.

The maximum input/output voltage was 6.8 V or greater, from 20 Hz to 20 kHz. There was no slew-rate limiting observed with an input of 2.0 V and a 1.2:1 expansion, even

at 100 kHz. The harmonic distortion was 0.03% or less over a range of levels across the band, except for increases with higher levels when using expansion.

The input impedance measured 920 kilohms at 20 Hz and 470 kilohms at 1 kHz, falling to about 30 kilohms at 20 kHz—still much higher than most high-fidelity equipment at this frequency. The output impedance was very close to 225 ohms from 20 Hz to 20 kHz. "Volume" and "Transition Level" could be controlled very smoothly over their entire ranges; with a fast, light touch it was possible to make changes of  $\pm 0.5$  dB, if required. Muting was very close to the rated 40 dB; the exact result depended on the 0-dB adjustment, which was affected by one's judgment of the LED's brightness for that level. The expansion settings also could be changed very smoothly, and the expansions remained accurate over a wide range of levels, from -60 to +20 dB.

Referred to 1 V, the signal-to-noise ratio was 93.5 dB with no expansion, and actually increased to over 100 dB with 1.5:1 expansion set in. Varying the "Transition Level" and "Volume" settings introduced some changes, as might be expected, but S/N did not change with variations in the "Impact Restoration" setting.

Tone bursts were used to check response times of the gain-change LEDs: 70 Hz for "LF," 700 Hz for "MF" and 10 kHz for "HF." For a correctly indicated +6 dB gain change, the required durations were 30 mS for "LF" and 8 mS for "MF" and "HF." The gain-change indicator thresholds were a bit on the low side near unity gain, with the steps more linear (in dB) toward the extremes. I did not judge this to be particularly negative, as the higher resolution near unity gain helps to set a good transition level, especially with moderate expansion.

Next, a look was given to the characteristics of the "Impact Restoration" circuit. Figure 2 shows the 4BX's response to a 500-Hz, 425-mS tone burst, first with just 1.3:1 expansion and then with maximum "Impact Restoration" added. The "HF/Transition Level" was set so that the expansion generated about +4 dB of gain change. "Impact Restoration" creates a sharp rise in level, to about four times (+12 dB) the level of the expanded waveform; then, quite quickly, there is a period of decay, approaching the expanded level at the time of cutoff. Another check showed that the decay time could be set anywhere from 25 mS to 1.5 S using the rear-panel control. The decay times, as would be expected, were longer for tone bursts in the "LF" band and shorter for those in the "HF" band. The decay-time pot was reset to about 0.6 S for further tests.

While trying the various controls and looking for the limits over which "Impact Restoration" would work, I noted some odd waveforms, but they seemed to be somewhat sporadic. Here's what emerged after a bit of digging: (1) "Impact Restoration" did not function on bursts that were well below the unity-gain point; (2) it functioned normally on bursts up to and above the transition level, and (3) there was a small range somewhat below this point where it acted incompletely or after a delay period. Figure 3 shows what one of these looked like (top), with a delay of almost 100 mS. Small increases in level smoothly eliminated the delay and produced the expected waveform (bottom). At this point, I



Even if the price is too challenging, the 4BX is worth a listen to hear what's possible with this well-designed unit.

decided that I could be chasing something of little significance as far as sonic qualities were concerned.

### Use and Listening Tests

The owner's manual is very well written, providing good detail in the instructions and the background material. The cautions on using "Pre" for tape recording are right to the point: Expanding into noise and saturation is all too easy! The remote control was used for all of the listening tests, and it was considered essential for using the dbx unit to its best advantage. Most tests were run with discs, although some time was spent trying local FM stations; it was quickly proven that the 4BX made great improvements in reception with all of the pop/rock stations. This was less certain with the classical stations, and I was interested in repeating the listening source—easy to do when I played records.

In general, I felt the 4BX improved the classical listening, and I concluded that, for the discs I tried, 1.3:1 expansion was about right, with "Impact Restoration" about halfway up. Portions of Mussorgsky's *Pictures at an Exhibition* (Colin Davis, Concertgebouw Orchestra, Philips 9500744) were especially enjoyable. Here and there, I seemed to hear some gentle garbling, but I couldn't pin anything down.

In the pop discs, the improvements were emphatic and most desirable. I had known how compressed many of these were, even some of the audiophile discs, but I was still surprised how great they sounded—usually with 1.4 to 1.5:1 expansion and "Impact Restoration" most or all of the way up. Ones I liked in particular were Linda Ronstadt's *Prisoner in Disguise* (Asylum 7E-1045) and Buddy Spicher and Friends with *Yesterday and Today* (Direct Disk DD 102).

Wondering if I could see any level oddities, I made a strip-chart recording of the first part of "Georgia on My Mind" from the Spicher record. Figure 4 shows the recordings for no expansion or "Impact Restoration," 1.3:1 with some "Impact Restoration," and 1.5:1 with maximum "Impact Restoration." The chart speed and pen response were not fast enough to show the effects of "Impact Restoration," but the smooth expansion is quite evident. Other runs demonstrated that shifts in "HF/Transition Level" did not affect the expansion in any way. High-speed recording did not reveal any jogs or delays in "Impact Restoration" response over the range of levels shown.

The dbx 4BX dynamic-range expander has a high price tag, so it is likely that most audiophiles will need proof of the value of this add-on. There are no caveats on its basic performance, and for those who enjoy pop/rock music from any source, this unit delivers a new and yet real world. It was astounding how lifeless some of the recordings became with a push of "Bypass." In a couple of the classical music trials, it seemed as though the bass was slightly less extended with the 4BX, but it was also noted that the sound was slightly brighter, and that might have affected the judgment on bass. For those who would like to revive the half-dead, constricted discs we all have, or hear over the air, the dbx 4BX could very easily be well worth its challenging price tag. Even if you don't think you would ever buy it, give the Model 4BX a listen with some of your favorite discs just to hear what's possible with this well-designed unit.

Howard A. Roberson

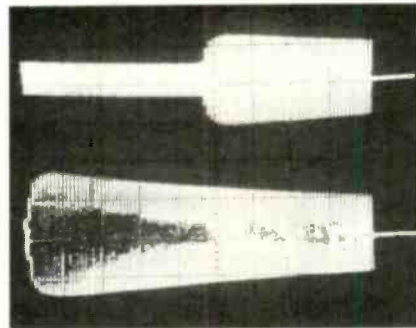

Fig. 3—For signals below transition level, a delay may occur before "Impact Restoration" takes effect (top). With input above transition level, "Impact Restoration" works

immediately (bottom). Signal shown is 500-Hz, 180-mS tone burst, with no expansion. Scales: Vertical, 0.2 V/div.; horizontal, 20 mS/div.

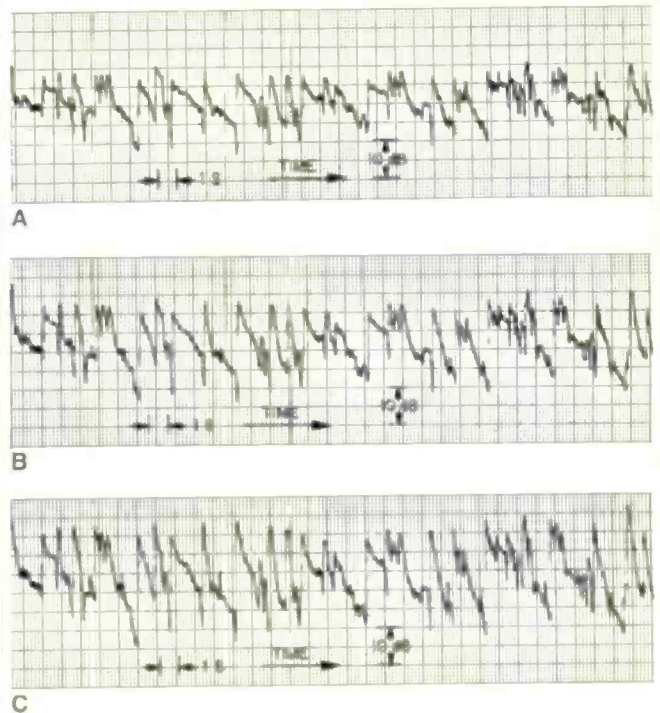

Fig. 4—Music levels of opening section of "Georgia on My Mind" (Buddy Spicher and Friends), in "Bypass" (A); with 1.3:1 expansion and "Impact Restoration" setting of 0.4 (B), and

with 1.5:1 expansion and full "Impact Restoration" (C). Effects of "Impact Restoration" are not clearly visible here because of the slow speed of the chart recorder.

## 2

# HAFLER DH-220 POWER AMPLIFIER

**Manufacturer's Specifications**

**Power Output:** 115 watts per channel, 8-ohm loads, 20 Hz to 20 kHz.

**Rated THD:** 0.02%.

**Frequency Response:** 6 Hz to 60 kHz, +0, -0.5 dB; 2 Hz to 160 kHz, +0, -3 dB.

**SMPTM IM:** 0.005%.

**S/N:** 100 dB, referred to rated output.

**Damping Factor:** 300 at 1 kHz, referred to 8 ohms.

**Input Impedance:** 47 kilohms.

**Input Sensitivity:** 1.55 V for rated output into 8 ohms.

**Slew Rate:** 30 V/ $\mu$ S.

**Rise-Time:** 2.5  $\mu$ S.

**Channel Separation:** Greater than 85 dB at 1 kHz; greater than 65 dB at 20 kHz.

**Power Consumption:** 125 VA, quiescent; 580 VA at rated output.

**Dimensions:** 16 in. (40.6 cm) W x 5 $\frac{1}{8}$  in. (13 cm) H x 10 $\frac{1}{2}$  in. (26.7 cm) D.

**Weight:** 26 lbs. (11.8 kg).

**Price:** \$449.95, wired; \$349.95 in kit form.

**Company Address:** 5910 Crescent Blvd., Pennsauken, N.J. 08109.  
For literature, circle No. 91



David Hafler is one of the true pioneers of the high-fidelity industry. Since I've been around audio for about as long as he has, I can well remember Mr. Hafler's noteworthy contributions in the field of output transformer design (when output transformers were needed to couple power

from vacuum tubes to loudspeakers), quadraphonic sound, and, perhaps most noteworthy of all, the popularization of audio kit-building in the United States. Long-term readers of *Audio* will remember the superb kits offered years ago by Dynaco, which was founded by none other than Dave



Hafler. More recently, Mr. Hafler was an owner of the Ortofon Company of Denmark, whose moving-coil and moving-magnet phono cartridges are among the world's most highly respected.

After selling Ortofon some years ago, it might have seemed that Mr. Hafler, having enjoyed two successful careers in the audio business, would perhaps retire, but that was never Dave Hafler's style. Just as soon as he was able, he formed the David Hafler Company, located it in a suburb of Philadelphia not far from where he had founded Dynaco, and began turning out one great product after another at prices which make it possible for not-so-affluent audio enthusiasts to own top-performing equipment. To those of us who remember the "good old days," Hafler's products are, in many ways, reminiscent of some of the early Dynakit. The major difference, of course, is in the advanced solid-state technology employed by Hafler, but the similarities are in the ease with which it is possible to assemble a Hafler product from its kit version, the high-quality component parts used, and the outstanding performance and reliability offered by his products, whether purchased in wired or kit form.

The only control on the front face of the DH-220 power amplifier is an on-off rocker switch. The amplifier modules themselves consist of tapered heat-sink structures (onto which output transistors as well as low-level signal p.c. boards are mounted internally). The heat-sinks are neatly fitted to the left and right ends of the amplifier chassis to form handsome side panels. The rear of the amplifier chassis is equipped with a pair of phono-type input jacks; color-coded, five-way speaker terminals, and left- and right-channel speaker fuse-holders. The fuse-holders are initially supplied with 2-ampere fuses, though 5-ampere fuses are supplied as alternatives; a quick calculation showed that I had better install them if I was going to measure continuous maximum power-output capabilities of the amplifier.

#### Layout and Circuit Highlights

The DH-220 amplifier circuit, according to Hafler, is a refinement of their DH-200 design. It employs MOS-FET output stages, a huge power transformer (relative to its rated output) and bridge rectifier, and a fully complementary, symmetrical, push-pull circuit, which is direct-coupled throughout, except at the input. Basic protection circuits provide security against damage to the amplifier or speakers. The amplifier contains a.c. line fuses, B+ (power supply) fuses, thermal breakers and the loudspeaker fuses previously referred to.

Although I did not build the unit from a kit, I learned from the owner's manual (which is also the kit assembly manual) that the left- and right-channel audio modules come pre-assembled and pretested. Besides making the remaining job very simple for even a novice, the modular design also makes it possible to operate one channel if the other should ever require service, avoiding the need to return the entire amplifier to the factory. Hafler makes accessories available for special applications, such as bridged monophonic use (with rated output of 350 watts), a panel for standard 19-inch rack mounting, and even an alternative power transformer for international a.c. line voltages.

#### Measurements

The Hafler DH-220 is conservatively rated. On my test bench, it delivered 138 watts per channel at mid-frequencies before reaching its rated THD of 0.02%. At its rated power-output level of 115 watts per channel, with both channels driving 8-ohm resistive loads, THD was only 0.005% at 1 kHz and only 0.008% at 20 Hz. The nominal rating of 115 watts per channel may have been governed by the fact that, at 20 kHz, the amplifier reached its rated distortion level at about 120 watts per channel. Figure 1 plots THD versus power output for the three key test frequencies of 1 kHz, 20 Hz and 20 kHz. SMPTE IM, though somewhat higher than claimed, was certainly low enough to cause no problems; it measured 0.017% at rated output.

Frequency response measured flat, within 1 dB from 10 Hz to 40 kHz and within 3 dB from 4 Hz to 130 kHz. Dynamic headroom for short-term music signals measured just a bit more than 1.0 dB, which translates to a 145 watt-per-channel, short-term power-output capability without clipping. CCIF-IM distortion, using a twin-tone test signal, measured

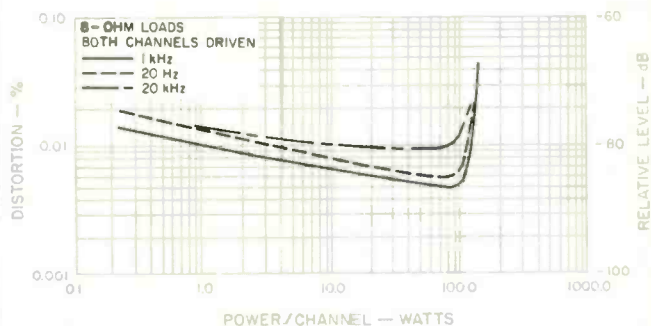
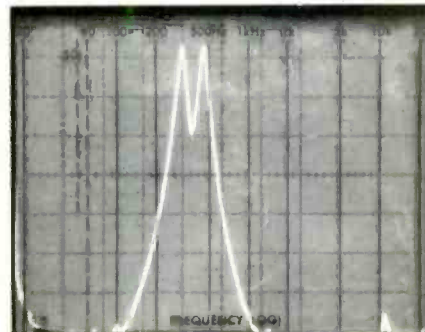

Fig. 1—Power output vs. THD.

Fig. 2—Twin-tone IHF-IM measurement.



Hafler's success, two times running, proves that he and his staff understand what's needed in audio kit design.

a very low 0.002%—or just about the residual distortion of my test instrument. I was able to detect just a bit of IHF-IM distortion, using spectrum analysis and sweeping linearly from 0 Hz to 20 kHz (see Fig. 2). The small "blip" at the right of the screen in Fig. 2 combines with the smaller blips just above and below the two test tones, seen at center-screen, adding up to a net IHF IM of 0.038%—hardly anything to get upset about.

Input sensitivity for 1-watt output into 8-ohm loads measured 140 mV. Signal-to-noise ratio, referenced to 1-watt output and using an A-weighting network, measured 83 dB. To translate that to an S/N number referenced to rated output (and therefore to Hafler's published specification) requires adding 20.6 dB (the difference between 1 watt and 115 watts, in dB), for an S/N rating of 103.6 dB compared with Hafler's claimed 100 dB.

The DH-220 amplifier proved to be stable under all load conditions to which it was subjected, including operation into 4- and 2-ohm resistive loads as well as operation into inductive and capacitive loads. I was unable to verify Hafler's claimed damping factor of 300 at mid-frequencies, perhaps due to the resistance of the 2-foot lengths of 14-gauge wire connecting the amplifier output terminals to the inputs of my test setup. Even so, I measured a damping factor of more than 150 at 50 Hz, still quite high.

#### Use and Listening Tests

I was very favorably impressed, not only by the sound quality delivered by this moderately priced amplifier but also by its very rugged design, conservative major ratings, and its ability to deliver high peak-power levels close to its rated level for long periods of time without becoming overly hot or shutting down. Bass reproduction, using my reference loudspeakers, was tight and unmuddied. Transient response during passages containing sharp attacks (from Compact Discs, of course) didn't strain the amplifier's high-speed performance at all.

Designers of components intended for kit construction must always make certain that their units will hold up—even if the kit-builder constructs a finished product that's a bit sloppier than the factory-assembled version. This means wiring layouts must not be terribly critical, the possibility of hum pickup must be minimized, etc. There have been many small companies who thought they could get into the audio kit business but failed after a short time. Hafler's success, two times running, proves that he and his staff understand what's needed in audio kit design. In its wired version, the DH-220 amplifier represents unusually fine value. If you are not afraid to spend an evening or two building the kit version, the cost per watt goes down considerably, making it an even better bargain.

*Leonard Feldman*

**NOW  
YOU CAN HEAR  
EVERYTHING  
YOU TAPE.  
WITHOUT  
HEARING  
THE TAPE.**

When you tape your music with a dbx Noise-Reduction System, you'll play back something only dbx can give you.

An exact copy of the original.

Because only dbx allows tape to capture the full 90dB dynamic range of digital compact discs. While completely eliminating hiss. Same goes for albums and broadcasts.

Try a dbx NX-40, 222, or 224 Noise-Reduction System with your tape deck. They give ordinary tape extraordinary sound.

For our full-line brochure, call or write: dbx Inc., 71 Chapel Street, Box 100C, Newton, MA. 02195. 617-964-3210.



**dbx**

Music can't live without us.



# One Step Closer to Perfection

The Ohm Walsh 2 is the "Speaker of the Year."  
The new Ohm Walsh 4 is even better.

Over 4,000 acknowledged experts chose the Ohm Walsh 2 as "The Speaker of the Year" in Audio Video International's 1982 Hi-Fi Grand Prix Competition. How could anyone make a better speaker than one that is "among the best speakers we have ever heard, regardless of price" (The Complete Buyers Guide to Speaker/Hifi Equipment), or that has received more rave reviews than any new speaker in the last 10 years? That question is answered by the new Ohm Walsh 4.

## Here's What We Did

- 1** We reproduced the sound quality the New York Times described as "a spacious acoustic ambience with precise stereo imaging creating a 'reach-out-and-touch-it' realism that this listener has rarely experienced."
- 2** We gave it the ability to play louder. The new Ohm Walsh 4 can handle 500 watts rms of music. It can reproduce a full orchestra at live levels in a normal listening room, flawlessly. It also can handle the new digital audio discs, effortlessly.
- 3** We made it play deeper. The Ohm Walsh 4 can reproduce over half an octave deeper bass. At 30 Hz the 4's put out 10 times as much volume as the superb 2s. Maybe only one record out of a hundred demands this—but the 4's are ready whenever you are. They let you physically feel the impact of a bass drum or timpani. An unusual luxury, but it's there.
- 4** We gave it more control range, so you can better match your own listening room to your musical taste. While most high-end speakers do have a high frequency control, the Ohm Walsh 2 has both a high frequency control and an additional Sub Bass Activator control to balance bass output—something no other speaker has ever had. The new Ohm Walsh 4 goes one better. We added a truly exciting and unique control called "perspective." This allows you to change your 'seat' in the audience from up front to



in the rear—matching your taste, your music, your room and your state of mind.

- 5** We made the Ohm Walsh 4 even more convenient to live with. They come built with casters for easy placement or movement. Moreover, our three ambience controls are placed within easy reach on the rear. The speakers are tall enough (40") not be blocked by most chairs and sofas but small enough (only 12½" square at the top) to be inconspicuous in most rooms. They come in five finishes (all genuine wood veneer) to match your furniture.

## Here's How We Did It

We used the same unique, patented technology as in the Ohm Walsh 2. The main transducer is in the shape of a conical pyramid, inverted like an upside down

ice cream cone. This driver is driven full range and by its very nature gives perfect dispersion, so you can still sit anywhere in your room and hear and hear everything correctly. Our patented design mates this driver to a tiny super-tweeter supplementing the highest octave. They are in time and phase alignment at all listening positions. This perfect alignment is what prompted The Washingtonian to say "... the Walsh 2s are among the best 'imaging' speakers at any price, which means they create the original setting in which the music was recorded—Evoking the broad expanse of an orchestra or the compact spacing of a jazz combo, for example."

The inverted driver and cabinet of the Ohm Walsh 4 are much bigger, which allows it to handle more power and go deeper.

## Now You Have A Choice

Either the Ohm Walsh 2 speakers which "... certainly must be rated a 'best buy'" (Audio), "The fact that a pair sells for well under a thousand dollars is, in our opinion, nothing short of a sonic miracle." (The Complete Buyers Guide to Speaker/Hifi Equipment), or the more expensive new Ohm Walsh 4, with both the luxury of extended bass and the ability to be played louder, which the New York Times said "is a bigger and more potent version of the remarkable Ohm Walsh 2 which has gained a devoted following among listeners since its first appearance about 2 years ago." In either case, you will get the sound Popular Mechanics has said, "... meets the ultimate audio test: It makes you unaware of its presence. You feel there's nothing between you and the music." One step closer to perfection.

To get details on buying directly from Ohm, call today toll free.

**800-221-6984**

Or write,

**Ohm Acoustics Corp.**  
241 Taaffe Place, Brooklyn, New York 11205



We make loudspeakers correctly.

Specifications	Ohm Walsh 2	Ohm Walsh 4
Frequency Response	45Hz to 16kHz ± 4 dB	32Hz to 17kHz ± 4dB
Size	32½" tall x 9¼" x 9¼" at top, 11½" x 11½" at bottom	40" tall x 12½" x 12½" at top, 15½" x 15½" at bottom
Weight	29 lbs.	63 lbs.
Sensitivity	87dB at 1 meter with a 2.83 volt input and all controls at maximum	87dB at 1 meter with a 2.83 volt input and all controls at maximum
Finish	Genuine wood veneer, walnut and oak standard. Scandinavian rosewood and black or white lacquer on oak finishes available on special order.	Genuine wood veneer, walnut and oak standard. Scandinavian rosewood and black or white lacquer on oak finishes available on special order.
Inputs	Press connectors accepting "banana plugs" or bare wire up to 12 gauge	Press connectors accepting "banana plugs" or bare wire up to 12 gauge
Controls	2 — low and high frequency each with 3 positions	3 — low, high and perspective each with 3 positions
Power requirement on Music	30 watts minimum/150 watts maximum	50 watts minimum/500 watts maximum
Impedance	4/4 ohms	4/4 ohms
Price per Pair	Under \$995 Depending on finish	Under \$1895 Depending on finish

Enter No. 17 on Reader Service Card

## 3

## NAD 5120 TURNTABLE

### Manufacturer's Specifications

**Speeds:** 33 $\frac{1}{3}$  and 45 rpm.

**Wow and Flutter:** 0.07% at 33 $\frac{1}{3}$  rpm, DIN 45-507.

**Rumble:** -70 dB, DIN 45-539-B.

**Speed Inaccuracy:**  $\pm$ 0.5%.

**Price:** \$248.00.

**Company Address:** 675 Canton St.,  
Norwood, Mass. 02062.  
For literature, circle No. 92

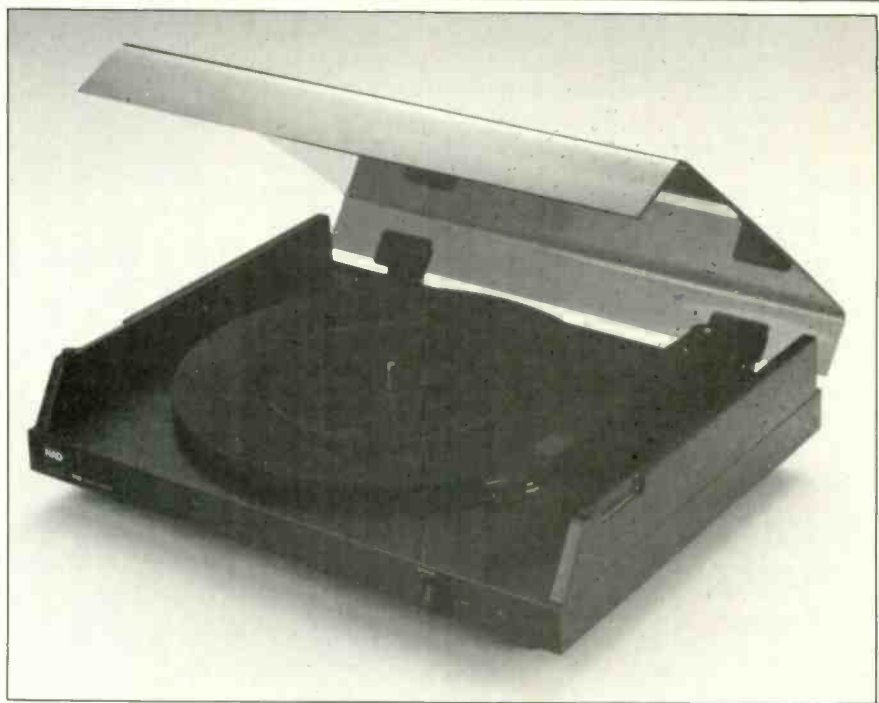

The NAD 5120 turntable was subjected to a few tests and a brief listening evaluation. I used the NAD 9001 high-output moving-coil phono cartridge which was supplied with the turntable. This cartridge showed a gentle downward slope at the high frequencies and was down 4 dB at 20 kHz. No attempt was made to optimize the loading on the cartridge for this review. The response did extend well beyond 20 kHz and was down 10 dB at 40 kHz.

The NAD 5120 turntable and tonearm combination is definitely the result of some innovative engineering, and its various features are well executed. The heavy rubber mat, which is really the turntable platter since it contributes most of the mass, provides effective damping for both itself and the record. The speed was about 1% slow at 33 $\frac{1}{3}$  rpm, and there is no speed vernier control. The turntable torque under load is similar to the old AR turntable and is reasonably good. A control marked "Stop/Lift-Play" is located on the front of the base and can be operated with the lid down. It applies a braking action to the platter as well as lifting the tonearm. At the end of a record, the tonearm is lifted and the turntable is stopped. There is a pilot light on the front of the base which lights when the turntable is running.

The tonearm is the most radical part of the NAD 5120. The thin, flat, ruler-like appearance seems very strange at first sight. The article in this issue mentions a dip at 140 Hz in the right channel; I measured a dip at about 170 Hz. The left channel did not have this dip. However, I did measure a dip of 4 dB at 47 Hz with the platter stationary during the tests of isolation from an external acoustic field. This shifted to 55 Hz with the turntable running. The tracking force, side-thrust, and damping adjustment controls are well-marked and easy to use. NAD supplies a list of most cartridges with their tracking force and damping requirements, and I used

**Fig. 1—Acoustic isolation of the NAD 5120 turntable in a 95 dB SPL sound field. (The 0 dB reference is 10 cm/S at 1 kHz.)**

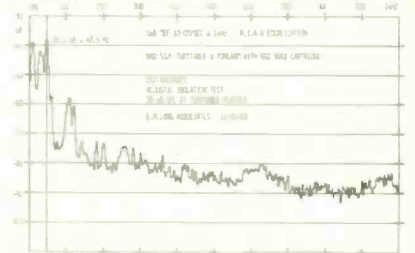

**Fig. 2—Arm-cartridge resonance, using NAD's 9001 phono cartridge. (Note the frequency multiplication factor is 0.1.)**

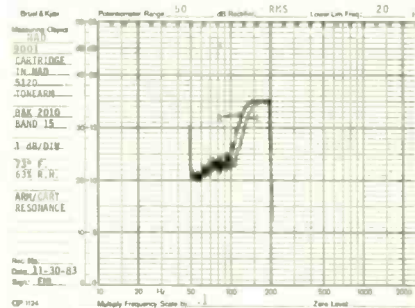

the settings listed for the NAD 9001 cartridge. I measured the tonearm/cartridge low-frequency resonance and verified the data shown in the article. The damping system works, and the result is a very firm, tight sounding bass.

The usual controlled mechanical-impulse tests were not made, but I did perform some quick tests by rapping my knuckle against the turntable base and slamming my fist against the platform upon which the turntable was resting; the stylus remained in the groove without skipping. During my brief listening, I found the sound to be brighter than I care for, but stereo imaging was quite good. *Edward M. Long*



# Polk Voted #1 In 1983 Hi Fi Grand Prix



For state-of-the-art technology, performance and value

### 3 Polk Winners in 3 Years

The Hi Fi Grand Prix is a prestigious annual competition for products that best exemplify the state-of-the-art in audio, combined with benefits and value for you the consumer. The winners are voted on by audio retailers with a concurring review of leading critics and:

Selected For:

- Quality
- Specifications
- Innovation in design
- Craftsmanship
- Cost/performance value

### 1983 Hi Fi Grand Prix Speakers of the Year

#1. Polk Audio

Total Brands Mentioned: 74

Polk speakers have won the Hi Fi Grand Prix for the last three years and this year Polk Audio was voted as the #1 loudspeaker manufacturer overall.

What is the secret of Polk's Grand Prix winning performance? Each and every Polk speaker (for home and car systems) is built with the same 100%+ dedication to the quality approach in every aspect of design construction and performance.

Enter No. 18 on Reader Service Card

### Hear why Polk is #1

There is a Polk loudspeaker which is the perfect choice to fulfill your sonic needs. Write to us or use the reader's service card for information on our loudspeakers and the name of your nearest authorized Polk dealer.

Polk Audio, Inc. 1915 Annapolis Rd.,  
Baltimore, MD 21230. In Canada,  
Evolution Audio.

**polkaudio**<sup>®</sup>  
The Speaker Specialists<sup>®</sup>



Use your convenient Mastercard, Visa, American Express, Diners Club. Ask about details on COD orders. Money orders accepted. Allow 4 weeks clearance on personal checks

# LABELLE

Send \$1 For Our Catalog

**NOW AT 2 LOCATIONS:**  
**155 MAIN STREET**  
**BIDDEFORD, MAINE 04005**  
 \*\*\*\*\*  
**224 WEST JERICO TURNPIKE**  
**SYOSSET, L.I., NEW YORK 11791**

**CLOSED SATURDAY**  
**OPEN SUNDAYS**  
**10 A.M.-8 P.M.**

Prices And Products In Effect Jan. 20-Feb. 20, 1984

Call information for phone number

Open Mon. Thru Fri. And Sunday, 9 A.M.-8 P.M. Closed Saturday

These Products Are For Mail & Phone Orders Only • All Merchandise Is New And Guaranteed • Quantities Are Limited And Subject To Availability

**FOR MAIL ORDERS CALL TOLL FREE 1-800-341-0783** In Maine, Alaska and Hawaii, Call 1-207-783-1401 Call for shipping and handling charges

<b>SONY</b> Walkman & Cassette Stereo. <b>\$49<sup>95</sup></b> Complete Set WM10 \$89.95 WM5 \$79.95 WM7 \$119.95 PROWD6 \$239.95	<b>SONY</b> FM Stereo Cassette FM-1 <b>\$77<sup>95</sup></b> Complete Set FM2 \$129.95 WA33 \$119.95 WA55 \$129.95 SRF 80W \$99.95 SRF 30W \$49.95	<b>TOSHIBA</b> FM Stereo Cassette KT-53 <b>\$54<sup>95</sup></b> Complete Set KTA-SI \$109.95 KT-VSI \$79.95	<b>SANYO</b> AM/FM Stereo Cassette MG-31A <b>\$49<sup>95</sup></b> MG 10 \$44.95 MG-7 \$24.95 MG 90 \$69.95 MG-100 \$99.95 MG 15 \$49.95 MG-1 \$59.95 MG 12 \$44.95 MG110DT \$109.95 MG34DT \$89.95 M5550 \$59.95	<b>AIWA</b> AM/FM Stereo Cassette W/Recording & Auto Reverse HS-J02 <b>\$129.95</b> Complete Set HS-T02 \$109.95
--	---	--	---	---

## TURNTABLES

## THIS MONTH'S HI-FI-SPECIALS

<b>Technics</b> SL-5 LINEAR \$109.95 SL-B100 \$62.95 SL-B200 \$72.95 SL-B300 \$82.95 SL-Q200 \$79.95 SL-Q300 \$89.95 SL-QX200 \$139.95 SL-QX300 \$149.95 SL-6 \$149.95 SL-7MD \$199.95 SL-10 \$399.95 SL-V5 \$129.95 SL-DL5 \$129.95 SL-BL3 \$119.95 SL-QL15 \$179.95 SL-B5 \$139.95 SL-D500 \$169.95 SL-1200 MKII \$289.95 CALL FOR OTHER TURNTABLE MODELS AND PRICES	<b>PIONEER</b> PL-2 \$ 62.95 PL-4 \$ 78.95 PL-5 \$ 94.95 PL-88F \$259.95 <b>SONY</b> PSLX-500 CALL PSLX-55 CALL PSFL-1 CALL PSFL-77 CALL <b>CARTRIDGES</b> SHURE DT-15P \$ 39.95 DT-25P \$ 59.95 DT-35P \$ 79.95 V15 TYPE 4 \$ 79.95 V15 TYPE 5 \$124.95 STANTON PRO-16 \$ 39.95 PICKERING TL-2 \$ 29.95	<b>RECEIVERS</b> <b>Technics</b> SA-110 109.95 SA-210 134.95 SA-310 164.95 SA-410 189.95 SA-510 279.95 SA-810 329.95 SA-1010 519.95 <b>PIONEER</b> SX-202 119.95 SX-303 139.95 SX-40 CALL SX-50 289.95 <b>Sansui</b> Z-3000X CALL Z-5000X CALL Z-7000X CALL Z-9000X CALL	<b>JVC</b> RK-22 159.95 RX-44 199.95 RX-60 249.95 RX-80 359.95 <b>NIKKO</b> NR-320 149.95 NR-700 199.95 ALPHA 230 CALL ALPHA 450 CALL BETA 30 CALL BETA 50 CALL GAMMA 30 CALL <b>SONY</b> STRVX-450 CALL STRVX-550 CALL STRVX-750 CALL <b>marantz</b> SR-520 209.95 SR-620 269.95 SR-8100 409.95	<b>CASSETTE-DECKS</b> <b>Technics</b> RS-M205 99.95 RS-M224 109.95 RS-M227X 134.95 RS-M234X 149.95 RS-M235X 174.95 RS-M245X 204.95 RS-M253X 289.95 RS-M222 209.95 <b>TEAC</b> V-400X CALL V-707RX CALL V-909RX CALL V500X CALL <b>Sansui</b> D-370 CALL D-570 CALL D-990 CALL D-W9 CALL	<b>J.V.C.</b> KDV-33 149.95 KDV-40 184.95 KDV-44 199.95 KDV-5 209.95 <b>SONY</b> TCFX-44 CALL TCFX-505R CALL TCFX-600 CALL TCFX-555 CALL TCFX-1010 CALL <b>PIONEER</b> CT-4 99.95 CT-5 139.95 CT-30 189.95 CT-50R CALL CT-70R CALL CT-80R CALL CT-90R CALL	<b>AKAI</b> HX-2 159.95 HX3 179.95 GX-7 269.95 GXF-91 487.95 GX-R5 229.95 GX-R6 274.95 <b>EQUALIZERS</b> ADC-SS-5 89.95 ADC-SS-115 159.95 ADC-SS-215 209.95 ADC-SS-315 249.95 SE-8 SANSUI 229.95 SEH-310 SONY CALL SEQ-11 CALL AUDIO SOURCE EQ-1 259.95
---	--	--	--	--	--	---

## BLANK TAPES

## VIDEO RECORDERS

## TELEPHONES & ANS. MACHINES

<b>VIDEO</b> MAX T-120 \$ 8.49 ea. MAX T-120 H.G.X \$10.95 ea. TDK-T-120 \$ 8.49 ea. TDK-T-120 H.G. \$10.95 ea. L-750 \$ 8.45 ea. L-750 H.G. \$10.95 ea. MINIMUM ORDER 10 TAPES	<b>MAXELL</b> UD-XLII C-90 \$ 2.49 ea. UD-XLII SC-90 \$ 3.19 ea. <b>TDK</b> SA-C90 \$2.39 ea. SA-XC90 \$3.39 ea.	<b>PANASONIC JVC</b> PV-1220 HRD-120 PV-820 HRD-225 PV-1520 HR-7650 PV-1720 HR-2650 PV-6600 GX-NSU GX-N7OU Call for other models and prices on Hitachi, Quasar, Olympus, Minolta, GE, Akai.	<b>UNIDEN PANASONIC</b> KXT-2220 \$119.95 KXT-1515 \$139.95 KXT-1521 \$179.95 KXT-1525 \$189.95 KXT-1530 \$299.95 KXT-2010 \$109.95 KXT-3830D \$169.95 KXT-3802D \$149.95 KXT-2130 \$159.95 VA-8020 \$199.95 VA-8030 \$219.95 <b>SANYO</b> TH-1010 \$129.95 TH-1015 \$ 89.95 TH-2000 \$159.95
--	---	--	--

## AM/FM CASSETTE CAR STEREO

## CAR SPEAKERS

## RADAR

<b>PIONEER</b> KPA700 \$174.95 KP2500 \$109.95 KPA400 \$139.95 KPA600 \$164.95 KPA500 \$149.95 KE3100 \$179.95 KE5100 \$179.95 KE6100 \$199.95 KP7500 \$169.95 KE7200 \$229.95	<b>JENSEN</b> RE-530 \$299.95 RE-520 \$259.95 RE-518 \$239.95 RE-512 \$219.95 RE-508 \$179.95 R-408 \$179.95 R-220 \$149.95 EQA5000 \$89.95 A-35amp \$49.95	<b>CONCORD</b> HPL-101 \$149.95 HPL-118F \$249.95 HPL-122 \$279.95 HPL-502 \$189.95 HPL-504 \$219.95 HPL-532 \$389.95 CALL FOR NEW MODELS	<b>MITSUBISHI CAR AUDIO</b> CZ-757 \$249.95 RX-735 \$209.95 CZ-727 \$159.95 RX-707 \$154.95 RX-726 \$129.95 RX-723 \$99.95 RX-909 \$209.95 RX-755 \$169.95 CV-23 \$89.95	<b>PIONEER</b> TS-1633K \$59.95 pr. TS-6905 \$74.95 pr. TS-6906 \$89.95 pr. TS-6907 \$99.95 pr. TS-6904 \$49.95 pr. TS-T3 \$32.95 pr. TS-1655K \$74.95 pr. TS-167 \$49.95 pr. TS-108 \$39.95 pr. TS-1044K \$49.95 pr.	<b>JENSEN</b> J3033 \$89.95 pr. J2020 \$79.95 pr. J3013 \$69.95 pr. J2037 \$69.95 pr. J2054 \$34.95 pr. J3003 \$56.95 pr. J1242 \$84.95 pr. J1065 \$59.95 pr. J1401 \$69.95 pr. J1405 \$44.95 pr.	Whistler Spectrum \$229.95 Z-70 \$79.95 Z-2000 \$199.95 Q120Q \$119.95 Intercept \$219.95 Fuzzbuster Het Model2 \$169.95 Call For Other Models & Prices
--	--	--	---	---	---	---

<b>BLAUPUNKT</b> Seattle \$189.95 Richmond \$219.95 Manhattan \$219.95 CR-3003 \$264.95 Tucson \$349.95 Washington \$439.95 BEA155 \$129.95 BE-55 \$69.95 BPA-415 \$89.95	<b>Clarion</b> 4350R \$89.95 5100R \$119.95 6300R \$129.95 5500R \$139.95 6700RT \$159.95 8100R \$159.95 6900RT \$169.95 6950RT \$169.95 7500R \$189.95 8500R \$179.95 8550R \$179.95	<b>SONY</b> XR-15 CALL XR-25 CALL XR-45 CALL XR-55 CALL XR-65 CALL XR-75 CALL XR-85 CALL XR-100 CALL XR-M10 CALL XM-120 CALL XM-E7 CALL	<b>PANASONIC</b> CQS-958 \$329.95 CQS-903 \$289.95 CQS-818 \$239.95 CQS-788 \$219.95 CQS-763 \$209.95 CQS-747 \$189.95 CQS-717 \$164.95 CQS-668 \$129.95 CY-SG100 169.95 CQS-793 CALL	<b>SANYO</b> FTV-100 \$159.95 FTC-1 \$49.95 FTV-90 \$129.95 FTC-38 \$89.95 FTC-120 \$199.95 FTX-140 \$229.95 FTX-160 \$249.95 FTX-180 \$289.95	Send \$1 for your copy of Labelle's catalog, over 300 pages of super buys. Name _____ Address _____ City _____ State _____ Zip _____
--	--	--	---	--	--

## 35MM CAMERAS

## 35MM CAMERAS

<b>Canon</b> AE 1 with 50mm 1.8 FD Lens \$179.95 AE 1 PROGRAM w/50mm 1.8 FD Lens \$219.95 A-1 w/50mm 1.8 FD Lens \$259.95 SURE-SHOT 35M w/Case \$119.95 CASES FOR CANON \$18	<b>MINOLTA</b> XGM w/50mm f1.7 \$169.95 X700 w/50mm f1.7.. \$219.95 XG-1 w/50mm f1.7. \$149.95 X-570 w/50mm f1.7 \$189.95 CASES FOR MINOLTA \$18	<b>PENTAX</b> K 1000 w/50mm f2.. \$119.95 ME SUPER w/50mm f2..... \$159.95 Super Program w/50mm f1.7A \$249.95 CASES FOR PENTAX \$18	<b>NIKON</b> FE w/50mm 1.8E... \$239.95 FM2 w/50mm 1.8E. \$239.95 FG w/50mm 1.8E... \$234.95 F3 Body w/Highpoint \$489.95 CASES FOR NIKON... \$18	<b>FAMOUS MAKER</b> 80-200mm MACRO ZOOM <b>\$69.95</b>
---	---	--	--	--

30 day return policy. All returns must be phoned in for prior authorization. All products must be returned in original factory packaging, clean and unscratched. Do not write, tape, or deface manufacturers original cartons. Please include blank warranty cards. If there should be a problem or a question upon receipt of your order, please feel free to call our customer relations dept. toll free 1-800-328-6800 or write to us.



4

## BOSTON ACOUSTICS MC-1vdH PHONO CARTRIDGE

### Manufacturer's Specifications

**Type:** High-output, moving-coil.

**Frequency Response:** 20 Hz to 20 kHz,  $\pm 1.5$  dB.

**Channel Balance:** Within 1 dB.

**Channel Separation:** 23 dB minimum from 200 Hz to 10 kHz; 20 dB minimum from 10 to 20 kHz.

### Recommended Tracking Force

**Range:** 1.5 to 2.1 grams.

**Output Voltage:** 2.5 mV at 3.54 cm/S rms at 1 kHz.

**Cartridge Weight:** 5.0 grams.

**Mounting:** Standard 1/2-inch (12.7-mm) centers.

### Recommended Load Impedance:

47 kilohms (non-critical); capacitance, non-critical.

**Cantilever:** Thin-walled, high-strength extruded aluminum alloy.

**Vertical Tracking Angle:** 20°.

**Dynamic Compliance:**  $8 \times 10^{-6}$  cm/dyne at 100 Hz.

**Stylus:** van den Hul, 0.14  $\times$  3.3 mil (3.5  $\mu$   $\times$  85  $\mu$ ), grain-oriented, square-shank diamond, nude-mounted.

**Effective Tip Mass:** 0.27 milligram.

**Tracking:** 70- $\mu$ m amplitude, 300-Hz lateral modulation at 1.8 grams.

**Price:** \$200.00.

**Company Address:** 247 Lynnfield St., Peabody, Mass. 01960.

For literature, circle No. 93

There seems to be a new trend developing in the field of audio transducers—speaker manufacturers introducing their own brands of phono cartridges. The latest entries come from Boston Acoustics, with two moving-coil cartridges, the MC-1vdH reviewed here and the MC-1E. They are identical except for their styli, with a van den Hul in the former and a standard elliptical stylus in the latter. It is most surprising

um, or high mass) and with just about any preamplifier, according to Boston Acoustics.

The MC-1vdH is fitted with the stylus tip developed by A. J. van den Hul of Delft, The Netherlands. The shape of this stylus tip resembles that of the cutting stylus, but instead of the cutter's 2- $\mu$  radius, it has a radius of 3.5  $\mu$ . Because of this small front-to-back contact radius, only a small part of the



that all manufacturers of electromechanical and mechano-electrical transducers have not joined forces long ago, since their products have the greatest effect on the sound of a high-fidelity system.

The MC-1vdH is a low-impedance, moving-coil phono cartridge with two horizontally opposed coils for each channel, producing a greater output than the usual moving-coil designs. Thus, there is no need for a stepup transformer or a pre-preamplifier. Further, Boston Acoustics states that the MC-1vdH's low effective moving mass results in an armature resonance above the audible range, without the need for an exotic, expensive, high-Q cantilever material. Channel separation is maintained to 20 kHz, groove tracing is improved, and record wear is minimized because the resonance is low Q and is not excited by audio signals.

The MC-1vdH, with its low mass and moderate compliance, is compatible with most any tonearm (e.g., low, medi-

record groove is traced at any one time, with only one specific moment of tracking for any portion of the groove. Thus, the tip movement is precisely the same as the groove modulation. The vertical groove-contact line is exactly vertical, with no curvature, and its radius measures 85  $\mu$ . The stylus is a grain-oriented, square-shank diamond, nude-mounted on the aluminum alloy cantilever. (For a further discussion of the van den Hul stylus tip, see my comments on page 62 of the November 1981 issue of *Audio*.)

The cartridge comes with the necessary mounting hardware, a small screwdriver, and a small paper alignment protractor that is quite accurate. Since the cartridge is rectangular with straight edges, it is quite easily installed with the aid of the protractor. Boston Acoustics has provided its dealers with an aluminum alignment gauge that permits absolutely accurate alignment of the MC-1vdH (or the MC-1E) in the headshell and tonearm.

It is ironic, now that the CD has been launched, there are so many high-quality phono cartridges being introduced—nearly a last hurrah.

### Measurements

The Boston Acoustics MC-1vdH phono cartridge was mounted in an Audio-Technica AT-N headshell and used with the Technics EPA-A250 (S-shaped) interchangeable tonearm unit attached to the Technics EPA-500 tonearm base, which was mounted on a Technics SP-10 Mk II turntable. The cartridge was oriented in the headshell and tonearm with the aid of the Denesen Geometric Soundtractor. When the cartridge alignment was finalized, I checked it against the paper alignment protractor supplied with the cartridge

and found it to be accurate. That alignment was checked against the Boston Acoustics aluminum alignment gauge, and the gauge was found to be very precise.

Laboratory tests were conducted at an ambient temperature of 70° F (21.11° C) and a relative humidity of 73%, ±3%. The manufacturer's recommended stylus tracking force of 1.8 grams was used for all laboratory measurements and listening tests. The anti-skating force was set at 2.0 grams. The load resistance was 47 kilohms, and the load capacitance 241 pF.

As is my practice, measurements are made on both channels, but only the left channel is reported unless there is a significant difference between the two channels (in which case both channels are reported for a given measurement).

The following test records were used in making the reported measurements: Columbia STR-100, STR-112, STR-170; Shure TTR-103, TTR-109, TTR-110, TTR-115, TTR-117; Deutsches HiFi No. 2, B & K QR-2010, and Ortofon 0002.

Frequency response, using the Columbia STR-170 test record (Fig. 1),

## FORETASTE OF THE FUTURE?

It is ironic, now that the digital Compact Disc has been launched, such a plethora of high-quality phono cartridges have been introduced recently, among which the Boston MC-1vdH ranks very highly. If this is nearly the last hurrah for phono cartridges, they are certainly not going out with a whimper.

However, in comparing the relative qualities of today's cartridges and records with CD players and discs, some observations are in order. I have been fortunate in having a superb Telarc LP and CD made from the same digital master tape, Stravinsky: *The Firebird* and Borodin: *Music from Prince Igor, Overture and Polovetsian Dances* (Telarc DG-10039 and CD-80039). To conduct an experiment, I used a pair of B & W 801S speakers and the Technics SL-P10 CD player, with its very accurate cueing mechanism, in addition to the components cited above. I set the sound level so that the speakers would provide what I consider my normal room listening level, at an SPL of 85 dB, C-weighted (dBC), at 10 feet for the identical *forte* passage. (My listening room is a modified live-end, dead-end type.) Under these conditions, the CD version provided an SPL of up to 10 dBC greater dynamic range than the same passage on the LP version. (Telarc's chief engineer, Jack Renner, has assured me that they use neither compression nor limiting when making the original digital tape.) The limitations of cutting geometry simply would not accom-

modate this 10-dBC increase, and thus the dynamic range on the CD more accurately reflects the dynamic range of the digital master recording. Irrespective of sheer numbers, the comparative listening experience incontrovertibly provides a much more exciting insight into the music, and that SPL of 10 dBC looms very large in terms of emotional impact.

While the Boston Acoustics MC-1vdH phono cartridge acquitted itself admirably, neither it nor any other phono cartridge can possibly challenge the superior sonic qualities of this Telarc Compact Disc. The digital recording is free of wow and flutter and the usual hiss and impulse noise associated with the playback of analog phonograph records.

Even for the highest quality audiophile recordings, a dynamic range of 62 to 64 dB is the best usually achieved in conventional mastering. It is true that, through the use of such new techniques as direct metal mastering, there can be further improve-

ment in dynamic range. However, the DMM process is expensive and not likely to become the standard cutting technology any time soon. Most important, even if an analog phonograph record could equal the performance parameters of a digital disc, this quality would be very transitory, as the inevitable stylus/groove wear would ultimately destroy the recording, while the non-contact laser beam playback would assure premium sound quality forever.

I hasten to add that, at present, there are very few CDs of the quality of Telarc's *The Firebird*. However, it is inevitable that, with time, most of the digital discs can be expected to equal or better this level of quality.

Am I saying that the death knell has sounded for analog phonograph records? Certainly not! Analog recordings will continue to be produced for many years, but it would be foolish to suppose that they could stem the digital tide indefinitely.

B. V. P.





I was particularly impressed with reproduction of the high recorded velocities on audiophile discs like Telarc's *1812*.

was 0 dB at 40 Hz, +1.75 dB at 50 Hz, -0.5 dB at 8 kHz, 0 dB at 12 kHz, and +1.5 dB at 20 kHz. The overall frequency response was +1.75, -0.5 dB from 50 Hz to 8 kHz and -0.5, +1.5 dB from 8 to 20 kHz. Separation was -21.5 dB at 1 kHz, -24 dB at 10 kHz, -20.5 dB at 15 kHz, and -18.5 dB at 20 kHz. It is apparent from these data that the MC-1vdH phono cartridge has a relatively flat frequency response and a good high-frequency separation. The 1-kHz square-wave response (Fig. 2) is typical for a moving-coil cartridge, with a minimal overshoot followed by some low-level ringing, which is undoubtedly present on the test record. After disabling the arm's anti-resonance system, the arm-cartridge lateral low-frequency resonance was measured as 9 Hz with a 4-dB rise. The high-frequency resonance point was at 20 kHz.

The arm-cartridge dynamic mass was measured as 13 grams, and the dynamic vertical compliance as  $11.5 \times 10^{-6}$  cm/dyne at the vertical resonant frequency of 13 Hz.

The harmonic distortion components of the 1-kHz, 3.54 cm/S rms, 45° velocity signal from the Columbia STR-100 were 1.78% second harmonic and 0.40% third harmonic, with less than 0.20% higher order terms.

The vertical stylus angle measured 24.5°, using the Vertical Tracking Angle Meter (Inclination Meter), Model 3002, developed by the CBS Technology Center.

Other measured data are: Wt., 5.0 g. Opt. tracking force, 1.8 g. Opt. anti-skating force, 2.0 g. Output, 0.71 mV/cm/S. IM distortion (200/4000 Hz, 4-to-1): Lateral (+9 dB), 0.8%; vertical (+6 dB), 3.6%. Crosstalk (using Shure TTR-109): Left, -27 dB; right, -24 dB. Channel balance, 0.4 dB. Trackability: High-freq. (10.8-kHz, pulsed), 30 cm/S; mid-freq. (1000 and 1500 Hz, lat. cut), 25 cm/S; low-freq. (400 and 4000 Hz, lat. cut), 24 cm/S; Deutsches HiFi No. 2, 300-Hz test band was cleanly tracked to an amplitude of 77 microns (0.0077 cm) lateral at 14.50 cm/S at +8.70 dB and to 55.4 microns (0.00554 cm) vertical at 10.32 cm/S at +5.86 dB.

The MC-1vdH played all the test bands cleanly on the Shure Audio Obstacle Course Era III musical test rec-

Fig. 1—**Frequency response and separation.**

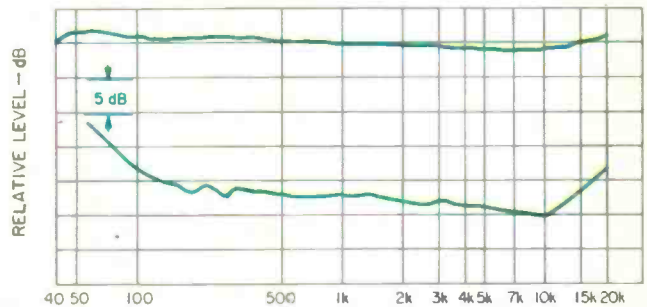
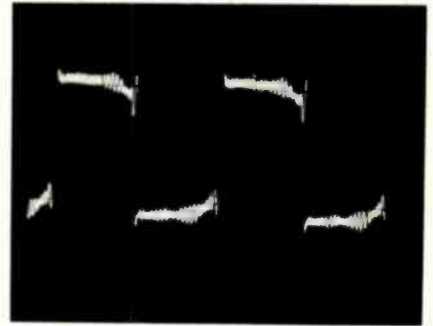

Fig. 2—**Response to a 1-kHz square wave.**



ord. On the Shure Audio Obstacle Course Era IV, the cartridge experienced a mild difficulty when tracking level 5 of the harp and flute test bands. The cartridge responded extremely well, considering that the velocities of the combined instruments, harp and flute, exceed 45 cm/S. (Commercial records rarely exceed 15 cm/S peak recorded velocity.) The Shure Audio Obstacle Course Era V test record was tracked without difficulty at all levels.

#### Use and Listening Tests

While auditioning the MC-1vdH prior to making any laboratory tests, I was quite impressed with its smooth sound, excellent stereo imaging, and sonically well-defined and tight bass. The laboratory data appear to confirm what my ears had already told me. The musical evaluation was made with the following equipment: The aforesaid tone-arm and turntable, the Audio-Technica AT-666EX vacuum disc stabilizer, Crown IC-150 preamplifier, Audire DM-700 power amplifier, and a pair of Pentagram P-10 full range loudspeakers that reproduce bass below 25 Hz without the need of a subwoofer. Following

the speaker manufacturer's recommendation, the P-10s were connected to the amplifier with 4PR Kimber Kable in parallel with Live Wire cable.

During the final listening evaluation, I was particularly impressed with the cartridge's ability to reproduce the high recorded velocities found on most audiophile records, including the cannon fire present on the Tchaikovsky *1812 Overture* (Telarc 10041). Tracking ability, transparency of sound, and transient response were all very good. Some of the exceptionally good records I used to audition the MC-1vdH were *Organasm* (Warren Lubich, organist, Sonic Arts LS-15), Poulenc: *Gloria and Organ Concerto* (Atlanta, Shaw, Telarc DG-10077), Sibelius: *Four Legends from the Kalevala* (Philadelphia, Ormandy, Mobile Fidelity MFSL 1-523) and RCA's superbly remastered recording of Rimsky-Korsakov's *Scheherazade* (Chicago, Reiner, RCA Red Seal Point Five ARP1 4427).

To sum up, the Boston Acoustics MC-1vdH should be considered as a superb choice for anyone desiring a top-notch, high-output moving-coil phono cartridge. *B. V. Pisha*

**FLY WITH THE EAGLES**







# FIERO MEANS "PROUD," PERFORMANCE MEANS EAGLES.



Eagle radials are the only performance tires available on Pontiac's hot new Fiero. Every Z28 Camaro. And every Datsun 300-ZX Turbo. Here's why:

**1. All-out performance.** In 1983 SCCA Showroom Stock national competition—street radial against street radial—Goodyear Eagles\* won more races than all other radials combined.

**2. All-around performance.** Goodyear Eagles are meeting the auto companies' toughest specifications for performance—radial tread wear, speed ratings, ride quality and steel-belted strength.

\*Tread shaved to racing depth.

**3. Race-bred performance.** Only Eagle radials give you the direct benefit of Goodyear's long-time domination of world racing. Example: The tread pattern of our Eagle GT radial is derived from our Formula One racing rain tire.

These are the reasons why Goodyear performance radials are standard equipment on more cars sold in this country than any other performance tires.

These are the reasons you should visit the Eagles' Nest at Goodyear today. Or write now: The Goodyear Tire & Rubber Company, Box 9125, Dept. 113, Akron, OH 44305.



**GOODYEAR**

Enter No. 19 on Reader Service Card

5

## MARANTZ CD-73 COMPACT DISC PLAYER

### Manufacturer's Specifications

**Frequency Response:** 20 Hz to 20 kHz.

**Dynamic Range:** 90 dB.

**S/N:** 90 dB.

**Channel Separation:** 90 dB.

**Harmonic Distortion:** 0.005% at 1 kHz.

**Output Level:** 2.0 V.

**Number of Programmable Selections:** 15.

**Dimensions:** 16 $\frac{3}{8}$  in. (41.6 cm) W x 3 $\frac{1}{4}$  in. (8.25 cm) H x 13 $\frac{3}{8}$  in. (34.6 cm) D.

**Weight:** 19 lbs. (8.6 kg).

**Price:** \$999.00.

**Company Address:** 20525 Nordhoff St., Chatsworth, Cal. 93111.

For literature, circle No. 94



If you are looking for all the bells and whistles that can possibly be incorporated in a CD player, the Marantz CD-73 is probably not for you. On the other hand, if you want flawless reproduction from Compact Discs, superb error-correction capabilities, unusually good shock resistance, and a CD player that looks good and is easy to operate, the CD-73 may be just what you are looking for.

As is true of many Marantz products, the company has added its own special touch to this, their first CD player.

There is, of course, the familiar gold-anodized aluminum front-panel casting, which adds a touch of elegance to the unit. But beyond that, Marantz engineers have managed to endow the CD-73 with a host of programming features and capabilities without ending up with a cluttered and intimidating front panel.

Up to 15 different selections can be programmed (providing there are that many "tracks" on the disc being played) to play in any order. The programmed selections can be



played over and over again, if desired, as can an entire disc. Should you change your mind after play has begun, you can cancel any track you decide you'd rather skip, and, of course, you can cancel the entire program at the touch of a single button. Should you decide you've heard enough of a given selection, a touch of another button advances you to the next pre-programmed or sequential track on the disc being played. Fast-forward or fast-reverse movement of the laser pickup is also actuated by front-panel buttons, but no audible sound is heard during these fast modes. The front-loading Marantz CD-73 resembles a modern cassette deck in its proportions.

As for the features that Marantz chose not to incorporate (but that are found on some CD players), the CD-73 does not have "phrase repeat" capability nor does it have an elapsed-time counter. Neither is there any provision for index cueing or cueing by time into a given track. While a remote control is not presently available for this model, Marantz plans to introduce one later, and the presence of two extra jacks on the rear panel suggest that, when it is available, it will be a wired type rather than an infrared. Marantz has indicated that the remote will operate only four functions of the player.

### Control Layout

A power on/off button and its associated indicator light, plus the "Open/Close" button for the disc compartment, are located at the extreme left of the unit. When the "Open/Close" button is touched, not only does the entire disc drawer slide out, but the front face of the door swings down by an angle of about 45°, while the retaining arm (which holds the disc down during play) swings up and out of the way, to make disc loading that much easier. The fast rewind, fast forward, "Next Program/Play" and "Pause" touch buttons are all along the lower edge of the drawer's front face.

Most of the right half of the front panel is given over to a large display window. Arranged in a horizontal row along the top of the display area are 15 small green LEDs which illuminate behind highly visible numerals, 1 through 15. When a disc is inserted and the drawer is closed, all 15 LEDs light up. Corresponding orange dots of light below each of these numerals light up to show what track is currently being played. As play progresses, the green lights go out, one at a time, while the orange light moves along to indicate successive tracks being played.

Programming buttons below the display area include "Stop/All Cancel," "Select," "Preset," "Repeat" and "Cancel." These are used to pre-program disc play in any of the ways previously described. Indicator lights above the buttons clearly depict not only what is happening, but what is being programmed as well. For example, if you wanted tracks 2, 4, and 7 to play, in that order, you would push the "Select" button to advance the orange indicator light to track 2. The orange light would flash on and off until you pushed the "Preset" button, entering the instruction in the player's memory circuits. You would then push the "Select" button again, advancing the lower light until it is flashing beneath the number 4, at which time you would press "Preset" once again. The same procedure would be fol-

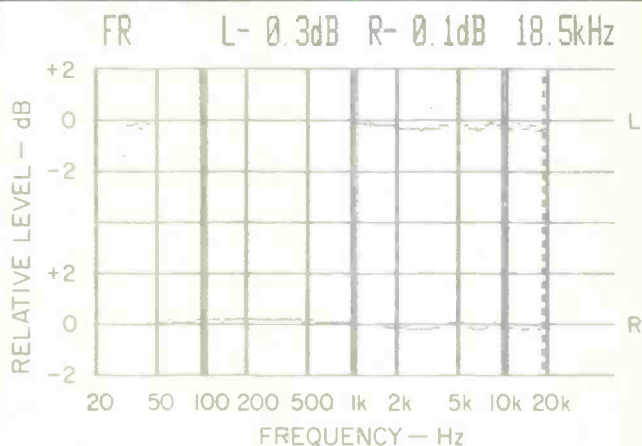

**Fig. 1—Frequency response, left (top) and right channels, at 0 dB (maximum) level.**

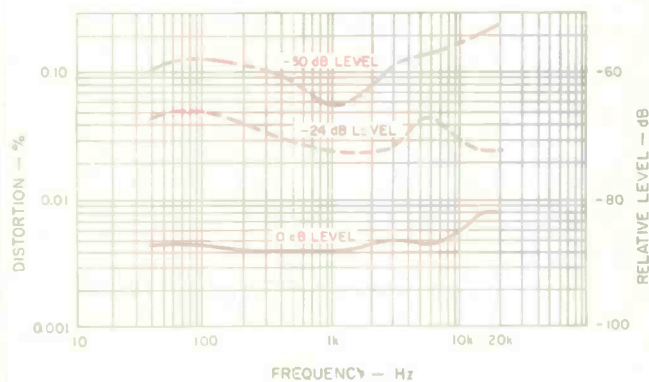

**Fig. 2—Harmonic distortion vs. frequency at levels of 0, -24, and -30 dB.**

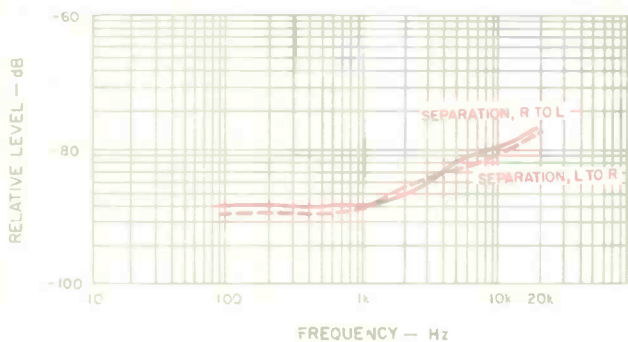

**Fig. 3—Channel separation vs. frequency.**

The CD-73 played through all my test disc's simulated defects without missing a beat. Only a very few players have done this.

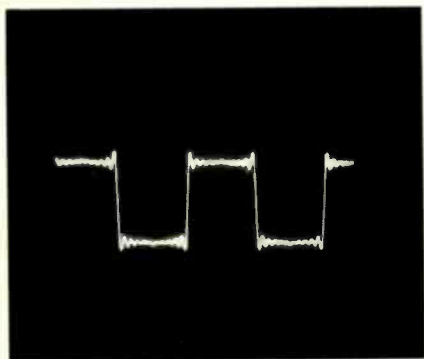

Fig. 4—Reproduction of 1-kHz square wave.

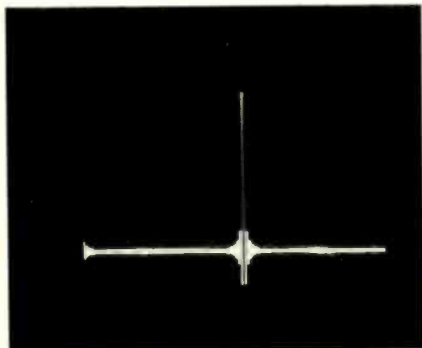

Fig. 5—Single-pulse test.

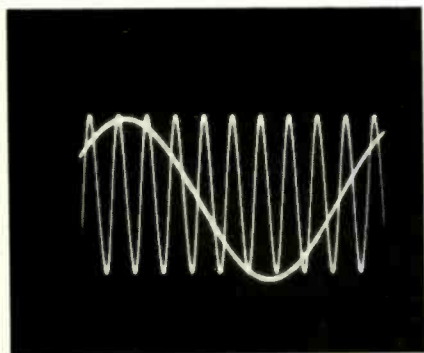

Fig. 6—Phase linearity test, 2- and 20-kHz signals.

lowed for programming play of track 7. Next, you would depress the "Play" button on the disc drawer. All but the desired track number lights would now be extinguished, the orange light would move to 2 (the first desired track to be played), and only the 2, 4 and 7 green LEDs would remain illuminated.

The rear panel of the Marantz CD-73 is equipped with the usual pair of audio output jacks (output level is not adjustable) plus a pair of jacks intended for the optional, four-function, wired remote-control unit.

#### Measurements

Figure 1, which shows the frequency response for both left and right channels, was plotted using my Philips test disc's sweep signals, which run from 20 Hz to 20 kHz. Frequency response within this band never deviated from the ideal by more than 0.3 dB. Note that the vertical scale in this figure has been expanded so that each division equals 2 dB instead of the usual 10 dB. If the less sensitive scale were used, all you would see would be a straight line.

Harmonic distortion at mid-frequencies, for maximum recorded output, was 0.0045%, rising only very slightly at the high frequencies to 0.008%, as shown in the graph of Fig. 2. At a -24 dB recorded level, distortion increased to 0.025% at mid-frequencies, while at a still lower recorded level of -30 dB, distortion at 1 kHz (actually, the test frequency is 997 Hz) was 0.045%.

Output linearity was accurate to within 0.1 dB from the 0-dB reference level down to -80 dB, below which it became difficult to read output with any degree of accuracy because of equipment limitations. Stereo separation for both channels (plotted in Fig. 3) was better than 85 dB for low and mid-frequencies, decreasing to 78 dB at 10 kHz and 74 dB at 20 kHz.

Intermodulation distortion measured a negligibly low 0.004% at maximum recorded output level, increasing to 0.03% at -20 dB recorded level. Signal-to-noise ratio was 97 dB, unweighted, increasing to 107 dB when an A-weighting network was introduced in series with the measuring instrument.

The shape of a 1-kHz square wave as reproduced by the Marantz CD-73 (see Fig. 4) was identical to that reproduced by other CD players (notably those manufactured by Philips for sale by Magnavox in this country) which employ pre-D/A digital filtering and oversampling. The same holds true for the single-pulse signal shown in the 'scope photo of Fig. 5. In fact, the Marantz CD-73 resembles Magnavox's top player in many physical respects as well as in the features that it incorporates and those that are omitted. If you haven't already guessed, the Marantz CD-73 is, in fact, manufactured for Marantz by Philips, its layout and performance characteristics having first been established by Marantz engineers.

A phase-check signal on the Philips test disc, consisting of a 2-kHz sine wave reproduced by one channel output and a 20-kHz sine wave signal on the other channel, was used to check phase error. When no phase error exists, the positive axis crossing of the high-frequency signal is supposed to correspond with the positive axis crossing of the low-frequency signal. As you can see by examining Fig. 6,



**The Marantz CD-73  
performs superbly—in both  
its sound and its simplicity  
and reliability of operation.**

that is almost precisely what happens when these signals are reproduced by the Marantz CD-73. As I have mentioned before in these reviews, there are many critical listeners who maintain that such phase accuracy contributes to greater accuracy of musical reproduction and to an improvement in high-frequency reproduction in particular.

I used my special error-correction test disc to check how well the player can overlook minor (and not so minor) defects in a disc. The test disc contains an opaque wedge of ever-increasing width, several artificial opaque "dots" (representing dust particles), and a simulated smudge. The Marantz CD-73 was able to play through all of these defects without missing a beat. This means it was able to correct errors from obstructions as large as 900 microns in width or diameter and that it completely ignored the simulated semi-opaque fingerprint smudge. Only a very few CD players I have tested have accomplished this feat, among them—you guessed it—the Magnavox player. The CD-73 was relatively impervious to mistracking when I tapped its surface or side panels. It took fairly firm blows on its outer case to cause mistracking.

**Use and Listening Tests**

I must confess that being limited to a maximum of only 15 programmable selections on a CD player can be a bit of a nuisance when testing such products, since one of my test discs contains 27 useful test bands while the other one contains 41. Of course, it is possible to play track numbers higher than 15 on the Marantz player by moving to track 15, and then selecting the "Next Program" button progressively, keeping count (or watching an oscilloscope) until the desired test signal is reached, but that's a bit cumbersome. When it came time to listen to music, this objection was quickly forgotten. There are virtually no classical CDs which contain more than 15 tracks (with the possible exception of some of the early sampler discs), and even in the case of pop records, few carry that many selections.

With that minor objection out of the way, I can attest to the fact that the Marantz CD-73 is a superb performer in every way, both in the way it sounds (given some decent source material, which is no longer the problem it once was) and in its simplicity and reliability of operation. Scanning forward to find a high-numbered track does take a bit of time (12 seconds to get to track 15, from a "cold" start at track 1), but few of us, I think, would normally program play in that manner. Mostly, I suspect, we simply want to hear a Compact Disc straight through, and for that purpose, I can think of no other CD player which performs this function better than Marantz's first entry.

*Leonard Feldman*



When the "Open/Close" button is touched, the disc drawer slides out and the door's front face swings down by 45°.

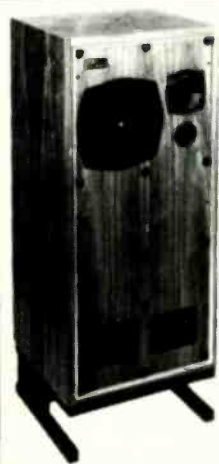

**HAVE YOU CHECKED THE PRICE OF A GOOD SUB-WOOFER LATELY?**

They certainly are not inexpensive. To use sub-woofers optimally, a pair of them are necessary. Most loudspeakers on the market require sub-woofers for extended bass response.

This is not the case with **IMF Electronics Studio Monitor** loudspeakers. Their one-eighth wavelength tapered and heavily damped transmission-line bass loading of the 8" polymer cone woofer provides low frequency response down to 23 Hz! With the inherently low distortion of transmission-line bass, coupled with ultra-rigid construction, bass sounds are reproduced with exceptional clarity and control, free of overhang and resonant colourations.

The vital mid-range of the **Studio Monitor** is reproduced by our 4" engineered polymer cone driver, ferro-

fluid damped to provide higher power-handling and lower distortion. This driver is mounted in its own tapered and damped line whose non-parallel walls ensure freedom from standing waves. Our 3/4" chemical cone tweeter is also ferro-fluid damped, and affords extremely linear response from 3 kHz to 40 kHz. The design of the mid-range and tweeter drivers permits "in-line" close mounting for improved acoustical coupling. Exceptionally smooth, high definition sound, with precise stereo imaging and the stunning power and clarity of transmission-line bass characterizes the **Studio Monitor** loudspeakers.

Even the most severe critics of the CD digital discs concede that their bass response is phenomenally clean and extended. The **Studio Monitor** has the "built-in" sub-woofer capability to effortlessly reproduce these low frequency sounds. The **Studio Monitor** loudspeakers are the least expensive and smallest embodiment of **IMF Electronics** transmission-line design.

For a dramatic and revealing experience, audition the **Studio Monitor** at selected dealers.

**IMF ELECTRONICS, INC.** 5226 State Street  
Saginaw, Michigan 48603 Tel (517) 790-2121 Telex 227461

**IMF ELECTRONICS, LTD.** Richardson Street, High Wycombe  
Buckinghamshire, England HP11 2SB Tel (0494) 35576 Telex 83545

# Acoustic Research introduces three essentials for the ultimate system.

**1.** Our new line of nine different computer-designed speakers, ranging from the economical, space-saving AR8B bookshelf model to the awesome AR9Ls with its Dual Dome™ mid-high range driver and thunderous Bass Contour Chamber.

**2.** A new three-point suspension turntable whose predecessor was a legend among audiophiles ten years ago. So much of a legend we decided to bring it back in a totally updated version—re-designed from the dustcover on down. With your choice of universal tone arm mounting platform, or AR's own new medium mass straight arm.

**3.** Our new AR compact remote control unit employing ultra-sophisticated microcircuitry. From wherever you sit or stand, you can control stereo balance and work a wide range of functions on your amp for maximum convenience and ideal sonic performance.

**AR**

Hear what you've been missing.

For additional details and dealer locations, please write: Teledyne Acoustic Research, 10 American Drive, Norwood, MA 02062, USA.





# SPEAKERS

This advertorial guide was prepared by those manufacturers wishing to show you the latest developments and designs in loudspeaker technology.



LINN  
S.A.R.A.  
ISOBARIK



polk  
audio

D  
D'Ascanio Audio

ALLISON

QUAD

A  
PYRAMID

B&W

JBL

ACOUSTAT  
SPEAKERS • ELECTRONICS

KEF

# SPEAKERS

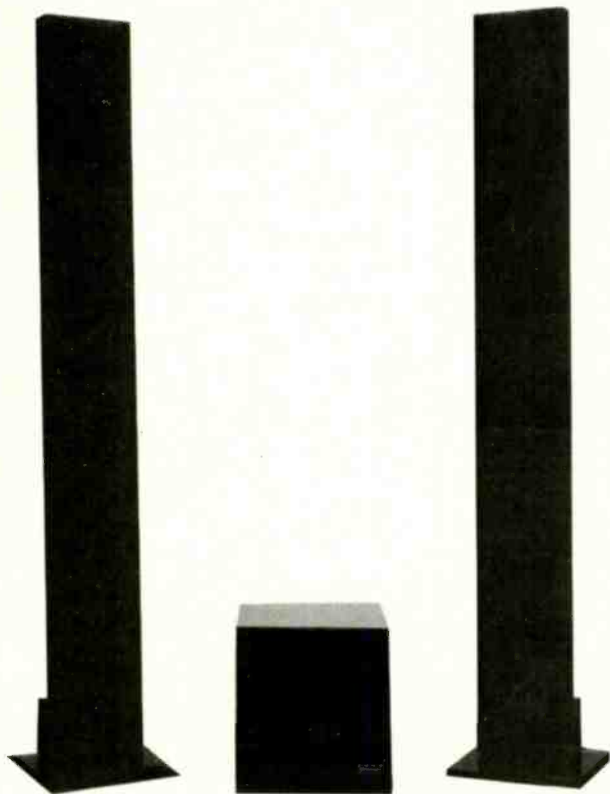

**Acoustat Corp.** has announced the **Model One + One** full-range electrostatic speaker system; the firm pioneered the design and development of high-resolution electrostatic speaker systems and pure-FET electronics. The Model One + One offers a spatiality, transparency, and sonic quality which was heretofore attainable only in the most expensive and exotic speaker designs. A floor-to-ceiling, vertical line source, the One + One offers ideal vertical and horizontal dispersion, while occupying a minimum of floor space for easy integration into the smallest of listening rooms. The dimensions are 94 H x 11½ W x 3½ D. The optional MK-131 bass-interface system, a new floor-firing sub-woofer assembly, allows increased dynamic headroom and higher efficiency, if selected. The unit comes in an attractive cubic table design, with finishes matching the One + One, which has 10 different grill cloth/base combinations to enhance virtually any decor. Suggested retail price is \$1395.00 per pair.

Frequency Response: 30 Hz to 20 kHz,  $\pm 3$  dB.  
Power Requirements: 70 to 200 watts per channel.  
Nominal Impedance: 4 ohms.

**ACOUSTAT**  
SPEAKERS • ELECTRONICS

Response of the tweeter in the Allison: Six, top, directly on axis to 88° off axis, and a well-known competitor which shows typical high-frequency loss over the same range of angles.

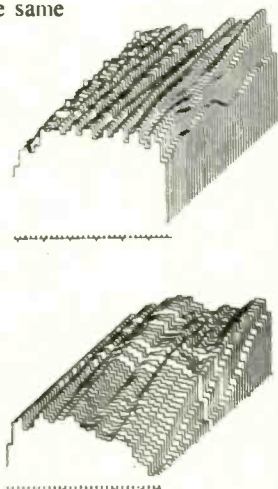

**Dispersion and Realism:** At Allison Acoustics we believe the ideal loudspeaker would radiate acoustic energy with equal strength in every direction at every audible frequency. For loudspeakers close to a surface, this means uniform dispersion in the forward hemisphere. Simple as it seems, this was never achieved in a practical tweeter until the **Allison Convex-Diaphragm** design. We abandoned the old rigid-piston idea and invented a diaphragm designed to flex so that it simulates closely the motion of an expanding/contracting hemisphere, in contrast to the simple axial motion of an ordinary tweeter's diaphragm. Success of this design is shown by response curve families for an **Allison: Six** (top) and a typical competing system (below). The curves are 1/3-octave analyses from 31 Hz, left, to 20 kHz, right, and are at angular increments of 2°. The on-axis curve (0°) is at the back and 88° is at the front. The Allison tweeter's fundamentally different performance is not merely a technical tour de force. It is audible as a convincing illusion of space, without distortion of natural size, and a stable stereo image for all listening positions. This tweeter is used in every Allison system.

Enter No. 21 on Reader Service Card

**ALLISON ACOUSTICS INC.**  
7 Tech Circle, Natick, Massachusetts 01760



# SPEAKERS



B&W has responded to the requirement for new levels of speaker quality for the new digital sources with the DM2000 and DM3000. Based on a new concept, the acoustical triangle, these speakers provide outstanding reproduction of digital source material. Stephen Roe, head of development for B&W, describes the concept: "Due to the vast difference in wavelength involved in the two extremes of the audio spectrum, it has always been necessary in serious hi-fi speakers to use a plurality of drive units of different sizes to adequately reproduce music. In the DM2000 and DM3000, the bass/midrange unit has been laser-optimized to behave as a source which diminishes in size with increasing frequency. At the lower frequencies, in the case of the DM3000, this unit is augmented with another identical drive unit with a first-order difference filter between the two. In the extreme bass, still more drive-unit area is obtained by use of an acoustic drive radiator. At frequencies above 3 kHz, a version of our laser-designed TZ26 is employed. This effectively gives a drive unit area which diminishes smoothly from 80,000 mm<sup>2</sup> at 20 Hz to 530 mm<sup>2</sup> at 20 kHz. In other words, an acoustic triangle."

Enter No. 22 on Reader Service Card

**B&W** the Best in the World



Frequency Range: 35 Hz to 20 kHz.  
Sensitivity: 88 dB SPL, 1 watt, 1 meter.  
Nominal Impedance: 8 ohms.  
Recommended Power: 15 to 200 watts.

The Heybrook HB-3 has been designed for the listener who demands the highest standards of musical reproduction at a realistic cost. The design therefore utilizes drive units which exhibit excellent transient attack and dynamic range with very smooth frequency response characteristics. Most importantly, their operational ranges are controlled by a crossover network which, although thoroughly researched and containing some unique features, is essentially simple. To insure that no unwanted cabinet colorations occur, the construction is of internally braced, 3/4-inch, wood-veneered chipboard with 1/2-inch heavy damping pads on all internal panels. The mid-range enclosure is a tube of 1/6-inch hardened plastic with neutral acoustic properties. Carefully calculated amounts of foam are used internally to further tune the system and eliminate standing waves. All internal connections are made with high-definition, multiple-strand cable. The flat front baffle assists high frequency dispersion and results in a stable stereo image which is further enhanced by the asymmetrical offsetting of the mid- and high-frequency drivers. The result is a loudspeaker unrivalled in its presentation of musical information. Price: \$989.00 per pair.

Enter No. 23 on Reader Service Card



**D'Ascanio Audio**

# SPEAKERS

**JBL's T545** is a 6 x 9-inch, 3-way car speaker system, which is designed to fit into the standard rear-deck mounting hole. It is capable of delivering live concert sound levels with punch and clarity, even in the largest automobiles. In addition to the 6 x 9-inch woofer with its 1½-inch flat-wire voice-coil, the unit is equipped with a 2½-inch driver capable of very high power handling with smooth musical reproduction through the mid and high frequencies. For added presence and clarity, the T545 also has a 1-

inch ultra high-frequency driver, which increases the model's efficiency and power handling. The tweeter in this system is angled at 15° relative to the low-frequency driver, so that the sound is directed at the listener for enhanced imaging properties. In addition, the T545 has connection terminals which allow installation in a bi-amped configuration. The system's crossover frequencies are 5 and 7 kHz, while the maximum power handling capacity is 100 watts. The manufacturer's list price is \$249.95 per pair.



**JBL**

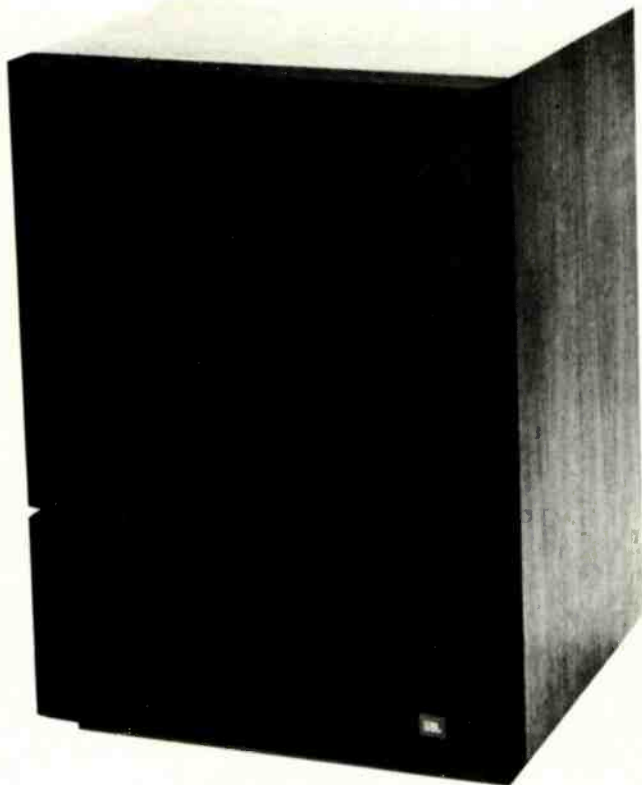

Without a doubt, some of the most dramatic moments in music involve the lowest audio frequencies. The lowest notes of a pipe organ, a bass drum, a synthesizer . . . such music is a big part of what makes a live performance special. Yet the octave between 25 and 50 Hz—the very octave with all the drama in it—is missing on most stereo systems. It takes a separate low-frequency system to reproduce this information at the levels needed to make it exciting. The **JBL B380** is just such a low-frequency system. Not only will it restore the missing octave, it will also improve midrange clarity. The woofers on most full-range systems are called upon to reproduce substantial amounts of mid-frequency information. Relieving them of the responsibility for low bass, with its attendant long cone excursions, reduces modulation of the higher frequencies. The **JBL BX63A** dividing/summing network is designed to work with the B380. The BX63A provides variable crossover frequencies to provide compatibility with almost any full-range system, and it also will bridge a stereo amplifier to give the single-channel signal to drive the B380.

**JBL**



# SPEAKERS



The new **KEF Standard Series** utilizes many advanced design techniques to produce a level of performance surprisingly close to the legendary KEF Reference Series but at prices affordable to virtually anyone interested in a serious music system. The **Carlton III** is a floor-standing, three-way system, employing a passive radiator for extended bass response. The **Carina II**, a bookshelf system uses a symmetrical driver arrangement for optimum horizontal or vertical placement. The **Coda III** is a significantly improved version of the two-way bookshelf model which has been widely acclaimed in the U.K. as a "best buy." The latest model in the Standard Series, the phenomenal **Chorale III** sets new standards for performance-to-price ratio. All the KEF Standard Series carries the KEF full five-year limited warranty.

### Carlton III

Frequency Range: 47 Hz to 20 kHz,  $\pm 2.5$  dB.

Sensitivity: 86 dB SPL, 1 watt, 1 meter.

Minimum Amplifier Power: 15 watts.

Price: \$750.00 per pair.

Enter No. 24 on Reader Service Card

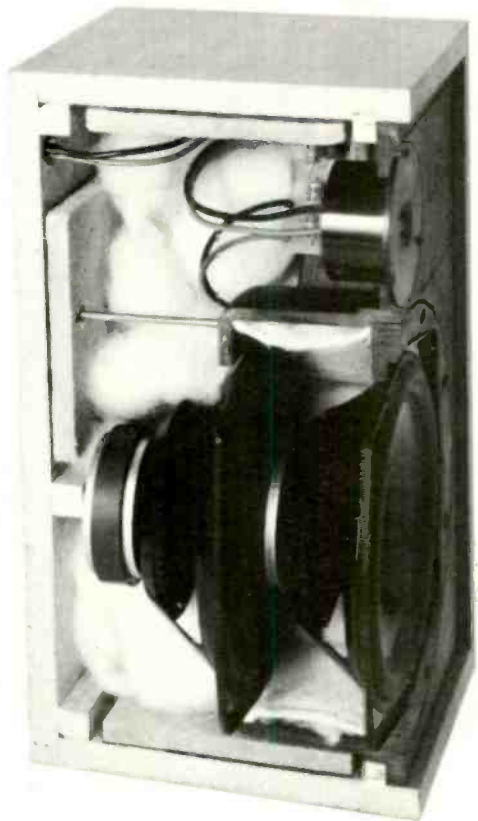
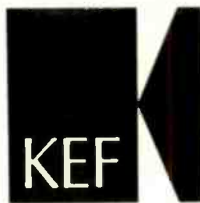

The **Linn SARA** is a monitor loudspeaker designed for applications where small size, without a corresponding sacrifice in performance, is a primary requirement. The SARA is a two-way, 4-ohm system with the crossover point at 3,000 Hz. The SARA's Isobarik bass-loading system employs a second woofer operating inside the sealed enclosure to maintain a region of constant pressure in a cavity between the two drivers. This control of the internal pressure extends the low-frequency response by allowing the woofer to perform as if it were in a much larger enclosure. In addition to being mechanically coupled by the enclosure, the woofers are electrically linked through a dual crossover system, which allows the internal woofer to correct errors produced by the external driver. This method of loading results in low frequency output flat to 35 Hz, with low distortion, from an enclosure 17 x 13½ x 9½ inches. The high energies developed by this system require some unusual construction techniques, including the use of an expanded foam-loaded plastic baffle sub-assembly and internal steel rods which prestress critical surfaces inside the enclosure. The Linn SARA has a suggested retail of \$1295 per pair. Linn also manufactures the DMS, a floor-standing 3-way loudspeaker, utilizing Isobarik loading, at \$2295 per pair. Enter No. 25 on Reader Service Card



# SPEAKERS

Revolutionary New Speaker: The Grand Prix award-winning **Polk SDA** loudspeakers incorporate a unique, new and fundamentally revolutionary speaker technology (patent pending), which can be said to make them the world's first true *stereo* (as opposed to mono) loudspeakers. The dramatic and easily heard performance benefits in spatial fidelity, dimensionality, and imaging have been praised by critical listeners and experts around the world with words like "mind boggling," "astounding" and "flabbergasting!" First True Stereo Speaker: What do we mean by the first true *stereo* speaker? When we went from mono to stereo 25 years ago the basic mono technology of loudspeakers was never changed to take into account the fundamental physical difference between mono and stereo reproduction and the design goal differences between a mono and a stereo speaker (until the SDAs). Problem of ICD: Basically speaking, the fundamen-

tal difference between mono and stereo reproduction is that mono utilizes a single signal, reproduces it over one speaker, and means it to be heard by both ears. Stereo, however, utilizes 2 signals and reproduces them over 2 speakers, but means each signal (and speaker) to be heard by only a single ear. The left ear should only hear the left stereo signal (and speaker), and the right ear should only hear the right stereo signal (and speaker). When each ear hears both speakers and signals (as occurs when you listen to mono speakers in stereo), your psychoacoustic hearing system becomes confused by too many signals, and your brain no longer properly recreates the full three-dimensional form of the recording. The signal each ear incorrectly hears from the wrong speaker is a form of acoustic distortion called interaural crosstalk. Did you ever wonder why headphones can sound so spacious and three dimensional? It's because there's no inter-

aural crosstalk distortion! In the Polk SDAs we eliminate ICD and realize tremendous sonic benefits. Polk's Elegant Solution: The Polk SDAs eliminate ICD by incorporating two completely separate sets of drivers (called stereo and dimensional drivers) into each cabinet. The stereo drivers radiate the normal stereo signal, the one you want to hear; the dimensional drivers radiate a different signal, one which effectively cancels the unwanted ICD (the opposite channel signal going to the wrong ear). Thus, each ear hears only its unmixed, proper, intended signal. SDA's Dramatic Audible Benefits: The resulting sound takes on a whole new dimension. The perceived sound expands beyond the speakers and often beyond the walls of the listening room itself. You will hear each instrument, vocalist or sound as it becomes distinct, tangible, and firmly placed in its own position in space. Listening will be a revelation!

Enter No. 26 on Reader Service Card





# SPEAKERS

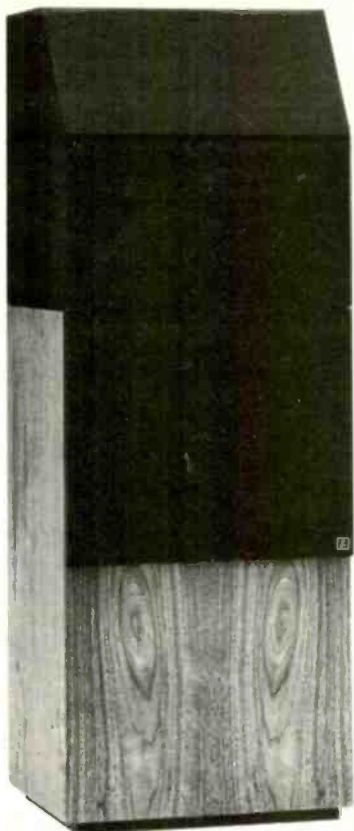

Because of driver/enclosure compromises, conventional multi-driver loudspeakers are limited in bandwidth and imaging and suffer inter-driver modulation distortion. Assigning portions of a system's frequency range to individually enclosed speaker cabinets reduces these limitations. Each module in the **Pyramid Futuresonic** system is designed and constructed for optimum driver/enclosure performance with rigorous crossover compatibility. This further avoids cabinet coloration through driver/enclosure mismatch and favorably affects costs. The centerpiece of the system is Pyramid's MET 7, a 2-way mini-speaker. When used alone, a pair of MET 7s serve as a complete system, delivering high-quality, full-range reproduction in a small size. To further extend the MET 7's performance, two additional modules are available: The MET 8W, a sub-woofer, and the MET T-9, a ribbon tweeter. Together they extend and enhance the lows and highs of the system while maintaining spectral balance, and increasing imaging and dynamic range. All three modules were designed to achieve an imperceptible transient blend, producing a homogeneously unified system. Sophisticated design assures no crossover glitches (ringing, peaks or suck-outs) between any of the drivers in the MET 7 or the extremely wide band of the entire system. Full spectral balance, unaltered by the vigorous demand of difficult program material, is scrupulously maintained.

Enter No. 27 on Reader Service Card

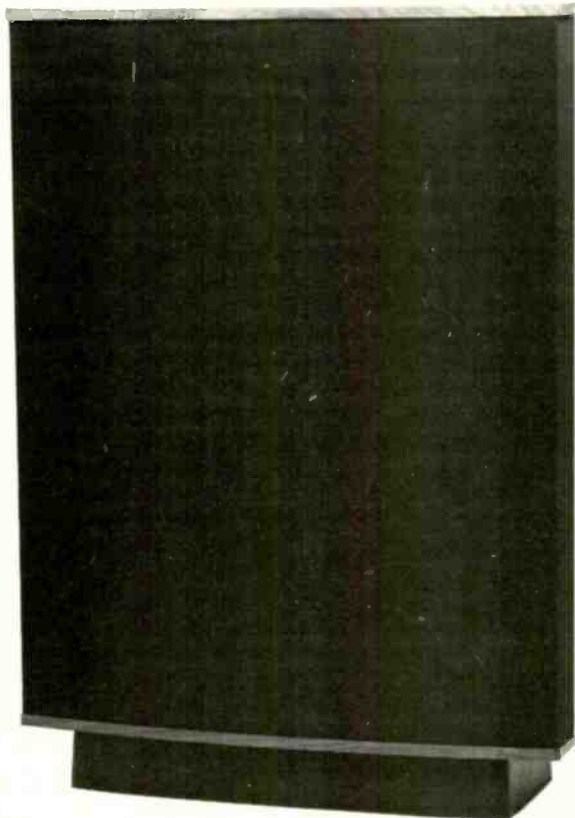

The combination of **Quad** electronics (**Model 34** preamplifier, **FM 4** stereo tuner, **405.2** power amplifier) and electrostatic loudspeakers (**ESL 63s**) is perhaps the only audio equipment equally revered by audiophiles and design-conscious music lovers alike. The unparalleled ergonomics of the Quad electronics are coupled with circuitry so far ahead of its time and so outstanding in performance that these components have become the heart of many "cost no object" systems. Similarly, the ESL 63 is probably regarded as the "best loudspeaker in the world" by more reviewers and audiophiles than any other speaker currently available. While the Quad components are not inexpensive, neither are they outlandishly priced. When you consider their advanced technology, elegant design and outstanding performance, Quad may not only make the finest one-brand system in the world, but the last audio system you might buy for many years to come.

Enter No. 28 on Reader Service Card

**QUAD**   
for the closest approach  
to the original sound

MICHAEL TEARSON  
JON & SALLY TIVEN

## SPIRITUAL MATTERS

**Infidels:** Bob Dylan  
**Columbia QC 38819.**

Sound: C — Performance: B

By now you've likely read plenty about how *Infidels* is Bob Dylan's return to form and his best album in years and a break with the overt spirituality of the last three albums.

Well, *Infidels* is, in fact, the best sounding album Dylan has done in years. This one wasn't done with the slap-dash studio techniques and chaos which have usually been a Dylan trademark. The new album is still essentially live in the studio, but it has as tight a band as Dylan has ever had behind him. The key is co-producer Mark Knopfler of Dire Straits, who, besides organizing the sessions, put the band together. In addition to his own guitar, he brought along Alan Clarke, the keyboardist in Dire Straits. Next came the far-famed Sly Dunbar/Robbie Shakespeare drums/bass rhythm section, and, to top it off, the guitar of Mick Taylor, alumnus of the Mayall Band and the Stones. Dylan, as usual, adds guitar, keyboards, and most importantly, harmonica.

The band really kicks old Bob along and makes him work harder than usual. The interplay is what makes the album memorable, especially between the guitars, with Knopfler eloquent and flowery and Taylor gritty and terse. The raw playing is the album's true star.

The songs of *Infidels* are revealing about where Bob Dylan's head has been lately, but, as usual, you have to be able to read between the lines. It is clear that the spiritual odyssey Dylan has been on—at least since the *Blood on the Tracks* album of '74—is not complete. Whether or not he is still involved in the charismatic Christianity or the rumored Hasidic Judaism which permeated his last three albums, all critically lambasted, is unimportant. What is important is that the search continues. Consider the song "Man of Peace," which is about Satan and his many alluring disguises, not Christ. The song travels along on a bouncing joyride of a melody, like vintage Dylan with a nasty edge. The equally spirited "Neighborhood Bully" is quite obviously about Israel and defends that country's policies vociferously. Pilfering riffs



Illustration: Rick Tulka

from "Jumpin' Jack Flash," "Union Sundown" rocks even more furiously, as it rants about the decline of American products and labor in the marketplace. This one's my favorite of the set. His attitudes in "Sweetheart Like You" seem determinedly old-fashioned, as he asks a lady out on the town why she isn't at home taking care of someone. The use of the word "sweetheart" appears significant here. "I and I" is a convoluted riddle of a song filled with jagged scenes of danger and foreboding, familiar scenery for Bob Dylan.

Still, it is the playing that I remember. I don't think that there is a lot of immortal songwriting on *Infidels*, although the great performances make it Dylan's best showing in ages. Just place any of these up against, say, "Like a Rolling Stone" or "Tangled Up in Blue" and you may find some nice wordplay, but not the ringing phrases.

*Infidels* isn't a return to anything. It is a very natural step in the ongoing evolution of an important American poet. Whether or not his most brilliant work really is behind him, is a question we must leave to time. For now, however, Bob Dylan in 1984 just isn't as crucially important as he was in 1964 or 1968 or 1975—but don't count out any voice as potentially eloquent as his.

What *Infidels* shows is that, for the first time in years, Bob Dylan is restless

to make songs and records that will matter to people even if he's not quite sure who they are. *Michael Tearson*

*Editor's Animadversions:* Yes, I'm going to do a Jann Wenner on po' defenseless M.T., above. Mostly, I'm going to do it because I've felt like Rock's William Blake has been singing my life, for near a quarter century now. Sometombs, to do a "Spannard," his music's been what I've just died through; other tunes, it's more nearly prophecy. But, also, because my notion of what it means to be a professional is to take every dog out for a walk when it's his birthday. Like God cares as much for the moment as for the hour (no, that's not mine; 's from Wm. Gaddis). And damn it, M.T., you say the "best album since *Blood*," that is, in 10 years, from an artist, who, arguably, is (with the Stones and Beatles) one of the three most important in this area of music; surely, Mister M.T., that deserves more than a "B" rating for performance.

So, anyway, and up front, this Dylan-freak's opinion is that if you ever had your neck hair raised by a Dylan tune, you should buy this LP. MTV plays a "Sweetheart" video, which I wish I had; it's different from the one on the LP, which seems like it had a "snarl filter" applied to the title words every time



RX-505 Unidirectional Auto Reverse Cassette Deck



## Nakamichi didn't invent auto reverse... We perfected it!...The RX-505



Unidirectional Auto Reverse Mechanism



Discrete 3-Head Configuration



Asymmetrical Dual-Capstan Transport



Precision Electronics

If you're willing to gamble performance, choose any auto-reverse deck. If gambling isn't your style, audition the RX-505—the auto-reverse deck that meets *Nakamichi* standards of perfection.

We *invented* the Discrete 3-Head configuration to ensure you of *total* performance. We know that only *physically* discrete recording and playback heads can be adjusted for perfect magnetic azimuth and optimized to utilize a tape's *full* potential.

We invented the Asymmetrical Dual-Capstan Diffused-Resonance transport to eliminate vibration-induced flutter and isolate the tape from reel perturbations. We perfected the transport so inter-capstan guides and pressure pads aren't required. With them removed, scrape flutter is gone and music emerges with *incredible* clarity.

We created precision equalizers and direct-coupled electronics to match our unique recording and playback heads and ensure unparalleled response and remarkably low distortion.

Until now, these tech-

nologies couldn't be applied to an auto-reverse deck that *records* and plays in both directions. Our newest creation—UDAR—Unidirectional Auto Reverse—changes that.

UDAR is a radically new concept in auto reverse. Tape doesn't change direction; the head doesn't "flip over." Such tricks cause azimuth misalignment and destroy frequency response. Instead, UDAR turns the *cassette* as you do by hand. UDAR is fast, reliable, and gentle. And, since the tape always moves in the *same* direction, there's *no* bidirectional azimuth error. The RX-505 provides *Nakamichi* performance on *both* sides!

Learn what *perfect* auto reverse is all about. Audition the RX-505 at your Nakamichi dealer. It has everything you expect from Nakamichi—and many

unique features that make auto-reverse *recording* easier than ever. You'll also find the RX-303—a 2-Head deck with the same transport and many of the features of the RX-505.

For more information, write Nakamichi U.S.A. Corporation, 1101 Colorado Avenue, Santa Monica, CA 90401.



 **Nakamichi**

Enter No. 29 on Reader Service Card

this guy sang them. But "Sweetheart" isn't the strongest song on the album; it's "Jokerman," which should have filled an entire side, as "Sad-Eyed Lady" did. And "I and I" gives me broken ribs from breathing hard, 'cause I'm getting maybe-old and I'm tired of adolescent angst of young love and let us be. But wouldn't you love a lady who'd owned the world or been the faithful wife of a righteous king in a former life and who will still be there, at home sleeping, after The Bomb?

Fools rush in where angels fear to tread,  
both of their futures so full of dread

He'll put both his arms around you;  
you can feel the tender touch of the beast.

But there's a woman on my block,  
sittin' there in a cold chill,  
she say, "Who's going to take away  
their last sons to kill?"

Trying to stick down a few lines of the poetry off this album made me realize just how strong this man sings. There's more than a few people who say Bob can't sing, but he does things on "Don't Fall Apart" that I doubt, seriously doubt, even Tony Bennett or Frank Sinatra could do. (Frank Sinatra sings *The Bob Dylan Songbook*?) But, no, Bob's voice isn't any smoother, and definitely not like you associate with a "good" singer and probably never will be. And, no, his range isn't any wider. What it is, is his timing, emotive power, and phrasing. The inside-outside, ahead-of-behind the beat phrasing on "Don't Fall Apart" is incredible—and hypnotic.

And another deceptively strong thing is the evenness of the songwriting. Like I can't make head nor tail of Middle Eastern politics, and I could quibble with Dylan on whether the Israelis have obsolete weapons (F-16s are pretty hot items, as the kill score shows, and their Uzi machine-pistol is the world's current standard), but when my pick for the disc's weakest song, "Neighborhood Bully," comes out of my music box, there's not much else I can do but listen. And the whole disc is like that—for me, an admitted Dylan-freak.



**Musicianship:** Dunbar's drums and Shakespeare's bass are as tight as a rhythm-machine, and everyone else is right there on top of their beat—except for Dylan's voice vamping along on triple time. The guitar work: I just wish there were more of it, a lot more of it. My left brain's been turned on inventing riffs and lifts ever since I first played this disc.

The sound (oh, man, what am I going to say? This record comes from another part of the company I get my paycheck from): Surface noise throughout the disc results in 30 to 40 dB of room between the Dunbar rimshots and the slush; there's a pop and a locked groove on "License," another lock groove on "Sweetheart," and why, why, why, Ian Taylor, was Dylan's voice mixed so far down in so many places (there's too many choruses where nobody can make out the words)? That's a "D" rating, M.T.

So, like I said ahead, if you've ever had any strong liking for Dylan's work, go get this one.—*E.P.*

**What's New:** Linda Ronstadt  
**Asylum 60260, \$8.98.**

Sound: B+      Performance: C+

*What's New* is the long anticipated album of Linda Ronstadt doing Tin Pan Alley standards, backed by Nelson Riddle's arrangements and orchestra.

Technically, this is a lovely album. The sound is deliciously clean and very mellow, with no sharp edges. Riddle knows his stuff; after over 30 years

with baton and charts he ought to. His settings never overwhelm a singer.

Ronstadt's singing is lovely too. She has obviously taken pains mastering the technical aspects of ballad singing. With songs like these, a singer stands fully exposed, as there's no meaty beat to hide behind, especially on the better-known ones.

And that is the rub. While Linda's singing is strong technically, she rarely sounds truly relaxed. Ideally, these songs should sound as if the lyrics are coming to the singer at the moment they are being sung, not as if they are being recited. I can't get past the feeling of Ronstadt *performing* the songs, and I never quite feel her plumbing their emotional content. Her phrasings are clear and basically sound, but she doesn't seem to have much emotional resonance to add—excellent recitation with too little catharsis. Still, pretty performances have made a very pretty album.

A note about the cover. The shot of Linda reclining on a satin sheet wearing a pink party dress is pure '50s. The addition of a Sony Walkman at her side is a subtle, witty satire.

*What's New* is easy listening. Take that any way you want to.

*Michael Tearson*

**Swordfishtrombones:** Tom Waits  
**Island 90095-1, \$8.98.**

Sound: C-      Performance: A-

If any artist anywhere is more of an idiosyncratic mystery than Tom Waits, I wish someone would point him out to



Tom Waits has cast himself out on the world of misfits and low-lives, and he has done it with total gusto.

me. He is so resolutely into the character he created for himself, that considerations of how well he handles it at a given time can be somewhat irrelevant. Waits has cast himself out on the world of misfits and low-lives, and he has done it with total gusto. Whether he employs a bohemian bop beat to recite or a melancholy piano bar melody for one of his sad Tin Pan Alley songs, Waits goes for deep feelings which are not always pretty.

*Swordfishtrombones* is quirky, even by Tom Waits standards. It is so weird that when his previous label, Asylum, heard the completed album, they summarily dropped him as an artist. Kudos to Island for adopting him.

Waits only plays his accustomed piano twice this album. One instance is the ballad "Johnsburg, Illinois," which ends on an eerie and uncertain discordant phrase. The other is "Rainbirds," a moody instrumental which closes the album.

Aside from occasional harmonium,



Tom Waits

organ and percussion, Waits concentrates on the songs and stories so that we see aspects of the Waits persona that hadn't quite surfaced before. There's the Howling Wolf-like mean growl of "16 Shells from a 30-06," the ominous Charles Ives-styled freedom bell intro to the dour "Town with No Cheer," the goony, mock-joyous lampoon of "In the Neighborhood," and the offhand and snide narrative of "Frank's Wild Years" (a tribute to F. Zappa?).

Waits has produced himself here for the first time, leaving behind the tasty knob work of Bones Howe. As a result, *Swordfishtrombones* has a more blood and guts sound than has been expected from Tom Waits. It is a relentlessly melancholy album with coal-black humor. But the challenge that Waits throws in the listener's face is what most impresses me.

Nobody will mistake this for easy listening, and it is not for everyone—Tom Waits is an acquired taste that may come with difficulty. I must confess to a

## Some Critical Comment About the PS-10!



"The PS-10 loudspeakers by Design Acoustics could be the last pair you'll ever buy...the speakers are able to handle anything you can deliver and provide tight bass and excellent imaging..."

— Paul Terry Shea  
*Rolling Stone*

"In our listening test, the PS-10's delivered a smooth, balanced sound...its compact size and unobtrusive looks should enable it to fit in almost anywhere both aesthetically and acoustically."

— Julian D. Hirsch  
*Stereo Review*

"The overall sound is smooth, clean, and detailed. Bass is surprisingly well maintained for so small a speaker. Imaging is also outstanding, with firm, stable stereo localizations and a good sense of spaciousness and depth."

— The Editors  
*High Fidelity*

"To these ears they provided a very open and transparent kind of sound, with excellent and stable stereo imaging."

— Len Feldman  
*Cvation*

Judge for yourself at your Design Acoustics dealer today!

**DA DESIGN ACoustics**

An Audio-Technica Company  
1225 Commerce Drive, Stow, Ohio 44224

Paul Kantner's album lacks punch and attack, with almost muted drums and lead parts.



Illustration: Rick Tulka

heartfelt bent in his direction, for I especially love chance-takers and risky music. *Swordfishtrombones* is by far the chanciest, riskiest album he has ever done. *Michael Tearson*

**The Planet Earth Rock and Roll Orchestra:** Paul Kantner  
RCA AFL1-4320, \$8.98.

Sound: C- Performance: C+

If Paul Kantner hadn't gone to such extensive lengths to write out the storyline of the album's concept, I'd have taken this as a mere album of songs that stand by themselves. There really isn't any overt continuity from song to song. In fact, I find the whole overriding concept nothing more than a pretentious and superfluous distraction.

So on to the record itself. It sounds, not too surprisingly, like a large-cast Jefferson Airplane/Starship album in the grand tradition, with large portions of both science fiction and folk music. Most surprising is that for his solo al-

bum Kantner does relatively few lead vocals, leaving much of it to Grace Slick and daughter China Kantner.

The production sound quality often baffles me. The record lacks punch and attack, with almost muted drums and lead parts. Paradoxically, the effect is a sound character that is both very big in scope and very empty and full of open spaces. This, too, is not unprecedented. As far back as Jefferson Airplane's *After Bathing at Baxter's* and *Volunteers*, I remember feeling frustrated that the records didn't sound louder. *Michael Tearson*

**#8: J. J. Cale**  
Mercury 811 152-1 M-1, \$8.98.

Sound: B- Performance: B+

#8 by J. J. Cale is a subtle balance of low-volume amps, churning rocking, and something to say. Proof you don't have to turn amps up to 10 to have musical muscle. You see, the thing about Cale's work is that you might not

even notice it the first time around, until pieces of his songs start bubbling back up in your mind later on. This is one seductive songwriter, his songs poised between country music and rock, yet at home in either camp.

"Money Talks," cowritten and sung with Chris Lakeland, sets the pace with a snaky rhythm, a mean guitar solo and some sharp, topical lyrics. In fact, there really isn't a non-topical or love song in the bunch, although "Losers" comes deceptively close with its haunting chorus. Titles like "Hard Times," "Unemployment," "Reality,"

## Come face to face with reality.

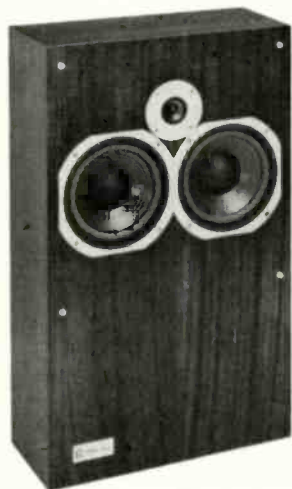

MODEL 21, \$1,695 a pair



MODEL 11, \$795 a pair



Robertson Audio's new loudspeakers re-define sound and space to virtually "put you there" as the music is played.

Only these speakers have cones of polymergraphite, a material that makes them light enough to follow the waveform with minimum inertia. Yet the cones are extremely rigid for remarkably distortion-free performance. And Robertson Audio's exclusive crossover network provides pinpoint definition, imaging and clarity throughout the spectrum.

Here, truly, is the reality of sound in one-of-a-kind speakers that combine the speed of an electrostatic system with the range capabilities of a dynamic cone system. Yours in finely crafted, furniture finish mahogany cabinets.

For a demonstration you'll never forget, write or call Robertson Audio to obtain the location of your local dealer.

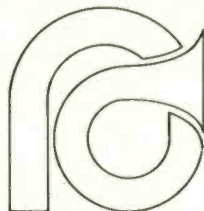

*Robertson audio*

P.O. Box 8449, Van Nuys, CA 91409  
Telephone (818) 994-9244





J. J. Cale is one seductive songwriter, his songs poised between country music and rock, yet at home in either camp.

"Trouble in the City" and "Taking Care of Business" should give a notion of what Cale's concerns are on #8. If his songs have any problem, it is that they are so short that they often end when the players are really hitting the groove and smoking it.

I'd like to have credits on who did what part where, because there are some really dandy moments, but specific credits are omitted, save for a catch-all list of musicians. This may be a minor quibble, but it's one I care about.

What I care *far* more about is how much I really like J. J. Cale's #8, more than anything he's done since 1976's *Troubadour*.  
Michael Tearson

**Uh-Huh:** John Cougar Mellencamp  
Riva RVL 7504, \$8.98.

Sound: B Performance: C+

Last year's *American Fool* and its two smash hits, "Hurts So Good" and "Jack and Diane," catapulted John Cougar into multi-platinum status and got him a fistful of Grammys. With that brand of clout in hand, he has decided to phase out his less than loved nom-de-tune of Cougar and use his given name of Mellencamp. In fact, he wanted to be John Mellencamp for this album, but more commercial heads prevailed and convinced him to use both in transition. No matter; everyone on radio calls him Cougar anyway.

The new album, *Uh-Huh*, is a good little record that I like more than anything Cougar has done before, but I still have some nagging, annoying doubts. The biggie is John's unabashed lack of originality. He has never pretended to be a great original, taking the pose of a Midwestern Bruce

Springsteen or a K-Mart Bob Seger. And he hasn't changed with success.

The first single out this time is "Crumbling Down," and it is a virtual rewrite of a latter-day J. Geils Band song of a similar title. "Pink Houses" is a little overview of what remains of America as the land of opportunity. He has cast it almost as a Bob Seger outtake. "Authority Song" is a snappy sing-song which contains the line that probably tells the most about Cougar: "I fight authority, authority always wins." Cougar has always cast himself as some James Dean descendant, and that was never clearer than it is here. These three songs really are the meat of the album, and they all appear on side one.

On side two, Cougar's snotty side gets fuller run. The side opens with "Jackie O," a bad joke of a song written with John Prine. "Play Guitar" is a tongue-in-cheek ode to the allure and unbelievable sexuality of dumb rock guitarists. "Serious Business" opens with superfluous profanity which does little to enhance the song. The second side goes a long way toward undoing the goodwill built up in me by the first.

*Uh-Huh* was recorded in just over two weeks at home in Indiana. The spirit of the project, Cougar's raucousness, is effectively conveyed. There is an anything-goes looseness to the pro-

John Cougar Mellencamp



## Dynavector's Moving Coil



### is Now Affordable.

You can now experience the superb musicality of Dynavector's moving coil cartridge at a reasonable price and without the additional expense of a step-up device.

The DV10X3 is a high output cartridge (no step-up device required) that embodies all the design advantages of Dynavector's moving coil technology, including low mass for wider dynamic range, precision wound silver coils for lower distortion and powerful Samarium cobalt magnets for increased product life.

With our DV10X3, you can hear the improvement—*honest music reproduction without coloration.*

The big surprise is that this new DV10X3 retails for only \$150.

We know that once you listen to the DV10X3, you'll be sold on Dynavector. Write or call for information or visit your audio specialist.

## Dynavector

World leader in moving-coil cartridges

Dynavector Systems USA  
1721 Newport Circle  
Santa Ana, CA 92705  
(714) 549-7204

Instead of being a gimmick, the different approaches John Hiatt takes on each album side reveal more about him as an artist.

ceedings that is belied only by strong playing (excepting "Jackie O").

The one thing that *Uh-Huh* proves most convincingly is that last year's hits were no flukes. John Cougar Mellencamp has a firm grasp on the pulse of puberty and the energy that goes with it.

*Michael Tearson*

**Riding with the King:** John Hiatt  
Geffen GHS 4017, \$8.98.

Sound: B Performance: A-

John Hiatt's new album is really a kind of two-in-one package. Side one has all parts, save John's guitar and voice, played by Scott Matthews; the side was produced by Matthews and Ron Nagle, together known as The Durocs. Side two is a Nick Lowe production, backed by Lowe's tight little band of Lowe, Paul Carrack, Martin Belmont and Bobby Irwin.

The two sides take somewhat different approaches. The first is the harder edged, more produced side, while the

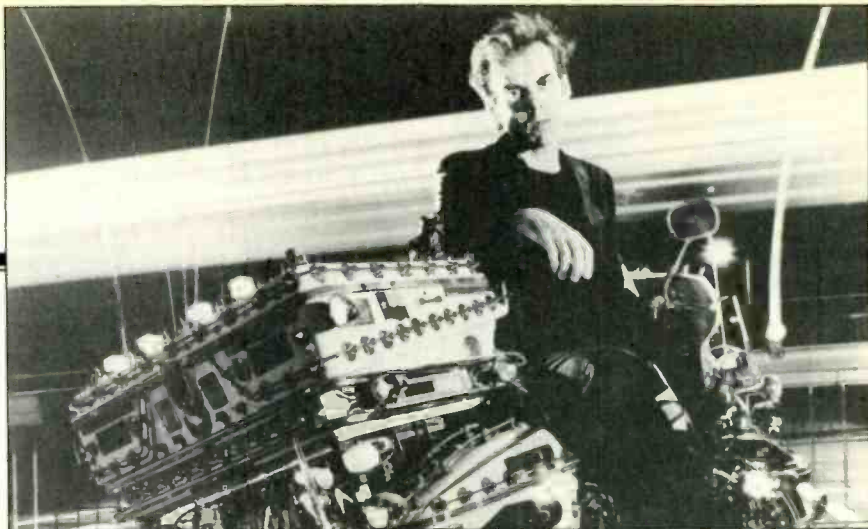

flip is more soulful and played mostly live in the studio, with few overdubs.

The songs on side one tend to show the nervier, more neurotic and dangerous sides of Hiatt. "Death by Misadventure" chronicles the self-demolition of the All-American family of a Secret Service man who had enough and blew his brains out, leading the kids to get into heroin and the wife into Nembutals. All this carnage is set to a throbbing, rocking beat. "She Loves the Jerk," a more tender-sounding melody, is the story of a fine lady who loves a scum of a man. "I Don't Even Try" recalls the romantic shenanigans

of early Elvis Costello songs—boy loses girl, boy gets mad, boy can do nothing about it. The Nagle/Matthews production is very sharp. The playing is surprisingly lively despite Scott Matthews' virtual one-man-band act. He achieves the feel of a real band.

Over on the Nick Lowe side, the songs aren't quite so desperate, as Hiatt lets more warmth show. Occasionally he even gets close to the mellowness of Eric Clapton's better soft stuff. "You May Already Be a Winner" is a delightful whimsy about those magic letters we all get, the ones addressed to Occupant. "Riding with the



Now that you've experienced the noiseless reproduction of today's digital technology, how does your present speaker system stack up?

In designing the new Acoustat Model ONE + ONE, our reference was live music—the ultimate test. So when it came to reproducing the startling clarity and increased dynamics that digital has to offer, the music came through loud and clear.

Our advanced full-range electrostatic speakers are free from the distortions and colorations of conventional multi-way box-type speakers. Music emerges with all the harmonics and sonic detail of the original performance.

The ONE + ONE's revolutionary floor-to-ceiling line-source array recreates the height and depth of the concert hall with realism unmatched by the most exotic designs.

Acoustat. We brought the price of high technology down to earth. Call toll-free for more information and the name of your nearest Acoustat dealer.

*Bringing Music To Life*

**ACOUSTAT**  
SPEAKERS • ELECTRONICS

Toll Free:  
1-800-327-3136  
In Florida:  
305-462-6700

**We put digital to the test!**

**Introducing the New Acoustat Model ONE + ONE Speaker**



Peter Weller's singing style, and his ability to write convincing and effective ballads, is quite a shock to the senses.

King" and "Love Like Blood" bring the feel of vintage Al Green soul struts to mind. Side two carries an easy, loping swing that makes it pass too quickly. One other element of Hiatt's work which certainly must have delighted Lowe is the nonstop wordplay that runs throughout Hiatt's writing, much as it does in Lowe's.

It adds up to a very satisfying John Hiatt album. There's no skimping on material and no filler either. The different approaches on the two sides could have worked out as gimmicks, but instead they reveal more about the artist. John Hiatt has been one of American music's best-kept secrets for too damn long. *Riding with the King* is a terrific album that should let the secret out of the bag. *Michael Tearson*

#### Introducing The Style Council

**Polydor 815-227**, mini-LP, \$4.98.

Sound: B+ Performance: A-

Having been only a peripheral fan of The Jam—who needs a second-class Who?—the first album by ex-Jam leader Paul Weller held only minor interest for this review team. Surprisingly enough, Weller has chucked off his treble-guitar sound and dug deeper into his roots. This is a heavily Tamla-influenced, semi-solo EP under the name of The Style Council. Weller's companion in this venture—at least the only one visible on the album cover—is a keyboard player named Mick Talbot who has obviously been heavily schooled in the Marvin Gaye/Booker T. traditions. In fact, his one soloish cut on the record, an instrumental called "Mick's Up," sounds like it could be an outtake from Marvin's *What's Goin' On*. The contemporary edge to the music comes from the synthetic drums and bass line that run through most of the songs. But, like his contemporary Paul Young, his use of said technique strays away from the disco crud currently masquerading as dance-rock. This is far closer to what you'd call soul music than something you'd hear at Studio 54, and thank goodness for that.

Weller's ability, not only to sing in this style but to write convincing and effective (and affecting) ballads, is quite a shock to the senses, for as a rock band The Jam reveled in their lack of musical maturity. There were

times when they got into a groove—"Town Called Malice" emulated the James Jamerson/Leroy Van Dyke rhythm section of "You Can't Hurry Love"/"I'm Ready for Love." But in general, The Jam flailed at, rather than dug their teeth into, the music. For Weller to have penned songs like "Long

Hot Summer" or "The Paris Match" is pretty amazing. This mini-LP, collecting their first few international singles, bodes well for their first full-length album, which is due out within a few months. We hope they can meet the demands these rising expectations have put upon them. *Jon & Sally Tiven*

## When you've heard it all...

When you've heard a sufficient number of live performances to establish your own meaningful criteria for evaluating audio equipment...

When you've heard enough hyperbole and technospeak to realize that there is no substitute for

sound engineering and intelligent design...

You may become one of the hundreds of thousands who for the past half century have demonstrated their serious commitment to music through their choice of serious audio equipment.

The Quad ESL-63 Loudspeaker

The Quad FM4 Tuner

The Quad 34 Control Unit

The Quad 405-2 Power Amplifier

**QUAD**

For the closest approach to the original sound.

For further details and the name and address of your nearest QUAD dealer, write: QUAD, 694 Oak Grove Avenue, Menlo Park, CA 94025. In Canada: May Audio Marketing Ltee. Ltd., Longueuil, Quebec J4G 1B8.

EDWARD TATNALL CANBY

## KING OF THE KEYBOARDS

Vladimir Horowitz



**Horowitz at The Met.** Music of Scarlatti, Rachmaninoff, Chopin, Liszt.

**RCA ARC1 4585**, digital, \$12.98; cassette, **ARE1 4585**, \$12.98.

Sound: A Recording: A Surfaces: A—

It is good that Horowitz reached the digital age, because now we have an optimum recording of the sound of this very great, if restricted, pianist in actual concert (the only way that he can be recorded). And, along with pianistic genius, we have a curiously accurate record of past times, the way it used to be, for Horowitz is not one of those who changes with the times. His incredible playing reflects the end of the great age of the piano as a living vehicle for living composers, back at the beginning of this century and before. His abilities—as player but not composer—surely come within striking distance of Liszt himself, whose music appears on this record along with the predictable Chopin and Domenico Scarlatti.

The Horowitz choice is indeed restricted, even though it spreads out within his own delimitations. For instance, there are always more Scarlatti Sonatas for harpsichord, some 500, to convert into those delicate, astonishing

piano transcriptions which are the Horowitz Baroque department. The music on this disc (and cassette) is definitely not warhorse, though the Chopin "Waltz" and the Rachmaninoff "Prelude" are familiar enough. Not worth the research to find out how many times the man has, or has not, played these pieces—the program is good for a recording, any way you listen.

As to the genius of Horowitz, it is both technical and musical, with an added and extraordinary flair for drama, which comes over in recorded form extremely well in spite of the pianist, who hates to make recordings. On the technical side he remains an absolute master, as recorded here in 1981—as powerful and as accurate, as far as I can tell, as in his youthful prime. His is the sort of genius that makes it all seem effortless, as well as potent beyond belief. One thinks of the old Rolls-Royce ads (the ticking of the clock—that dates them). His trademark, you might say, is the pure, delicate, absolutely controlled *piano*—i.e., soft passage—which bursts forth incredibly into a roar when the time comes. Listening, I was full of analogies: The sound of this big Steinway, at full volume, somehow brought to mind

surprise—a stuck bull, let us say, a ringing bellow as though the instrument were astonished to hear itself making such noises! That, again, is control, an absolutely even power from those two hands, like, say, a V-16 engine.

But, of course, it is the impeccable, if now authentically old-fashioned, shaping and phrasing and rhythm which put this power to work. Such finesse here in the precise timing of every note, the tiny pauses, the rubato, the quick lift are what make the music more than merely powerful!

The six Scarlatti Sonatas that take up most of side one are a clever beginning for an LP or a CD, even though you may tend to set volume too high. For 16 minutes you listen to the light, airy, ideally controlled Horowitz, and you will not be displeased even if you are a harpsichordist—for this is music honestly transformed into the sheerest gossamer piano music. Then, with scarcely a change, comes the Chopin "Ballade in F minor," opening quietly, almost casually, building into a blaze of Steinway-style glory, which continues with the unbelievable bass rumbling of the Liszt, side two . . . enuff! Get it.

**Dvořák: Symphonies 7, 8, 9.** The Philharmonia Orchestra, Andrew Davis.

**CBS 70342**, three-record set.

We have to distinguish now between two British Davises, Colin and Andrew; both are active in big-time music operations. Andrew is the younger, and a newcomer.

I was shocked at this large album of well-known, large-scale Romantic music played by one of the world's leading orchestras. Davis may have "arrived" by this very fact, but after one and a half symphonies I turned the whole thing off. I could not face the "New World" in any such casual, routine, even sloppy performance.

The whole thing reeks of—"do we have to do *this* so-and-so music again?" Tired. All the notes are there, and there are, of course, many satisfactory passages. Nothing is downright bad—this is a top orchestra, after all. But so much is barely adequate, so many edges are dulled and unfocused, the big places are so lackluster, compared to what they could be—



and have been. Do you know that Schwann lists as available *now* something like 30 performances of the "New World," No. 9, including many famous versions from the past? A waste of time to put out current big names in *this* fashion, as though the mere title guaranteed the Grreatest of performances.

I do not know how much Andrew Davis has to do with it. Conceivably he is too new and too young to impress his players (though he has been busily around, doing very good things, for quite some time). Or maybe it was the proverbial "three o'clock in the morning"? You can take my vote as a re-sounding NO on this album.



Andrew Davis

**Paige Brook: Page One/Book II Paragraph 21.5.** Paige Brook, flute, etc. **Mirror Image Pressings MIP 1005,** half-speed mastered. (Mirror Image Pressings, 23757 Canzonet St., Woodland Hills, Cal. 91367.)

Now what do you make of a record title like this? Not exactly informative. May I re-title: *French Music with Flute by Debussy, Poulenc, Messiaen*? That helps. But the cover, alas, looks as if somebody had spilled breakfast pepper and salt on it. All in all, not a very happy presentation. And yet—this is one of the most beautiful recordings of French music I ever hope to hear, both



If you're a friend of Jack Daniel's, drop us a line. We'd like to get to know you.

WE'RE PLEASED TO ANNOUNCE that some things in America are still moving slow. The whiskey in these barrels will sleep for years in the Tennessee hills before it's properly aged. Good whiskey, you see, should never be hurried. And ours never is. You may feel too many things in America move too quickly today. But after a sip of Jack Daniel's, you'll be pleased some things (and even some people) still take it slow.



CHARCOAL  
MELLOWED

DROP

BY DROP

Tennessee Whiskey • 90 Proof • Distilled and Bottled by Jack Daniel Distillery  
Lem Motlow, Prop., Route 1, Lynchburg (Pop. 361), Tennessee 37352

87 Placed in the National Register of Historic Places by the United States Government.

When things are right and intelligently done, analog is still a remarkable medium for sound and for music.

in the superbly idiomatic playing and the equally wonderful recorded effect. Such an airy, buoyant sound! Such perfect reproduction of each instrument, flute, piano, harp, viola. (The disc is mastered at half speed, but I assure you there is much more to it than just that.) An exquisitely present-

ed version of the late-Debussy Sonata for Flute, Viola and Harp, plus "Syrinx" for solo flute; the jaunty Poulenc Sonata for Flute and Piano, and a short Messiaen work, "Le Merle noir," full of bird songs: Lovely sounds, beautifully rendered.

Just goes to show. Masterpieces of

the recording art, small gems of priceless value, continue to appear on lesser-known labels and are published and propagated for those who can discover them. I would rate this as one of the all-over best recordings I have heard in years.

Yes, I know who did the recording: The well-known team of Marc Aubort and Johanna Nickrenz, whose work usually shows a high sense of musical appropriateness. Marc, I should say, is one of those who look with the traditional jaundiced eye on all this digital stuff—there are others, too, not so much against digital as simply pro-analog. When things are right and intelligently done, analog recording is still a remarkable medium for sound and for music. If you want to hear, go out of your way to get hold of this one.

# FOR THE SHEER LOVE OF MUSIC

## The Linn SARA

The bookshelf speaker that outperforms most full sized models. As the final link in a chain of uncompromising audio components, it will reveal the music on your records as you have never before encountered it.

Linn SARA. It must be heard.

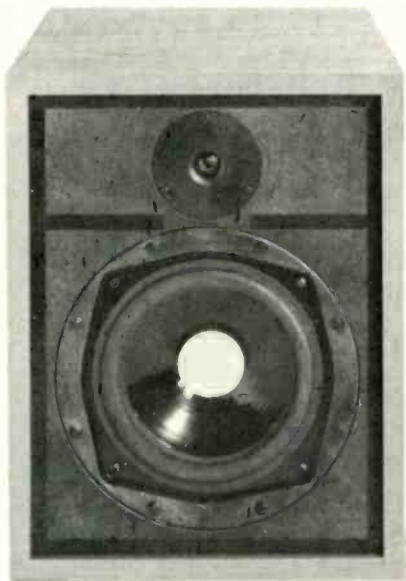

For further information contact:  
 AUDIOPHILE SYSTEMS LTD., 6842 HAWTHORN PARK DRIVE,  
 INDIANAPOLIS, INDIANA, USA 46220  
 ALDBURN ELECTRONICS LTD., 50 ROLARK DRIVE,  
 SCARBOROUGH, ONTARIO, CANADA M1R 4G2



## The Hindsley Transcriptions with the University of Illinois Concert Band, Vol. I.

**Golden Crest CRS 4215**, six-record set, \$55.00. (Golden Crest, P.O. Box 2859, Huntington Station, N.Y. 11746.)

Those small record labels which have tied themselves in with major centers of music education have chosen a wise method of staying alive. The educational people have a first-quality pro outlet for recording their performances, and the record company in turn has a valuable source of musical art, with all the verve and interest that comes from advanced student-musicians of many sorts, as well as teaching faculty. Golden Crest has thus attached itself to the New England Conservatory, for instance, and also this prime mid-country band organization, at the very center of band country. Best of all is that, given the needed info on where to obtain this set, the general listening public can also benefit and enjoy when the going is good.

These six discs are all transcriptions of orchestral works for the concert band by Mark Hindsley, one of the grand old men of the band world. They are extraordinarily well done, if inevitably some come off better than others. There is music here for winds alone, which is easily as effective as the originals for standard orchestra. Every proper chestnut of the regular repertory is displayed, from "Sorcerer's Ap-





*The University of Illinois Concert Band*

prentice" to "Pictures" (note well that this one is in turn a transcription from a variable piano original). There is "Scheherazade"—even the violin solo part—the overtures to "Die Meistersinger" and "Tannhauser," music by Beethoven, Brahms, Tchaikovsky, "The Dance of the Seven Veils" (R. Strauss), as well as "Till Eulenspiegel" and "Don Juan." All this and much more is played with incredible precision and expertise by the large concert band, minus any strings, the whole taken from a set of 75th Anniversary concerts from 1965.

Two things are even more remark-

able. The actual performances, the renditions, if you will, are some of the finest Romantic interpretations I have heard *anywhere*, band or orchestra, far ahead of hundreds of much-touted celebrity recordings by internationally known conductors. The "Romeo and Juliet" here—a work I know particularly well over a long stretch of time—is the most intense and musical performance I have heard, bar none, since Mengelberg, who recorded it back in the 1930s. The whole feel for Romantic music is astonishingly right and good—somebody is a genius, to elicit such playing from what must be a

high-turnover musical ensemble. But *who?*

Very odd. Is it Mark Hindsley himself (he had not then retired)? If so, why is there absolutely no mention of a conductor or director of these performances? Can it be an accident? Or does some ghost of an earlier band leader hover above the Hindsley shoulder as co-conductor? I'd like to know.

The album dates from much later, 1982, and the sound is disc analog at its most faultless. By 1965, as we know, master tapes could be very, very good and they respond superbly to today's improved processing.

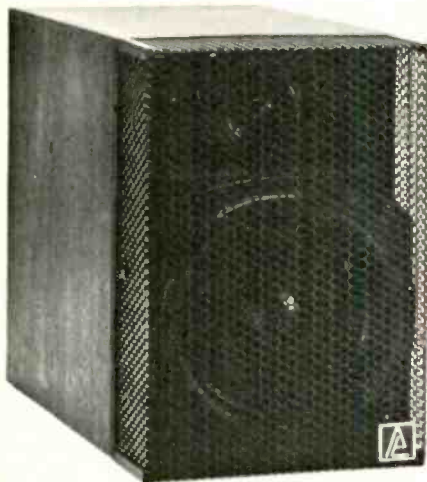

PYRAMID  
METRONOME  
MODEL 7



**UNIQUE STYLE**

**COMPACT SIZE**

**SONIC EXCELLENCE**

The Metronome Model 7 is astonishing the HI-FI world with a quality of sound reproduction in a compact size that is able to satisfy the most discriminating audiophile. Our two-way full-range mini loudspeaker (7-5/8" x 5-1/4" x 10") outperforms speaker systems many times its size or cost. Available in a wide selection of decorator finishes, it allows the opportunity of conveniently blending the MET 7 easily into your home decor.

Unique styling, sonic excellence and modestly priced, a remarkable value from Pyramid Loudspeaker.

**Freq. Response:** ±3 dB 76 Hz to 22 KHz  
**Two LED Level Indicators:**  
 Green: 1/2 Watt, Red: 100 Watt Peak  
**Impedance:** 4-8 Ohms  
**Sensitivity:** 1 Watt/1 Meter/87 dB SPL  
**Recommended Amplifier Power R.M.S.:**  
 Min 20 Watts; Max 200 Watts per channel  
**Driver Complement**  
**(Both with sheer radiators):**  
 5 inch Coaxial Woofer/Mid-Range;  
 2 Inch Coaxial Tweeter



**Pyramid Loudspeaker Corporation**

P.O. Box 192 • 131-15 Fowler Ave. • Flushing, NY 11355 • (212) 762-1300

Enter No. 36 on Reader Service Card

# COMPACT DISCS

BERT WHYTE, JOHN M. EARGLE,  
C. VICTOR CAMPOS

## BRANDENBURGERS RARE

**Bach: The Brandenburg Concertos Nos. 1, 2 & 3.** Academy of St. Martin-in-the-Fields, Neville Marriner. Philips 400 076-2.

**Bach: The Brandenburg Concertos Nos. 4, 5 & 6.** Academy of St. Martin-in-the-Fields, Neville Marriner. Philips 400 077-2.

There are many recordings of the Brandenburg Concertos currently available, but few can approach this version for sheer quality of sound, near-definitive performance, and superb musicianship. This is not surprising considering the illustrious personnel in the Academy of St. Martin-in-the-Fields orchestra. There is Henryk Szeryng on violin, Jean-Pierre Rampal on flute, Heinz Holliger on oboe, and Andre Bernard on trumpet, all well-known virtuosos of their particular instruments. The other musicians in the ensemble are of a very high caliber as well. Add to this the authoritative conducting of Neville Marriner in the type of music that is his particular metier, and you have all the elements for great music-making.

Recorded moderately close-up, the sound has exceptional clarity and high definition. The acoustic perspective affords a warm ambience that nicely balances the instrumental detail. Szeryng's violin has a smooth, lovely sheen not marred by edginess. Bernard's trumpet is heard cleanly in spite of the stratospherically high registers in which he plays his instrument. Good imaging and stable instrumental localization are bonuses. All in all, an exemplary recording of the Brandenburg Concertos. *Bert Whyte*

**Chopin: Piano Works.** Malcolm Frager, pianist. Telarc CD-80040.

Some years ago I reviewed the LP version of this release and gave it accolades. What a pleasure now to hear the sound of the Bösendorfer Imperial grand with absolutely no break-up in its full-out tutti passages. Frager's playing is even more thoughtful and intelligent than I had remembered.

One very important note should be made here: This piano recording was made fairly close-in, an approach



*Neville Marriner*

which many instruments simply will not allow. The result of this is a very detailed sound and a good bit more bottom end than most listeners are used to in piano recordings. Climaxes are massive, and the instrument in no way clangs or makes ugly sounds.

*John M. Eargle*

**Holst: The Planets.** The Philharmonia Orchestra, Simon Rattle. EMI Angel CC38-3028.

The search for the perfect *Planets* goes on. There are CD versions by Karajan and Maazel, neither of which is satisfactory from the viewpoint of microphone placement and technique. This CD, a product of Toshiba-EMI, shows another problem, that of quantizing noise (or some other equivalent difficulty), which intrudes during all soft passages. Frankly, I am surprised that any Japanese company, given their accustomed fanatical concern with quality, would issue this disc. The recording was made in December 1980; by that time, the noise problems inherent in most digital recording systems had been worked out. I wonder what went wrong here—and where.

*The Planets* does not easily come across in the concert hall. It is made to

order for recording, but it is by no means easy to record. The CD medium seems just right for it, since the music's wide dynamic range can now be contained without compromise. And what about those 32-foot octave fundamentals in "Saturn"? For years, recording engineers and producers have cut out such details, thinking them to be inaudible or insignificant. Not so, over an extended range system. Maybe it is time for Telarc to give it a try.

Beyond the technical problems mentioned here, Rattle and the Philharmonia do a good job with the work; the flaws, however, suggest that you look elsewhere. *John M. Eargle*

**Copland: Appalachian Spring, Rodeo, Fanfare for the Common Man.** The Atlanta Symphony Orchestra, Louis Lane. Telarc CD-80078.

Aaron Copland's music is distinctive, unmistakable, and uniquely his—and this CD offers a good sampling of his genius.

Copland's "Fanfare for the Common Man" is certainly his most famous work. Every time I hear it, it dredges up old memories. The piece was originally commissioned by Eugene Goossens,



who in the early part of World War II was conductor of the Cincinnati Symphony Orchestra. He wanted a stirring fanfare to stimulate patriotic feelings. Copland was so taken with the "Fanfare" that he later incorporated it into his Third Symphony. Years later, I recorded his Third Symphony, with Aaron conducting the London Symphony Orchestra.

Ironically, several days previous to that recording I was recording the London Symphony Orchestra with Eugene Goossens, who by then had become *Sir Eugene!* In spite of their close proximity, Aaron and Sir Eugene's paths never crossed.

This recording of the "Fanfare," with its huge bass drum, tympani and tam-tam outbursts and the full-throated sonority of the trumpet, trombone, horn and tuba fanfares, will really clear your sinuses! Start playback of this at a high level, and you may be very sorry you were not more temperate. This is a *big* sound, friends!

Copland's popular ballet, "Rodeo," is a joyous, uptempo, exuberant salute to the West. Lane and the Atlanta Symphony provide a most spirited performance, with the boisterous "hoedown" finale particularly (and properly) uninhibited.

In marked contrast, Louis Lane gives us a wonderfully evocative, tenderly wrought reading of Copland's master-



Louis Lane

piece, "Appalachian Spring." Here we have smooth and luscious string tone and pure-toned woodwinds. With the total lack of noise, the pastoral introduction to the work and the hushed diminuendo of the finale are pure magic. Overall sound is very clean, well defined in a warm, spacious acoustic perspective. If you like Copland, this CD is a must.

Bert Whyte

**Ravel: Boléro, Rhapsodie espagnole, La Valse, Alborada del gracioso.** The Montreal Symphony Orchestra, Charles Dutoit.  
London 410 010-2.

I commented very favorably on this release in LP form a few months back. The sumptuousness of the sound is all there, and then some. The CD version handles tutti passages a bit better than the LP, and the utter lack of noise in quiet passages reveals more music.

If you are interested in building up a Ravel collection on CD, I suggest that you take a good look at all the Dutoit/Montreal recordings. *John M. Eargle*

**Moussorgsky: Pictures at an Exhibition; Night on Bald Mountain.** The Cleveland Orchestra, Lorin Maazel.  
Telarc CD-80042.

This CD recording is an absolute gem, one of those rare recordings where everything was *right*—a synergistic combination of great orchestra, conductor, sterling performance, felicitous hall acoustics, and the optimum mike pickup, for a proper balance of orchestral definition with a smooth, natural ambience.

"Night on Bald Mountain" is very well done, with exceptional playing from the orchestra, but the "Pictures at an Exhibition" is a tour de force in every

Model AT152LP  
Vector Aligned™ Dual Magnet™  
Stereo Phono Cartridge

**"I would rank it...  
among the best phono  
cartridges now available,  
and...suited for use in  
the finest of systems."**

—NORMAN EISENBERG  
Ovation Magazine

Direct Plug-in  
to P-Mount 3rms plus  
universal mounting adapter



**audio-technica.**

If you play the Mussorgsky CD with your pianissimo levels set just above the ambient noise floor, you better have a brute of an amplifier!

aspect. Every strand of Ravel's opulent orchestration is clearly revealed. Dynamic range is very wide, and fortissimos have tremendous impact. If you attempt to play this CD, and if you set your pianissimo levels just above the ambient noise floor of your listening room, you'd better have a brute of an

amplifier and loudspeakers that can handle high levels!

The amount of orchestral detail which can be perceived in this recording is a revelation, yet the overall sound is totally coherent in its very natural perspective. Maazel's performance does not equal the legendary

Kubelik/Chicago Symphony Orchestra recording made by the late Bob Fine for Mercury, but it is very good indeed. The overall sound quality establishes this disc as one of the prime examples of CD technology.

*Bert Whyte*



## WHY BUY "BUDGET" LOUDSPEAKERS, WHEN FOR THE SAME PRICE YOU CAN OWN KEF?

Today many speaker companies are offering budget loudspeakers, but which of them has ever produced products of the calibre of KEF's world-acclaimed Reference Series?

Which of them can draw from this Reference technology to produce affordable products that do not compromise sound quality?

Only KEF, manufacturers of the world's most thoroughly engineered loudspeakers.

The new KEF "Standard Series." For people with higher standards.

**KEF**  
The Speaker Engineers

Intrac, P.O. Box 17414, Dulles Int'l. Airport, Washington, D.C. 2001



*Lorin Maazel*

**Vaughan Williams; Barber; Grainger; Fauré; Satie.** The St. Louis Symphony Orchestra, Leonard Slatkin.  
**Telarc CD-80059.**

Most people equate Telarc recordings with spectacular repertoire and sound. This is quite understandable. Small new record companies want to impress the audiophiles, and this isn't done with string quartets. But now that Telarc is well established, they have made this recording, perhaps to show the gentler side of their musical sensibilities.

This CD might be regarded as a showpiece for the string section of the St. Louis Symphony Orchestra. The orchestra does indeed have an outstanding string body, which, with all due respect to Leonard Slatkin, is a legacy of my dear friend, the late Wal-



This CD is not the usual Telarc blockbuster, but the blandishments of totally noiseless surfaces tip the scales in its favor.

ter Susskind. In his years with the St. Louis Symphony, his leadership brought the orchestra to its present eminence.

Maestro Slatkin has maintained and nurtured the finesse and élan of this fine orchestra, a fact quite audible in these recordings. From the noble themes of Vaughan Williams' "Fantasia," the lovely strains of Satie's "Gymnopédies," the searing intensity and supercharged emotionalism of Samuel Barber's famous "Adagio for Strings," Fauré's tender "Pavane" and Percy Grainger's heartfelt "Danny Boy," this is some of the most beautiful music extant.

The warm acoustics of Powell Hall afford a spacious ambience for the strings, which, for the most part, are quite smooth—richly resonant with only an occasional touch of over-brightness.

Gorgeous string playing, gorgeous music—a feast for the ears! *Bert Whyte*



*Leonard Slatkin*

**Pachelbel; Borodin; Vaughan Williams; Tchaikovsky.** The St. Louis Symphony Orchestra, Leonard Slatkin. **Telarc CD-80080.**

This Telarc CD is obviously a showcase for the string sections of the St. Louis Symphony Orchestra. Starting off with the ubiquitous Pachelbel "Kanon," the program continues with the ever-lovely Borodin "Nocturne," Vaughan Williams' "Greensleeves" and winds up with Tchaikovsky's "Serenade for Strings."

The St. Louis string section is indeed virtuosic, with fine, cohesive ensem-

ble-playing under the direction of Maestro Slatkin. The sound abets the lovely performances, with good forward projection in a moderately spacious acoustic perspective. There is a nice, wide stage image and good perception of depth. String tone is smooth, but a shade on the bright side. This CD

is not the usual Telarc blockbuster, but it is useful for analog/digital comparison as dynamic range is about equal on the two media. All things considered, the tonal qualities are virtually identical, but the blandishments of totally noiseless surfaces tip the scales in favor of the CD. *Bert Whyte*

The Model 17 Preamplifier epitomizes Amber's dedication to sophistication made simple...and incomparable sound made affordable. Passive RIAA equalization minimizes phase shift and improves detail. While direct-coupled circuitry heightens strong, clean bass response. Recreating live-sounding sound is critical. But so, too, is controlling it. The Model 17 features three recording loops, contoured tone controls, high output headphone jack and bass-boost... making it ideal for beginner and audiophile, alike. Visit your Amber dealer. Hear the difference between mere components and fine musical instruments.

**From the Amber Collection of  
Fine Musical Instruments:  
The Model 17 Preamplifier.**



P.O. BOX 2015 CHARLOTTESVILLE, VA 22902 TLX 901601 (804) 296-5696





## CLASSIFIED ADVERTISING RATES EFFECTIVE JANUARY 1984 ISSUE

**BUSINESS ADS**—\$1.25 per word, MINIMUM charge PER AD \$30. All centered or spaced lines \$10.00.

**NON BUSINESS ADS**—85¢ per word, MINIMUM charge PER AD \$15. All centered or spaced lines at \$8.00.

**ALL LINE ADS**—First line set in bold face type at no extra charge. Additional words set in bold face at \$1.50 extra per word. One point ruled box is \$10.00.

**CLASSIFIED LINE ADS ARE PAYABLE IN ADVANCE BY CHECK OR MONEY ORDER ONLY.** (Sorry, we cannot accept credit cards or bill for line advertising.) **ALL LINE ORDERS** should be mailed to:

AUDIO MAGAZINE  
P.O. Box 1790V  
Greenwich, CT 06836

**ORDERS WILL NOT BE PROCESSED WITHOUT ACCOMPANYING CHECK OR MONEY ORDER FOR FULL AMOUNT.**

**CLOSING DATE**—First of month two months preceding the cover date. If the first of the month falls on a weekend or holiday, the closing date is the last business day preceding the first. **ADS RECEIVED AFTER THE CLOSING DATE WILL BE HELD FOR THE NEXT ISSUE UNLESS OTHERWISE STATED.**

**FREQUENCY DISCOUNTS**—3 times less 5%, 6 times less 15%, 12 times less 20%. These discounts apply to line ads only. Ads submitted for a three time frequency are unchangeable. Frequency discounts not fulfilled will be short rated accordingly. Agency discounts do not apply to line advertising.

**BLIND ADS**—Audio box numbers may be used at \$5.00 extra for handling and postage.

**GENERAL INFORMATION**—Ad copy must be typewritten or printed legibly. The publisher in his sole discretion reserves the right to reject any ad copy he deems inappropriate. **ALL ADVERTISERS MUST SUPPLY:** Complete name, Company name, Full street address (P.O. Box numbers are insufficient) and telephone number. Classified LINE ADS are not acknowledged and do not carry Reader Service Card Numbers. **AGENCY DISCOUNTS** do not apply to line advertising. **FREQUENCY DISCOUNTS** not fulfilled will be short rated accordingly. Only those advertisers who have prepaid for their entire contract time will be **RATE PROTECTED** for the duration of that contract, in the event of a rate increase.

### CLASSIFIED DISPLAY RATES

1 col x 1 inch	\$250.
1 col x 2 inches	\$395.
1 col x 3 inches	\$565.
2 cols. x 1 inch	\$450.
2 cols. x 2 inches	\$760.

One column width is 2 1/8". Two columns wide is 4 1/2". For larger display ad rates and 6, 12, 18 and 24 times frequency rates call (212) 719-6338.

**DISPLAY ADVERTISERS** should make space reservation on or before the closing date. Ad material (film or velox) may follow by the 10th. **DISPLAY ADVERTISERS MUST SUPPLY COMPLETE FILM NEGATIVE READY FOR PRINTING OR VELOX.** PRODUCTION CHARGES WILL BE ASSESSED ON ANY AD REQUIRING ADDITIONAL PREPARATION.

**ALL DISPLAY CORRESPONDENCE** should be sent to:

Laura J. Lo Vecchio  
AUDIO MAGAZINE  
1515 Broadway  
New York, NY 10036

**FOR ANY ADDITIONAL INFORMATION** contact Laura directly at (212) 719-6338

**1-800-431-3232**  
*specializing only in*  
cartridges + styli + mics + headphones

B&O • audio-technica • AKG • Ortofon  
Dynavector • Grace • PICKERING • Stanton  
ADC • SIGNET • SHURE • Sennheiser  
*We quote pro advice - lowest price*  
*24 Hr Shipment on all our equipment*  
*COD's are Okay, call us, don't delay*  
P.O. Box 37, Brooklyn, NY 11204 (212) 438-6400

audiofon

### FOR SALE

**AAAAA, PS 2C \$265.**, Jordan Modules and cabinet B.O., Mitsubishi DA-F10 Tuner \$160., Dynaco PAT-5 preamp \$135., Transcripator Turntable Vestigial Arm B.O., Pioneer TX-9500 Tuner B.O., call Michael 313-874-8369

**AAAA—PRECISION AUDIOPHILE COMPONENTS.** Q/LC Audio has Vandersteen, PS Audio, Haffler, Precision Fidelity, Audire, Grace, CJ Walker and more. Q/LC Audio 1006 Berkshire Road, Dayton, Ohio 45419 (513) 293-7287.

**AAAMAZING GRACE F9E \$99** (Can \$135 in Canada), **THE AUDIO ADDICT**, 327-163 University Ave. W, Waterloo, Ontario, CANADA N2L-3E5

**ABBIE'S AUDIO OFFERS EXCEPTIONAL PRODUCTS** David Berning, Audioquest, Apt Holman, Heybrook, Goetz Systems, Pink Triangle, Sonographe, Pentagram, M & K, Spica, Talisman, Sumiko, Grace, and more. Send for free list Abbie's Audio, 302 E. High St., Waynesburg, PA 15370 (412) 852-1134

### FOR SALE

**AAAA Amazing JAPANESE STEREO EQUIPMENT.** Anything on sale in Japan now available to you at low direct prices. Many items available only through us. Why buy a discontinued model? Get the **NEWEST** equipment! New and recommended items this month: **SONY'S NEWEST ES SERIES CD PLAYER CDP-501ES** \$820.-, includes remote. Yamaha's newest fully programmable **CD-X1**, \$495.-. Dynavector **DIAMOND CANTILEVER 17DSMK2**, only \$199.-; **STAX SRLambda Pro** with driver \$450.- (**WORLD'S BEST HEADPHONES**); Sony's **BEST ES** cassette deck **TC-K777ES** \$800 (waiting list). **NEC-803**, \$895.; Also Kyocera; Accuphase **AC-2** \$245.-; Denon **PRA-2000Z** \$1,100; **NAKANICHI DRAGON** \$1,280.-; **KOETSU Black** \$385.-; Dynavector's new Karat Series Nova **17D2** \$350.-. Sony **CDP-701ES** \$1,120.-. Denon **PMA-790** \$850.-. **SONY ESPRIT TAE-901**, \$1,150.-. **LUX's** new M-05, 105 watts Pure Class A, \$2,200. Thinking about warranties? Ours are the best! Write for information. Our catalog \$3 (cash OK), refundable. **JAPANESE STEREO MUKASHIYA**, 1-14-32-210 Jingu-gumae, Shibuya-ku, 150, Tokyo Phone (03) 404-1170.

**AAAUDIOPHILE SPEAKER BUILDER? JORDAN MODULES** exclusive importer. **STRATHEARN** midribbon, Polypropylene Drivers, EMIT Tweeters, Domes, IBM Computerized Designs, Capacitors, Low DC Coils, Crossovers. (Dealers inquire an letterhead) **CATALOG** \$2.00 Sound-box, 841-A S. American Street, Philadelphia, 19147

## HERE'S WHAT HAPPENS WHEN YOU GIVE THE WORLD'S FINEST AUDIO ENGINEERS CARTE BLANCHE.

The team of engineers that developed Sony Esprit was not asked to work within the narrow confines of a budget.

Nor were they asked to adhere to the compromising deadlines of some production timetable. Or to the arbitrary figures of a spec sheet.

They were asked, quite simply, to develop components that would approach, to the closest possible degree, perfect sound.

There is no gimmickry in Esprit components; only those technological improvements that contribute to sound-quality were considered meaningful.

There are no question marks either. For the Esprit engineers fully re-search their equipment before production. Not afterward.

For more information write Sony Esprit, Sony Drive, Park Ridge, New Jersey 07656.

**SONY ESPRIT.**



**ALTERMAN AUDIO**  
3213 17th Street  
Metairie, LA 70002  
(504) 834-7772

**D S AUDIO**  
545 Penn Avenue  
West Reading, PA 19611  
(215) 376-4917

**PARIS AUDIO**  
12401 Wilshire Blvd.  
Los Angeles, CA 90025  
(213) 820-2578

**PARK AVENUE AUDIO**  
425 Park Avenue South  
New York, NY 10016  
(212) 685-8101

**PEERLESS ELECTRONICS**  
15093 West Eight Mile Road  
Detroit, Michigan 48235  
(313) 342-4500

**PROFESSIONAL PRODUCTS**  
AUDIO CENTER  
4964 Fairmont Avenue  
Bethesda, MD 20014  
(301) 657-2141

**Q. AUDIO**  
959 West Moana Lane  
Reno, Nevada 89509  
(702) 827-4434

**RECORDER CENTER**  
2003 North Henderson  
Dallas, TX 75206  
(214) 826-8700

© 1982 Sony Corp. of America. Sony and Sony Esprit are registered trademarks of the Sony Corp.



## THE NOVA CPA-100

The world's finest all JFET solid-state preamp. Dealer inquiries invited.

Contact:

**NOVA**  
ELECTRO ACOUSTICS

P.O. BOX 25488, LOS ANGELES, CA 90025 (213) 477-7491

## FOR SALE

AAA AUDIO DISCOUNTS OFFERS THE FINEST lines of audio components (INCLUDING THE ESOTERIC) at DISCOUNT PRICES. If you're in the market for speakers, receivers, cassette decks, to the best in separate components including amps, pre-amps, turntables, cartridges etc. or a new **CAR STEREO** our knowledgeable sales staff will be glad to assist you. For more information Monday thru Saturday **PLEASE CALL 301-593-8833** or write to **AUDIO DISCOUNTS**, 1026 McCeney Avenue, Silver Spring, MD 20901. We honor VISA-MC and COD for your convenience.

**ABARGAIN: ALL UNUSED/WARRANTY:** STAX SIGMA \$230., LAMBDA \$169., SRX/MK3 \$130., SRD-7 \$68., PRO-LAMBDA/SRM-1MK2 \$520., SUPEX SDX2000 \$249., 901E SUPER \$120., 900E SUPER \$130.; GRACE F9E \$105., RUBY STYLUS \$110., F9E RUBY \$165.; ACCUPHASE AC-2 \$265.; TECHNICS EPC205CIII \$140., TECHNICS STYLUS GUAGE \$49.; DENON 103D \$170.; KOETSU BLACK \$410.; DYNAVECTOR 23R \$139., 17DS \$365., 10X3 \$79., DV501 \$315.; TECHNICS EPA100MKII \$475., EPA 500 \$299., EPA 250 \$299.; GRACE 707MKIII, 747 \$170.; FIDELITY RESEARCH 64FX \$320., 64SS \$389.; MAYWARE FORMULA IV \$75., INTERCONNECTS: BANSEI 3 Feet \$27., 6 Feet \$37.; CD DISC \$13. P.P.; ALL STYLUS REPLACEMENTS, SEND S.A.S.E., Box 6312, L.I.C., NY 11106 (212) 784-2939 (EVES); (305) 487-1048 (EVES)

## In New England...



The knowledge, creativity and dependability you expect from a dealer who represents these manufacturers.

Acoustat	Kiseki
ADS	Magnepan
Alpha	Mission
Audio Interface	NAD
Audio Pro	Nakamichi
Audioquest	Niles
Bang & Olufsen	Nitty Gritty
Boston Acoustics	Oracle
Bryston	Plexus
Carver	Proton
Counterpoint	Pyramid
C.J. Walker	Robertson
Dennessen	Signet
Denon	SOTA
Dynavector	Stax
Energy	Sumiko
ESB	Tandberg
Grace	Threshold
Hafner	Vandersteen
KEF	VPI
Keith Monks	Wooden Images

Listening rooms... New England's largest Audiophile record dealer... Keith Monks record cleaning... In-store service... All shipments pre-paid and insured in the continental U.S.

**5 TAKE AUDIO**

105 Whitney Ave., New Haven, CT  
(203) 777-1750

Mon., Tue., Wed., Fri. 10-6, Thurs. 10-8, Sat. 10-5

## DISCOUNT CAR STEREO 30 DAY MONEY BACK GUARANTEE

PRICES TOO LOW TO LIST  
MANUFACTURER'S NAMES

NEW BREED MOST MAJOR BRANDS FOR PRICES AND INFORMATION  
NY (516) 665-6670  
P.O. Box 1390 • Bay Shore, N.Y. 11776

## FOR SALE

**ABARGAIN.—KENWOOD KD600/SME3009—III** \$245.00—3DAcoustics Satellites/woofer \$295.00 MINT.—201-997-9162.

**ABARGAIN:** SUPEX SDX2000 \$299., 901ESUPER \$130., 901E SUPER \$120.; GRACE F9E \$115., F9E RUBY \$165., F9ERUBYSTYL \$120.; ACCUPHASE AC2 \$280., AC1 \$189.; TECHNICS 205CMKIII \$130., TECHNICS ELECTRONIC STYLUSGUAGE \$49.; DENON 103D \$165.; DYNAVECTOR 23R \$175., 17D \$299., 10X3 \$89.; KOETSU BLACK \$445., SA-1100DMKII \$450.; LINN ITTOK \$445.; TECHNICS EPA100MKII \$499.; FIDELITY RESEARCH 64FX \$385.; ALL UNUSED/WARRANTY; WON'T BE UNDERSOLD; (212) 784-2939 EVES; (305) 487-1048 EVES.

A BRAND NEW

## WONDER CAP!!

A TOTALLY NEW DESIGN from IAR research. It's bigger, it's far better—and it costs **LESS!** How much better does it really sound, compared to our old Wonder Cap? Excited users have said: **SPECTACULAR! UNBELIEVABLE!** What will you say when you hear the **NEW IAR Wonder Caps™** in your own electronics and speakers? Write for **FREE** application notes and order forms.

IAR WCB

2449 Dwight Way, Berkeley CA 94704

## LISTEN TO A LEGEND



For more than a decade Rogers has earned a reputation for producing musically articulate loudspeakers.

If you take the time for a serious demonstration, Rogers performance will become self evident.

For the name of your nearest authorized dealer, please write:

**Rogers**

BRITISH HIGH-FIDELITY

U.S.A.  
Nalad Products Inc  
Box 1250 Falls Sta.  
Niagara Falls, N.Y.  
14303-0260

CANADA  
Nalad Products Inc  
Box 1840  
Brantford, Ont.  
N3T 5W4

## FOR SALE

**ABBIE'S AUDIO OFFERS USED EQUIPMENT.** Tandberg 2060 rec. \$350, Thorens TD-147 w/warr. \$375., QED330 amp. \$275., NAD 1020 pre (new) \$125., Polk Audio 10B \$250., and more. Free shipping, 302 E. High St., Waynesburg, PA 15370. (412) 852-1134.

**A BETTER SYSTEM? PEOPLE WHO KNOW STEREO BUY THEIR SOUND DIRECT.** Now you can buy the finest in high fidelity components, including esoterics and auto-sound at unheard of prices. **DIRECT SOUND MARKETING** provides sensible expert advice, in-house service facilities, and factory fresh components on an in stock basis. Discover America's best kept audio secret. Send for our **FREE** catalogue to **DIRECT SOUND MARKETING**, Dept. A, 3095 Bolling Way, Atlanta, Georgia 30305 or call 404-233-9500. MC/Visa/Amex accepted. Sales tax charged to GA. residents only.

**ABSOLUTE AUDIO:** ROBERTSON, SPICA, AMBER, COUNTERPOINT, ORACLE, CONRAD-JOHNSON (including PREMIERS), DYNAVECTOR, NAD, OHM, RGR, SNELL, VPI, THIEL, THRESHOLD, MAGNEPAN, MIRAGE, WALKER, ETC. AUDIO FILE, 1202 S. Congress, Austin, Texas 78704, (512) 443-9295

**ABSOLUTE ELIMINATION OF STATIC ELECTRICITY** from your records for their entire life. Never be troubled with static caused wear and noise again. Sufficient supply to treat 500 records - \$15.00. For information and free sample, write to **NEUTRASTAT**, P.O. Box 724, Corpus Christi, Texas 78403.

**ABSOLUTELY UNBEATABLE VALUE** reviewed November 82 Gramophone "indeed the combination Mayware MKIV tonearm \$125 & MC-2V 'Vital' stylus \$89 + T-24 transformer \$150 reproduced my Test records with unusual accuracy and tonal naturalness. Worlds best loudspeaker manufacturer says "combination performed extremely well & cures mlstracking that occurred with SME." New MC-3L/11 High output MC \$89. Paying more is futile. VISA/MC accepted. Info \$1 bill. Mayware P.O. Box 58, Edgware, Middx. England.

### ACCURATE AUDIO—SOUTHERN CALIFORNIA

Alpha-One, AR Turntable, Audio Pro, DCM, Denon, Kindel, Monster Cable, NAD, Nitty Gritty, Perreaux, Phantoms, Premier, Sonagraphe, SOTA, Spica, Stax, Sumiko, Syrinx, Randall Research, Talisman  
SANTA MONICA LAGUNA BEACH PASADENA  
(213) 399-HIFI (714) 494-2030 (213) 792-4444

**ACCURATE IMAGING AND REPRODUCTION SYSTEMS** has developed a devastating little speaker system called the **MINI-MONITOR**. It's ability to place instruments in their proper perspectives is uncanny. The **MINI-MONITOR** offers a high level of accuracy seldom achieved by loudspeakers of any type. A free demonstration in your home will say it all!!!

For more information write to: A.I.R. Systems,  
47 Strong Place, Brooklyn, N.Y. 11231.

### ACOUSTAT AND PS AUDIO—SUPERB!

Free shipping! Fast service! Also Nakamichi, Thorens, Talisman, Proton, Hafner, Adcom, Sony, Carver, digital discs and players. **READ BROTHERS STEREO**, 593 King Street, Charleston, South Carolina 29403. (803) 723-7276.

### ACOUSTAT IN WISCONSINI!!

AUDIO ELITE, Menasha, WI. 414-725-4431

**ACOUSTAT 2+2 OWNERS** the "ACOUSTAT MOD" eliminates midrange and hi-end colorations for state-of-the-art sound. \$295/pr. No risk, 30 day trial. For info send SASE to John Koval, Linear Acoustics Labs, 11521 Cleo Pl., Santa Ana, CA 92705, 714-838-6555.

**CROWN BEST QUALITY AMPLIFIERS, TUNERS, PRE-AMPLIFIERS. PROFESSIONAL CONSULTATION—BEST PRICES.** EAST: (904) 262-4000; WEST: (213) 840-0878.

**ADS PLUS**—Own the incredible ADS Loudspeakers for the home or car at tremendous savings. All models in stock. **DESIGNATRON'S STEREO STORES, INC.**, 260 Old Country Road, Hicksville, NY 11801, (516) 822-5277.

**ADVENT RECEIVERS**—Model 300, 15/15W, \$199; Model 350, 50/50W deluxe, \$299. Warranty. SCC, Box 551 (AM1283), Dublin, OH 43017; (614) 889-2117, VISA/MC/COD.

**AMBER PreAmp and Amp**—\$600 Call Terry 402-391-3842



## FOR SALE

**ELECTRO-VOICE INTERFACE AND CD SERIES QUALITY SPEAKER SYSTEMS. PROFESSIONAL CONSULTATION—BEST PRICES. EAST: (904) 262-4000; WEST: (213) 840-0878.**

**AEOLIAN LOUDSPEAKERS LTD** brings you nothing but the best. We fulfill the promise of the **JORDAN 50mm** with our exclusive modification. We introduced you to **FOCAL** and offer the most creative, advanced designs for these drivers. We bring you the amazing qualities of the wide range, high efficiency **SHACKMAN ELECTROSTATIC**. We assist individuals and manufacturers alike in creating music beyond the mundane. We are the source for high quality drivers. Watch for our complete systems this spring. Aeolian Loudspeakers Ltd., Box 1005, W. Newbury, MA 01985 (617) 363-5495.

**A FREE CATALOG—CARTRIDGES,** tonearms, turntables, electronics, Denon, Grace, Supex, Dynavector, Thorens, Michell, Ariston, Signet, Stax, lustre. All with USA Warranty. Audio Unlimited, 1798B Technology Drive, San Jose, CA 95110 408/279-0122 11-6M-Th.

**HAFLER, REVOX, TANBERG, CARVER, DBX AND OTHER QUALITY COMPONENTS. PROFESSIONAL CONSULTATION—BEST PRICES. EAST: (904) 262-4000; WEST: (213) 840-0878.**

**HARMAN-KARDON SEPARATES, RECEIVERS, CASSETTE DECKS, TURNTABLES, PROFESSIONAL CONSULTATION—BEST PRICES. EAST: (904) 262-4000; WEST: (213) 840-0878.**

**ALL CLASSIC QUAD ELS OWNERS.** Hard to believe QUADS can be improved? The "KOVAL QUAD MOD" has been unbelievably successful in satisfying the most ardent QUAD lover. No risk 30 day trial \$140/pr. For info send SASE to John Koval, Linear Acoustics Labs, 11521 Cielo Pl., Santa Ana, CA 92705, 714-838-6555

## APPALLING? ISN'T IT?

How many esoteric audio products look and feel as if they were made by orangutans with screwdrivers. If you are fed up with sacrificing reliability, aesthetics and quality of construction to obtain purer sound, don't despair!

There are many high end audio components built by small yet solid professional companies which not only express the utmost in musicality but also reflect the highest level of design integrity, craftsmanship and quality control. At Sound by Singer we select and blend only such components into systems designed to extract the most music from your audio dollars.

ACOUSTAT • ADCOM • AMPLITON • AUDIO DESIGN • AUDIOQUEST • AUDIBLE ILLUSIONS • AUDIO NOTE • AUDIO INTERFACE • BEARD • BELLES • BERNING • COUNTERPOINT • DYNAVECTOR • FRIED • FUSELIER • GRACE • GRADO • ITC • KISEIKI • KLOSS • KRELL • KYOCERA • LINN SONDEK • LIVE WIRE • MERIDIAN • MICRO SEIKI • MONSTER CABLE • NAD • NAIM AUDIO • NITTY GRITTY • PARADIGM • PIONEER VIDEO • PRECISION FIDELITY • PROTON • REGA • SNELL ACOUSTICS • STAX • SUPEX • SYMDEX • SYRINX • TALISMAN • THRESHOLD

## SOUND BY SINGER

227 Lexington Avenue  
New York, NY 10016  
(212) 683-0925  
WE SHIP ANYWHERE

### A.R.C. EQUIPMENT FOR SALE

D-90 (new), 1095.00, D-90(B) 1295.00 OTHER EQUIPMENT FOR SALE (2) Beveridge 2SW-1 amps, 740.00, MR-67 mint 295.00, MC2105 615.00, MR-66, 150.00 MR-77 435.00. (317) 283-1361, Ask for Dave.

### AUDIO CONNECTION In Northern New Jersey

**TURNTABLES:** AR, Denon, HK, Heybrook, VPI  
**TONEARMS:** Audioquest, Helius, Souther, Zeta  
**CARTRIDGES:** Argent, Grado, Monster C., Promethean  
**ELECTRONICS:** Audible Illusions, Beard, FM Acoustics, Electrocompaniet, Denon, Harman Kardon, Magnum, PS Audio, Fuseller, Heybrook, Kindel, Melos, Rauna, Spondor, Spica, Spectrum, 3D Acoustics, Vandersteen  
**SPEAKERS:**  
**ACCESSORIES:** Last, LiveWire, Tweek, Nitty Gritty, Kimber Kable, VPI Industries  
201-239-1799  
615 Bloomfield Ave, Verona, NJ 07044

## FOR SALE

**ARIZONA MUSIC LOVERS NOW HAVE AVAILABLE THE SUPERB products of CONRAD-JOHNSON DESIGN.** Including the new superb PV-5 preamp, the MV75A-1 poweramp, and the **LINK REFERENCE** and the fabulous **ALPHA 1** phono cartridge; the superb **ZETA** pickup arm; Audible Illusion's **MODULUS ONE** preamp; Esoteric Audio Research's 509 poweramps and The Preamp; **ENTEC** powered subwoofers, strathearn ribbon drivers, **VPI** turntable and RCM, Last, phono cartridges by **GRADO, ACCUPHASE, AUDIOQUEST, KOETSU;** the **SONOGRAPHE** turntable, and Grace, Premier, and Talisman. Write for free info, or phone 602-943-6877 evenings and weekends. **TWO JEFFREYS AUDIO, 527 W. Butler Dr., Phoenix, AZ 85021**

**ATTENTION, NEW 1984 CATALOG** featuring Audax, Dynaudio, Becker, Eclipse, Focal, Peerless, Morel, VIFA, speaker kits, and much more! Meniscus Systems, 3275 W Gladiola, Wyoming, Michigan 49509

**ATTRACTIVE PRICES: ACCUPHASE, ALPHASON, DYNAVECTOR, DENON, LINN, FULTON, STAX, KOETSU, GOLDAERO, AUDIBLE ILLUSIONS, BERNING, SOTA, WALKER, FR, LAST, BRB. 713-728-4343. MAURY CORB 11122 ATWELL, HOUSTON TEXAS 77096**

## Quality Tapes

### BELOW WHOLESALE SPECIALS!

TOK		DISC WASHER	
SA 90	2.15	AD 90	1.85
SA 60	1.85	AD 60	1.45
SAX 90	2.70	D 90	1.19
SAX 60	2.40	D 60	.99
MA 90	4.29	LX 35-90	5.15
MA 60	3.89	LX 35-60R	5.85
MAR 90	6.29	HD 01 DEMAG	12.75
MAR 60	5.78	T-120	6.95
ADX 90	2.55	T-120 EX HG	9.50

MAXELL		SONY	
UDXL II 90	2.20	UD 60	1.85
UDXL II 60	2.19	LN 90	1.35
XL II 5 90	2.79	LN 60	1.05
MX 90	4.69	UD 35-90	4.95
UD 90	2.15	XL I 35-90R	6.39

FUJI		BASF	
FR METAL 90	3.69	PRO II 90	2.39
FR II 90	2.19	MEMOREX HB 90	2.39

LICKS	
90	2.45
60	2.35
LNK 90	1.10
LNK 60	.95
L-500	6.49
L-750	7.49
L-750 HG	8.95
T-120	6.95

TO ORDER BY PHONE CALL 212-434-3417 OR ORDER BY MAIL - ON ORDERS UP TO \$70 ADD \$3.50 SHIPPING - OVER \$70 ADD 5% OF TOTAL ORDER - OUTSIDE UPS ZONES DOUBLE ABOVE - OUTSIDE USA WRITE FOR SHIPPING CHARGES - MASTERCARD/VIISA ORDERS ADD 3% EXTRA FOR HANDLING - PRICES SUBJECT TO CHANGE

### QUALITY TAPES

864 East 7th Street, Dept. A2, Brooklyn, NY 11230

## LEGENDS EVOLVE AND IMPROVE.

Chestnut Hill Audio is at the leading edge of musical technology. Hear our new Sony CDP-101 Compact Digital Disc Player as well as legendary products from: Accuphase, Acoustat, Acoustic Electronics, Adcom, Amber, Apature, BK Components, Berning, Cabasse, Colter, Denon, Dynavector, EMT, Euphonics, Fourier, Fried, Grace, Halfer, Infinity, Janis, Kenwood Purist, Koetsu, Kiseki, Krell, LAST, Leach, Linn Sondek, J.A. Michell, Monster Cable, Music Reference, NAD, Oracle, Origin, PS Audio, Pioneer Video, Proton, Pyramid, Quad, RGR, Rogers, Signet, Sony, Spectral, Spondor, Syrinx, Tandberg, Thorens, Threshold, 3D Acoustics, VPI, VSP Labs and Vandersteen, 311 Cherry Street, Philadelphia, Pa. 19106 (215) 923-3035.

## CHESTNUT HILL AUDIO LTD.

MEET THE  
DIGITAL  
CHALLENGE



## WITH THE ALPHA 1 MOVING COIL CARTRIDGE BY MONSTER CABLE

Analogue or digital?

The Alpha 1 meets the digital challenge by reproducing your conventional analog disks with unprecedented accuracy. The new Alpha 1 incorporates the latest design techniques, utilizing sophisticated computer analysis of amplitude and phase response, to produce superb dynamics, smooth quick transients, and a panoramic soundstage that recreates the original musical event with startling reality.

A rigid boron cantilever with a unique dual damper provides exceptional clarity and dynamic range without the "harsh" sound typical of moving coil designs. So meet the digital challenge.

Audition the new Alpha 1 at your nearest Monster Cable dealer.

And rediscover how good your analog records can sound.

Monster Cable Co. 101 Townsend St.  
San Francisco CA USA 94107  
(415) 777-1355 telex: 470584 MCSYUI

alpha  
by MONSTER CABLE USA



## THE NEW TECHNOLOGY

### Tube Quality— Transistor Prices

New from Kinergetics.  
The KBA-100 Amplifier \$795.00.  
The KPA-1 Preamplifier \$775.00.

Hear them now at selected  
audio dealers.



6029 Reseda Boulevard - Tarzana, California 91356 · (818) 345-2851

### FOR SALE

**ATTENTION DYNA AND HAFLER OWNERS**

We build new circuits into most Dyna and Hafler units. We transform Dyna ST-80, ST-120, ST-150, ST-300, ST-400, ST-416, SCA-50, and SCA-80Q amplifiers into modern POWER MOS-FET amps with new PC cards, precision parts, and low inductance power supplies. We install five new PC cards in Hafler DH-200 and DH-220 amplifiers with ground plane output networks for much improved transient performance. We install new circuits in DH-101, PAT-5, PAT-4, and PAS-3X preamplifiers with exact RIAA equalization, matched precision parts, precision controls, and complete freedom from transient and digital overload. Audiogram said we make the world's best tuner in the FM-5 chassis. Sensible Sound has reviewed several of our amplifiers. Our \$99 phono cartridge has a satisfaction guarantee or your money back. Call or write for free catalog and sample copy of our monthly newsletter, Audio Basics. We ship worldwide and have new 120 and 240 volt equipment available.

**JENSENS STEREO SHOP**  
2202 RIVER HILLS DRIVE  
BURNSVILLE, MINN. 55337, (612) 890-3517

### FOR SALE

**ASK ANY CARTRIDGE-HELIUS DESIGNS TONE-ARMS ARE USER FRIENDLY.** For dealer list, contact IAI, 723 Bound Brook Road, Dunellen, NJ 08812, or call 201-968-8771.

**AUDIO ELITE IN WISCONSIN!!!**  
Acoustat Loudspeakers—Fantastic  
Acoustat Pre-amp and power-amp—Superb  
AUDIO ELITE, Menasha, WI, 414-725-4431

### FOR SALE

**AUDIO CONCEPTS D-1** and Caldwell woofer at dealer cost. Also, PSE Studio D amp, Counterpoint SA-3, Perreux SM-2, Pro-AC Tablette, VSP Amp, C.J. Walker. All with manufacturer's warranty. 303-963-3269

**A&S OFFERS HIGH-END SPEAKER KITS,** raw drivers and auto speaker systems from the world's finest manufacturers. For beginners and audiophiles. We carry Audax, Dynaudio, Dalesford Cambridge, Jordan, Peerless, JVC, SEAS, Jordan-Watts, Morel, Pyle, Siare, Volt, Becker. Featuring the new Caldwell Compact Monitor and Subwoofer, and Dynaudio's "Authentic Fidelity" kits. Free price list. A&S SPEAKERS, Box 7462A, Denver, CO 80207. (303) 399-8609.

# HOUSTON

## Comes of Age

The nation's fourth-largest city proudly  
welcomes a truly distinctive audio dealer:

## AUDIO PROFILES

Fully authorized dealer representing:

Audio Research	Threshold
Counterpoint	PS Audio
Sequerra	Tandberg
DCS/Gestalt	Musical Fidelity
Amber	Hafler
Horman Kardon	Kyocera
Quad	Acoustat
Vandersteen	Thiel
KEF	Dahlquist
Spica	Janis
Goldmund	Oracle
Walker	VPI
Syrinx	Helius
Sumiko	Lustre
van den Hul/EMT	Kiseki
Marovskis MIT	Dynavector
Grace	Signet

Kyocera DA-01 digital Compact Disc player  
Audioquest/Live Wire - Sonex Professional

Five listening rooms on two levels  
Spacious, relaxed atmosphere  
Knowledgeable, experienced staff  
Wide selection of audiophile recordings

**Hear the finest music system  
in the entire Southwest.**

Quad ESL-63s \* Janis W-1/1A subwoofer  
Goldmund Studio T3D \* van den Hul/EMT  
Audio Research SP-10 and D79C electronics  
Sequerra FM-1 \* Tandberg TD20A-SE tape  
Sonex Professional "L.E.D.E." listening room

audio profiles inc.

12651 Memorial Drive, between Gessner & W. Belt  
Houston, Texas 77024 (713) 973-0000  
Mon.-Thurs. 10 am-8 pm, Fri 10-7, Sat. 10-6  
MasterCard, Visa and American Express accepted

**AUDIO EMPORIUM,** representing hifi's best values. Free Catalog. 6914 W. Brown Deer Rd., Milwaukee, WI. 53223. 414-354-5082.

**AUDIO PULSE SERVICE.** Factory trained technicians. Write us about Model One update kits. White Labs, 10528 Lower Azusa Rd., Suite 192A, El Monte, CA 91731. (213) 446-5346.

### AUDIO HOUSE—FLINT MICHIGAN

ROGERS	SOTA	CONRAD JOHNSON
ROBERTSON AUDIO	NEC VIDEO	DNKYO
REVOX	AUDIO PRO	SYSTEMDEK
ALPHA-1	BELLES	SPECTRUM

GONZA Speaker wire 12 gauge 100 ft. \$49. 4304 Brayan, Swartz Creek, Mich 48473, 313-655-8639 by appointment

**AUDIO INTERFACE STEP-UP TRANSFORMER.** Low impedance version \$110.00. Call 617-256-4998.

**AUDIONICS CC-3, A NEW STANDARD**  
We have in stock the SUPERB Audionics CC-3 for immediate delivery, \$745.00. FREE SHIPPING in US and PR. Worldwide shipping available. Visa and MasterCard honored. OXFORD AUDIO CONSULTANTS, INC., Box 145, Oxford, OH 45056-0145, 513-523-3333, TLX427791.

**AUDIONICS PZ3 POWERAMP.** Call Terry 402-391-3842

**AUDIO RESEARCH D76A,** \$500 or best offer; Audio Pulse Model 1, \$175. 615-483-6293 EST.

**AUDIO RESEARCH SP-10 PREAMP** new in box, \$275/0 b.o. (415) 527-5736 eves.

**AUDIO RESEARCH SP10 and D250,** the reference components. 716-262-2909

**AUDIO RESEARCH SP4 PreAmp** Call Terry 402-391-3842

**AUDITION THE INCOMPARABLE INFINITY RS-1**  
Exclusively in New England  
at Audio Vision of N.E., 617-863-5221

**Prompt Insured Shipments**

# GUARANTEED SAVINGS

*"Why Settle For Less When You Can Own The Best"*

## AUDIO/VIDEO/CAR STEREO COMPONENTS

✦ Professional Advice    ✦ FREE Delivery & Set Up    ✦ Relaxed "NO RUSH" Showroom  
 ✦ Financing Available    ✦ Trade-Ins Accepted    ✦ Custom Installation & Repairs

**FEATURING OVER 60 BRANDS INCLUDING:**

•ADS	•Boston Acoustics	•Gem	•Onkyo	•Sony
•Advent	•Celestion	•Grace	•Ortofon	•Sound Dynamics
•AIWA	•Concord	•Grado	•Phase Linear	•Thorens
•Amber	•DBX	•Horman Kardon	•Pyramid	•Vampire Wire
•AR	•Denon	•Hilachi	•Sequerra	•C J Walker
•Blaupunkt	•Dynavector	•Kyocera	•Soundcraftsmen	and more
•Bose	•Energy Loudspeaker	•Mitsubishi	•Signet	

CALL OR WRITE HAROLO MINTO

## PERFORMANCE AUDIO/VIDEO

**(516) 378-4389**

365 S. Bayview Ave. • Freeport, L.I., New York 11520

Retail  
Mail Order  
Export



## FOR SALE

**AUTO SOUND—SOUTHERN CALIF.** For the best in truly audiophile quality—Precision tuned to your car—Call John at THE AUTO CONCERT, 714-730-9011

**BANG & OLUFSEN PRODUCTS AND NAKAMICHI CASSETTE DECKS—IN STOCK AT BEST PRICES.** (717) 774-2618

**BARGAIN SPECIALS!** Advent, AR, Audio Control, Celestion, Dual, Dynaco, Harman-Kardon, Jensen, Marantz, Mordaunt-Short, MXR, Scott, etc. FREE "specials" list, SCC, Box 551 (AM1183), Dublin, OH 43017.

**BEARD ELECTRONICS, PINK TRIANGLE TURNTABLES, HELIUS TONEARMS** are now available at Audio Consultants in Philadelphia, Pennsylvania, 215-843-9476.

**BEARD TUBE ELECTRONICS AT PERSONALIZED AUDIO** in New Jersey. Call 201-752-3883.

**B.E.S.—SM300 SPEAKERS—LIKE NEW,** 215-567-4626.

**BEST TRADES OFFERED.** Free newsletter. Dealer for: Acoustat, Audio Research, Goetz Systems, Haller, ESB, David Berning, Classe, Nakamichi, Pro-Ac, Perreux, Quicksilver, Pentagram, Rogers, Spondors, Futterman, Koetsu, Spica, Souther, Synrx, Snell, VPI, Sota, Oracle, Rega, Rauna, PS, Kiseki, Dynavector, Counterpoint, Sumiko, Premier, AR turntables, Grado, Nitty Gritty, Audioquest, Livewire, Monster Cable, Belles, Bedini, Accuphase, Precision Fidelity, Spondor and more. Audio Doctor, PO Box 390, 1518 West Commercial, Buffalo, MO 65622. 417-345-7245.

"**BEST \$1200 SOLID STATE AMPLIFIER THAT I AM AWARE OF!**" ... says Grey Rollins. To hear the RGR Five-1 High Current Amplifier in South Carolina, contact Upstairs Audio, 200 Meeting St, West Columbia (803) 791-1885, or call RGR (312) 673-9320.

**BIG REWARD !!** All Mac equip., JBL spkrs, and electronics, Altec Acousta-voicette, MXR ETC 31 band equalizers, Thorens TD 125, SME 3009-3, JBL speaker cabinet blueprints. 1-313-229-5191 aft. 7 EST

## BIG TEN SYSTEM

(UNDER \$10,000)

Turntable: Linn Sondek Lp-12  
Tonearm: Syrinx PU-3  
Cartridge: Kiseiki Blue  
Tuner: Adcom GFT-1A  
Preamp: Krell PAM 1-A  
Amp: Krell KSA-100  
Speakers: Snell Type A's

## SOUND BY SINGER

227 Lexington Avenue  
New York, NY 10016  
(212) 683-0925

**CARVER C-9 Sonic Hologram Generator.** \$175. (707) 525-8335.

## KIMBER KABLE

HIGH PERFORMANCE  
SPEAKER WIRE

Strong in the West, headin' East.

## ASK YOUR DEALER

Manufactured by:

RKB Industrial, Inc.  
2058 Harrison Blvd.  
Ogden, Utah 84401  
(801) 621-5530

## THE PS IV IS THE SECOND BEST VALUE IN AUDIO. THE FIRST IS YOUR RECORDS.

There's magic in your record grooves. And the experts agree: the PS IV brings it all out.



THE PS IV IS NOW THE PS IV "HI"  
Smoother than ever! Imaging and harmonic integrity have improved. 1% Resista metal film resistors now used throughout. All without any change in price! PS OWNERS: contact your PS dealer for upgrading details.

**PS AUDIO**  
NO ONE EVEN COMES CLOSE

3130 Skyway Drive 301, Santa Maria, California 93455. 805-928-2631.

## FOR SALE

**BOSTON ACOUSTICS PLUS—**Dollar for dollar, one of the most exceptional speaker lines to come along in years. Boston Acoustics delivers unbelievable performance at very reasonable prices. All models in stock. DESIGNATRON'S STEREO STORES, INC. 260 Old Country Road, Hicksville, NY 11801 (516) 822-5277.

**BRYSTON 4B \$1050., Bryston 1B \$550., Carver TXII \$425., Denon DP60L \$425., M&K SAT, 1B's & Volkswوفر 1B \$1000., 6 months old, extras 207-772-1720 Malne**

**B&W-801F's. MATCHED PAIR, WALNUT,** with covers. Mint condition, \$2500. Call Bill at (307) 789-9425 after 4 p.m. M.T.

**CABLE TV DESCRAMBLERS AND CONVERTERS.** Plans and parts. Build or buy. For information send \$2.00. C&D Electronics, Inc., P.O. Box 21, Jenison, MI 49428.

CALL TOLL FREE 1-800-826-0520 For Acoustat, Dahlquist, NAD, Carver, Hafer, B&W, Tandberg, Denon, Astatic, Amber, Oracie, Pe reaux, Proton, Snell, 3D, Grace, VSP, Belles, Pyramid, Sota, Audioquest, M&K, Bedini, dbx, Thorens, Stax, Nitty Gritty, Dynavector, CWD, Grado. The Sound Seller, 1706 Main St., Marinette, WI. 54143 (715) 735-9002.

## BOTH SIDES NOW!

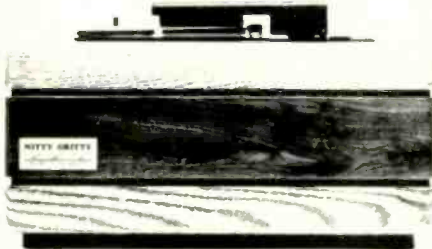

Introducing the NITTY GRITTY "PRO" the world's first record cleaning system to wash and vacuum dry both sides of a phonograph record. Just 30 seconds from start to finish. Easily, Beautifully. Perfectly. Available from select NITTY GRITTY dealers only.

If the preservation of your record collection is important to you, NITTY GRITTY has a record cleaner that you need - seven models to choose from.

**NITTY GRITTY**  
RECORD CLEANING SYSTEMS

NITTY GRITTY  
RECORD CARE PROD.  
4650 ARROW HWY., F-4  
MONTCLAIR, CA 91763  
(714) 625-5525

## FOR SALE

**CARVER PLUS—**Featuring the new 130 Watt/Channel Carver Receiver and all Carver products through the mail at extra savings. PLUS-FREE shipping anywhere in the continental U.S. DESIGNATRON'S STEREO STORES, INC., 260 Old Country Road, Hicksville, NY 11801, (516) 822-5277.

**CROWN BEST QUALITY AMPLIFIERS, TUNERS, PRE-AMPLIFIERS, PROFESSIONAL CONSULTATION—BEST PRICES.** EAST: (904) 262-4000; WEST: (213) 840-0878.

**HAFER, REVOX, TANBERG, CARVER, DBX AND OTHER QUALITY COMPONENTS.** PROFESSIONAL CONSULTATION—BEST PRICES. EAST: (904) 262-4000; WEST: (213) 840-0878.

**C.J. WALKER TURNTABLE—\$225 NEW save \$125 Call Terry 402-391-3842**

**CROWN DC300A, factory sealed \$775. 716-262-2909**

## The Lowest Price on Sound Advice

Call SOUND STAGE to compare product, price and service. Our friendly informed staff makes sure you get only the best stereo values. Call/write for monthly demos and specials lists.

Shop SOUND STAGE for:

- knowledgeable service
- 30-day price guarantee
- super selection in stock
- extended warranties
- prompt, free delivery
- free repair pick up
- authorized dealership

**NAD**

New, NAD "La Gata" turntable with interchangeable, "floppy" tonearms.

In stock and on display.

ADS	ALPINE	DENON	PROTON	THE UNGO BOX
FAS	GRACE	CARVER	AUDIO-PRO	BANG & OLUFSEN
BES	AMBER	LUXMAN	CJ WALKER	DACODOOD LOCKS
NAD	ADCOM	ALLISON	3D ACOUSTICS	BOSTON ACOUSTICS
DCM	SIGNET	PYRAMID	AUDIOSOURCE	CHAPMAN SECURITY
GRADO	HITACHI	TALISMAN	AUDIOCONTROL	PHILIPS ULTRASONIC

212 961-9888  
FREE, 24-pg. catalog

184-10 Horace Harding Blvd  
Fresh Meadows, NY 11365  
Exit 25 I.E., Utopia Pkwy  
(In Queens, 20 min. from Man.)



## ACTIVE ELECTRONIC CROSSOVERS

STEREO BI-AMP ..... \$139  
STEREO TRI-AMP ..... \$230

Level controls and sub-sonic filters, summers, optional. Filters, regulated power supplies, equalizers, are also available.

Free catalog and price sheet

*DeCoursey* Eng. Lab.

11828 Jefferson Bl. Culver City, CA 90230  
PHONE (213) 397-9668

## FOR SALE

CONRAD JOHNSON DESIGN IS  
AVAILABLE IN BOSTON

Only at Audio Vision of N.E., 617-863-5221

COUNTERPOINT IS NOW IN BOSTON

at Audio Vision of N.E., 617-863-5221

CROWN SL2—\$349 NEW Save \$200 Call Terry 402-391-3842

CROWN SX824—tape deck, with remote tape counter and walnut cabinet—\$995 Call Terry 402-391-3842

DB SYSTEMS OFFERS PRECISION ELECTRONICS AND AUDIOPHILE ACCESSORIES. Five year warranty. Write for our complete product list. DB SYSTEMS, Main Street, Rindge, NH 03461 (603) 899-5121.

ELECTRO-VOICE INTERFACE AND CD SERIES QUALITY SPEAKER SYSTEMS. PROFESSIONAL CONSULTATION—BEST PRICES. EAST: (904) 262-4000; WEST: (213) 840-0878.

## High Performance Review

Fine Audio Components Reviewed Using a Sophisticated Blend of In-Depth Listening Evaluations and Leading-Edge Laboratory Tests. Recent reviews include: Levinson ML9, ML11 & 12, Quad 405-2, Accuphase AC2, Dynavector 17D&23R, Nakamichi Dragon, Snell Type E, Sony Esprit TAE900 & XL88D, Audible III, Modulus, B&W 801F, Hafler 220. Coming: Conrad-Johnson Premier 3, Infinity RS2A, Levinson ML7 and other exciting products (many exclusive). Each 170 page quarterly issue reviews: 10-15 components, 80+ high quality records and a technical article. Extensive photographs and graphs. **H/PR** is guided by an expert Technical Advisory Board. Audiophiles praise our magazine: "Great approach, helpful... unsurpassed." Join us today!

### High/Performance Review

PO Box 2989, Stanford CA 94305 USA

- Yes, start me with Volume 2, four issues. \$26.00 check or money order enclosed.  
 I want both Volumes 1 & 2, eight issues. \$50.00 enclosed (reduced price offer)

Overseas and Canadian Subscribers: Check in US Funds net on US Bank or International Postal Money Order. Add \$4.00 per volume for non-US surface mail delivery.

Name \_\_\_\_\_  
Street \_\_\_\_\_  
City \_\_\_\_\_  
State \_\_\_\_\_ Zip \_\_\_\_\_  
For Questions: Telephone: (408) 446-3131, M-F 10-4 (Pacific Time)

## FOR SALE

DYNACO OWNERS: 60,000 LBS parts/accessories/kits. Free catalog. SCC, Box 551 (AM 1183) Dublin, Ohio 43017. (614) 889-2117

## DEEP SIX SYSTEM

(ABOUT \$6000)

Turntable: Linn Sondek Lp-12  
Cartridge: Talisman S  
Tonearm:: Linn Basik LV-X  
Tuner: Adcom GFT1-A  
Preamp: Acoustat TNP  
Amplifier: Acoustat TNT-200  
Speakers: Acoustat 2 + 2

## SOUND BY SINGER

227 Lexington Avenue  
New York, NY 10016  
(212) 683-0925

DAHLQUIST DQ 10 Speakers Call Terry 402-391-3842

ELECTRONIC CROSSOVERS: 6, 12, 18dB/octave. Kits from \$106.50. Transient-Perfect Crossover, \$175. Free folder. ACE AUDIO CO., 532-5th St., E. Northport, NY 11731-2399. (516) 757-8990.

### ELECTRONIC REPRESENTATIVES NEEDED!!

LOWEST POSSIBLE PRICES!! OVER 100 BRANDS!  
AUDIO—VIDEO—CAR STEREO—COMPUTERS  
ELECTRONIC EXPERTS 1000 ORANGE AVE.,  
WEST HAVEN, CT 06516

FACTORY FRESH GOLD LION TUBES: KT88's—\$29.00  
KT77's—\$25.00, KT66's—call. Quantity discount available.  
Dealer inquiries invited. Microtel Electronics, 38A Siracusa Blvd., Smithtown, NY 11787. 516-543-3195

## FOR SALE

ESOTERIC AUDIO . . . SERVING SOUTHEASTERN MICHIGAN. FEATURING: AUDIBLE ILLUSIONS, BELLES, ESOTERIC AUDIO RESEARCH, ESB, DYNVECTOR, AUDIOQUEST, BEAM, CELESTION SL6, SL600, ARISTON, HARMAN KARDON, JVC, MERIDIAN, PS AUDIO, PROAC, ROGERS, RAM, SPICA, WALKER, SUMIKO, J.A. MICHELL, ORACLE, SYRINX, ZETA, SME, HELIUS DESIGNS, MONSTER CABLE & ALPHA 1, KISEKI, ORTOFON.

"Serving Michigan's most discriminating Music Lovers."

27861 Orchard Lk. Rd.  
Farmington Hills, Michigan 48018  
313-553-8240

"Finest Performance"

—EXCEPTIONAL AUDIO REPRODUCTION SYSTEMS—  
REGA, HEYBROOK, AR, ARISTON, THORENS, DUAL turntables; ZETA, SYRINX, PREMIER, HEGEM, HEYBROOK, REGA tonearms: ADCOM, ARCAM, AUDIRE, CREEK, COUNTERPOINT, KENWOOD BASIC, KYOCERA, SHERWOOD, VSP LABS electronics; FRIED, HEYBROOK, MAS 925 loudspeakers; SUPEX, TALISMAN, GRADO & SIGNATURE, REGA, ARCAM cartridges; AUDIOQUEST, DECCA, NITTY-GRITTY, The PIG and other accessories. WE CARRY PRODUCTS THAT WE WOULD WANT TO OWN! EARS, P.O. BOX 658-U, W. COVINA, CA 91790. 818-961-6158 (818-961-6158 after January 7) EVENINGS, WEEKENDS. MC/VISA. MONTHLY SPECIALS.

### FINALLY!

#### RANDALL RESEARCH speaker

wire and Interconnect cables improve your system as dramatically as significantly upgrading your cartridge or pre-amp. ACCURATE AUDIO, 1207 N. Coast Hwy., Laguna Beach, CA 92651. (714) 494-2030

FM ACOUSTICS power amplifiers are best suited for difficult loads: a MUST for Dayton-Wright owners. Audio Connection 201-239-1799



## Series 140 Power Amplifier

The power amplifier combination you have been searching for . . . excellent music reproduction at an affordable price.

In the Series 140 Power Amplifier, B & K Components, Ltd. has developed a simplified design concept and produced it with rigid quality controls. The result — a highly reliable unit with Class "A" capability for under five hundred dollars.

### Check these outstanding features:

- 3.2 db of Dynamic Headroom;
- All 1% Metal Film Resistors;
- Class "A" complementary symmetry up to the driver stage;
- Seventy watts per side mosfet design;
- Outstanding linearity and wide bandwidth capability through the use of a Cascode differential;
- A 47,000 MFD power supply guarantees peak demand performance;
- Digital Audio Disc Compatibility for optimal system flexibility;
- Matched pair transistors in front end circuitry assures absolute D.C. stability;
- Gold-plated connector posts.

Call toll-free or write today for information.

**B & K Components, Ltd.**

P.O. Box 331

Orchard Park, N.Y. 14127 U.S.A.

Toll-Free: 1-800-543-5252

716-652-7650

(New York State only) 1-800-235-5020

Telex: 466482



## FOR SALE

### FM ANTENNA

Indoor Circularly Polarized FM-Stereo Antenna Maximized reception with multipath rejection Patented contemporary design . . . \$29.95 MAXTENNA, P.O. Box 3101, Quincy, IL, 62305.

### FOCAL LOUDSPEAKERS AND KITS FROM FRANCE

Featuring: Neoflex cones, Fiberglass domes, Flatwound wire, Active or passive crossovers, Compound woofer systems. Extensive design parameters. Available in the US from **MADISOUND SPEAKER COMPONENTS** 8982 Tablebluff, Box 4283, Madison, Wisconsin 53711 608-767-2673.

**FOR DOMESTIC & OVERSEAS USE NTSC/PAL/SECAM** TV's, VCR's, Video Cameras, Games & Computers, Stereos, SW Radios & Appliances 110-220V, 50/60 Hz. Lowest prices, Quick Delivery, Contact: Roma Ent., P.O. B. 41127, Cincinnati, OH-45241, (513) 769-5363

**FREE SPEAKERKIT CATALOG!** 17 proven designs. Also, 42 pages on 400 components. (JBL, crossover parts, polypropylene woofers), \$2. **GOLD SOUND**, Box 141A, Englewood, CO 80151. (303) 789-5310.

**FRIED LOUDSPEAKERS IN NJ: AUDIO NEXUS** has them all. (201) 464-8238, (201) 730-2409.

### FRIED SPEAKERS & KITS

State-of-the-art sound. Try our prices! Free shipping. Also Nakamichi, Hafler, Carver, Adcom, Taisman, digital discs and players. **READ BROTHERS STEREO**, 593 King Street, Charleston, South Carolina 29403. (803) 723-7276.

**GOETZ SYSTEMS**—Finally, a full-range dynamic system that out-images and out-class the small mini-monitors. If you are a serious music lover, then these should be at the top of your list. Goetz Systems, USA., PO Box 453, Buffalo, MO 65622. Dealer Inquiries invited.

**GOETZ SYSTEMS**—Manufacturer of new, state of the art loudspeaker systems, in a class by themselves. 404-441-2190

**GOETZ SYSTEMS**—New, Demo & Trade-in Electronics and Accessories; Accuphase, Hafler, Sansul, Infinity, etc. Save 404-441-2190

**GOLD LION POWER TUBES:** KT88, KT77, KT66, Premium 12AX7, 12AU7, 12AT7, and 6DJ8, available from **IAI:** 723 Bound Brook Rd. Dunellen, NJ 08812, or call 201-968-8771.

**GOLDMUND T3B**—new, factory sealed in box. \$2000 813-238-9711

### GRACE—RUBY CANTILEVER FOR F9 SERIES

We offer the Grace 747, 707MK2, 704, F11L, F9E and RUBY. Visa and MC. **FREE SHIPPING IN US AND PR.** **OXFORD AUDIO CONSULTANTS, INC.,** Box 145, Oxford, OH 45056-0145, 513-523-3333, TLX427791.

**HAFLER DH-500 POWER AMP, \$395;** Thorens TD-160 Super turntable with SME Series III tonearm, \$375; Pioneer RT-701 open-reel tape deck, \$250; Sansui AU-D11 integrated amp, \$450; B&O MMC-1 cartridge (unused), \$185; Denon DL-103 Gold cartridge (unused), \$135. Call Michael at (212) 794-1430 (leave message).

**HARTLEY SPEAKERS NOW ON LONG ISLAND.** Featuring the Reference, SPL-1, and the "H" series. Hear them in a home environment. Call (516) 751-5190 for appointment, Gyrodec, Zeta, Gold-bug, Arcam, Eidolan, Esoteric Sound Systems, Stony Brook, N.Y.

**INFINITY RS3A SPEAKERS LIKE NEW.** 215-567-4626

## THIS BOOMERANG IS NOT FOR THROWING!



It's not a toy. It's Cart - A - Lign. A precision cartridge alignment tool that has been proven to make a remarkable improvement in the sound of any audio system.

Lateral tracking error is now known to be a major cause of distortion. Cart - A - Lign permits precise stylus alignment using a patented engraved mirror. You actually align the stylus shaft - not the cartridge body. Available through quality audio dealers at \$29.95 or order direct. Read how the reviewers picked Cart - A - Lign over the others. Free reviews.

Cart - A - Lign Research FA, 40 Linden P. O. Box 160, Plainsboro, NJ 08536

## FOR SALE

### HAFLER IN THE SOUTH

In stock, the superb Hafler pre-amps, amplifiers, tuner and equalizer. Immediate. **FREE** shipping. Also Acoustat, Adcom, Audire, Carver, Conrad-Johnson, Fried, Kilpsch, Mirage, Nakamichi, PS, Proton, SAE, Thorens, Vandersteen, digital discs and players. **READ BROTHERS STEREO**, 593 King Street, Charleston, South Carolina 29403. (803) 723-7276.

### HAFLER PLUS MUSICAL CONCEPTS

Our new generation mods for the Hafler amps and preamps far surpass earlier versions. The M-200C (DH-200) and M-500B (DH-500) convey unsurpassed smoothness and body, with solid state definition and clarity. The M-220B (DH-220 and new version DH-500) offers stunning spatial clarity and absolutely pristine high frequencies. SuperMod III (DH-101) and M-110S (DH-110) challenge any preamp, tube or solid state. The OPS-2 and OPS-4B toroid outboard power supplies add the icing to the cake when used with Hafler preamps. SuperConnect II interconnect, uniquely delivers an unaltered signal. Most interconnects veil or fall to deliver clean transients, not so with SuperConnect II. Write for our eight page brochure. Musical Concepts, 1060 Fifth Plaza, Florissant, MO 63031 314-831-1822

**HAFLER PLUS**—The new Hafler DH220 power amplifier—replacing the DH 200, reinforces David Hafler's commitment to quality in every product he designs. We carry the full Hafler line, available in either kit or factory assembled. Own some of the finest audio equipment! Now at extra savings! **PLUS-FREE** shipping anywhere in the continental U.S., **DESIGNATRON'S STEREO STORES, INC.**, 260 Old Country Road, Hicksville, NY 11801, (516) 822-5277.

**HEAR COUNTERPOINT'S SUBERB LINE** of tube electronics on display at Take 5 Audio. (203) 777-1750

**HELIUS TONEARMS AT PERSONALIZED AUDIO** in New Jersey. Call 201-752-3883.

**HEAR THE BEARD P-100 IN NEW ENGLAND** only at Audio Vision of N.E., 617-863-5221

**EMPIRE SHURE**

DIAMONDS ARE NOT FOREVER!

A worn stylus can do damage to your priceless record collection. It is more economical to replace your stylus periodically (every 500-600 hours) than to ruin your records — especially at today's prices! We are specialists and carry in stock **FACTORY ORIGINAL REPLACEMENT STYLUS** for most of the popular lines.

For those with new Technics turntables we have **Pre-mount cartridges** in stock from \$14.95 & up.

Call Toll Free 1-800-221-0906  
For Price Quotes & C.O.D. Orders  
Fax: (212) 871-3303

For FREE Catalog send self-addressed stamped envelope to:  
**LVLE CARTRIDGES**  
Dept. A Box 59  
Brooklyn, N.Y. 11218

Phones Open Mon. - Sat. 9am - 8pm

**audio-technica**

## FOR SALE

### HAFLER—3 YEAR WARRANTY

Assembled units are now warranted for three years. We should have the following in stock: DH-100K \$149.95, DH-100A \$199.95, (NEW PREAMPS); DH-110K \$324.95, DH-110A \$395.95, DH-112 \$74.95, DH-160K \$299.95, DH-160A \$399.95, DH-220K \$349.95, DH-220KE \$359.95, DH-200A \$449.95, DH-220AE \$459.95, DH-330K \$374.95, DH-330A \$449.95 (NEW TUNERS), DH-500K \$599.95, DH-500KE \$619.95, DH-500A \$749.95, DH-500AE \$769.95. Accessories for above units. **FREE SHIPPING IN US AND PR. WORLDWIDE EXPORTING.** Visa and MasterCard. **OXFORD AUDIO CONSULTANTS, INC.,** Box 145, Oxford, OH 45056, 513-523-3333, TLX427791.

**HAFLER, REVOX, TANBERG, CARVER, DBX AND OTHER QUALITY COMPONENTS.** PROFESSIONAL CONSULTATION—BEST PRICES. EAST: (904) 262-4000; WEST: (213) 840-0878.

**HARMAN-KARDON SEPARATES, RECEIVERS, CASSETTE DECKS, TURNTABLES, PROFESSIONAL CONSULTATION—BEST PRICES.** EAST: (904) 262-4000; WEST: (213) 840-0878.

## Threshold precision crafted audio components



The Threshold FET one STASIS preamplifier places fewer electronic devices between the source and the listener than any other preamplifier.

Threshold considers it axiomatic, all other things being equal, that a simple audio circuit will always sound better than a complex audio circuit. The FET one approaches the theoretical limit of this ideal by using a *single fet* for the voltage gain required of each preamplifier stage.

Sophisticated peripheral control circuits assure that this single fet is always held at maximum linearity while the output topology employs, for the first time in a preamplifier, Threshold's proprietary STASIS technology.

Component parts, assembly craftsmanship and finish are maintained at the highest level, and each FET one is *individually* hand calibrated for exact phase and amplitude adherence to the RIAA characteristic.



For a full color brochure and technical specification sheet on the full Threshold line write:

**Threshold Corporation**  
1832 tribute road suite e sacramento california 95815



## FOR SALE

**HARMAN-KARDON SEPARATES, RECEIVERS, CASSETTE DECKS, TURNTABLES, PROFESSIONAL CONSULTATION—BEST PRICES. EAST: (904) 262-4000; WEST: (213) 840-0878.**

# VMPS AND TECHNOLOGY

The six floor-standing VMPS Speaker Systems represent some of the most advanced technology in design and materials available today in production loudspeakers. Our goal was to overcome the limitations of dynamic range, restricted bandwidth, high distortion and low output levels common to "audiophile monitor" speakers, without sacrificing flat amplitude response and signal phase integrity or adding the screeching colorations characteristic of many high output "digital-ready" systems. To this end we developed the Multi-Band Bass technique in which each enclosure (in our six-way systems) houses separate subbass, low-bass and midbass drivers, each optimized to reproduce only one-third of the range to 600Hz. Such a "division of labor", when combined with large cone surface areas, a special method for restricting cone excursion (and thus many non-linear distortion products), ultra-low-loss 6dB/oct crossover networks, polypropylene woofer and midrange diaphragm materials, finest quality treble drivers & internal wiring, and the elimination of system resonance in the audible band, results in music reproduction of unexcelled fidelity and dynamic impact.

Hear all the VMPS Minimum Phase Response Speaker Systems, including our new **Subwoofer** (19Hz-600Hz -3dB, 0.5%THD/1W input, \$250 ea kit, \$375ea assembled), the **Minitower II** (28Hz-30kHz -3dB, 1.5%THD, \$309ea kit, \$438ea assem), **Tower II** (22Hz-30kHz -3dB, 0.7%THD, \$419ea kit, \$599ea assem), **Super Tower/R** (20Hz-50kHz -3dB, 0.5%THD, \$679ea kit, \$969ea assem), **Super Tower IIa/R** (17Hz-50kHz -3dB, 0.25%THD, \$999-1199ea kit, \$1499-1699ea assem, depending on finish), the five-piece **Widerange Ribbon** (19Hz-50kHz -3dB, 0.5% THD, ribbon transducers from 300Hz to 50kHz, \$4795ea kit, \$5995ea assem), and our two new John Curl-designed **Electronic Crossovers**, the 6dB/oct lowpass-only Model 1 (\$250) and the 12dB/oct, low-and-highpass Model 2 (\$395), at the dealers listed below, or write us for brochures and test reports. Note: Owners of VMPS Speaker Systems purchased since 1974 can upgrade their units to current factory specs at low cost. Latest updates include our innovative Superdome tweeter with ferrofluid cooling and 200W rms power handling, Wondercap™ crossover networks, and ribbon supertweeters; contact us for details. Kits supplied with fully assembled cabinets, and all prices include **free shipping** in USA.

## VMPS AUDIO PRODUCTS

div Itone Audio

1016 Contra Costa Dr., El Cerrito, CA 94530 (415) 526-7084

Hear VMPS at: The Listening Studio, Boston; Mike Hilliard Audio, Shreveport La; Audio Labs, Des Moines Ia; Efficient Stereo, Torrance Ca; Woodland Stereo, Woodland Hills Ca; The Long Ear, Big Bear Lake Ca; Sounds Unique, San Jose Ca; The Listening Post, San Francisco; Itone Audio, El Cerrito Ca; A-Vidd Electronics, Long Beach Ca; Lesure Electronics, Chugak Alaska

## FOR SALE

**HILL PLASMATRONICS \$5,000, Pyramid Metronome III's with stands under warranty \$1,250, MGA 72" screen TV \$3,500, Marantz 2330 receiver \$600, David King, 2602 Atlantic St., Winston-Salem, NC 27107, (919) 788-8870**

**HONG KONG! 25% TO 60% SAVINGS** on prestige audio products from Europe and Japan. NAKAMICHI, GRACE, ACCUPHASE, ROGERS, STAX, CELESTION, DYNAVECTOR, ALPINE, FR, SUPEX, SME, KEF, AUDIOCRAFT, ORTOFON, QUAD, AND MORE. For information and price list send USS1 to: AUDIOPHILE EXPORTS CO., 503A Dragon Seed Building, 39 Queens Road Central, Hong Kong

**INTERSONICS—YOU'VE HEARD OF US:** direct-export specialists: Japanese high-end/esoteric audio components, accessories, parts, Japanese pressings, OEM sourcing, more. Serving audiophiles and dealer/distributors with exceptional volume pricing, prompt delivery, responsible backup. An AMERICAN enterprise: INTERSONICS, PO Box 113, Toyohashi 440, JAPAN.

**INVENTORY REDUCTION SALE!** Infinity RS111A \$519, Crown SL-2 \$395, Halter DH-220 \$385, Tallman S \$210, Monster Alpha 1 \$360, Denon DL-1000A \$450, B & W DM 22 \$199, Souther arm \$650. 512-366-3691.

**JANIS WOOFERS & INTERPHASE CROSSOVER/AMP** The Janis bass systems are the finest universal subwoofer systems available. **FREE SHIPPING IN US AND PR.** Visa and MC. **WORLDWIDE EXPORTING.** OXFORD AUDIO CONSULTANTS, INC., Box 145, Oxford, OH 45056-0145, 513-523-3333, TLX427791.

**JBL HARTSFIELDS, EV PATRICIANS, W'DALES.** 408-379-7965; 408-371-3512 PO Box 1211 Campbell CA 95009

**J. B. L. SPEAKERS AND COMPONENTS** used - bought, sold, and traded 1-313-229-5191 eves. aft. 7 EST

**KANSAS AUDIOPHILES REJOICE** The Music Room proudly presents Counterpoint. (913) 764-2022.

## FOR SALE

### JULIUS FUTTERMAN OTL AMPLIFIERS

The worlds only tube amplifier that has an output transformer, has the proper harmonics of tubes with the speed and power of a transistor amplifier. This unique tube amplifier has received the highest awards from the underground press. A complete explanation of the circuit, including reviews and comparison to other amplifiers in our book, "Understanding Tube Electronics II". Send \$3 to New York Audio Laboratories, Inc., 33 North Riverside Avenue, Croton-on-Hudson, New York 10520.

**KOETSU AT PERSONALIZED AUDIO** in New Jersey. Call 201-752-3883.

**LEACH AUDIO PRODUCT KITS NOW AVAILABLE DIRECT FROM THE MANUFACTURER.** The Leach Amp 160 watt/channel stereo amplifier and the Leach Superamp 300 watt mono amplifier. All electronic modules are completely assembled and tested. Chassis is 3 1/2" rack mount in black anodized aluminum with solid walnut side panels. Moving coil preamp also available. Price schedule by request. Assembly manuals \$5.00 each, refundable with order. LSR&D, Inc., 481 Buckingham Circle, Marietta, Ga. 30066.

**LEVINSON ML-2 AMPLIFIERS.** Mint! \$3875/pr. (213) 934-1817-eves./weekends; (213) 736-7483-weekdays, PST.

### LINN NAIM PRICE ROLLBACK

We are pleased to offer a complete Linn/Naim System (LP12, Basic LV-X with cartridge, Naim NAIT, Kan's with stands and 8 meters of Naim cable) for \$1986. Price cuts on most Linn/Naim products. **FREE SHIPPING IN US AND PR.** Worldwide shipping available. Visa and MasterCard honored. OXFORD AUDIO CONSULTANTS, INC., Box 145, Oxford, OH 45056-0145, 513-523-3333, TLX427791.

### LINN PRODUCTS & NAIM AUDIO:

Simply The Best Available  
GENE RUBIN AUDIO (213) 571-1299

**MAGNEPLANAR TYMPANI I-D's.** Mint. New fabric. \$695/pr. (213) 934-1817-eves./weekends; (213) 736-7483-weekdays, PST.

# The art of shaping sound.

Does your music sound better in the next room? Pro audio kills resonances with SONEX acoustic foam, and now you can too. Control acoustics and turn your room into a studio. At midrange, SONEX has twice the sound absorption of good carpeting for about the same cost. If your dealer doesn't have SONEX, send us \$40 for a sample box of four 24" x 24" sheets, or write for our color brochure.

**illbruck/usa**

techniques with foams

3800 Washington Ave. N. Minneapolis, MN 55412





## FOR SALE

### LINN SONDEK OWNERS SAVE \$65

You can buy LINN's isolation base for \$100, or 3 of our TIPTOES for \$15. Same sonic benefits (we guarantee it!) at a fraction of the cost. Immediate shipment available from THE MOD SQUAD, 144 Athena Street, Leucadia, CA 92024 (619) 436-7666.

**MAC, MARANTZ, A.R.C., LEVINSON.** Quad, other esoteric and collectible gear bought and traded. I handle only guaranteed used equipment, but I invite inquiries from dealers who have changed lines, are overstocked or who have, or wish to take trade-ins in the future. I now have: Beveridge III's late, oak \$1950. Colonye AB-1 air TT \$1000. Fried M2 excel. sound, large rare ones \$600. Audio Pro B250 \$600. Dahlquist DQ10's oak w/stands & oak DQ1W's \$995 all. Acoustat 2 + 2 \$1250. Sony Esprit TAE 900 preamp w/rosewood case \$1550. Marantz 18 and 19 receivers \$325 and \$495. Marantz mod. 1 mono preamps prof. modified \$625 pr. Linn Itok \$325. Denon DP7000 \$375. Cotter B1/FR66 Denon combo b/o over \$1100. Kenwood L07D \$995. more. Call noon til 3 p.m. N.Y.C., time only. (212) 377-7282. Sound Investments, NY

**MAGNEPAN TONEARM** Call Terry 402-391-3842

**MARANTZ, McIntOSH** original tube covers, cabinets, manuals. Reasonable (805) 646-5862

**MCINTOSH AUDIO EQUIPMENT**—Bought-Sold-Traded S.D.R. Box 176 Walton, NY 13856 eves. & weekends. 607-865-7200. If no answer 607/865-5387.

**MCINTOSH** multi-function C-33 preamp, w/computer + equalizer: \$1650! S.A.E. 250 WATT/CHANNEL A501 AMP: \$650!!! Both pieces ONLY SIX MONTHS OLD, all packaging, warranties. AudioVisions (516) 661-3355

**MELOS AUDIO AT PERSONALIZED AUDIO** in New Jersey. Call 201-752-3883.

## FOR SALE

**MCINTOSH PLUS**—McIntosh instruments are the Laboratory Reference Standard for the world. McIntosh designs their equipment for a long life with low maintenance and high quality performance. **PLUS-FREE** test report on your new McIntosh equipment, on request. **FREE** shipping anywhere in the Continental U.S.. Prompt delivery, Credit cards accepted. **DESIGNATRON'S STEREO STORES, INC.**, 260 Old Country Rd., Hicksville, N.Y. 11801 (516) 822-5277

**MCINTOSH MI200AB'S 200 WATTS** mono tubed \$550 each. MR71 w/cabinet \$400, 1900 \$800, C24 w/new glass \$225, MA230 \$270, Advent 500 delays demos \$375, 220V \$375. Capps CM2250A w/3003 \$150, Altec 150A \$150. Crown D60 \$185, Pioneer VP-1000 video laser player \$385 w/ remote. Factory sealed laser discs half price, open \$10. Teac AL700 ELCASET list \$1,100 factory sealed \$349. Elcasets are 1/4", 3.75ips. lower wow, flutter, more dynamic range than cassette, S/N almost 100dB w/RX10, 3 head, diecast frame. RX10 matching DBX factory sealed \$250. Sony EL-4 elcaset \$139 list \$500. ELCASET tape. Many Scott integrated tube amps \$40. Sansui QSD2 \$275, T-5 \$90, Pioneer TS11U transport demo \$600. Accoustat RP2 \$450. KLH 9's \$850. DBX 124 \$175, 122 \$125. Ampex 351 w/console mint \$1,500. Citations: 1 \$150 3X \$225, 11 \$175. Phase Linear 3000MK2 w/headamp demo \$185. Lux ST50 \$550. Levinson JC-2 \$1,250. Alwa 6700 cassette \$275, minis: A60 \$75, ST-R80H \$99, MX-100H \$100, ST-R50H \$135, GE80H \$100, ST-L80H \$150, FX100H \$200 SD-L50H \$150, SA-C30U \$75, RB10 \$85. Nakamichi 700 \$400, 550 \$400 Crown SX-824 just factory serviced \$1,100. ReVox A77MK3 w/Kent mod. \$700. B77's QTLs mint \$900. HTLS \$900. A700 1/2 track \$1,800, G-36 \$500, B790 table demo \$500. Ortofon STM72 \$35. Panasonic SH3433 quad scope \$275. Mullard 12ax7's \$5.95. 5000 original factory service manuals. STAX LAMB DAS. Sealed \$300. 300 prerecorder r/r tapes \$6.00. Everything money back guaranteed. Other items call, write for list now. Trades welcome. Martin Gasman 779 Worcester St. Wellesley MA 02181 617-CEL-TICS.

**MCINTOSH** 6200 Integrated Amplifier—only \$849 NEW \$1649 Call Terry 402-391-3842

Luxman  
Harmor Kardon  
Tandberg  
Boston Acoustics  
Audio Control  
Sherwood  
Hitachi  
Denon  
Revox  
Onkyo  
Ortofon  
Hafler  
Thorens

ADS  
AIWA  
Grace  
M&K  
B&O  
SME  
& Many More

# Get It Free!

We Deliver FREE  
Anywhere in the  
Continental USA!

**the SOUND Approach**  
6067 Jericho Tpke., Commack, NY 11725  
Charge It...Call 516-499-7680

## FOR SALE

**MELOS MAKES MUSIC ... FINALLY!**  
**POINT SOURCE RIBBON LOUDSPEAKERS: NO LONGER IMPOSSIBLE!**  
Ribbon midrange, "P.E.T." tweeter, dynamic woofer, 25 Hz to 25kHz, less than \$2000. **POINT ONE SYSTEM** by **MELOS AUDIO**: 723 Bound Brook Road, Dunellen, NJ 08812; OR CALL 201-968-8771.

**MERIDIAN M-10 INNER ACTIVE LOUDSPEAKERS** (rosewood). New. \$3,300.000 313-535-3806.

**MERRILL AR MODIFICATIONS** Subchassis Kit \$75. Platter Coating \$10. Replacement Spindle \$25. Spring Kit \$8. High Torque Motor \$45. Platter Balancing Service \$10. Underground Sound, 2125 Central Ave., Memphis, TN 38104. (901) 272-1275.

**MERRILL AR MODIFICATIONS.** Subchassis Kit \$75. Platter Coating \$10. Replacement Spindle \$25. Spring Kit \$8. High Torque Motor \$45. Platter Balancing Service \$10. Underground Sound, 2125 Central Ave., Memphis, TN 38104. (901) 272-1275.

# An Industry First!

Rather than distribute the **PINNACLE ML-1** thru the normal dealer channels (allowing the usual 50% dealer profit margin), we decided to take a different approach—and a big chance. The sugg. retail price of the ML-1 is \$185.00 (with an established dealer cost of \$92.50) yet we have opted to eliminate dealer sales entirely and offer the ML-1 direct to the consumer at the distributor net price of only \$88.50! Not only that, we feel so strongly about the quality of our cartridge that we even provide a home-trial period of 15 days. So if you're not delighted with the improvement in your system, simply return the cartridge to us, undamaged and in the original packing, for a full and prompt refund [less shipping charges]. Sure, at \$185.00 we have some strong competition, but at \$88.50 no one even comes close! Try it and see if you don't agree.



The PINNACLE ML-1 is manufactured to the highest quality standards by DYNAVECTOR SYSTEMS LTD., JAPAN.

# PINNACLE ML-1 Cartridge

### TECHNICAL SPECIFICATIONS:

Type: moving-coil, high-output (2.1 mV)  
Freq. Response: 20-40,000 Hz ±3dB  
Stylus: hi-grade elliptical  
Tracking Force: 1.5g-1.8g  
Channel Separation: 25 dB @ 1KHz  
Coil Diameter: 11 microns  
Magnetic Material:  
Samarium Cobalt (BH MAX 18)  
Body Material:  
Acoustically-inert  
fibre glass  
reinforced plastics.

No step-up device needed!

For a risk-free home trial send only \$88.50 (plus \$3.50 shipping) or use your VISA, M/C by calling toll-free 1-800-443-4434.

**PINNACLE PRODUCTS**  
CN834 Princeton, N.J. 08542

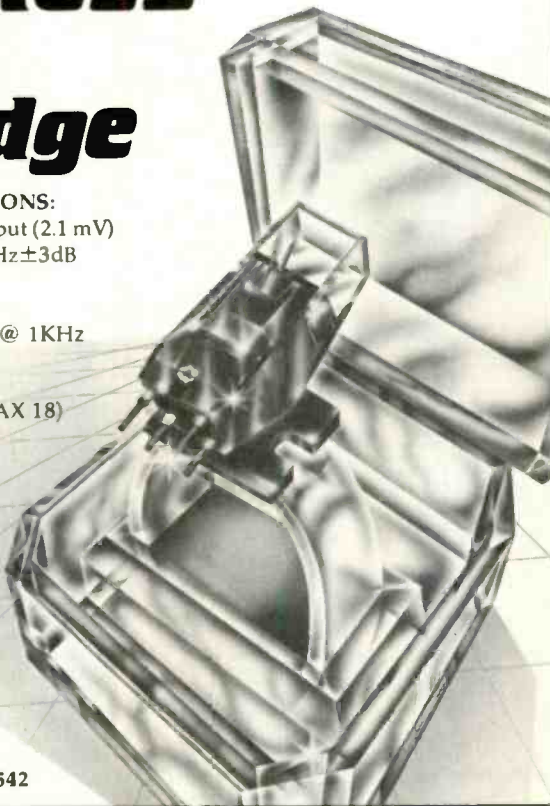



# bse<sup>TM</sup> compusound<sup>®</sup> SPEAKER SYSTEMS

Twenty years of research  
and six years of development  
to bring you *the first*  
*wholly new technology*  
in loudspeaker systems  
in fifty years.

**BENNETT SOUND CORPORATION**  
P.O. BOX 565 - RESEDA, CA 91335 - (818)345-1608

## Electrified Discounters

**203-937-0106**

**Lowest Possible Prices !!**

**AUDIO VIDEO CAR PRODUCT  
COMPUTERS — (HARDWARE - SOFTWARE)  
VIDEO GAMES TELEPHONES MORE**

**FULL WARRANTY — FAST DELIVERY  
SEND FOR FREE CATALOG !!**



996 ORANGE AVE.  
WEST HAVEN, CT. 06516



# Discover the SOURCE

20 Nassau St., Princeton, N.J. 08542  
609-921-0800

Our subscribers enjoy the benefits of international shopping at home!

- THE SOURCE newsletter filled with international industry news and lively product reviews.
- The best of next-year's models available today.
- Exclusive worldwide closeout offers.
- Comprehensive extended warranties.
- Traditional salon service and professional advice from dedicated personnel.
- \$15 subscription includes a \$15 discount coupon and money-back guarantee.

	RETAIL	SUBSCRIBER COST
<b>ELECTRONICS</b>		
Sansui 2-9000X (130 W/ch)	\$960	\$528.
Yamaha R2000 (150 W/ch)	\$900	\$598.
H/K 560 (40 W/ch)	\$399	\$148.
Sansui AU-D11 MKII (130 W/ch)	\$1,000	\$549.
Yamaha Personal Stereo (w/headphone)	\$199.	\$99.
<b>TURNTABLES</b>		
Denon DP-11F	\$200	CALL!
Lusman PX-101 (linear tracking)	\$400	\$299.
AR table w/turnarm (includes shipping)		\$429.
Thorens TD-147	\$525.	CALL!
<b>PHONO CARTRIDGES</b>		
Grado GTE-1 (includes shipping)		\$119.
Grace Level II Boron/MR	\$425	\$217.
Dynavector DV-170 (lim. qty.)	\$650	\$235.
<b>COMPONENT SYSTEMS</b>		
Mitsubishi D4 Series (lim. qty) pre-amp, amp, tuner, cass. deck	\$1,320.	\$499.
<b>CASSETTE DECKS</b>		
H/K 705 (dolby B, HQ)	\$450	\$188.
Aiwa AD-F990	\$595	\$386.
Nakamichi 700ZXE (lim. qty.)	\$2,400	\$990.
<b>SPEAKERS</b>		
BSW DM110 (per pair)	\$300	\$218.
KEF Canna II (per pair)	\$500	CALL!
Mission 700s (per pair)	\$399	\$278.
JBL 4311X (per pair/lim. qty.)	\$760	\$488.
<b>CAR STEREO</b>		
Alpine 7138	\$300	\$239.
Kenwood KRC-1022	\$650	\$467.
Sony XR-75	\$475.	\$255.
<b>CD PLAYERS</b>		
Hitachi DA-1000	\$1,000	\$466.
Sanyo DAD-8	\$1,000	\$466.
Sony CDP-701ES	\$1,500	\$1,197.

All offers subject to availability

**Orders Only Call 1-800-443-HIFI**  
CALL FOR FREE SOURCE SAMPLE

## FOR SALE

### MERRILL TURNTABLE

Features: Beautiful hand-crafted solid oak base. Seven layer, lead lined, laminated plinth. A unique and sophisticated, three point, turntable suspension system designed to absorb tonearm release energy and maintain a constant resonant frequency. Twenty-four pole synchronous motor. Two piece high inertia aluminum platter with unique lead damping ring. Comes with soft vinyl dust cover. Price: \$495. Call or Write MERRILL AUDIO, 2125 Central Ave., Memphis, TN 38104. (901) 272-1410.

MITSUBISHI Micro PreAmp, Amp, Tuner—only \$550 Save \$300 Call Terry 402-391-3842

### MOD SQUAD MASTERPIECES

Extraordinary products (TRIPLANAR Tonearm, Phoenix Preamplifier, Oracle Power Supply, MacMod Tonearm & Interconnect Cables, Tiptoes, MacMod Cross-over), and exceptional modifications (QUAD amplifiers, Belles and Spatial preamplifiers, Ittok, Mission, SME and Technics EPA-100 tonearms, QUAD 63 and Rogers LS3/5A speakers). We combine the supremacy of aerospace technology with the sensitivity of meticulous handcraftsmanship. Request a complete catalog from THE MOD SQUAD, 144 Athena Street, Leucadia, CA 92024 (619) 436-7666.

MONSTER CABLE .69¢ PER FOOT CUT TO ANY LENGTH. We carry all Monster Cable accessories. Haller, Precision Fidelity, Systemdek, Alpha 1 moving coil cartridge, MAXELL UDXL115 C90 \$2.99 each min. of 12. \$3.00 shipping charge. Call or write for other great prices. VISA and MC. TROLLEY STEREO 451 Moody St. Waltham, MA. 02154 (617) 924-3336.

## FOR SALE

### MORE WITH FOUR SYSTEM (UNDER \$4300)

Turntable: Linn Sondek Lp-12  
Tonearm: Linn Basik LV-X  
Cartridge: Audioquest 404  
Tuner: Adcom GFT1-A  
Preamp: Counterpoint SA-7  
Amplifier: Robertson 2140  
Speakers: Fuselier 3.3

### SOUND BY SINGER

227 Lexington Avenue  
New York, NY 10016  
(212) 683-0925

NAKAMICHI 1000 2XL serial no All703787, 2 mo. use. absolutely mint! \$1800.00 o.b.o payable thru L. Scott Rosendahl PSC1 Box 559. APO S.F. Cal. 96286

NAKAMICHI "DRAGON" ABSOLUTELY MINT \$1,300. Three weeks old. Nakamichi warranty. (913) 888-4664, ask for Miguel 1:00 to 4:00PM.

NAKAMICHI PLUS—Featuring the incredible BX-1 cassette deck. Now you can have Nakamichi performance for under \$300. We also carry the full line of Nakamichi products. PLUS-FREE calibration and bias adjustment, on request, FREE shipping anywhere in the continental U.S. DESIGNATRON'S STEREO STORES, INC., 260 Old Country Road, Hicksville, NY 11801, (516) 822-5277.

# DISCOUNT WORLD

## CAR STEREO SPECIALS

CONCORD HPL 122  
SONY XM 45  
COMPLETE \$319

WRITE  
FOR  
FREE  
CATALOG

SONY XR-75 Black  
SONY XM-45  
SONY XM-120  
COMPLETE \$529  
PKG. PRICE

Pioneer Car Stereo KP5500 . . . \$129.  
Pioneer Car Stereo KPA400 . . . 139.  
Pioneer Car Stereo KE5100 . . . 179.  
Pioneer Car Stereo UKE7100 . . . 229.  
Sony Car Stereo XR15 . . . . . 129.  
Sony Car Stereo XR25 . . . . . 149.  
Concord Car Stereo HPL122 . . . 289.  
Superfox Remote Radar Detector 189.

Pioneer Car Speaker TS108 . . . . . \$39.  
Pioneer Car Speaker TS6905 . . . . . 69.  
Pioneer Car Speaker TS6906 . . . . . 89.  
Pioneer Car Speaker TS6907 . . . . . 99.  
Sony Car Speaker XS102 . . . . . 49.  
Sony Car Speaker XS301 . . . . . 59.  
Jensen Car Speaker J1069 . . . . . 45.  
Altec Car Speaker 6X94C . . . . . 89.

DISCOUNT WORLD, P.O. BOX 191, MINEOLA, N.Y. 11501 516-294-6136  
Shipping charges are \$4.00 per order to continental U.S.A. We accept money orders, cashiers or certified checks.  
Personal checks - 3 weeks delay. N.Y.S. Residents add sales tax. Write for FREE catalog.

**CHALLENGE:** Create a fixed coil cartridge, in the \$200 price range, better than the Grace F-9E.

**ACHIEVEMENT:**

The Grace F-9E Super



The original F-9E became a "cult classic" among audio enthusiasts because it rivaled even the most expensive esoteric moving coils in harmonic accuracy, clarity and image localization.

Now the new Grace F-9E Super raises that standard by improving

tracking, smoothing the top octaves and solidifying the bottom end.

Raise your standards.  
Hear it at your authorized Grace dealer.

**Sumiko**

P.O. Box 5046, Berkeley, CA 94705



## FOR SALE

**MUSIC AND SOUND IMPORTS** is proud to announce that the **CREEK 3040 FM TUNER** is now available to match the already accepted **CREEK 4040 INTEGRATED AMPLIFIER**. Reviewers, dealers and customers alike are all applauding the exceptional performance of these fine British components. This superb combination offers musicality that the Japanese amp and tuner combinations have yet to achieve. For more information on **CREEK** and our other fine products like **CJ WALKER & MAS** Mk1 Belt drive turntables, **ALPHASON & MAS** precision tonearms, and the exciting **MAS 925** Loudspeaker, please contact **MUSIC & SOUND IMPORTS**, 30 Snowflake Rd. Huntingdon Valley, PA 19006 (215) 357-7858 or (516) 585-4746. **DEALER INQUIRIES INVITED.**

**NAKAI'S AUDIOWORKSHOP: THE WORLDS BEST CASSETTE DECKS!** 20% To 40% Off Retail. All Makes And Models. New, Warranties, Prepaid Shipping, VISA/MC, COD. (206) 323-4987

**BANG & OLUFSEN PRODUCTS AND NAKAMICHI CASSETTE DECKS—IN STOCK AT BEST PRICES.** (717) 774-2618

**NEW! MARK 9 POWER AMPLIFIERS.** Vacuum tube mono amp rated at 250 watts, 30 Hz to 20 KHz. Six 6550A output tubes, Dynaco A491 output transformer, regulated power supply—\$750.00 wired and tested. Quantities limited. Write today for free products brochure. Audio Classics/Atlanta P.O. Box 690 Roswell, GA 30077-690

### NEW PRODUCTS DEBUT AT WCES

It only takes a self-addressed, stamped manila envelope to get information and white papers on the new Symmetry amplifier, subwoofer, Phasors, Bass Interface (Pat Pend), crossover and headamp. Write Symmetry CES, P.O. Box 210465, San Francisco, Ca. 94121. But to hear them demonstrated properly you have to go to a world class audio dealer like **FIDELIS** in San Francisco (415) 540-8350 and **AMERICAN AUDIOPHILE** in Valley Stream NY (516) 561-7114

**NEW 83 RAW LOUDSPEAKER CATALOG**, 25c. Meniscus Systems, Dept A, 3275 Gladiola, Wyo., MI 49509

## RELAX-LISTEN

with  
**Smooth Remote Control**

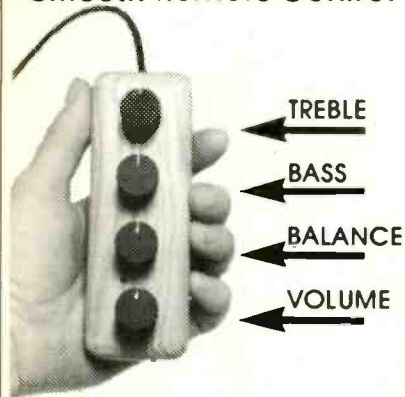

Standard 20 foot cable with easy installation to most stereos. All controls are precise, continuous, without backlash. Only low volts DC in cable. Blends with finest furniture. 80 dbS/N. 0.05% THD. Wide band. Price of \$129.95 includes main unit (at stereo), hand held unit, & cable. 20 foot extension cables are \$10.00 each. Ask your dealer or order Model ARC factory direct. Further details available. Order by check, MO, or VISA/MC. 30 day return policy.

**COVOX INC.** 675-D Conger St.  
Eugene, OR 97402  
Tel (503) 342-1271

## FOR SALE

**NJ AUDIO CONNECTION NY**  
Where in the metro area can you addition the best values in all of audio in a relaxed environment? **AUDIO CONNECTION**. Where will every effort be made to assure you a component or system that is best suited to your musical taste and budget? **AUDIO CONNECTION**, 615 Bloomfield Ave. Verona NJ 07044 201-239-1799

**NOISE REDUCTION—Burwen DNF—1201A** Jim Dale (805) 525-6319.

**NO PREAMP IS PERFECT**, not even our new **LUMINESCENCE**—but in 1984 it will be the BEST. Silicon Valley's premiere tube designer, Bruce Moore (father of the Paragon, Precision Fidelity, Audible Illusions preamps) has pushed his engineering skills to its limits to create audio's most advanced state-of-the-art design, in collaboration with his associate Scott Frankland (formerly of Daybreak Acoustics). We guarantee this to be the fastest, quietest, most reliable and highest gain tube preamp ever. To prove it, **UPDATES** will be FREE for one year. Dealer and subscriber inquiries welcome. MFA Systems, 1384 Alvernaz Drive, San Jose, CA, 95121. (408) 224-2176.

## ONE STEP UP SYSTEM

(UNDER \$1200)

Turntable: Rega 2  
Receiver: NAD 7120  
Speakers: Snell Type K's  
**SOUND BY SINGER**

227 Lexington Avenue  
New York, NY 10016  
(212) 683-0925

**PAY TV RECEPTION.** "How-To" Book. \$4.95. **DIPTRON-ICS**, Box 80 (AS), Lake Hiawatha, NJ 07034.

## plateau<sup>®</sup>

SPEAKER STANDS

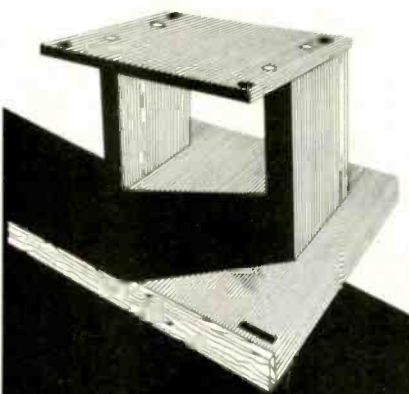

Plateau speaker stands provide an easy and inexpensive way to dramatically improve the performance of your audio system. Designed to acoustically decouple and position the speaker, Plateau provides tighter bass, more focused mid-range and precise stereo imaging. For more information and the name of your nearest Plateau dealer, please write:

Canada	United States
Naiad Products Inc	Naiad Products Inc
Box 1840	Box 1250 Falls Sta.
Brantford, Ontario	Niagara Falls, N.Y.
N3T 5W4	14303-0260

## FOR SALE

# AudioVisions

a new store... with a fresh view

At **AudioVisions** you will find the very latest in technology, combined with truly old-fashioned hospitality

• FOUR LARGE, PRIVATE DEMO ROOMS •

electronics  
**BELLES • BRYSTON • DENON • LUXMAN • PLEXUS • SAE II**  
loudspeakers  
**ALLISON • DESIGN ACOUSTICS**  
I.T.C. • M&K • SNELL • 3D "CUBE" • THIEL  
turntables, cartridges, tape decks  
**ASTATIC • AUDIOQUEST • DENON • DYNAVECTOR • GRACE**  
**GRADO • ORACLE • SUMIKO • THORENS**

### 1984: ORWELL WARNED YOU

Technological hardware should be only a means to an end. Thus, we believe that audio systems should exist for just one reason: *To reproduce music, correctly, accurately, convincingly.* Yet, musical reproduction is offered, really, by only a few, select systems. We are confident that the experience of listening to one of these rare systems will cause you to cease thinking, finally, about pieces of audio gear and inspire you to feel that what matters is "the music... nothing but the music."

We also believe that a fine audio system need not cost \$10,000 or more, or be something that looks appropriate in a hardware store but out of place in your home. One of the secrets of a truly musical audio system is the **careful matching** of superior components, achieved through lengthy trial and error testings. Our system packages are the end result of many, many hours of intense comparative experimentation. (For example, we go so far as to stock four different speaker cables, and we recommend different cables for different systems.) Maybe that's why our customers almost never sell or trade the equipment they purchase from us.

### THIEL 04a/BELLES/THORENS/GRACE: \$2,155 !!!

The *International Audio Review* describes the **Thiel 04a** speakers (\$750/pair in book-matched teak, oak, or walnut) as "an outstanding bargain...exquisitely balanced." *The Absolute Sound* comments: "excellent reproduction of musical detail and transients...excellent soundstage...outstanding in their price range." The 04a does demand — and deserves — superior electronics, and the amazing new **Belles II** amp and **DMM** preamp offer performance with the 04a speakers that, at \$440 (amp) and \$295 (preamp), we had simply never thought possible. (What a great New Year's surprise!) The **Thorens 146** auto-lift turntable (\$350) with remote power supply (to minimize hum pickup) works very well with the classic **Grace F-9E** (\$200) cartridge. Our special package price even includes a tuner, the handsome **Luxman T-115**, as well as \$40 of cable. Come listen. We'll enjoy watching as you begin to smile.

### SNELL "C"/BELLES/ORACLE/DYNAVECTOR: \$3,950

"The Power and the Majesty"...Have you heard the record? Have you heard it through the **Snell type C** speakers? All of the quality of Snell's famous type A (including **BI-WIRE** capability) and most of its performance can now be yours for much less (\$1,570/pair, in walnut or oak), in this very handsome, easier-to-drive new model. The new **Belles I** amp (\$675) handles musical dynamics with ease. And the **Belles DMC** preamp (\$500) accepts the **Dynavector 23 Ruby DIRECTLY** far better than anything we have heard in this price range. In comparison with other turntables, the new **Oracle Alexandria** (\$995) offers "important differences" (*High Fidelity*) which are "aimed at preventing extraneous vibration from being transmitted to the stylus and thereby coloring the sound." Our special package price includes the excellent new **Luxman TX-101** tuner, and \$50 of cable. All this for \$3,950...impossible, but true!

### ULTIMATE ELECTRONICS: BRYSTON

Substituting the **Bryston 1B** preamp and **4B** power amp and the **Dynavector 6Z** transformer for the **Belles** equipment in the above system: \$5,100 including \$150 of cable. The folks at Snell use **Bryston** with their speakers. Think about that, and maybe you, too, will come to appreciate the exceptional advantages of owning **Bryston** equipment.

### ULTIMATE CABLE: DISCRETE TECHNOLOGY

At \$6 per foot, this speaker cable is, admittedly, expensive. But wait till you hear it: The results fully justify the price. And please note, in our **Snell/Bryston** system above, the generous \$150 cable allowance.

### THE "NITTY GRITTY" CLEANING MACHINE • AKG MIKES

1067 MONTAUK HIGHWAY, WEST BABYLON  
NEW YORK 11704 (516) 661-3355

## VANDERSTEEN AUDIO DIMENSIONAL PURITY

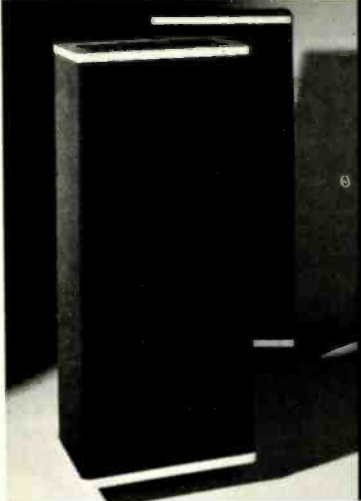

MODEL 2C

Vandersteen Audio was founded in 1977 with the commitment to offer always the finest in music reproduction for the dollar. Toward this goal there will always be a high degree of pride, love, and personal satisfaction involved in each piece before it leaves our facilities. Your Vandersteen dealer shares in this commitment, and has been carefully selected for his ability to deal with the complex task of assembling a musically satisfying system. Although sometimes hard to find, he is well worth seeking out.

Write or call for a brochure and the name of your nearest dealer.

VANDERSTEEN AUDIO  
116 WEST FOURTH STREET  
HANFORD, CALIFORNIA 93230 USA  
(209) 582-0324

## FOR SALE

ORACLE TURNTABLE; Fidelity Research FR-12 arm with extra headshell, MC-201 cartridge; QM1 (Quatra) GC-2 headamp; Mel Shilling interconnect. \$995.00. **REVOX B77** tape recorder with extras. \$995.00. 504-392-2536.

## PHILADELPHIA AUDIOPHILES

We invite you to visit our establishment to hear a selection of the finest State-Of-The-Art audio components. Our knowledgeable staff will be glad to assist you in choosing the proper equipment for your specific needs.

We have over 2 decades of experience, plus a complete in house service department. We will be pleased to set-up and calibrate your system without charge.

We proudly represent:

ALPHASON	HEGEMAN	PS AUDIO
AMPLIWIRE	IMF	REGA PLANAR
ANDANTE	KENWOOD PURIST	RH LABS
AUDIOQUEST	KIMBER KABLE	ROBERTSON
BEYER	KOETSU	ROGERS
BRYSTON	LINN ISOBARIK	SONOGRAPHE
BURWEN	LINN SONDEK	SOUNDCRAFTSMAN
CELESTION	LIVEWIRE	SPECTRUM
CREEK AUDIO	MICRO SEIKI	SPICA
CJ WALKER	NAO	STAX
DB SYSTEMS	NAGAOKA	SUMIKO
DYNAVECTOR	NAGATRON	SUPEX
ELECTROCOMPANET	NAIM AUDIO	TALISMAN
FUSELIER	NETTY GRITTY	TAMANTON
GOLDRING	ONKYO INTEGRA	TANGENT
GRACE	PROTON VIDEO	THIEL

## SOUND SERVICE COMPANY

8010 Bustleton Avenue  
Philadelphia, PA 19152  
(215) 725-1177-8

## GREENFIELD EQUIPMENT

Audio components and systems dedicated to the presentation of the art form, THE MUSIC.

Accuphase • Adcom • Ariston • Audio Interface • Beveridge • Berning • Classe Audio • Clear Audio  
Counterpoint • DB Systems • D & K Imports • Dynavector • Electrocompaniet • Electron Kinetics  
Entec • Estonic Audio Research • Grace • Grado • Hafler • ISOS • Kiseki • Kimber Kable • Klyne • Koetsu  
Lustre • Micro Seiki • NEC • Orsonic • Ortofon • Precision Fidelity • Profile • Sideral Akustic • SME  
Snell • Souther • Spica • Stax • Supex • Symmetry • Thorens • Triad • VPI • VSP Labs

Call or write for information. Complete shipping and export facilities available.  
Additions by appointment

7805 Greenfield Street • River Forest, Illinois 60305 • (312) 771-4660

PINK TRIANGLE TURNTABLES AT PERSONALIZED AUDIO, in New Jersey. Call 201-752-3883.

PINK TRIANGLE TURNTABLES: THE PERMANENT PURCHASE PREFERRED BY PURISTS. For dealer list, contact IAI, 723 Bound Brook Road, Dunellen, NJ 08812, or call 201-968-8771.

PIONEER A90 AMP & F90 TUNER, Like new, 215-107-4626

PLANS, CIRCUIT BOARDS, AND KIT PARTS (author approved) for M. Leach's home audio projects. Power amps, preamps, pre-preamps, and loudspeakers. Send SASE for information. Custom Components, Box 33193, Decatur, GA 30033.

PORTABLE EQUIPMENT: UHER, Sony, Sennhelsler, AKG, Beyer-Dynamic, Fostex, Accessit, GLI, Send SASE. (Specify Model), Carpenter Sound Sales, Box 1321, Meadville, Pa. 16335-0821

POWER TO THE PEOPLE—Most comprehensive publication available on regulated power supply construction. Everything you should know for \$16.50. **MEGACABLE**—SENSIBLE SOUND rates Megacable as least colored, most neutral, mostly widely compatible interconnects available! Designed for high-tech microwave systems. MEGACABLE is SOTA for high resolution audio signal transmission. 37¢ SASE brings info. MIDWEST AUDIOPHILE SUPPLY, Box 3 Emerson, NE 68733, (402) 695-2509

PRO-AC LOUSPEAKERS IN NEW ENGLAND  
only at Audio Vision of N.E., 617-863-5221

# Micro-Acoustics

THE WORLD'S FIRST  
MICROPHONICALLY TUNED & DAMPED  
PHONO CARTRIDGE

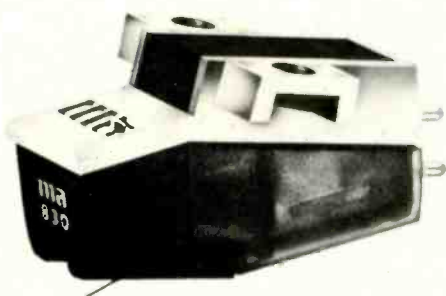

## THE MICRO-ACOUSTICS 830CSA

From the Company that brought you beryllium cantilevers, direct-coupled electrets, micro-circuits, carbon fiber housings, vari-balance and more, comes a significant New breakthrough in cartridge design; Controlling Microphonics. Microphonic resonances exist in All electro/mechanical devices. Though difficult to measure, they are perceived by the Most sophisticated instruments; The Human Ear. Each 830CSA is individually tuned, damped and calibrated to assure you of the finest performance achievable. In addition, the 830CSA incorporates a newly shaped diamond stylus which is an analogue to the cutting stylus produced by the World's largest supplier of recording styli, Micro-Point. This assures precise stylus to groove tracing. Hear more from Micro. Auditon the 830CSA.

**ma**  
Micro-Acoustics

99 Castleton Street, Pleasantville, NY 10570 914-747-1570

*Fine Audio.  
The Best Price.  
The Best Advice.*

audio  
advisor, inc.  
Box 6202, Grand Rapids, MI 49506  
(616) 451-3866 Catalog \$1.





## FOR SALE

### PS AUDIO = SUPERB VALUE

Gene Rubin Audio (213) 571-1299 (PAC.)

**PS IV PRE-AMP WITH HCPS**, very latest modifications \$395. Acoustat TNT 200 Power-Amp with over 3 years warranty (transferrable) \$695. 405-843-1580 evenings.

### QUAD OWNERS CLUB

Join us to maximize the pleasure of this Imperial transducer. We have mods that will take ten minutes and dramatically improve performance. NEWS LETTER is \$30 per year. New York Audio Laboratories, 33 North Riverside Avenue, Croton-on-Hudson, New York 10520

## RANDALL RESEARCH

"Indispensable . . . These cables, individually or in tandem, evoked a great many superlatives regarding the quantity and quality of sound . . . an absolute advance in cable performance." These are statements expressed by the editor of Audiogram, Gary Vart, after reviewing our new Symmetrical TX Interconnect and 32 TBC Speaker Cable systems. Send or phone for this review. Better yet, listen for yourself in one of our dealer sound rooms!

### RANDALL RESEARCH

719 Fernleaf  
Corona Del Mar, CA. 92625  
(714) 760-1539

**RAY LUMLEY TUBE LAMPS.** Cost \$3500., sell \$1800 pair perfect. 716-262-2909

**CROWN BEST QUALITY AMPLIFIERS, TUNERS, PRE-AMPLIFIERS. PROFESSIONAL CONSULTATION—BEST PRICES.** EAST: (904) 262-4000; WEST: (213) 840-0878.

### REFERENCE RECORDINGS

Announcing: TAFELMUSIK: POPULAR MASTERWORKS OF THE BAROQUE. Keith Johnson has made another beautiful recording for your delectation. This time, he has captured Canada's original-Instrument Baroque orchestra playing favorites including Bach's "Air on the G String," the Pachelbel Canon, and dances and suites by Handel, Purcell and Telemann. Recorded in Toronto in a vaulted ceiling stone church, the acoustics are perfect for music of this elegant era. This deluxe 45 rpm edition only \$16.98 post-paid. Order RR-13 directly from Reference Recordings, PO Box 77225X, San Francisco, CA 94107. Visa/MC welcome. (408) 745-7159. Free Catalogs. Dealer inquiries invited!

### RGR SIGNATURE ONE DYNAMIC RANGE EXPANDER.

"Just unbelievable. The only device of its kind with no sonic trace!" . . . John Myerson. To hear the Signature One in California, contact Jonas Miller Sound, 2336 Santa Monica Blvd, Santa Monica (213) 828-5613, or call RGR (312) 673-9320.

**HAFNER, REVOX, TANBERG, CARVER, DBX AND OTHER QUALITY COMPONENTS. PROFESSIONAL CONSULTATION—BEST PRICES.** EAST: (904) 262-4000; WEST: (213) 840-0878.

**HARMAN-KARDON SEPARATES, RECEIVERS, CASSETTE DECKS, TURNTABLES, PROFESSIONAL CONSULTATION—BEST PRICES.** EAST: (904) 262-4000; WEST: (213) 840-0878.

**CROWN BEST QUALITY AMPLIFIERS, TUNERS, PRE-AMPLIFIERS. PROFESSIONAL CONSULTATION—BEST PRICES.** EAST: (904) 262-4000; WEST: (213) 840-0878.

## BOSTON AREA'S FINEST

Adcom	Spica
Conrad Johnson	Creek
Robertson	Ariston
Souther	Counterpoint
ProAc	A.E.C. (Air 2.2)
Audioquest	Koetsu
Beard	Thorens
Pink Triangle	Stax
Perreaux	and others
VPI.	



40 Mass. Ave.  
Lexington, MA 02173  
617 863-5221



# Sidereal Akustic<sup>T.M.</sup>

Finally, a full-range dynamic loudspeaker with speed and accuracy beyond that of even the finest electrostatics without the size, complexity and sonic drawbacks of these systems. Of course, we cannot offer the prestige associated with having a pair of seven foot screens in your living room but the Sidereal Akustic<sup>T.M.</sup> Model Four loudspeaker system will present the beauty and excitement of live music in a size and price you will find very easy to live with.

Write or call for free literature and information.

*Dealer inquiries invited.*

**Sidereal Akustic.. Audio Systems Inc.** (714) 726-3150

4035 Oceanside Blvd. Unit G-57 Oceanside, CA 92054

# stereophile

**SAVVY EQUIPMENT REPORTS AND SPIRITED EDITORIAL CONTENT**

Send \$20 for 10 issues. Stereophile, 1107c Early Street, Santa Fe, NM 87501 or  
**Call toll-free 800/821-3528**

## aq audioquest

The AudioQuest stable of products includes the famous AQ series of moving coil cartridges with hollow sapphire cantilevers. The AQ404, AQ606 and AQ808 are high output models designed to feed a normal phono input. The AQ505, AQ707 and AQ909 are low output models requiring an extra gain stage. The new AQ1.1 is a medium output model designed for the new generation of "high gain" preamps. We also make the remarkably inexpensive GroovDancer MC+ high output moving coil and the GroovDancer IM+ induced magnet cartridge. The AQ Shadow tonearm along with the AQ 317/LW and AQ 407/LW all come with LiveWire headshell leads and a LiveWire tonearm cable. Whether you are spending \$325, \$575 or \$825 these arms will let you hear what your cartridge is supposed to sound like instead of the harshness and resonance-induced mistracking so common in other arms. Don't forget the superb LiveWire interconnecting and speaker cables, the only good looking sound paneling, AudioQuiet One and Two, the AQ record brush and AQ stylus cleaner. The latest AQ product is an extremely effective record mat which supports and damps for the least colored sound possible.

**AT AUDIOQUEST WE TALK MERIT — NOT MARKETING!**

3857 birch street, #610

newport beach, california 92660

714 / 720-1995

# LIVE WIRE™



# We outperform the rest

Knowledge, custom service plus the best names in stereo:

- ACOUSTAT
- ACOUSTIC ELECTRONICS
- AUDIO RESEARCH
- COUNTERPOINT
- LINN SONDEK
- AUDIO QUEST
- PROAC
- DENON
- THIEL
- NAD
- B & O
- AND MANY MDRE



(201) 744-0600  
CSA AUDIO, 193 Bellevue Ave.  
Upper Montclair, NJ 07043



## SONY CDP-101

New England's headquarters for Compact Disc players, software, and associated components.

**Sound & Music**

92 King St., Northampton, MA 413-584-9547

## FOR SALE

SEE UNDER CATEGORY "WANTED TO BUY" David Yo

**ELECTRO-VOICE INTERFACE AND CD SERIES QUALITY SPEAKER SYSTEMS. PROFESSIONAL CONSULTATION—BEST PRICES. EAST: (904) 262-4000; WEST: (213) 840-0878.**

**HAFNER, REVOX, TANBERG, CARVER, DBX AND OTHER QUALITY COMPONENTS. PROFESSIONAL CONSULTATION—BEST PRICES. EAST: (904) 262-4000; WEST: (213) 840-0878.**

**HARMAN-KARDON SEPARATES, RECEIVERS. CASSETTE DECKS, TURNTABLES, PROFESSIONAL CONSULTATION—BEST PRICES. EAST: (904) 262-4000; WEST: (213) 840-0878.**

**TEAC, TEAC: SPECIAL PRICES, Z5000, 6000, 7000. Prepaid Shipping, VISA/MC, COD. AudioWorkShop, 206-323-4987, 206-323-2676.**

## FOR SALE

**SIMPLY THE FINEST:** Audio Research, Perreaux, Spectral, ATC SCM 50 and 100 (England's finest loudspeakers), Ray Lumley, Spectrascan, Pentagram, Spendor, Audio Lab 8000A. Always plenty of good used gear. Audio Ecstasy, 46 Hickory Street, Rochester, NY 14620, 716-262-2909

**SOUNDCRAFTSMEN COMPONENTS AT A LOW, LOW PRICE.** High definition, high performance. Rugged and reliable. A great audio value. Made in the U.S.A. 220 volts available for lowest prices call or write **HAROLD MINTO, PERFORMANCE AUDIO LIMITED.** 365 South Bayview Ave., Freeport, Long Island, N.Y. 11520 (516) 378-4389. Retail, mail order, export, financing, Visa, M/C, Amex.

**SPEAKER DESIGNS** offer their **PROJECTION SERIES** of audio speakers for your evaluation. Try any of our systems for 15 days. If you know of anything better, ship them back. Priced from \$458 to \$793 per pair, stands included. For information write: Speaker Designs, 528 Demmler Drive, Pittsburgh, Pa. 15237 or call (412) 367-1573 from 10:30 to 5:30, (412) 367-8066 from 5:30 to 8:30.

**TANBERG TPA 3003 Poweramp/TCD3004 Cassette Deck** Call Terry 402-391-3842

**THE AUDIOFILE® CASSETTE INDEXING SYSTEM** is here! This compact accessory will organize your tape collection quickly and simply. Send \$12.00 or for more information. P.O. Box 8533, Minneapolis, MN 55408.

## FOR SALE

### START WITH SEPARATES SYSTEM 1

(UNDER \$2700)

- Turntable: Rega Planar 3
- Cartridge: Dynavector DV-10X3
- Preamp: Adcom GFP-1A
- Tuner: Adcom GFT1-A
- Amplifier: Adcom GFA-2
- Speakers: Snell Type E's

### SOUND BY SINGER

227 Lexington Avenue  
New York, NY 10016  
(212) 683-0925

**TELEFUNKEN, AMPPEREX, GENALEX** and other top quality audio tubes available. Contact S.J. Wallace, 1203 Success St., Pittsburgh, PA 15212.

### THE HIGHLY ACCLAIMED SPICA TC-50 IS IN BOSTON

only at Audio Vision of N.E., 617-863-5221

**THE INCREDIBLE COUNTERPOINT SA-4 Amp** is in Houston. Hear it at Audio Profiles. (713) 973-0000.

**THE MUSIC ROOM**—Trade up to the best. Acoustat Counterpoint, Creek, Grace, Heybrook, Robertson, Walker, etc. Write or call for information and newsletter. Free shipping. Visa/MC. 15701 West 127th Terrace, Olathe, Kansas 66062. (913) 764-2022

This month **AUDIO CONNECTION** is featuring: Heybrook-Helius-Promethean front-end, PS Audio IV H & 2C + electronics and Spica TC-50 speakers. For audition call 201-239-1799

## AUDIO KITS POWER AMPLIFIERS

### MOSFET



120 WATT RMS (Mono) **\$219.95**

ILP MOSFET power amplifiers are the logical choice for superb performance, compact size, excellent design, ease of assembly, and bargain prices! All models use famous ILP audio power amplifier modules, factory pre-assembled with bonded heat-sink and tested. Assembly is quick, easy, and assured. Each model features an ILP toroidal power transformer: half the weight and size of conventional transformers, toroids are also much quieter. ILP MOSFET power amps give no-compromise state-of-the-art performance: frequency response 15Hz - 100kHz (-3db), harmonic distortion 0.005% (1kHz), signal-to-noise ratio 100db, slew rate 20v ps. Each kit mounts into a precision die-cast aluminum chassis. Like all ILP products, MOSFET power amp kits carry a five year limited warranty. Also available MODEL UP60 60 watts RMS MOSFET amplifier \$159.95. Available direct and from selected dealers. Write for details.

CALL TOLL-FREE TO ORDER 800-833-8400  
In New York call (716) 874-5510.  
Mail orders accepted. VISA, Mastercard or checks.

**GLADSTONE ELECTRONICS, INC.**

1585 Kenmore Avenue Buffalo, New York 14217  
In Canada: Gladstone Electronics, Toronto 800-268-3640

## THE MOST RESPECTED AUDIO DEALERSHIP



James Gala

During the past five years, GALA SOUND has emerged to become among the most highly regarded audio dealers in the United States — according to many of the world's pre-eminent musicians and audio engineers.

Located in Rochester, New York and established by pianist James Gala, GALA SOUND sells musically accurate and correctly engineered audio components.

In addition to meeting the needs of audiophiles throughout the country, major recording companies, musical institutions, and philharmonic orchestras interested in achieving the highest level of reproduction of music rely on GALA SOUND for their audio equipment needs.

We fly our customers round trip — at our expense — from anywhere in the continental U.S. to our store for the selection and purchase of a stereo system of \$6,000 or more. Or, if it's more convenient, we will ship you the audio components of your choice the day you order.

Phone (716) 461-3000 today, and ask for Mr. Gala. If music is important in your life you deserve a stereo system from GALA SOUND.

MARK LEVINSON • THRESHOLD • KEF • B & W • QUAD  
ACOUSTAT • MAGNAPLANAR • ORACLE • MCINTOSH  
NAKAMICHI • BANG & OLUFSEN • LUXMAN • NAD  
THORENS • BRYSTON • POLK • KYOCERA • GRACE

# GALA SOUND

650 Monroe Avenue Rochester, New York 14607  
(716) 461-3000



## FOR SALE

**THE SIGNATURE ONE DYNAMIC RANGE EXPANDER.**  
"The only state of the art expander" . . . says Mike Gruber.  
To hear the RGR Signature One in New York, contact American Audiophile in Valley Stream or Manhattan (212) 751-9733, or call RGR (312) 673-9320.

**THIRSTY EAR**—Nakamichi, NAD, Denon, KEF, VSP Labs, Apt Holman, Tandberg, Thorens, Bang & Olufsen, Dahlquist, Polk Audio, Dynavector, Adcom, Conrad-Johnson. **THIRSTY EAR**, 9 East Main, Bozeman, MT 59715, (406) 586-8578.

**THORENS REFERENCE!** Of world-wide 100 produced record-players is only one to be sold for bidding! Least bidding \$30,000! W. Wanzke, Zugspitzstrabe 1, 8081 Althegenberg West Germany. Revox A700 1/2 track \$4,000!

**THRESHOLD AUDIO** is offering Conrad Johnson, Nakamichi, VSP, Pyramid, Harmon Kardon, Carver, PS Audio, Grado, Infinity, Stax, VPI, and more. Prepaid Shipping. Trade-Ins Welcome! PS Audio Model III PreAmp 199, Magnephaner III B speakers, (retail \$2200), sell \$999, 409 South 22nd Street, Heath, Ohio 43056, (614) 522-3762, or 3520.

**THRESHOLD STASIS 1 POWER AMPS.** Exceptional condition. Custom pair modified Marantz 8B amplifiers. Bill Frias, 1580 Morse Ave #52, Sacramento CA 95825, 916/485-1743.

**TOP-RATED TANDBERG 3001 FM TUNER**, \$850; professional Revox A-700 4TR recorder, \$1200; mint Crown SX-822-P4 studio recorder, \$900; Wheaton RABCO-SL8E arm; Acoustat Monitor IV, updated amps, \$1000. Must sell! Offers? Chuck Cabell, (617) 274-8130

**TUNE-UP YOUR TONEARM!** Better sound begins in your tonearm. Call today for a free consultation on our important improvement options. When you give your system a richer signal, it gives you more "musical" music. **THE MOD SQUAD**, 144 Athena Street, Leucadia, CA 92024 (619) 436-7666.

We specialize in Phonograph Needles & Cartridges.  
Toll Free: 800-368-3506

Featuring the cartridges of

**Boston Acoustics**

**Needle in a Haystack, Inc.**

P.O. Box 17435 • Washington, DC 20041

"We're Needling the World!" Send for a free catalog.



## FOR SALE

1-800-245-6000  
TAPE WORLD

TDK: MAR-90	6.39
TDK: MA-90	4.39
TDK: SAX-90	3.09
TDK: ADX-90	2.69
TDK: SA-90	2.19
TDK: SA-60	1.89
TDK: AD-90	1.89
TDK: AD-60	1.49
TDK: D-90	1.19
TDK: D-60	1.05
MAXELL, TDK: T-120, L-750 Hi-Grade	10.49
MAXELL, TDK: T-120, L-750	7.49
MAXELL: XLI or IIS-90	3.15
MAXELL: UDXL I or II-90	2.39
MAXELL: UDXL I or II-60	2.19
MAXELL: UD-90	1.99
MAXELL: LN-90	1.29
MAXELL: XL I 35-90B	6.49
MAXELL: UD35-90	4.99
SONY: UCX5-90	2.49

WE WILL HONOR ANY COMPETITORS PRICE OF THE TOTAL ORDER. \$3.75 Shipping any size order in US. VISA, MC no extra charge. COD add \$1.65. Minimum COD order \$40.00. PA add Sales Tax. All orders shipped within 48 hours. M-F, 8:30-5:00

323 Brown Ave., Box 361, Butler, PA 16001

412-283-8621

(2) ARC D-76 AMPLIFIERS \$1,000 for pair. 515-277-3775.

## ADD STEREO SOUND TO YOUR TV!



**RHODES**

## TELEDAPTER®

Model TE-200 easily connects between any TV or VCR and your stereo systems aux. or tape inputs. Teledapters matrix stereo circuitry takes a mono signal from the TV or VCR, and synthetically produces two stereo channels, so exciting and dimensional, you will think you're at the theatre. The TE-200 also matches the impedances and serves as an isolation interface. Order yours today, complete with all instructions, cables, and prompt 30 day refund guarantee if you're not satisfied. Only \$39.95 plus \$3.00 ship. Mail: check, MO. Visa, MC or DC # or call 24 hours, ask for our free catalog and the name of your nearest dealer.

TOLL FREE

1-800-251-8608

DEPT. 122, P.O. BOX 1316  
COLUMBIA, TENN. 38402-1316

## FOR SALE

**TUBE DYNACO LOVERS!** (matched pairs): Amperex EL-34/6CA7 @ \$19.50/MP; Gold Lion KT-88 @ \$79.00/MP; GE 6550 @ \$38.00/MP. (single tubes): Mullard EL34/6CA7 @ \$8.00; Mullard 6550 @ \$29.00; Tunggram 12AX7/ECC83 @ \$2.50. (tube preamp kit): Dyna PAS-3X (complete), \$149.00. (tube amp kit): Dyna Mk4, 40W mono (complete), \$199.00. All brand new! Any Dyna assembly/repair manual @ \$4.50 postpaid. \$2 shipping on tubes. SCC, Box 551 (AM1283), Dublin, OH 43017; (614) 889-2117, VISA/MC/COD.

## TUBE ELECTRONICS EXPLAINED

Our new revised edition of "Understanding Tube Electronics" is now ready. Over 700 pages of articles, technical papers and essays on the proper design of tube electronics including a TUBE PRIMER. Learn why tubes are more musical than transistors. Send \$3 to New York Audio Laboratories, inc., 33 North Riverside Avenue, Croton-on-Hudson, New York 10520.

**VANDERSTEEN 2C LOUDSPEAKERS** Used Call Terry 402-391-3842

### ALABAMA

Likis Audio

### ALASKA

Alaska Music  
C.G. Elect  
Hoff's Stereo  
Pyramid Audio

### ARIZONA

Jerry's Audio

### CALIFORNIA

Absolute Audio  
Amtron  
Audio Gallery  
Audio Today  
Calif. Sound Works  
Cattana  
Century Stereo  
dB Audio  
Desert Audio  
Dexter & Hi-Fi  
Eber Elec  
Executive Sound  
Herman's  
Jack Hanna  
Monterey Stereo  
Newport Audio  
Paris Audio  
Paninsula Audio  
Sound Factor  
Sounds by Dave  
Stereo Horizon  
Stereo Solution  
Stereo Store  
Sunnyvale Elec  
Turntable Unit  
Western/Olympic Audio  
The Works

### COLORADO

Crisman Audio/Video  
Estes Park Music  
Gramophone Audio  
Norm's TV & Sound  
Profound Sound  
Select Systems  
The Sound Co.  
Wave Length

### CONNECTICUT

Audiotronics  
Hi-Fi Stereo House  
Music Box-Valetti's  
Sound Advice  
Sounds Incredible  
The Stereo Lab  
Take 5 Audio

### WASH., D.C.

Myer-Emco  
FLORIDA

Audio Encounters  
Audio Labs  
Audio Video  
Brandman  
Electronic Equip.  
The Elec. Store  
Exclusive Elec.  
Harris Audio  
House of Hi-Fi  
Joyful Noise Snd.  
Kuban's  
M & E  
Neco  
Oversee's Elec  
Ritz Shop/Las Fabrics  
Sensuous Sound  
The Sound Factory  
Sounds Great  
Sound Shack  
Southern Audio  
Stereo World

# CARVER

## CORPORATION

### GEORGIA

Georgia Music  
Hi-Fi Buys

### IDAHO

Sound Co.  
Stereo Shop

### ILLINOIS

Appietree Stereo  
August Systems  
Gill Custom House  
Hi-Fi Hutch  
Mr. D's  
Muscraft  
United Audio

### INDIANA

American Audio  
Audio Connection  
Audio Junction  
Audio Specialists  
Lehman Elect  
Pro Audio  
Risley Elect  
Sound Prod.

### IOWA

John's Hi-Fi  
Sound  
World Radio

### KANSAS

Accent Sound  
Audio Elec.  
Audio Junction  
Audio Systems  
Elect. Inc.  
Hayes Sound  
Kell's Gramophone  
World Radio

### KENTUCKY

Bowling Grn. Audio  
FM Hi-Fidelity  
Ovation Audio  
Risley Elec.

### LOUISIANA

Kaders  
Sound Advice  
Sound Trail Audio  
Unlimited Sounds

### MAINE

Hi-Fi Etch  
Sound Center

### MARYLAND

Audio Assoc.  
Golden Ear  
Myer-Emco  
Soundscape  
Sound Studio

### MASSACHUSETTS

Natural Sound  
Sound Dynamics  
Sound Music  
Sound Track Audio  
Tweeter

### MICHIGAN

Gramophone  
Hi-Fi Buys  
Kurtz Music Ctr.  
Listening Room  
Pointe Elect.  
Stereo Showcase

### MINNESOTA

Audio King  
Mei's TV Audio  
Sound Elect.

### MISSISSIPPI

Hooper Sound

### MISSOURI

Best Sound  
Stereo Buff  
Stereo One  
Video Westport  
World Radio

### MONTANA

Rocky Mt. Hi-Fi  
Sound West  
Stereo Shop

### NEBRASKA

Good Music  
Stereo Studio  
World Radio

### NEVADA

Sound Emporium

### NEW HAMPSHIRE

Cuomo's  
Harcovier Audio  
Tweeter

### NEW JERSEY

Bryn Mawr Stereo  
Conkin's  
C.S.A. Audio  
Har's Stereo  
Hi-Fi Connection  
Hi-Fi Haven  
Leonard Radio  
Rand's Camera Hi-Fi  
Sight & Sound  
Sound Inc.  
Sounding Board

### NEW MEXICO

Candman  
Sound Ideas  
Sound Room  
West Coast Sound

### NEW YORK

Adriacac Music  
Audio Exchange  
Audio Experts  
Audio Genesis  
Designation  
Ear drum  
Gordon Elec.  
Grand Central Radio  
Harvey Sound  
Innovative Audio  
Jencho Audio  
JSG Audio  
Leonard Radio  
Lyric Hi-Fi  
Marri Elec.  
Morn's Stereo  
Sound Chamber  
Sound Odyssey  
Sound Stage Audio  
Square Deal  
Stereo Plus  
Thalia Hi-Fi  
Unicom Audio

### NORTH CAROLINA

Rainbow Audio  
Sound One  
Stereo Sound  
Stereo Station  
Stereo Village

### NORTH DAKOTA

Midwest Audio

### OHIO

Audio Corner  
Audio Craft  
Carlin Audio  
Electronics Ltd.  
Golden Gramophone  
Hart's Audio  
Palmer Elec.  
Phil Redman Stereo  
Swaile's  
Threshold Audio

### OKLAHOMA

Cowland  
World Wide Stereo

### OREGON

Cheslea Audio  
Good Guys Stereo  
Ladrianda Stereo  
Landon's  
Perrington's Audio  
Shackel's Stereo  
Sound Chamber

### PENNSYLVANIA

Bryn Mawr Stereo  
House of Records  
Listening Post

Mack Audio Elec.  
Pat's Stereo  
Pro Audio  
Shepard Stereo  
Stereo Outlet  
WES, The Stereo Store  
World Wide Stereo

### RHODE ISLAND

Tweeter

### SOUTH CAROLINA

John B. Lee "For Music"  
Read Brothers Stereo

### SOUTH DAKOTA

Pro Audio  
Stereo Town  
Team Elect.

### TENNESSEE

College Hi-Fi  
Lindsay Ward  
Sound Concept

### TEXAS

Audio Center  
Audio Video  
Beaumont Sound  
Branch Patton  
Century Sound  
Electric Ear  
El Centro Sound  
Marvin Elect.  
Melody Shops  
Mister  
San Antonio Audio  
Sheffield Audio  
Soundquest  
Stereo Den  
Stereo Int'l

### UTAH

Allen's Sound  
Audio Works  
Crisman Audio  
Lynn's Audio

### VERMONT

Audio Den

### VIRGINIA

Audible Image  
Audio Assoc.  
Audio Connection  
Digital Sound  
Lindsay Ward  
Myer-Emco  
Sound Machine

### WASHINGTON

Audio Northwest  
Bremerton Stereo  
Definitive Audio  
Hoffman Music  
Huffman Hi-Fi  
Magnolia Hi-Fi  
Patterson's  
QC Stereo  
Sterecraft

### WEST VIRGINIA

Mack & Dave's  
Sound Investments

### WISCONSIN

American TV  
Engandela Musical  
Mountain Elect.  
Port of Sound  
Salon T  
Sound Seller  
Sound Investments  
Crisman Audio

# Superphon

Introducing a new name to Audio from Oregon. STAN WARREN, formerly of PS Audio has moved.

New designs, optimized for high volume quality circle production, spell high value for you and big trouble for other brands.

Our budget preamplifier will set new standards of excellence for pre-amps of all price brackets. The Gemini universal head amp is the world's first optimized interface for moving coil and magnetic cartridges, it even comes with a custom version of an industry favorite magnetic.

There is more to come so watch for reviews and ads.

For more information ask your dealer or write to:

2375 W. 21st Avenue  
Eugene, Oregon 97405

# Superphon

A relatively, but not completely, accurate listing of AUTHORIZED CARVER DEALERS.

# The Classic Combination.

Combine the finest products in the audio industry, an educated and perceptive staff, in-house Technical Service, and 11 years of the most reputable and reliable customer service, and you get what you've been looking for — a combination ensuring satisfaction to the most demanding audiophile!

**woodbridge  
stereo  
center.**

Snell • Koetsu • Accuphase • Oracle • Souther • VPI • Yamaha  
B&O • Magnepan • Infinity • Threshold • Kyocera • Bryston  
Audio Research • Conrad Johnson Premer • Tandberg  
Apl • Nokamichi • Dahlquist • Boston Acoustics

751 Amboy Avenue (Rt. 35)  
Woodbridge, NJ 07095  
(201) 636-7777

## FOR SALE

**TURNTABLES IN PITTSBURGH—AR—THE LEGEND RETURNS.** New NAD 5120, New Sonographe SG-3, Walker, SOTA Sapphire. **BETTER SOUND CONCEPTS**, 400 South Craig St., Pittsburgh, PA 15213, Oakland, (412) 687-3737.

### VANDERSTEEN-DIMENSIONAL PURITY

We offer the remarkable 2C's at \$990 per pair (stands \$75). Visa and MC. **FREE SHIPPING IN US AND PR. WORLDWIDE EXPORTING.** OXFORD AUDIO CONSULTANTS, INC., Box 145, Oxford, OH 45056-0145, 513-523-3333, TLX427791.

### VANDERSTEEN LOUDSPEAKERS 1B & 2C

We are pleased to offer the new 1B's \$600, the 2C's \$990, and 2C stands \$75. Prices per pair. Visa and MC. **FREE SHIPPING IN US AND PR. WORLDWIDE EXPORTING.** OXFORD AUDIO CNSLTS., INC. Box 145, Oxford, OH 45056, 513-523-3333, TLX427791.

**BANG & OLUFSEN PRODUCTS AND NAKAMICHI CASSETTE DECKS—IN STOCK AT BEST PRICES.** (717) 774-2618

## FOR SALE

**VANDERSTEEN 2C'S**—hear them demonstrated superbly at Audio Connection, NJ 201-239-1799

**WESTERN ELECTRIC TUBES, SPEAKERS, AMPLIFIERS WANTED, MAURY** 713-728-4343.

**WOULDN'T YOU LIKE A WARM "BEARD" (AMPLIFIER) TO COME HOME TO?** For dealer list, contact: IAI, 723 Bound Brook Road, Dunellen, NJ 08812, or call 201-968-8771.

**HAFLER, REVOX, TANBERG, CARVER, DBX AND OTHER QUALITY COMPONENTS. PROFESSIONAL CONSULTATION—BEST PRICES.** EAST: (904) 262-4000; WEST: (213) 840-0878.

**SIGNATURE ONE DYNAMIC RANGE EXPANDER.** "RGR has made a believer out of us!" ... says Paul Kadair. To hear the latest RGR components in the South, contact Paul Kadair Audio in their **NEW** location: 11420 Airline Highway, Baton Rouge, Louisiana (504) 292-5105, or call RGR (312) 673-9320.

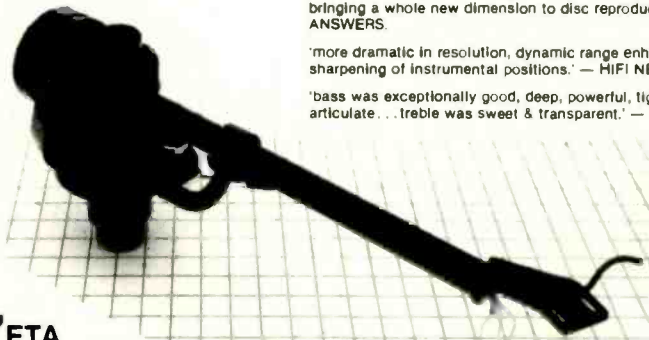

'the Zeta is the best sounding arm I've tried... capable of bringing a whole new dimension to disc reproduction.' — HIFI ANSWERS.

'more dramatic in resolution, dynamic range enhanced, general sharpening of instrumental positions.' — HIFI NEWS.

'bass was exceptionally good, deep, powerful, tight & articulate... treble was sweet & transparent.' — HIFI CHOICE.

probably the best tonearm in the world?

'the sound overall was gratifyingly delicate... stereo imagery I frankly thought superb... good subjective dynamic range... excellent trackability... the Brier is a superb pick-up.' — HIFI NEWS



**GOLDBUG**

hand building sweeter MC cartridges

REFERENCE MONITOR INT. INC. 6074 CORTE DEL CEDRO, CARLSBAD, CA 92008

## RECORDS

**AUDIOPHILE ALBUMS, COMPACT DISCS, DISCOUNT PRICES!** Largest selection anywhere. **SPECIAL:** "Fresh Aire V," \$14.98. **FREE** Catalog: For The Record..., Box 21201-AF, Columbus, Ohio 43221.

**AUDIOPHILE RECORD GALLERY** discounts on ultra sound direct disc, half mastered, digital, Japanese Imports, more! We specialize! Only the finest fidelity recordings. Catalog \$1.00 P.O. Box 1073, Vienna, VA 22180

### CLASS — A — UNDERGROUND

We **DISCOUNT** audiophile discs - stock on  
"Mobile Fidelity" Sheffield Labs  
"Nautilus Records" Compact discs

**VISA** and **MASTERCARD** accepted, **FREE** catalog:  
35 North Greenbush Road, West Nyack, NY 10994

**PROTECT YOUR LPS POLY SLEEVES** for jackets 13c. Poly lined paper 15c. Square bottom Inner sleeves 8c. White jackets 35c. Postage \$2.50. House of Records, Hillburn, NY 10931

**SHOWS.** 14 legitimate private ORIGINAL cast LPs plus live. Buy, sell, trade for records, live, equipment. (212) 347-1640 7736 250th, Bellerose, NYC, 11426

### ★SUPERSOUND RECORD SERVICE★

presents:

- 1) Audiophile recordings. Labels include: Sheffield, Reference, Meridian, Sonic Arts, Windham Hill, Opus 3, Fresh Aire, Propnis and many more.
- 2) Half-Speed Master recordings Pop/Rock from Mobile Fidelity and others.
- 3) DBX encoded records and cassettes
- 4) Japanese import Jazz—the largest inventory stocked in this country
- 5) Japanese Import Rock—hundreds of new and classic titles in stock.

Send \$1 for each catalog to: **SUPERSOUND RECORD SERVICE**, P.O. Box 82-A, Forest Park, IL 60130 (312) 366-1300

**THOUSANDS OF LIKE NEW LP's** and prerecorded tapes. Catalogue—\$2.50. House of Records, Hillburn, New York 10931.

**YSL RECORDS** (Japanese pressings exclusively)—NEW 1983 11,000-plus title catalog. \$3.00 Postpaid. **YSL STYLE**—top quality, great selection for most popular magnetic cartridges. Free list. **YSL RECORDS**, Box 8330-U, Van Nuys, CA 91409.

## SPEAKERS

**ELECTRO-VOICE INTERFACE AND CD SERIES QUALITY SPEAKER SYSTEMS. PROFESSIONAL CONSULTATION—BEST PRICES.** EAST: (904) 262-4000; WEST: (213) 840-0878.

**SPEAKER KITS AND SPEAKER CABINETS.** Constant voltage crossovers and heavy gauge air core coils. Will manufacture custom design cabinets to your specifications. Let us quote "free" on quantities of 10 or more. Send \$3.00 for our 1984 speaker kit catalog. **AUDIO DESIGN PRODUCTS**, P.O. Box 2166, Knoxville, TN 37901

## WANTED TO BUY OR TRADE

**ATTENTION WANTED:** MCINTOSH, MARANTZ, WESTERN ELECTRIC, ARC, BERNING TUBE EQUIPMENT. 713-728-4343. MAURY CORB, 11122 ATWELL, HOUSTON TX 77096

**AUDIO INTERNATIONAL COMPANY SINCE 1974.** All items listed by Aberst, Corb, Yo. Highest price, Integrity. (805) 646-5862

**CASH FOR USED STEREO RECEIVERS** and integrated amps, Dyna 400's, Phase Linear Amps. 716-262-2909

**DYNACO ELECTRONICS, SPEAKERS, PARTS—BOUGHT, SOLD, TRADED, REPAIRED.** Free "buy/sell" pricelist. **CASH** for "blown" Dyna components! SCC, Box 551 (Am1283), Dublin, OH 43017 - (614) 889-2117.

**MCINTOSH, MARANTZ TUBE COMPONENTS,** Western Electric speakers, amps, etc. John Conrad 1178 Blackbird St. El Cajon, CA. 92020 (619) 449-9155



## WANTED TO BUY OR TRADE

**HURRY! CONTACT ME FOR BEST RESULTS:** Tube Type Components by McIntosh, Marantz, Quad, Leak, Thorens TD124, Garrard 301, 401, Old Tannoy Monitor Speakers, Altec 604'S, 288-16G'H, 830A Laguna, Old Western Electric Equip (Tubes, Amps, Mixers, Consoles, Drivers, Tweeters, Horns, Speakers, Parts, Others) Tel: 213/576-2642 David Yo PO Box 832 Monterey-pk, Ca. 91754

**MCINTOSH, MARANTZ TUBE EQUIPMENT,** Thorens TD-124, Western Electric, Altec/JBL/EV/Tannoy/Stevens raw speakers, etc. Top cash. Scott Dowling, 9908 Daines Dr., Temple City, CA 91780 (213) 286-9122. Weekends and after 6PM (PST) M-F

**MCINTOSH SOLID STATE**—bought, sold, and traded. 1-313-229-5191 aft. 7 EST

**QUADRAPHONIC OPEN REEL TAPES,** LP's, Q-8's, some hardware. Michael Robin, 120 Atlanta Place, Pittsburgh, PA 15228, 412-341-1686.

**TOP PAID! WESYAN ELECTRIC TUBES** 300A-B, 274A-B, 252A, MCINTOSH C-22, MC-275, MARANTZ 2, 7C, 9, 10B, ALTEC 830A LAGUNA SYSTEM, 604 SERIES. Must be in good shape and reasonable. SOUND INC. PO Box 34, Shimodate, JAPAN 308.

**WANTED:** McIntosh, Scott, Fisher, Eico, Dyna, Marantz, Citation. Bought, sold, traded, brokered, consigned. 716-262-2909

**WANTED: NAKAMICHI 480Z**—will pay top dollar. Ask for Dave (612) 738-7625.

**WANTED-REWARD \$50.00 ROBERTS/AKAI** 10 1/2 Reel Adaptors Model 3810 (1964) fts 192, 400, 455 Call 415-552-5512 Collect, 258 Dorland, San Francisco 94114

## COMPACT DISCS

### CD DISCS!

The first compact disc dealer in North America (see Billboard cover story 3/12/83), and still the best. We have inventory! Nearly 1200 titles in stock, or readily available. Fair prices. Same day shipping. Our stock changes daily: phone orders a must.

Capitol Record Shop  
7 Capitol Ave., Hartford, CT 06106  
203-278-6530

### COMPACT DIGITAL DISCS AND PLAYERS!

In stock! Many titles. Fast, FREE shipping. Also: Mitsubishi, Sony, Klipsch, Nakamichi, more (see our Haffer ad.) READ BROTHERS STEREO 593 King Street, Charleston, South Carolina 29403. (803) 723-7276.

### A SINGER'S DREAM!

#### REMOVES VOCAL FROM MOST STEREO DISCS

Our VOCAL ELIMINATOR can remove most or virtually all of a solo vocalist from a standard stereo record and leave most of the background untouched! Not an equalizer! We can prove it works on the phone. Write or call for brochure and demo record.

### YOU SHOULD SEE US

For:

- Time Delay/Ambience
- Studio Echo/Reverb
- Tape Noise Reduction
- Parametric Equalization
- Electronic Crossovers
- Compressor/Expanders
- Mic Preamp/Mixers



We manufacture a full line of high quality audio and recording equipment. You will probably have to pay twice as much elsewhere to obtain comparable quality. Only Direct Sales make our prices and quality possible. Write or call for a 24 page brochure and demo record.

Write to: **LT Sound, Dept. AU, P.O. Box 338,**  
Stone Mountain, GA 30086, Phone (404) 493-1258  
**TOLL FREE: 1-800-241-3005 — Ext. 13**

## COMPACT DISCS

**COMPACT DIGITAL DISCS** exclusively—in stock—large selection and inventory - catalog \$1.00, refundable with order—Ethel Enterprises, P.O. Box 3301, Dept. A, Falls Church, VA 22043

**COMPACT DISCS-650 TITLES-AVAILABLE NOW!** Immediate delivery! Classics—Pop—Jazz!—FREE Catalog available. Phone or mail orders—Master Card & Visa. LAURY'S RECORDS 9800 North Milwaukee, Des Plaines, IL 60016 (312) 296-0420

**THE MOST COMPLETE CATALOG ANYWHERE** of compact discs, including new releases from CBS, RCA, Denon, Telarc, Delos, Realtime, Chandos, Windham Hill, DG, London, Warner, Erato, Virgin, Yupiteru, Telchiku, Tokuma, Canyon, Toshiba, Phillips, Pierre Veranu and many more. Looking for the best price? Take the SUPERSOUND price challenge: pay \$1 less per disc than the price in anyone else's catalog you send us.

Send \$1 to SUPERSOUND RECORD SERVICE, P.O. Box 82-A, Forest Park, IL 60130 (312) 366-1300

## TAPE AND TAPE RECORDERS

**AMPEX PROFESSIONAL SERIES AUDIO TAPE SALE** High quality open reel 1800' or 2400' on 7" reels, used once. Case of 40, \$45.00. 10 1/2" x 3600' and cassettes available. Master Card/Visa. Valtech Electronics, Box 6-A, Richboro, PA 18954 (215) 322-4866.

**SURPLUS AMPEX 671 SCOTCH 24 00'** box of 62, \$56. SCOTCH 3600' box of 30, 75. COD or check. CK Ltd., P.O. Box 527, Cottondale, Florida 32431

**60 MINUTE BLANK CASSETTES. \$8 PER DOZEN PLUS \$3 SHIPPING AND HANDLING.** R. A. B., PO BOX 2, PONETO, IN 46781

When judging design,  
the only criterion is  
musicality.

This simple fact is why every Counterpoint design receives world-wide recognition as being among the very best, regardless of price.

Meticulous circuit design results in surprising musical clarity and dimensionality. Exacting standards offer consummate value, today and tomorrow.

Counterpoint technology  
Complementing art.

FOR INFORMATION WRITE

Counterpoint Electronic Systems, Inc.

P.O. Box 12294, La Jolla, California 92037

USA (619) 453-9090

TELEX: 691600 TCILSA ATTN: CPT

## SERVICES

**ATTENTION AUDIOPHILES-MITSUBISHI, KENWOOD, AUDIO PURIST, HARMAN KARDON, SOUNDCRAFTSMEN, BOSTON ACOUSTICS, GRADO, JANSZEN, & CUSTOM SPEAKER RECONING FOR OVER 25 YEARS.** NEAL'S SPEAKERS & STEREO 1728 FULTON AVE, SACRAMENTO, CA 95825 (916) 486-9372.

**AUDIO PULSE REPAIR SPECIALISTS.** Model One's modified. Twall's Audio Service, 111 E. Riatto Ave., Riatto, CA 92376 (714) 875-0776

# THE LEGEND

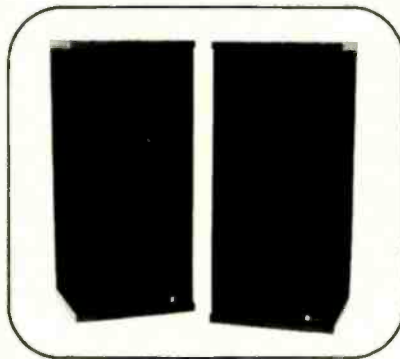

(Under \$400. pr.)

It'll blow  
you away ...

Hear it!

**CALIFORNIA**  
Milpitas: One More Stereo (408) 946-0500  
**CONNECTICUT**  
Manchester: J. Robert Barry (203) 646-5210  
New London: Stereo Lab (203) 447-9802  
Old Greenwich: Audiocore (203) 837-3821  
**FLORIDA**  
Bradenton: Bradenton Audio Workshop (813) 748-3868  
Stuart: Fox Audio (306) 287-4335  
**GEORGIA**  
Atlanta: Stereo Designs (404) 955-2533  
**IDAHO**  
Moscow: Sound West (208) 863-0530  
**ILLINOIS**  
Skokie: Component Stereo (312) 673-0430  
**INDIANA**  
Lafayette: Pro-Audio (317) 448-1547  
**KENTUCKY**  
Lexington: Sound Audio (606) 268-4112

**LOUISIANA**  
New Orleans: Wilson Audio (504) 866-3457  
**MASSACHUSETTS**  
Framingham: Natural Sound (617) 873-3556  
North Attleboro: Audio Concepts (617) 699-8819  
West: Hatfield Matrix Audio (413) 247-5699  
**NEBRASKA**  
Omaha: Custom Electronics (402) 397-1111  
**NEVADA**  
Las Vegas: Tech Stereo (702) 731-1016  
**NEW HAMPSHIRE**  
Portsmouth: Soundsmith (603) 438-0123  
**NEW JERSEY**  
Verona: Audio Connection (201) 239-1799  
**NEW YORK**  
Batevia: Unicorn Audio (718) 343-6470  
Commack: Sound Approach (516) 499-7680  
Fresh Meadows: Sound Stage Audio (212) 782-3220  
Ithaca: Stellar Stereo (607) 272-2944  
NYC: American Audiophile (212) 751-8733  
Ontario: Stereo Lab (607) 433-2286  
Valley Stream: American Audiophile (516) 561-7114

**PENNSYLVANIA**  
Blantown: Harlan's Sound Studio (215) 432-2598  
Fairless Hills: Audio Lab (215) 946-3476  
Philadelphia: Chestnut Hill Audio (215) 923-3035  
**TENNESSEE**  
Memphis: Opus II (901) 682-2455  
**TEXAS**  
Austin: Audio File (512) 443-9295  
Houston: Audio Profiles (713) 873-0000  
**VIRGINIA**  
Richmond: Audio Exchange (804) 282-0438  
Virginia Beach: Digital Sound (804) 424-5850  
**VERMONT**  
Essex Junction: Concert Electronics (802) 878-5884  
**WASHINGTON**  
Spokane: Hal's Stereo (509) 747-4266  
**WISCONSIN**  
Madison: Happy Medium (608) 255-2887  
Marinette: Sound Seller (716) 735-8002  
River Falls: House of Hi-Fi (715) 425-0470  
Wisconsin Rapids: Saton One (715) 421-5910

For further information contact:

**3D Acoustics/652 Glenbrook Rd./Stamford, CT 06906/203-327-7199**

## SERVICES

### G.A.S. REPAIRS—ALL MODELS

4 Month Limited warranty—Parts/Labor

For more information write or call between 10:00 & 6:00 EST. Audio Diagnostics, Inc. 19888 Kelly Rd. Harper Woods, MI 48225. (313) 527-5400

## TAPE RECORDINGS

**DIRECT-TO-TAPE RECORDINGS:** REAL TIME DUPLICATED REELS (2/4 track, Dolby B.C. TypeX), CASSETTES (Dolby B.C. TypeX), and DIGITAL CASSETTES from MASTER TAPES. FREE CATALOG. Direct-to-Tape, 14-R Station Ave., Haddon Heights, NJ 08035.

**OPEN REEL TAPES** from studio masters. Catalogue \$1.00. Barclay-Crocker, 313-A Mill Street, Poughkeepsie NY 12601.

## RADIO PROGRAMS

**OLDTIME RADIO** ... Classic broadcasts on high quality tapes. Free catalogue. Carl A. Froelich, 2 Heritage Farm, New Freedom, PA 71349.

# USED

MAGNEPAN MG-1 imp \$379	YAMAHA T2 \$399
AUDIO RESEARCH D79 \$1899	DENON DP60L \$329
AUDIO RESEARCH D76 \$549	OHM L \$199
AUDIO RESEARCH D76A \$699	JANIS W1 demo \$499
AUDIO RESEARCH SP6A \$679	MIRAGE SM2 \$249
AUDIO RESEARCH SP6B \$749	REVOX A740 \$749
AUDIO RESEARCH SP5 \$329	REVOX A730 \$1499
CROWN DC300A 10c. \$899	REVOX B710 999
CROWN D150A \$329	REVOX B780 \$1699
CROWN D75 \$199	SONY EL-7 Ekaset \$269
NAKAMICHI ZX-7 \$699	PHASE LINEAR 400 \$329
SEOUERRA FM-1 demo \$4599	ROGERS LS 3/5a \$379
MAGNEPLANAR Tympani Id \$699	KLH 9 \$399
OLUAD ESL refurb \$749	DYNACO ST150 \$169
B & W 801I demo \$2499	NAKAMICHI 730 \$649
CONRAD JOHNSON PV3 \$199	TEAC/Tascam 80-B call
DCM T/Window & T/Bass \$799	SHERWOOD SEL300 \$279
FIDELITY RESEARCH FR66 \$499	
INFINITY Black Widow \$129	PYRAMID MET 7s/Bw \$479

sale prices cash/certified check all items subject to prior sale  
all equipment 14 day money back guarantee  
limited warranties no less than 60 days



95 Vassar St  
Cambridge, MA 01239

617-547-2727

## HELP WANTED

**STEREO SERVICE TECHNICIANS NEEDED.** Live and work near Disney World and EPCOT in sunny, warm Orlando Florida. Must be familiar with modern test equipment, and be able to professionally service all brands of receivers, tape decks, turn tables, amplifiers, etc. Top salary/benefits. Call MASTERTRONICS today at 305-277-7371.

## INSTRUCTION & EDUCATION

**THE MUSIC BUSINESS INSTITUTE** A Career program in music: course includes recording, studio, concert and video production; artist representation and management; retailing and wholesaling; record promotion and marketing; copyright and music publishing, and more. Employment assistance. Accredited. Financial aid available. Write for free brochure and career guide. MBI, Dept. A, 3376 Peachtree Road, N.E., Atlanta, GA 30326; (404) 231-3303.

## MISCELLANEOUS

**CLOCKS:** The absolute finest ships bell and mantel clocks. Discounted "high-end" send \$3 for catalog. San Joaquin Clockworks P.O. Box 60322 Dept.-A, Bakersfield, CA 93386

**FIREWORKS—Discount prices.** Firecrackers, bottle rockets, and much more. For catalog send 50c to Spartan Fireworks, P.O. Box 203, Randolph, Ohio 44265.

### AUDIO

#### BACK ISSUES

Single copy back issues of AUDIO for 1981, 1982 and 1983 are available (NOTE: Jan-Aug '81 issues are in limited supply.) \$5.00 per issue postpaid.

#### BOUND ISSUES

A ready reference for audiophiles! A full year of AUDIO is carefully hard-bound for easy reference. Complete volumes for the years '77, '79, '80 thru '83 are available. \$40.00 each plus \$2.50 for postage and handling.

#### BINDERS SLIPCASES

Maintain your AUDIO collection in top quality binders or slipcases. BINDERS: \$9.00 each, 3/\$26.00, 6/\$50.00. SLIPCASES \$7.65 each, 3/\$22.00, 6/\$40.00. Please include \$2.50 per order handling and postage.

**TO ORDER** Indicate issue/book/binder/slipcase. Include proper amount for postage and handling. California residents must include 6% sales tax. Allow 4 weeks for delivery. \$15.00 MINIMUM CREDIT CARD ORDER. Make checks/money orders payable to: Old Del Mar Emporium (ODME), P.O. Box 1621, Spring Valley, CA 92077. FOR CREDIT CARD ORDERS CALL TOLL FREE 1-800-854-2003, EXT. 835. In CALIF. CALL 1-800-522-1500 EXT. 835.

# AD INDEX

## Firm (Reader Service No.)Page

Acoustat .....	72, 84
Acoustic Research .....	5, 70
ADC (2) .....	4
Adcom (15) .....	31
Allison Acoustics (12, 21) .....	26, 72
Amber Electronics (39) .....	93
Audiophile Systems (25, 35) .....	75, 88
Audio-Technica (37) .....	91
B&W Loudspeakers (9, 22) .....	21, 73
BASF (4) .....	12
Bryston Manufacturing (40) .....	94
Camels .....	33
Carver Corp. (10) .....	22
Chevrolet .....	3
D'Ascanio (14, 23) .....	29, 73
dbx .....	56
Delco/Bose (5) .....	15
Design Acoustics (31) .....	81
Dynavector (33) .....	83
Goodyear (19) .....	64 & 65
Harman/Kardon .....	Cover II
IMF (20) .....	69
J&R Music World (41) .....	94
Jack Daniels .....	87
JBL .....	19, 74
KEF (24, 38) .....	75, 92
LaBelle .....	60
Linn SARA (25, 35) .....	75, 88
McIntosh (13) .....	27
Maxell (6) .....	17
Memorex .....	Cover III
Nakamichi (11, 29) .....	23, 79
Ohm (17) .....	57
Polk (18, 26) .....	59, 76
Pyramid (27, 36) .....	77, 89
Quad (28, 34) .....	77, 85
Robertson Audio (32) .....	82
Salem .....	24
Sansui (8) .....	20
Signet (7) .....	18
Soundcraftsmen (30) .....	9
Tandberg (3) .....	6 & 7
TDK (1) .....	1
Technics (42) .....	Cover IV
Winston .....	11

**NY  
METRO  
AREA**

ADS, AGI, APT, Astatic, Audio Control, Audio Dynamics, Audio Pro, Audio Research, Audio Tech, onics, Beyer, Blaupunkt, B&O, Burwen, B&W, Carver, CAT, Colter, CWO, Dahlquist, DCM, Denon, Dynavector, Ev, Fidelity Research, Grace, Grado, Haller, Janis, KEF, Koetsu, Linn, Sonder, Live Wire, Lustre, Nakamichi, Quad, Queen Labs, Revox, RG Dynamics, RGA, RH Labs, Rogers, Shal, Stax, Symmetry, Tandberg, 3D Acoustics, VPI, Yamaha

**Audiocom**  
high technology audio

SERVICE ON PREMISES • CUSTOM INSTALLATIONS  
THREE LISTENING ROOMS ON TWO LEVELS  
LARGE INVENTORY • PROMPT DELIVERY



177 Sound Beach Avenue, Old Greenwich, CT 06830  
Major credit cards honored. Open 10 AM-6 PM Mon-Sat.

INFORMATION LINE 203-637-3821



# FOREVER IS A LONG TIME



## Presenting High Bias II and the Ultimate Tape Guarantee.

Memorex presents High Bias II, a tape so extraordinary, we're going to guarantee it forever.

### We'll guarantee life-like sound.

Extraordinarily flat frequency response at zero dB recording levels, combined with remarkably low noise levels, means music is captured live. Then Permapass,<sup>®</sup> our unique oxide-bonding process, locks each oxide particle—each musical detail—onto the tape. So music stays live. Not just the 1st play. Or the 1000th. But forever.

### We'll guarantee the cassette.

We've engineered every facet of our transport mechanism to protect the tape. Our waved-wafer improves tape-wind. Silicone-treated rollers insure precise alignment and smooth, safe tape movement. To protect the tape and mechanism, we've surrounded them with a remarkable cassette housing made rigid and strong by a mold design unique to Memorex.

### We'll guarantee them forever.

If you ever become dissatisfied with Memorex High Bias II, for any reason, simply mail the tape back and we'll replace it free.

**YOU'LL FOREVER WONDER.**

**IS IT LIVE,  
OR IS IT  
MEMOREX.**







## The new Technics Digital Disc Players. Now lasers and computers give you the one experience your conventional audio system never could: Reality.

Reality: The duplication of a live musical performance. The most elusive goal of all. Yet reality is precisely what you hear with Technics digital disc players.

How? Technics revolutionary digital disc players have a laser instead of a conventional stylus. Because instead of conventional record grooves, digital discs have a computer code. The laser "reads" this code as a computer instantaneously translates it into music.

What you hear is not just a reproduction of the music, but a re-creation of it: reality.

And nothing touches the digital disc except the laser beam. That means there is no wear. No noise. And no distortion. All of which can plague conventional records.

All this Technics digital technology comes together in the new generation Technics digital disc players. The remarkable SL-P8 and SL-P7.

You can program the SL-P8 up to 32 different ways. Play any selection you want. In any order you want. Repeat the selections you like. Even skip ones you don't.

Auto Music Scan automatically plays the first 10 seconds of every selection. So finding the selection you want is easy.

The fluorescent display shows you precisely where the laser is on the disc. So you can even find the exact notes you want to hear.

And to let you do all this from across the room, there's even an infrared remote control.

Experience the full range of Technics digital technology. Including the new SL-P8 and affordable SL-P7. The digital revolution continues at Technics.

COMPACT  
disc  
DIGITAL AUDIO

**Technics**  
The science of sound

Buy a Technics Compact Disc Player between January 1 and May 31, 1984 and Technics will send you 5 free Digital Audio Discs. See your participating Technics dealer for details.

Enter No. 42 on Reader Service Card