

Scenes!
AES Convention

Audio

THE AUTHORITY MAGAZINE ABOUT HIGH FIDELITY • FEBRUARY 1976 • \$4.00

47425

U0803760 0476 30725005P0101212
DON L. HEYSER
2608 CENTRAL BLVD
EUGENE OR 97403

Build
A
Low-TIM
Amplifier

Heyser On
Harmonic Distortion

Best of each

4-track units. With three motors and three heads, it has virtually every professional feature you'd want. Yet it's extremely simple to use. In addition to stereo record/playback, it also highlights 4-channel playback. The RT-1020H (15, 7½ ips) is the high speed counterpart of the RT-1020L. While the RT-1011L shares most of the features of the RT-1020 series, it does not include 4-channel playback. The complete extent of their capabilities becomes apparent only after you've worked with them. Then you'll recognize the magnitude of Pioneer's accomplishment.

The RT-1050 is a 2-track, 2-speed (15, 7½ ips) 3-head deck which, like all all Pioneer models, can handle professional 10½-inch tape reels. Its unique combination of bias and equalization switching controls give 12 different settings to optimize the performance of any tape on the market.



12 Bias & Equalization settings optimize performance.

The RT-1050's 3-motor transport system is activated electronically by full logic, solid state circuitry, triggered by feather touch pushbutton controls. Its transport is completely jam- and spill-proof, permitting you to switch from Fast Forward to Fast Rewind, bypassing the Stop button.

The RT-1050 was specifically designed for easy operation with a wide combination of professional features like extended linearity VU meters with adjustable sensitivity, mic/line mixing, pushbutton speed selection and reel tension adjustment buttons. There's also an exclusively designed pause control, and independent control of left and right recording tracks.

The same 2-track recording system studios use for better signal-to-noise ratios and higher dynamic range is incorporated into the RT-1050. Yet it can be easily converted to 4-track use with an optional plug-in head assembly. Everything considered, it's the most versatile open-reel deck you can buy. Professionals prefer it for its studio-quality performance. Everyone appreciates its completely simple operation.

Pioneer open-reel and cassette decks are built with the same outstanding quality, precision and performance of all Pioneer high fidelity components. That's why, whichever you choose, you know it's completely professional and indisputably the finest value ever in a studio-quality tape deck.

U.S. Pioneer Electronics Corp.,
75 Oxford Drive, Moonachie,
New Jersey 07074.

West: 13300 S. Estrella, Los Angeles
90248 / Midwest: 1500 Greenleaf, Elk
Grove Village, Ill. 60007/ Canada:
S. H. Parker Co.

PIONEER
when you want something better

Pick The Cassette Features You Need

Model	Dolby	Memory Rewind	Frequency Response (Chrome Tape)	Peak Indicator	Level Limiter	S/N (with Dolby)	Wow & Flutter (%-WRMS)	Priced Under
CT-9191*	Yes	Yes**	20-17kHz	Yes	Yes	62dB	0.07	\$450
CT-7171*	Yes	Yes	30-16kHz	Yes	Yes	58dB	0.10	\$380
CT-6161*†	Yes	Yes	30-16kHz	No	No	58dB	0.12	\$300
CT-5151	Yes	Yes	30-16kHz	Yes	Yes	58dB	0.12	\$280
CT-4141A	Yes	No	30-15kHz	No	No	58dB	0.13	\$250
CT-2121*	Yes	No	30-16kHz	No	No	58dB	0.12	\$200††

*Front loading ††Less cabinet **Plus Rec/Play auto start †Not shown

Pick The Open-Reel Features You Need

Model	Speeds (ips)	Frequency Response (± 3dB)	Tape Bias/Equalization Positions	Wow & Flutter (% at highest speed)	S/N	Mic/Line Mixing	4-Ch. Play	Priced Under
RT-1050	15, 7½	30-22kHz	3/4	0.06	57dB	Yes	No	\$690
RT-1020H†	15, 7½	30-22kHz	3/2	0.06	55dB	Yes	Yes	\$650
RT-1020L	7½, 3¾	40-20kHz	3/2	0.10	55dB	Yes	Yes	\$650
RT-1011L	7½, 3¾	40-20kHz	2/2	0.10	55dB	Yes	No	\$600

†Not shown

*Dolby is a trademark of Dolby Labs., Inc.

The values shown are for informational purposes only. The actual resale price will be set by the individual Pioneer dealer at his option. With the exception of the CT-2121, all models include a cabinet constructed as follows: CT-9191, CT-7171—walnut veneered top and side panels; CT-6161—walnut grained vinyl top and side panels; CT-5151, CT-4141A—walnut grained vinyl front and side panels; RT-1050—leather-like vinyl side panels and front cover; RT-1020L, RT-1020H—walnut veneered side panels; RT-1011L—walnut grained vinyl side panels. Optional cabinet for CT-2121 with walnut veneered top and side panels (approx. value—\$25).



RT-1050



CT-7171

Bringing you the k is up to us.

High fidelity is important to us at Pioneer. It's all we do and it's all we care about. We are excited that cassette tape decks have reached a level of performance that meet the highest standards. We are excited because we know that it means more enjoyment for you from your high fidelity system. We also know that you can now get more versatility and value out of your high fidelity system than ever before.

The great advances in cassette technology have had impact on the reel-to-reel tape deck concept as well. We believe that the era of the small, inexpensive 7-inch reel tape deck is past. Neither its convenience nor its performance make it a good value compared to the new cassette technology. And it is now possible for Pioneer to offer you a professional, studio-quality 10½-inch reel deck at prices that compare favorably with what you might expect from old fashioned 7-inch reel units. In our judgment the old ideas must move aside for the new ideas. And Pioneer has some very intelligent new ideas in tape for you.

The convenience of cassette. The performance of open-reel.

The new CT-9191, with built-in Dolby* establishes a new and incomparable level for cassette deck performance and features. Designed with up-front controls and cassette loading, you can stack other components above it or under it.

Performance features stack up, too.

Bias and equalization switches insure optimum recording and playback for every type of cassette tape made. There's even automatic bias/equalization switching when the new type CrO₂ cassette, equipped with the special identifying notch, is inserted. A front panel indicator light signals this automatic operation.



Simple vertical cassette insertion visible at all times.

Distortion- and interference-free recordings are consistently produced, thanks to a combination of wide-scale range VU level meters (-40dB to +5dB), an LED peak level indicator light, a selectable level limiter circuit, and an FM multiplex filter switch.

Locating a desired program point in a cassette is simple with the new CT-9191. A specially designed memory rewind switch (including record/play automatic re-start) and 3-digit tape counter, make precision cueing a breeze.

Operation is further simplified with automatic tape-end stop, dual concentric rotary mic and line input controls — for mic and line mixing — and separate rotary output level controls, all with adjustable

memory index markers. In addition, there are soft-touch solenoid operated transport controls. This combination makes the 9191 the recording studio that fits on a shelf.

Two independent drive motors, plus solid ferrite record/playback heads combine to provide a new low in wow and flutter (0.07% WRMS) and a new high in



Memory rewind with record/play automatic re-start.

frequency response (20 to 17,000 Hz; CrO₂ tape).

Whether you choose the ultra sophistication of the CT-9191 or Pioneer's other front loaders — CT-7171, CT-6161, CT-2121, or the top loading CT-5151 and CT-4141A, which snare many of its features, you're assured optimum performance and maximum value in their respective price ranges. One tradition that never changes at Pioneer.

Open-reel. A professional recording studio in your home.

Professionalism comes with all four studio-quality open-reel models. The RT-1020L (7½, 3¾ ips) is unequalled in



CT-9191



**Whether you
use a
cassette or
open reel deck
is up to you.**





RT-1020L



RT-1011L

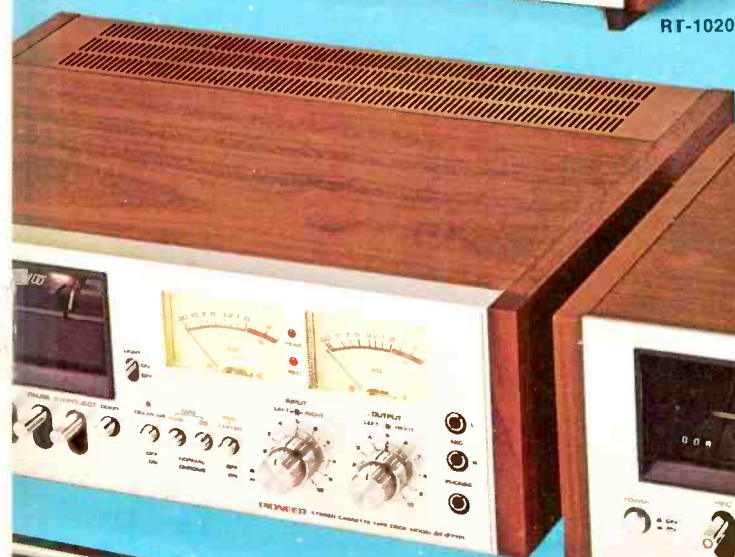

CT-5151



CT-2121



CT-414-A

Check No. 34 on Reader Service Card

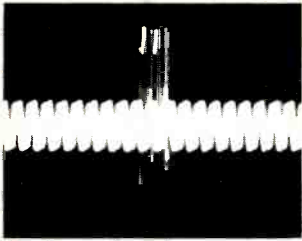

Actual, unretouched photo of an oscillograph test.

The oscillograph you see is an actual photo of a high-quality audio system "playing" a fingerprint.

You're hearing fingerprints now through your speaker system. Instead of the sound your precious discs are capable of. And no vacuum record cleaner, brush-arm or treated cloth will remove them. None.

The sound of your fingerprint

But Discwasher™ — with new **du** fluid — removes fingerprints completely. Along with dust. And manufacturing lubricants (added to make pressing faster) that can act like groove-blocking fingerprints. All this cleaning without pulling polymer stabilizers from your vinyl discs.

Discwasher™. The only safe, effective way to silence the printed finger. At Audio specialists world wide.



Discwasher, Inc.
909 University,
Columbia, Mo. 65201

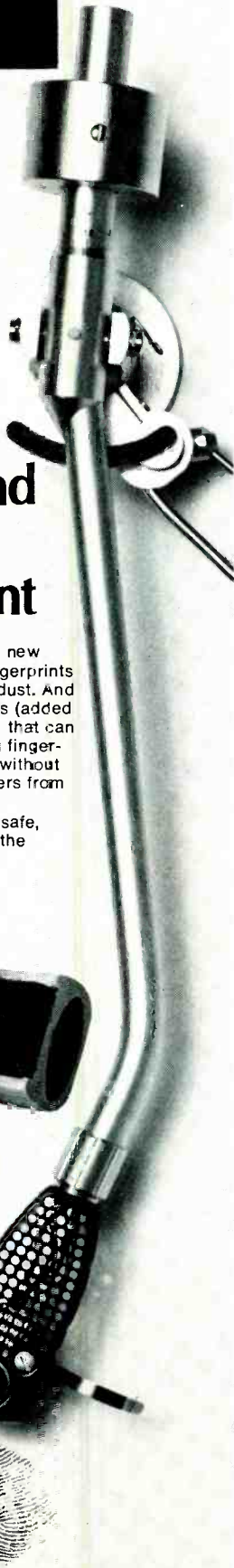

Audio

February, 1976

"Successor to **RADIO** Est. 1917"

Vol. 60, No. 2

Feature Articles

- 18 Speaker Tests: THD/Richard Heyser
- 30 Build A Low TIM Amplifier/W. Marshall Leach
- 76 Let's Be Fair to Our Favorite Composers/Felix Arnstein
- 79 Of Rosie, Mame, Liza, Ellen and Rod/Donald M. Spoto

Equipment Profiles

- 48 GTE Sylvania RS4744 Receiver/Leonard Feldman
- 54 Quintessence Equalizer 1/Leonard Feldman
- 58 SAE Mk VII Tuner/Leonard Feldman
- 64 Dynaco PAT-5 Preamplifier/Bascom H. King
- 74 Pioneer PL-71 Turntable/George W. Tillett

Record & Tape Reviews

- 81 The Column/Fred DeVan & Jon Tiven
- 94 Canby's Capsules/Edward Tatnall Canby
- 96 Classical Reviews/Edward Tatnall Canby
- 98 Jazz & Blues/Dan Morgenstern, John Lissner, & Eric Henry
- 103 Theater Music/Donald M. Spoto
- 106 Tape & Turntable/Bert Whyte

Audio In General

- 4 Audioclinic/Joseph Giovanelli
- 6 Tape Guide/Herman Burstein
- 8 What's New In Audio
- 18 Audio ETC/Edward Tatnall Canby
- 24 Behind The Scenes/Bert Whyte
- 28 Dear Editor:
- 88 Advertising Index
- 108 Classified Advertising

EDITOR Eugene Pitts III
ASSOCIATE EDITOR Edward Tatnall Canby
ASSOCIATE EDITOR Bert Whyte
ADVERTISING PRODUCTION Lynn Lyons

PUBLISHER Jay L. Butler
MARKETING DIRECTOR Sanford L. Cahn
DESIGN Janet Lee
CIRCULATION MANAGER Jean Davis

Contributing Editors: Herman Burstein, Martin Clifford, Fred De Van, Leonard Feldman, Martha Sanders Gilmore, Joseph Giovanelli, Richard C. Heyser, Bascom H. King, C.G. McProud, Dan Morgenstern, B.V. Pisha, Donald M. Spoto, George W. Tillett, Jon Tiven.

AUDIO (title registered U.S. Pat. Off.) is published monthly by North American Publishing Co., Irvin J. Borowsky, President; Frank Nemeyer, and Jay L. Butler, Vice Presidents; R. Kenneth Baxter, Vice President/Production; Vic Brody, Promotion Director; Mary Claffey, Circulation Director.

RATES—United States only: 1 year for \$7.00, 2 years for \$12.00, 3 years for \$17.00; outside the U.S.: 1 year for \$9.00, 2 years for \$16.00, and 3 years for \$23.00. Printed in U.S.A. at Columbus, Ohio. All rights reserved. Entire contents copyrighted 1976 by North American Publishing Co. Second class postage paid at Philadelphia, Pa. and additional mailing office. Back issues, \$2.00 each. **World Library Congress** number: ISSN 0004-752X. **Dewey Decimal** number: 621.381 or 778.5.

REGIONAL SALES OFFICES: Jay L. Butler, Publisher and Sanford L. Cahn, Marketing Director, 41 East 42nd St., New York, N.Y. 10017, telephone (212) 687-8924.

Jay Martin, 2525 West 8th St., Los Angeles, California, 90057, telephone (213) 385-2917

REPRESENTATIVES: **Continental Europe:** John Ashcraft, 12 Bear St., Leicester-Square, London W.C.2, telephone 930-0525.

For Benelux and Germany, W.J.M. Saunders, Mgr., Herengracht 365. Amsterdam, Holland, telephone 24.09.08. Japan: Japan Printing News Co., Ltd., No. 13.2 Chome Ginza Higasi, Chuo-ku, Tokyo, telephone 541-5795.

AUDIO Editorial and Publishing Offices, 401 No. Broad St., Philadelphia, Pa. 19108

Postmaster: Send Form 3579 to the above address





“A dream come true”

In just 18 months, B-I-C Multiple Play Manual Turntables have become the sensation of the high-fidelity industry.

Today, they're fast becoming the best-selling **B·I·C**[™] turntables in America.

Recently, we received a letter from Peabody, Mass. which explains the B-I-C phenomenon better than we ourselves ever could.

“As an audio salesman (our correspondent writes) I have the opportunity to compare very closely many different makes of equipment.

Also, I have the opportunity to get a ‘feel’ for the attitude of the company towards its customers.

It is B-I-C's total excellence in both these areas that has prompted this letter of congratulations on a fine product and your ability to achieve such quality inexpensively, compared to other manufacturers.

Your turntable is like a dream come true; all the superior characteristics of a fine manual, but which, if the occasion arises, a party for instance, can also be used as an automatic. It is in my opinion and the opinion of most of my colleagues, the best all-around turntable available today.”*

Need we say more?

*THIS LETTER IS IN OUR FILES. IN THE INTEREST OF PRIVACY THE WRITER'S NAME HAS BEEN OMITTED. B-I-C 960, ABOUT \$150— B-I-C 980, ABOUT \$200— B-I-C 940, ABOUT \$110. FOR LITERATURE, WRITE: BRITISH INDUSTRIES CO., WESTBURY, L.I. 11590— A DIVISION OF AVNET INC. © 1975.

Check No. 8 on Reader Service Card

The \$750
alternative.

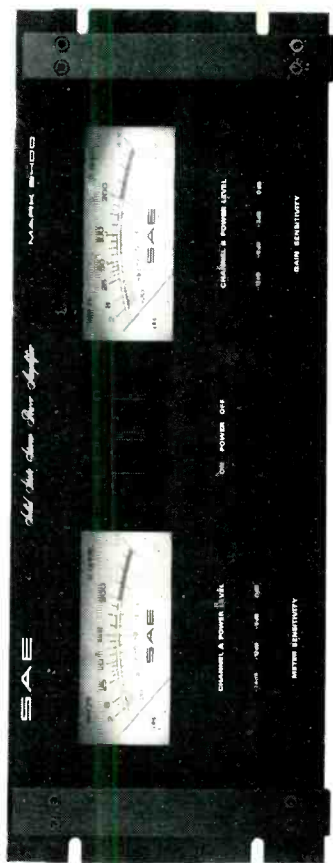

SAE 2400 Professional Dual-Channel Power Amplifier

- 200 Watts RMS, per channel, both channels driven into 4 or 8 Ohms from 20Hz to 20KHz at no more than 0.05% Total Harmonic Distortion.
 - 0.05% IM into 4 or 8 Ohms
 - (signal to noise) greater than 100dB
 - plug-in board modules
 - forced air cooling
 - only 11" deep
 - weighs less than 42 lbs.
 - superb construction using only the finest materials and component parts
 - available in black rack mount (as shown) or our traditional satin gold and black
- You'd have to look a long time to find a power amplifier that delivers this much value.



Scientific Audio Electronics, Inc.
P.O. Box 60271, Terminal Annex
Los Angeles, California 90060

Please send me the reasons (including available literature) why the SAE 2400 Professional Amplifier is the "\$750 Alternative."

NAME _____
ADDRESS _____
CITY _____ STATE _____ ZIP _____

Check No. 39 on Reader Service Card

Audioclinic

Joseph Giovanelli

Magnet Weight

Q. *What is the different in meaning between the terms "magnet weight" and "magnet structure weight" in speaker specifications?—Edward Esposito, Brooklyn, N.Y.*

A. Magnet weight simply refers to the weight of the magnet used in the loudspeaker. Magnet structure weight includes not only the weight of the actual magnet but also includes the weight of all the iron which surrounds it and the polepiece in the center.

In either case, the terms are not really pertinent because they do not convey anything about the amount of magnetic flux appearing in the gap to move the voice coil. One naturally tends to think that the greater the weight of the magnet used in a design, the more intense will be the field strength for the voice coil. While this is partially true, there are, however, many other factors which influence the design, including relative strength of the magnet for its weight, gap distance, length of wire in the coil, etc.

Four-Speaker Hook-up And Placement

Q. *I have two pairs of speakers, both by the same maker, however, each pair is a different model. Pair-A speakers are two-way, bass-reflex systems, with 12-in. woofers and 2 1/2-in. tweeters. Pair-B units are three-way, bass-reflex designs, with 10-in. woofer, 3 1/2-in. midrange, and 2 1/2-in. tweeter. Pair B has a three-position high frequency adjustment, while pair A does none.*

If I place them in a four-corner arrangement for stereo, how should I pair the speakers? Also, if I decide to go to a synthesizer for four-channel sound, which ones would you suggest be used for the rear speakers?—F. T. Overby, Jr., Richmond, Va.

A. It is best to have all speakers be of the same make and model in situations of the kind you describe. When this is not possible, pick the two speakers you prefer and use them up front and use the ones you like least in

the rear positions. The particular design parameters of the speakers should not influence your choice here, though you may have to add a level-control pot if their efficiencies are very different.

In the case of a four-corner stereo set-up, the front and rear speakers for a given channel may be paralleled. Their combined impedance, however, must not be lower than the minimum impedance that can be handled by your amplifier. The important thing here is to find out from a test report or the manufacturer what the MINIMUM impedance is, since in many cases this is significantly lower than the nominal or rated impedance.

For either synthesized or true four-channel set-ups, those speakers whose sound you prefer should again be placed up front. The exact manner of speaker hook-up will depend on the equipment employed, and generally the maker of the unit will have some specific recommendations.

Speaker Impedance With Separate Amps

Q. *I have two pairs of 6-ohm speakers. If I connect one pair normally to my receiver and the other to a separate amplifier fed from the Tape Out jacks of the receiver into the AUX inputs of the amplifier, does it make any difference that the speakers' impedance is less than 8 ohms? Would it make any difference if a four-channel adaptor was connected between the receiver and the amplifier?—Marvin Foley, Portland, Maine.*

A. So long as your speakers are connected to two separate power amplifiers, there is no interaction between them, which might lower their impedance. This is also true with a four-channel decoder interconnecting the two amplifiers. 

If you have a problem or question on audio, write to Mr. Joseph Giovanelli, at AUDIO, 401 North Broad Street, Philadelphia, Pa. 19108. All letters are answered. Please enclose a stamped, self-addressed envelope.

the Finest Separates

...for the Finest in Stereo
from **KENWOOD**

KENWOOD tuners and amplifiers are recognized the world over for their outstanding performance and exceptional dependability. Little wonder. KENWOOD separates perform better because they're engineered better: The most advanced audio concepts establish their performance parameters. The finest workmanship and material go into their construction. The most stringent quality controls assure that each unit is operating at its optimum peak. So when you listen to KENWOOD's luxurious KT-8007 Stereo Tuner and KA-8006 Stereo Amplifier—or to the deluxe KT-6007/KA-6006 Series—you can be sure you are hearing the finest stereo reproduction that advanced engineering and superb craftsmanship can produce.



KT-8007 . . . AM/FM-Stereo Tuner
KA-8006 . . . Stereo Amplifier
 with 70 watts per channel,
 Minimum RMS at 8 ohms, 20-20k Hz,
 with no more than 0.2%
 Total Harmonic Distortion.

KT-6007 . . . AM/FM-Stereo Tuner
KA-6006 . . . Stereo Amplifier
 with 48 watts per channel,
 Minimum RMS at 8 ohms, 20-20k Hz,
 with no more than 0.3%
 Total Harmonic Distortion.

For complete information,
 visit your nearest
KENWOOD Dealer, or write . . .



15777 S. Broadway, Gardena, CA 90248 • 72-02 Fifty-first Ave., Woodside, N. Y. 11377 • In Canada: Magnasonic Canada, Ltd.
 Check No. 22 on Reader Service Card

Super THE PROBLEM SOLVER

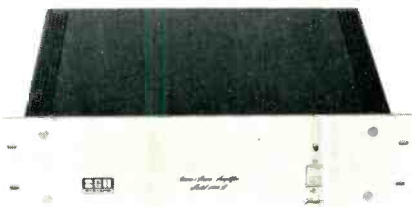

THE BGW 250B DOESN'T HAVE—

- Fuses
- Knobs
- Meters
- Current limiting
- Hum
- Noise
- Thumps
- High price

BUT, IT DOES HAVE—

- Enough muscle to drive 2-ohm loads (340-watts*)
- Absolute speaker protection (exclusive BGW SCR crowbar)
- Virtually unmeasurable distortion*
- Modular construction
- 12 rugged 150-watt output transistors
- High speed magnetic circuit breaker
- True op-amp front end
- Heavy 3/8" thick rack panel
- Totally enclosed heat sinks
- 660-square inches of efficient heat radiating surfaces
- Rugged steel chassis
- Mono-stereo switch

*Guaranteed specifications:

Stereo mode: 90-watts/channel into 8-ohms, 20-Hz-20-kHz with less than .1% total harmonic distortion (THD). 100-watts/channel into 4-ohms, 5-Hz-15-kHz with less than .15% THD.

Mono mode: 180-watts into 16-ohms, 20-Hz-20-kHz with less than .1% THD. 200-watts into 8-ohms, 5-Hz-15-kHz with less than .15% THD.

The perfect mate is our new model 202 stereo preamplifier featuring the industry's most accurate phono system—82-dB S/N, .01% THD, active 18-dB/OCT. Hi-Lo filters, studio type graphic controls. See all 6 BGW power amps and our new preamplifier at your local dealer.



BGW Systems
P.O. Box 3742
Beverly Hills
CA 90212
(213) 973-8090

Check No. 7 on Reader Service Card

Tape Guide

Herman Burstein

Left-Channel Dropouts

Reader Bob Nicholas, Long Beach, Calif., provides a possible cause of left-channel dropouts:

"I have encountered dropouts and loss of highs on certain reels of tape, even supposedly high-quality mastering tape made by some well-known companies. The cause of the problem, sometimes, are wide spots in the tape. This causes the tape to 'hang up' in the guides, with the result that the outer edge breaks contact with the tape head. It is easy to tell when this is happening, if the deck has tension arms, because the drag caused by the hang up causes the arms to flip until the tension is normal again.

"When the reel is wound smoothly, I can even see the overhang of the wide spots. My tape supplier can't believe this is a problem even though I have shown him the defective reels of tape. I guess the cause is improper adjustment of the tape slicers during the cutting process."

Evaluating A Deck

Q. I had my American-made tape deck tested by Revox engineers. Their analysis showed for channel A "ragged bass response between 20 and 50 Hz, a steady rise in response from 50 Hz to 15 kHz, signal-to-noise ratio of 40 dB at 0 VU, and wow and flutter of 0.5 per cent at 7 1/2 ips. Could you please explain the ragged response at very low frequencies? Why is there a steady rise from 50 to 15,000 Hz? Why is there 3 per cent distortion at 0 VU on this channel and what is the significance of the 40-dB signal-to-noise ratio?"— A. F. Hasson, Carlstadt, N.J.

A. The ragged response at the bass end is rather usual, due to the fact that at low frequencies where the recorded wave length is long, the entire head and not just the gap tends to react to the magnetic patterns on the tape. The treble rise may be due to insufficient bias current or to a fault in record treble boost or both. At 0 VU you should have about 1 per cent distortion, rather than 3 per cent THD.

The excessive distortion appears due to insufficient bias, and this is consistent with the excessive treble response, which can also result from too much bias. The 40-dB S/N ratio is quite poor. At 0 VU, corresponding to 1 per cent harmonic distortion, S/N ratio should be about 48 dB in a high-quality machine. With reference to 3 per cent distortion, S/N ratio should be somewhat higher, about 55 dB.

Adjacent-Channel Crosstalk

Q. I purchased a Revox A77 to dub my tape collection onto larger reels, but whenever I record music with much low-frequency energy, I can hear crosstalk on the other side of the reel, especially between selections. The amount of crosstalk also seems to vary with tape thickness, thin tapes giving less crosstalk than the thicker ones. How much crosstalk is normal with a quarter-track machine? I told my dealer about this and he measured the deck, reporting that separation between channels was -52 dB or seven dB better than the maker claims. He also stated flatly that audible crosstalk interference is normal in quarter-track machines.—Peter Thrift, Bellevue, Neb.

A. Your dealer is wrong. In measuring channel separation, it seems he measured separation between the left and right electronics of the tape deck, rather than between adjacent tracks of a recorded tape. His measurement has nothing to do with adjacent-channel crosstalk. The NAB standard says that crosstalk must be down 60 dB at all frequencies from 200 to 10,000 Hz, which is inaudible. Your problem is probably due to vertical misposition of the heads or (much less likely) to a manufacturing defect which resulted in excessively long gaps in the heads.

If you have a problem or question on tape recording, write to Mr. Herman Burstein at AUDIO, 401 North Broad Street, Philadelphia, Pa. 19108. All letters are answered. Please enclose a stamped, self-addressed envelope.

You make a tape with time and thought. Carefully chosen selections recorded in the sequence that most pleases you. The musical coherence and perception is yours, a personal expression. And when the time is right to share



that experience with someone you care for, having to stop and turn the tape over can break the mood you worked to create. Interruptions like that don't happen with the A-4300. You

can enjoy continuous music on both sides of a tape with the automatic reverse function. And with automatic repeat, a favorite tape will play as long as you like. Whether you want the music up front or in the background, the A-4300 can give you solid music for the better part of an evening.



Check out the A-4300, and listen to it for as long as you like. Just call (800) 447-4700* for the name of your nearest TEAC retailer. In Illinois, call (800) 322-4400.

TEAC®

The leader. Always has been.
TEAC Corporation of America
7733 Telegraph Road
Montebello, Ca. 90640
©TEAC 1975

when you don't want the music to stop
TEAC A-4300

What's New in Audio

Phase Linear Preamplifier

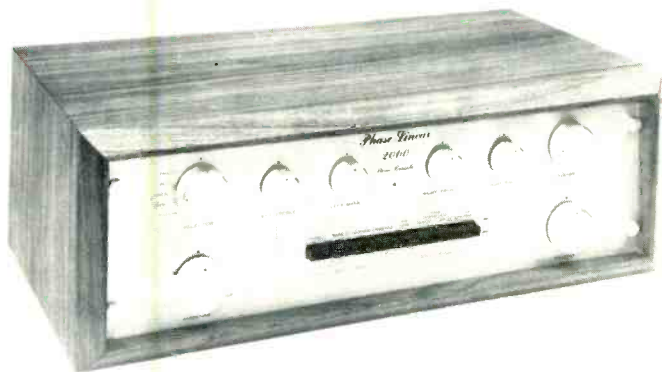

The 2000 preamp incorporates several unusual controls with the latest low-noise ICs for less than 0.1% THD, typically under 0.03%, and S/N ratio (phono) of -74 dB below 10 mV. Separate bass and treble controls for each stereo channel have detents to permit precise resetting. Two tape monitor inputs are provided, along with a low-frequency active equalizer. Pushbut-

tons are provided to permit temporary disabling of the tone controls (return to flat response) a choice of either 5 or 2 kHz treble turnover, and either 50 or 150 kHz bass turnover points. Other pushbuttons cut in or disable the low-frequency equalization and the continuously variable "stereo ambience." Priced at \$299.00

Check No. 81 on Reader Service Card

TEAC Mixer Console

Designed to handle up to six input signals, process them, and feed up to four outputs, the Model Two includes high- and low-cut filters, cue out, buss in, and accessory send-receive patch points. Any signal from any input may be assigned to any or all outputs. When more than one channel is assigned, pan is engaged, which permits shifting of the apparent acoustic image from extreme left to extreme right. Microphone inputs are phone plugs, line inputs standard phono plugs. In addition to line outputs, parallel AUX outputs are provided. Channel-assign buttons are push-push and color-coded to correspond to output busses. Price is \$299.50.

Check No. 83 on Reader Service Card

Janis Low-Bass Speaker



This low-frequency system uses a 15-in driver to extend the bass response of existing speaker systems. It reproduces the range from 100 down to 30 Hz ± 1.0 dB, cutting off between 30 and 20 Hz with a slope of more than 6 dB/oct. Harmonic distortion in its effective range (at 85 dB SPL at one meter) is less than 1.5% second, 1.0% third, and 0.3% higher-order products. A 60-watt power amplifier can drive the speaker to full output. It requires an 18-dB/octave crossover network at 100 Hz. Dimensions of oiled walnut (four sides, with inlaid walnut top) enclosure are 22 in. square x 18 in. high. Price: \$599.00.

Check No. 84 on Reader Service Card

Uher CR-210 Portable Cassette Recorder



Billed as the world's smallest portable stereo cassette recorder, the Model CR-210 is 7-in. W. x 2-in. H. x 7-in. D. and can be used as a stereo tape deck, for film synchronization ("sound hunting"), in an automobile (powered by the car battery), or anywhere else with its optional rechargeable batteries. Wow and flutter are stated to be less than 0.12%, frequency response is 20 to 16,000 Hz

(with CrO₂ tape) and S/N ratio 58 dB or better. Either the built-in condenser microphone or external mikes may be used for mono or stereo recording. Small loudspeakers and power amplifiers are included. Automatic loudness control operation may be disabled for high fidelity recording. The CR-210 is priced at \$605.95.

Check No. 82 on Reader Service Card

ESS Bookshelf Speaker

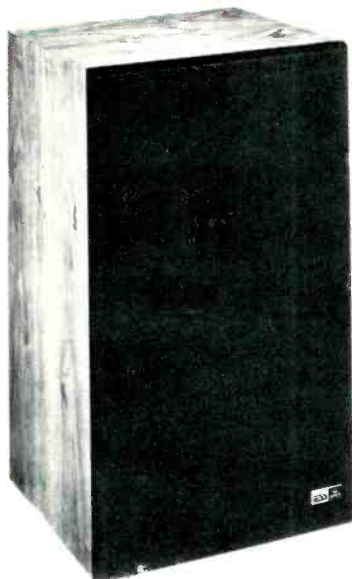

The two-way amt 5 features an ESS Heil "power ring" air-motion transformer tweeter which was designed specifically for this system. The tweeter has a 16-fold miniaturized diaphragm which operates in an identical fashion to the larger ESS Heil midrange/tweeter transformer. Low frequencies are reproduced by a 12-inch acoustic suspension cone woofer. The oiled walnut enclosure measures 24 in. H x 14½ in. W x 12¾ in. D and has a sculptured black fabric grille. A three-position brightness switch permits high frequency adjustment. Price: \$189.

Check No. 85 on Reader Service Card

PAIA Portable Amplifier Speaker

Portable speaker system is 9½ in. H x 6½ in. W x 4½ in. D, and contains its own amplifier for use as a practice amplifier for a micro synthesizer or other electronic instruments. Any signal source may be plugged into the Pygmy amplifier to drive the 5-in. acoustic suspension speaker. Output of the amplifier is 1.2 watts rms (up to 8 watts peak). Power is supplied by eight penlight batteries which provide 12 volts to the system which PAIA says should last for about a month (in irregular use). Switch selects speaker, headphone jack, or line level outputs (1V). Supplied with all hardware, but less strap, it weighs 5¼ lbs. The Pygmy kit takes about three hours to assemble, costs \$39.95 plus shipping.

Check No. 86 on Reader Service Card

Crown D-150A Amplifier



Employing the output circuitry used in the Crown DC-300A power amplifier, this new basic amp is rated at 80 watts/channel into 8 ohms from 1 Hz to 20 kHz at less than 0.05% harmonic distortion. THD is under 0.01% from 20 to 400 Hz, increasing to 0.05% at 20 kHz, at 80 watts per channel into 8 ohms. IM is 0.01 from 0.25 watts up to 80 watts, and under 0.05% from 0.01 watts to 0.25 watts. Damping factor is more than 400 at frequencies up to 400 Hz, 8 ohms. Output impedance is less than 15 milliohms in series with less than 3 microhenries. Although rated for 8 ohms, the D-150A will drive any load safely, including completely reactive loads. May be connected for mono by switch on rear panel, giving 160 watts. Operates on 110 or 240 volts. Input level controls. Price \$479.00.

Check No. 87 on Reader Service Card

Community Light & Sound Crossover C100X



Electronic Crossover C100X for bi-amplifying loudspeaker systems has a slope of 18 dB per octave for the highpass section, and 12 dB per octave for the low-pass section. Crossover point may be 300, 500, 800, or 1200 Hz (others available on special order). THD is rated at 0.05%, and output level is 9 volts across 10 K ohms. The unit can be powered by the firm's power amplifier or by a separate power supply, which is priced at \$45.00. The crossover is very compact, 3 in. x 5 in. front panel, same size as the firm's companion units. They are a 120 watt (4 ohms) power amplifier, Model C100A, priced at \$239, a four-input mike mixer, model C100M, priced at \$135, and a musical instrument pre-amplifier, Model C1001P, priced at \$115.

Check No. 88 on Reader Service Card

Burwen SP 5200 Preamplifier



The 5200 Low Noise Stereo Preamplifier provides dynamic range of 115 dB at zero dB. It includes provision for connecting a dynamic noise filter and a program equalizer in the record channels. An equalizer may also be inserted in the monitor channels. 15 pairs of jacks are provided, plus a center channel (mono output). The monitor selector permits listening to the signal source whether that source is being processed or not, and to either of two tape signals. The phono preamp section uses circuitry through which, it is claimed, the lowest noise level is achieved with conventional phono pickups. Input resistance in combination with the preamp input gain is adjustable so the unit can accommodate any cartridge, regardless of how low its output voltage is. Response is within 0.1 dB 20 to 20,000 Hz. THD from 20 to 10,000 Hz is 0.05% max. At rated output (2.5 V) noise is down 95 dB, 20 to 20,000 Hz. With four switched and one unswitched a.c. convenience outlets on the rear panel, the 5200 can switch up to a kilowatt of a.c. power. Price is \$489.95.

Check No. 89 on Reader Service Card

Avid Speaker System

Model 105 loudspeaker is a four-way system with a 12-in. woofer whose in-cabinet resonance is 35 Hz. The woofer crosses over at 500 Hz to a 3-in. cone, which extends the response up to 4 kHz. Frequencies from 4 kHz up are handled by a main tweeter, 1-in. in diameter, and above 9 kHz by a pair of auxiliary 1-3/8-in. tweeters angled to the sides. Midrange and tweeter levels are adjustable by means of controls on the rear of the enclosure. Response is within 2½ dB from 30 to 18,000 Hz, and the system can handle up to 200 watts of program material. Sensitivity of the 105 is such that one-watt input will provide 84-dB SPL at one meter on-axis. The unit is 26½ in. H x 20 in. W x 15 D, and weighs 75 lbs. It's priced at \$300.00.

Check No. 90 on Reader Service Card

TUNER SECTIONS

SPECIFICATION	MEAS. IN	2-CH. RECEIVERS								4-CH. RECEIVERS		
		STR-7065A	STR-7055A	STR-7045	STR-7035	STR-6046A	STR-7025	STR-6036A	STR-7015	SQR-8750	SQR-6750	SQR-4750
Sensitivity, HF	μV	2.0	2.0	2.6	2.2	2.2	2.2	2.2	2.2	1.9	2.2	2.2
S/N ratio	dB	70	70	70	68	68	68	68	68	70	70	68
Capture ratio	dB	1.0	1.0	1.5	1.5	1.5	1.5	1.5	3.0	1.2	1.5	1.5
Selectivity, IHF	dB	75	75	70	60	60	60	60	60	75	50	50
Harmonic distortion (@ 400Hz)												
Mono	%	0.2	0.2	0.2	0.3	0.3	0.3	0.3	0.3	0.2	0.3	0.3
Stereo	%	0.4	0.4	0.5	0.8	0.8	0.8	0.8	0.8	0.5	0.6	0.6
FM stereo separation (@ 400Hz)	dB	43	43	38	35	35	35	35	35	40	38	38
FM frequency response		20Hz-15kHz +1dB	20Hz-15kHz +1dB	20Hz-15kHz +1dB	30Hz-15kHz +1dB	30Hz-15kHz +1dB	30Hz-15kHz +1dB	30Hz-15kHz +1dB	30Hz-15kHz +1dB	40Hz-15kHz +0.5,-1dB	40Hz-15kHz +1,-3dB	40Hz-15kHz +1,-3dB

PREAMPLIFIER SECTION

Input sensitivity and impedance													
Phono	mV/ohms	3.0/47k	3.0/47k	1.8/47k	2.5/47k	2.5/47k	2.5/47k	2.5/47k	2.5/47k	2.5/47k	2.5-5/50k	2.5-5/50k	5/50k
Phono-low	mV/ohms												
Microphone	mV/ohms	1.6/47k			2.0/47k	2.0/47k	2.0/47k	2.0/47k	2.0/47k	1.5/50k	1.5/50k		
Tuner, Aux., Tape, REC/PB	mV/ohms	250/50k	250/50k	140/100k	250/100k	250/100k	250/100k	250/100k	250/100k	250/50k	250/50k	250/50k	
Output voltage and impedance													
Preamp	V/ohms	1.0/4.7k	1.0/4.7k			0.5/5k							
Rec out	mV/ohms	250/10k	250/10k	250/10k	250/10k	250/10k	250/10k	250/10k	250/10k	250/10k	250/10k	250/10k	250/10k
REC/PB	mV/ohms	30/82k	30/82k	30/82k	30/82k	30/82k	30/82k	30/82k	30/82k	30/82k	30/82k	30/82k	30/82k
THD @ rated output*	%	0.2	0.2			0.8							
IM distortion @ rated output**	%	0.2	0.2			0.8							
S/N ratio, IHF													
Phono	dB	72	72	70	60	60	60	60	60	72	70	70	
Phono-low	dB												
Microphone	dB	65			60	60	60	60	60	65	65		
Tuner, Aux., Tape REC/PB	dB	90	90	90	70 (80tape)	80	70 (80tape)	80	70 (80tape)	90	90	85	

*AUX. input @ 1kHz

**AUX. input, 60 Hz: 7kHz = 4:1

POWER AMPLIFIER SECTION

CONTINUOUS POWER OUTPUT												
2-Channel Operation Minimum RMS per channel @ 8 ohms from 20Hz to 20kHz	WATTS	65	40	30	24 40Hz -20kHz	20	18 40Hz -20kHz	15	15 40Hz -20kHz	50	50	
4-Channel Operation Minimum RMS per channel @ 8 ohms from 20Hz to 20kHz	WATTS									30	20	15
Total Harmonic Distortion @ rated output 2-Ch./4-Ch.	%	0.2	0.2	0.2	0.8	0.8	0.8	0.8	0.8	0.5/0.2	0.5/0.2	-/0.8
IM distortion @ rated output 2-Ch./4-Ch.	%	0.2	0.2	0.2	0.8	0.8	0.8	0.8	0.8	0.5/0.2	0.5/0.2	-/0.8
Frequency response @ 1W output		10Hz-100kHz +0,-1dB	10Hz-100kHz +0,-1dB			10Hz-80kHz +0,-3dB						
S/N ratio	dB	110	100			90						
Damping factor (@ 8 ohms)		50	50	50	25	25	25	25	25	25	25	25
Dimensions (height, width, depth)	inches	6 3/16 18 1/4 14 3/4	6 3/16 18 1/4 14 3/4	6 3/16 18 1/4 14 3/4	5 7/8 16 7/8 13 3/8	5 11/16 17 1/8 13 9/16	5 7/8 16 7/8 13 3/8	5 11/16 17 1/8 13 9/16	5 7/8 16 3/8 13 3/8	7 1/2 20 1/2 14 5/8	7 1/2 20 1/2 14 5/8	6 1/8 8 1/8 13 5/8
Weight	lbs. ozs.	33.8	22.11	21.1	18.15	19.13	18.12	18.15	16.5	47.11	43.6	29

FEATURES AND CONTROLS											
FM interstation muting	•	•	•	•	•	•	•	•	•	•	•
FM signal strength indication	•	•	•	•	•	•	•	•	•	•	•
FM center station meter	•	•	•	•	•	•	•	•	•	•	•
Tape monitor quantity	2	2	1	2	1	2	1	2	1	2	1
Microphone mixing	•	•	•	•	•	•	•	•	•	•	•
VU meters	4	4	4	4	4	4	4	4	4	4	4
Bass control	•	•	•	•	•	•	•	•	•	•	•
Treble control	•	•	•	•	•	•	•	•	•	•	•
Balance	•	•	•	•	•	•	•	•	•	•	•
High filter slope (dB per octave)/ rolloff frequency	12/9k	12/9k	6/5k	6/5k	6/5k	6/5k	6/5k	6/5k	6/5k	6/5k	6/5k
Low filter slope (dB per octave)/ rolloff frequency	12/50	12/50									
Loudness compensation	•	•	•	•	•	•	•	•	•	•	•
Preamp output and power amp input	•	•	•	•	•	•	•	•	•	•	•
V-FET											
Speaker selector for no. pairs	3	3	2	2	2	2	2	2	2	2	2
Front panel/input jack	MIC	AUX	MIC	MIC	MIC	MIC	MIC	MIC	MIC	MIC	MIC
Phono/quantity	1	1	1	1	1	1	1	1	1	1	1
4-Channel functions	•	•	•	•	•	•	•	•	•	•	•
Full-logic SQ-decoding	•	•	•	•	•	•	•	•	•	•	•
R-MTX decoding	•	•	•	•	•	•	•	•	•	•	•
2-4 enhancement	•	•	•	•	•	•	•	•	•	•	•
Accommodates discrete sources	•	•	•	•	•	•	•	•	•	•	•
General features	2/1	-/1	-/2	-/1	-/2	-/1	-/2	-/1	-/2	-/1	-/1
AC outlets switched/unswitched											
FM antenna terminals	300/75	300/75	300/75	300	300/75	300	300/75	300	300/75	300/75	300/75
AM antenna/built-in-bar/external	Both	Both	Both	Both	Both	Both	Both	Both	Both	Both	Both
Supplied Wooden case	•	•	•	•	•	•	•	•	•	•	•
Optional Wooden case	•	•	•	•	•	•	•	•	•	•	•

SPEAKERS											
Weight (lbs.)	60	60	50	50	38	29	17				
Power Handling Capacity (Watts)	100	75	60	50	50	50	50				
Dimensions (HxWxD)	27 1/2" x 15 3/4" x 12 1/2"	26" x 14 3/4" x 12"	24" x 13 5/8" x 10 1/2"	23 1/8" x 13 3/8" x 10"	17 11/16" x 11 11/16" x 8 1/4"						
Frequency Response	30Hz-20kHz	35Hz-20kHz	40Hz-20kHz	45Hz-18kHz	50Hz-18kHz						
Impedance (ohms)	8	8	8	8	8						
Speaker Comments	1 1/2" Soft Dome M 2" Soft Dome W 10" Cone x 2	1 1/2" Soft Dome M 2" Soft Dome W 12" Cone	1 2" Cone M 1 1/2" Soft Dome W 10" Cone	1 3" Cone W 10" Cone	1 3" Cone W 8" Cone						
System	Acoustic Suspension	Acoustic Suspension	Acoustic Suspension	Acoustic Suspension	Acoustic Suspension						
Network	3-way	3-way	3-way	2-way	2-way						
Model	SSU-1800	SSU-1600	SSU-1400	SSU-1200	SSU-1000						
Drive System											
Speed Control											
S/N (Rumble) NAB											
S/N (Rumble) DIN B											
Wow & Flutter (WRMS)											
Tonearm Type											
Tonearm Length (Pivot to Stylus)											
Platter Diameter											

*PS-2251/LA (without tonearm)
**PS-1100 Includes magnetic car

Sony reveals some little



If you ask anybody what they think of when they hear the name Sony, chances are they'll say our televisions. And rightly so. Because our TV's have

done more to get us where we are today than anything else. The problem is not many people have a clear picture of the terrific things we make besides televisions. For example, we make receivers. And into our receivers goes over 20 years of

experience in working with solid-state audio equipment. We make turntables. And we make them with our unique servo motor to eliminate the noises that cause a record to sound badly. We make separates. Which are a variety of amplifiers and tuners that offer tremendous flexibility in

© 1975 Sony Corp. of America. Sony, 9 W. 57 St., N.Y., N.Y. 10019. SONY is a trademark of Sony Corp.

known things about itself.



putting together a system.

And have you heard our speakers? That when matched with our components offer sound quality unequaled anywhere.

If we've gotten you this far and you'd like to know more, simply fold down this ad. You'll find some not so important things like our

model numbers to some very important things like our specs.

If you're still not satisfied after that, there's only one place left for you to go.

To your local Sony dealer. Because while here you can only listen to what we

have to say, there you can listen to what our components have to say.

SONY®

Check No. 143 on Reader Service Card

TUNERS						PREAMPS		INTEGRATED AMPS						POWER AMPS			
STC-7000	ST-5130	ST-4950	ST-5150	ST-5055	ST-5066	TAE-8450	TA-2000F	TA-8650	TA-1130	TA-4650	TA-1150	TA-1055	TA-1066	TAN-8250	TAN-8550	TA-3200F	TA-3140F
1.7	1.5	1.9	2.0	2.2	2.2												
70	75	70	70	68	68												
1.0	1.0	1.0	1.0	1.0	1.5												
100	100	80	70	70	55												
0.3	0.2	0.15	0.3	0.4	0.5												
0.5	0.3	0.3	0.5	0.6	0.8												
40	42	40	40	35	35												
30Hz-15kHz +1dB	20Hz-15kHz +1dB	20Hz-15kHz +1dB	20Hz-15kHz +1dB	30Hz-15kHz +2dB	30Hz-15kHz +2dB												

2.0/47k						1.5-4.5/ 50k	1.2/33k-82k	2.5-4.5/ 50k-100k	1.2/47k	2.5/47k	2.0/47k	2.0/47k	2.5/47k				
						0.16/10-1k	0.06/10-30	0.1/30									
0.63/47k						0.16/50k	0.5/100k	0.2/50k				2.0/47k					
200/50k						150/50k	110/100k	150/100k	130/100k	150/100k	140/50k	250/50k	250/50k				
2.0/2k						1.0/1k	0.3-1.0/ 3k-6k	1.0/600	1.0/5k	1.0/3k	0.8/2.7k						
250/10k						150/1k	100/10k	150/600	150/10k	150/4.7k	140/10k	250/10k	250/10k				
30/82k						30/82k	30/82k	30/82k	30/82k	17/82k	24/82k	30/82k	30/82k				
0.1						0.03	0.03	0.03	0.1	0.1	0.1						
0.1						0.05	0.05	0.05	0.1	0.1	0.1						
67						70-75	73	70-75	70	70	70	70	70				
						60	50	55									
52						50	50	40				65					
90						90	90	85	90	90	90	90	90				

								80	50	30	30	20 40Hz -20kHz	15 40Hz -20kHz	150	100	100	35
								0.1	0.1	0.1	0.2	0.5	0.8	0.1	0.1	0.1	0.1
								0.1	0.1	0.1	0.2	0.5	0.8	0.1	0.1	0.1	0.1
								DC- 100kHz +0,-1dB	10Hz- 200kHz +0,-2dB	2Hz- 100kHz +0,-2dB	12Hz- 150kHz +0,-2dB			DC- 100kHz +0,-1dB	DC- 100kHz +0,-1dB	5Hz- 200kHz +0,-2dB	10Hz- 200kHz +0,-2dB
								100	110	110	110			100	100	110	110
								100	100	45	100	22	22	250	200	170	100
5 9/16 18 13/16 13 9/16	5 7/8 15 3/4 13 9/16	6 5/8 16 7/8 13	5 7/8 15 3/4 13 9/16	4 3/4 16 1/8 11 1/4	4 3/4 16 1/8 11 1/4	6 3/4 17 3/8 13 3/8	5 7/8 15 3/4 12 7/8	5 3/4 17 3/8 16 1/8	5 7/8 15 3/4 12 7/8	6 5/8 16 7/8 12 3/4	5 7/8 15 3/4 12 7/8	4 3/4 16 1/8 11 1/16	4 3/4 16 1/8 11 1/16	6 3/4 17 3/8 16 1/8	6 3/4 17 3/8 16 1/8	5 7/8 15 3/4 12 3/4	5 7/8 7 7/8 12 9/16
22 11	16 8	17	15 5	10 13	10 9	26	19 2	44 5	28 11	25 6	18 5	13 9	13 4	55 2	41 14	30 10	14 5

Harmonic Distortion

Richard C. Heyser

ONE TYPE of distortion a loudspeaker system can produce is the generation of extraneous harmonics when the system is driven by a single sustained tone. Thus, if a speaker drive signal consisting of a perfectly pure tone with no musical partials is reproduced with tonal harmonics in addition to the pure tone, then harmonic distortion has occurred. Since we are concerned with a sustained tone, the distortion components will consist of whole number harmonics of the fundamental pitch, that is the second, third, etc. harmonics of the fundamental pitch.

It is our belief that readers of *Audio* can relate more easily to musically based tones in distortion measurements than to test frequencies which might have a technical but non-musical basis. For that reason, we use test frequencies based upon the musical scale.

The test tones for these measurements were chosen with some care. First, the number of tones needed to be limited to keep the data from overwhelming the interpretation of performance. Second, it was decided that the span of the tones should encompass not only the usual range of fundamental notes produced by musical instruments, but also be placed to show possible speaker problems. Finally, the harmonic structure to be measured needed to be meaningfully related to both musical experience and to conventional speaker problems.

The three tones finally chosen were E1 or 41.2 Hz, A2 or 110 Hz, and A4 or 440 Hz. E1 was chosen to represent the lowest fundamental one might generally find in music. The note is also near or below the low frequency cutoff of even the largest reproducing systems we might be called upon to test.

A2, in the octave below middle C, was chosen for its tonal position at the transition point one might conceive between bass and middle tones, as well as the fact that even the smallest systems should be able to reproduce it.

A4, a fundamental note for many instruments and vocalists, was chosen not only for its musical significance, but also

because it is in the range where many speaker systems are in crossover or where the bass driver is running out of steam. In those instances where the crossover is below 500 Hz, we replace A4 with a musical tone approximately a half octave below the actual crossover frequency.

Another reason for choosing these three frequencies is that the significant harmonics fill up the frequency range between the three chosen tones without overlap. In analysis of this measurement, the harmonics or distortion terms which are significant are the second harmonic (the same tone in the next higher octave) and the third harmonic (the fifth in the next octave). Fourth and higher harmonics are rarely of any significance when the speaker is driven within the maker's recommendations. When these harmonics do occur, they show up as an audible breakup or knocking, which usually signifies mechanical problems.

Measurement Scales

Harmonic distortion is measured in per cent. The fundamental's level is defined as 100 per cent at each point of our measurement, and the distortion component is given as a percentage of this level.

This percentage measurement of harmonic distortion can be related to musical experience in the following manner. In an out-of-doors situation, the sound pressure will halve each time you double your distance to a source. If, for example, you were ten feet from a soloist and stepped back to twenty feet, the direct sound would be reduced by 6 dB. This would take a 100 per cent value at ten feet and reduce it to 50 per cent at twenty feet. If you stepped back to forty feet, the reduction would be another 6 dB to produce a 12 dB pressure drop, or a change to 25 percent of the original ten foot level.

If you divide the harmonic percentage value into 100 this gives the distance you must move away to hear that level of sound. Ten per cent is a distance of 10 times, or 100 feet for

our example where 10 feet was 100 per cent. This simplified analysis assumes free-field conditions for the direct sound and is a reasonable rule of thumb for those who would be able to relate this to out-doors concerts.

Thus a twenty per cent third harmonic distortion of A2 could be musically equated to listening to two instruments. One instrument is playing a pure A2 and is at a given subjective distance. The second instrument, representing the distortion, is playing the musical fifth in the next octave and is at an open air distance five times that of the fundamental instrument with respect to you.

The musical effect of the second or phantom instrument may not be great. In fact, the harmonic distortion of this type can subjectively enrich an otherwise dull sine wave. Beware, however, of the error of assuming that if the effect is benign for a sine wave, that it will be similarly all right for a complex musical tone. Complex musical tones are themselves composed of harmonics, and they may have that structure of harmonics altered because each harmonic in the original tone can act as an equivalent fundamental and produce additional distortion products. The result is not necessarily musically correct.

Harmonic distortion is also measured as a function of amplifier power. Each of the three fundamental tones we measure has its pressure for that value of power converted to the equivalent one-meter on-axis sound pressure level, and this is why each fundamental has a separate horizontal SPL scale. The reason we do this is to give you a measure of the amount of relative distortion to be expected for wide-range program material that hasn't been modified by the use of tone controls. This lets you determine how loud you may play music for an acceptable distortion level and shows the amount of amplifier power demanded at that sound level. It also lets you see how much distortion can be expected if you equalize the speaker for "flat" amplitude.

Test Procedure

The actual method of measurement of harmonic distortion performed by *Audio* is a bit different from conventional methods. A narrow-bandwidth, Wiener matched filter is used, and it has been optimized for slightly less than a one-second time measurement. This filter has its center frequency of acceptance phase-locked to the appropriate harmonic of the actual sine-wave signal used to drive the speaker. A transmit attenuator, which is stepped in 2-dB increments, feeds the fundamental to the power amplifier used in the test. A receive attenuator, which compensates exactly relative to the transmit attenuator, reduces the microphone signal. In this way, the received level into the Wiener filter remains constant throughout the measurement.

When a measurement is to be made, the filter is "enabled" and a 980 millisecond burst of the fundamental is fed to the amplifier. At the end of this period, the transmit power is clocked off and the output of the filter transferred to a memory circuit. An X-Y plotter, which produces the original of the graph shown in the reviews, is programmed to draw a straight line between the previous distortion-versus-power value to the new distortion-versus-power value of the measurement just completed.

During the measurement, several precautionary techniques are used. First, an oscilloscope is used to view the normalized speaker output signal, which is also listened to over an auxiliary speaker system. This is done to discover rattles, buzzes, or other mechanical problems, which would indicate that the maximum safe power limit has been reached. The short power burst was chosen to prevent speaker damage, since sustained high power levels can soon

char even the most robust speaker. As an additional precautionary measure, automatic equipment measures the instantaneous volt-amperes and the accumulated watt-seconds of energy and will quickly terminate a measurement if predetermined safe limits are exceeded.

One side benefit of these precautionary measures is that every power measurement is started from the same operating temperature. This has disclosed that some speakers "settle into" a tone burst within an acoustically significant period of time. The implication is that harmonic distortion in some speakers is a function of time as well as drive power. This will be pointed out in reviews when it appears to be sonically significant.

The measuring microphone is placed in close proximity to the transducer under test. This is done to guarantee that polar response patterns will not give erroneous distortion readings.

What It Means

The first thing to keep in mind about these harmonic distortion measurements is that the magnitude of distortion is much higher for speakers than for amplifiers. Harmonic distortion in a speaker may be a thousand times greater at a robust sound level than in the amplifier driving that speaker. The reason for this disparity in the magnitude of distortion and the relative "listenability" of speakers, amplifiers, and the other parts of the reproducing chain is a research subject much too deep to go into here. The basic point to remember is that the high percentage values of harmonic distortion for speakers relative to amplifiers is normal. However, do not assume that you cannot tell the difference between a good and a bad amplifier simply because the speaker through which you're listening to the two amplifiers has relatively higher distortion measurements. The differences between the two amps will be audible in most cases.

When checking the harmonic distortion graphs, note if the distortion increases smoothly with power level since deviations from a smooth curve can tell you a great deal. A nonlinear suspension is generally indicated by a second harmonic which is moderately high at lower power levels, say 1 per cent at 0.1 watt, and rises very slowly with increased power. Quite often some of these curves will actually drop with increasing drive level over a substantial range. In such a case, a second nonlinearity, such as an off-center voice coil, may become prominent at higher drive levels and cause a rapid rise of distortion. When this occurs in the lowest register, the sound is often muddy in tonal balance.

While generalities are of course hazardous, it can be stated that a distortion curve which does not rise smoothly with increasing drive level tends to invert the subjective ordering of the ways sounds behave when we hear them naturally. Such a distortion is perceived as something that's different or odd about the reproduced sound, but something you can't quite put your finger on.

Harmonic distortion will generally be higher for E1 than for A2 or A4. Usually, though not always, this will be because of greater cone excursion. If the distortion level rises smoothly with increases in power, then abruptly increases, the problem is probably due to cone motion. In the case of third harmonic increases, the voice coil may be running out of the linear region of the magnet structure. The sound in this case will be mushy and may subjectively appear louder than it actually is.

In all cases, the harmonic distortion should continually drop with a decrease in drive power. If, however, the distortion levels off and stays at a moderately high level even at 0.1 watt drive, the reproduced sound will definitely be colored by distortion.

Audio ETC

Edward Tatnall Canby

IT'S GETTING to be a game for those with wits, both musical and engineering, this tracing-down of the LP reissue, unidentified as to origin. There are thousands of them, and prizes for all in the guessing game courtesy of the record companies, who remain singularly mum and give you no hints at all 95 per cent of the time. Guess and guess again. Mum for sales. Every record, today, must look brand new, even if it isn't, even though it may be an honorable and timeless oldie, quite imperishable. Whatever it is, give it a new cover and shrink wrap it! And say not a thing about its past, the when and the where. Not even the copyright. Have you noticed it's always of the current year, at least in this country?

In due time, a hundred years, the scholars and the painstaking researchers will have to get busy on this problem. I can see PhDs granted by the dozens. If I were such a scholar, I should already be in 47th heaven—there's so much to do. But I am not and never will be. I love a good mystery and I hate to dispel it too quickly with dull facts. I don't make investigative phone calls. I much prefer to *listen*, and put my 2 and 2 together. I do indeed respect the oldies now being reissued by the hundreds; many of them I reviewed when they were genuine newies. The LP is more than a quarter of a century old and the 78 electric goes back half a century—I was there, more or less, all along. I saw and I heard. I listened all the way. Often I can, with great luck, actually put hand to the original record itself on my own shelves, the

source of the reissue, though so often unnamed. In Europe, most reissue recordings are dignified with at least an original copyright date, if not more precise info as to first label and date of recording. Not here. Wouldn't sell. Everything must be new. (Well, if not new, then legendary.)

So I can't help doing a bit of not-so-amateur sleuthing when a familiar sound hits my ear—now where have I heard *that* before? No phone calls, no reportage *à la* TV and newspaper. Just putting clues together, which gets to be more fun each year as time gets ever longer and more crammed with the records of the past. Take, for instance, a recent brand-new (?) Olympic Records release, the Bach *Brandenburg Concertos*, 8131/2, complete on only 2 LPs (we cut grooves close and fine these days), as performed by the Boyd Neel Orchestra under Boyd Neel.

For all you know, Mr. B. Neel is one of those young, longhaired squirts of a conductor fresh out of something or other and "acclaimed" already until acclaim comes out of his ears. But Boyd Neel happens to be a name I've known all my life, on records. Facts? The library? Phone calls to Authority? Why bother? I already know, because I *heard* them, and own them. I know that in the early 1950s there were Boyd Neel Orchestra recordings of Mozart, Bach, and such on the Oiseau-Lyre lable, which has long been a subsidiary of London (English Decca) though originally a French one-woman outfit, if I remember rightly. She went back, far back into 78s. My persistent but quirky memory tells me that somewhere up in my at-

tic I might find another batch of 78s—I see them with bright green labels, or do I?—on which the selfsame Boyd Neel and his Orchestra played—was it Mozart? Maybe some of the early little Symphonies. I am indeed vague, but very positive none the less.

Recherche du Temps Perdu

Right here my early 78 research must end. For years I've fought to keep up with the LP flood and the 78s have just had to wait. Shelvesful of albums. Horizontal piles of mixed 78 singles (we always bought singles, even out of larger works), carefully stashed so they won't "pour" like Dali's limp watch, which shellac discs can easily resemble, given time and gravity. So you must take my word, such as it is, on the green-labeled Boyd Neel 78s. They surely lie within 20 feet of me right now; but as just surely, it would take me 20 days to dig them out. Anyhow. . . Boyd Neel does go back. Definitely, I'd say, he is now a reissue and no musical spring chick.

But this Olympic reissue of Neel has a modern sound, even so. It is clearly from tape (says my ear) and not 78. A late operation? Now my interest is really piqued. And I do have an LP card catalog. Let's look.

Eureka! Under Brandenburg Concertos (after I had found them in the wrong place in the Bach file, under *B* instead of *C*), I note a white card (mono—stereo is blue) which says that this very music, by the same orchestra under Neel himself, can be found on Unicorn 1041 in my collection, as of c. 1957. So—out to the stacks and to Unicorn. Typical! I still have some four inches of the LP pro-

Introducing the small speaker with 'big' ideas Celestion UL6

Compact Shape

How small? 1 1/2 x 1 6 x 8 3/4 in. to be precise; these measurements are the only 'small' thing about UL6.

Expansive Sound

UL gives expansive, open, natural sound; only Celestion have truly conquered the technical problems which have previously been held to be insurmountable.

An intensive three year development programme has crystalized a life times know-how of speaker design and given birth to UL.

Superior Performance

Inside the beautiful exterior are the new 'acoustic motor units' which make these designs possible. New soft dome 'tweeters' of impeccable design to give smooth sweet treble sounds; bass units built on to diecast chassis, with small ultra-low distortion bextrene diaphragm, extra large voice coil (1 1/2 in.) and magnet for high accuracy and ability to handle wide dynamic range and high peak music levels when required.

The third diaphragm is Celestions auxiliary bass radiator 'ABR' which comes into its own on the extreme low notes of instruments

such as organ and double bass.

UL means ultra linear; UL also represents unlimited quality of sound; Celestion experience makes possible a prestige product at an ordinary cost.

The UL6 speaker has precise and beautiful balance both aurally and visually.

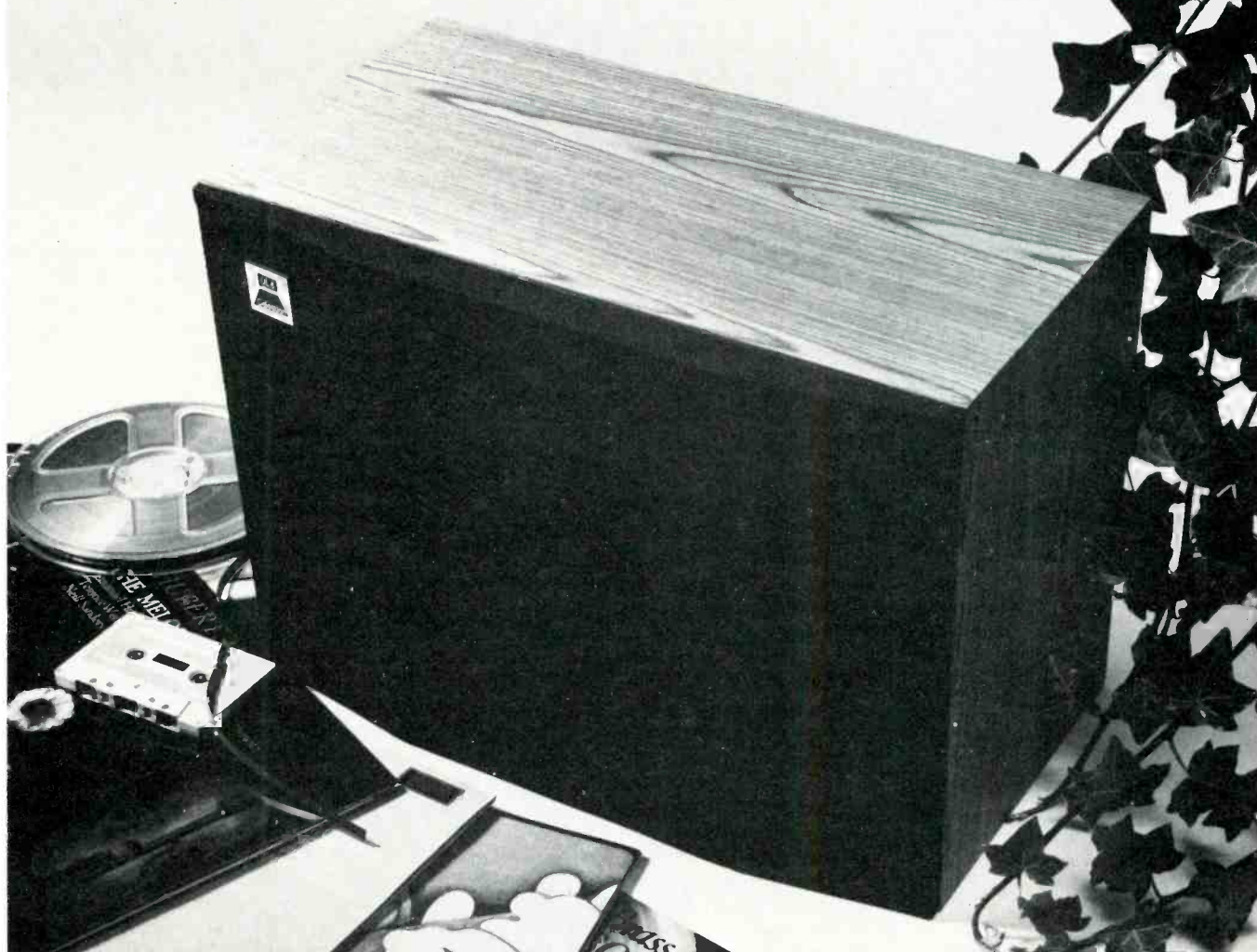

Hear the full range speak for itself:

Please send me full details of
UL6 UL8 UL10 and inform me of my
nearest franchised demonstration centre.

Name _____

Address _____

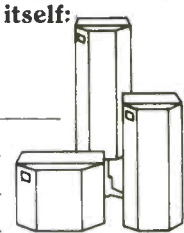

ROCELCO INC. 160 Ronald Dr. Montreal, Canada H4X 1M8 Phone (514) 489-6842
Los Angeles: (213) 985-5707 Chicago: (312) 381-4559 New York: (516) 938-4057

Check No. 10 on Reader Service Card

THE
COLOSSUS
 by KUSTOM ACOUSTICS

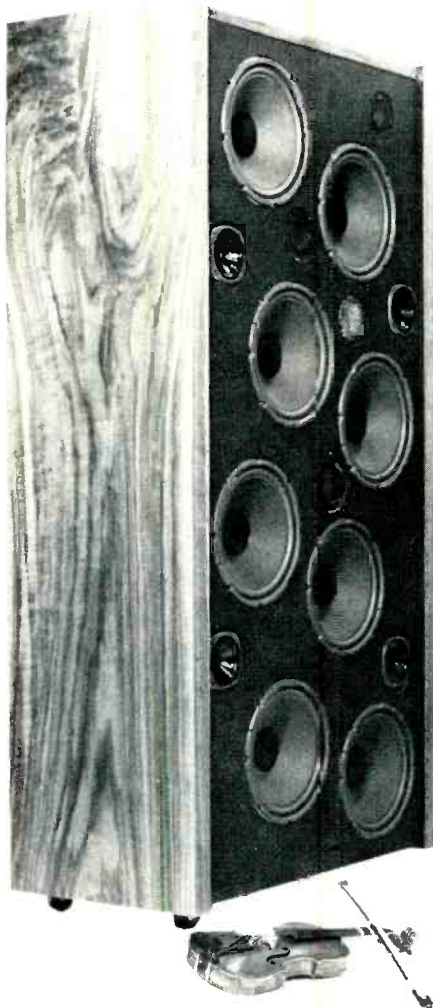

(Grill Removed)

Shown in Standard Swirly-Crotch, Semi-Figured, Walnut Veneer Construction

Left Channel Speaker Shown of Matched System, Specifically Designed and Built for Audiophile and Commercial Application.

**Nine Other High End
 Speaker Systems from \$299**

Dealer Inquiries Invited

K KUSTOM ACOUSTICS Inc.
 6606 West Irving Park Road
 Chicago, Illinois 60634
 Telephone (312) 685-6609
 Check No. 24 on Reader Service Card

duction from that small and genteel Boston label, which departed not too long after its birth. But record number 1041 is missing. I did have it—otherwise no card. Somebody, then must have “borrowed” 1041 years ago, as too often many another somebody has done with dozens of my records, now mysteriously absent. All well intentioned, you understand, and my friends are never thieves (hardly ever); it is merely what I call convenient forgettery. Anyhow—no 1041.

Too bad. A direct A/B comparison would very quickly tell me whether the two recordings are one and the same, not only in the general sound but, more discreetly, via musical clues very much available to the practiced ear—tiny slurs and wavers, say, in a solo violin, minutely out-of-time entrances, microscopic lapses in pitch which would never occur twice the same. Yes—there are numerous “takes” but usually the final master tape, at least until recently, is definitive. The re-mix is relatively a new thing. So—no A/B between Olympic and Unicorn 1041, alas.

Give up? Not yet. Right next to where 1041 should have been was Unicorn 1042, Mozart, played by the Boyd Neel Orchestra under Boyd Neel. Not an exact A/B, but do you think I could pass *that* one up? Probably, almost surely, it came out of the selfsame recording sessions. Wouldn't you think? So let's compare.

First, some thoughts. Where do old tapes go when their parent companies depart? As we know, many are reborn, but in various guises. First: the new owner takes over the whole catalogue, perhaps for a song, and makes cash simply by continuing to press the same old discs, so long as demand continues. Cheap—he doesn't have to pay for the recording process. Like the guy who buys a gas station, ready to pump, from the original guy who couldn't keep up the mortgage. There are dozens of classical labels which exist pretty much on this basis, statically. Some go back a quarter century. Or second: somebody buys up the master tapes and puts them out on a new label, as new records. That's how they look, anyhow (and they are often improved). So it seems to be in our present case. Not a single indication on the Olympic album that these aren't brand-new, original recordings. (And had you ever heard of Boyd Neel?)

Or third: the tapes are licensed out, for limited-area reissue, often without

the requirement that the original source be indicated—“an EMI recording” for example. Anyhow, the source *is*, in fact, often missing. Moreover, pirated recordings tend to omit the tell-tale details, even to total anonymity, though others brazenly tell all in total defiance. But we are not on a pirate chase at the moment; so, fourth: there are the reissues put out by the parent company itself, often—not always—on its low-price label. Ah yes, The Great Columbia Stereo Recordings, now on Odyssey, and the same for Angel (EMI) on Seraphim, and so on. The only point here is that many of these, too, carry no dates of origin. As G & S once said, they may very well pass for 43 in the dusk with the light behind them. As I say, everything, *everything*, must look new. Silly. You can probably think of other categories of reissue, but enough.

The Plot Thickens

So I played Unicorn 1042 and Olympic 8131/2 and, by golly, they do sound very much alike in the base sound (not *bass*—base!), allowing for a different composer and for 1957 vs. 1970 engineering. Maybe I'm right. Could be, I say to myself, adding process-of-elimination to the verdict of my ears. Not 78s. And those Oiseau-Lyre recordings of the 1950s were conducted by a house conductor, Thurston Dart, not by Neel. A new point of interest. The Unicorn music, it says on 1042, was “mastered” by Peter Bartok. A new mystery, a subplot, here. Did he make the tapes? Or the disc masters? Or both? Not clear.

Peter Bartok, son of the composer Bela Bartok, was, in the mid-50s, already a dedicated, conscientious independent recording engineer whose own label, Bartok Records, was mainly for works of his father, not yet widely recorded elsewhere. His outside jobs, too, were generally high class and state of the art including one I played the other day, **Sounds of Antique Autos**, also Unicorn. (I hear his voice on that one, asking questions about the old cars.) So—he did do important original *taping* for Unicorn. But “mastering”? I'm thinking that maybe Layout & Production, at Unicorn, wasn't entirely clear in its mind as to what that magic word meant—this was 1957, or so, remember. Did P. Bartok also cut the disc master?

I looked at 1042 itself, right their in my hand. Not a sign of the indented PB which is on all of Bartok's own masters. Instead, a boldly scratched-in set

LUX offers three good reasons for the growing movement toward separate amplifiers and tuners.

Possibly the highest acclaim a receiver can be awarded is to have one or more of its elements compared favorably with its equivalent in a separate tuner, preamplifier, or power amplifier. Nevertheless, for most music lovers, a good receiver more than fulfills their requirements. But for a growing number of dedicated audiophiles, who are seeking the ultimate in music reproduction, nothing but separates will do.

They know what kind of power it takes to reproduce music's original wide dynamic range and high levels without peak clipping or distortion. (A barely detectable 3-dB increase in output level requires double the amplifier power.) A very powerful amplifier must have massive power-supply components to be able to deliver the large amounts of current demanded by high-level output circuits. The size and weight of the power transformers alone means receivers must leave off well below where really high power begins.

For those who want to hear their music at realistic sound levels, LUX audiophile/engineers have designed products such as the M-4000 power amplifier. This unit is capable of 180 watts per channel, minimum continuous average power, and even with both channels driven simultaneously to full output into 8-ohm loads, each channel has no more than 0.05% total harmonic distortion at any frequency from 20 to 20,000 Hz.

Sophisticated protection circuits react to the electronically-subtle differences between normal high-level audio signals and abnormal voltage/current conditions. Hence, the M-4000 won't be fooled into producing unpredictable and audible distortions when operating with certain reactive

loudspeaker loads. Each of the stages—Class-B output and Class-A drive—has independent power-supply sections to minimize intermodulation effects. And fully independent power-supplies for each channel maintain full wattage potential under large-signal drive conditions.

Similar considerations went into the design of the C-1000 preamplifier. Every parameter that contributes to sonic differences, subtle as well as obvious, was examined anew. Among them: phase linearity, rise time and small-signal overload. One result: the magnetic-phono input circuits are virtually overload-proof—accepting almost half a volt at 1000 Hz! Another: the phono-preamplifier circuits have astonishingly low distortion of 0.006%, and the rest of the preamplifier circuits add only 0.001% more.

The Luxman T-310 AM/FM stereo tuner has everything from calibrated Dolby circuits for decoding Dolbyized FM broadcast and tapes to variable AM muting. Among its typical specifications: an IHF-ratio sensitivity of 1.7 microvolts and an exceptional 2.2 microvolts for 50 dB of quieting. And special five-pole phase-compensating filters in the IF section contribute to a 1.5-dB capture ratio and exceptionally low distortion levels (0.1% mono, 0.12% in stereo).

Of course, it takes some technical knowledge to fully appreciate the design approaches described above. But only your ears are required to hear the end result. In either case, you may soon be among those who own one or more of the thirteen LUX power amplifiers, preamplifiers, integrated amplifiers or tuners. You'll

find them at a select number of dealers who are dedicated audiophiles themselves.

Luxman C-1000
Preamplifier,
\$895.

Luxman M-4000
Power Amplifier,
\$1,495.

Luxman T-310
AM/FM Tuner,
\$595.

Dolby is a trademark of Dolby Laboratories, Inc.

LUX Audio of America, Ltd.

200 Aerial Way, Syosset, New York 11791

In Canada: AMX Sound Corp. Ltd., British Columbia; Gentronic Ltd., Quebec

THE GOLD-PLATED RELIABILITY FACTOR.

In this age of planned obsolescence, unreliable performance and shoddy workmanship are almost taken for granted. But there are still a few exceptional products that are built to last and one of them is the Revox tape recorder.

Revox dependability is a combination of many factors, but perhaps the most important of them is advanced engineering. Borrowing from space age technology, Revox gold-plates all of the electrical contacts on its plug-in circuit boards, relays and rotary switches. The result: every one of these movable contacts, the ones that usually cause most of the problems, can be depended upon to perform well for the life of the machine. Obviously, gold plating is considerably more expensive than conventional tinning, but Revox thinks it's worth it.

Because Revox engineers demand margins of performance and reliability that far exceed ordinary production standards, you can own a tape recorder that will work perfectly the first time you use it and for years to come. And that's why Revox is the only one to back its A77 machines with a lifetime guarantee.

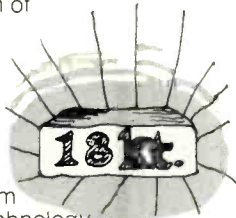

REVOX DELIVERS WHAT ALL THE REST ONLY PROMISE.

Revox Corporation
155 Michael Drive
Syosset, N.Y. 11791
The illustration contains optional extras.

of initials with a rectangle around it, on both faces—DBH. Now are we really getting into history! Without a doubt, DBH did the actual cutting of that disc and, in all probability, its partner too, Unicorn 1041, the missing Bach.

The sound? Rather to my initial surprise, 1042 seemed to me—by today's standards, of course—to be a bit on the high-level scratchy side, not any too clean. Are we now spoiled? Yet isn't this what we would expect from the middle 1950s? We had superb tapes then, in the late mono period, but LP disc cutting still was, shall I say, so-so. Or so we now feel. Even if P. Bartok cut this disc, it just might sound a wee bit scratchy today, my common sense tells me. No? Well, in any case we must not too quickly blame the mysterious DBH. He simply could have been using his company's currently operating lathe, cutting head, and stylus, not to mention well-used recording circuitry (tube), and he might even be required by company policy to cut high in level—who knows? I can easily imagine that DBH, in the cutting room, had been pestering the upstairs brass to let him throw out this old equipment and get something really up to date. . .speculation, but it could have been the truth. I searched my non-memory and could not come up with a name for DBH.

On Olympic, we have a smooth modern cut, of the sort that today is available from a thousand excellent studios all over, the very best of the 1970s. Not in the least surprising. But wha—? more mystery. Are there two Olympic labels? Very likely. At last count there were four Advents. Seems that the Univ. of Washington has an Olympic label, out in the far N.W., maybe named after the nearby Olympic Peninsula; but *this* Olympic, our Olympic, is based in New York, though it seems to be an offshoot of the Everest reissue empire on the southern West Coast. Well, let's put that one aside. At this point I couldn't care less if there are 10 Olympic labels, and maybe there are. One of them, ever so definitely, is putting out old Boyd Neel, and that is what interests me. But if you want his actual dates, this Boyd Neel, go look them up for yourself. And if you discover that the man actually turned a ripe 24 in 1975, I will be utterly confounded (and delighted at the game). On the other hand, if he is still around and kickin', live, then I say he is another Stokowski, or soon will be. He'd have to be.

Calling Mr. H. . .

Now, will a certain DBH, recording engineer, possibly still in the Boston area, maybe in New York, or wherever, kindly step forward? And for goodness' sake, DBH, don't get piqued; you did decidedly OK for 1957, if that was the date of Unicorns 1041 and 1042; and if you didn't, then it was probably too many Unicorn cooks with their fingers in the engineering stew. It happens, even today. Hey, and definitely, too, we'd be glad to hear from anybody else who might add a bit of detail to this particular mini-story, among thousands such. For fun & games.

Yeah, I know. Now we get the inevitable "didn't-you-know?" letters. Nope, I didn't. Why should I? I am not really sure (not having the direct audible A/B evidence) that Olympia's *Brandenburg Concertos* with Boyd Neel are, in fact, Unicorn's, and maybe Peter Bartok's. I'm not sure I want to be sure. I like a mystery. Especially an ear mystery. But really, now, couldn't I make a quick phone call to Olympic Records (one of them), straight to the horse's mouth? Nope. They probably wouldn't know, except the Big Boss, maybe, and why should he give gratuitous info to any inquiring press? Not *these* days. What do origins matter, just so he has a saleable tape, free and clear, and "mastered" by one Peter Bartok.

Oh yes—stereo. Olympia's Bach *Brandenburg Concerto* album 8131/2 is plainly marked STEREO on the yellow cover. No indication of stereo simulated. Unicorn's 1041 and 1042, same performers, were of course mono discs, released before the advent of disc stereo. Olympic could, I would say, be offering simulated stereo, not so indicated. Possible. (I could test that by ear if I had a few moments more.) But remember that many a fine tape—including Peter Bartok's?—was made in two-channel mode years before the stereo disc hit the market; mixed down to mono, for disc.

Did Peter Bartok, then, record the present Olympic 8131/2, and many another tape, for the old Unicorn label? And were his tapes indeed done in actual stereo—still extant on the master tapes though not appearing on the original discs? Again, it seems possible. Need I say more? I go *no* further. Not even one simple phone call to an old friend. See phone book under Bartok.

P.S. I'VE GOT IT!! PB and DBH. Come out of your hole, David B. Hancock!

JBL Loudspeaker Components



Twelve brand new pages. Forty-seven JBL components — dividing networks, lenses, horns, transducers, everything.

Lots of these goodies have never been available as individual components before. (They've been performing inside JBL's newest professional studio monitors.)

Write us. We'll send you the catalogue, free, along with the name and location of your nearest

authorized JBL Loudspeaker Components Dealer.

He's important. Besides all those components he's got a fresh supply of the new JBL Enclosure Construction Kits that tell you everything you need to know about building your own JBL enclosure.

Fill out this coupon and send it along to JBL, the people who wrote the book on sound.

Check No. 21 on Reader Service Card



3249 Casitas Avenue
Los Angeles 90039

Gentlemen:
I can't beat the price. Send
me the book.

Name _____

Address _____

City _____ State _____ Zip _____

James B. Lansing Sound, Inc.
High fidelity loudspeakers
from \$99 to \$3210.

Behind The Scenes

Bert Whyte

Autumn in New York, a beleaguered city with the fiscal hounds yapping at its heels, a creaky old vessel floundering in a sea of red ink, the Big Apple riddled with the worms of worry—is this any place to hold an Audio Engineering Society Convention? Why not? There still is a venue there called the Waldorf-Astoria and, nothing daunted, this is where the AES held its 52nd Convention on October 31 to November 3rd of last year.

Inevitably, some AES conventions are more interesting than others. Some have the excitement of new technical breakthroughs or the introduction of quadrasonic sound, for example. While no rockets were launched at this 52nd convention, there were some noteworthy papers presented and some interesting new equipment was on display. As usual, the Grand Ballroom of the Waldorf was crammed with the tools of the audio engineer's trade: multi-channel tape machines, mixing consoles, noise reduction equipment, delay units, microphones, measuring equipment, etc. Darned if I know the reason why, but the "hot" item on the floor seemed to be portable mixers. I lost count of the offerings, but there were units in every possible input/output configuration. A new piece of equipment that was getting plenty of attention was United Recording Electronic Industries Model 200 Automatic Response Plotting System. The result of an unusual collaboration between UREI and Hewlett-Packard, this combines a basic Hewlett-Packard X-Y plotter with a UREI audio analysis plug-in module. The first of a series of modules, the Model 200 has an automatic frequency sweep generator and

receiver, which can be used for such things as EQ and filter measurements, tape machine response, sine-wave loudspeaker and microphone response, room acoustics analysis, etc. An important feature of this unit is a rate-sensing device, which automatically slows the sweep rate when rapid amplitude changes are encountered and resumes the normal sweep rate following these large excursions. I can think of plenty of audio applications for this item, and although the price of the unit is \$2250, it is claimed that this is less than half the usual cost of such an instrument.

At the Bruel and Kjaer stand, they were demonstrating their always fascinating $\frac{1}{3}$ -octave analyzing equipment, along with the new gating-technique equipment for analysis of transducers and new IM analyzers for making swept IM measurements to 200 kHz. Henning Moller and Carsten Thomsen, both of B&K, presented papers of these devices and their applications, and it is claimed that the gating technique will give more meaningful data on loudspeaker performance than the usual testing in anechoic rooms.

The Tandberg people were showing their new 10½-in. reel machine with crossfield head and built-in Dolby-B noise reduction, for which a S/N ratio of some 73 dB is claimed. Point of pride was their new three-head monitoring cassette machine, which incorporates such niceties as azimuth adjustment. This unit, which costs just under \$1000, will be available in the spring of 1976.

Amplex was showing a production version of their tape counter for the MM1100 tape machine, and it is such a useful accessory, I once again plead

the case for such a unit for the 440C tape machines.

The 5th floor of the Waldorf houses the active demonstration rooms and is more than ever beginning to resemble a mini hi-fi show. Pioneer was on hand with their new dynamic range expander. Variable controls on the unit permit as much as 15 dB expansion, depending on the source material. It must be used judiciously, for too heavy a hand and you can hear the system "working" or "breathing." At the point where the action is not perceptible, there is still 7 or 8 dB of usable expansion, and it is disheartening to hear how much limiting and compression is used even with classical recordings. Used with discretion, the system works quite well. Pioneer was also showing a prototype 10½-in. open-reel tape recorder. The interesting feature on this machine is that it is expandable to four channel with a change of heads and the addition of an amplifier module. Another big plus is that finally on a consumer tape recorder the bias and equalization controls are easily accessible on the front panel. Pioneer's high-polymer film, which was such an interesting item at the last New York AES convention, is now used in the high frequency section of an imposingly large speaker system. Unfortunately I didn't really hear it long enough to venture an opinion on overall quality, but the top end did indeed sound very smooth.

Down the hall, Teac/Tascam were showing some interesting items, such as a 16-channel deck using one-inch tape, with built-in dbx noise reduction as an option. There is a strong possibility that Teac will offer dbx in some of their audiophile tape ma-

We're #1—and the critics totally agree!

HIRSCH-HOUCK LABS . . . Stereo Review

“The Pickering XUV/4500-Q is obviously one of the best phono cartridges presently available. There are few stereo cartridges that can outperform it in any of its individual characteristics, and we know of none that could be said to be a better stereo/CD-4 pick-up.”

B. V. PISHA . . . Audio Magazine

“The Pickering XUV/4500-Q ranks among the top cartridges for stereo, SQ, QS and CD-4. The sonic clarity is exceptionally good, with superb transient and applause response, and good definition, particularly in the low bass region.”
“To sum up, we can recommend the Pickering XUV/4500-Q cartridge without reservations, based upon our laboratory and listening tests.”

MAURICE HOLTHAM . . . Canadian Stereo Guide

“In fact, the reproduction of all material . . . stereo, CD-4 and matrix . . . was absolutely superb. Good recordings were reproduced with outstanding fidelity and clarity, and tracking was secure at one gram with even the most heavily modulated bands. Solo instruments and voice were rendered with exciting realism; large orchestral and choral works came through in all their magnificence.”

Hi-Fi Stereo Buyers Guide

“In both stereo and CD-4 one of the most outstanding under any program conditions. Sound so clean and crisp it almost hurts.”
“This pickup is a perfect example of why measurements cannot truly express the sound quality from a transducer; though the measurements are good, the sound quality was rated by the entire listening panel as superb.”

The specifications of the XUV/4500-Q are so exciting that we hope you will write to Pickering and Company, Inc., Dept. A, 101 Sunnyside Blvd., Plainview, New York 11803 for further information.



“for those who can hear the difference”

Reprinted by permission of Audio, Canadian Stereo Guide, Hi-Fi Stereo Buyers Guide and Stereo Review Magazines.

Check No. 33 on Reader Service Card

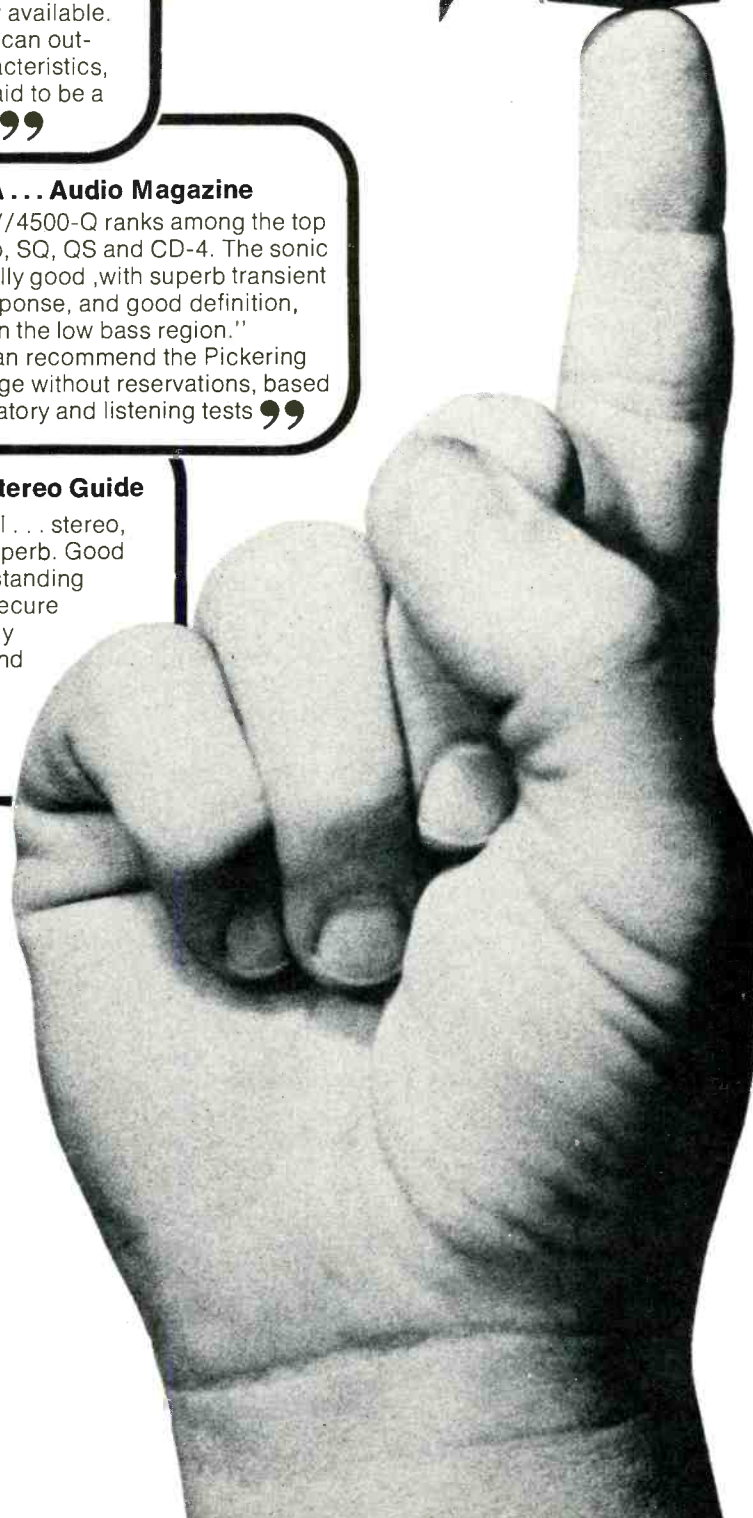

Incredible.

How else would you describe a preamplifier with:

- A **Peak Unlimiter** that restores dynamics lost in recording to closely approximate the original.
- A **Downward Expander** that reads "gain riding" and expands dynamics down to precisely the intended level.
- An **AutoCorrelator** that makes record/tape hiss and FM broadcast noise virtually vanish without affecting musical content.
- **Plus** an Active Equalizer that gives you flat energy distribution over the full audio spectrum, Joystick Balance and Step Tone Controls that allow precise music tailoring to your listening environment *and* SQ* and Phase Linear differential logic for Quad Sound.

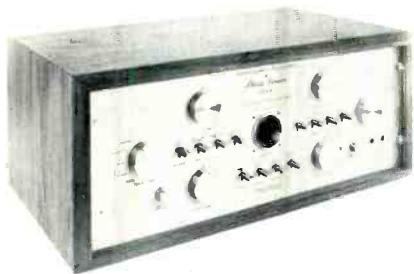

The 4000 is an advanced stereo preamp that actually puts back in what recording studios take out ... lets your music (at last) reach life-like levels without distortion ... lets you (for the first time) hear your music from a silent background. It is, in a word, incredible. Ask your dealer for an audition.

Warranty: 3 years, parts & labor.

Phase Linear 4000

THE POWERFUL DIFFERENCE

PHASE LINEAR CORPORATION
P.O. Box 1335 • Lynnwood, Wash. • 98036

*SQ is a trademark of CBS, Inc.

Check No. 32 on Reader Service Card

chines and perhaps even in a cassette recorder! dbx had their own room and were demonstrating their noise-reduction system in various configurations. What was startling there was to hear some very high level Karl Heinz Stockhausen percussion music suddenly assault your ears from a tape with an utterly silent background.

In the Yamaha room, much attention was centered on their big V-FET B-1 amplifier and their new pre-amp powering their monitor speakers with the interesting beryllium diaphragm mid-and high-frequency units.

Sennheiser had one of the most unique items at the AES convention, a remote control system for microphones and headphones utilizing an infrared carrier system, in other words, wireless mikes and headphones. Reportedly the system is in use in some TV sets in Europe. In this application, it is possible to view a TV set, with private listening via the infrared system wireless headphones.

You hear a lot of propaganda these days about the low status of quadraphonic sound. Maybe so, but the people at the Columbia SQ, the Sansui QS, and the JVC CD-4 demonstration rooms were putting on first-class shows, and the excellence of their quadraphonic sound was keeping the rooms well filled. I met former AES president John Eargle at the JVC room, and he showed me an interesting thing about the new JVC-1000 professional demodulator! By adjusting the controls in a certain way, it was possible to hear the carrier channels, without the baseband channels. To prove that we were hearing only the carrier channels, John removed the pickup from the record and flicked the stylus ... and no sound was heard from the speakers!

AES Banquet

At the AES awards banquet there is always a guest speaker, and on this occasion it was none other than Avery Fisher. Mr. Fisher spoke entertainingly about his early days in the audio industry and touched on some of the highlights in his career. Then he went on to detail some of the aspects of his munificent gift to the New York Philharmonic Society which as you probably know renamed Philharmonic Hall as Avery Fisher Hall in gratitude for his generosity. Then, most importantly, Mr. Fisher discussed the acoustic problems that have plagued Avery Fisher Hall.

The hall was designed by the very well-known acoustical consultants, Bolt, Beranek and Newman. The hall

design was based on extensive studies of acoustic principles and theory. It was a reasoned scientific approach, with no room for "cut and try" techniques or strictly intuitive thinking. All the resources in the armamentarium of acoustical science were applied to the project. Nonetheless, when the hall was built, the acoustics were disappointing. The sound of the New York Philharmonic Orchestra was thin, with poor projection and attenuation of bass frequencies. An acoustic "facelift" was undertaken some time later, but the improvements were marginal. The last time I was in Avery Fisher Hall, the Boston Symphony orchestra was performing the massive Mahler 5th Symphony. What I heard was a disaster. In the big *tutti* and *forte* passages, the string sections were sawing madly away, and I could barely hear them. The huge concert bass drum was being lustily whacked, but instead of a bang, all I got was a whimper. Instead of a great outpouring of sound, what I heard sounded compressed and attenuated. The hall was like a sponge, and frankly I haven't been back to the hall since.

Thanks to the generosity of Avery Fisher and his very strong feelings that New York should have a fine concert hall with really good acoustics, a new project has been undertaken to reconstruct the hall and hopefully achieve this goal. It was obvious that some drastic measures were going to be necessary to change the acoustics of the hall, but I wasn't quite prepared for Mr. Fisher's announcement that beginning in May 1976, the entire interior of the hall would be removed, leaving only the steel and concrete shell of the building! As Mr. Fisher remarked, "we're going to start from scratch." He then told us some of the details of the new hall, the fact that it was expected to reopen in October 1976, and that the architect/acoustician on the project was Cyril Harris, designer of the new Orchestra Hall for the Minnesota Orchestra. Therein lies the tale I will relate to you next month.

But before I close this month's edition, let me extend a warm and heartfelt round of public applause to John Woram, Irv Diehl, and all those others who helped make their production of *The Magnificent Men and Their Music Machines* the entertainment event of this year's Convention. This retrospective view of electronic music synthesis and applications featured, along with Robert Moog and Michael Colchimaró, Suzanne Ciani on her Buchla system. Well done, all!

Avid makes the differences in speakers clear.

If you're a real stereo buff, you know that flat frequency response means flat, uncolored sound.

Like several other manufacturers, we too try to build the flattest, most linear frequency response we can into our speakers.

But we don't stop there. Because we know that great sound depends on more than just frequency response.

Transient response, for instance.

It's all in your head

To understand transient response, it's important to understand how you hear.

You see, you don't really hear with your ears. You hear with your brain.

For instance, it's the brain that helps you identify what you're listening to. The direction it's coming from. And that re-creates that illusion of "being there."

The thing is, every musical note is really a complex tone. A basic tone—the fundamental—plus subtle musical overtones—harmonics—that give every instrument a unique personality.

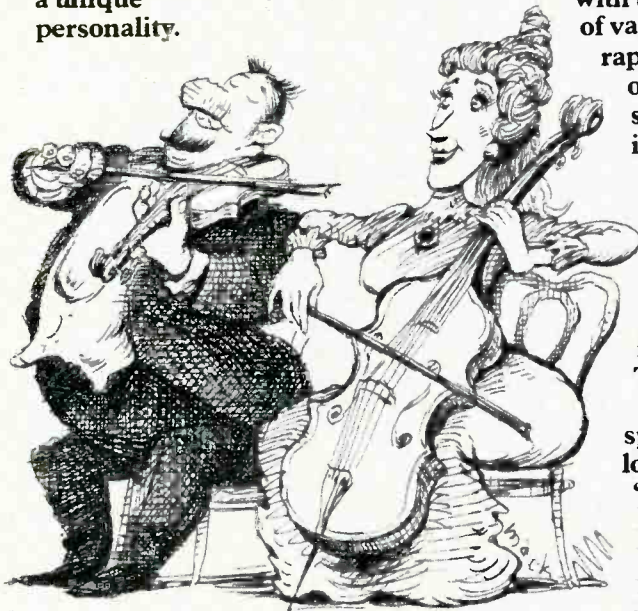

Not only that, musical notes are constantly starting and stopping. When they do, the number and intensity of the harmonics change.

This basic tone, together with all those changing harmonics, is called a transient. The brain takes all of them into account in interpreting any sound the ear receives.

On making things imperfectly clear

It's when a speaker can't react quickly or accurately enough to all those changing musical notes, all those transients, that distortion can occur.

And distortion means muddy-sounding music. With little definition or clarity.

A bad situation made worse when a speaker over-reacts to all those changing tones. The speaker actually adds tones of its own. And that's bad.

Most experts feel the best way to measure transient response is with tone bursts. Pure tones of various frequencies are rapidly switched on and off to simulate the transient nature of voice and instrument signals.

In Pattern A, the speaker hasn't reproduced accurately. It's completely overshoot the level of the input signal. And the result is a sizzling, hot sound. Totally colored.

In Pattern B, the speaker has taken too long to react. This "hangover" can cause considerable blurring. So what you hear is dull and lifeless.

Now look at Pattern C. The speaker here has reacted both quickly and accurately. And the result is exceptional clarity and definition. The kind that Avid builds into all of its speakers.

The proof is in the hearing

Now you know there's a lot more to a speaker than just flat frequency response. Like good transient response.

But even the best, most accurate transient response in the world isn't the be-all and end-all of a superb speaker. There's more.

The point is, we're a company that is committed to one thing and one thing only. The design and construction of the clearest, best-sounding stereo speaker systems in their price range.

But you've got to hear for yourself. So go to your hi-fi store and listen to an Avid.



Input Signal

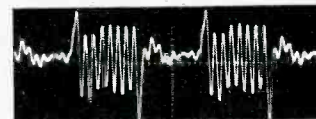

Pattern A



Pattern B



Pattern C

Then some other speaker in the same price category.

Then decide. We don't think you're going to have any trouble at all.

AVID

CORPORATION

10 Tripps Lane, East Providence, R.I. 02914
Distributed in Canada by:
Kairon Electronics, Montreal, Quebec.



Check No. 6 on Reader Service Card

Dear Editor:

Another Sage Down Under

Dear Sir:

It was indeed a pleasure to read Ray Newman's discussion of the monumental work of A. N. Thiele in the August issue of *Audio*. I have no complaint with the technical content of this article, but I think it might be well to put the article into a better perspective with a few historical notes and additional references.

Primarily, I feel that Ray has understated the role of Dr. Richard H. Small of the Univ. of Sydney in building on the foundation laid by Thiele. In early 1971, Dick Small sent me a copy of Thiele's paper and, after the first reading, I called the editorial office of the *Journal of the Audio Engineering Society* to arrange for reprinting. Thus, credit for making this work known outside of Australia really belongs to Dick.

From a theoretical standpoint, the credit for the understanding of the box-volume, efficiency, and low-frequency cut-off exchange must also go to Dick Small (20, 21, 22), and the quantitative relationships for cone excursion (really, displacement volume) were developed by Small. The foundations were in Thiele's work, but the extension was done by Small.

Finally, it might be well to mention Small's work on closed-box (sealed, acoustic suspension, etc.) systems (21). Throughout his article, Ray preaches my sermon that vented boxes can be 3 dB better than sealed boxes, but Thiele said nothing about sealed boxes. Don't forget, most acoustic suspension systems are near or remote copies of Villchur's AR-1 of 1955 (23). Until Small's 1973 work, there was no complete design theory for

closed boxes to compare with Thiele's 1961 theory for vented boxes. (Here in this country, the marketplace was the opposite—closed boxes have long been closer to optimum than commercially available vented boxes. The Klipsch Cornwall, designed in 1959, is the exception to prove the rule.) It was only when Small put closed and vented boxes on the same level of theoretical design excellence that the 3-dB advantage for vented boxes became "obvious to the most casual observer."

J. Robert Ashley
Prof. of Engineering
Univ. of Colorado
Colorado Springs, Colo.

References

(Note: The numbering takes up where Newman left off.)

20. R. H. Small, "Direct-Radiator Loudspeaker System Analysis," *IEEE Trans. Audio and Electroacoustics*, Vol. AU-19, No. 4, p. 269, Dec. 1971. Also, *J. Audio Eng. Soc.*, Vol. 20, No. 5, p. 383, June 1972.
21. R.H. Small, "Closed-Box Loudspeaker Systems" (in two parts). "Part 1: Analysis," *J. Audio Eng. Soc.*, Vol. 20, No. 10, p. 798, Dec. 1972. "Part 2: Synthesis," *J. Audio Eng. Soc.*, Vol. 21, No. 1, p. 11, Jan. 1973.
22. R. H. Small, "Vented-Box Loudspeaker Systems" (in four parts). "Part I: Small-Signal Analysis," *J. Audio Eng. Soc.*, Vol. 21, No. 5, p. 362, June 1973. "Part II: Large-Signal Analysis," *J. Audio Eng. Soc.*, Vol. 21, No. 6, p. 438, July/Aug. 1973. "Part III: Synthesis," *J. Audio Eng. Soc.*, Vol. 21, No. 7, p. 549, Sept. 1973. "Part IV: Appendices," *J. Audio Eng. Soc.*, Vol. 21, No. 8, p. 635, Oct. 1973.
23. E. M. Villchur, "Commercial Acoustic Suspension Speaker," *Audio*, Vol. 39, No. 7, p. 18, July 1955.

Editor's Note: Mr. Newman's article was submitted in Sept., 1972, having been written the previous summer. As nearly all of the above referenced articles were thus not available to him, he should receive credit for independently working out the theory.

Save O-R Prerecorded Tapes

Dear Sir:

As you may have read in our literature and various newspaper articles, Ampex has decided to leave the pre-recorded tape business which may prove to be the death knell of the pre-recorded open-reel format. Those of us who have been with Ampex's direct-mail programs since 1970 are trying to keep that from happening. *But we need your help!!!*

Your support of our most recent efforts has caused the General Manager to take a second look at reel-to-reel, and I believe we can change his mind but there are two things we must prove. First, we must show him that the market exists. Industry figures show that the reel market is minute, but past experience has shown me that your loyalty more than makes up for small numbers. Second, we must show him that this market can be developed and serviced profitably. I'm certain we can do both!

We have taken a long, hard look at our manufacturing costs and the methods of operating The Tape Society. I think we have come up with some significant cost-saving ideas which, if implemented, could change the management's position.

Please take a few minutes to write to me, even if you've never purchased tapes from The Tape Society; I'm still interested in your opinions on open reel. There are two major things I need to know about your tape library: first, is the bulk of it pre-recorded or is it home made? Second, if it was home made, was it that way by necessity, i.e. because you could not find a source of the pre-recorded tapes you wanted?

I'm a reel-to-reel freak myself, and I don't want to see it go the way of the 78. Become a vocal minority! Let your opinions be heard! If you don't speak out now, you'll leave no one to blame but yourself if this campaign fails!

Russell Fields
Manager
Direct Marketing/Advertising
Ampex Corp.
2201 Lunt Ave.
Elk Grove Village, Ill. 60007

Addendum

Audio Oscillator October, 1975

The values for resistors R4A and R4B were inadvertently dropped from Table 2, the parts list, though they might have been calculated from the Wein bridge formula. The proper values are 143 kOhms.



BSR Silent Performers

**State-of-the-art belt-drive turntables
at today's state-of-the-wallet prices.**

For years most expensive manual record-playing devices have used belt-drive as a smooth, trouble-free—and most important—*silent* method for transmission of power. Now, our engineers have succeeded in integrating a highly-refined belt-drive system into more affordably-priced turntables. They offer a combination of features and performance not yet available in even more expensive competitive models. We call them the Silent Performers.

Four models are available. The 200 BAX is the deluxe automatic belt-drive turntable. Full automatic capability is achieved with a gentle yet sophisticated 3-point umbrella spindle. It has a heavy die cast platter, high-torque multi-pole synchronous motor, tubular "S" shaped adjustable counterweighted tone

arm in gimbal mount, viscous cueing, quiet Delrin cam gear, automatic arm lock, dual-range anti-skate, stylus wear indicator and much more. Included are base, hinged tinted dustcover, and ADC VLM MKII cartridge.

The 20 BPX is an automated single-play belt-drive turntable. It has the "S" shaped tone arm and features of the deluxe automatic model with a precision machined platter and ADC K6E cartridge. It comes complete with base and dustcover. Model 20 BP is identical but without cartridge.

Model 100 BAX (not shown) automatic belt-drive turntable has a low mass aluminum tone arm with square cross section and a precision machined platter. It is packaged with base, hinged tinted dustcover, and ADC K6E cartridge. Check No. 9 on Reader Service Card



Consumer Products Group
BSR (USA) Ltd. • Blauvelt, N.Y. 10913



BSR 200 BAX—Deluxe automatic belt-drive turntable

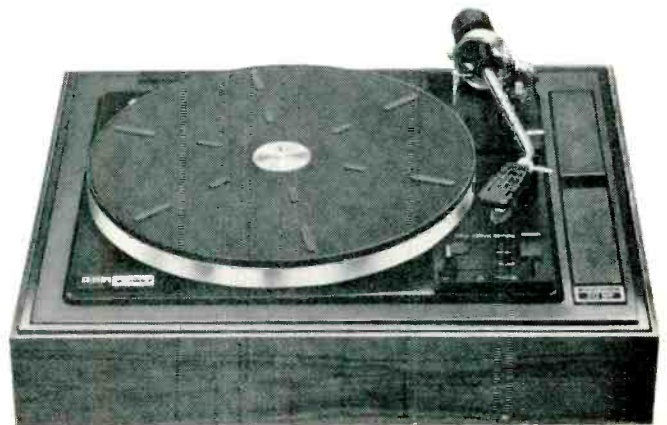

BSR 20 BPX—Automated single-play belt-drive turntable

Build A Low TIM Amplifier

W. Marshall Leach*

SOME OF THE causes and cures of transient intermodulation (TIM) distortion have been discussed in a previous article [1]. There, TIM distortion was defined as a transient overload phenomenon which results from the use of a very large negative feedback ratio with attendant heavy lag compensation. It was stated that TIM distortion can be eliminated by designing power amplifiers with a lower overall open-loop

gain, by designing each internal stage for maximum bandwidth and linearity, and by using lead compensation rather than lag compensation to insure stability. Stated in more practical terms, the amplifier should have an open-loop gain that is greater than the closed-loop gain by no more than about 25 dB, and the open-loop bandwidth should be at least 20,000 Hz, preferably greater. As a final step, the amplifier should have a low-pass filter

at its input to prevent inaudible ultrasonic or r.f. signals from accidentally overloading the input stages.

Since the use of less overall negative feedback can result in an increased distortion, it is important that the circuit be a fully complementary-symmetry design. In addition, each internal voltage gain stage should utilize local negative current feedback for maximum linearity. In this way, the open-loop distortion will be sufficiently low so that 25 dB of overall negative feedback will result in an acceptably low distortion level in the closed-loop amplifier.

Although there exist no present standards for the measurement of TIM distortion (in a private communication, Prof. Matti Otala of the University of Oulu in Finland has told the author that he is presently constructing a TIM measuring instrument), the susceptibility of an amplifier to it can be determined in some cases with an oscilloscope and a fast rise time square-wave generator. With a square-wave input signal, the signal at the output of each internal stage in the amplifier should ideally be a square wave with little or no overshoot or ringing. Unfortunately, however, in the majority of amplifiers, the internal stage which is most susceptible to TIM distortion is almost always a current gain stage rather than a voltage gain stage. Since an os-

*Assistant Professor, School of Electrical Engineering, Georgia Institute of Technology, Atlanta, Georgia 30332

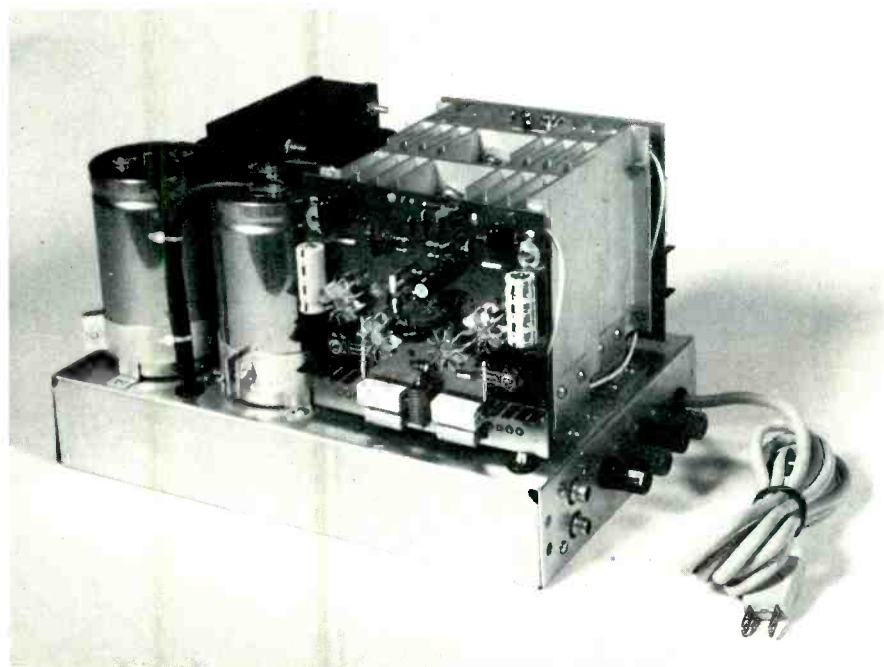

Fig. 1—Photograph of the author's chassis layout. The case on the power transformer has been changed so that it could be mounted vertically without the use of L-brackets.

cilloscope is a voltage measuring instrument, it is almost impossible to observe internal transient overshoot problems in such amplifiers without their modification or the use of expensive current probes.

In this article, a practical design example is presented which is based almost entirely on the design philosophy presented in the previous article. Since each internal stage in this amplifier utilizes local negative current feedback, the impedance levels in the amplifier are sufficiently high and the feedback ratio is sufficiently low so that the transient response of each internal stage can be measured easily with an oscilloscope. The circuit has been carefully designed so that transient inter-loop signal overload cannot occur, even with ultra-fast rise-time square-wave signals applied to the amplifier input. Since no internal stage is subject to transient overload problems, the amplifier is theoretically free of TIM distortion, and the results can be startlingly audible, especially with full-range electrostatic speakers.

When used within its power limitations, the amplifier can be used with the finest associated equipment. In several subjective listening tests, it has audibly equaled or surpassed any amplifier to which it has been compared. The audible differences are greatest during music which contains loud high-frequency material and percussive sounds. These differences are attributed to the controlled inter-loop transient response of the amplifier and the lack of TIM distortion in the reproduced music. These are principally a direct result of the fact that the open-loop frequency bandwidth is 38,000 Hz or approximately twice that of the audible spectrum.

The amplifier is a fully complementary-symmetry, direct-coupled design. It has a closed-loop frequency response which extends from approximately 0.5 Hz to 150,000 Hz. The response outside these limits has been intentionally rolled off. Otherwise, the small-signal frequency response would extend from d.c. to over 800,000 Hz. With the specified

power supply, the power output is 70 watts per channel, both channels driven simultaneously, or 84 watts from either channel driven alone. Both the IM distortion (SMPTE Standard) and the THD are less than 0.2% at 70 watts or less, where the THD is measured at any frequency between 20 Hz and 20,000 Hz. At lower power levels, the distortion is much lower, typically 0.04% or less. However, no ultra-low distortion levels are claimed since an unrealistically low THD specification can indicate the presence of TIM distortion in an amplifier [2]. With the feedback loop disconnected, the amplifier will produce 50 watts into an 8-ohm load with a THD of only 0.5% at 1000 Hz. This low distortion is indicative of the inherent linearity of the open-loop amplifier. Thus, the addition of negative feedback has not been used to "clean up" problems of the basic design, but to improve it. As the power level is decreased, both the IM distortion and THD decrease monotonically. This indicates the absence of crossover distortion.

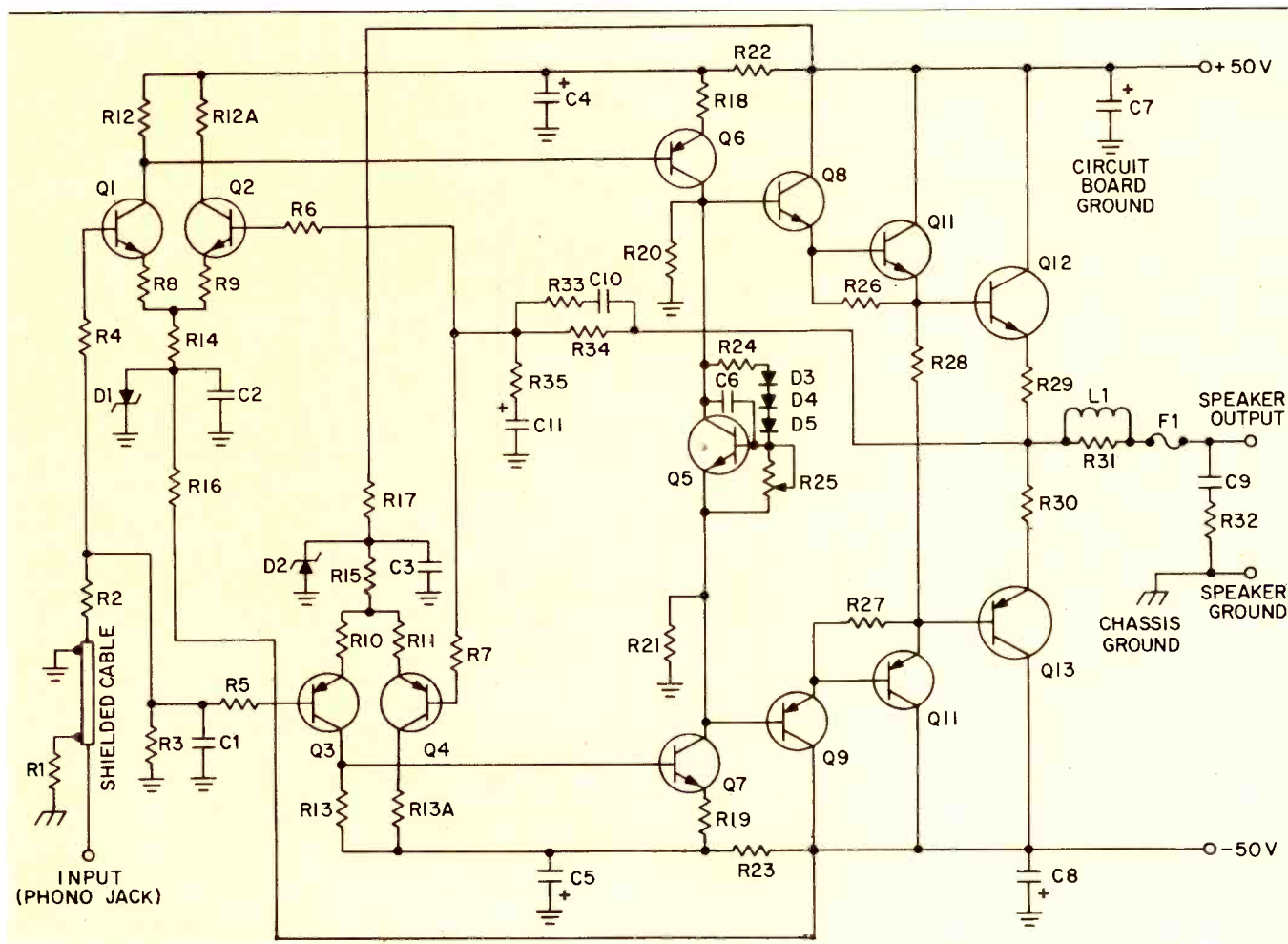

Fig. 2—Complete circuit diagram of one channel.

The damping factor is approximately 250 from 20 Hz to 20,000 Hz. Although this is only moderately high, it does not change appreciably with frequency in the audio band. In contrast, an amplifier with an inadequate open-loop bandwidth will exhibit a damping factor which can change appreciably with frequency, often by a factor as high as 100 or more. A damping factor which is relatively insensitive to frequency indicates that the output impedance of the amplifier is essentially constant and does not vary with frequency. Whether this can be audible is not known, however, it is felt that a frequency-sensitive output impedance can lead to transient problems with certain reactive loads, particularly full-range electrostatic speakers.

Description of the Circuit

The overall circuit diagram of a single channel of the amplifier is

shown in Fig. 2. With few exceptions, the basic configuration is rather conventional. However, each component has been selected specifically to prevent inter-loop transient problems from occurring. In addition, the circuit has been designed for a controlled open-loop gain and bandwidth that are essentially insensitive to frequency variations of the speaker load impedance. The amplifier as presented in Fig. 2 has no protection devices, such as current limiters or VI limiters, as it is felt that these devices represent a compromise in the ultimate sound quality which can be achieved. However, the circuit board has been designed to accommodate a VI limiter which will be described in a later article. For home use, this is not recommended unless the amplifier might be subjected to abuse.

The basic amplifier consists of two stages of voltage gain, three stages of current gain, a temperature-sensing bias regulator, and a feedback net-

work. With the exception of the output transistors, all transistors have been selected from the manufacturer recommended lists published in the current Motorola Semiconductor *Master Selector Guide*. Thus, they should be easily obtained by those who wish to construct the amplifier from scratch. The output transistors are relatively new units which are manufactured by Texas Instruments. They are rated at 200 watts and 30 amperes, and they have the necessary minimum breakdown voltage (BVCEO) of 100 volts.

The input stage is a conventional double-ended differential amplifier which has a gain of about 10 to 12. The complementary transistors Q1 through Q4 in this stage are specifically recommended by Motorola for low-level, low-noise audio frequency applications. The bias current in these transistors is set at 0.6 mA by the Zener diodes D1 and D2 and the emitter bias resistors R14 and R15. Resistors R8

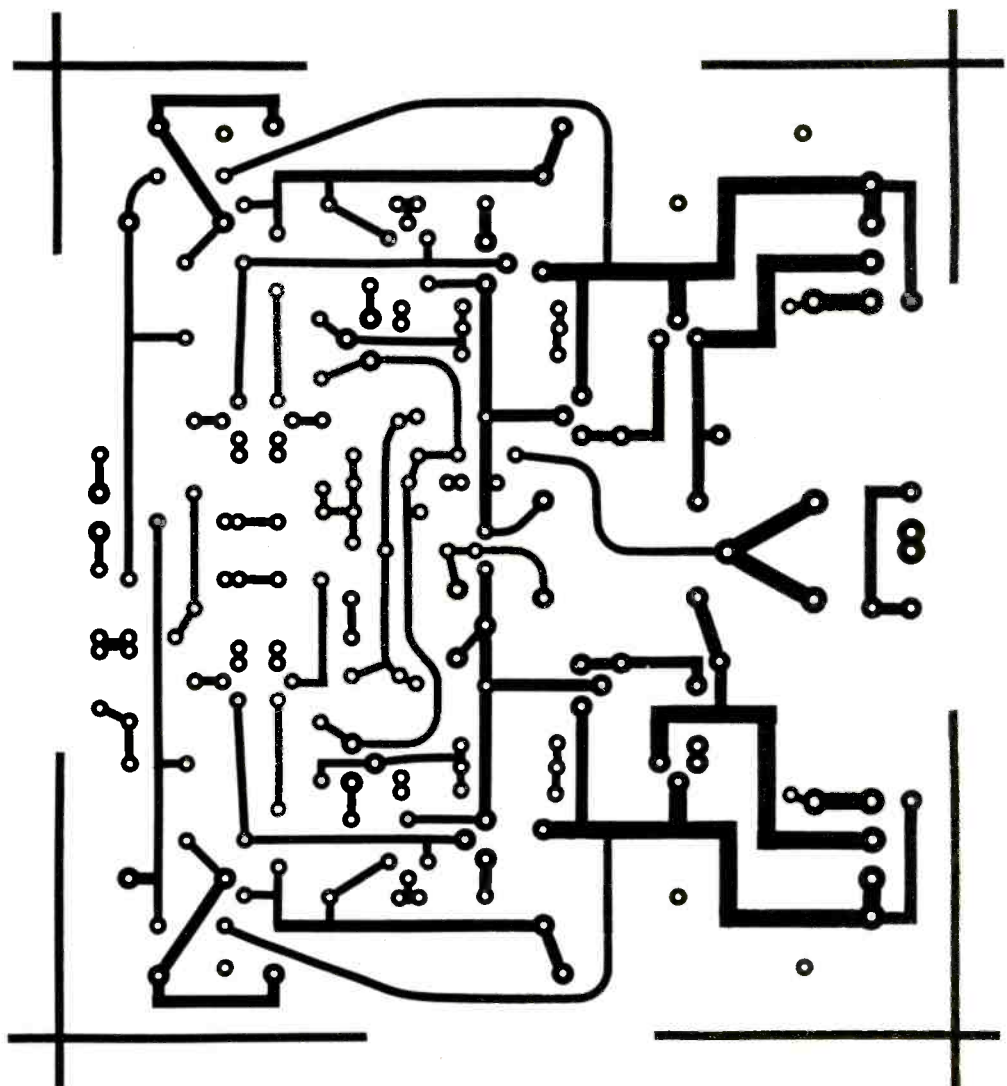

Fig. 3(a)—Circuit side of printed circuit board foil patterns for one channel.

through R11 provide local negative current feedback to linearize the gain characteristics and improve the bandwidth of the input stage. In addition, these resistors, in conjunction with the collector load resistors R12 and R13, set the gain of the input stage.

The input signal is coupled to the differential amplifiers through a low-pass filter which has a nominal 3-dB cutoff frequency of about 150 kHz. When used with a preamplifier with a 10-kOhm output impedance, the cutoff frequency of this filter will drop to about 50 kHz.

The differential amplifiers have two outputs which are electrically in phase but have a d.c. voltage of about 45 volts between them. These two outputs are connected to the second stage of voltage gain consisting of transistors Q6 and Q7. These transistors are biased at about 4.3 mA, and they provide a push-pull voltage gain of about 45. The gain of this stage is set by the two emitter resistors R18

and R19 and the two collector load resistors R20 and R21. In addition, resistors R18 and R19 provide heavy local negative current feedback for linearity and wide bandwidth.

The second voltage gain stage has two outputs which are electrically in phase but are separated by a d.c. voltage of about 3.45 volts. This d.c. voltage is regulated by transistor Q5 which is connected as a constant voltage regulator. The purpose of Q5 is to provide a constant quiescent bias current in the output transistors so that they operate in a true class-AB mode. Since the quiescent base-to-emitter junction voltage in the output transistors decreases with temperature, it is necessary for a voltage across Q5 to decrease by the same amount if the bias current in the output transistors is to remain constant as they warm up under load. The three diodes in the base bias network for Q5 provide the necessary thermal feedback. They are mounted on the heat sinks with the

output transistors so that they will both be in thermal equilibrium. The nominal voltage across Q5 is given by the equation

$$V = 0.6 \left(1 + \frac{R24}{R25} \right) + 1.8 \quad (1)$$

This voltage will drop by about 6 mV per degree Celsius as the output transistors warm up under load. This provides essentially perfect thermal regulation of the bias current in the output transistors and prevents thermal runaway. From an audible point of view, the bias current is not over-compensated for absolute protection from thermal runaway, for this can lead to the production of crossover distortion in the output stage as the amplifier warms up under load.

Transistors Q8 through Q11 are connected as a complementary Darlington driver stage. Although Darlington transistors are available, they cannot match the bandwidth and

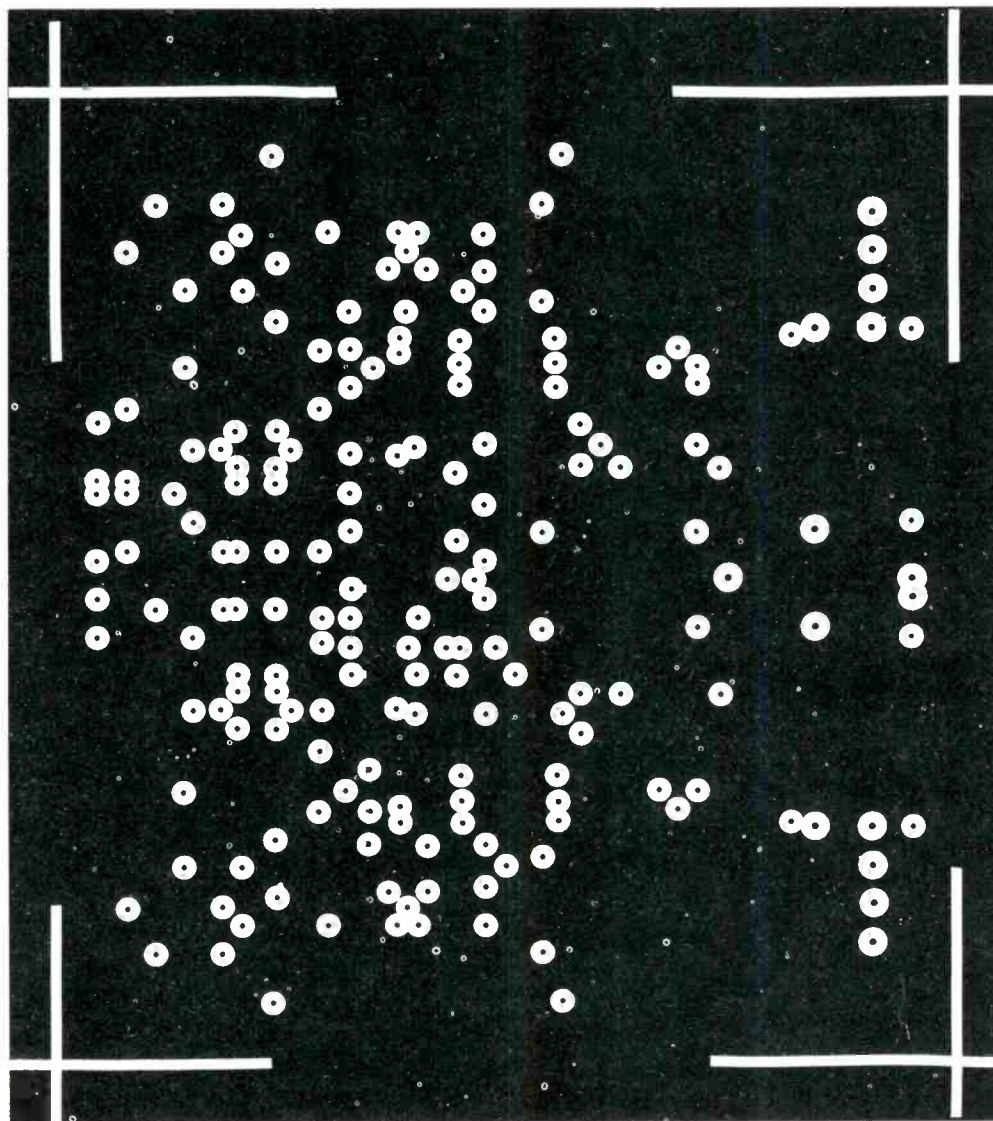

Fig. 3(b)—Ground plane side of printed circuit board foil patterns for one channel. This layout contains the V1 limiter circuit which will be described later.

thermal stability of the discrete transistors used in the Darlington configuration. All four of the driver transistors are forced to operate in a true class-A mode since their emitter outputs are not connected directly to the speaker output. Since the driver transistors never cut off under load, the driving point impedances seen by the bases of the output transistors remains constant as the output transistors turn off and on in the class-AB mode. Thus, the driving point impedance remains very low during each half cycle of the output voltage swing. This low impedance aids in draining out the charge stored in the base region of the output transistors when they turn off, thus speeding up their turn-off time and improving the open-loop bandwidth of the amplifier.

The class-A driver stage is similar to one described by Locanthi [3] in what the author considers one of the true classic transistor amplifier designs. This is the JBL "T circuit" which was introduced in 1966. To the author's knowledge, this amplifier is no longer being manufactured. A simplified two-transistor version of the "T circuit" driver is used in certain amplifiers currently marked by SAE and the Great American Sound Co.

The complementary output transistors are connected in the emitter follower or common collector configuration for maximum bandwidth. They operate in a class-AB mode for minimum distortion and minimum power dissipation. In the class-AB mode, both transistors are conducting

current during no or very small signal inputs. However, as the input signal level increases, one transistor will progressively conduct more and the other progressively less during any half-cycle of the signal until the latter transistor turns off. Thermal stability has traditionally been a problem associated with class-AB output stages. However, this problem is completely eliminated in this circuit by the thermally compensated bias regulator. The regulator will maintain a constant bias current in the output transistors as the heat sinks warm up from no load to their maximum temperature. This occurs at approximately 40% of the maximum output power. The 0.22-ohm resistors in series with the emitters of the output transistors serve two purposes. First, they pro-

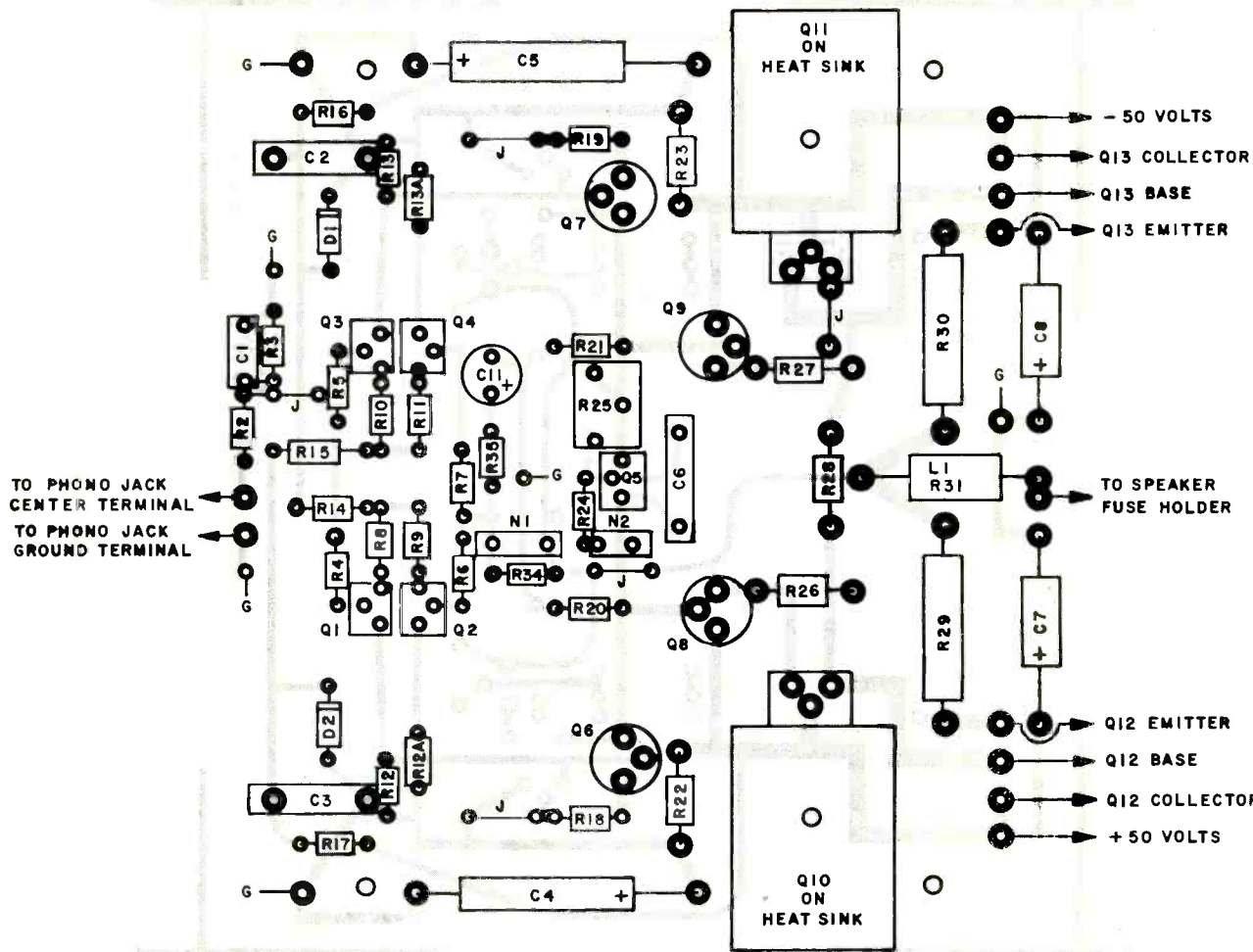
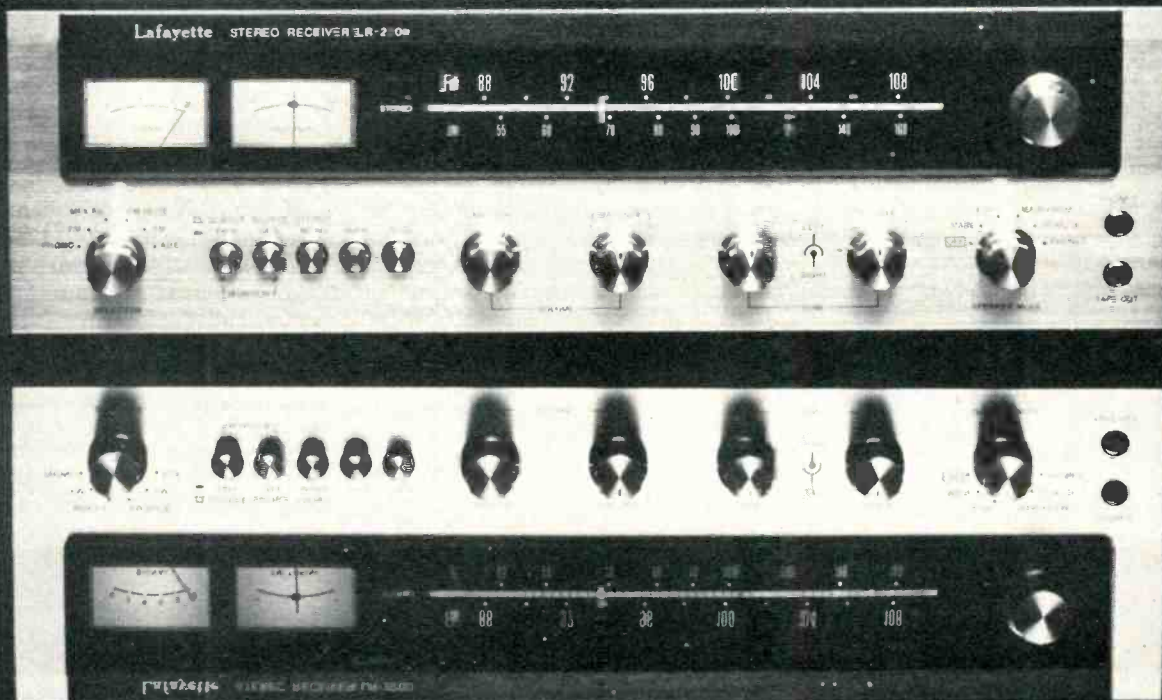

Fig. 4—Circuit board parts layout for one channel. View is from component side of board.

- G - GROUND PLANE CONNECTION
- J - JUMPER
- N1 - R33 AND C10 IN SERIES
- N2 - D3, D4, AND D5 CONNECTIONS



The Image of Performance

The new Lafayette LR-2200 has the look of performance many receivers try to achieve. But real performance comes from within. That's where the LR-2200 stands out.

This serious receiver performs to the highest standards with advanced circuitry, a most selective AM/FM stereo FM receiver, full music controls including two tuning meters, dual tape monitoring jacks and derived four channel matrix. The sensitive performance of the LR-2200 comes across powerfully through 27 watts per channel, minimum RMS. Both stereo channels are driven at 8 ohms from 20-20,000 Hz, with no more than 0.5% total harmonic distortion.

The Lafayette audio designers performed in the creation of the LR-2200. Lafayette put the most features, the cleanest specifications, the most power for any receiver Lafayette has ever offered at this price. 299.95

Because Lafayette performed in the creation of this receiver it will perform for you for years.

See it, hear it at a Lafayette store. It gives you a performance.

Like to see more of the performers? Visit any of the Lafayette stores coast to coast. Or write for our free catalog.

Electronically Speaking,
Who Knows Better Than

Lafayette
Radio Electronics & Shopping Centers

vide local negative current feedback for linearity. Second, they protect the output transistors from an accidental short circuit across the speaker output terminals. For short circuit protection, these resistors must be fused resistors such as those manufactured by Workman.

The feedback network consists of resistors R33, R34, and R35, and ca-

pacitors C10 and C11. For all audible frequencies, C11 is a short circuit and C10 is an open circuit. Thus, the amplifier gain is given by

$$G = 1 + \frac{R34}{R35} \quad (2)$$

or 26 dB. Below 1 Hz, C11 becomes an open circuit. This reduces the d.c. gain of the amplifier to unity to insure d.c. stability. Between 150 kHz and 800

kHz, C10 becomes a short circuit, thus increasing the high-frequency feedback ratio. This lead compensates the amplifier by increasing the high-frequency loop gain. By performing the lead compensation in the feedback network, optimum inter-loop transient response is obtained and, simultaneously, the closed-loop frequency response is rolled off.

Construction

Although straightforward, construction of the amplifier requires care if it is to be done properly. The construction details are broken into two parts. In this section, the circuit board/heat sink assembly is discussed; in the following section, the chassis construction details are presented. Before construction is begun, all parts should be assembled so that the layout can be modified to accommodate any parts which may have different dimensions from those used by the author. The printed circuit board is a double-clad board, one side of which is used as a ground plane for the circuit. Ground-plane construction is standard practice in r.f. amplifiers, and it is highly recommended for this amplifier. The front and back printed circuit board layouts are shown in Fig. 3. The parts locations on the boards are shown in Fig. 4.

Care must be taken when laying out the board to insure that the layouts on both sides align. This is relatively simple since the only areas which must be etched on the ground plane side are circular pads through which the component mounting holes are drilled. First, prepare a negative for the circuit side of the board using standard PC layout techniques. Second, tape a clear sheet of mylar over the component side of this negative. Then place 0.125-inch adhesive circular PC layout pads on the mylar, carefully aligning one over each of the solder pad locations on the negative. There are 12 solder pad locations on each board which should not be covered with the circular pads. Six are used for connections from the circuit side of the board to the ground-plane side. The others locate the mounting screws for transistors Q10 and Q11 and the four mounting screws for attaching the PC board to the heat sink. After the mylar sheet is prepared, it can be used "as is" for exposure of the ground plane side of the board. However, it is preferable to make a photographic positive (i.e. double negative) of the layout to expose the board with.

To expose the board, first tape the two negatives together along two op-

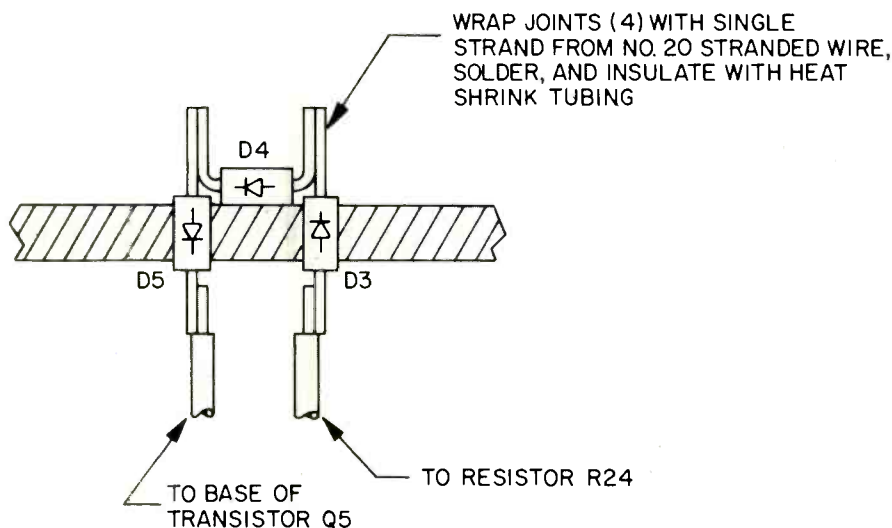

Fig. 5—Diagram showing proper mounting of the temperature compensating bias diodes on the main heat sinks.

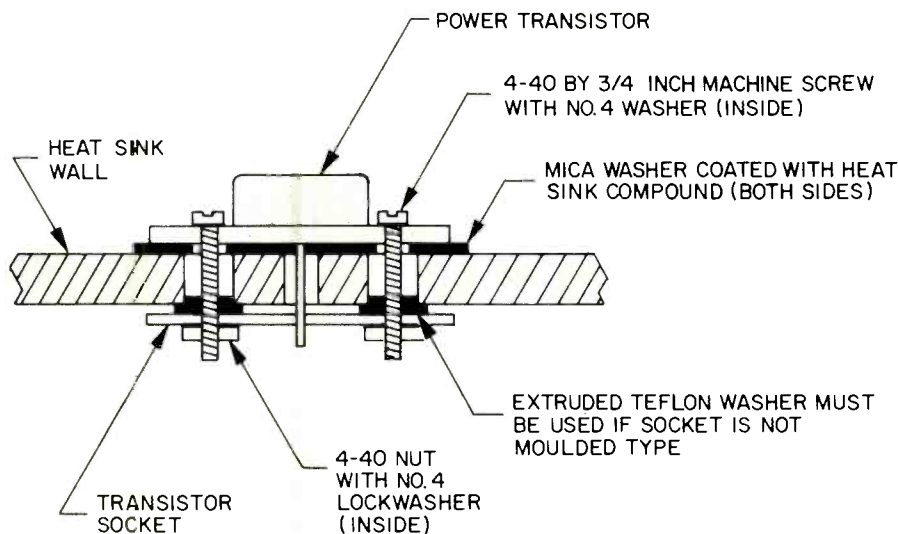
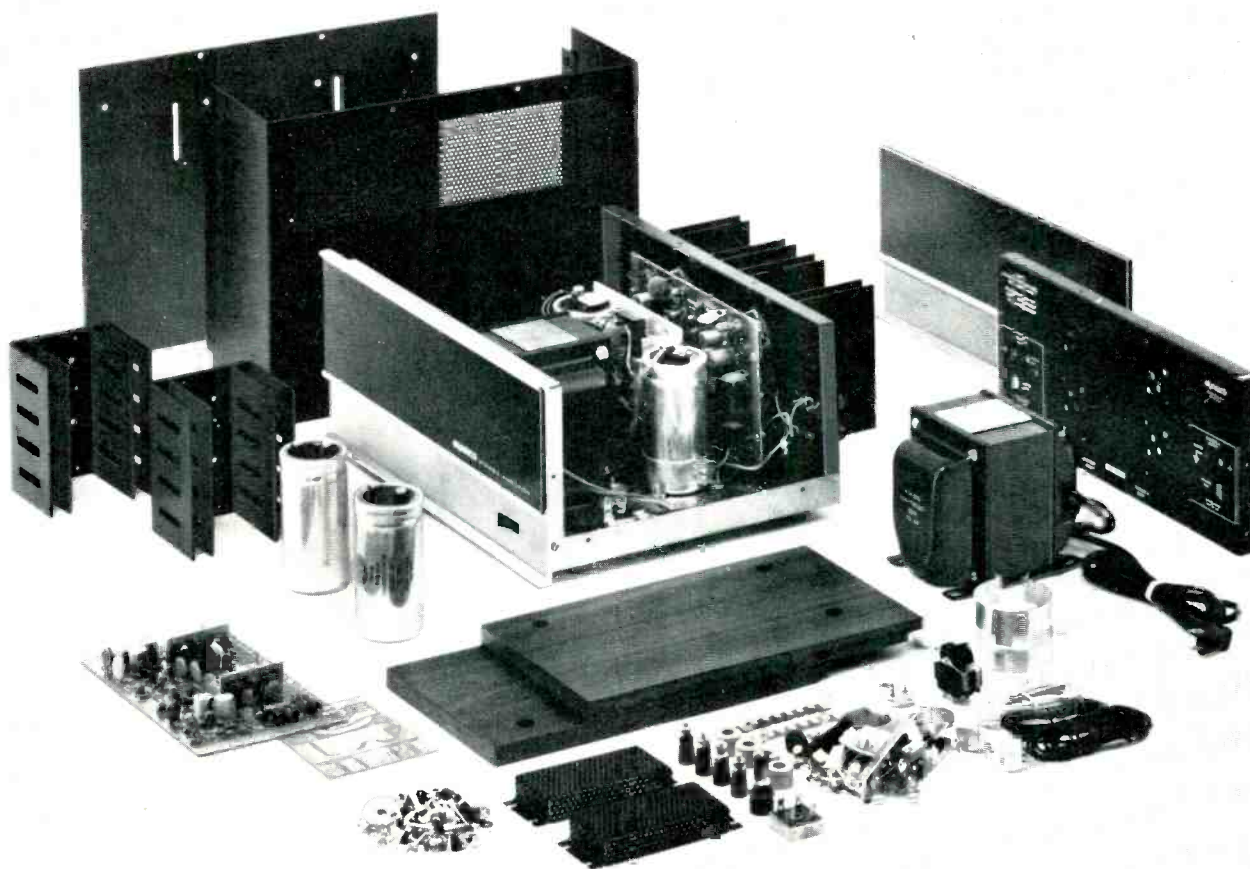

Fig. 6—Diagram showing proper mounting for transistors Q12 and Q13 on the main heat sinks.

not everyone could build a stereo kit...



until now.

Dyna takes the worry out of building kits.

If you've been scared away from stereo gear in kit form, let the new Stereo 150 amplifier change your mind. It's the superb new power amplifier from Dynaco—hi-fi kit specialists for 20 years.

The Stereo 150's preassembled circuit board pretests 90% of the audio circuitry so you *know* it'll work right before you open the kit. Plus saving \$120 in two evenings with screwdriver, pliers and soldering iron. You'll have the best *sounding* power amp going... DC coupled, full complementary symmetry 75 watt/channel*

output, a massive power supply to handle peaks perfectly, and the biggest heat sinks per watt.

Typically extraordinary Dynaco sound value... easy as **A B C**... **Any Body Can!**

*Into 8 ohms, 20-20kHz, at less than 0.25% total harmonic distortion.

For detailed specs on all Dynakit, and Dynaco speakers, write,

dynaco
dynakit P.O. Box 88
Blackwood, N.J. 08012 U.S.A.

posite edges after the two-sided layout has been carefully aligned. Be sure that the circuit side of each layout is on the *outside*. Otherwise, a mirror image circuit will result. Under dim yellow light, insert a double-clad, photosensitized blank board between the negatives. Next tape the negatives to the board along two opposite edges on both sides of the board. The negatives should now be properly aligned on the board, and it can be exposed one side at a time under ultraviolet light. If the board is developed in a flat pan, care should be taken not to scratch the fragile photoresist on the bottom surface of the board. The best rule to follow is not to rock the developing tray enough to cause the board to slide, otherwise the photo-resist will be scratched. A spray developer or vertical developing tank will eliminate these problems. After the board has been developed, it can

be etched and cut to size along the crossed lines which locate its four corners. All component mounting holes should next be drilled to the proper diameter. Too large a drill bit will lift the copper solder pads from the board, so care should be exercised. The four mounting screw holes for the board and the two mounting screw holes for transistors Q10 and Q11 should be drilled for a 4-40 screw.

The next step is to solder the six ground connections on each board. To do this, bend a 5/8-inch length of No. 20 solid wire into a 1/8 by 1/2-inch L-shape. Insert the wire through a ground hole with the 1/8-inch side against the ground plane. Solder the wire to the ground plane with a 100-watt soldering gun. To prevent the solder from running, do not touch the ground plane with the gun tip, but hold it against the wire and parallel to the ground plane. While applying

heat, feed solder to the tip until it fills the gap between the tip and ground plane, then lift the gun from the board. The resulting solder joint should then be in the form of a circular pad which firmly bonds the wire to the ground plane. The ground wires on the reverse side of the board can now be soldered and clipped.

After the ground wires are soldered, the boards should be thoroughly cleaned and the ground-plane side sprayed with a good brand of clear laquer to prevent corrosion. Before spray painting the boards, cover the four screw mounting holes which are used to attach the boards to the heat sinks with 3/8-inch circular adhesive pads to prevent the paint from insulating the areas where the mounting screw heads make electrical contact to the ground plane. After the paint is dry, the circuit side of the boards can be plated to prevent corrosion if desired. If a water-soluble tin-plate solution is used, the temperature of the solution should not be so high as to cause the painted ground-plane surface to peel.

The next step is to mount and solder all components to the boards using Fig. 4 as a reference. Care should be taken to insure that all transistors, diodes, and electrolytic capacitors are mounted exactly as shown in the figure and that no component leads come in contact with the ground plane. It is necessary to use mica washers and heat sink compound between transistors Q10 and Q11 and their heat sinks. These transistors should be secured to the board with 4-40 by 1/2-inch screws, lockwashers, and nuts. The screws should be tightened only enough to engage the lockwashers, otherwise the transistors may be damaged. The parallel combination of R31 and L1 is formed by tightly winding a length of insulated No. 20 solid copper wire around a 2.7-ohm, 2-watt resistor and soldering it to the resistor leads. All components should be mounted flush with the board except transistors Q1 through Q9, R29, and R30. These should be mounted 1/4 inch above the board. A TO-5 heat sink should be installed on each of transistors Q6 through Q9.

The next step is to prepare the temperature compensating diode assemblies. These must be mounted in holes drilled in the heat sinks between the power transistors as shown in Fig. 5. The holes should be just large enough for the diodes to fit as snugly as possible. The diodes can be any general purpose silicon rectifier diodes with an epoxy (not glass or metal) case. Be-

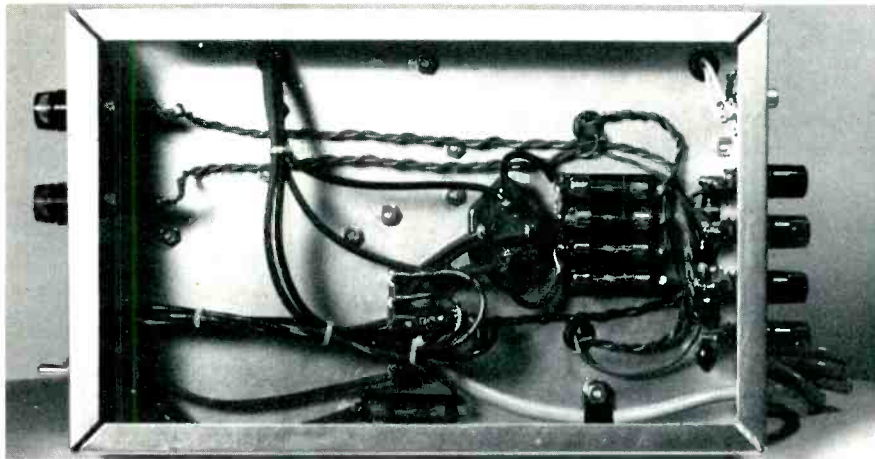

Fig. 7—Photograph of the underside of the chassis.

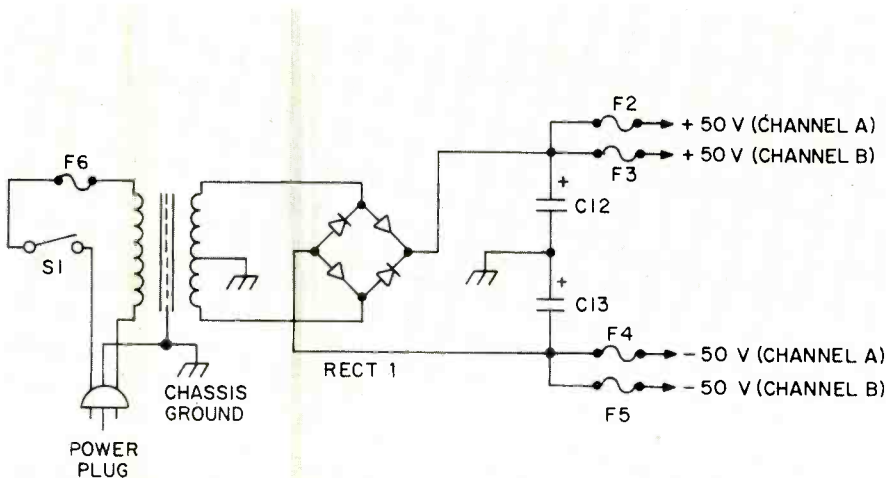

Fig. 8—Circuit diagram of the power supply.



OUR FLAT RESPONSE TO HIGH PRICES.



THE SUPER AS 210A. ONLY \$99.95.*

Our AS210A speaker gives a power frequency response that's flat ($\pm 3\text{db}$) all the way from 33Hz to 15,000 Hz.

Your ears will also be grateful for what it *doesn't* give you.

There's no bass boom acting as a poor substitute for good low-end response.

There are no high-frequency peaks providing phony brilliance at the treble end.

In sum: no exaggeration of highs or lows.

How did we do it?

By making significant improvements in a two-way ten-inch—one of the most thoroughly researched speakers.

You get a deluxe 10" woofer with a powerful

1-lb., 9-oz. ceramic magnet. A 1½" voice coil epoxy-bonded to the speaker cone for outstanding power handling. A 1½" Mylar dome mid/tweeter with a hefty Alnico V magnet. Sealed

air-suspension, of course. And much more.

What you hear is an extremely accurate copy of the original audio input.

At \$99.95, we think you'll find that our **SUPER AS 210A** is one of the best values on the market today.

For details, see your Sylvania dealer. Or write to: GTE Sylvania, 700 Ellicott St., Batavia, N.Y. 14020.

*Manufacturer's suggested retail price.

GTE SYLVANIA

Check No. 45 on Reader Service Card

fore soldering the diode bias assemblies together, install the diodes in the holes in the heat sinks, as shown in Fig. 5, and wrap a single strand of wire from No. 20 stranded wire around the leads to hold them together. The diode bias assembly can now be soldered together in place. It is very important to insulate all solder junctions with heat shrink tubing to prevent them from coming in contact with the grounded heat sinks. The leads from the diodes to the circuit board should be 6 inches long, and they should be twisted tightly together before they are soldered to the board from its circuit side. These leads should be No. 22 stranded wire, and they should be color coded to indicate the cathode and anode sides of the diode assembly.

Each power transistor should be installed on the heat sinks using a TO-3 insulating heat sink washer, a TO-3 transistor socket, and two firmly tightened 4-40 by 3/4-inch screws with lock washers and nuts. If mica insulating washers are used, both sides should be liberally coated with heat sink compound. The newer and more efficient silicon rubber washers do not require a heat sink compound, and they are recommended. If the transistor sockets are not of the molded type, it is very important to insulate the 4-40 screws from the heat sinks with extruded Teflon washers. Remember that the case of the output transistors and their mounting screws are at the full power supply voltage. Therefore, extreme care should be taken to insulate them properly from the heat sinks. The proper mounting of the output transistors is illustrated in Fig. 6. After the sockets are installed, solder a 6-inch length of No. 20 stranded wire to each of the three terminals on each socket. These can now be soldered to the correct points on the circuit side of the board. Before mounting the circuit boards to

the heat sinks, solder a 16-inch length of No. 20 stranded wire to the speaker output lead and an 8-inch length of No. 20 stranded wire to the +50 volt power supply input and the -50 volt power supply input on each circuit board. These wires should all connect from the circuit side of the board, as do the leads from the diode bias assemblies and output transistors.

The circuit boards can now be mounted to the flanged edges of the heat sinks with four 4-40 by 3/4-inch screws, four nuts, and eight lock washers (one under each screw head and one under each nut). A 1/2-inch insulating sleeve must be placed on each mounting screw between the circuit board and the heat sink to provide the necessary clearance between the two. The mounting screws should be tightened sufficiently to firmly engage the lock washers, for it is through them that the ground connection for the circuit boards is made.

The Chassis

Figure 1 shows the amplifier constructed on a 7 x 11 x 2-inch chassis. The top of the chassis contains the two circuit board heat sink assemblies, the power transformer, and the two filter capacitors. The rear panel contains the four speaker output terminals, the phono input jacks, and the feedthrough hole for the a.c. power cord. Although not visible in the figure, the front panel contains the a.c. power switch and the two speaker fuse holders. The underside of the chassis contains the bridge rectifier, a five-lug terminal strip, the a.c. power-line fuse clip, and four fuse clips for fusing the d.c. power supply leads to each circuit board. The layout of these components is shown in Fig. 7.

The first step in assembling the chassis is to drill all chassis mounting holes and mount all components with the exception of the circuit board/heat sink assemblies. As shown

in Fig. 1, the two heat sinks are mounted 1/2 inch above the chassis on L-brackets which can be fabricated from 1/16-inch sheet aluminum. The heat sink fins are interleaved to conserve space. In addition, this creates a chimney effect to aid in the circulation of air through the heat sink assemblies. For adequate cooling, the heat sinks should not be mounted closer than 1/2 inch to the chassis. In addition, the outer two edges of the heat sinks should not be closer than 1-1/4 inches from the edge of the chassis. This will allow sufficient room to mount the circuit boards on the heat sinks without their components overhanging the edge of the chassis.

A total of four 3/8-inch holes should be drilled in the top of the chassis, and rubber grommets installed in them. One hole adjacent to the filter capacitors carries the four leads from the power supply to these capacitors. One hole directly above the phono input jacks carries the two signal input leads from the jacks to the circuit boards. One hole centered 1 inch behind each circuit board carries the two power supply leads and speaker output lead for that respective channel.

The power supply circuit shown in Fig. 8 uses a single ground point for all high current leads to minimize hum and ground-loop problems. The ground point used in Fig. 8 is the center ground lug of the terminal strip. To this point are connected the power transformer secondary center-tap lead, the two filter capacitor ground leads, and the two speaker ground leads. To further minimize ground loop problems, the ground terminal of each phono input jack is isolated from chassis ground by a 2.7-ohm resistor. Although insulated phono jacks are available, the phono jacks and 2.7-ohm resistors for the unit in Fig. 1 are mounted on a small printed circuit board behind the rear panel of the chassis. Ground connection to the circuit board is made through two of the 4-40 by 1/4-inch mounting screws, lock washers, and nuts.

After drilling all mounting holes in the chassis and installing grommets in the appropriate ones, the power transformer, filter capacitors, phono jacks, speaker output connectors, a.c. power switch, speaker fuse holders, power supply fuse clips, bridge rectifier, and terminal strip should be mounted on the chassis. Lock washers should be used under all nuts, and the mounting screws should be tightened securely. The chassis is wired with No. 18 and No. 20 stranded wire. Red and

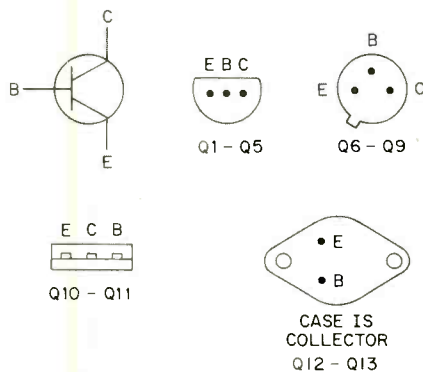

Fig. 9—Transistor lead connections.

The New AR-16

A Best Buy from Acoustic Research

The best kind of loudspeaker is one that plays back the music on the record or tape with the greatest degree of fidelity. The best value is the loudspeaker that comes closest to this ideal at the lowest cost. This is true whether it is the music of The Stones, Coltrane, or Stravinsky. What you want from the record is exactly what the musicians, composers, and engineers put there. Nothing more, nothing less.

Acoustic Research has been designing and manufacturing high fidelity loudspeakers based on this approach for over 20 years. It is against this background of experience that we make the statement that the AR-16 is the best buy we have ever offered the public.

Performance

For a price of \$100, the AR-16 offers a unique combination of uniform energy response and flat anechoic frequency response. A crossover network of much greater refinement than is found in other two-way speaker systems gives the AR-16 uniform radiation over almost as wide a frequency range and solid angle as the most expensive AR speakers.

The performance of the AR-16's 8 inch woofer has been improved to the level of most 10 inch acoustic suspension designs. With a system resonance frequency of 55 Hz and near-critical damping, usable

response has been extended to below 40 Hz, approximately the lowest note on the orchestral double-bass.

A new cabinet design eliminates audible diffraction effects by avoiding all unnecessary projections and allowing for the mounting of both drivers flush with the front surface.

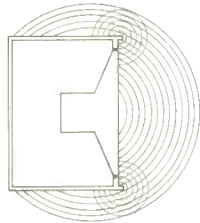

Cabinet diffraction effects, graphically illustrated above, are absent in the AR-16 because of the elimination of unnecessary moldings and projections.

These performance characteristics, rarely combined even in far more expensive speakers, are essential for the accurate reproduction of music under actual listening conditions and for maintaining proper tonal balance for listeners in various parts of a room.

Appearance

The special cabinet construction of the AR-16 has also made possible an attractive departure in appearance from conventional speakers. The oiled walnut wood



finish of the cabinet sides is continued on the front. An acoustically transparent foam grill, mounted in the center of the front baffle, is the only element that projects beyond the flush-mounted drivers.

'Best-Buy' value

The AR-16 is an extremely accurate — and attractive — high fidelity reproducer. Its combination of price, performance, and styling place it at the point beyond which improvements are achieved only at disproportionately higher cost ... exactly what value is all about.

Guarantee

The performance specifications of the AR-16, like those of the most expensive AR speakers, are guaranteed for five years.

For a complete description of the AR-16, fill out and mail the coupon today.



Acoustic Research
10 American Drive
Norwood
Massachusetts 02062
Telephone 617 769 4200

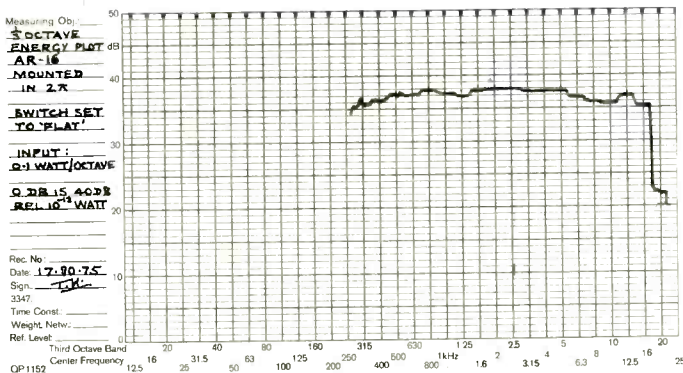

Energy response of the AR-16 speaker system. Woofer performance below 40 Hz (not shown above) is equivalent to that of most 10-inch acoustic suspension designs.

Please send me a complete description of the AR-16

Please send me the AR demonstration record 'The Sound of Musical Instruments' (check for \$5 enclosed)

Name _____

Address _____

black color-coded leads are recommended to distinguish between the ground and different polarity leads. No. 18 wire should be used for all leads to and from the filter capacitors and bridge rectifier. No. 20 wire should be used for all power supply leads from the fuse clips to the circuit boards and for all speaker leads.

After the power supply has been wired, the circuit board/heat sink assemblies can be mounted on the chassis and wired to the power supply fuse clips and the speaker fuse holders. The No. 20 wires for these connections should have already been soldered to the circuit boards. After this is done, the speaker output connectors can be wired to the speaker fuse holders and the chassis ground connection on the terminal strip. No. 20 stranded wire should be used for these connections. To make the wiring neater, the two power supply leads to each circuit board should be twisted together before soldering them in place, as should the two wires to and from each speaker fuse holder and the two speaker ground wires.

Across the speaker output terminals of each channel, a 10-ohm, 2-watt resistor in series with a 0.1 microfarad capacitor should be soldered. These should be connected and insulated so that it is impossible for the solder junction between the resistor and capacitor to accidentally come in contact with a hot terminal under the chassis.

Cable ties are recommended to bind the transformer and filter capacitor leads as shown in Fig. 7. In addition, an insulated strain-relief feedthrough or a grommet and insulated strain-relief clamp should be used to prevent the a.c. power cord from being accidentally pulled from the amplifier. This will also insulate the power cord jacket from the sharp metal edges of its feedthrough hole.

The final step is to connect the

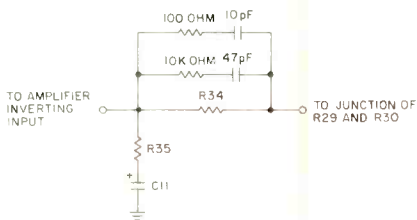

Fig. 10—Circuit diagram of the alternate feedback network.

shielded phono cables from the phono input jacks to the circuit boards. These cables should not be routed near any speaker or power supply lead, otherwise oscillations could occur due to mutual coupling between the leads. The input cables should be routed through the chassis hole above the phono jacks, up the outer edge of the circuit board/heat sink assemblies as shown in Fig. 1, and soldered to the rear of the circuit boards. After this step is completed, all wires connecting to the rear of the boards should be checked to see that they do not make contact with any component on the ground plane side of the board. If any of these wires protrude through the boards to the ground plane side, they should be clipped flush with the board.

Initial Turn-On and Adjustments

Before any attempt is made to apply power to the amplifier, it is strongly recommended that the entire unit be checked very carefully for errors. All solder joints, transistor and diode lead connections, and polarity of electrolytic capacitors should be checked especially. If everything appears to be correct, the initial tests can be performed. First, install the a.c. power fuse. Do not install the four d.c. fuses to the circuit boards at this point. Plug the a.c. power cord into a Variac auto-transformer, turn the amplifier on, and slowly increase the a.c. voltage with the Variac while monitoring the + and - d.c. outputs of the bridge rectifier. The two voltages should have equal magnitudes, and the polarities should be correct. If both filter capacitors are polarized correctly, the a.c. voltage can be increased to 120 volts. (Do not increase the Variac above that value.) The positive and negative d.c. power supplies should then read within one or two volts of 50 volts. The a.c. power can now be removed and the filter capacitors discharged by holding a 1-kOhm resistor across the terminals of each until the voltage falls to zero.

In the next test, d.c. power is applied to each circuit board individually. Before proceeding, adjust potentiometer R25 for maximum resistance, i.e. 5 kOhm. This should be veri-

fied with an ohmmeter, otherwise the power transistors may be damaged in the next test. Install the two fuses for the d.c. power to one channel. Connect a 1-kHz signal of amplitude 1 volt rms to the input of that channel and an oscilloscope to its speaker terminals. Do not connect any other load to the amplifier. With the a.c. power switch on, slowly increase the a.c. voltage with the Variac until the output signal is observed. The signal will initially appear as a clipped sine wave. There should be no d.c. voltage on the speaker terminals. The a.c. voltage should not be increased by more than about 10 volts at a time without feeling each transistor in that channel including the output transistors for overheating. If any transistor becomes hot to the touch, immediately remove the a.c. power, for the circuit contains a wiring error or has a defective component.

If no transistor overheats, the a.c. voltage can be increased to 120 volts. The sine wave output should no longer appear clipped, and its amplitude should be 20 volts rms or about 56 volts peak-to-peak. The a.c. voltage can be reduced to zero and the other channel tested similarly after first discharging the filter capacitors with a 1-kOhm resistor.

If the preceding tests are successful, the bias potentiometers (R25) can be adjusted next. With no input signal or load on either channel, turn the amplifier on and decrease R25 until the voltage across Q5 is 3.45 volts on each channel. A d.c. voltmeter with a floating ground should be used for this adjustment. The voltmeter leads can be clipped to the heatsinks on transistors Q6 and Q7, for the collectors of these transistors are connected across Q5. While adjusting R25 for a 3.45 volt reading, alternately feel each output transistor in that channel for overheating. If either output transistor begins to warm up, that channel is defective or the d.c. voltmeter is not calibrated correctly. When R25 is properly adjusted, the heat sinks on which the output transistors are mounted will be barely warm to the touch after the amplifier has idled for approximately 30 minutes.

An alternative adjustment of R25

Table I—Parts List for power supply and one channel

All resistors are 1/4 watt, 5% unless otherwise specified.

R1—2.7 ohm

R2—2.7 kOhm

R3—33 kOhm

R4, R5, R6, R7—1 kOhm

R8, R9, R10, R11—100 ohm

R12, R13, R12A, R13A, R16, R17—3.9 kOhm

(Continued On Next Page)

TWICE AGAIN, HISTORY REPEATS ITSELF.

Carrying on the innovative tradition of our almost ninety year involvement in music,
Yamaha announces a double breakthrough in all-FET technology.

Yamaha's C-1.

At \$1800, you've never seen a preamplifier like this before.

It's so different we call it the Master Control Center. You'll call it well worth waiting for.

From input to output, it's the first to use advanced FET's exclusively throughout the signal path.

Yamaha's C-1 is made for perfectionists who appreciate the superb clear tonality and exceedingly low distortion that only FET's can bring.

For advanced audiophiles who want the complete control over literally thousands of audio variables that only the most advanced circuits and features can offer.

A built-in oscillator.

Consider the C-1's unique built-in oscillator with level control, a professional test instrument that's usually found only in sophisticated audio labs.

By generating both random "pink" noise as well as the four most useful test tones (70 Hz, 333 Hz, 1 kHz and 10 kHz), the C-1's oscillator can be put to a variety of tasks:

Determining the precise phono impedance loading, checking the frequency response of speakers, A-B speaker comparisons, setting up a tape deck, balancing the output level of an entire system, and balancing room acoustics. You'll discover more and more uses as you go along.

(A word of caution: because the C-1's oscillator can be used externally, all your audiophile friends will want to use it to test their own components.)

Where most other manufacturers use a negative feedback design in their phono equalizer amplifiers, Yamaha specified the more sophisticated passive interstage equalizer (CR-type). The results were worth it:

Greater stability, lower distortion, superior tonality.

In our all-out effort to reduce noise at all preamp output levels (not just at

maximum output), the C-1 features a unique four-gang volume control that simultaneously adjusts inputs and outputs.

You're totally in control.

With the C-1's selectable equalization controls for presence and acoustic balance, you enjoy the equivalent of a separate equalizer. For those occasions when you don't want to use equalization controls, the C-1's special circuitry lets you bypass them completely.

Another unique feature that sets the Yamaha C-1 Master Control Center apart from other so-called state-of-the-art preamplifiers:

Six-position selectable phono impedance that allows your cartridge to be precisely loaded for optimum high frequency performance.

The Yamaha C-1's absolute control over sound also includes a pair of extra wide-range (-50 db to +6 db) peak reading meters. Electronic damping provides both faster peak readings and slower decay, assuring precise monitoring. You can also use the C-1's meters to monitor any external component that doesn't have meters.

Writing in *Audio* about our unique metering system, Bascom H. King stated:

"...by far the most accurate and meaningful of any meter set-up seen thus far."

Individual level controls let you balance the input from all signal sources, except the tuner. (Yamaha's companion tuner, the CT-7000, has its own variable output level adjustment.) So the volume level stays the same when you switch, for example, from tape to phono, tuner to aux, etc.

And there's more.

Enough that once you hear the Yamaha C-1, you'll never be satisfied with another preamplifier again.

Yamaha's B-1.

At \$1600, it's already redefined state-of-the-art amplifier performance in a lot of people's minds. Yours might be next.

Revolutionary Vertical-FET design produces a completely different kind of sound. Clean, open and transparent. With a richness that goes beyond the best vacuum tube amplifiers.

And, up to now, unavailable.

Worth the wait.

As late as a few years ago, there existed only two types of transistors: bipolar and horizontal FET. Each operated in a completely different manner.

The bipolar device uses input current to control output current. On the other hand, the horizontal FET uses input voltage to control output current—a more suitable audio technique that's quite similar to vacuum triode tube design. (Both use input voltage to control output current; both have sharp cut-off characteristics which eliminate high-order harmonics and notch distortion.)

Only there was a small problem.

Because current passage was restricted to a single path, the horizontal FET didn't produce enough power to be used in the output stages of a power amplifier.

Then, in 1971, Prof. Nishizawa of Tohoku University drastically changed the FET's internal structure. The shape of the voltage-controlled constriction was altered to let the current take an almost infinite number of paths.

And so, the Vertical-FET was born.

During the past three years, working exclusively with Prof. Nishizawa, Yamaha's engineers have brought the Vertical-FET to the forefront of audio technology, where it serves as both driving and output devices in our new B-1 amplifier.

The B-1's rated 150 watts per chan-

nel (20 Hz to 20 kHz, less than 0.1% THD) are produced by only two Vertical-FET output devices per channel.

Compare that with the minimum of six to eight output devices per channel found on most other amps!

Yamaha knows that fewer output devices minimize the distortion caused by out-of-balance output devices during transistor switching cycles. And maximize tonality.

People are talking.

Here's what Julian Hirsch of *Stereo Review* had to say about the power-handling capacity of Yamaha's new Vertical-FET:

"Each of the FET's is about the size of an ordinary power transistor, but it can dissipate 300 watts!"

Audio's Bascom H. King observed that the B-1's power output at visual onset of clipping for an 8-ohm load was 220 watts—46% over spec!

So you can see that our 8-ohm rating of 150 watts is quite conservative indeed!

Because the B-1 is used as a reference amp by many of our dealers, we supply an optional control unit that can A-B up to five pair of speakers and balance them for efficiency at the head amp. Without the insertion of T-pads that degrade low-end response by decreasing damping characteristics.

It's called the UC-1. It costs \$250. And you don't have to be a Yamaha audio dealer to own one.

Besides speaker switching, the UC-1's extra wide-range peak delay meters, with faster peak and slower decay like those on the C-1 (but calibrated in both dB's and watts of power output), offer an extremely precise monitoring capability to your system.

Yamaha's C-1 and B-1, \$3650 the pair, with the UC-1 control unit.

After you hear them together, you'll never be satisfied with anything less.



International Corp., P.O. Box 6600, Buena Park, Calif. 90620

Check No. 51 on Reader Service Card

Equipment Profiles

GTE Sylvania Model RS4744 Stereo Receiver



MANUFACTURER'S SPECIFICATIONS

FM Tuner Section

IHF Sensitivity: 1.8 μV (10.5 dBf). **50 dB Quieting:** 3.0 μV (14.93 dBf). **S/N Ratio:** 67 dB. **Capture Ratio:** 1.5 dB. **Image Rejection:** 53 dB. **I.F. Rejection:** 50 dB. **Selectivity:** 55 dB. **AM Suppression:** 35dB. **Spurious Rejection:** 80dB. **THD:** Mono, 0.4%; Stereo, 0.4%. **Stereo Separation:** 1 kHz, 40 dB; 50 Hz to 10 kHz, 30 dB. **FM Muting Threshold:** 5 μV (19.37 dBf).

AM Tuner Section

Sensitivity: 200 $\mu\text{V/m}$ (internal antenna). **Image Rejection:** 60dB. **Selectivity:** 28dB.

Amplifier Section

Power Output: 60 watts per channel min. rms at 8 ohms from 20 Hz to 20 kHz, with no more than 0.25% total harmonic distortion. **Damping Factor:** 20. **IM Distortion:** 0.25% at rated power output. **Frequency Response:** Phono, RIAA ± 1.5 dB; High Level, 7 Hz to 70 kHz ± 1.0 dB. **Input Sensitivity:** Phono, 2.2 mV; Mike, 1.2 mV; Tape and AUX, 250 mV. **S/N:** Phono, 70 dB below 10 mV input; Mike, 65 dB below 5 mV input; AUX and Tape, 75 dB below 250 mV input. **Tone Control Range:** Bass, ± 18 dB @ 50 Hz; Mid-Range, ± 10 dB @ 1.5 kHz; Treble, ± 12 dB at 10 kHz. **Filters:** Low, -20 dB @ 20 Hz, 12 dB/octave; High, -20 dB @ 20 kHz, 12 dB/octave.

General Specifications:

Dimensions: 17-3/4 in. W by 6 in. H by 15 in. D. **Weight:** 29 lbs. **Suggested Retail Price:** \$479.95.

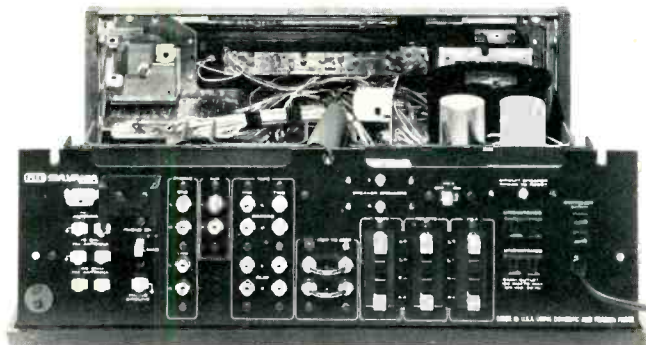

Fig. 1—Rear view of Sylvania RS4744.

It is fairly obvious, even from a cursory examination of the RS4744, that GTE Sylvania means to capture whatever share of the high end of the component audio business that is to be had, and wipe out whatever association the firm had with medium-fi compacts and consoles. "Obvious," we say, since it seems obvious to us that the Batavia, New York firm has spent a great deal of engineering and design time to create a line of stereo receivers that combines the advantages of American mass-production economies with the top audio performance of true componentry. If the RS4744 is typical of the results, we would say that Sylvania's efforts should prove successful.

This most powerful of Sylvania's new receivers has a good looking, bronze-gold colored front panel with enough controls and buttons to satisfy the audio perfectionist. A large black-out dial area includes a long, linearly calibrated FM frequency scale (with markings at every half MHz), an equally long AM scale, and a 0-100 reference logging scale. The dial pointer is illuminated for easier visibility. To the left of the scales are a pair of illuminated meters for signal strength and center-of-channel FM tuning. At the right of the dial scale, the words "FM MPX" light up to indicate stereo FM reception, and beyond the dial area to the right is a large metal tuning knob coupled to a fairly effective fly-wheel.

A power on/off push button and phone and mike jacks are located at the lower left of the panel, followed by main and remote speaker lever switches. Operation of these switches is such that with both main and remote levers in their "up" positions, main speakers are engaged. To activate remote speakers, that switch must be thrown downward, as must the "main" switch to *turn off* the main speakers—a nice touch of human engineering that maintains symmetry of switch positions for most often used applications.

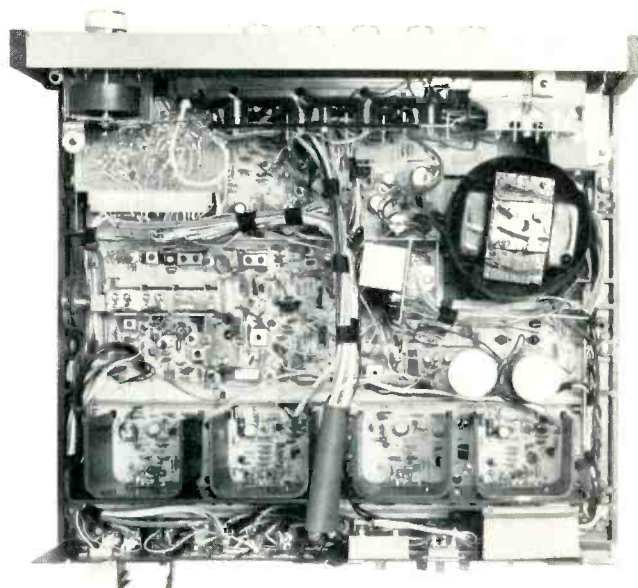

Fig. 2—Internal view.

Dual concentric, clutch-type bass, mid-range, and treble controls of the rotary type come next, followed by the usual balance and master-volume controls. At the lower right of the panel are two rows of pushbuttons. The upper row of six handles two tape monitor circuits, high- and low-cut filters, mono/stereo switching, and loudness control activation. The lower row of six selects program sources (a pair of phono inputs, AUX, AM and FM) and muting for FM. If both phono buttons are depressed simultaneously, the mike input circuit is selected—another nice touch that cuts down on the number of required buttons.

The rear panel of the RS4744 is pictured in Fig. 1. The AM ferrite-bar antenna is supplied in a separate package, and must be slipped into a retaining slide and plugged in to an appropriate multi-contact socket on the rear panel. This simplifies packaging of the receiver and prevents possible breakage of the bar antenna during shipment. Screw terminals are provided for external AM antenna and 75-ohm or 300-ohm FM antennas. Of the two pairs of phono inputs, one pair is associated with a slide switch which converts it to a ceramic phono-cartridge input. While it is convenient to be able to thus use a ceramic cartridge directly, we question whether anyone investing just under \$500.00 in a stereo receiver would really use a ceramic cartridge with it. AUX input jacks and tape in and out jacks for the two tape monitor circuits come next, followed by preamp out/main amp in jacks with the usual jumpers connected between them. There are three sets of speaker terminals of the push-to-insert speaker wire type. Besides main and remote pairs of speakers, a pair of speakers may be connected to the third set, identified as PQ-4, and turned on by means of a slide switch to provide a synthesized four-channel effect through a passive matrix network built into the receiver. Speaker and power line circuits are equipped with resettable circuit breakers—tiny red buttons are pressed to reset the breakers in the event of overload, thereby eliminating the need for fuses. A pair of unswitched and one switched a.c. receptacle and a chassis ground terminal complete the rear panel layout.

An internal view of the RS4744 chassis is shown in Fig. 2. Most of the circuit parts are contained on a single, massive printed circuit board, as opposed to the modules used by other manufacturers. It is clear, too, that this same master board is used for less powerful, less expensive models in the Sylvania line. A sub-panel PC board containing one row of switches (tape monitors, filters, mono/stereo and loudness) is wired to the "mother board by means of a multiple connector cable.

FETs are used in the FM front-end as r.f. amplifier and mixer, which are tuned by means of a three-section variable capacitor. A pair of ceramic filters are used between i.f. stages, followed by an IC limiter-amplifier-quadrature detector. The MPX circuit is a phase-lock-loop type, contained in a single IC which requires no coil alignment for optimizing separation. A rather elaborate muting circuit utilizes several transistor stages plus an FET Mute Gate. The AM section uses discrete parts and is tuned by means of a three-gang capacitor and tunable i.f. coils. Phono preamplifiers utilize two transistors each with negative feedback applied for RIAA equalization. Tone-control circuitry is of the negative-feedback type, and tone-amplification circuits use a single Darlington circuit for each channel. The first stage of each power amplifier section is a differential amplifier, and there is direct coupling from input to speaker output in these sections. Output stages are powered by plus and minus 50 volts in a push-pull complementary (NPN-PNP) symmetry arrangement. An electronic current-limiting circuit protects the amplifier from improperly connected speakers, ex-

cessive current or short circuits. In the event of overload, a relay actually disconnects the secondary of the power transformer from the high-voltage supply rectifiers.

FM Section Measurements

The graphs in Fig. 3 show some of the most important FM performance characteristics. Usable sensitivity measured 1.9 μV (11.0 dBf), as against 1.8 μV claimed. The 50-dB quieting figure exceeded the published 3.0 μV claim, requiring only 2.8 μV (14.33 dBf) of input signal strength. Ultimate quieting in mono was 72 dB, with best quieting of 60 dB obtain in stereo operation. Stereo usable sensitivity was a low and excellent 4.0 μV (17.4 dBf), and muting threshold was set to 5 μV . Distortion at mid-audio frequencies measured 0.27% in mono; 0.3% in stereo, both better than claimed. Capture ratio measured exactly 1.5 dB as claimed, and selectivity was 57 dB, a bit better than claimed but not as good as other receivers in this price category. This specification, as well as the moderate i.f. rejection (50 dB) and AM suppression (35 dB), appears to be a combined result of the rather minimal r.f. and i.f. circuitry used in this design.

Stereo FM separation is plotted in Fig. 4 and measured 40 dB at mid-frequencies, decreasing to 32 dB at 50 Hz and 31 dB at 10 kHz. Distortion in both mono and stereo remained at or below 0.5% for all frequencies up to 9 kHz. At the three frequencies specified in the new FM measurement standards, THD was 0.4% (100 Hz), 0.27% (1 kHz) and 0.22% (6 kHz) in mono and 0.5%, 0.3% and 0.25% in stereo.

Power Amplifier Measurements

While GTE Sylvania, like all high-fidelity component makers, properly specifies power output for the RS4744 in accordance with FTC regulations, they also publish (in suitably

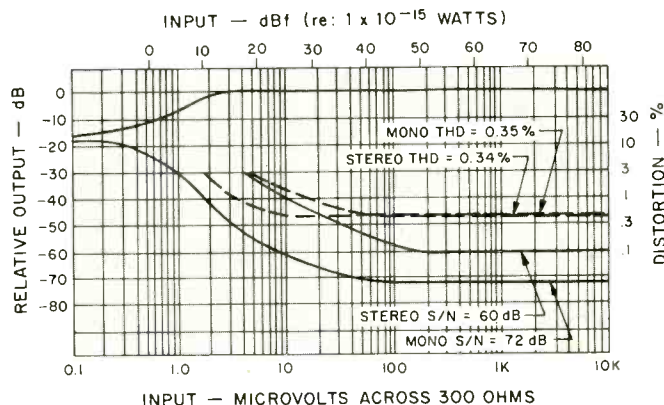

Fig. 3—FM quieting and distortion characteristics.

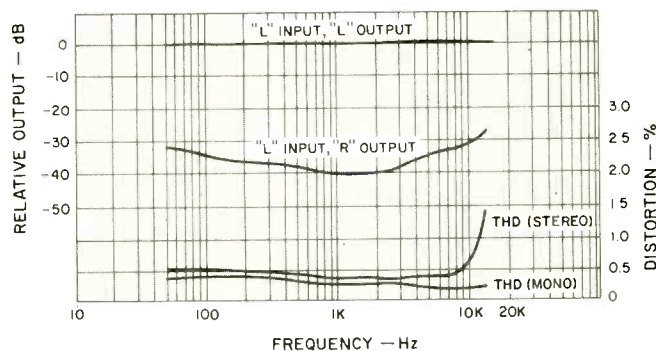

Fig. 4—Separation and distortion vs. frequency.

smaller type face) mid-frequency power capability, which is listed at 75 watts per channel. We actually measured 77 watts of output per channel at 1 kHz with both channels driven, into 8 ohm loads, before the 0.25% rated THD figure was reached, as shown in Fig. 5. At the nominal "FTC power" of 60 watts per channel, THD measured below 0.1% for this mid-frequency. IM distortion in our sample was a bit higher than specified, reaching 0.3% at the nominal 60 watts output, and 0.45% at 75 watts output. The reason for the lower (60 watts) rating over the entire audio band becomes clear when you examine the distortion-versus-frequency graph of Fig. 6. At 20 Hz, with 60 watts delivered from each channel, THD reaches the specified 0.25%. All of these measurements were made after first preconditioning the receiver for one hour, during which time it delivered continuous power of 20 watts per channel into 8 ohm loads.

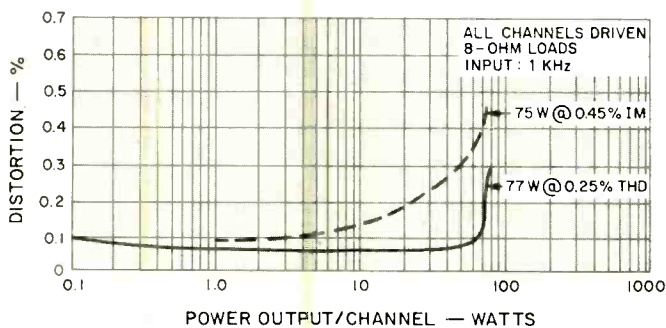

Fig. 5—Harmonic and intermodulation distortion characteristics.

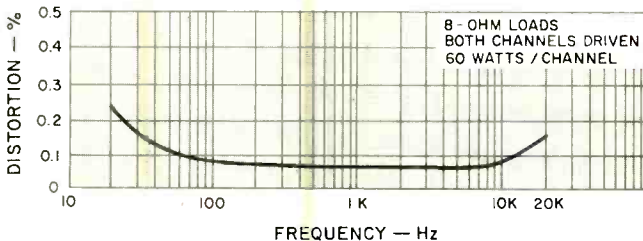

Fig. 6—Distortion vs. frequency.

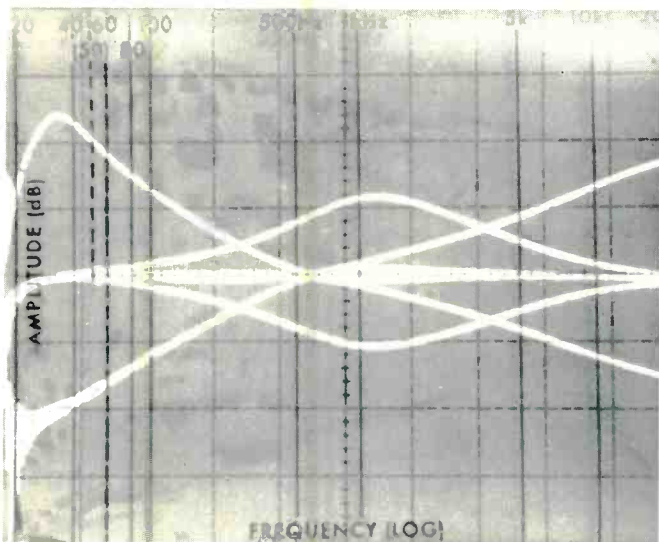

Fig. 7—Control range of base, mid-range, and treble controls.

Preamplifier Control Section Measurements

Phono input sensitivity was identical for both sets of inputs and measured 2.8 mV. Maximum signal input at 1 kHz before overload distortion became apparent was 125 mV. RIAA equalization accuracy was within 1 dB from 30 Hz to 15,000 Hz, and frequency response for high level inputs was flat to within 1 dB from 5 Hz to 38 kHz, with the 3-dB roll-off point occurring at 70 kHz. Figure 7 is a 'scope photo of sequential traces made by our spectrum analyzer from 20 Hz to 20 kHz and depicts the full range of all three tone controls of the RS4744 receiver. Bass boost and cut range is greater than we normally find on receivers, with nearly 20 dB of boost and cut available at the 50-Hz point (each vertical division of the 'scope graticule is equal to 10 dB of amplitude). The action of the extra mid-range tone control is exactly as expected and is centered at around 1.5 kHz as claimed.

In Fig. 8 we plotted action of the loudness compensation circuit from full volume to a -50 dB setting in approximately 10 dB steps and, as can be observed, action involves bass emphasis only. Action of high- and low-cut filters is shown in the 'scope photo of Fig. 9, and a comparison with maximum attenuation of the bass and treble controls (Fig. 7) shows the advantage of these 12-dB-per-octave filters in eliminating noise and rumble with least degradation of musical frequency response.

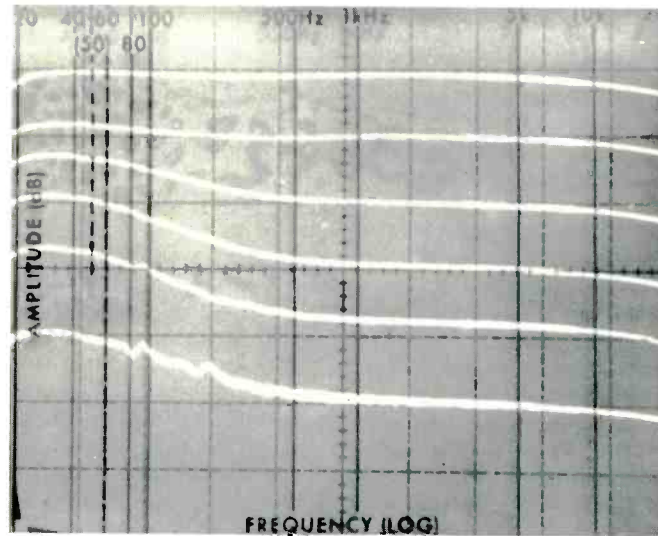

Fig. 8—Loudness control action from full cw setting of volume control to -50 dB below full volume.

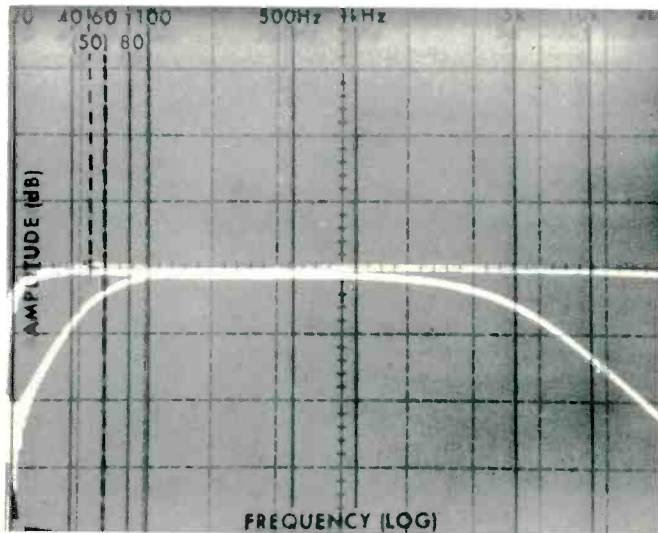

Fig. 9—Action of high-cut and low-cut filters.

Four questions you must ask about any multiple-play turntable.

1. Does it perform as well as any single-play turntable?



There are some who believe that a single-play turntable is somehow inherently better than a multiple-play unit. All right—the Z2000B is a single-play turntable. Its capacity to function as a multiple-play unit offers convenience with no compromise of performance. The *automatic* mechanism which gently indexes the arm, lifts it at the end of play, returns it to the arm rest and shuts off the motor—is completely disengaged during record play. A 2-position control sets the proper vertical tracking angle for single or multiple play. The Z2000B can truly be called the automated single-play turntable with multiple-play capability.

2. Does it have belt-drive and variable speed?

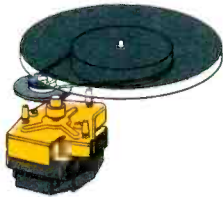

Garrard engineers have attained remarkable results by combining the world famous Synchro-Lab motor and an inventive belt/idler drive combination. A 5 lb., die-cast, dynamically balanced platter is rotated via a flexible belt. Not only are the tiniest fluctuations of speed smoothed out, but an extraordinary -64dB rumble is only one example of the impressive specifications achieved. A variable speed control corrects out-of-pitch recordings and an illuminated stroboscope provides optical confirmation. The Z2000B combines all of these elements to achieve the main goal of Garrard engineering: superior performance at reasonable cost.

3. Does it handle records gently?

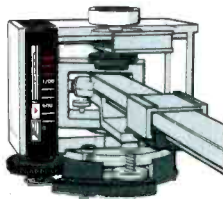

All responsible turntable manufacturers are concerned with protecting your records. With Garrard, it's an obsession. The Z2000B boasts an array of features designed solely to prolong the life of your records. In addition to the exclusive, articulated tonearm, it incorporates an exceptionally accurate magnetic anti-skating device. Cueing is viscous damped in both directions. The ingenious built-in automatic record counter keeps track of how many LP sides the stylus has played. And unlike some of the highest priced changers that support records only at the center hole, the Z2000B supports them at the hole *and* edge, and the release mechanism operates at *both* points. Protection for your records indeed!

4. Does it eliminate tracking error?

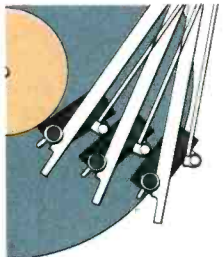

The grooves of a record are cut by a stylus that travels in a straight line. Conventional playback tonearms move in an arc. The difference between these two paths is called "tracking error." Simply stated, tracking error launches a cycle of distortion and record wear. In good design, the error is averaged over the record so that distortion is minimal. But such compromise was unacceptable in the Z2000B. What Garrard engineers did about it was summed up by High Fidelity Magazine which described the Zero Tracking Error Tonearm as "...the best arm yet offered as an integral part of an automatic player." The Z2000B is the *only* automatic turntable in the world without tracking error.

The Garrard Z2000B. Yes. Yes. Yes. Yes.



\$229.95

Garrard

The Automatic Choice

For your free copy of the New Garrard Guide, write to Garrard, Division of Plessey Consumer Products, Dept. C, 100 Commercial St., Plainview, New York 11803

Check No. 17 on Reader Service Card

**Infinity reshapes
the state of the art.
Again.**

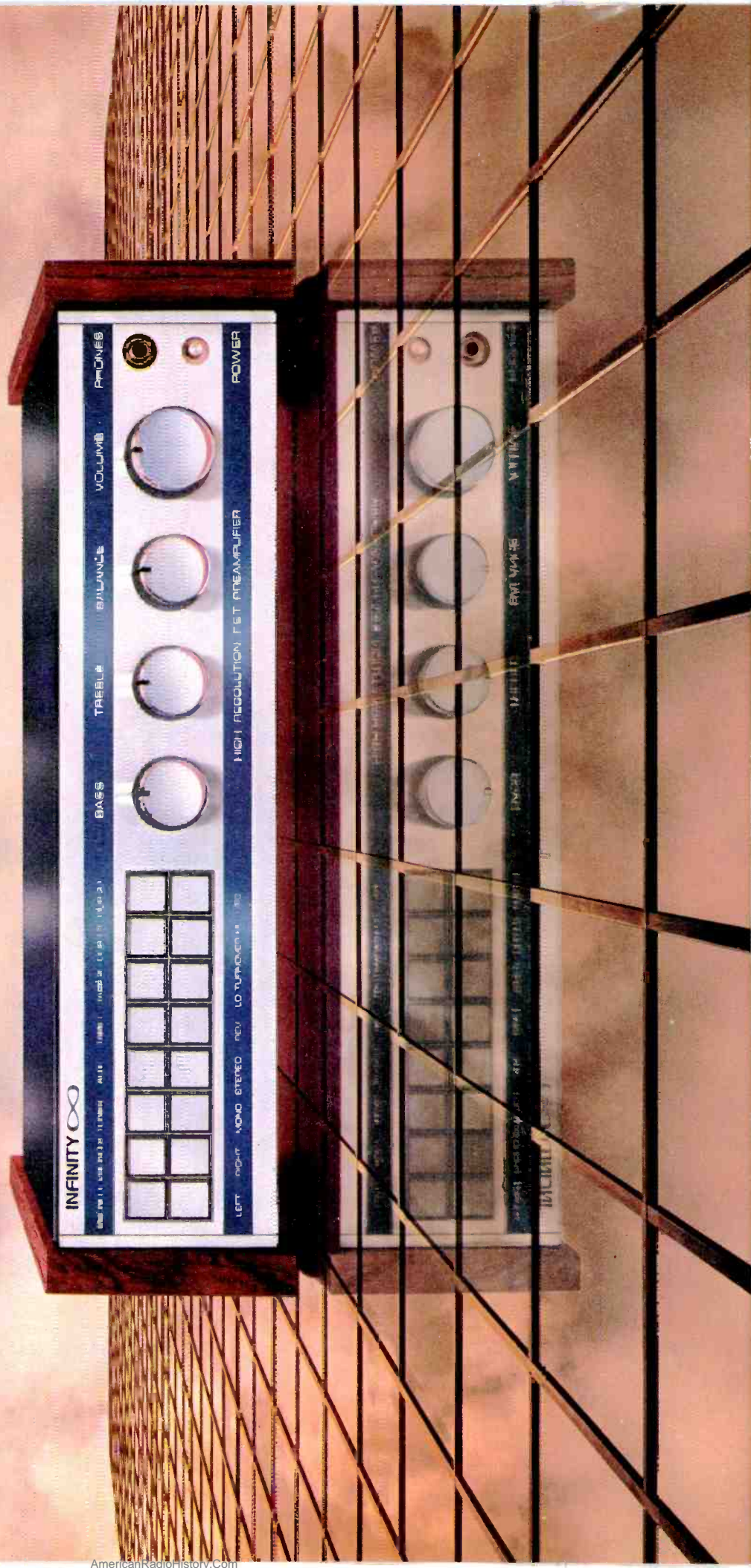

Announcing The Infinity FET Preamplifier. A product of computer science and Infinity obstinacy.

By now you'd expect it of Infinity: a totally new and highly advanced approach to the concept of preamplification. Our refuse-to-compromise attitude has indeed produced a proper companion to our DSP Switching Amplifier™, the world's first consumer application of Class D amplification.

The Infinity High Resolution FET Preamplifier™ is advanced in every way: in Field Effect Transistor gain stage design, in circuitry, in styling and in features.

The result is an FET Preamplifier whose musicality, warmth of tone and accuracy of transient response combines the best features of the finest triode tube preamplifiers (with their warm, mellow, liquid musical qualities) and the finest transistor preamplifiers (with their articulation and clarity); but without the significant limitations of both tube and transistor devices.

The gain stage design.

Our concept for the ideal gain stage design employed an esoteric mathematical formula known as the Calculus of Variations. We then utilized the computer to optimize the parameters we had defined for this concept. Over a period of years and fourteen iterations of computer optimizations, hypercritical listening tests, engineering changes, more hypercritical listening tests, more engineering changes and more hypercritical listening tests—we feel we've arrived at

our goal: the world's finest preamplifier for high quality systems.

The circuitry.

A time delay relay circuit allows other circuits to stabilize before opening the outputs. This allows the preamp to be turned on or off without putting pulses through the system. (You hear no pops, clicks or thumps.) The voltage is precisely regulated; regardless of fluctuation in line voltage the biases never change; the device is always to specification.

The styling.

A single PC board contains two rows of feather-touch switch controls in a slim

preamp. (Those 8 watts will also drive a modest set of speakers!) There is a *pre*-preamp for moving-coil cartridges, which can be plugged directly in. Input impedance characteristics can be adjusted; from 10 ohms to 500 ohms.

You have tremendous flexibility; a source signal can be simultaneously recorded on two tape decks, or dubbed from L to R or R to L. Infinity tone controls give you optional turnover frequencies, extending bass boost from the normal 100 Hz down to 50, and from 5 kHz on the high end, to 10 kHz.

We believe our dogged obstinacy has paid off in a superb instrument—one that will demonstrate the stunning difference a state-of-the-art preamplifier can make in the enjoyment of music, even with an average system.

And you don't have to have audiophile ears, either. Just patch in the Infinity Preamplifier and listen to your favorite and most familiar records.

We guarantee you'll be hearing them for the first time.

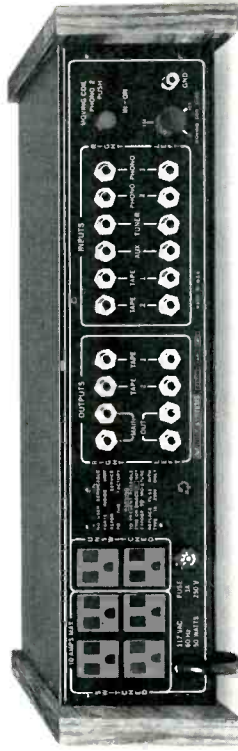

compact configuration. Unobtrusive edge-lit illumination allows you to read the modes in a darkened room.

The features.

We wanted everything: a built-in 8 watt per channel headphone amplifier allows you to plug headphones into the front panel and listen directly from the

Infinity

We get you back to what it's all about. Music.

©1976 by Infinity Systems, Inc.

7930 Deering, Canoga Park, Ca. 91304 T.W.X. 910-949-4919

Hum and noise in phono measured 61 dB below maximum input sensitivity of 2.8 mV. Translated to a 10-mV input the S/N figure would be 72 dB, better than the 70 dB claimed by Sylvania. Hum and noise in high level use was -84 dB and, at minimum volume, residual hum and noise measured 100 dB below full output.

Use and Listening Tests

Judged by our listening tests, the amplifier section of the Sylvania RS4744 comes out a bit ahead of the tuner section. Power is solid and ample, and when listening at loud levels, one gets the impression that there is actually more power available than the conservatively rated 60 watts per channel. Since enough bass boost range is provided to drive the amplifier into bass clipping even when moderate listening levels are used, this control should be approached with caution, as misuse can really play havoc with reproduced sound.

The FM muting was positive, though we did encounter listening situations where better selectivity would have

helped. Admittedly, our Long Island location is a very difficult reception area, and this may not be a problem in less crowded listening areas, where fewer stations are spread across the FM band. AM reception was about average, though sensitivity did not seem as good as we might have expected from a 3-gang tuning system. The PQ-4 circuit works somewhat like the old Dynaco passive four-channel circuit and does provide an interesting, if relatively random, quadraphonic effect with most stereo discs and matrixed quadraphonic records. Glancing through *Audio's* October, 1975 equipment directory issue, we note that most receivers in this price range offer less power (usually 50 or fewer watts per channel) and don't have as many control features as this top-of-the-line entry from Sylvania. If you desire this much power and "under \$500" is your price bracket, the Sylvania RS4744 might just be the one you take home. As we said at the outset, the RS4744 should prove to be a successful entry into high-end audio componentry for Sylvania.

Leonard Feldman

Check No. 96 on Reader Service Card

Quintessence Equalizer 1



MANUFACTURER'S SPECIFICATIONS

Gain: Unity, with controls set to mid-points. **Distortion:** Less than 0.020% at any frequency between 10 Hz and 20 kHz up to maximum output of +16 dBm into 600-ohm load. **S/N Ratio:** 100 dB. **Input Impedance:** Main, 20 kOhm; Monitor, 20 kOhm. **Load Impedance:** Main, any load greater than 600 ohms; Record, 20 kOhm. **Rise Time:** 1 volt per microsecond. **Equalization Center Frequencies and Range:** ±12 dB at 120 Hz, 400 Hz, 1.2 kHz, 4 kHz, and 12.5 kHz.

General Specifications

Dimensions: 11 in. W x 14 in. D x 4 in. H. **Weight:** 11 lbs. **Price:** \$500.00

Many accessory electronic components are often given the figurative designations of "black boxes" to show that they have an input and an output that are intended for insertion in the signal path or at some point in an overall system, be it audio or other. In the case of the Quintessence 1, the equalizer is a black box both figuratively and literally. This black box is a black-anodized aluminum case/chassis tube which contains no mounting feet or even holes for feet. The case and chassis are mated to each other using

high friction-coefficient techniques, rather than conventional hardware, thereby creating a totally sealed and well-shielded unit.

While some equalizer designers make a big point of providing a great number of divisions in the audio frequency spectrum (10 and 20 or 24 frequency levers are not uncommon these days), Quintessence believes that only five carefully selected frequency center-points are needed to compensate for non-linearities in system frequency response or for the tastes of recording engineers with whom we don't agree. Accordingly, the front panel of the Equalizer 1 sports five large rotary knobs (also black) which correspond to frequency bands centered at 120 Hz, 400 Hz, 1.2 kHz, 4 kHz, and 12.5 kHz. The two extreme controls provide "shelving" below and above the two frequencies cited, that is, rather than provide a "bump" in the response curve, response of frequencies above or below the end points named is raised or lowered out to the end of the audio spectrum. As for the chosen frequency centers, Quintessence explains that these were selected to correspond with specified crossover points on the standard RIAA equalization curve. There are also three push-buttons on the front panel. One turns on power, the next one introduces tape monitoring circuitry which may have been used up on your receiver or amplifier when connecting the equalizer, and the



Fig. 1—Back panel.

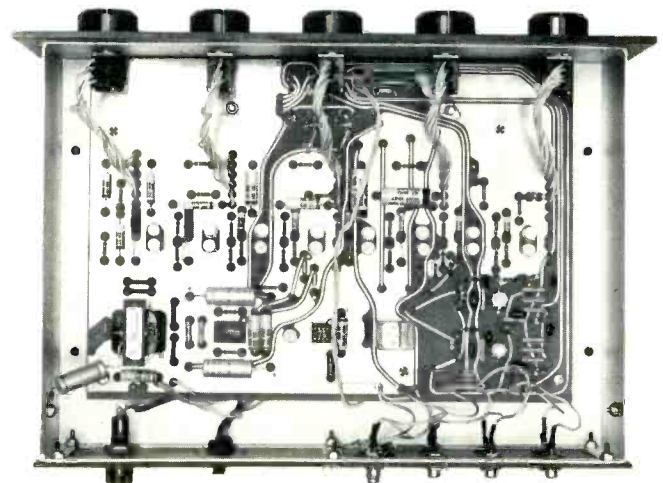

Fig. 2—Interior view.

**Now
you can have
Dual precision
any way
you like.**

Every Dual, from the 1225 to the CS701, is designed to fulfill one basic concept: to provide more precision than you are ever likely to need.

Perhaps this is why more component owners—audio experts, hifi editors, record reviewers and readers of the music/equipment magazines—own Duals than any other turntable. These serious music lovers, whose investment in records typically exceeds their investment in equipment, prefer Dual for only one reason. Quality.

Until recently, Dual quality has been available only with fully automatic turntables with both single-play and multi-play facility. Now the choice is much broader. Of the seven Dual models, three are single-play only. Two of these are fully automatic: one is semi-automatic. Dual turntables also use all three types of drive systems: belt, rim and direct.

The way a tonearm is moved to and from the record is not critical. Nor is the type of drive system. What is critical is how faithfully the tonearm permits the stylus to follow the contours of the groove and how accurately and quietly the platter rotates.

If precision performance and reliability are of primary importance to you—as they should be—you'll find them in every Dual.



Dual 1225



Dual 1249



Dual CS701

Dual 1225. Fully automatic, single-play/multi-play. Viscous damped cue-control, pitch-control. 10% platter. Less than \$140, less base.
Dual 1226, with cast platter, rotating single-play spindle, less than \$170. Dual 1228, with gimballed tonearm, synchronous motor, illuminated strobe, variable tracking angle. Less than \$200.

Dual 1249. Fully automatic, single-play/multi-play. Belt drive. 12" dynamically-balanced platter. Less than \$280, less base. Full size belt-drive models include: Dual 510, semi-automatic, less than \$200; Dual 601, fully automatic, less than \$250. (Dual CS601, with base and cover, less than \$270.)

Dual CS701. Fully automatic, single-play. D.C. brushless, electronic direct drive motor; tuned anti-resonance filters. Less than \$400, including base and cover. **Check No. 15 on Reader Service Card**

United Audio Products, 120 So. Columbus Ave., Mt. Vernon, N.Y. 10553
Exclusive U.S. Distribution Agency for Dual



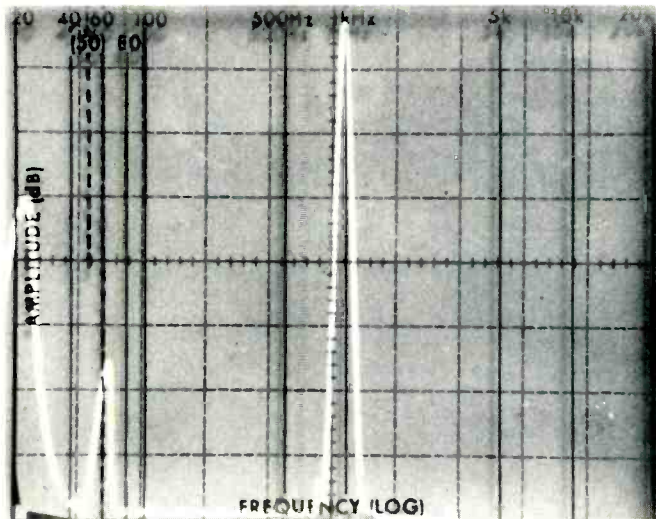

Fig. 3—Spectrum analyzer display shows minute amount of 3rd harmonic distortion to the right of the centered 1-kHz fundamental tone observed at the output of the Quintessence Equalizer.

third bypasses the equalizer from the circuit so that A-B comparisons can be made instantly between equalized and unequalized sound results.

In addition to a heavy line cord and fuseholder, the back panel, pictured in Fig. 1, contains a pair of output jacks, left and right input jacks, recording output jacks, and monitor or tape playback jacks. A photo of the internal layout of the Equalizer 1 (Fig. 2) discloses the printed circuit board (glass epoxy), and the minimum of external wiring required and the care with which power supply components have been positioned and shielded are clear from this picture.

Performance Measurements

Since any equalizer is intended to operate at approximately a gain of 1, there are not too many significant laboratory measurements that can be made on a piece of equipment of this type. With a nominal input of 0.775 volts and all controls set to their mid-positions, output measured exactly 0.775 volts and total harmonic distortion was a very low 0.016%, consisting almost entirely of third-order product, as shown by our spectrum analysis of the signal (Fig. 3). The

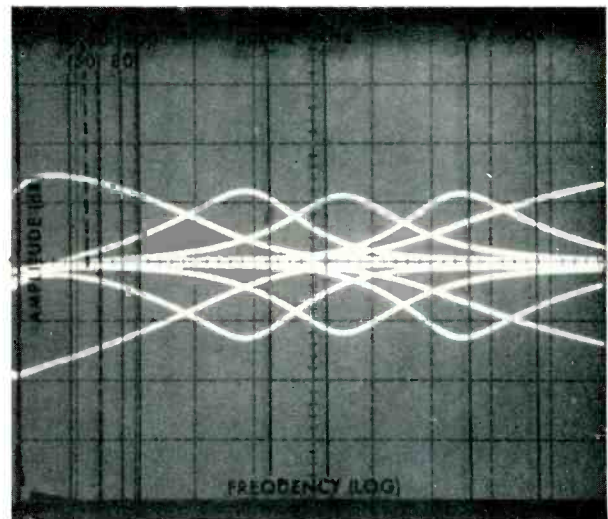

Fig. 4—Range of controls.

primary signal indication at the center of the 'scope face is the fundamental signal, while the tiny "blip" to the right of it represents 3-kHz content (third harmonic) and is down some -76 dB from the fundamental. Increasing the input and output levels to 3 volts (more than you are likely to find at the tape monitor jacks of your receiver or amplifier regardless of program source connected) distortion increased to a mere 0.2%. IM distortion, measured for these two conditions, was of the same order of magnitude, specifically, 0.018% for 0.75 volts in and out, 0.028 for 3 volts in and out.

Signal-to-noise ratio referred to our nominal input of 0.75 volts measured -85 dB. Translated to the +16 dBm reference, this would equal -96 dB of S/N, just a bit short of the -100 dB claimed but so low as to be completely inaudible in any actual listening situation.

Using the sweep-tracking generator associated with our spectrum analyzer and a storage 'scope, we "laid down" successive plots of the range of boost and cut afforded by each of the five equalizer controls. The results are shown in the 'scope photo of Fig. 4. Center points corresponded almost exactly to those specified by the manufacturer and maximum available boost or cut was 12 dB (each vertical box in the display equals 10 dB).

Using the Equalizer

We agree with Quintessence that their choice of band centers makes the equalizer very effective in altering playback recording curves, though we found that the rather broad action of each control does interact with adjacent control settings to some small degree, so that some up and down readjustment is necessary in trying to establish a precise overall response curve on an arbitrary basis.

Under actual use conditions, however, the equalizer is a lot more flexible in its ability to tailor overall response to one's individual taste than one might first suppose by simple judging of the "number of controls." While uncompromising efforts by Quintessence have commendably reduced distortion to near the absolute minimum and delivered a very high signal-to-noise ratio (a black box should only introduce those sonic changes for which it is intended), we do have to raise an eyebrow at the rather high price the company asks for this add-on unit, though for many it may well be justified by the device's excellent design and fabrication.

Leonard Feldman

Check No. 91 on Reader Service Card

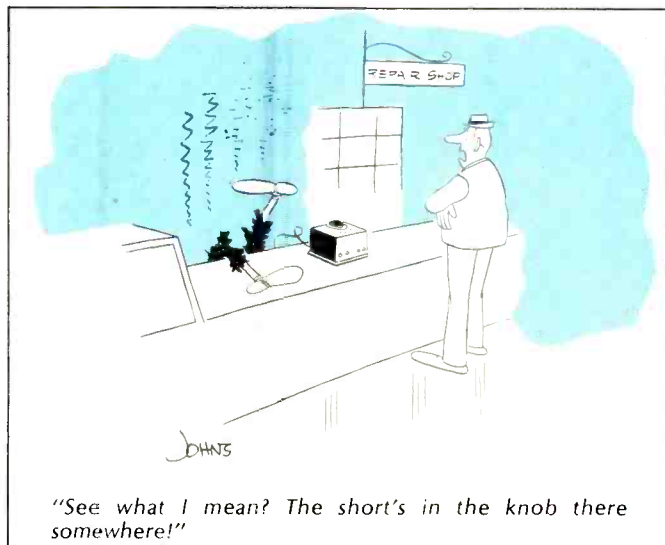

The Rule:

“Only separate components can deliver truly great performance.”

This is how TR-2075 broke the rule.

Very powerful amplifiers can degrade tuner and preamplifier performance. So separate components became the rule and—for years—the rule made sense. But now we've found ways to break the rule and build a very high-powered receiver with better performance for less cost than comparable separate components.

We started with a high-power toroidal transformer to eliminate stray electrical influence on other components within the unit. An expensive device not usually found in consumer products, it offers superior stability and performance.

The transformer feeds two powerful amplifiers. They have a wide frequency range for transparent sound. Ample overload margin for low distortion. And true complementary, direct-coupled circuits. Four protective circuits help deliver this exceptionally clean high power safely to your speakers.

TR-2075 has separate preamplifiers for each input to keep low-level signals noise-free. And sensitivity controls to equalize listening levels. (First stages of amplification occur within millimeters of signal input. An expensive, but effective, way to achieve low noise and clean sound.)

Push-button electronic time-delayed diode switching provides noise-free blends when changing program sources. This innovation allows us to put the controls in the best position for easy operation and the electronics where they can deliver the best performance. Independent tape-to-tape facilities add to the extreme versatility of TR-2075.

TR-2075 also offers electronic FM tuning for stability and long life. Phase-locked loop decoding for superb stereo separation. And phase linear filtering for low distortion. (Just a few of the reasons why this FM tuner/IF circuitry equals—or excels—any we know.)

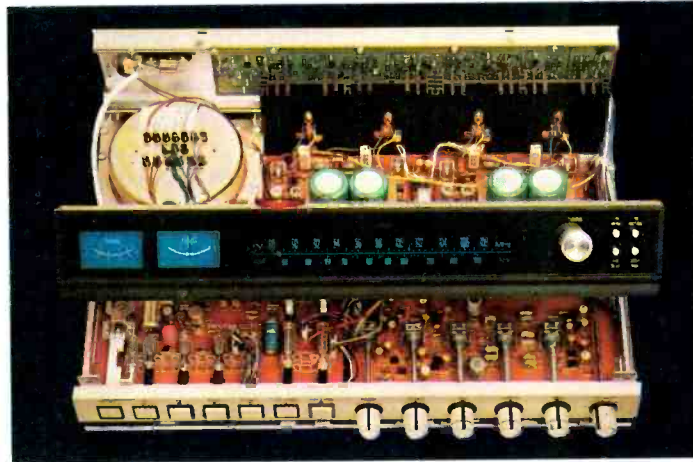

Put it all together and you can see Tandberg has actually built three separate components—and overcome the problems of combining them on one chassis. Your ears can tell you more than our technical descriptions. So we invite you to listen to the new TR-2075. But don't compare it only to receivers that cost the same. Compare it to separate components that cost far more. (While you're at it, check *all* the Tandberg receivers, including the brilliant TR-1055 AM/FM and TR-1040 FM only.) You'll be glad you listened to Tandberg.

TANDBERG

We're our only competitor.

Tandberg of America, Inc., Labriola Court, Armonk, New York 10504.

A. Allen Pringle Ltd., Ontario, Canada.

Check No. 46 on Reader Service Card

**S.A.E. MARK VIII
Stereo FM Digital Tuner**

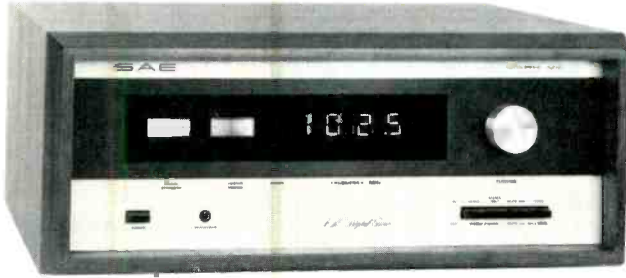

MANUFACTURER'S SPECIFICATIONS

IHF Usable Sensitivity: Mono, 1.6 μ V; stereo, 3.0 μ V. **50-dB Quieting:** Mono, 3.0 μ V; stereo, 30 μ V. **THD:** Mono, 0.15%; stereo, 0.20%. **S/N:** Mono, 70 dB. **Capture Ratio:** 1.5 dB. **AM Suppression:** 100 dB. **Image Rejection:** 100 dB. **Alternate-Channel Selectivity:** 120 dB. **Spurious Rejection:** 100 dB. **Frequency Response:** 20 Hz to 15 kHz \pm 0.5 dB. **Stereo Separation:** 1 kHz, 45 dB; 10 kHz, 35 dB. **Drift:** 15 kHz. **Rated Output Voltage:** 1.0 V rms.

General Specifications

Power Requirements: 110-125 V 50/60 Hz, 25 watts. **Dimensions:** 17 in. W x 5 3/4 in. H x 10 1/2 in. D. **Weight:** 23 lbs. **Price:** \$650.00.

The term "digital" as applied to an FM tuner may mean one of two things. Either the tuner employs crystal-controlled operation of a frequency-synthesis scheme, which insures absolute tuning accuracy and which readily lends itself to digital display of tuned frequencies, or the tuner employs conventional continuously variable tuning and has added digital "counting circuitry" and displays to replace the conventional tuning dial pointer and printed frequency scale. The SAE Mark VIII tuner falls in the latter category, which means that additional money is being spent on those attractive numeric readouts and associated circuits, and if LED readouts were all the SAE tuner had to commend it, we would have had to think twice about extolling its virtues. However, this particular "digital readout tuner" is such an excellent one in so many other respects that it is possible to overlook the extra cost on the premise that even without this digital display, the Mark 8 tuner would still be worth its price.

The front panel of the tuner has a long blacked-out section which becomes illuminated with giant numerals and a pair of meters when power is applied. Numbers change in increments of 0.2 MHz, and we were able to tune down to 87.5 and up to 108.5 MHz by turning the large tuning knob which is flywheel-coupled and behaves for all the world just like any other FM tuning knob. Four pushbuttons at the

lower left turn on power, select one of two muting threshold levels, activate the muting circuit, and select one of two output levels which are set 10 dB apart. A symmetrically positioned array of four more pushbuttons at the lower right activate a stereo noise filter, change de-emphasis from 75 microseconds to 25 microseconds, switch from mono to stereo, and select stereo-only reception. At the lower center of the panel is a tape-out jack (of the two-circuit variety similar to a headphone jack) to which a tape deck can be connected for recording purposes. High-impedance phones may also be connected at this point for direct listening to the tuner, bypassing the need for an amplifier. Between the signal-strength and center-of-channel tuning meters and the digital display areas is a stereo indicator light.

The rear panel of the SAE Mark VIII contains a pair of output jacks, vertical and horizontal 'scope jacks (for 'scope observation of multipath), a four-channel (detector) output jack, and a barrier-type terminal strip for connection of other 75-ohm or 300-ohm antenna transmission lines. A fuseholder containing a half-ampere line fuse is also accessible from the rear panel.

Circuit Description

Aside from the sealed front-end, the internal layout of the chassis contains two major circuit boards, both of glass-epoxy material. (See Fig. 2). The lower p.c. board contains i.f. and MPX circuitry, while the upper board contains the necessary IC logic circuits to activate the digital display. A block diagram of the tuner is shown in Fig. 3. A 5-ganged, capacitor-tuned front-end uses 3 MOS-FETs, two of which are used in a cascode-type r.f. amplifier. Five double-pole, monolithic, fixed tuned-resonance, pass-band filters are used in the i.f. section, coupled with seven symmetrically limiting differential-amplifier, IC limiter stages followed by a wideband ratio detector. Five of these limiter amplifiers have their output coupled to amplitude detectors which are connected to a summing amplifier to activate the logarithmically calibrated signal-strength meter.

A phase-locked-loop IC is used for MPX detection, followed by separate 19-kHz and 38-kHz, double-tuned, low-pass filters. Complementary d.c.-coupled, feedback pair amplifiers are used in the audio amplification chain.

A 4-digit readout system is coupled to the local r.f. oscillator. Readout is indicated by four seven-segment displays, which use a total of 56 LEDs. Fourteen digital ICs referenced to a quartz crystal having 0.004% accuracy, are used in the divide-down and frequency-counter logic system.



Fig. 1—Back panel view.

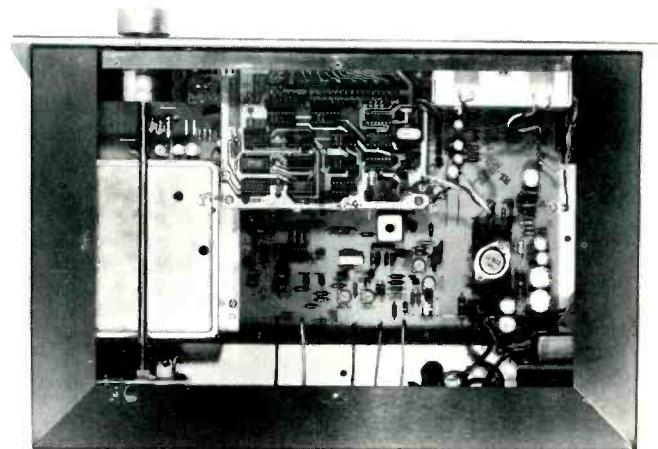

Fig. 2—Interior view.

Laboratory Measurements

Noise and THD curves for mono and stereo operation of the Mark VIII tuner are plotted in Fig. 4. IHF Usable sensitivity in mono measured $1.8 \mu\text{V}$ (10.5 dBf), while in stereo, $4.2 \mu\text{V}$ (17.9 dBf) of signal was required to achieve the same noise-plus-THD level of 3%. The 50-dB quieting mark in mono was achieved with a signal input of only $2.2 \mu\text{V}$ (12.2 dBf), about the lowest we have ever measured since this important new specification became a required disclosure. In stereo, $25 \mu\text{V}$ (33.35 dBf) was needed to achieve 50 dB of quieting—again, much better than average. Ultimate S/N in mono measured 75 dB, while in stereo the best signal-to-noise reading was 73 dB, remarkably low compared with even higher priced tuners we have measured.

Harmonic distortion in mono was 0.13% at mid-frequencies; 0.15% in stereo. At the more difficult test frequencies of 100 Hz and 6 kHz, THD was 0.19% for both mono and stereo operating modes at 100 Hz, and 0.11% and 0.35% for the 6-kHz tests. Distortion versus frequency for the entire FM audio band is plotted along with stereo FM separation characteristics in Fig. 5.

Rejection ratios (image, i.f., and spurious) were all better than 100 dB—the limit of our test equipment. Capture ratio measured 1.4 dB, and AM suppression was an outstanding 97 dB, though some degree of error may have been introduced when trying to measure such high suppression ra-

tios. Alternate-channel selectivity was outstanding and well above 110 dB (again, our limit of measurement). Stereo separation was outstanding, with readings above 50 dB obtained for mid frequencies and 36 dB at 10 kHz. The two muting-threshold levels were set at the factory for $3 \mu\text{V}$ (14.9 dBf) and $13.0 \mu\text{V}$ (27.7 dBf), while stereo switching took place at $4 \mu\text{V}$, by which time S/N was already 35 dB below full output and THD was precisely at the 3% point deemed least usable. The 19-kHz and 38-kHz sub-carrier products at the output were filtered out to a level of -65 dB with respect to full modulation. What's more, this effective filtering is accomplished without significant alteration of frequency response, which remains true to the appropriate de-emphasis curve selected within 0.3 dB from 30 Hz to 15 kHz. That's really good low-pass filter design!

Use and Listening Tests

It goes almost without saying that any tuner having such superb measured performance will be limited in practical use by the quality of signals broadcast in your area. Unfortunately, in the metropolitan New York area, where we perform our laboratory measurements and listening tests, there are but one or two really good FM signals, and even those don't measure up to the ability of this tuner to reproduce clean, quiet signals. We have learned that one station is about to undergo what amounts to a transmitter overhaul in an attempt to bring its broadcast signal quality up to that of

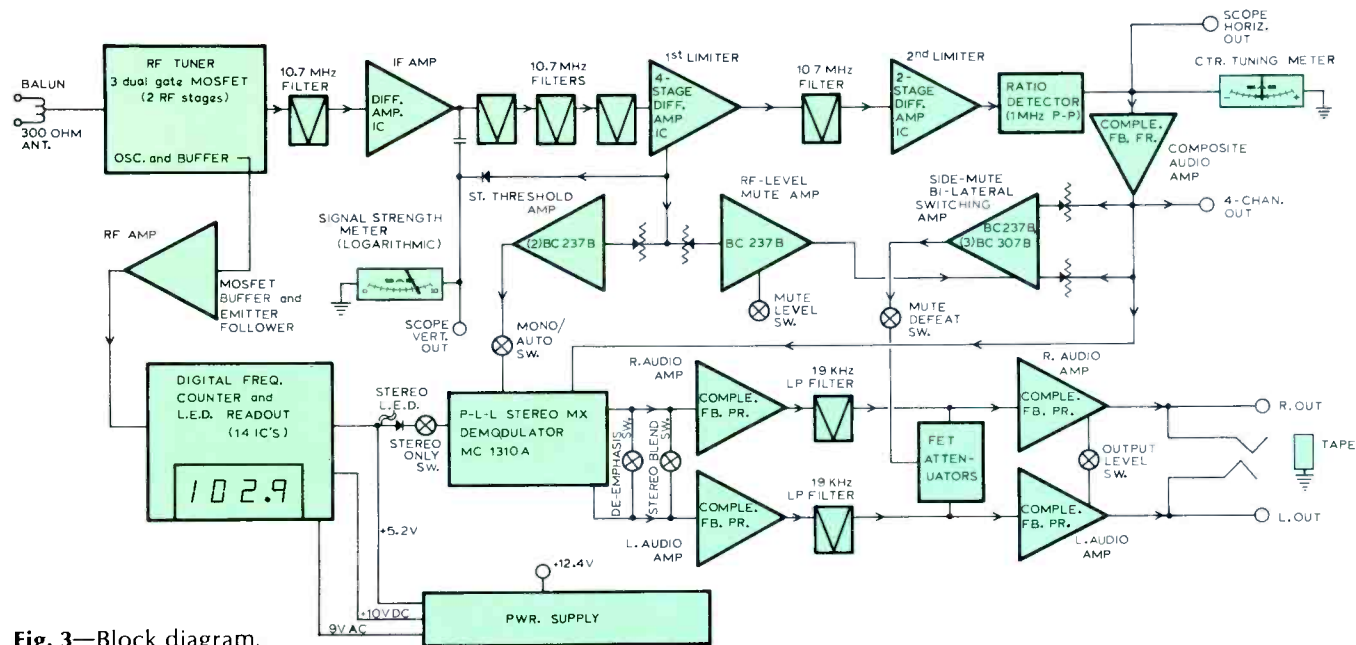

Fig. 3—Block diagram.

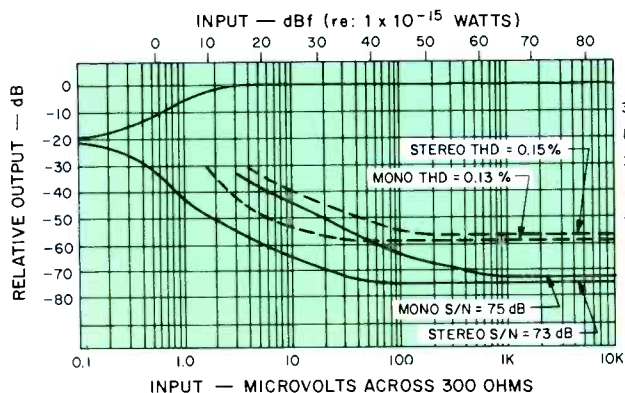

Fig. 4—FM quieting and distortion characteristics.

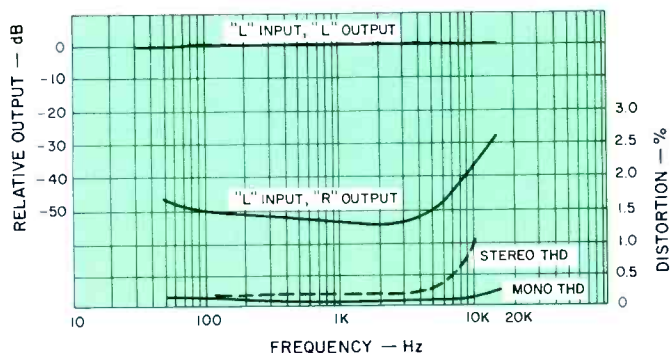

Fig. 5—Separation and distortion versus frequency.

THE MARANTZ



servo control direct drive/auto shut off

TURNTABLE



marantz
Model 6300

DIRECT-DRIVE with optically-actuated auto lift and shutoff

The **direct drive DC servo motor** is featured in the Marantz 6300 for three compelling reasons. One: The shaft of the motor is directly connected to the center of the turntable for more accurate rotation. Two:



Direct-Drive DC Servo Motor

The direct-drive motor eliminates the need for belts, pulleys and other mechanical parts that increase friction, impair accuracy. Three: The DC motor is electronically controlled for even greater precision. And precision is what the 6300 is all about. That's why Marantz design engineers chose the manual system in the first place. Then they incorporated **optically-actuated auto lift and shutoff** to afford the Marantz owner automatic convenience without sacrificing quality. Here's how it works:

When the tone arm is in position over the lead-in record groove, the **manual/auto push switch** is on "auto" and the Cue Down switch is depressed, the platter will rotate



Manual/Auto Push Switch

and tone arm will descend. At the end of the record, a beam of light activates an electronic circuit that automatically lifts the tone arm and shuts off the unit. This optical circuit replaces mechanical linkage. Result: no friction, no mechanical wear. And **viscous damped creing** provides smooth tone arm lowering and raising.

Stroboscopic control—again sophisticated optics come into play. Surrounding



Stroboscopic Control

the edge of the platter are small aluminum dots that are illuminated by a neon **strobe light** during play. The light on the moving dots creates easy-to-see patterns that visually indicate platter speed. Here's how:

Once you have depressed either the **33-1/3 or 45 RPM selector push switch** and activated the platter, the moving-dot patterns will begin. Then you simply turn the **pitch control** until the moving dots appear to stand still. Now you've



Pitch Control

accurately set the speed for the original recorded pitch. If you wish to adjust the pitch to your personal taste, turn the control for a variance of $\pm 3\%$.

The Marantz **S-shaped static-balanced tone arm** has an easy-to-read tracking force control knob and vertical and lateral counterbalancing, plus Marantz anti-skate for still greater accuracy. There's even a plug-in cartridge shell for convenient cartridge exchange and a storage-mount for holding an extra cartridge.

The 6300. From its **hinged dust cover**, to its **anti-static turntable mat**, right down to its **adjustable shock absorber feet**, it's all Marantz. Common sense design with the future in mind...like the **low capacitance phono cables** that assure 4-channel capability whenever you need it.

Stop by your local Marantz dealer and see the incomparable Marantz 6300. And while you're there, ask about the complete Marantz turntable line previewing soon.



marantz.

We sound better.

(The enclosure for the 6300 is constructed of plywood, finished in genuine walnut veneer. The enclosures for the 6200 and 6400 are finished in walnut grain vinyl.)
© 1976 Marantz Co., Inc., a subsidiary of Superscope Inc., 20525 Nordhoff St., Chatsworth, CA 91311. In Europe: Superscope Europe, S.A., Brussels, Belgium. In Canada: Superscope Canada, Ltd., Ontario. In the Far East: Marantz Far East, Tokyo, Japan. Prices and models subject to change without notice. Consult the Yellow Pages for your nearest Marantz dealer.

TURNTABLE



marantz
Model 6300

some of the state-of-the-art tuners available. SAE's Mark VIII certainly is a tuner we will be most anxious to hear again when that station's signal has been refined—especially since the man who has been charged with the task is none other than Richard Sequerra, whose latest tuner design abilities are familiar to readers who follow *Audio's* test reports.

The only negative note I can sound is a personal expression that I find the giant digital readout somewhat splashy despite its high visibility from across the room. However, I have to admit that many people, if not the majority of po-

tential buyers, will find the display attractive. Since the performance would have been exactly the same if a conventional dial pointer and frequency scale had been used instead of the digital display, I wonder how much lower the price would have been without the display. And whether those who could then afford and would purchase the tuner wouldn't offset the number who were purchasing it simply because of the digital display. All this is, of course, idle speculation since taste is a rather unpredictable item.

Leonard Feldman

Check No. 92 on Reader Service Card

Dynaco PAT-5 Preamplifier



MANUFACTURER'S SPECIFICATIONS

Frequency Response: 10 to 50,000 Hz \pm 1dB. **Rated Output:** 2 volts. **THD at Rated Output:** 0.05 per cent. **IM at Rated Output:** 0.05 per cent. **Signal-to-Noise Ratio:** 70 dB re 10 mV phono input. **Phono Sensitivity:** 2.7 mV. **Dimensions:** 13 1/2 in. W \times 11 1/4 in. D \times 4 1/4 in. H. **Weight:** 13 lbs. **Price:** \$369.00 wired, \$219.00 kit.

Dynaco's PAT-5 is a new solid-state design that supercedes as top of the line their first transistor preamp, the PAT-4 which is still being made. Physically, the PAT-5 is quite similar to the PAT-4 but is deeper and uses push-button switches instead of rocker switches. The chassis is made up of three pieces: front subpanel, bottom plate, and rear panel. The top cover is a U-shaped piece which encloses the top and sides. Active circuitry is distributed among five PC boards: power supply, two output section amps, and two phono preamps. There is considerable hard wiring that interconnects back panel input and outputs to the selector switch, PC boards, and front-panel controls. An internal shield runs from front to back, separating the speaker selector switch, power supply, speaker input and outputs, and a.c. wiring from the rest of the unit. Rotary controls on the front panel are used for the selector switch, volume, balance, tone controls, and speaker selector switch. Push-button switches handle the tape monitor functions, mode, filters, tone control in/out, and "EPL" function. (EPL stands for External Processor Loop.)

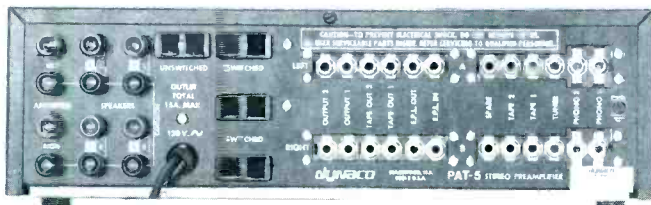

Fig. 1—Back panel view of the Dynaco PAT-5.

On the rear panel are the signal input and output connectors, a.c. line cord, and convenience outlets, and six pairs of five-way binding posts for connection of the system power amp outputs and two pairs of speakers.

Circuit Description

As is fairly easy to see in Figs. 3 & 4, the PAT-5 has four amplifier blocks per channel: phono preamp, high-level-input voltage follower, high-cut filter amp, and tone control/output amp. The high-cut filter stage is completely bypassed when switched out. The high-level-input voltage follower, hereafter called the voltage follower, serves to present a constant input impedance (50 kOhms) for high-level inputs and to present a low output impedance to drive the parallel combination of the balance and volume control (10 kOhms).

From a signal flow standpoint, the input signal selected comes off of the selector switch and passes through the tape monitor and EPL switches to the input of the voltage follower. The EPL switch permits an external device, such as a frequency equalizer, to be switched in or out of the signal path at the input to the voltage follower. Coming out of the voltage follower, the signal passes in turn through the mode switch; low-cut filter, volume, and balance controls; high cut filter, and finally arrives at the input of the tone control/output amplifier. After passage through the output amp, the signal emerges at the main preamp outputs. From the foregoing, it is evident that a minimum of three amplifiers are in the signal chain when using the phono function.

The phono preamp is a two-stage common-emitter circuit, with RIAA equalization accomplished in the feedback

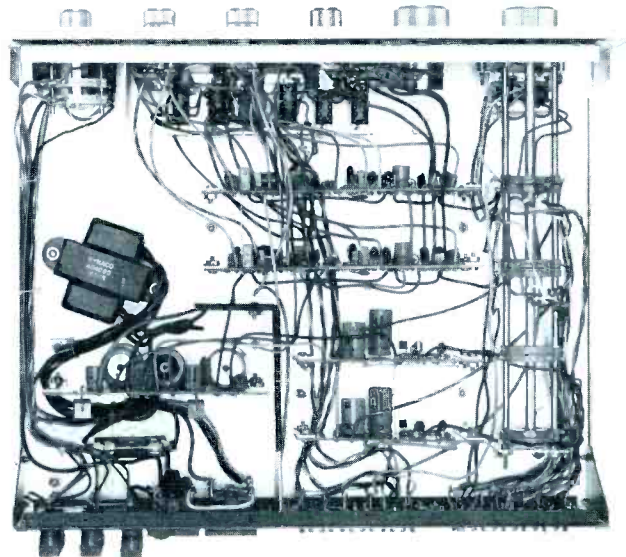

Fig. 2—Interior view.

The look of denim. The Sound of Koss.



"Mini-plug" adapter
for equipment
with 1/8" jacks.

The new Koss Easy Listener™

If you're looking for a lightweight, hear-thru stereophone with a style and sound all its own, the new Koss Easy Listener™ is just what you're looking for. Because not only is it as comfortable to wear as your favorite denim outfit, but it also delivers the breathtaking Sound of Koss. The Easy Listener's wide 20 to 20,000 Hz frequency response gives you a sound that'll curl your toes at the deepest notes of a bass guitar, send tingles

up your spine at the brilliant highs of the brass section. And just to make the Easy Listener easy to use with all your audio equipment—like portable radios, TV's or tape players—Koss has included a "mini-plug" adapter.

Why not stop at your favorite Audio Dealer for a little easy listening today. You'll like the sound and the style of the new Koss Easy Listener. And even the price is easy to take.

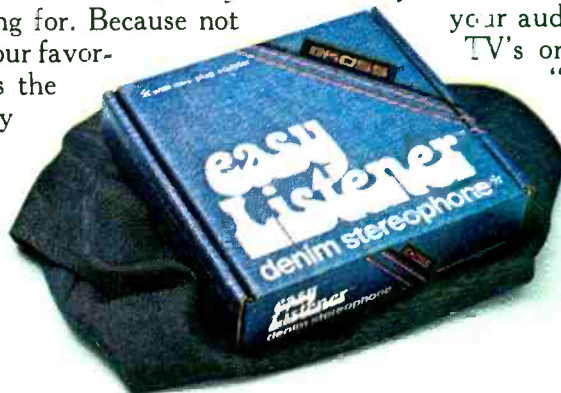

Check No. 23 on Reader Service Card

© Koss Corporation

 **KOSS® stereophones**
from the people who invented Stereophones.

KOSS CORPORATION, 4129 N. Port Washington Ave., Milwaukee, Wisconsin 53212. Koss International/London, Milan, Dublin, Paris, Frankfurt • Koss Limited/Ontario.

loop from second-stage collector to first-stage emitter. Nominal 1-kHz equalized gain is 37 dB, although Dyna gives instructions in their manual for setting the gain from 34 to 43 dB in three dB steps. Further, one can wire the unit to have different gains for the *phono 1* and *phono 2* functions so that two different pickups can be used and have about the same output from the phono preamp.

The voltage follower is composed of a compound connection of opposite polarity transistors. The collector signal of Q301 drives the base of Q302, whose collector signal is all fed back to the emitter of Q301, thus forming a resultant emitter-follower with a voltage gain of about 1X.

High-cut filter action is accomplished with an active low-pass filter. Input emitter-follower Q303 presents a high-input impedance to the volume control and a low output impedance to the actual filter, which is a three-pole (three resistors and three capacitors) circuit involving emitter-follower Q304. Overall gain of the filter amp is slightly less than one.

The final 20 dB of total preamp gain is generated by the output/tone control amp. This output amp is a LM301 operational amplifier connected in a tone-control circuit that so far has been used in three other firms in two preamps and an integrated amplifier. It has the advantage that output-amplifier gain and tone-control action is accomplished in one circuit block, rather than two as is the common prac-

tice. Further, the circuit is noninverting and has high input impedance, allowing it to be driven directly from the volume control. The circuit arrangement of resistors, capacitors, and bass and treble control potentiometers is similar to the Baxandahl circuit used in many preamps but is different in two major respects. First, the control potentiometers are log taper, having 10 per cent of total resistance from end to wiper at 50 per cent mechanical rotation, and second, one of the two ends of the control pot divider string is grounded rather than being the signal input. The signal input for this circuit is the noninverting input of the op amp.

With the control pots at 50 per cent rotation, these pots and associated resistors and capacitors form two frequency-insensitive, 10/1 voltage dividers off of the amplifier output, with the wipers resistively summed into the inverting input of the op amp. This forms a closed-loop, noninverting, flat gain of 10X. Rotating either pot from center unbalances the frequency insensitivity of the associated divider and results in the closed-loop gain of the circuit giving a boost or cut in the associated frequency range. The tone control in/out switch, when out, substitutes a flat-resistive 10/1 divider for the feedback network around the output amplifier. An overall d.c. feedback loop is around the op amp, causing it to have a d.c. gain of one for good d.c. operating stability.

The power supply delivers Zener-regulated plus and minus 15 volts to the output amp and voltage follower and

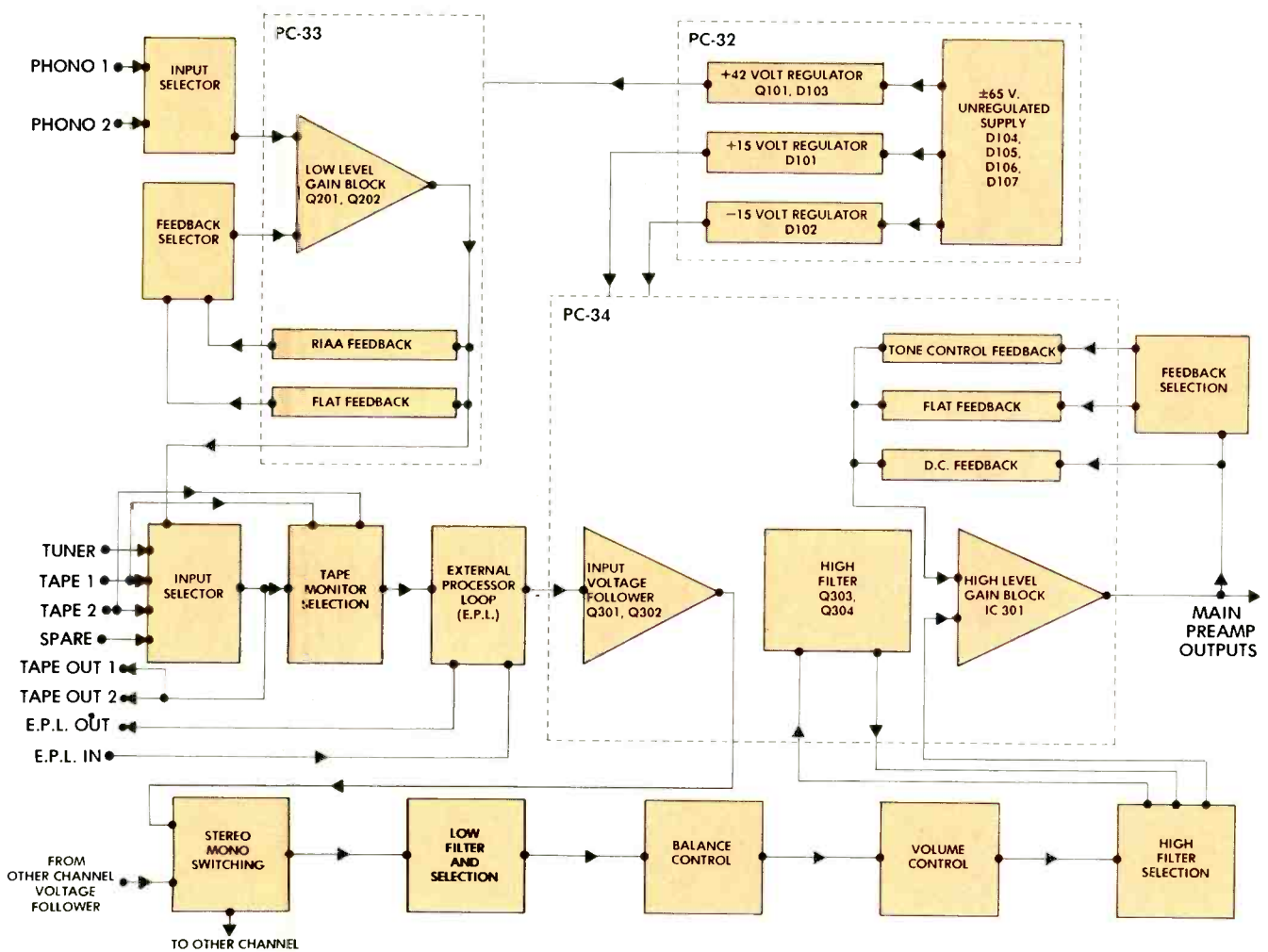

Fig. 3—Block diagram.

AU+TU=VALU

The great Sansui equation

For those who want and can appreciate superior high fidelity, here are three great values. These integrated amplifiers and tuners are both matched and designed to give you incredibly clean tonal quality, versatility, and performance.

The AU-5500 integrated amplifier with 32 watts per channel, min. RMS, both channels driven into 8 ohms from 20 Hz to 20kHz, has no more than 0.15% total harmonic distortion. Features triple tone controls with a middle frequency control to add pleasure to your music;

high and low cut off filters; 7 position tape play/dubbing switch for creative recording versatility. The AU-5500 is matched with the TU-5500 tuner, with a $1.9\mu\text{V}$ sensitivity and a selectivity of better than 60 dB.

The AU-7700 integrated amplifier offers a power output of 55 watts per channel, min. RMS, both channels driven into 8 ohms, from 20Hz to 20kHz and no more than 0.1% total harmonic distortion. Features a 7-position tape play/dubbing switch for creative recording versatility; selectable phono input impedance. It is matched with the TU-7700 tuner, featuring a $1.8\mu\text{V}$ sensitivity for picking up even the weakest signals. Selectivity of better than 80 dB.

Sansui also offers an AU-4400 integrated amplifier and TU-4400 tuner which display the same Sansui high quality performance and many of the same features as the other pairs in this series of separates.

If you should not be as yet a devotee of separate components, any of these pairs is sure to make you one. Stop in soon at your nearest Sansui franchised dealer to select any of the three combinations for musical enjoyment you will value for many years to come.

TU4400
AU4400



TU 5500
AU5500



TU7700
AU7700



SANSUI ELECTRONICS CORP.

Woodside, New York 11377 • Gardena, California 90247

SANSUI ELECTRIC CO., LTD., Tokyo, Japan • SANSUI AUDIO EUROPE S.A., Antwerp, Belgium

In Canada: Electronic Distributors

Check No. 40 on Reader Service Card

decoupled plus 15V to the filter amp. The raw, rectified plus d.c. is regulated by a Zener diode and emitter-follower to provide plus 42.5 volts to the phono preamps.

An interesting departure from conventional practice is used in the primary a.c. wiring of this unit. The circuit is always powered when plugged in, and the power switch merely controls the switched a.c. outlets. This makes good sense as the unit draws about 12 watts and, being continuously on, keeps the internal environment of the unit at a reasonably constant temperature, extending the life of components. Further, no annoying and potentially speaker damaging thumps occur when the entire system is powered on and off. Dynaco makes a concession to energy conservation purists by giving instructions for wiring the unit so that the preamp power is also switched by the power switch!

Listening Tests

The PAT-5 was first listened to as a phono preamp only, with output signal taken at the tape-out jacks, followed by a dual 50K volume control directly into the power amp. A Supex SD-900 and Fidelity Research FR-1 MK II were the cartridges used through the reviewer's own pre-preamp and into the phono 1 inputs of the preamp. Listening was done with Dahlquist DQ-10 loudspeakers on loan from the maker for these tests and Stax SRX MK2 phones.

This preamp has an open sound with good overall definition, though, like other transistor preamps, it has some high frequency edginess and irritation. Bass reproduction is solid and well defined and generally on a par with other top-quality solid-state preamps. Switching in the output section of the PAT-5 caused a noticeable decrease in definition and some increase in high frequency edginess. All controls op-

erated well and with no noticeable switching pops or transients. The tone controls were judged particularly effective in making small corrections to the overall frequency response with different records and other program sources.

Kit Builder' Comments

Although the PAT-5 was much easier to assemble than the ST-400 basic power amplifier (reviewed in *Audio*, p. 47, May 1975), it is not a kit I'd recommend to the beginning kit assembler because of the considerable amount of point-to-point wiring between the large selector switch assembly and the many input and output terminals (due to the unusually flexible input/output switching, as well as the EPL).

The 35-page manual is Dynaco's usual thorough job of presentation, and it has a circuit diagram as well as a detailed functional block diagram, both necessary for complete understanding of the extra features. Also included is a 17-by-22 in., full-size wiring and assembly diagram, showing every wire and component, which I taped to the wall over my work bench. At the bottom of the diagram, there's a 16-in. scale for measuring wire cut from the four hanks supplied.

Most of the circuitry is on the four preassembled PC boards—two identical audio boards and twin preamp boards. The audio boards are connected to the rest of the components via 27 edge-mounted solder eyelets, while the preamp boards have nine eyelets each. Only the board for the regulated power supply required assembly. Its seven capacitors, six diodes, and three resistors took 20 minutes to mount and solder in place.

Dynaco divided the wiring and assembly into six sections which are listed below with the number of steps and the time required to finish each:

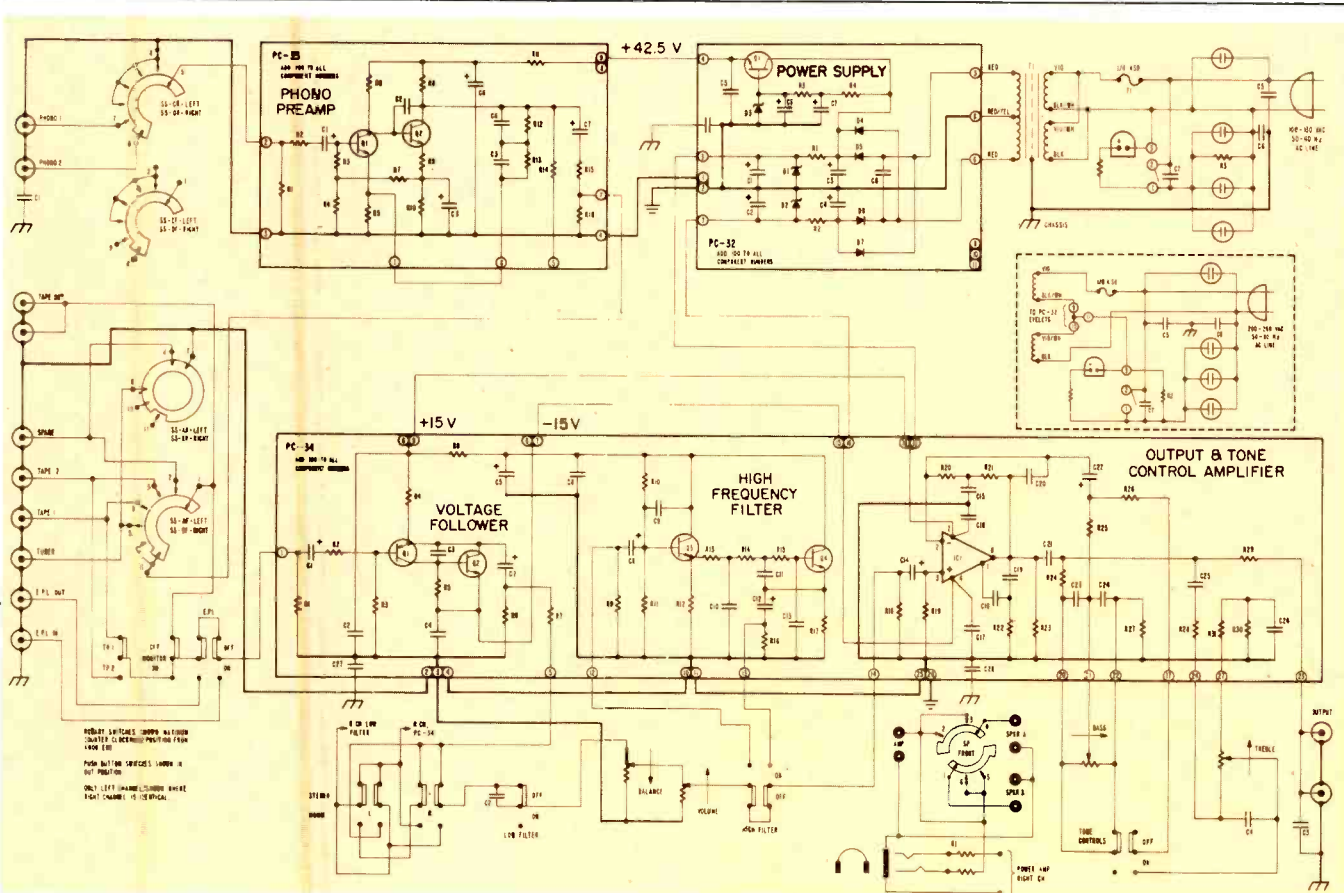

Fig. 4—Schematic diagram.

ACCUSOUND'S 80A OUTPERFORMS THE LARGE ADVENT AT ABOUT HALF THE PRICE

Recent discoveries on how reactive energy behaves in speaker cabinets has elevated performance in small enclosures to unparalleled heights. Deep bass, high efficiency, greater power and lower distortion are now possible at a half to fifth the price of brands with equivalent performance. These discoveries (Pats. 3816672, and others pending) reveal why the 80A is four ways better.

80A
\$79



DEEPER BASS:

The reactive network shown below utilizes the transducer (historically called a woofer) to energize 80% of the cabinet. The energizer air is propelled into an accelerator. The accelerator bombards the rear of the reactor diaphragm. The transducer, energizer, accelerator and reactor are kept in air tight equilibrium by increasing the reactor diaphragm 300%. The reactor network produces unparalleled bass, 6 db more than the Large Advent at 24 Hz, 3 db more at 30 Hz. As much as 180 times greater than brands many times higher in price.

FULL NATURAL VOICE TONES:

No demand is made on the transducer to deliver deep bass. It is engineered as a superb unsurpassed voice driver. Fullness, naturalness, presence, smoothness, dynamic contrast characterize baritones and soprano voices alike.

WIDE DISPERSION:

Small transducers have wide dispersion. Not having to pull voices out of woofers frees power demands and broadens the area of full fidelity projected sound.

LOW DISTORTION:

Unwanted energy from the rearward side of transducers is the source of most of a speakers distortion. This energy is used in Accusound high efficiency systems. Harmonic distortion is reduced to the lowest levels ever recorded. The result is clean, tight, dynamic bass unparalleled - unmatched anywhere.



80A REACTOR NETWORK SYSTEM

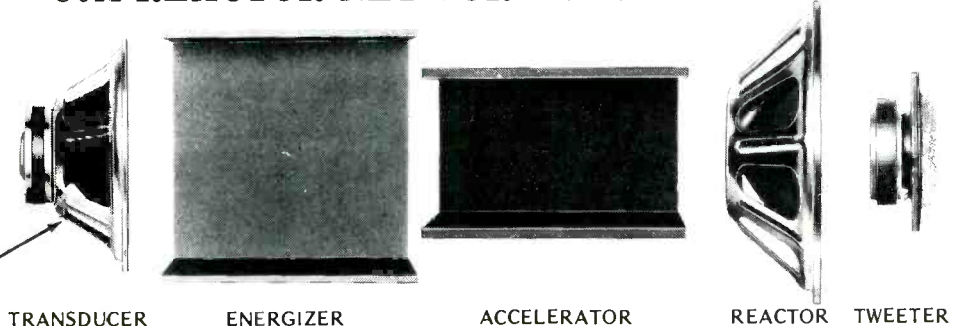

Listen to the excitement of discovery.

PERFORMANCE (CREDIBILITY) + EXCLUSIVITY = + PROFITS

TSI

Inc. 60 E. Ida St. Antioch, Ill. 60002 (312) 395-6321

36 page booklet and dealer plan available from factory

Check No. 49 on Reader Service Card

PIONEER INTRODUCES AN AMPLIFICATION SYSTEM THAT WILL FORCE YOU TO TAKE A HARD LOOK AT YOUR SPEAKERS.

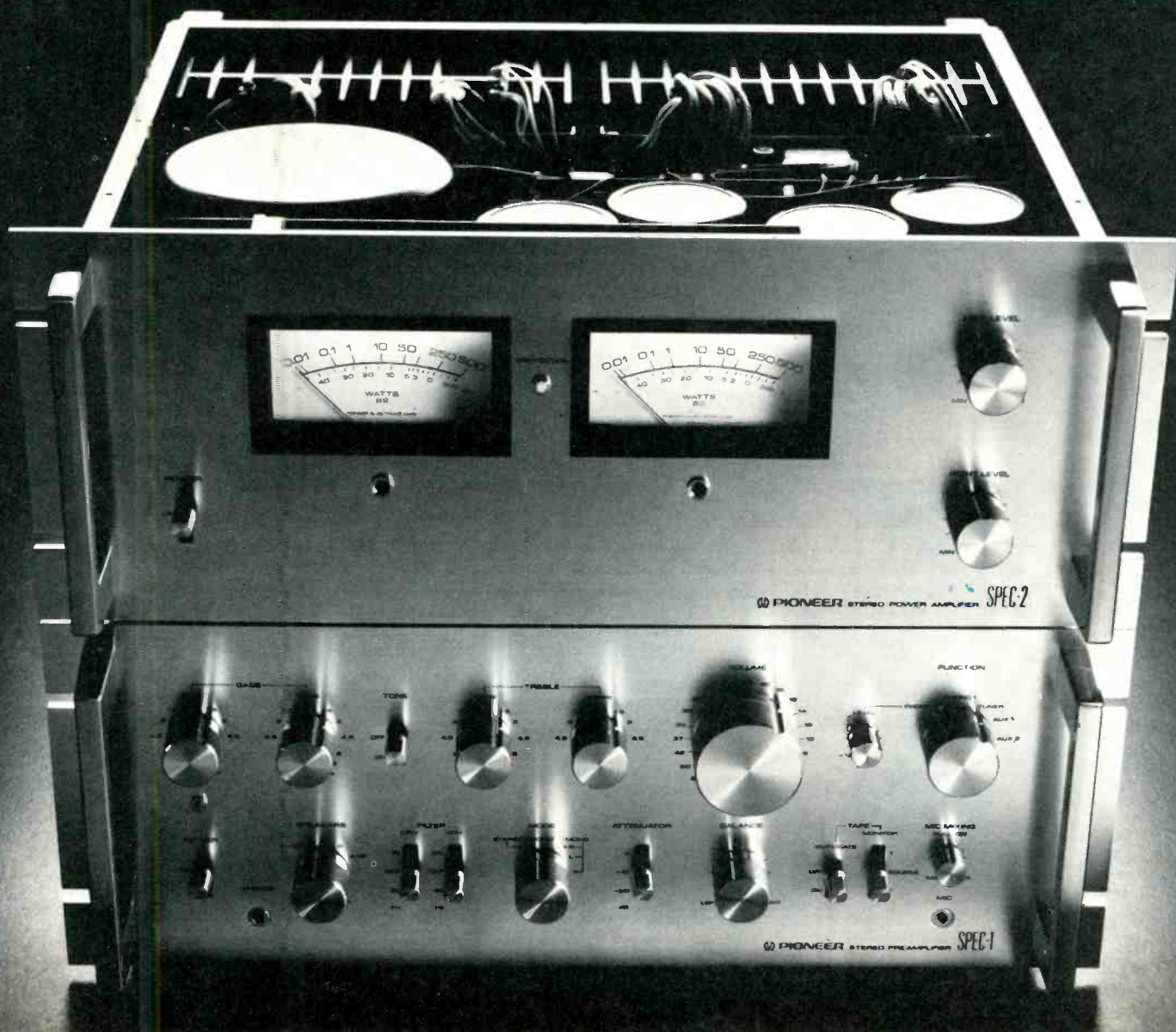

Pioneer's new Spec 1 and Spec 2 are capable of producing a level of high-quality sound most speakers are simply incapable of reproducing.

So, unless you're willing to listen to Spec 1 and Spec 2 at something less than their full potential, don't make the decision to invest in them if you're not prepared to invest in a new pair of speakers.

SPEC 2: 250 GOVERNMENT-APPROVED WATTS A CHANNEL

Spec 2 was the first power amplifier designed to deal with the new F.T.C. power regulations. It has a continuous power output of 250 watts per channel minimum RMS. At 4 or 8 ohms. From 20 to 20,000 Hz. With no more than 0.1% harmonic distortion.

Other power amplifiers that used to claim a lot more power can't do that anymore.

WHO NEEDS ALL THIS POWER AND WHY

When you listen to a live performance it can have an average sound level of 84 dB. Which most high fidelity systems can reproduce with half a watt of power. But a sudden musical peak of 110 dB takes four hundred times as much power. Which means you need 200 watts of power to reproduce that peak. If your amplifier doesn't have that much reserve power, you get "clipping." Which doesn't happen during a live performance.

So, if you want your system to be able to give you all the power, all the sheer presence of live performance, you need an

amplifier with all the reserve power of the Spec 2.

STATE-OF-THE-ART DESIGN

Spec 2 not only produces an uncompromising amount of sound; it does so in a totally uncompromising manner.

For example, Spec 2 uses an advanced toroidal coil power transformer. It's a more expensive transformer than most amplifiers use. But a more efficient transformer. And one that keeps magnetic flux leakage to an absolute minimum.

Also unlike many power amplifiers, Spec 2 doesn't use fans. Because fans can cause noise. Instead, Spec 2 has massive heat sinks and special Pioneer-developed protective circuitry to keep the operating temperature under control.

Spec 2 even has wattage meters that indicate music output

compensate for any deficiencies in program material or listening area.

And, so you can make sure you've made all the right adjustments, Spec 1 has a "tone off" switch that lets you compare your setting with a completely flat setting.

Spec 1 even has its own microphone amplifier, with its own volume control. So you can mix into any program material without touching the main volume control.

THE BEAUTIFUL SOUND OF NOTHING

One thing Spec 1 doesn't do is add anything to the sound it reproduces. The phono section has a completely inaudible signal-to-noise ratio of 70 dB (IHF, short-circuited A network). All other inputs are rated at 90 dB. Which is even more inaudible. And it has a total harmonic distortion of no more than 0.03%. Which is five times under what your ear is capable of detecting.

DESIGNED FOR EIA MOUNTING

Both Spec 1 and Spec 2 are 19" wide. So you can place them in any standard EIA laboratory rack.

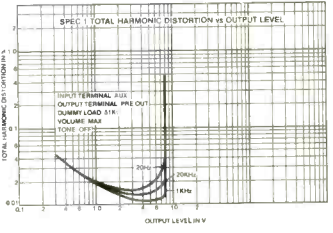
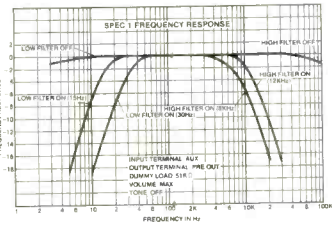
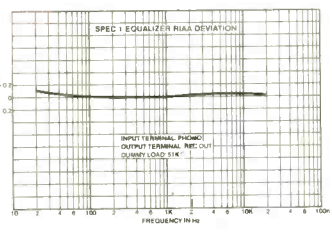
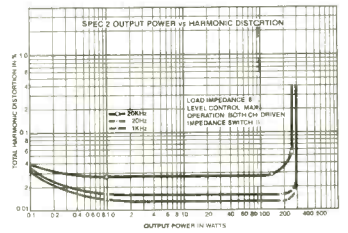
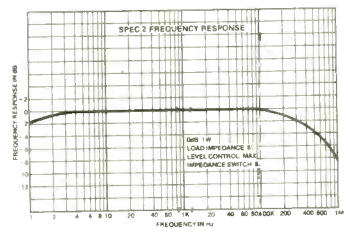
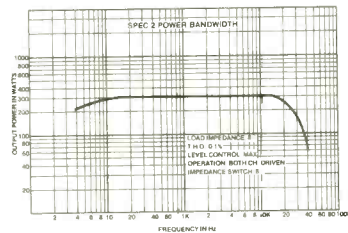

in RMS watts at 8 ohms. These had to be specially designed, too. Because conventional VU meters couldn't give an accurate enough power reading.

SPEC 1: TWICE THE CONTROL OF MOST PREAMPLIFIERS

Most preamplifiers have two tone controls. Some have three. But Spec 1 has four. Each of which is calibrated in 1.5 dB clickstops. All together, they give you a total of 5,929 ways to

Or you can stack them like conventional home entertainment components.

Which they definitely are not.

SPEC 1 SPEC 2 PIONEER®

U.S. Pioneer Electronics Corp., 75 Oxford Drive, Moonachie, New Jersey 07074

Check No. 35 on Reader Service Card

Section	No. Steps	Time, mins.
Back Panel Asmby.	45	135
Front Panel Asmby.	50	160
Selector Switch Asmby.	19	85
Audio Circuit Bd. Asmby.	60	100
Power Supply Asmby.	14	40
Final Asmby.	41	200
Total	229	11 hrs., 20 mins.

Because I made a couple of mistakes when I assembled the ST-400, I was especially careful in wiring the PAT-5. Either because it's a simpler kit or perhaps because I was more careful with this kit, it worked perfectly the first time I connected it to the system. If there'd been trouble, however, I probably would have been able to clear it up by using the information in the four pages of troubleshooting aids Dynaco supplied in the manual. These include pictorial layouts of the components on each board, with voltage tables for each board and for each transistor, diode, and the two ICs.—Charles Graham.

Phono Preamp Measurements

Gain of the phono preamp at 1kHz measured 78X and 74X in the left and right channels respectively, which works out to 37.8 and 37.4 dB. Input noise with shorted inputs in a 400Hz to 20kHz band was 0.26 μ V for left and right channels and with the measurement bandwidth extended to 20 Hz to 20 kHz band was 0.6 and 0.7 μ V for both channels. The 20 Hz to 20kHz noise was largely "1/f" or lower frequency noise and was relatively free of 60 Hz line harmonics. These are excellent noise figures and represent a phono signal-to-noise ratio of 83 to 84 dB below 10 mV at 1 kHz.

The 20 kHz THD, standard SMPTE IM, and CCIF IM for equal amplitude 10 and 11 kHz output levels are plotted in Fig. 5 vs. phono preamp rms output level. The data shown is for a high impedance measurement load at the tape-out-

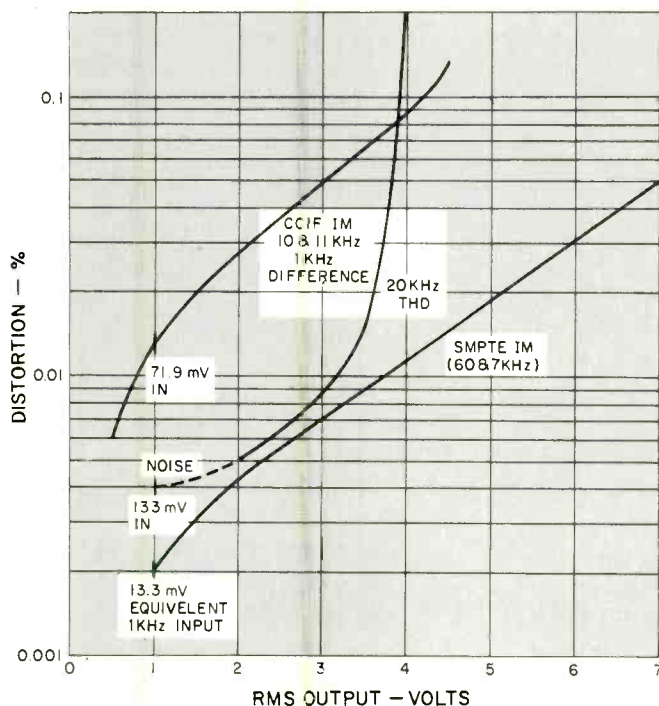

Fig. 5—Output voltage vs. CCIF and SMPTE IM and 20-kHz THD.

jacks of the preamp. This presents the normal load to the *phono preamp* output, which is the 50-kOhm input impedance of the voltage follower. Loading the phono preamp output with 10kOhms increased all the distortion levels somewhat and reduced the maximum output before clipping, which can be seen most easily in the phono overload measurements shown in Table 1.* Standard SMPTE IM is quite low up to 7 V output. The 20-kHz THD is low up to about 3.5 volts and then climbs rapidly beyond 4 V. This rapid increase in THD above 4 V output is caused by the relatively low impedance reactive load of the RIAA feedback network upon the output stage of the phono circuit. Since the impedance of this network decreases with increasing frequency, it becomes more difficult for the output stage to swing to the lower frequency, lightly loaded voltage clipping level. This distortion in the region of rapid increase with output level is mainly even harmonic due to the output stage cutting off on the plus half cycle of the output voltage waveform. Since, due to the reactive nature of the load, the transistor output current is out of phase by some 60 to 80 degrees with the output voltage, the current cuts off when the output voltage goes past zero on the way to the positive peak of the sine wave. When this happens, the output transistor has lost control of the situation and the collector load resistor continues to pull the output positive but in a non-sinusoidal manner. This same effect causes first-order difference tone generation in the CCIF IM test.

All of the above simply means that the output voltage deliverable at low distortion decreases as frequency increases. This is not unique with the PAT-5 phono preamp but is characteristic, more or less, of all the two-stage, feedback-equalized phono preamps on the market. More sophisticated complementary output stage circuits can reduce this kind of *Dynaco specifies 15 kOhms as the load.

Table 1—Frequency and load vs. phono overload. Dynaco specifies 15 kOhms as the load.

Frequency, Hz	Input, millivolts		Output, volts	
	Hi-Z Load	10-kOhm Load	Hi-Z Load	10-kOhm Load
20	15.8	12.5	11.0	5.7
100	30.2	19.8	11.0	6.0
1k	132	83	10.0	5.6
5k	298	202	8.8	5.4
10k	420	320	6.7	4.7
20k	540	480	4.3	3.5

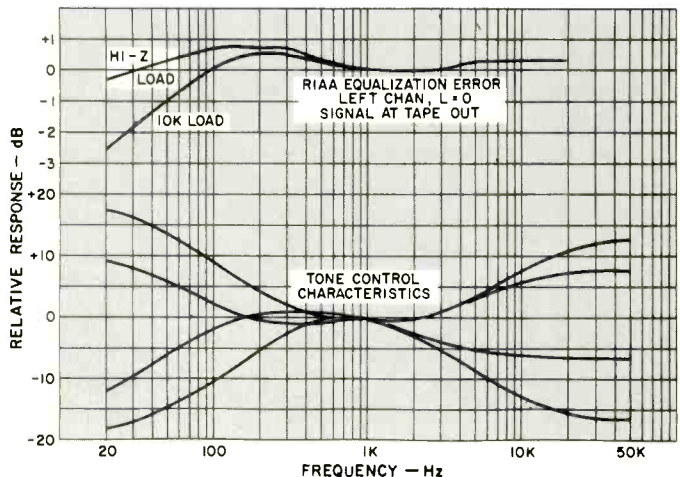

Fig. 6—RIAA equalization error and tone control characteristics. Dynaco specifies 15 kOhms as the load.

distortion but don't necessarily sound better. The Dyna PAT-5 phono stage has enough high frequency input signal acceptance to not be in trouble with most all high-quality magnetic cartridges.

RIAA equalization error with a noninductive source is shown in Fig. 6. The broad rise between 50 and 500 Hz in the left channel plotted is enough to be audible as a slight upper bass heaviness. The right channel was considerably flatter in this region. The low-frequency rolloff with 10 kOhm loading is mainly due to the relatively small 1 μ F output coupling capacitor. The effect of nonideal 47-kOhm input resistance and possible interaction of reactive sources on the feedback equalization was checked using representative low- and high-inductance cartridges. With the high-inductance cartridge source, the response was found to rise with frequency being up about 0.8 dB at 5 kHz, +1.6 dB at 10 kHz, +1.8 dB at 15 kHz, and +1.6 dB at 20 kHz. This is in contrast to other preamps tested which have tended to roll off the last octave by 1 to 2 dB. This characteristic would tend to make the PAT-5 sound slightly brighter than other preamps when using most magnetic cartridges which are high inductance types. With the low-inductance source, the effect was much less pronounced and more like other preamps tested which, in general, tend to be up 0.3 to 0.6 dB from 3 to 20 kHz.

Phono overload vs. input frequency is shown in Table 1 below for an open circuit and 10-kOhm load at the tape-out jacks. Overload was judged visually on a scope and was either onset of peak clipping at low frequencies or the positive slope distortion at high frequencies discussed under distortion observations.

Scope photos of pre-equalized square waves are illustrated in Fig. 8 for test frequencies of 40 Hz, 1 kHz, and 10 kHz. The rise time of the input signal is limited to 7 μ s to give an equivalent input bandwidth of 50 kHz. With a 10-kOhm load, the low-frequency tilt shown for 40 Hz about doubled.

Channel-to-channel crosstalk of the phono preamp was measured on a pre-equalized basis and found to be down 80 dB or more from 100 Hz to 5 kHz, decreasing to -49 dB at 20 Hz and -68 dB at 20 kHz. These are quite good measurements for this test.

Output Section Measurements

Except where otherwise noted, the measurements of the output section are made with the filters and tone controls switched out. Signal input was into *Tuner*, output taken at main output with volume control at maximum.

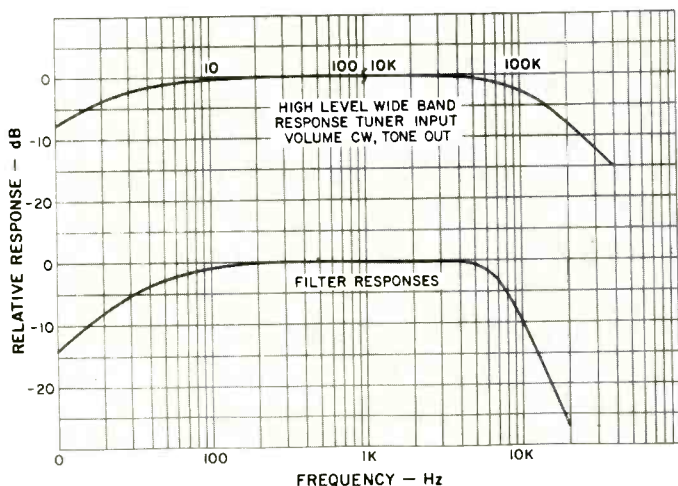

Fig. 7—Filter responses (lower curve) and high-level response (upper curve; note break at 100 Hz/10 kHz).

Output section voltage gain was found to be 9.8X and 10.2X for left and right channels respectively, which works out to 19.8 and 20.2 dB. IM distortion was low indeed, being less than 0.002 per cent for output levels of 7 V rms or below, with load resistances of 10 kOhms or higher. Harmonic distortion was also very low, being less than 0.01 per cent for 20 Hz to 20 kHz at rated output of 2 V rms with a 10-kOhm load or higher. THD was highest at 20 kHz and was just under 0.01 per cent. At 9 V rms output with a 10-kOhm load, THD was still under 0.01 per cent from 20 Hz to 10 kHz and was 0.025 per cent at 20 kHz. To get an idea of how low THD really was at mid frequencies, a wave analyzer was used to measure the distortion products at 2 V output at 1 kHz with a 10-kOhm load. The technique is to feed the wave analyzer from the distortion output of the Sound Technology 1700A THD meter. This keeps the fundamental out of the wave analyzer, reducing its own spurious responses to very low values and extends the percentage measurement range to the residual of the Sound Tech oscillator. This measurement yielded 0.0005 per cent second, 0.0005 per cent third, 0.00013 per cent fourth, and less than 0.0001 per cent fifth. Extremely low measured distortion levels to say the least!

High-level frequency response, along with filter responses, are plotted in Fig. 7. Tone control characteristics for maximum boost and cut and for boost and cut settings of plus and minus 6 dB at 50 and 19 kHz are shown in Fig. 6. The characteristics of this type of tone-control circuit are nicely revealed here, showing that the turnover frequency for bass boost and cut is clearly variable with amount of control rotation and that the treble turnover frequency is lower for cut than boost.

A comment is in order here on the relation between mechanical and electrical center of the tone control pots. This type of circuit is sensitive to the accuracy of 10 per cent resistance at 50 per cent rotation in the control pots and to the tolerance in the associated resistors and capacitors. It was noticed that this factory wired unit didn't have equal rotation of the tone control knobs on either side of center, i.e. the knobs were adjusted on the shafts so that the response was flat with the tone controls engaged and the slots in the

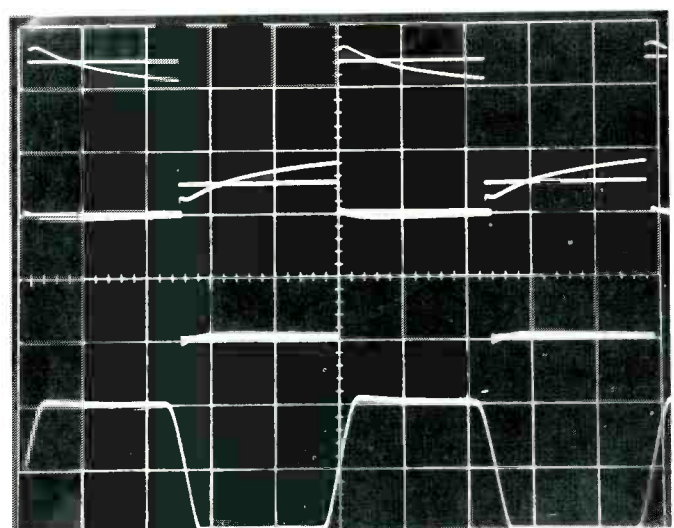

Fig. 8—Pre-equalized square-wave responses from phono preamp. Top, 40 Hz; middle, 1 kHz; bottom, 10 kHz. (All outputs, 0.5 V/cm; inputs adjusted to overlay outputs; top, 5 mS/cm; middle, 200 μ S/cm; bottom, 20 μ S/cm.)

knobs were at 12 o'clock. The kit instructions* tell the builder to put the knobs on so that the amount of mechanical rotation is equal on either side of center. When that was done with this unit, response was down 3 dB at 20 Hz and 2 dB down at 10 kHz. The effect of this on a 100-Hz square wave is shown in the middle trace of Fig. 9. If the kit builder wants flattest response with the tone controls engaged and knobs set at 12 o'clock, it would be wise to use an a.c. VTVM and oscillator and set the shafts for flattest response and then put the knobs on with slots straight up. Square-wave response at 20 Hz and 20 kHz is shown in Fig. 9. The 20-Hz tilt with a 10-

kOhm or higher load was about the same, a good feature especially when driving a 10-kOhm input impedance power amplifier.

*Ed. note: Dynaco tells us that the first kit manuals were in error on this point. Subsequent printings describe approximate knob positioning correctly, so the knob rotates clockwise from 6 o'clock to 4 o'clock.

Output noise vs. bandwidth and volume control rotation is in Table 2. The higher noise level in the 20-Hz to 20-kHz measurement bandwidth was mainly due to line harmonics. Switching the high-cut filter in caused the 20 Hz to 20 kHz noise to be 75 and 72 μ V in left and right channels respectively and was dominantly a high-frequency hiss increase due to the added noise of the filter amplifier. These output noise levels are in the area of possible audibility at the speakers if the speakers are high efficiency and the power amplifier used has higher than usual (28-32 dB) voltage gain.

Channel-to-channel crosstalk in the output section was measured and found to be greater than 80 dB down from 20-1500 Hz, decreasing to -70 dB at 4 kHz, -60 dB at 12 kHz, and -56 dB at 20 kHz.

In summary, the Dynaco PAT-5 offers good sonic performance and control features and would appear to be a good value for the money, especially if purchased as a kit.

—Bascom H. King

Check No. 93 on Reader Service Card

Table 2—Output section noise vs. volume control rotation and bandwidth.

Bandwidth, Hz	Left Output, μ V			Right Output, μ V		
	CCW	WC	CW	CCW	WC	CW
400-20K	38	41	40	38	40	39
20-20k	62	74	74	46	49	49

Notes: CCW is counterclockwise; WC is worst case, usually about 6 dB down from maximum position, and CW is clockwise.

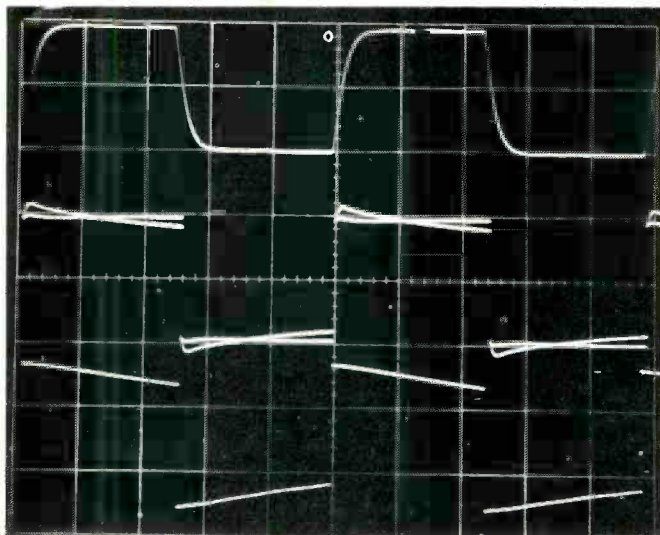

Fig. 9—Square-wave response of the output section. Top, 20 kHz, filters and tone controls out; middle, 1 kHz, tone controls electrically and mechanically centered; bottom, 20 Hz, filters and tone controls out. (Scales: top, 20 μ S/cm, 1 V/cm; middle, 200 μ S/cm, 1 V/cm; bottom, 10 μ S/cm, 1 V/cm.)



Pioneer PL-71
Direct Drive Turntable

MANUFACTURERS SPECIFICATIONS

Speeds: 33-1/3 and 45 rpm. **Wow and Flutter:** 0.05% (WRMS) or less. **Rumble:** Better than 60 dB. **Platter:** 31 cm., aluminum alloy. **Effective Arm Length:** 224 mm. **Tracking Error:** +3, -1 deg. **Usable Cartridge Weight:** 4 to 32 gms. **Dimensions:** 18-7/8 in. W. x 16 in. D. x 7 1/4 in. H. **Weight:** 24 lbs. 4 oz. **Price:** \$299.95.

The Pioneer PL-71 is one of the most elegant, professional looking turntables we have yet tested, and its performance is top rate, as we will see later. Unlike most units, the motor panel is made of wood. The controls are all located on a handsome metal subpanel mounted on the right-hand side. From the front, there are three push-buttons for on/off, 33-1/3 or 45 rpm; then come two small rotary controls for speed variation (one for each speed) and, next to the arm base, is a long cue lever. The arm itself is a beautifully made S-type with counterweights, and there are adjustments for anti-skating, stylus force, lateral balance, arm height, and overhang. The anti-skating control is mounted on an extension to the arm base and is calibrated 0 to 4 grams, as is the tracking force dial. This is in the form of a ring on the rear of the tone arm (see Fig. 1). The reference mark is on the tone arm, and the dial is set to zero until the arm is balanced in the usual manner. The lateral balance is a little unusual, consisting of an angled bar fixed to the arm just in front of the

pivot. A weight is placed on the end and a set-screw locks the bar on the arm so that no further adjustment is required. The cartridge shell is held by a quick-release collar, and the cartridge is positioned for optimum overhang by using a gauge which doubles as the 45-rpm adaptor.

The motor is a d.c. servo type, direct-coupled to the turntable spindle so there is no belt, idler wheel or gears. It is driven by a single power transistor in a feedback circuit working at about 30 volts. The 3-lb. platter has strobe markings on the rim, and illumination is provided by a neon tube called a *strobe-light* which is mounted at the front left corner. Direct-drive systems have inherently low wow and flutter, while the servo control helps to maintain long term stability. The motor and pickup arm are not spring mounted, but acoustic feedback is prevented by elaborate shock absorbers built into the four mounting feet.

Measurements

No trouble was experienced in mounting the phono cartridge which was my standard Shure V-15 III. Balancing and setting the other adjustments are fully described in the well-illustrated instruction manual so that even an absolute beginner should have no difficulty. The first test for wow and flutter measured a shade over 0.05% using the DIN standard. Rumble was exceptionally low at -65 dB ARRL. Speed variation was +4 to -3.5% at 45 rpm and +3 to -3.6% at 33-1/3. No change was detected when the line voltage was varied between 90 and 130 volts—a tribute to the servo system. (Incidentally, the PL-71 works just as well on a 50-Hz supply—no capstan or other change is necessary. There are connections for 200 to 240 volt operation.) The stylus force gauge was extremely accurate—certainly within 3%—and arm resonance with the Shure V-15 III came out at just under 8 Hz with a negligible 3-dB rise. Lateral and vertical bearing friction was too low to be measured accurately, and tracking error was less than 0.5 degrees per inch. Cable capacitance was found to be less than 100 pF, so some of the tests were made with a CD-4 cartridge, an Audio-technica AT-20.

Use Tests

The PL-71 was used for several weeks, mainly with CD-4 records, and I must say I was very impressed. I *did* miss an automatic stop, but apart from that I have no criticisms to make. Optimum tracking force for the Audio-technica AT-20 was 1 ¼ grams and just over 1 gram for the Shure V15 Mk

III. Actually, many records could be played at under one gram but I invariably adjust for the difficult ones or use the Shure test disc. Many people do not realize that too low a tracking force can do as much damage as one that is too high! What about the anti-skating control? Well, optimum position was found to be a little higher than the tracking force but it was not unduly critical. The cue lift is nicely damped with no sideplay, and all the controls worked smoothly. Once the speed control was set, no readjustment was necessary—the speed remained constant—right on the nose. The motor itself is exceptionally quiet, and taken all round, I would put the PL-71 in the highest class—even the most fastidious audiophile will not be disappointed.

George W. Tillett

Check No. 94 on Reader Service Card

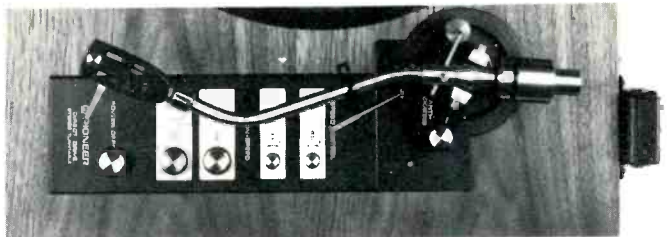

Fig. 1—Close-up of arm.

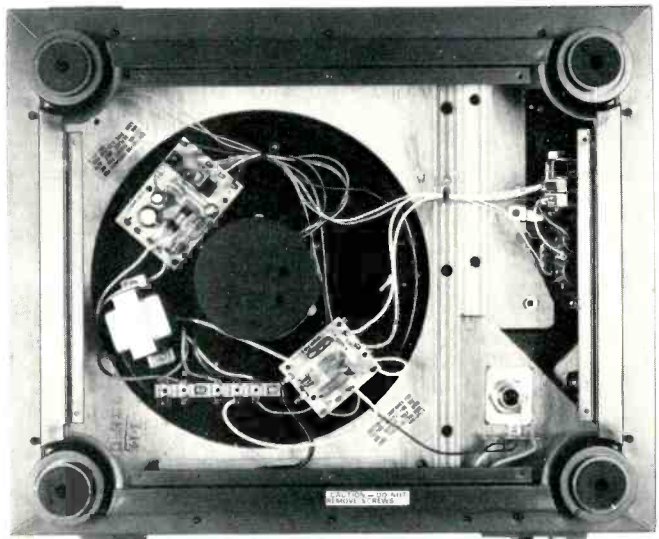
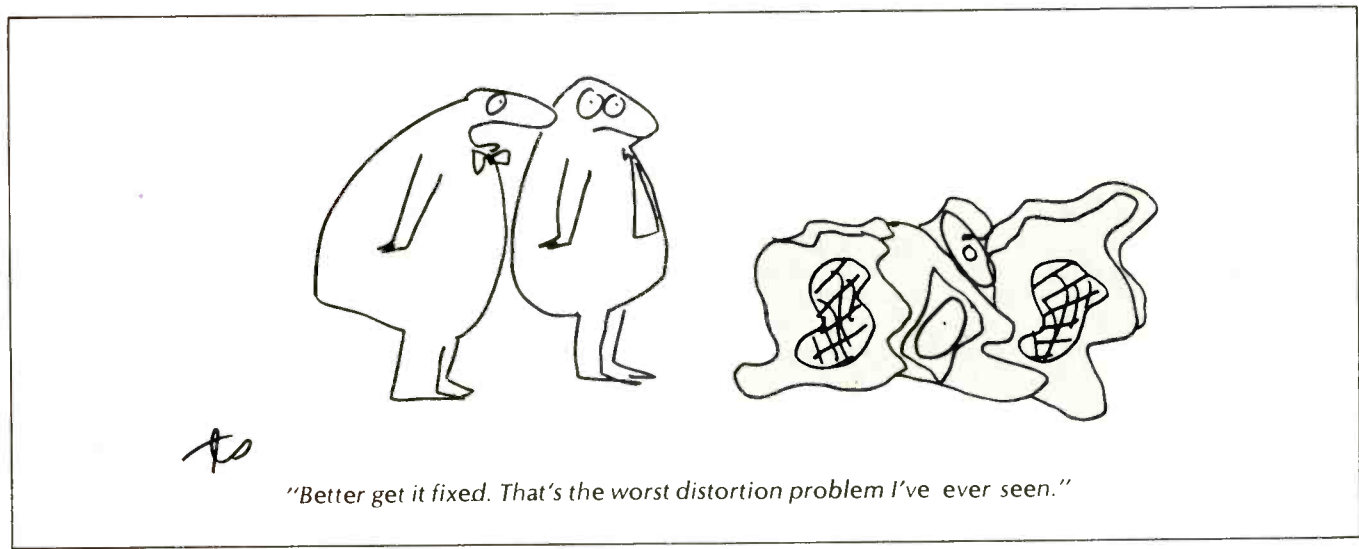

Fig. 2—View from beneath.



Let's Be Fair To Our Favorite Composers

Felix G. Arnstein

SO YOU THINK your favorite composer is a Great Genius? Perhaps he is. If his name happens to be Ludwig van Beethoven or Richard Wagner—or Verdi, Puccini, Bach or Johannes Brahms—then the answer must be yes, yes, a thousand times YES.

But just how can we judge the “true greatness” of a composer? By his compositions, of course, by what he wrote, that is to say, but what he wrote during his lifetime. Note here that I am going to pay special emphasis to that last phrase, “during his lifetime,” since no dead composer—however great—can compose any further works.

When comparing the respective outputs of our favorite composers, therefore, we find ourselves facing rather squarely the following problem: how to compare the output of a composer who died, let us say, at age 31 (Franz Schubert) with that of a composer who did at, say, 91 (Jean Sibelius)? Or 56 (Beethoven) or 88 (Verdi) with 35 (Mozart)? How, in other words, may we arrive at a “fair” way of comparing our favorite composers?

Should we not have, for purposes of this comparison, a cut-off age, an age which all the “greats” attained, so that we may compare each respective composer’s output as of this cut-off age?

And how shall we arrive at this cut-off age? There is really no choice in the matter. Simple logic would dictate this age to be 31, the earliest age at which a famous composer (Franz Schubert) died.

Schubert was virtually unknown during his brief lifetime, and most of his works remained hidden in desk drawers or nooks and crannies for decades after his death, but all told some 1,000 compositions left his incredibly prolific pen. About 600 of these were “art songs,” a form Schubert himself created. At 17 he set several of Goethe’s poems, *Der Erlkönig* among them, to music. Schubert is also cred-

ited with the most famous *Ava Maria*, with almost numberless miniatures for piano (impromptus, *moments musicaux*—another form he created), 18 string quartets (*Death and the Maiden* among them), polonaises, sonatas, and, of course, his nine symphonies, of which the 9th, or *Unfinished*, is one of the most popular ever written.

How would some of Schubert’s near-contemporaries have fared had they the misfortune to have lived merely to the age of 31? Well, for one, “Papa” Haydn would today not be known at all, had he died at Schubert’s age. Though he did attain the quite respectable age of 76, Haydn was not called “Papa” because of that, nor did his being the “father” of the modern symphony have anything to do with it. While still a young man barely into his mid-thirties, Haydn was given the responsibility of leading Prince Esterhazy’s Court Orchestra. But Haydn proved to be more than merely the orchestra’s musical leader; he so concerned himself with the lives of the musicians under his charge (some of whom were twice his own age), helping many with personal difficulties having nothing to do with music, that he was soon called “Papa” by everyone. The name stuck even after Haydn left the Esterhazy Court. Indeed, it was only then that he became a truly great composer. By the time he was 31, Haydn had written only his very early symphonies, his first at 27, and absolutely none of the works on which his reputation now rests.

Even Mozart, whose very name is practically a synonym for “child prodigy,” would not have written a fair number of major works we associate with his name. He would not have composed his last three operas (*Così fan Tutte*, *The Magic Flute*, and *La Clemenza di Tito*). We should likewise not have his famous *Requiem* (which he never actually completed himself), nor his last (and probably best) three symphonies, including the *Jupiter*.

How about the composer who is considered by many as the greatest who ever lived? Suppose Ludwig van Beethoven had not lived past the age of 31—what would he have, and not have, composed? He would have written his first three piano concertos, a few songs and sonatas, his first symphony, the ballet *Prometheus*, and the oratorio *Christ on the Mount of Olives*. Excellent, for such a young man, but is this the Beethoven we know today? Hardly. Missing would be such trifles as his last two piano concertos, including the *Emperor*, his Symphonies 2 through 9, his opera *Fidelio*, the music from *Egmont*, the *Missa Solemnis*, and other works. We would have, in short, a minor, perhaps occasionally played, composer; we would not have *Beethoven*.

Let’s go back just a bit in time to pick up Handel. Except for the *Water Music*, on which he was still working at the age of 31, he would have written none of the works on which his reputation rests today. He had, it is true, completed numerous oratorios and operas, some of which had considerable local, or fleeting, success, but these are virtually never performed today.

Let us now consider Schumann. He is today noted chiefly for his four symphonies, all standard works in the repertoire. Had he lived only until the age of 31, we should have to content ourselves with his *First Symphony*. ‘Til 30, Schumann wrote almost entirely for the piano; we would, therefore, be fortunate in having his lively *Carnaval*, his *Kinderscenen* for piano, and his *Kreisleriana*, but his reputation would nevertheless be only a fraction of what it is now. He lived into his forties.

The rather difficult name of Tchaikovsky we would scarcely have to bother with today, had he died at 31 instead of 53. We would have only his *First Symphony*, which is not considered particularly outstanding and which gave him so much trouble that

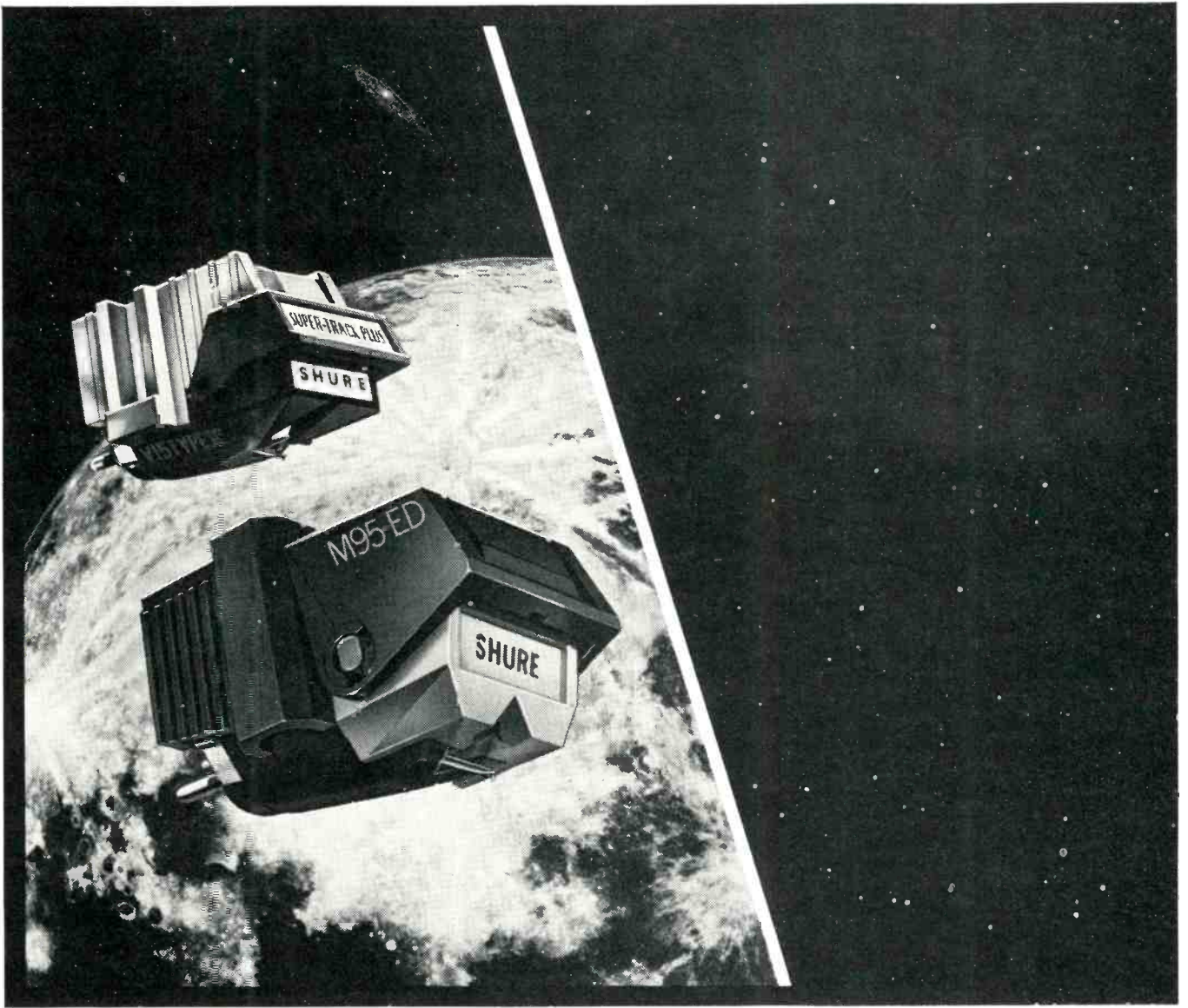

II'nd only to the III.



The new Shure M95ED phono cartridge combines an ultra-flat 20-20,000 Hz frequency response and extraordinary trackability with an utterly affordable price tag! To achieve this remarkable feat, the same hi-fi engineering team that perfected the incomparable Shure V-15 Type III cartridge spent five years developing a revolutionary all-new interior pole piece structure for reducing magnetic losses. The trackability of the M95ED is second only to the Shure V-15 Type III. In fact, it is the new "Number 2" cartridge in *all* respects and surpasses much higher priced units that were considered "state of the art" only a few years ago. Where a temporary austerity budget is a pressing and practical consideration, the M95ED can deliver more performance per dollar than anything you've heard to date.

Shure Brothers Inc.
222 Hartrey Ave., Evanston, IL 60204
In Canada: A. C. Simmonds & Sons Limited



FREE! 1976 Stereo Directory & Buying Guide with the purchase of a Shure V-15 Type III, or the M95 series, M75 Type II or M91 series of cartridges. Simply send us your warranty card with the notation "Send Free Buying Guide" before March 1, 1976. (Offer subject to supply and may be withdrawn at any time.)

Check No. 42 on Reader Service Card

it lead to the first of his many nervous breakdowns. We would not have his other symphonies (including the *Pathétique*), his surpassing ballets (*Swan Lake*, *Nutcracker*, *Romeo and Juliet*, *Sleeping Beauty*), his operas (*Eugene Onegin*, *Queen of Spades*), nor his brilliant *Capriccio Italiane*.

We all know that Verdi, who died at 88, produced some of his greatest works at a relatively advanced age: *Otello* in his middle seventies, *Falstaff* at 80. But what kind of genius was Verdi in his youth? Before reaching the age of 32, he had completed such earth-shaking gems as *Oberto*, *Un Giorno di Gegno*, *Nabucco*, *I Lombardi*, *Ernani*, and *I due Foscari*. Quite impressive, to be sure. But, would not these works be sufficient only to per-

nor *Butterfly*, *Tosca*, nor *Turandot*—nor even *Girl of the Golden West* nor the *Trittico*—would exist.

Likewise the Italian opera composer Gaetano Donizetti, who died at 50, would not have composed the three operas for which he is famous, and without which he would today be just as unknown as Puccini, had neither of them reached the age of 32. Donizetti's unwritten (so far as concerns us here) operas are *L'Elisir d'Amore*, *Lucia di Lammermoor*, and *Don Pasquale*—in other words, the works we think of when we hear mentioned the name Donizetti.

At the age of 31 Gounod's *Faust* was still 10 years away; Humperdinck had not written his *Hansel and Gretel*; Leoncavallo had not written *Pagliacci*

Pelleas et Melisande.

Dvorak, at thirty-one, had composed nothing, having spent most of his time playing in an orchestra and studying composition on the side.

Richard Strauss, a musical *enfant terrible*, started composing at an early age and yet, had he not made it past 31, he would today be lucky to have the reputation of a Respighi. He would have written such true masterworks as *Don Juan*, *Death and Transfiguration*, and *Til Eulenspiegel*, but he would not have written *Der Rosenkavalier*, to say nothing of *Ariadne*, *Arabella*, *Die Frau ohne Schatten*, *Salome*, *Elektra*, *Don Quixote*, *Ein Heldenleben*—need one go on?

Need one go on indeed! Certainly no one would dream of taking Richard Strauss to task for living to the ripe old age of 85 (though, as it turned out, he might have been spared much unpleasantness had death taken him a couple of decades earlier); nor do we blame Brahms for having the audacity to wait until his early sixties, and the completion of all his symphonies, songs, and concertos, before calling it a life; nor are we angry at Handel for surviving to 74. We do not blame Richard Wagner for not calling it *schluss* after the *Dutchman* and doing away with himself at 31 simply in order to be "fair" to Franz Schubert.

No, none of this is indicated, but we do want to have a certain perspective. We should realize that certain composers *did* have an advantage in living to a ripe old age, giving them time to write all of which they were capable.

Of course, other conditions must also be considered. Some composers were born with a musical spoon in their mouths. Mozart, for instance, had every opportunity to avail himself fully of a musical life from, quite literally, the cradle, and he made the most of it. Wagner had a bit more trouble in that respect, as did Beethoven and, for that matter, Schubert himself.

All this is, of course, not to say that we must immediately drop our favorite composer merely because he had the audacity to have lived past the age of 31 and to "adopt" Franz Schubert merely because the poor, but incredibly talented, devil passed away in the full bloom of his youth. No. It is enough merely to remind us to keep things in perspective, to maintain a sense of value, in short, to be "fair" to your favorite composer. The greatness of his accomplishments will rise above any advantages or disadvantages he may have had during his lifetime, be it a short or a long one. 

"We should recognise that certain composers did have an advantage in living to a ripe, old age."

mit their composer to join the ranks of today's all-but-complete unknowns? Verdi's name, far from being a household word the world over, would rarely be uttered outside the confines of his native Italy, and probably not very frequently even there. It is redundant to mention that we would not have such works as *Rigoletto*, *Trovatore*, *Traviata*, *Aida*, etc. In short, we would have but the thinnest shadow of Verdi, an apparition that we might puzzle over, but scarcely recognize.

Verdi's perhaps even greater contemporary (both were born in 1813), Richard Wagner, would scarcely have fared much better. *Rienzi* aside, we would have to judge his reputation by *The Flying Dutchman*, a most worthy opera and an amazing feat for a thirty year old, to be sure. But the Wagner we know today, the one who wrote *Tannhauser*, *Lohengrin*, *Die Meistersinger*, *Tristan und Isolde*, *Parsifal*—not to mention that incredible tour-de-force, *Der Ring des Nibelungen*, all four operas, all 15 magnificent hours of it—this Wagner we would be totally unaware of, had he not reached his late sixties.

While on the subject of the opera composers, a quick look at Puccini, who like Wagner lived into his sixties, would reveal the most distressing fact that, had the jaunty Italian succumbed, as did Schubert, at less than half the age he actually attained, he would be a complete unknown today. Neither *Manon Lescaut* nor *Boheme*,

(though Mascagni finished his *Cavalleria Rusticana* at the unlikely age of 26); Offenbach would be completely unknown, with neither *Hoffmann* nor his operettas written; Bizet would not have composed *Carmen*, though he died at an early 37; Massenet had nothing whatsoever to show us; even Rossini, who devoted only the first half of his life to composition (he died in his seventies), would not have written his masterpiece, *William Tell*.

Handel's great contemporary Bach would be able to claim only his organ music; missing would be virtually all his chamber music, including the concertos, to say nothing of the works that mean "Bach" to most of us: his masses, passions, oratorios, cantatas, chorales. He would hardly have been rediscovered a century after his death, as there would have been precious little to be rediscovered.

And so it goes right down the line. Had Brahms died at the age of 31, we would today have none of his four symphonies, which bear the weight of his reputation. Anton Bruckner, Schubert's fellow-Austrian, born about a quarter of a century later and living into his mid-seventies, was nearly thirty when he decided to abandon a teaching career for one of music; his *First Symphony* was written when Bruckner was over forty.

Debussy did not even begin to compose his "impressionistic" music, upon which all of his fame rests, until he was 31; these are the works headed by *Afternoon of a Faun* and the opera

Of Rosie, Mame, Liza, Ellen and Rod

Donald M. Spoto

FIFTEEN Broadway seasons have come and gone since the Styne-Sondheim-Laurents trio gave us *Gypsy*. And almost as much time elapsed before the show went to England. RCA's recently released London cast album makes one wonder why they ever sailed away with Angela Lansbury (RCA LBL 1-5005), who sounds badly miscast.

Lansbury belts her way bravely through *Some People* and *Everything's Coming Up Roses*, but comparisons are unavoidable, and Ethel Merman she isn't. Lansbury mistakes volume and a sort of edgy crankiness for that puffy, abrasive quality that makes Rosie, the mother of Gypsy Rose Lee and June Havoc, the irresistible character she is. Perhaps it's because Lansbury conveys too much chic decadence; that's what made her so fine in *Mame* and the *Madwoman of Chailot*. But here I don't believe much of what she hurls through the carefully separated stereo microphones. And with Rosie, credibility is all.

Zan Charisse and Debbie Bowen fare better as the daughters: *If Momma Was Married* has an easy, naive charm in its humor (how good Sondheim's lyrics were then, how much better they'd be later in *Company*, *Follies*, and *A Little Night Music*). And

Lansbury, Charisse, and a study baritone named Barrie Ingham do a neat job with *Together Wherever We Go*, which is infectious fun. But the rest is like half-set gelatin.

I wonder, too, why *Gypsy* is subtitled "a musical fable." It's as straightforward a musical biography as you could want. Is the idea of the dominant mother, defeated in the end but still appreciated, to be some sort of Grand Paradigm? Apparently some of the ghastly *preciosite* we're afflicted with now started back in the late fifties.

But if Merman is the only Rosie, Lansbury is the only Mame, and Lucille Ball can't hold a mike to her in Warners' soundtrack album (W 2773), which should have opted for honesty and been spelled *Maim*. All the charm of the Broadway version has been lost in this transformation. Lucy and Beatrice Arthur are hard to distinguish in *Bosom Buddies*, which was deliciously wicked in the original. Now it's an arid, confusing bore that sounds faintly like a Seattle drag show opener.

Throughout, the cuts are startling (was composer-lyricist Jerry Herman party to this hatchet job?). The role of Miss Gooch (here, as before, Jane Connell) has been weakened to the point of comedic anemia. And Kirby Furlong, as the young Patrick, should

take lessons in *How Not To Be Cutesy-Poo* from Frankie Michaels, the original.

Mame's *That's How Young I Feel* has disappeared, and *Loving You* has been added for a nervously pitched Robert Preston. Herman's lyrics are telescoped, tossed out, toughened up; and even the soundstage orchestra comes out cheap and under-rehearsed.

Put this record in a sunny spot and have fun watching it met.

Now take *Liza* (Columbia PC 32854) Minelli. Here's a voice with a real person attached to it. There's nothing phoney about her performance at the Winter Garden Theatre that is now available.

You can almost see her curl around a song. *Come Back to Me* has that unabashedly seductive quality, and her gamine attitude makes the delivery more sensational. *The Circle*, with its unself-conscious moral, packs a whallop, and *More Than You Know* has that telling languor that she must have learned from her mother's method.

Minelli worshippers tell me her appeal lies in her direct attack. Certainly no emotion is left musically undefined here: cheerful, wild abandon (*Ring Them Bells*), romantic wonder (*Maybe This Time*), tentative hope based on pride (*I'm One of the Smart*



the audio amateur?

What a trip old Richard's Rhine journey could have become had he built his own mixers, 900 watt amps, octave equalizers, 24 inch woofers, electronic crossovers, and home brew electrostatics. Zounds what sounds!

Ask our Rhine maidens for details.

the Audio Amateur

Box 176A
Peterborough, N. H.
03458

Send for a free prospectus.

Craig Stark of STEREO REVIEW says: "Top quality, only U.S. publication devoted to the serious audiophile constructor."

Name
Street
City State
Zip

Check No. 2 on Reader Service Card

WHAT CREATURE CAN:

- Make outer space sounds for rock musicians"
- Demonstrate principles of music & acoustics for educators?
- Create sound effects for theatre companies?
- Provide rhythmic pulses and tones for modern dance groups?
- Be one of the neatest toys in the world for an audiophile?

PAIA'S GNOME,



of course!

The 1st Micro-Synthesizer...
under \$50 in kit form.

FOR DETAILS AND PHOTOGRAPHS OF THE GNOME, AS WELL AS DOZENS OF OTHER KITS FEATURING INNOVATION RATHER THAN IMITATION, WRITE TO US FOR A

FREE CATALOG

PAIA Electronics, Dept. 1-A
Box 14359, Oklahoma City, OK 73114

Check No. 31 on Reader Service Card

Ones), and the wish for emotional security (*Quiet Things*). And her signature tune, *Cabaret*, is about as close as any song ever written to being a whole era.

Six arrangers are credited on the sleeve, which results in some palpable unevenness. And are there really only two percussionists among the 28 musicians listed? Sounds more like a dozen, and they tend to hog the scene. There's too much of the applause recorded, too. Since this can be electronically controlled (like electric guitars!), the home audience should be trusted to find its own response, without the now-canned, encouraged response.

How different the audience sounds in the most recent in Argo's **People Past and Present** series: **Ellen Terry: a Reminiscence by Sybil Thorndike** (Argo Stereo ZPL 1157). Here, as in the others previously reviewed in this column, the audience was in attendance at London's National Portrait Gallery, this time to hear a great actress read and reflect on a predecessor.

Ellen Terry died in 1928 at the age of 80 and left behind her a life and an art that are incalculably rich. Neither libertine nor rebel by nature, she nonetheless married three times, and bore her only children out of wedlock (her son was the famous British designer-writer Edward Gordon Craig). Acknowledged on both sides of the Atlantic during her lifetime as one of the half dozen greatest actresses of her time—and her time was a very long time indeed—she herself, as Dame Sybil points out, never saw her acting as claiming first place in her life. Perhaps, her friend and colleague hints, that is what made her so great: her art was genuine and sprang from deeply creative inner resources, and she was more surprised than anyone by good notices and high compliments. Her correspondence with George Bernard Shaw is well known, and Dame Sybil quotes freely and judiciously from it. And Terry was perhaps most of all known for her Shakespearean performances, as she was the quintessential Portia and a great (if unhappy) Lady Macbeth. (She felt the character too "unnatural" ever to be happy in it.)

Dame Sybil, not exactly unknown in the profession herself, remembers and reflects with refreshing charm and wit. It's hard to realize that she's 90 (the disc was cut only a couple of years ago): the voice is crisp and hearty, capable of several scales of pitch. She communicates perhaps a

little bit more than we would know to know about Terry's early years, but in so doing we get a good picture of Victorian England. The wonderful British sense of reserve and understatement is a lesson for all speakers here: she pays tribute to a great woman without maudlin sentimentality, without gilding the lily or making Ellen Terry a wax figure in Madame Tussaud's.

Everyone interested in theatre history, past and present, should be collecting this Argo series; I look forward to seeing future volumes (how about Dame Edith Evans, or my friend Siobhan McKenna?). And oh, yes, the audience—genuinely enjoying themselves. Laughing. Practically audible in their respectful silence. And, thanks, God—applauding only at the finale.

If there were awards for pretentiousness, Rod McKuen should win hands down. **Rod McKuen Sings the McKuen/Brel Songbook: Seasons in the Sun** (Warners BS 2785) is one of the most self-gratulatory records ever made.

Jacques Brel is known by his powerful songs—songs which range from social satire to personal apologiae. Rod McKuen's translations (on the sleeve he insists they are not translations but "collaborations," which at least has the unwitting merit of absolving Brel of some of this drivel) are banal exercises. How McKuen managed to bleed so much life out of Brel's songs is beyond my comprehension. He has a voice that is neither that of a *diseur* nor a *chanteur*. It sounds as if a slightly tipsy Godfather, recovering from a siege of flu, ambled up to a microphone and tried to persuade an audience that whispers along are dramatic and affective. Blah, blah, blah.

The best known Brel songs are here: *Ne me quittez pas—If You Go Away, Amsterdam, and The Women*. The ultimate insult to our intelligence is that McKuen felt compelled to offer pithy comments on the album cover: he tells us what each song "means," thus implying that they are not self-contained in their sense. That there are two and a half pictures of Brel and four pictures of McKuen on this album cover indicates where McKuen's loyalties really lie, and let us hope that this kind of record (a true vinyl auto-eroticism) marks the end of a trend.

I always thought McKuen was over-rated as a poet and as a performer. "This album is the best of all possible worlds," he writes. This performer is the worst of all possible critics!

The Column



Venus & Mars: Paul McCartney & Wings

Capitol SMAS-11419, stereo, \$6.98.

Roger McGuinn & Band: Roger McGuinn & Band

Columbia PC 33541, stereo, \$6.98.

The Byrds and The Beatles were, along with The Beach Boys, The Stones, and Dylan, the cornerstones of mainstream 60s rock. With the ordinary consumer as well as the hardcore rock fanatic on their side, they could count not only on lasting power but immediate singles appeal. Halfway into the 70s both the Byrds and the Beatles are no more, their fragments wander through the world of rock in many directions. These two survivors in particular have little in common except the surname prefixes. Paul McC. rarely plays live concerts, releases his songs to the public only occasionally, and has found public acceptance on a grand scale. Roger/Jim McG., on the other hand, stayed on the concert circuit, put out as many albums as possible, and have captured only a small fragment of the Byrds' audience as their own. How do their records' quality relate to how popular each is? Surprisingly, in these instances the public has exercised its sense of good taste; R. McGuinn's records have been uniformly dismal,

while McCartney continually excels himself.

McGuinn has made several errors in his post-Byrds career, most obviously in his latest album. Either he *will not* write, he *refuses to believe* he can write, or he simply *can not* write great songs anymore, allowing the bulk of the songs on this album to be composed by members of his band, who are nothing to shout about as writers. They occasionally come up with a winner (*Somebody Loves You*), but most of the songs they compose could easily be ignored. Aside from that single track, the only ones on **Roger McGuinn & Band** worth listening to are *Knockin' on Heaven's Door* (a gorgeous arrangement of a Dylan tune) and *Lover of the Bayou* (adequate, but inferior to the live treatment on the Byrds' untitled LP). A pretty dismal record for as well-respected a singer as McGuinn, not to mention a former Byrd. (Is McGuinn's fate the worst of the former Byrds? Given the untimely demise of Gram Parsons I'd have to dispute that, slightly.)

As far as the band itself goes, they're all right—but Richard Bowden is no Clarence White, and the sound of the band is anonymous until Roger adds his distinctive twelve-string Rick-

Keith Monks Audio Ltd.

presents



"THE ZERO FRICTION ARM"

Zero Friction? Not really. The friction of the M9BA MkIII Laboratory Arm actually measures about 4 mg (in any plane). For all practical purposes, that is close enough to zero to make accurate measurements impossible. It is less than one third the friction found in other top quality arms.

The low friction is accomplished through the use of a sophisticated unipivot riding in a micro-ball race. The friction causing lead-out wires have been replaced by pools of mercury and friction-free antiskating is applied magnetically.

Add to this, low effective mass and silicone damping and you have an arm that will not only elicit the best performance from the finest cartridges available today, but also presents a challenge for the development of even better cartridges.



Imported by:

audiophile systems

851 West 44th Street
Indianapolis, Indiana 46208

Copyright © 1975 by Audiophile Systems

enbacker guitar. The production is your average 1970s overengineered wall of sludge, full of phasing and limiting, and all that other stuff which tries to make a garage band sound professional with a flick of the knob. There's a real problem with McGuinn's voice—most of the time you can barely hear it. And when you can, it sounds like a bad self-imitation. Perhaps he was ill when these sessions were held—he's never before sounded so sickly. This will be a very de-

pressing album for you to listen to if you're a Byrds fan. If you're not, it probably won't make any impression on you at all.

McGuinn is unlike McCartney whose career, though marked by occasional dips, has overall been moving upward. McC's latest disc, **Venus & Mars**, reveals nothing really new about McCartney—the guy's been putting his music in front of the public for more than 10 years now, and most people can anticipate what he's going

to do. But Paul is just flexing a muscle or two here. He's got to put out an album every so often just to remind everyone what an incredible melodic sense he has, as well as what a creative force he is. Most critics haven't liked his lyrics, but I've never found him as self-conscious as the post-Sixties Stones, not to mention as dull as post-60s Dylan. Actually, his so-called nonsense rhymes can be fairly entertaining, but no matter—McCartney has learned the important lesson: one doesn't have to rely on other musicians to keep producing good music if one matures.

True, the McCartney ego is strong—it's doubtful that any other musician could be in a band with Denny Laine (Wings' guitar/bassist, and a major singer/songwriter) and totally obscure him.

But Paul's positivism and humor is refreshing, vital enough to carry an album like **Venus And Mars** off as one of the finer pieces of music by a solo artist released this year. The McCartney ego is never any larger than the McCartney genius. The programming of the album is similar to **Band on the Run** in the type of songs and the order in which they appear. The opening track, *Venus & Mars* is a short theme (repeated throughout the album) followed by a longer rocker (*Rock Show*) that's not a typical McCartney pondering lovesong, but a light narrative, very much like the rocking segment of **Band on the Run**.

The parallels between the two albums are rather obvious—*Treat Her Gently* and *Lonely Old People* sound like the followup to *Picasso's Last Words*—but who's complaining? The production is among the best, McCartney having impeccable ears, fine engineers (Irish O'Duffy and Geoff Emerick), and training from one of the most skilled rock producers of the 60s, George Martin. McCartney knows the value of variety (no two songs are in the same vein on any album) and strong arrangements (check out *Listen To What the Man Said*), and he simply does not make a false step. McCartney is the most popular ex-Beatle because his records embody what the Beatles meant to the masses: beautiful songs, recorded exquisitely. John may be the most adventurous, Ringo the most comical, and George the most self-effacing, but Paul continues the spirit of the Beatles, and we love him for it.

Jon Tiven

McCartney

Sound: A Performance: A+

McGuinn

Sound: C Performance: C-



If you truly appreciate sophistication in sound reproduction, you should know about Accuphase. Uncompromising audio electronics for those who have the ear for it.

To that end, TEAC Corporation of America has reserved a free copy of a very informative booklet for you. In it, you'll find a comprehensive collection of test reports on Accuphase equipment. In-depth, unabridged investigations and conclusions by the nation's most respected experts and testing laboratories. Reports that will likely surprise even the most knowledgeable audio enthusiast.

To claim your free copy, simply send us this completed reservation. If you have the ear for it, we think you'll agree that the critical acclaim is as impressive as the product itself.

Accuphase

Your name _____

Your address _____

TEAC Corporation of America 7733 Telegraph Road, Montebello, CA 90640

**Tale Spinnin': Weather Report
Columbia PQ 33417, SQ, \$7.98.**

It is as if these men one day met and collectively decided to define a new trend in music. From its very beginning as a band, Weather Report has been blazing bright, wide swaths of gleaming light, illuminating the formless, dark cavern of the new music called "fusion" by music writers and "crossover product" among the record marketeers. Whatever it's called, it is a musical form which is viable to broad and growing audiences—acceptable to rock-oriented ears, white audiences as well as Black, male and female; it's commended by audiophile and musicologist alike.

Fusion music should be sonically stunning, as well as creatively complete. Its audience is evenly distributed through all the parts of the population, yet it is reachable enough to insure a comfortable and steady response to promotion and media. Music for every kind of ears, even the Corporate Accountant. Cosmic sound forms and ideas to follow you and me around all day. Universal music with universal appeal. Cosmic music, Karmic music!! Whatever it is, we have it, and it's working out great.

Weather Report's new album, **Tale Spinnin'**, is a precise, definitive report on the musical climate of this nameless form. It brings into sharp focus the directions of many forces who have joined with Weather Report to germinate the seeds that are coming in from all areas of the musical world. **Tale Spinnin'** is a straight-out barometer of the musical future.

This is the world Weather Report lives in. A state that is a true affirmation of one of my pet suspicions in life—that Stanley Kubrick's orange day-date-chronograph was running outrageously fast when he made parts of his movie.

If W-R's world is now a relatively lonely one, as things progress, it won't be so for long. **Tale Spinnin'** is a musical expression by artists with the obvious intention of saluting their neighbors. It's certain to be applauded by their public, their critics, and their peers. For as much as it entertains and fascinates the casual listener, to the technically minded the disc is a constructional masterpiece of textural and musical nuances such as Joe Zawinul's Arp 2600 adding an edge to the attack of Wayne Shorter's saxophone notes that were seemingly taken at random from a prearranged tone row or sequence. But, Zawinul does it so subtly that it took me five

replays to begin to identify the origin of this controlled reshaping of textural symmetry from the acoustically miked saxophone. It sounded like a slight bit of "big D" distortion (thought my cartridge had died) when I first heard it, but the tone is pure Arp synthesizer and is not in time (yet it is in tune) with the saxophone.

The group's infinite attention to such details of their music is absolutely incredible, yet the performance is

direct and spontaneous. It is orchestrated like a dance—undulating, dynamic, human, a living synthesis. It is never mechanical, dry or studied, but always rich, expressive, expansive, mature, uncompromised total music. Unified, happy, tender, bodacious—**Tale Spinnin'** is all of those and more, a harbinger in the blossoming move towards uni-music, a music unfettered by convention, yet committed to communicative perspicuity

NOT TOO LONG AGO, CrO₂ WAS IT. TODAY, TDK SA IS IT.

TDK SA, the cassette proven to outsound chrome and the tapes that tried surpassing chrome.

Chrome was a big step forward. It provided the best S/N and superior high-end. But it had a few disadvantages.

Now TDK SA (Super Avilyn) has stepped past chrome. It offers better high-end with excellent low and mid range response, and greatly reduced abrasiveness. It's just about distortion-free.

How? For years the solution eluded chemical engineers. Until TDK developed the particle it called AVILYN.

TDK has provided the optimal density of the cobalt ion and combined it with pure gamma ferric oxide in a unique process that's different from other cobalt-treated tapes. *SA is the world's only non-chrome tape that can take full advantage of CrO₂'s bias/equalization settings.* That gives you the advantage of the high-end noise reduction

properties of chrome playback equalization. TDK Electronics Corp., 755 Eastgate Blvd., Garden City, N.Y. 11530. Also available in Canada.

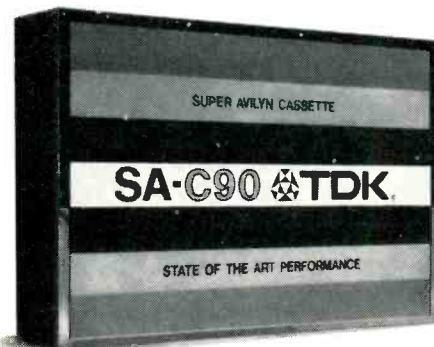

TDK
Wait till you hear
what you've been missing.

Check No. 47 on Reader Service Card

of the unity of man in a coadunate and more musical form.

Whew!! It is really work to distill down a concept that is spoken of best in musical terms. To mutate it down into these few words!! But this album, with its empyrean authority and immense power, has forced me to attempt to do that. True to the personal nature of the men involved, **Tale Spinnin'** is never really mind-crushingly loud, never boisterous. It does not need to accost you with its majesty.

Both Zawinul and Shorter are quiet giants of music. Neither has the temperament to emulate the acknowledged public stars for whom they long played a supportive role. Besides the years spent with and around Miles Davis and serving as *The Jazz Piano Eclectic*, Joe Zawinul has brought his keyboard genius to a structure where his input is not in conflict with a center-stage ego or instrument. The same can be said for the amazing saxophones of Shorter. The Weather Re-

port concept and style is a personal and collective statement of the integrity and humanity of these men. They understand the kind humility in being real. Their music is the complete human extension—laughing, singing, crying, dancing, fragile, intense, vital, alive!!

Joe Zawinul, Wayne Shorter, along with Al Johnson on bass, Alyrio Lima on percussion and Ndugu on drums, are the ultimate incarnation of the band and its concept. Each has apparently long needed a group which felt the music they made together was the only star, the only reason for making music.

The sound quality in this disc is so markedly superior it can *only* be described as state of the art. The performance and production are deft perfection. The disc and this band are one of the highest expressions of contemporary music and its creation, a creation which cannot exist without the recording arts. The recording studio is the origin of the music. It is created via the studio, not recreated for record. The recorded performance in its final, definitive form. Still its force, its source, is in the streets, in the world, in life, in all of us. The music of Weather Report is a gift to our changing world. A delicate gift with promise of a mellowing happiness coming closer to who and what we are as human beings.

P.S. This fusion thing has brought back an almost lost art—the liner notes!! These liner notes by Robert Hurwitz to **Tale Spinnin'** are must reading. While browsing in your record store, ask the clerk for the store copy and read them. If they don't make you want to hear the record, nothing will. Hurwitz sums up Weather Report in 18 words: "It is rare these days to hear people sing together, to sing with great feeling, with great warmth." *Fred DeVan*

Sound: A+

Performance: A+

Slade in Flame: Slade
Warner Brothers BS 2865, stereo,
\$6.98.

Sometimes it becomes all too obvious that 70s music lives in the shadow of John, Paul, George, and Ringo. On the surface, a group like Slade is another good rock band, but in their hearts you know they adore the Beatles and hope to make a million dollars by emulating them. It's unlikely that they can—they've been around too long, their timing was off, and the wrong people were the victims of

Some things hold up better than others.

The accepted concept of durability is based on several very important factors. Material. Design. Engineering. Function. And inherent value. Coincidentally, these are also the hallmarks of the Thorens TD-125 AB Mark II.

The materials are the finest available. The design and engineering incorporate the ultimate in turntable technology. Functioning flawlessly, it originates state-of-the-art that others have yet to achieve. To match the impeccable performance, this Thorens is constructed to hold up . . . not wear down. It has inbred longevity instead of built-in obsolescence.

The precision performance of the TD-125 AB Mark II serves as continuing proof of the Thorens determination to remain the classic name in turntables.

There are other models, too, starting at \$169.95.

Elpa Marketing Industries, Inc.
East: New Hyde Park, N.Y. 11040; West: 7301 E. Evans Rd., Scottsdale, Ariz. 85260.

THORENS®



their hype. But regardless, they make records that are a lot of fun and should be listened to by a lot more people than they currently are reaching.

Slade in Flame is the soundtrack of their first full-length motion picture (which I haven't seen yet). I'm told it is about four lads trying to make it as a rock band (shades of Hard Day's Night). Jimmy Lea (bass) and Noddy Holder (rhythm guitar/lead vocals) are the Lennon/McCartney of Slade, musically speaking, writing all the songs and fronting this foursome. Lead guitarist Dave Hill looks and sounds like a comical rendition of George Harrison, playing hilarious lead guitar and space-aging his way across the stage with grins and side-splitting gestures. Don Powell is the drummer, the rock of Gibraltar who delivers the straight four-four. A great lineup, if only they were innovative geniuses...

But they aren't—neither stylistically nor compositionally. They write Beatlesian tunes (*Far, Far Away, Bangin' Man*) and look a little too much like the other British glamrock groups around (T. Rex, D. Bowie, et. al.) to break through to the major leagues. They're good at what they do, put on an exciting show, and make well-crafted records. But sensational they're not. Believe me, I'd like a "new" Beatles as much as anyone would, but this ain't it. *Jon Tiven*

Sound: B+ Performance: B

Fleetwood Mac: Fleetwood Mac **Reprise MS 2225**, stereo, \$6.98.

Fleetwood Mac isn't a rock group—it's a label, a home for homeless musicians, a sanctuary for unemployed rocksters. Its musical personality has undergone so many changes thus far that it's difficult to know at any particular time whether or not you're a Fleetwood Mac fan.

They started as the vehicle for blues guitarist Peter Green, who has since retired to grave-digging and seeking cosmic powers. Other ex-guitarists are Jeremy Spender, their most positive musical force to date, and writer of most of the original material on their highly acclaimed **Kiln House**, last playing with the British group Albatross; Danny Kirwan, a fine but fragile player not heard from for two years; Bob Weston, a Ron Wood lookalike last seen auditioning for Steve Marriott's band, and Bob Welch, who recently quit to become a record producer. People have exited the group for all sorts of reasons from "musical (Continued on page 89)

Why any cartridge (even ours) with an elliptical stylus must be considered just a bit old-fashioned.

As a premium stylus, elliptical designs have only one real advantage over a Shibata stylus: lower cost. Which is why we still offer them.

But when it comes to performance, a Shibata stylus is far, far better. It provides the small scanning radius needed to track highs (up to 45 kHz for CD-4), but without the penalty of requiring extremely low stylus force settings.

In fact, even when tracking at up to 2

grams, a Shibata stylus is easier on your records than an elliptical stylus trying to track at 1/2-gram! New records last longer, old records sound better, and you can play every kind of two or four-channel record made.

All Audio-Technica Universal Series cartridges have genuine Shibata styli. Anything less would be false economy for you...and out-dated technology for us. Prove it to yourself today.



AT12S

AT14Sa

AT15Sa
AT20SLa



audio-technica

INNOVATION / PRECISION / INTEGRITY

AUDIO-TECHNICA U.S., INC., Dept. 26A, 33 Shiawassee Ave., Fairlawn, Ohio 44313
Available in Canada from Superior Electronics, Inc.



Realistic STA-225
Stereo Receiver
About \$400

Realistic? Pioneer? Marantz?



Who's #1 in audio equipment?

Three famous national component brands, each with fine equipment at all the traditional price points, each with fine magazine ratings and lots of customers. Naturally we at Radio Shack like to think Realistic* is top dog. Our reasoning goes like this:

Realistic has over 4000 stores—the entire worldwide Radio Shack system—and 21 years of manufacturing experience. Realistic has exclusive Glide-Path* and Auto-Magic* controls. An audio consultant named Arthur Fiedler. Service like no tomorrow. And prices like yesterday.

Maybe a better question is who's #2?

Radio Shack® *A Tandy Company.*
Great sound since 1923

Over 4000 Stores/Dealers — USA, Canada, England, Australia, Belgium, Germany, Holland, France

*Registered Trademark

THE MISSING LINK

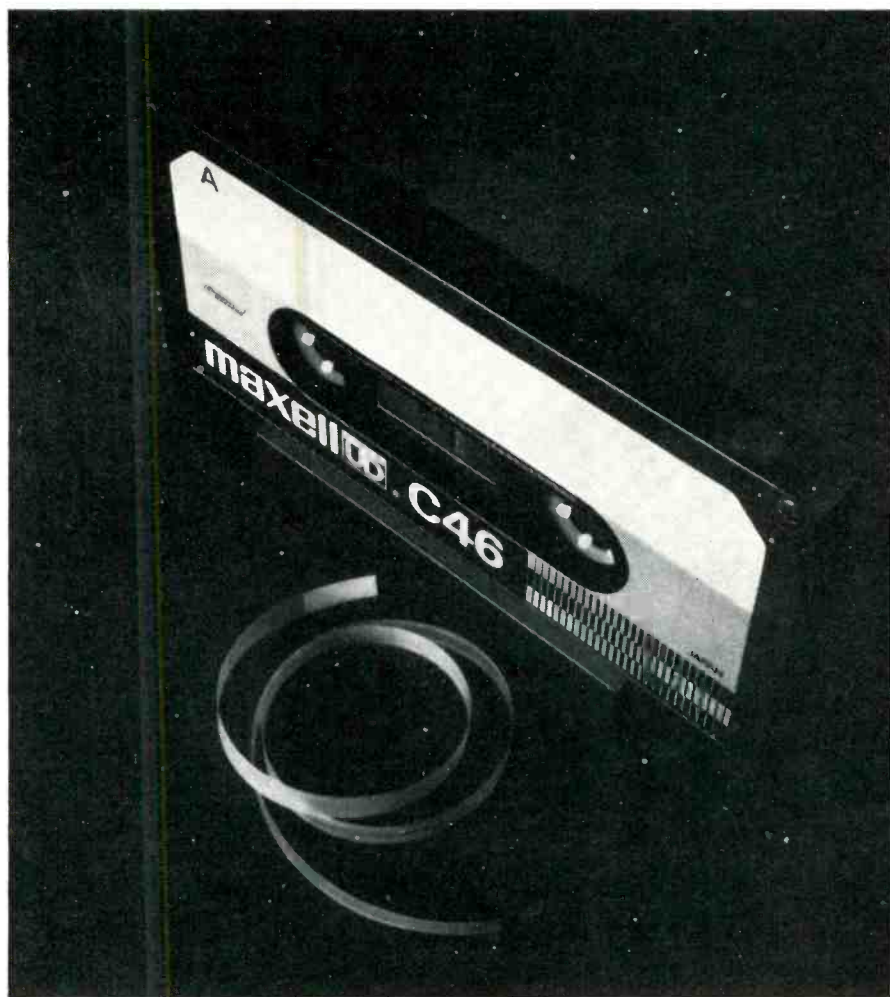

The first five seconds of every Maxell UD cassette cleans your recorder heads. Another Maxell exclusive.

The leader in our UD cassettes sweeps dust and debris off your recorder heads before they can foul-up a recording. And it sweeps gently, with no damaging abrasives to ruin your equipment.

Our head-cleaning leader is also calibrated, so you can use it to cue your recordings.

It's on both ends of all Maxell Ultra Dynamic cassettes. It's another reason you can record the very best sounds (both high and low) your equipment produces, without tracking dust all over your music.

Maxell Corporation of America, Moonachie, New Jersey 07074. Also available in Canada.

maxell.

For professional recordings at home.



Check No. 26 on Reader Service Card

differences" and "to find God," or "to find my wife." The only members of the original group who remain now are drummer Mick Fleetwood, and bassist John McVie, who gave the group their names.

John's wife Christine holds the reins of the group, writing a good number of songs on this album, and she's a talented woman. She established herself as a star years ago in Britain, leading a blues combo named Chicken Shack. With Fleetwood Mac, however, she's become a writer, and in this case success has been spelled W-O-M-A-N. They've sold more records than ever before since she joined the group.

How do they sound here? Not bad, not great. Fleetwood Mac has survived because they always have had excellent guitarists, usually two working as a team, playing wonderful double leads, or something similar. But no more, the guitars no longer dominate, as the vocals are very much up front. Although all the singers are adequate, only Christine is really distinctive. The songs range from pretty catchy (*Monday Morning*) to pretty dismal (*Landslide*). What is even more unsettling is that the group has gone to an MOR/pop style which is really bland. The progressive Fleetwood Mac is dead, for sure, and I'm just waiting for them to go into the studio and start to make their top-40 singles. But if they think that Fleetwood Mac is any more of a rock act than Captain & Tenille, I'm afraid they're only fooling themselves.

Jon Tiven

Sound: D+ Performance: C

Captured Angel: Dan Fogelberg
Full Moon PE 33499, stereo, \$6.98.

Wind on the Water: Crosby & Nash
ABCD 902, stereo, \$6.98.

Once again, proof that if you have enough facial hair and cry enough on record you can win the hearts of America. On both of these records there is not even one good song, only one decent singer (Graham Nash . . . and him strictly for harmonies), and yet these are supposedly the cream of the crop of the singer/songwriters. Overrated is hardly the word—rather than call these performers overrated I'd call them undertalented.

Jon Tiven

Dan Fogelberg

Sound: C Performance: F

Crosby & Nash

Sound: C+ Performance: F+

Feelings: Herb Ohta
A & M SP-4541, stereo, \$6.98.

If you want one of the best examples of flowery, well-made background music, this is it. It's a musical confection that deserves to be in any broad-based record collection. It could be especially useful as a stereo system demo for those who can't relate to your standard fare. This album will offend nobody.

Herb Ohta's sleepily eloquent touch on, of all things, four- and six-string ukuleles is surprisingly inspiring. He at times even makes you wish for more strength of content, but alas, it's so pretty, why not leave it trivial. *Fred DeVan*
Sound: A Performance: A

Earthbound: Fifth Dimension
ABC ABCD-897, stereo, \$6.98.

Whatever possessed me to play a Fifth Dimension record? Why would anybody make another Fifth Dimension record? Whatever it was that made any of this happen is evil, and its influences are to be avoided. Leave your sensitivities intact. Leave this record in the rack. *Fred DeVan*

Sound: C Performance: F

Eric Carmen: Eric Carmen
Arista 4057, stereo, \$6.98.

If I wanted to play devil's advocate, I could pick nits about this album's tendency to sound like **Pet Sounds** period Beach Boys, the production's tendency to sound like Phil Spector circa 1975, and Eric Carmen's tendency not to look Jewish (which he is, readers). But why should I bother to point out the few blemishes, if such they are, when they are outweighed by such prominent positive aspects? In total the album actually ranks as *The Best Record To Reach My Turntable In Months*. Eric Carmen hasn't even begun to reach his peak—he's just starting to step forward from his influences and reveal himself—and he's making the best records out today. I just can't wait until a little more of the picture is shown.

The Raspberries lived in the shadow of British pop, most famously as Beatleboys, but actually sounded more like the Small Faces (or The Who). Carmen owned up, claiming he was a big fan of the lost era of British pop, also of Brian Wilson and Phil Spector. Now the latter two influences are becoming more dominant as Eric edges toward maturity, cuts down on his guitarwork and sits down at the piano

to write songs which he hopes will have more depth, songs like *Sunrise* (which could be comfortable right next to the Beach Boys' *Long Promised Road*), *All by Myself* (I can't wait for Andy Williams to cover this one), and *Great Expectations* (a song based on Carmen's rock 'n' roll business experiences, as are the two which follow, *Everything* and *No Hard Feelings*). The boy is convincing, and so is the band, an extraordinarily tight bunch of musicians from Cleveland who are with him 100 per cent of the way, rocking their socks off on the semi-Spectorish *Last Night* and *That's Rock 'n' Roll*, among other.

This album makes me proud to be an American, rockfans, knowing that someone born under the Star-Spangled Banner can come up with songs like this in the vacuity of 1975. Just as American blues were tapped by the English, Eric Carmen has dug a well in British pop and American bounce music, which is deep and plentiful. Jenner's production is magnificent, Carmen's voice recorded to sound just as big as the echo chambers put on it afterward, and all in all the perfect cure for a headache due to discophobia. Need I say more? *Jon Tiven*

Sound: A Performance: A

Vibes of Truth: The 3 Pieces
Fantasy F-9476, stereo, \$6.98.

Vibes of Truth ranges from funky to exploratory and succeeds admirably. The enormous orchestra that really makes the music is as deftly controlled as it is contrived. The melodic lines run through the ensemble as if there were no limit. What starts as a bass, keyboard, and percussion trio becomes a seven-man combo and then a huge ensemble, with the trombone, synthesizer, and keyboards of Lincoln Ross at center stage, if there is such a place in their concert. The lack of a dominant individual personality is disconcerting to those who insist that there be such a role. The result is music from a collective mind. Ideas from a number of points of view merge to form a musical entity which is greater than the sum of its parts, so well-executed that it is prevented from being "slick" only by the vibrance and gutsiness of the basic form.

This album represents the folk music of the cities, a sophisticated, articulate, intelligent form of street music that is accessible to anyone. The level of musicianship is second to none in any style. Almost too good and too professional, tight stylized instrumen-

When you
hear the
incredible
sound . . .



when you
touch the
sensitive,
responsive
controls . . .



and when
you see
the beautiful
craftsmanship . . .



you'll want
to own one.

Onkyo offers a full line of highly rated stereo receivers, amplifiers and tuners; the world's 1st fully automatic 4-ch receiver; 2/way & 3/way speaker systems . . . all in a broad price range. See your dealer.

ONKYO

Onkyo U.S.A. Corporation
25-19 43rd Ave. Long Island City, N.Y. 11101
935 Sivert Drive, Wood Dale, Ill. 60191

Check No. 30 on Reader Service Card

Advertising Index

ADVERTISER	PAGE	ADVERTISER	PAGE	ADVERTISER	PAGE
Acoustical Mfg Amplifiers Check No. 1 on Reader Service Card	94	Infinity Systems..... Preamp Check No. 19 on Reader Service Card	52, 53	Rectilinear..... Hi-Fi Components Check No. 38 on Reader Service Card	104
Acoustic Research..... Speakers Write Direct to Advertiser	43	Infonics..... Tape Duplicators Check No. 20 on Reader Service Card	105	Revox..... Tape Recorder Write Direct to Advertiser	22
Audio Amateur..... Constructors Publication Check No. 2 on Reader Service Card	80	JBL..... Loudspeaker Check No. 21 on Reader Service Card	23	Rocelco..... Speaker Check No. 10 on Reader Service Card	19
Audio Imports..... Hi-Fi Components Check No. 3 on Reader Service Card	96	Kenwood..... Tuners and preamps Check No. 22 on Reader Service Card	5	SAE..... Hi-Fi Components Check No. 39 on Reader Service Card	4
Audio International..... Hi-Fi Components Check No. 4 on Reader Service Card	109	Koss..... Speakers Check No. 23 on Reader Service Card	65	Sansui..... Hi-Fi Components Check No. 40 on Reader Service Card	67
Audiophile Systems..... Hi-Fi Components Write Direct to Advertiser	81	Kustom Acoustics..... Hi-Fi Components Check No. 24 on Reader Service Card	20	Saxitone..... Cassette Labels Write Direct to Advertiser	110
Audio-technica..... Cartridges Write Direct to Advertiser	85	Lafayette..... Hi-Fi Components Check No. 25 on Reader Service Card	37	Schwann..... Record Catalog Check No. 41 on Reader Service Card	97
Avid..... Speakers Check No. 6 on Reader Service Card	27	Lux Audio..... Hi-Fi Components Write Direct to Advertiser	21	Shure..... Hi-Fi Components Check No. 42 on Reader Service Card	77
BGW Systems..... Pre-amp Check No. 7 on Reader Service Card	6	Marantz..... Turntables Write Direct to Advertiser	60-63	Sony Corp..... Hi-Fi Components Circle No. 43 on Reader Service Card	10-15
British Industries Corp..... Hi-Fi Components Check No. 8 on Reader Service Card	3	Maxell..... Cassettes Check No. 26 on Reader Service Card	86	Speakerlab..... Speakers Write Direct to Advertiser	93
BSR..... Turntables Check No. 9 on Reader Service Card	29	McIntosh..... Tuners and Preamps Check No. 27 on Reader Service Card	104	Spectro-Acoustics..... Hi-Fi Components Check No. 53 on Reader Service Card	102
Capitol Magnetics..... Recording Tape Check No. 11 on Reader Service Card	95	Nuclear Products..... Hi-Fi Components Check No. 28 on Reader Service Card	101	Stax..... Headphones Write Direct to Advertiser	105
C/M Labs..... Hi-Fi Components Write Direct to Advertiser	100	Onkyo..... Receivers, amplifiers and tuners Check No. 30 on Reader Service Card	87	Superscope..... Hi-Fi Components Write Direct to Advertiser	Cover III
Crown..... Tape Deck Check No. 13 on Reader Service Card	98, 99	PAIA..... Synthesizer Check No. 31 on Reader Service Card	80	Tandberg..... Hi-Fi Components Check No. 46 on Reader Service Card	57
Amps & Preamps Check No. 14 on Reader Service Card		Phase Linear..... Hi-Fi Components Check No. 32 on Reader Service Card	26	TDK Electronics..... Magnetic Tape Check No. 47 on Reader Service Card	83
Discwasher..... Hi-Fi Components Write Direct to Advertiser	2	Pickering (Stanton)..... Cartridges Check No. 33 on Reader Service Card	25	TEAC..... Reel-to-Reel tape deck Check No. 29 on Reader Service Card	7, 82
Dual (United Audio)..... Turntables Check No. 15 on Reader Service Card	55	Pioneer..... Tape Deck Check No. 34 on Reader Service Card	Cover II, 1, 70, 71	Catalog Write Direct to Advertiser	
Dynaco..... Hi-Fi Components Write Direct to Advertiser	39	Hi-Fi Components Check No. 35 on Reader Service Card		Technics..... Receiver Check No. 48 on Reader Service Card	Cover IV
Elpa..... Turntables Write Direct to Advertiser	84	Plessey (Garrard)..... Hi-Fi Components Check No. 17 on Reader Service Card	51	Technisound..... Loudspeaker Check No. 49 on Reader Service Card	69
GTE Sylvania (Entertainment Products)..... Hi-Fi Components Check No. 45 on Reader Service Card	41	Primo Co..... Hi-Fi Components Check No. 52 on Reader Service Card	107	Toshiba..... Hi-Fi Components Check No. 50 on Reader Service Card	47
Heath..... Hi-Fi Components Check No. 18 on Reader Service Card	101	Radio Shack..... Stereo Receiver Check No. 36 on Reader Service Card	85, 107	Tripod Audio..... Hi-Fi Components Write Direct to Advertiser	111
		Electronics Catalog Check No. 37 on Reader Service Card		Yamaha Audio..... Hi-Fi Components Check No. 51 on Reader Service Card	45

tals, strong rhythm and short, competent instrumental solos are the backbone of this music. Rich colors and textures with the brash swagger of the street-hip urbanite. Too meaningful to be disco, too intricate for bar music. Too verbal, too danceable to be jazz, too strong to be pop, too long to get on AM radio. Too ethnic for FM, yet truly a product and reflection of our times.

In my opinion, this recording is perfect—both musically and technically. Donald Byrd's deft production is as musical as his best trumpet ballad. A quadranut will flip at the superb "boogie sonics" demonstrated on **Vibes of Truth**. Of necessity, technology is an active musical component on both ends of the creation of music, and, as is the case with most non-classical music today, the record is the performance. Studio recorded performances seldom can be reproduced live without the immense musical instrument of the recording studio. Crazies with a system as big as mine will watch their light bulbs keep cadence with the robust rhythm section, and neighbors will only be reachable through their lawyers. It's all worth it. Buy it for friends who like Rock, like Jazz, and love to boogie. They will love this gift.

Fred DeVan

Sound: A+ Performance: A

Born to Run: Bruce Springsteen
Columbia PC-33795, stereo, \$6.98.

Having seen Bruce Springsteen live on a few occasions, I am now beginning to understand his appeal and cult following. He is one of the few major Rock finds in recent years. The energy and scope of this vocal performance are all but smothered by downright dreadful sonics. Poor sound destroys what could and should be a very fine album. My suggestion is to get the most your tone controls will allow and forgive Bruce for being involved with the worst example of the state of the art of Rock and Roll recording today.

Fred DeVan

Sound: F Performance: B?

Not For Sale: Travis Wammack
Capricorn CP-0162, stereo, \$6.98.

Now here is a real surprise. If you had to associate Travis Wammack's music with a particular style, it would be best called Rock-A-Billy-Soul. The country element is fully fused with solid Rock and Roll and a dash of Soul. The effect may disappoint a country music purist, but the open-

eared will be delighted. Folkies, rockers, and even Poco, Jerry Jeff Walker, and Commander Cody fans will find this more than appealing.

The selections are varied in pace, and four out of ten songs on the album are originals. Wammack transcends all the requisite country conventions, choosing instead only songs which suit his nature. He is able to give a song like *You've Got Your Troubles* theumph and warmth it has always deserved rather than the unfaceted, flatly performed, sing-song treatment it usually gets.

The sound from Fame Studios in Muscle Shoals, Alabama is as good as can be. The vocals are noticeably well-done, the instruments and overall mix are state of the art and a credit to producer Rich Hall. Clean, open clarity adds much to the total impact of this fine, fine record.

Fred DeVan
Sound: A Performance: A

Captain Fantastic and the Brown Dirt Cowboy: Elton John
Rocket/MCA 2124, stereo, \$6.98.

How in 1976 does anybody review an Elton John record? A new Elton issue is by this time more relevant when related to the prior works of Elton,

Bernie and company. Secondly, by the time you get the thing into print there is bound to be a newer Elton John release! At the rate he makes records, he would do us all a favor by including both a consecutive number and the date of issue in the title. Elton has never made a bad album. Indeed part of his success is that you can pick up any album and always find something satisfying. **Captain Fantastic and the Brown Dirt Cowboy** is worth all the fal-de-ral and hype. It, like most of Elton John's albums, is a total success. It is a good, strong, likeable album, doubly so if you are addicted to Elton. Many people are, and he never lets them down.

What more can you say about an artist who could validly make every third album a "Greatest Hits" disc (and still leave out a few good songs), except hope that it never gets to that point. If Elton would slow down maybe he could reach for more depth, and this review would have more to say, but he shows no intention of doing that. I have to close now—the mailman is approaching, and I heard rumors that Elton was in the studio last week.

Fred De Van

Sound: A Performance: A

Build your own speakers and save up to 50%

Our speaker kits cost less than ready-made speakers because you get twice as much for your money when you put them together yourself.

Suddenly you can afford exponential horn/drivers, 12-inch butyl-cone woofers, sturdy 1 1/4-inch walnut laminate enclosures, real L-pads and all the other goodies you only find on speakers costing \$500 on up.

Our \$272 Speakerlab 7 kit has exponential horn tweeter and midrange, and two woofers. It wipes up speakers costing over twice as much and you can assemble it yourself in a couple of hours with simple tools.

For a free 32-page catalog-manual, send in the coupon or call our toll-free number, 9 a.m.-4 p.m., Pacific Time, Mon.-Fri.

**OPERATOR AD-1
1-800-426-7736**

I'm interested in getting my money's worth when I buy speakers. Send me your free 32-page catalog.

Name _____
Address _____
City _____ State _____ Zip _____ AD1

MAIL TO: Speakerlab Department AD1
5500-35th N.E.
Seattle, Washington 98105



Canby's Capsules

Ravel: Daphnis and Chloe (complete ballet). Tanglewood Festival Chorus, Boston Symphony, Ozawa. **Deutsche Grammophon 2530 653**, stereo, \$7.98.

Stravinsky: The Firebird (complete 1910 ballet score). N.Y. Philharmonic, Boulez. **Columbia MQ 33508**, SQ quadraphonic, \$7.98.

Igor Stravinsky plays his Firebird (complete). Player piano recording. **Klavier KS 126**, stereo, \$6.98.

The international age!! Here's the BSO and an American chorus singing French music (always BSO's specialty) under a Japanese conductor—recorded by a German team and the disc reimported from Germany; I listen to it practically where the sound started. A splendidly dynamic and colorful performance, lively and razor-sharp, the beginning virtually inaudible, the ending to blow fuses. Full dynamic range, if that's what you want. Rather distant, resonant stereo sound.

The original scoring is fuller, more lush by a lot, than the familiar (1919) Firebird Suite—it's marvelous stuff for Columbia's elaborate spaced-out recording. Boulez-plus-Columbia—Boulez is so good in contemporary music (and so dull in the concert classics)!!—makes for a stunning SQ four-channel effect, matrix at its most mature; it'll give you pause to hink. Dig that big drum, too.

Here is the original piano "sketch," put down by Stravinsky in the 20s (as he taped his later works) to be a factual document for his intended tempi, etc. Well, maybe; but the thing is most unpianistic as it sounds here, with much twiddly "tremolando" to keep the long tones going and an overall didactic effect. OK if you know the piece well.

What have Quad been up to recently?

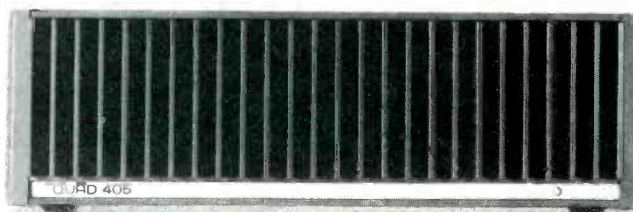

Current Dumping that's what

Current Dumping is the name given to a totally new power amplifier circuit developed by QUAD.

A current dumping amplifier basically consists of a low power amplifier of very high quality, which controls the loudspeaker at all times and a high powered heavy duty amplifier which provides most of the muscle.

The small amplifier is so arranged — it carries an error signal — that provided the heavy duty transistors (the dumpers) stay within the target area of the required output current, it will fill in the remainder accurately and completely.

The reproduced quality is solely dependent on the baby

amplifier, which because of its low power, can be made very good indeed.

The QUAD 405 is the first amplifier to incorporate current dumping.

There are no internal adjustments, so nothing to go out of alignment.

There are no crossover distortion problems and performance is unaffected by thermal tracking.

The QUAD 405 offers impeccable performance, reliably and predictably.

Send postcard for illustrated leaflet to Acoustical Manufacturing Co. Ltd., Huntingdon, Cambs., PE18 7DB, England.

QUAD

for the closest approach to the original sound

QUAD is a Registered Trade Mark

Check No. 1 on Reader Service Card

Massenet: Piano Concerto. Saint-Saens: Piano Fantasy "Africa." Gounod: Piano Fantasy on the Russian Nat. Hymn. Marylene Dosse; Westphalian Symph., Landau. **Vox Candide QCE 31088**, QS stereo/quadrasonic, \$4.98.

Massenet: Scenes Hongroises. Lalo: Rapsodie Norvegienne. Chabrier: Fete Polonaise. Orch. Radio Luxembourg, Cao. **Vox Turnabout QTV-S 34570**, QS quadrasonic/stereo, \$3.95.

Salvador Bacarisse: Concertino for Guitar & Orch. op. 72. Ernesto Halffter: Guitar Concerto. Narciso Yepes; Orch. de la R.T.V. Espanola, Alonso. **Deutsche Grammophon 2530 326**, stereo, \$7.98.

Haydn: Concerto in F for Violin and Harpsichord; Concerto in F for 2 Flutes. (a) Manzone, Petit; Orch. cond. Fantapie; (b) Dwyer, Legrand; Mozart Soc. Orch., Bozzi. **Orion ORS 75198**, stereo, \$6.98.

Gilbert & Sullivan: The Mikado. D'Oyly Carte Opera Co. Royal Philharmonic, Nash. **London OSA 12103**, 2 discs, stereo, \$13.96.

What quantities of big late 19th c. showpieces are still lying around!! From famed composers like these, too. Being French, they are seldom bombastic a la Liszt, though the stuff does run on, skillfully pro. I liked the Massenet most, here, but it's all very easy "concerto" listening and well done.

More Romantic French fantasy—note the then rage for nationalistic color stuff. It was mostly pretty superficial, hardly "authentic" in today's manner, yet it made for pleasing listening—what more? This bargain QS single-inventory quadrasonic/stereo disc sounds very good even on a plain QS matrix, minus logic, if you have your four speakers/amps set up.

20th c. Spanish "classical" guitar music is mostly a world apart, 50 years behind the times but so what? it entertains. Variably! The Bacarisse (b. 1898) is a stilted, unfluent work, not even decently favoring the guitar itself—ugly, I say. But the Halffter (b. 1905) on side 2 is delightful, sprightly, wry, after De Falla with a strong tinge of 1920s Milhaud-type dissonance, warm and friendly and beautifully balanced. Buy for side 2—use side 1 for your noisiest cocktail party.

Two pleasantly familiar little Haydns, two performing teams, sharply different in the sonics—a bit disturbing, but both are well done. The violin/hps. concerto is recorded close, the fiddle loud, the harpsichord down—not a good balance; but the playing is fine. The two flutes are much better handled, the whole at a bigger distance; also very nicely played. Never too much Haydn, if you enjoy him!!

The umphth recording from the original company and each new version further alters the traditional sound. Now, the voices are standard opera, the whole bigger, more symphonic—even the chorus!! OK, but some of us miss the old recordings (1920s, 1930s), presumably nearer to the original. 

Let the sound shine in...

Or out. That's exactly what The Music Tape™ by Capitol with chromium dioxide does. It was designed for people like you, who purchase only the finest recording equipment with a CrO₂ bias switch...and demand the finest quality tape. The Music Tape CrO₂ is unsurpassed in both frequency response and signal-to-noise ratio.

Why settle for a mediocre tape? Let the sound shine in and out today, with The Music Tape by Capitol CrO₂.

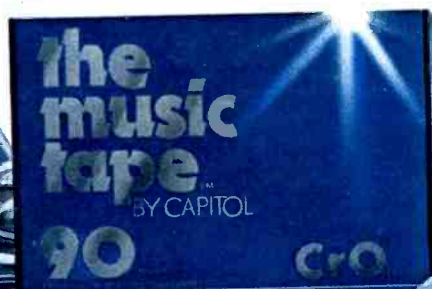

Capitol, CAPITOL MAGNETIC PRODUCTS • A DIVISION OF CAPITOL RECORDS, INC. • LOS ANGELES, CALIFORNIA 90028

Check No. 11 on Reader Service Card

J. E. SUGDEN & CO. LTD.
AUDIO EQUIPMENT
OF BRITISH DESIGN



AMPLIFIERS AND TUNERS
AS WELL AS LABORATORY
MEASURING INSTRUMENTS

by the *QUALITY MINDED*
for the *QUALITY MINDED*

WHY SETTLE
FOR ANYTHING ELSE?

FOR INFORMATION WRITE:
AUDIO IMPORTS
EXCLUSIVE IMPORTERS
& DISTRIBUTORS
P.O. BOX 27345
INDIANAPOLIS, IND. 46227

Check No. 3 on Reader Service Card



SAVE!

AUDIO

Custom designed Library Cases will protect your magazine copies. These files are rugged and made with a rich Kivar cover. Shipped postage paid. Prices: \$7.50 each; 3 for \$20; 6 for \$37. Return the order form below with your payment.

Please send me _____ library cases. Prices: \$7.50 each; 3 for \$20; 6 for \$37. My check or money order is enclosed.

My Name _____
Company _____
Address _____
City _____ State _____ Zip _____

Mail to: **Audio**, AU/2/76
401 N. Broad Street
Philadelphia, Pa. 19108

Allow four weeks for delivery.

Classical Reviews

Edward Tatnall Canby

R. Strauss: Deutsche Motette, Op 62; Der Abend, Hymne, Op. 34. Soloists, Schutz Choir of London, Norrington. **Argo ZRG 803**, stereo, \$6.98.

"Rarely performed and never before recorded," it says—and it's easy to hear why! These are three of a kind, the *Opus 34*, a first try at the genre; the *Opus 62*, altogether a bigger and better work, an ultimate superchoral giant that not even Arnold Schoenberg could have concocted. What we have in these minor side-thoughts of Richard Strauss (he was that prolific) is nothing less than a monster tone poem for professional, opera-trained voices, any of which could fill the Met or Carnegie Hall without any amplification. There are no less than 16 choral parts, plus a battery of extra solo voices, up to seven in each of the works. The amount of sheer breath power sounds as if it could challenge a mighty Wurlitzer organ with all stops wide open!

The *Opus 62, Deutsche Motette*, fills the whole of side 1 and is musically a major piece, really very much worth the listening, quite aside from the extraordinary sound of this super-choir of enormous voices all going at once in so many directions. It has interesting, strong, well-made themes, ideas, and rhythms, grand sonorities down to the lowest bottom and high-high top, and a serene flow that is like the sound of a great choral organ, as though no singer ever took a breath but all had built-in air supplies without end.

I found the earlier pair of works somewhat less interesting as music though the styling is very much the same. No instruments whatsoever in any of the music, just voices a *cap-pella*.

What is most extraordinary, at least for a choral conductor such as myself (The Canby Singers), is that the whole of the music is strictly in tempered pitch, moving freely through all sorts of Straussian harmonies and strange key changes in which, at every chord,

there must be pitch adjustments by the voices away from the pure or natural overtone-series sound which is normal for voices alone. These singers are trained to sing tempered pitch, even without the usual instrumental accompaniment (from keyboard and orchestra) which makes it easy. (Tempered pitch is, of course, tuned into the fixed-pitch instruments.) Having tried this sort of thing myself with my own singers, I know how difficult some of the Strauss harmonies are—they are faultlessly tuned by these British pros. All in all, a great recording of its kind.

Rags and Other American Things. Eastern Brass Quintet. **Klavier KS 539**, stereo, \$6.98.

Ring in the Bicentennial and carry on the Rag! Actually, this humorous collection of musical Americana, ranging from something called the Swipsey Cake Walk through Joplin, et al., a Gershwin suite and four songs by Charles Ives (arranged for brass)—has a rather classical sound to it. For all the title and contents, the music is played *molto romantico*, with much expression, right out of the conservatory. No rough edges, no homespun, not a trace of honky and tonky. You'll hardly find this any problem if you like mellifluous brass, and it's just what we *should* get from a brace of young and extremely expert players who obviously did *not* learn their instruments just by picking them up and blowing into them one day. The music conservatories, after all, have been plugging Joplin, Ives and Co. like crazy these last couple of years or so.

Nice names. Remind me of the once-famous English Singers, another quintet who sang madrigals and the like in the Twenties. (They broadcast from England on Christmas eve when transatlantic broadcasts were still miraculous.) Mellifluous names, which seemed to be chosen for their rhythm: Cuthbert Kelly, Norman Not-

ley, Sara Silk ... Here, in 1975, we have Richard Green and William Wich (which?) on trumpet and a tuba player with the name of Tucker Jolly—jolly good tuba, one is tempted to say, and I bet he's heard *that* before. To round out the rhythms, there's Tupper Turner, who doesn't play a thing but enthuses nicely on the record jacket. All very three and four syllabled. And that's just the way it sounds.

See also their previously reviewed disc, **Rags, Blues, Boggie Bugaloo, and a Sweet Goodnight, Amen!** They do have a way with words!

Marni Nixon - Songs of Love and Parting by Ernest Gold; Coplas by Mario Castelnuovo-Tedesco. Orch. of the Vienna Volksoper, Gold. **Crystal S501**, stereo, \$6.98.

Interesting and curious how much of the current small-company recording originates these days in California, on dozens of labels, and is produced and performed largely by California-based artists (even though for economic reasons the orchestras are usually European). Here is a California singer (movies) and conductor-composer (movies) on a California label, P.O. Box 65661, L.A. 90065.

The best side of the disc, I'd say, is the Castelnuovo-Tedesco (transl. "The New German Castle"), a work in which Marni Nixon has specialized the orchestrated version done for her in 1967 by the composer himself. The music, however, dates from 1915 in the original version with piano and belongs to that then-still-popular "pseudo-Spanish" category which includes well-known music by such non-Spanish composers as Debussy, Ravel and plenty more, all of it in a colorfully impressionistic vein. The work suits Nixon's somewhat sharp and highly colored voice, and she obviously lives easily in it. As for conductor Gold's own music, it is eclectic, by which I mean not-very-modern and yet up-to-date, sounding efficient, expert and slightly of the movies. Yep, he writes for films and lives in Hollywood. Oddly, like so many big film composers in Hollywood, he comes originally from Vienna.

Marni Nixon would be more effective if her recording engineers would move back a bit and mix her at a lower level in relation to the orchestra. She is close and loud. It's the old habit: beef up the featured soloist! Goes back to mono days when it was really necessary. Not any more. 

The Schwann Record Catalog

Did You Know That???

Did you know Mozart's Serenade No. 12, K. 388 is the same as his String Quintet, K. 406? That Mozart's Concerto No. 2 in D for Flute is the same as his Concerto in C for Oboe? That Bach's Concerto No. 3 in c minor for 2 harpsichords, S. 1062 is an alternate version by him of the famous Concerto in d minor for 2 Violins? Bach's Concerto No. 1 in a minor for Violin, S. 1041 is the same as his Concerto No. 7 in g minor for Harpsichord, S. 1058? That his Missa 1773 is the Kyrie and Gloria from the b minor Mass?

Did you know that both Rossini and Paisiello wrote an opera "Barber of Seville?" Both Leoncavallo and Puccini wrote a "Boheme?" Both Gluck and Monteverdi wrote an "Orfeo?" Music to "Romeo & Juliet" was written by Berlioz, Gounod, Prokofiev, Tchaikovsky? Music to "Pelleas et Melisande" was written by Debussy, Faure, Schoenberg and Sibelius? That some of the most famous 'Spanish' pieces were written by a Russian composer (Capriccio espagnol) and a French composer (Rapsodie espagnole, Bolero, Iberia)? That Ravel wrote "Sheherazade" and Rimsky-Korsakov "Scheherazade?"

Did you know that there are records by 6 members of the Bach family? That 111 of Bach's 215 surviving cantatas are recorded? That there are records by both Mozart and his father? There are two composers named Brown, 3 Jones, 6 Smiths? That "Haydn's Toy Symphony" actually is movements 3, 4, 7 of Leopold Mozart's "Cassatio?" That there are records of music by King Frederick II of Prussia; Wilhelmine Markgräfin von Bayreuth, Louis XIII, Benjamin Franklin? That composer/musician Pablo Casals lived to be 97, Julius Reubke died at 24?

What else can *you* find? Be sure to get a Schwann Record Catalog each month — an indispensable reference work which should be in every home. Available at record dealers everywhere.

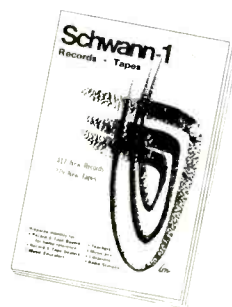

For a sample copy, sent postpaid directly to your home (but **please** try your record shop first) send \$1.60 check to
Dept. AU

Schwann Record & Tape Guide
137 Newbury Street, Boston, Mass. 02116

Crown The Known Value... at an uninflated price!

An honest value isn't hard to find, if you know an honest supplier. CROWN's reputation for providing more recorder value for your dollar is as old as our company. Nothing would ever cause us to change that.

CROWN recorders offer you day-in, day-out worry-free reliability, plus brilliant performance. Both result from simple, rugged design, with only a few moving parts. The CROWN belt drive and massive flywheel almost completely isolate the capstan drive from any vibration or rumble.

CROWN electronic circuits are carefully designed for maximum reliability, and electronic components are thoroughly tested before assembly. Oversize meters and easy-to-handle-controls make operation simple. The result? A professional tape deck, used to produce quality recordings in many a studio.

Each CROWN transport has undergone 100 hours of testing. Each CROWN recorder has its own performance report, signed, not stamped, by a CROWN inspector. And each CROWN recorder is backed by a one-year full warranty on parts and labor; and an additional two-year limited warranty on parts only. We put the CROWN name on these recorders proudly - we believe they've earned it.

Why not talk to your nearby CROWN dealer about the long-term values of a CROWN recorder. And the uninflated price. It could be the year's best buy.

Write us for his name. CROWN, Box 1000, Elkhart, IN 46514



CROWN

WHEN LISTENING BECOMES AN ART

Check No. 13 on Reader Service Card

Jazz & Blues

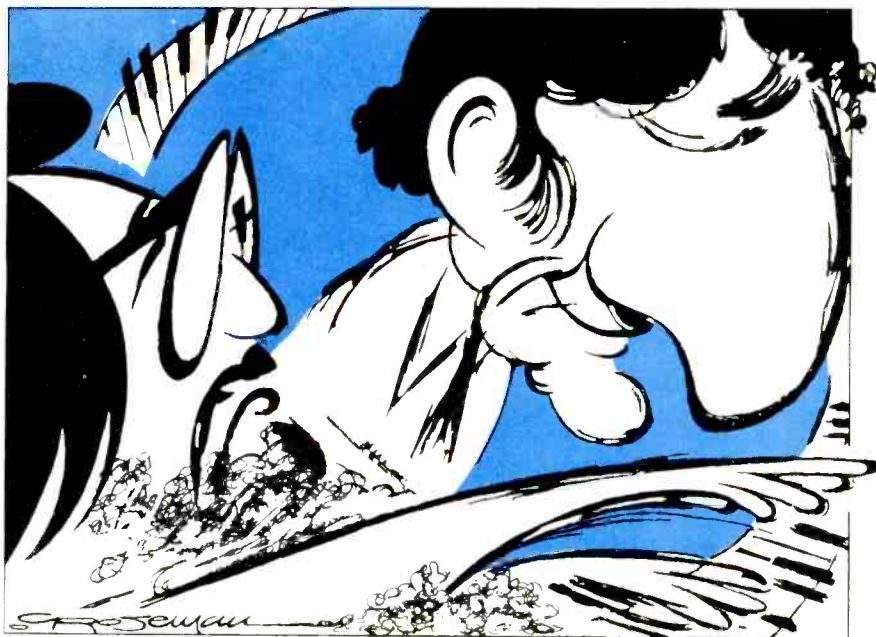

The Tony Bennett-Bill Evans Album:

Musicians: Tony Bennett, vocals; Bill Evans, piano.

Songs: *Young and Foolish, The Touch of Your Lips, Some Other Time, When in Rome, We'll Be Together Again, My Foolish Heart, Waltz for Debby, But Beautiful, Days of Wine and Roses.*

Fantasy F-9849, stereo, \$6.98.

Intuition: Bill Evans-Eddie Gomez

Musicians: Bill Evans, acoustic and electric piano; Eddie Gomez, bass.

Songs: *Invitation; Blue Serge; Show-Type Tune; The Nature of Things; Are You All the Things; A Face Without a Name; Falling Grace; Hi Lili, Hi Lo (For Ellaine).*

Fantasy F-9475, stereo, \$6.98.

Two very different kinds of duos involving Bill Evans. The Bennett-Evans combination will surprise only those unaware of the singer's lifelong admiration for the best in jazz. Not that this is a particularly jazz-flavored record, in the obvious sense. There are no "swingers" here; rather, this is a contemporary *Lieder* recital. (It has never seemed presumptuous to me to compare the best in popular songwriting with the tradition of the Ger-

man *Lied*, which, after all, was also popular.) However, only artists informed by jazz practices could take such liberties with time and meter, be so surefooted rhythmically, and show such a flair for the well-turned phrase in this idiom.

Bennett has never sung better. He is naked here, supported only by Evans' crystal-clear piano sound. But he does not hold back. An emotional singer, he wisely doesn't attempt to change his approach, but since there is no need for him to strain, he doesn't. Evans, proving himself a superb accompanist, never intrudes, never calls attention to his presence with a fancy fill or pointless arpeggio, but gives the singer the invaluable comfort and security of his absolutely certain harmonic ear and equally sure musical taste.

There are songs here I like very much and others I don't much care for, but not one that's less than well done. Not surprisingly, Evans' own touching *Waltz for Debby* is one of the program's high points, and so is Ray Noble's warm *The Touch of Your Lips*—a strong melody offering Bennett at his romantic best.

A real surprise, though, is *Some Other Time*, a fine Leonard Bernstein

song from his early Comden & Green period, new to me, full of pitfalls for the unwary singer, and brilliantly realized by Bennett and Evans. Was the next song, *When In Rome*, deliberately placed in this position to point up the difference between genuine and fake sophistication?

There are brief solos, sometimes in unexpected places, from the pianist. All are exquisite and understated, with that unique touch and harmonic flavor. The recording is good, though there's a bit too much presence on Bennett for my ears. Highly recommended to fanciers of good songs, good singing, and true artistry.

Eddie Gomez has been Evans' bassist for almost a decade, so it is little wonder that these two remarkable instrumentalists should be so finely attuned to each other. This is their first recorded duet album; the otherwise ubiquitous drummer isn't missed. Not one bit. His absence (not of the specific drummer with the Evans Trio, we hasten to point out, but of the drum sound and presence *sui generis*) allows for greater clarity of sound and more rhythmic flexibility and precision. It makes one realize what remarkable time Evans has, though this should always have been evident.

This is a delightful album. There is a serenity, a joy in Evans' work here that is new. Even a dark-hued piece like *Blue Serge* (from the Ellington canon, and beautifully translated to the keyboard) does not become brooding, and *Show-Type Tune*, a charming Evans original, is positively buoyant.

His use of the electric keyboard (I don't know which of the many different types he employs here) refutes the saw that personal pianistic touch cannot be translated to it. He makes it sound evanescent. And he employs a distorting device that would become annoying in most other hands and makes it work. On *Serge*, *Nature*, and *Grace* he duets with himself on acoustic and electric; he uses the latter exclusively on *Show-Type* and *Are You*. Outstanding is the intense and percussive *Invitation*, on which Gomez has some of his best moments, and the wistful, elegiac *Hi Lili*.

The absence of the drummer makes the virtuosic Gomez work more in a time-keeping vein; it suits him well. He is prominently featured on *Grace*, a piece by fellow bassist Steve Swallow, but the point about Evans and Gomez is not featured spots but interplay. Intuition is not an overstatement.

The recording is first-rate; every

nuance of the sound of the instruments is captured, and in perfect balance.

Dan Morgenstern

Sounds: A Performances: A+

CCC: Creative Construction Company

Musicians: Leroy Jenkins, violin, viola, recorder, toy xylophone, harmonica, bicycle horn; Anthony Braxton, alto sax, soprano sax, clarinet, flute, contrabass clarinet, orchestral chimes; Leo Smith, trumpet, flugelhorn, French horn, seal horn, percussion; Muhal Richard Abrams, piano, cello, clarinet; Richard Davis, bass; Steve McCall, drums, percussion.

Selection: Muhal

Muse MR 5071, stereo, \$6.98.

The Creative Construction Company was, like the Art Ensemble of Chicago, an outgrowth of Chicago's Association for the Advancement of Creative Musicians. As with the AEC's early recordings, which were released under the names of Roscoe Mitchell and Lester Bowie, the CCC was introduced with an album recorded under Anthony Braxton's name (**Three Compositions of New Jazz**, Delmark DS-415). Like the AEC, however, the CCC was a leaderless cooperative group (consisting of Braxton, Jenkins, Smith, and McCall), and not by any means the "Anthony Braxton Band."

This is made musically clear on CCC, a live recording made in May, 1970, near the end of the cooperative's existence. Previously unissued, it presents a collective improvisational music so logically coherent and inter-related that it is difficult to believe it wasn't composed beforehand. But then, a composer could hardly map out such an inspired interaction with either the precision or the poignancy with which these men communicate quite spontaneously. Both musically and emotionally, the artists express their individual conceptions with a sensibility of the total ensemble constantly in mind.

The basis for improvisation is a Leroy Jenkins theme entitled *Muhal*, in honor of Richard Abrams who, along with the stylistically kaleidoscopic Richard Davis, guests on this recording. *Muhal* is a touchingly disconsolate motif, couched in sympathetic horn dissonances which support a melancholy violin line. After Davis and McCall allow a slightly up tempo to set in, Jenkins ponders a profoundly sad gypsy-tinged melody, as Smith and Braxton weave a wistful web in and around it. Jenkins wavers between this gypsy pose and a sar-

Hi-fi Harmony



Crown IC-150 and D-150A

*80 watts per channel min. RMS into 8 ohms (1 Hz-20 KHz), total harmonic distortion of .05%.

In any great vocal group, each singer could make it on his own. Together, they're beautiful.

That's how we designed the Crown IC-150 pre-amp and the Crown D-150A power amp.

The IC-150 provides precise control with minimum distortion. The D-150A provides reliable power* to drive almost any stereo speakers. Each one could be a superb addition to your system.

But together we think they're incomparably beautiful, whether you think of beauty as powerful, clean sound; or honest, uncluttered appearance; or simple, accurate control.

If the receiver or integrated amp in your current system seems somehow limited, please consider seriously the Crown IC-150/D-150A combination. You'll be pleased at a new quality of sound, and surprised at a real bargain.

Write us today for the name of a dealer near you. It could be the start of a harmonious relationship.

When listening becomes an art,



CROWN

Box 1000, Elkhart, IN 46514

Check No. 14 on Reader Service Card

donic, disjunctive mock-Heifetz throughout the piece, while Abrams and the hornmen, particularly Smith, arouse harsh anger as the complex backdrops become increasingly chaotic.

There are solo moments for the four melodic players, but it is the group improvisations that dominate the action. On side two, there is a furious free-for-all, every man for himself, yet even here the effect is not

one of anarchic delirium, but of self-control, artistic discipline, ultimate submission to the cooperative whole. Thus, while individual parts are easy to follow (and well worth following), the music is best listened to with the same spirit of totality in which it was produced. Approached in this manner, *Muh* is a beautifully moving and deeply meaningful experience.

One of the most noteworthy aspects of this performance, and many

other Chicago or Chicago-influenced recordings is the use of "little" or "toy" instruments. Jenkins, whose bicycle horn plays a prominent role in the above-mentioned free-for-all, explains them away as sources of color. While, of course, this is obviously true, their use seems to go beyond mere coloration. Both the CCC and the AEC use toys not merely as sound effects, but as legitimate musical components. Too much care is given to their integration with the total color pattern to dismiss their use so lightly. A twittering bird whistle leads into a pastoral flute solo by Braxton. Jenkins treats his toy xylophone like the real thing. The brasher toy horns are reserved for more tumultuous moments than, say, Jenkins' back-porch harmonica doodling. Soft percussives add textures to quiet sections. On the other hand, the "real" instruments are occasionally used for effect, from Smith's trumpet spurts on side one to Davis' bovinisque bass mooing under Abrams' jagged piano runs near the opening of side two.

What this implies is that no sound is without its musical significance to the whole, with one possible exception—that delightfully uncharacteristic moment on side two when Braxton attempts to intrude on Smith's solo, but apparently has second thoughts after honking a solitary note. What makes this so delightful? Simply that it reminds us so unintentionally, yet so undeniably that this is a spontaneous, unplanned improvisation after all.

Tom Bingham

Sound: B+ Performance: A+

Our CC-2 preamp was both simple and superlative. Our new CC-2A is simply better.

At C/M, we've always known that the simpler the design of audio equipment, the better it performs. A perfect example of this philosophy is our CC-2A preamp. Its design includes everything you need for maximum performance but nothing extra to add distortion. You get features like a phono input level control, individually defeatable tone controls and space age Opto-Isolators (which eliminate "turn-on" thumps).

In short, at under \$260, the CC-2A is the logical choice for the discerning audiophile.

Praise for its predecessor.

Our new preamp is the second-generation version of our simplified and budget-priced CC-2. And when High Fidelity reviewed that earlier model, they praised it for its "superlative audio performance." Noting that it was "conceived as a no-frills but high-performing nerve center for a stereo system," they added that it achieved its design aims "hands down."

Specifications of the CC-2A □ Phono signal-to-noise ratio better than 74 dB (ref. 10mV) □ High-level signal-to-noise ratio better than 100 dB (the "A" weighted) □ Total harmonic distortion less than 0.1% at rated output (2V) □ Output at clipping greater than 8V □ Tone control range ± 15 dB



You can judge for yourself whether our new CC-2A is even better than its famous predecessor—by visiting your C/M dealer.

For the name of the dealer nearest you, write us at C/M Laboratories, 327 Connecticut Avenue, Norwalk, Connecticut 06854.

And discover a simple way to bring superb sound within reach.

C/M LABORATORIES
EXCEPTIONAL COMPONENTS FOR THE EXCEPTIONAL EAR.

Golden Age Jazz Band Arhoolie 4007, stereo, \$6.98.

The Golden Age Jazz Band is one of many (and there are dozens of them) local semi-pro groups of traditional jazz musician-buffs who spend their work-week as bankers, brokers, salesmen, engineers, computer operators, and what-have-you, who record and play weekend gigs to small but enthusiastic audiences.

Banjoist-leader Dick Oxtot, for some years a fixture in the San Francisco Bay area, has recorded with New Orleans veteran George Lewis and blues singer Barbara Dane. Residing in Berkeley, he has organized traditional jazz recording sessions in his home, as well as live concerts and performances in local clubs and halls. Oxtot's band usually features a singer who belts in the Ma Rainey-Bessie Smith urban blues style—in 1963, Janis

Joplin made a number of sides with Oxtot (also available on Arhoolie). On this recording, the Golden Age Jazz band is joined by Diane Holmes, a fetching blond. Ms. Holmes has a big voice that conveys some suggestion of Bessie Smith's timbres, but the majesty that was Bessie's escapes her as it escapes most white singers who try to recapture the style.

The band makes a brave attempt to evoke Jelly Roll Morton, King Oliver and early Louis Armstrong, but for the most part, its playing lacks the heat and drive of the original. Only on *Savoy Blues* and *Chattanooga Stomp* is the music touched with the natural, easy flow and swinging gait of its classic model—on these two tracks Jim Goodwin's cornet is strong and singing; trombonist Bob Mielke is properly soulful and gutty. Clarinetist Bill Napier is the most consistent player, performing well throughout the album in the George Lewis style, but lacking Lewis's soaring fervor. *John Lissner*

Sound: A Performance: B

The World's Greatest Jazz Band Plays Cole Porter

Musicians: Yank Lawson, John Best, trumpets; Carl Fontana, George Masso, trombones; Peanuts Hucko, clarinet; Tommy Newsom, tenor sax; Ralph Sutton, piano; Bob Haggart, bass; Gus Johnson, drums.

Songs: *Love for Sale; All of You; It's All Right with Me; Let's Do It; I Concentrate on You; Just One of Those Things; Anything Goes; It's D'lovely; Rosalie; So in Love; You'd Be So Nice to Come Home to; From This Moment on.*

World Jazz WJLP-S-6, stereo, \$6.98.

Hot Coles: Shelly Manne

Musicians: Oscar Brashear, trumpet; Tom Scott, soprano sax, flutes; Victor Feldman, piano, vibes, marimba, percussion; Mike Wofford, acoustic and electric piano; Tommy Tedesco, guitar; Chuck Domanico, bass; Mailto Correa, Moacir Santos, percussion; Shelly Manne, drums, percussion.

Songs: *From This Moment On; Easy to Love; Get Out of Town; Begin the Beguine; Night and Day; All of You; Love for Sale; In the Still of the Night.*

Flying Dutchman BDL1-1145, stereo, \$6.98.

Two approaches to one of America's greatest songwriters: It's an indication of Porter's appeal to jazz musicians that only three of the WGJB's 12 and Manne's eight selections overlap.

A further indication: Even Manne's

READ WHAT THE EXPERTS SAY ABOUT HEATHKIT HI-FI:

“Once assembled, you can't tell the difference between the finished product and factory-assembled receivers costing at least \$150 more.” **Stereo, Fall, 1974 Heathkit AR-2020**



Heathkit AR-2020 AM/FM 4-Channel Receiver

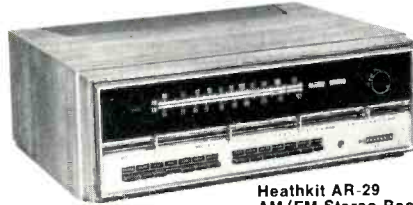

Heathkit AR-29 AM/FM Stereo Receiver

“On every count, the completed AR-29 either met or exceeded its published performance specifications—and did so with only the normal adjustments spelled out for the kit-builder.” **High Fidelity Test Reports, 1974 Heathkit AR-29**

“The electrical performance of the Heath AA-1640 makes comment superfluous. In every respect it ranks with the finest high-power amplifiers on the market. We were constantly impressed with the conservatism of its construction and ratings.” **Stereo Review, May 1975 Heathkit AA-1640**



Heathkit AA-1640 Stereo Power Amplifier

FREE The world's largest catalog of electronic kits. More than 400 in all. Send for it today!



Heath Company, Dept. 41-14, Benton Harbor, MI 49022

HEATH	
Schlumberger	Heath Company, Dept. 41-14 Benton Harbor, MI 49022
Please send my FREE Heathkit Catalog	
NAME _____	
ADDRESS _____	
CITY HF-301	STATE ZIP

Check No. 18 on Reader Service Card

How do you keep a clean record clean?

By eliminating the static charges that attract and hold dust to the records' grooves!

Only Staticmaster, with its exclusive *Polonium 210* element, completely eliminates static and whisks away dust in one quick and easy operation. It works in seconds to protect your investment, prolonging record and stylus life.

Suggested retail price \$14.95. To find out more about Staticmaster's unique *Polonium 210* element, see your audio dealer or write to us.

staticmaster
Nuclear Products Company, P.O. Box 5178, El Monte, CA 91734
The leader in static elimination for over 25 years.

Check No. 28 on Reader Service Card

SPECTRO POWER!

THE SUPER CLEAN
SPECTRO ACOUSTICS
MODEL P-202



Suggested Retail \$375.00
Spectro-Acoustics Model P-202

CLEAN, STABILIZED POWER

SPECTRO-ACOUSTICS embodies both in its Model P-202 Power Amplifier. Specifications and price are two good reasons to invest your listening pleasure in SPECTRO-ACOUSTICS equipment. Craftsmanship comes with the name.

- Not less than 100 watts, RMS, continuous power per channel. Both channels are driven into 8 ohms at any frequency from 20 Hz to 20,000 Hz with no more than 0.25% total harmonic distortion.
- Power at clipping is typically 200 watts per channel.
- Instantaneous clipping indicators far more accurate than conventional meters.
- Easily driven by any receiver or pre-amp.
- Automatic limiters and protectors for all load conditions.
- SCAMP (Self Contained AMPLifier) modular construction for rugged, reliable operation and serviceability.

For more detailed information, see your local dealer or contact SPECTRO-ACOUSTICS, INC. today.

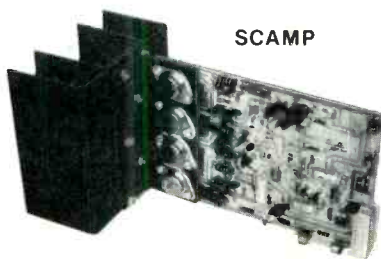

Ask about our Model P-101 pre-amp and Model 210 Graphic Equalizer.

**SPECTRO
ACOUSTICS, INC.**

1309 E. SPOKANE [509] 545-1829
PASCO, WASHINGTON 99301
Check No. 53 on Reader Service Card

modernists respect Porter's melodies enough to state them at least once, if not always at the start. Not that these are very radical interpretations, but they aren't commercial and strictly contemporary.

They are also, by and large, more imaginative than the WGJB's, and give the players a better chance to apply their improvisatory skills. This becomes evident when one considers that Manne & Co.'s eight tunes add up to 40:17 while the WGJB's 12 take only 32:23. Which is not to say that brevity can't be the soul of wit. One of the best pieces in either collection is *D'lovely*, at a scant 2:41, but that's because it is a showcase for the astonishing trombone of Carl Fontana, who is not only the fastest slide in town, but also has a musical mind.

Fontana is one of the alumni of the WGJB when it was a duly constituted ensemble. As such, it lasted almost seven years with, under the circumstances, remarkably few personnel changes. That it currently consists of co-leaders Lawson and Haggart, an extensive book of arrangements, and a pool of musicians on both coasts and elsewhere who are either graduates of the band or familiar with its style is not to its discredit. On the contrary, it's an admirable achievement, for the years of its peak activity were often dry ones for the WGJB's kind of jazz.

That kind is a not at all unoriginal mix of traditional jazz (I detest the term dixieland and will use it only under duress) and swing, with plenty of freedom for gifted soloists as well as deft ensemble writing, almost all of it by Haggart.

If this is not one of the band's best albums, it's mainly due to two factors. One, this is a studio band, not a working one, and it tells; two, aside from Fontana, the stalwart Lawson, the reliable Sutton, and the pleasantly surprising Masso, the soloists are not that interesting.

The best moments come when the trombonists are in action or when Haggart rises to the occasion with a setting worthy of his best (*Let's Do It, I Concentrate*). Otherwise, things get a bit strident here and there, and the tempos are too consistently peppy. So *In Love* fares nicely as a relaxed bossa nova, however, and the band's fans won't mind the grassiness.

Manne's most engaging soloists are trumpeter Brashear, finally given a chance on record to show what he can do, which is to play very fluently and inventively in the Clifford Brown-

Freddie Hubbard tradition. He's especially good on the languid *Beguine* and the aggressive *Sale*. This also spots Scott's versatile soprano; his good tone on flute enhances several tracks. Tedesco's guitar is nicely featured on *Get Out of Town*, one of Porter's best.

Generally, the tempos and meters chosen have little to do with the original versions, but no violence is done to the composer's intentions. The rhythms are modern, often poly, and tinged with exotica. Manne has fun with a berimbau (Brazilian music bow) on a couple of tracks, and otherwise proves himself still one of the best drummers around (as does Gus Johnson on the WGJB disc).

A final thought: It's nice to hear a modern jazz record with eight tunes that have real, genuine, complex changes, which the players consistently use in their improvisations. Could it be that the days of two-chord tunes are numbered?

Dan Morgenstern

Strike Up the Band: Bobby Hackett, Zoot Sims, Bucky Pizzarelli, Hank Jones, Mel Lewis, Richard Davis.

Flying Dutchman BDL 1-0829, stereo, \$5.98.

Like a breath of fresh air on a smoggy day comes this delightful album. Producer Bob Thiele has brought together six fine musicians of diverse musical backgrounds and mingled their talents to produce the kind of spontaneous coordination that results in memorable jazz. There is a touch of Dixie, a few boppish strains, but most of the music is straight-ahead mainstream swing that abounds in the *joie de vivre* of the genre.

The level of inspiration is consistently high whether the sounds are stomping or warmly melodic. The co-leaders, cornetist Hackett and tenor man Sims, take solos on *These Foolish Things*, *Teresa B.*, and *Embraceable You*, which are marvels of construction, lyricism, and invention. Pianist Hank Jones matches their improvisations note for note, and the beauty and facility of his expression is, as always, a joy to the ears. On *Strike Up the Band*, *Zoot's Toot*, and *Full Circle*, everyone swings crisply and compulsively. Zoot and Hackett solo with concisely-edited choruses in bristling style, and the tremendous rhythm section lays down the beat with awesome authority. Flying Dutchman's **Strike Up the Band** is what jazz is all about, and the stereo sound is first class. *John Lissner*

Sound: A Performance: A+

Theater Music

Donald M. Spoto

The Adventures of Robin Hood: A sound picture of Errol Flynn and Symphonic Suite of Erich Wolfgang Korngold. Narrations by Tony Thomas and Basil Rathbone.

Delos F25409, stereo, \$6.98.

I seldom like to take up this valuable space with words of condemnation, but this sort of nonsense demands solid excoriation. Delos Records, apparently trying to cash in on (to name only one other label) RCA's "film buff" series, has come up with this absurd disc. On one side is a scratchily transferred recording of the 1938 recording of Korngold's suite from "Robin Hood," which is in itself unexceptional music. It is not made more interesting by the late Basil Rathbone's overworked narration. I suppose it is justified in the mind of producer Tony Thomas by the fact that it is so closely associated with Errol Flynn, whom Thomas would, it seems, place fourth after the Trinity. But only the most naively romantic six-year-old child could sustain this sort of thing, and the transfer of the 78-rpm discs is sloppy.

On side two is a *Requiem* for a Cavalier, in which Thomas talks about, interviews (in excerpts from old tapes), and celebrates Errol Flynn with an adulation that borders on necrophilia. David Niven, Nora Black (one of the several Mrs. Flynns), and director Vincent Sherman talk of Flynn rather naturally until Thomas—in tones like a starry-eyed cadet of an interviewer—practically gets them to admit that he was one of the most glorious personalities of our time. I don't think this sort of adolescent slobbering does anything for the memory of Flynn, who was a much drooled-over but finally dull screen presence, and a man who, by drink and drugs and wild living, burnt him-

self out at 50. Can't we let him (and Marilyn Monroe and James Dean) rest in peace? Records like this insult both the living and the dead.

Sound: C Performance: Strained

A Chorus Line: Marvin Hamlisch, music. Edward Kleban, lyrics. Original Cast Recording.

Columbia Stereo PS 33581, stereo, \$6.98.

This year's Broadway musical smash, another Joe Papp/N.Y. Shakespeare Festival success story, started off-Broadway and moved uptown as evenings continued to sell out. Like all original cast recordings, this disc can only partially explain why. As I write this, I haven't seen the show. The record makes me want to. Marvin Hamlisch's music has all the divergent moods that must overtake people trying out for a chorus part—which is the idea of the show, a pastiche of personality numbers. Edward Kleban's lyrics tell about real feelings, and reveal the truth of the show-biz world in those old cliches. *I Hope I Get It* gets it all off to a rousing start, although in this—and in *Hello Twelve*, *Hello Thirteen*, *Hello Love*—I kept hearing Sondheim's title song from **Company**. The show-stopping number must be *One*, in which the whole company sings, shouts, almost beats its heart out, sharing of all the theatrical agony and ecstasy. From his arrangements of Joplin for **The Sting** and the somewhat icky-poo score for **The Way We Were**, I'd not have expected this sort of musical sophistication from Hamlisch. He's obviously growing.

One problem: why not publish a libretto with albums like this? One really needs the words (especially for ensemble numbers) when the score fa-

vors segues or rapid fugue-like orchestrations to accompany very modern English. The engaging cast is as fresh as tomorrow's baguettes, and the CBS disc, produced by Goddard Lieberson, is flaw-free. Even the electric organ sounds good.

Sound: A Performance: A

Those Glorious MGM Musicals
—Soundtrack Albums
MGM, mono.

As part of the nostalgia for yesteryear's entertainment, MGM is releasing soundtracks from its vintage musicals, and on several new 2-disc sets there are some 13 films represented, covering the years from 1946 to 1955. Presumably more are being prepared—the current list, in any case, has serious lacunae.

Till the Clouds Roll By opened in December, 1946. It was based on the life of Jerome Kern, and MGM must have figured it a sure winner. They were only partly right. The best of the lot includes Virginia O'Brien's deadpan *Life Upon the Wicked Stage (Ain't Nothin' for a Girl)*, considered naughty 27 years ago. It has an antique charm to it, like the funny hat of a beloved aunt. Lena Horne's smokily sexy *Can't Help Lovin' Dat Man*, from the film's 17-minute capsule version of *Show Boat* hits the mark beautifully, but Caleb Peterson's *Ol' Man River* (or, as he says it, "Ol' Man Ribber") is a self-contained, almost offensive parody. It shows how fine Paul Robeson's original was in 1936 and William Warfield's in 1951.

But Judy Garland—with her still-innocent "Dorothy" voice—offers *Who?* and *Look for the Silver Lining*, which *afficionados* will rush to own. Otherwise, there's heavy editing of the greater Kern songs, since con-

Our gimmick is no gimmicks at all.

Most speaker designers loudly proclaim accurate reproduction as their primary goal.

And so they should.

Regrettably, it doesn't always work out that way. A booming bass, a peaky midrange or some other dramatic device often suggests something quite different.

At Rectilinear, we have always avoided the dramatic...shunned gimmickry like the plague.

Witness our new Contemporary Laboratory Series.

Initial critical reaction has been very complimen-

tary and remarkably similar in expression.

Here's Norman Eisenberg commenting on the new Rectilinear 7, "The Rectilinear 7... offers totally 'ungimmicked' sound that is low in distortion, extremely transparent and devoid of any boxy resonances."

And in assessing the Rectilinear 5, Len Feldman was moved to write, "I liked the Rectilinear 5 for its freedom from gimmicky sound, its sense of naturalness."

No gimmicks. Isn't that what great sound is all about?

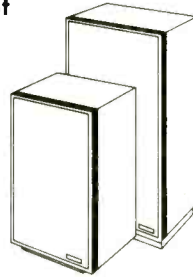

Rectilinear®

Rectilinear Research Corporation, 107 Bruckner Boulevard, Bronx, N.Y. 10454.

Check No. 38 on Reader Service Card

FREE McIntosh CATALOG and FM DIRECTORY

Get all the newest and latest information on the new McIntosh Solid State equipment in the McIntosh catalog. In addition you will receive an FM station directory that covers all of North America.



MX 113

FM/FM STEREO - AM TUNER AND PREAMPLIFIER

SEND TODAY!

McIntosh Laboratory, Inc.
East Side Station P.O. Box 96
Binghamton, N.Y. 13904
Dept. 1

NAME _____

ADDRESS _____

CITY _____ STATE _____ ZIP _____

If you are in a hurry for your catalog please send the coupon to McIntosh. For non rush service send the Reader Service Card to the magazine.

Check No. 27 on Reader Service Card

tracts prevented the transfer to disc of most of them. This makes the interest value of the first soundtrack album in the history of recorded music highly heretical.

Then a broad jump to 1948, and *The Pirate*, which is Cole Porter at his least inspired. Garland and Gene Kelly sing five numbers from this *soi-disant* satire on operettas. The only one worth mentioning is the sprightly *Be A Clown*. Richard Oliver's liner notes claim *The Pirate* is a neglected musical. Rightly, if we are to believe the selections here presented.

Irving Berlin wrote seven new tunes for *Easter Parade* (inexplicably premiering in July, 1948). Judy Garland had three solos, five duets with Fred Astaire, and one with a very nervous Peter Lawford. Of those composed especially for the film, *A Couple of Swells* is the best. It's so right musically and lyrically that a proper balance is struck between humor and light pathos. (It became, with *Over the Rainbow*, the Garland trademark.)

Ann Miller's subdued *Shakin' the Blues Away* probably looked better on screen than it sounds; Doris Day's exciting version in the truly glorious *Love Me or Leave Me* (1955) was truer to the Ruth Etting original.

But the real revelation in *Easter Parade* is Fred Astaire, whose appeal eluded me until this record. Almost, but not quite, a *diseur*, Astaire had a direct attack to a song, shorn of pretense, credibly personable. The charm of Cliff Edwards and the sophistication of Rex Harrison, but uniquely Astaire, uniquely American. For Judy, *Better Luck Next Time*, complete in her feeling delivery, takes an added poignance in light of her later years ("Don't say better luck next time/That never can be/Because there ain't gonna be a next time for me"). In this, Berlin's scoring is pointedly right.

Spring 1950 brought *Annie Get Your Gun* to Radio City (where most of these opened), and it's one of the splashiest, happiest scores, popular from its Broadway debut in 1946 to the Lincoln Center revival in 1966 and today. (Berlin even added a song for the last revival, *Old Fashioned Wedding*, a show-stopper for Ethel Merman.) Betty Hutton in the film was no Merman—she mistakes hoarseness for toughness—but when *They Say It's Wonderful* needs a tender huskiness, she gives it what Merman couldn't.

Howard Keel had his first Hollywood role in *Annie*, and he lasted in singing romantic leads for over a decade. His *Anything You Can Do* duet

with Hutton catches all the steely adolescent ego of each character and the appropriately broad edges of Berlin's lyrics.

This is a very different show from the stage versions of '46 or '66, but very interesting on its own terms. But let's not talk about *There's No Business Like Show Business*, a song which I think no one ever really believed.

Three Little Words (summer 1950) continued the musical biography form. Fred Astaire and Red Skelton played Bert Kalmer and Harry Ruby to Vera-Ellen's Jessie Brown. *Who's Sorry Now?* is the best of an unexciting melange, even though Gloria DeHaven's delivery lacks real warmth and sounds woefully underrehearsed. Helen Kane's *I Wanna Be Loved By You* has, apparently, an eternal charm: it achieves that precarious balance between innocent and not-so-innocent flirtation. Curious editing omits the final notes, presumably because dialogue intervened. It was to be several years before soundtrack albums had sophistication in adapting from screen to turntable. Anita Ellis' *Thinking of You* is as good as anything Jerome Kern ever wrote (and I compare it to his lovely *Can I Forget You?*), and is a warming surprise in an otherwise unexceptional film score.

Pagan Love Song (winter 1950) was one of Esther Williams' less successful water musicals: *Jupiter's Darling* and *Neptune's Daughter* stand out in my memory as better crafted. Howard Keel's success in *Annie* brought him most of the banal solos, but happily he survived the Freed-Warren-Brown feast of cliches.

Not the least interesting thing about *Show Boat* (summer 1951) is that only the album—not the film's original soundtrack on celluloid—preserves Ava Gardner's *Can't Help Lovin' Dat Man* and *Bill*. They're more than just curiosities; they reveal Miss Gardner's neglected vocal ability and pellucid sense of projection into the corners of a role. *Make Believe* and *You Are Love* have become national staples from this score. Their modesty, their naive American romanticism and pure lyricism make them quite irresistible now as then—two, in fact, of the best Kern and Hammerstein wrote.

One might detect some electronic tampering with Kathryn Grayson's *spinto* on this record. Otherwise, the fidelity is remarkable, and Adolph Deutsch's MGM orchestra was carefully modulated to the nuances of the score. *Show Boat* remains one of the half dozen greatest musicals in American cultural history.

The Amplifier Tester:

Only one name in headphones—**STAX**—can transduce musical depth to actually tell you which amplifiers are “thin” sounding (some are very expensive) and which amplifiers are “musical” in their sound definition.

STAX—a courageous small company dedicated to ultimate high-fidelity. **STAX** Electrostatic Headphones: so definitive they are known as the “Amplifier Testers”. Ask for them where the best audio products are tested first—then sold. \$235.00

Exclusively distributed in the USA, with integrity, by

American Audioport Inc.
909 University Avenue,
Columbia, Missouri 65201

American Audioport Inc.
909 University Ave., Columbia, Mo. 65201



STAX

headphones

COMMERCIAL DUPLICATING SYSTEMS

INSTALLATION AND PREVENTIVE
MAINTENANCE TRAINING
INCLUDED IN PRICING

Mid Atlantic Service Center

CASSETTE SYSTEMS

199 Davis Avenue

Woodstock, Md. 21163

Phone: (301) 922-8865



infonics
MICHIGAN CITY, INDIANA
(219) 879-3381

A
PHOENIX
ENTERPRISE
COMPANY

P.O. BOX 1111
INDIANA 46360

Tape & Turntable

Bert Whyte

Tale Spinin': Weather Report. **Columbia PCQ 33417**, SQ quadraphonic disc, \$6.98.

Every once in awhile a record comes along which is so outstanding both musically and sonically, that it achieves almost instant status as a "demonstration special." This recording by Weather Report is just such a phenomenon.

One of the most extraordinary things about this recording is that this tremendous outpouring of really exciting sound is the product of just five musicians. The exceptionally talented members of Weather Report are: Joe Zawinul, composer of four of the numbers of this disc, who plays acoustic piano, Rhodes piano, ARP 2600 synthesizer, Melodica, West African, steel drums, cymbals, organ, and xylophone; Wayne Shorter, composer and master of the soprano and tenor saxes; Al Johnson on electric bass; Alyrio Lima who plays a myriad of percussion instruments, many of a very exotic nature; and Ndugu on drums and tympani.

There are six original works on this disc, and while they may be generally

Open-reel Tape Freaks Unite!

If you care about the continuance of the prerecorded open-reel tape medium, you ought to get and answer a questionnaire which is being distributed by Russell Fields, Manager of Direct Marketing and Advertising, Ampex Music Division, P.O. Box 178, Elk Grove Village, Ill. 60007. The short questionnaire asks some very interesting questions about how you would like to see prerecorded open-reel tapes distributed and has some suggestions about simplifying open-reel handling and processing. The results will be sent to the General Manager of Ampex with the idea of saving the prerecorded open-reel tape format.—Editor.

categorized as a sort of jazz/rock fusion, there are unusual variations on this basic theme. For example, in *Badia*, we first hear at quite a low level, the eerie souging and sussurations of a wind machine. Then from different quadrants of the sound field, we hear tiny temple-bells, the dissonant pizzicato of what sounds like a loosely-strung samisen, then progressively heavier beats from a large drum and the electric bass, all this giving the music a decidedly oriental flavor. However, this in turn gives way to some chant-like sounds of African origin, and so help me, at a later point, the distinctive sound of Greek bouzouki music! Sounds weird, but it works.

All the numbers on this disc are consistently interesting and the orchestrations are replete with all manner of percussive sounds to delight the audiophile. From the sonic viewpoint, this recording is a technical tour-de-force. Inner balances among the instruments are precisely maintained, none of the instruments ever covering or masking another. There is good forward projection of the sound, and instrumental definition and the delineation of musical timbres is of exceptional accuracy. Overall sound was pristine clean, with quite a wide dynamic range for this type of music.

This music sounds fine in stereo, but played through a good full-logic SQ decoder, it really comes alive. The mixing engineer has done a superb job of assigning the various instruments to the quadrants of the surround-sound field in a manner that exploits both their harmonious and contrasting sonorities. This recording unquestionably ranks as one of the best examples of SQ technology. If your hi-fi tastes are a bit jaded, the Weather Report is the kind of tonic that can quickly recharge your batteries!

Sibelius Symph. Nos. 5 and 7: Colin Davis cond. the Boston Symph. Orch. **Philips 7300415**, Dolby-B cassette, \$6.98.

Bruch Violin Concerto No. 1 "Scottish Fantasy": Arthur Grumiaux, violin; Heinz Wellberg cond. the New Philharmonia Orch.

Philips 7300291, Dolby-B cassette, \$6.98.

Mozart Piano Concertos K. 595 and K. 456: Alfred Brendel, piano; Neville Marriner cond. the Academy of St. Martin-in-the-Fields.

Philips 7300383, Dolby-B cassette, \$6.98.

It is a pleasure to report that these cassettes and others that Philips has recently sent to me (which we will duly review) are among the best I have ever heard. Their overall excellence of reproduction has to be heard to be believed. The frequency response is smooth and wide in range, dynamic range unusually wide, and little or no modulation noise is audible. Signal-to-noise ratio is variable. If the master tape was recorded with Dolby-A professional noise reduction, then the Dolby-B cassettes derived from this master are nice and quiet. However, since Philips was slow to adopt Dolby-A recording, many of their masters are "straight" and consequently the Dolby-B cassettes made from these masters have various amounts of residual hiss. Playing these cassettes through a Phase Linear autocorrelator or a Burwen DNF can remove most of this hiss.

The performances are uniformly good on these cassettes. The Sibelius 5th of Colin Davis is especially noteworthy—a really stirring, exciting reading. The dynamic range and the brass and percussion sounds are just amazing coming from a cassette. Smooth, clean violin sound in the Bruch concerto, and if you have a speaker that can really get down to the sub-basement, wait 'till you hear

the huge bass drum in the *Scottish Fantasy*. The piano sound in the Mozart concertos is very well defined, clean, and highly articulate. All of the above cassettes have exemplary balances between the orchestras and their acoustic environments. These Philips cassettes come as close to being a viable alternative to a high quality disc as any I have yet encountered, and I recommend them to your attention.

Mahler Symph. No. 4 in G: James Levine cond. the Chicago Symp. Orch., Judith Blegan, soprano.

RCA ARK1-0895, cassette, \$6.98.

James Levine is supposed to be the new *wunderkind* at RCA, and the fact that at this stage of his development, they have embarked him on a traversal of all the Mahler symphonies, is ample evidence of their regard for him. Thus far, he has recorded the 1st Symphony with the London Symphony Orchestra, and this 4th Symphony with the magnificent Chicago Symphony Orchestra.

While his performance doesn't challenge the readings of such Mahlerian stalwarts as Solti, Szell or Fritz Reiner (this last with the same orchestra), it has much to recommend it. Noteworthy is his respect for the dynamic markings and tempo indications of Mahler, who was always very explicit in these matters. Levine has the considerable advantage of great playing from the incomparable Chicagoans, and in the final movement, soprano Judith Blegan sings her important solo with a lovely warm tone and the requisite tenderness.

RCA favors Levine with a splendidly sonorous recording. The sound is wide in frequency and dynamic range, with overall and inner balances quite good in relation to the spacious acoustic perspective. This was a multi-track recording with a profusion of microphones. As such, orchestral definition is pronounced, almost to the point of being clinical at times. Fortunately there were no serious excesses, and the sound is quite clean. For a commercially recorded cassette, the quality is very good, with substantial low-frequency response and little modulation noise. The one glaring bug-a-boo is the gross amount of tape hiss in this non-Dolby processing. C'mon, RCA, now that even Philips has embraced Dolby B cassette processing, don't you think it is time you did the same? Your tape masters are all Dolby A, and you certainly have the means and the technology to produce Dolbyized cassettes.

Primo —Leader in the Microphone Field—



MODEL ▶ DM-1525
◀ MODEL EMU-4520

- **Professional Studio Unidirectional Electret Condenser Microphone**
 - ◆ The EMU-4520 offers top studio quality within the reach of even the smallest studio integral 10dB level pad and low frequency control. Flat line response and great cancellation. High signal-to-noise ratio. Quality detachable us. Easily converted to omnidirectional or super-cardioid.
- **Omnidirectional Dynamic Microphone**
 - ◆ Perfect feel and balance for all handheld use. Ideal all around entertainers microphone.
 - ◆ Unique head design eliminates popping and handling noise.

SPECIFICATIONS:

MODEL	EMU-4520	DM-1525
Frequency Response	20~20,000Hz	40~15,000Hz
Output Level	-71dB ±2.5dB	-76dB ±3dB
Output Impedance	200Ω, Balanced	

● For further information write or call us today.
PRIMO MICROPHONE INC. 2468 DELTA LANE, ELK GROVE VILLAGE, ILL. 60007
PHONE: 312-595-1022
PRIMO COMPANY LTD. TOKYO, JAPAN

Check No. 52 on Reader Service Card

Try Audio's Classifieds—
They Pull!

Get your new Radio Shack catalog
at one of our 4000 stores today!

FREE! 1976 EDITION
OVER 2000 PRODUCTS
EXCLUSIVES ON EVERY PAGE
BEAUTIFUL FULL COLOR
164 pages of the finest
in home and hobby
electronics



**Save! Our Prices
Are Within 1% of
Our July, 1974 Prices!**

**Hi-Fi • CB • Kits • Parts
Phonos • Recorders • Tape
Radios • Antennas • Tubes
Auto Tuneup • Much More**

See what's *really* new. It's the most-wanted, most popular catalog in electronics, and loaded with our own exclusive nationally advertised brands: Realistic, Micronta, Archer, Science Fair, others — you've seen them advertised on TV. Come in for your free copy today!

**AVAILABLE BY MAIL TOO —
JUST SEND US THIS COUPON**

To: **Radio Shack** 658
P.O. Box 1052, Ft. Worth, TX 76101
Rush me your 1976 catalog.
(Please Print)

Name _____ Apt. # _____
Street _____
City _____
State _____ ZIP _____

Check No. 37 on Reader Service Card

Classified

FOR SALE

AUDIO RESEARCH MAGNEPLANARS and Electronics, ESS, Infinity, Ohm, Dahlquist, EPI, Audionics, Radford, Crown, Citation, BGW, Transcriptor, Linn-Sondek, Keith Monks, ERA, Connoisseur, SME, Supex, Decca, Grace, Sony, Spectrum Scanning Tuner, Epicure Amplifier, Marantz 500, OBX, ADC, Nakamichi, B&O, Tandberg, Celestion, Stax, Dayton-Wright, others. **THE GRAMOPHONE LTD.**, 757 Asp St., Norman, Okla. 73069. 405-364-9477

ANTI-SKATING for AR TURNTABLES!! Proven counterweight design of nickel steel & aluminum construction. Install yourself in minutes. \$7.00 postpaid. (Dealer inquiries invited.) **AUDIO INNOVATIONAL PRODUCTS**, P.O. Box 137, Ballardvale Station, Andover, Mass. 01810

SUPER — ORTOFON — OTHER MOVING COIL CARTRIDGE OWNERS: Send for free literature on our Micro-Preamp. Superb performance at \$99.95. Huntington Electronics, Box 2009-A, Huntington, Conn. 06484

ELECTRONIC CROSSOVERS — ALL TYPES. Updated definitive booklet describes applications; how to improve speaker systems; \$5.00 postpaid, credited to first purchase. Huntington Electronics, Box 2009-A, Huntington, Conn. 06484

LOWEST DISCOUNT PRICES ANYWHERE on audio equipment. All major brands discounted. Write for quotes, K&L Sound Services, 75 N. Beacon St., Watertown, Mass. 02172

DIAMOND NEEDLES and Stereo Cartridges at Discount prices for Shure, Pickering, Stanton, Empire, Grado and ADC. Send for free catalog, **LYLE CARTRIDGES**, Dept. A, Box 69 Kensington Station, Brooklyn, New York 11218

GRAPHIC EQUALIZER PLANS: Novel circuit very effective/inexpensive, requires no inductors. Ten knobs (octave bands) compensate your Hi-Fi/Tape providing better listening. Complete plans rushed only \$3.49. **GREEN BANK SCIENTIFIC**, Box 100C, Green Bank, WV 24944

BAUMAN RESEARCH INSTRUMENTS CO. Low noise—low distortion, stereo preamps. Why buy our preamps? Free info, write B.R.I.C., 1400 Gardenia Circle, Rosenberg, Tex. 77471

AUDIO BREAKTHROUGHS

"We're closing the gap on perfection"

Long Island's finest audio dealer. The incredible Lux M-6000 now you can hear what a \$3,000 amplifier sounds like! See the original Transcriptors turntable with new fluid damped arm; complete selection of ultra-fidelity records: Sheffield, Levinson, Fulton, Jonas Miller and more! Just arrived; the new elliptical Decca Mk V, Audiocraft and Grace damped tonearms. Satin "ultimate" cartridge, plus Paoli tube amplifier, Magneplanar, Linn Sondek, Lux turntable, B&W, KEF speakers and drivers, Yamaha (CT-7000, B-1 and NS-1000M!), Supex, M&K super woofer, IAD ultra-low distortion dynamic range expander! Levinson, new Polk, IMF and the list goes on. **AUDIO BREAKTHROUGHS**, 1681 Northern Blvd., Manhasset, N.Y. 11030. (516) 627-7333

DON'T PAY THE HIGH MAIL ORDER PRICES THIEVES WAREHOUSE OF FT. WALTON BEACH

652-0 BEAL PKWY., N.W., FT. WALTON BEACH, FL 32548

FOR SALE

DON'T LET VOLTAGE TRANSIENTS ZAP YOUR HI-FI. Solid State Equipment Protector. Plugs into outlet. Check or money order \$6.95. Kopp Sales & Service, 1650 William St., Buffalo 14206. Free brochure—send SASE.

RECORDING TAPE CLOSOUT: Dozen reels 2400', \$12.00. Dozen 1200', \$8.00. 24 reels 900', \$6.00. 24 600', \$5.00. Postpaid Guaranteed. Mitchell, Box 132A, Flushing, N.Y. 11367.

ONE STOP for all your professional audio requirements. Bottom line oriented. F.T.C. Brewer Company, P.O. Box 8057, Pensacola, Florida 32505.

DON'T PAY THE HIGH MAIL ORDER PRICES THIEVES WAREHOUSE OF SARASOTA

6564 GATEWAY AVENUE, SARASOTA, FLORIDA 33581

BUILD YOUR OWN SPEAKERS AND SAVE UP TO 50%. You can assemble your own high quality, multi-element stereo speakers in a few hours and save up to half the cost of comparable speakers. Send for our free 32-page catalog of speaker kits, raw speakers and accessories. **SPEAKERLAB**, Dept. A2, 5500—35th N.E., Seattle, WA 98105

OPERA TAPES. Historical performances of past 40 years. Unbelievable treasures and rarities. ALSO LP RECORDS. Free catalog. Ed Rosen, 66-33 Saunders St., Rego Park, N.Y. 11374

WESTCHESTER AND FAIRFIELD COUNTY AUDIOPHILES TAKE NOTE! THE AUDIOPHILE, 231 BEDFORD STREET, STAMFORD, CONN. specializes in equipment for the connoisseur. Ampzilla, Koss Model One, ADC, Citation, Crown, Dahlquist, Dyna, Epicure, Infinity, Philips, SAE, SME, Stax, TEAC, Technics, Thorens and many more (203) 348-3551 (Closed Mondays).

STEREO TIMER AND ELECTRONIC DIGITAL CLOCK. P.C. Board with instructions \$9.95. Kit with box \$99.95. Assembled unit \$149.95. Wake up and fall asleep to strains of your favorite AM/FM, record, or tape. This product will be an attractive addition to your stereo equipment. Switches up to 1200 watts. Cosmos Electronics, Dept. A5, P.O. Box 33278, Seattle, Wash. 98133

NEW VIDEO EQUIPMENT-LOW PRICES

PANASONIC—cameras, monitors, vtrs

RCA—cameras (low light), monitors

GYR—time lapse vrt

Many accessories

Write or call your needs.

ELECTRONIC EYE

9044 Eldora Drive

Cincinnati, Ohio, 45236

(513) 891-9044

CANADIANS — DYNACO COMPONENTS AT TREMENDOUS DISCOUNTS. Write En-Jay Sales, Hornepayne, Ontario

DISGUSTED WITH AMERICAN RECORDINGS? Tired of paying import prices? Join us at STEREOPHILE in mounting a campaign to bring US record companies back to the view that high fidelity means musical realism, not tick, boom and screech. For information about this lively, literate publication that is still leading the audio industry since 1962, write STEREOPHILE, Box 49S, Elwyn, Pa. 19063, or send \$7 for 4 issues.

FOR SALE

ATTENTION...
LUCKY OWNERS OF:
DYNA STEREO 70
RABCO SL8(E)
DYNA PAS-3(X)
INFINITY 2000A
DECCA MKV AND "EXPORT"
DYNA MARK III
SHURE SME and
other tubular tonearms

THE DKL LABORATORY, INCORPORATED HAS DEVELOPED UNIQUE MODIFICATIONS ENGINEERED SPECIFICALLY FOR THESE COMPONENTS. NOW YOU CAN GREATLY IMPROVE THE SOUND QUALITY TO "ULTRA DEFINITION".

PRICED FROM \$25.00 TO \$170.00, OUR MODIFICATIONS OFFER VAST AUDIBLE IMPROVEMENTS AT REASONABLE COST.

FOR MORE INFORMATION CONTACT:

OKL LABORATORY, INCORPORATED
BOX 683

SEVERNA PARK, MARYLAND 21146

OR CALL: (301) 588-6257

MONDAY, WEDNESDAY, THURSDAY,

SATURDAY 2-8 PM

WE SPECIALIZE IN ONLY THE FINEST SOUND COMPONENTS—ALLOW OUR STAFF OF AUDIO EXPERTS TO HELP YOU CREATE YOUR "ULTRA DEFINITION" SOUND SYSTEM. CHOOSE FROM THE WORLD'S FINEST COMPONENTS LIKE:

AUDIO RESEARCH—electronics and speakers

BGW—power amplifiers

DBX—noise reduction systems, dynamic range enhancers

"HAND-TUNED" **DECCA MKV**—cartridges

DYNACO—tube electronics

FULTON—regular and MODULAR speakers

HK CITATION—amps, tuners

IMF—"MONITOR-ORIENTED" speakers, kits, sub-woofers

LINN—SONDEK—turntables

MAGNEPAN—speakers

M & K—sub-woofers, matrix systems

PAOLI—tube amplifiers

RABCO—turntables

RTR—electrostatic speakers

SOUNDCRAFTSMEN—pre-amps, equalizers

STAX—electrostatic headphones

"SUPER SHURE" **SME**—tonearms

TANNOY—turntables, speakers

AND SCORES MORE.

WASHINGTON D.C., MARYLAND, VIRGINIA

AREA RESIDENTS TAKE NOTE—

YOUR "STATE-OF-THE-ART" DEALER IS:

DKL SOUND LAB

943 BONIFANT

SILVER SPRING, MARYLAND 20910

Hours: MONDAY, WEDNESDAY, THURSDAY,

SATURDAY 2-8PM FRIDAY BY

APPOINTMENT ONLY, CLOSED TUESDAY

(301) 588-6257

Rates: 35¢ per word per insertion for noncommercial advertisements; 60¢ per word for commercial advertisements. Frequency discounts as follows: 3 times, less 10%; 6 times, less 15%; 12 times, less 20%. Closing date is the FIRST of the second month preceding the date of issue. Payment must accompany all orders. Use the handy self-addressed, postage paid card at the back of this issue. When replying to Audio box number ads, send letters c/o Audio, 401 N. Broad Street, Philadelphia, Pa. 19108. For more information about classified advertising, circle Reader Service Card #135.

FOR SALE

AMPEX TAPE—NEW 1800' on 7" reel 12 for \$18 POST-PAID; 1200' 12 for \$13 POSTPAID—free list—WIDE RESPONSE. 6114A SANTA MONICA BLVD., HOLLYWOOD, CA. 90038.

ELECTROENCEPHALOPHONE: brainwave monitor, Professional biofeedback instruments. J&J 8102-A, Bainbridge, WA. 98110.

10 1/2" RECORDER SPECIALISTS: Fresh new Scotch L/N 3600 ft. on new 1/4" NAB metal reels five for \$35.00. New Ampex GRANDMASTER tape on 10 1/2" metal reel, six for \$73.00. New 4 channel 8-track blank cartridge loaded with 40 minutes Scotch L/N tape, \$23.00 per dozen. Reconditioned NAB metal 10 1/2" reels, \$24.00 per dozen. 10% on above for postage. Sound Investment, POB 88338, Dunwoody, Ga. 30338.

CENTRAL NEW YORK HI-FI ENTHUSIASTS—Britain's finest loudspeakers on demonstration—THE IMF STUDIO AND ALS40—as well as Marantz, Pioneer, Revox, Beyer, Epicure (3 lines), Thorens, Ortofon, XLM, Discwasher... THE SOUND SHOP, 96 Seneca Street, Geneva, N.Y. 14456 (315) 781-0215.

SIGHT & SOUND LTD.

Catering to the audiophile who desires the absolute in sound, equipment, service and professionalism.

OUR LINES

Ampzilla, ADS/Braun, AKG, B&O, Beyer, Bose, Crown, Dahlquist, DBX, Linn Sondek/MAL, Magnepan, McIntosh, Micro Acoustics, Ortofon, Revox, Soundcraftsman, Tandberg, Yamaha.

OUR STAFF

Engineers, physicists, musicians, teachers — all devoted audiophiles dedicated to providing the epitome in experience, patience and service.

OUR LOCATION

Campus Hills Shopping Center, Five miles northeast of Bel Air, Maryland 21014 on Route 22. Phone 1-301-838-2100.

STATE-OF-THE-ART comes to NORTH-CENTRAL FLORIDA serving you with: AUDIO RESEARCH, Citation, Crown, Dahlquist, Denon, Dynaco, Fidelity Research, DBX, G.A.S. Co., Hartley, Infinity, Magneplanar, Mark Levinson, Ortofon, Rabco, Revox A-700, SME, Supex, Thorens, Transcriptors, and \$10,000 worth of test equipment for in-store audio analysis. We maintain a mobile recording van and sell professional recording equipment. **AUDIO, ETC., INC.**, 1999 N.W. 43rd Street, Gainesville, Florida, 32605. 1-904-377-4107.

ATTENTION

WESTERN NEW YORK AUDIOPHILES

The word is getting around!! Our personalized, honest service and quality equipment make a winning combination. In addition to the incomparable AUDIO RESEARCH line, (T-1B's black/natural in stock), we carry AMPZILLA, SAE, Phase Linear, Yamaha, Quintessence, LEVINSOHN, B&O, IMF, MAGNEPAN, M&K Subwoofers, Hegeman, Infinity, RTR, ESS, DAHLQUIST, Fulton Music, QUATRE, Onkyo, Connoisseur, Technics, Thorens, Dynaco, Transcriptors, Cerwin Vega, Soundcraftsman, Supex, Ortofon, ADC, Micro-Acoustics, Damped SME, Linn Sondek, KMAL, Naim Audio, etc. The Stereo Emporium, 3407 Delaware Ave., Buffalo, N.Y. 14217. (716) 874-3372.

AUDIOPHILES WANTED!! Put your knowledge to use, earn an excellent spare time income. We need campus representatives to sell name brand stereo equipment at substantial discounts in your area. No investment necessary. For information and application please write: ABCO, Dept. CR, 915 Grand Avenue, New Haven, Conn. 06511

CERWIN-VEGA PRODUCTS

(312) 581-7436

STEREO COMPONENTS: Over 50 brands & accs. List \$30 refundable Custom Audio c/o Dick Walen 4226 Robert St. Red Wing, Minn. 55066

FLORIDA AUDIOPHILES! Phase Linear, I.M.F., B&O, H/K, Marantz, Quatre, Thorens, Sony, Klipsch, Revox, Barzilay cabinets. Sales and expert repairs. INTERIORS PLUS SOUND, 3038 N. Federal Highway, Ft. Lauderdale, Florida 33306 (305) 566-3511.

FOR SALE

NOW ALMOST 14 YEARS OLD, STEREOPHILE has become the most widely-copied audio publication of them all. It should be: We pioneered subjective testing (by ear), devised a unique vocabulary for describing nuances of reproduced sound, proved that a subscriber-supported magazine could be blunt without being churlish, and led the industry by demanding higher standards of reproduced fidelity than it could provide. STEREOPHILE is not for the neurotic compulsive who must own the Best On the Block, but for the listener who wants the most natural possible reproduction of music. Only \$7 for 4 issues, or write to STEREOPHILE, Box 49S, Elwyn, Pa. 19063 for details.

FULTON J-MODULAR speaker system, new walnut, also ARC EC-3A 919-449-4132.

ACUSTECH complete audio system, mint cond. \$950 Firm, SONY Stereo tape recorder mod. No. 660 portable 4 track auto. reverse, including 30 prerecorded classical tapes \$495 all ex. cond. Recorded L.P.s stereo classical mint cond., \$150. George Stevens, 7506 Ambergate Pl., McLean, Va. 22101.

DON'T PAY THE HIGH MAIL ORDER PRICES

THIEVES WAREHOUSE OF ST. PETERSBURG,
9151 Park Boulevard, North Largo, Florida.

CROWN, MCINTOCH, EPICURE, PHASE LINEAR, Yamaha, B&O, Nakamichi, Soundcraftsman, Dahlquist, Magnepan, Frazier, Avid, Ortofon, Fulton, Tandberg, Harman-Kardon Rabco, Stax, and many others. Bryn Mawr Stereo & TV, 1016 Lancaster Ave., Bryn Mawr, Pa. 19010. (215) 525-6300.

AUDIOPHILES NEEDED!! Sell Over 100 Brands!! Lowest Possible Prices!! — Krasco — 623 Campbell Avenue, West Haven, Conn. 06516

FOR SALE

TUNED ROCK P.A.'s. Customized high intensity touring/permanent installation sound systems, including narrow band (5 Hz!) feedback suppression, detailed regenerative response. Acousta-Voicing/environmental equalization (+1dB at your ears), room design/measurement/treatment, $\sqrt{15\%}$ articulation loss of consonants, 1000's of customized professional products including... fiberglass horns, consoles, comp/rms/peak limiters, 18db continuously variable electronic crossovers, digital/acoustic delays, omnipressors, phasers, reverb, echo, doubling/tripling effects. P.A. noise reduction, piezo transducers, frequency shifters from... J.B.L./Altec Pro, Tascam, U.R.E.I., Eventide, Gately, Studer, Beyer, Crown, Community Light/Sound, Mom's Audio, McIntosh, Bzok, Allen Health, Gauss, Cetec, Scully, Multi-track, etc., etc. All shipped prepaid/Insured. Music & Sound Ltd. 11 1/2 Old York Rd., Willow Grove, Pa 19090 (215) 659-9251.

DEALERS!! CONSUMERS!!

Write for quotes on all medium and many High End lines. We need campus reps and people seriously interested in hi-fi to properly demonstrate a fantastic loudspeaker line. Liberal compensation for qualified individuals. Write: Audio P.O. Box 36 Salsberry, Indiana 47459, or call (812) 825-9750 or (812) 332-4252.

MAKING HIS MOVE — Mel Schilling, formerly of Willow Grove, Pa., has taken his knowledge of music and sound to California, where he will continue to serve a select nationwide clientele devoted to ultra state-of-the-art stereo. All shipments prepaid and insured. Write or call — 20929 Ventura Blvd., Woodland Hills Village, Woodland Hills, Calif. 91364. (213) 348-4600.

CASSETTE LABELS: 1,000 labels sheeted 6 up or type-writer roll, \$9.95. Shipping 10%. TARZAC, 638 Muskogee Avenue, Norfolk, Virginia 23509.

Why don't you buy where it all comes from?



W. GERMANY'S leading mailorder & discount specialist offers:

REVOX A77
only \$ **499,-***

for A77 Dolby please add \$ 149,-
incl. insurance, freight collect

DUAL 701
only \$ **249,-***

incl. insurance, freight collect

THORENS, BRAUN, IMF, GALE, SME, CELESTION, B & O, DECCA, B & W and many others.

European leading products at very competitive prices. Please send for your individual quotation. Reply by airmail (please include \$ 2 for airmail postage).

AUDIO INTERNATIONAL GMBH i.G.

1000 Berlin 30 . Postfach 4030 . W. GERMANY

* Everything will be shipped immediately after receipt of your cheque.

Check No. 4 on Reader Service Card

FOR SALE

CASSETTES

Plain white cassette labels, Norelco cassette cleaners, famous brand cassettes. Send for open reel and cassette discount catalog.

Cassette Labels	1-9	10-99	100	1000	10M
Norelco Cassette Cleaner	.65	.60	.55	.50	.45
10" Metal, NAB, Used Reel	1.00	1.00	.90	.80	.75
10" Fiberglass used 3/8" Hole	.50	.50	.40	.35	.30
Scotch Cassette SC90HE	2.72	2.55	2.44	COBALT	

*Buy 2, SC90HE, get 1 free.
Plus Postage by Weight and Zone. Minimum Order \$5.00

OPEN REEL STEREO TAPE BUYERS!

At last! An open reel catalog, including titles, songs, etc. of 95 long play, 2-3 hour albums by American Airlines or Ampex 4 track stereo tapes. Send \$1.00—and we will also mail you a 140-page Harrison stereo tape guide—so you'll get both for \$1.00—and this \$1.00 is refundable on your first \$10.00 purchase of open reel stereo tapes at our 30% discount.

We've Got the "Spirit" The Prices And The Address To Prove It
Saxitone's Bicentennial Tape Shoppe
1776 Columbia Rd., N.W., Wash. D.C. 20009



PROFESSIONALLY SPEAKING. Klipsch, Nakamichi, Crown, Yamaha, SAE, Bose, Burwen, DBX, Soundcraftsmen, Transcriptor, Microacoustic, Teac, Sonab, Dokorder, Supex, Grace, JBL. For that extra personalized service visit — HAL'S STEREO SOUND CENTER, INC., RT. 1 & Texas Ave., Trenton, N.J. 08638, 609-883-6338.

Audio Research	M & K	Fidelity Research
Quintessence	Gale	Mark Levinson
Techniques	KMAL	Connoisseur
Dahlquist	Supex	Magnepan
Hartley	Yamaha	Sequerra
Quatre	Win Labs	Fulton
Braun	Audionics	Grace
SME	Nakamichi	Stax
SAE	Linn Sondek	DBX

GARLAND AUDIO, INC.

2960 Stevens Crk. Blvd.
San Jose, California 95128
(408) 244-6724

CYBERACOUSTIC LABS presents the new RTR DR-1 DIRECT DRIVE ELECTROSTATIC TRANSDUCER SYSTEM! DRIVEN by its own internal servo-feedback amplifier!

MORE musical than any tube or fet system ever devised! ITS uncanny realism is totally unequalled by any other electrostatic system, including headphones!

THE first true non-directional (360°) electrostatic system! GATHER your most revealing records or master tapes and call for an appointment today!

Cyberacoustics by Barclay—
Philadelphia's Exclusive RTR Distributor
503 Haverford Ave., Narberth, Pa. 19072
1-215-667-3048

CUSTOM BUILT SPEAKER SYSTEMS. enclosures, kits, foam grills, crossovers & parts. Raw speakers, veneers vinyl. Warehouse prices. Custom Sound Service, Algonac, Michigan 48001

KLIPSCH HERESYS. walnut, new, factory sealed cartons, \$515.00 one pair Prepaid. MARANTZ 3300, new, walnut, warranty. \$285.00. (318) 868-0451/861-7174.

SOUNDAMERICA — Northern Minnesota's finest Audio dealer. Crown, SAE, Infinity, Yamaha, Ortofon, Shure, Thorens, Pioneer, Sony, Kenwood, E-V, Teac. Finest selection — will ship prepaid. SOUNDAMERICA 2116 Maple Grove Rd., Duluth, Minn 55811

LET STEREO ONE bring a new excitement to your listening pleasure. Stereo One is at 1229 Post Rd., Fairfield, Conn. 06430. For the discriminating listener we offer: McIntosh, Mark Levinson, Braun ADS, Quatre, Nakamichi, Revox, Thorens, Supex, Dahlquist, Ortofon, B&O, Denon, F-R, JBL, Yamaha, Phase Linear, Jecklin Float, & Bi-Amplified Bozak Speakers. We ship pre-paid. For competent, professionally objective advice call:

STEREO ONE
1229 Post Road
Fairfield, Conn. 06430
Phone 203-255-5939

FOR SALE

ENGINEERED ENCLOSURE & CROSSOVER DESIGNS — free w/purchase of our J.B.L., Gauss, Altec, and Community raw drivers and horns. Music & Sound Ltd., 11-1/2 Old York Road, Willow Grove, PA 19090 (215) 659-9251.
Loudspeaker Reconciling Labs

PROPRIETARY CUSTOMIZED MOODS reduce tone arm friction, damp spurious resonances, minimize torsional forces, improve tracking, and reduce hum and record wear. For S.M.E.'s—\$30.00* For Rabco SL-8(E)—\$100.00. For Transcriptors—free* (*with purchase).

NOW

LISTEN to our calibrated Sain/Denon/F-R/Ortofon/Supex moving coils. B&O/Grace/Micro-Acoustics. From the laboratories of Music & Sound Ltd., 11 1/2 Old York Rd., Willow Grove, Pa. 19090 (215) 659-9251

Levinson & Stax Cartridge Preamps

NORTHERN N.J.'S FINEST AUDIO STORE, 20 minutes from N.Y.C. Ampzilla, Avid, Bozak, B&O, Crown, Dahlquist, DBX, Dual, IMF, Kenwood, Magneplanar, Micro-Acoustics, Ortofon, Phase Linear, Pioneer, Quintessence, Thorens. Write or call University Stereo, 57 E. Ridgewood Ave., Ridgewood, N.J. (201) 447-5700.

MCINTOSH MPI-4 INDICATOR 18 months old. \$399.00. Call after 6 PM, 413-569-5494.

BUY DIRECT FROM ENGLAND'S HI-FI MAIL ORDER SPECIALISTS! Save on B&O, Celestion, Decca, Tandberg, Revox, Transcriptor, Jordan-Watts, Lowther, KEF, Rogers, SME, Ariston, HPD, Sugden, Radford, Neal, Ferrograph, etc. Shipping lists free or send \$3.00 bills to include literature. Goodwin Ltd., 7 Broadway, Woodgreen, London N.22. Phone 01-888-0077. Visitors welcome.

SURPRISE! SURPRISE! Digital Piano Tuning Device tunes musical instruments Accurately! Perfectly! Inexpensively! Construction-Instruction Plans Complete \$12.95 Airmailed Postpaid! Moonlighting quickly repays \$40 electronics investment! GREEN BANK SCIENTIFIC, Box 100E, Green Bank, W.Va. 24944

WESTCHESTER AND FAIRFIELD COUNTY AUDIOPHILES TAKE NOTE! THE AUDIOPHILE, 231 BEDFORD STREET, STAMFORD, CONN. specializes in equipment for the connoisseur. Ampzilla, Koss Model One, ADC, Citation, Crown, Dahlquist, Dyna, Epicure, Infinity, Philips, SAE, SME, Stax, TEAC, Technics, Thorens and many more (203) 348-3551 (Closed Mondays).

DYNA STEREO 70 MOO KIT. Tighter bass, improved transient response, higher definition. Complete instructions, schematics, parts list, \$5.00. With parts kit, including all new tubes, \$58.00. Or we will modify \$105.00 all postpaid. Audio Designers, Box 122, Ledyard, Conn. 06339.

DAYTON WRIGHT XG8 Mk II—\$995, XG8 Mk III; IMF Monitors, Mark III Improved—\$1,400; Rabco SL8 (modified)—\$125; Levinson LNC-1 100 Hz crossover—\$550; Pair Hartley 10" subwoofers in 7' transmission lines, walnut—\$500; Marantz 20B tuner—\$395; Stax SRX—\$165; Stax SR3—\$75; Quintessence Amp, latest model—\$900; B&O 5700 speakers, rosewood, with stands—\$525. All equipment with full warranties. John Boland, 2912 S. Auburn Place, Kennewick, Wa. 99336 (509) 587-1286.

ATTENTION DYNA OWNERS. Our Dyna Double 400 modification with 16 output transistors, front end bypass, and 80,000 mfd power supply is twice as fast and twice as strong as a stock ST-400. Our Super PAT-5 has lightning fast ICs and improved high gain phono section. With a Denon DL103S straight in, these Super Dynakits show you just how great our Fulton Js and Magneplanars will play. JENSENS STEREO SHOP, where Start of the Art is affordable, 2202 River Hills Drive, Burnsville, Minnesota. 55337. 612-890-3517

CYBERACOUSTIC LABORATORY is a research and development center combined with the most scientifically advanced audio acoustics lab; featuring Crown, IMF, Mark Levinson, Nakamichi, Burwen, UREI, RTR, DBX, Ortofon, Decca, HK-Rabco, AKG, and more. Crown tape recorder specialists. Send for free catalog! 503 Haverford Avenue, Narberth, Pa. 19072. (215) 667-3048.

FOR SALE

AN IMPORTANT ANNOUNCEMENT

Parnassus Audio is now producing a full Class A (not AB) stereo power amplifier capable of relatively high output power.

The amplifier additionally satisfies the theoretical criteria for completely eliminating transient intermodulation distortion.

The difference in sound quality between this amplifier and conventional amplifiers is easily audible, even to the inexperienced.

We welcome requests for a descriptive brochure.

Dealerships will be limited.

Address all inquiries to: **PARNASSUS AUDIO, INC., 2918 Harper Street, Berkeley, California.**

MINNEAPOLIS — High Quality Audio Has Finally Arrived! Audio Research, Bang & Olufsen, Klipsch, Audionics, Radford, Revox, Bozak, Crown, DBX, Sequerra and others... **THE SOUND ENVIRONMENT**, Butler Square, Suite 114, 100 North Sixth Street, Minneapolis, Minn. 55403. (612) 339-4641

DON'T PAY THE HIGH MAIL ORDER PRICES

THIEVES WAREHOUSE OF BETHESDA
P.O. BOX 34251, WEST BETHESDA, MD. 20034

NORTHWEST'S FINEST — Audio Research, Audionics, Braun, Burwen, Crown, Dahlquist, Dayton Wright, Decca, Denon, Dunlop Clark, Fidelity Research, FMI, Gale, GAS, Grace, Hartley, IMF, Linn Sondek, Magnepan, Mark Levinson, Nakamichi, Otari, Quad, Quatre, Quintessence, Radford, Sequerra, Stax, Supex, Tandberg, Technics, Yamaha, also Custom Designed Superwoofers, and many more, HARTLEY ELECTRONICS, 1502 Butternut, Richland, WA 99352. (509) 946-4459 until 6:00 PM, Then 946-1529 evenings.

NAME BRAND RECORDING TAPE, custom loaded. Available in cassettes, reels, and cartridges. Huge savings direct from manufacturer. MJS, 516 Brooks, San Jose, Calif. 95125.

BERKELEY, CALIFORNIA

speakers & headphones	ADS FMI M&K Gale Polk Stax Braun Beyer Fulton Quatre Magnepan Quad ESL Audionics Cambridge Dahlquist Sennheiser Beveridge ESL	electronics	ADS GAS Quad Hercic Quatre Radford Ampzilla C/M Labs Audionics Cambridge Parnassus Quintessence Mark Levinson
tape-recorders, processors, & accessories	ARK Dbx Lamb Beyer Braun Revox Sheffield Vac-o-rec Nakamichi Quintessence	record-playing equipment	SME BSR KMAL Dual Grace Supex Win Labs Connoisseur Keith Monks Linn-Sondek Mark Levinson Fidelity Research

STEREO WORKSHOP
2985 College Avenue
Berkeley, California 94705
(415) 843-5836

new hours

Tues-Sat
12-5 PM
6-10PM

Sun-Mon

closed

open for browsing

private appointments for auditions & consultation

FOR SALE

SHOP AROUND — Listen to every speaker available — then come to Cyberacoustic Laboratory and hear RTR's New Direct Drive Electrostatic DR-1 speaker system at Philadelphia's exclusive distributor — by appointment — 503 Haverford Ave., Narberth, Pa. 19072. (215) 667-3048.

CAR STEREO — all major brands. Lowest prices. Audio, Suite 47, 947A Dyer Avenue, Cranston, R.I. 02920

NEW GENERATION Crown Amplifiers, Cleanest, Smoothest sound ever produced — Crown D1200/HP1200, on demo only at Barclay Recording, 503 Haverford Ave., Narberth, Pa. 19072. (215) 667-3048.

ROCKFORD'S APPLE TREE STEREO® — Audio Research Magnaplanar Speakers and Electronics, Crown, Denon, H/K Rabco, Linn Sondek, Micro-Acoustics, Ohm, SME, Sony, Technics, and many other fine audio components. 1645 N. Alpine Rd., Rockford, Ill. 61107, 815-226-9826

SOUTH'S LOWEST QUOTES FOR DYNACO AND EICO KITS. AllKits, Box 864, Destin, Fla. 32541.

YOUR ROOM IS THE MISSING LINK

A state of the art system is usually junk in the typical poor listening environment, and therefore a rip-off. Our acoustical consulting division will have a calibrated "reverberation curve vs. frequency" measurement performed in your room, and our engineering dept.'s plan of correction, loudspeaker placement, and room equalization, all at no cost with your purchase or upgrade. Music & Sound Ltd., 11 1/2 Old York Rd., Willow Grove, Pa. 19090. (215) 659-9251.

CANADIANS: Best Hi-Fi discounts on over 96 leading Hi-Fi brands. Many exclusive factory closeout and special deals. Quotations via return mail. Nationwide mailorder service. FREE catalogs jam pack with bargains in: Hi-Fi equipment, tape and recording accessories, calculators, telephones and accessories, kits, parts, etc. Hundreds of factory and government surplus specials too! American inquiries welcome. Rush free catalog request to: ETCO, Dept. AUA, Box 741, Montreal H3C 2V2.

AKG, ALTEC, AUDIO RESEARCH, Beyer, CROWN, DAHLQUIST, DBX, DECCA, INFINITY, K.L.H. 9s, Koss, Nakamichi, Ortofon, PHASE LINEAR, P.M.L., REVOX, SAE, Sennheiser, Sequerra, Sony, Stanton, Stax, Supex, Tandberg, TASCAM, Technics, Thorens, etc.

HI-FI HAVEN

28 Easton Ave.
New Brunswick, N.J. 08901
201-249-5130

PROFESSIONAL brand name quad receivers and dual performance turntables at one third wholesale cost. Sansui tuner AU-9500, 80 watts RMS \$275.00. Sansui tuner AU-7500, 40 watts RMS \$160.00. Send \$1.00 for Fall preview catalog. Audio Smith, 7225 S. Jeffery, Apt 1A, Chicago, Illinois 60649.

INFRA WOOFER™ world's largest, deepest, most powerful sub-woofer system can be had only at Music and Sound, Ltd. 50 dB per octave crossover, bandpass 16 Hz. \$1495.

DAHLQUIST, F.M.I., I.M.F., HARTLEY SUB-WOOFERS, for the closest approximation to dipole definition \$132 up! Shipped prepaid/insured. Music and Sound, Ltd., 11 1/2 Old York Road, Willow Grove, Pa. 19090 (215) 659-9251.
+ Free PassiveX-over Design w/Purchase +

DON'T PAY THE HIGH MAIL ORDER PRICES THIEVES WAREHOUSE OF TAMPA

1531 SOUTH DALE MABRY, TAMPA, FLORIDA 33609

INFONICS DUPLICATORS! For a bunch of reasons you can't afford not to consider Infonics Duplicators — especially since factory installation and training are included in the list price! **INFONICS DUPLICATORS,** 219-879-3381.

ORIGINAL TRANSCRIPTOR HYDRAULIC REFERENCE TURNTABLE (do not confuse with smaller "Skeletal" table/Vestigial arm package from Ireland) now available direct from U.S. importer. Magnificent turntable complete with silicone-damped Unipivot arm, \$498.00 freight prepaid. Without arm, including blank arm-mounting board or one cut for SME, \$398.00. Send \$100.00 down for COD shipment. Audiophile Imports, 10 East Erie, Chicago, 60611. (312) 787-0754.

FOR SALE

FLORIDA'S LARGEST AUDIO RESEARCH DEALER. Full Audio Research Systems on display SP3-A-1 Dual 76A/Dual 150/Dual 52/Magneplanar Tympani 1 C/Tympani IV. Plus AR B&O, Crown, Denon, Fulton, IMF, Magneplanar, Marantz, Mark Levinson, Nakamichi, Paoli, Phase Linear, Revox, Russound, SAE, Satin, Sequerra, Sherwood, Shure, Stax, STR, Supex, Tandberg, Technics, Transcriptors, Uher, Yamaha. SOUND AND SIGHT, INC. 20 N. Federal Highway, Boca Raton, Florida 33432, (305) 391-1843.

DON'T PAY THE HIGH MAIL ORDER PRICES

THIEVES WAREHOUSE OF MOBILE

1770 BELTLINE HIGHWAY, MOBILE, ALABAMA 36609

CURRENT AND RECOMMENDED:

SDNEX speaker. Originally developed as a mix down monitor, a piezoelectric has been added for dispersion. The result is a very efficient, accurate reproducer with very good power handling. \$185 each.

DREADNAUGHT power amps by Dunlap Clarke. Absolutely stable, superior protection. Despite other claims this is the first solid state amp we have heard which is as good or better than the best tube equipment we have heard. We used to have to specialize depending on what the amplifier was to be used for. This is the amp for super-woofers or any part of a bi or tri-amped system, or for PA or band use. Models 500 and 1000. \$800 and \$1200. These amps will also be available under the Sequerra name with different cosmetics.

SUPLEX SMM5 moving magnet cartridge. Not the best but exceptionally smooth. Nothing can touch it for \$50.

GRACE 940 oil damped, uni-pivot tone arm. \$149.

FIDELITY RESEARCH cartridge and transformer. The best moving coil yet. Highly regarded even by resident Decca freak. Great depth of image and detail. Also variety of preamps. Cart. \$130, Toroidal transformer \$150.

CAMBRIDGE AUDIO P50 and **P140** integrated amplifiers with toroidal power supply and state of the art preamp. \$350 and \$550. Also TL 200 transmission line speakers.

DECCA BRUSH. Over a million conductive bristles eliminate need for liquids and reduce static. \$15.

DECCA CLEAN-UP. The ultimate dust bug. Same bristles as brush, conductive shaft and ground wire. \$15.

also: **GAS Ampzilla, Dayton Wright, C/M Labs, Sony, Lux, BGW, Audionics, Lexson, Revox, Otari, Nakamichi, Neal, F.M.I., Celestion, IMF, Linn Sondek, ERA, Micro 700, Dual, Decca, Ortofon, Supex, Sennheiser, Beyer, Sequerra.**

Shipped free anywhere in U.S. and Canada.

GREENWOOD SOUND, INC.

P.O. Box 2069

Portland, Ore. 97202

503 235-1776

THE JANIS WOOFER IS ABSOLUTELY FLAT TO 30 Hz!

The specifications can only hint at the effortless, ultra-clear and detailed bass reproduction to the limits of hearing. Typical response 30 - 100 Hz + 1/2dB, distortion about 1% max. About 60 W is enough to drive this speaker. Elegant in size (22"x22"x18" high) and appearance. Full details: Janis Audio Associates, Inc., Box 88 Throgs Neck Station, New York, N.Y. 10465.

HONG KONG, TAIWAN, JAPAN, Asia Directory. World products information. Mail-orders, bulk-orders. Listings. Directory and information \$1.00 today. World Trade Inquiries. Box 6224, Spokane, Wash. 99207.

YOUR DOLLAR BUYS MORE IN BRITAIN. Whether you are visiting or require export shipment UPL will get you more component value per dollar. UPL, 35 High Street, New Malden, Surrey. Phone 01 942 9567/8.

THE BOTTOM END, as reviewed in the April *Stereophile*. A new compact super bass speaker that retails for around \$200.00. A no-compromise performer with smooth response below 20 Hz. Ideal for use with Magnaplanars, Quads, Dahlquist, ESS, or any system deficient in low bass, because of room placement. **BOTTOM END CROSSOVERS** permit the use of one woofer, no bi-amping, one amplifier does it all. Model X1 for all Magnaplanars, Model X2 for all others. Literature and information available upon request, dealer inquiries invited. Consumers write for the name of your nearest dealer. M & K Sound Inc., 8719 Wilshire Blvd., Beverly Hills, Calif. 90211.

FOR SALE

massachusetts

tripod audio offers you advice on & demonstrations of the finest equipment available. our emphasis is on giving you the best sound/dollar value we can.

our suppliers include... dahlquist • ampzilla • thaedra • b & o • allison • yamaha • citation • sonus • nakamichi • advent • ads • technics • tandberg • phase linear • stax • denon

tripod audio
219 main street
northampton (413) 584-6498

CONSIDER YOUR SOURCE FOR SOUND

I. Credentials

College instructors in audio /acoustics, Inventors/graduate electrical engineers, Recording & disc mastering engineers; MEMBERS: United Inventors & Engineers Acoustical Society of America Institute of Electronic Engineers

II. Facilities

Anechoic Chamber: >.9a working floor
\$50,000 research laboratory
Factory authorized "A" warranty stations
Loudspeaker Reconciling Lab

III. Our Distinguished Suppliers

Audio Research, Sequerra, Satin/Denon/F-R, Transcriptors, F.M.I./R.T.R., Linn Sondek, Nakamichi, Dayton Wright, Dahlquist, Crown, Infinity, I.M.F., London Decca, Quad, Rogers, Spondor, Stax, B&O, Grace, Supex, Micro Acoustics, Custom Rabco, Braun, Revox A-700, Ortofon, Damped S.M.E., Scully, Mark Levinson, Koss-ELS, Yamaha.

+

1000's of PROFESSIONAL products (see Tuned Rock P.A. ad).

Music & Sound Ltd., 11 1/2 Old York Rd., Willow Grove, Pa. 19090. (215) 659-9251.

Whom Would You Trust?

THOUSANDS OF LIKE NEW LP's and prerecorded tapes. Catalogue \$1.50. House of Records, Hillburn, New York 10931.

AUDIO RESEARCH, AUDIONICS, BANG & OLUFSEN, BOZAK, CROWN, DBX, KLIPSCH, KMAL, LINN SONDEK, NAKAMICHI, PHASE LINEAR, RADFORD, REVOX, SEQUERRA, STAX, TANDBERG, BEYER, SENNHEISER, and other fine instruments for the reproduction of music. Send for list of used equipment **AUDIO SYSTEMS AND DESIGN,** 5421 South 84th St., Lincoln, Nebraska 68516 (402) 489-9888... and 4408 Capital Ave., Omaha, Nebraska 68131. (402) 556-7559.

PROTECT YOUR LP's. Poly sleeves for jackets 8c round bottom inner sleeves 6c. Poly lined paper sleeves 15c. White jackets 35c. Postage \$1.25. House of Records, Hillburn, New York 10931.

SCOTCH-AMPEX TAPE — Lowest prices! Ampex Grandmaster, 10 1/2", our metal flanges, boxed — \$13.50 postpaid. Cheaper in quantity. Free price lists. Omega Audio, 25520 Graham Road, Detroit, Mich. 48239.

ESS TRANSTATIC I Speaker (Rosewood pair) \$600. Ess 500 power amplifier with meters, \$350. Crown DC-300, \$400. ESS electronic crossover, \$60.00. Revox A-76 tuner, \$250.00. Dynakit PAT-5 \$175.00. Marantz 500, \$800.00. All in excellent condition. M. Ginnis, Box 1, Pompano Beach, Fla. 33061 (305) 942-8584

FOR SALE

PORTLAND, OREGON HAWTHORNE STEREO

An uncommon Hi-Fi store serving Portland for thirty years with the finest in products, service, and people.

Audio Research	Radford
Quad	Crown
Quatre	Harmon-Kardon
Sony V-FET	Yamaha
Manantz	McIntosh
Dahlquist	Mangeplanar
Beveridge	Fulton
Polk	Advent
Audionics	Phase Linear
Technics	SME
Grace	Denon
Mark Levinson	Stax
Nakamichi	Fidelity Research
G.A.S.	Philips

West: 8680 S.W. Canyon Rd., Portland, Oregon 97225
East: 3580 S.E. Hawthorne Blvd., Portland, Oregon 97214
503-292-4401.

REVOX OWNERS — Factory authorized service, parts & accessories for the Western states. Beverly Stereo Audio Clinic, 8413 Beverly Blvd., L.A., Calif. 90048. (213) 651-3652.

Mc 275; DYNA PAT 4. Call Tom Hill, 716-484-9191; 716-962-3941

JBL PARAGON, walnut, \$1800. Mark Conrad, 1004 Havelock Dr., Taylors, S.C. 29687. (803) 268-6840.

HI-FI ENTHUSIASTS WANTED!! Earn more than just spare money in your spare time. We need campus representatives to sell name brand stereo components at discount prices in your area. High commission, no investment required. Serious inquiries only, please. Contact: Alan Weisberg, K&L Sound Services Co. 75 N. Beacon St., Watertown, Mass. 02172.

DON'T PAY THE HIGH MAIL ORDER PRICES

THIEVES WAREHOUSE OF PENSACOLA
3731 NAVY BOULEVARD, PENSACOLA, FLORIDA 32507

MINT USED EQUIPMENT. ESS amt-3 speakers \$650; Citation 11a preamp w. case \$290; Audio Research D-51A amp \$500; Audio Research Tympani III T/M speakers \$550; Audio Research EC-4 crossover \$240; Audio Research SP-3A-1 preamp \$600; Infinity Monitor speakers \$650; Teac A-4010 GSL tapedeck \$350; Crown IC-150 preamp \$265; Marantz 2245 receiver \$345; Rabco SL8E tonearm \$110; Shure SME non-detachable tonearm \$100; Dynaco PAS 3X modified by Audio Research \$225; Acoustic Research 4ax speakers \$90; Acoustic Research 3a speakers \$325. Also demonstrator specials, Audionics TL-30B speakers \$275; Audionics TL-50 speakers \$415; Radford HD22 preamp \$375; Audionics .03 amp \$325; Citation 12 amp \$225. SOUND ADVICE, 536 State Road, Emmaus, PA 18049. (215) 967-4418.

AUDIO'S HI-FI HANDBOOK

Complete reference guide to over 1,000 components, including prices and specs. All arranged in tabular form for easy comparison. Plus over 30 outstanding articles on audio topics, trends and advances. State-of-the-art reading for audiophiles. Only a limited quantity available. Over 200 pages. Send \$3.95 (includes shipping and handling) to: Jean Davis, Audio Hi-Fi Handbook, 134 N. 13th St., Phila., Pa. 19107.

CARBON FILM RESISTORS—1/4W, 5% from 10—4.7 megohms for 3 1/2¢ each. Fifty per value \$.85. Discounts available. FREE samples/specifications. Other quality components. \$1.00 postage. Components Center, Box 134A, N.Y., N.Y. 10038

AUDIO RESEARCH D-76 (2) \$750, each. Ampzilla \$650. All mint with warranty. Wolfe, 509-547-9361.

SAVE 70% OR MORE; eight detailed, tested speaker enclosure designs; includes transmission line; send \$2.50; Cobrasound, Box 1011, Madison, WI. 53701.

WESTCHESTER HEADQUARTERS for the great sounds in the world. Quad, Cambridge, Dahlquist, Bose ESS, Braun, SAE, EPI, Crown, Phase Linear, Tandberg, Thorens, Yamaha, Nakamichi, Technic, BGW, Dual, Revox, Leak, B&O, DBX, Burwen, We stock Ampzilla. The listening Room, Inc 590 Central Ave Scarsdale, N.Y. 10583 (914) 472-4558.

FOR SALE

DON'T PAY THE HIGH MAIL ORDER PRICES

THIEVES WAREHOUSE OF NORTH TAMPA
1441 EAST FLETCHER AVENUE, TAMPA, FLORIDA 33612

USED EQUIPMENT: AUDIO RESEARCH TYMPANI IA, \$650; BGW 500R, \$495; GALE SPEAKERS, \$575; QUINTESSENCE PREAMP, \$360; EQUALIZER, \$360; CROWN D60, \$220. HARTLEY ELECTRONICS, 1502 Butternut, Richland, WA. 99352. 946-4459 or 946-1529 evenings.

SEQUERRA Tuner all features 2,100 Dyna FM3 tuner 50.00 Shure SME (Damped) Non-Detachable \$135.00 (8-5) 1-216-733-7924.

STEREO REPRESENTATIVES NEEDED!! Lowest Price List Buying!! Over 80 Brands!! Krasco Stereo, 623 Campbell Ave., West Haven, Conn. 06516.

NEW YORKERS - THE CHOICE IS YOURS!

Consult with us about your individual audio needs. IMF, BGW, SAE, OHM, INFINITY, KLIPSCH, ORTOFON, THORENS, LINN SONDEK, KEITH MONKS, SME, LEVINSON JC-1AC, STAX, ADS-BRAUN, DECCA, TANNOY, DBX, REVQX, CROWN, PIONEER, KENWOOD, MARANTZ, C/M LABS, KEF, INNOTECH, CELESTION & many others.

INNOVATIVE AUDIO

"THE FACTORY"

129 DeGraw Street

Brooklyn, N.Y. 11231

(212) 596-0888

Call For Appointment

DON'T PAY THE HIGH MAIL ORDER PRICES

THIEVES WAREHOUSE OF ATLANTA
2769 LAKEWOOD AVE. S.W., ATLANTA, GEORGIA 30315

COMPLETE LINE of disco systems and professional sound equipment. CMG SOUND INC, 12020 Milton St., Wheaton, MD. 20902 (301) 942-8665.

SERVICE MANUALS for all audio equipment. Includes schematic, parts list and servicing. Send make, model and \$5.00 to Daugherty Audio Service, 7313 Inzer, Springfield, VA 22151.

TEAC AN-180 DOLBY UNIT NEW AND NEVER USED \$200.00 Fisher XP-9 Bookshelf speaker \$100.00. Jim Bennett, 159 Mayfield Ave., Crystal Lake, Illinois 60014.

THE CONNECTION

20-60% Discounts on Thorens, Stanton, Altec, Dual, Pioneer, and other brand names. For your free quote on any model or System write THE CONNECTION, 35 Congress St., Bldg. I, Shetland Park, Salem, Mass. 01970. Get on our Mail list!

DON'T PAY THE HIGH MAIL ORDER PRICES

THIEVES WAREHOUSE OF ATLANTA
4166 BUFORD HIGHWAY, N.E., ATLANTA, GEORGIA 30345

DON'T PAY THE HIGH MAIL ORDER PRICES

THIEVES WAREHOUSE OF ATLANTA
1030-3 CHEROKEE ROAD, SMYRNA, GEORGIA 30080

DON'T PAY THE HIGH MAIL ORDER PRICES

THIEVES WAREHOUSE OF MONTGOMERY
3386 NORMAN BRIDGE RD., MONTGOMERY, ALA. 36105

DON'T PAY THE HIGH MAIL ORDER PRICES

THIEVES WAREHOUSE OF ATLANTA, 4162 JONESBORO RD., ZAYRE CENTER, FOREST PARK, GA. 30050

MICHIGAN AUDIOPHILES

MICHIGAN'S ONLY HIGH END DEALER PROUDLY PRESENTS:

DAHLQUIST	KOSS ESL
AMPZILLA	ORTOFON
MARK LEVINSON	REVOX
LINN SONDEK	KMAL
RABCO	FIDELITY RESEARCH
S.A.E.	CITATION
SOUNDCRAFTSMAN	ESS
MAGNEPAN	GALE
M&K	SME
BURWEN	DBX
TECHNICS	JBL
THORENS	and much more!

ABSOLUTE SOUND, INC.

12400 Morang

Detroit, Michigan

(313) 527-2244

FOR SALE

DON'T PAY THE HIGH MAIL ORDER PRICES

THIEVES WAREHOUSE OF ATLANTA
3164 PEACHTREE RD., N.E., ATLANTA, GEORGIA 30303

AR TURNTABLE OWNERS: Add cueing Precision machined. Silicon damped. American made \$16.00, postpaid. Lyrelift, 582 Franklin Street, Cambridge, Mass 02139

SAVE ON SACRED COWS

BOSE, JBL, SAE, Thorens, Philips. Over 50 Top Brands Write for quote - Answered in 24 hrs. SOUTHBOUND SOUND P.O. Box 52508 Atlanta, Georgia 30305

ATTENTION AUDIOPHILES

Ampzilla, Burwen, Dahlquist, Decca, Denon, Dynaco (Modified), Ferragraph, Fulton E and J Systems, Grace, IMF, Koss Speaker, Lecson, Lux, Magnepan, Mark Levinson, Fons, M & K, Quad, Quintessence, Quatre, SAE, Satin, Stax, Sonus, Technics, Transcripator, and many others. All equipment pretested and guaranteed to meet specifications, and shipped prepaid and insured in continental U.S. AUDIOPHILE'S SOUND STUDIO 7459 Elmwood Ave. Middleton (Madison), Wisconsin 53562 Phone 608-836-3807

AUDIO STRIP CHART RECORDER KIT —

Uses your amplifier and function generator. Run frequency response curves on amps, cartridges, speakers, etc. Uses chart or adding-machine paper, generates markers, etc. The first practical recorder for the audio amateur at a sensible price - \$85.00 post-paid. Write for information. POWER RESEARCH PRODUCTS, 1401 Clipper Heights Avenue, Baltimore, Maryland 21211

DISCOUNT PRICES on stereo components. All major brands. Write for quote. Seashore Stereo Sales, 204 Woodcrest Ave., Absecon, N.J. 08201

SAN FRANCISCO

At last a source for truly superior audiophile products. Accurate advice, unsurpassed service, and incomparable components from: **THE SOURCE**, Box A512-2, c/o Audio, 401 N. Broad St., Philadelphia, Pa. 19108.

2 Marantz 9 amplifiers rack mount. Excellent condition, Kenwood KF-8011 multi-band dynamic noise filter. (617) 358-2254.

DECOURSEY ELECTRONIC CROSSOVERS

Complete with plug-in Butterworth filters of your specified frequencies and with 6, 12, or 18 db./octave attenuation. Regulated power supply. Bi-amp or triamp for monaural, stereo, or quadraphonic systems. Other options; Electronic summer for single woofer stereo; VLF noise filters. For OEM and home builders; Series 500 and 600 Hi-pass and Low-pass filter pairs. Also regulated power supplies. Write for brochure. DeCoursey Engineering Laboratory, 11828 Jefferson Blvd., Culver City, CA 90230

ARP SYNTHESIZERS!

New Rock Bottom Prices

Explorer, AXE \$730; Pro-Soloist \$875; Odyssey \$1165; String Ensemble \$1315; Model No. 2600 \$2260. Dickstein Distributing, 1120 Quincy Avenue, Scranton, Pennsylvania 18510.

BRAUN TG-1000-4, (2) AKG 200E, 200' cable, Switchcraft 30TR Mixer, (2) AR-3A, (2) AR-2AX, SX-626, SL-65B, PRO 4AA. Mint (419) 448-0225. Kessler, 303 1/2 N. Washington, Tiffin, Ohio 44883.

NOW AVAILABLE

FAMOUS REFLECTING SYSTEM'S 4 1/2" REPLACEMENT DRIVERS. \$7.98 POSTPAID. QUANTITY DISCOUNTS. FREE SPECIFICATIONS. AURATONE, Box 580-28A, DELMAR, CALIFORNIA 92014.

THE AUDIO RESEARCH ROOM. The complete line of Audio Research equipment on display under ideal listening conditions. AUDIO SYSTEMS & DESIGN, 5421 South 84th St., Lincoln, Nebraska 68516 (402) 489-9888.

MARANTZ (USA) PREAMPLIFIERS Model 3300 - \$275. Model 33 - \$225. Like new. Genuine walnut cabinets. Also Model 250 Amplifier in walnut finish cabinet - \$350. Bill Kirkness, 8009 Chatham Drive, Manlius, N.Y. 13104

CROWN SX822 Deck, 7 1/2 - 15 ips, \$1200; D150 Amplifier \$300, both units 6 months old with WARRANTY & CARTONS: Gary Davison, 128 West End Ave., Binghamton, N.Y. 13905; (607) 729-2064

FOR SALE

'AUDIOGRAM'

Impact of the "quarterlies" at a fraction of the price per word, and at least 3 times the publication frequency. Ever heard of the DB Systems preamp, Berning EA 2-150 power amp, Formula 4 tone arm, IAD BC3 preamp, CM Labs 912 power amp? With solid state finally coming into its own, can you afford to be 6 months behind the latest developments in the exciting, fast moving world of audio? Clear, concise and comprehensive, AUDIOGRAM will not leave you in doubt as to what a component sounds like or what our collective opinion is concerning it. Rates: \$10.00 per 12 issues. Write: The Audio Advisor, P.O. Box 40094, Washington, D.C. 20016

MARANTZ 3300 preamp - "In a class with Audio Research and Levinson" - Absolute sound. Mint condition, walnut case. \$350. (617) 648-4191

AUDIOPHILES—BEAT PRICES: Fantastic Tympani 111 System, \$1,150. Technics SL-1100, \$230. Pioneer SD-1000 (Display Center) \$270. Questions? Call Ahmad, After 10 PM, 616/392-5111 Ext. 2361

NO CHARGE TO INSERT ADS! NO COMMISSION WHEN ITEMS ARE BOUGHT OR SOLD! BUY, SELL OR TRADE YOUR HIGH ENO HI-FI THROUGH AUDIOMART. THE AUDIOPHILES CLASSIFIED NEWSLETTER. SUBSCRIBE \$5/12 BOX 821, STRATFORD, CONNECTICUT 06497

MARANTZ 500 (demo) with warranty card - \$1200 Everett Parhiala, 6 Stratford Ave., Durham, New Hampshire 03824

AVSOUND-THE ULTIMATE MUSIC MACHINE - Truly "state of the art" reproduction in an automotive system. Send \$1 for stereo and P.A. discount catalog. Phase Concept, 3975 Omaha Drive, Norcross, Georgia 30071

CROWN CX-722—\$1150. George Bourke, 579 Harris Road, Ypsilanti, Michigan 48197

TOP NOTCH PLAYBACK SYSTEM Thorens TO-125 MKII, Sony PUA-237, DECCA MKV Select (export). Flawless condition. Just \$390.00 Will ship C.O.D. call Sam 503-666-4421, 830 N.W. Division St., Gresham, Oregon 97030

JBL L100A's, \$450/pair, AR LST/2's, \$350/pair. B&D 4000 Receiver, \$400. B&D 3000 Turntable, \$200. B&D 2200 Cassette Deck, \$300. All with warranty cards and factory cartons. 415-965-4515

MCINTOSH COMPONENTS, as new C-28 Preamp with speaker relay box \$450 MR 77 Tuner \$450 Both for \$850 201-584-3921

MCINTOSH MC-240 AMP, H/K CITATION 1 PREAMP, CITATION 3X TUNER, DYNA STEREO 70 AMP, FM-3 TUN PHILIPS GA-212 TABLE/W AUDIO TECHNICA AT-14 CARTRIDGE. CALL 1-203-488-7908 ANY NIGHT AFTER 8 PM

PHASE LINEAR 400 AS NEW: \$375. Call or write Tom Misiak, 180 Toronto Ave., Massapequa, N.Y. 11758 (516-541-7778).

MC INTOSH ML-1C's and MQ102 equalizer. Excellent condition. \$550 - Morgan, Box 134, Rte 1 Northport, Mich. 49670. (616) 271-3585

TEAC 3340S, USED SLIGHTLY. ORIGINAL BOX. WARRANTY CARD. ASKING \$750, NEGOTIABLE. (814) 238-5680 EVENINGS.

AUDIO RESEARCH SP3 \$450. REVOX A77 MARK III almost unused \$500. DECCA EXPORT \$55. Mint Condition. (714) 684-6244

MINT USED EQUIPMENT. Phase Linear, 400, \$325 Phase Linear 4000, \$435 ESS AMT3, \$600. Audio Research SP3A1, \$600. Audio Research Dual 75, \$700. Audio Research Dual 51, \$500. Dahlquist DQ 10, \$600. AR 3A, \$325. TEAC 6010 S1, \$525. TEAC 4010 GSL, \$350. Dyna PAS 3X Audio Research Modified, \$200. Dynaco PAS 2X, \$60. Dynaco Stereo 70, \$75 Shure SME 3009, \$100. Thorens 124B W/Audio Design arm, \$250.

DEMONSTRATORS WITH WARRANTIES Epicure 1AMP, \$525. Radford HD22, \$350 Radford HD 250, \$525. Radford 03, \$300. Citation 12, \$225. Citation 12 Deluxe, \$240. Citation 11A, \$275. C/M Labs CC-2, \$185. Sherwood S 3300, \$100. Audionics TL 30B, \$300. Audionics TL 50, \$450. Sound Advice, 536 State Road, Emmaus, Pa., 18049—967-4418. Daily 12-9:30. Wed. 6-9:30, Sat. 10-6

DON'T PAY THE HIGH MAIL ORDER PRICES THIEVES WAREHOUSE OF PANAMA CITY, 5220 W HWY. 98, SUITE D, PANAMA CITY, FLA 32401.

FOR SALE

TRADE IN YOUR KLH 9s, QUADS, & MAGNEPLANARS The incomparable Fulton J, Modular Speaker Systems are available. Upgrade your Dual 76 or Marantz tube amplifiers with the Paoli 60M (at \$600 a pair they are only half the price of the only other comparable tube amplifier). Replace your tired cartridge with a Decca or a Denon. We serve the discriminating audiophile with the finest equipment available, both new and pre-owned. We give generous trade-ins. Come and hear the incomparable Js with the THAEDRA—the "ultimate" preamplifier and the finest tube (Paoli) and transistor (Ampzilla) amplifiers available on the Linn-Sondek with the perfectionist arm, KMAL, and all of the "state-of-the-art" cartridges. Quality equipment in all price ranges. While waiting for your inheritance: Connoisseur turntables, Sonus cartridges, modified Dynaco tube equipment, PAT 5s. Stereo 150s. Fulton 80s, 100s, E-Modular systems, KEF 104s (a sensational English speaker at \$590 a pair), Quad electrostatics. Used equipment: Pair Marantz 8Bs (\$750) Dual 76s (\$750 each), Magneplanar Tympani IIIa (\$1350), Quads (\$650), Citation 11 & 12 (\$450) NATURAL SOUND, 1021 Claremont St., Lincoln, Nebr. 68508 (402) 475-3325 and E-7 Institute and Einhorn-WPI, Worcester, Mass. 01609, (617) 755-1461.

IMF MONITORS MK-III With Latest Crossovers, All Factory Perfect \$1650. 704/847-4705

TOAD HALL HI-FI, "QUALITY WITH THE ASSURANCE OF QUALITY!" Some of our fine brands include: Audio Research, Burwen, OBX, Magneplanar, Magnepan, G.A.S., Sony V-FET, Nakamichi, RTR, Dahlquist, ADC, Radford, Audionics, Polk Audio, Yamaha, SME, Advent, Revox, Klipsch, and Teac. Shipping charges pre-paid anywhere in U.S. TOAD HALL HI-FI, 922 Northwest Kings Boulevard, Corvallis, Oregon, 97330, (503) 752-5601 and 150 West Broadway, Eugene, Oregon, 97401, (503) 485-1262.

ELECTRO VOICE 664 (3) for \$700.00, Altec 511 with driver pair Norelco-Phillips "King" speakers, Pair Stereo Amplifiers \$25 each 25 watt mono \$15, more Jim Phillips, 414 Washington Ave., Defiance, Ohio 43512 419-782-8591

MAS-1 - A UNIQUE MOVING COIL PREAMPLIFIER THAT VIRTUALLY WILL NOT ALTER SOUND. VARIABLE IMPEDANCE SWITCH EXACTLY MATCHES YOUR DENON - SUPEX - EMT - ORTOFON - FIDELITY RESEARCH ETC. CARTRIDGE FOR OPTIMUM PERFORMANCE. \$229.00 - DEALER INQUIRIES INVITED. MEL SCHILLING ENTERPRISES, 7205 PO-MELO DRIVE, CANDGA PARK, CA. 91307 (213) 348-4600

MAJOR SOUND SERVICE
ANNUAL INVENTORY TURNOVER
\$300,000.00

INVENTORY AVAILABLE
FOR IMMEDIATE DELIVERY
WRITE FOR DETAILED
LISTING OF INDUSTRIAL
AND MUSICAL SOUND EQUIPMENT
STANAL SOUND LTD.
816 East 25th P.O. Box 396
Kearney, Nebr. 68847
308-237-2207

BOSE 1801 AMP W/LEO AND METERS, \$625. SAE MARK I preamp, \$275. Hoffman Transformer for moving coil, \$115. \$950 takes all. Jim Heusi, Box 471, Defiance, Ohio 43512 (419) 782-5657

DECCA INTERNATIONAL Tone arm, new, make offer, Decca 4RC, \$40 (716) 235-9259

MARANTZ 4430 QUAD RECEIVER, WITH SQ DECODER and cabinet, Mint, \$400. Roberts 770X-SS Tape Recorder (similar Akai M9) built-in speakers. Excellent, \$175. Mitchell Arney, CNFJ N2 Div Box 12, FPO Seattle 98762.

FIDELITY RESEARCH FR # 1-MK 11 Cartridge (never used, still in original sealed box) \$85. Supex SD-900 E SD-900 Cartridge \$60, and SDT-180 Cartridge Transformer \$100. VESTIGAL ARM - \$60, (212) 454-3205

JBL SPEAKERS - S7 plus 075 ring radiators - beautiful Sovereign cabinets in dark oak - absolutely mint condition. \$750 for the pair - call 901-683-5355 or 901-527-2463

CONNECTICUT: Yamaha, Advent, JBL, Bose, Citation, McIntosh, Tandberg, B&D, Harman/Kardon, Ortofon, Epicure. Will ship prepaid. Sounds Incredible, 226 White St., Danbury, Conn. 06810, (203) 748-3889

FOR SALE

MC INTOSH MR-73 AM/FM STEREO TUNER - McIntosh C-28 stereo preamp - Tandberg 9000X RR Deck w/Teac AN60 Dolby - Harmon Kardon CAD-5 Dolby Cassette Deck - Pioneer CT-5151A Dolby Cassette Deck Glen Hill, 58 Farrell Ave, Trenton, N.J. 08618 (609) 883-5097

CHICAGO - CHICAGO - CHICAGO
ATTENTION

CHICAGO AREA AUDIOPHILES

State-of-the-art has finally come to the windy city. **STEREO EMPORIUM** of Buffalo, N.Y., and **PAUL HEATH AUDIO** of Rochester, N.Y. have joined together to form **PAUL HEATH AUDIO, LTD.** of Chicago. Acoustically designed demonstration facilities, Instant A-B comparison of **ANY** components without loss of audio quality, experienced, knowledgeable personnel and an extensive array of quality products combine to make this one of the finest audio salons in the U.S. For your delicate ear, we offer products from: **AUDIO RESEARCH, MAGNEPLANAR, GAS/AMPZILLA, KOSS ESL, DAYTON WRIGHT, QUATRE, SAE, SEQUERRA, YAMAHA, GENESIS, QUAD, GALE, DAHLQUIST, MAGNEPAN, M&K, IMF, KEF, RTR, DUNLAP-CLARKE, LUX, STAX, B&O, REVOX, CROWN, DECCA, FR, DENON, WIN, KMAL/LINN, AOS, GRACE, NEAL, AND MORE.** Stop in, give us a call, or drop us a line for more information. **PAUL HEATH AUDIO, LTD. - STEREO EMPORIUM, 2036 N. Clark, Chicago, Illinois 60614, PH. 312-549-8100.**

SAN DIEGO

Audio Research, Fulton (FMI), Paoli, Decca, Win, Shure V15-G ERA, Grace, Connoisseur, Dr. Johnson, by appointment, 714/274-6613

Are you missing **StereOpus?** Two issues of this new quarterly equipment review journal are now in the mails or delivered. Issue # 3 out soon will review Koss Model One Full Range Electrostatic Loudspeaker, the Webb Transmission Line Speaker, LUX C-1000 preamp and M-4000 power amp, Harman Kardon Citation 16 power amp, and much more. \$9.00/year (\$11.00 first class), \$12.00 foreign (\$15.00 for air mail), \$11.00 Canada. Four issues. P.O. Box 269, Fort Walton Beach, Florida 32548

ENGLISH HI FI

Radford, Rogers Export Monitor, I.M.F., B.M.W., Celestion, S.M.E., Decca MK-5, Tannoy, Garrard, other continental products also available. Please write or telex, your quote will be returned by airmail. Southern Audio Services Limited, 43 High Street, Kingston-upon-Thames, Surrey, England. Telephone 01-549-3194 or telex 929679 AEL G.

THE ABSOLUTE SOUND, in its eighth issue, will be examining in depth the Lux Audio tube equipment, Audio Research's 300 watt tube amp, the EMT cartridge, Peter Pritchard's new cartridges, the Sequerra loudspeaker, the Infinity switching amp and FET preamp. Bongiorno's preamp (Phaedra), the Koss electrostatic, the Stax Class A amp, the Luxman turntable, the Win Labs cartridge. In other words, we are preparing a powerhouse issue. And, to put icing on the cake: the SAE 2500 basic amp, the Dahlquist bookshelf speaker, the ADS 810 speaker. The nation's foremost audiologist will also be on hand to tell you why very loud listening levels irreversibly destroy your hearing (and it's about time someone said it). Subscriptions (four issues): \$10 by third class mail; \$12 by first class mail; \$13 foreign. The Absolute Sound, P.O. Box 5, Northport, New York 11768.

MANUALS FOR CLASSIC GEAR

Allegro Sound, 15015 Ventura Blvd., Sherman Oaks, CA 91403

DYNACO RACK MOUNTS for pre-amps, tuners, integrated amps. \$24.95 postpaid, \$22.50, three or more. **AUDIO BY ZI-MET, 1038 Northern Blvd., Roslyn, N.Y. 11576 (516) 621-0138**

MARANTZ 500, excellent, factory tweaked unit \$800. (919) 467-9198.

SPEAKER CATALOG

Up to date. Top quality drivers. Hop-up the speakers you have or build new ones. Transmission-line speaker plans \$5.00. Foam damping material. E & E Audio, 2816 Church Ave., Brooklyn, N.Y. 11226. (212) 462-0984

B&O 4002 TURNTABLE, Harman Kardon Citation 16, Soundcraftsman 2217, Dahlquist - Reasonable. (515) 274-1092.

FOR SALE

FRIED LOUDSPEAKERS, sensational incomparable Model H here. Denon cartridges, Stax headphones, Stax incomparable arm/cartridge/Demodulator. Discwasher products. DBX, Burwen, Levinson, C/M, Futterman electronics. Oryx hauntingly beautiful Concert - St. Preux record, \$6.98 add 60c postage. Leak Stereo-50 tubed amplifier \$200. Leak Point One Stereo preamp, tubed \$125. RTR 400E electrostatic speakers, mint \$235 each. Jensen Fives speakers, mint, \$290 pair. Russian Switching Patching Center. **STEREOPHILE** says Fantastic. Trades accepted. **WANTED:** Marantz, Futterman, McIntosh tubed equipment. **GOLDEN EAR**, Box 5, South Rockwood, Michigan 48179. (313) 379-9945.

IN PURSUIT OF EXCELLENCE WE OFFER: Infinity, Crown, Revox, Fulton, Sennheiser, Philips, Ortofon, ESS, SAE, Beyer, DBX, Altec, Technics direct drives, RTR, McIntosh, JBL, Transcriptors, Klipsch, Citation, Decca, SME, Sequerra, Micro/Acoustics, Lamb Dahlquist, Tannoy, Yamaha, Soundcraftsmen, Marantz, and more. Also custom room equalization, individually damped Altec & JBL Monitors and an ongoing equipment evaluation program. The House of Sound, 821 Kent Ave., Baltimore, Md. 21228.

TOURING SOUND SYSTEMS, 2, 4, and 8 Track Studios, Disco Sound, Cerwin Vega BGW, Altec, Shure, AKG, Tapco, Dyna, Revox, EV, Beyer, Cetec, etc. K & L Sound Service, 75 North Beacon At., Watertown, Mass. 02172, (617) 787-4072-Att: Ken Berger.

STERED SOUND LABS

FACTORY SPECS OR BETTER BY 10% ON ALL REPAIRS ON MAJOR BRANDS. WARRANTY 90 DAYS PARTS AND LABOR. SHIP US YOUR GEAR PROPERLY PACKED AND INSURED. 4419 JOHN MARR DRIVE, ANNANDELE, VIRGINIA 22003. (703) 941-5707.

**ATTENTION: LATIN AMERICAN AUDIOPHILES
ATTENTION: VACATIONERS VISITING THE
MIAMI AREA**

ATTENTION: RESIDENTS OF SOUTH FLORIDA

SOUND COMPONENTS, INC. is THE place for state of the art stereo. Some of our products include

LOUDSPEAKERS - SPENDOR BCII and BCIII, Audio Research Corporation Magnaplanars, Quads, Magnepan, Allison I and II Bowers & Wilkins, FMI including the J System, Gale, M&K Sub-Woofer, Dayton Wright XG-8 Mark III, IMF Small Monitor, IMF Studio IIB, IMF Super Compact

TURNABLES - Linn-Sondek, The Michell Engineering Co. Transcriptors, B&O 3000-2 and 4000-2, and Yamaha

PICKUPS AND TONEARMS - Ultimo DV38/20A, Denon 103-S, Satin M15 Conic, Supex 900 and 901, Ortofon SL-15E Moving Coil Pickups, SME, Audiocraft, KMAL, Grace 707 Tonearms, Dayton Wright 535 Infrasonic Cartridge Pre-pre-amp, Denon Transformers, Ortofon Transformers, and Hoffman Transformers

ELECTRONICS - Audio Research, Lecson, Quad, BGW, Ampzilla, Dayton Wright, Paoli, Yamaha, B&O Citation, Stax, Radford

RECORDINGS - A range of selected British, French, and German pressings. Also, the Fulton and Sheffield discs.

All of the above products are in stock and on demonstration in our 110 sq. ft. showroom.

Hours: 10 - 6 Monday through Saturday
We accept Master Charge and BankAmericard
Will ship mail order in continental U.S., prepaid

Sound Components, Inc.
2710 Ponce de Leon Blvd.
Coral Gables, Florida 33134

Telephone: 305-446-1659 TWX: 810-848-7627
Superb Products For The Discriminating Audiophile and Music Lover

GOODY DEPARTMENT

DECCA Megafilm Brush \$15.00
SUPEX SL4 6 gram universal head shell \$7.00
SUPEX AL2 cueing device, damped for AR/Thorens/KMAL/Rekoku \$19.00
SUPEX AC11 stylus cleaner \$4.00
CM LABS electronic crossover, 6 db, 100 hz steps \$158.00
PAC Piezoelectric add on tweeter, two per burl finish enclosure, 6 db/octave crossover \$100.00 pr.
All shipped postpaid/satisfaction guaranteed
Perfectionist Audio Components
172 Ocean Ave. Lynbrook, N.Y. 11563

AMPZILLA - THAEDRA

Sound Advice, 536 State Road,
Emmaus, Pa. 18049. Hours: Daily 6-9:30, Sat 10-6.

FOR SALE

STERED NEEDLES AND CARTRIDGES—ADC, Audio Technica, B&O, Empire, Grado, Micro Acoustics, Pickering, Ortofon, Shure, Sonus, Stanton, Supex, BSR, G.E., RCA, Sony, Panasonic and others. For **FREE CATALOG**, write: **NEEDLE IN A HAYSTACK, INC.**, P.O. Box 17436, Washington, D. C. 20041.

FORMULA 4 PROFESSIONAL LABORATORY TONE ARM

Only viscous pivot damping with low effective mass can ensure natural sound without 'listening fatigue' enabling all cartridges to reach their region of best performance, the so-called 'Linear Region' absolutely essential for perfect Stereo and Quadraphonic transcription due to the suppression of instantaneous tracking force extremes reducing record wear and H.F. playback distortion. Viscous silicone damping means better tracking even of warped records the sound having exceptional definition with full clean bass plus a tape-like consistency, steady stereo image and near pin-point localization. Optimum performance with ultra high or low compliance cartridges weighing 2-10 gms. Jewelled Uni-pivot friction below 0.005 gm. Effective mass 4.50 gm. VTF 0-3 gm Stylus/pivot 224 mm. Price \$89 including Airmail. Leaflet \$1 deductible from purchase. Formula 4, 15 Heather Walk, Edgware, Middlesex HA8 9TS England.

SDUND ADVICE MAGAZINE - with audio equipment reviews that don't pull any punches. Disgusted with the "one of the best" type of reviews that really tell you nothing about how products sound and perform? Discover Sound Advice with subjective listening evaluations conducted "blind" so that no panel member is aware of the product being tested. Prejudices, pre-conceived notions and favoritisms are eliminated with results that are quite astonishing. Check our reviews before you buy. The money you save could be considerable. With the high price of today's audio equipment, you need Sound Advice - four issues \$9.00 (\$11.00 first class, \$12.50 overseas sent air mail). 225 Kearny, # 200W, San Francisco, California 94108.

SUPERIOR PRODUCTS AT LOWER PRICES: B&W, Decca, EMT, Leak, KMAL, Naim, Quad, Linn Sondek, Spondor, Stax, many others. **THE SOUND AFFAIR**, 364 Mission Court, St. Louis, MO 63130 (314) 863-6037

CARDLINA'S ONLY AUDIOPHILE CENTER - Infinity Servo-Statiks, Switching amp, Ampzilla, Dahlquist, Magnepan, FMI, Ortofon, Crown, Accuphase, SME, Decca, Hegeman, Klipschorn, Technics, Teac, Marantz, Harmon Kardon on demonstration.

Vickers Audio
210 West Franklin St.
Chapel Hill, North Carolina 27514
(919) 929-4554

MILWAUKEE & WISCONSIN'S ONLY AUDIOPHILE DEALER.

Specialists in components by Dahlquist, Transcriptors, SAE, Nakamichi, Epicure, Bozak, Citation, Ohm, SME, Ampzilla, DBX, Infinity, Revox, RTR, Phase Linear, Quintessence, Advent, Tandberg and over 50 others. Wisconsin's first Audio Research dealer with the complete product line on demonstration. PLUS-one of the truly largest display of tape decks in the entire country. Over 130 machines on display. **WACK ELECTRONICS INC.** 5722 W. NORTH AVE. MILWAUKEE 53208 414-442-3441.

MICHIGAN AREA AUDIOPHILES: Win Labs, Denon, Paoli, Ampzilla, Transcriptors, Magnepan, Fulton, KMAL, Linn Sondek. Available at Equinox Systems, (616) 457-2117 or Box 333, Grandville, Michigan 49418.

CALIFORNIA AUDIOPHILES: Allison Acoustics, BGW, Dayton Wright, DBX, Decca, Dynaco, Gauss, Hartley, RTR, Quad, Sonus, Soundcraftsmen, Stax, Transcriptors. **AUDIODI TECHNQUES**, 351 South Baywood, San Jose, California, 95128. (408) 984-6655

SUPER FLASH—JUST ARRIVED The "Post-Ultimate" Sat-in-M-117 obliterates EVERY other cartridge. High output (3.5 mv) moving-coil says forget expensive, sound-degrading "head" amps or fancy transformers. Choice of INTERCHANGEABLE conical, elliptical, or Shibata-type USER-REPLACEABLE stylus. Outperforms other cartridges by several magnitudes. Beg your dealer to order you one today. Prices, by stylus choice: \$179, \$189, or \$199. Exclusive US Importer: Audiophile Imports, 10 East Erie, Chicago, IL 60611.

RADIO PROGRAMS

1930-1962 RADIO PROGRAMS, Reels, \$1.00 hour! Cassettes, \$1.00 show! Mammoth catalog \$1.25. **AM TREASURES**, Box 192 AU, Babylon, New York 11702.

RENT RADIO SHOWS - Make your own copies or just listen. Great way to build your collection reasonably. Catalog \$1 refundable. **OTR Rental**, Box 1146, Livermore, Ca. 94550

YESTERDAY'S RADIO PROGRAMS ON TAPE. Reels, cassettes - fast reliable service. Catalog \$1.00 refundable with first order. **ADVENTURES**, 1301-A North Park Avenue, Inglewood, California 90302.

RENT OLD RADIO PROGRAMS as low as 50c per reel week.

GOOD OLD RADIO
P.O. Radio
Lone Pine, Calif. 93545

OLD RADIO ON TAPE AND CASSETTES. THOUSANDS AVAILABLE, 6 HOURS \$8.00. Immediate Service. Catalogue 50c. **Nostalgic Radio**, Box 29K, Peoria, IL 61601

RADIO AS IT WAS - Rag time, Honky-Tonk, etc. others. Reel, Cassette, Cartridge, Custom discs. Our package or recorded to your order from our library. Sample cassette and list \$1.25, Refundable. **Nostalgic Enterprises**, P.O. Box 3786, St. Louis, Mo. 63122

OLD TIME RADIO PROGRAMS on cassette. Catalog \$1.00. **MB/JB Enterprises**, Box 724, Spencer, Iowa 51301.

GOLDEN AGE RADIO - your best source for radio tapes. Box 25215-D, Portland, Oregon 97225.

OLD RADIO PROGRAMS at low rates, high quality! Six hour reel: \$6.50 - cassette: \$2.50/hour. Catalog \$1.00. **BRC Quality Dubs**, 17173 Westbrook, Livonia, Michigan 48152.

SPEAKERS

SAVE 50%. Construct speakers and save money. Send for free catalog and instructions. **SpeakerKit**, Box 12A, Menomonie, WI 54751.

**MUSICAL SPEAKERS REPAIRED
ALTEC WARRANTY STATION**
Hughes Electronics Service
45 Dunn St., Asheville, N.C. 28806

SHORTWAVE

HEAR POLICE FIRE Dispatchers Catalogs show receivers, exclusive directories of "confidential" channels. Send 10c stamp. **Communications**, Box 56AU, Commack, New York 11725

SITUATION WANTED

FORMER DJ would like to return to radio in a similar position or as a Program Director. I have a third class broadcast endorsed license, 2 years college, 2 years experience. Contact: **Doug Gallher**, 3907 Angol Place, Jacksonville, Florida 32210. (904) 771-7386.

PHOTOGRAPHY

12 EXPOSURE Roll Kodacolor Film developed-printed-just-bo. \$1.50. **Capri Color**, Box 831, Laredo, Texas 78040.

TELEPHONE ANSWERING EQUIPMENT

DICTAPHONE-ANSAFDNE - below wholesale. All brand new in original cartons. Model 520, \$200; Model 610, \$145; Model 640, \$275; Model 1700, \$825. E.B.L., (212) 377-8424 (24 Hrs.)

COMMUNICATION EQUIPMENT

CB - MARINE - SCANNERS - LINEARS Buy Below Wholesale! Save up to 50%. Buy Direct From Factory Warehouse! Guaranteed Lowest Prices Anywhere! Catalog \$1.00. **WHITLOCK INTERNATIONAL**, P.O. Box 131, Westland, Michigan 48185.

AUDIO • FEBRUARY, 1976

PLANS & KITS

CONSTRUCT YOUR OWN speaker enclosure. Send \$2.00 for drawing to: Creightney Sounds, 140-25 169th Street, Jamaica, N.Y. 11434.

COMPUTER freaks, we have parts, kits, boards, C8080, C8008, P2101, P2111, C1702A, 91L02A. Write for catalog. **A.R.B.**, Ltd. PO Box 1392, Scottsdale, AZ 85252

GUITAR synthesizer creates new sounds with your electric guitar. Send \$5.00 for plans to: **ELECTRAX**, Box 149, Tarzana, CA 91356

AUDIO DEALER PRODUCTS

AUDIO POWER METER. Uses modern analog techniques to compute true power into any loudspeaker, independent of impedance. \$500. Write for details. Serendipity Systems, Inc. P.O. Box 3273

Greenville, NC 27834

AT LAST! OPENABLE, LOW COST Component Switching Devices for A-B comparison of speakers, amplifiers, and tape decks. Write for information and prices to—B. A. Kunz Electronic Equipment, 12111 La Padera, St. Louis, Mo. 63033.

MUSICAL INSTRUMENTS

UP TO 60% DISCOUNT. Name brand instruments. Catalog. Freeport Music, 455R Route 110, Melville, N.Y. 11746.

\$300-\$1200 off on new pianos & organs. Catalogue, Liberty Music, Box 88, E. Weymouth, Mass. 02189.

ELECTRONIC MUSIC SYNTHESIS MODULES: Designs, kits, plans & parts. For info: send SASE or 25c in coin, **CFR ASSOCIATES**, POB F, Newton, NH 03858.

TAPE RECORDINGS

RENT Open Reel or Cassette Prerecorded tape. All labels. Catalog \$1.00. Tape & Time, P.O. Box 740, Hopkins, Minn. 55343.

EVERYTHING ON OPEN REEL! Prerecorded classical/popular tapes. Latest releases. Dolby Quad, 96-page catalogue \$1. Barclay-Crocker, Room 857A, 11 Broadway, NYC 10004.

CASSETTE LIBRARY 2000. Gain extra hours listening while working, driving relaxing. Educational, motivational, nostalgic tape cassettes. Sales, rentals. Catalog \$1.00 refundable. Drawer 2871-A, Springfield, Mass. 01101

SONAR'S OPEN REEL TAPES. Duped one-to-one from the master. Quad and stereo; 1/4, 1/2 track, 7 1/2, 15 ips, 7", 10 1/2" reels. Highest quality anywhere! Sonar Records Corp., P.O. Box 455A, Kingsbridge Station, Bronx, NY 10463

TAPE PLAYERS, Recorders, Stereo Amps Repaired—units returned C.O.D. Stereo Labs, Box 150, Chesterhill, Ohio 43728.

COLLECTORS RCA Cartridge tape Player/Recorder. Two Transistorized Pre-amps. Ceramic microphone. Direct radio/phone jacks. Auto shut off. 1408 So. Central Rockford, Ill. 61102. (815) 962-3205

GOVT. SURPLUS

MANUALS FOR GOV'T. SURPLUS Radios, Test Sets, Scopes, List 50c, Books, 7218 Roanne Drive, Washington, DC 20021.

BOOKS

1974 ENCYCLOPAEDIA BRITANNICA 3. Leather bound, flawless - smells brand new. Sells for \$850. Sacrifice for \$525.00. Call Sam 1-503-666-4421 830 N.W. Division St., Gresham, Ore. 97030

STAMPS

SCIENCE ON Stamps! Space, Medicine, Scientific Events, etc. Nice selection only 25c to applicants for approval service. DORSTA, Dept 16, P.O. Box 56217, Harwood Heights, Ill. 60656.

SERVICES

CUSTOM RECORDING SERVICE. Tapes, discs, and cassettes. Stereo and mono. Live and copies. Editing. Masters and pressings. High quality at reasonable rates. Joseph Gliovannelli, Audio-Tech Laboratories, 2819 Newkirk Ave., Brooklyn, N.Y. IN9-7134.

COMPLETE CUSTOM RECORDING SERVICE — Record pressing, cassette duplication — editing — location recording. Omega Audio, 25520 Graham, Detroit, Mich. 48239.

THE NEW YORK AUDIO SOCIETY INC. is a unique, non-profit, member supported hi-fi club featuring interesting monthly meetings about sound and the latest audio techniques. We invite all N.Y. area audiophiles to attend one of these sessions as our guest. Details about meetings and membership available. Write Box 5889 Grand Central P.O., N.Y.C. 10017. Call 212-722-2781.

STEREO MASTERS, RECORDS AND ALBUMS. Check our prices. Newest type high level cutting equipment featuring: Neumann VMS 70 Computer control lathe, Parametric Equalization, Dolby, DBX, and the new SX74 Cutting System by Neumann. Special package prices on pure vinyl album and single record production. 1000 45 RPM stereo singles \$273.00 including mastering. 100 LP albums \$436.00 including printed jackets. Write or call for brochure. A & R Record Manufacturing Corp., 902 N. Industrial Blvd., Dallas, Texas 75207. (214) 741-2027.

TAPE RECORDER HEADS brought back to spec. Wear removed. Brilliant finish \$10.00 each. One day service. E. Maher, 5 Evans Place, Drinda, Calif. 94563

DON'T PAY the high mail order prices. Thieves Warehouse is coming to your area. Franchises available. Thieves Warehouse, P.O. Box 8057, Pensacola, Florida 32505

HIGH FIDELITY SPEAKERS REPAIRED
AMPRITE SPEAKERS SERVICE
655 Sixth Avenue, New York, N.Y. 10010
212-CH3-4812

NASHVILLE RECORD PRODUCTIONS WILL PRESS HIGH QUALITY PURE VINYL RECORDS FROM YOUR TAPES. SEND FOR SAMPLE RECORD AND PRICE LIST. ALSO FINEST DISC MASTERING. 469 Chestnut St., NASHVILLE TENNESSEE 37210.

CANVAS PHOTO TOTE BAG. Your favorite color or BW picture. We'll blow it up in full color on our 12x14 canvas tote bag. Send \$2.50 for catalog and price list. Refundable with your first order. Write to: Giensova Marketing Assn., P.O. Box 4991, Washington, D.C. 20008

45 RPM RECORDS—Top Quality—Affordable Prices. TARZAC, 638 Muskogee Avenue, Norfolk, Virginia, 23509.

AUDIO PROBLEMS YOU CAN'T SOLVE? CONTACT: Sound Advisory Service, P.O. Box 34045, Bethesda, Md. 20034.

IMPROVE YOUR CARTRIDGE

Proprietary modification greatly improves definition, impact, smoothness, and clarity throughout the frequency range. Does not alter original integrity of the cartridge. You must be satisfied or we restore your cartridge to its original state at no cost. Write for information or send us your cartridge. \$7.50 - 48 hour service. POWER RESEARCH PRODUCTS, 1401 Clipper Heights Avenue, Baltimore, Maryland 21211

CUSTOM CASSETTE LABELS: 638 Muskogee Avenue, Norfolk, Virginia, 23509

HELP WANTED

AUDIO IS EXPANDING its editorial staff and is seeking knowledgeable audiophile with editing and writing experience. Must be good writer and have magazine production experience. Position is in head office in Philadelphia. Send resume with salary requirements, in confidence, to Frank Nemeyer, North American Publishing, 401 No. Broad St., Philadelphia, Pa. 19107.

MISCELLANEOUS

GOLD LABELS! Gold stock - script type! Order 500 today \$1.00 — Guaranteed! Bertram Press, Box 302, Desk 3AG2, Beltsville MD 20705

RECORDS

SOUNTRACKS/OC, JAZZ/PERSONALITY — FREE NEWSLETTER! RTSA, 3700 S. Plaza Drive, Bldg F/211, Santa Ana, California 92704.

SHOW ALBUMS—Rare. Out of Print LP's. 52 page list 50c. Broadway/Hollywood Recordings Georgetown, Conn. 06829. Phone (203) 544-8288.

5,000,000 SURPLUS Records, Tapes—100 new LP's major labels \$65.00; 60 8-track prerecorded, all major labels \$90.00; 40 prerecorded cassettes, major labels, new \$50.00; 25 open reel prerecorded, all major labels, new \$49.50. Catalogue available \$1.00 refundable with first order. Surplus Records & Tapes, Box 496, Lone Pine, Calif. 93545.

PERFECTLY CLEAR™ ultra hi-fi record Burwen Laboratories Bl. 2. The East Bay City Jazz Band — Big Bear Stomp. Oriental Strut. Louis-i-an-i-a Blues My Naughty Sweeties Gives to Me. Dans Le rue d'Antibes, etc. \$10.50 each postpaid \$70.00 postpaid in lots of 10. Send check or money order. Massachusetts residents add 3 sales tax Dealers wanted. Burwen Laboratories Inc. 209 Middlesex Turnpike, Burlington, Massachusetts 01803 617-273-1488.

SOLO @ AUCTION: COLLECTORS RECORDS, LP's; Jazz, Soundtracks, Personalities, Original Casts, Country/Western, Blues. Indicate which list from: Ray Macknic, (or) Theo's, P.O. Box 7511, Van Nuys, Calif. 91406.

FREE 200-PAGE CATALOG. 1,400 New Stereo Recordings. Renaissance, Baroque, Classical, Romantic, Modern Music. Not sold in stores. Not listed in Schwann's. Highest quality! Budget label prices! Available only by mail. MUSICAL HERITAGE SOCIETY, Box 932 AU, New York, N.Y. 10023.

RECORD COLLECTORS' CONTACT GUIDE. Dealers, magazines, societies, Handbooks and directories listed. \$3.00. Jackson, 1506 W. Barker, Peoria, Ill. 61606

OLOIES — 45 RPM Original hits. Catalog 50c C&S Record Sales, Box 197, Wampsville, N.Y. 13163

WHILE YOU WERE LOOKING for out-of-print records, you should've been looking for us. DISContinued, 216 N. Rose, Burbank, California 91505

FILM-STAGE SOUNTRACKS. Large free list. A. Lutsky, P.O. Box 557342, Miami, Fla. 33155.

CATALOGS. Broadcasts, soundtracks. Personalities of Thirties, Forties. Box 225, New York, N.Y. 10028

DISCONTINUED RECORDS, CLASSICAL, OPERA, POPULAR, JAZZ, ALL SPECS, LISTS. STEINMETZ, ONE SEAVIEW, MASSAPEQUA, NY 11758

CUTOOT LPs, 78s, Classical, Jazz, etc. Choice items Reasonably priced. Free List. Lightfoot Collection, Box 554, Greenport, N.Y. 11944.

HUNDREDS OF MOVIE, STAGE SOUNTRACK LONGPLAYS. ONLY RAREST ONES. \$50 FOR LIST. 1ST AUCTION ALICES RECORDS, RR1, L.S. 300, DAVIS ILLINOIS 61019

RX FOR COLLECTORS

If you are a serious collector, particularly of 78's - you want a simple highly effective noise suppression system that is not intrusive. Write to us for information about the Source Noise Suppressor. Source Engineering, Box 506, North Wilmington MA 01887.

COLLECTORS: Songs/Week, chronological top 52 each year, 1950-1975. Only \$5.95 ppd. Info 10c. Hydra, Box 792, Palatine, IL 60067.

SOUNTRACKS - JAZZ - POP. Vincent, Box 5202, Long Island City, N.Y. 11105.

QUADRAPHONIC RECORDS AND TAPES - World's largest selection - all labels, over 1000 titles - at discount prices! For your free illustrated quad catalog, write: SOUND CONCEPTS, 8510 N. Mt. Hawley, Dept. C2, Peoria, Illinois 61614

Try Audio's Classified Ads... They Pull!

HELP!

Anytime you have a question about your Audio subscription, please include a mailing label to insure prompt service on your inquiry.

CHANGE OF ADDRESS

If you're about to move, please let us know approximately four weeks before the move comes about. Or, if there is anything wrong with your current mailing label, please let us know on this form also. Simply affix your present label here, and carefully print the updated information below.

AFFIX
LABEL
HERE

PLEASE HELP US TO SERVE YOU BETTER

AUDIO MAGAZINE
401 N. Broad Street • Phila., Pa. 19108

Name _____
(Please Print)
Company _____
Address _____
City _____ State _____ Zip _____

AU/2/76

TAPE & TAPE RECORDERS

SCOTCH RECORDING TAPE, lowest prices TAPE CENTER Box 4305B, Washington, D.C. 20012.

SCOTCH, CAPITOL. Blank cassettes, cartridges, reels. Discount prices. Lawson's, Box 510, Livermore, CA 94550

RECORDING TAPE: Custom Loaded, 8 track, reel, cassette. Prices on request. DICK WALEN, 4226 Robert St., Red Wing, Minn. 55066

TDK, BASF, Memorex, Maxell, cassettes, reels, 8-tracks. Lowest Prices, Guaranteed, New. S&S Audio P.O. Box 56039 Harwood Heights, Il. 60656

TRY OURS, P.S.I. FERRODYN CASSETTES. Compare them with anything available. Sample C-46 with brief recorded message one dollar post paid. 12 C-90's 27.00 dollars post paid. R.S.I. P.O. Box 1678, Los Gatos, CA. 95030

AUTO ACCESSORIES

SANDBLASTERS - \$39.50-\$839.50. Free Catalog. Truman, 1330A Market, Youngstown, Ohio 44507.

INSTRUCTION & EDUCATION

DIGITAL ELECTRONICS! Design and understand Digital Circuits. Increase technical competence. Complete and guaranteed course is highly effective. \$10.00. Free literature. DYNASIGN, Box 60AM, Wayland, Mass. 01778

PROFESSIONAL HI-FI COURSE—Instructors include Len Feldman, Julian Hirsch, Larry Klein, and Larry Zide. Home study course also available. Send \$1.00 for audio primer and full information or visit HI-FI EXPD, Dept A, 393 5th Ave., New York City 10016

FREE EDUCATIONAL ELECTRONICS CATALOG. Edukits Workshop, Department 506FK, Hewlett, New York 11557.

BUSINESS OPPORTUNITIES

EARN \$100.00 NIGHTLY PLAYING RECORDS. DISCOTHEQUES ARE IN COMPLETE DETAILS. DOS, DONTS, PHOTOS, DESCRIPTIONS, ETC. SEND \$5.00 TO "DYNAMIC UNO," P.O. Box 8116, CORPUS CHRISTI, TEXAS 78412.

Business loans: 20 sources \$2.00. N&N, Box 3483-A Temple, Texas 76501.

\$25.00 DAILY POSSIBLE: Addressing—stuffing envelopes. Typing/longhand. Details—Rush stamped envelope. Elite, Box 715—AO, Lynbrook, N.Y. 11563.

CANADIAN DEALER looking for American or British trade connections willing to work on cost plus basis (for cash quantity purchase) on closeouts and regular stock. Interested JBL, Thorens, Shure, BASF, TDK, Scotch, Watts, Marantz, etc. Replies held confidential. Electronic Shoppers World, 278 Havelock, Toronto, M6H 3B9.

GET RICH DOING WHAT YOU'VE ALWAYS WANTED TO DO: people will pay big money for your advice on hi-fi equipment. President of a California hi-fi corporation spills the secrets of starting your hi-fi store using your knowledge and other peoples' money. \$10.00 to Hi-fi stores, 7804 Westminster Ave., Westminster, Ca. 92683

UNIQUE COLLECTION TECHNIQUE for business with past-due accounts. Rush \$1 for sending free guide. Raymond Fry, 1702 S. Palm, Ontario, CA. 91761.

\$100 WEEKLY POSSIBLE! Clipping newspaper items. Stuff/address envelopes. Information - send stamped envelope. Income Opportunities, Box 721 - AO, Lynbrook, N.Y. 11563.

EQUIPMENT WANTED

CASH FOR Mint Ips & prerecorded reel tapes. Records, Box 323, Hillburn, New York 10931.

WANTED: Reel to Reel Tape Deck, Cassette tape deck with speakers and headphones by Soundesign. Write: Hubert Woods, 162 Curry Court, Talladega, Al. 35160.

RECORDS WANTED — LP's—"Odessa" & "Cucumber Castle" by the Bee Gees. Near new condition. Wm. J. Riese, 3429 S. Nucla Way, Aurora, Colo. 80013.

WANTED: HARMON KARDON Citation A preamp. Also need volume control for Citation A. J. P. Sammut, 432 Chestnut Ave., San Bruno, Calif. 94066.

WANTED: USED Tandberg 9000X or 9100X. Indicate condition and price. Gary Niedenthal, 1231 Perrysburg Rd., Apt 1, Fostoria, Ohio 44830.

MARANTZ 7C,9. State condition and price. J. Fong, 1238 Green St., San Francisco, CA. 94109

FIDELITY RESEARCH FRT-3 transformer, Service manual or schematic for Quad 303. C.R. Cail, 594 Wimbledon Rd., N.E., Atlanta, Georgia 30324.

FISHER K-1000 Power Amp. Don't care condition. Berringer, 1513 Alamo Dr., Apt. No. 17, Vacaville, Cal. 95688

WANTED: CASE (CS-343) for TEAC A-3340. Also, need an AX-20 and two AX-10's; condition of these units must be good and in original boxes. Also desire good, used TEAC AX-300 or used Sony MX-16 or MX-18 mixer. SSgt. Douglas Diidine, Box 408 7551 ASUPS, APO New York 09607

SAE MARK XXV POWER AMPLIFIER, Model 2500, Garrard Z2000B, Marantz Imperial (9) FLOOR-STANDING SPEAKER SYSTEM

WANTED - Info on BOSE 4401 Preamp, Oval 701, any audio equipment. Louis Sonier, 139 Dawes Road, Toronto, Ont. M4L 501.

Cash for your inventory.
NATIONWIDE LIQUIDATORS
51 Glenbrook Rd., Warwick, R.I. 02889
401-737-0979
No buy too large or small.
Mr. Tony Bicho
I go anywhere in U.S. and Canada.

ELECTROSTATIC TWEETERS—Realistic, Rystil, Equivalent. G. Lee Kl 7-3586, 2931 Cruger Ave., Bronx 10467

DYNACO STEREO 70. Any condition. State price. Harner, 316 West Fairmount Ave. State College, PA 16801.

NEED, two SL-1500, Audio Research D-150, Audio Research SP-3A-1. **NEED** two Jennings 2/4. Trevor Hartley, 3346 Fenton Ave., Bronx, New York, 10469

CASH FOR 2 KLIPSCH LA SCALLA'S J. P. Robillard P.O. Box 189, Haynesville, La. 71038 318-624-0105.

WANTED: WHARFEDALE W70 Speaker Must Be In Good Condition - R. Schwend, 65 Drake Rd., Somerset, N.J. 08873 - 201-846-3015 After 7 PM or during day 212-889-8000, Ext. 220

HIGH FIDELITY

NOW AVAILABLE
FAMOUS REFLECTING SYSTEM'S 4 1/2" REPLACEMENT DRIVERS. \$7.98 POSTPAID. **BIG QUANTITY DISCOUNTS, FREE SPECIFICATIONS, AURATONE, BOX 580-28, DEL MAR, CALIFORNIA 92014.**

DYNAKITS, DYNASPEAKERS - Lowest Prices IAO, IMF - Displayed. Underground HiFi, 324C Broadwater Road, Arnold, Md. 21012. (301) 647-0919.

"The Sony TC-756 set new records for performance of home tape decks"

(Stereo Review, February, 1975)

Hirsch-Houck Laboratories further noted, "The dynamic range, distortion, flutter and frequency-response performance are so far beyond the limitations of conventional program material that its virtues can hardly be appreciated."

The Sony TC-756-2 features a **closed loop dual capstan tape drive system** that reduces wow and flutter to a minimum of 0.03%, **logic controlled transport functions** that permit the feather-touch control buttons to be operated in any sequence, at any time without spilling or damaging tape; an **AC servo control capstan motor** and an eight-pole induction motor for

each of the two reels; a record equalization selector switch for maximum record and playback characteristics with either normal or special tapes; mic attenuators that eliminate distortion caused by overdriving the microphone pre-amplifier stage when using sensitive condenser mics; tape/source monitoring switches that allow instantaneous comparison of program source to the actual recording; a mechanical memory capability that allows the machine to turn itself on and off automatically for unattended recording.

In addition, the TC-756-2 offers 15 and 7½ ips tape speeds; Ferrite & Ferrite 2-track/2-channel stereo

three-head configuration; and symphase recording that allows you to record FM matrix or SQ* 4-channel sources for playback through a decoder-equipped 4-channel amplifier with virtually non-existent phase differences between channels.

The Sony TC-756-2 is representative of the prestigious Sony 700 Series — the five best three-motor 10½-inch reel home tape decks that Sony has ever engineered. See the entire Sony 700 Series now at your nearest Superscope dealer starting at \$899.95

SONY® Brought to you by
SUPERSCOPE.



*SQ is a trademark of CBS, Inc. © 1976 Superscope, Inc., 20525 Nordhoff St., Chatsworth, CA 91311. Prices and models subject to change without notice. Consult the Yellow Pages for your nearest Superscope dealer.

Don't buy any receiver until you compare its price, power, and specs to these.

Technics' four new stereo receivers. All with impressive specs. And a lot more.

All four have direct coupling. To give you a tighter, cleaner bass.

All with reserve power to float through complex, high-level musical passages without distortion or clipping. Because all have large capacitors, conservatively rated transformers, and bridge rectifiers in the power supplies.

All with a Phase Lock Loop IC and flat group delay filters in the tuner section. For clean, well-separated highs as well as lower distortion on FM. And about 20% less wiring. To reduce hum.

All with Technics' exclusive linear dial scale.

For effortless tuning on both AM and FM. Negative feedback low distortion tone controls. And all the inputs and outputs you'd expect from Technics.

Whichever Technics receiver you choose, you get all the advantages of Technics' sophisticated engineering, good power, and good specs. And all at a good price.

The concept is simple. The execution is precise. The performance is outstanding. The name is Technics.

FOR YOUR TECHNICS DEALER, CALL FREE 800 447-4700. IN ILLINOIS, 800 322-4400.

SPECIFICATIONS	SA-5150	SA-5250	SA-5350	SA-5550
Price*	\$229.95	\$299.95	\$349.95	\$479.95
Min. RMS Power per channel into 8 ohms	16 watts	23 watts	28 watts	58 watts
Bandwidth	40Hz-20kHz	20Hz-20kHz	20Hz-20kHz	20Hz-20kHz
Total Harmonic Distortion (Max.)	0.8%	0.5%	0.5%	0.3%
FM Sensitivity (IHF)	1.9 μ v	1.9 μ v	1.9 μ v	1.8 μ v
Selectivity (IHF)	70dB	70dB	70dB	70dB
FM Stereo Separation at 1 kHz	40dB	40dB	40dB	40dB
at 10 kHz	30dB	30dB	30dB	30dB

*Suggested minimum price, which is the fair trade price in states where Technics products are fair traded.

Check No. 48 on Reader Service Card

Technics

by Panasonic

