

**Test-
Record
Library**

Audio

THE AUTHORITATIVE MAGAZINE ABOUT HIGH FIDELITY • MARCH 1974 75c © ©

47425 

**CD-4 PHONO
CARTRIDGES
TESTED**

**DYLAN
AT THE
SPECTRUM**

U0803760 0476 30725005P0101212 * *
DON L HUNTER
2608 CENTRAL BLVD OR 97403
EUGENE



5.1 SURROUND SPEAKER SYSTEMS.

That is destined to become the
standard reproduction system.



R500

R300

PIONEER'S NEW SERIES

An acoustic achievement that
universally preferred sound



R700

The critics unquestionably agree...



AUDIO (George Tillet)

"The Pioneer R300 is a rather unusual speaker system — both in styling and design . . . Bass was solid and tight . . . the sound had an immediate projected quality. Stereo image was excellent . . . Can be recommended to those who require a good system at a reasonable price and one that would give outstanding results from a modestly powered receiver."

STEREO & HI-FI TIMES (Larry Zide)

" . . . This (R500) speaker will please many with its big, bright sound . . . The middle ranges . . . are most prominent, but there is more than enough good bass, too . . . The high end response is excellent; midrange and tweeter contribute to a smooth, wide range sound that goes well beyond audibility . . . It's time that we began to demand appearance along with performance. This, Pioneer is certainly giving us with this model, and they are to be commended for the effort . . . The R500 is a quality speaker and deserves your attention."

HIGH FIDELITY (CBS Laboratories)

"The R700 did a fine job with any program material we fed into it . . . The clean, smooth, honest, wide-range performance of the R700 puts it unquestionably among the more attractive speakers in its class."

MODERN HI-FI & STEREO GUIDE

(Robert Angus)

"There are some important differences between the R series . . . and most other bookshelf speaker systems on the market . . . The R500 is designed to make electronic rock music sound more dramatic . . . There's no doubt that with either folk or rock music, these speakers really produce brilliant sound . . . bass is remarkably clean and full under any circumstances . . . Sound is clean and undistorted up to 18,000 Hz . . . at the low end, clean frequency response is measurable down to 22 Hz."

FM GUIDE

"If you think it's time for a new sound sensation and you suspect your present speaker system is holding out on the lows and highs, try Pioneer's R500 speaker system."

OPERA NEWS (Hans Fantel)

"The cadre of relatively low priced high-performance speakers has recently been augmented by a distinctive newcomer: Pioneer's R300, whose tonal characteristics have been tailored to the results of extensive preference-testing with large groups of listeners. The R300 has a quality of 'presence' and immediacy which made Salome's murderous ecstasies positively scary when I listened, and the massive sonorities of the Strauss score didn't faze this speaker a bit."

Too often these days superlatives are used to camouflage mediocrity. Let's just say you'll be excited with the magnitude of the achievement of the new Pioneer series R speaker systems, once you hear them. They represent the culmination of our more than six years of intensive research in every phase of speaker design on just this series alone.

We investigated, tested and evaluated every known area: frequency response, dispersion, distortion, transients, drivers, configurations, cabinetry — rejecting, accepting, improving until we were completely satisfied that we had the perfect combination. The sound most people would prefer when compared with the conventional speakers now available.

The story behind the grille

To achieve this exceptional sound reproduction, Pioneer has endowed the new series R with a host of meaningful refinements that have become the hallmark for our extensive collection of high fidelity components.

Flush mounting. Unlike other speaker systems on the market today, the R series' drivers are flush mounted to the face of the enclosure, rather than recessed. Combined with the advanced design of the individual speaker units, there is added vitality to the mid tones and wider dispersion.

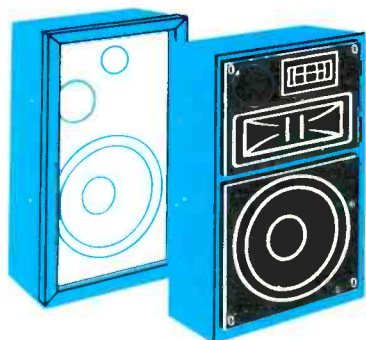

Conventional recessed speaker mountings.

New up-front flush mounting of Pioneer series R.

Exclusive FB cones assure robust bass, clear mid and high tones, improve damping, while keeping distortion at an absolute minimum. High input signals are handled with complete ease.

| | R700 | R500 | R300 |
|---------------------|---|--|--------------------------------|
| Speakers | 12" woofer, midrange horn, multicell horn super tweeter | 10" woofer, 5" midrange, horn tweeter | 10" woofer, horn tweeter |
| Maximum Input Power | 75 watts | 60 watts | 40 watts |
| Crossovers | 750 Hz, 14,000 Hz | 800 Hz, 5,200 Hz | 6,300 Hz |
| Dimensions | 15" x 26" x 13 $\frac{1}{16}$ " | 13 $\frac{3}{4}$ " x 24" x 12 $\frac{1}{16}$ " | 13" x 22 $\frac{1}{2}$ " x 11" |
| Price | \$229.95 | \$159.95 | \$119.95 |

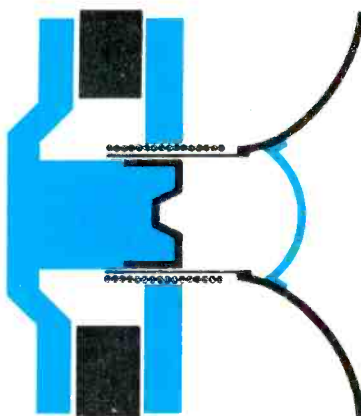

Unique concave center pole design and pure copper cap/ring combination. The concave center pole of the drivers' magnetic structure is covered with a pure copper cap. Not only does this reduce the inductance of the voice coil, it also decreases the voice coil's intermodulation distortion generated by the magnetic field. The result: vastly improved bass and midrange transient responses. Another example of Pioneer's meticulous engineering detail.

Improved design horn tweeters of die-cut aluminum have completely replaced the more conventional (and less costly) cone and dome-type tweeters in the entire series. You can hear the difference with wider dispersion, and you gain all the advantages of horn drivers, such as high transient response and lowest distortion.

Crossovers are precisely designed in each model. In contrast to other speakers that rely on the capacitance method only, Pioneer has combined both inductances and capacitances for minimum intermodulation distortion. And you'll never hear bass tones wandering to the tweeters, or highs intruding on the woofers. You couldn't ask for better linear response.

The acoustically padded enclosures are sturdily built and faced with handsome two-piece, two-color, removable grilles. The staining process of the hand selected walnut requires ten steps alone, and utilizes an exclusive oil created by Pioneer. Each unit is produced as if it was the only one.

Sound-absorbing foam polyurethane surrounds the woofers of the R700 and R500 to reduce distortion even further. The three R series models each employ long-throw voice coils providing greater cone movement for higher excursions.



There are many technical reasons why you should buy a pair of the new Pioneer series R speakers systems. But, in the final analysis, when you compare them with comparably priced speakers at your Pioneer dealer, their absolute superiority in sound reproduction is why you will buy them.

U.S. Pioneer Electronics Corp.
75 Oxford Drive, Moonachie,
New Jersey 07074

PIONEER

when you want something better

Check No. 29 on Reader Service Card

You're
reading
this page
for the
same
reasons
we build
our
speakers.

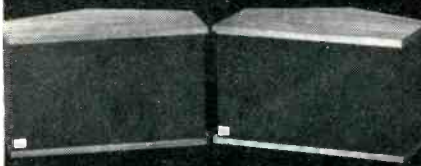

Better music, wherever you listen. Real fundamental, bass, including the attack of tympani and organ. An almost tactile feeling of presence. And transparent highs, providing unusual instrumental definition.

First and foremost, we built the LDL 749A to satisfy our own desire for musical enjoyment. Including the spatial sensations: from the intimacy of small groups to the awesomeness of full orchestra.

With their precise combination of forward-radiated sound and panoramic reflection, LDL 749A are a compact, elegant way to put the concert hall in your listening room. And the price is as realistic as the sound!

**Linear
Design
Labs** Inc.

20 Willett Avenue, Port Chester, N.Y. 10573

Audio

MARCH 1974

Successor to **RADIO** Est. 1917

Vol. 58, No. 3

FEATURE ARTICLES

- | | | |
|----|---|-------------------------------|
| 30 | From the Ortofon Test Record Library | <i>Henning S. Madsen</i> |
| 28 | AUDIO Tests Nine CD-4 Cartridges | <i>B. V. Pisha</i> |
| 46 | Quadra-Direction Discrete Compatible Stereo System—Conclusion | <i>Fumitaka Nagamura</i> |
| 83 | Dylan at the Spectrum | <i>Sherwood L. Weingarten</i> |

EQUIPMENT PROFILES

- | | | |
|----|-------------------------|-----------------|
| 60 | Pilot Receiver | 366 |
| 66 | Nakamichi Cassette Deck | 1000 |
| 70 | Frazier Loudspeaker | <i>Concerto</i> |

RECORD REVIEWS

- | | | |
|----|--------------------------|-------------------------------|
| 85 | Classical Record Reviews | <i>Edward Tatnall Canby</i> |
| 86 | Film Scores | <i>Donald M. Spoto</i> |
| 87 | Canby's Capsules | <i>Edward Tatnall Canby</i> |
| 90 | Sherwood's Forest | <i>Sherwood L. Weingarten</i> |
| 94 | Jazz & Blues | <i>Martha Sanders Gilmore</i> |

AUDIO IN GENERAL

- | | | | | | |
|----|---------------------|--------------------------|-------------------|------------------------|-----------------------------|
| 4 | Coming in April | 16 | Behind the Scenes | <i>Bert Whyte</i> | |
| 4 | Audioclinic | <i>Joseph Giovanelli</i> | 20 | Audio ETC | <i>Edward Tatnall Canby</i> |
| 8 | Tape Guide | <i>Herman Burstein</i> | | | |
| 12 | What's New in Audio | | 76 | Advertising Index | |
| 14 | Editors Review | | 82 | Workbench | |
| | | | 98 | Classified Advertising | |

EDITOR *Eugene Pitts III*

ASSOCIATE EDITOR *Edward Tatnall Canby* MARKETING DIRECTOR *Sanford L. Cahn*

ASSOCIATE EDITOR *Bert Whyte*

COVER DESIGN *John Kwasizur*

ASSISTANT EDITOR *Peggy Bicknell*

CIRCULATION MANAGER *Jean Davis*

CONTRIBUTING EDITORS: *Herman Burstein, Martin Clifford, Leonard Feldman, Martha Sanders Gilmore, Joseph Giovanelli, C. G. McProud, George W. Tillett, Sherwood L. Weingarten.*

AUDIO (title registered U.S. Pat. Off.) is published monthly by North American Publishing Co., Irvin J. Borowsky, President; Frank Nemeyer, Jay L. Butler and Roger Damio, Vice Presidents; R. Kenneth Baxter, Vice President/Production; Nate Rosenblatt, Promotion Director; Mary Claffey, Circulation Director.

RATES—U.S. Possessions, Canada, Mexico, \$6.00 for one year; \$10.00 for two years; all other countries, \$9.00 per year. Printed in U.S.A. at Columbus, Ohio. All rights reserved. Entire contents copyrighted 1974 by North American Publishing Co. Second class postage paid at Philadelphia, Pa. and additional mailing office. Back issues, \$2.00 each.

REGIONAL SALES OFFICES: Jay L. Butler, Publisher and Sanford L. Cahn, Marketing Director, 41 East 42nd St., New York, N.Y. 10017, telephone (212) 687-8924.

Jay Martin, 15010 Ventura Blvd., Sherman Oaks, Calif. 91403, telephone (213) 981-7852.

REPRESENTATIVES: Continental Europe: John Ashcraft, 12 Bear St., Leicester Square, London W.C. 2, telephone 930-0525. For Benelux and Germany, W.J.M. Saunders, Mgr., Herengracht 365, Amsterdam, Holland, telephone 24.09.08.

Japan: Japan Printing News Co., Ltd., No. 13.2 Chome Ginza Higasi, Chuo-ku, Tokyo, telephone 541-5795.

AUDIO Editorial and Publishing Offices, 134 N. 13th St., Philadelphia, Penna. 19107

Postmaster: Send Form 3579 to the above address

Now BIC VENTURI™ puts to rest some of the fables, fairytales, folklore, hearsay and humbug about speakers.

Fable

Extended bass with low distortion requires a big cabinet.

Some conventional designs are relatively efficient, but are large. Others are small, capable of good bass response, but extremely inefficient. The principle of the BIC VENTURI systems (pat. pend.) transforms air motion velocity within the enclosure to realize amplified magnitudes of bass energy at the BIC VENTURI coupled duct as much as 140 times that normally derived from a woofer (Fig. A). And the filtering action achieves phenomenally pure signal (Scope photos B & C). Result: pure extended bass from a small enclosure.

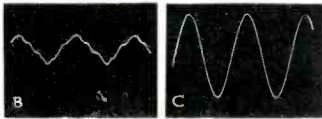
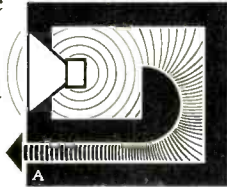

B—Shows output of low frequency driver when driven at a freq. of 22 Hz. Sound pressure reading, 90 dB. Note poor waveform.
C—Output of venturi coupled duct, (under the same conditions as Fig. B.) Sound pressure reading 111.5 dB, (140 times more output than Fig. B.) Note sinusoidal (nondistorted) appearance.

Fairytale

It's okay for midrange speakers to cross over to a tweeter at any frequency.

Midrange speakers cover from about 800 Hz to 6000 Hz. However, the ear is most sensitive to midrange frequencies. Distortion created in this range from crossover network action reduces articulation and musical definition. BIC VENTURI BICONEX horn (pat. pend.) was designed to match the high efficiency of the bass section and operates smoothly all the way up to 15,000 Hz, without interruption. A newly designed super tweeter extends response to 23,000 Hz, preserving the original sonic balance and musical timbre of the instruments originating in the lower frequencies.



Folklore

Wide dispersion only in one plane is sufficient.

Conventional horns suffer from musical coloration and are limited to wide-

angle dispersion in one plane. Since speakers can be positioned horizontally or vertically, you can miss those frequencies so necessary for musical accuracy. Metallic coloration is eliminated in the BICONEX horn by making it of a special inert substance. The combination of conical and exponential horn flares with a square diffraction mouth results in measurably wider dispersion, equally in all planes.

Hearsay

A speaker can't achieve high efficiency with high power handling in a small cabinet.

It can't, if its design is governed by such limiting factors as a soft-suspension, limited cone excursion capability, trapped air masses, etc. Freed from these limitations by the unique venturi action, BIC VENTURI speakers use rugged drivers capable of great excursion and equipped with voice coil assemblies that handle high power without "bottoming" or danger of destruction. The combination of increased efficiency and high power handling expands the useful dynamic range of your music system. Loud musical passages are reproduced faithfully, without strain; quieter moments, effortlessly.

Humbug

You can't retain balanced tonal response at all listening levels.

We hear far less of the bass and treble ranges at moderate to low listening levels than at very loud levels. Amplifier "loudness" or "contour" switches are fixed rate devices which in practice are defeated by the differences in speaker efficiency. The solution: Dynamic Tonal Compensation™. This circuit (patents pending) adjusts speaker response as its sound pressure output changes with amplifier volume control settings. You hear aurally "flat" musical reproduction at background, average, or ear-shattering discoteque levels—automatically.



A system for every requirement

FORMULA 2. The most sensitive, highest power handling speaker system of its size (19¼ x 12 x 11½)!" Heavy duty 8" woofer, BICONEX mid range, super tweeter. Use with amplifiers rated from 15 watts to as much as 75 watts RMS per channel. Response: 30 Hz to 23,000 Hz. Dispersion: 120° x 120°. \$98 each

FORMULA 4. Extends pure bass to 25 Hz. Has 10" woofer, BICONEX mid-range, super tweeter. Even greater efficiency and will handle amplifiers rated up to 100 watts. Dispersion: 120° x 120°. Size: 25 x 13¼ x 13" \$136 each.

FORMULA 6. Reaches very limits of bass and treble perception (20 to 23,000 Hz). Six elements: 12" woofer complemented by 5" cone for upper bass/lower midrange; pair of BICONEX horns and pair of super tweeter angularly positioned to increase high frequency dispersion (160° x 160°). Size: 26¼ x 15¼ x 14¾!" \$239 each.

Sturdily constructed enclosures. Removable grilles in choice of 6 colors. Optional bases for floor standing placement. Write for brochure A-3.

Audition today's most advanced speakers at your BIC VENTURI dealer.

 BRITISH INDUSTRIES Co., Inc.
Westbury, New York 11590.
A division of Avnet, Inc.
Canada: C.W. Pointon, Ont.

BIC VENTURI™

Check No. 14 on Reader Service Card

Coming In
April

Special Tape Recorder Issue
All About "Q"—Don Davis, of Syn-Aud-Con, explains how to figure speaker directivity and why it is important.

Guide to Folk Music Labels—Ira Mayer discusses the modern-day folk process.

Equipment Reviews Include
—Pioneer SX-949 four-channel receiver
Technics SL-1200 turntable.



About the cover: Not many people have eyesight as sharp as our artist who looked down into the grooves of a CD-4 Quadradisc and shows us what he saw. (Actually, this is a color conversion of a 1500X scanning electron microscope photo of a CD-4 disc's grooves, photo courtesy of RCA Victor.)

Using a VU Meter to Read Power Output

Q. In two super-power, basic amplifiers, specifically, the Phase Linear 700 and Phase Linear 400, "VU meters" are used to indicate power output during complex musical passages. These meters are calibrated in decibels in much the same way as my Simpson 270-4 Volt-Ohm-milliammeter is. Is it possible to connect this meter to the speaker outputs to determine the output of the amplifier during complex passages? If this can be done, what power level, in watts, does 0 VU refer to?—Phil Saba, McLean, Virginia

A. It would be possible to use your meter to indicate average power output produced by an amplifier. The only catch is that the damping of the meter might be different from that of a standard VU meter. If it is, you will miss some of the peaks which should register, or you will read peaks which are higher than those which would have been obtained on a standard VU meter. VU meters are designed to have a particular characteristic of attack and "fall-back" in order that an indication on one meter will be equal to that read on any other similar meter associated with the chain of equipment.

In any case, assuming that your meter has reasonably good dynamic characteristics, it should be possible to use it with any amplifier to indicate power output. You must watch out for the possibility of ruining the meter with excessive signal. (While my following comments deal basically with VU meters which require external multipliers, they more or less apply to your specific meter. Its internal multiplier may be used, but some additional external, variable resistance will be required for trimming.)

VU meters are designed to respond to signals of less than 10 mW. This is a very small amount of power. You would have to calibrate your amplifier in terms of voltage versus power output. You also need to know the ohms per volt of your meter. You would then have to provide a multiplier, similar to what would be contained in a VOM or VTVM, to fit the full-scale voltage of 0.707 volt which causes a standard VU meter to deflect to 0 VU. This voltage could either be made equal to the full power output of the amplifier, to a point which is 3 dB less than this full power or equal to perhaps the loudest listen-

ing level you might expect to use—whichever best suits your requirements. You would want to make a portion of the divider—or multiplier as you will—variable for exact calibration and inter-channel balance.

Reception of Distant FM Signals

Q. I like to catch "FM skips." Please tell me what conditions produce these effects so that I can know when to look for them.—Alan A. Durrenberger, Fort Walton Beach, Florida

A. "FM skips" are not heard at all times. They are the result of atmospheric phenomena.

When listening to shortwave signals, it is often possible to hear signals which are a long distance from the receiving site. A listener who is much closer to the transmitter might not even hear this same signal; it has *skipped* over the closer receiving antenna. For this reason we often refer to distant-signal reception as "skip reception." FM reception is considered to be limited by the horizon. Often, signals transmitted from much greater distances than the horizon can be heard, but these signals can be heard at all points between the transmitter and the most distant receiver, with no skipping. Despite all of this, it does appear that the term "skip" is becoming synonymous with the reception of any distant station, whether or not it has skipped over some receiving sites.

Foggy conditions up and down the coast and/or temperature inversions provide opportunities to look for "skip" stations.

If a meteor shower is likely, try to listen for distant FM signals then. Reception will be erratic. Identification of stations and their locations can be difficult.

Magnetic storms and auroras can cause an increase of distant-signal reception on the FM band, but not in all latitudes. Such reception is not likely in your area. It is likely in extreme northern and southern latitudes.

Look for weather fronts. The time just before the passage of a front is often good for the reception of distant signals.

Spring and fall months are best for such reception because the greatest temperature contrasts are present. These contrasts cause the greatest changes in atmospheric density. As we learned in high school physics, different densities result in diffraction of light rays. Exactly the same thing happens when radio

See son... there really is a 4-channel 8-track record/playback deck!

Perhaps that surprises you, son. But it's true. You see, there's been a lot of excitement lately about 4-channel stereo. And, like most people, you probably thought that all 4-channel recorders are open-reel.

Well, AKAI will change your mind.

You'll discover a whole new world of 4-channel recording when you see—and hear—AKAI's exciting new CR-80D-SS... a remarkably engineered 8-track 4-channel/2-channel compatible record/playback deck.

The CR-80D-SS is compact... easy to operate. And conveniently placed front-panel controls make professional 4-channel discrete recording a breeze.

Which means that you'll be able to make your own 4-channel tapes. And also enjoy the increasing availability of pre-recorded 8-track 4-channel music.

What's more, the CR-80D-SS is equipped with professional features such as Automatic Stop/Continuous Play... Fast Forward... Automatic 4/2-channel Stereo Selector... Illuminated Program Selector... 4 VU Meters... front panel 4-channel headphone outputs... and much more.

So don't assume that all 4-channel recorders are alike. They're not, my son.

See your AKAI dealer. He'll give you a new outlook.

From

AKAI™

The innovators

AKAI America, Ltd. / Dept. M

2139 E. Del Amo Blvd., Compton, California 90220 / (213) 537-3880

signals (of high enough frequency) pass through atmospheric layers having different densities. This signal diffraction causes the signals to follow the curvature of the earth rather than being radiated out into space as would otherwise be the case.

There is always a certain amount of this diffraction, caused by dust particles and by random fluctuation in atmospheric density.

To take advantage of these minute opportunities, however, you need a high-gain receiver, as well as a high-gain receiving antenna. You must aim such an antenna carefully, both in terms of azimuth and in terms of elevation. This requirement calls for two rotators, one for conventional azimuthal alignment, and the other for elevation adjustments.

Unlike AM signals, distant FM signals can often be heard during daylight hours. Do not miss them by failing to check on reception during appropriate weather times during daylight hours.

Hum in a Receiver

Q. I have become aware of a problem in my receiver that may have existed for a long time before I noticed, but since that moment it is harder and harder to live with.

There is a slight hum in the speakers of both channels (also present with headphones), that persists regardless of input selected, volume, and which way the balance control is set. It has nothing, either, to do with tone controls which can be switched out entirely.

I took the unit to the local service shop. They tell me that the equipment conforms to specifications. It has not, however, improved since that wasted visit. I suspected the power supply or a problem with grounding.

Because it is next to impossible to hear the humming (which can get on your nerves if you can hear it) in a noisy showroom, the service people probably did not notice that there is any problem at all.

Will I be stuck until servicemen make house calls, or is there something I can do for myself?—Steven L. Meyers, Buffalo, New York

A. Generally speaking, the earlier stages of a receiver have more filtering than the later stages because of the need to isolate these early stages from common coupling situations which would otherwise be present. Thus, even when the main filtering of a power supply begins to fail, hum is present only in the later stages—those stages which come later on in

the chain than tone and volume controls. Therefore, the amount of hum is not influenced by the setting of these controls.

An efficient speaker also adds to the difficulty. Your service shop might not have used efficient speakers. Hence, hum would not have been audible.

There is a hum and noise specification for most pieces of equipment. One such specification measures hum and noise with the volume completely turned down. When your equipment was checked, the technician might actually have performed this measurement rather than an aural test, and, if so, it could be that the equipment has some inherent, audible hum, at least with your speakers.

The replacement of power supply filter capacitors should eliminate the hum, assuming that the problem is not inherent in the design of the equipment.

If you have a problem or question on audio, write to Mr. Joseph Giovanelli, at AUDIO, 134 North Thirteenth Street, Philadelphia, Pa. 19107. All letters are answered. Please enclose a stamped self-addressed envelope.

“Hey...what do you want for under \$100?”

If you're looking for the best combination of features, performance and value . . . look no further. Glenburn delivers just that.

The features . . .

- Tone arm damping in manual and automatic modes . . . up and down
- Tone arm height and stylus pressure finger adjustments . . . no tools required
- Automatic tone arm lock
- Cartridge and dust cover and base standard . . . Nothing else to buy.

The performance . . .

- Lowest tripping and tracking forces available under \$100
- Largest turntable bearing in the industry
- Exclusive uni-planar mechanism . . . results in smoother, quieter turntables by putting most moving parts on a single plane.

And, the value . . .

All these unsurpassed features and improved performance available in four great new automatic turntables . . . All priced under \$100. Prove it to yourself. At your nearest Glenburn Dealer. He'll help you choose a Glenburn automatic turntable to fit your needs as well as your pocketbook.

Sometimes you have to pay a little less to get a lot more.



Gi GLENBURN better by design

GLENBURN/McDONALD, INC., 787 Susquehanna Ave., Franklin Lakes, N.J. 07417 • (201) 891-8250

Check No. 19 on Reader Service Card

Year after Year... Crown equipment pays for itself

STUDIO MONITOR AMPLIFIERS

All models have complete internal protection. IM distortion is better than 0.05% from 0.01 watt to full power. All units mount in a 19-inch rack. Three year warranties cover parts, labor and round-trip shipping.



D150

delivers 75 watts RMS per channel into 8 ohms; height 5 1/4 inches.



DC300A

delivers 150 watts RMS per channel into 8 ohms, or 600 watts output in monaural operation; height 7 inches.



D60

delivers 30 watts RMS per channel into 8 ohms; height 1 3/4 inches.

MAGNETIC TAPE EQUIPMENT.....IN THE PRODUCTION STUDIO

All models are designed to work 18 hours a day, 7 days a week for 10 years with three head replacements. Modular construction and plug-in circuit boards mean fast, easy field servicing. These precision instruments will make clean, accurate recordings years after the economical semi-pro decks are retired. All models handle 1/4-inch tape and 7-inch and 10 1/2-inch reels. All mount in 19-inch racks. Standard speeds are 15, 7 1/2 and 3 3/4 ips. There are individual record, erase and play heads for 1 to 4 channels. Over 40 standard models are available with numerous professional accessories.

ES224



STUDIO TRANSDUCERS

Four models of superior quality speaker systems have advanced-design electrostatic elements for midrange and treble and acoustic suspension base woofers, for finest possible reproduction for the professional recording studio. Two models of excellent cone speakers provide fine sound for broadcast monitoring.

Reliable performance and superior audio quality give you years more valuable service, making that higher original investment a real bargain. Every piece of equipment is ruggedly constructed, rigorously tested and guaranteed to meet or exceed printed specifications. All circuits are outstanding for low noise and distortion, wide bandwidth and high frequency response. It's to your credit when you specify the manufacturer with 26 years experience in broadcast and professional studio equipment.

DISTORTION ANALYZER

Model IMA tests audio equipment easily, quickly and accurately. Both intermodulation distortion analyzer and internal oscillators are enclosed in one compact unit. Even an inexperienced technician can take ten power level measurements in 5dB steps in just 60 seconds. The ranges are 100, 30, 10, 3, 1, 0.3, and 0.1%.

CX822 Mastering Recorder

computer logic control for safe, rapid tape handling and editing ■ full remote control optional ■ TracSync available ■ each channel has two mixing inputs and individual bias adjust and equalizers ■ third-head monitor for meters or headphones with A/B switch



...IN THE CONTROL ROOM

SP722 Studio Player

simple tape transport system has only 9 moving parts ■ remote start/stop optional, automatic stop in play mode



...ON LOCATION

SX822 Recorder/Mixer

integral mixing facility simplifies setup ■ same tape transport system and meter monitoring as CX822 ■ two mic or line inputs per channel

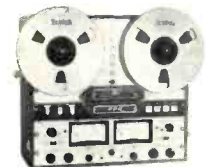

CROWN, Box 1000, Elkhart, Indiana 46514 Phone (219) 294-5571
Send technical data on Crown audio equipment for potential use:
 within Continental U.S.A. outside Continental U.S.A. A

Name & Title _____

Company _____

Address _____



MADE ONLY
IN AMERICA

CROWN

Check No. 16 on Reader Service Card

Tape Guide

Herman Burstein

Recording Current

Q. I have two tape recorders with a common problem. Although they are different brands, the circuit problem is common to both. I use the same kind of tape on both machines. I find that when I have the record bias adjusted properly (-1 db from the peak) I have more playback volume than I should have. I think the audio current to the record head is too high. Can this be lowered without any sacrifice of audio quality?—John C. Frank, Santa Ana, California

A. Unless you are getting noticeable distortion, the recording current to the record head is not too high. If you reduce the amount of audio current to this head while the meter reads 0 VU, you will reduce the signal-to-noise ratio, which of course is undesirable. In the event that distortion is noticeable at the 0 VU level, you can either reduce the signal to the record head, or else change the calibration of your VU meter, thereby getting a 0 VU indication at a lower and proper recording level. There may be an adjustment in your tape deck which will cause the VU meter to give a lower reading for a given playback signal. If the VU meter reading in playback is a function of the setting of the playback gain control, you merely have to adjust this control to avoid over-driving the meter.

Indexing Tapes

Q. (1) I find it quite frustrating to attempt to locate selections, usually classical, on tapes indexed for one machine and played on another, since invariably the indexing for the two machines (of different makes) is not the same. I wonder if it might not be more practical to place some sort of indexing marks on the back of the tape which would aid in visual location of a selection while fast winding the tape. The question is what substance would be durable, non-damaging, etc. (2) Is it true that bulk erasing a new or reused tape prior to recording will result in a higher signal-to-noise ratio? My question is prompted by a desire to determine if it is worth investing in a bulk eraser.—C. J. Hill, San Francisco, California

A. (1) I would strongly advise against

pastoring any substance onto the tape for the purpose of indexing, for this may cause the tape to stick in going through the system of guides, rollers, etc. More appropriate would be to intersplice your tape with leadertape, which is available in various colors if you wish.

(2) Bulk erasers can do a more effective job than the erase head of a tape machine. If a tape has been heavily over-recorded, the erase head may not be able to remove all the signal, and a bulk eraser is then recommended. It is claimed that a bulk eraser can lower the noise level of a virgin tape. However, this advantage is usually lost when the tape goes past the erase head, according to one correspondent, who claims that the erase head imposes some noise on the tape. This correspondent states that he has therefore deactivated the erase head of his machine (check the bias going through the record head if you deactivate the erase head).

Speed Change With Age

Q. I have had the following experience with medium-priced Roberts tape recorders (770, 1630, 770X, etc.): increasing wow and flutter as the machine is used, starting noticeably after about 150 hours of use and getting awful after about 600 hours of use. Does anyone know the cure for this?—Robert Colvin, Hayward, Calif.

A. Possibly the wow and flutter of which you complain may be due to accumulations of dirt, grease, etc. on the capstan. A thorough cleaning of the capstan and other parts contacted by the tape may help.

Treble Peak

Q. I have an Ampex 1455A. Everything about it is excellent except the 7½ ips frequency response. Using Scotch 203 tape, setting the bias at one point gives a flat record-playback response at 3¾ ips to 10 kHz, down 2 db at 12 kHz. However, at 7½ ips there is a peak from 3 kHz to 10 kHz of more than 5 dB. Setting the bias at 7½ ips will not lower this peak below 3 dB at 8 kHz without totally wiping out anything above 12 kHz. In short, the 3¾ ips record-playback response is smoother than that at 7½ ips.

The record equalization appears to be the same at both speeds, while one resistance is changed during playback. Is there any modification I can make to the equalization to correct the 7½ ips response?—W. Craig Chambers, Rantoul, Illinois

A. Use of low-noise tape requires both an increase in bias and a decrease in high-frequency record equalization. The additional bias is about 15%. The cut in treble is about 3 dB at 15,000 Hz. I would guess that you have been increasing bias too much in the attempt to remove the treble peak. As you recognize, a change is also needed in the record equalization. I cannot give you specifics as to what changes to make in your equalization circuit. This is a matter for the manufacturer, and I strongly advise you to consult him.

Demagnetizing Heads

Q. An article I read on tape recorder maintenance has raised some doubts in my mind as to whether I've been following the correct procedure in demagnetizing the heads of my recorder. According to the article, it is important to turn on the demagnetizer when it is about two feet or so from the heads, then slowly advance it toward the heads and proceed to demagnetize in the usual manner. Up to now, I've always started with the pole pieces next to the heads, and have heard no audible ill-effects. Assuming the recorder itself is turned off beforehand, is any harm likely to result to the heads or the recorder itself by switching the demagnetizer on when it is in close proximity to the recorder?—Stephen Sarper, Pittsburgh, Pennsylvania

A. Instructions and procedures usually try to provide a healthy safety margin. It is safer to turn on the head demagnetizer while it is a good distance away from the heads than when it is close to them. Whether the recorder is off or on does not matter. If you turn on the demagnetizer while it is next to the heads, this may magnetize them to an extent that they cannot be demagnetized—at least not by a head demagnetizer with a relatively weak field.

Loop Connection Recording

Q. My question concerns a kind of "loop" connection of my two TEAC

Some of the reasons why other turntables don't perform quite like a Dual.

Because of the wide acceptance and acclaim Dual has earned over the years, especially among audio experts, many Dual features inevitably appear on competitive turntables.

To copy a Dual feature is one thing; to achieve Dual performance and reliability is quite another matter. The true measure of a turntable's quality is not its features alone, but how well the entire unit is designed and manufactured.

Following are just some of the ways in which Duals differ from other automatic turntables.

Gyroscopic gimbal suspension.

The gyroscope is the best known scientific means for supporting a precision instrument that must remain perfectly balanced in all planes of motion. That is why the tonearms of the 1218 and 1229 are suspended in true, twin-ring gimbals.

Every Dual gimbal is hand-assembled and individually checked with gauges especially developed by Dual for this purpose. This assures that the horizontal bearing friction of the 1229 for example, will be no greater than 0.015 gram, and vertical friction no greater than 0.007.

True single-play automatic tonearm.

A turntable of the 1229's caliber is used primarily in its single play mode, so the tonearm is designed to parallel a single record on the platter. For multiple-play, the entire tonearm base is moved up to parallel the tonearm to the center of the stack.

The 1218 tonearm provides the single-play adjustment within the cartridge housing, and the cartridge pivots around the stylus tip to maintain the correct overhang.

Stylus pressure around pivot.

Today's finest cartridges, designed to track at around one gram, have little margin for error. In the 1229, therefore, the tracking pressure scale is calibrated within 0.10 gram from 0 to 1.5 grams.

To maintain perfect balance on every Dual tonearm, stylus pressure is applied internally and around the pivot. This is accomplished by a very long spring coiled around the pivot. Only a small portion of the spring's length is needed to apply the required pressure, thus contributing greatly to the accuracy of the calibrations.

Avoiding sounds that weren't recorded.

The rotor of every Dual motor is dynamically balanced in all planes of motion. Each motor pulley and drive wheel is also individually examined with special instruments to assure perfect concentricity.

Any residual vibration within the motor is isolated from the chassis by a three-point damped suspension. Finally, every assembled Dual chassis is "tuned" to a resonance frequency below 10 Hz.

The best guarantee.

All these precision features and refinements don't mean that a Dual turntable must be handled with undue care. So we're not being rash when we include a full year guarantee covering both parts and labor for every Dual. That's up to four times the guarantee you'll find on other automatic units.

Now, if you'd like to know what several independent test labs say about Dual, we'll send you complete reprints of their reports.

Better yet, just visit your franchised United Audio dealer. You'll see for yourself that only a Dual performs precisely like a Dual.



Dual 1214, \$119.95

Dual 1216, \$154.95

Dual 1218, \$189.95

Dual 1229, \$259.95



United Audio Products, Inc., 120 So. Columbus Ave., Mt. Vernon, N.Y. 10553

Exclusive U.S. Distribution Agency for Dual.

Check No. 47 on Reader Service Card

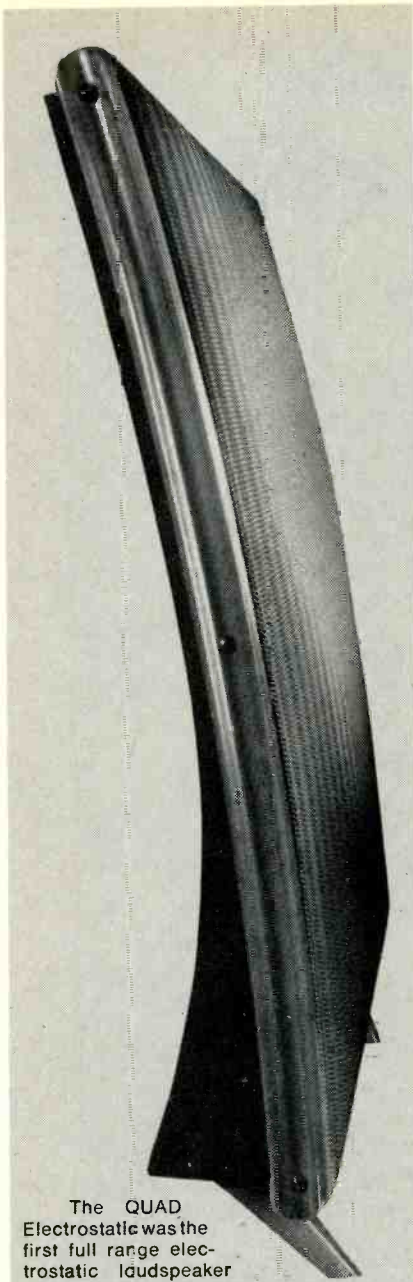

The QUAD Electrostatic was the first full range electrostatic loudspeaker produced commercially and is still the standard by which all others are judged. Using closely coupled moving elements some two hundred times lighter than the diaphragms of moving coil loudspeakers and being entirely free of cabinet resonances and colouration, this loudspeaker overcomes the usual major problems of loudspeaker design and provides remarkably natural reproduction of sound. This explains why the QUAD electrostatic loudspeaker is used by broadcasting and recording organisations all over the world, in applications where quality is of prime importance, and as a standard of reference by the majority of loudspeaker manufacturers.

QUAD for the closest approach to the original sound.

QUAD

is a registered trade mark

For details of your nearest dealer write to Acoustical Manufacturing Co. Ltd., Huntingdon PE17 7DB, England.

A4010S tape decks. I have occasionally made two tape copies of old discs at the same time, by connecting the tape output from the preamp to the first tape deck, the output of the first tape deck to the line-in on the second tape deck, and the output of the second tape deck back into the input jack on the pre-amp. This setup seems to work quite well, but I have noticed on occasion a loss of high frequencies in the product of the second tape deck. I clean and demagnetize my tape heads once each week, so I am quite sure this is not the problem. Would there be a possible further loss of fidelity if a third tape deck is used in the same loop?—Ronald Burnett, APO San Francisco

A. Have you tried reversing the sequence of the two tape machines in your loop? If the output of formerly your "second" deck (and now your "first" deck) has adequate high frequency response, the fault would not appear to be in this deck. Rather, the fault would appear to be in the cumulative effect of a slight treble loss in each machine.

High quality tape machines, in order to obtain an optimum combination of low noise, low distortion, and good treble response, typically are down 2 to 4 db at 15,000 Hz at 7½ ips. This is consistent with industry standards. While such a drop tends to be inaudible if one goes through only one step of recording and playback, it becomes audible when one goes through two steps, as you do in your loop. Introducing a third machine into the loop would increase the problem.

Bias Requirements

Q. (1) I have many tapes recorded at 3¾ ips, and occasionally have to dub parts of one reel onto another, connecting the line out directly to the line in jacks of the tape recorders. This works OK, but of course it works twice as fast if the speed of both recorders is set at 7½ ips. My question is, if I use the 7½ ips speed, at which speed should I set the bias on the recorders? (2) When using a good brand of low-noise tape, what is about the average range of recording in dB from distortion on the top end to noise on the bottom end? Some program material ranges from sounds so low that the VU meters won't register to crescendos that peg the meters. (3) If one's machine is biased for low-noise tape, what is the result of using the so-called standard tape?—L.N. Norman, Winthrop, Iowa

A. (1) Set the bias at 7½ ips. Keep in mind that if you play and record at double the speed, all frequencies are doubled. This means that the elec-

tronics of your tape machines have to handle frequencies to about 30,000 Hz. Also, to avoid the possibility of beat frequencies between the oscillator frequency and the audio frequencies, the oscillator frequency of your recording machine should be about five times the highest audio frequency—about 150,000 Hz.

(2) Good tape has a dynamic range of something like 65 dB.

(3) Low-noise tape requires more bias than conventional tape. If conventional tape is used on a machine adjusted for low-noise tape, a fall-off in treble response may be expected. This is made worse by the fact that a machine adjusted for low-noise tape employs less treble boost in recording than one set for regular tape.

Mono and Stereo Playback

Q. I am contemplating the purchase of two cassette recorders, specifically the Sony Model TC-100A and the Crown Model CSC 9350 M. The former is monaural, and the latter is a stereo recorder. The Sony recorder is to be used for voice type letter recordings made on the Crown recorder, and vice versa. I am told that because of the two different type heads (one stereo and the other mono), that playback may not be possible. It is this point that I am unfamiliar with and would appreciate your comments on.—Jose F. Reyes, APO San Francisco

A. If the Sony (mono) machine has quarter-track heads (permitting four tracks to be recorded), then you should be able to interchange recordings made on the Sony and Crown machines. That is, a recording on either can be successfully played back on the other. If the Sony has half-track heads, then there is a problem of compatibility. A recording made on the Sony can be played back on the Crown (although with some loss of signal-to-noise ratio, because the quarter-track head of the Crown does not cover all the track recorded by the Sony). However, a recording made on the Crown cannot be played back on the Sony, unless you avoid recording on tracks 2 and 3 (the middle tracks). The reason is that the half-track head of the Sony will span more than one of the quarter-tracks of the Crown.

If you have a problem or question on tape recording, write to Mr. Herman Burstein at AUDIO, 134 North Thirteenth Street, Philadelphia, Pa. 19107. All letters are answered. Please enclose a stamped, self-addressed envelope.

Realistic thinks you shouldn't have to buy a new deck to get Dolby*

And you don't! Just add the Realistic® DNR-1 Dolby noise reduction system to your present deck. And get a signal-to-noise improvement of up to 10 dB at 10 kHz—for virtual elimination of tape hiss and noise. Use it with any stereo cassette, cartridge or open-reel deck. Or Dolbyized FM broadcasts. A "record check" switch lets you monitor the Dolbyized signal, as it's being recorded, on 3-head decks. And there are dual, illuminated VU meters. Built-in 400 Hz generator for precise calibration. Response, 20-15,000 Hz, ± 2 dB. Harmonic distortion, under 0.5%. The low-cost way to Dolbyize. #14-893. **99⁹⁵**



Unless you want to.

The Realistic SCT-6C stereo cassette deck is a pretty good reason for wanting to. Not only does it have Dolby built in, but it has a lot of other good things too. Like a bias switch for low-noise chromium dioxide cassettes—with or without Dolby. A handy "edit lever" for skipping unwanted material as you record. Pushbutton pause. Memory rewind. Automatic end-of-tape shutoff. Big, illuminated VU meters. And there's a preamp output level control for matching any amp. Response, with CrO₂ tape, 30-15,000 Hz ± 2 dB. Signal-to-noise ratio, with Dolby in, 56 dB. Wow & flutter, 0.14% RMS. Exclusively at a Radio Shack store near you. #14-898.

249⁹⁵

*Dolby is a trademark of Dolby Laboratories, Ltd.

Check No. 31 on Reader Service Card

REALISTIC®
at
Radio Shack®

and Allied Radio Stores

A TANDY CORPORATION COMPANY



FREE 1974 CATALOG 362

AT 2000 RADIO SHACKS OR BY MAIL

Full Color—180 Pages! Hi-Fi, CB, Kits, Recorders, Antennas, Parts, More!

Name (print) _____ Apt. # _____

Street _____

City _____ State _____ ZIP _____

MAIL TO: Radio Shack, P.O. Box 1052, Fort Worth, Texas 76107

Retail prices may vary at individual stores.

What's New in Audio

Communications Company Reverb Timer



The RT 60 reverberation timer measures reverberation time in real time and does not require a chart recorder for analysis. The compact, lightweight, portable unit is powered by a self-contained ni-cad battery and has digital readout. Third-octave band pass filters with frequencies centered on 250, 500, 1k, 2k, and 4k Hz are used. The unit comes in a metal carrying case, with handle, and measures 5 in. by 5 in. by 7½ in. Price: \$395.00 F.O.B. the manufacturer.

Check No. 49 on Reader Service Card

3M Cartridge Decks



Dolbyized models 8075 (2-channel record/playback) and 8080 (2-channel record/4-channel playback) were demonstrated at the Winter CE Show in Chicago. The units were designed specifically for use with the new 3M ferric oxide tape, said to boost frequency response to the 15,000 Hz range. Each deck has a selector switch enabling it to record or play either standard or the

new 3M tape. The Dolby circuits function in both recording and playback modes and in conjunction with Dolbyized FM broadcasts. Signal-to-noise ratio is said to be increased 10 dB at 4,000 Hz and above. Model 8075 features a minutes-and-seconds timer, fast forward mode and a special cueing system to assure that the tape is always at the beginning when the unit is placed in the record mode. Model 8080 has a digital minutes-and-seconds counter and, in addition to recording and reproducing stereo, plays pre-recorded 4-channel tapes. Model 8075: \$299.95; Model 8080: \$344.95.

Check No. 50 on Reader Service Card

Polk Loudspeaker



The Model Nine 3-way column features four 4½-in. extended range drivers, an 8-in. passive radiator and a piezoelectric high frequency unit in a controlled dispersion array. This arrangement is said to provide primarily direct radiation of the upper frequencies, progressing gradually to primarily indirect radiation for the lower and lower-mid frequencies. The piezoelectric principle eliminates the magnet and voicecoil of conventional dynamic designs and replaces them with a ceramic crystal element which eliminates the need for a cross-

over network. The speaker can be driven by as little as six watts (rms) per channel or as much as 100 watts/channel without damage. The unit measures 9 in. x 10½ in. x 33½ in. high and is priced at \$165.00.

Check No. 51 on Reader Service Card

Nortronics Booklet

Next time you visit your Nortronics dealer, pick up his free Form #7334. The brochure contains details on the company's line of test and alignment tapes for cassette, 8-track cartridge, reel-to-reel, and broadcast spot announcer recorders. Discussed are: the need for and use of test tapes, detailed info on Nortronics' comprehensive line of tapes, and a brief section describing the QM-Series Recorder Care Products.

Catalogs

The free, 48-page Audel Book Catalog is now available. Described are 98 books specifically written for the do-it-yourselfer and craftsman. Some titles included are: *Electronic Security Systems*, *Home Workshop*, *House Wiring*, *Radio and Television Library*, *Electrical Library*, plus many more.

* * *

Over 400 titles are featured in the Sams Book Catalog for electronics enthusiasts and do-it-yourselfers. The books themselves are written by experts and professionals in easy-to-understand language and are loaded with photos and drawings for better understanding. Covers topics from amateur radio to circuits and components to test equipment.

* * *

The 1974 Heathkit catalog features a huge selection of electronic kits for the home builder. Choose from color TVs, 4-channel audio components, amateur radio equipment, a digital electronic clock or any of dozens of projects. Each kit comes complete with an easy-to-understand and follow assembly manual.



In Quest of Perfection...

"Jonathan Livingston Seagull" is a story about striving, struggling, soaring in quest of perfection.

In the film adaptation of the best selling book, "Jonathan Livingston Seagull," the spirit of the quest is captured in a moving original music score composed and performed by Neil Diamond.*

Transforming the celebrated book into a unique motion picture was a monumental task that demanded the finest cinematography and music reproduction modern technology could produce. So Neil Diamond selected BOSE 901® Speakers to reproduce his music for the press premières of "Seagull," commenting: "After auditioning what were reputed to be the best high fidelity speakers on the market today, I chose BOSE 901 Speakers because they offer the ultimate in theatre music reproduction." This is no surprise to thousands of 901 owners around the world who believe they enjoy the ultimate in music reproduction in their homes.

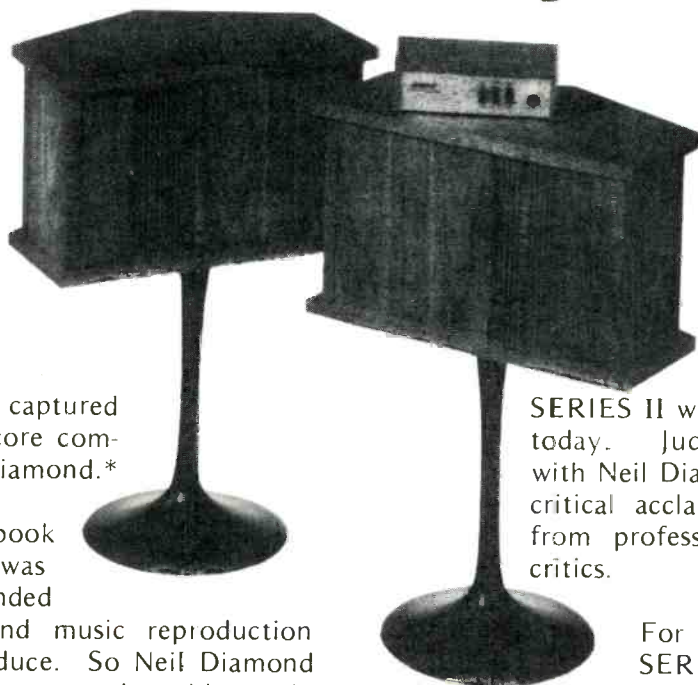

In our ever-continuing quest of audible perfection, we developed the new BOSE 901 SERIES II Speakers -- a product of over 15 years of research in musical acoustics.† We invite you to compare the BOSE 901

SERIES II with any speaker on the market today. Judge for yourself if you agree with Neil Diamond's selection and with the critical acclaim the original 901 received from professional music and equipment critics.

For information on the BOSE 901 SERIES II, complimentary copies of the rave reviews on the original 901, and a report on the theatre sound system competition, circle your reader service card or write Dept.A1.

*Original motion picture soundtrack recording available on Columbia records and tapes.

†This research is presented in the article "Sound Recording and Reproduction" published in TECHNOLOGY REVIEW (MIT), Vol. 75, No. 7, June '73. Reprints are available from BOSE for fifty cents a copy.

Check No. 13 on Reader Service Card

BOSE

The Mountain, Framingham, Mass. 01701

Editor's Review

ONE OF THE MOST interesting chores one assumes when taking over the editor's chair at a magazine such as AUDIO is reviewing, or assigning for review, the various publications which are sent in. These range from the catalogs of the different manufacturers and sales organizations, through the latest transistor substitution handbooks, to the regularly appearing and, I must add, much needed guidebooks for the novice (needed to keep them from achieving listings in the *Guinness Book of Records* under acoustic feedback and ground-loop hum). Items falling into the first category generally are quickly placed in the proper hanging file in one of four file cabinets. Those in the last two categories often will receive a short write-up, which eventually appears in the "What's New in Audio" column, and then the book is placed in the proper area of AUDIO's small library.

Now and again, we will receive a volume which will deserve a considerably more complete discussion. Two of these have come in recent months, and I would be remiss in my duties were I not to share them with you.

The first is *ACOUSTICS: Historical and Philosophical Development*, a collection of 39 articles, some of which have been translated into English from the French, German or Latin for the first time. R. Bruce Lindsay, of Brown Univ., is the editor of the volume and of the series to which it belongs, *Benchmark Papers in Acoustics*, which is being published by Dowden, Hutchinson & Ross, Inc., Stroudsburg, Penna. 18360. Price of the 480-page book is \$24.00, and it is distributed outside the U.S. and Canada by John Wiley and Sons, Inc., 605 Third Ave., New York, N.Y. 10016.

Lindsay opens the book with a short introduction, entitled "Acoustics: Science, Technology, and Art," which is then followed by Lindsay's account of the "historical progress of the science of acoustics," which appeared in the April 1966 issue of the *Journal of the Acoustical Society of America*, of which Lindsay is Editor-In-Chief. The other papers in the book, from Aristotle's *De Anima* and *De Audibilibus* through Sabine's "Reverberation," are presented in chronological order and include selections by Galileo, Boyle, Newton, Helmholtz, and Lord Raleigh.

To say the very least, this volume should be considered a "must" for most everyone seriously concerned with acoustics. It is intended by the editor "to serve as an introduction to the series as a whole, in that it emphasizes through its 39 articles the his-

torical and philosophical growth of the whole subject from very early times up to approximately 1900." To my lights, it accomplishes this purpose very well. About the only criticism I have, something which others may like, is that the type used to print most of the articles has been photocopied from early editions of the various works. While in my opinion, this makes for difficult reading, others might well reply that it helps give the reader the flavor of the time.

Two other volumes in the Benchmark series have been published: *Underwater Sound* edited by Vernon Albers and *Speech Synthesis* edited by J. L. Flanagan and L. R. Rabiner. Some 10 other volumes have been announced, including *Physical Acoustics* edited by Mr. Lindsay, *Psychological Acoustics* edited by Arnold Small, *Physiological Acoustics* edited by Small and Joel S. Wernick, and *Acoustical Instrumentation* edited by Benjamin Bauer.

The second book which I would like to commend to your attention may appear somewhat more prosaic since it is a dictionary, but, oh, what a dictionary. It's the *IEEE Standard Dictionary of Electrical and Electronics Terms*, and it contains more than 13,000 definitions, which are the official standards of the IEEE. As the flyleaf notes, the work is the product of decades of labor and contains hundreds of new terms as well as revisions of earlier ones.

The definitions are arranged in standard alphabetical fashion and are supplemented with data on preferred usage, variations in meaning among specialties, cross-indexing to related words, and code numbers which identify the source of definition and the field in which it originated. The *Dictionary*, which has been approved by the ANSI, is available through John Wiley & Son's Wiley-Interscience division or the IEEE.

Boston Section for AES

Formed last Fall, the Audio Engineering Society's Boston Section will have its next regular monthly meeting on Wednesday, February 27th. Scheduled speaker is Richard Burwen, who is to demonstrate his noise-reduction system for discs if preliminary work can be completed in time. For further information on the meeting or on how to join the Society, call or write Joe Hostetter, Chairman of the Section, at 39 Bay State Road, No. 2-R, Boston, Mass. 02115 (617) 262-6965 or Paul Moverman, 225 Merrymount Dr., Warwick, R.I. 02888 (401) 463-7272. E.P.



To fulfill the requirements of the most critical listening and auditioning... Stanton is the professional standard.



Ms. Gladys Hopkowitz, Recording Engineer
Mastertone Recording Studio, Inc., New York

in STEREO— The Stanton 681EE

If critical listening is to be unbiased, it must begin with a stereo cartridge whose frequency response characteristics are as flat as possible. One that introduces no extraneous coloration as it reproduces recorded material. For anyone who listens "professionally," the 681EE offers the highest audio quality obtainable at the present 'State of the Art.'

Many record critics do their auditioning with Stanton 681EE. Recording engineers have long used the Stanton 681A to check recording channel calibration. The 681EE provides that logical continuation

of the Stanton Calibration Concept. High compliance and low tracking force assure minimum record wear. Its low-mass, moving magnetic system produces virtually straightline frequency response across the entire audio spectrum. Its built-in longhair brush keeps the stylus dust-free, and protects record grooves, thus reducing noise and wear. Each 681EE is individually calibrated, and the results of these calibration tests are included with each cartridge.

The Stanton 681EE — used by recording engineers, broadcasters, critics and audio professionals — the cartridge that sounds like the record sounds, always.

in DISCRETE 4-CHANNEL— The Stanton 780/4DQ



QUADRAHEDRAL

A totally revolutionary stylus design concept proves to be the best solution for discrete playback. It's the Quadrahedral — all tests and in-use demonstrations authenticate the value of the discovery. Stanton has this new stylus in its four channel cartridge.

This is the first American designed and manufactured stylus developed for discrete four-channel records. It was especially engineered for the Stanton 780/4DQ cartridge which is already the first choice of professional record reviewers, anxious to evaluate the new discrete 4-channel discs coming on the market.

The performance of the stylus (and cartridge) fulfills all the extensive demands and sophisticated requirements necessary for playback and review of all the material recorded on discrete discs. And while performing brilliantly, it is actually very kind to records in terms of wear. Stanton's own engineers, whose professional products are the standards of the industry, tested and proved its characteristics, and report that it functions with total reliability in every measurable aspect.

This new cartridge, the 780/4DQ is available at your franchised Stanton dealer.



For further information, write: Stanton Magnetics, Inc. Terminal Drive, Plainview, N.Y. 11803.

Check No. 42 on Reader Service Card

Behind The Scenes

Bert Whyte

TEN YEARS AGO Phillips of Holland introduced what they called the "compact cassette." In essence it was a miniature reel-to-reel tape system enclosed in a handy-sized plastic cassette. With a tape width of less than an eighth of an inch, and operating at a snail-paced 1½ ips, the frequency response and signal-to-noise ratio were quite restricted, but deemed adequate for its intended purpose . . . that of a convenient format for dictation and sonic "note-taking." Incorporated into pocket-sized battery-operated portable recorders, the cassette system soon caught the fancy of millions of people.

As with any tape recording system, it was inevitable that the cassette would inspire experimentation as to its feasibility as a storage medium for music. In spite of the pitiful quality of those early monophonic recordings, it was obvious that quite a few people felt that the cassette had great potential as a vehicle for commercially produced recordings. A great deal of money, time and technology was lavished on the cassette to make it a viable music playback system, and the rest is history . . .

Today, the devotee of cassettes has a highly sophisticated system at his disposal. There are hundreds of models of cassette recorders, and from \$150 units on up to \$1100, Dolby B-Type noise reduction is virtually standard. Even the modestly-priced recorders have quite respectable motion performance. Blank cassettes come in a wide variety of configurations, replete with exotic ferric oxide formulations as well as chromium dioxide coatings.

Along with solid state electronics, these features have the cumulative effect of making cassette recorders available that have a 30 Hz to 15 kHz frequency response along with signal-to-noise ratios on the order of 58/60 dB. The owners of these cassette recorders have a voracious appetite for blank cassettes, whose sales keep skyrocketing higher every year.

As for commercially recorded music cassettes, there are thousands from which to choose covering every aspect of music. For quite a period it was a common practice of the record companies to have simultaneous releases

of the same productions on disc and on cassette. The cassette world looked rosy indeed and, as you might expect, some of the rabidly enthusiastic cassette boosters and any number of pundits were claiming that the high fidelity quality of the cassette was as good as the phonograph record, and maybe even as good as open reel tape. Once again we were assured, the demise of the disc was at hand. However, in the midst of all this euphoria, you will note that I made my comment on the simultaneous disc/cassette release policy of the record companies in the *past tense*. And there, friends, hangs a tale . . .

In this cold winter of our energy crisis discontent, the situation anent the release of recorded cassettes can only be described as bleak. The number of new cassette releases each month has been reduced to a trickle. RCA, for example, issues cassettes on a "selective" basis now, with only those productions they consider of "hit" status as candidates for the cassette format. Truth is, months have gone by without any RCA cassette releases. Ampex Stereo Tapes, once the fountainhead for a veritable torrent of recorded cassettes, is also operating on a "selective" basis. Of course, they represent so many different record companies, that even with this restriction, a fair amount of cassettes are released each month. Reduced output of cassettes is the order of the day with most record companies, with Columbia apparently the only record company maintaining its output at or near the levels of the past several years. To put this whole business of recorded cassette releases in the most candid perspective, let me say that it is fairly common knowledge within the industry that a number of companies would like to get out of the cassette business altogether.

The decline of the recorded music cassette is due to a number of factors. From the record companies viewpoint, it is simply a question of ever diminishing sales. Why are cassette sales down? To put it succinctly, and rather bluntly I'm afraid, the cassette at its present technological level cannot compete with the sound quality of the phonograph record. A strong statement this,

and I can see the hackles rising on the necks of the cassette contingent. But examined dispassionately, in a direct cassette/disc comparison, the ear validates the quality differentials which tips the balance in favor of the disc. Before going into some of the problems encountered with recorded cassettes, let me state that I am not "anti-cassette," nor do I have any particular axe to grind for the phonograph disc. As far as I am concerned, the size, shape, speed or any other parameter of a music storage medium is entirely irrelevant. My one criterion is that the medium be capable of reproducing music with the highest possible fidelity.

I have been in Ray Dolby's laboratory in London where I watched him making Dolby B cassette copies from Dolby A-Type 15 ips master tapes. The cassette recorders he used were high quality units, but nonetheless were standard models available in any hi-fi shop. On direct A/B comparison between master tape and copy, it was difficult, if not impossible to detect any difference between them. I have done the same thing with my equipment at home. The important factor here is that Dr. Dolby and I were making copies at a one-to-one ratio. This essentially is what every cassette recorder user does when he engages in the common practice of recording "off-the-air," or copies phonograph records. With virtually any standard recorder, using correct level settings, it is quite easy to produce high quality recordings, which is why this form of activity is so popular, and why sales of blank cassettes keep rising.

Contrast this one-to-one recording, with the standard duplicating process used in producing recorded music cassettes. Naturally the dictates of economy call for higher speed multiples in commercial duplicating, with a ratio of 32 to 1 in general use. There are problems enough with this duping ratio, so one is aghast when stories circulate about the use of ratios as high as 128 to 1! The tiny width of the cassette tape operating at these speeds imposes severe guidance problems in the transport of the slave recorder and often gives rise to tape "skew," which can cause crosstalk. In fairness, it must be said that nowadays the guidance

Silent Partners



If you're involved in the business of tape recording either professionally or simply for the love of it, we have an interesting proposition for you.

A couple of silent partners, who will work day and night, assure excellent results, let you maintain full control and be unfailingly reliable.

They're the new Revox/Dolby B tape recorder and the Beyer DT 480 headphones. And both of them come with excellent credentials.

The Revox/Dolby B is the most recent version of the critically acclaimed Revox A77, a machine which was described by the *Stereophile* magazine as, "Unquestionably the best tape recorder we have ever tested."

Listening to tapes made on the new Revox with its built-in Dolby Noise Reduction system is a revelatory experience. Tape hiss is virtually nonexistent. The music seems to emerge from a background of velvety silence. And at $3\frac{3}{4}$ i.p.s. the absence of extraneous noise is truly startling.

As for the Beyer DT 480

headphones, they are in a class by themselves. Their superb frequency response and enormous dynamic range permit you to critically monitor and evaluate recording quality and balance. Add featherweight comfort and an ingenious "ear seal" that effectively screens out ambient noise and you begin to understand why a modified version of the DT 480 was chosen as the European Din Standard in headphones.

Together or separately, our remarkable silent partners could open your ears to recording possibilities you never knew existed.

Your nearest Revox-Beyer dealer will be delighted to arrange an introduction.

We think once you've met them, you'll wonder how you ever did without them.

For additional information and complete technical specifications, write: Revox Corporation, 155 Michael Drive, Syosset, New York 11791.

California: 3637 Cahuenga Blvd. West, Hollywood 90068. Canada: Revox Sales and Service, Montreal.

Check No. 32 on Reader Service Card

A brilliant idea realised to perfection:



DIASA

Our patented Diamond Phonograph Point on a Sapphire Shaft.

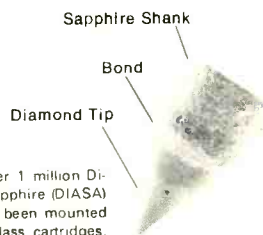

So far over 1 million Diamond Sapphire (DIASA) styli have been mounted into top-class cartridges.

Due to the low specific weight of sapphire (3.9) we are in a position to produce a phonograph point with exceptionally low dynamic mass. —The very narrow tolerances in diameter and length render the setting of the styli into the holder possible with a maximum of precision.

We are also in a position to offer the following high-quality articles produced in our own works:

Diamond Phonograph Styli with a stainless steel shank —

Holders for styli manufactured out of the lightest possible aluminum tubes, mounted or unmounted.

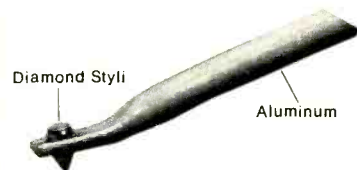

Our standard measurements for phonograph styli are:

| | |
|------------------------------|----------|
| Ø .010" x .020" long | R .0007" |
| Ø .012" x .025" - .040" long | R .0007" |
| Ø .016" x .040" - .060" long | R .0007" |

For samples and offers please contact:
Benz Micro-Diamonds,
Landstrasse 20,
CH 8450 Andelfingen, Switzerland,
or our representatives in the USA:
Arthur C. Agazim & Son,
P.O. Box 129, Lake Forest, Ill.
60045
Phone: (312) 234-4314.

problems are far fewer than they were several years ago.

The main problem with high speed cassette duplication is modulation noise. Modulation effects are caused by magnetic discontinuities. If the tape stock used for duplication has poor crystal structure, which cause the formation of dendrites (clumping particles and accretions which appear on the surface of the tape as protuberances), dropouts will occur. Although some of these dropouts would be detectable at the 1½ ips real-time speed of the consumer cassette recorder, at the 32 to 1 duping speed multiple dropouts are passing by the recording head. This causes the sound on the recorded cassette to have an undulating, wavering sort of characteristic. On many types of music this is not too noticeable; the ear simply is aware of a general lack of clarity in the sound. However, in any music where woodwinds such as flute, clarinet or oboe are in an exposed position, especially in solo passages, the instruments sound blurred and buzzy.

When a consumer plays back a recorded music cassette on a unit which is in optimum operating condition, he may encounter any or all of the following. The sound may wow and waver in a rather gross fashion, especially noticeable during sustained piano chords. This wow is not inherent in the unit, but can be the result of a poor wind in the cassette tape pack or a poor quality and insufficiently lubricated inner liner in the plastic cassette. On sections of the cassette, the sound may exhibit occasional distortion because in the process of duplication the tape overload limits have been exceeded and the magnetic particles have become saturated. As mentioned earlier, the most frequent flaw is the "burbling" sound of modulation noise. I should mention that for the most part there are no problems with the playback of Dolby B-Type cassettes, but there is the factor that because the Dolby process has reduced the tape hiss, this often makes the modulation noise more apparent.

It is all these noise and distortion problems, singly, or in combination, which have frustrated those people who have wanted to use recorded cassettes as a viable alternative to phonograph records. Of course, not all cassettes have these playback problems. Nor does everyone have the quality of associated playback equipment which is more revealing of these sonic flaws. Nonetheless, enough hi-fi enthusiasts are aware of the problems to account for the declining sales of recorded music cassettes.

Can anything be done to resolve these cassette problems? I should note here that the worst culprit, the modulation noise, is not a consequence of high speed duplicating ratios alone, but a combination of the speed and the quality of the tape oxide. As noted in these pages before, Advent Corp. is planning to issue recorded music cassettes which have been duplicated at a speed ratio of only 4 to 1 and use chromium dioxide tape. This approach is all right for a specialized "premium" product, but most engineers feel that this is not an economical idea for large scale duplication. Mr. M.B. Martin, an engineer for the Memorex Corp. writing in the November 1973 issue of the *Journal of the Audio Engineering Society* on cassette duplication, has some very interesting ideas. In essence, he feels that the modulation noise problem could be solved by the use of higher quality tape oxides, and he lists the various oxides and describes their properties. He acknowledges the generally superior characteristics of chromium dioxide, such as the almost perfect acicular particle which makes it free of dendrites, its higher coercivity, improved short wavelength (high frequency) performance. He also points out that chromium dioxide requires a much higher bias current for optimum recording, it is higher in cost than any other oxide, and there are special equalization criteria to be met. Understandably, Mr. Martin is keen on Memorex's new MRX-2 ferric oxide tape, and gives some very cogent reasons for its use in duplication. If what Mr. Martin says holds up in practice . . . and I'm inclined to think that it will . . . it would be a shame if the duplicators didn't try such a product. As Mr. Martin points out, the extra cost involved in using his oxide is on the order of 3 cents for a C-60 cassette, and a nickel for a C-90 cassette. If the better oxides, used at the same standard duping ratios, results in a cleaner, better-sounding cassette free of modulation noise, the record companies should make such a product available to the consumer, even if it had to be sold at a slight premium to offset higher costs.

I have an experimental Dolbyized chromium dioxide cassette recording of *La Traviata*, sent to me by Ampex Stereo Tapes, and some similar cassettes from BASF. Significantly, they are free of modulation noise, although they are not perfect in all sonic respects, i.e. some tape saturation. It is food for thought at least, and maybe some people will be interested in the resuscitation of the recorded music cassette. Æ

The 'Best Buy' Line

S-7050. "The winner in our evaluation;" Music World. (36 watts IHF; 10 + 10 RMS [8 Ohms @ 1 KHz]; 3.5 μ v FM Sensitivity [IHF]; 40 dB selectivity)

S7200. "Best Buy," a leading consumer testing magazine. (40 + 40 watts RMS [8 Ohms @ 1 KHz]; 1.8 μ v FM Sensitivity [IHF]; 60 dB selectivity)

S7100A. "Best Buy," a leading consumer testing magazine. (22 + 22 watts RMS [8 Ohms @ 1 KHz]; 1.9 μ v Sensitivity [IHF]; 50 dB selectivity)

S7900A (AM/FM) & S8900A (FM only), "Best Buy," a leading consumer testing publication. (60 + 60 RMS [8 Ohms 20 - 20,000 Hz]; 1.7 μ v sensitivity [IHF]; 65 dB selectivity)



Check No. 33 on Reader Service Card

There are certain rewards for producing the best receivers in this business.

One of them is critical acclaim.

And we admit, that when a leading consumers' testing magazine picks three of our receivers as "Best Buys" and

another independent publication rates our S-7050 as the best of the low-priced receivers, to us it's like getting an Oscar.

But nothing is more exciting than being discovered by thousands of new consumers who choose Sherwood over the giants of the industry.

And, this year, as never before, the word is getting around. Sherwood Electronic Laboratories
4300 N. California
Chicago, Illinois 60618

Sherwood
The word is getting around.

Audio—ETC

Edward Tatnall Canby

Total Everything I. End of an Era

Well, it really is the end of an Age, and the beginning of another. Who'd have believed it? These are days we will all remember. The old era of limitless bigger and better, the More and the Most, is a dead duck. Or rather a tired jalopy, clean out of gas.

We are going to have to convert our thinking and our acting to a new age, unaccustomed as we are, an age of economy and careful common sense. What an order, for *us*, the biggest free spenders on earth! We'll do it, though, and it won't do us a bit of harm. Far from it. Not even in audio. But it's going to take a lot of new ingenuity, applied in strange new ways. Not how can we make MORE and still more, but how can we make more with *less*. How do we get along with what we have, and not very much of that? Unthinkable, but healthy. Turn that thermostat down, buster.

Luckily for us, we still have the know-how. There is still plenty of that well-known Yankee horse sense around, the envy of much of the world, the ability to DO. It's the truth! Living in Europe awhile last summer, I could actually feel it and see it. To observe how other people can bog down into frustrating complexity, where we at home would sail blithely right on through, is to marvel that with all our problems we really are still the original big-time industrial country. It's not just money. It's thinking, acting. Thinking out a system and carrying it all the way through, making it work no matter how complex or big. Or small. We are so direct—we move so fast! We boil things

to essentials in moments, we know how to function and to get on with it, we demand results, or else, and we get them or quit. If we must, we also know how to change, to backtrack like lightning, cut our losses, come out roaring in another direction. We are still uniquely *flexible*. Flexible, that is, when we have a mind to. We very seldom bog down into the unworkable in our enormous expanse of industry. Go man, or get out.

Trouble is we've been misapplying our talents. Now we get back to basics and use our leverage where it counts. Back to Ben Franklin, to Thomas Edison and Henry Ford! With all the modern trimmings. The last Frontier is gone, the Petroleum Frontier. Just try, young man, to Go West on petroleum. (Was it Horace Greeley said it?) Young man, if you do try that, you will not get from New York to Hoboken. As for the Nuclear Frontier, it isn't out of the ground yet and the idea of limitless energy that way is a pipe dream (but more power to it). So off to work, fellows and gals, to see what we can do with what we have. It'll be fun. Grueling fun.

* * *

On my work desk, for instance, sit two file boxes in which for years I've dumped the detritus a writer always files under his ABC. One file is made of ordinary office metal, finished a dull gray. Undistinguished. The other, identical in size and operation, taking the same hanging file folders, is made of wood, a rather elegant veneer. I like it. That box was a product of WW II. No metal! So they converted to wood, and did better than ever. Good job.

Then, back in my closet, there is a pile of old ETs, electrical transcrip-

tions, big shiny lacquer discs professionally cut for studio and off-the-air recordings in the days before tape. Most are of me, so I could find out how I sounded. (I sounded awful.) Nothing special about these oldies, the big 16-inchers and the 12-inch 78s (so I could play them at home). The usual aluminum base blanks, cut with good-looking grooves (wish they sounded that good). But a half dozen or so are different. On the envelope is a big red label. *GLASS*. These, too, date from the depths of WW II. No metal. So they converted the ET to glass, and went right on recording. Some of those glass discs sound better than the metal-base discs that came after the war. Hold the disc up to the light and you can see right through the lacquer, a deep purple red. That was some breakthrough, if I may coin a breakable pun. It's the kind of thing we will be doing *these* days.

You know, it is quite possible that we may some day convert to glass discs. More in a few moments. Materials like that are the things we will now keep our beady little eyes upon, just in case. It's a material that we *have*, and it isn't petroleum based. Suddenly, things like that are important. They should be. As for wood, you can never tell when that ancient, reliable and renewable raw material is going to turn out to be the best thing for a job. Hey, you kids, did you know we once used wooden phonograph styli? I tried them. The "needle" wasn't even round; it was square. You had a cutter-slicer gadget and you sliced off a new edge for every record side, if you had the patience. Built-in automatic noise filter, around 3 kHz and nothing higher. You couldn't possibly chip the shellac record, even if you tried.

The BSR 810.

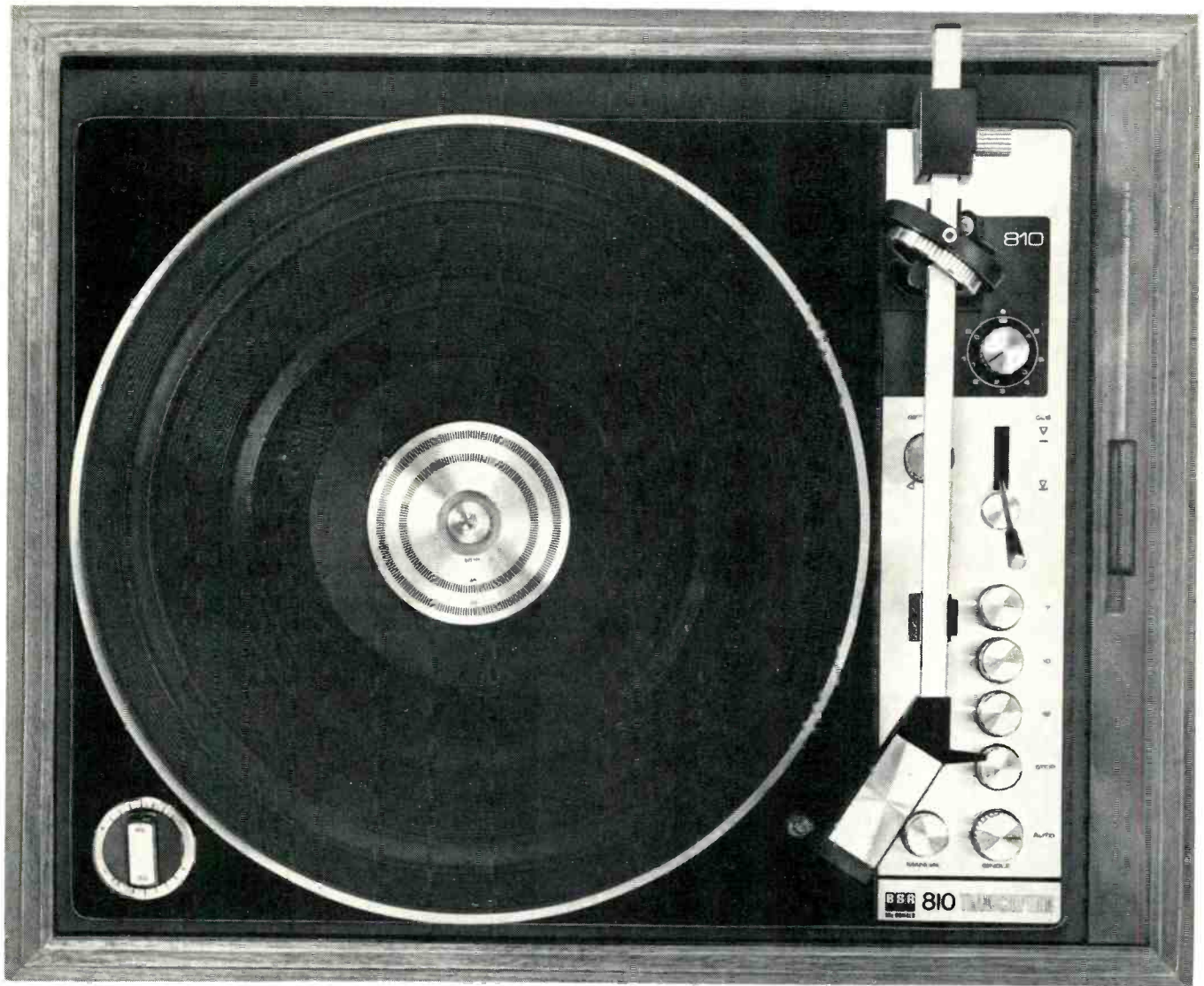

For the record.

The BSR 810 starts as a record player—a machine to spin discs and generate music.

It's a pretty special machine, loaded with engineering advances, design innovations, and all kinds of fancy hardware that impresses even professional audio experts who don't impress easily. The 810 looks classy, runs smoothly, keeps quiet, and is probably more reliable than any other record changer you can buy.

The 810 is all of these things; it fills many complex needs for many kinds of people. But if you just want to play records, it's just fine. You shouldn't settle for anything less... and you just can't find anything more.



BSR (USA) Ltd., Blauvelt, New York 10913

Check No. 10 on Reader Service Card

So the new age is here, and I am glad. I am fascinated with the possibilities for us Americans, once we really accept the economical sanity that is about to break upon us. Just look back—we're already that far away—on the dizzy, zany age that is now gone. An era, you know, is often better reflected by its words, what it says, than what it does. For years I've been writing down the Bigger-and Better dillies that I overhear, in conversations, off the air, just so I can remember them and so that posterity, some of it, may read and marvel.

Take my favorite grammatical nonsense out of that age, all too familiar, what I call the Dangling Comparison. (That idea comes from the dangling participle of our English classes: "Taking off his shoes, they went swimming.") It is, rather, a limitless non-comparison, hanging tantalizingly, unfulfilled, absolutely meaningless (but oh—so persuasive). Part of our general madness in these last fine years! The Dangling Comparison is useful, all right. "Krispie Krunch give you MORE." More what? They never say. More everything, anything. Sounds so good. Ginger ale is better. Oh yeah? Gasoline is faster. And liquor is quicker. You get the idea. How could you help it? Listen to this genuine one, taken off the air in the very middle of Bigger and Better, Hallowe'en eve, Oct. 31, 1965. A new FM station in the New York region. It described itself thus: "This is station XXXX-FM—where more New Yorkers listen to the most, in stereo."

Well, I'm a more New Yorker, all right. As a New Yorker, after all, I *must* be more. But have I ever listened to the most? That's a question. I can do you better, with the quote that is the title of this piece. It was real. On June 6th of 1966, I rushed to my typewriter to get down this succinct dilly of a commercial message. It sums up the whole crazy, wonderful age we are now leaving. "Enjoy Total Everything—All Day!" End of message. End of era.

* * *

Will our present sh---ges (don't say that word!) mean, shortly, that fewer New Yorkers will be listening to the least, in mono? I doubt it. I think that we may even be able to enjoy Total Everything, if we are really careful. All day, too. But it's going to take every bit of our traditional ingenuity, swung over to a new viewpoint, a new game plan. I expect, then, that I will be into a lot of the facets of our own audio area these next months, as seen along such stimulating and challenging new lines. I'm not bearish. I just believe in keeping the eyes open, the better

to see ahead. The power of positive thinking, yes?

2. Noise

Look briefly at audio noise. It's a big thing, these days. It'll get to be an even bigger thing, I suspect, as those sh---ages (don't mention them!) ease their way into our taken-for-granted quality standards. Noise in sound reproduction is maybe the first thing to be affected by our, er, changed circumstances. It isn't yet. I'm just looking confidently ahead.

Confidently, because of the wealth of superb thinking and engineering that has gone into noise reduction in these last few years. There's Dolby, and JVC, and in another general category, DBX and Burwen, and the Editor can probably add a dozen more right here. Whatever the brand, the fact is that most of these systems have been primarily occupied with the fruitful area of tape. The tape makers, too, hand in hand with noise reduction electronics. Lovely cooperation, from two vantage points, the tape itself and the selective suppression of unwanted residual noise. But noise reduction must go where the noise is. Noise is where there exists an imperfect medium—tape, for instance. But noise, too—do not forget—is when deterioration sets in. And where will that be but on *disc*. That is where my mind is roaming right now.

In WW II, you may remember, our supply of shellac for discs was inconveniently cut off by the Enemy, who took over and wouldn't send us any. Plastics? They went to war, but weren't advanced to the point of usefulness in 78s. So what did ingenuity do? For lack of any other solution, we suddenly found ourselves turning in an old shellac record for every new one we bought. Round and round! Reprocessing. (Where have I heard that term before?) This Spartan approach kept the record biz more or less alive for a number of crucial years. I wouldn't say it thrived. It existed. We had new records. Of course the quality, never any too good in terms of noise, went from awful to subliminal and horrendous. Better horrendous noise, we thought, noise and music 50/50, than no music at all. So we bought records, and we played records, on the recirculating basis.

We could do a lot better now. It might come to pass, I'd say, that one of these days we will start recirculating our present wad of vinyl. It would save untold tons of petroleum. That's enough to make us think twice, and stay one step ahead of the allocations. If this were to happen, the first big challenge would land on the reproprocessors, to make

old vinyl sound like new. We are good at things like that. But we start off, in this case, with near-total silence on our present discs, whereas shellac's loud old hiss covered a multitude of sins. With our best efforts, recycled vinyl noise levels would creep up only slowly, quite slowly. Heroic efforts to minimize the effect.

The reproprocessors would soon have allies. A second approach is the use of noise reduction circuits. If our present noise reducers were to adapt themselves from tape towards disc, we could have new means to combat possible sonic deterioration. Between the reproprocessors and the noise circuit people, I think we could do some amazing things, to Preserve Our Natural Resources *and* keep the disc alive. Dolby, of course, has already spread out into other areas than tape: optical film tracks, FM stereo broadcasts. I was interested to find that DBX now has a disc noise reduction system, the whole two-step bit, code and decode, with special discs cut to the DBX characteristic and a decoding box to play them through. Total silence! (But there weren't any ticks to suppress.) No distortion that I could hear, on a once-through audition. I forgot to ask whether the discs could also be cut with SQ or CD-4 modulations. This system and/or others of a like nature could take care of a lot of problems, if and when. They just might have to.

But I doubt if present noise circuitry is the whole answer. Those ticks and pops, the violently on-off transients of vinyl noise, are very different from the less jagged noise you generally find on tape, which is what the present circuitry removes. The human ear is fiendishly sensitive to very tiny transients, the jagged kind, set against a silent background. You can hear a swarm of tiny ticks on vinyl that will scarcely register in a laboratory measurement.

Think back again to another time, when the great flood of LPs burst out in the early 1950s after the change-over from 78. It was the noisiest flood you ever heard, a billion ticks and pops a minute, and we just plain got used to it. Didn't even listen. That's one way out but it's not the best. Then came vinyl improvements, pressing improvements, and lo—there were only a thousand ticks a minute, then a hundred. Fantastic. The first Dolby tapes brought us, finally, the first tick-free discs, their clarity at last revealed. Well, maybe not free. But nowadays you can play a record for a minute and not hear a single tick. Maybe three or four on a side is par for the course in good records right now. Down on the micro-scale of the stylus

The speaker system that revolutionized speaker systems.



AR-3a

Professional audio critics and musicians agree that the AR-3a is probably the best speaker system designed for home use. It was the first to feature the highly sophisticated suspension woofer in a 3-way system. It also incorporated the industry's first hemispherical dome midrange and tweeter. These revolutionary drivers resulted in a new dimension of accuracy in sound reproduction.



The AR-3a remains unsurpassed in terms of low distortion, flat frequency response and broad dispersion as compared to any speaker system of its type.

If you recognize the difference between good sound and great sound, the AR-3a is the speaker system you'll want to own and enjoy.

For complete specifications please write.

ACOUSTIC RESEARCH, INC., 10 AMERICAN DRIVE, NORWOOD, MASS. 02062

Check No. 1 on Reader Service Card

STOP

BEFORE YOU BUY THAT RECORD . . .

WAIT A MINUTE!

IS IT REALLY A BARGAIN?
IS IT THE PERFORMANCE YOU REALLY WANT?

Check the other performances and recordings in the latest Schwann Record & Tape Guide.

If it saves you disappointment over one poor purchase, it's well worth the time to look in Schwann first.

Schwann-1 Monthly. Special new listing section has latest releases: records, 8-track cartridge and cassette tapes. Nearly 45,000 total listings on 773 labels in classical, recent popular, rock, jazz, musical shows, country, opera, ballet, electronic, quadrasonic, etc.

Schwann-2 Semi-annual catalog for specialized categories: pop more than two years old, classic jazz, older and re-released mono and reprocessed stereo classical recordings, classical on lesser-known labels, international pop & folk on domestic labels, spoken, educational, religious, etc.



SPECIAL PRICE SAMPLE OFFER

If your favorite store doesn't carry Schwann, order samples by mail. Prices include postage and handling.

- Schwann Sampler one Schwann-1 (monthly) and one Schwann-2 (semi-annual) \$2.50
- Latest Schwann-1 (monthly) \$1.50
- Latest Schwann-2 (semi-annual) \$1.25
- Newly revised Basic Record Library booklet.

Lists 1,000 suggestions in classical music by musical periods for your enjoyment. Send 15¢ for cost of handling, also 8¢ stamped self-addressed long envelope.

I enclose \$.....for the items checked above.

Name _____

Address _____

City _____ State _____ Zip _____

Dealer's Name & Address _____

Schwann Record & Tape Guide

137 Newbury Street, Boston, Mass. 02116

AU

tip, though, it doesn't take micro-much to set off a very loud noise. Our present standards are almost too high to last.

Somehow, then, the noise reduction circuits, one-step direct and/or two-step code-decode, must begin to re-think themselves in terms of this thorny disc noise pollution, even before we have it, if we ever do. A rough challenge. It might be important. I would think that the immensely sophisticated computer-speed actions in this advanced type of circuitry might be able to do a lot for those swarms of ticks and pops. (If anybody needs samples, I have thousands from the 1950s.) If not to eliminate them, then to reduce them to genteel unobtrusiveness.

Maybe they can round off the jags, convert those vicious little sonic cliffs and gorges into smooth little hills, up and down as gently as you please. Like the live-audience concert coughs that get edited into gentle swishes. Maybe they could average the little hills down to a gray noise—and then simply remove the noise? Double action. I just can't wait for the pops and ticks to begin.

Oh yes—the glass disc. Just a rumor I heard, but I suspect it's out there. Of course, we have all sorts of discs waiting in the wings. Most of them involve far-out conversion, like the "TV discs," and so are impractical for the moment, at least in a big way. A glass disc is something else. Play anywhere.

The rumor (I'll call it a rumor, just to be safe) is that Corning has a special type of glass which can be *pressed directly into grooves*, and is flexible enough not to break easily. It does not use petroleum. Glass generally is made of sand and gravel and such junk, of which we would seem to have plenty all over the place. Eureka! What are we waiting for? Smooth as glass? Maybe this would solve all our noise problems in one fell swoop. So to heck with vinyl.

Well, not quite. Maybe this glass deal isn't yet right around the corner. We still might have to make do with the noisy stuff, as described above. If we must, then we will. So common sense says think vinyl, all the way. Until Corning takes over.

If we use our good heads this way, we should be ready for anything—glass, vinyl, maybe even shellac. And I'm not even talking about the day when sawdust makes its debut, all unheralded, as a vinyl extender. Or maybe pumice, mica, chicken feed. Who knows. I'm not being bearish because these things will *not* happen. But in our present circumstances we must think that they *might* and be ready. So many more challenges to our ingenuity! It'll be exciting.

Æ

READER INQUIRY CARD

MARCH 1974

THIS CARD EXPIRES MAY 31, 1974.

CHECK BOX A or B beside each coupon number

A to help me make an immediate decision to purchase

B to explore a new method or to keep my files on the subject to date

1

| | A | B | | A | B | | A | B | | A | B | | A | B | | A | B | | A | B | | | | | | |
|----|---|---|----|---|---|----|---|---|----|---|---|----|---|---|----|---|---|-----|---|---|-----|--|--|-----|--|--|
| 1 | | | 16 | | | 31 | | | 46 | | | 61 | | | 76 | | | 91 | | | 106 | | | 121 | | |
| 2 | | | 17 | | | 32 | | | 47 | | | 62 | | | 77 | | | 92 | | | 107 | | | 122 | | |
| 3 | | | 18 | | | 33 | | | 48 | | | 63 | | | 78 | | | 93 | | | 108 | | | 123 | | |
| 4 | | | 19 | | | 34 | | | 49 | | | 64 | | | 79 | | | 94 | | | 109 | | | 124 | | |
| 5 | | | 20 | | | 35 | | | 50 | | | 65 | | | 80 | | | 95 | | | 110 | | | 125 | | |
| 6 | | | 21 | | | 36 | | | 51 | | | 66 | | | 81 | | | 96 | | | 111 | | | 126 | | |
| 7 | | | 22 | | | 37 | | | 52 | | | 67 | | | 82 | | | 97 | | | 112 | | | 127 | | |
| 8 | | | 23 | | | 38 | | | 53 | | | 68 | | | 83 | | | 98 | | | 113 | | | 128 | | |
| 9 | | | 24 | | | 39 | | | 54 | | | 69 | | | 84 | | | 99 | | | 114 | | | 129 | | |
| 10 | | | 25 | | | 40 | | | 55 | | | 70 | | | 85 | | | 100 | | | 115 | | | 130 | | |
| 11 | | | 26 | | | 41 | | | 56 | | | 71 | | | 86 | | | 101 | | | 116 | | | 131 | | |
| 12 | | | 27 | | | 42 | | | 57 | | | 72 | | | 87 | | | 102 | | | 117 | | | 132 | | |
| 13 | | | 28 | | | 43 | | | 58 | | | 73 | | | 88 | | | 103 | | | 118 | | | 133 | | |
| 14 | | | 29 | | | 44 | | | 59 | | | 74 | | | 89 | | | 104 | | | 119 | | | 134 | | |
| 15 | | | 30 | | | 45 | | | 60 | | | 75 | | | 90 | | | 105 | | | 120 | | | 135 | | |

Name _____

Address _____

City _____ State _____ Zip _____

Are you a subscriber to AUDIO Magazine? Yes No

READER INTEREST INFORMATION:

- 1 High Fidelity Enthusiast
- 2 Home Recordist
- 3 Professional Recordist
- 7 Other _____
- 4 Broadcast Engineer / Manager
- 5 Audio Service Technician
- 6 Audio Manufacturer or Dealer

I would like to see more Technical articles Articles for beginners
 Construction projects Articles on music
 Music reviews Classical Jazz Rock
 Other _____

I buy an average of _____ records a year Age _____

I have purchased the following equipment after seeing it advertised in AUDIO Magazine _____

I am planning to purchase the following equipment in the next year _____

Comments _____

SUBSCRIBE

Don't wait until your subscription runs out. Renew now and insure uninterrupted service. The remaining issues on your current subscription will be added. Postage will be paid.

Gentlemen: Please enter my subscription to **AUDIO**.

Name _____

Address _____

City _____ State _____ Zip _____

- New Subscription Payment Enclosed
- Renewal Bill me
- 1 Year—\$6 2 Years—\$10 3 Years—\$14
- (Foreign—\$9) (Foreign—\$15) (Foreign—\$20)

You may pay for your subscription on your credit card.

Credit Card No. _____ American Express

Diners Club

Master Charge

Card expires _____ Bank No. _____

Signature _____

| |
|--|
| |
| |

For office use

1

FIRST CLASS
Permit No. 22,489
Philadelphia, Pa.

BUSINESS REPLY MAIL

No Postage Necessary if Mailed in the United States

POSTAGE WILL BE PAID BY:

AUDIO

134 North Thirteenth St.
Philadelphia, Pa. 19107

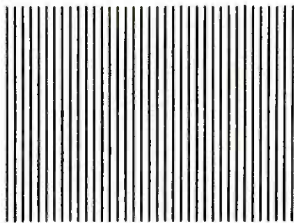

FIRST CLASS
Permit No. 22,489
Philadelphia, Pa.

BUSINESS REPLY MAIL—No Postage Necessary if Mailed in the United States

Postage will be paid by

Audio Magazine
P.O. Box 8671
Philadelphia, Pa. 19101

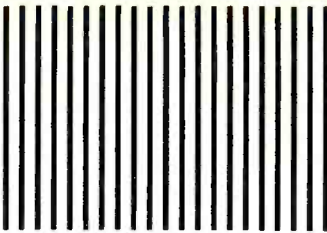

READER INQUIRY CARD

Fill in other side to get more information on advertised products

SUBSCRIPTION ORDER CARD Fill in other side to order a new subscription



Soundcraftsmen PE2217—the NEWEST Preamp...

... the most controls... the most flexibility... the most functions...
the most useability... a \$1,000 worth of control for \$499.50!

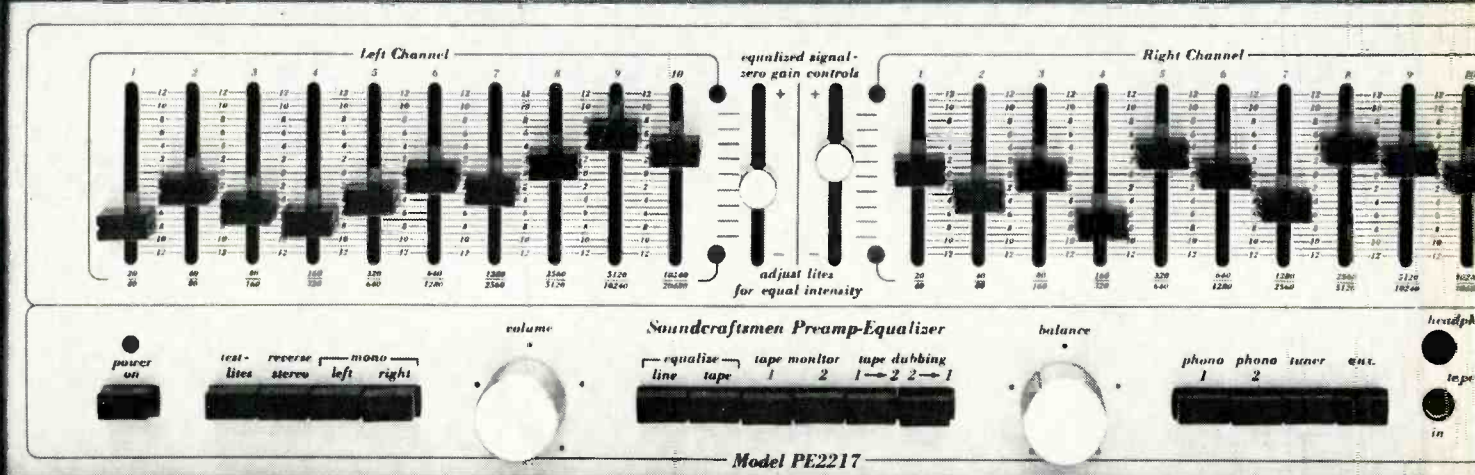

Audio engineers agree that the ultimate Preamp must have all the CONTROL flexibility of a patch panel... our new PE2217 has pushbutton-patching, plus 22 more MUST features...

\$499.50

includes walnut-grain cabinet, or rack-mount.

- ALL PUSHBUTTONS INTERLOCKED to prevent inadvertent program destruction
- DISCRETE-OCTAVE EQUALIZATION CONTROL of ten octaves on each channel, $\pm 12\text{db}$ each octave
- FULL-SPECTRUM LEVEL CONTROL for each channel
- AUTOMATIC CONTINUOUS MONITORING by light-emitting diodes for visual warning of overload in output circuits
- VISUAL ZERO-GAIN EQUALIZATION BALANCING on music, white noise or pink noise
- SELECTION OF TEST LITES on or off.
- TAPE DUBBING BETWEEN TWO MACHINES, with optional simultaneous equalizing and monitoring
- DOUBLE-DUBBING into two recorders simultaneously
- SEPARATE SYSTEM-SELECTION enables full use of all other functions during the tape dubbing operation
- LINE OR TAPE equalization selector
- AUTOMATIC EQUALIZER-DEFEAT when line or tape equalizer is not in use
- FRONT PANEL TAPE input-output jacks for easy 2nd and 3rd tape recorder hookup access
- TAPE MONITORING of either tape at any time
- TWO stereo headphone jacks
- MONO SELECTOR for left, right or both channels to both outputs
- REVERSE-STEREO mode
- TWO low-level phono inputs
- FOUR independent phono preamps
- SIX A/C outlets, 4 switched, 2 unswitched
- ELECTRO-PLATED FERROUS CHASSIS — (eight sections) — provides optimum shielding to minimize magnetic field-coupling
- SINGLE-POINT system ground connector minimizes ground-loops
- TWO REGULATED power supplies.

SPECIFICATIONS

FREQUENCY RESPONSE — Hi-level inputs: $\pm 1/4\text{dB}$, 5 Hz to 100 KHz
FREQUENCY RESPONSE — Phono inputs: $\pm 1/2\text{dB}$, 20 Hz to 20 KHz (Typ. $\pm 1/4\text{dB}$)
HARMONIC DISTORTION: less than .05% at 1 volt, (Typ. .01% at 1 volt)
IM DISTORTION: less than .05% at 1 volt, (Typ. .01% at 1 volt)
SIGNAL-TO-NOISE — Hi-level inputs: 100 dB below full output
SIGNAL-TO-NOISE — Phono inputs: 84dB below a 10mv input
SIGNAL-TO-NOISE — Equalizer section: 90dB below a 1 volt input
GAIN — Phono: 57dB
GAIN — Hi-Level: 15dB
INPUT IMPEDANCE — Phono: 47,000 ohms
INPUT IMPEDANCE — Hi-level: 50,000 ohms
OUTPUT IMPEDANCE: 600 ohms
MAXIMUM OUTPUT: 5 volts into hi impedance, 2.5 volts into 600 ohms

EQUALIZER LEVEL: Zero-gain controls for left and right channels, continuously variable, for unity-gain compensation from -12dB to $+6\text{dB}$.
EQUALIZER RANGE: 12dB boost and 12dB cut, each octave centered at 30, 60, 120, 240, 480, 960, 1920, 3840, 7680 and 15,360 Hz.
MAXIMUM OUTPUT SIGNAL: Variable master volume control allows adjustment of optimum output to match amplifier capability up to 5 volts.
CIRCUIT BOARDS: Military grade G-10 glass epoxy
RESISTORS: Low-noise selected carbon-film
POWER SUPPLY: Separate supply for phono and equalizer
DIMENSIONS: Walnut-grained case $7\frac{1}{4}$ " high x 20" wide x $11\frac{1}{4}$ " deep. Genuine oiled-walnut cabinet available, \$49.00 extra. Front panel size $5\frac{1}{4}$ " x 18" Rack-mount panel size $5\frac{1}{4}$ " x 19", \$20.00 extra.
WARRANTY: 2 years parts and labor
SHIPPING WEIGHT: 28 lbs.

Check No. 41 on Reader Service Card

Soundcraftsmen • 1721 Newport Circle, Santa Ana, California 92705

From The Ortofon Test Record Library

Henning S. Madsen*

KEEPING TRACK of the test records available in the world is almost a full time job, particularly if one wants to know what is cut into the records and what this can tell you when testing a particular phonograph cartridge. Ortofon has quite a library but fortunately only a few of them are used frequently. The important measurements are: frequency response and crosstalk, output, square-wave response, distortion, tracking angle, and tracking ability.

These measurements can be conducted on various test records, but how does one choose from the big selection? Ortofon has been cutting quite a few test records themselves, and therefore it is natural to standard-

ize on some of our own, but on top of these, quite a few other records are frequently used. In reviews and technical articles test results are reported, and it is necessary to be able to repeat these measurements. Since Ortofon cartridges are sold in most countries of the world, we end up using German DIN records as well as American and Japanese test records.

After a very brief description of how a magnetic cartridge works, our test record collection is listed. Finally the instrumentation which is necessary for carrying out various measurements is discussed together with typical results. The conclusion deals with the difficulties encountered in making measurements involving records. A standard measuring method applying some kind of a piezoelectric shaker is suggested. Two earlier articles about test records

can be recommended (ref. 1 and 2). They give many fundamentals.

Magnetic Phono Cartridge Principle

A magnetic phonograph cartridge is a transducing element capable of changing the mechanical movement to which the stylus is subjected in the record groove into electrical signals. The most common method is via a tiny rod magnet mounted at the end of the cantilever opposite the stylus in a magnetic airgap. Figure 1 illustrates how the armature is pivotally mounted at its center of gravity. Variations in the airgap cause a varying magnetic flux through the pole pins, which in turn induces an electrical voltage across the two surrounding coils connected in series.

The guiding mathematical formula for such a magnetic transducer is given below (ref. 3):

$$e = Tv$$

where v is the velocity; T is the electro-mechanical coupling factor which only depends on the magnetic circuit, and e is the voltage. This tells us that the magnetic pickup is a velocity transducer and not an amplitude transducer as the crystal pickup. This is important to know when talking about frequency response measurement. A flat frequency response measurement requires a test record with a constant velocity sweep

*Ortofon Manufacturing A/S, Valby, Denmark

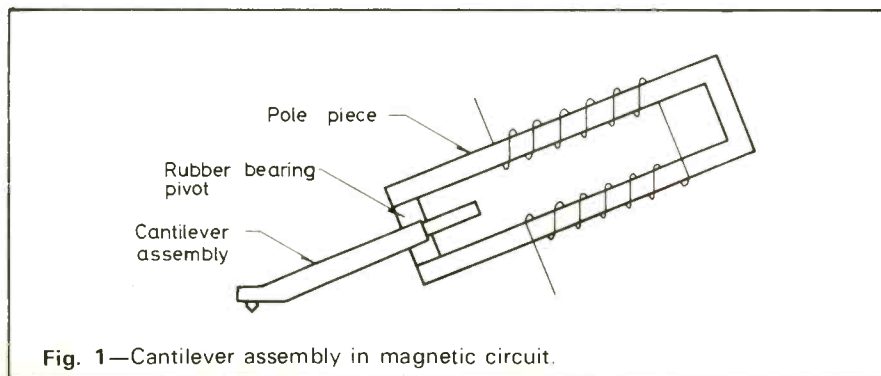

Can you live without a 400 watt amplifier?

Maybe. If you're content to listen to music at a less than realistic level. Or if you don't mind the loss of quality caused by clipping during the more dramatic passages in your favorite records. On the other hand, if you want to listen at a real-life level without distortion, you need *at least* 400 watts of amplifier power. Other things being equal, the more power you have to drive those fine speakers, the more faithful the sound. Julian Hirsch put it this way: "Anyone using a low-efficiency speaker . . . with an amplifier in the 30 to 50 watt class cannot approach realistic listening levels without severe clipping." And *Audio*, after listening to the Phase Linear 400, said, ". . . many people do not realize just how much power is necessary to handle peaks without clipping . . ."

Stereo Review summed up: "A superb amplifier, furnishing the essential qualities of the (Phase Linear) Model 700 at a much lower price (almost a bargain in today's market)."



Advanced design heat sink provides protective cooling.

At \$499.00 why live with anything less than the Phase Linear 400? Ask your dealer for an audition.

Phase Linear 400

THE POWERFUL DIFFERENCE

PHASE LINEAR CORPORATION
P.O. BOX 549
EDMONDS, WASHINGTON 98020

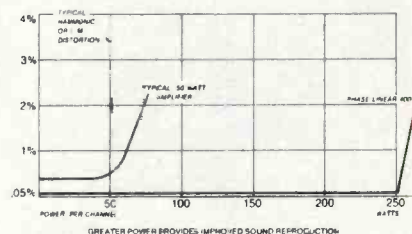

Phase Linear 400
400 watts RMS direct coupled solid state stereo power amplifier.

POWER: Greater than 200 watts/channel RMS both channels driven into 8 ohms. Power at clipping typically 250 watts/channel into 8 ohms and 400 watts/channel RMS into 4 ohms. **HARMONIC OR I.M. DISTORTION:** Less than .25%, typically less than .05%.

PROTECTION: Patented protection circuit monitors energy, shuts down amplifier if safe operating levels are exceeded. **HUM AND NOISE:**

Better than 100 db below 200 watts. **STABILITY:** Absolutely stable with all speaker loads including electrostatic units. **WARRANTY:** Three years, parts and labor.

PRICE: \$499.00

WALNUT CABINET: \$37.00.

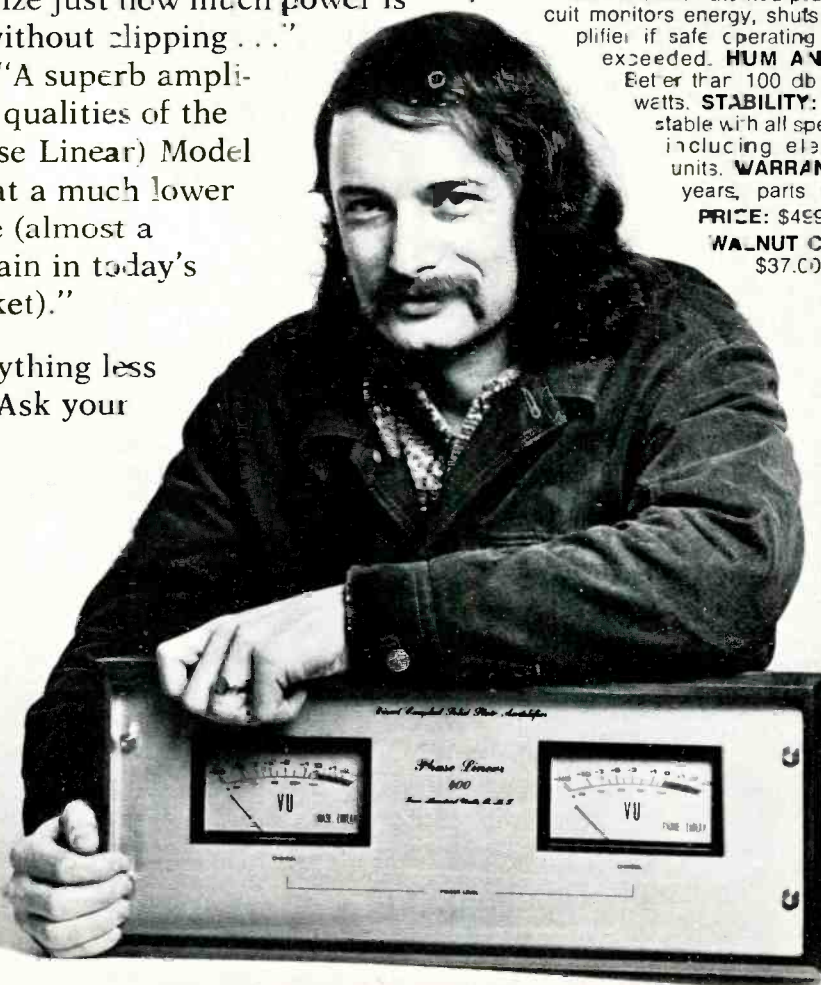

Check No. 27 on Reader Service Card

from 20 Hz to 20 kHz or more. We will return to this subject later.

One special magnetic cartridge is the moving-coil cartridge. It works by moving a few turns of a coil in a homogenous magnetic field. A step-up transformer or preamplifier is normally required. Also this kind of transducer is of the velocity type.

Test Record Library

Table 1 lists the records presently in Ortofon's library. A description of

what type of measurements can be performed with the records is also given, though a detailed specification is not included. Some of the test records have been the subject matter for technical papers. In these cases the reference literature is given.

Most Frequently Used Records

The output level at 1 kHz of both channels at a standard velocity of 3.54 cm/s rms is a rather important figure. The laboratory standard record is the

CBS STR 100. It is a very simple measurement requiring only a record player and an electronic voltmeter. In between can be connected a left/right switching box with the standard electrical load of 47-Kohms built in. In this way also the separation or crosstalk can be measured.

Why is this measurement important? It is because it correlates with many other important figures like frequency response and tracking ability. If the pivot point is not correctly mounted, the moving mass is increased and a drop at 20 kHz results but at the same time the output voltage is either increased, that is when the pivot point is moved closer to the stylus allowing greater movement of the armature in the airgap, or decreased when the pivot is moved away from the stylus. The first situation also reduces the tracking ability at low frequencies because the compliance is reduced. One can see that a high output normally characterizes a cartridge with a low performance. On the other hand, there is a minimum output which can be tolerated in order to keep the signal-to-noise ratio high.

That the difference between the channels is not too great is measured at the same time. All these measurements are included in the performance test in the quality control at Ortofon. The OR 1013 is presently the test record which every single cartridge must play before leaving the factory. The relative level at 7.5 kHz, 15 kHz and 20 kHz is also tested.

The tracking ability at 300 Hz is also tested with this record. The laboratory standard is the German HiFi record No. 2 which has increasing levels from 20 μ m peak to 100 μ m peak at 300 Hz. A combination of watching the signal on a dual-beam oscilloscope and listening with headphones is used. Figure 2 shows the set-up.

Frequency response is a very common measurement in the laboratory. Usually the OR 2015 test record is used. It has a very fast sweep. The measuring set-up is shown in Fig. 3 and a typical result is shown in Fig. 4. The curve is not flat in the low end since it is not possible to cut a constant velocity of 3.54 cm/s down to 20 Hz as the cutterhead is not able to cut such large amplitudes. The RIAA characteristic is adopted on this record in the low end. Another test record, the CBS STR-100, has a constant amplitude up till 500 Hz and then a constant velocity from 500 Hz–20 kHz.

A more complicated measuring set-up is required if one wants the

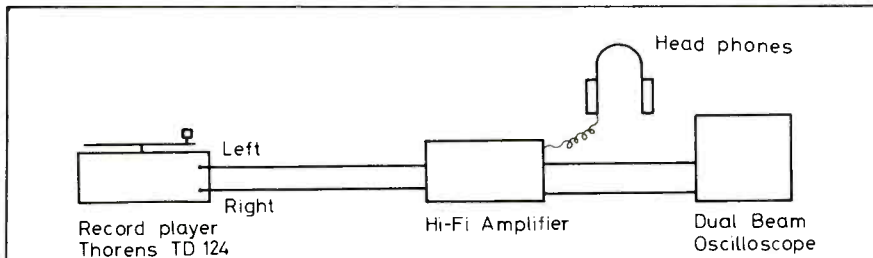

Fig. 2—Set-up for measuring tracking ability.

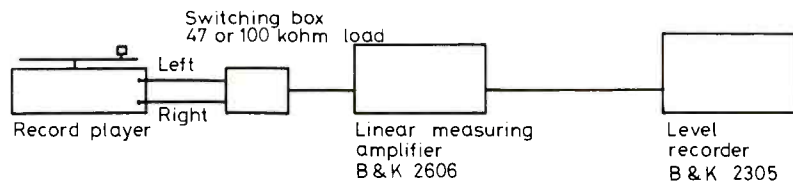

Fig. 3—Set-up for measuring frequency response and crosstalk.

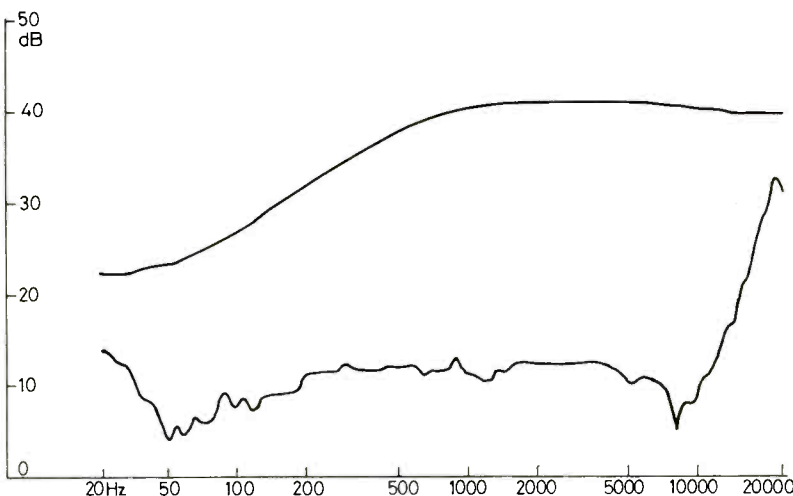

Fig. 4—Typical frequency response and crosstalk without low-end compensation.

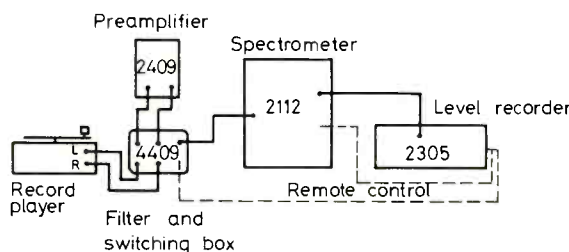

Fig. 5—Brüel & Kjaer measuring set-up with filter.

response to be flat down to 20 Hz. It involves a filter, and the crosstalk can only be measured if it is measured with a spectrometer. Brüel & Kjaer has a special arrangement for this measurement (Fig. 5 and ref. 4).

With the advent of the CD-4 four-channel system, new test records with frequency sweep up to 50 kHz were required. Ortofon has, in cooperation with the two other Danish companies, Brüel & Kjaer and Bang & Olufsen, cut the new test record QR 2010 which has a very fast sweep like the OR 2015. Measuring CD-4 cartridges can be done on the same measuring set-up if the switching box has a built-in alternative electrical load of 100 Kohms as required for CD-4.

The JVC record TRS 1005 is commonly used in the laboratory for measuring CD-4 cartridges. It has a sweep from 1 kHz to 50 kHz.

Distortion measurements are perhaps the most powerful measurements to establish the different cartridges' ability to reproduce sound from records. Distortion can be divided into harmonic distortion and intermodulation distortion. The latter of these is most frequently used and several test records are available.

At Ortofon the German DIN record 45542 is most frequently used. It has two different tones, 300 Hz and 3000 Hz. The low tone has a level of 12 dB higher than the high tone. If the low tone is filtered out, only the high tone should remain but some trace of the low tone will usually remain. See Fig. 6. These low-pitched variations can be detected with a wow-and-flutter meter, as shown in Fig. 7. Figure 8 shows the result for two Ortofon cartridges.

A recent test record from Shure, TTR 103, has tone bursts of 10.8 kHz with a repetition frequency of 270 Hz (ref. 5). This record will tell about tracking ability at higher frequencies because distortion is just a more technical term for tracking ability. The measuring set-up is shown in Fig. 9 with typical results in Fig. 10.

RCA presented long ago their two-glide-tone intermodulation test record (ref. 6). With the wave analyzer set at the difference tone, the distortion is measured up to 20 kHz at four different levels. Figure 11 shows typical results.

The harmonic distortion measurement has more recently become a very sophisticated test since new measuring equipment has made it possible to measure the second, third or any higher harmonic during a sweep. The measuring set-up involves a heterodyne ana-

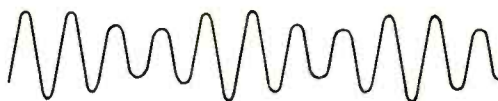

Fig. 6—3 kHz with 300 Hz modulation.

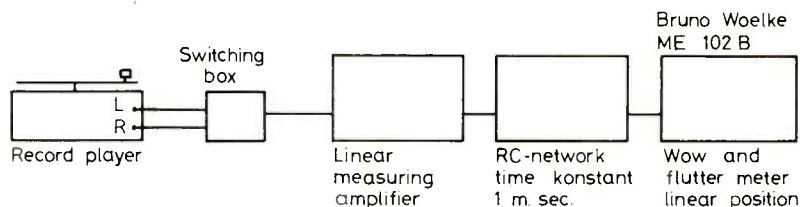

Fig. 7—Set-up for measuring frequency intermodulation distortion (FIM).

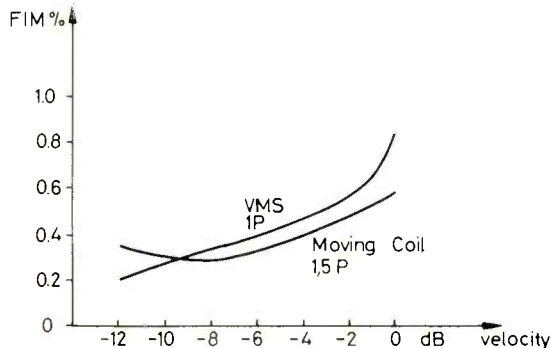

Fig. 8—Non-linear distortion (FIM). 0 dB: $v(300 \text{ Hz}) = 8 \text{ cm/sec}$, $v(3000 \text{ Hz}) = 2 \text{ cm/sec}$.

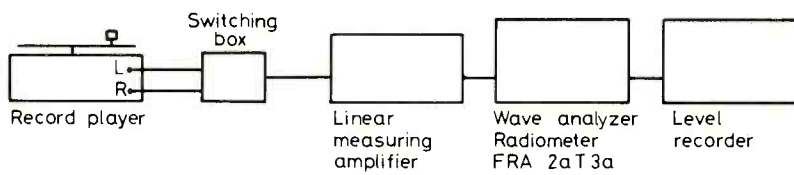

Fig. 9—Set-up for measurements incorporating a wave analyzer.

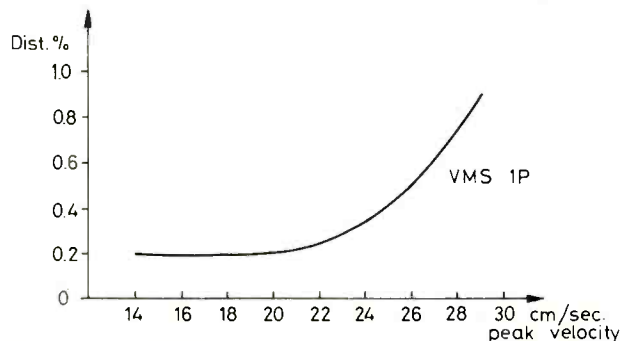

Fig. 10—High-frequency trackability. Test record TTR 103.

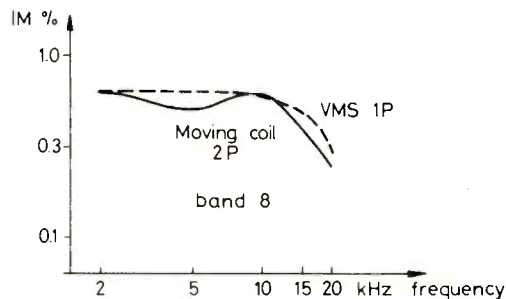

Fig. 11—Intermodulation. Two-tone glide.

lyzer and a tracking frequency multiplier, as shown in Fig. 12. Figure 13 shows typical results.

The *tracking angle* is the angle between the record surface and a line from stylus tip to the pivot point. For many years this angle has been 15° as a standard, but recently a change to 20° has been recommended because 15° was very difficult to meet. It is very important that the angle with which the record is cut coincides with the tracking angle during replay, since the distortion increases tremendously if this is not the case. The way to measure the tracking angle is by means of distortion. Again, the German DIN record 45542 is adopted. Two different tones are cut into the record simultaneously with different angles from 6 to 30 degrees. When measuring with a wave analyzer adjusted to the sum frequency, one gets

a minimum output when there is a coincidence between the pick-up tracking angle and the angle with which the groove is cut. See Fig. 9.

Square-wave response. As when testing loudspeakers and amplifiers, a square-wave response will tell a lot about the performance of a cartridge. The CBS record STR 111 has 1 kHz square waves. Figure 14 shows the result as watched on an oscilloscope. The overshoot and ringing should be as little as possible as this is a measure of difference between actual sound and reproduced sound.

Among *miscellaneous* records used for testing, the Pacific Transducer Corp. 102M and 103L are very informative. They have 70 Hz–10 kHz and 70 Hz–15 kHz sweep respectively, repeated at high rate so that the whole response can be watched on an oscilloscope. Output

level, frequency response, and tracking ability can be detected at a glance.

The *absolute phase* of a cartridge is not important as long as only stereo is involved, but the four-channel CD-4 cartridge must have a positive response when the stylus moves to the periphery of the record. JVC has come out with the test record TRS 1004 for testing the absolute phase. It has a square-wave cut with a shorter positive cycle than negative cycle. For correct phasing, the shorter wave must always go positive if the measuring equipment is not changing the phase.

New Standard Equipment

The foregoing were the various measurements and tests frequently performed on phonograph cartridges using test records. One big problem with these tests is that records are never 100 per cent the same. They change with wear, temperature, pressing, and material. In order to get reproducible results, one has to go through elaborate testing with standard cartridges. It would be of great help if someone would develop some kind of shaker which could be internationally adopted as a measuring standard. At Ortofon we often use a cutterhead directly but this cutterhead and the cartridge are both magnetic devices and this causes big shielding problems. The ideal shaker should be a piezoelectric device.

Of course it will always be necessary also to use test records since the action between the stylus and the moving groove never could be completely duplicated with a shaker, but a reference instrument which was the same for all parties involved would certainly be helpful.

The ultimate test is the listening test. Ortofon is paying an increasing attention to listening. What selections are we using? Well, this would lead into a new subject which gives material enough for a new article.

References:

1. Arnold Schwartz, *Test Records, dB*, April, 1969.
2. C.G. McProud, *How we test a phono cartridge*, AUDIO, August, 1972.
3. F. V. Hunt: *Electroacoustics. The Analysis of Transduction and its Historical Background*, Harvard U.P., Cambridge, Mass., 1954.
4. Brüel & Kjaer. Instruction Manual for level recorder type 2305.
5. C. Roger Anderson and Paul W. Jenrick: *A Practical High Frequency Trackability Test for Phono Pickups*, JAES, Vol. 20, No. 3.
6. J.G. Woodward and R. E. Werner: *High-Frequency Intermodulation Testing of Stereo Phonograph Pickups*, JAES, Vol. 15, No. 2.

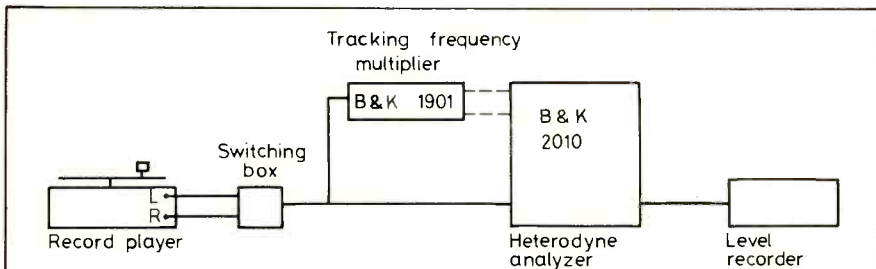

Fig. 12—Set-up for harmonic distortion sweep.

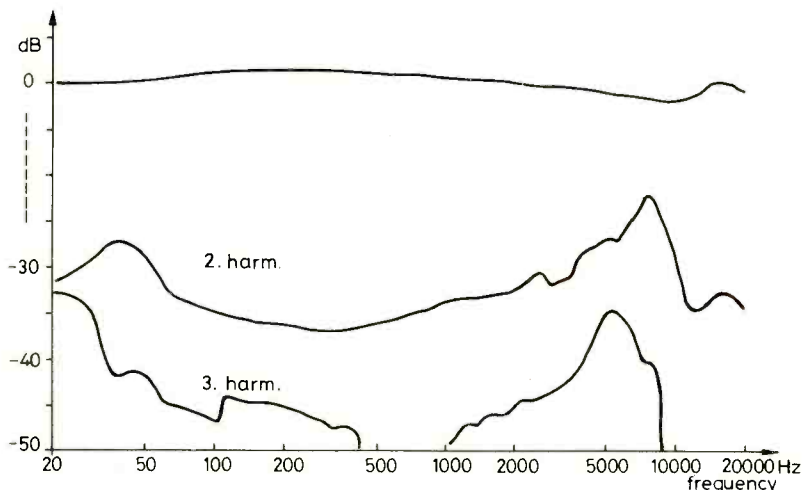

Fig. 13—VMS-cartridge, 1P. Frequency response, 2nd and 3rd harmonic. Test record QR 2009.

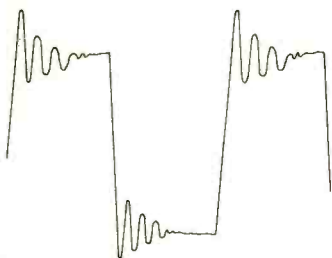
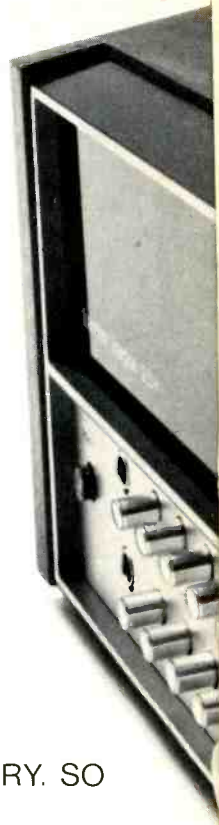

Fig. 14—Typical square-wave response.

| Brand name | Sweep | Spot Frequencies | Transient | Chan. recog- nition phas- ing balance | Music | Tracking Ability | Wow & Flutter | Rumble | Tone Arm Resonance | Tracking Angle | Inter-modulation | Miscellaneous |
|------------------------------|--------------|-------------------|-----------------|---|-------|------------------|---------------|--------|--------------------|----------------|------------------|------------------|
| Ortofon: | | | | | | | | | | | | |
| OR 2015 | S 20Hz-20kHz | | | | | 300Hz | x | x | x | | | |
| QR 2010 | S 20Hz-45kHz | | | | | 1kHz | x | x | x | | | |
| OR 1013 | | 1.7, 5, 15, 20kHz | | x | | 300Hz | | | | | | |
| OR 1010 A | | 3, 10kHz | | | | | | | | | | |
| OR 2008 C | M 20Hz-15kHz | | | | | 100Hz | | | | | | |
| OR 1006 A | | 1 kHz | | | | | | | | | | |
| Shure: | | | | | | | | | | | | |
| TTR 101 | | | | | x | x | | | | | | |
| TTR 102 | S 20Hz-20kHz | 1, 10kHz | | | | x | | | | | 400Hz-4kHz | |
| TTR 103 | | | | | | x | | | | | 10.8kHz | |
| CBS: | | | | | | | | | | | | |
| STR 100 | S 40Hz-20kHz | x | | | | x | | | x | | | |
| STR 111 | | | 1 kHz | | | | | | | | | |
| STR 120 | S 10Hz-50kHz | | RIAA pink noise | | | 300Hz | | x | | | 400Hz-4kHz | |
| STR 140 | | | | | | | | | | | | |
| STR 160 | | | | | | | | | | x | | |
| German HiFi: | | | | | | | | | | | | |
| Record No. 1 | | | | | x | | | | | | | |
| Record No. 2 | S 20Hz-20kHz | x | | x | | 300Hz | | x | | | | |
| Büel & Kjaer: | | | | | | | | | | | | |
| QR 2009 | S 20Hz-20kHz | | | | | | | | | | | |
| RCA: | | | | | | | | | | | | |
| 12-5-78 | | | | | | | | | | x | | |
| 12-5-105 | | | | | | | | | | | 2 tone glide | |
| Miscellaneous: | | | | | | | | | | | | |
| Ranger RRM-002 | | 1.3kHz | 1 kHz | | | | | | | | | |
| Dual PVK 321 | | 1 kHz | | | | | | | | | | |
| Goldring GMC-100 | | 1 kHz | random noise | | | 300Hz | | | | | | |
| HIFI Sound HF S 69 | | | | x | | x | x | x | | | | |
| Decca SXL 2057 | | x | | | | | | | | | | |
| Victor RG 1221/22 | | | | | | | | | | | | |
| Victor TRS 1003 | S 1kHz-50kHz | 1kHz-50kHz | | | | | | | | | | |
| Victor TRS 1004 | | 1kHz-50kHz | | | | | | | | | | |
| Victor TRS 1005 | | 1kHz-40kHz | | | | | | | | | | absolute phase |
| W & G WG 25/2434 | S 1kHz-50kHz | x | white noise | x | piano | x | | | | | | translation loss |
| Pacific Transducer Corp 102M | M 70Hz-10kHz | | | | | | | | | | | |
| Pacific Transducer Corp 103L | M 70Hz-15kHz | | | | | | | | | | | |
| Grado RL 1758 | | 1, 5, 10, 20kHz | | | | 300Hz | | | | | | |
| DGG LAB 0968/20 | | | | | | | | | | | | |
| DGG LAB 01127 = 2A2/01126 | | | | | | | | | | | | |
| Toshiba PRC 7 | | | | | | | | | | | | |

IT'S AS FAR AS YOU CAN GO.



IF YOU'RE UP WITH WHAT'S HAPPENING IN THE HIGH-FIDELITY INDUSTRY YOU'LL KNOW HARMAN/KARDON IS CURRENTLY PRODUCING THE WORLD'S MOST ADVANCED RECEIVER LINE.

THIS 900+ IS THE CREAM OF THAT LINE.

IT CARRIES BOTH DISCRETE AND MATRIX FOUR-CHANNEL CIRCUITRY. SO IT WILL REPRODUCE EVERY TYPE OF QUADRIPHONIC MUSIC AVAILABLE. MOST FOUR-CHANNEL RECEIVERS CARRY ONLY ONE.

THE 900+ PUTS OUT AN ASTONISHING 32 WATTS PER CHANNEL, CONTINUOUS, WITH ALL CHANNELS DRIVEN SIMULTANEOUSLY. THAT'S A GOOD DEAL MORE POWER PER CHANNEL THAN MANY STEREO RECEIVERS CAN MUSTER.

THE 900+ DOES NOT WEASEL THROUGH THE PROBLEM OF STEREO RECORD REPRODUCTION BY MERELY SHUTTING OFF THE TWO REAR SPEAKERS. INSTEAD, IT USES A UNIQUE PHASE SHIFT NETWORK TO PRODUCE AN ENHANCED STEREO SOUND THROUGH ALL FOUR SPEAKERS. YOUR STEREO RECORD LIBRARY WILL SOUND BETTER THAN EVER.

BUILT INTO THIS REMARKABLE MACHINE IS AN ANALOG COMPUTER THAT DISTINGUISHES BETWEEN MUSIC AND NOISE ON FM SIGNALS. NO OTHER RECEIVER

CAN PIN DOWN A STATION WITH SUCH HAIR-SPLITTING ACCURACY.

AND LIKE OTHER HARMAN/KARDON PRODUCTS, THE 900+ CARRIES ULTRA WIDEBAND CIRCUITRY. THIS ABILITY TO REPRODUCE FREQUENCIES YOU CAN NOT HEAR, SIGNIFICANTLY IMPROVES THE CHARACTERISTICS OF THOSE FREQUENCIES YOU CAN HEAR. HARMAN/KARDON PRODUCTS

ARE WORLD FAMOUS FOR THEIR FIDELITY.

IF YOU ARE IN QUEST OF THE PERFECT SOUND, THIS

COULD BE WHAT YOU'RE

LOOKING FOR.

harman/kardon

55 AMES COURT, PLAINVIEW, N.Y. 11803, U.S.A. ALSO AVAILABLE IN CANADA

Check No. 20 on Reader Service Card

Nine CD-4 Phono Cartridges Tested

B. V. Pisha

IN OCTOBER 1970, the world was first introduced to a new phenomenon in the audio industry—CD-4—as presented by the Victor Company of Japan (JVC) at the fall meeting of the Audio Engineering Society in New York. This development, together with the CBS/Sony SQ and Sansui QS matrix systems, constituted a revolution not unlike that which occurred in 1958 when the stereo record was introduced.

The advent of compatible, discrete, four-channel, CD-4 recordings, with their FM-modulated 30-kHz carrier, brought about the need to develop a cartridge that would have a wide frequency response—beyond 30 kHz and preferably to 50 kHz—so as to properly reproduce the new CD-4 records that have almost three times the frequency range of conventional records. To accomplish this, the new cartridge had to have a lower mechanical impedance (mass) of the vibrating system and an elevated high-end resonant frequency. The new stylus tip, as developed by Shibata in Japan, was designed to meet these requirements by enlarging the contact area of the stylus. The Shibata stylus has nearly the same tip radius as the elliptical stylus but, also, four times as much contact area with the record groove. Proper reproduction of the recorded signal in the 30-50 kHz region requires intimate stylus-to-groove contact. In order to seat the Shibata tip firmly into the record groove, an increased tracking force of two grams is required. However, because of its increased contact area, the two-gram tracking force of the Shibata tip can be expected to decrease by about four times both record and stylus wear, as compared to a conventional elliptical tip tracking at 1.5 grams.

In June 1971, JVC marketed in Japan a CD-4 demodulator and the first CD-4 cartridge with the Shibata stylus, identified as the 4MD-1X. This cartridge was never sold in this country,

but is still available in Japan. To indicate the progress that has been made in the design of CD-4 cartridges, the early Victor 4MD-1X (manufactured by Victor) is profiled along with the other cartridges. The current JVC cartridge sold in this country is the 4MD-20X, manufactured by Audio-technica and similar to the AT-14S.

With RCA announcing that they were going to produce the CD-4 records, it did not take long for the industry to introduce the new-type cartridge. Currently, the influx of cartridges capable of reproducing the CD-4 records is increasing dramatically. It seems that every few weeks another cartridge manufacturer is announcing his intention to market the new-type cartridge. To date, only a few of the cartridges are available on the market. Most of these cartridges use the Shibata tip (Victor, Audio-technica, Technics, Ortofon, and Grace) either as a nude diamond or the diamond tip fused to a metal shank; Pickering/Stanton are using their Quadrahedral tip which is designed to cover the same contact area and is somewhat similar to the Shibata tip; whereas Grado Laboratories is continuing to use the conical tip, but with a low tip mass that obviates the need of a Shibata-type stylus to track CD-4 records. This, also, is the only standard cartridge with a very low inductance so that a lead as long as 20 feet may be used without a detrimental effect on the 30-kHz carrier signal.

As noted earlier, CD-4 cartridges are coming from many manufacturers and sometimes from unexpected sources. For example, AKG, well-known for their microphones and headphones, has been reported to be preparing to market a CD-4 type cartridge in three models, with the top cartridge to be designated the PU4E. The Diamond Stylus Co. of London also announced their forthcoming entry into the field with the MG14E and MD14D cartridges. (Additional CD-4 capable cartridges will be profiled later this year.—Ed.)

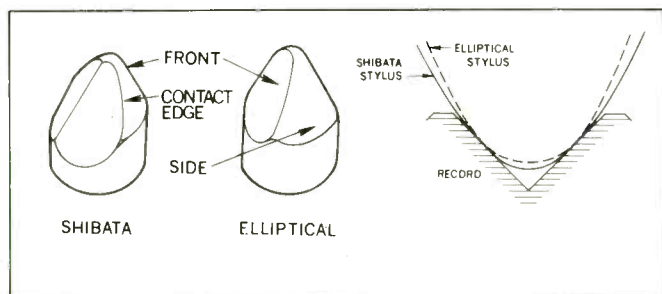

Equipment

To perform a reasonably accurate evaluation of the CD-4 cartridges, the playback equipment was chosen with great care. After trying a few direct-drive turntables, the Technics by Panasonic Model SP-10 and base was chosen because of its consistency and ability to preset the 33 $\frac{1}{3}$ - and 45-rpm speeds by individual speed controls. It is most important, when using test records at both 33 $\frac{1}{3}$ and 45 rpm, that the speed regulation remain constant as the speed rate is shifted from one to the other. Vertical rumble for the SP-10 is specified at less than -65 dB (DIN A) and less than -70 dB (DIN B), while wow



and flutter of less than 0.03% wrms is claimed.

A number of tone arms were examined and the Audio-technica AT-1009 was installed on the Technics turntable. The AT-1009 tone arm was specifically designed for use with CD-4 cartridges. The arm is lifted and lowered by a pneumatic control. One advantage of the AT-1009 tone arm is that the antiskating can be varied in the dynamic state when checking this parameter. It is essential that the anti-skating pressure be adjusted as accurately as possible for all CD-4 cartridges so that the front and rear right channels reproduce properly with a minimum of mistracking distortion. Our experience indicates that this is of primary importance, especially when lower-priced cartridges are installed in a tone arm or cartridges having other than the Shibata or Shibata-like configuration are used. The Audio-technica AT-1009 cable capacitance between the cartridge connectors and the phono plugs is 77 pF for the right and 78 pF for the left side.

The Shure Brothers C/PEK-3 Stereo Cartridge Analyzer with its accompanying test records (TTR-107 and TTR-103) was acquired and modified so that it could be used to evaluate the CD-4 cartridges with their 50-kHz bandwidth. The modified version of the C/PEK-3 will be available shortly from Shure Brothers. The C/PEK-3 was used to check channel orientation, crosstalk, balance tests, phase relationship, and antiskating and tracking force optimization. The monitor outputs on the C/PEK-3 with their 700-ohm output impedance appeared to introduce no recognizable errors, so the sweep-frequency response, IM distortion, and square-wave measurements were made from this point.

The sweep-frequency is plotted automatically on the Justi-Meter III, the graphic audio recorder designed and developed by the former editor and publisher of *AUDIO*, C. G. McProud, and marketed by Audio-technica U.S., Inc. The sweep source for this unit is supplied by the Bruel & Kjaer frequency-sweep record, QR-2009, with a range from 20 to 20,000 Hz. The high frequency-sweep range from 1000 to 50,000 Hz is supplied by the JVC test record, TRS-1005. The time of the sweep in the TRS-1005 is such that it matches the B&K QR-2009, assuming that the 1000-Hz reference tone is started at the 50 Hz mark on the chart. The actual high frequency-sweep starts at the 100 Hz line on the chart so that the recorded plot is just ten times the indicated frequency on the chart. We found the Justi-Meter III to be more than adequate for measuring cartridge performance. Its response closely matches a point-to-point response plotted for one cartridge. It is also quite use-

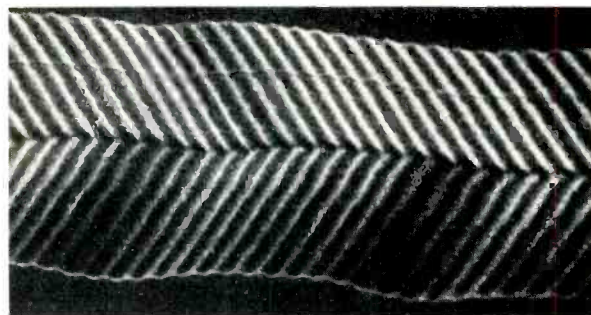

Discrete four-channel record groove as seen with the scanning electron beam microscope (original magnification 1500x). Each wall of the groove carries two sets of signals: the sum of the front and rear signals on the stereo base band and the difference of the front and rear signals on the carrier band.—*Courtesy RCA Records.*

ful for recording sweep-frequency response of amplifiers, filters and experimental units.

The measuring preamplifier has two positions—**FLAT** and **BASS BOOST**. The bass-boost position is equalized to provide a boost of 6 dB/octave below 500 Hz, and to be flat above that turnover frequency. IM measurements are made through the preamplifier which is set for **BASS BOOST**. The square-wave photographs are also made through the preamplifier when it is set to the **FLAT** position. The measuring preamplifier with its gain of 40 dB was described by C. G. McProud in *AUDIO*, June 1972.

To prevent the attenuation of the 30-kHz carriers, it is imperative that the cable capacitance between the cartridge and the input to the demodulator not exceed 100 pF total, which includes the wiring in the tone arm. This requirement places a burden on the salesman who is demonstrating a turntable that is quite a distance from the demodulator, as is the case in most every audio demonstration room. To overcome this problem, there is available from M&W Radio Corp., Williston Park, N.Y. 11596, a very small stereo booster amplifier voltage follower to which the turntable is connected by an audio cable not exceeding 100 pF per stereo side from the cartridge to the preamplifier. This unit properly loads the CD-4 cartridge. Subsequently, a length of audio cable not exceeding 8200 pF per stereo side may be connected between the output of the booster amplifier and the input to the demodulator. Up to 546 feet of low-capacitance cable (15 pF/ft) may be used without causing a significant response change or a phase rotation up to 50 kHz. The ideal location for this unit is inside the turntable base or separately close-by, thus eliminating the necessity of low capacity cable. The unit has been tested and approved by JVC for use in conjunction with CD-4 demodulators. We have tested all the cartridges in this evaluation with this booster amplifier, and all results were identical with the original results.

A Polaroid 350 camera is used to make all the square-wave photographs. The camera is fitted with a portrait lens adapter, as is the view finder, and a cable release. The camera is mounted on a rigid tripod and placed 19-20 inches from the oscilloscope. The intensity of the oscilloscope trace is reduced to a barely visible state after focusing the camera. With the black and white Polaroid film (speed 3000), the exposure time is three seconds. The exposures are made in a totally dark room to eliminate the light reflections from the face of the oscilloscope and to defeat the photocell shutter-control mechanism of the camera.

The remaining test equipment consisted of an IM distortion analyzer; an audio VTVM that can measure down to one millivolt, full scale; a resistance, capacitance, and inductance bridge; oscilloscopes, low-capacitance connecting cables made up from any of the following: Alpha 2312 (15 pF/ft), Columbia 01395 (11 pF/ft), or Daburn 2693 (11 pF/ft), and the following test records: B&K QR-2009, JVC TRS-1005, Columbia STR-111, Columbia STR-100, Shure Brothers TTR-107 and TTR-103, DIN 2, and Grado Laboratories RL-1758. We tested only one cartridge per day, thus providing a 24-hour recovery period for the groove walls of the test records as well as the CD-4 music test (listening) records.

To eliminate the power line variations, an autotransformer followed by a Variac is employed and the line voltage constantly monitored for a reading of 117 volts. The room temperature for all cartridge tests was maintained at $69^{\circ}\text{F} \pm 1^{\circ}$ and the relative humidity was $33\% \pm 3\%$.

Procedures

The cartridge to be tested is weighed on a gram balance-beam scale and the weight recorded. This is followed by the measurements of the d.c. resistance and the inductance. The stylus is then examined under the microscope at 200x to ascertain that it is clean and properly mounted.

Following these procedures, the cartridge is mounted onto the Audio-technica AT-1009 tone arm cartridge shell and adjusted for a 15 mm overhang. At this point the arm is balanced so that the stylus is about $\frac{1}{8}$ in. above a blank acetate disc and the stylus tracking pressure is then set using a Shure SFG-2 precision stylus force gauge. It is generally accepted that the ideal stylus pressure for the Shibata stylus (or its equivalent) is two grams when playing CD-4 discs. However, because there may be some CD-4 cartridges in the near future that should not be used at a two-gram stylus pressure, the arbitrary stylus pressure of 1.75 grams is used for all the evaluations. Therefore, the optimum stylus pressure was *not* determined for any cartridge. However, the Grado FTR+1 was also evaluated at 1.25 grams stylus pressure. It was also noted that at the 1.75 gram stylus pressure all cartridges and the AT-1009 tone arm were able to track the worst warped records in our collection, including a washboard type warp, without noticeable distortion. Prior to actual use of the cartridge, the stylus is again cleaned. It takes only a little dust on the stylus or the CD-4 disc to cause mistracking with subsequent deterioration in the rear-channel signal.

To measure the channel orientation, crosstalk, and balance tests, the cartridge is connected to the Shure Brothers C/PEK-3 Stereo Cartridge Analyzer, using the TTR-107 test record. A phase check is then performed using the TTR-103 test record. This is an important test inasmuch as improper phasing of the cartridge and the rest of the connections employed in the CD-4 system will prevent a null point when adjusting the separation controls on the demodulator. The final testing of the cartridge with the C/PEK-3 analyzer is adjusting the antiskating device and performing the trackability tests, using the TTR-103 test record. There are three sections to the trackability test: high frequency, mid-frequency, and low frequency. The high-frequency tracking test is a 10.8 kHz pulse; the mid-frequency tracking test is a 1000 + 1500 Hz lateral-cut tone; and the low-frequency tracking test is a 400 + 4000 Hz lateral-cut tone. The low- and high-frequency tests have four velocities: 15, 19, 24, and 30 cm/sec. The mid-frequency test has four velocities: 20, 25, 31.5, and 40 cm/sec. The TTR-103 test record, in conjunction with the C/PEK-3 cartridge analyzer, is the best available means to determine the trackability of a cartridge, and the oscilloscope displays leave little or no doubt about its performance. This test is usually augmented by listening concomitantly to the reproduced sound via speakers. However, in

most instances you can hear the buzzing the cartridge makes when it no longer can track a given band as well as see the distorted display on the oscilloscope. We must point out, however, that the majority of recorded music on discs generally has a velocity below 15 cm/sec and only occasionally does it reach 25 to 30 cm/sec.

Although the C/PEK-3 does measure cartridge output in millivolts, we measured the voltage output of each cartridge, correctly terminated, with the STR-100 test record and an audio VTVM capable of measuring microvolts. The signal output of the cartridge is measured at a signal of 3.54 cm/sec at 1000 Hz. This figure is divided by 3.54 to obtain a relative output in mV for a stylus velocity of 1 cm/sec, thus providing a comparative figure.

(Although all our Columbia and RCA test records were lost sometime ago, most of them have been replaced by the ever present generosity of W. Rex Isom [RCA] and Benjamin B. Bauer [Columbia] to whom we owe a debt of gratitude. We also wish to thank Ben Bauer for loaning us his copy of the CBS STR-111 test record so that we could examine the IM distortion and square waves of the cartridges. We regret that Columbia is not considering a new cutting of the out-of-stock but very important STR-111 test record, since it is the standard of the industry for IM distortion and square waves.)

IM distortion measurements are made using the STR-111 test record with the cartridge connected to the C/PEK-3 and the monitor output of the C/PEK-3 connected to the measuring preamplifier set to BASS BOOST. The output of the measuring preamplifier is connected to the IM distortion analyzer. Although IM distortion measurements are made on all bands of the STR-111, we follow the C. G. McProud reporting method and report only the +9 dB lateral modulation at 200 and 4000 Hz and the +6 dB vertical modulation at 200 and 4000 Hz. The resulting figures are only relative rather than absolute.

Continuing to use the STR-111, the square-wave photos are made, using the FLAT position on the measuring preamplifier.

For the frequency-response measurements, the monitor output of the C/PEK-3 is connected to the cartridge input of the Justi-Meter III graphic audio recorder. The B&K QR-2009 sweep record is used to record the sweep and separation from 20 to 20,000 Hz. The sweep from 1000 to 50,000 Hz is obtained from the JVC TRS-1005 sweep record. Recordings are made from both channels, but only the left channel is reported.

In all of the above test procedures, the total capacitance of the tone arm cable plus the interconnecting cables did not exceed 100 pF per channel.

When examining and comparing the data on the cartridges, it must be borne in mind that the data represents only the specific cartridges examined and can vary from cartridge to cartridge within any production run as well as from one production run to another.

CD-4 Cartridges and Demodulators

There are, at present, four separate demodulators, JVC 4DD-5, Lafayette 99H03345W, Panasonic SE-405H, and Pioneer QD-240, plus many receivers using the JVC system, under license. The Panasonic SE-405H is a unique demodulator in that it comes with a special semi-conductor-type cartridge, EPC-450C, that requires a 4-volt d.c. bias, which is available from the demodulator. This cartridge will be reported on in a future issue of AUDIO. A switch at the rear of the demodulator changes the cartridge input circuit to accept a moving-magnet cartridge or the Ortofon transformer for the SL15Q. The Panasonic demodulator is also unique in that the 30-kHz carrier level can be set for each channel simply by using the outer grooves of a Quadradisc and adjusting the carrier level until the 4 CH RADAR indicator just lights up. The JVC system

requires that a 400-Hz distorted signal, supplied by the CD-4 adjustment record (not a test record), be converted to as pure a tone as possible (as heard and/or seen on the oscilloscope) by use of the 30-kHz carrier control. Separation adjustments are made in the same manner for all demodulators. Should it be impossible to obtain a null point when adjusting the separation control for one channel, reverse the cartridge connections for that channel and repeat the separation adjustment until a null point is reached. The inability to obtain a null point is usually caused by incorrect connections at the cartridge (one side being out of phase).

As a part of the cartridge evaluation, each cartridge is connected to the Panasonic SE-405H and JVC 4DD-5 demodulators, respectively, and adjusted using the following adjustment records: General, JVC 4DE-205 (45 rpm); for rechecking the separation setting, the 33 $\frac{1}{3}$ JVC 4D-101, band 1; for rechecking the amplifier controls for equal volume (0 dB), the WEA PR 186; and for a final check of the separation, the 33 $\frac{1}{3}$ JVC RG 1281, band 1. Normally, the 45-rpm JVC adjustment record, 4DE-205, is sufficient for all adjustments, including the 30-kHz carrier level for the JVC 4DD-5 and Pioneer QD-240 demodulator. The Pioneer and Lafayette demodulators have not been used in any of our evaluations, as yet.

Listening Evaluation

The listening evaluation is made using a variety of records representing the gamut of CD-4 recorded music. Therefore, each cartridge underwent a rigorous listening evaluation with the following experimental and commercially available records:

1. Harman/Kardon *CD-4 Calibration and Demonstration Quadradisc*—DPD1-0062
2. Mancini *Salutes Sousa*—RCA Quadradisc, APD1-0013
3. Carly Simon—*No Secrets*—Elektra Quadradisc, EQ-5049
4. Carolyn Hester—RCA Quadradisc, APD1-0086
5. RCA Quadradisc Highlights, DJD1-0072
6. Dolly Parton—*Bubbling Over*—RCA Quadradisc, APD1-0286
7. *Mandolin Serenade*—JVC CD-4 Quadradisc, CD4W-7016
8. Artur Rubenstein—*Rachmaninoff: Piano Concerto No. 2*—RCA Quadradisc, ARD1-0031
9. Debussy—*La Mer*—RCA Quadradisc, ARD1-0029
10. Virgil Fox—*Heavy Organ at Carnegie Hall*—RCA Quadradisc, ARD1-0081
11. Webersinke—*Famous Organ Works by J. S. Bach*—JVC, CD4K-7507E

12. Walter Carlos—*Switched on Bach*—CD-4 Experimental Record
13. Walter Carlos—*Clockwork Orange*—CD-4 Experimental Record
14. *Difficult Passages*—CD-4 Experimental Record

The speakers used in the listening evaluation are the Cerwin-Vega 211-R's in front and the AR-2a's in the rear. The last five records were used again when the speaker placement was reversed, the Cerwin-Vega 211-R's in the rear and the AR-2a's in front. It is realized that these speakers are disparate in their characteristics, especially in terms of efficiency. Because of these characteristics, the speaker placement was also used in the reverse. This is especially important when the sound emanating from the rear speakers is primarily ambience. The Integral System preamplifiers, Model 10, and amplifiers, Model 200 (100 watts per channel), were used to drive the speakers.

The last five records gave each cartridge a workout. In particular, the CD-4 experimental records, *Switched on Bach* and *Clockwork Orange*, are superb for checking CD-4 cartridges. Both of these records separated the excellent cartridge from the good cartridge with no uncertainty because of the highly explosive transients common to the Moog synthesizer.

In most instances, the listening evaluation agreed with the measurement tests. However, the listening evaluation should be the final criteria by which a cartridge is judged. We believe in the axiom put forth many years ago by the late C. J. LeBel—"If it measures good and sounds bad, it is bad."

Conclusions

All the CD-4 cartridges evaluated reproduced the CD-4 recordings well and the resultant sound was pleasant to the ear in the listening evaluation. Three cartridges stand apart from the rest to this listener—Audio-technica AT20SL, Ortofon SL15Q, and Audio-technica AT15S. The AT20SL and SL15Q are considered to be equal in our listening evaluation with the AT15S a close second. These three cartridges appear to have a better definition of individual instruments, especially of the percussive nature. The Audio-technica AT20SL and the Ortofon SL15Q reproduced the last five records, and especially the last three, smoothly, with a very clean sound.

In a letter written to AUDIO (November 1973), Mr. James H. Kogen, vice president, Shure Brothers, Inc., made a point that is well-taken—that a separate cartridge should be used for stereo reproduction and another for CD-4 reproduction. In general, we agree with Mr. Kogen. However, we take a small exception and feel from our own listening that the very top CD-4 cartridges can play both without a trade-off.

Audio-technica AT20SL

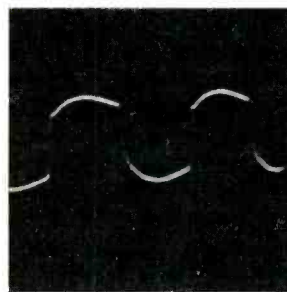
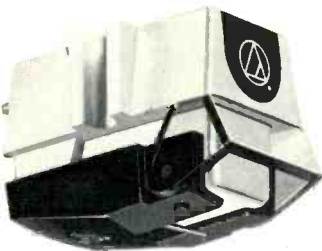

Audio-technica cartridges use two independent permanent magnets mounted at 45-degree angles, perpendicular to the two sides of the record groove. Each magnet is an electrical generator reproducing only the signal from one side of the record

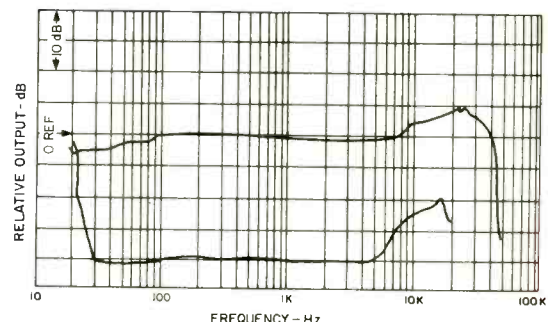

groove, thus maximizing separation. This model is identical to the AT15S, except that the AT20SL is hand-selected for all parameters, including flattest possible response to 50 kHz. Frequency response is flat from 50 Hz to 8 kHz \pm 2 dB, + 3 dB

at 10 kHz, and +4 dB at 20 kHz. The double peaks at about 23 and 26 kHz are +5 dB, then the response drops to +1 dB at 40 kHz. Separation averages 20 dB from 100 Hz to 5 kHz, down to 15 dB at 10 kHz and 16 dB at 20 kHz. Trackability is one of the best we have ever seen. The AT20SL is one of the two top CD-4 cartridges reported here. Its sonic clarity is superb, one of the smoothest we have ever encountered. Transient response is excellent. One does not realize all the sounds present on a CD-4 recording of the Moog synthesizer, as well

as both electronic and pipe organs, until played with a top-of-the-art cartridge.

Wt. 9.03 g; d.c. res. 550 ohms; Ind. 378 mH; Output 0.65 mV/1-cm/sec; IM dist. 2.5% lat., 3.4% vert.; Crosstalk -22 dB; Ch. Bal. 0 dB; Trackability: High freq. (10.8 kHz pulsed) 30 cm/sec; Mid-freq. (1000 + 1500 Hz lat. cut) 31.5 cm/sec; Low freq. (400 + 4000 Hz lat. cut) 30 cm/sec. The stylus is a nude diamond with the Shibata configuration. \$150.00.

Check No. 66 on Reader Service Card

Audio-technica AT15S

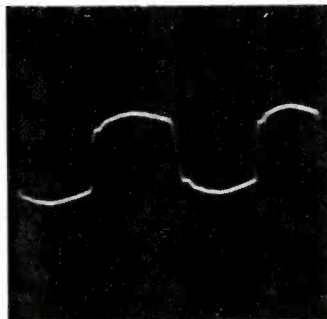
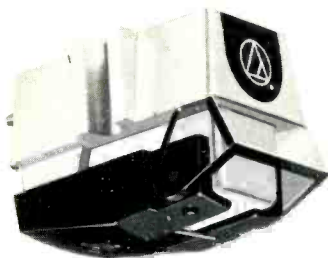

Construction is identical to the AT20SL, since the top of the line cartridge is hand-picked from the production run of the AT15S. Frequency response is flat from 50 Hz to 8 kHz ± 2 dB, +2 dB at about 15 kHz, +1 dB at 20 kHz, +1 dB at 30 kHz, -2 dB at 40 kHz, and -5 dB at 50 kHz. Separation averages 20 dB from 50 Hz to 10 kHz, down to 16 dB at 12 kHz and 12 dB at 20 kHz. Musically, the AT15S is not quite as good as the AT20SL. Transient response is excellent, as is the bass response. Sonic clarity is excellent, particularly in elec-

tronic synthesizers, electronic and pipe organ, and piano. Overall, it produces crisp, clean sound.

Wt. 8.52 g; d.c. res. 445 ohms; Ind. 408 mH; Output 0.83 mV/1-cm/sec; IM dist.: 2.6% lat., 2.4% vert.; Crosstalk -24 dB; Ch. Bal. 0.5 dB; Trackability: High freq. (10.8 kHz pulsed) 30 cm/sec; Mid-freq. (1000 + 1500 Hz lat. cut) 25 cm/sec; Low freq. (400 + 4000 Hz lat. cut) 19 cm/sec. The stylus is a nude diamond with the Shibata configuration. \$100.00.

Check No. 67 on Reader Service Card

Audio-technica AT14S

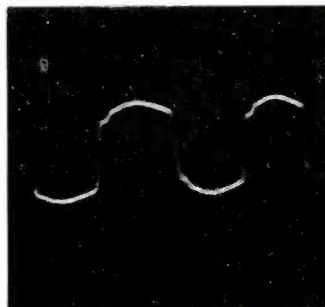

The AT14S is next to the lowest priced CD-4 cartridge with a Shibata stylus in this line. The response curve is one of the flattest we have encountered, ± 2 dB from 30 Hz to about 45 kHz, and down -3 dB at 50 kHz. Separation is about 20 dB throughout the spectrum up to about 17 kHz and then decreases to 9 dB at 20 kHz. Although the sound is crisp, it has a tendency towards stridency at the high frequencies and the bass has a slight tendency towards being boomy, especially low bass. There is some distortion present in the loud bass passages in the rear channels as well as in some difficult music passages.

This cartridge and the JVC 4MD-20X are reported to be identical—both are made by Audio-technica.

Wt. 6.5 g; d.c. res. 446 ohms; Ind. 383 mH; Output 0.69 mV/1-cm/sec; IM dist.: 2.4% lat., 1.7% vert.; Crosstalk -30 dB; Ch. Bal. 0.5 dB; Trackability: High freq. (10.8 kHz pulsed) 24 cm/sec; Mid-freq. (1000 + 1500 Hz lat. cut) 31.5 cm/sec; Low freq. (400 + 4000 Hz lat. cut) 24 cm/sec. The stylus is a nude diamond with the Shibata configuration. \$75.00.

Check No. 68 on Reader Service Card

Grace F8/F

The Grace cartridge is manufactured by the Shinagawa Musen Co., Ltd., in Japan. We have not seen many examples in the West, though Sumiko, P.O. Box 5046, Berkeley, Calif. 94705, has started importing two Grace cartridges, this model

and the F8/L. The response curve is ± 3 dB from 20 Hz to about 10 kHz, dropping to -4 dB at 10 kHz, then slowly rising to -2 dB at 30 kHz, and down -6 dB at 50 kHz. Separation is about 19 dB throughout the spectrum to 20 kHz. Musi-



How did the 9200XD get to the top of our line? Very quietly.

Yesterday:

Unanimous praise for our Cross-Field technique

Tandberg has long been famous for its Cross-Field Recording technique. Cross-Field extends frequency response and makes it possible to record at slower speeds with minimum distortion. More important, it dramatically improves signal-to-noise ratio. In fact, Tandberg performance at 3¾ ips matches other machines at 7½ ips! Here's what the experts said shortly after we introduced our 9000X Cross-Field stereo tape deck:

STEREO REVIEW found the signal/noise measurements "...equivalent to the best figures we have ever obtained on a consumer tape machine." (August, 1973)

HIGH FIDELITY said, "...the Tandberg already gives you the extra 10 dB of S/N claimed by the Dolby-B* process... Performance... without Dolby* is similar to that of most decks with Dolby.*" (October, 1973)

Today:

We've added Dolby* to Cross-Field.

Enter the 9200XD. We call it The Super Silencer.

The "X" stands for Cross-Field, the "D" for built-in Dolby* circuits. The 9000X gave a 65 dB weighted signal/noise ratio at 7½ ips and 3% THD with UD/SD tape. Good—but not good enough for our steely-eyed Norwegian engineers. Now the new top-of-the-line 9200XD gives a *guaranteed minimum* 73 dB signal-to-noise ratio under the same conditions. That's Super Silence.

Tomorrow:

You must hear the 9200XD for yourself.

STEREO REVIEW called the 9000X "...the current state of the art for consumer tape recorders." But that was before they heard the new 9200XD. It's the best recorder we've ever made.

You can see The Super Silencer at your Tandberg dealer's now. Stop in soon... and ask to hear what tape hiss doesn't sound like.

*Dolby is a trademark of Dolby Laboratories, Inc.

We're our only competitor.

TANDBERG OF AMERICA INC.

Labriola Court, Armonk, New York 10504 A. Allen Pringle Ltd., Ontario, Canada
Check No. 45 on Reader Service Card



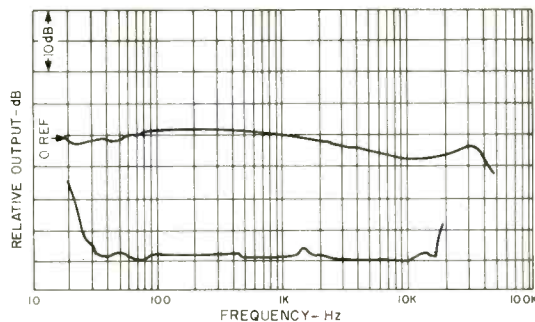
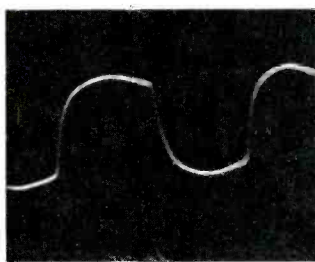
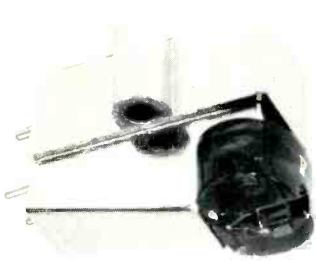

cally, the high frequencies appear to be a bit strident. Some tracking difficulties and distortion were encountered in loud mid-frequencies and bass. The overall sound was a little hard.

Wt. 6.5 g; d.c. res. 472 ohms; Ind. 359 mH; Output 0.58 mV/1-cm/sec; IM dist.: 0.8% lat., 2.3% vert.; Crosstalk -27 dB; Ch. Bal. 0 dB; Trackability: High freq. (10.8 kHz pulsed)

24 cm/sec; Mid-freq. (1000 + 1500 Hz lat. cut) less than 20 cm/sec; Low freq. (400 + 4000 Hz lat. cut) less than 15 cm/sec. The stylus is a nude diamond with the Shibata configuration. \$109.95.

Check No. 69 on Reader Service Card

Grado Laboratories FTR + 1

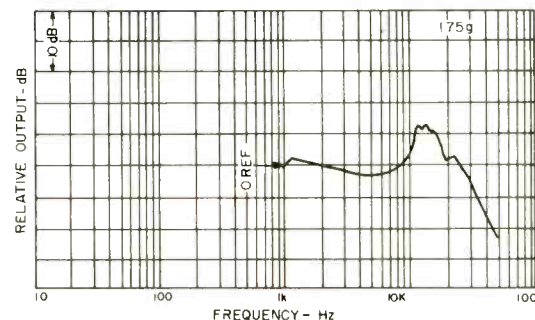
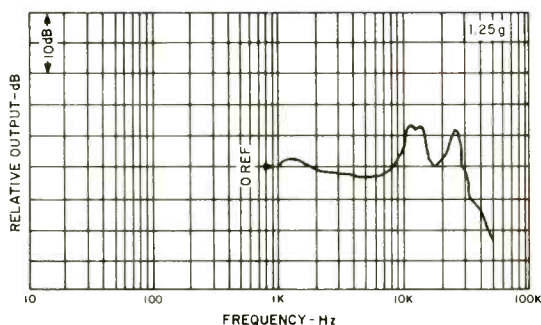
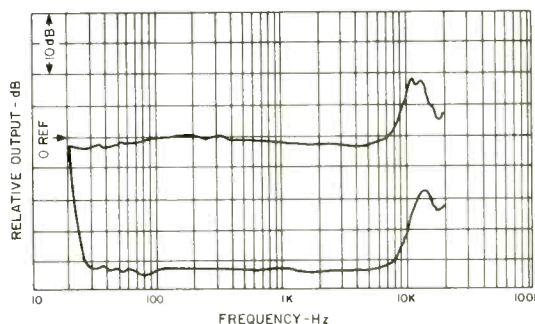
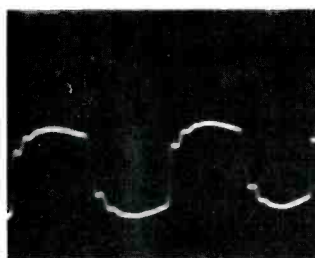
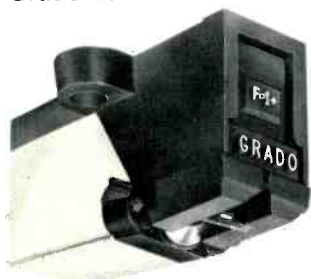

This is the sleeper among the CD-4 cartridges. The stylus is a spherical diamond (0.5 mil) with a tip mass so low that it doesn't require special facets to track CD-4 records. And the price quoted is \$11.95. Although we used a stylus tracking force of 1.75 g for all the cartridges, we made an exception for the FTR + 1 and also measured it at a tracking force of 1.25 g, as suggested by Grado Laboratories. The cartridge is a type of variable reluctance, not too different from the old General Electric variable reluctance cartridge. Because of its low inductance, up to 20 feet of cable may be used without any effect upon the very high frequencies. The frequency response curves were reasonably identical from 20 Hz to 20 kHz at both 1.75 and 1.25 g tracking force. At 1.25 g the response is ± 2 dB from 20 Hz to 8 kHz, rising to + 9 dB at about 13 kHz, + 1 dB at 20 kHz and about + 7 dB at about 26 kHz and then falling off rapidly, + 1 dB at 30 kHz, - 8 dB at 40 kHz, and - 13 dB at 50 kHz. At the 1.75 g tracking force, there is a + 2 dB peak at about 23 kHz and then rapidly falling off, - 2 dB at 30 kHz, - 8 dB at 40 kHz, and - 13 dB at 50 kHz. It appears that the 1.25 g tracking force brought about another peak at about 26 kHz, whereas at the 1.75 g

tracking force there is only a minor peak at about 23 kHz. Separation is about 21 dB from 50 Hz to 10 kHz, dropping to 17 dB at 15 kHz and 15 at 20 kHz. Musical response is relatively clean, but is not as crisp as with others. Transient response is good. It is a bit strident in the high end with some distortion at the very high end. This cartridge acquitted itself well with the bass organ pedals as well as the Moog synthesizer. Some distortion was noticed in the very loud musical passages.

This is an amazing cartridge when one considers its price. We would not hesitate to recommend it for medium-priced systems or OEM use.

Wt. 5.4 g; d.c. res. 710 ohms; Ind. 58.7 mH; Output 0.61 mV/1-cm/sec; IM dist. 2.3% lat., 2.7% vert. (3.2% vert. at 1.25 g.); Crosstalk -28 dB (-30 dB at 1.25 g.); Ch. Bal. 0.75 dB (0 dB at 1.25 g.); Trackability: High freq. (10.8 kHz pulsed) 24 cm/sec; Mid-freq. (1000 + 1500 Hz lat. cut) 25 cm/sec (20 cm/sec at 1.25 g.); Low freq. (400 + 4000 lat. cut) 19 cm/sec (15 cm/sec at 1.25 g.). \$11.95.

Check No. 70 on Reader Service Card

Ortofon SL15Q

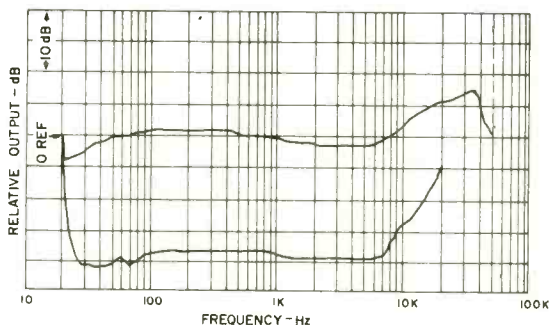
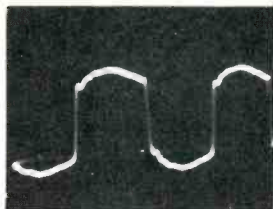
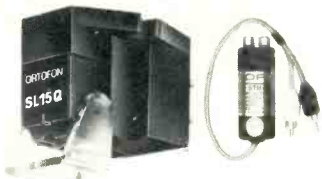

This is the only moving coil cartridge among the current CD-4 cartridges and requires a transformer to step up the voltage for the average preamplifier. Frequency response is ± 2 dB from 40 Hz to 13 kHz, $+5\frac{1}{2}$ dB at 20 kHz, $+8$ dB at 40 kHz, and $+2$ dB at 50 kHz. Separation is generally about 17 dB across the spectrum to 9 kHz, dropping to 16 dB at 10 kHz, 15 dB at 15 kHz, and 11 dB at 20 kHz. This cartridge is tied with the Audio-technica AT20SL as one of the two top cartridges reported here. Like the AT20SL, its sonic clarity is superb and it is one of the smoothest cartridges we have encountered. Transient response is excellent. All the sounds recorded by the Moog synthesizer are reproduced clearly as are the electronic and pipe organ sounds. This is a state-of-the-art cartridge. We might add that the transformer should be marked to identify the left and right channels. The white dot on the transformer is for the right cartridge lead and the white phono plug from the transformer goes to the right phono jack on the demodulator.

Wt. 7.6 g; d.c. res. 2.55 ohms; Ind. 112 *micro* H; Output with transformer 2.79 mV/1-cm/sec; IM dist. 1.5% lat., 2.0% vert.; Crosstalk -26 dB; Ch. Bal. 1.5 dB; Trackability: High freq. (10.8 kHz pulsed) 30 cm/sec; Mid-freq. (1000 + 1500 Hz lat. cut) 25 cm/sec; Low freq. (400 + 4000 Hz Lat. cut) 19 cm/sec. The stylus appears to be a nude diamond with the Shibata configuration. \$160.00 (estimated).

Check No. 71 on Reader Service Card

Pickering UV-15/2400-Q

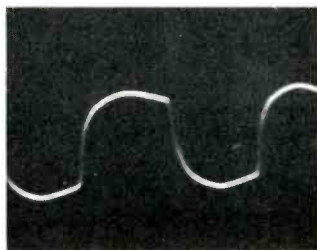
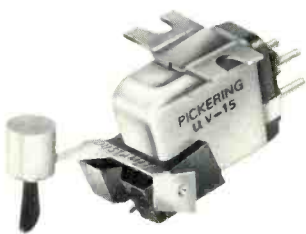

This Pickering cartridge is considered the first U.S.-made CD-4 cartridge. The response curve is quite flat, ± 3 dB from 20 Hz to over 20 kHz, -3 dB at 10 kHz, $+2$ dB at 20 kHz, $+4$ dB at 30 kHz, $+1.5$ dB at 40 kHz, and -4 dB at 50 kHz. The resonant peak is from about 21 kHz to 30 kHz. Separation

UNIQUE



That's the only word for MAGNEPLANAR® Tympani loudspeakers. Unique in design... unique in the clarity and naturalness of the sound they produce. MAGNEPLANAR Tympanis incorporate a host of advanced features. Low-mass, thin Mylar diaphragm with patented tympanic suspension; distributed magnetic field; bi-polar radiation; folding floor screen design. The speaker is a straight wire device with essentially no inductive or capacitive reactance. All elements that have plagued previous state-of-the-art attempts — including voltage supplies, step-up transformers, and complex crossovers — have been eliminated. When used with commensurate high quality associated components, MAGNEPLANAR Tympanis provide a listening experience surpassed only by a live performance. Fabric covers are available in several decorator colors to complement room interiors.

A variety of models and speaker configurations allow you to build the kind of sound system you want. See your Audio Research dealer for a demonstration of the MAGNEPLANAR Tympani loudspeakers. They're in a class by themselves.



audio research corporation

Box 6003
Minneapolis, Minnesota 55406
Tel: (612) 721-2961

©MAGNEPLANAR, INC.

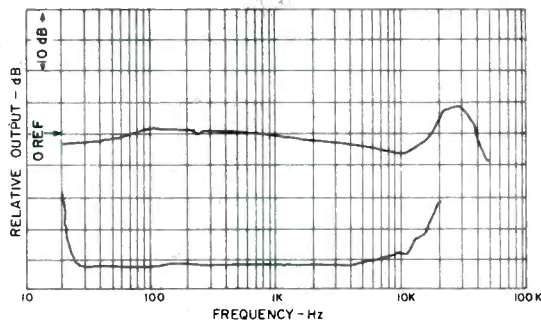

averages 21 dB from 50 Hz to about 8 kHz, down to 17 dB at 10 kHz, and 11 dB at 20 kHz. This cartridge has the lowest IM distortion of the cartridges reported herein. If some param-

Stanton 780/4DQ

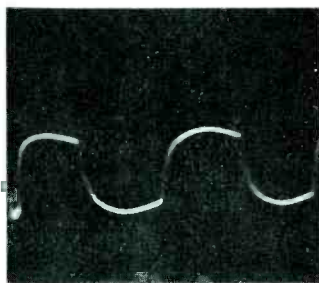
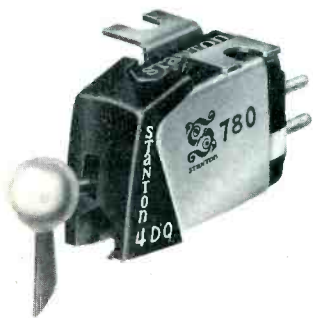

This cartridge is considered to be the second U.S.-made CD-4 cartridge. The response curve is ± 3 dB from 20 Hz to about 25 kHz, +5 dB at 30 kHz, +3 dB at 40 kHz, and +0.5 dB at 50 kHz. As with most of the other CD-4 cartridges, the resonant peak is at 30 kHz. Separation averages about 19 dB to 9 kHz, 17 dB at 10 kHz, and 11 dB at 20 kHz. This cartridge also has a very low IM distortion. Perhaps, like the Pickering, if some parameters could be altered, it too would be a superior cartridge. Musically, the Stanton 780/4DQ had some difficulties with loud organ bass passages and the high end was a bit strident. There was some distortion present in

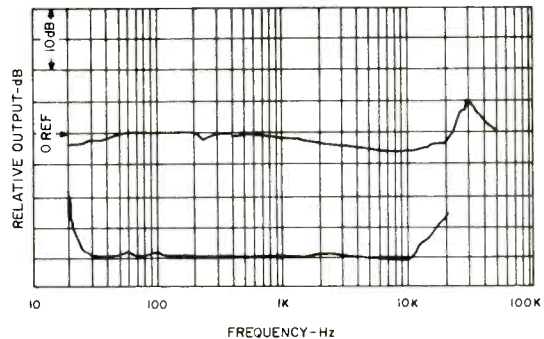

eters can be redesigned and the IM distortion remain as is, it would be a superior cartridge. Musically, the high frequencies sound a little strident, particularly on string instruments. Transient response is good. Some tracking distortion was evident on loud organ bass passages. There was some distortion in the mid-frequencies. The overall sound is a little hard.

Wt. 5.66 g; d.c. res. 672 ohms; Ind. 297 mH; Output 0.58 mV/1-cm/sec; IM dist: 1.0% lat., 0.8% vert.; Crosstalk -25 dB; Ch. Bal. 0.75 dB; Trackability: High freq. (10.8 kHz pulsed) 24 cm/sec; Mid-freq. (1000 + 1500 Hz lat. cut) less than 20 cm/sec; Low freq. (400 + 4000 Hz lat. cut) less than 15 cm/sec. The diamond stylus has a Quadrahedral configuration which is not unlike the Shibata configuration. Both the back and front end of the stylus appear to have identical facets. Evaluation of this cartridge was performed with the "Dustamatic" brush removed. \$124.95.

Check No. 72 on Reader Service Card

Victor 4MD-1X

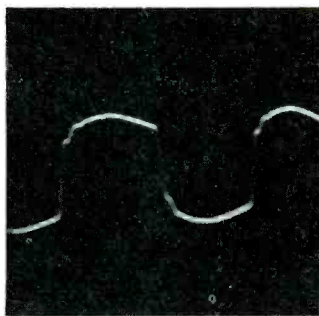
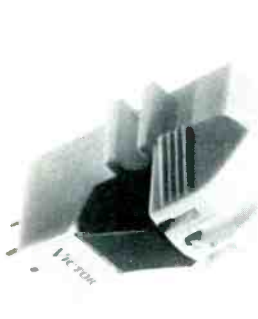

This cartridge is considered to be the first CD-4 cartridge to be marketed. Although it has never been available in the U.S., it is still sold in Japan. The frequency response is flat from 40 Hz to above 16 kHz ± 2 dB, then climbs to +5 dB at 20 kHz and 28 kHz, down to +1 dB at 40 kHz and -1 dB at 50 kHz. Separation is 19 dB from 100 Hz to 10 kHz, dropping to 15 dB at 15 kHz and 9 dB at 20 kHz. Musically, we find it to be a bit muffled at the high end. The bass is adequate although some tracking difficulties were encountered in the pedal notes of the electronic and pipe organ. Transient

the mid-frequencies. The overall sound is a little hard. Evaluation was made with the dust brush attached to the cartridge, but compensated as described in the instructions.

Wt. 6.64 g; d.c. res. 655 ohms; Ind. 291 mH; Output 0.54 mV/1-cm/sec; IM dist: 1.2% lat., 1.7% vert.; Crosstalk -25 dB; Ch. Bal. 0 dB; Trackability: High freq. (10.8 kHz pulsed) 24 cm/sec; Mid-freq. (1000 + 1500 Hz lat. cut) less than 20 cm/sec; Low freq. (400 + 4000 Hz lat. cut) less than 15 cm/sec. The diamond stylus is a Quadrahedral, similar to that used in the Pickering UV-15/2400-Q. \$125.00.

Check No. 73 on Reader Service Card

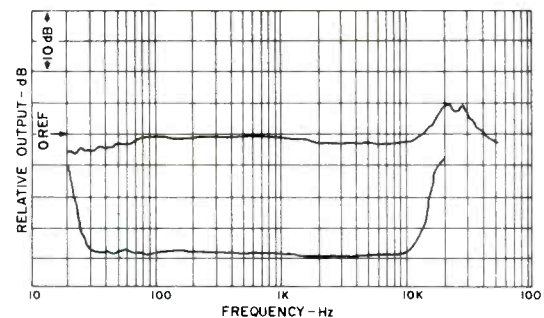

response is somewhat muddy and there was some distortion in the mid-frequencies. Distortion was evident when reproducing music recorded on the Moog synthesizer.

Wt. 7.24 g; d.c. res. 446 ohms; Ind. 405 mH; Output 0.62 mV/1-cm/sec; IM dist. 1.3% lat., 6.8% vert.; Crosstalk -30 dB; Ch. Bal. 1 dB; Trackability: High freq. (10.8 kHz pulsed) 30 cm/sec; Mid-freq. (1000 + 1500 Hz lat. cut) 25 cm/sec; Low freq. (400 + 4000 Hz lat. cut) 24 cm/sec. The stylus is a nude diamond with the Shibata configuration. N.A. in U.S.

Check No. 74 on Reader Service Card

4 for 4



QRX-3000



QRX-3500



QRX-5500



QRX-6500

SANSUI'S FOUR 4-CHANNEL RECEIVERS

Sansui's QRX series AM/FM receivers are the most advanced 4-channel units you can own. All four have Sansui's QS vario matrix to give you unparalleled 4-channel performance. QS and SQ matrix recordings and broadcasts are decoded with true-life fidelity. All Sansui QRX receivers feature the unique QS synthesizer to create 4-channel sound from stereo sources with true directionality. Discrete sources such as tape and CD-4 demodulators can be used with any Sansui QRX 4-channel receiver. Plus you get Sansui's famous engineering excellence in amplifier and tuner sections as well. Hear them all at your nearest franchised Sansui dealer.



SANSUI ELECTRONICS CORP.

Woodside, New York 11377 • Gardena, California 90247

SANSUI ELECTRIC CO., LTD., Tokyo, Japan

SANSUI AUDIO EUROPE S. A., Antwerp, Belgium • ELECTRONIC DISTRIBUTORS (Canada) Vancouver 9, B.C.

Check No. 36 on Reader Service Card

Quadra-Direction Discrete Compatible Stereo

Conclusion

Fumitaka Nagamura*

CONCERNING NUMBERS of channels for disc records, the conventional philosophy, based on which contemporary stereo and quadraphonic systems have been developed, interprets the number of channels reproducible from discs to be limited to two, simply due to the fact that only two channels of signal transmission are employed in disc-cutting.

However, the fact that recording signals input to discs in cutting are along two axes spatially perpendicular to each other, makes it possible to input an infinite number of channels by selecting appropriate magnitude ratios and phase relationships for signal vectors projected on the two axes. Then in reproduction, detection of the infinite number of recorded signal vectors must be effected separately in three or more sectors of the domain covered by such recorded vectors, i.e. a 360° circular distribution around the no-signal center, in order to detect all of the signals without duplication. Thus, symmetry and efficiency dictate the minimum number of channels for detection to be four.

*N.F. Farrd Systems, Tokyo

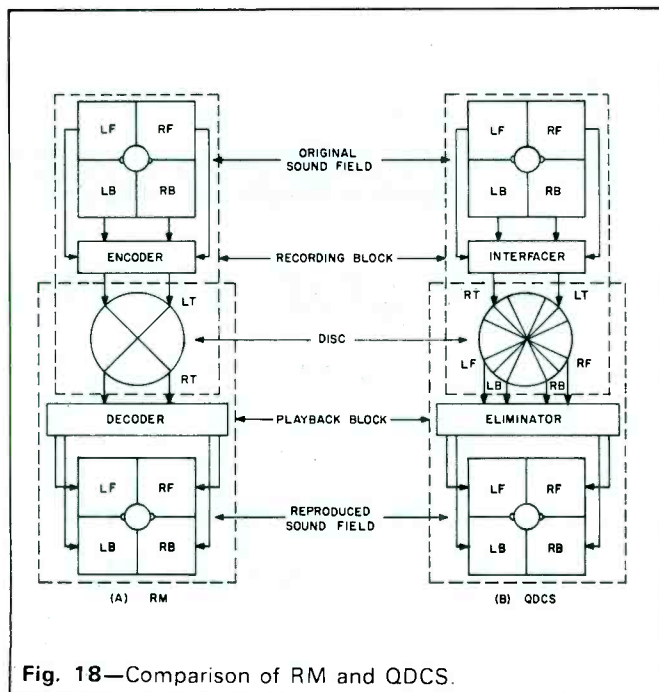

Fig. 18—Comparison of RM and QDCS.

Figures 18 (A) and (B) illustrate the foregoing approach, i.e. QDCS, in comparison with RM which is the closest thereto on the recording side among conventional systems.

Figure 18 (A) detects, through only the two transmission channels, such signals as had been specifically arranged spatially to eliminate all duplication, so that in effect it has cast away a portion of the fundamental capabilities of discs.

QDCS represented by Figure 18 (B), on the other hand, directly detects such information as recorded within each pre-designated sectorial domain, so that it is a system that not only retains the same basic quality as that of conventional stereo systems, but also fulfills the fundamental continuity, balance, and symmetry of recorded and reproduced sound.

By symbolizing these two approaches using the often used terminology of n-2-m, n-4-m, etc., they may be represented as follows:

$$\text{RM: } m - 2 - m' - 2 - m''$$

$$\text{QDCS: } m - 2 - m' - 4 - m''$$

where m denotes the number of localized groups of original sound sources, m' that of recorded localized images, and m'' that of reproduced localized images. One difference is that while the RM localization denoted by m' may either represent real or imaginary sound images (i.e. via discs or tapes), with QDCS they are limited to real sound images. QDCS, therefore, works only with media which provide real images for m', or exclusively with discs at the present time.

Ideal Recording Vectors Under QDCS

At this point it should be appropriate to take special note of the fact that localization of sound recorded on discs is as accurate as however close to straight-line vectors the disc cutting vectors had been. It is by the same principle as that governing reproduced sound which can be as accurately localized depending on how close it is to an in-phase relationship. Our experience with conventional stereo confirms truth of this principle, but expression by only two speakers is necessarily limited in localizing countless sound sources or reproducing the entire sound field. Besides, discs are not always cut in strict adherence to the principle, especially when special overall effects are desired.

However, if the same disc were subjected to detection along many different directions and then reproduced by the same number of speakers, the resultant localization of sound would be more accurate when the disc had been cut in full conformity with the foregoing principle. For such accurate recording of localization, the pair of signals fed to the disc cutter should ideally be in phase with or in opposite phase

Instead of racking our brains to find rating systems that would yield the highest specs for Sony components, we rack our consciences.

Take our STR-7065 receiver, for example. We rate it at 60 watts per channel—but under the most rigorous and meaningful conditions: continuous power at all frequencies from 20, to 20,000 Hz., both channels driven into 8 ohms.

Which is why *High Fidelity Magazine* says: "The Sony... is comparable in its output capabilities to many amplifier sections regularly advertised at, say, 75 watts per channel or more."

That power rating is taken at a meaningful low distortion figure,

too: less than 0.2% harmonic or IM distortion.

High Fidelity comments: "Not only does the amplifier stay below its ratings to the frequency extremes (which the amplifier sections in many receivers do not quite do), but intermodulation stays under this figure to beyond 95 watts at 8 ohms, and beyond 125 watts at 4 ohms.

High power, free of distortion are two of the most important requisites of a high quality music system. The STR-7065 excels in both.

Describing the tuner section, *High Fidelity* said: "... Both on paper and in the listening room, FM performance of the receiver is excellent." Some of the circuit features that make it so are newly

developed Sony FET's in the mixer and RF stages (for 2 μ V IHF sensitivity with 90 dB spurious response rejection on strong local signals), and special Sony IC's which give it a 1.0 dB capture ratio and 70 dB selectivity (the easier to pluck stations from a crowded dial). Such power and performance doesn't come cheaply. Yet, when you consider that the specifications you get are better than the specifications you are paying for, the STR-7065 is a remarkable value at \$529.50.

And the same value is offered by other Sony receivers starting at \$229.50. Hear them at your Sony dealer and see which one rates best with you. **SONY.**

How we rate with you depends on how we rate ourselves.



Sony Corporation of America,
9 West 57th Street, New York, N.Y. 10019
Prices suggested retail. Includes cabinet.

Check No. 40 on Reader Service Card

to each other. Other phase relations are used for recording or synthesizing indirect sound, and except where special unnatural effects are sought, phase shifting direct sound simply creates confusion in reproduced sound localization.

As long as phase relations of pairs of signals conform to this principle, countless localized sources can be recorded as motional vectors, each distinct from the others. In other words, cut disc recording makes it feasible to record all sounds as independent motional vectors, irrespective of the number of channels employed in sound pickup for the recording, although the more the channels used for pickup, the greater the percentage of direct sounds that are picked up, and so the more of localized sound sources that get accurately recorded. No direct connection, however, exists between the number of channels employed in sound pickup for recording and that used in detection or reproduction.

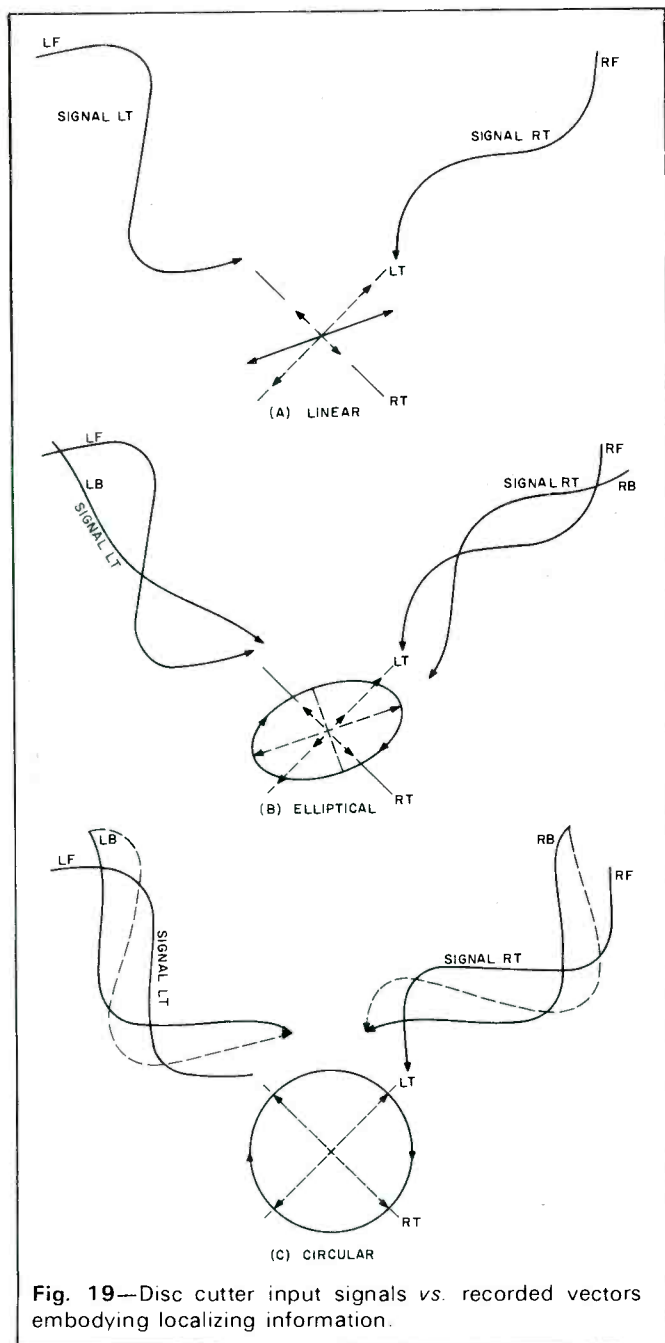

Fig. 19—Disc cutter input signals vs. recorded vectors embodying localizing information.

Actually, three types of disc cutting vectors represent direct sound localization, linear, elliptical, and circular motional vectors, as shown in Figure 19 (A), (B), and (C), but even the latter two, elliptical and circular, manifest themselves as pairs of in-phase linear motions when projected on detecting axes. These recording vectors, together with projections on detection axes and the resultant localization of reproduced sound, are illustrated in Figure 20 (A), (B), and (C). Musical information comprises plurality of these vectors which are further complicated by addition of indirect sound and other complex elements.

New Disc Recording of Natural Sound Fields— QDCS Recording

Heretofore, the usual RM recording technique relied on phase-shifting the rear channels only in order to reduce losses during two-channel transmission, but while no problem arises between LF and RF, or LB and RB, when signals from the same sound source are input to LF and LB or RF and RB, the cutter tip motion is no longer along a straight line axes, and thus a uniform utilization of the 360° tip motion is not accomplished.

Sound source S in Figure 21 (A) located between LF and RF gets picked up by microphones LF and RF, each signal decomposed into projections on LT and RT axes, and then again these vectors are recombined to form the original vector S, as shown in Figure 21 (B), which drives the cutter tip correctly. Similarly, sound sources in between LB and RB are correctly cut into discs.

However, as shown in Figure 22 (A), when the source is between LF and LB, LT and RT projections of LB which first passes through the phase shifter are shifted by 90°, and then vectorially added to LT and RT projections of LF, so that these do not form a linear motional vector, resulting in a non-linear motion of the cutter tip and incorrect sound localization. The same goes for sound sources between RF and RB.

In order to correctly recombine these vectors, firstly, pickup microphones should be arranged in a manner shown in Figure 23, and secondly, vectorial additions representing LT directions and vectorial subtraction RT directions as shown in Figure 22 (B), should be used for transmission after phase-shifting in a manner to avoid transmission losses as well as to eliminate crosstalk, thereby to correctly drive the cutter head.

Thus, sound sources located in the four quadrants, FL-FR, RF-RB, BR-BL, and LB-LF, are cut into discs in a mutually equal, uniform distribution of recorded vectors.

Crosstalk Eliminator

With cartridges with Figure 5 (A) ideal sensitivity distribution, signals picked up for the four independent channels from recorded discs need only be processed through a simple phase shifter to provide excellent reproduction. However, in the present state of art, only Figure 5 (B) approximation is feasible, so that further enhancement by electronic circuitry to reduce crosstalk is necessary to simulate Figure 5 (A) in overall performance. This electronic circuit is entitled "Crosstalk Eliminator" and its block diagram is shown in Figure 24.

This circuit differs from the usual logic circuits in that it involves no non-linear amplification and separation among channels is held constant.

The basic technique is to cancel crosstalk with the same signals in opposite phase, and does not involve such often-used methods incorporating variable parameters, as cancelling by simulated signals as practiced in logic circuits of matrix decoders, cancellations to accentuate predetermined peculiar

(Continued on page 54)



way out!

Tape cassettes and cassette recorders were once regarded pretty much as novelties. Sure, they were great for voice recordings, but they weren't taken seriously by hi-fi buffs. Then along came TDK's Super Dynamic, the tape that started a revolution in the industry. It gave the cassette true high-fidelity capability for the first time, thereby stimulating the development of improved cassette recorders.

As a result, manufacturers of both tape cassettes and cassette recorders started turning out better and better products. So today the question is "how well do they match each other in performance capability?" And with the devel-

opment of TDK's great new Dynamic-series of cassettes, the whole world of sound reproduction has changed.

When it comes to matching or exceeding the performance capabilities of present-day cassette recorders, TDK's new Dynamic series is way out front. Extra Dynamic (ED) cassettes offer an entirely new dimension in recording fidelity that is vastly superior to any other cassette now on the market. Super Dynamic (SD), the tape that started it all, still has better-balanced total performance characteristics than any other brand made and is available in cassette or open-reel format. And Dynamic (D) is an entirely

new hi-fi cassette offering excellent quality at moderate prices, with characteristics superior to most "premium" cassette tapes.

So, if you want to be sure of using cassettes that provide the best total performance on any recorder . . . for performance capabilities that are and always will be ahead of the industry . . . discover the dynamic world of TDK!

the new dynamic world of

TDK

TDK ELECTRONICS CORP.
755 Eastgate Boulevard, Garden City, New York 11530

Check No. 44 on Reader Service Card

DIGITAL COLO

Bell & Howell Schools introduces an amazing new color TV featuring channel numbers and digital clock that flash on the screen and automatic channel selector!

Now you can build and keep a color television that's ahead of its time!

You've seen TV's that swivel, TV's with radios built in, TV's small enough to stuff in a suitcase and TV's that have remote control.

But now comes a color television with features you've *never* seen before. Features now possible as a result of the new technology of digital electronics ... features that make Bell & Howell's new 25-inch diagonal digital color TV ahead of its time! Like ...

Channel numbers that flash big and clear right on the screen. An on-screen digital clock that flashes the time in hours, minutes and seconds with just the push of a button. An automatic channel selector that you pre-set to skip over "dead" channels and go directly to the channels of your choice.



And, to insure highest quality performance, this new TV has all-electronic tuning, reliable integrated circuitry, and 100% solid-state chassis for a brighter, sharper picture with long life and dependability.



Perform fascinating experiments... test your new TV as you build it... with the exclusive Electro-Lab[®] electronics training system. It's yours to build and keep!

Designed exclusively for our students, this new Bell & Howell Electro-Lab[®] features the most sophisticated and up-to-date "tools of the trade". In-

Simulated TV picture.



You build and keep this revolutionary new Bell & Howell 25" diagonal digital color TV! Mail the postage-free card today for complete details, free!

struments you can use professionally after you finish the program.

A new digital multimeter that measures voltage, current and resistance and displays its findings in big, clear numbers. Far more accurate and readable than conventional "needle pointer" meters that require guesswork and interpretation.



The solid-state "triggered sweep" oscilloscope is a "must" for accurate analysis of digital circuitry. With it you are able to make measurements of circuits in much the same way that heartbeats are measured on an electrocardiograph. Includes DC wide-band vertical amplifier and "triggered sweep" feature to lock in signals for easier observation.

The design console is a valuable device for setting up and examining circuits without soldering! Features patented modular connectors, AC power supply and transistorized dual range DC power supply.

R TV IS HERE!

Build it yourself... the perfect way to learn all about the exciting new field of digital electronics!

It's a fascinating spare-time project you can enjoy at home!

Imagine spending your spare time actually building your own 25-inch diagonal digital color TV! It's a project you can enjoy working on right in your home. And you'll be amazed at the electronics knowledge you'll pick up in a relatively short period of time!

There's no travelling to classes, no lectures to attend, and you don't have to give up your job or paycheck just because you want to get ahead. When you finish this new Bell & Howell Schools program, you'll have the skills you need plus a great color TV to keep and enjoy for years!



Digital electronics is changing our lives!

There's a lot more to digital electronics than just the numbers! True, that's what you see on more and more products like digital calculators, clocks and watches. But behind the numbers lies a fantastic new technology that's creating higher standards of accuracy and dependability. The versatility of digital electronics has begun another industrial revolution. Its growth and applications are limitless, giving us new and better ways of doing things and spectacular products like this new Bell & Howell digital color TV!

You don't have to be an electronics expert to build it... we help you every step of the way.

One of the beauties of this TV is that you don't need previous electronics experience to build it! With a few simple household tools, our step-by-step instructions and the exclusive Electro-Lab®, you've got all the basics you need. Should you ever hit a 'snag', you're just a toll-free call away from one of our expert instructors who can help you solve it. You can also take advantage of our in-person "help

sessions" held in major cities throughout the year where you can enjoy "talking shop" with instructors and fellow students.

Pick up valuable skills in digital electronics that could lead to extra income full or part time... or a business of your own!

Once you have your new TV, cash in on all that you learned from building it! This new Bell & Howell program employing digital electronics will help you gain valuable new skills that could easily lead to extra income, part time. A service or repair business of your own? Why not! We even show you how to get started with a complete volume on the basics of setting up a TV servicing business. Get the complete story on this exciting, learn-at-home program... the world's first color TV course employing digital electronics technology!

Mail card today for full details, free!

Electro-Lab is a registered trademark of the Bell & Howell Company.

If card has been removed, write:

598

An Electronics Home Study School
DeVRY INSTITUTE OF TECHNOLOGY

ONE OF THE
BELL & HOWELL SCHOOLS
4141 Belmont, Chicago, Illinois 60641



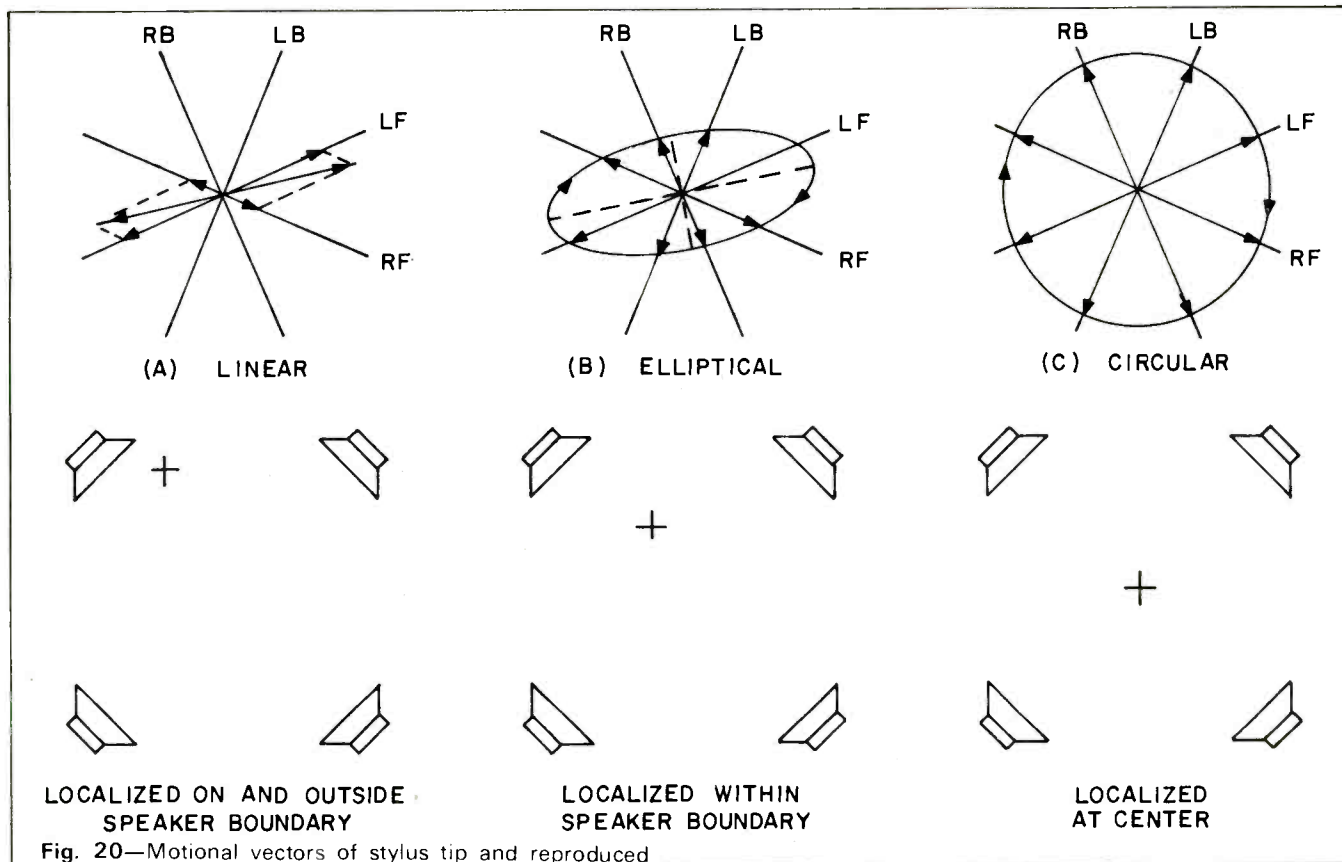

Fig. 20—Motional vectors of stylus tip and reproduced localization by QDCS.

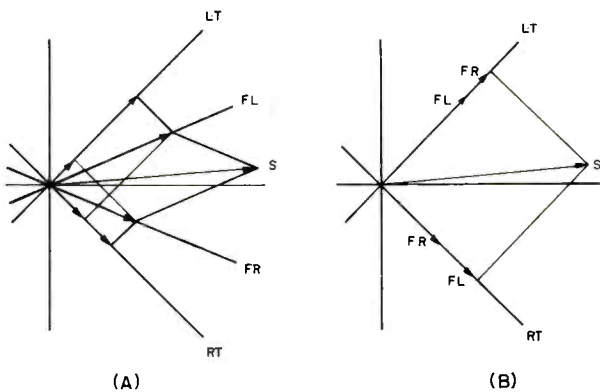

Fig. 21—Vectors by a front sound source.

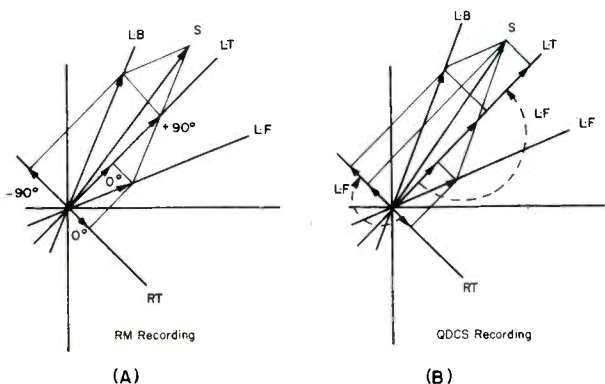

Fig. 22—Vectors by a left sound source.

(Continued from page 48)

spatial distributions of sound pressure, or separation enhancements by varying matrix parameters when under predetermined sound pressure distributions. Nor does it employ gain controls or other variables that are not part of the original sources, so that high fidelity in reproduction of sound pressure variations and localization of sound images are maintained at the same high levels as those of the two-channel stereo.

To describe the actual cancelling process, referring to Figure 25, definition of symbols used would first be necessary. Signals whose magnitude is expressed by the length of radial lines are also expressed in phase relationship by their radial angles to coincide with phase angles, where the counterclockwise direction is defined to be positive.

On this basis, the four-channel signals appearing at output terminals of the cartridge can be arranged to be expressed as in Figure 25 (A) where LF and RF are in phase, LB leads LF and RF by $+90^\circ$, and RB lags behind LF and RF by -90° , in the same manner as is done under RM encoding systems (for the sake of compatibility).

First, by letting front and rear signals be cancelled against each other in the left channels and also the right channels, main signals and opposite-phase crosstalk signals cancel out as shown in Figure 25 (B).

Next, by a similar process between left and right signals in the front channels and also the rear channels, remaining original crosstalk signals get cancelled out as shown in Figure 25 (C). Here, residual crosstalk and tertiary crosstalk generated by the secondary still remain, but their levels should be small enough to be negligible, and are not illustrated.

Generally, signals appearing at cartridge output terminals may be described as follows, where $\frac{1}{4}$ denotes the fractional rate of crosstalk from adjacent channels:

KLH is well into its second decade of manufacturing extraordinary high performance loudspeakers that don't cost an extraordinary amount of money. We've kept costs down by making every loudspeaker ourselves. And by selling a staggering number of them.

In short, we've had a lot of practice.
And that's perfect for you.

For now you can own a pair of our new Model Thirty-One loudspeakers for just \$89.95†. Think of it. Two superb sounding full-range loudspeakers at a price you might consider fair for just one! A pair of Thirty-Ones deliver a truly inordinate amount of sound for their modest size. You can drive them to big listening levels

with virtually any decent amplifier or receiver. They're handsome, featuring a new sculptured acoustically transparent foam grille. Rugged. And best of all, incredibly inexpensive. With the money you save, you might even trade-up to a better turntable or receiver, perhaps even get into quadraphonic sound. The Thirty-Ones can help make it happen. A pair is at your KLH dealer now. Listen to them soon. We're sure you'll agree that no one has ever offered you a better value in sound.

And we've had a lot of practice.

For more technical information, write to KLH Research and Development, 30 Cross Street, Cambridge, Mass. 02139. Or visit your KLH dealer.

What does it take to make an important new loudspeaker and sell it for \$89.95[†] a pair?

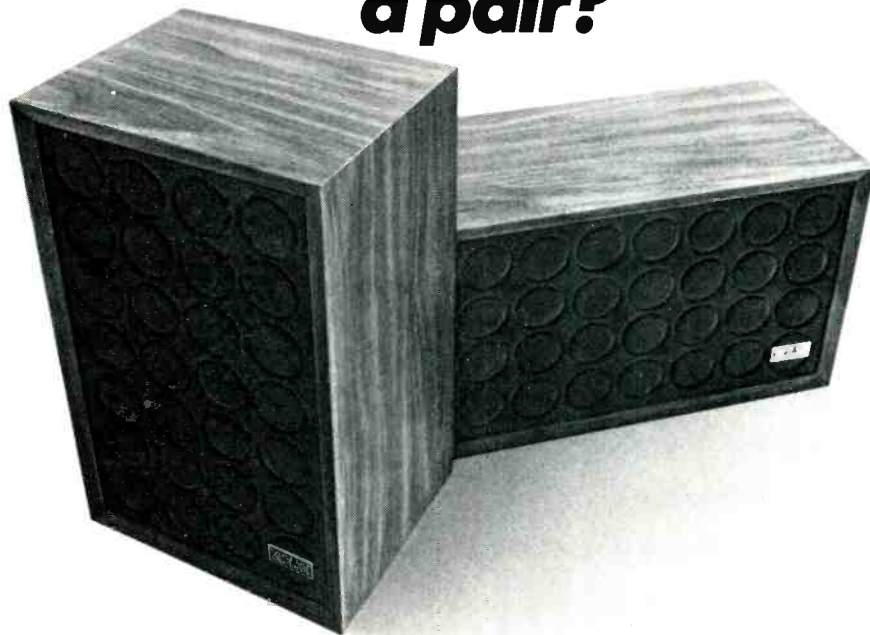

Practice. A whole lot of practice!

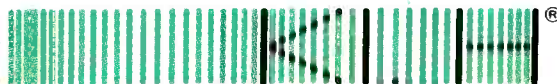

KLH RESEARCH AND DEVELOPMENT CORP.
30 Cross St., Cambridge, Mass. 02139

†Suggested retail prices—slightly higher in the South and West.

Check No. 22 on Reader Service Card

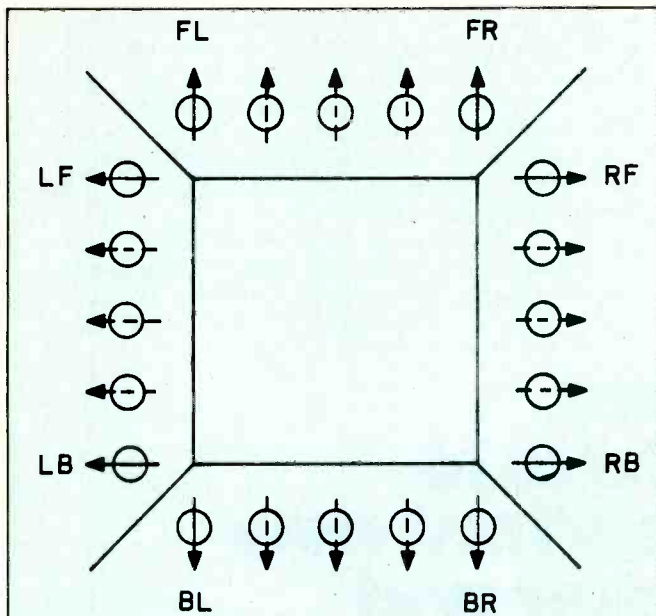

Fig. 23—Microphone setting for QDCS recording.

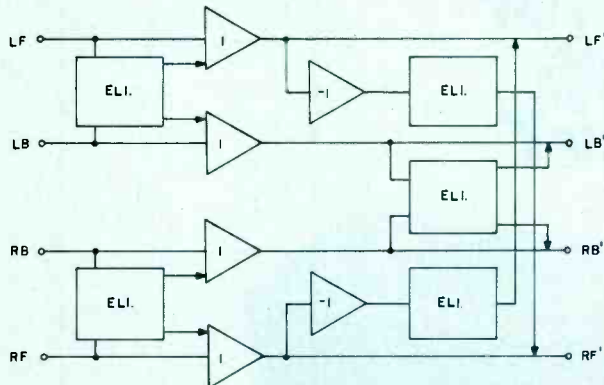

Fig. 24—Block diagram of "Crosstalk Eliminator."

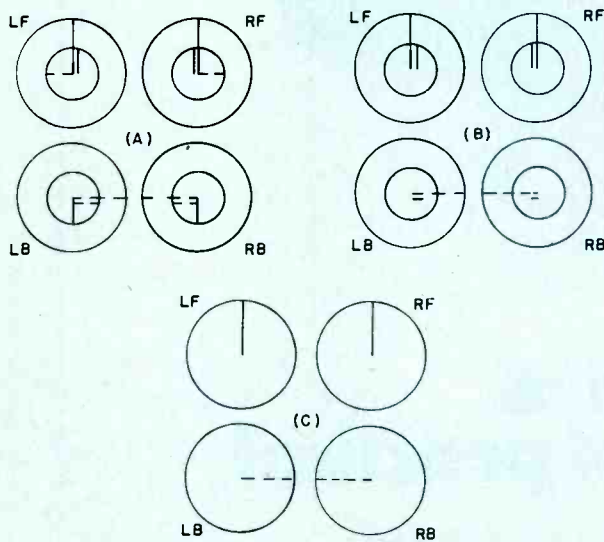

Fig. 25—Crosstalk cancelling process.

$$\left\{ \begin{aligned} LF &= Lf + \frac{1}{2}Rf + \frac{1}{2}Lb \\ RF &= Rf + \frac{1}{2}Lf + \frac{1}{2}Rb \\ LB &= Lb + \frac{1}{2}Rb + \frac{1}{2}Lf \\ RB &= Rb + \frac{1}{2}Lb + \frac{1}{2}Rf \end{aligned} \right.$$

By supplying $\frac{1}{2}$ times opposite-phase signals within the crosstalk eliminator, signals appearing at output terminals thereof may be described as follows:

$$\left\{ \begin{aligned} LF' &= Lf + \frac{y-x}{xy-2} Rf + \frac{y-x}{xy-2} Lb - \frac{2}{xy-2} Rb \\ RF' &= Rf + \frac{y-x}{xy-2} Lf + \frac{y-x}{xy-2} Rb - \frac{2}{xy-2} Lb \\ LB' &= Lb + \frac{y-x}{xy-2} Rb + \frac{y-x}{xy-2} Lf - \frac{2}{xy-2} Rf \\ RB' &= Rb + \frac{y-x}{xy-2} Lb + \frac{y-x}{xy-2} Rf - \frac{2}{xy-2} Lf \end{aligned} \right.$$

As expected, the greater the channel separation of cartridge, the more discrete will be the overall reproduction.

For example, if a cartridge outputs:

$$\left\{ \begin{aligned} LF &= Lf + \frac{1}{2}Rf + \frac{1}{2}Lb \\ RF &= Rf + \frac{1}{2}Lf + \frac{1}{2}Rb \\ LB &= Lb + \frac{1}{2}Rb + \frac{1}{2}Lf \\ RB &= Rb + \frac{1}{2}Lb + \frac{1}{2}Rf \end{aligned} \right.$$

and, if $\frac{1}{2}$ times opposite-phase signals are supplied within the eliminator, the resultant output therefrom will become:

$$\left\{ \begin{aligned} LF' &= Lf + \frac{1}{11} Rf + \frac{1}{11} Lb - \frac{1}{11} Rb \\ RF' &= Rf + \frac{1}{11} Lf + \frac{1}{11} Rb - \frac{1}{11} Lb \\ LB' &= Lb + \frac{1}{11} Rb + \frac{1}{11} Lf - \frac{1}{11} Rf \\ RB' &= Rb + \frac{1}{11} Lb + \frac{1}{11} Rf - \frac{1}{11} Lf \end{aligned} \right.$$

Solid Angle Recording and Detection, "QDCS Mark II"

Multichannel disc recordings should make full use of the cutters tip's ability of motion in any direction within the 360° angle around its stationary position, and QDCS MK I has been developed to achieve this goal.

However, closer review of recording methods brings us a step further to the realization that so far only such tip motions as within a given flat plane have been utilized by the above approach, and three-dimensional considerations have not been made.

Basically, vectors with up to two spatial directions can only constitute a single plane, but those with three or more directions can compose a solid angle. For effective utilization of three-dimensional tip motions, therefore, first consideration should be directed to the fact that front and rear

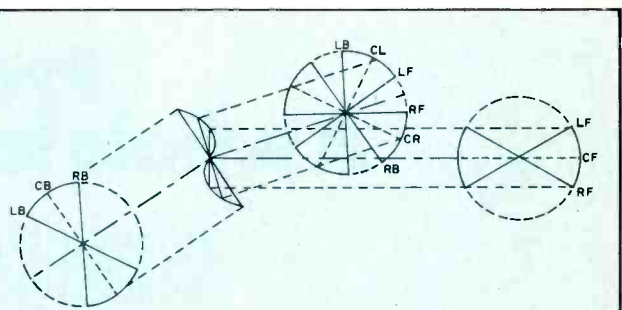

Fig. 26—QDCS MK. II: Three-dimensional disc cutting.

The Technics SA-8000X demodulates or decodes any kind of 4-channel. Even some that haven't been invented yet.

The Technics SA-8000X is master of all 4-channel systems. With special talents in discrete. Like a built-in demodulator for CD-4 records. Plus jacks for up to three 4-channel tape sources. And jacks for future discrete 4-channel FM.



It can handle any matrix method with ease. Because the Acoustic Field Dimension (AFD) controls and phase shift selector adjust to the coefficients of all the popular systems. Plus some that haven't been tried yet. And the same controls can help compensate for poor speaker placement and unfortunate room acoustics.

Each of the 4 direct-coupled amplifiers delivers 16 watts of RMS power at 8Ω, all channels driven.* (4x16w = 64w.) And because they can be strapped together, you get 42 watts RMS per channel at 8Ω, all channels driven,* in the 2-channel mode. (2x42w = 84w.)

That's double-power stereo.

In the FM section, we have combined a 4-pole MOS FET, ceramic IF filters, a monolithic IC and epoxy resin coils for superb reception. FM sensitivity measures 1.9μv.

Insist on the SA-8000X for total 4-channel. The concept is simple. The execution is precise. The performance is outstanding. The name is Technics.

*T.H.D.: less than 0.5%. Power Bandwidth: 5Hz-40kHz -3dB.

200 PARK AVE., NEW YORK, N.Y. 10017
FOR YOUR NEAREST AUTHORIZED
TECHNICS DEALER. CALL TOLL FREE
800 447-4700. IN ILLINOIS, 800 322-1400.

Technics

by Panasonic

Check No. 46 on Reader Service Card

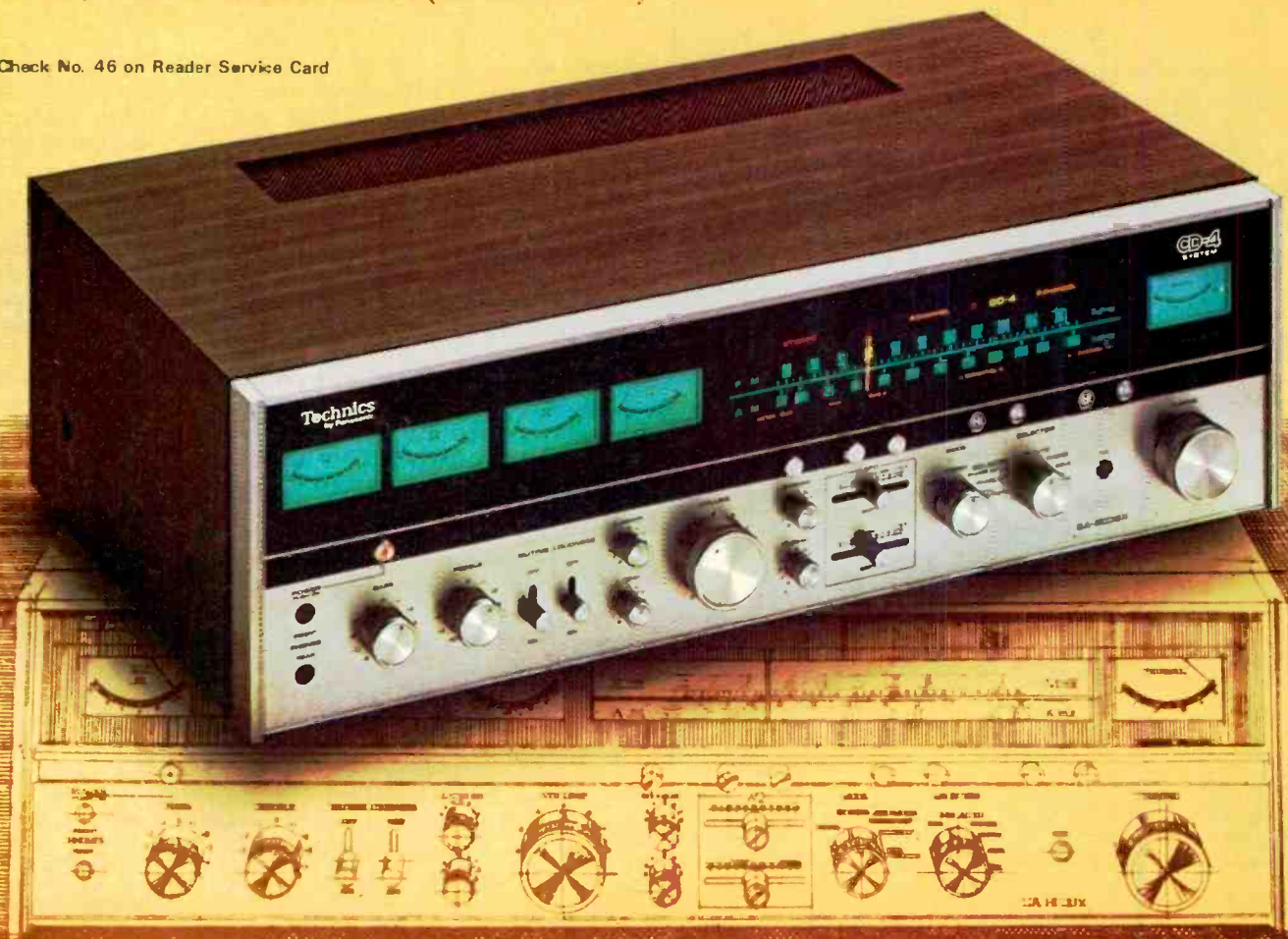

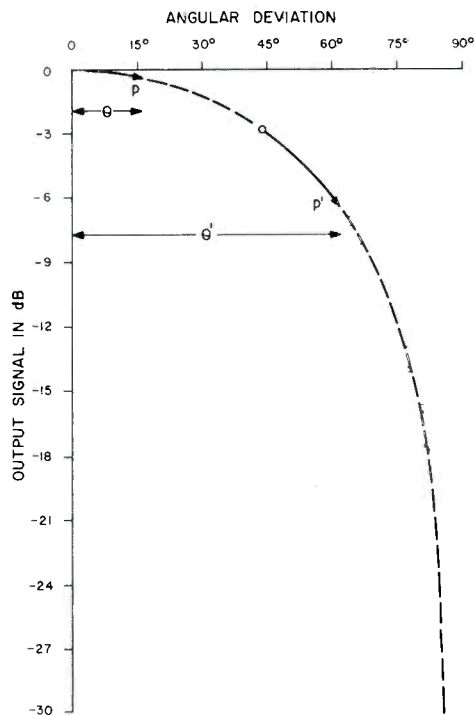

Fig. 27—Detection output vs. angular deviation between recording and detection axes.

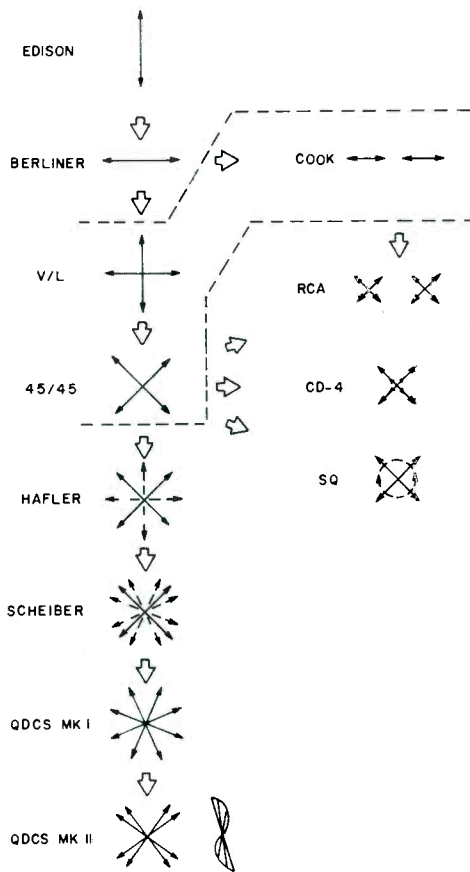

Fig. 28—Historical flow of recording developments as expressed by recording vectors.

channels border on axes horizontally (from left to right of the tip) symmetrical around the vertical tip axis. From this is suggested a three-dimensional format for one side of the border to include axes leaning toward the front and back of the tip, symmetrically around the vertical axis (for the sake of rationalism and compatibility with two-channel stereo and matrix systems).

It would be appropriate to assign these tilting angle vectors to rear channels that are under greater influence of vertical axes (gravity) than the front.

By incorporating in the cutter head such a front-rear angular driving mechanism as synchronizing with input cutting vector angles, distribution of actual cutting vectors can be broadened to encompass a three-dimensional solid angle. Assigning such broadened solid angles to appropriate recording channels (maintaining 90° angles between opposite channels for best results) enhances independence and separation of the channels, as compared with two-dimensional recordings. A representative distribution of such vectors is shown in Figure 26.

It follows that by incorporating in playback cartridges a mechanism responsive to the above, a greater channel separation should be attainable than when recording vectors are restricted within a two-dimensional flat plane.

Such playback cartridges should not only be effective for solid angle vector recordings, but also for conventional flat plane vector recordings in that an improved channel separation is attainable. The reason for this is that if in solid angle recordings the main signal vector were tilted by an angle θ from that for flat plane recordings, and its crosstalk vector θ' , these two angles would vary in the following ranges:

$$0 < \theta < 45^\circ, \quad 45^\circ < \theta' < 90^\circ$$

These signals could be expressed as gain levels by shifting of points, p and p' in Figure 27, so that as long as $\theta \leq \theta' - 45^\circ$. The crosstalk level should invariably be reduced below the level when $\theta = 0^\circ$ and $\theta' = 45^\circ$.

Summary

By analyzing individually the two mutually perpendicular transmission axes employed in disc recording and the multiple radial transmission axes employed in disc reproduction, we have shown that while impossible with tapes, multi-channelization in the form of direct systems is feasible with discs which are the most appropriate media for this purpose.

Secondly, we propose this QDCS system as the solution for the self contradiction and imperfection inherent in conventional two-channel disc systems as have been pointed out through analysis of properties of discs and ideal reproduction thereby.

Under these philosophies, we have also derived from correlation of sound pickup procedures and disc cutting vectors that the 4-2-4 effect, hitherto considered to be purely accidental, really has a theoretically sound basis.

From the foregoing we have introduced and described the QDCS disc cutting principle which is a balanced redistribution of the signals that are fed along the two transmission axes in recording.

To fulfill all of the foregoing leads to a simultaneous solution for compatibility and the sound field structure.

As a final summation, the relationship between conventional cut disc recording systems and QDCS MK I & MK II is shown in Figure 28.

This system, we believe, should be appraised by the fact that originally anticipated in Figure 1, it has finally materialized in the form shown in Figure 28.

Lastly it should be added that further development with QDCS as the basis is presently under way for still newer systems with a broader application.

AE

I bought a Marantz 4 channel receiver because I refuse to be stuck with an electronic antique.



Not one to tolerate obsolescence (planned or unplanned), I considered the stereo vs. 4-channel question carefully, then purchased a Marantz receiver for three compelling reasons.

One. Marantz has Dual Power. This means you get full power of four discrete amplifiers working all the time. When you're listening to regular 2-channel tapes and records you can combine the power of all four channels into the front speakers. This means even if you're not ready to commit yourself to a complete 4-channel system, you can buy Marantz now and when you get the other two speakers just flip a switch. You have 4-channel. Meanwhile, you're not compromising 2-channel because you're getting more than twice the power for super stereo.

Reason number two. Marantz receivers feature the exclusive snap-in snap-out adaptability to any 4-channel matrix decoder. This means that your Marantz stereo will never be made obsolete by any future 4-channel technology because the Marantz snap-in SQ[®] module is designed to keep up with the changing state of the art. What's more, Marantz receivers have Vari-Matrix—a built-in circuit that will synthesize 4-channel sound from any stereo source (including your stereo records and tapes) and will also decode any matrix encoded 4-channel disc or FM broadcast.

Reason number three. Marantz receivers, from the Model 4230 up, feature built-in Dolby[®] noise reduction to bring you the quietest FM reception ever. And you can switch the built-in Dolby into your tape deck for noise-free, no-hiss recording from any source. A real Marantz exclusive.

I chose the Marantz Model 4270 because it suits my needs perfectly. It delivers 140 watts continuous power with under 0.3% distortion. And it's literally loaded with features. However, your requirements may be more modest than mine. In which case you can own the Marantz Model 4220 which delivers 40 watts with Dual Power. Or you can go all the way and get the Marantz Model 4300 with 200 watts. It is the very best. Choose from five Marantz 4-channel receivers from \$299 to \$899.95.

The point to remember is this—whichever model Marantz 4-channel receiver you do buy, you can buy it today without worrying about its being obsolete tomorrow. Look over the Marantz line of superb quality receivers, components and speaker systems at your Marantz dealer. You'll find him listed in the Yellow Pages. Think forward. Think Marantz.

marantz.
We sound better.

*SQ is a trademark of Columbia Broadcasting System, Inc.
**TM Dolby Labs, Inc.



©1973 Marantz Co., Inc., a subsidiary of Superscope Inc., P.O. Box 99A, Sun Valley, Calif. 91352. In Europe: Superscope Europe, S.A., Brussels, Belgium. Available in Canada. Prices and models subject to change without notice. Consult the Yellow Pages for your nearest Marantz dealer. Send for free catalog.

Check No. 43 on Reader Service Card

Equipment Profiles

Pilot Model 366 Four-Channel Receiver



MANUFACTURER'S SPECIFICATIONS

FM TUNER SECTION:

IHF Sensitivity: 1.8 μ V. **S/N:** 65 dB. **THD:** (Mono), 0.4%; Stereo, 0.8%. **Selectivity:** 65 dB. **Capture Ratio:** 1.5 dB. **IF Rejection:** 90 dB. **Image Rejection:** 80 dB. **Spurious Response Rejection:** 90 dB. **Stereo Separation:** 36 dB @ 400 Hz.

AM TUNER SECTION

IHF Sensitivity (Internal Antenna): 200 μ V. **Selectivity:** 35 dB. **S/N:** 45 dB. **Image Rejection:** 60 dB. **IF Rejection:** 60 dB. **Bandwidth** (-6dB): 7 kHz.

AMPLIFIER SECTION:

Power Output: 60 watts per channel, Stereo Mode; 30 watts per channel, 4-channel mode, continuous power at 1 kHz. **Rated THD:** 0.5%. **Rated IM:** 0.5%. **Power Bandwidth:** 10 Hz to 40 kHz. **Frequency Response:** High Level: 15Hz to 25kHz \pm 1 dB. **Damping Factor** (8-ohms): 35. **Input sensitivity:** Phono 1 & 2, 2.5/4.5 mV; High Level, 250 mV; Microphone, 1 mV. **Tape Output:** 350 mV.

GENERAL SPECIFICATIONS:

Dimensions: 7 in. H x 18 1/2 in. W x 17 1/2 in. D. **Power Requirements:** 120 V 50/60 Hz. **Weight:** 44 lbs. **Price** (Includes walnut enclosure): \$499.90.

The Pilot 366 4-channel receiver is a large, imposing unit, laden with control features and control flexibility which will appeal to the audiophile who wants quadraphonic sound mixed in with a bit of a recording facility. We're referring to the fact that in addition to the features you would expect, the Model 366 has a pair of microphone inputs located right on the front panel, above which is a dual level control knob which enables the user to "mix" mic or instrument inputs together with any other program source. Unfortunately, the mixing control affects

both mic inputs, thereby limiting its flexibility. As for the front panel, it is black epoxy-coated aluminum, screened with white letters of good, readable size and equipped with silver colored knobs and pushbuttons. Major front panel controls include a SELECTOR switch (with two PHONO and two AUX positions plus AM and FM), a five-position mode switch (MONO, STEREO, MATRIX-4, SQ and DISCRETE), separately operated dual-concentric clutch type BASS and TREBLE controls, a pair of BALANCE controls (front-back and left-right), also clutch operated for individual channel balance, and a master VOLUME control. There are twelve push buttons for secondary control functions such as LOW and HIGH FILTERS, TAPE MONITOR, LOUDNESS, MUTE, speaker NORMAL-REVERSE (which affects rear speakers only), speaker selector switches for MAIN and REMOTE (duplicated for stereo power mode or quadraphonic power mode) and a POWER on/off push button. The previously referred to MIC level control and input jacks are located at the lower left of the panel while a matching pair of PHONE jacks are symmetrically located at lower right. Upon application of power, the upper portion of the panel is illuminated either by a single word, denoting selector switch position or, in the case of AM or FM selection, by a green dial scale and a yellow pointer tip. At the left of this portion of the dial are two meters, a center-of-channel meter which is illuminated only when FM listening is selected and a signal strength meter, illuminated during AM listening. This area of the panel also has illuminated lights to tell the user whether the mode switch is in mono, stereo or 4-channel settings. In our view, the separate buttons for two-speaker and four-speaker mode (with "double power available in stereo") is a bit confusing, though not dangerous, for Pilot's instruction manual cautions against pushing, say, a "main speaker" button for both 2-channel and 4-channel operation at the same time! These buttons would

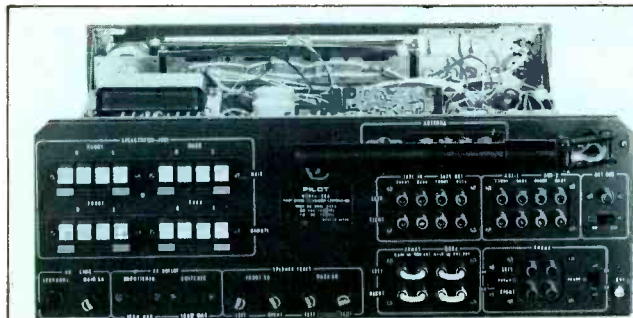

Fig. 1—Rear panel layout.

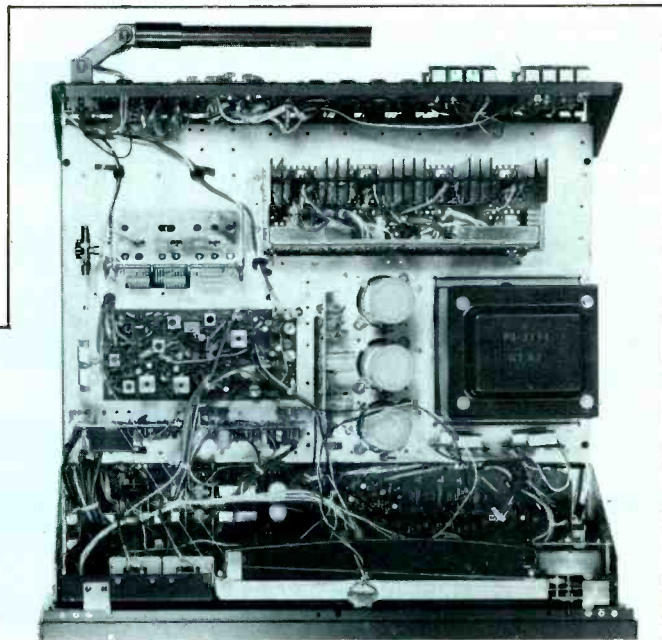

Fig. 2—Internal chassis layout.

have been better off combined as a single rotary selector switch, much as other manufacturers of "strapped" four-channel receivers have done.

Figure 1 is a view of the rear panel layout of this receiver. Sixteen black and red color coded spring loaded terminals make speaker connections simple. Stripped wire ends are merely inserted in holes that are accessible when each button is depressed and are firmly retained in place when the button is released—no twisting or turning of screws required. In addition to screw-type antenna terminals for 300 ohm FM and external AM antennas, there is provision for a coaxial connector for 75 ohm FM transmission lines. Each pair of phono inputs is accompanied by a slide switch which varies phono input sensitivity from 2.5 mV to 4.5 mV. Jumpers installed in four pairs of PHONO jacks permit separation of each preamplifier channel from its associated main amplifier section. Sixteen additional phono jacks take care of AUX 1, AUX 2, TAPE IN and TAPE OUT circuits. (It's amazing how the number of jacks multiplies when you double everything for four-channel applications!) An FM detector output jack is located at the extreme right of the rear panel, and there is a switch which turns off this facility (for the next couple of years until discrete FM broadcasting begins) and we are at a loss to understand why this jack must be disconnected when not used, since it is simply a connection point to the FM detector output. In fact, we could detect no difference in FM performance with the switch "on" or "off." Four speaker line fuses, a power line fuse, a switched and unswitched convenience a.c. receptacle, a ground terminal and the usual ferrite bar AM antenna complete the rear panel arrangement.

A view of the internal layout of the Pilot 366 chassis (Fig. 2) discloses that it is constructed of individual p.c. board modules, although there seems to be an inordinate amount of interwiring required. The sealed and shielded front-end utilizes a four-section variable capacitor for FM and a three section unit for AM. Three dual-gate FET's are used in the circuitry of the FM front-end. The relatively small i.f.-MPX module contains three IC's in the FM i.f. section as well as ceramic filters. An IC does most of the job of stereo decoding as well, while the AM circuitry consists of bi-polar transistor circuits. Preamplifier, voltage amplifier and tone control stages are constructed using conventional circuitry and separate transistors rather than IC's while NPN power output transistors are powered by dual positive and negative 33 volt supplies, eliminating the need for coupling capacitors between outputs and speakers. The SQ decoder module employs minimal phase shift networks, which are switched out of the circuit when the MATRIX-4 decode position is selected. This setting is recommended by Pilot for listening to conventional stereo records and extracts ambience

or out-of-phase information in the now familiar way. A novel additional circuit is a locally-generated 1 kHz oscillator which is used as a test signal to balance sound levels from all four speakers. A central PILOTONE button, not previously mentioned, is located on the front panel for this purpose. This test signal presumes that program sources as well as internal amplification in the receiver, are equal, which may or may not be the case. Power supply voltage is obtained by means of a bridge rectifier arrangement with 6800 mfd capacitors used for primary filtering of both negative and positive output stage voltages. Each basic amplifier section has a differential amplifier stage as an input and coupling is direct from this stage to output transistors.

Tuner Section Measurements

IHF sensitivity in FM, as measured on our sample, was exactly 1.8 μ V as claimed. A 50 dB S/N ratio was obtained with an input signal of only 3 μ V, but ultimate S/N was 63 dB in mono, as opposed to the 65 dB specified. Both mono and stereo THD were considerably better than claimed by the manufacturer, measuring 0.2% and 0.4% respectively, at mid-frequencies of audio modulation. Results of these measurements are plotted in Fig. 3. Muting and stereo switching threshold occurred at an input signal strength of about 10 microvolts. For stereo reception, ultimate S/N was 63 dB, a value obtained for all input levels above about 100 microvolts.

Stereo FM separation and distortion versus frequency in FM are plotted in Fig. 4. At mid-band frequencies, separation exceeded manufacturer's claims by roughly 3 dB, measuring 39 dB. Separation decreases gradually to about 30 dB at 100 Hz and 27 dB at 10 kHz—figures which are more than adequate for this parameter. Mono THD remains less than 0.5% for all frequencies from 50 Hz to 4 kHz rising to an acceptable 0.7% at high audio frequencies. Stereo THD hovers around the 0.5% mark until "beats" appear at higher frequencies, resulting in a spurious output reading of about 2.3% at 5 kHz. Selectivity measured 65 dB as claimed, while capture ratio fell a bit short of published claims, measuring 1.8 dB. Spurious response rejection measured 93 dB, a bit better than claimed, while i.f. and image rejection conformed almost exactly with Pilot's published specifications. The AM section proved to be quite good, with sensitivity reading of 150 μ V as opposed to the 200 μ V claimed. Using an external dummy antenna, sensitivity was just under 20 microvolts, while selectivity measured 38 dB.

Amplifier Measurements

In the four-channel mode, maximum continuous power output obtained for rated THD (0.5%) equalled 28 watts per channel. At the rated value of 30 watts per channel,

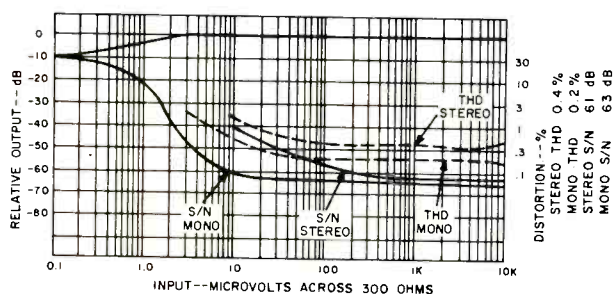

Fig. 3—FM quieting and distortion characteristics.

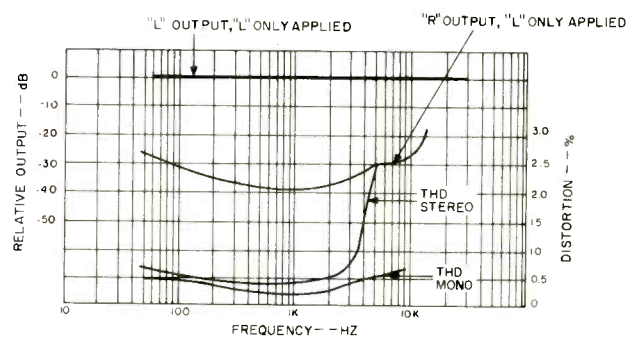

Fig. 4—Separation and distortion vs. frequency.

Enclosure: Oiled walnut airtight cabinet having a volume of approximately 2.5 cu. ft.

Heavy 12-inch acoustic-suspension woofer with massive magnet and low-resonance cone produces powerful true bass to the very lowest regions of musical sound.

¾-inch Mylar dome tweeter projects uppermost highs with exceptional clarity over broad arc, resulting in "open" sound with accurate stereo space image.

Contour control with four distinct settings permits precise acoustic matching of the WDDS-12 to the acoustic requirements of almost any listening room.

1½-inch Mylar dome tweeter assures smooth frequency transition into midrange while providing wide dispersion and crisp transients in the crucial "presence range."

Optional base in handsome matte black

Angled dome tweeters generate a uniform sound field over 120° dispersion. Location of all drivers in the same curved plane, creates a Wide Dispersion Discrete Source (WDDS), vital for realistic stereo location and making the most of the speaker's outstanding transient response. WDDS avoids spurious sound scatter and infuses the sound field into the listening room in a pattern virtually analogous to that of a stage or auditorium performance. As a result, the listener remains unaware of the speaker—the music seems "simply there."

WDDS-12 SPECIFICATIONS

- NOMINAL IMPEDANCE:** 6 ohms
FREQUENCY RESPONSE: 30Hz.-25KHz ± 2 db. Average over 120° lateral radiation field and anechoic conditions above 300Hz.
LOW FREQUENCY DRIVER: 12" high compliance, heavy duty.
HIGH FREQUENCY DRIVERS: Two 1½" dome radiators and two ¾" dome radiators.
CROSSOVER FREQUENCY: Crossover takes place gradually between 600Hz and 5KHz.
DISPERSION: Frequency Response varies by no more than 3db from the "on axis" response over a 120° lateral field.
GUARANTEE: 5 years, as detailed in our guarantee form. All service to be carried out by authorized dealer or agent, eliminating need to return speaker to factory.
PRICE: \$350.00

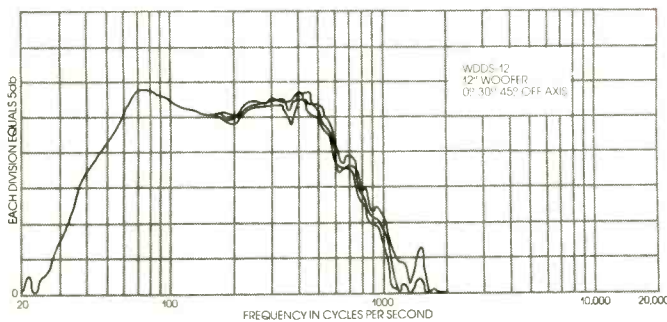

Woofer response, on and off axis, shows effective output below 30Hz, reaching the lowest range of musical sound.

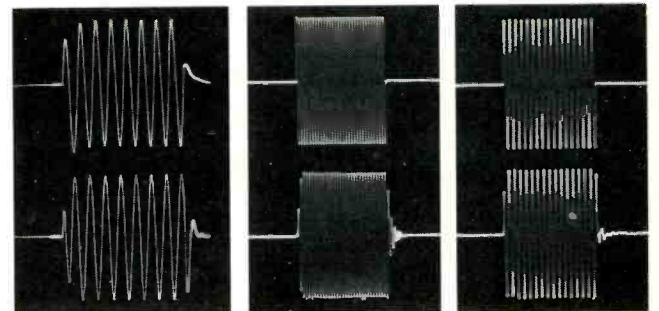

Woofer tone burst at 45Hz and supertweeter tone burst at 16 and 4 kHz attest remarkable clarity of transients throughout audible spectrum.

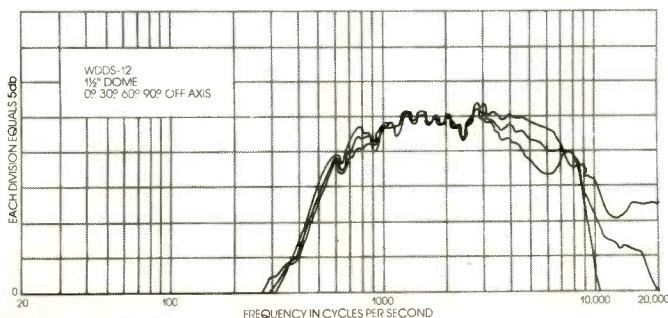

Tweeter response curves on and off axis almost coincide, proving uniformity of sound spread in listening space.

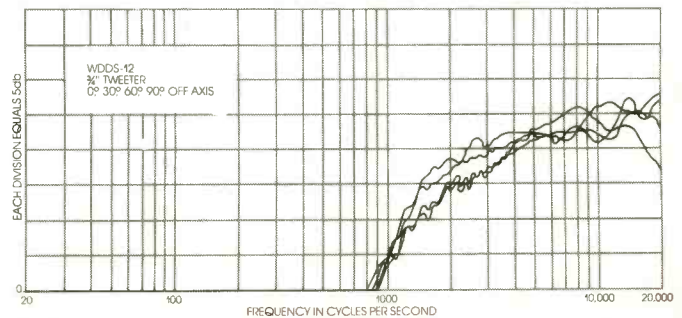

Supertweeter response curves off axis also closely parallel on-axis response, showing superior sound dispersion.

Introducing the WDDS-12 Pritchard Loudspeaker System

More confusion?

There are literally hundreds of speakers on the market. There are 2-way systems, 3-way systems, omnidirectional, rearward sound projection, et al. All, according to their makers, are outstanding. And, frankly, several are.

Small wonder the public is confused. And good reason why serious listeners rely on expert opinions, as well as recommendations from knowledgeable equipment owners.

Our new Pritchard system will surely add to the confusion. And our claims will fall, unfortunately, on many deaf ears.

But among those people who, over the years, have learned to separate fact from fiction...who trust their own ears...and who respect "inside" opinions, this new speaker will be a revelation.

If you're a serious listener, unfamiliar with ADC speakers, we urge you to talk to people familiar with our products. They know that, among the relatively few outstanding speaker systems on the market, ADC's line ranks among the best. And, now, with the introduction of the Pritchard System, ADC's probably number one!

For most, the confusion about speakers will continue. For some, the WDDS-12 Pritchard System will shout "hello."

**ADC speakers
-the insider's choice.**



AUDIC DYNAMICS CORPORATION, Pickett District Road, New Milford, Conn. 06776

Check No. 5 on Reader Service Card

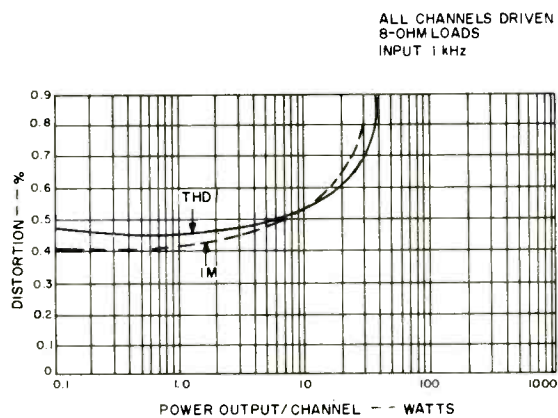

Fig. 5—Harmonic and intermodulation distortion characteristics.

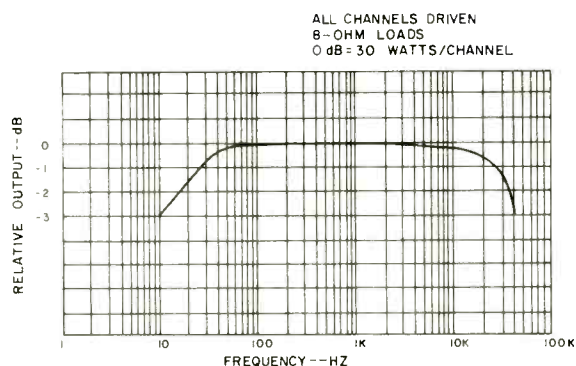

Fig. 6—Power bandwidth characteristics.

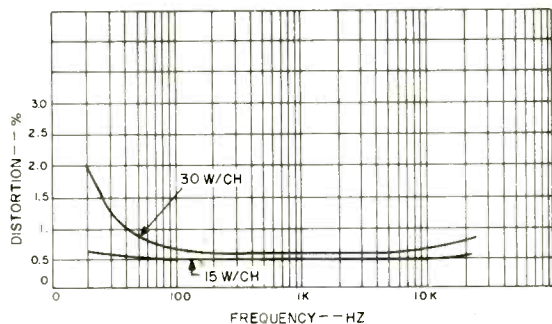

Fig. 7—Distortion vs. frequency.

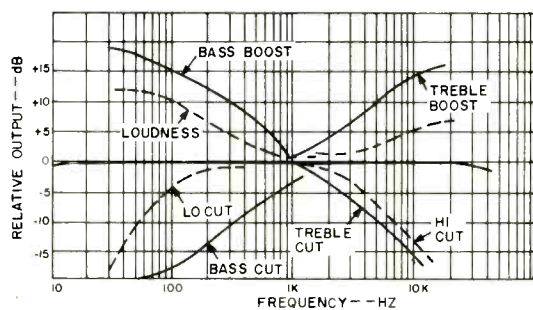

Fig. 8—Tone control range, filter and loudness characteristics.

THD was 0.7%. IM distortion measured 0.8% at rated output under the same conditions. Distortion at lower power levels remained at or near 0.5%, while IM decreased to roughly 0.4% for lower power output levels. These values are plotted on a continuous basis in Fig. 5. It should be noted that no plot is made for the strapped condition (stereo operation), however, results were essentially the same using a reference of 60 watts continuous power per channel. All readings were taken with all channels driven into 8 ohm loads.

Power bandwidth, plotted in Fig. 6, extends from 10 Hz to 40 kHz as claimed. It should be noted however that the 0 reference point in this plot is 30 watts per channel and since actual power output for rated THD is slightly lower than 30 watts, mid-band points on the curve also fall below the 0 dB reference. If Pilot had chosen to rate the unit more conservatively (say, 25 watts per channel), power bandwidth on that basis would have extended somewhat beyond the limits of 10 Hz and 40 kHz.

If the amplifier section of the Model 366 is driven to 30 watts at 20 Hz, THD rises to about 2%, as shown in Fig. 7. At half power, however, distortion remains fairly constant over the entire audio spectrum. Action of preamplifier section controls is plotted in Fig. 8. Bass boost action is a bit extreme and this control should therefore be used in moderation to avoid overloading the amplifier at low frequencies. The low frequency filter has a slope of 12 dB per octave, while the high-cut filter behaves much like the treble cut control, at a slope of only 6 dB per octave. Loudness-contour (measured at 30 dB below maximum volume control setting) is typical of this circuit and Pilot's designers have chosen to emphasize treble as well as bass when the loudness control is activated, though the treble boost is more moderate as it should be.

Listening Tests

In the course of listening to the Pilot 366, we discovered and used a couple of additional features which we had not noticed up to that point. For example, the illuminated pointer, we found, changes color from yellow light to red light when a station is precisely tuned in on FM. It takes a fairly strong signal to make the light color change, however, and under those circumstances, the "window" of color change is fairly broad and we still preferred setting accurate tuning by means of the center-of-channel meter. Still, it's an interesting feature. We also found that the MATRIX-4 setting of the mode switch worked well with some stereo discs but worked to our satisfaction even on some quadraphonic-encoded discs—sometimes better than when the same discs were played in the SQ position.

The built in SQ decoder circuit in the Pilot 366 is the simple non-logic type and in certain instances this type of SQ decoding results in some ambiguities, particularly when a "stage front and center" soloist is involved in the recorded performance. It was with such recordings that we found the MATRIX-4 setting to be more effective than the SQ setting.

Power output of the receiver was adequate for medium-low efficiency speakers in the four-channel mode. Power capability seemed noticeably better when we hooked up only a pair of stereo speakers and treated the receiver as a two-channel unit. We're well aware of the fact that the difference in power output under those circumstances is only 3 dB and that it should have been "barely noticeable" but we can only report on what we heard. Perhaps that three dB made the difference between bass distortion and clean bass at the levels we used in our tests.

For those interested in adding CD-4 demodulator equipment to this receiver, the fact that there are a pair of AUX inputs

The best of both worlds— PICKERING'S STATE-OF-THE-ART CARTRIDGES...

Pickering has done it again! In 1957—the *first* American-made magnetic stereo cartridge that helped build the industry was a Pickering. Now—in 1973—the *first* American-made discrete, 4-channel cartridge that will change the world's listening is a Pickering. Today, Pickering invites you to enjoy the *best* of the world of your choice.

For the world of STEREO— XV-15/1200E

Designed for use with all stereo and four-channel derived compatible systems.

"PRECISION" is the one word that best characterizes the extraordinary quality of the new Pickering XV-15/1200E cartridge, the culmination of Pickering's 25 years in contributing important technological advances to the manufacture of magnetic cartridges. We sincerely feel that the 1200E is the furthest advance achievable today—and perhaps in the foreseeable future—in stereo cartridge design and performance. Its exceptional ability to pick up *all* the material recorded at the lightest possible tracking forces make it totally unique and superior. This cartridge is for the sophisticate—one who possesses components of such superlative quality that the superiority of the XV-15/1200E is a requirement.

And all of Pickering's exhaustive testing shows that the 1200E is superior in the flatness of its frequency response and channel separation in comparison to competitive cartridges.

SPECIFICATIONS

Frequency Response: 10 Hz to 30 kHz
 Channel Separation,
 Nominal: 35 dB
 Tracking Force: $\frac{3}{4}$ gram, $+\frac{1}{2}$ gram,
 $-\frac{1}{4}$ gram.
 Nominal Output: 4.4 mv
 Stylus Tip: 0.0002" x 0.0007"



For the world of DISCRETE 4-CHANNEL— UV-15/2400Q

Designed and engineered specifically for playback of discrete recordings.



The introduction of the discrete 4-channel system required a completely new cartridge that could not only faithfully reproduce the 20 Hz to 20 kHz AM signals, but also the 30 kHz FM modulated signals. The result is the Pickering UV-15/2400Q discrete 4-channel cartridge, which represents a new level in the state of the art. It consists of a completely redesigned cartridge and a new high performance stylus assembly, the Quadrahedral™, which was specially developed for this application, and features a revolutionary new diamond stylus. The UV-15/2400Q performs in a superior manner by every measurable test, and is capable of satisfying all the technical and aesthetic requirements for playback of all the material recorded on both discrete and stereo disks. Moreover, its stylus is so designed that it not only perfectly reproduces the music recorded, but also reduces record wear.

SPECIFICATIONS

Frequency Response²: 10-50,000 Hz
 Channel Separation: 35 db
 Tracking Force¹: 1-3 grams
 Output³: 3.8 mv \pm 2 dB
 Stylus: Quadrahedral

Notes:

1. Recommended by manufacturer for optimum performance.
2. When the cartridge is terminated in the recommended load of 100K ohms and 100 PF.
3. Output with reference to 5.5 cm/sec record velocity.

The right Pickering cartridge for your equipment is the best cartridge money can buy.



For further information write Pickering & Co., Inc.
 Dept. F, 101 Sunnyside Boulevard, Plainview, New York 11803

Check No. 28 on Reader Service Card

available in a convenience and permits you to hook up a CD-4 demodulator without having to disconnect your tape recorder or other high level program source.

FM reception was acceptable, and we were favorably impressed with the positive action of the muting circuits. There was no audible transition noise as stations were approached when the muting circuit was in use. The threshold point (10 microvolts) chosen by Pilot seemed right for a tuner of this sensitivity as well, though we were able to listen to three or

four stations with acceptable quieting with the mute defeated that would have otherwise not been received.

Under \$500 is what you would normally expect to pay for a stereo receiver with 60 watt per channel capability. The fact that Pilot is able to offer that "dollars per watt" ratio and quadraphonic capability with built in decoding facilities as well makes the Pilot 366 worth a second look.

Leonard Feldman

Check No. 52 on Reader Service Card

Nakamichi Tri-Tracer 1000 Cassette Recorder



MANUFACTURER'S SPECIFICATIONS

Wow and Flutter: Less than 0.10% (DIN). **Frequency Response:** 35 to 18,000 Hz \pm 3 dB, Low Noise Tape; 35 to 20,000 Hz \pm 3 dB, CrO₂ tape (both using Dolby). **Signal-to-Noise:** Better than 60 dB (DIN), Dolby, weighted at 3% distortion. **Total Harmonic Distortion:** Less than 2%, 0 VU, 1 kHz. **Channel Separation:** Better than 35 dB, 0 VU, 1 kHz. **Bias Frequency:** 105 kHz. **Headphone Output:** 3 mW. **Dimensions:** 20.7 in. W x 11.7 in. H x 8.6 in. D. **Price:** \$1,100.00.

The Nakamichi 1000 must surely be considered the Rolls Royce of cassette recorders with its two noise reduction systems (Dolby and Philips DNL), variable speed, separate record head with monitoring facilities, IC logic control, and a host of other features. It is intended for professional users but it will obviously appeal to many enthusiasts who want state-of-the-art performance—and can afford the \$1100! The unit is housed in a wooden case for vertical operation but it is available for rack mounting if desired. At the left is the cassette compartment and just above that is a hinged

door covering the speed control and head alignment controls (see Fig. 2). Adjustment is simplicity itself and it works like this: A built-in oscillator or generator supplies a 400 Hz signal which is recorded on the tape. Output from the recording and playback heads is taken via a phase-comparison amplifier to two LED indicator lamps called alignment beacons. All the user has to do is turn an adjustment control so that the lights are balanced. The control affects only the record head. In other words, it is matched to the playback head which is aligned at the factory. There is an azimuth adjustment for this head and it can be checked with a standard test tape if necessary. Incidentally, tape motion is from right to left and the heads are mounted above the tape. The tape speed control gives a variation of \pm 6% in playback only and it is labelled PITCH CONTROL.

Under the cassette compartment are six touch-control buttons labelled PAUSE, RECORD, F. FORWARD, REWIND, STOP, and PLAY and each one has an indicator light. To the right of these controls is a small panel on which is mounted the tape counter, EJECT button, AUTO REW and MEMORY rewind switches plus a headphone jack. The MEMORY rewind switch allows the tape to be wound back to a preset point and the AUTO REW switch will automatically ensure that the tape will be rewound at the end of the tape—a useful device! At the top right are the two large VU meters (peak reading), and underneath them are switches for TAPE SELECTION (NORMAL and CrO₂), LIMITER, DOLBY and DNL noise reduction and tape-source MONITOR. To the right is the ON/OFF switch and three MIC INPUT sockets—one for each channel and one for center. OR BLEND. To the left of these

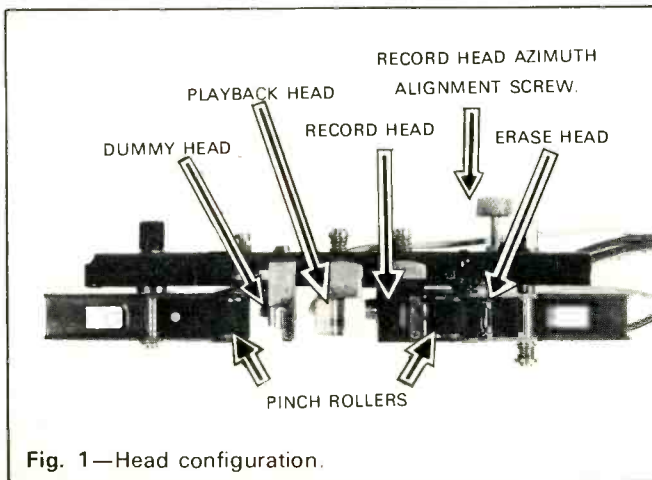

Fig. 1—Head configuration.

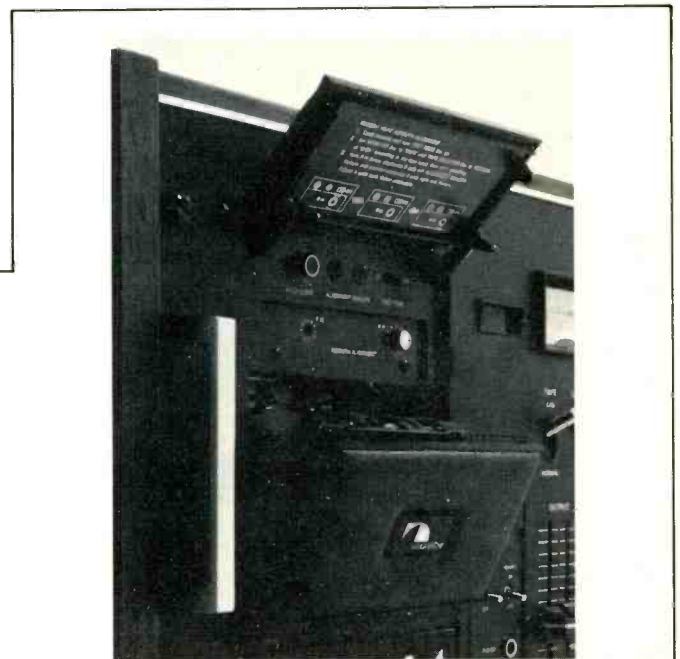

Fig. 2—Showing compartment containing speed and head alignment controls.

Dynaco A-25
\$89.00

Experts Agree: the Dynaco A-25 loudspeaker is unquestionably the best!

"... (The Dynaco A-25's) are quite probably the best buy in high fidelity today."

The Stereophile Magazine

"... The Dynaco had a remarkably neutral quality... The A-25 had less of this coloration than most speakers we have heard, regardless of price... Nothing we have tested had a better overall transient response... Not the least of the A-25's attraction is its low price..."

Julian Hirsch in Stereo Review

"... it was its outstanding transient response which really impressed us. Tone bursts throughout the meaningful frequency range showed up its excellence. In truth, the A-25 produced the finest tone-burst response of any speaker in this manner, regardless of price."

Audio

dynaco inc. Division Tyco

3060 JEFFERSON ST., PHILADELPHIA, PA. 19121

Also available in Canada from DYNACO OF CANADA, LTD.

DYNACO, INC.

A3

3060 Jefferson Street, Phila., Pa. 19121

Gentlemen:

Please send new full color Dynaco catalog.

Name _____

Address _____

City _____

State _____

Zip _____

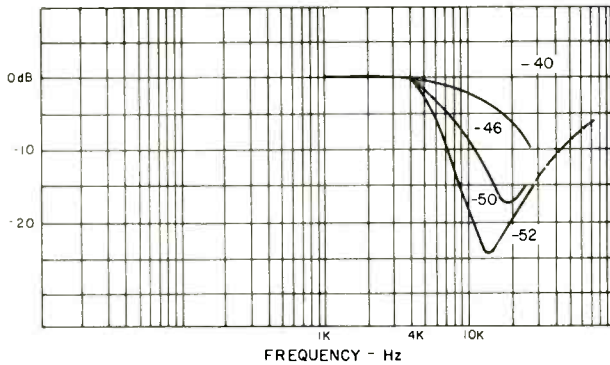

Fig. 3—Showing operation of the DNL noise reduction system.

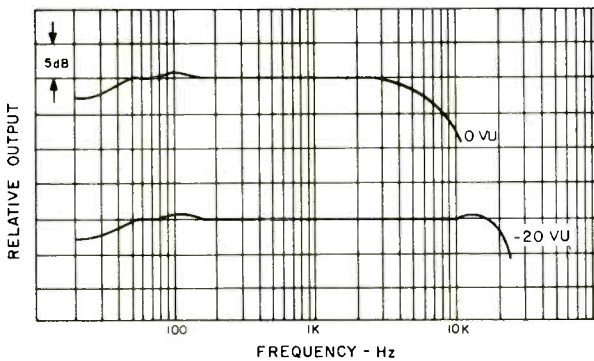

Fig. 4—Record-replay response with Nakamichi CrO₂ tape.

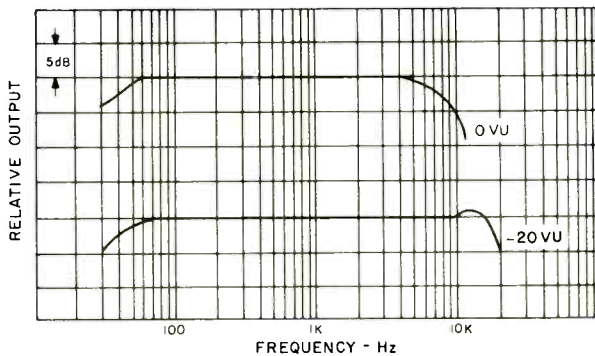

Fig. 5—Record-replay response with low-noise tape.

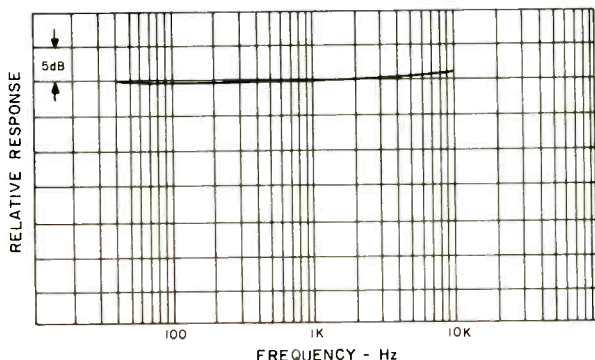

Fig. 6—Response from standard playback tape.

are twin slide controls for OUTPUT, LINE INPUT, and MIC INPUT and a single one for the BLEND MIC position. Finally, at the top center is an illuminated tape run indicator. At the rear are the input and output sockets, test-tone level control and calibration controls for both CrO₂ and NORMAL tapes. There are also two DIN sockets (one for stereo mic) and an MPX switch that cuts response above 18 kHz to prevent the FM 19 kHz carrier from interfering with Dolby operation and—I almost forgot—a socket for a remote control unit.

Model 1000 employs no less than 138 transistors, 59 diodes and 8 ICs. A very complex logic circuit is used for precise control to ensure foolproof, effortless operation and freedom from click noise. Thus, if you want to record when the machine is in the STOP position, you press (or rather touch) the appropriate buttons and the sequence of events is as follows: First the bias oscillator is switched on, then after 100 milliseconds the head moves to position and the pinch roller starts to rotate. When the tape movement is stable (520 mS), the record amplifier is turned on and is ready after 70 mS. Finally, after 790 mS the playback amplifier is turned on. When recording stops, first the recording amplifier is switched off, then the bias oscillator slowly "dies" and the playback amplifier is switched off—the whole sequence taking 200 mS.

As mentioned above, two noise reduction systems, Dolby B and Philips DNL, are used and it might be thought that this is really gilding the lily or at least extravagant. However, a moment's thought will show that these two systems are not incompatible but actually are complementary. As most readers know, the Dolby system functions by boosting high frequency signals during recording and then reducing them at playback (A simplified explanation, but it will suffice). Now, the DNL is rather different in that it works only during playback. Frequencies above 4 kHz are cut in proportion to level as shown in Fig. 3. Note that the maximum effect is in the region of 10 kHz and that the system has virtually no effect above levels of -40 dB. So the DNL system can be used on playback with ordinary tapes and the Dolby reserved for recording. Can you use both together? The answer is yes, and the total noise reduction is then about 13 dB. For most purposes, it is probably better to use them separately as suggested.

The main play-transport motor is a servo-controlled phonic wheel d.c. type and a double capstan is used with staggered heavy flywheels. A second motor handles fast forward and rewind. Because there are separate record and playback heads, each can be designed for optimum results. Thus, the gap in the record head is 5 microns but the playback head has an exceptionally small gap of only 0.7 microns! This enables the high-frequency response to be maintained up to 20 kHz or so, but it does mean that care must be taken to keep the heads clean and aligned properly. Figure 4 shows the record-replay response from the Nakamichi CrO₂ tape supplied, and Fig. 5 shows the response with low-noise tape, also Nakamichi. The chromium dioxide tape has a wider response (3 dB point at 21 kHz against 19 kHz) but the difference in practice is small. Incidentally, the tape selector switch is marked CrO₂ and NORMAL, but in this instance NORMAL refers to low-noise tapes like TDK SD or Maxell UD and so on. Figure 6 shows the response from a standard playback tape and distortion is shown in Fig. 7. Distortion at 0 VU was a low 1.4% increasing to 3% at +3 VU. Distortion versus frequency can be seen in Fig. 8. Signal-to-noise measured 53 dB (ref. 0 VU) increasing to 63 dB with Dolby. Some makers still use a 3% distortion reference figure which would make the figures 56 and 66 dB respectively. Erasure, with CrO₂ tape, was 66 dB. Line input sensitivity was 100 millivolts and microphone sensitivity was just under 0.5 mV—0.45 mV to be

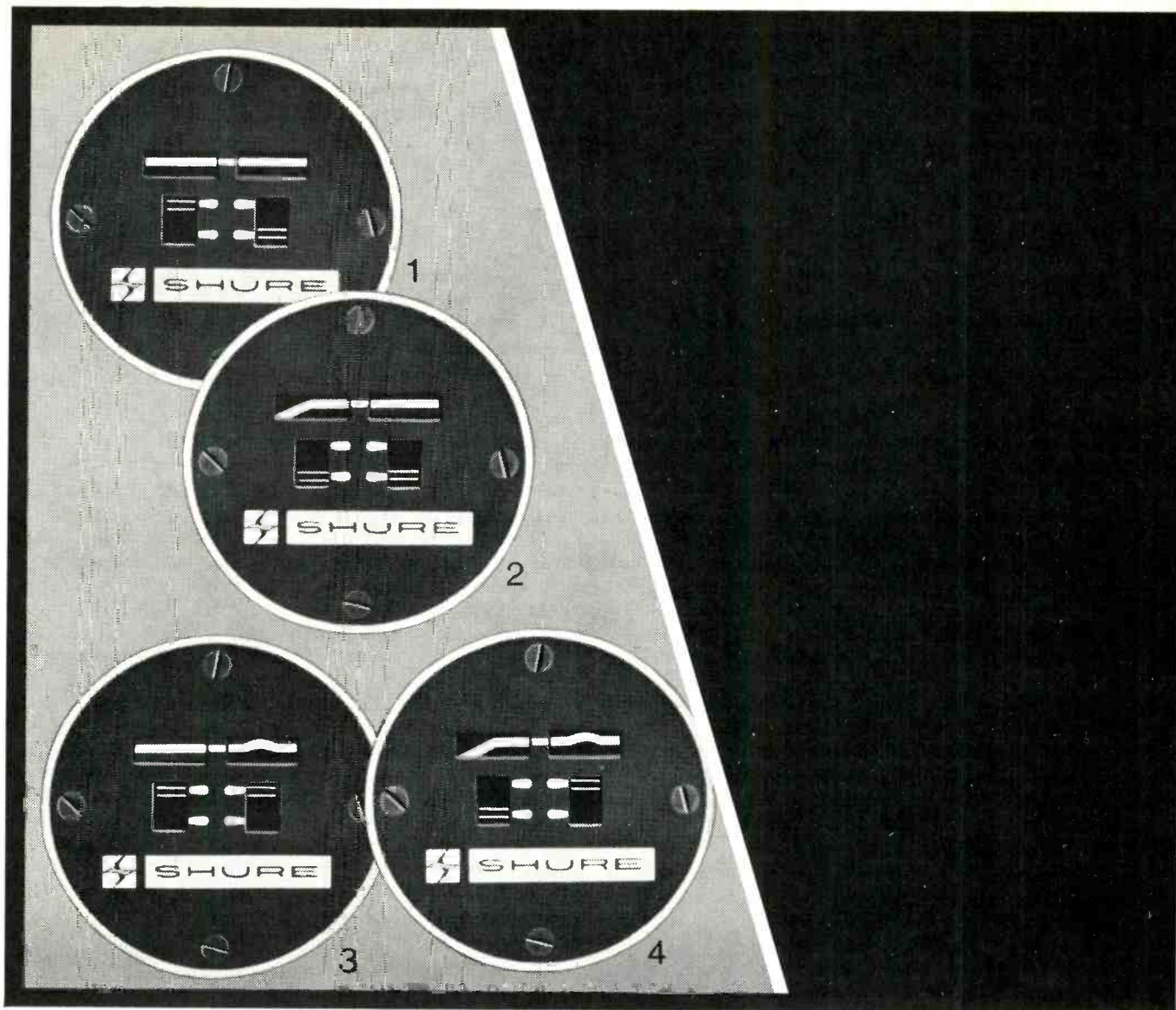

What you see is what you get.



The extraordinary Shure SM7 professional microphone features something you've never seen before: a *built-in Visual Indication Response Tailoring System* that offers you four different frequency response curves—and shows you the curve you've selected with a graphic readout (see above) at the back of the microphone! Choose: 1. flat response; 2. bass roll-off; 3. presence boost; 4. combination of roll-off and presence. And there's more: the SM7 delivers exceptional noise isolation with a revolutionary pneumatic suspension mount . . . an ultra-wide, ultra-smooth frequency response . . . an integral "pop" and wind filter . . . and a cardioid pickup pattern that looks "text-book perfect." The Shure SM7 Studio Microphone was extensively field-tested in recording studios and broadcasting stations! Write:

Shure Brothers Inc.
 222 Hartrey Ave., Evanston, Ill. 60204
 In Canada: A. C. Simmonds & Sons, Ltd.



Check No. 39 on Reader Service Card

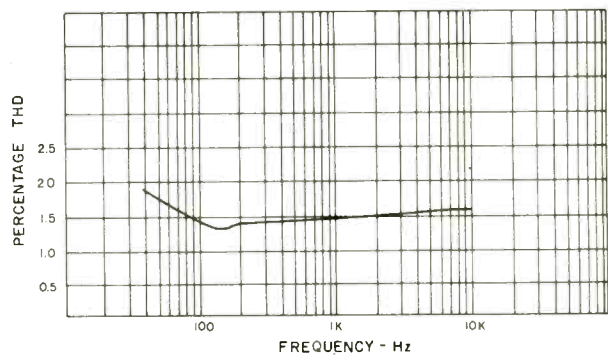
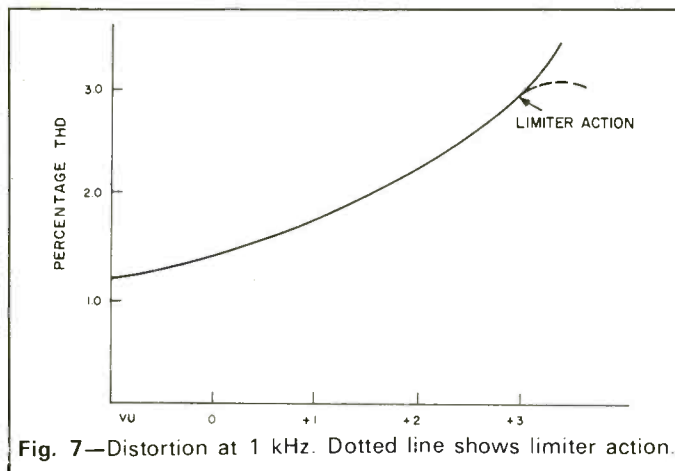

precise. Output for 0 VU recording level was 1 volt. Wow and flutter came out at 0.17% unweighted peak which corresponds to a weighted figure of about 0.06% (DIN 45507). This, incidentally, is the best we have ever measured for any cassette recorder. Rewind time was 57 seconds for C60 cassettes.

The first thing I did after making sure everything was OK, was to check the head alignment. It was right on the nose but the adjustment was investigated to see how well the device really worked. Once you got used to the time delay, there was no difficulty whatever and even the most ham-handed novice can get perfect alignment every time. So, full marks to Nakamichi for a most ingenious idea! After the various measurements were taken, recordings were made with and without the Dolby system, and they compared very favorably with those made with a standard open-reel machine. The DNL system was used on occasion and it certainly helped when playing back some old tapes. It was not found necessary to use the limiter, although it might well prove useful when making direct recordings. The controls themselves, especially those feather-touch buttons, were a joy to use. The eject button does *not* throw the tape half-way across the room, and it cannot operate when the tape is running. In fact, none of the

tape controls will function until the STOP button is touched—that logic system is foolproof!

The 1000 comes complete with a large linen-bound folder or case in which are cleaning sticks and solvent, a Dolby alignment cassette, a special cassette with a built-in mirror so you can see the heads, a CrO₂ cassette, a head cleaning wand and a dusting cloth. The comprehensive technical manual also includes an individual specification sheet with a frequency response curve.

Summing up: The Nakamichi 1000 is definitely a state-of-the-art cassette recorder. Because of the low tape speed and reduced track width, cassette tapes are severely handicapped with respect to open-reel, but with the use of separate record and playback heads, accurate alignment, plus efficient noise reduction systems, Nakamichi has achieved results which would have been thought absolutely impossible not so long ago. Not only that, but they have come up with a professional machine that is even simpler to operate than an ordinary domestic recorder!

Memo to Nakamichi—please do not ask me to return the recorder yet!

George W. Tillett

Check No. 75 on Reader Service Card

Frazier Concerto Model F-10W-37



MANUFACTURER'S SPECIFICATIONS

Nominal Impedance: 8 ohms. **Drivers:** One 10-in. woofer in ported enclosure, one high frequency horn. **Crossover Frequency:** 2000 Hz. **Control:** Tweeter Balance. **Usable Frequency Range:** 35 to 17,000 Hz. **Grille:** Removable sculptured foam. **Dimensions:** 16 in. D x 16 in. W x 21½ in. H. **Price:** \$200.00.

The Frazier Concerto is a two-way speaker system using a high compliance 10-in. woofer in a vented enclosure for bass and medium frequencies, and a horn tweeter for frequencies above the crossover of 2000 Hz. The top and both sides of the enclosure are attractively finished in natural wood and a removable sculptured-foam grille is available in burnt orange, brown, or black.

This system is designed to be a floor-standing reproducer, and with a height of 21½ inches and a mar-resistant floor-standing base, it is, as stated by Frazier, perfect end table height. The enclosure has a sufficiently sturdy top and a low enough center of gravity that lamps, ashtrays, and the like may be safely placed on the Concerto if this recommendation is taken, but the finish of the wood top can suffer if abused, as with any piece of fine furniture.

The unfinished back of the Concerto contains the tweeter control in a recessed cavity. Unfortunately, this rotary control is neither labelled nor supplied with a knob to identify position should it be desired to change the balance. Because



If it doesn't say Hitachi on the receiver, it won't say three years on the warranty.

The last thing you look at in a stereo receiver should be one of the first.

If you're like most people, you never glance at your receiver's warranty until you get the set home.

Which could be unfortunate, since a major repair could be a major expense. (Funny how people always ask about price, but not about repairs.)

But you don't have to worry when you buy a Hitachi receiver. Because Hitachi gives you one of the longest warranties in the industry: three years, parts and labor, with a five year guarantee on the transistors.

Frankly we can give such a warranty because we don't expect you to use it. That's because almost everything that goes into a Hitachi is made by Hitachi—to our standards, not to some sub-contractor's.

This holds true even for our most modestly priced receivers. Like the Hitachi SR-5200 shown above.

It gives you 20 watts of power per channel (RMS at 8 ohms), along with such features as dual meters for more accurate FM tuning, and four-channel speaker matrix connections.

Incorporated into it are Hitachi-developed LTP (Low Temperature Passivation) transistors which reduce amplifier noise to practically nil.

Not shown is the lower-priced Hitachi SR-3200, identical in every way to the SR-5200 except it gives you one tuning meter and 13 watts of power per channel—so the sound won't overwhelm you in a small room.

Like all Hitachi components, the SR-5200 and SR-3200 produce rich, clear, true sound.

Hear the complete line of Hitachi Maxi-Fi® components, priced to \$600, at your Hitachi stereo dealer's. Or for more information, write Dept. A-9, Hitachi Corp. of America, 48-50 34th Street, Long Island City, N.Y. 11101.



Quality always comes first at

HITACHI



Check No. 21 on Reader Service Card

the control is a potentiometer that can be set from zero tweeter output to a level much "hotter" than the woofer, it is hoped by this reviewer that Frazier will improve this situation in future production units. In the unit tested by AUDIO, the most accurate balance for direct sound was found to occur about midway between the extreme positions of this control.

A terminal strip is mounted on the back for electrical connection to the speaker, and the terminals are marked with small but legible polarity marks. This is a screw terminal type of mounting which will take either spade lugs or bare wire. The screw terminals are very close together and no mechanical barrier is provided between the exposed terminals. Care must therefore be taken in hookup so that an accidental short circuit does not occur due to a loose or improperly made connection. Single conductor wire, rather

than stranded hookup wire, is recommended by this reviewer for the Frazier Concerto to minimize the possibility of an amplifier-damaging short circuit during hookup, and the chance of such an occurrence if the speaker is frequently moved for cleaning or decor purposes. Under no circumstance should hookup be made to the speaker while the amplifier is on and delivering program material. Again, this reviewer hopes Frazier will improve this situation on future models. (Frazier tells us that the current version of this model uses banana plugs to alleviate this problem.—Ed.)

No hookup instructions or recommendations (that would be helpful to a less technical user) were supplied with the model received by AUDIO. The Frazier Concerto carries a five-year warranty against defects in workmanship and materials.

Technical Measurements

The Concerto is rated as an 8-ohm system, and this is a realistic minimum value as shown in the impedance plot of Fig. 1. The impedance plot has the two low-frequency peaks characteristic of a vented system. The lower peak occurs at 18 Hz and the upper peak at slightly above 60 Hz. Because the tweeter control is potentiometric, the plot is made for the two extreme control positions. In any other control position, the impedance will lie between these two curves.

The one-meter anechoic frequency response for a one-watt excitation is shown in Fig. 2. The Concerto ranks as a moderately efficient system and satisfactory sound level can be produced from amplifiers rated 20 to 50 watt. The pressure amplitude shows a low frequency roll-off below 90 Hz. The fact that this does not occur near the 38 Hz impedance minimum of Fig. 1, as well as the nearly 12 decibel per octave roll-off, suggests that this phase-inverter vented enclosure was not designed by Frazier engineers according to the more conventional alignments of such systems.

The pressure phase spectrum of the Concerto is technically very interesting because there is an exact 180 degree phase change which occurs between 1400 Hz and 2100 Hz. The conventional logarithmic frequency plot is difficult to interpret under these circumstances, however a linear frequency plot of the phase spectrum (not included) discloses that the woofer is precisely in phase with the drive voltage. By this we mean that a positive voltage applied to the positive speaker terminal will produce an acoustic pressure increase exactly in phase with that voltage for high frequencies. The Concerto is thus phased properly for bass should it be desired to use it with other speakers, such as for quadrasonic rear channel operation. The tweeter is 180 degrees out of phase above 3 kHz and has a mean average acoustic position approximately 2.4 inches behind that of the woofer. The SPL response dip at around 1.4 kHz is due to this polarity reversal between woofer and tweeter.

This does not mean that Frazier was careless in assembly. Quite the contrary, reversing the tweeter leads to bring it into phase with the woofer actually produces a very audible broad dip in response at around 2.5 kHz.

The three-meter room response of Fig. 3 shows the effect of the room in filling up this apparent dip. Figure 2 is the anechoic response which does not contain any wall, floor, or ceiling reflections. Figure 3 is the spectrum of the first 10 milliseconds of "early" sound when the Concerto is placed on a carpeted floor. The on-axis and 30 degrees off-axis measurements are shifted 10 dB in Fig. 3 for simplicity of presentation. The low height of the woofer above the floor causes a multiplicity of SPL interference notches below 2 kHz due to the grazing sound incidence when the speaker is listened to in a conventional manner. Ceiling reflections are less severe than floor reflections because of

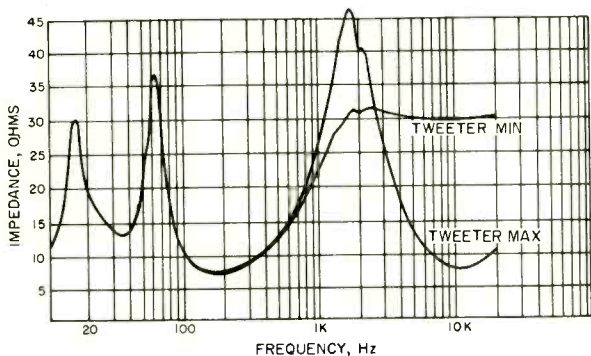

Fig. 1—Impedance for two extreme positions of tweeter control.

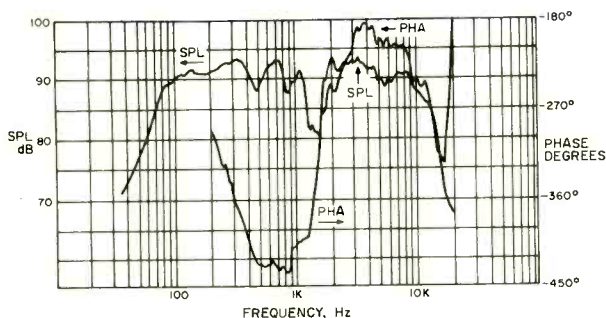

Fig. 2—Magnitude and phase of the anechoic frequency response one meter on-axis with one watt input.

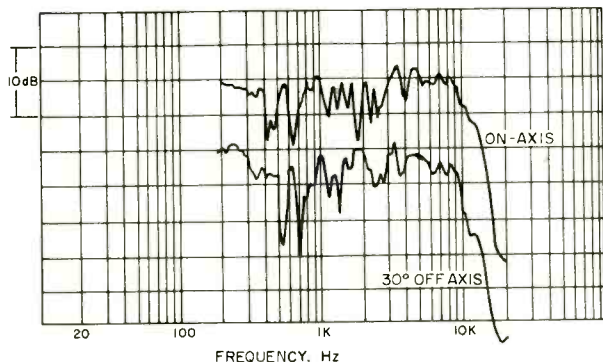
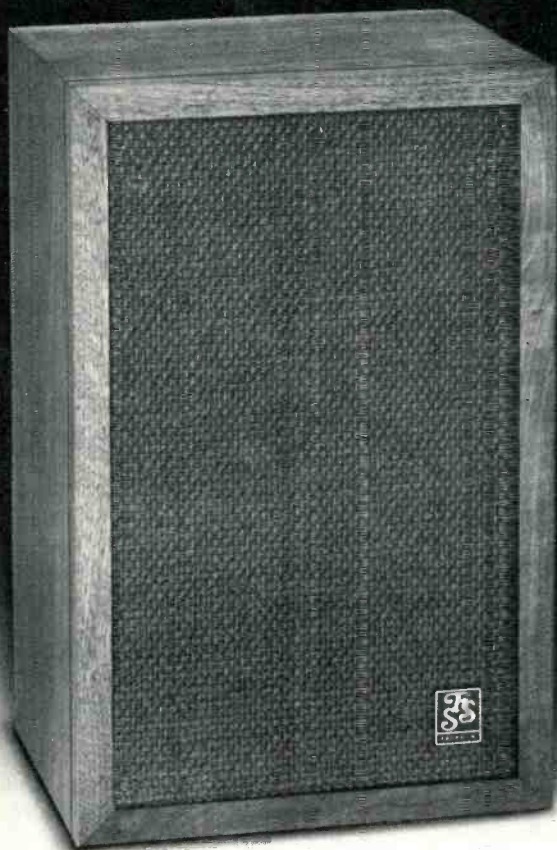

Fig. 3—Frequency response of the first 10 milliseconds of sound in a conventional listening situation three meters from the Frazier Concerto. On-axis and stereo response shifted 10 dB for clarity.

NOT FOR SALE

AT ANY PRICE



We Earned Our Top-Rating

The **Fairfax FX-300** was recently top-rated over 20 leading medium-priced speakers by one of the most respected consumer reporting organizations in the world.

That's something money can't buy! Like any of the nationally advertised brands we topped, we could make all sorts of claims and super-claims for Fairfax speakers, including a number of SPEAKER FIRSTS we have to our credit. We could follow the pack and excerpt reviews or we could spend lots of money to buy endorsements.

However, at Fairfax, our money goes into the speaker. And we think you will agree with "The Report Money Can't Buy"—the investment is well worth it. But in order for you to agree that the **FX-300** is the most accurate sounding speaker (rated at 8 ohms with a minimum of seven watts RMS required) you will have to listen to ours and compare it to theirs—any of the 20 other speakers we topped and then some.

Visit your nearest audio dealer and ask to hear the **Fairfax FX-300**, and compare it to any other speaker in its price range—even some costing considerably more.

If your dealer is not a Franchised Fairfax Dealer, have him contact us and we will send him a pair of **FX-300** speakers for your evaluation—at our expense. Only Fairfax has the confidence in their product, and your judgment, to make such an offer.

FAIRFAX INDUSTRIES, INC.,
900 Passaic Avenue, East Newark, New Jersey
Distributed in Canada exclusively by
Omnimedia Corporation Ltd., Lachine, Quebec



Check No. 17 on Reader Service Card

www.americanradiohistory.com

the vertical polar response of both woofer and tweeter. The power spectrum of the early sound shown in Fig. 3 is thus much more uniform on the average than the anechoic response of Fig. 2. The Concerto should, and does, sound quite smooth in the 1 to 5 kHz range even though the anechoic response shows a dip. However, the severity of interference notches due to the shallow vertical height of the Frazier Concerto suggests that this speaker should be placed on an acoustically dead surface, such as a rug, in preference to a hard floor. The surprising feature of the three-meter test is that the phase (not shown) of the early sound uniformly changes its full 180 degrees, starting at 1.4 kHz and ending at 2.1 kHz without the slightest trace of a power spectrum dip or peak.

The harmonic distortion for the musical tones E_1 , A_2 , and A_4 is shown in Fig. 4. These are measurements made on the

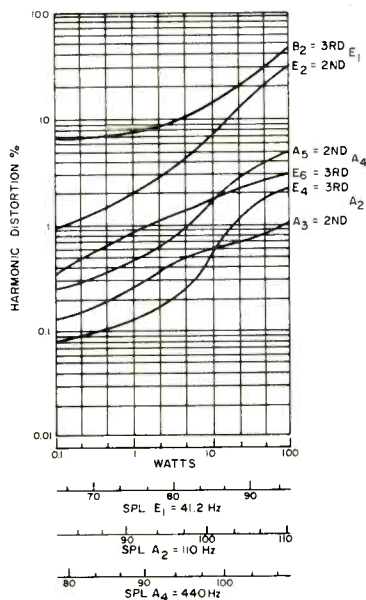

Fig. 4—Harmonic distortion for musical tone of E_1 , A_2 , and A_4 .

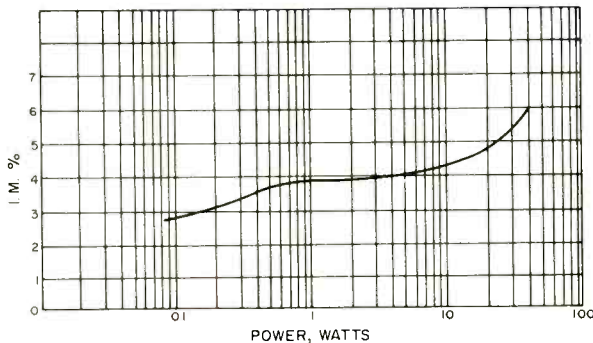

Fig. 5—Intermodulation distortion of A_4 (440 Hz) by E_1 (41 Hz) mixed 1:1.

woofer since it handles the spectrum below 2 kHz.

Intermodulation distortion for the tones E_1 and A_4 mixed 1:1 is shown in Fig. 5. The rather unusual shape of this curve is due to the spectrum modification of the modulation with increase in drive. At low power levels the dominant side bands about A_4 are even order harmonics of E_1 . With increase in drive power, the odd order sidebands become prominent while some even order sidebands remain constant and the others decrease. At the higher power levels, this particular two tone intermodulation is almost equally due to phase and amplitude modulation. The implication of both the harmonic and intermodulation characteristics is that low bass program material such as pipe organ will not be reproduced to the full satisfaction of highly critical listeners.

Crescendo handling capability is measured by noting the extent to which an inner musical voice is suppressed by the introduction of a higher power wide-band random-noise signal. One decibel of 440 Hz suppression occurred with a peak power of 450 watts, corresponding to an average noise power of 50 watts spread over a band of 20 Hz to 20 kHz. The Concerto is thus capable of handling musical peaks well above its stated continuous rating of 25 watts.

The one-meter polar energy response is shown in Fig. 6. This is quite an acceptable polar pattern and shows that good stereo separation of sound should be obtained without any tendency to bias the sound image either to the right or left. Slightly better high frequency response in a stereo configuration can be obtained by rotating the speakers toward the listening area.

The response to a band limited impulse is shown in Fig. 7. The equivalent signal applied for this test is a nearly perfect impulse which has been band limited in its frequency content to contain only components from 20 Hz to 20 kHz. The shape of this frequency spectrum is modified by what is called hamming weighting to more accurately portray the time response of Fig. 7. The data plot of Fig. 7 has been automatically clipped to a baseline 40 dB below the peak energy value. The double humps centered at 3.25 milliseconds are due to the woofer. The main peak at 3.43 milliseconds is due to the horn tweeter as are the subsequent peaks at 3.65 and 3.9 milliseconds. The equivalent positions of major components in the Frazier Concerto are shown in Fig. 7 for comparison.

Listening Test

The Concerto does a creditable job of realistically reproducing program material which possesses strong midrange components. While the extreme high frequencies are down in level, the dropoff is smooth and free from annoying presence peaks. It is thus possible to employ a moderate high frequency boost without incurring a "spitty" top end.

In this reviewer's opinion, the Concerto's deficiency of very low bass response is its least advantageous acoustic characteristic. Three positions of the speaker were auditioned: floor standing away from a wall, against a flat wall, and in a corner. Only the corner position provided a reasonable bass response without the excessive use of a tone control equalization. In other room positions the deficiency in bass was quite noticeable. Bass boost by means of a conventional tone control is not recommended for moderately loud reproduction of material which has good low frequency content because good, deep bass begins to sound "blasty" as the level is raised.

Subsonic frequencies, such as due to reproduction of a badly warped record, can cause audible program modulation at high sound levels in the Concerto. For this reason, this

(Continued on page 81)



They're talking about Capitol 2 recording tape.

Musicians, high-fidelity perfectionists, music lovers of all sorts, are talking about Capitol 2, the world's best iron-oxide tape.

Cassette users rave about the frequency response (20-22,000 Hz), the backcoating that makes the cassette jamproof, and the new package (Stak-Pak™) that ends cassette clutter.

Everyone's giving the Stak-Pak special mention. Probably because it's without a doubt the world's ultimate cassette storage method. Stak-Paks come with two Capitol 2 cassettes, and they slide or snap together to form a tiny chest of drawers, each with its own two labels.

Reel-to-reel bugs get excited about being able to buy a tape that's as good as the best tape the recording studios themselves use.

And 8-track cartridge people are delirious with the Capitol 2 Audiopak® High Output/Low Noise cartridge, already a standard of the music industry. It's even available in a newly engineered 100-minute playing time.

Visit your favorite tape store, and try the new Capitol 2 tape. So that the next time your friends start talking about tape, you'll have something significant to add to the conversation.

Capitol 2

cassettes

Get the good sounds right.



AUDIO DEVICES, INC. A CAPITOL INDUSTRIES—EMI COMPANY, GLENBROOK, CONN. 06906

Check No. 4 on Reader Service Card

www.americanrecording.com

Advertising Index

| ADVERTISER | PAGE | ADVERTISER | PAGE | ADVERTISER | PAGE |
|---|--------|---|------------|---|--------------|
| Acoustic Research Loudspeakers Check No. 1 on Reader Service Card | 23 | Fairfax Industries Loudspeakers Check No. 17 on Reader Service Card | 73 | Rhoads & Co. Teledaptor Write Direct to Advertiser | 100 |
| Acoustical Mfg. Co. Quad Speakers Check No. 2 on Reader Service Card | 10 | Glenburn/McDonald Turntables Check No. 19 on Reader Service Card | 6 | Rogersound Labs Loudspeakers Check No. 33 on Reader Service Card | 97 |
| AKAI America 4-Channel Cartridge Deck Write Direct to Advertiser | 5 | Harman/Kardon Receivers Check No. 20 on Reader Service Card | 34, 35 | SAE High Fidelity Components Check No. 34 on Reader Service Card Loudspeakers Check No. 35 on Reader Service Card | 86, 97 |
| Audioanalyst Loudspeakers Check No. 3 on Reader Service Card | 95 | Hitachi High Fidelity Components Check No. 21 on Reader Service Card | 71 | Sansui Electronics QRX5500 Check No. 36 on Reader Service Card | 45 |
| Audio Devices Capitol 2 Cassettes Check No. 4 on Reader Service Card | 75 | KLH Research & Development Model 31 Loudspeaker Check No. 22 on Reader Service Card | 55 | Saxitone Tape Sales Magnetic Tape Write Direct to Advertiser | 99 |
| Audio Dynamics Corp. WDDS-12 Loudspeaker Check No. 5 on Reader Service Card | 62, 63 | Kenwood Electronics 2-4-Channel Receivers Check No. 23 on Reader Service Card | Back Cover | Schober Organ Co. Organ Kits Check No. 37 on Reader Service Card | 92 |
| Audionics TL-90 Speaker Check No. 6 on Reader Service Card | 91 | Linear Design Labs 749A Loudspeakers Write Direct to Advertiser | 2 | Schwann Record & Tape Guide Current Listings Write Direct to Advertiser | 24 |
| Audio Research Corp. High Fidelity Components Check No. 7 on Reader Service Card | 43 | Logic Newsletter Sample Copy Write Direct to Advertiser | 102 | Sherwood Electronic Labs High Fidelity Components Check No. 38 on Reader Service Card | 19 |
| Audio-technica, U.S., Inc. Headphones Check No. 8 on Reader Service Card | 96 | Magnepan, Inc. Loudspeakers & Dealers Check No. 24 on Reader Service Card | 96 | Shure Brothers Cartridges Check No. 39 on Reader Service Card | 69 |
| Avid Corp. Series 100 Speakers Check No. 9 on Reader Service Card | 93 | Marantz Co. 4-Channel Receivers Check No. 43 on Reader Service Card | 59 | Sony Corp. Full Logic Decoder Check No. 40 on Reader Service Card | 47 |
| BSR (USA) Ltd. 810 Turntable Check No. 10 on Reader Service Card | 21 | McIntosh Free Catalog Check No. 26 on Reader Service Card | 86 | Soundcraftsmen Equalizers Check No. 41 on Reader Service Card | 27 |
| Bell & Howell Schools Digital TV Write Direct to Advertiser | 50-53 | PAIA Electronics Synthesizer Kits Write Direct to Advertiser | 101 | Stanton Magnetics Cartridges Check No. 42 on Reader Service Card | 15 |
| Benz Micro-Diamonds Phonograph Styli Check No. 12 on Reader Service Card | 18 | Phase Linear 400 Amplifier Check No. 27 on Reader Service Card | 29 | Superscope High Fidelity Components Check No. 63 on Reader Service Card | 104, Cover 3 |
| Bose Corp. Loudspeakers Check No. 13 on Reader Service Card 1801 Amplifier Write Direct to Advertiser | 13, 92 | Pickering & Co. Cartridges Check No. 28 on Reader Service Card | 65 | TDK Electronics Cassettes Check No. 44 on Reader Service Card | 49 |
| British Industries Co. Venturi Loudspeakers Check No. 14 on Reader Service Card | 3 | U.S. Pioneer Electronics Series R Speakers Check No. 29 on Reader Service Card | Cover 2, 1 | Tandberg of America High Fidelity Components Check No. 45 on Reader Service Card | 41 |
| Cerwin-Vega Loudspeakers Check No. 15 on Reader Service Card | 87 | Precision Electronics Grommes 600 Check No. 30 on Reader Service Card | 91 | Technics by Panasonic SA-8000X Receiver Check No. 46 on Reader Service Card | 57 |
| Crown International Professional Components Check No. 16 on Reader Service Card | 7 | Radio Shack 1974 Catalog Check No. 31 on Reader Service Card | 11 | United Audio Products Dual Turntables Check No. 47 on Reader Service Card | 9 |
| Dynaco A-25 Loudspeaker Write Direct to Advertiser | 67 | Revox Corp. High Fidelity Components Check No. 32 on Reader Service Card | 17 | Utah Electronics Loudspeakers Check No. 48 on Reader Service Card | 81 |

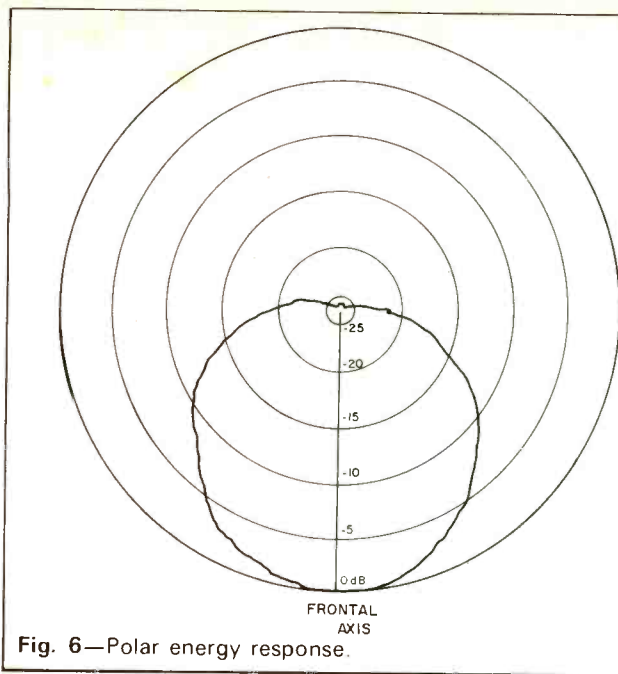

Fig. 6—Polar energy response.

Angular dispersion is quite smooth within thirty degrees of the on-axis position. Mounting the Concerto in a corner should provide a smooth stereo sound image since most listening positions will be within this angular spread. For wall or floor mounting positions it is helpful to rotate the speakers slightly toward the listening area.

Acoustic balancing of the unmarked tweeter controls can be quite a chore for stereo listening. This reviewer recommends that after placing the Concertos where you want them to be, rotate each tweeter control shaft to a position halfway between its extreme left and right position. Using an FM

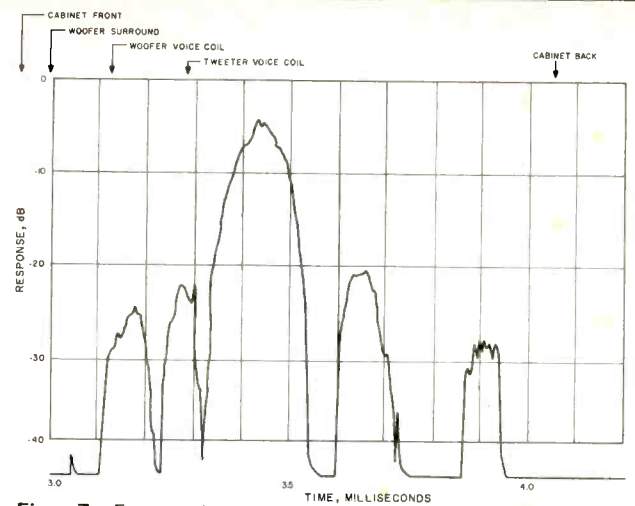

Fig. 7—Energy-time response for a perfect impulse, hamming weighted and band limited 20 to 20,000 Hz, measured one meter on axis.

tuner as source, tune it off station so as to get the characteristic "rushing" sound. Then make any fine adjustments necessary to the tweeter controls to make the noise sound as close as you can to the sound of a shower spray which seems to come from a position halfway between the speakers. Because of the high frequency de-emphasis in the FM tuner, it is advisable to apply some tone control treble boost to aid the sonic illusion of a shower spray.

The Frazier Concerto can be recommended to those whose preferences run to "easy listening" music, but in this reviewer's opinion, this speaker would not fare so well with those who demand low organ, bass, cello or piano fundamentals.

Richard C. Heyser

Check No. 55 on Reader Service Card



A little Traveling Music, Please

Daily frustrations make a person want to get away from it all. And, the UTAH MP-3000 Speaker will take you there better, faster than any comparable unit. With the MP-3000, you **know** you are in Tahiti, Paris or even Kentucky. Your day becomes more pleasant, too, as the MP-3000 conquers the sound barriers.

MP-3000 combines the rare attributes of sound and styling. Clean, undistorted sound comes from this 4-speaker, 3-way speaker system. The oiled and hand-rubbed walnut veneer cabinets, and unique grille of sculptured foam are both acoustically and geometrically beautiful. The system contains a 15" high compliance woofer with a 2" voice coil, as well as two horn-loaded-dome-tweeters. It's a distinguished combination of well-defined, distortion-free sound reproduction. Size: 27" x 20 1/2" x 14" deep, excluding base. Shipping weight: 70#.

Come travel with us. Get complete information about the exciting MP-3000 Speaker System.



UTAH ELECTRONICS
Huntington, Ind. 46750

Check No. 48 on Reader Service Card

The Workbench

Herman Burstein

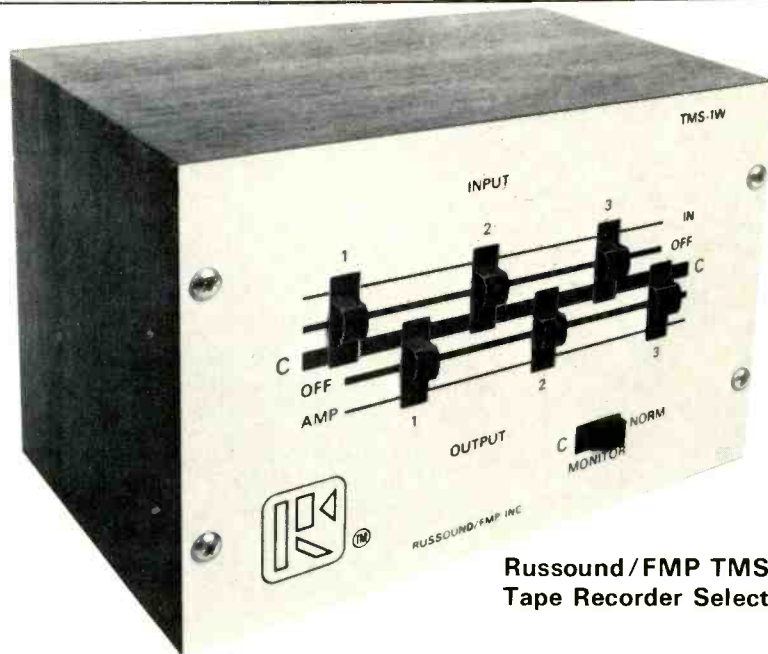

**Russound/FMP TMS-1W
Tape Recorder Selector Switch**

IF YOU HAVE BEEN wondering how to connect two or three tape decks to your audio system, and to each other for dubbing and phasing (described in the December 1973 issue of *AUDIO*), the TMS-1W offers an excellent solution at a reasonable price (about \$33).

Basically, it is intended for up to three stereo tape decks. However, a quadraphonic system can be served by two TMS-1W units in parallel; more than three decks can be accommodated by TMS-1W units in series.

The TMS-1W is connected to an amplifier's (or receiver's) tape output and tape monitor jacks in exactly the same way as a single tape deck would be. The amplifier jack marked TAPE OUT (OR TO TAPE RECORDER) gets connected to the TMS-1W jack marked TO OUTPUT. The amplifier's TAPE MONITOR jack gets connected to the TMS-1W jack marked TO INPUT.

The inputs of one to three tape decks are connected to the INPUT jacks of the TMS-1W. Thus, one to three decks can record the signal from the amplifier's TAPE OUT jack. Similarly, the outputs of one to three tape decks are connected to the OUTPUT jacks in the TMS-1W. Thus, the amplifier can receive the playback signal from any one deck or from a mixed combination of them.

In addition to permitting up to three tape decks to be connected to an audio system, a primary purpose of the TMS-1W is to permit dubbing. A playback signal from one deck can be recorded on one or two other decks. Or the playback signals from two decks can be combined and recorded on a third deck. A MONITOR switch gives the user the option of monitoring either the playback (source) signal or the dubbed signal which has just been put on tape.

For each deck the TMS-1W provides two switches, one to direct the input of the deck and the other to direct the output of the deck. Each input switch has three positions: OFF; IN, so that the deck can record a signal from the amplifier; and C (common), so that the deck can record a signal directly from decks whose outputs are connected to the TMS-1W.

Each output switch also has three positions: OFF; AMP, so that the deck can provide a playback signal to the amplifier; and C, so that the deck can provide a playback signal directly

to the decks whose inputs are connected to the TMS-1W.

The previously mentioned monitor switch has two positions: NORM supplies the amplifier with the playback signal from one or more decks if their output switches are in AMP position; C furnishes the amplifier with the playback signal from one or more decks if their output switches are in C position (as could be the case when dubbing).

The TMS-1W can be used to "interface" not only tape decks but other audio components as well. For example, one could use it to connect the outputs of several tuners, or of several preamps, to a power amplifier; to feed a TV audio output to one's audio system; to hook up a reverberation unit, noise reduction unit, graphic equalizer, or other component between the amplifier's TAPE OUT and MONITOR jacks without eliminating the ability of the audio system to accommodate a tape deck.

All told, the TMS-1W is a versatile signal splitter, mixer, selector, and patch panel for high level inputs and outputs of audio components. Being a passive device (no transistors or tubes), it does not introduce distortion, noise, or frequency change. Its switches are quiet and positive acting, and, at least in the system in which it was tested, does not introduce clicks. In its walnut case it measures 3 $\frac{3}{4}$ x 5 $\frac{5}{8}$ x 3 $\frac{3}{8}$ inches (in its utility steel case, 3 x 4 $\frac{1}{4}$ x 3 $\frac{1}{2}$ inches), and should ordinarily raise no problem of finding room to accommodate it in a cabinet or bookshelf. In any event, in its walnut case, it is attractive enough to be mounted externally.

I have but one, quite minor reservation about the TMS-1W. This concerns identification of the position of each switch. These are slide switches, and the slider is black against a black background. However, a dab of red fingernail polish on each slider quickly and effectively disposes of this problem. A toggle switch in a future version might be a further visual aid. Once the user has identified the position of the slider switch, the front panel of the TMS-1W is well marked to make clear what is connected to what.

In conclusion, Russound deserves compliments for coming up with a well-conceived, well-executed, and useful auxiliary item for home audio systems, particularly where tape decks play an important role.

Check No. 54 on Reader Service Card

Dylan at the Spectrum

Sherwood L. Weingarten



THE WIND PLAYED hide-and-seek with the denim army methodically approaching the circular walls of Philadelphia's Spectrum. It whipped through the nearby parking lots that jammed in as many cars from New Jersey and Delaware and other states as from Pennsylvania. Those who hawked souvenir programs, posters or soft pretzels waved their arms wildly, as much to keep warm as to sell their overpriced wares.

A handful of optimists meandered through the crowd that overcast Sunday afternoon in January in futile search

of their own version of a rainbow: "Anybody got an extra ticket?" They were ignored mostly, now and then silently laughed at for their foolishness. It was a sellout, and had been for some time, almost from the moment the concert was announced.

Dylan. The name meant magic. It conjured up slightly sullied visions of the '60s: protest, hope, originality, revolution. But this was the dream come true, the symbol live, in person, here, now.

It was the second stop of the national tour, his first in almost eight

years. The beginning was only a few days past, in Chicago, and now it was Philly's turn. And Philadelphia didn't even seem to mind it was second-rate one more time.

Inside the auditorium that soon would seat nearly 20,000 remnants of a wistful, chameleon decade, a paper airplane glided from the top tier, setting off a flurry of similar launchings. It was almost 2 o'clock, almost time for what many still hoped would be a Second Crusade. "When did he get into town?" asked one

friendly stranger to another. "I dunno. Heard he came in last night."

"Bet this is a ripoff," said another. "He'll probably do all his old stuff, in about a 15-minute gig, and then split."

"Bet he does some new things," retorted still another. "And he'll keep that aura of mystery. Wouldn't be surprised if he appears out of nowhere in a puff of smoke."

On the ground level, with the seats packed in so tightly you could tell if your neighbor had bad breath, a couple of inflated balloons were being bounced along by an otherwise placid audience-in-waiting. Upstairs, a giant's handful of spectators sat at the balcony edge, arms entwined in railings, feet dangling in nothingness and mouths chanting: "We're ready, we're ready, we're ready."

At 2:20 the clapping and whistling of impatience started; even worshippers wear watches these days. At 2:32, with the sweet smell of marijuana virtually filling the place, the catcalls began, and the rhythmic foot-stomping. Abruptly all that ended, replaced instead, as the house lights went off, with one massive roar. Bob Dylan and members of The Band stepped up to the oriental rug-covered stage. Squeak, twang, urp. They tuned, and the audience hushed to hear it all.

Eight minutes later, after the Living Legend had unfurled his long scarf, seemingly the same one that adorned the cover of *Blonde on Blonde*, he was singing one of his most obscure pieces, *The Ballad of Hollis Brown*. Few apparently recognized it, but fewer cared: The Vietnam generation had its spokesman back, and so what if we've all aged, slid into the apathetic '70s?

Lay, Lady, Lay followed, an echo from a later time, a remembrance of the Nashville scene, and the audience relaxed. Tranquility personified.

Just Like Tom Thumb's Blues was a momentary exorcist: some of the former counter-culture freaks could actually be seen keeping time with a tapping toe or two. The beat was different this time around, but no one was booing, as they had earlier in his career, because he played an electric guitar.

And when he was joined on the chorus of *It Ain't Me, Babe* by two members of The Band, the excitement grew. His switch to harmonica drew cheers; his sometimes muffled voice, drowned out by his backup men, now superstars in their own right, fazed no one. His bushy hair and scraggly beard were familiar, oh so pleasantly

familiar. So was the voice that was never a voice meant for music in the classic sense.

Next came a turn at the piano, and then, 27 minutes after it had begun, he moved to the rear of the stage to let The Band have some undivided attention.

The crowd listened and listened well, for the acoustics were better than for most rock concerts in the hall. But the uneasiness was evident, and every so often some guy would yell, "Come on, Dylan, we paid to see you." Still, the countrified sound blasted without him. *The Night They Drove Old Dixie Down, I Shall Be Released*. A couple more, drawn mostly from their classic first two LPs.

Half an hour later, the return. Bob Dylan. With sunglasses, still wearing the black suit with which he started the concert. *Knockin' on Heaven's Door*. from the recent **Pat Garrett and Billy the Kid** soundtrack album that bombed, got the audience up again, just in time for a short intermission. "Don't go 'way," said Dylan in one of his longest speeches of the day.

Part two was what they, many who hadn't even learned their ABCs when Dylan was hitting it big as a pop poet, were waiting for. The jacket gone. Work shirt and vest obvious, the image aided by muted lighting. Armed with acoustic guitar and harmonica. Solo.

Love was the name of the game. They gave it to him, as best they could remember how, and he gave it back, sort of. Through oldies, and through new songs, love songs, tunes with absolutely banal lyrics that showed the times, they had indeed a'changed. He never told the titles, merely referred briefly to the latter as "new songs," but the buffs assumed they were from his new Elektra-Asylum album, *Ceremonies of the Horsemen*, as of then unreleased. Something was wrong, though. *Except You*, a first half entry, and *Forever Yours*, part of the solo set, sounded as if they were penned by Harry Highschool, not the Bob Dylan.

But the uneasy feeling they created didn't last. *It's All Right Ma. I'm Only Bleeding* had rolled in like the ghost of revolutions past. The crowd collectively recalled who it used to be, and momentarily interrupted Dylan's singing with hoots and right-on, baby, and yeah, yeah when he intoned: "Even the President of the United States/Must sometimes stand naked."

And when the solo section had ended, and The Band had taken over again for a while, there were periodic

cries of "Dylan, Dylan" from the faithful, most of whom couldn't see him fussing with his hair at the back of the stage. When he returned stagefront, they had again shouted, reveled in the idea that an old friend had come back. But it was a strange shouting, not like the routine, fanatic rock audience, more like a chorus that knew it was *supposed* to be excited and therefore *was*, not unlike an expensive New Year's Eve party a couple of weeks late.

Like a Rolling Stone was an appropriately rousing final number. Even a few people stood and kept clapping time. And when it was over, an ending that resembled a quasi-religious orgasm, Dylan said simply: "This is it . . . so we'll see you next time."

It took a few moments to sink in. Over. Done. The Happening was finished. And like a sleeping giant, the audience went wild, really wild for the first time all afternoon, breaking the restraints of somebody's idea that the whole thing was sacred and not, as Dylan's men had been touting for weeks, that it was a concert, just a concert, and not a cosmic event.

So the firecrackers went off, as they had during intermission. And thousands of matches were lit, making the hall resemble an indoor skyscape, and the feet-rumbling grew more intense, and the cheers ran into one another. Six minutes worth. When the house lights went on, the boos came, but few left until a stage manager took the mic and said, "On behalf of Bob Dylan and The Band, we thank you for coming."

It was *really* over now.

Outside, the chill having grown more vicious, the army of youth filed neatly away from the Spectrum, back to its cars, back to the creature comforts of the Mainline and suburbia. They'd heard *Leopard Skin Pillbox Hat*. And *The Lonesome Death of Hattie Carroll*. And more, so much more.

They'd lived through the '67 cycle crash and its aftermath, the rumors of Dylan being crippled, dead. And through the country scene with Johnny Cash. And through him trying to sing sweetly. Through it all.

"Wasn't that just great?" asked one young man rhetorically of the 2½-hour concert.

"Yeah, he was groovy," said another, lapsing into the vernacular of history.

"I don't know, man," said a third, pulling his collar higher. "If you ask me, old rock singers never die or fade away, they just go on a 25-city tour. Æ

Classical Reviews

Edward Tatnall Canby

SMALL-COMPANY

RENAISSANCE

Bartók: Sonata for Two Pianos and Percussion (1937); Seven Pieces for Two Pianos (Microcosmos). Katia and Larielle Labeque, pfs., Sylvio Gualda, Jean-Pierre Drouet, Percussion I and II. **Mus. Heritage MHS 1499**, stereo. (Mail: 1991 B'way, NYC 10023).

Offenbach Overtures. City of Birmingham Symp. Orch., Frémaux. Klavier **Patrician KS 517**, stereo. \$5.98.

Alec Wilder: Sonata for Clarinet and Piano, Suite for Flute, Clar. and Pf. Frank Levy: Sonata for Clar. and Pf., Adagio and Rondo for 2 Clars, Bass Clar. Mitchell Weiss, cls., Janet Weiss, fl., Zita Carno, pf. **SoundMaster SMP 1003**, stereo (37 W. 57th St., NYC 10019).

Brother Martin Senior High Chorus, 1972 Stage Band. Custom pressed. (Recorded Publications, Inc., Camden, NJ 08105).

Take heart, you record buyers! Look out, big companies. The small labels are in front again. It hasn't been this way since the great LP rush of the early 1950s, when hundreds of small outfits explored the brand new combination of portable tape recordings and the LP disc.

The top-size U.S. record companies have worked themselves into an astonishing disarray at this point. Just look at their "new release" classical lists. Quite soberly, these concerns are for the moment largely repackagers of their own earlier product. Fine idea, but not very progressive. The little outfits, taking flexible advantage of superb technical facilities, once again are exploring the world of music outside the narrow big-name, big-cost system, for new artists and for new sonic material to match present technical know-how. And they can beat the big companies hands down! They have the dedication and the time and they do it relatively inexpensively.

The Bartók *Sonata*, for two furious, unbelievable pianos and an incredible two-man battery of percussion, is often heard in its bigger *Concerto* format. On records, the *Sonata* version is much the most dramatic, especially when recorded, as here, at sawed-off-shotgun range! This is a great recording, considering the horrendous technical

problems—the unbelievable dynamic range, the rifle-shot transients in piano, drums, xylophone (wait until you hear *that!*), the whole incredibly complex and super-rhythmic score. These two furious ladies play mostly percussive piano, which is OK though there are lyric moments as well; the two percussionists are marvelous and the neat right-left division, one battery of percussion and one piano on each side (as per Bartók's own direction, if I remember) makes really top listening. Memorable moments: the xylophone explosion, beg. of side 2; the infinitesimal snare drum taps that end the work. What a piece! What a record!

Can't afford a big-name orchestra? Try the City of Birmingham. The fizzy, zesty Offenbach *Overtures* are played here with a precision and verve that few big orchestras could match, and the recorded sound is excellent too.

Alec Wilder has composed quantities of music; these two pieces are very much of his generation (b. 1907), modern but a bit quirky, testy, the touches of jazz and folk and classical technique not too well blended. Enjoyable nevertheless for expert writing and plenty of energy and color. Frank Levy, of a younger generation, writes smoother, more polished music, nicely humorous, a sort of much-lightened-up Hindemith with U.S. overtones. I enjoyed his music for three clarinets, one in each loudspeaker and the bass clarinet in the middle. All three, triple tracked, are the same player.

As for Brother Martin High School, somewhere in Louisiana, I gather (they don't say), the Chorus is kids just out of the soprano/alto stage, bursting with 'teen energy, and the recording of their concert has such extraordinary presence that it makes my favorite demo disc—especially as heard quadraphonically via a decoder. (It isn't coded.) Every voice is clear, you get each word, each breath, you can almost touch the faces before you, yet the ensemble is perfect, the surround ambience excellent, the blend and balance ideal. Maybe it was just luck, but no matter! An extraordinary job. The singing varies from endearing to disastrous (they go flat each verse); some of it is first rate. *The Stage Band*, on the other side, is good too, a big-band-type ensemble with the kids trying

hard to sound grown up and a bit bored by it all. Understandable, and there is virtuoso playing, good in the technique and in the musical understanding. A lot better *this* music than the dreary "classical" band music so many kids play in school. My opinion, anyhow. Try it and see.

César Franck: Pièce Héroïque; Prière; Final, Pastorale (Six Pièces). Michael Murray, organ of St. Meinrad Archabbey, Indiana, **Advent 5007**, SQ, (23366 Commerce Park Rd., Cleveland, OH 44122).

Triple-threat combination of this disc. A splendid big modern-Romantic organ in a grand stone Archabbey, an unusually musical and sensitive young organist, in the direct line of succession from Franck himself, and a fine, big recording, coded for SQ quadraphonic.

There are plenty of practitioners of French organ music. A good many of them, however famed in organ circles, leave the non-specialist ear out in the cold—especially in César Franck's long, personal meandering semi-mysticisms. This non-Frenchman will catch your listening ear if anybody ever can. He feels and understands. He plays with continuity and drama. He listens to his space, and paces his music to fit (so few organists do!). As a student of Marcel Dupré, who was a student of Guilmant, who worked directly with César Franck, Murray has the performing style and registration from the horse's mouth, and he knows what to do with it.

Superb rumbly bass is a nice added feature. Rattled my teacups and occasionally blasted my system—my fault, I suspect, not the groove's fault. This is a marvelous example of the grand old-fashioned roarer organ at its most persuasive.

César Franck: Sonata for Violin and Piano. Szymanowski: Mythes. Wanda Wilkomirska, vl., Antonio Barbosa, pf. **Connoisseur Society CSQ 2050**, SQ quadraphonic, \$5.98.

The Franck *Sonata* is a lovely old-fashioned work that was once played wherever chamber music was heard, has more lately been in eclipse, betwixt and between—not yet "classical" and no longer new. It is coming

THE ULTIMATE AMPLIFIER FROM SAE



To find out what makes the Mark 111CM the finest amplifier ever made, send today for your free copy of "The Ultimate Amplifier."

SAE
*Components
for the
Connoisseur*

SAE, Inc.
Electronics Division
P.O. Box 60271 Terminal Annex
Los Angeles, California 90060

Please send my free copy of "The Ultimate Amplifier."

NAME _____
ADDRESS _____
CITY _____ STATE _____ ZIP _____
TUA 3A

Check No. 34 on Reader Service Card

back, and this is an understanding performance by two young people who know all about the somewhat perfumed Franck style with its never-ending sequential changes of key, phrase by phrase. They are equal partners, as the music demands, and the recording gives them equal sonic billing. The much more lush, thick, mystic-late-impressionist Szymanowski, Polish-French of around 1915, is even more firmly taken in hand, an excellent performance of its complex double stops for the violin and the watery cascades of sound that must flow from the piano.

An odd SQ effect—but I suspect it is a quirk of the hall: The piano stays solidly put, but the violin has a sort of fluttering ghost-double, a second fiddle somewhere in the back of the hall. Could be a reflecting wall, off some distance. Very live sound, in any case. I seem to remember similar sounds in earlier Connoisseur recordings, probably made in the same place. Nothing to bother you in the least, just interesting to hear in your living room.

* * *

FILM SCORES

Captain from Castile,

The Classic Film Scores of Alfred Newman RCA Red Seal, ARL1-0184, \$5.98.

Warners and MGM are doing it, too: releasing the scores composed by their music directors for the most popular films over the decades. Erich Wolfgang Korngold, Max Steiner, Franz Waxman, Bernard Herrmann, Alex North—names known only to a few cineastes, although they flashed briefly on the screen as part of the credits. But what sounds they composed to accompany scenes in the Golden Age of Hollywood often became as well-known as the classics. Consider Max Steiner's *Tara's Theme* from *Gone With The Wind*, or, more recently, Maurice Jarré's *Lara's Theme* from *Doctor Zhivago*. People still whistle and hum them—and, perhaps, make love by them (life, as it will, tending to mimic art).

Alfred Newman, music director for 20th Century Fox and nine time Oscar winner, wrote scores which have been newly recorded by Charles Gerhardt and an orchestra called the National Philharmonic, which sounds impressive and is completely unknown to me. The fact that the album does not lift the

FREE McIntosh CATALOG and FM DIRECTORY

Get all the newest and latest information on the new McIntosh Solid State equipment in the McIntosh catalog. In addition you will receive an FM station directory that covers all of North America.



MX 113

FM/FM STEREO - AM TUNER AND PREAMPLIFIER

**SEND
TODAY!**

McIntosh Laboratory, Inc.
East Side Station P.O. Box 96
Binghamton, N.Y. 13904
Dept. 1

NAME _____
ADDRESS _____
CITY _____ STATE _____ ZIP _____

If you are in a hurry for your catalog please send the coupon to McIntosh.
For non rush service send the Reader Service Card to the magazine.

Check No. 26 on Reader Service Card

AUDIO • MARCH 1974

scores directly from the soundtracks is not always to the good—those who own the original recordings, where available, will discern some unfortunate lacunae.

The score for *Captain from Castile* is typical Newman (the film was released in 1947). It has the kind of convincing romanticism needed to support Tyrone Power and Jean Peters in Montezuma's empire. And the conclusion, called *Conquest* (the allusion is, presumably, military rather than amatory), features a full drum and bugle corps augmenting the orchestra: 128 instruments in all. The effect in stereo is impressive.

The familiar theme from *Wuthering Heights* is plaintive, almost achingly tender, and I defy anyone to recall a scene more typical of the era than Merle Oberon swooning in Laurence Olivier's arms.

But whereas the romantic ambience suited him well, Newman was uncomfortable with religious themes: his score for *The Song of Bernadette* sounds today like a mawkish musical cliché: tremolo strings, oddly erotic woodwinds—and the inevitable oooo-ing

angelic chorus (here, the Ambrosian Singers). How different from, say, Franz Waxman's undeservedly ignored score for Warners' *The Nun's Story* (1959), which evoked a sense of profound spiritual struggle and purpose through understatement and understanding. (Free of saccharine and full of straightforward musical ideas, it remains for me a consistently moving score, and one that supports the idea of religious quest—something that Newman's music never addressed in spite of all its harmonic niceties.)

Page Cook's notes accompanying the record gild the lily: he terms the score for *The Bravados* one of "unusual angularity and dramatic determination." Harrumphh. It's eminently forgettable.

Anastasia does have a certain naive charm to it, but the intrusion of bells and harp glissandi suggest a lack of inventiveness. Too, there is no juxtaposition of grandeur and lowliness in the score—and that is the key to the story's ambivalence. Newman's score for *The Best of Everything* was gently sweet, which just about defines the limits of his work.

Airport's score has a basic latin rhythm that (the album notes again) "effectively portrays the excitement of a modern airport." I have the feeling, however, that it's simply a mambo Newman never had a chance to use elsewhere, and inserted it here as a coda (it was his last film score before his death in 1970).

I have the original soundtrack recording of *The Robe* (1953, originally released on the Decca label), with Newman himself conducting. While the sound quality in this newer disc is decidedly superior, the music is truncated and the score's real power, and its curiously sad theme, are rather diminished. Also, *Caligula's March* (with its tempo now almost doubled from the original!) seems amusing, not grandly decadent. Yet after twenty years I still find its finale really poignant. Maybe because it takes me back to my less complicated youth. But maybe, too, because this was one of Alfred Newman's enduring successes, as he set to music thoughts too deep for tears.

Donald M. Spoto

Performance: B

Sound: A+

BACH WOULD BE MOVED...

...by 145db at 36Hz



..... reproduced by a Cerwin-Vega Double "D" horn radiating a sustained pedal D (36Hz) from his Toccata and Fugue in D minor. **OUTRAGEOUS!!!** Definitely for home use, but very desirable in outdoor sound reinforcement. Cerwin-Vega constantly strives with fanatic dedication to expand the boundaries of the audio experience. The Double "D" horn is just one example.

Some others: --Our new 24" servo bass speaker that handles 1,500 watts continuous power.
--Our A-3000 power amp delivering 1,500w. (RMS) with less than .05% distortion.
--The Magnastat(tm). The first practical realization of the perfect "textbook" speaker.



Cerwin-Vega

Double "D" Horn

- max. power: 2,000w. (RMS) continuous
- response: 32-500Hz ± 3db
- max output: 145db @ 2,000w. (RMS) @ 3'
- horn cutoff: 32Hz
- dimensions folded: 26"x49"x32"
- dimensions erected: 48"x49"x60"
- drivers: 2-special 18" Cerwin-Vega L-189-D 28 lb. magnet system 1,500w. (RMS) maximum each.
- finish: Epoxy fiberglass black

WRITE NOW FOR DATA

and expand your perceptual boundaries. Because what's outrageous today may be industry standard tomorrow.

6945 Tujunga Avenue/North Hollywood/CA/91605
(213) 769-4869

Check No. 15 on Reader Service Card

Canby's Capsules

Edward Tatnall Canby

Mozart

Mozart: Flute Concerto K. 313, Oboe Concerto K. 314. Mozart: Flute/Harp Concerto; Sinfonia Concertante K. 297b. Claude Monteux, fl., Neil Black, oboe, Osian Ellis, harp, et al., Academy St. Martin-in-the-Fields, Marriner. **Philips 6500 379,380**, stereo, \$6.98 each.

Mozart: The Complete Piano Concerti: Nos. 11 K. 413, 20 K. 466, Lili Kraus; Vienna Festival Orch., Stephen Simon. **Columbia P 11814**, stereo, \$5.95.

Rudolf Serkin/Mozart Piano Concerti Nos. 11 K. 413, 12 K. 414. Marlboro Festival Orch., Schneider. **Columbia M 31728**, stereo, \$5.98.

Colin Davis Conducts Mozart (Symphonies 39 and 40). London Symphony. **Philips 6500 559**, stereo, \$6.98.

Mozart: Divertimento No. 17, K. 334; March in D. N.Y. Philomusica Ensemble. **Vox Candide CE 31074**, stereo, \$3.98

When Mozart wasn't too involved—flute, oboe, harp works—he invariably composed bland, marvelously perfect and relaxed music, as in three of these 4 works on 2 discs. They are really beautifully played, with superb soloists. The Concertante, with four solo winds, is another story. A large-scale, more profound piece (lost in Paris, found later in a questionable copy—if Mozart didn't write it, the other guy was just as good), and a too-light, too-fast performance here, too much like the other three; the music can "take" a lot more and often does.

One of a dozen discs, remastered from 1965-66, available to choice. Europe's top Mozart pianist and a good little Viennese orchestra, plus—an American overlay—Stephen Simon. Intimate, serious, well-styled, somewhat rapid performances, with the right small-scale recorded sound and piano tone. Very clearly a good reissue from Columbia Special Services.

One of these is a reissue—who knows when music is recorded, these days? (And does it matter?) Typically bright, youthful playing out of Marlboro's young American players and Schneider's pushing drive—plus the familiar Serkin bounce: it's not really up to best European recording but has its U.S.-style points, even so.

Bravo! Davis turns from Berlioz to Mozart—the best new recordings of these symphonies for years, full-bodied, stylishly light in texture, fast-paced and accurate, yet reverent and solid in sound, with velvet strings, tailored brass, wind. A lovely sound and a fine way to learn these works if you don't know them yet.

Vox's intermediate label—and history repeats: one of Vox's earliest albums, c. 1946 (10-in. shellac 78s), excerpted this same work ("Saltzburg Serenade"). I loved it then, I love it now. The Philomusica does the hi-level "entertainment" music in the preferable solo-instrument form—it can also be done with small orchestra. Nicely paced, with Felix Galimir's fiddle in the lead. The little March makes entrance and exit music.

Little Marches by Great Masters. Netherlands Wind Ensemble. **Philips 6599 172**, stereo, \$6.98.

This absolutely crack wind ensemble, finest in our century, makes lilting rhythms out of these little 18th c. marches—the Beethoven ones are terrific. Side 1 is best; the stuff begins to wear thin by side 2 (unless you are marching). Superb recording, Philips' usual.

Bach: Sonata No 1, Partita No. 2, for unaccompanied violin. Wanda Wilkomirska. **Connoisseur CS 2040**, stereo, \$5.98.

One violin, all alone! The more Dolby, DBX etcetc. you use, the more you hear those faint busses and cars, maybe 70 dB down. That's the fact of life. The price is worth it here—the lady plays splendid Bach, beautifully in tune, uneccentric, easy to follow. A fine exposition of a very difficult art.

New York Brass Quintet Plays Knight. **Now Records** (stereo 4), \$5.98.

"... fascinating listening for brass specialists" sums up the *Times*. Correct! A super-pro brass prof (Ball State Univ.) writes like a computer for hugely pro NYC brass quintet, and it's a field day. Such a range of brass noises you'd never guess. Dry, academic, complex, going on and on, but not unhumorous, notably the mod jazz implications and vast stretches of chicken-like cluckings and scratchings. Weird! Very fine recording in "stereo 4" decodes dramatically via SQ.

Baroque Harpsichord. (Bach, Gibbons, Couperin, Scarlatti). Wm Neil Roberts. **Klavier KS 524**, stereo, \$5.98.

A forceful but somewhat heavy-handed player, a curiously twangy instrument (with notes out of kelter), recorded too close with an over-boomy bass. I liked the Bach Partita No. 1, and the Gibbons (hardly Baroque); the Scarlatti is weighty but strong-minded. Didn't like the Couperin much. No lift.

Canby's Capsules

Edward Tatnall Canby

Vignettes of Old Russia. Sergi Tarnowsky, piano. **Genesis GS 1004**, stereo, \$5.98.

Right out of the turn-of-the-century Russia, this old-time Russian pianist (California since 1930) plays salon pieces by the Russian greats, many of whom he knew—Arensky, Liadoff, Scriabine, Cui, Rachmaninoff, Medtner, Glazounov, Borodin, Tchaikovsky. The fingers are a bit stiff but the style is fabulous—the authentic late-Romantic manner, first hand. Uneven recording, often near overload, and a woody piano (Baldwin) will put you off only momentarily. The message comes through.

Mahler: Symphony No. 7. Concertgebouw Orch., Haitink. **Philips 6700.036** (2 discs), stereo, \$11.96.

Less known than the other enormous symphonies, and without voices, this still is a gold mine of good Mahlerisms, at the beginning of late-period harmonic concentration and dissonance. A solid Dutch performance here, quite beautifully shaped for the long (*very* long) pull, and nicely recorded. I like the inner mvts best (as usual); outer parts are too big and loud for my taste! Suit yourself.

Borodin: Prince Igor. Soloists, Bolshoi Cho. and Orch., Ermler. Melodiya—**Angel SRDL 4116** (4 discs), stereo, \$23.92.

We all know familiar “Prince Igor” excerpts (Polovtsian Dances, etc.)—here’s the whole huge opera, in Russian, a massive, handsome production sounding like “Boris Godounov.” But “Igor” is basically mild and mellow, for all the vast pageantry and the huge Russian voices.

Music of Paul W. Whear. (*Decade Overture; Catharsis Suite; Psalms of Celebration; Joyful-Jubilate*). London Concert Orch. and Choir, Whear. **Advent USR 5001**, stereo, (23366 Commerce Park Rd., Cleveland, O. 44122).

Whear is a top U.S. local professional conductor and composer—out of Indiana, presently operating in W. Virginia—recipient of endless honors, commissions, voluminous producer of fat works for local performing groups all over. His music is big, thick, highly professional, wholly unoriginal, reminding of everybody you can remember from Brahms to c. 1940. Just fine for the local performers to work on but who on the outside wants to listen? You can if you want—see address. (Note incongruous British performance—economic necessity.)

Schumann: Quintet for piano & strings Op. 44; Quartet for piano & strings, Op. 47. Cohen, Martin, Mester, Kouguell; David Hancock, pf. **Monitor MCS 2132**, stereo, \$4.98.

Doesn't say so—but I'll bet D. Hancock was the recording engineer—or at least supervisor. He is the pianist, and a well known audio man as well. This is good Schumann of modern sort, not as all-out breathless as the older tradition demands, a bit too Bach-like in tempi, but always musical. Nicely recorded, too.

Music for Trumpet and Organ. Maurice André, Marie-Claire Alain. **Mus. Heritage Soc. MHS 1176**, stereo, mail order: (1991 B'way, New York 10023)

A single modern trumpet here, and an organ not very distinguished in the recorded sound (Detlef Kleuker), doing a brace of transcriptions, none of them apparently for trumpet, old *or* new. As such, they're not bad. The organ sounds confined, the trumpet is far off, in a big space—curious effect.

Oscillations. Synthesized Themes and Bridges by Don Voegeli. NCAE, Madison, Wis.

These aimable bits of synthetic radio music mostly use oldies and humorous tune oddities (*King Tomb's Tut*) for an old-fashioned sound in a new format. Expert synthesizing, with a few weeps and bleeps thrown in for color here and there, along with the fluent straight harmony. For Public Broadcasting.

Sound Beds 1. Recorded in binaural. NCAE, Madison, Wis.

These “sound effects” are NCAE's first binaural release. They are scenes of the expected variety—waves, cocktail party, traffic, walking, car body shop, bowling, football, etc., in longish (but not long enough) segments, from 2 to 4 minutes, starting and ending abruptly—you do your own fading. They *are* usable as stereo (loudspeakers), with some separation, but the intent and real impact is binaural via headphones. In that form they are startling. For Public Broadcasting.

Sherwood's Forest

Sherwood L. Weingarten

Dear Boss:

I'm fatigued, dead, exhausted, bushed, dragging, beat, weary, droopy, pooped, worn. Besides that, I'm tired. And lazy. And I have a writer's block.

The weather's bothering my scars, the miserable heating system at home's bothering my sinuses, my back aches from sitting at an antiquated typewriter that refuses to do my work for me. The March deadline keeps tugging at me and though I might look like the proverbial lion with my shaggy mane and whiskers, I appeal to you like the lamb that I really am: Help!!!

I need an idea, direction, but, mostly, the ability to decide on a theme.

Should the column deal with lyrics, that oft-neglected factor of rock discs? If so, I can easily write about **Larry Norman's** second album, **So Long Ago So the Garden** (MGM, SE 4942), which is extraordinary because there isn't a bad track among the nine Norman-penned tunes on it. The underrated, virtually unknown composer-singer's first package, **Only Visiting This Planet** (Verve, V6-5092) contained 10 cuts that were outstanding; this LP's even better, more mature.

The first time around he dealt with love and humanism, with the music shifting from blues to country to rock to change-of-pace stuff. His voice ranged from squeaky to strong, but his lyrics never lacked potency. And the listener could revel in the excellence of *Why Don't You Look Into Jesus*, a heavy blues; *The Outlaw*, a folk ballad, and *Reader's Digest*, a lament for both pop music and the shape of the world.

The second session also emphasizes creative variety. *Meet Me at the Airport* (*Fly, Fly, Fly*), for instance, provides Jamaican rhythms that form a together piece that's hummable, singable and likable; it can't miss being a hit if it's promoted at all. In contrast, there's *It's the Same Old Story*, a slick but pleasant country-rock number, and *Be Careful What You Sign*, a bluesy thing that lingers in the memory. *She's a Dream*, aided by a roomful of strings, is lovely, a poignant entry more baroque in tone than the good, but badly-titled, *Baroquen Spirits*.

Nightmare, however, is the *tour de force*, a composition that does more effectively to Hollywood what Don

McLean did to pop music via *American Pie*. Norman, in addition, is obviously more concerned with social consciousness. Witness:

*"With the continents adrift and the sun about to shift
Will the ice caps drown us all or will we burn?*

We've polluted what we own: will we reap what we have sown

Are we headed for the end or can we turn?

We've paved the forest, killed the streams

*Burned the bridges to our dreams
The earth is bursting at the seams*

*And in pain of childbirth screams . . .
Let the proud but dying nation kiss the last generation*

It's the year of the pill, age of the gland

We have landed on the moon but we'll clutter that up soon.

Our sense of freedom's gotten out of hand

*We kill our children, swap our wives
We learned to greet a man with knives
We swallow pills in four and fives
Our cities look he just survives. . . ."*

Great poetry it isn't, but, then, even Bob Dylan couldn't have hacked it in the company of T.S. Eliot. Still, Norman is a comer, a guy with something to say and the talent with which to showcase it.

Perhaps instead, boss, I should do something about the heavy drug-orientation in the pop-rock scene. I could, for example, couple the anti-drug LP by **The Dramatics, A Dramatic Experience** (Volt, VOS-6019) with the apparently pro-drug package by **Chris Sedgwick, The Singer Sang The Song** (RCA, LPL1-5001).

The former, a recording distributed by Stax, is mostly funky soul dealing with love themes. Two of the tunes, though, hit hard at the drug counter-culture: *The Devil Is Dope* intones exactly what the title indicates, and *Beware of the Man* (*With the Candy in His Hand*) is a warning about the pusher with a smile who is a friend only as long as the user supplies the money.

Sedgwick, on the other hand, is a Briton who offers mostly up-tempo folk-rock via a pleasant but ordinary voice and a comparatively narrow

range. Among the 11 cuts is *Mexico Gold*, with the following tidbit: "Lawdy, Lawdy, watch the blue smoke/Fly every morning and every night/To get you out of your head/ . . . who needs a natural high/When you livin' down South/And it's growin' right outta your bed."

I could take a stand, of course, but I'm neither a crusader nor an advocate, neither a narc nor a freak; guess I'll stay out of it, except to mention that I am opposed to limiting discussion of drugs by excluding booze. Alcohol is as poisonous as the other stuff, and it too has a place in today's music.

Consider, if you will, **Lee Clayton** (MCA, MCA 365), a singer-composer with a husky voice and lots of style, some of which seems borrowed from one of his "pickin' buddies," Kris Kristofferson. Among the nine cuts, which include the Waylon Jennings' hit *Ladies Love Outlaws*, are a pair dealing with firewater. *Bottles of Booze* makes note that "heroes and losers seem to all end up in bars," while *Lonesome Whiskey* wails, "I swear I'm not the kind of man that drinks up 'til he's blind/That likes to soak his mind away one sip at a time/But I'll bet that if I died today I'd never get the news/And the best thing for those nobody blues/Is lonesome whiskey."

Perhaps, boss, I should write about comebacks, the obvious choice being **Ol' Blue Eyes Is Back** (Warner Bros., FS 2155), **Frank Sinatra's** re-entry into the pop marketplace.

It's too easy, though, taking potshots at his loss of range (attempts to hit high notes are almost embarrassing) or occasional voice-cracks; rather, it should be stressed that the phrasing that made him *The King* is still intact, that his sensitivity to lyrics, the scars of life are still present. It's all schmaltzy, of course, with a lot of soft, stringed stuff conducted by Gordon Jenkins and arranged by both Jenkins and Don Costa. But there's no attempt, thank goodness, to cover up the flaws demanded by Old Man Time, something that was tried (mostly by jazzy, blaring, up-tempo creations) on several albums before retirement. Instead, the record stands as a monument of sorts to the greatness of a singer whose absence could not be filled by any other. Come to think of it, the LP's nine cuts do not really consti-

tute a comeback at all; they're a lesson that the master was never away.

Or, maybe, boss, I should deal with the fag-drag-glitter-ghoul trend in rock, including *Lou Reed's Berlin* (RCA, APL1-0207) and *Alice Cooper's Muscle Of Love* (Warner Bros., BS 2748). The first is a cornucopia of decadence, a disgusting melange that out-Tennessee's Williams. Reed, who tosses in a multitude of non sequiturs and an occasional bit of bizarre humor for flavor, perhaps sums up his real feelings in *Men of Good Fortune*. Says the main character, "Me, I don't care about anything at all." The LP is depression personified, with depravity to spare. Cooper, on the same hand, is a refugee from Maliceland, even though he adds "nice" background vocals this go-round by Liza Minelli on *Teenage Lament '74* and *Man With the Golden Gun*. There are good changes-of-pace, from slow to hard rock, but the emphasis, as always with the guy whose legendary stage act included mutilation of baby dolls, a 13-foot boa constrictor and mock hanging or guillotinings is freak rock. As distasteful as recordings are, however, they're sure to add some gold to the glitter-boys.

More to my liking, boss, might be a column based on humor in music, or, in the case of *10 C. C.* (UK-London, UKS 53105), humour in music, since the latest protegés of Jonathen King are veddy definitely British. The quintet, which spoofs Top 40 and bubble-gum rock tunes (as in their sleeper hit, *Rubber Balleis*), almost does in the entire genre, with the emphasis on parodying early '60s material. *Johnny Don't Do It* is a marvelous pastiche of motorcycle death melodies, as a case in point. Trouble is the stuff has to be heard to be appreciated; words on paper eliminate the verve and the fun.

Or, boss, should I deal with professionals who lose the ability to communicate what they feel, as with *Kris Kristofferson* and *Rita Coolidge* on *Full Moon* (A&M, SP 4403)? Each of the two, individually, had no difficulty letting the audience know, nay feel, exactly what was in their minds and hearts. Now that they're blissfully wed, however, there's a block—unless the listener is in a similar state of ecstasy. The dozen cuts here might be described as country mush, an exercise in double ennui despite the presence of Mike Utkley, Lee Sklar, David Bromberg, Nick DeCaro, Gary and Randy Scruggs, Booker T. Jones and Herb Alpert as instrumentalists. Even the highlights, *Hard to Be Friends* and *I Never Had It So Good*, both of which are getting a fair share of airplay, don't equal any

of their individual performances.

Then, of course, I might be able to do something with a trio that's growing geometrically, (Keith) *Emerson*, (Greg) *Lake &* (Carl) *Palmer*. *Brain Salad Surgery* (Manticore, MC 66669) is on the menu, and the eight cuts provide a digestible, exciting combination of heavy electronic rock and strains of classics, not unlike some of the stuff Emerson had done with The Nice (except that it's more complicated, more interesting, more original now). The vocals tend to be poetic, except for the gruff *Benny the Bouncer*, but it's the music that stops the audiophile in his tracks. If you must choose one selection, and that's a difficult task, try *Toccata*, a fascinating item developed from Ginastera's *First Piano Concerto, Fourth Movement*.

Still another alternative, boss, is to do a bit about newcomers, such as *Billy Joel* on *Piano Man* (Columbia, KC 32544), which features good rock piano, good vocals and a together sound that equals, as a debut LP, early Carole King. The title tune is the winner, with a harp-like blues backdrop blending exquisitely with lines such as "They share a drink they call loneliness/But it's better than drinking alone." Another success is the schmaltzy, Hugo Winterhalter-like but oddly memorable *Ballad of Billy the Kid*.

Or, I could do a column *without* a theme, much like this one, hop-scotching the world of pop and rock, combining bits and pieces of a dozen kinds of material. Just a line or two on each disc. Such as—

Millie Jackson's It Hurts So Good (Spring, SPR 5706) offers a dozen cuts including two instrumental reprises (*Hypocrisy*, her own tune, and *Breakaway*). The soul singer, a future star, has a crusty voice with a feel of suffering that clearly comes through your amplifiers. Best tune on the Polydor-distributed vinyl is *I Cry*, a bluesy, bluesy piece aided by good instrumentation, particularly the wah-wah pedal.

Rod McKuen, who sounds, as always, as if he's just getting over a cold but still has a sore throat, spotlights other people's material on four entries on *Cycles* (Buddah, BDS 5138); the other eight tunes are his. The pop-poet with the raspy voice is duly sad and pretty on the title tune, and many of the others, but the standout cut is *Love Child*, a highly personal tone poem to his own bastard beginnings, a recitation set to bland background music.

Davey Johnstone, who joined Elton John in early '72 debuts as a solo on *Smiling Face* (Rocket Records, 340) and

Introducing the TL-90



The TL-90 by Audionics* incorporates a full complement of RADFORD components with transmission line bass loading. The TL-90 is one of four high performance transmission loudspeakers from Audionics. Write or call for the name of your nearest dealer.

*Assembled in U.S. under license by Radford Audio Ltd.

AUDIONICS, INC.

8600 NE Sandy Blvd.
Portland, Oregon 97220
503-254-8224

Check No. 6 on Reader Service Card



Newest Soundsation Grommes 600

AM/FM 50 Watt Stereo
Grommes 600

Enjoy superb sound at a very muted price. Exquisitely designed "shelf-size" cabinet with 10 front panel controls. Finest American-made components. Precision engineered and balanced for true reproduction. Under \$200. At fine stores everywhere. Or write.

MADE IN THE U.S.A.
Grommes
9101 KING • FRANKLIN PARK, ILL. 60131

Check No. 30 on Reader Service Card



RUGGED!

The BOSE name and a full FIVE YEAR WARRANTY are your assurances of reliability and performance with the BOSE 1800™ Professional Power Amplifier.

- 800 Watts rms
- LED Displays
- Over 1,300 Square Inches of Heat Sinks
- Sturdy Packaging
- Rack Mountable

Please send complete information on the BOSE 1800 to:

Name _____

Address _____

City _____ State _____ Zip _____

Mail to: BOSE, Dept. AP,
The Mountain, Framingham, Mass. 01701

Now the most enjoyable, do-it-yourself project of your life—a Schober Electronic Organ!



You'll never reap greater reward, more fun and proud accomplishment, more benefit for the whole family, than by assembling your own Schober Electronic Organ.

You need no knowledge of electronics, woodwork or music. Schober's complete kits and crystal-clear instructions show you— whoever you are, whatever your skill (or lack of it)— how to turn the hundreds of quality parts into one of the world's most beautiful, most musical organs, worth up to twice the cost of the kit.

Five superb models, with kit prices from \$500 to around \$2,000, each an authentic musical instrument actually superior to most you see in stores.

Join the thousands of Schober Organ builder-owners who live in every state of the Union. Often starting without technical or music skills, they have the time of their lives—first assembling, then learning to play the modern King of Instruments through our superlative instructions and playing courses.

Get the full story FREE by mailing the coupon TODAY for the big Schober color catalog, with all the fascinating details!

The Schober Organ Corp., Dept. AE-50
43 West 61st Street, New York, N. Y. 10023

- Please send me Schober Organ Catalog.
- Enclosed please find \$1.00 for 12-inch L.P. record of Schober Organ music.

NAME _____

ADDRESS _____

CITY _____ STATE _____ ZIP _____

Check No. 37 on Reader Service Card

manages to climb mediocrity. The album, carrying John's own label, is mostly soft rock, with Johnstone singing and playing electric piano, mandolin, harmonium, dulcimer, sitar, banjo and electric and acoustic guitars. In addition, he wrote all but one of the dozen tunes. Highlights of the MCA-distributed disc, if they really can be termed that, include *The Boatman*, a reggae; *Walking Out*, a honky-tonk success; *After the Dance*, an instrumental with some good guitar work, and *A Lovely Day*, with a lead vocal by Di Johnstone, his old lady.

Burt Reynolds can remove the staple from his navel and use it to play his album, *Ask Me What I Am* (Mercury, SRM-1-693), for the more copies he destroys, the better off the public is. There are 11 songs, eight specifically penned for the actor; on all of them, he half-talks, half-sings in the style originated by Rex Harrison years ago in *My Fair Lady*. Harrison was better, even though he didn't have unbilled Dinah Shore backing him on *I Like Having You Around*.

I'm a Writer, Not a Fighter (MAM-London, MAM7) finds 26-year-old singer **Gilbert O'Sullivan** doing a lot of his own things that sound too much like past smashes, particularly *Clare* and *Alone Again (Naturally)*. Witness *Get Down* from this album, a hit despite the musical mirror phrases, or *A Friend of Mine*, *They've Only Themselves to Blame* and *I Have Never Loved You As Much As I Love You Today*. Imitation may be the sincerest form of flattery, but is it really necessary to flatter yourself?

Mississippi (Fantasy, F-9438) is the album's name and the name of the three-man Australian group starring on it. Russ Johnson, lead guitarist; Graham Goble, rhythm guitarist, and John Mower, drummer, do a BeeGee-like job, combining ballads and soft rock to a faretheewell. All three sing nicely, offering think-rock with folk overtones. The pleasant result is best noticed on *Kings of the World*, a song that won the Aussie equivalent of the Grammy; *Save the Land*, an ecology-based thing with excellent harmony; and *Sweet World*, a blues.

Pacific Gas & Electric Starring Charlie Allen (Dunhill-ABC, DSX-50157) brings country-rock to the fore (with touches of blues, soul and folk tossed in). The group has reorganized, but is not as good as the original. Of the 11 cuts, *Hold On*, a bouncy rocker, shines. The rest, whether emphasizing country or gospel or bluegrass or whatever, don't carry that much weight.

Angel Clare (Columbia Quadraphonic, CQ31474) proves that **Garfunkel** (he's shed the Art) can go it alone, sans Paul Simon's lyrical lovelies (despite Simon doing some backup work on the LP, along with Jim Gordon and Jerry Garcia). Garfunkel continues valid use of his choirboy voice and continues musical patterns that are reminiscent of the S&G blockbuster, *Bridge Over Troubled Water*. Best of the bunch are *I Shall Sing*, a catchy pop tune with a Latin-calypto beat worthy of hitting the charts; the traditional folksong, *Barbara Allen*, and *All I Know*, already a smash single. It's a pretty LP, aided by songs by Paul Williams, Van Morrison, Randy Newman and Jimmy Webb.

Boogie Woogie Bugle Girls (Paramount, PAS-6075) owes a debt to Bette Midler, who almost single-handedly brought back the sound of the **Andrews Sisters**. This, with the original Patti, Maxene and LaVerne version of *Bugle Boys* intact, shows that the '40s really did have some life to them (though these 14 cuts were done only a dozen years ago, to improve the sound quality via stereo). Highlights by the singing Andrews include *Rum and Coca Cola*, *Beat Me Daddy Eight to the Bar*, *In the Mood*, *Don't Sit Under the Apple Tree (With Anyone Else But Me)*, *Old Piano Roll Blues*, *Bei Mir Bist Du Schon*, *Oh Johnny, Oh Johnny, Oh!*, *Pennsylvania Polka* and *Pistol Packin' Mama*. Memories, as the lyric goes, are made of this.

Food of Love (MCA-356) is schlock, pure and simple, from the ordinary voice of **Yvonne Elliman**. At best, it's good background music (despite the presence of Peter Townshend and Caleb Quaye on guitar). Best cut is Townshend's *I Can't Explain*, a rocker. Ms. Elliman wrote one of the 11 cuts, *Hawaii*, and that lacks luster too.

One Live Badger (Atco, SD7022) showcases a quartet that offers rock as hard as diamonds. Six cuts comprise the LP, recorded live at the Rainbow Theatre in 1972. Brian Parrish stands out, occasionally, with his lead guitar. There are times, be warned, that the music approaches a decibel count sure to deafen.

Imagination (Buddah, BDS 5141) begins with the hit single, *Midnight Train to Georgia*, a good combination of blues, soul and pop. Another sparkler by **Gladys Knight & The Pips** is a healthy rendition of *I Can See Clearly Now*. It's basic, soft soul with little of the screaming that dots most LP's by Black groups.

Isleys' Greatest Hits (T-Neck, TNS 3011) puts the Brothers into a

fittful rhythm 'n' blues bag . . . or is it soul? . . . or is it pop? No matter. It's good, it's exciting, spirited and exhilarating. Includes *Shout* and *It's Your Thing* and *Love the One You're With*. Atlantic distributed the money-saving anthology, and we should be grateful.

Childgrove (Adelphi, AD1022) provides cerebral music by *Suni McGrath*. The composer-guitarist (who excels on six and 12-string instruments) offers a soft classical orientation with folk overtones. Side Two is one tremendous 22-minute track, *Lion of Judah*, with a short vocal by Ellen Matthews at the tail.

Fillet of Soul (Stax, STS-3021) is an anthology that causes the blood to circulate faster. Best of the dozen cuts are *Never Can Say Goodbye* and *The Look of Love*, soul-pop hits by the Black Moses, *Isaac Hayes*; *Watcha See is Watcha Get*, another hit by the *Dramatics*, and *Starting All Over Again*, an oldie chartbuster by *Mel and Tim*. Others performing are the *Staple Singers*, the *Bar-Kays*, *Frederick Knight*, *Johnnie Taylor*, *Rufus Thomas*, *Mavis Staples*, and *Little Milton*.

The Best of Procul Harum (A&M, SP-4401) contains four tunes (three in mono) never before released in America in album form, *Lime Street*

Blues, *Homburg*, *In the Wee Small Hours of Sixpence* and *Long Gone Greek*. But for those who've followed the cult-like successes of the rock group, highlights must be *A Whiter Shade of Pale* and the orchestra-backed *Conquistador*.

JANIS JOPLIN'S GREATEST HITS (Columbia, KC 32168) allows us to mourn while reveling in her greatness. It's the hardest of blues and rock, 10 cuts worth; four are with Big Brother and the Holding Company, one with Kozmic Blues Band, the rest with Full Tilt Boogie Band. Sit back and enjoy the likes of *Piece of My Heart*, *Summertime*, *Try (Just a Little Bit Harder)*, *Me and Bobby McGee*, *Down on Me*, *Bye Bye Baby* and *Move Over*.

JONATHAN LIVINGSTON SEAGULL (Dunhill-ABC, DSD-50160) is a narration of the utopian book by *Richard Bach*; delivery is via the resonant voice of *Richard Harris*, whose talent outshines the words he speaks. Music was composed, arranged and conducted by Terry James, who must have had something better to do with his time. Strictly for Norman Vincent Peale addicts. Personally, I think the company had a lot of gull to release it.

FRAMPTON'S CAMEL (A&M, SP-4389) is a quartet fronted by *Peter Frampton*, who left Humble Pie after three years to do his own thing. He's probably one of the most underrated performers extant, but it takes a couple of hearings to determine just why: subtlety. There are nine easy rock offerings, all but one by the singer-writer (who, not incidentally, approaches being a one-man band by playing piano, organ, guiter, tambourine, drums and percussion, and bass).

CHAPTER VII (Columbia, CQ 32048) provides rock 'n' soul by the *Buddy Miles Band*. The quadrasonic recording is screamin' stuff, topped by some exquisite guitar work. Miles proves his mettle on organ, guitars, bass, drums and vocals (the last being his weakest suit), and is backed by his six-man group and eight other musicians. There are nine listenable cuts, including the two-part *Life Is What You Make It* that is the standout.

Anyway, boss, have you got any ideas? I'm dry. If not, well maybe next month's batch of mail will bring something better to build on. . . .

*Your slave,
Sherwood*

What's the gimmick with new Avid Speaker Systems?



There isn't any. Just quality design and thorough engineering. That's what makes the difference.

Avid's Series 100 Speaker Systems are the premium quality products of extensive research and testing by a team of audio experts whose knowledge and experience is unsurpassed in the field today (Avid has pioneered in the design of quality audio components for broadcasting, industry and education for the past 20 years). Each Series 100 model is unrivaled for performance and value in its class.

Superlatives come easy, but the only way you'll be convinced is to visit your Avid dealer, listen to the accuracy of sound reproduction and see the innovative styling for yourself. We're confident of your favorable verdict.

Avid Corporation, 10 Tripps Lane, East Providence, R.I. 02914 Tel. (401) 438-5400.

AVID

Check No. 9 on Reader Service Card

Jazz & Blues

Martha Sanders Gilmore

RAHSAAN ROLAND KIRK: Prepare Thyself to Deal with a Miracle

Musicians: Rahsaan Roland Kirk, clarinet, nose flute, flute, black mystery pipes, baby E flat sax, tenor sax; Charles McGehee, trumpet; Dick Griffin, trombone; Harry Smiles, English horn, oboe; Ron Burton, piano; Henry Pearson, bass; Robert Shy, drums; Sonny Brown, percussion; Ralph MacDonald, percussion; Selwart Clarke, violin; Sanford Allen, violin; Julien Barber, violin; Gayle Dixon, violin; Al Brown, viola; Kermit Moore, cello; Jeanne Lee, vocals; Dee Dee Bridgewater, vocals.

Songs: *Salvation and Reminiscing; Seasons; Celestial Bliss; Saxophone Concerto.*

Atlantic SD 1640, \$5.98.

The material on this recording, all composed and arranged by Rahsaan Roland Kirk, lies somewhere in the midst of that experimental gray area between classical music and jazz. Thus it is difficult to describe or characterize.

Kirk, the mighty miracle worker is here in all his splendor, playing on a menage of instruments simultaneously and moving *breathlessly* through the movements of his creations. Take for instance *Saxophone Concerto* in which Kirk plays a 21-minute tenor saxophone solo without even once taking a breath until its completion—sheer mastery of an instrument that will leave you breathless. Set against a backdrop of horns and percussion, the movements of the concerto are as different one from the other as night from day and encompass “all levels and progressions in Black Music (Swing, Bebop, and Now).” The first movement, *Saxophone Miracle*, begins with a train whistle which the instruments immediately take up and imitate. A fast walking bass under the aegis of Henry Pearson then sets forth alongside Kirk’s gut-filled tenor playing. A cymbal crashes. Kirk loses himself

amid his churning whirlpool of motion. The train passes on.

In the second movement, *One Breath Beyond*, Kirk plays his sax front on, then it is as though he wheels around, turning his back upon us for the saxophone sounds faint in the distance. Suddenly he breaks into a snappy polka which is great fun as pitted against Ron Burton’s piano. It is undoubtedly the highlight of the album. Kirk, flying along as fast as his wind will carry him, shows off his cognizant technical skills, taking one’s breath away once again.

Never actually putting down his horn he glides into *Dance of Revolution*, the third movement of the *Saxophone Concerto*, leading us on a merry fox and hounds chase that admittedly oversteps its mark. There is essentially too much repetition. The train chugs by, stops. We hear footsteps walking away. Then it is as if someone drops a long string of bells. They clink to the floor. (If all this sounds experimental, it is).

Salvation and Reminiscing opens with Kirk’s lovely lush-toned clarinet which he takes to piercing heights alongside plucked strings and timpani. There is a propelling forward motion to this, a majesty.

Seasons begins with an English round or folk tune, Kirk playing flute and nose flute at the same time. Over the great rolling surge of it all he plays quick, darting flute trills after which Ron Burton’s piano solos against Henry Pearson’s pivotal bass. It must be said here again that Kirk and crew go to interminable lengths without much happening.

Celestial Bliss, with Kirk on E flat sax and “black mystery pipes,” is played to a Calypso beat as he sets down a single note on one horn over which he imposes his lacework via the other.

The recording is by and large well produced although at times Kirk’s backup group is too loud for him.

So if you like to experiment I think you will get something out of this recording by Rahsaan Roland Kirk. He is a musician through and through and will breathe life into you.

Performance B+

Sound B+

DUKE ELLINGTON PRESENTS IVIE ANDERSON

Musicians: Arthur Whetsol, trumpet; Cootie Williams, trumpet; Freddie Jenkins, trumpet; Joe Nanton, trombone; Lawrence Brown, trombone; Johnny Hodges, alto, soprano saxophones; Harry Carney, alto, baritone saxophones; Barney Bigard, clarinet, tenor sax; Duke Ellington, piano, arranger; Freddie Guy, banjo, guitar; Wellman Braud, bass; Sonny Greer, drums; Juan Tizol, valve trombone; Otto Hardwicke, alto, bass sax; Joe Garland, tenor sax; Rex Stewart, cornet; Ben Webster, tenor sax; Billy Taylor, bass; Hayes Alvis, bass; Pete Clard, alto sax; Wallace Jones, trumpet; Harold Baker, trumpet; Billy Strayhorn, vocal, Jimmy Blanton, bass.

Songs: *It Don't Mean a Thing; Delta Bound; Happy As the Day Is Long; Raisin' The Rent; Get Yourself a New Broom, I'm Satisfied; Truckin'; Isn't Love the Strangest Thing; Love Is Like a Cigarette; Kissin' My Baby Goodnight; Oh Babe, Maybe Someday; Shoe Shine Boy; It Was a Sad Night in Harlem; I've Got To Be A Rug Cutter; There's A Lull in My Life; It's Swell of You; Alabamy Home; All God's Chillun Got Rhythm; If You Were in My Place; Swingtime in Honolulu; You Gave Me the Gate; Rose of the Rio Grande; When My Sugar Walks Down the Street; I'm Checkin' Out, Goodbye; In a Mizz; A Lonely Coed; You Can Count on Me; Your Love Has Faded; Killing Myself; Solitude; Stormy Weather; Mood Indigo.*

Columbia, KG 32064, \$9.98.

That Ivie Anderson was the most distinguished vocalist to ever front the Ellington Orchestra is an undeniable fact. Those who followed in her footsteps attempted to emulate her but could never quite fill her shoes or reach the rare heights she had attained during her twelve-year reign with the band from 1931 to 1942. Ivie left the band to open a restaurant in California and subsequently died of asthma in 1949, a malady she had suffered during her stint with the band. But in spite of that she sang, oh how she sang!

The thing that strikes one most, I suppose, from listening to this two-record collection of Ellingtonia recorded between 1932-1940 is the immense dignity of Ivie's delivery, the way she takes total command of a song and wields it into shape. Recalled Harry Carney: "Ivie always came on stage dressed in white, looking angelic, very chic and above it all. Yet backstage and on the bus, in hotels or restaurants, everywhere, she was always regular one hundred percent. With the boys, with the girls, with Ellington, everyone. There was no side to her. She had no fancy ways."

Ivie's voice, which lies well within the alto range, has a glassy edge to it that is able to penetrate and soar above the most sophisticated and elaborate of Ellington's orchestrations. She had a keen sense of timing, her diction was absolutely faultless, and her use of dynamics was both provocative and intelligent. In addition, she was able to sustain a note at a phrase ending in such a subtle way that one could never hear her actually put a period to it. It just kind of tapered off. Her vocal delivery was ultra-smooth and ripple-free. But above it all was Ivie's seemingly effortless style, her very natural manner of attacking a lyric illustrated here in *It Don't Mean A Thing If It Ain't Got That Swing*, an anthem of the Swing Era, all the way to *Mood Indigo*, a perennial classic.

These recordings contain many Ellington originals—some of his better known compositions such as *Solitude* which features tenor saxophonist Ben Webster in some throaty embellishments and the *Piano Player*. Ellington himself playing glistening descending runs, to lesser known tunes out of the Ellington notebook such as *A Lonely Coed* in which Ivie curls about the tune with sheer poignancy against Cootie Williams' muted trumpet lines.

There are also songs by other American songwriters of the highest order such as Harold Arlen's *Raisin' the Rent*, *Happy As the Day Is Long*, and *Get Yourself a Broom*, all infectiously humorous, to Harry Revel's breezy

There's a Lull In My Life

And there are crackerjack solos by the very best soloists the Ellington organization had to offer during this twelve-year era of Swing. We are treated to Bunny Bigard's merrily simmering clarinet work in *Truckin'*, *Isn't Love the Strangest Thing*, and *Kissin' My Baby Goodnight*, while Cootie Williams plays a muted trumpet that growls its way through *It Was a Sad Night in Harlem* wherein Johnny Hodges evokes a pervasively bluesy feeling on alto saxophone, then sub-

mits a protracted statement in *If You Were In My Place*. Solos by other Ellington stars abide as with Rex Stewart, Joe Nanton, and Lawrence Brown who does some elegant trombone work.

Tenorman Ben Webster plays blissful obbligati under Ivie's *Stormy Weather*, a vehicle that is perfectly suited to her voice. And Ivie's rendition of *All God's Chillun Got Rhythm* is absolutely spellbinding. She gives it a grand treatment together with Her Boys from Dixie.

Audioanalyst



ACCEPT OUR INVITATION TO THE MODEL A-200 EXPERIENCE

If you want to hear trumpets that "sting" you, bass instruments that "stab" your viscera, ensemble clarity that is always perfectly sorted out—ask your dealer to pull out everything he's got for comparison!

No, we're not kidding. You'll find this is the one that makes it in every way: balance, dispersion, overall clarity, frequency response . . . you name it!

So if you want to hear your music and not just your loudspeakers, give the model A-200 accuracy a hearing.

You demand state-of-the-art performance in your other components, now you can have it in your loudspeakers.

6-year warranty.

Audioanalyst P.O. BOX 262, BROOKFIELD, CT. 06804

SPECIALISTS IN ENVIRONMENTAL SOUND RESEARCH

Distributed in Canada by Kairon Electronics, Montreal.

If you have a head for numbers, look at these:

Lightweight, comfortable, headphones from Audio-Technica deliver superb sound at a modest price. Open-back bipolar design needs no heavy earcups or harsh springs, yet delivers full bass and impressive transient response. No unneeded, redundant controls or gimmicks. Just simple listening pleasure. Now at your Audio-Technica dealer. Get your head into better sound today.

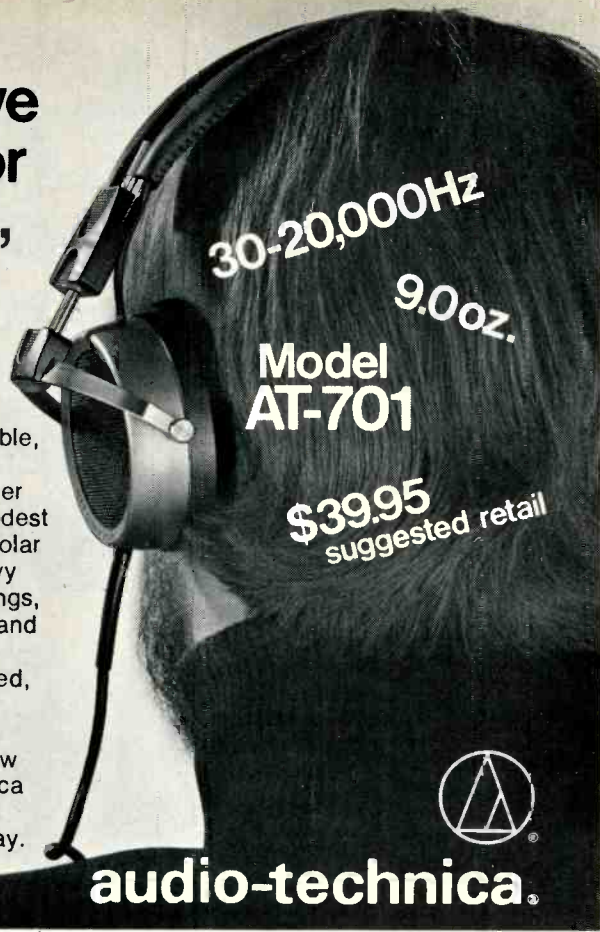

audio-technica.

AUDIO-TECHNICA U.S., INC., Dept. 34A, 1655 W. Market Street, Fairlawn, Ohio 44313
Check No. 8 on Reader Service Card

MAGNEPLANAR™
loudspeakers are . . .

extremely realistic sounding — and they're only 1" thick. Our top-of-the-line Tympani series which look like folding floor screens are sold through Audio Research dealers. We now have smaller, less expensive models available at the following dealers:

- University Stereo / Ridgewood, N.J.
- Transcendental Audio / Buffalo, N.Y.
- Hi-Fi Gallery / Indianapolis, Ind.
- Hi-Fi Gallery / Evansville, Ind.
- Audio Unlimited / Arlington Hts., Ill.
- The Stereo Shop / Cedar Rapids, Ia.
- The Gramophone Ltd. / Norman, Ok.
- Audio Uncommon / Portland, Or.
- Sound Center / Beverly Hills, Ca.
- Stereo Hi-Fi Center / Gardena, Ca.
- Garland Audio / San Jose, Ca.
- Roman's / Minneapolis, Minn.

Contact us if there is no dealer in your area.

MAGNEPLANAR
MAGNEPLANAR™ PRODUCTS
P.O. BOX 9542, WHITE BEAR LAKE, MINNESOTA 55110

Dealer inquiries welcome.

Check No. 24 on Reader Service Card

HELP!

Anytime you have a question about your Audio subscription, please include a mailing label to insure prompt service on your inquiry.

**CHANGE
OF ADDRESS**

If you're about to move, please let us know approximately four weeks before the move comes about. Or, if there is anything wrong with your current mailing label, please let us know on this form also. Simply affix your present label here, and carefully print the updated information below.

AFFIX
LABEL
HERE

PLEASE HELP US TO SERVE YOU BETTER

AUDIO MAGAZINE

134 N. 13th Street • Phila., Pa. 19107

Name _____
(Please Print)

Company _____

Address _____

City _____ State _____ Zip _____

Despite the early years when these tunes were actually first recorded on labels like Brunswick, the sound is remarkably free of static and bumps and Columbia wisely did not rechannel them to simulate stereo.

That Ivie Anderson was an artist extraordinaire, there is no mistaking. She will ever remain a timeless performer. At the 1972 Newport Jazz Festival Bobby Short paid a tribute to her by singing some of the songs associated with her. Short testifies about Ivie: "Like Gertrude Lawrence, she could sing the worst songs in the grandest way. Hers was a rare gift. She was a popular singer who listened to the lyrics, and stayed within the character of the song. She was my favorite singer—not only then, but for all time."

When you hear this, you may agree with Bobby.

Performance A Sound B

KLAUS DOLDINGER: Passport

Musicians; Klaus Doldinger, tenor saxophone, soprano saxophone, Moog synthesizer, electric piano; John Mealing, organ, electric piano; Bryan Spring, drums; Wolfgang Schmid, bass guitar, electric guitar.

Songs: *Mandragora; Nexus; Fairy Tale; Get Yourself a Second Passport; Lemuria's Dance; Madhouse Jam; Horizon Beyond; The Cat from Katmandu.*

Reprise MS 2143, \$4.98.

Klaus Doldinger's pre-eminence among European musicians is well borne out in this very excellent recording which is actually an amalgam of two of his former LP's. And his credentials earned at the conservatory at Dusseldorf where he formally studied clarinet, piano, and conducting vibrantly emerge in this collection. The group met with great success at their debut last year at the international festival held in Ljubljana, Yugoslavia.

Seven of the eight tunes included here are Doldinger's own compositions, the eighth, *Fairy Tale*, is traditional and adapted by Klaus. While the music itself falls into no one single category it spans several, namely jazz, folk, classical, straight unladen rhythm and blues, but *primarily* rock. Doldinger is looked upon as an expert on traditional jazz, composes and produces pop material as well as composing and playing music for TV, commercials, and films. Comments this talented jack-of-all-trades: "A musician must be able to play anything, and still know his limits."

AUDIO • MARCH 1974

It is clear upon listening to this 42 minute, 32 second long LP—certainly your money's worth—that Doldinger can play anything. We hear him here on a potpourri of instruments which include tenor and soprano saxophones, Moog synthesizer, and electric piano. The remainder of his group which together comprise a very together unit includes John Mealing, organ and electric piano, Bryan Spring, drums, and Wolfgang Schmid, bass guitar and electric guitar.

Mandragora is definitely the sound of today, a deliberate and authoritative number that features Doldinger on a low-born tenor saxophone with a strong assist by drummer Spring. It is of great interest dynamically. There is much going on in *Nexus* which has Klaus on soprano saxophone in a call and response pattern with Wolfgang Schmid on electric bass and wah-wah. The seemingly indefatigable group sets up a virtual madhouse of rhythm.

Fairy Tale is a pretty tune with a mystical, poetic quality about it in which Doldinger whisks us away on his magical musical carpet. He achieves a very lovely open tone on soprano saxophone, using the echo machine to great avail and thereby playing a duet with himself, allowing his sound to fade away into the distance, then return. Doldinger also plays some well-placed notes on electric piano.

The foursome sets up a turbulent rhythm in *Get Yourself a Second Passport* with Doldinger creating a French horn-like effect on saxophone. As if from a House of Horrors comes *Lemuria's Dance* with its shimmying, neighing, swarthy sound. Schmid puts down a period to it all with a bone-dry bass thud.

Doldinger and crew take us a step beyond in *Horizon Beyond* which is piloted by Spring's rushing drums and Schmid's dancing bass. John Mealing plays a punchy organ solo aided and abetted by wah-wah and Doldinger plays a jazz-prone soprano saxophone. In *The Cat from Katmandu*, a raunchy rhythm and blues, Doldinger effects a raspy tone on tenor.

Although the album doesn't state it anywhere, one assumes Doldinger is taking the lead on flute in *Madhouse Jam* against Mealing's crashing organ. Unfortunately, however, the flute does not penetrate as well as it should and I encountered some surface noise on the beginning of this side as well.

There is no singing in this recording. It is purely instrumental and a mesmerizing experience to listen to indeed.

Performance A Sound B

AUDIO • MARCH 1974

YOU'VE JUST FOUND.....

THE SPEAKERS
YOU THOUGHT
YOU'D NEVER
FIND



RSL SPEAKERS SOUND BETTER THAN THE COMPETING BRANDS. RSL IS THE FASTEST GROWING BRAND AMONG PROFESSIONALS IN THE U.S. THEY ARE CONSTRUCTED LAVISHLY AND LOOK AS WELL AS SOUND VERY EXPENSIVE. THEY WOULD BE VERY EXPENSIVE, EXCEPT THAT YOU CAN BUY THEM DIRECT FROM THE FACTORY SAVING YOU ABOUT ONE-HALF!

WE GUARANTEE YOUR OVERWHELMING SATISFACTION OR NOT ONLY DO YOU GET A FULL REFUND, BUT WE WILL PAY THE SHIPPING COSTS BACK TO US!

SAVE ENERGY...GET OUR SENSATIONAL
CATALOG WITHOUT HARDLY LIFTING A FINGER!
CALL US TOLL FREE! 800-423-3190

from anywhere in the U.S. (except Calif.) during business hours.



ROGERSOUND LABS

6319 VAN NUYS BLVD. VAN NUYS, CA. 91401 [213] 78-SOUND
Check No. 33 on Reader Service Card

SAE

The most respected
name in electronics
introduces state-of-
the-art loudspeakers.

MARK X Dynamic Transducer Three-way Speaker System, utilizing four drivers (1—12", 1—5", 2—2") with low and mid-frequency control. Oiled walnut

MARK XI Dynamic Transducer Three-way Speaker System, utilizing seven drivers (1—12", 2—5", 4—2"), with low, mid and high frequency control. Oiled walnut

MARK XII Solid State Electrostatic Transducer, three panel array of electrostatic elements, 1—12" low frequency driver, 1—5" driver, for lower mid-frequencies, electronic protection circuit, with low, mid and high frequency control. Oiled walnut

MARK XIV Solid State Electrostatic Transducer, six panel array of electrostatic elements, 1—12" low frequency driver, 2—5" mid-frequency drivers, with low, mid and high frequency control. Oiled walnut or rosewood.



MARK, XI

Scientific Audio Electronics, Inc.
Acoustics Division
P. O. Box 60271, Terminal Annex, Dept. A-34
Los Angeles, California 90060

Please send comprehensive data
on SAE state-of-the-art loudspeakers.

Name _____

Address _____

City _____ State _____ Zip _____

*Components
for the
Connoisseur*

Check No. 35 on Reader Service Card

Classified

Rates: 25¢ per word per insertion for noncommercial advertisements; 50¢ per word for commercial advertisements. Frequency discounts as follows: 3 times, less 10%; 6 times, less 15%; 12 times, less 20%. Closing date is the FIRST of the second month preceding the date of issue. Payment must accompany all orders under \$10.00. Use the handy self-addressed, postage paid card at the back of this issue. When replying to AUDIO box number ads, send letters c/o AUDIO, 134 No. 13th St., Phila., Pa. 19107. For more information about classified advertising, circle Reader Service Card #135.



FOR SALE

ATTENTION ALL SERIOUS CASSETTE ENTHUSIASTS—At last—No nonsense cassette labels. Send for free samples. Joe Bly Enterprises, 339 W. 88th St., N.Y. 10024.

FREE 64 PAGE CATALOG offers hundreds of recordings of rare Renaissance, Baroque and Classical music. Some records priced as low as \$1.00 each! All late recordings. In stereo only. Musical Heritage Society, Box 932-AU, New York, N.Y. 10023.

FIREWORKS NEWS—Monthly magazine covering Fireworks, Construction, Sources of Supplies, New Firms—Products. FREE Fireworks Catalogs with Subscriptions! \$9.00 per calendar year. Pyro Press, Box 12016, Lexington, Kentucky 40511.

ONE OF FLORIDA'S ONLY AUDIO RESEARCH DEALERS. Complete Audio Research on demonstration. SP-3/Dual 75/Dual 51/Magneplanars and Bass Panel (Tri-amped). Plus Phase Linear, Crown, McIntosh, Hartley, Decca, Stax, S.A.E. Braun, Tandberg, Advent, B&O, Rabco, J.B.L. Thorens, E.S.S. (Heil). Complete audio counselling. Sound & Sight, 20 N Federal Highway, Boca Raton, Fla. 33432 (305) 391-1843; 141 Lakeview Ave, West Palm Beach, Fla. 33401 (305) 655-2236.

AUDIO RESEARCH. Magneplanar, Crown, McIntosh, Thorens, Decca, Stax, Revox on display. Free List used equipment. Stereo Shop, 107 3rd Ave. SE, Cedar Rapids, Iowa 52401. 319-365-1324.

SENSIBLE SYSTEMS & PRICES: Hegeman, LTD, ARP Synth, AR-LST, JVC, Citation, Marantz, BGW, Thorens, B&O, Connoisseur, Equa, Akai, Dokorder, Tandberg, Revox-Beyer, Soundcraftsmen, Hartley, JansZen, Design Acoustics, Kirksaeter, Audio Technica, 54 other makes. Trades, 89 Day Speaker Approvals. By appointment only (404) 634-0856. Write for famous "Blue Sheet" ATLANTA AUDIO PROJECT Ltd. 2126 Faulkner Road, Atlanta, Ga. 30324.

FOR SALE

PROTECT YOUR LPs. Poly sleeves for jackets 6¢ round bottom inner sleeves 5¢ Poly lined paper sleeves 12¢ White jackets 27¢ Postage \$1.00. House of Records, Hillburn, New York 10931.

CYBERACOUSTIC AND EQUIPMENT TESTING laboratory. CROWN tape recorders, amps, AURLINEARS, warranty service station, IMF and Infinity monitors, AKG, Rabco, Decca, UREI, Fairchild and more. Barclay, 503 Haverford Avenue, Narbeth, PA 19072 (215) 667-3048 or 120 Villa Crest Drive, State College, PA 16801 (814) 466-6500.

CANADIANS: Brand name audio at warehouse prices. FREE price list. Baltimore Audio Inc., 2385 Eglinton Ave. E., Scarborough, Ontario, Canada M1K 2M5.

THE AUDIO RESEARCH ROOM. The complete range of Audio Research equipment on display under ideal listening conditions. By appointment C.M. Santmire, AUDIO SYSTEMS & DESIGN, 5421 South 84th St., Lincoln, Nebraska 68516 (402) 489-9888.

FLORIDA AUDIOPHILES! E.S.S. AMT 1 Phase Linear, Klipsch, Sony, Marantz, B & O, Quad, Revox, Barzilay, INTERIORS PLUS SOUND 3038 N. Federal Hwy, Ft. Lauderdale, Fla. 33306. (305) 566-3511.

NEUMANN MICS & ACCESSORIES. Gately Pro kits and mixers. Most models in stock. Immediate prepaid shipment. Mastercharge. Write or call Dick McGrew Recording Service. 7027 Twin Hills, Dallas, Texas 75231. 214-691-5107.

WE SPECIALIZE in components matched for INFINITY 2000AXT, MONITORS, and SERVOSTATIK II's. Our combinations insure the most REALISTIC, LIFE-LIKE sound possible. Strictly for the AUDIO PERFECTIONIST. THE DKL LABORATORY, BOX 683, SEVERNA PARK, MD. 21146, or CALL (301) 647-8918, evenings 6-9 PM.

FOR SALE

TRANSCENDENTAL AUDIO, LTD. BUFFALO, N.Y. 716-897-3984.

JAPAN HONG KONG DIRECTORY. World Products information. \$1.00 today World Trade Inquiries. Hillyard, Washington 99207.

MAGNEPLANAR, CELECTION, EPI, OHM, RTR. Audionics (transmission line), ERA and Connoisseur perfection turntables. BGW, Sony, B&O Crown, Transcriptor, Stax, Decca, Intregal Systems, many others. Hear our Magneplanar & Audionics super speaker system for \$1,100. High definition Audio Specialists. The Gramophone, Ltd., 757 Asp St., Norman, Okla. 73069, 405-364-9477.

PROFESSIONAL AUDIO EQUIPMENT: Microphones, recorders, equalizers, limiters, turntables, lathes, cutterheads, disc mastering systems, portable mixers, consoles, alignment tapes. Package deals and installations. Request Flyer. Wiegand Audio, Middleburg, Pa. 17842 717-837-1444.

CIZEK LOUDSPEAKERS Lowest price in the country. Quotes on your favorite system. Sound Center, Box 1242, Bloomington, Indiana 47401. 812-332-4252.

SPEAKER SPECIALIST TOBY Corporation of America: 4620 Camp Bowie, Fort Worth, Texas 76107.

DIAMOND NEEDLES and Stereo Cartridges at Discount prices for Shure, Pickering, Stanton, Empire, Grado and ADC. Send for free catalog. All merchandise brand new and factory sealed. LYLE CARTRIDGES, Dept. A, P.O. Box 69 Kensington Station Brooklyn, New York 11218.

AUDIO RESEARCH, BRAUN, CERWIN-VEGA, DECCA, ESS, HEGEMAN, IMF, MAGNUM OPUS, PHASE LINEAR, QUAD, QUINTESSENCE, RABCO, RADFORD, SAE, STAX. Paul Heath Audio, 354 State Street, Rochester N.Y. 14608, (716) 232-2828.

FOR SALE

ELECTROENCEPHALOPHONE: brainwave monitor. Professional biofeedback instruments J&J Rt. 8, Box 8102, Bainbridge Island, Wash. 98110.

CONNECTICUT AREA Audio Research speaker and amps. Dyna-mod kit and Transcripator turntables. The Stereo Lab. 168 State St., New London, Conn. (203) 447-9802.

SCOTCH MAGNETIC TAPE, discount Box 167A, Orwigsburg, Pa.

10 1/2" RECORDER SPECIALISTS: Used boxed 10 1/2" metal and fiberglass recording reels NAB center Metal \$2.00 each fiberglass \$1.25 each. New 1 mil quality tape on above metal reel 5 for \$24.00 on fiberglass 5 for \$19.00. Replacement content labels for 10 1/2" tape box samples \$.25 Sound Investment Co., POB 88338 Dunwoody, Ga. 30338.

FLAT FREQUENCY RESPONSE TO 18 Hz. Sound Systems presents its new Earthshaker One woofer system. The system includes an electronic crossover variable from 20 to 300 Hz and 100 watt rms amplifier.

SOUND SYSTEMS

Palo Alto, Calif. (415) 328-3761.
Mill Valley, Calif. (415) 383-6556.

SCOTCH 150 STUDIO TAPE—1800' on 7" reel degaussed and boxed. 12 for \$12 POSTPAID Free price list. WIDE RESPONSE, 6114A SANTA MONICA BLVD., HOLLYWOOD, CALIF. 90038.

ARE YOUR TAPES BEING SPOILED by recording or playback on equipment that may be magnetized? The magnetic signal "printed" on tape is quite sensitive to subsequent magnetic field exposure. You can now actually measure such damaging residuals and really demagnetize offending components using an Annis Audiophile Han-D-Kit. Write for Bulletin & copy of article "Notes On Demagnetizing" R. B. Annis Co. 1103 N. Delaware, Indianapolis, Ind. 46202.

WORLD'S FINEST LOUDSPEAKERS on DEMONSTRATION—AUDIO RESEARCH CORPORATION'S NEW T-1A, T-II, T-III; IMF MONITOR III, STUDIO III, ALS 40, ESS AMT-1, RTR 280DR, ESR-6, CERWIN VEGA 320 MT—320C, HEGEMAN, QUAD, BROCHURES AVAILABLE. PAUL HEATH AUDIO, 354 STATE, ROCHESTER, N.Y. 14608 (716) 232-2828.

MAKE A SOUND CHOICE. Our switching equipment allows instant comparing of all our products. Audio Research, Magneplanar, B&O, Braun, Crown, DBX, Decca, Infinity, Phase Linear, Rabco, SAE, Soundcraftsmen and many more.

SOUND SYSTEMS

Palo Alto, Calif. (415) 328-3761.
Mill Valley, Calif. (415) 383-6556.

DECCA MK V EXPORT—HAND SELECTED. Custom lateral damping for SME tone arms (for maximum performance).

SOUND SYSTEMS

Palo Alto, Calif. (415) 328-3761
Mill Valley, Calif. (415) 383-6556

LOWEST DISCOUNT PRICES ANYWHERE on audio equipment. All major brands discounted. Write for quotes: K&L Sound Services, 75 N. Beacon St., Watertown, Mass. 02172.

SCOTCH RECORDING TAPE, lowest prices. TAPE CENTER Box 4305B, Washington, D.C. 20012.

HAN-D-MAGS, Audiophile Han-D-Kits and Magnetometers—Free Data, R. B. Annis Company, 1103 N. Delaware, Indianapolis, Indiana 46202.

SONY TA-3120A, \$120 R.C. Nuebling, 519 Sixth, Ann Arbor, Mich. 48103.

FOR SALE

BUY DIRECT FROM ENGLAND'S HI FI MAIL ORDER SPECIALISTS! SAVE ON SME, LEAK, DECCA, TANDBERG, REVOX, GOLD SPEAKERS, ELECTROSTATIC SPEAKERS, B&O, CELESTION, TRANSCRIPTOR, CAMBRIDGE, AUDIO DESIGN, ORTOFON, LOWTHER, GOLDRING, KEF. INSURED SHIPPING QUOTES FREE OR SEND \$2.00 BILLS TO INCLUDE LITERATURE. GOODWIN LIMITED, 7 BROADWAY, WOOD GREEN, LONDON N. 22 VISITORS WELCOME TO SHOW ROOMS PHONE 888-0077.

THE LARGEST OLDIES CATALOGUE. Over 6000 records for sale 50¢ to \$150.00 covering years 1948-1972. Cost of 60 page catalogue is \$3.00 refundable with the first order. Send to Collectors Records, Box 44017 Dallas, Texas 75234.

OPERA TAPES. Historical performances of past 40 years. Unbelievable treasures and rarities. ALSO LP RECORDS Free catalog. Ed Rosen, Box 97, Freeport, N.Y. 11520.

CANADIANS—DEEP DISCOUNT PRICES. Name Brand Hi-Fi components. All "Canadian Warranty" protection. No Duty. Send quotation requests to Cartronics, Box 783, Hazeldean, Ontario.

MAGNEPLANAR® LOUDSPEAKERS are extremely realistic sounding. Our top quality models are sold thru AUDIO RESEARCH dealers, some of which advertise on these pages. We now have two less expensive models for sale. They are the MG1672-P Room Divider and the MG2167-F Floor Standing model. You may buy direct from the manufacturer until there is a dealer in your area. Write us for details. Magneplanar Inc., P.O. Box 8642, Write Bear Lake, Minn. 55110.

UNBELIEVABLE SAVINGS on 8 track cartridges. Latest list 25¢. Bob Musial, Box 11907-A Chicago, 60611.

ONE STOP for all your professional audio requirements. Bottom line oriented. F. T. C. Brewer Company, P.O. Box 8057, Pensacola, Florida 32505.

PORTLAND'S OWN HAWTHORNE STEREO now offers the finest in nationally known and esoteric audio components. We stock Advent, Braun, EPI, ESS, Harman-Kardon, Infinity, Klipsch, McIntosh, Quatre, Rabco, Revox, SAE, Stax, and Phase Linear among others. Home trials available as well as complete back-up service. Mail and phone inquiries welcomed. HAWTHORNE STEREO, 3580 S.E. Hawthorne Blvd., Portland, Oregon 97214.

ELECTRONIC CROSSOVERS—ALL TYPES. Definitive booklet describes applications: how to improve all types speaker systems—\$5.00 credited to first purchase. Huntington Electronics, Box 2009, Huntington, Conn. 06484.

THE MONEY SAVER! Write STEREO SPECTRUM, Box 1813, Miami Beach, FL 33139.

NORTHERN N.J.'S FINEST AUDIO STORE, 20 minutes from N.Y.C. Bozak, B&O, Hartley, Infinity, Magneplanar, Marantz, Phase Linear, Quintessence, SAE, Thorens. Write or Call UNIVERSITY STORE, 57 E. RIDGEWOOD AVE., RIDGEWOOD, N.J. 201-447-5700.

AT LAST—an ULTRA-HIGH DEFINITION Record Playing System for the PERFECTIONIST. Discover far greater **DETAIL, RESOLUTION, and DEFINITION** in your system. Available only from **THE DKL LABORATORY, BOX 683, SEVERNA PARK, MARYLAND 21146**, or CALL (301) 647-8918 EVENINGS 6-9 PM.

CANADIANS: FREE BARGAIN HiFi and Electronics Catalogs. Etco (Au), Box 741, Montreal H3C 2V2.

SCOTCH MAGNETIC TAPE (USED)

#150, 1800 ft., 7 inch reel, 1 mil polyester recorded once, bulk erased (no box), 99¢, plus 10% shipping & handling (min. order \$10.00); slightly used 10 1/2 inch fiberglass reels, 7/8" hole, 50¢, metal, NAB, \$1.00 each (plus shipping by weight and zone)

SAXITONE TAPE SALES

1776 Columbia Rd., N.W., Washington, D.C. 20009



FOR SALE

NAB HUB ADAPTERS—Fit Revox, Crown, TEAC, Robert. \$3/pair postpaid. No C.O.D. Quantity prices available. John Kountz, 1065 Van Dyke Dr., Laguna Beach, Calif. 92651.

SCOTCH CASSETTES, CARTRIDGES, REELS. Discount prices. Lawson's, Box 510 Livermore, Ca. 94550.

ORTOFON OWNERS—IMPROVE SOUND with our Micro-Preamp, which replaces Ortofon transformer. Send for free literature. Huntington Electronics, Box 2009, Huntington, Conn. 06484.

CUSTOM LOADED MAXELL UDC-90 CASSETTES AS LOW AS \$1.00 PRIVATE LABELING AND OTHER CUSTOM LENGTHS AND TAPES AVAILABLE FOR ALL NEEDS. MJS 1126 Cobb St., San Mateo, Calif. 94401.

ROGERS B.B.C. MONITOR, IMF, B&W Ltd., Celestion, Radford, Decca, ERA, Connoisseur, Audionics TL-90, Goldring, Revox, Beyer, Lamb and more. Custom design and modifications. SUFFOLK AUDIO, INC., 120 Boylston St., Suite 220, Boston, Mass. 02116 (617) 423-2051.

MCINTOSH, AUDIO RESEARCH, CROWN, ESS, QUINTESSENCE, HEGEMAN, BOSE, ADVENT, EPI, STAX, REVOX, RABCO, CITATION, PIONEER, TEAC, FISHER STUDIO-STANDARD and many more. Finest Service on premises. Stereo Designs, Mercury Mall, Hampton, Va. 23666 (804) 838-6394.

AUDIO RESEARCH, TRANSCRIPTORS, INFINITY, SAE, Ortofon, KLH, Thorens, B & O, Phase Linear, Stax. Florida's only state-of-the-art audio shop. Stereo Stuff, 650 W Tennessee Street Tallahassee, Florida 32304 (904) 222-0812.

DON'T PAY THE HIGH MAIL ORDER PRICES THIEVES WAREHOUSE OF TAMPA, 1531 SOUTH DALE MABRY, TAMPA FLORIDA 33609

INDUCTORS, MYLAR CAPACITORS, networks & raw speakers plus, new 4 channel (commode/satellite) speaker system component kits. Custom networks (manufacturers inquiries invited). New catalog. Mike Lewis, 3673 W. 113th St., Inglewood, Ca. 90303.

ANTIQUES—700 CYLINDER RECORDS, \$3500 the lot. Birnbom, 3655 Ridgewood, Montreal.

BUILD YOUR OWN highest quality microphone mixers, consoles, phono preamps, crossovers, equalizers, or voltage controlled devices, using modules. Free catalog. Burwen Laboratories, 209 Middlesex Turnpike, Burlington, Mass. 01803 Tel. 617-273-1488.

COMPARE AND SAVE \$50, \$100 AND MORE. Send \$1.50 for complete list of major component discount houses in U.S. to—Component Discounts, P.O. Box 937, Sunnyvale, Calif. 94086.

GRAPHIC EQUALIZER PLANS: Novel circuit very effective/inexpensive, requires no inductors. Ten knobs (octave bands) compensate your Hi-Fi/Tape providing better listening. Complete plans rushed only \$3.00 GREEN BANK SCIENTIFIC, Box 100C, Green Bank, WVa. 24944.

BOSE 800 SPEAKERS and amplifiers. Phase Linear amplifiers. Shure mikes, mixers. Specialists in Professional Sound and Service. COMM-TRONICS, 108 W. Poplar, Mankato, Minn. 56001 507-387-8291.

LISTEN TO TV THROUGH YOUR STEREO WITH TELEADAPTER!



Works with any television & stereo. No wiring, just takes a minute to plug in. Now enjoy all TV programming with a full new sound. Complete and ready to use with instructions. 10 day money back guarantee. SEND ONLY \$2.00 for C.O.D. or save C.O.D. charges and send \$16.95 in check, cash or mastercharge No. to:

RHOADES & CO.

P.O. Box 817 Hendersonville, Tn. 37075

-Dealer inquiry invited-

FOR SALE

IMF, B&W, DAHLQUIST, QUAD, BRAUN, B&O, McINTOSH, TANDBERG, CROWN, REVOX, ADVENT, STAX, ORTOFON, BEYER, PHASE LINEAR, and many others. Also wide selection of first-class used equipment. Expert advice. No sale final until you are satisfied. **AUDIO CONSULTANTS**, 517 Davis St., Evanston, Ill. 60201, (312) 864-9565.

AKG, ALTEC, AUDIO RESEARCH, Beyer, CROWN, DAHLQUIST, DECCA, INFINITY, KLH 9s, Koss, Ortofon, PHASE LINEAR, PML, REVOX, SAE, Sennheiser, Sony, Stanton, Tandberg, TASCAM, Thorens, etc. . . .

HI-FI HAVEN

28 Easton Ave.

New Brunswick, N.J.

201-249-5130

DAYTON-WRIGHT XG8-II Speakers, new, sacrifice, (919) 467-9198.

NEW! RECORD, DUB, EDIT, MIX, FADE, MONITOR. Eliminate "jangles" of tangled wires with Dubie Tape Aid control for 1 to 3 tape decks. Dubie Tape Aid Corp Dept A, 2305 N. Penn. Oklahoma City, Oklahoma 73107 (405) 524-8588.

QUADRAPHONIC ADAPTOR—\$12.95 postpaid. Converts any stereo into 4 channel, concert hall sound. Free information. **ELECTRO-RESEARCH**, P.O. Box 20285, Ferndale, Michigan 48220.

CANADIANS—DYNACO COMPONENTS AT TREMENDOUS DISCOUNTS. Write En-Jay Sales, Hornepayne, Ontario.

STUDIO EQUIPMENT: Ampex 440B Mono \$51.73, Stereo \$68.98, 4 track \$103.48, 8 track \$195.50; MM-1100 16 track \$379.50. Scully 280B Mono \$55.09, Stereo \$71.18, 4 track \$107.99. Tascam Console \$43.47, Stereo 2 track Recorder \$34.96, 4 track \$44.85. JBL 4310 \$5.93, 4320 \$13.25. Phase Linear 400 \$11.47, 700 \$18.38. Gately 16 track Console \$499.00. Dolby 361 \$14.95, M-16 \$184.00—Above prices per month on 60 month purchase plan. Also available on purchase plan Electro-Voice, Atlas, Schoeps, Prokit, Pentagon Duplicators, Metrotech Recorders and Loggers. In South call Bill Brock at 615-794-7537. Other areas call Bill Hamilton or Ed Gately at 215-449-6400. **GATELY ELECTRONICS, INC.**, 57 W. Hillcrest Avenue, Havertown, Pa. 19083.

ATTENTION RABCO SL8-E OWNERS!!! You can GREATLY IMPROVE the DEFINITION of your system for ONLY \$90.00 **HOW???** Contact the **DKL LABORATORY** (301) 647-8918 weeknights 6-9 PM.

SPACE AGE STEREO. SPECTACULAR!! Details .25¢ **ARABELL, PITOGO QUEZON, PHILIPPINES.**

FOR SALE

VACUUM TUBE EQUIPMENT has been recognized by many of us as capable of producing the finest and most pleasing reproduction of recorded music. **NEW YORK ELECTRIC GRAMOPHONE WORKS** is pleased to announce a new program for the supply and maintenance of classic vacuum tube equipment. We have undertaken to rebuild Marantz and other makes of classic tubed sets to equal or better original specification. How? Write or call for details, or an appointment to visit. We can supply equipment or refurbish your own. We are at 47 Jane Street, #10, New York City. (212) CH3-6822.

MAGNEPLANAR SPEAKERS \$850; Soundcraftsman 20-12 \$225; Crown DC-300. Uher 4000L with accessories, Nordmende radio. **HYDE**, 301 Springdale Ave., Wintersville, Ohio 43952. 614-264-4987.

MELLOTRONS—ARP SYNTHESIZERS. Best prices anywhere! Dan Keen, Dept. A, 219 19th Street, Avalon, N.J. 08202.

MARK LEVINSON AUDIO SYSTEMS—LNP-2 preamplifier, JC-1 cartridge preamplifier for moving-coil cartridges, LNC-1 crossover system, portable mixers, professional recording and playback equipment, 1-in. 4-chan. 15 & 30 ips master recording, custom design and fabrication. Pure Acoustic Master Tape Reference Recording. Vol. 1, organ and choir, extremely flat, low distortion recording with no equalization, compression, transformers, noise reduction or intermasters; excellent for evaluating phono systems, \$10.50 postpaid. Please send for information on our series of records. **Mark Levinson Audio Systems**, 21 Carriage Drive, Woodbridge, Conn. 06525 (213) 393-2600.

JECKLIN-FLOAT ELECTROSTATIC HEADPHONES offer extreme clarity, wide dynamic range, low distortion, great detail; excellent for professional monitoring and home use by the most demanding user. Dealer inquiries welcomed \$300 with power supply. **Mark Levinson Audio Systems**, 21 Carriage Drive, Woodbridge, Conn. 06525 (203) 393-2600.

SUPEX MOVING-COIL PHONO CARTRIDGE, use with the Mark Levinson JC-1 cartridge preamplifier for the ultimate in disc reproduction, \$125.00. **Sumiko, Inc.**, P.O. Box 5046, Berkeley, Calif. 94705

RECORDING TAPE: Dozen reels 2400', \$14.00; dozen 1200', \$11.00; 24 reels 900', \$8.00; 24 600', \$6.00. Postpaid, Guaranteed. **Mitchell**, Box 132, Flushing, N.Y. 11367.

NAGRA III, MINT CONDITION. Write: Joseph Peterson, 506 Brookland Park Drive, Iowa City, Iowa 52240.

THE SS-3 PORTABLE MIXING CONSOLE provides unmatched performance in remote recording applications. Available in 2, 4, 8, 16, and 24 track configurations. Write for specs. Reply Box No. A42-1.

CENTRAL NEW YORK HI-FI ENTHUSIASTS—IMF Studio-ALS40, Infinity, EPI, Marantz, Audio-Technica, Philips, Stax, Pioneer TX9100, Discwasher . . . ORTOFON M15E SUPER—79.95 postpaid, insured. NYS res. add 7% sales tax. **THE SOUND SHOP**, 96 Seneca St., Geneva NY 14456 (315) 781-0215.

FULTON SENSATIONAL \$89.95 monitor speaker \$179.90 pair. Futterman custom-engineered monophonic direct-coupled tubed amplifiers, your specs reasonable as \$595.00. **IMF Loudspeakers, Grommes-Starck components.** Lee Music Chambers. Pair good AR-3's \$225. Trades taken. **Audiocraft**, South Rockwood, Michigan 48179. Telephone: (313) 379-9945.

FOR SALE

FOR SALE: A BRAND NEW PHASE LINEAR 700B Power Amplifier, \$500.00. A pair of electrostatic panels and a woofer console, the **Infinity Servo Statik I**, \$1500.00. A pair of Quad full-range panels \$900.00. One pair of Electro-Voice EV-Interface: A \$300 with equalizer. Brand new **Sony TC-850-4** for only \$800.00. For information call (612) 920-4272 for **Audio King**, 7010 France Ave. S., Minneapolis, Minnesota 55435.

LINN SONDEK, the turntable for the perfectionist. Available from highly qualified audio specialists. Write for specifications and dealer list. Exclusive distributor: **AUDIOPHILE SYSTEMS**, 5242 N. Keystone, Indianapolis, Indiana 46220.

AUDIO & DESIGN ARM (IMPROVED), mercury contacts, magnetic antiskate, damped cueing, unmeasurable friction, low mass. **LINN SONDEK TURNTABLE**, precision machined oil bath bearing, ultra low rumble. **AUDIONICS TRANSMISSION LINES**, custom woofers, crossovers. More **AUDIOPHILE SYSTEMS**, 5242 N. Keystone, Indianapolis, Indiana 46220.

HI-FI YEARBOOK 1974 Complete guide to British stereo. 460 pages, hard cover. Specifications on 2000 products, 800 photos. Directories of British magazines, books, dealers, manufacturers. \$8.95 plus 50¢ postage. **AUDIOPHILE SYSTEMS**, 5242 N. Keystone, Indianapolis, Indiana 46220.

AUDIO RESEARCH, AUDIONICS TRANSMISSION LINE SPEAKERS, BANG & OLUFSEN, BOZAK, BRAUN, CROWN, KLIPSCH, LINN SONDEK, PHASE LINEAR, QUINTESSENCE, RADFORD, REVOX, SAE and other fine instruments for the reproduction of music. Custom design and construction, component analysis, consultations, demonstration by appointment. Send for list of top grade used equipment. **AUDIO SYSTEMS AND DESIGN**, 5421 South 84th St. Lincoln, Nebraska 68516 (402) 489-9888.

BLANK CASSETTES: C-20's thru C-100's. Buy direct from manufacturer and save! Example: C-20's 40¢. **TARZAC**, 638 Muskogee Avenue, Norfolk, Virginia 23509.

CITATION 11 pre-amplifier. Perfect condition. \$210. 430 Tulane Ave., D-81, New Orleans, La. 70112.

THOUSANDS OF LIKE NEW LP's and pre-recorded tapes. Catalogue \$1.00. **House of Records**, Hillburn, New York 10931.

AUDIO RESEARCH, RADFORD, PHASE LINEAR, CROWN, QUAD, ALTEC, INFINITY, DECCA, GRACE, AKG, REVOX, BRAUN, PANASONIC SP-10, ESS, TANDBERG and many more. **Hartley Electronics** (Audio Consultants) 1502 Butternut, Richland, Wa. 99352 (509) 947-5026 after 5 p.m. weekdays, all day weekends.

OREGON'S ONLY AUDIOPHILE STORE has some uncommonly good things: **Radford, Crown, BGW, Integral systems, Quintessence, Magneplaner, Dayton-Wright, Ohm, Janszen, Decca, Stax, Thorens, Braun, ADC, Connoisseur, Linn-Sondek, ERA, Supex, SME, Grace,** passive and speaker crossover kits, and basic drivers. **Audio-Uncommon**, 8600 N.E. Sandy Blvd., Portland, Oregon 97220 503-254-6202.

MARANTZ MODEL 15 BASIC AMP, pre-superscope, with case. Best offer over \$250. **McIntosh C-26** preamp, with case. Best offer over \$225. Stereo salesman's hand-picked personal system. **Fred Bieler**, Box 2126, Norman, Oklahoma 73069. (405) 329-7548.

FOR SALE

20 JBL PROFESSIONAL SERIES 6006B 60 watt amps. Used—Excellent condition. Contact: Celebrity Theatre, P.O. Box 5178, Phoenix, Ariz. 85010. (602) 267-7505.

SME 3009II HE arm \$50; Stanton 681EE cartridge \$25. (301) 838-7398.

HAND-TUNED DECCA MK V'S—each cartridge INDIVIDUALLY ADJUSTED for MAXIMUM SOUND PERFORMANCE. Only \$109.50, shipped from stock. THE DKL LABORATORY, BOX 683, SEVERNA PARK, MD. 21146.

CUSTOM BOARD 8 in—2 out full EQ and Echo under \$1000—negotiable. Ampex PR-10 Recorder 7½ and 15 ips half track stereo—\$650—as new. TEAC 33405—4 channel Recorder—new—\$850. 4 Koss Headphones—\$25 each. 2 RCA 77DX Mikes, 1 used—\$100, 1 new—\$150. Dual 1009 Turntable w/Shure Cartridge—\$115. Fisher Tube Amp—50 watt—\$100. Call or write for full details. All above mint or new condition. Box 102C, Chubbic Rd., R.D. 1, Canonsburg, Pa. 15317. (412) 746-2540.

AUDIO RESEARCH SP-3 PRE-AMP—Dual 75 Amp—E.C.—3 Electronic Crossover, Magnepanar 1 + speakers, Dayton Wright XG-8-MkII Electrostatic Speakers. All items like new (some are new)—reasonable prices (919) 467-9198 nites or weekends.

JVC VP-10 PREAMP, Mint \$450.00; Sony 5130 Tuner, mint \$230.00; SME 3009 Arm and ADC-XLM cartridge, mint \$95.00; Marantz Model 20B Tuner, Gem \$450.00; Marantz Model 30 Integrated Amp \$250.00. (617) 326-8921.

MAGNEPLANER TYMP. I—excellent condition \$650. (215) W15-7185, Levittown, Pa.

FOR ADULTS ONLY—Outstanding Comedy tapes on open reel—8 track cartridge—cassettes. Write for flyer and prices. House of Comedy, 1613½ N. Mariposa Ave., Los Angeles, Calif. 90027.

HI-FI ENTHUSIASTS WANTED!! Earn more than just spare money in your spare time. We need campus representatives to sell name brand stereo components at discount prices in your area. High commission, no investment required. Serious inquiries only, please. Contact: Mike Santillo K&L SOUND Services Co. 75 N. Beacon St. Watertown, Mass. 02172.

ACOUSTECH X SPEAKER SYSTEM, \$1100.00 complete, prepaid, Keene, 120 Gary Lane, Cocoa, Florida 32922.

NEW GARRARD Zero 100C, Walnut Base, Shure M44C; Package deal \$150. Components. Kentsmith, Box 1261, Kingsville Texas 78363.

ENGLAND'S LEADING MAIL ORDER AND DISCOUNT SPECIALIST OFFERS:—SME, B&W, Sansui, Cambridge Audio, Revox, Celestion, Armstrong, Decca London Mk V, KEF, Garrard Decks at very competitive price for Personal Export. Reply by Airmail, shipped immediately. Freight collect. Southern Audio Services Ltd., 43 High Street, Kingston-Upon Thames, Surrey, England. Telex no. 935437.

CROWN CX-824 P4C 4 CHANNEL deck with D40 amp and Advent 100 Dolby built in. Cost \$3060, sell for \$1995. (216) 292-2864. P. Kuruzovich, 24575 Donover Rd., Warrensville Hts., Ohio 44128.

2 RTR 400E SPEAKERS, bi-amped with Citation 12's, Infinity SPC, Rabco SL8E, Ampex 960, Thorens TD124, free Scott tuner. Best offer over \$2600.00. Will deliver in Northern California. (916) 756-9631; 752-2075 days. Will sell as system only with small exceptions.

FOR SALE

SCA ADAPTOR KIT \$15.00 For full info and diagram send \$1.00 to: Arnold McGall, 9 Clarkes Crossing, Fairport, N.Y. 14450.

MIXERS—Two Shure M-68F, four D-19E and one D-1000E microphones, three microphone stands, two baby booms, seven microphone cables (250 feet total). Cost \$670.00, will sell as package only, \$325.00 firm price. J. C. Mathews 212/483-7575, evenings.

COMPLETE LOUDSPEAKER—POWER AMP SET-UP, FOR BIAMPLIFICATION, consisting of the following equipment: one pair Lowther Audiovector loudspeakers; one Single Channel Woofer, model AR1W; one pair Quad model II Power Amps; Pioneer Electronic Crossover; single 60 watt Solid State Bass Amp. Ready to go—all you need is a preamp. Call (212) 243-6822.

OUR INDIVIDUALLY CALIBRATED London Exports. Ortofon and Supex moving coils, B&O and Micro-Acoustics supes are incomparable in our customized damped S.M.E.'s. Music and Sound, Ltd., 11½ Old York Road, Willow Grove, Pa. 19090. (215) 659-9251.

+ Levinson Cartridge Preamp +

FREE ROOM EQUALIZATION with purchase of filters. This is **not** a misprint. Music and Sound, Ltd., 11½ Old York Road, Willow Grove, Pa. 19090. (215) 659-9251.

Inventors—Engineers

INFRA WOOFER®, world's largest, deepest, most powerful sub-woofer system can be had only at Music and Sound, Ltd. 50 db per octave crossover, bandpass 16 Hz. . . . \$1295. FULTON F.M.I. SUB-WOOFER, for the closest approximation to dipole definition—\$300! Also, the rave five-way Fulton/R.T.R. super speakers. Shipped prepaid/insured. Music and Sound, Ltd., 11½ Old York Road, Willow Grove, Pa. 19090. (215) 659-9251.

!THE INVENTORS, ENGINEERS, COLLEGE INSTRUCTORS, AND PROFESSIONAL MUSICIANS at Music & Sound Ltd. offer their clients a new standard of technical competence, certain proprietary testing procedures, a real anechoic chamber, a mind boggling research laboratory, and a host of the most advanced professional services, including hand-picked component alignment/customization, room acoustical design/treatment, calibrated environmental equalization ±1db at your ears, and the most flexible demonstration facilities anywhere!! 11½ Old York Road, Willow Grove, Pa. 19090. (215) 659-9251.

Total "A" Warranty Station Service

STEREO COMPONENTS, M91ED \$22. We'll match any price. Write: Quote, Box 8123, Rochester, N.Y. 14617.

SENSATIONAL NEW VACUUM RECORD CLEANER removes dust and pollution for better sound. Battery operated. Satisfaction guaranteed or money refunded, \$10.95 postpaid. Calif. residents add sales tax. Ruxton Electronics, PO Box 30312, Santa Barbara, Calif. 93105.

CROWN IC150, D150 AMP, has faceplate, \$550.00 pair. SME 3009HE \$85.00. Thorens TD-125B w/SL8E and V-15 II imp. \$380.00. All perfect, hardly ever used, unregistered. Rob Stuehler, 1421-b Broad St., San Luis Obispo, Calif. 93401.

REVOX A77—bought new in 1971—NEVER USED recent \$40, adjust and relay cleanup. Ready to play. Also New TEAC AN80 Dolby unit. Price—\$795. firm for \$1,000. performance. Write R. Unterbrink, 418 West Third St., Lexington, Kentucky 40508.

PAIA HAS... synthesizer KITS



MODELS
PRICED FROM
\$139

BUT DID YOU KNOW WE ALSO HAVE...

A DEMO RECORD FOR 75¢
AND A FREE CATALOG LISTING
DOZENS OF OTHER GOODIES

PAIA ELECTRONICS
BOX M14359, OKLAHOMA CITY, OK 73114

FOR SALE

OUR DISTINGUISHED PRODUCTS come from Audio Research, Sequerra, Dayton-Wright, Dahlquist, Infinity, Crown, London Decca, I.M.F., Quad, Rogers, Spondor, B.B.C. Monitors, Stax, E.S.S., B&O, J.B.L./Altec Professional, Schoeps, Beyer, Custom Rabco, Gately, Braun, Tascam, Ohm, F.M.I., R.T.R., Supex, Revox Pro, damped S.M.E., Ortofon, DBX, etc., etc. All shipped prepaid/insured. Music and Sound, Ltd., 11½ Old York Road, Willow Grove, Pa. 19090. (215) 659-9251.

Full "A" Warranty Service Station

PROPRIETARY CUSTOMIZED MODS reduce tone arm friction, damp spurious resonances, minimize torsional forces, improve tracking, and reduce record wear. For S.M.E. series I, II, and low mass—\$30.00. For Rabco SL-8E—\$100.00. From the laboratories of Music and Sound, Ltd., 11½ Old York Road, Willow Grove, Pa. 19090. (215) 659-9251. New products shipped prepaid/insured.

Special! Dynaco ST-70 Mods!

TUNED ROCK P.A.'s + MULTI-TRACK RECORDING STUDIOS. Customized touring sound systems, including narrow band (5 Hz) feedback suppression, detailed acoustical voicing/environmental equalization ±1db at your ears, room design/measurement/treatment. 100's of our customized professional products, including fiberglass horns, consoles, omni/comp/limiters, electronic crossovers, phasors, digital delays, 1-way noise reduction, transducers, frequency shifters from J.B.L. & Altec Pro., Tascam, DBX, U.R.E.I., Eventide, Gately, Schoeps, Beyer, Crown, Community Light & Sound, MacIntosh, Mom's Audio, etc., etc. All shipped prepaid/insured from Music and Sound, Ltd., 11½ Old York Road, Willow Grove, Pa. 19090. (215) 659-9251.

Inventors—Engineers

AR, KLH, ADVENT, DYNACO, RECTILINEAR, ADC OWNERS—Our electronic equalizer gives your speakers a full octave of new bass, plus three broadband tone controls. Three reviews, literature, from NORMAN LABORATORIES, 2280 Industrial Boulevard, Norman, Oklahoma 73069.

FAIRCHILD MODEL 641 STEREO DISK Cutting System \$2500. Oak Recording Service, P.O. Box 336, Worth, Illinois 60482. (312) 425-4443.

LOGIC NEWSLETTER

SAMPLE COPY \$ 1.00
LOGIC NEWSLETTER
POB 252AA
WALDWICK,N.J. 07463

SERVICES

EXCITING ANNOUNCEMENT

UNIQUE APPROACH TO AUDIO REPORTING AUDIO REVIEW QUARTERLY, a unique publication featuring revealing, in-depth discussions of controversial issues, **EQUIPMENT REVIEWS**, ratings, recommendations, audio highlights and more. **AUDIO REVIEW QUARTERLY** reports issues and ideas other magazines ignore by exposing factual "behind-the-scenes" information. Upcoming issues feature **PROFESSIONAL EQUIPMENT REVIEWS**, exciting exposes, **BUYERS DISCOUNT SERVICE** with so much more! Special Introductory Subscription Rate: \$7.50/year. Write **AUDIO REVIEW** for exciting details on many new services available to subscribers. Take advantage of this offer and mail your subscription TODAY! **AUDIO REVIEW**, Box 175, North Branford, Conn. 06471.

STEREO MASTERS, RECORDS AND ALBUMS.

Check our prices. Newest type high level cutting equipment featuring: Neumann VMS 70 Computer control lathe, Parametric Equalization, Dolby, DBX, and the new SX74 Cutting System by Neumann. Special package prices on album and single record production. Stereo LP masters \$30.00/side, 7" stereo masters \$10.00/side, 1000 45RPM stereo singles \$217.50 including mastering. Write or call for brochure. Dick McGrew Recording Service, 7027 Twin Hills, Dallas, Texas 75231, 214-691-5107.

PROFESSIONAL AUDIO INSTALLATIONS

We service and sell over 50 lines of professional audio equipment including TASCAM, Scully, Revox, and TEAC. We will install anywhere in the U.S. Call or write for a proposal for your custom studio. Sound Genesis Inc., 445 Bryant St., San Francisco, Calif. 94107, 415-391-8776.

PROFESSIONAL SERVICES FOR PROFESSIONALS.

PHILA. AREA MUSICIANS' SERVICE. Location recording, record pressing, custom P.A.'s, and guitar amps. Mini studios sound reinforcement. Write for catalog or call 215-885-2403. Synthe Sound, 329 Harrison Ave., Elkins Park, Pa. 19117.

DON'T PAY the high mail order prices. Thieves Warehouse is coming up to your area. Franchises available. Thieves Warehouse, P.O. Box 8057, Pensacola, Florida 32505.

HIGH FIDELITY SPEAKERS REPAIRED

AMPHRITE SPEAKERS SERVICE
655 Sixth Avenue, New York 10, N.Y.
212-CH3-4812

THE NEW YORK AUDIO SOCIETY is a hi-fi club with a comprehensive activities program and numerous member benefits. Come and be our guest at one of our meetings and see what we have to offer. For details write N.Y. Audio Soc., Dept. A; Box 5889, Grand Central Sta., N.Y., N.Y. 10017 or call M-Fri. 10AM-6PM (212) 242-3900.

RECORDS MADE FROM YOUR TAPES. Also, editing and mastering. Send for free brochure. Nashville Record Productions, Inc., Dept. AM 204 19th Ave., So., Nashville, Tennessee 37203.

CUSTOM RECORDING SERVICE Tape and disc. Stereo and mono. Live and copies. Editing. Masters and pressings. High quality at reasonable rates. Joseph Giovanelli, Audio Tech Laboratories, 2819 Newkirk Ave., Brooklyn, N.Y. IN9-7134.

SERVICES

TAPE RECORDER HEADS brought back to spec. Wear removed. Brilliant finish. \$10.00 each. One day service. E Maher, 5 Evans Place, Orinda, Calif. 94563.

THE ABSOLUTE SOUND is a quarterly magazine devoted to the reproduction of music. Its upcoming issue (No. 4) reviews: the Dahlquist loudspeaker; the Marantz 500; the Supex cartridge; the Ohm F; Dynaco's 400. Also evaluated: CD4 disc, EMI imports, and Philips' resuscitation of the Mercury Living Presence series. Cost: \$8 annually (4 issues) The Absolute Sound, Box 115J, Sea Cliff, N.J. 11579.

RECORDS OR CASSETTES FROM YOUR TAPES. Complete record production, custom jackets, high speed tape and cassette duplication. Great quality & prices. Write AVCon Records, 5408 Silver Hill Rd., Washington, D.C., 20028.

QUAD AND STEREO LOCATION RECORDING in Houston area. Tascam 10 console, Crown, TEAC equipment. Jim Garman, Soun-Tex Recording, 9600 Braes Bayou #70, Houston, Texas 77036.

SHORT RUN RECORD PRODUCTION (100 & UP) FROM YOUR TAPES. We do it all—from the master—to the pressing—to the album jacket. LP's or 45's. Trutone Records, Dept. A, 6411 Bergenwood Ave., North Bergen, New Jersey 07047, 201-868-9332.

MASTERS AND ACETATE DEMOS (STEREO OR MONO) PRECISION CUT using the Scully-Westrex 3D cutting system. Request brochure—you'll be surprised at our prices. Studio discount available. Trutone Records, Dept. A, 6411 Bergenwood Ave., North Bergen, New Jersey 07047, 201-868-9332.

GOVERNMENT SURPLUS

JEEPS, TRUCKS, Cars From \$31.50 Airplanes, Typewriters, Clothing, Multimeters, Transceivers, Oscilloscopes, Photographic-Electronics Equipment . . . 100,000 Surplus Bid Bargains Direct From Government Nationwide Typically Low as 2¢ on Dollar! Complete Sales Directory and Surplus Catalog \$1.00 (Deductible First \$10 Order From Included Catalog) U.S. Surplus Disposal, 2200 Fuller 601-B-AUD Ann Arbor, Michigan 48105.

AUTO ACCESSORIES

FANTASTIC New Spark Plug Installation Tool. Save Those Burnt-Fingers. Only \$2.00 Postpaid. J&J Mfg., Box 5265, Lincoln, Nebraska 68505.

BUSINESS OPPORTUNITIES

\$10 DAILY WRITING SHORT ARTICLES at home. Begin immediately! Copyrighted report reveals how and where. Send \$1.00. Specialty Merchandise Co., 7659 So. 42nd St., Omaha, Neb. 68147.

8-TRACK TAPES 52¢. Directory Manufacturers. Send \$3.00 Star Enterprises, 35-AM2 Woodcrest, Dayton, Ohio 45405.

\$25.00 HUNDRED stuffing envelopes. Immediate earnings. Beginner's Kit, \$1.00 (refundable). Lewcard, A392 DU, Brea, California 92621.

MAILORDER MILLIONAIRE helps beginners make \$500 weekly. Free report reveals secret plan! Executive (1Q2), 333 N. Michigan, Chicago 60601.

EARN AT HOME ADDRESSING ENVELOPES \$800.00 monthly possible. Details 25¢ and stamped addressed envelope. Modern World, Dept. 142, 489 Bernard Street, East Meadow, N.Y. 11554.

BUSINESS OPPORTUNITIES

FREELANCE RECORDISTS. Earn extra income with your recording equipment. You record church & school choirs and bands; we manufacture stereo records with custom jackets. Territories are available. Modest investment. Send resume to: AVCon Records, 5408 Silver Hill Rd., Suite 501, Washington, D.C., 20028.

\$10,000 REWARD MONTHLY NEWSLETTER identifies best business, investments, finders fee opportunities. Guaranteed to add \$10,000 to your assets—or pay nothing. Robinson Enterprises, Box 38, Augusta, Ga. 30901.

EQUIPMENT WANTED

WANTED: JBL SE460 OR SE400S Energizer. Wm. J. Riese, 16163 E. Brunswick, Aurora, Colo. 80013.

WANTED—WHARFEDALE SUPER 12 SPEAKER. L. Stecklow, 70 East 8th St., Brooklyn, N.Y. (212) 871-4958.

CROWN D-150, AKG D200E microphones. HYDE, 301 Springdale Ave., Wintersville, Ohio 43952, 614-264-4987.

CASH FOR YOUR unwanted stereo LP's and reel to reel tapes. Record House, Hillburn, New York 10931.

WANTED: CROWN, R.O.M. Write Jim Hollinger, Galen Hall Rd., Rt. #3, Wernersville, Pa. 19565.

WANTED: INFINITY 2000A Speakers. 9500 Detroit Ave., Cleveland, Ohio 44102. (216) 631-9173

WANTED: SONY PUA-286 or Shure/SME 3012 tone arm. State price first letter. Betz, Box 33806 Station "D", Vancouver 9, B.C., Canada.

JBL PROFESSIONAL DRIVERS and Horns wanted—new or used—and related equipment. Collect 305-523-5647 nights. Apt. 1, 200 Southwest 19th St., Ft. Lauderdale, Fla. 33315.

I NEED USED RECORDERS IN MINT CONDITION. Must take 10½ reels, half track and quarter track, 7½ ips—15 ips and 3¾ ips—7½ ips. Something similar to Revox 6-36. Box 102C Chubbie Rd., R.D. 1, Canonsburg, Pa. 15317. (412) 746-2540.

WANTED—PIONEER #T-8800 Tape Deck w/ remote control. Dick Kuehnemund, Box Q, Whitney Pt., N.Y. 13862.

WANTED: PAIR JBL 100 LOUDSPEAKERS in pristine condition @ a reasonable price. C.R. Lee, 220 South 7th St., Lompoc, Calif. 92426. (805) 736-4163

WANT LIBRARY TRANSCRIPTIONS pre-1945, World, Associated Muzak, Standard, MacGregor, etc. Bob Nicholas, 4200 Blackthorne, Long Beach, Calif. 90808.

WANTED—HEATH W6-A (W6-M) MONO 70 watt rms tube type amplifier. Reasonable price. David Rodger, 13865 NE 20th Place, N. Miami, Fla. 33161.

QUAD: USED FM3 TUNER. Also Transcripator Reference Turntable. (716) 897-1368.

WANT JBL PARAGON OR OLYMPUS reasonably priced. Call or write 615-629-7337, Sam Soloff, 2833 Calhoun Ave., Chattanooga, Tennessee 37407.

PHOTOGRAPHY

DISCOUNT PRICES on all photographic equipment, send for price quote of exact items you want, instant reply. Hope Camera Stores 27179 Chagrin Blvd., Cleveland, Ohio 44122.

REAL ESTATE

IDEAL 5-ACRE RANCH. Lake Conchas, New Mexico. \$5,475 No Down. No Interest \$40/mo. Vacation Paradise. Good investment. Free Brochure. Ranchos, Box 2006XS Alameda, California 94501.

MUSIC

BRAZILIAN—Latest hits from Brazil. Not Sergio Mendes. Not available in the U.S. Write Braziliansound, Box 1280, Bellaire, Tx. 77401.

RARE ROMANTIC PIANO SCORES—Moscheles, Henselt, Herz, Litolff, Scharwenka, Scriabin, etc. Free catalog MUSIC TREASURE PUBLICATIONS, Box 127, Highbridge Station, Bronx, New York 10452.

MUSICAL INSTRUMENTS

NEW PLAYER PIANO ROLLS. 3000 selections. Free Catalog. David T. Dupree Piano Rolls, 2940D8 Grace Lane, Costa Mesa, California 92626

30% DISCOUNT. Name Brand Musical Instruments. Free Catalog. Freeport Music, 455R Route 110, Melville, N.Y. 11746.

INSTRUCTION & EDUCATION

LEARN TO READ MUSIC IN ONE EVENING! Free details. Write: Anthony Cappeloni, 130 Meloy Road, West Haven, Conn. 06516.

BRICKLAYING BIBLIOGRAPHY. Programmed instruction, Bricklaying. Latest Reliable Information. The Pretlo Services, P.O. Box 114, Durham, North Carolina 27707.

TAPE & TAPE RECORDERS

8 TRACK CARTRIDGES AT GREAT SAVINGS Latest catalog 25¢. Bob Musial, Box 11907-A, Chicago, 60611.

RENT CASSETTE or Open Reel Pre-recorded tape. All Labels. Catalog 75¢. Tape & Time, P.O. Box 740, Hopkins, Minn. 55343.

RADIO PROGRAMS

RADIO PROGRAMS. CATALOGUE OF THOUSANDS. \$1.00 (Refundable). THE RADIO VAULT, BOX 9032-TV, WYOMING, MICHIGAN, 49509.

NOSTALGIA RADIO PROGRAMS traded. Private collection. Drawer 3226, Newport, Delaware 19804.

THOUSANDS OF OLD RADIO COMEDIES. Dramas, Band Remotes, Mysteries, etc. \$6.00 for 6 Hour Reels Catalogue: \$1.00 (Refundable). Cassettes also available. RADIOVOX 1756 Washtenaw, Ypsilanti, Michigan 48197.

1930-1962 RADIO PROGRAMS, Reels, \$1.00 hour! Cassettes, \$2.00 hour! Catalog, \$1.00. AM TREASURES, Box 192M, Babylon, N.Y. 11702.

GOLDEN AGE RADIO—your best source for radio tapes. Box 25215-D, Portland, Oregon 97225.

WANTED—"GRAND CENTRAL STATION" radio dramas written by Roger Gallagher 1946-1950. Contact Gallagher, RFD2, Amherst, Mass. 01002.

OLD RADIO SHOWS ON CASSETTES. List 25¢. MJB Enterprises, Box 724, Spencer, Iowa 51301.

TAPE RECORDINGS

RENT 4-TRACK open reel tapes—all major labels. 3,000 different. Free brochure. Stereo-Parti. 55 St. James Drive, Santa Rosa, Cal. 95401.

KENNEDY/TIPPIT/OSWALD MURDERS! Actual episodes & police recordings! Reels/cassettes \$10. Majestic. 9651 Foxbury, Pico-Rivera, California

EVERYTHING ON OPEN REEL! Pre-recorded classical/popular tapes. Latest releases. Dolby Quad. 96-page catalogue \$1. Barclay-Crocker, Room 857A, 11 Broadway, NYC 10004.

OPERA TAPES, RECORDS, "live" performances. broadcast. Free catalog. Hathaway, 49A Merbrook, Merion, Pa. 19066.

8-TRACK TAPES \$1.75

By joining Star Tape Club. Buy as many as you want or none. No obligation. Big name hit tapes. Rock, Soul, Popular, Best of, Religious, Bluegrass, Classical, Country, Jazz, also Party. Join direct from this ad. Send \$4.00 to:

STAR ENTERPRISES

35-AM Woodcrest Ave., Dayton, O. 45405

RECORDS

CATALOGS Broadcasts, soundtracks, Personalities of Thirties, Forties, Box 225, New York, N.Y. 10028.

SHOW ALBUMS—Rare Out of Print Lp's. 52 page list—50¢. Broadway/Hollywood Recordings, Georgetown, Conn. 06829.

FILM-STAGE SOUNDTRACKS. Large free list A. Lutsky, Box 557342, Miami, Fla. 33155.

OLDIES—45 RPM Original hits. Catalog 50¢ C&S Record Sales, Box 197, Wampsville, N.Y. 13163.

FREE LP CATALOG—Deleted Soundtracks Shows, Nostalgia, A. Roseman, P.O. Box 16083, Phila., Pa. 19114.

FREE 200-PAGE CATALOG. 1,400 New Stereo Recordings. Renaissance, Baroque, Classical, Romantic, Modern Music. Not sold in stores. Not listed in Schwann's Highest quality! Budget label prices! Available only by mail MUSICAL HERITAGE SOCIETY, Box 932 AU, New York, N.Y. 10023.

HISTORIC JAZZ AND SWING RECORDINGS. Many broadcasts, rare cuts. Catalog for 10 cents from Tulip Records, P.O. Box 6277, San Francisco, Calif. 94101.

RECORDS—soundtracks, show, cut-outs. Send wants—we'll quote. Lesco, 2205 Marylane, Broomall, Pa. 19008.

SOUNDTRACKS, original casts and personality recordings—Many hard-to-find titles at reasonable prices. Send for large, new catalog free. Robert Hiott, Box 471, Miami, Florida 33144.

PSYCHIC MEDITATION-WITCHCRAFT MUSIC RECORDS. Free Brochure! (Dealers Welcome) Brotherhood, Box 1363, Spring Valley, California 92077.

SOUNDTRACK RECORD ALBUMS—Mail Auction. Free list—Whalon, 2321A Hill—Redondo Beach, Calif. 90278.

SOUNDTRACK MAIL AUCTION. Originals. Raintree, Anastasia, Streetcar, and 300 other real rarities. Send 3-10¢ stamps for auction list. Bill Anderson, RR1, Egan, Illinois 61026.

SEARCHING FOR OLD RECORDS? DISCONTINUED. 216 N. Rose, Burbank, California 91505.

SOUNDTRACKS—Large free catalog Star-53, Box 850, Arroyo Grande, Calif. 93420.

RECORDS

LP JAZZ COLLECTION OF LIFETIME BEING SOLD. Many rarities. Some Pops. No Rock. \$1.00 refundable. Box A43-1.

MIDWEST'S LARGEST SELECTION of rare mint soundtracks—Band of Angels, Destination Moon, etc. Free catalog. Old Record Warehouse, 5516 N. Kimball, Chicago, Ill. 60625.

INTERNATIONAL SHOW, MOVIE, RADIO SOUNDTRACK Club—non-profit. Write M.G.O., Box 8123, Rochester, N.Y. 14617.

RARE RECORDS. SEND WANTS. 47-15 Astoria Blvd., Astoria, N.Y. 11105.

RARE RECORDINGS—Soundtracks, Shows, Personalities. Reasonable Prices. Large New Catalog Free. Hiott, Box 440471, Miami, Fla. 33144.

INVENTIONS WANTED

PROSECUTE YOUR OWN Patent Application. All Material Necessary—Write Inventors Service, Box 3574, Washington, D.C. 20007.

PLANS & KITS

COMPONENT CABINETS

Direct from the factory at low factory prices. Finished-Unfinished-Kits. Free brochure.

AUDIO ORIGINALS

546 S. Meridian St.
Indianapolis, Ind. 46225

WAVEFORM Generator Kit \$10.00 Stereo Multiplex Kit \$19.95. Free Kit Catalog. Photolume Corp., Box 139, N.Y., N.Y. 10016.

BOOKS

G.A. BRIGGS titles. Catalog \$1.00 (refunded first order) CAEB, Box 1471, Tucson, AZ 85702.

HIGH FIDELITY

LOUDSPEAKERS—4 1/4" ORIGINAL EQUIPMENT, for nationally advertised reflecting/multi-speaker systems. Cloth suspension, 10 ounce ceramic 1" coil \$7.98 postpaid. Eight—\$56.00; eighteen—\$108.00; fifty-four—\$397.00. Auratone, Box 580-6, Del Mar, California 92014.

HOME MOVIES

CAGNEY! BOGART! DRESSLER! FAIRBANKS! FLYNN! TEMPLE! SWANSON! Many more! The usual, the unusual, 16-S8-8mm sound & silent. 200 ft. S8-8mm sampler \$2.00. Cat. free. Thunderbird, Bx 4081-AM, Los Angeles 90054.

MISCELLANEOUS

PORTABLE WATER PURIFIER—Purifies naturally with activated oxygen, the most effective water purifier agent known. Helps protect health by killing disease producing bacteria and removing toxic impurities. No chemicals to buy. Does not remove minerals essential for health and good taste. PRODUCT OF U.S.A. TECHNOLOGY. For more information contact PRINCE STERLING, 323 Garces Drive, San Francisco, California 94132.

RADIO CLUB

OLD RADIO BUFFS—Let's get together. Non-profit club forming. Contact Mike O., Box 8123, Rochester, N.Y. 14617.

SPEAKER ACCESSORIES

SPEAKER INSURANCE? Hi-Damp Speaker Protectors can help you protect your investment. Catalog with much more \$1.00 (refunded first order). CAEA, Box 1471, Tucson AZ 85702.

first came the word...



And then there was music.
And then came Sony tape recorders
to capture the words and music
with perfect fidelity. Right from the
start, Sony has always been first with
the best, the newest and the broadest

selection of tape recording equip-
ment in the world. Sony tape
recorders, Sony accessories, Sony
microphones, Sony recording tape.
We could go on and on and on.
We are. **SONY**. Ask anyone.

Brought to you by **SUPERSCOPE**

Check No. 63 on Reader Service Card



MODE

4 CH

RM

2 CH

SQ

MO

DISCRETE

the big TWO-FOUR switch

**makes the switch
to 4-CHANNEL
irresistible**



KR-6340

 The KENWOOD 'Two-Four' Receivers give you all the great new 4-channel sounds, *plus* the finest 2-channel reproduction! A unique 'strapping' circuit more than doubles the RMS output per channel when you turn that simple switch from 4- to 2-channel mode. For example, 17 watts x 4 (RMS Power at 8 ohms, 20-20k Hz) automatically becomes 40 watts x 2 for the KR-6340. Just one of the many features that make switching to 4-channel with KENWOOD completely irresistible:

Built-in SQ, RM, Discrete, plus Optional CD-4 Plug-In Adapter ■ Full 4-Channel Control Center ■ Direct Coupling for Minimal Distortion ■ Exclusive DSD in the MPX for Unexcelled Channel Separation ■ And much, much more!

For complete specifications write . . .

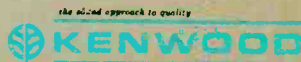

15777 So. Broadway, Gardena, Calif. 90248
72-02 Fifty-first Ave., Woodside, N.Y. 11377
In Canada: Magnasonic Canada, Ltd.



KR-6340

TWO-FOUR
STEREO RECEIVER

Check No. 23 on Reader Service Card

www.americanradiohistory.com