

**JAZZ**  
at Newport/1956

# Audio

THE AUTHORITATIVE MAGAZINE ABOUT HIGH FIDELITY • OCTOBER 1973 60¢ 

23602

**Cassette  
Tape Tests**

**High Fidelity  
From Cassette  
Systems**





**Check:** ■ **CRAFTSMANSHIP**  
■ **VERSATILITY** ■ **SPECIFICATIONS**  
■ **PERFORMANCE** ■ **POWER** ■ **FEATURES**  
■ **CRITICS' REVIEWS** ■ **DEALER RECOMMENDATIONS**  
■ **VALUE** ■ **MUSIC REPRODUCTION**  
■ **PIONEER OWNERS** ■ **RELIABILITY** ■ **WARRANTY**  
■ **REPUTATION** ■ **SERVICE** and you'll  
reach  
the inevitable  
conclusion...



Incredible as it may seem, six years ago only the most avid followers of authentic sound reproduction were familiar with the Pioneer name. Yet, Pioneer's reputation for quality craftsmanship has been 35 years in the making. And it's continually being enhanced with each new component introduced. Case in point. Pioneer's outstanding AM-FM stereo receivers. They're the superb result of everything we've learned about sound and quality sound reproduction.

**Reliability through exhaustive quality control.**

Pioneer builds each receiver as though it was one-of-a-kind. To begin with, we produce virtually every part that goes into our receivers on our own production lines. So we know we're putting in the best there is. Until it's a completed unit, each receiver is continuously checked and inspected every step along the way. (A receiver in production travels on the average of twice the length of a football field. You can imagine how many quality checks it undergoes.) Still, that's not where our quality control stops. Because each receiver is then subjected to another rigid round of inspection before it's shipped to your Pioneer dealer. As a result, the Pioneer receiver that ends up in your home is as trouble-free as a receiver can be. To top it off, Pioneer backs it up with a full two-year warranty on parts and labor.

**All the versatility you need — plus.**

Pioneer designers are people-oriented. You'll appreciate this when you see that each receiver has more than a full complement of connections

for every music source available: records, tape, FM, microphone, and 4-channel. You can do your own tape-to-tape duplicating and even make listening tests of different phono cartridges and speaker systems.

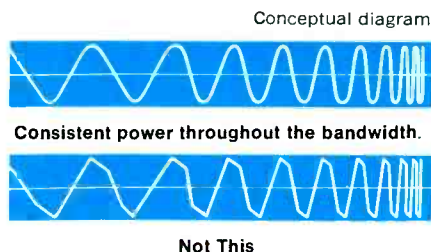

**Consistent power to spare.**

Merely comparing the power capabilities of different brands of receivers does not tell you what's behind the power. Not only do these Pioneer receivers provide more comparable watts for your high fidelity dollar, they also deliver consistent power throughout the most vital listening area — the 20 — 20,000 Hz bandwidth. This is important. It means you get better bass response plus greater across-the-board frequency response with absolute minimum distortion.

**Great specs + top sound = outstanding performance.**

To many hi-fi buffs top performance means great specifications and impeccable waveforms. However, most people listen first and check the specs later. Whatever your modus operandi, you'll be more than delighted with Pioneer's outstanding performance.

**Here's a mini spec list:**

SPECIFICATIONS	SX-828	SX-727	SX-626	SX-525
IHF Music Power 4 ohms	270 watts	195 watts	110 watts	72 watts
RMS @ 8 ohms. Both channels driven @ 1KHz	60+60 watts	40+40 watts	27+27 watts	17+17 watts
FM Sensitivity (IHF) (the lower the better)	1.7uV	1.8uV	2.0uV	2.2uV
Selectivity (The higher the better)	+75dB	+70dB	+70dB	+45dB
Capture Ratio (the lower the better)	1.5dB	2.0dB	2.5dB	3.0dB
Power Bandwidth	All exceed by a wide margin the usable sound frequency spectrum			
<b>INPUTS:</b>				
Tape monitor	2	2	2	2
Phono	2	2	2	Phono/Mic.
Auxiliary	1	1	1	1
Microphone	2	1	1	Phono./Mic. (as above)
<b>OUTPUTS:</b>				
Speakers	3	3	3	2
Headsets	2	1	1	1
Tape Rec.	2	2	2	2

**Easy-to-use features increase listening enjoyment.**

All four receivers share many basic features for simplified operation, such as loudness contour, FM muting, click-stop tone controls, mode lights, signal strength meters, and a super wide FM dial scale. With Pioneer's wide variety of models to choose from, you're bound to find just what you're looking for in the way of sophistication and refinements.

**Unanimous acclaim from the experts.**

**Stereo Review:** "Pioneer's moderately priced SX-727 has a degree of operating flexibility and electrical performance previously found only in some of the most expensive receivers . . . The array of operating features is impressive . . . In its flexibility and in many areas of its measured performance it is somewhat better than much of the competition at its price level."

**Audio:** "We find the SX-727 to be a rugged, reliable instrument that certainly represents state-of-the-art receiver technology in its design and performance."

**Hi-Fi Stereo Buyers' Guide:** "This (SX-828) excellent performer features full power output at all frequencies . . . excellent reception of weak FM signals . . . selectivity was excellent."

**High Fidelity:** " . . . Solid quality . . . Pioneer has avoided a make-do approach in the SX-626; we wish we could say the same for all under \$300 receivers."

**Stereo Review:** "...We were especially impressed by the solidity and precise 'feel' of the SX-626's controls. Clearly, nothing has been skimped in the mechanical design and construction of this receiver. It is a joy to use, a very good value in every respect."

**A Pioneer receiver costs less than you'd imagined.**

Normally you'd expect to pay a lot more for such quality, performance and features. But not at Pioneer. We believe sensible pricing goes hand in hand with craftsmanship. Let your capable Pioneer hi-fi dealer give you a complete comparison demonstration. It's the only way to find the best in high fidelity and the best high fidelity for you.

SX-828 — \$469.95; SX-727 — \$399.95  
SX-626 — \$329.95; SX-525 — \$259.95.  
Prices include walnut cabinet.

U.S. Pioneer Electronics Corp.  
178 Commerce Rd., Carlstadt,  
New Jersey 07072.



You're  
reading  
this page  
for the  
same  
reasons  
we build  
our  
speakers.

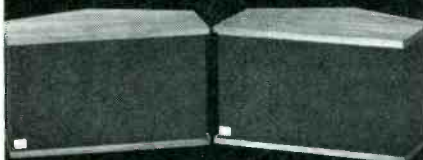

Better music, wherever you listen. Real fundamental, bass, including the attack of tympani and organ. An almost tactile feeling of presence. And transparent highs, providing unusual instrumental definition.

First and foremost, we built the LDL 749A to satisfy our own desire for musical enjoyment. Including the spatial sensations from the intimacy of small groups to the awesomeness of full orchestra.

With their precise combination of forward-radiated sound and panoramic reflection, LDL 749A are a compact, elegant way to put the concert hall in your listening room. And the price is as realistic as the sound!

**LD**  
Linear  
Design  
Labs, Inc.

20 Willett Avenue, Port Chester, N.Y. 10573

# Audio

OCTOBER 1973

Vol. 57, No. 10

## FEATURE ARTICLES

- |  |  |
|--|--|
| 20 High Fidelity From Cassette Systems | <i>M. B. Martin</i>                            |
| 33 Dolby B-Type Noise Reduction System | <i>Robert Berkovitz and<br/>Kenneth Gundry</i> |
| 40 Cassette Tape Survey                |  |

## EQUIPMENT PROFILES

- |                    |               |
|--------------------|---------------|
| 54 Onkyo Receiver  | <i>TX-555</i> |
| 56 BGW Amplifier   | <i>500R</i>   |
| 66 Hegeman Speaker | <i>H-1</i>    |

## RECORD REVIEWS

- |  |                               |
|--|-------------------------------|
| 69 Jazz & Blues: Newport Jazz Festival | <i>Martha Sanders Gilmore</i> |
| 78 Weingarten Looks at Paul Simon      | <i>Sherwood L. Weingarten</i> |
| 81 Classical Reviews                   | <i>Edward Tatnall Canby</i>   |
| 82 Joel Grey/Live                      | <i>Donald M. Spoto</i>        |

## AUDIO IN GENERAL

- 4 Coming in November
- 4 Audioclinic *Joseph Giovanelli*
- 8 Tape Guide *Herman Burstein*
- 14 Behind the Scenes *Bert Whyte*
- 18 Editor's Review
- 37 From the Lab *George W. Tillet*
- 60 Advertising Index
- 83 Classified Advertising



EDITOR <i>Eugene Pitts III</i>	PUBLISHER <i>Jay L. Butler</i>
ASSOCIATE EDITOR <i>Edward Tatnall Canby</i>	MARKETING DIRECTOR <i>Sanford L. Cahn</i>
ASSOCIATE EDITOR <i>Bert Whyte</i>	COVER DESIGN <i>John Kwasizur</i>
ASSISTANT EDITOR <i>Peggy Bicknell</i>	CIRCULATION MANAGER <i>Jean Davis</i>

CONTRIBUTING EDITORS: *Herman Burstein, Martin Clifford, Leonard Feldman, Richard Freed, Martha Sanders Gilmore, Joseph Giovanelli, C. G. McProud, Harry E. Maynard, Alexander Rosner, George W. Tillet, Sherwood L. Weingarten.*

**AUDIO** (title registered U.S. Pat. Off.) is published monthly by North American Publishing Co., Irvin J. Borowsky, President; Frank Nemever, Jay L. Butler and Roger Damio, Vice Presidents; R. Kenneth Baxter, Vice President/Production; Nate Rosenblatt, Promotion Director; Mary Claffey, Circulation Director.  
**RATES**—U.S. Possessions, Canada, Mexico, \$6.00 for one year; \$10.00 for two years; all other countries, \$9.00 per year. Printed in U.S.A. at Columbus, Ohio. All rights reserved. Entire contents copyrighted 1973 by North American Publishing Co. Second class postage paid at Philadelphia, Pa. and additional mailing office. Back issues, \$2.00 each.  
**REGIONAL SALES OFFICES:** Jay L. Butler, Publisher and Sanford L. Cahn, Marketing Director, 41 East 42nd St., New York, N.Y. 10017, telephone (212) 687-8924.  
 Jay Martin, 15010 Ventura Blvd., Sherman Oaks, Calif. 91403, telephone (213) 981-7852.  
**REPRESENTATIVES: Continental Europe:** John Ashcraft, 12 Bear St., Leicester Square, London W.C. 2, telephone 930-0525. For Benelux and Germany, W.J.M. Saunders, Mgr., Herengracht 365, Amsterdam, Holland, telephone 24.09.08.  
 Japan: Japan Printing News Co., Ltd., No. 13, 2 Chome Ginza Higashi, Chuo-ku, Tokyo, telephone 541-5795.

**AUDIO** Editorial and Publishing Offices, 134 N. 13th St., Philadelphia, Penna. 19107  
 Postmaster: Send Form 3579 to the above address



# Now BIC Venturi puts to rest some of the fables, fairytales, folklore, hearsay and humbug about speakers.

## Fable

*Extended bass with low distortion requires a big cabinet.*

Some conventional designs are relatively efficient, but are large. Others are small, capable of good bass response, but extremely inefficient. The Venturi principle (pat. pend.) transforms air motion velocity within the speaker enclosure to realize amplified magnitudes of bass energy at the Venturi-coupled duct as much as 140 times that normally derived from a woofer (Fig. A). And the filtering action achieves phenomenally pure signal (Scope photos B & C). Result: pure extended bass from a small enclosure.

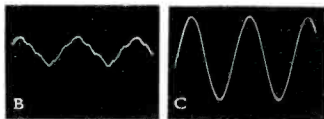
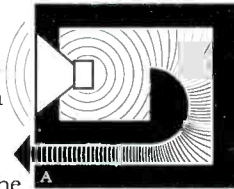

B—Shows output of low frequency driver when driven at a freq. of 22 Hz. Sound pressure reading, 90dB. Note poor waveform.  
C—Output of Venturi coupled duct, (under the same conditions as Fig. B.) Sound pressure reading 111.5 dB, (140 times more output than Fig. B.) Note sinusoidal (nondistorted) appearance.

## Fairytale

*It's okay for midrange speakers to cross over to a tweeter at any frequency.*

Midrange speakers cover from about 800 Hz to 6000 Hz. However, the ear is most sensitive to midrange frequencies. Distortion created in this range from crossover network action reduces articulation and musical definition. BIC Venturi's Biconex horn (pat. pend.) was designed to match the high efficiency of the bass section and operates smoothly all the way up to 15,000 Hz, without interruption. A newly designed super tweeter extends response to 23,000 Hz, preserving the original sonic balance and musical timbre of the instruments originating in the lower frequencies.



## Folklore

*Wide dispersion only in one plane is sufficient.*

Conventional horns suffer from musical coloration and are limited to wide-

angle dispersion in one plane. Since speakers can be positioned horizontally or vertically, you can miss those frequencies so necessary for musical accuracy. Metallic coloration is eliminated in the Biconex horn by making it of a special inert substance. The combination of conical and exponential horn flares with a square diffraction mouth results in measurably wider dispersion, equally in all planes.

## Hearsay

*A speaker can't achieve high efficiency with high power handling in a small cabinet.*

It can't, if its design is governed by such limiting factors as a soft-suspension, limited cone excursion capability, trapped air masses, etc. Freed from these limitations by the unique Venturi action, BIC Venturi speakers use rugged drivers capable of great excursion and equipped with voice coil assemblies that handle high power without "bottoming" or danger of destruction. The combination of increased efficiency and high power handling expands the useful dynamic range of your music system. Loud musical passages are reproduced faithfully, without strain; quieter moments, effortlessly.

## Humbug

*You can't retain balanced tonal response at all listening levels.*

We hear far less of the bass and treble ranges at moderate to low listening levels than at very loud levels. Amplifier "loudness" or "contour" switches are fixed rate devices which in practice are defeated by the differences in speaker efficiency. The solution: a dynamically acting tonal balance circuit (patents pending) adjusts speaker response as its sound pressure output changes with amplifier volume control settings. You hear aurally "flat" musical reproduction at background, average, or ear-shattering discoteque levels—automatically.



## A system for every requirement

FORMULA 2. The most sensitive, highest power handling speaker system of its size: 19 $\frac{3}{4}$  x 12 x 11 $\frac{1}{2}$ " Heavy duty 8" woofer, Biconex mid range, super tweeter. Use with amplifiers rated from 15 watts to as much as 75 watts RMS per channel. Response: 30 Hz to 23,000 Hz. Dispersion: 120° x 120°. \$98 each.

FORMULA 4. Extends pure bass to 25 Hz. Has 10" woofer, Biconex mid-range, super tweeter. Even greater efficiency and will handle amplifiers rated up to 100 watts. Dispersion: 120° x 120°. Size: 25 x 13 $\frac{1}{4}$  x 13" \$136 each.

FORMULA 6. Reaches very limits of bass and treble perception (20 to 23,000 Hz). Six elements: 12" woofer complemented by 5" cone for upper bass/lower midrange; pair of Biconex horns and pair of super tweeters angularly positioned to increase high frequency dispersion (160° x 160°). Size: 26 $\frac{1}{4}$  x 15 $\frac{3}{4}$  x 14 $\frac{3}{4}$ " \$239 each.

Sturdily constructed enclosures are finished in genuine oiled walnut veneer. Removable grilles in choice of 7 colors. Optional bases for floor standing placement. Write for informative brochure.

Audition today's most advanced speakers at your BIC Venturi dealer



BRITISH INDUSTRIES Co., Inc.  
Westbury, New York 11590.  
A division of Avnet, Inc.  
Canada: C.W. Pointon, Rexdale, Ont.

# BIC VENTURI

Check No. 9 on Reader Service Card

# coming in November

**John Eargle** on Equalizers in the Home.

**Martin Clifford** on Bias Requirements in Cassette Recorders.

**Equipment Reviews Include:**  
AKAI 46D cassette recorder  
Sony 7065 receiver

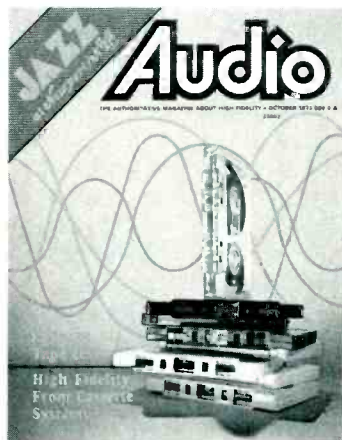

**About the cover:** This month our editorial theme is cassettes, and our cover artist decided to give his impression of how signals are placed on tape. There has been an enormous amount of work on both cassette tapes and recorders over the past few years, and the results are quite comparable to open-reel recorders of the same price level. Our tests of 23 cassette tapes begin on page 40.

## Audioclinic

Joseph Giovanelli

### Record Player Used With a Timer

*Q. I have recently purchased a manual turntable and a Shure M91ED cartridge. When listening to records at night, I sometimes fall asleep in the middle of one, which results in the turntable's being left on for hours with the cartridge tracking in the end groove. Rather than continuing this unnecessary stylus wear, I have considered buying a timer which would shut off both the amplifier and the turntable at some prearranged time. This, however, would result in the stylus remaining on the record without its rotating, for a considerable length of time.*

*Would this have any deleterious effect on stylus or records? If so, what would they be?*—Michael Carrano, Cahokia, Illinois.

A. If your turntable is belt driven, there will be no problem in having it turned off by way of a timer. The stylus, resting on the surface of the disc overnight, will not be harmed. Just remember that it is there, and remove it carefully first thing in the morning.

Remember that the disc, being left on the turntable all night, will have lots of time to collect dust. Therefore, be sure to remove as much of this dust from the surface of the disc as possible **BEFORE YOU REPLACE IT IN ITS JACKET.**

Not all turntables are driven by belts. Some are driven by idlers, wedged between the motor shaft and the inner rim of the table. If you have one of these, you must not leave the idler engaged when the table is not turning. If you do, pressure from the motor shaft will cause flat spots to develop on the idler's surface which may not be removed during operation of the table. The irregular motion of the idler, caused by the flat portions, will be heard as added background noise when records are played.

With a turntable of this sort, turning it off with a timer is not a good idea.

### Tuner Signal Loss

*Q. While playing my FM stereo receiver, I noticed that the volume was decreasing steadily. I also noticed that the reading on my signal strength meter dropped from a normal reading of 6 (on*

*a scale of 0 to 10) to almost 0. As a result, I am led to believe that there is something wrong with the tuner section of my receiver. The amplifier still works perfectly on the phono input. I would appreciate it if you could advise on what is wrong with the tuner and what steps can be taken to remedy the problem.*—Gerard F. Tripptree, Bronx, N.Y.

A. I agree with your diagnosis that the loss of volume is the result of some problem in the tuner section of your receiver. There are any number of things which could produce the results that you have described. It could be that the main resistor feeding voltage to the tuner has increased in value, thus depriving the tuner section of its proper operating voltage. It could also be that the bypass capacitor associated with this same resistor has become leaky. A leaky capacitor causes excessive current to flow in the resistor, with a loss of operating voltage.

If you still hear normal, interchannel hiss, all of the above can be ruled out. The tuner is receiving proper voltage. The absence of interchannel hiss, however, does not necessarily prove the above either. Such a situation may be caused by a defective i.f. transistor or IC. If hiss is nearly normal, I suggest that you check the r.f. and oscillator circuits. Defective transistors in these circuits can cause the loss of signal as can defective r.f. bypass capacitors or open resistors.

In addition, it is always well to check for cold solder connections or small cracks in the printed circuit board foils.

Voltage regulator elements associated with the tuner circuit could be defective, leading to loss of operating potentials at some points in the circuit, again resulting in a loss of signal.

I suggest that you obtain a service manual for your receiver and use it to check for proper voltages and resistances.

Just how far you can proceed with this kind of trouble shooting will depend on your background. I certainly think anyone who is capable of working on equipment should obtain service notes when he buys his equipment. If none are available, I would personally be strongly tempted not to buy the equipment.



# The Technics SA-5400X. 4-amplifier 4-channel and 4-amplifier 2-channel.

Technics doesn't force you to choose between 2-channel or 4-channel. We give you both in one unit. The SA-5400X.

It's a very impressive 4-channel receiver. Each of its 4 amplifiers delivers 11 watts RMS, 8 $\Omega$ , each channel driven. And its full discrete capabilities include jacks for a CD-4 demodulator. Plus jacks for both 4-channel and 2-channel tape sources. And two tape monitor circuits.

There are also two different matrix decoding circuits that can handle all the popular matrix methods.

The SA-5400X is a great 2-channel receiver, too. Because it has Balanced Transformerless (BTL) circuitry. Our special way of strapping the front and rear amplifiers in tandem for 4-amplifier 2-channel. Which more than doubles the power per channel in stereo. Producing 25 watts RMS per channel (each channel driven) at 8 $\Omega$ .

The amplifiers all have direct-coupled circuitry which vastly improves their low-

frequency performance and power bandwidth. And a special phono-equalizer circuit so you can use virtually any kind of phono cartridge efficiently.

There's also a very potent FM section that boasts sensitivity of 20 $\mu$ V (IHF). With a 4-pole MOS FET and IF amplifiers whose ceramic filters yield 65 dB selectivity.

We knew you'd have a hard time trying to make up your mind about which kind of receiver to buy. So we put both 2-channel and 4-channel in one easy-to-afford unit.

The SA-5400X. The concept is simple. The execution is precise. The performance is outstanding. The name is Technics.

200 PARK AVE., NEW YORK, N.Y. 10017  
FOR YOUR NEAREST AUTHORIZED  
TECHNICS DEALER, CALL TOLL FREE  
800 447-4700. IN ILLINOIS, 800 322-4400.

Check No. 42 on Reader Service Card

# Technics

by Panasonic



# Are you ready for a REAL



## CONTROL CENTER?

If you're a music lover looking for more enjoyment from your music collection, we have a pleasant surprise for you.

Up to now you've enjoyed the few control functions on your tape deck, amp or receiver. But think what you could do with a discrete control center! Not a lo-fi economy model, but the famous CROWN IC150, with a variety of versatile controls unavailable in any other model under \$300, and some models over \$500.

This is the control center praised by that dean of audio, Ed Canby: "This IC150 . . . is the finest and most versatile control unit I have ever used. For the first time I can hook all my equipment together at once. I find many semi-pro operations possible with it that I have never before been able to pull off, including a first-class equalization of old tapes via the smooth and distortionless tone controls. I have rescued some of my earliest broadcast tapes by this means, recopying them to sound better than they ever did before."

The IC150 will do the same for you. You could record from any of seven sources: tuners, turntables, guitars, tape players, microphones, etc. You could also tape with one recorder while listening to a second one. Even run two copies of the same source at once while monitoring each individually. How about using the IC150's exclusive panorama control to improve the stereo separation of poorly produced program material or to correct that ping-pong effect with headphone listening? It's all up to your creativity.

You'll feel perfectly free to copy and recopy through your IC150, since it creates practically no deterioration whatsoever. Cleaner phono and high-level circuits cannot be found anywhere. Harmonic distortion is practically unmeasurable and IM is less than 0.01% (typically 0.002%).

Of course, construction is traditional Crown quality, backed with a three-year warranty. The price is \$299. The enjoyment is unlimited. The opportunity is yours. Visit your local Crown dealer to discover if you are ready for a real control center, the IC150.



# CROWN

BOX 1000, ELKHART, INDIANA, U.S.A.

Check No. 10 on Reader Service Card

### Channel Imbalance

*Q. I own an 8-track car stereo tape player. I notice that one channel is substantially weaker than the other. When I adjust the balance control all the way to the right and then to the left, the left channel does not match the right channel in volume. Also, when the volume control is turned all the way down, the right channel still is heard "loud and clear" if the balance control is adjusted to favor that channel. The left channel remains quiet. I know that both channels should remain quiet when the volume is turned all the way down.*

*What causes this peculiar behavior?—Gary De Bouver, Detroit, Mich.*

A. At this time I would not want to say that your cartridge has shorted out or if something else has gone wrong. Cartridges short out so rarely that I suggest you make some other checks before giving up on it.

Do you have a mode switch accidentally set in its "mono" position?

Are you using a Y connector to mix two channels into one for making mono recordings? This arrangement can result in the loss of separation on the main outputs of some music systems.

Are there loose strands of wire shorting "hot" leads in the tonearm's shell?

Look for solder bridges or for loose strands of wire which can short between the terminals (under the table) which interconnect the leads from the tonearm and the cables which feed the amplifier.

If all these checks prove negative, see if you can borrow a cartridge known to be good. Insert it into your shell as a final check to see if separation returns. If separation has returned, the problem really is in your cartridge. I have seldom seen an occurrence.

### Cartridges and Load Resistance

*Q. I have just purchased a Sansui 2000A tuner amplifier. It has provisions for both a 50 K ohm cartridge and for a 100 K ohm cartridge. My turntable is a Dual 1219 with a Shure M91E cartridge. The recommended load impedance for the cartridge is 47 K ohms per channel. Which phono input should I use?—Carter Rhodes, Midville, Ga.*

A. You should use the 50 K ohm phono input for your 47 K ohm cartridge. This slight difference between what is called for by Shure and what is supplied by Sansui is negligible and cannot be heard.

### European Equalization

*Q. I often purchase imported phonograph records, mainly from Germany and England. These discs would have the*

*European equalization. My amplifier has RIAA equalization. Am I losing quality when playing back these discs? If so, is there any way to correct the situation?—Louis Hone, Montreal, Canada*

A. As far as I know, European discs are equalized just as ours are. Therefore, you should not encounter any problems in this regard when playing them.

### NOTE

From time to time this column receives suggestions from readers with the thought that such suggestions would benefit other readers. The following is one such item:

*Dear Mr. Giovanelli:*

*Sometimes an electrostatic speaker will produce audible output even though unconnected to a signal source. This output sounds like "snapping" or "crackling."*

*This is caused by corona discharge from the high voltage supply for the speaker. It may take place within the speaker itself. (The 2,000-6,000 volts are insulated by only 0.001 inch of air in the wiring or in the power supply.)*

*Cause: high humidity, insulation breakdown, dust, cat hairs, etc.—anything that will provide a path for the high voltage to discharge or arc.*

*Locating: in a dark room, look inside the enclosure. (No hands, please.) You will see the arc or a blue glow of discharge.*

*Remedy: if the wiring has broken down, coat the wires and power supply components with high-voltage dope. (General Cement Company makes a product called Corona Dope.)*

*If the arcing is in the speaker and if the speakers can be taken apart, do so. Clean the speakers with a lint-free brush or cloth. Do this in a dust-free room.*

*In any event, let the speakers stand with the power disconnected for several days before getting into them. This will permit the high voltage to reduce to zero.—Captain John C. Wiles, Jr., Niceville, Fla.*

If you have a problem or question on audio, write to Mr. Joseph Giovanelli, at AUDIO, 134 North Thirteenth Street, Philadelphia, Pa. 19107. All letters are answered. Please enclose a stamped self-addressed envelope.



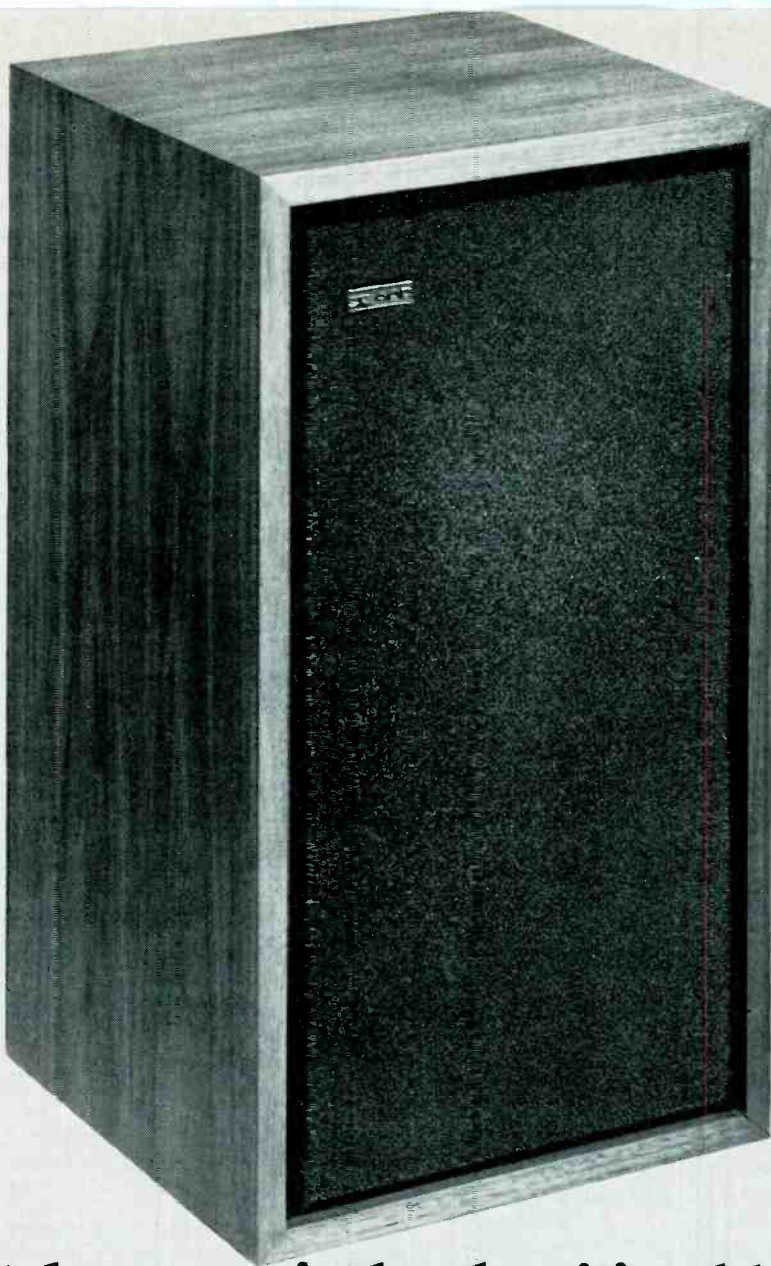

## The new ADC-XT 10.

If you believe, as we do, that the ultimate test of any speaker is its ability to produce a true audible analog of the electrical signal fed to it, you'll be very impressed with the new XT 10.

The XT 10 is a two way, three driver, system employing a newly developed ten inch, acoustic suspension woofer with an extremely rigid, light weight cone and a specially treated surround that permit exceptionally linear excursions.

Matching the XT 10's outstanding low frequency performance are two wide dispersion tweeters that extend flat frequency response to the limits of audibility (see accompanying frequency response curve) and significantly improve power handling capacity.

All three drivers are mounted in a beautifully finished, non-resonant, walnut enclosure. And in place of the conventional grille cloth is an elegant new foam grille.

An extraordinarily accurate transducer, the XT 10 is characterized by very flat frequency response, excellent high frequency dispersion and extremely low distortion. Finally, it is distinguished by outstanding transient response assuring exceptional clarity and definition.

As a result, the ADC-XT 10 rivals and in many instances, surpasses the performance of units costing several times as much.

But why not experience for yourself what a truly well behaved speaker sounds like. Audition the XT 10 at your ADC dealer now.

For more detailed information on the ADC-XT 10 write: Audio Dynamics Corporation, Pickett District Road, New Milford, Conn. 06776.

### It does precisely what it's told.

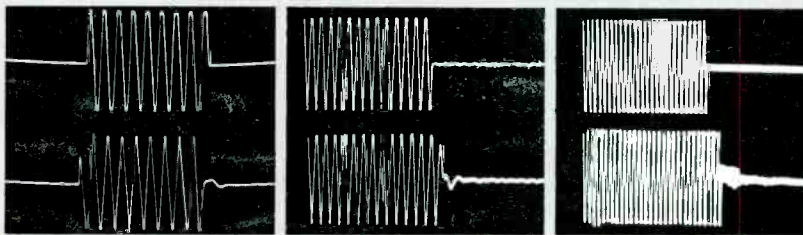
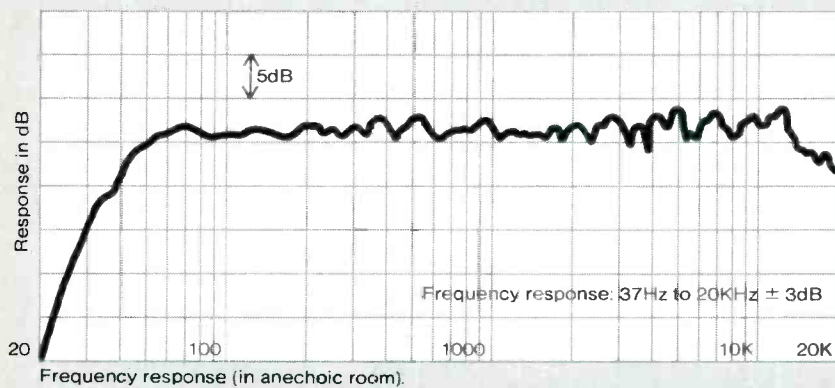

Tone bursts at 500Hz, 1200Hz, 15,000Hz  
Virtually identical waveforms from signal generator above  
and speaker below demonstrate superior transient response.

 **Audio Dynamics  
Corporation**

Check No. 2 on Reader Service Card

# Tape Guide

Herman Burstein

## Pan Pot

*Q. I would like a control that would permit me to use one microphone on Channel A or Channel B or both. I guess this would employ a pot which would gradually allow the signal to pass from Channel A, to AB, to B.—Louis Hone, Montreal, Canada*

A. If you have a stereo preamplifier cable of being fed from a mike, you can use its balance control as a panpot. Set the preamplifier to MONO and feed the mike in the normal manner, with the gain advanced to provide reasonable output with the balance control in the mid position. The outputs of the preamplifier can then be fed into your stereo recorder. The position of the balance control of the preamplifier will determine the apparent location of the microphone in the sound field.

All of this assumes that your preamplifier has provisions for a microphone. The microphone should not be connected to a phono input because the frequency response of such an input is not flat. There will be considerable bass boost and treble cut.

An alternative arrangement would consist of using a Y connector. One of the ends of the Y would be terminated in a receptacle which could accept your microphone. The other two ends of this Y connector would be terminated in plugs which could be connected to your recorder or mixer. Thus, we have a system whereby one microphone will feed into both channels of your recorder. By adjusting the relative levels of the inputs controls for these channels, we have a method for adjusting the effective position of the microphone in the sound field.

I think it would be difficult for you to obtain a special pan pot for use directly with high impedance microphones. Further, I do not like the idea of connecting a potentiometer directly into a microphone circuit. The adjustment of this potentiometer would result in the introduction of noise.

## R.f. Interference

*Q. Is there a practical method of shielding an audio system from r.f. interference? I am about 45 miles from a defense radar installation whose*

*signals modulate very distinctly when my audio gear is operated in any mode. I also pick up radio dispatched commercial services. The problem, which is shared by my friends, is most noticeable on the high gain inputs such as phono and microphone. The noise is very bothersome when I am recording a program, because then I get the extraneous signal on the tape, and in addition pick up more interference during playback.—Stephen Bruce, Mt. View, Calif.*

A. To eliminate r.f. interference, you might try using small capacitors (roughly around 10 to 50 pfd) between the input point of the audio signal and ground. However, the interference might also be getting into your equipment at following stages, and it may be necessary to follow the same procedure at these later stages as well.

## Car Speaker Sound Level

*Q. I have an 8-track car stereo tape player. There are two 4-inch speakers in the front and two 6x9 speakers in the rear. The rear speakers are louder than the front ones. Could you tell me what is wrong?—Marion Segler, Gary, Indiana.*

A. The difference in level appears to be due to the fact that the rear speakers are more efficient. To cut down the level of the rear speakers, you can use L-Pads, obtainable from your local audio store or from electronic mail order houses. These pads usually come with instructions for mounting.

## Meters, Response & Heads

*Q. How does one set the VU meter so that it is reading the recording level properly? For my tape recorder, the adjustment can be made by turning a pot, but I have noticed that the reading varies with frequency even though the input to the circuit is kept constant. What is the best frequency to use? What should one see on a 'scope connected to the output of the tape system when the recording level is set too high?*

*What should be considered to be good frequency response ( $\pm 1$  dB) of a good quality tape deck?*

*Is there a book that explains interchangeability of tape heads? Are they like phono cartridges in that the electrically similar types can be interchanged (e.g. one magnetic cartridge can be interchanged with another magnetic)?—William R. Lafferty, Wilmington, Del.*

A. An accepted way of setting the VU meter is to have the pointer 0 VU at a recording level such that a 400 Hz signal results in 1% harmonic distortion on the tape. Alternatively, you can purchase a test tape which contains such a signal, equate your recording signal level at 400 Hz with the test signal, and adjust the VU meter to read 0. To equate the two signals, you adjust the recording signal until it produces the same playback output as does the test signal. If the recording level is too high and you are recording and playing a low-frequency signal, you should be able to see a distorted waveform on the 'scope. However, if your signal is a high-frequency one, you will still get a sine wave on the 'scope, because the harmonic distortion products are outside the capability of the tape system.

A high quality tape system should be able to provide response flat within approximately 1 dB between about 40 and 16,000 Hz at 7½ ips, and between about 40 and 10,000 Hz at 3¾ ips, along with high S/N and low distortion. The upper response limit can be considerably extended at both speeds if one is willing to let distortion rise and/or signal-to-noise ratio decline.

Your question about interchangeability of tape heads might better be addressed to a manufacturer of heads, such as Nortronics. In a general manner, I can say that tape heads are not interchangeable in the way that phono cartridges of the same type are.

## Tape Squeal

*I have been a victim of this horrendous defect of Scotch 203 for a long time and with three entirely different tape recorders. The squeal is due to "sticktion" of the lubricated tape surface to the small-diameter tape guides after they warm up a little. The fol-*



# Picture your system on the tube.

## The Heathkit AD-1013 Audio-Scope—seeing is believing

A professional-grade oscilloscope that visually monitors stereo and 4-channel discrete and matrixed systems. Now you actually can see channel separation, phasing, relative signal strengths, multipath reception, center tuning of receivers and tuners, and more. And in easy-to-build kit form you save virtually hundreds of dollars over what you would normally pay for an instrument this reliable and versatile.

Only the Heathkit Audio-Scope gives you triggered sweep for a stable, jitter-free trace without constant re-adjustment. Inputs are provided on the rear panel of the Audio-Scope for Left-Front, Left-Back, Right-Front, Right-Back, and Multipath. Any of these inputs can be switched and observed on the cathode ray screen, independently or in combination.

In addition, a front panel input is provided for observing any external source, permitting you to use the AD-1013 as a conventional oscilloscope for checking out malfunctions in various stages of your tape equipment receiver, amplifier, tuner, turntable, etc. A built-in independent 20 Hz to 20 kHz low distortion audio oscillator

provides a convenient means of setting up and checking your 4-channel or 2-channel stereo system. Front panel controls are provided for frequency selection of the audio oscillator as well as controlling the amplitude of the generated signal. Outputs from the audio oscillator are located on both front and rear panels. Output voltage will not vary with frequency change.

Cabinet-matched to the Heathkit AR-1500 Receiver, for obvious reasons, the AD-1013 nevertheless looks great and works great with any receiver or tuner having multiplex outputs.

You can build the Heathkit Audio-Scope even if you have never built a kit before. Most components mount on one large, roomy circuit board — and point-to-point wiring is held to a minimum. At this low kit price, it's well worth your time. Because when it comes to an unbelievable audio system, one picture is worth a thousand words.

**Kit AD-1013**, less cabinet, 19 lbs., mailable . . . . **199.95\***

**ARA-1500-1**, walnut cabinet, 8 lbs. . . . . **24.95\***

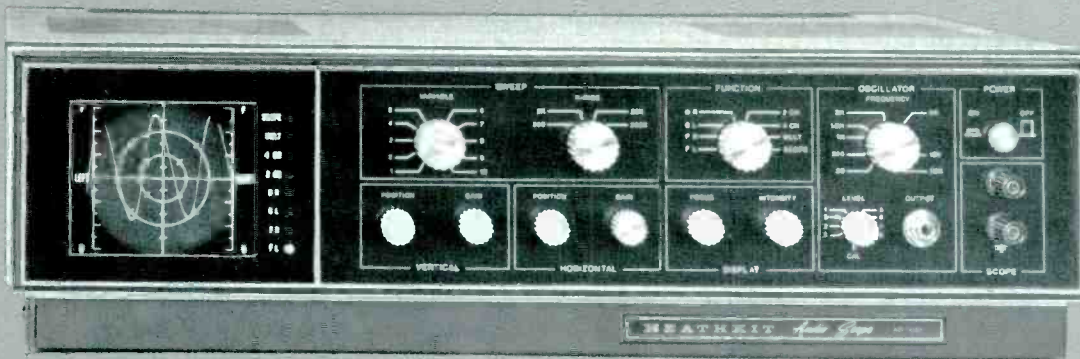

### SPECIFICATIONS

**AD-1013 SPECIFICATIONS — FRONT PANEL —** Scope Input: Vertical Sensitivity: 25 millivolts P-P/cm. Input Impedance: 100 k $\Omega$ . Frequency Response: 5 Hz to 200 kHz  $\pm 3$  dB. Audio Oscillator Output: Range: 20 Hz to 20 kHz. Voltage Level: 2 mV to 3 volts (rms) (variable). Output Variation:  $\pm 2$  dB 20 Hz to 20 kHz. Output Impedance (front panel jack): Approximately 600 $\Omega$ . Calibrator Voltage: 1.0 volt P-P  $\pm 5\%$ . Total Harmonic Distortion: 1% or less. **REAR PANEL —** Oscillator Output Impedance: 6000 $\Omega$ . Multipath Input (Scope Horizontal and Scope Vertical): Sensitivity: 25 mV P-P/cm. Input Impedance: 100 k $\Omega$ . Left Front, Right Front, Left Back and Right Back Inputs: Sensitivity: 25 mV P-P/cm. Input Impedance: 100k $\Omega$ . Frequency Response: 5 Hz to 200 kHz,  $\pm 3$  dB. 4-Channel Input: Sensitivity: 1 volt P-P/cm. Input Impedance: 5000 $\Omega$ . **GENERAL —** Triggered Sweep Generator: Range: 10 Hz to 100 kHz. Power Requirement: 120 or 240 volts AC, 50/60 Hz, 15 watts with no accessory load. AC Outlet (on rear panel): Unswitched. Dimensions (overall): 5 1/2" H x 18 1/2" W x 13 1/2" D.

**ATTENTION AR-15 AND AJ-15 OWNERS:** In less than an evening you can add multipath provision to your equipment. The AR-15-1 Adaptor Kit makes your AR-15 or AJ-15 compatible with the AD-1013 above, or any DC-coupled oscilloscope, for observing multipath conditions which may be limiting the quality of your FM reception. **Kit ARA-15-1**, 1 lb., mailable . . . . . **24.95\***

**ATTENTION U.S. MILITARY PERSONNEL IN W. GERMANY:** All Heathkit products and catalogs are available at your nearest Audio Club.

See it at your Heathkit Electronic Center, or fill out coupon below.

**HEATHKIT ELECTRONIC CENTERS —** ARIZ.: Phoenix; CALIF.: Anaheim, El Centro, Los Angeles, Pomona, Redwood City, San Diego (La Mesa), Woodland Hills; COLO.: Denver; CONN.: Hartford (Avon); FLA.: Miami (Hialeah); GA.: Atlanta; ILL.: Chicago, Downers Grove; IND.: Indianapolis; KANSAS.: Kansas City (Mission); MD.: Baltimore, Rockville; MASS.: Boston (Wellesley); MICH.: Detroit; MINN.: Minneapolis (Hopkins); MO.: St. Louis; N.J.: Fair Lawn; N.Y.: Buffalo (Amherst), New York City, Jericho; L.I.: Rochester; OHIO.: Cincinnati (Woodlawn), Cleveland; PA.: Philadelphia, Pittsburgh; R.I.: Providence (Warwick); TEXAS.: Dallas, Houston; WASH.: Seattle; WIS.: Milwaukee.



World's largest selection of electronic kits SEND FOR FREE CATALOG

**HEATH COMPANY, Dept. 41-10**  
Benton Harbor, Michigan 49022



Please send FREE Heathkit Catalog.  
 Enclosed is \$\_\_\_\_\_, plus shipping.  
Please send model \_\_\_\_\_

Name \_\_\_\_\_  
Address \_\_\_\_\_  
City \_\_\_\_\_ State \_\_\_\_\_ Zip \_\_\_\_\_

\*Mail order prices; F.O.B. factory. HF-276

# imagine:

THAT A MANUFACTURER PERFECTED AN ENCLOSURE THAT ALLOWED A SPEAKER TO BE SO CLEAN THAT IT MAY BE THE BEST YOU'VE EVER HEARD FOR ONLY:

**\$299** but . . . . .



RSL MAX

# imagine:

YOU COULD BUY IT WHOLESALE FOR

**\$160**

# ROGERSOUND LABS

# A REALITY!

MANY MODELS TO CHOOSE FROM—ALL FACTORY DIRECT.

FREE TRIAL ON ALL RSL SPEAKERS!



6319 VAN NUYS BLVD.  
VAN NUYS, CA. 91401  
Phone: (213)78-SOUND

Check No. 32 on Reader Service Card

lowing measures help: (1) Use a quiet blower (Rotron and similar) to keep tape contact surfaces cool. (2) Wrap a layer or two of teflon adhesive tape around all tape guides on the feed-reel side and between heads. (3) Try tape of other makes, although I must admit Scotch 203 is a beautiful tape.—Alex Azelickis, Morton Grove, Ill.

To other readers who have also written in with advice more or less along the above lines, let me express thanks and apologies for not being able to print their exact comments.

### Misalignment Spillover

*Q. I have a Revox 6-36 stereo tape recorder. I use this monophonically. When I record on channel 1 (outside tracks 1 and 4) the machine records a sputtering sound on the adjacent tracks (inside tracks 2 and 3); thus when I record on track 1, the sputtering sounds are recorded on track 2. What could be the cause?—John Napoliello, Philadelphia, Pa.*

A. It may be that there is noise in the channel 2 electronics, and that due to adjacent channel "spillover" or to vertical misalignment of the record head with respect to the playback head, this noise is being recorded on the adjacent channel.

### Receiving Dolby Broadcasts

*Q. Please explain how I can hook up a Dolby B decoder to my FM stereo tuner or receiver in order that I can receive Dolby-processed FM broadcasts.—Michael Libretto, Brooklyn, New York*

A. To receive Dolby-encoded FM broadcasts, the simplest approach is to substitute the Dolby decoder for a tape recorder, making use of the "tape out" and "tape monitor" jacks on your equipment. This will eliminate some of the problems which could come up when using a separate FM tuner rather than an integrated receiver.

The jacks on your Dolby decoder normally used in conjunction with the output of your tape recorder are connected to the "tape out" jacks of your sound system. The jacks on your Dolby decoder which normally go to a power amplifier input, high level aux. input and the like, now go to the "tape monitor" jacks of your sound system. If your Dolby processing equipment is equipped with separate recording facilities, they may be disregarded at this time.

The only problem is that you will have to wait for a time when the station employing the Dolby system is

transmitting calibrating tones for Carefully mark the calibration knobs so that you can accurately reset them whenever you wish to use the decoder with your FM equipment. In this way you can use your Dolby equipment for any other purpose and at any time you can once again listen to Dolby-processed FM broadcasts without waiting for calibration tones.

If you plan to record such broadcasts, feed the tape machine with no Dolby circuits used. The programs are already encoded so no further encoding is required or desirable. However, the tape must be played with the Dolby decoding circuits activated. Be sure to record at proper levels, established during the calibration of your tape machine and Dolby processor. This will allow you to decode the broadcasts properly when playing back the tape.

### Microphone Connection

*Q. I have a pair of relatively expensive microphones with 50,000 ohms impedance, which I purchased for use with the Miranda Nocturne Tape Recorder. I have added a Concord Mark III deck, with an input impedance of 20,000 ohms. Its manufacturer recommends a mike with an impedance of between 6,000 and 20,000 ohms and an operating level between -70 and -50 db. Would either the mikes or the deck be harmed by using the mikes directly with the Mark III? If not, what would I lose in quality?—George W. Ferguson, Metuchen, New Jersey*

A. I doubt very much that any of your equipment could be harmed by the connection you describe. If you connect your high impedance microphones to an input impedance of 20,000 ohms, I think that the principal adverse effect will be a loss of sensitivity. However, your microphones may have enough sensitivity so that, together with the gain of the tape deck, the loss is tolerable. There may also be an increase in distortion; offhand, I cannot tell whether this would be a noticeable increase, although I am inclined to doubt that it would be.

If you have a problem or question on tape recording, write to Mr. Herman Burstein at AUDIO, 134 North Thirteenth Street, Philadelphia, Pa. 19107. All letters are answered. Please enclose a stamped, self-addressed envelope.



# This is "one powerful set!"

**"It was in the area of audio amplification, however, that we got our biggest surprise. The S-7200 is one powerful set."**

This quote from Audio Magazine, May 1973, evaluating the Sherwood S-7200 AM/FM stereo receiver, surprised us.

Not that the reviewers found it to be such a powerful set. But that they found it so surprising.

The fact is, most people who are into Hi-Fidelity components, are discovering that Sherwood delivers on its claims. And then some.

Or, to quote further from the review:

"The 40 dB mid-band separation figure is exceeded by 3 dB."

"With a signal as little as 5 uv, quieting had already reached an impressive 52 dB."

"THD in mono exceeded

published claims, reaching a low figure of just 0.2% at mid-audio frequencies."

"Our power amplifier tests were confined to 8-ohm loads, but at that, the Sherwood S-7200 exceeded its claims and pumped nearly 43 watts into each load, with both channels driven."

"Based upon a 40-watt rated output per channel, power bandwidth extended from 10 Hz to 40 kHz, quite a bit better than claimed. At the audio limits of 20 Hz and 20 kHz, 1% THD was reached at 36 watts per channel and 40.5 watts respectively, while at all power levels below 40 watts, THD remained well under 0.5% for all audible frequencies."

"The loudness-volume control of the S-7200 deserves special mention. The tracking of the two sections of this control was excellent—with no more than 1 dB

variation all the way down to 60 dB from the full clockwise position—which means that high quality potentiometers are used in this all important control."

But in the end, it is the power of Sherwood receivers that normally turns people on.

"Using low efficiency speaker systems in our main listening area, we just could not overdrive the amplifier portion at any desired listening level—and we mean all the way up to over 100 dB sound-pressure levels."

Which perhaps brings us to this point. If there is one impressive factor about Sherwood receivers, it is that they often not only out-perform their specs: they almost always out-spec competition.

Sherwood Electronics  
Laboratories, Inc.  
4300 North California Avenue,  
Chicago, Illinois, 60618

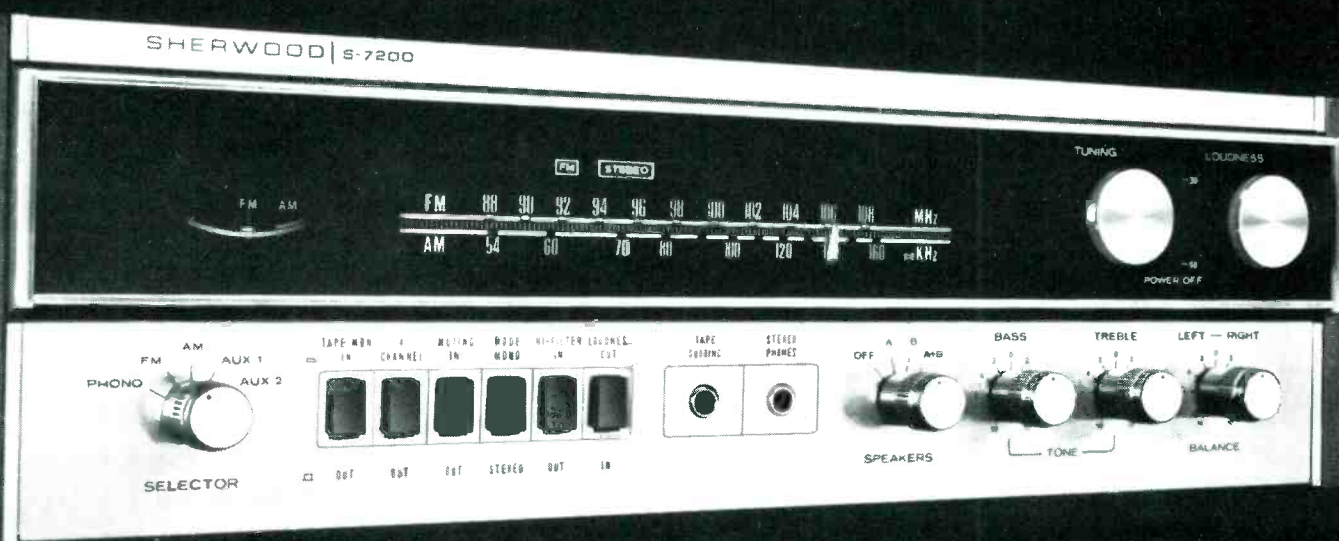

## Sherwood

The word is getting around.

Check No. 34 on Reader Service Card



# Behind The Scenes

Bert Whyte

THE OTHER day I was leafing through the pages of that venerable British publication, *The Gramophone*, and I came across a wonderful "letter to the editor," in which the writer was heartily condemning quadrasonic sound. "Sound around me . . . a concert hall experience?" he asked. Then he went on to say that "the only sounds I ever hear behind me at a concert are the coughing of my fellow concert-goers and the whispering of bored ushers."

It goes without saying that this "Bah! Humbug!" attitude is not too unexpected. People have always resisted change. The transition from mono to stereo began in 1958 and it is only in the past several years that record manufacturers in this country ceased production of mono discs. Some of my friends in the European hi-fi press have told me in no uncertain terms, that Europe still is quite substantially a monophonic market.

Be that as it may, and with all due respect to our fustian friend in *The Gramophone*, quadrasonic sound is an idea whose time has come. Certainly the advent of the universal four-channel receiver at the CES is indicative that we are well and truly beginning the era of quadrasonic sound. It is well to remember that in this space age, things can happen a great deal faster than was the case in 1958. New developments in four-channel stereo are frequent these days, and the time factor in turning a laboratory exercise into a commercial product is remarkably brief. A case in point is the use of Dolby B-Type noise reduction in stereo and quadrasonic 8-track cartridges.

Readers of this column know I have been advocating this idea for some time. In my report on the CES, I related that 3M/Wollensak had two cartridge units fitted with Dolby B circuits, and that Ampex Stereo Tapes made available a Dolbyized demonstration cartridge. Now, in short order, I learn that by the time you read this, Columbia, and EMI (England), will be issuing both 2- and 4-channel Dolbyized cartridges, and Hispavox (Spanish Columbia) will be issuing 2-channel stereo cartridges. I now have a Dolby level set cartridge, Catalog #54, which is the same 185 nWb/m flux level as the open-reel standard. With the Dolby B chip now available, it is obvious we will soon have cartridge units capable of Dolbyized quadrasonic playback. Thus in retrospect, from the time I started to nag about the need for Dolbyized 8-track cartridges to the

actual appearance of such a product (plus Dolbyized playback equipment) is slightly over a year. That's what I call space age hustle!

I have always maintained that one of the big problems with quadrasonic sound is that most people who are exposed to it rarely get a proper demonstration of the true worth of the medium. Admittedly, the configurations of many hi-fi dealers' showrooms aren't conducive to good speaker placement. And the noise levels in these places is definitely inimical to demonstrations of ambient-type quadrasonic. The more venturesome dealers have invested in special four-channel stereo sound rooms. A few of them are really splendid facilities, but it is becoming apparent that even when the effort is made in furnishing such amenities, their value is negated by lack of sales personnel who are knowledgeable about quadrasonic sound and by poor utilization of the various formats of four-channel stereo music. It is obvious that as we get further into the quadrasonic era, special training in this medium is going to be a requisite for dealer personnel. Part of this training may have to originate with the manufacturers of quadrasonic hardware, or become a function of their sales reps. The training classes at the Society of Audio Consultants in New York could also be a most significant factor. And I repeat again, some method of getting loan equipment into the home of the customer is unquestionably the best way to convince him about the virtues of quadrasonic sound.

My personal involvement with quadrasonic sound is quite extensive (as you may have noticed!). I have many people visit me, some of whom have never heard any kind of quadrasonic sound, and others who have heard it, but were either unimpressed or even soured on the whole idea. Of course I have friends who are "believers" too! In any case, I am equipped to give these people a good quadrasonic demonstration, whatever their cultural or economic levels. For example, I am currently utilizing the following equipment: An Ampex 440-4, running half-inch wide tape at 15 ips through four Dolby A361 units. Commercially recorded tapes in this format are not available so you must either make your own live recordings or be a member in good standing of the "Intra-Industry Tape-Swapping, Chowder and Marching Society." Some splendid recent acquisitions are a rousing *1812 Overture*, the Bartok *Concerto for*

*Orchestra and Petrouchka*. Needless to say, this is discrete four-channel stereo and Grade A . . . all the way!

For quarter-inch discrete four-channel stereo tapes, I use the big Crown 844-4CX, running through four channels of Dolby 505 B-Type noise reduction for things like the Vanguard "fore and aft" Dolbyized quadrasonic recordings. Incidentally, Ampex Stereo Tapes will soon be issuing open-reel Dolbyized four-channel tapes.

Four-channel eight-track cartridges are nicely handled by a Wollensak 8060 unit which, by the way, I have just checked out with the new Dolby level set cartridge and soon will bring you a report on recording Dolby cartridges.

On the disc aspects of quadrasonic sound, my QS matrix recordings are decoded by a Sansui QS 500, the SQ matrix recordings through the full/wave matching logic section of the Lafayette LR-4000 receiver. CD-4 discrete quadrasonic discs are played back with a Panasonic demodulator using either the Audio-technica AT20S cartridge or the new Stanton 4DQ780 cartridge. The cartridges are mounted in a Rabco SL8E radial-tracking servo arm, and the turntable is the Technics by Panasonic SP-10. I must take a moment to tell you that this is a most extraordinary turntable, utilizing a direct-drive brushless DC motor and a servo speed control system. The wow and flutter are at a 0.03% WRMS level and rumble is a totally inaudible -65 dB (DIN A). Most important is that vertical rumble, which can raise hob with stereo and quadrasonic recordings, is also inaudible. The 33 $\frac{1}{3}$  and 45 rpm speeds can be adjusted plus or minus 2% with a strobe light indicator to tell you when you are "on the nose." The SP-10 turntable is mounted on a special shock-mounted base (model SH-10B1). Rarely have I been as satisfied with a hi-fi product as with this beautifully finished turntable. The motor is completely silent and placing your hand on either the turntable framework or the wooden base reveals no vibration whatever. Playing recordings with heavy bass at high level with the turntable practically next to a speaker elicits not the tiniest hint of acoustic feedback.

As you can see from the foregoing line-up of equipment, I should be capable of handling any kind of quadrasonic eventualities.

My fancy disc playback equipment has been kept busy the past few days, since the first batch of Elektra/Nonesuch



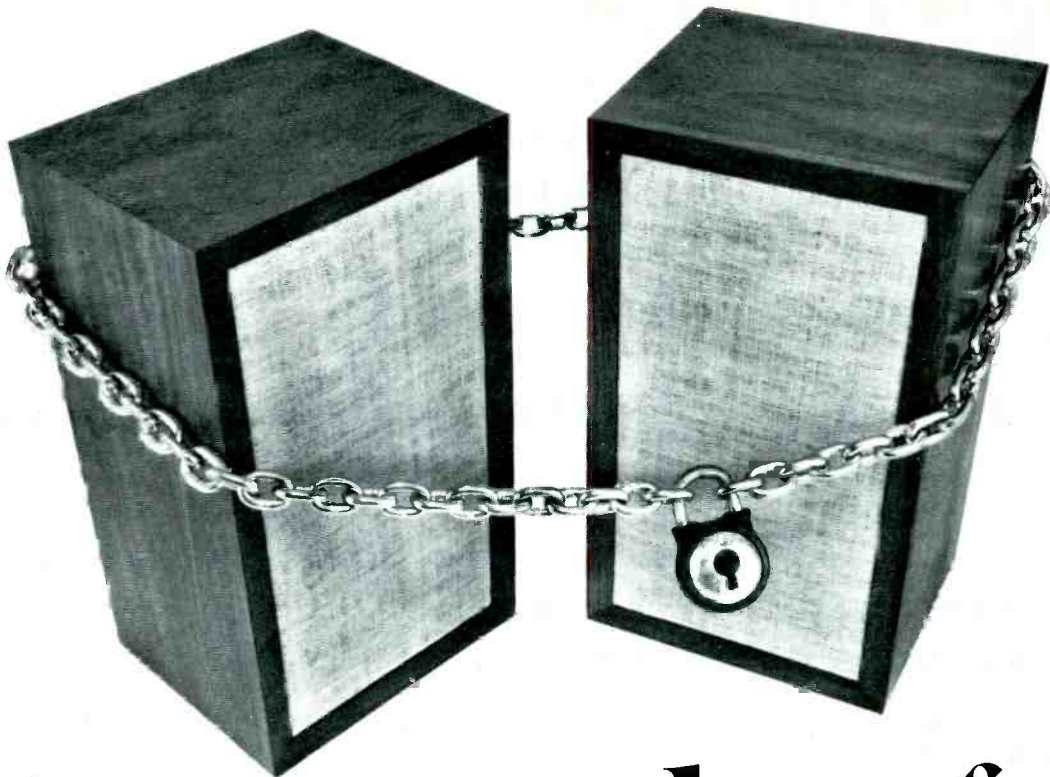

# Set your speakers free!

Your amplifier is probably too weak to break the chains that bind your speakers. An under-powered amplifier will lock your stereo system into clipping during low frequency passages or on musical peaks, forcing you down to a less than realistic listening level.



The key to the solution is a high-powered amplifier, specifically, the Phase Linear 400. Listen to Julian Hirsch of Stereo Review: "Anyone using a low efficiency speaker system with an amplifier in the 30 to 50 watt class cannot approach a realistic listening level without severe clipping."

The Phase Linear 400 will unlock music you never dreamed existed in your favorite records. How long has it been since you've had a dream fulfilled? Listen to the Phase Linear 400 at your dealer's soon.



**Phase Linear 400**  
400 watts RMS direct coupled solid state stereo power amplifier.



Advanced design heat sink provides protective cooling.

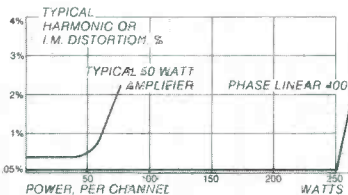

GREATER POWER PROVIDES IMPROVED SOUND REPRODUCTION

## SPECIFICATIONS

**POWER**—Greater than 200 watts/channel RMS both channels driven into 8 ohms. Power at clipping typically 250 watts/channel into 8 ohms and 400 watts/channel RMS into 4 ohms.

**HARMONIC OR I.M. DISTORTION**—Less than .25%; typically less than .05%.

**PROTECTION**—Patented protection circuit monitors output voltage and current, shuts down amplifier instantly if safe operating levels are exceeded.

**HUM AND NOISE**—Better than 100 db below 200 watts.

**STABILITY**—Absolutely stable with all speaker loads including electrostatic units.

**WARRANTY**—Three years, parts and labor for normal use.

**PRICE**—\$499.00 Cabinet: \$37.00

## Phase Linear 400

THE POWERFUL DIFFERENCE

PHASE LINEAR CORPORATION, P.O. BOX 549, EDMONDS, WASHINGTON 98020

Check No. 26 on Reader Service Card

CD-4 records finally arrived. These are the first CD-4 records from other than RCA or JVC, and the overall impression I have formed thusfar, is that Elektra/Nonesuch know what they are doing. On an album entitled "Stardrive," EQ5058 Elektra, which is a sort of far-out semi-rock, pseudo-spaceship type music featuring the electronic synthesizer of Robert Mason, it is obvious the original intent was a quadraphonic recording. Although it is true that instruments can be placed anywhere in the four-corner scene of surround sound, you usually can tell if a quadraphonic recording was the result of taking some sixteen-channel stuff out of the vault and hoping the quad mix will be acceptable, versus the deliberate instrumental positioning and arranging for maximum dynamic effects in a quadraphonic original. Good clean sound throughout this disc, apparently at or close to standard stereo level and with a solid bass line. On another Elektra Quadradisc, "The Best of the New Seekers," EQ5051, we have an excellent vocal group, 3 male, 2 female, who along with appropriate instrumental background harmonize on some pleasantly innocuous ballads. The main point is that here again is audible evidence of care in arranging and positioning with quadraphonic sound

in mind. Bright, clean sound, nicely articulate voices, good level and bass. Turning to classical material, we have Kurt Weill's *Suite from the Threepenny Opera*, coupled with Darius Milhaud's *La Creation du Monde* on Nonesuch Quadradisc HG1281. Conductor Arthur Weisberg and the Contemporary Chamber Ensemble do a thoroughly workmanlike job on these two disparate pieces of music. Yes, both works have so-called "jazz" elements incorporated into the scores, but in my opinion each represents a different milieu. The fine engineering was the work of my good friend, Marc Aubort, of Elite Recordings. Marc has found a certain church in New York with superbly spacious acoustics, which, however, with just the right mike placement, allows for excellent orchestral detail as well. This is ambient style quadraphonic recording, and the enhancement of the principal "up front" information is masterfully handled by Marc, so that at a rest in the music where the sound has a chance to naturally decay, your ears perceive the sound progressing from front to rear. Here too, nice clean sound, fine instrumental balances, with normal levels and good bass. I have saved mention of record surfaces until now. The pop recordings were beautifully quiet, but alas, the classical disc was

full of spits and sputters. It is said that the lubricant in the CD-4 compound (and in the case of RCA with the anti-static material as well) will, under certain circumstances have to do with the heating/cooling cycle during the pressing process, deposit out in the record grooves in the form of tiny crystals. When the stylus encounters these crystals, you get the sputtering and popping sounds, even though the record is brand new from its shrink-wrapped sleeve. Lou Dorren of Quadradisc and CD-4 chip reknown, says that after playing an offending record several times, and then cleaning it with some special "glop" he concocted, the noise disappears. Lee Kuby of Harman/Kardon has a bottle of this stuff and says he will let me try some. (He's a lot nearer to me than Lou). I understand RCA has a new compound, with superior overall characteristics to what is used at present and that with this material this noise problem has been licked. Undoubtedly, with all the cooperation among the Quadradisc people, Elektra will be privy to the information on this compound.

In the meanwhile, 9 more new Elektra/Nonesuch CD-4 discs to audition, and on the basis of what I have heard thus far, they are off to a good start.



## A little Traveling Music, Please

Daily frustrations make a person want to get away from it all. And, the UTAH MP-3000 Speaker will take you there better, faster than any comparable unit. With the MP-3000, you **know** you are in Tahiti, Paris or even Kentucky. Your day becomes more pleasant, too, as the MP-3000 conquers the sound barriers.

MP-3000 combines the rare attributes of sound and styling. Clean, undistorted sound comes from this 4-speaker, 3-way speaker system. The oiled and hand-rubbed walnut veneer cabinets, and unique grille of sculptured foam are both acoustically and geometrically beautiful. The system contains a 15" high compliance woofer with a 2" voice coil, as well as two horn-loaded-dome-tweeters. It's a distinguished combination of well-defined, distortion-free sound reproduction. Size: 27" x 20½" x 14" deep, excluding base. Shipping weight: 70#.

Come travel with us. Get complete information about the exciting MP-3000 Speaker System.



**UTAH ELECTRONICS**

Huntington, Ind. 46750

Check No. 45 on Reader Service Card



# Sony was the first electret condenser microphone and still is.

Since 1969 when Sony manufactured the first condenser microphone using the electret principle of capsule polarization, they've been expanding and improving the line. (Just because you're first doesn't mean you stop trying.) The result—Sony's NEW ECM-280 and ECM-250 Cardioid Condenser Microphones that deliver all the accuracy of studio-quality sound. Both feature unidirectional, cardioid pick-up patterns to minimize background noises and acoustical feedback. And each incorporates FET electronics that insure low noise, high sensitivity and stable performance.

The NEW ECM-250 from Sony offers excellent frequency response characteristics and the lowest possible distortion at maximum sound pressure levels. Plus a built-in protective windscreen makes the versatile ECM-250 ideal for outdoor miking.

These incredible NEW Sony microphones are just two in a complete line of condenser microphone models with prices as pleasing as their performance. As low as \$19.95. Listen to the difference in Sony microphones and all the exciting Sony tape recording equipment at your Superscope dealer. Sony was and is the first.

**SONY Ask anyone.**

Check No. 63 on Reader Service Card

The Sony ECM-280 has a bass roll-off switch (a feature found in only the most sophisticated professional studio microphones). When the kettle drum's got too much boom or the speaker's voice has too much resonance, one simple setting will remove those low frequencies to balance out the entire frequency range. (And the additional windscreen makes noise-free outdoor recordings a snap.)

A Product from **SUPERSCOPE®**

©1973 Superscope, Inc., 8132 Vineland Ave., Sun Valley, Calif. 91352. Prices and models subject to change without notice. Consult the Yellow Pages for your nearest Superscope dealer. Send for free catalog.

# Editor's Review

**M**AYBE IT'S JUST a sign of the times, what with Watergate, the Soapbox Derby champ being busted (or is it washed out?), mass murder/sex crimes, two dollar devaluations, food so expensive you can scarcely afford to buy it, but I seem to have had a rash of complaints about audio gear lately. What struck me as odd about the complaints was that they were about equipment and manufacturers I knew to be good and reliable. Further, fully three-quarters of the complaints were for alleged poor service either before or after the sale, and I could see no reasonable basis for the complainers thinking that they ought to have been treated differently, since they would only have gotten worse service.

There probably is something I don't understand about all this, and I used to put such things down to what my father called the innate animosity of inanimate objects. (We need not go into the fact that I tend to use simpler, plainer, more descriptive Anglo-Saxon words.) But I am beginning to wonder now—perhaps I'm getting old—whether or not we've a right to expect a very complicated machine, such as a receiver, to work right the first time and every time thereafter. Indeed, the very expectation that such machines *ought* to work in that fashion is something of a tribute to the engineers who design systems for putting all that stuff into one relatively little box. After all, who ever said that a turntable had to work as well as a hammer. (No, wiseguy in the back row, that's not what turntables do to records.)

Mostly what my complainers wanted was to have their hands held until the pain and shock of a broken expectation went away. They got that, with an apology from me for perhaps having told them that the equipment they bought after reading our equipment profile would never break down or produce more than 1 per cent THD under any circumstances.

The fact of the matter, as I have indicated above, is that we have come to expect and do actually receive an extremely high level of performance from audio equipment. Further, the state of the art seems to be advanced every couple of years and it is becoming more and more difficult to attain that level of performance at all, let alone consistently.

I'm not suggesting that we ignore shortcomings of components, but rather that we be a bit more tolerant of the service rep. Everybody knows all the jokes about complaint windows, but I've never

seen the owner of a smoking amp joke at all. I certainly wouldn't want to have a job where my only relief from checking transistors, resistors, and capacitors was to have such a guy holler at me. Maybe the next time you take your busted component to be serviced, it might be nice to thank the guy behind the counter for doing something you can't or don't want to do yourself.

## Electronics Design Contest

Motorola HEP Semiconductors has announced a "Design-In," an electronic project design contest offering scholarships totaling \$9,000. Open to students, experimenters, technicians, inventors, teachers, and professional engineers, the contest will run until December 31st of this year.

There are two general categories, with professional engineers in one and everyone else in the other, and equal prizes are being offered for both. Grand prize in each category is a \$2,500 scholarship; first prizes are \$1,000 scholarships; second prizes, \$500 scholarships; and two third prizes in each category are \$250 scholarships.

First elimination judging will start at the close of the contest, with judging based on originality and simplicity of design, usefulness of the project, convenience and ease of construction, and suitability of design. Parts must cost less than \$100 total and must include at least two HEP semiconductors.

Contestants selected for semi-final judging will be provided with all parts required for their project at no cost and will then be expected to construct their projects for final judging by a panel of electronics experts. Contest rules and entry blanks are available from any HEP supplier.

## "Aw, Gee Whiz" Dept.

According to a wire service story, the Clark Equipment Co.'s Industrial Truck Division in Battle Creek, Mich., has installed an anechoic chamber to test lift trucks for noise emission levels. Said to be one of the first of its kind to be used in assisting in the design and manufacture of material handling equipment, the chamber has a "silenced" ventilation system which completely changes air in the room every minute, allowing the instruments to be monitored while a truck is running.

Thank goodness for that silenced vent system. I wouldn't want to be overcome by a lack of emission controls while testing noise controls. *E. P.*



# The best of both worlds— PICKERING'S STATE-OF-THE-ART CARTRIDGES...

Pickering has done it again! In 1957—the *first* American-made magnetic stereo cartridge that helped build the industry was a Pickering. Now—in 1973—the *first* American-made discrete, 4-channel cartridge that will change the world's listening is a Pickering. Today, Pickering invites you to enjoy the *best* of the world of your choice.

## For the world of STEREO— XV-15/1200E

Designed for use with all stereo and four-channel derived compatible systems.

"PRECISION" is the one word that best characterizes the extraordinary quality of the new Pickering XV-15/1200E cartridge, the culmination of Pickering's 25 years in contributing important technological advances to the manufacture of magnetic cartridges. We sincerely feel that the 1200E is the furthest advance achievable today—and perhaps in the foreseeable future—in stereo cartridge design and performance. Its exceptional ability to pick up *all* the material recorded at the lightest possible tracking forces make it totally unique and superior. This cartridge is for the sophisticate—one who possesses components of such superlative quality that the superiority of the XV-15/1200E is a requirement.

And all of Pickering's exhaustive testing shows that the 1200E is superior in the flatness of its frequency response and channel separation in comparison to competitive cartridges.

### SPECIFICATIONS

Frequency Response: 10 Hz to 30 kHz  
 Channel Separation,  
 Nominal: 35 dB  
 Tracking Force:  $\frac{3}{4}$  gram,  $+\frac{1}{2}$  gram,  
 $-\frac{1}{4}$  gram.  
 Nominal Output: 4.4 mv  
 Stylus Tip: 0.0002" x 0.0007"



## For the world of DISCRETE 4-CHANNEL— UV-15/2400Q



Designed and engineered specifically for playback of discrete recordings.

The introduction of the discrete 4-channel system required a completely new cartridge that could not only faithfully reproduce the 20 Hz to 20 kHz AM signals, but also the 30 kHz FM modulated signals. The result is the Pickering UV-15/2400Q discrete 4-channel cartridge, which represents a new level in the state of the art. It consists of a completely redesigned cartridge and a new high performance stylus assembly, the Quadrahedral™, which was specially developed for this application, and features a revolutionary new diamond stylus. The UV-15/2400Q performs in a superior manner by every measurable test, and is capable of satisfying all the technical and aesthetic requirements for playback of all the material recorded on both discrete and stereo disks. Moreover, its stylus is so designed that it not only perfectly reproduces the music recorded, but also reduces record wear.

### SPECIFICATIONS

Frequency Response<sup>2</sup>: 10-50,000 Hz  
 Channel Separation: 35 db  
 Tracking Force<sup>1</sup>: 1-3 grams  
 Output<sup>3</sup>: 3.8 mv  $\pm$ 2 dB  
 Stylus: Quadrahedral

#### Notes:

1. Recommended by manufacturer for optimum performance.
2. When the cartridge is terminated in the recommended load of 100K ohms and 100 PF.
3. Output with reference to 5.5 cm/sec record velocity.

The right Pickering cartridge for your equipment is the best cartridge money can buy.



"for those who can **hear** the difference"

For further information write Pickering & Co., Inc.,  
 Dept. F, 101 Sunnyside Boulevard, Plainview, New York 11803

Check No. 39 on Reader Service Card

# HIGH FIDELITY FROM CASSETTE SYSTEMS

M. B. Martin\*

**T**HE PURPOSE of this article is to discuss a relatively small number of factors which affect the quality of recording and reproduction from cassette tape. The discussion is confined to considerations which came to light as part of the work of developing a new cassette tape and no attempt is made to completely analyze the cassette recording system.

The modern cassette tape system has reached a point where high fidelity sound recording and reproduction is a proven fact and effective competition with the phonograph disc is technically feasible. The development from the high noise, low quality system to the present state has been unusually rapid; one of the reasons being that the standards of tape speed and recorded track width have been adhered to, thus permitting technical development to be applied to improving quality and not to achieving greater economy of tape or providing a larger number of tracks per unit width. In the past, technical improvements in magnetic recording have, to a large extent, been applied to the economics of the system; whereas, with phonograph records, the standards have been fixed over long periods of time permitting developments to be applied to the improvement of quality thus, at the consumer level, the phonograph record has always been able to compete with tape from a quality of sound viewpoint, as well as being a more easily handled medium at a lower price per playing minute.

As part of the design project for a new cassette tape, the cassette recording system was analyzed to better understand demands made upon the recording media by the hardware and current recording standards. The work included a study into the effects of noise reduction systems, the relationships between recording head gap length and coating thickness, and some brief investigation into the energy spectra of music. The latter investigation confirmed the belief that, in many ways, the best method of testing to provide the most meaningful results, in relation to music recording, is to use as the signal source pink noise, the energy of which reduces at the rate of three dB per octave as frequency increases.

## The Test System

Much of the data presented was generated by the use of white or pink noise as the signal source and a General Radio Real Time Analyzer, Type 1921, as the detection system. Frequency response curves, music spectra, and spectrum analysis of noise are printed out by the analyzer on an X-Y Plotter. When white noise is used as the signal source, the analyzer is adjusted to have a sensitivity which reduces by 1 dB for every third octave with increasing frequency; under these conditions a system with a flat frequency response will produce a horizon-

tal line printout. When pink noise is used, the analyzer is set to a flat response so that a system with a flat response will also produce a horizontal line printout.

The frequency response data presented here was analyzed using an integration time of eight seconds, system and tape noise spectra were taken with an integration time of eight seconds, and a variety of integration times up to 32 seconds were used for the analysis of music spectra. This method of taking data has a number of significant advantages; two worthy of mentioning are:

1. Families of related curves can be plotted in a period of time short enough to permit the exclusion of system drift effects from consideration as affecting measurement accuracies.
2. The use of pink noise tests the tape and system under conditions which are a good approximation to those generated by modern music incorporating electronic synthesizers, heavy percussion, and electronically assisted string instruments.

All data presented in this article was taken on recorders which have very low electronics noise and, therefore, the signal-to-noise performance is dependent on the tape characteristics alone. Unfortunately, in real life, this is not always the case; the author has seen more than a few so-called high fidelity cassette recorders where the electronics noise predominates. With modern solid state circuitry, this is unforgivable particularly when, as so often happens, the recording amplifier is so noisy that the recorded noise completely obscures the bias noise of the tape. Obviously, with such a machine, there is no way that a better tape can improve the situation.

## Tapes

Reasonable high fidelity recording and reproduction can be achieved with four classes of tape. Listed in order of appearance on the market as cassette tape, they are:

1. Low noise, high output tapes;
2. Chromium dioxide tapes;
3. Chemically modified gamma ferric oxide tapes—cobalt or  $\text{Fe}_3\text{O}_4$  (magnetite) doped particles, and
4. Highly developed gamma ferric oxide tape such as MRX<sub>2</sub>.

The characteristics of the tapes are determined by the magnetic particle used. Within each of the four categories, there will be differences in performance from manufacturer to manufacturer determined by the differences in the processing and formulations of the binder system used by each company.

Category 1: Low noise, high output tapes, use a magnetic particle which is unmodified gamma ferric oxide ( $\gamma\text{Fe}_2\text{O}_3$ ). The improvement in performance over the earlier ferric oxide tapes is achieved by a reduction of particle size and some improvement in shape. The particle still is troubled by the

\*Memorex Corporation



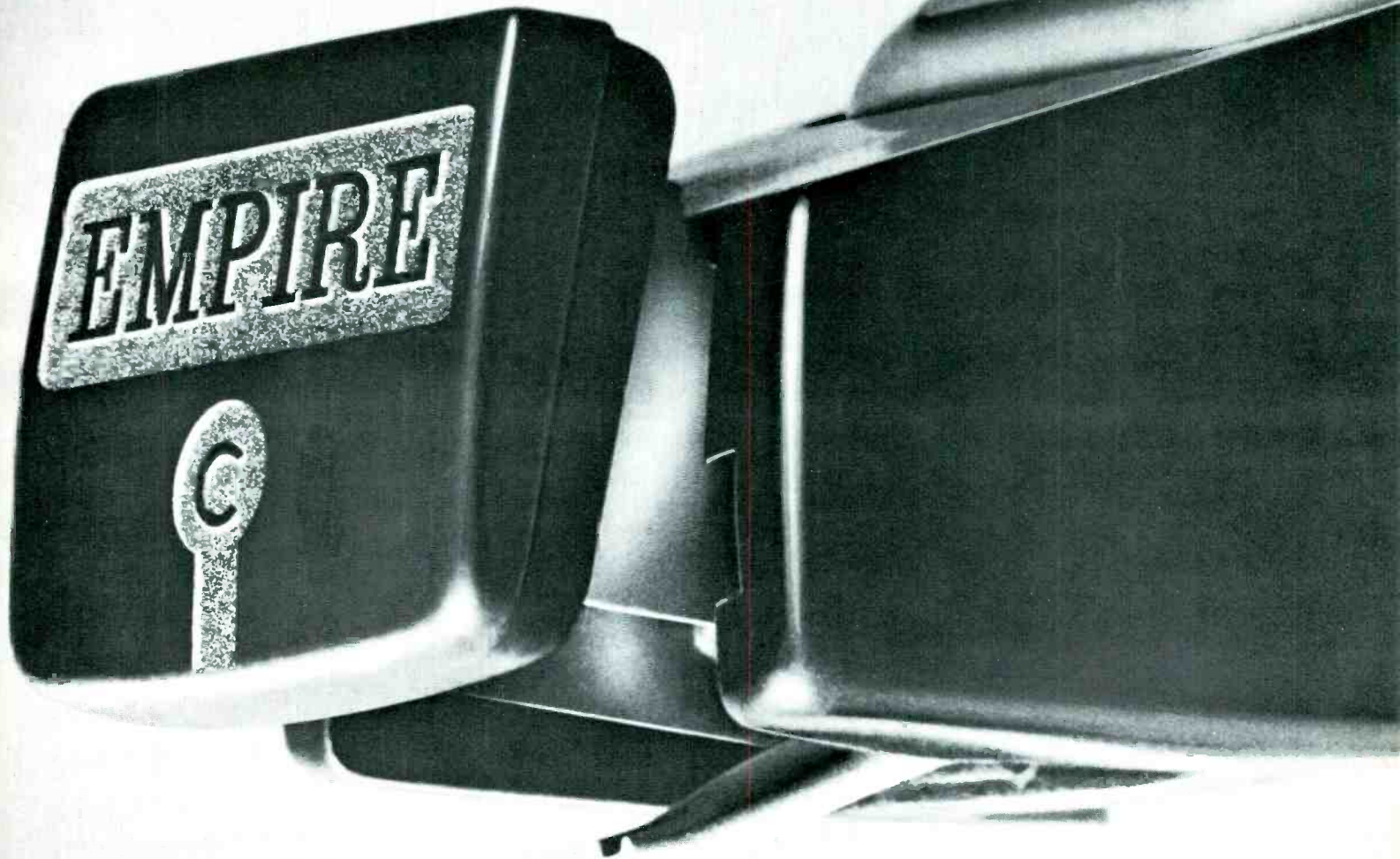

# Facts not double talk about the empire cartridge

## From the critics...

"Separation was tops... square wave response outstanding. We tracked as low as 1/4 gram."

*Audio Magazine, U.S.A.*

"The I.M. distortion at high velocities ranks among the lowest we have measured. A true non-fatiguing cartridge."

*Stereo Review, U.S.A.*

"A design that encourages the hi-fi purist to clap his hands with joy."

*Records and Recording Magazine, Great Britain*

"One of the world's greatest cartridges," Dealer's Choice, Scotty's Stereo

*Sound Magazine, Canada*

"Among the very best. The sound is superb. Frequency response was flat within  $\pm 1\frac{1}{2}$  dB from 20-20,000Hz. Compliance measured 35 x 10<sup>-6</sup> cm/dyne."

*High Fidelity, U.S.A.*

"A real hi fi masterpiece. A remarkable cartridge unlikely to wear out discs any more rapidly than a feather held lightly against the spinning groove."

*Hi-Fi Sound, Great Britain*

"Grand Prize for cartridges in first all Japan Stereo Component competition."

*Radio Gijutsu Magazine, Japan*

## From the public...

"They last a very long time... my first one 12 years", G.M., Hayward, Calif. • "It's 'State of the Art' in performance", D.D., Toledo, Ohio • "The best available", T.D., Utica, N.Y. • "It's fantastic — nothing like it", R.S., N.Y., N.Y. • "Incomparable quality", R.A., Sharon, Pa. • "Made in U.S.A.", H.H., Phila., Pa. • "Your cartridge improved the sound of my system by at least 100 percent", D.D., Riverdale, Md. • "Sounds are clearer, more distinct, really great", L.M., A.P.O., N.Y., N.Y.

# EMPIRE

Write for your free "Empire Guide to Sound Design"

Mfd. U.S.A.

*Empire Scientific Corp.* 1055 Stewart Avenue, Garden City, New York 11530



Check No. 13 on Reader Service Card

presence of protuberances known as dendrites and holes and the important length/width ratio varies from 4:1 to 6:1.

Category 2: Chromium dioxide<sup>2</sup>, is a synthetic compound with magnetic properties that are, in some ways, superior to those of ferric oxide. The fundamental particle size is approximately the same as the iron oxide particles in category 1, but its shape is almost perfect, being a single crystal with a length to width ratio of 8:1 with no dendrites or holes. In addition, the coercivity is higher, 500 oersted as compared with 300 approximately. As a result of the better shape, the particles can be more accurately aligned in the direction of tape travel which, with the high coercivity, results in a much improved magnetic performance at the short wavelengths; i.e., high frequencies.

Category 3: The chemically modified gamma ferric oxide particles, are, in size and form, the same as the pure ferric oxide used in category 1. The improvement in performance is obtained by the addition of carefully controlled small amounts of impurities; either metallic cobalt or magnetite ( $Fe_3O_4$ ),

another oxide of iron. The effect of these impurities is to raise the coercivity of the particle and increase its magnetic efficiency. The formation of the crystal is not improved. Additionally, there is a tendency for chemical instability which results in some magnetic instabilities under certain conditions which can easily occur in practical use. There have been several short-lived attempts to make tapes from these types of particles over the past 38 years. Time alone will tell whether today's particle chemists have solved the problems.

Category 4 uses a pure ferric oxide particle chemically identical with that used in category 1 which means that it has all the inherent stability and other properties which have made  $\gamma Fe_2O_3$  the only wholly successful magnetic compound of iron for tape since its introduction in 1936. The improved performance is obtained entirely because of a perfected crystal shape with a length/width ratio of approximately 10:1. The absence of dendrites and holes gives the tape designer the capability of increasing the magnetic density and, hence, the magnetic efficiency of the coating. Much better orientation is also achieved and the resulting tape is considerably more efficient at all frequencies. Because of the better particle packing, dispersion, and orientation, the undesirable modulation noise effects caused by magnetic discontinuity are significantly reduced. At the time of writing, we believe MRX<sub>2</sub> is the only cassette tape containing this magnetic oxide.

Figure 1 shows the differences in the frequency response of these four categories of tape at 1 1/8 ips when recorded with the bias carefully optimized for each and the signal recorded at a level 20 dB below that level which gives 2% total harmonic distortion at low frequencies. For the purpose of showing the differences in response between these tapes, the recording pre-emphasis was maintained at the optimum for the perfected gamma ferric oxide. The chromium dioxide essentially has the same output; i.e., the same sensitivity at low frequencies as the low noise, high output tape, whereas the cobalt modified and the perfected particle have a higher output at the long wavelengths resulting from approximately 2 dB greater sensitivity and the ability to accept a higher recording signal. The perfected particle also has a greater efficiency at the high frequency or short wavelengths which result in up to 8 dB more sensitivity at 10 kHz at 1 1/8 ips when compared with high output, low noise ferric oxide tapes and about 2.5 dB less sensitivity than chromium dioxide tape.

Figure 2 gives typical bias output curves for each of the four types of tape at three signal frequencies, 333 Hz, 3kHz and 10 kHz. The optimization points for the three ferric oxide tapes are very similar provided the criteria of optimization is that over-bias which reduces 10 kHz signal by 3 1/2 dB. As is well known, chromium dioxide requires approximately 40% more bias current to provide adequate biasing field. Decreasing the bias slightly would obviously improve the high frequency performance; however, this is undesirable from the point of view of long wavelength distortion and it also increases the susceptibility to drop-outs caused by surface asperities.

As with any other magnetic recording system, the highest biasing frequency possible should be used to minimize modulation noise and beat effects. The data given later in this article was taken with a bias frequency of 102 kHz and the even harmonic distortion present in the bias waveform was 0.05% second harmonic. This low even-order harmonic distortion is essential to minimize the effects of d.c. noise and second harmonic distortion of the signal due to unbalanced bias waveform.

### Equalization

The standard replay equalization for cassettes operating at 1 1/8 ips has a bass roll-off created by a circuit with a time

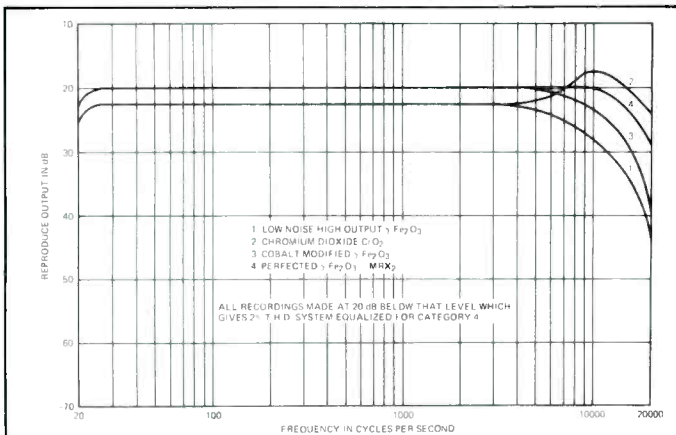

Fig. 1—Comparison of frequency response.

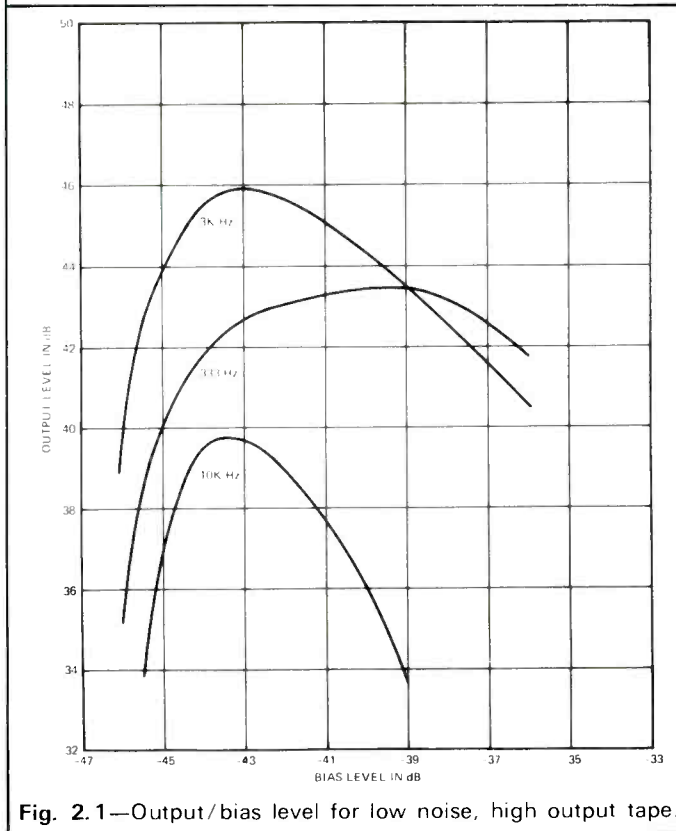

Fig. 2.1—Output/bias level for low noise, high output tape.



# FIRST AGAIN.

All systems in one big, beautiful package. The 900+ multichannel receiver by Harman/Kardon.



Harman/Kardon Inc., 55 Ames Court, Plainview, N.Y. 11803, U.S.A. Also available in Canada.

Check No. 16 on Reader Service Card

constant of 1590 microseconds and a high frequency boost with a 120 microsecond time constant. Recently, a second equalization standard has been proposed to permit fuller use of the characteristics of modern tapes, specifically chromium dioxide. The new proposed standard has a low frequency

roll-off of 3180 microseconds with a 70 microsecond equalization curve at the high frequency and recorders are now on the market which use this proposed standard.

The two replay characteristic curves are shown in Fig. 3. The old standard has the advantage that with improved high frequency performance of tapes, the high frequency compression generated by tape overload is significantly reduced because of the reduced recording pre-emphasis required to produce a flat frequency response. However, under these conditions, the use of chromium dioxide would not significantly improve signal-to-noise ratio of the system when compared with the same system using low noise tape; it would only result in an extended frequency response and reduced modulation noise. The proposed new standard improves the signal-to-noise ratio at the expense of the greater risk of high frequency compression; however, with chromium dioxide, this compression is no worse than with low noise, high output ferric tapes using the 120 micro-second equalization curve. Excellent results can be achieved by using the same recording pre-emphasis for both chromium dioxide and low noise tape

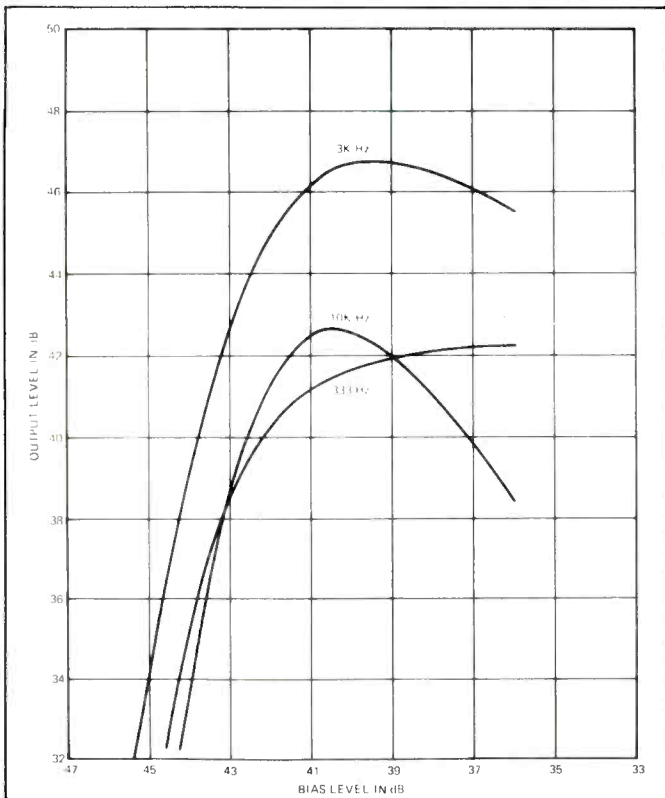

Fig. 2.2—Output/bias level for chromium dioxide tape.

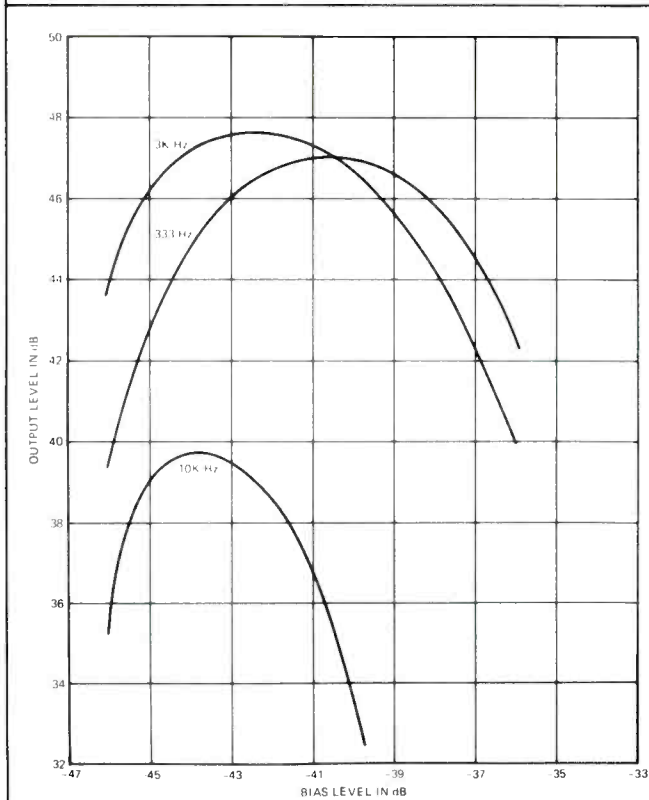

Fig. 2.3—Output/bias level for cobalt modified tape.

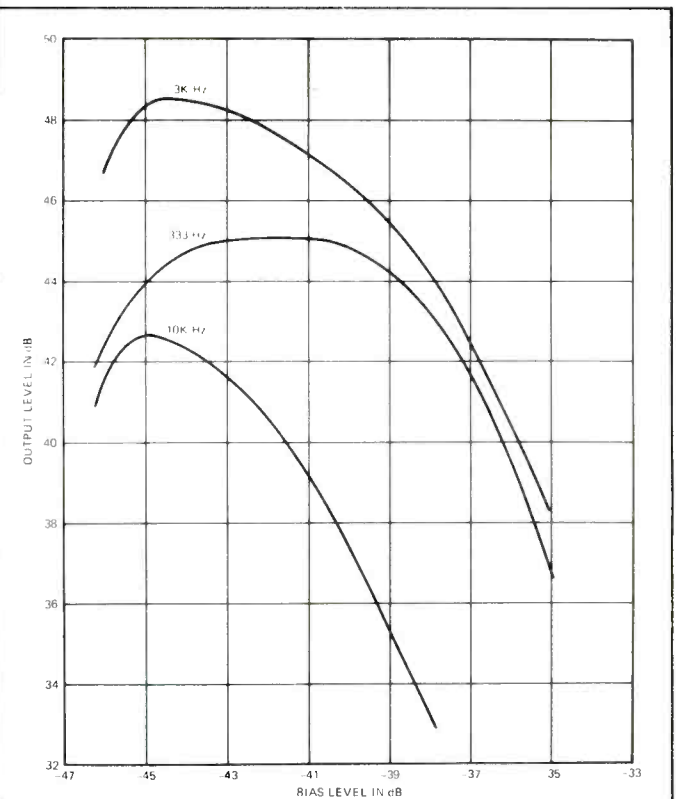

Fig. 2.4—Output/bias level for improved gamma ferric oxide tape.

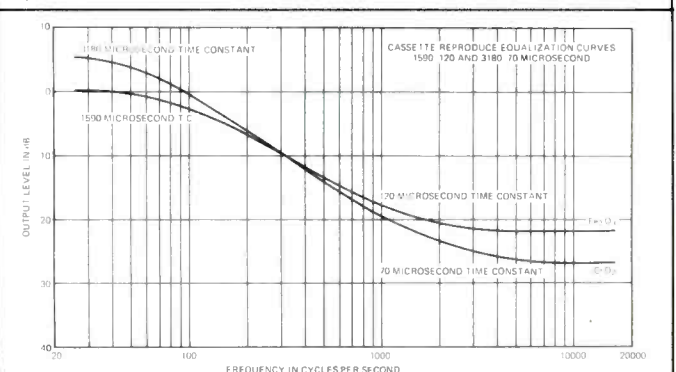

Fig. 3—Equalization energy standards.



Manufacturers often talk and write about performance specifications, particularly their wide frequency range, as an indication of their equipment's quality. But how does this relate to "listening quality"? Speaker manufacturers publish nearly identical specifications—but these are of interest only as theoretical abstractions, since no one can significantly relate them to "listening quality."

Bozak Speakers have only one purpose, we call it the "Bozak Ideal"; to recreate your favorite sounds technically and musically—rock or Bach—in all of their subtle detail and

thrilling power. With clean, true-pitch bass, clearly defined mid-tones and clear, warm treble.

Bozak's Sonora speaks for itself too! Designed especially for those with an ear for superb sound but with limited budget, as well as space, Sonora has more quality for its size than any other bookshelf speaker available. Hear them at your Bozak dealer today. You'll discover that every Bozak is *all* Bozak!

BOZAK, Box 1166, Darien, Conn. 06820  
Overseas Export: Elpa Marketing Industries Inc.  
New Hyde Park, N.Y. 11040

**It's tough  
to compare something  
in a class by  
itself.**

*Bozak*<sup>®</sup>

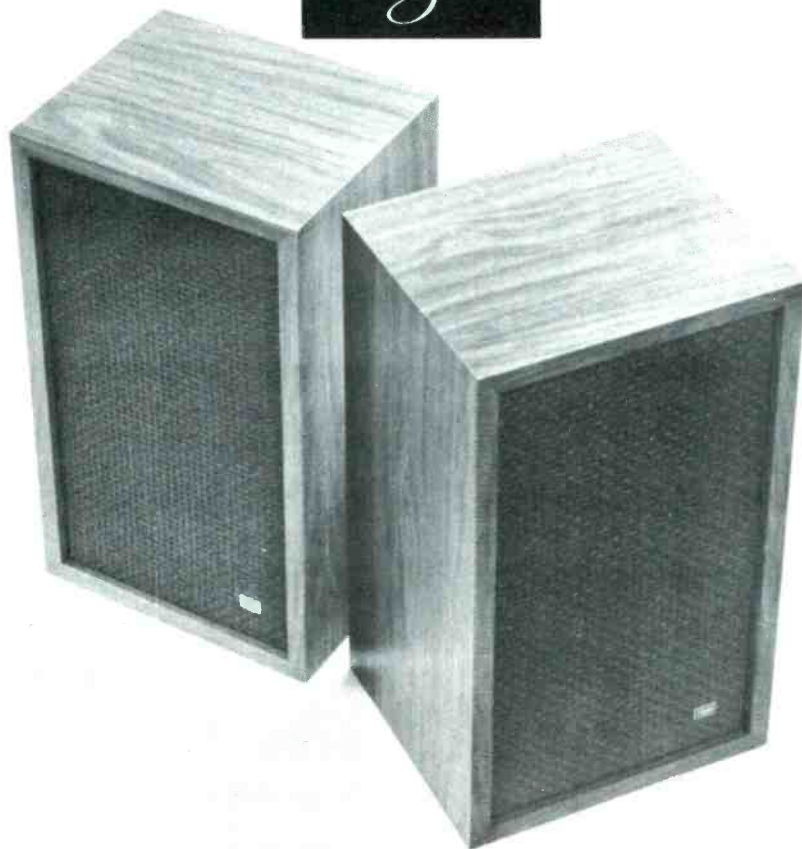

by switching the bias and replay equalization leaving the recording pre-emphasis the same for both tape types.

The change at the low frequency end reduces the risk of low frequency distortion. A good case can be made for eliminating all low frequency pre-emphasis in the recording process and, thus, removing the need for the roll-off at low frequencies on replay. With modern solid state circuitry, the elimination of power line generated noise is relatively simple and inexpensive. The reason for the low frequency de-emphasis on replay was to simplify the electronics designers' problems with hum. The reason no longer exists with cassette tape and the heavy bass which is characteristic of much

modern music makes it painfully difficult for a duplicator to record a satisfactory cassette without low frequency overload. The elimination of this bass equalization would significantly assist in this problem.

### Music

Before considering further the demands placed upon cassette tape by equalization and signal-to-noise ratio improvement systems, it is appropriate to examine the energy spectra of the musical sources available. The most likely source of high quality signal within the scope of the home user is the phonograph record; few users have a better source of quality music, such as high speed master tapes, and with the average standard or quality exhibited by today's FM broadcasters, even when they are transmitting from tape, the transmission quality is such that it rarely reaches the fidelity available from even moderate quality discs.

Analysis of the spectra of two or three disc selections by means of the GR Real Time Analyzer gave the spectra shown in Figs. 4 through 6. Figure 4 is the spectrum of a cymbal crash from Deutsche Grammophon's recording of the Boston Symphony/Steinberg performance of the Holst *Planets* Suite. As can be seen, there is considerable high frequency energy to the limits of the analyzer at 20 kHz and the energy from 125 Hz through 5 kHz approaches a horizontal line which, with the setting of the analyzer used, means that the energy was reducing at the rate of 3 dB per octave with rising frequency. Figure 5 is from a record made by a combination using a wide variety of percussion instruments with very strong electronically generated bass. In this record, energy is concentrated around the bass tones at 80 Hz and falls off fairly rapidly up to the limits of 10 kHz where apparently the record cuts off. Figure 6 is of some Latin American music, using heavy orchestration with percussion, electronic instruments and brass; this disc has an energy spectrum approaching that of pink noise. These examples by no means represent an exhaustive study; however, they do point to the fact that discs can easily be found with a very wide recorded bandwidth and high energy levels at the extremes of the band. The duplicator of music cassettes obviously has to cope with tape masters having energy at high levels over the whole of audible band which present a formidable problem to him.

It would appear from these analyses that the use of pink noise to study the behavior of a recording system is a test technique with greater validity than the use of pure sine waves at discrete frequencies.

The use of recording pre-emphasis which rises at high frequencies at a rate greater than 3 dB per octave will eventually result in tape overload when trying to record, from records such as those analyzed, if the record level indicators do not take account of the modified frequency characteristic created by the pre-emphasis. "Flat" level indication presumably is used by equipment designers on the assumption that musical spectra still conform to the classical spectra published in most of the literature which show considerably reduced energies at the very low frequencies and at frequencies above 5 kHz. Modern orchestration involving the use of synthesizers and electronically reinforced instruments has changed the picture.

### The Compromise

The problem of establishing good high fidelity performance and the choice of equalization resolves itself into a compromise between tape overload or compression at the short wavelengths and a good signal-to-noise ratio. Pre-emphasis in the recording mode reduces the replay equalization necessary at the price of the reduction in high frequency performance at high signal levels with, consequently, high inter-

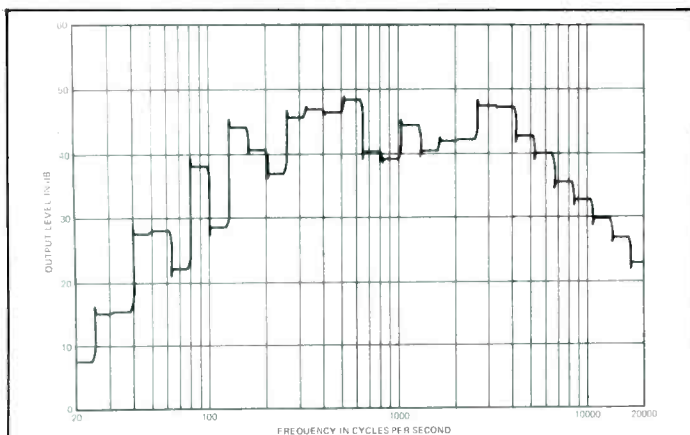

Fig. 4—Recorded frequency spectrum for cymbals in Holst's *Planets*, DG 2530-102.

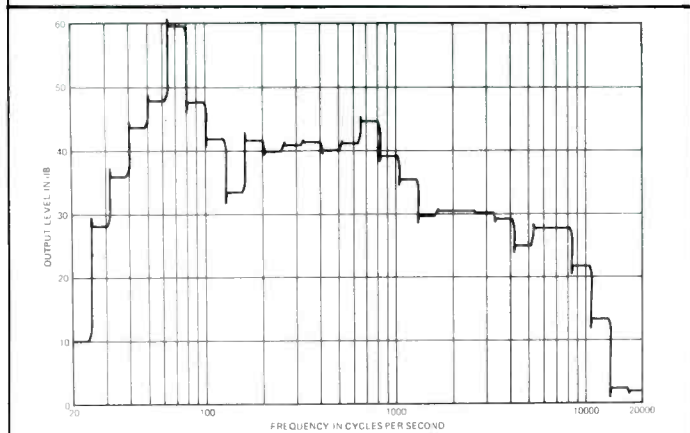

Fig. 5—Recorded energy spectrum for *Mendocino*, Polydor 24-4508.

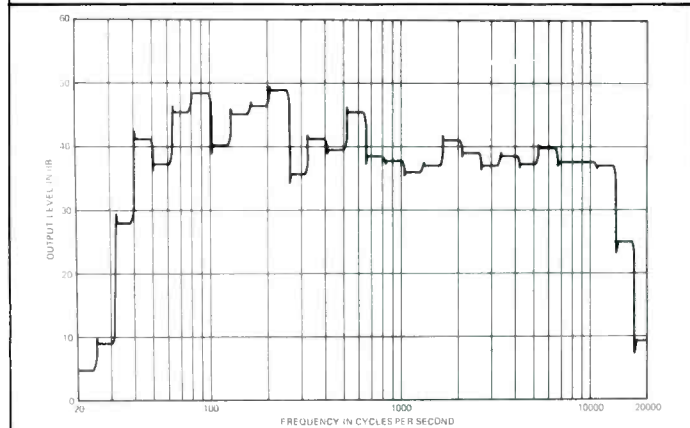

Fig. 6—Recorded energy spectrum for *Happy Brasilia*, Polydor 24-4509.



modulation distortion; the benefit of this choice is that the reproduced tape noise is lower than with a system where most of the equalization for high frequency losses is done on replay.

Within the limits of the existing standards, the biggest contribution the tape designer can make is to increase the sensitivity of the tape and/or maximum usable output from the tape at all frequencies, without deteriorating the fundamental bias noise of the tape or the frequency response and, thus, provide greater output on playback. The tapes developed with this aim include categories with chemically modified particles and the improved gamma ferric oxide particle. As has been stated, chromium dioxide does not increase the sensitivity of the tape over the whole band but does provide much improved performance at the very short wavelengths (i.e., the high frequencies); therefore, it does not meet the goal. The cobalt and magnetite doped gamma ferric oxide particles provide a much increased sensitivity at all frequencies and the improved gamma ferric oxide, of the MRX<sub>2</sub> type, gives a greater improvement in the performance at the short wavelengths. All three types will give an improved signal-to-noise ratio by virtue of replay output which is increased by as much as 4 dB.

The improved gamma ferric oxide tape of category four has the added advantage of significantly improved short wavelength performance which enables the recording pre-emphasis to be reduced by up to 8 dB at 10 kHz at 1 1/2 ips. Thus, with this type of tape, not only is there an improvement in signal-to-noise ratio, there is an improvement in high frequency overload or compression. As will be seen in the following discussion, this reduction in compression improves the situation when signal-to-noise reduction systems such as the B Dolby are used; it results in improvements in system tracking when compared with the response errors which can occur with tapes which have significant compression problems.

### Noise Reduction Systems

For practical purposes, this discussion is limited to the B Dolby signal-to-noise improvement system, since other systems are either similar in behavior or are not seriously affected by the behavior of the recording system. Also, the majority of the machines equipped with a noise reduction system use Dr. Dolby's circuitry and the only "stretched" pre-recorded cassettes in production by duplicators use the B Dolby mode.

During the recording process, the Dolby circuit detects the high frequency levels of the incoming signal. When these signals are below a pre-determined level, the gain of the amplifier is increased to boost the high frequencies before they are recorded; in addition, the frequency at which the boost starts is varied in relation to the HF signal level. The maximum boost at the lowest HF signal level is in the order of 10 dB. No account is taken of the low frequency signal level; low frequencies are recorded unmodified. On replay of the recording, the process is reversed.

From the viewpoint of the tape, the Dolby provides a variable high frequency pre-emphasis, the degree of which is dependent on the high frequency signal level; the lower the level the greater the pre-emphasis. A difficulty with this system is that the degree of tape magnetization does not take account of frequency, but responds to the sum of the energy at all frequencies at any given instant. Therefore, if one has the situation where the low frequency signal level is very high, approaching the usable recording limits, and riding on this high level of bass there is a high frequency signal at lower level, such as sibilance on a voice or a quietly brushed cymbal, the Dolby circuit will boost the level of these high frequencies and can drive the tape further into

high frequency compression. On replay, because of the recording errors, the high frequency signal level is lower than it would have been if there had been no compression; therefore, the Dolby will react to this low level and reduce the gain at high frequencies by an amount which is greater than the boost which was applied during the recording process. The result of this tracking error is a loss of brilliance and an increase in distortion which is not a fundamental fault of the recording system, neither is it a malfunction of the signal-to-noise improvement device.

Figure 7, Curve A, shows the transfer characteristics of a cassette system at 10 kHz using low noise, high output tape. Curve B is the transfer characteristic of 10 kHz recorded and played on the same system in the presence of an 80 Hz tone recorded at "0" level, that is, at the same level as the pronounced energy peak shown in Fig. 5. Curve C is the transfer characteristic of the same 10 kHz signal in the presence of 80 Hz at "0" level but with the use of B Dolby. The increase in compression at the "0" level at 10 kHz caused by the presence of the 80 Hz signal is 1.0 dB and the use of Dolby gives a further response error of 2.0 dB. A more significant problem is probably the increase in distortion; the lower frequencies will produce audible harmonic distortion and the high frequencies whose harmonics are outside the system pass band produce intermodulation products within the replayed bandwidth.

If compression effects described above are to be avoided using conventional tapes and a Dolby stretcher, the recording level must be reduced. This, in turn, reduces the replay level and decreases the basic signal-to-noise ratio which, of course, reduces the effective improvement achieved by the use of the Dolby.

Another effect, which can easily be avoided with the self-contained recorder, but is a little more difficult to establish control over with pre-recorded cassettes using the B Dolby characteristic, is the effect generated when the recorded bandwidth is greater than that which can be reproduced. Most recording systems are capable of recording to shorter wave-

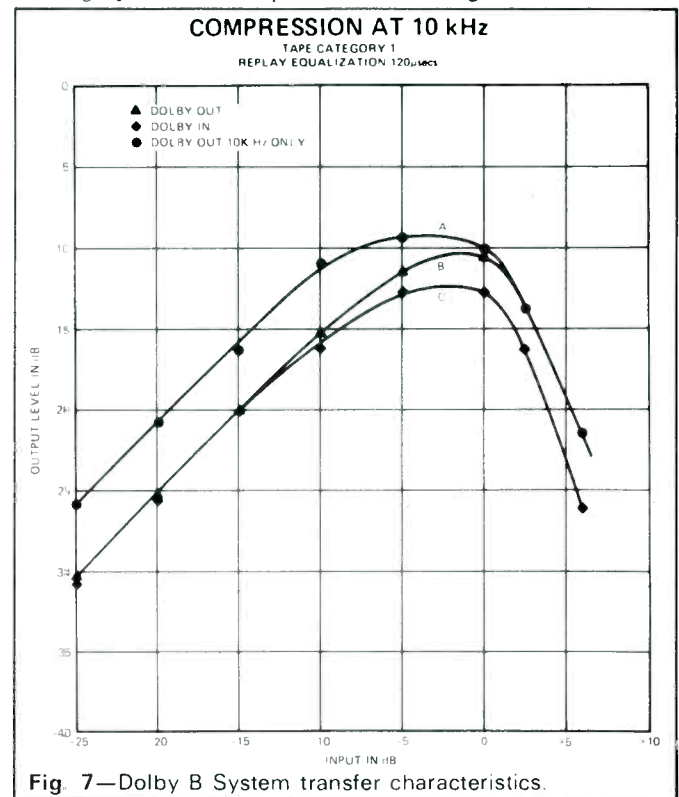

lengths than the replay channel of the recorder can satisfactorily reproduce; the limitation being the replay head gap length. If a wide band signal is received by the recorder such as that shown in Fig. 4, the lower high frequency levels, i.e., from 12 to 20 kHz, will be sensed by the Dolby and be pre-emphasized before recording. If now the recorder only reproduces up to 12 kHz, these signals will not be received by the Dolby circuit on replay. Therefore, the Dolby loop is not correctly closed and there is no corresponding reaction from the replay circuit to correct the level change generated in the recording mode. In a severe case, this tracking error results in a frequency response with a significant dip at low levels in frequencies around 5 kHz as shown in Fig. 8. The fre-

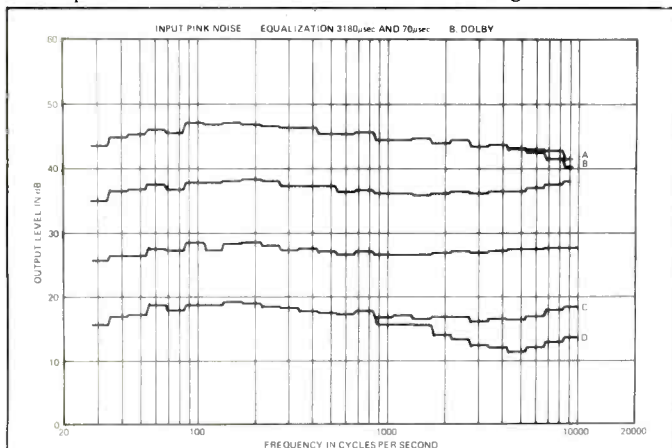

Fig. 8—Bandwidth mistracking.

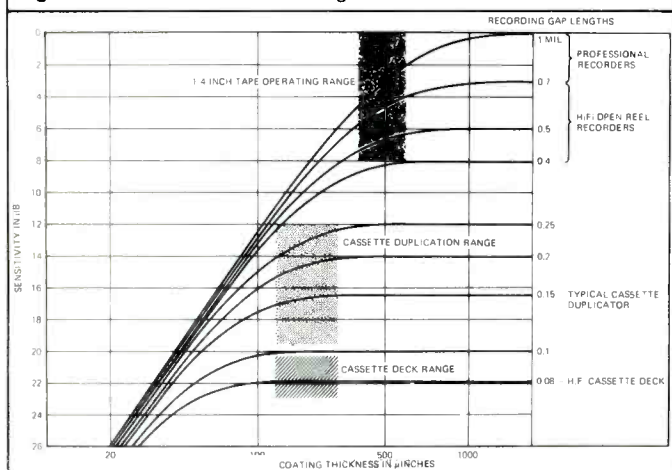

Fig. 9—Recording gap length effects.

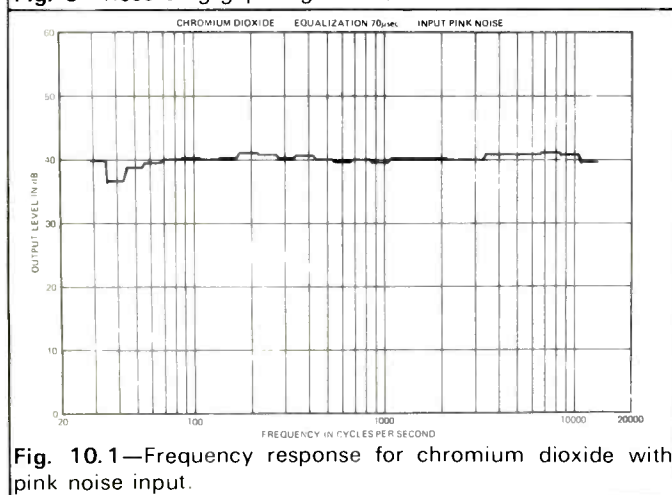

Fig. 10.1—Frequency response for chromium dioxide with pink noise input.

quency responses shown in Fig. 8 are taken at 10 dB intervals with the top one at a level equivalent to maximum recording level. Responses B and D are taken with the recording bandwidth wide open and A and C were the controlled recording bandwidth. The mid-frequencies would not be significantly boosted during the recording process, but on replay the B Dolby HF gain reduces to its minimum because of the much reduced high frequency energy in the replay signal. A possible solution to this problem for the duplicator is to limit the bandwidth which activates the Dolby, during the recording of music cassettes, to about 10 kHz. With a cassette recorder, another solution is to design the recording amplifier to have the same bandwidth as the replay system.

### Recording Gap Length

The full presentation of the study into the gap-length/coating thickness relationship will be published as a separate article. However, it is appropriate for the purposes of this article to publish the theoretical relationships shown in Fig. 9. These have been verified experimentally. As can be seen with recording gaps which are shorter than the coating thickness, the performance of the tape/record head combination is not dependent on the coating thickness because they do not utilize the whole coating. Gaps which are significantly longer than the coating thickness record through the whole of the magnetic layer and, therefore, the sensitivity of the system at long wavelengths is coating thickness dependent.

Apart from the fact that a duplicator operates at speeds which are much higher than 1 1/8 ips, the principal difference between recording on a duplicator and a consumer cassette recorder lies in the dimension of the recording head gap. Most duplicators use special record heads whose gaps are in the region of 150 microinches to 400 microinches long, whereas the consumer machines use dual purpose heads which have a gap whose dimensions are determined by the desired replay performance. On high fidelity machines intended to record and play frequencies up to 15 kHz, an 80 microinch or smaller gap is essential. Typical cassette tape coating thicknesses lie in the range from 120 microinches for C-120 product to 250 microinches for some C-60's.

The development of higher efficiency ferric oxide particles of the type used in MRX<sub>2</sub> tape gives the tape designer the freedom to optimize the coating thickness for overall performance on a duplicator at coating thicknesses considerably thinner than has been the former practice. This has several advantages:

1. The coating thickness can optimize to the biasing requirements at the short wavelengths without sacrificing distortion and output at the long wavelengths and this bias can be adjusted to be approximately the same as with conventional gamma ferric oxide tapes when using a typical duplicator record head. Because of the improvements in the oxide, the output available from the thinner coating is 4 dB greater than with high output low noise tapes at low frequencies and 8 dB at high frequencies.
2. The same coating thickness can be used for all configurations.
3. The thin coating of approximately 130 microinches does not sacrifice any performance when used in a blank cassette on a consumer machine.

### Practical Systems

Two separate high fidelity systems have been used for tape evaluation and the parameters chosen for both systems are based on the study described and utilized consumer type cassette decks carefully adjusted to meet our requirements. Most of the listening tests and demonstrations of recorded quality have been performed without the use of any noise



# There are some things you'll appreciate about a Dual right away. Others will take years.

You can appreciate some things about a Dual turntable right in your dealer's showroom: its clean functional appearance, the precision of its tonearm adjustments and its smooth, quiet operation.

The exceptional engineering and manufacturing care that go into every Dual turntable may take years to appreciate. Only then will you actually experience, play after play, Dual's precision and reliability. And how year after year, Dual protects your precious records; probably your biggest investment in musical enjoyment.

## It takes more than features.

If you know someone who has owned a Dual for several years, you've probably heard all this from him. But you may also wish to know what makes a Dual so different from other automatic turntables which seem to offer many of the same features. For example, such Dual innovations as: gimbal tonearm suspensions, separate anti-skating scales for conical and elliptical styli, and rotating single play spindles.

It's one thing to copy a Dual feature; it's quite another thing to match the precision with which Duals are built.

## The gimbal, for example.

A case in point is the tonearm suspension. Dual was the first manufacturer of automatics to offer a true twin-ring gimbal suspension. More importantly, every Dual gimbal is hand assembled and individually tested with precision instruments especially developed by Dual. The vertical bearing friction of this gimbal is specified at 0.007 gram, and quality control procedures assure that every unit will meet this

specification. Only by maintaining this kind of tolerance can tonearm calibrations for stylus pressure and anti-skating be set with perfect accuracy.

Other Dual features are built with similar precision. The rotor of every Dual motor is dynamically balanced in all planes of motion. Additionally, each motor pulley and drive wheel is individually examined with special instruments to assure perfect concentricity.

## The Dual guarantee.

Despite all this precision and refinement, Dual turntables are ruggedly built, and need not be babied. Which accounts for Dual's unparalleled record of reliability, an achievement no other manufacturer can copy. Your Dual includes a full year parts and labor guarantee; up to four times the guarantee that other automatic turntables offer.

If you'd like to read what several independent testing laboratories have said about Dual turntables, we'll be pleased to send you reprints of their impartial reports. To appreciate Dual performance first hand, we suggest you visit your franchised United Audio dealer.

But your full appreciation of Dual precision won't really begin until a Dual is in your system and you hear the difference it will make on your own records.

Play after play. Year after year.



**Dual**<sup>®</sup>

United Audio Products, Inc., 120 So. Columbus Ave., Mt. Vernon, N.Y. 10553  
Exclusive U.S. Distribution Agency for Dual.

Check No. 44 on Reader Service Card

reduction system; although some testing has been carried out to determine whether the data presented earlier is, in fact, important in relation to what is heard. The recordings used were made from very high quality 15 ips stereo masters and which have recorded signals at significant levels to 20 kHz. There is little doubt that where the high frequency energy is present in the input signal, the variable frequency response generated by the B Dolby System is audibly worse than with the same tape and recorder used without the Dolby in circuit. Apart from this reason, the noise reduction system was not used because the objective of our study was to evaluate tapes under development; for this purpose it is better to compare tape performance with as little intrusion from electronics as possible.

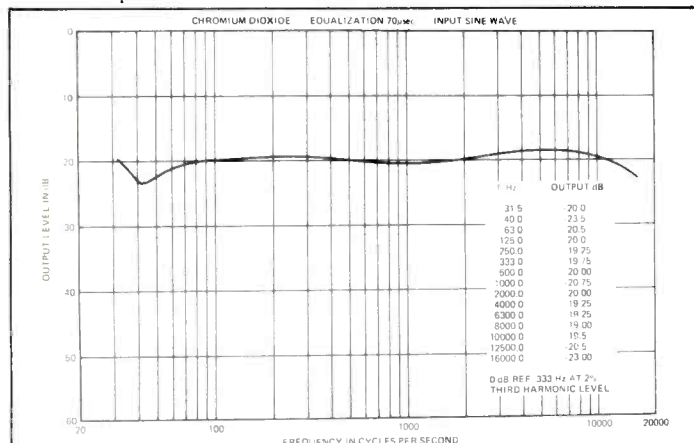

Fig. 10.2—Frequency response for chromium dioxide with sine wave input.

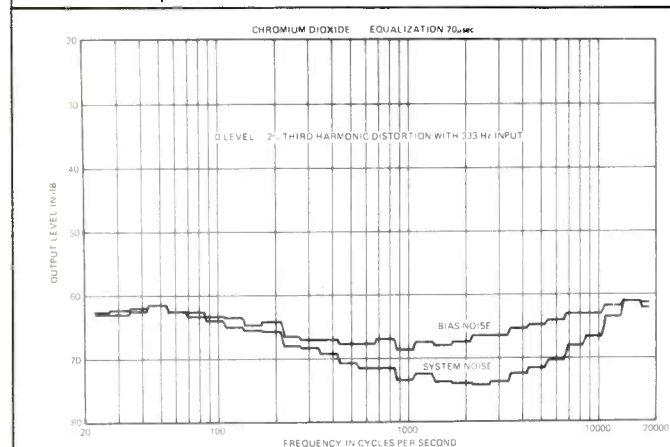

Fig. 11—System and bias noise for chromium dioxide.

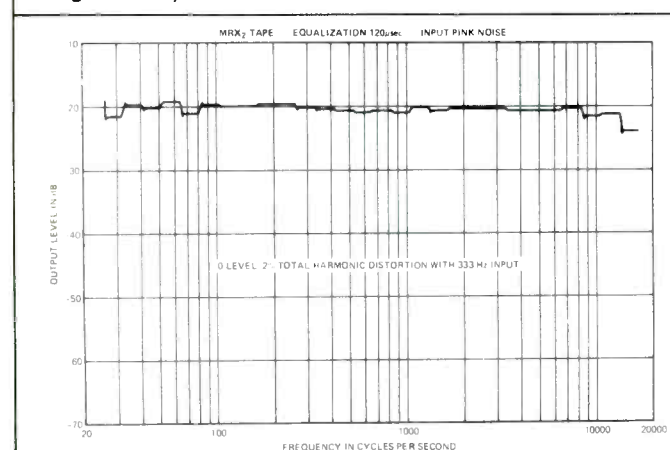

Fig. 12—Frequency response for improved gamma ferric oxide tape.

The first system was designed for chromium dioxide and incorporated the new proposed replay equalization at 3180 microsecond bass curve and 70 microsecond treble curve. Figures 10 and 11 respectively give the frequency response and the noise spectra of this system using Memorex chromium dioxide tape. As a matter of interest, the response is presented in the form generated by the noise/analyzer system and the more conventional presentation taken manually with sine wave signals. The dip in the response at 40 Hz is caused by the contour of the record/play head. The unweighted signal-to-noise ratio is 53 dB referred to 333 Hz at the level which gives 2% total harmonic distortion. At mid-frequencies, the slot noise is -65 dB.

The second system used for the improved gamma ferric oxide MRX<sub>2</sub> used the standard replay system of 1590 microsecond bass curve and 120 microsecond HF curve. The response of this system is shown in Fig. 12; Fig. 13 shows the spectra of the bias and the system noise. The unweighted signal-to-noise ratio is 52.5 dB referred to 333 Hz and 2% total harmonic distortion and the slot noise is 71 dB at mid-frequencies. The excellent signal-to-noise ratio of the MRX<sub>2</sub> ferric oxide system is due to the 2 dB extra sensitivity of this tape at long wavelengths plus the capability of accepting 2 dB more recording drive without the bias noise having been deteriorated in comparison to low noise high output tapes. Thus, the unweighted signal-to-noise ratio is 4 dB better than one would obtain from standard ferric oxide particles. The slot noise at mid-frequency is 6 dB better than with chromium dioxide but because the 120 microsecond replay equalization was used for MRX<sub>2</sub> and the 70 microsecond for chromium dioxide, the final signal/noise ratios are approximately the same. However, MRX<sub>2</sub> exhibits less high frequency compression than chromium dioxide when the two tapes are equalized in these differing manners.

### Acknowledgements

The author wishes to acknowledge the excellent experimental work carried out by Mr. Roy F. Nelson of Memorex Corporation, Audio/Video Group, without which this article would not have been possible. The curves for the recording head gap/coating thickness relationships were calculated by Mr. E. D. Daniel.

### References

- <sup>1</sup>*Acoustical Tests and Measurements*, Davis; Published by Howard W. Sams and Company, Inc.; Page 60.
- <sup>2</sup>*Chromium Dioxide Audio Cassette Tape*, Jordan, Kerr and Dickens; *Journal of the Audio Engineering Society*, January/February 1972.

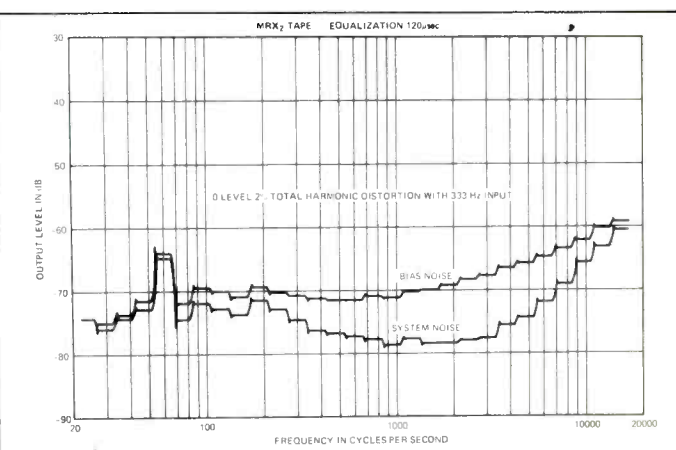

Fig. 13—System and bias noise for improved gamma ferric oxide tape.



# Dolby B-Type Noise Reduction System - Part 2

Robert Berkovitz and Kenneth Gundry\*

## The Dolby B-Type Noise Reduction System

The Dolby B-Type circuit is a specialized form of compandor which avoids the usual deficiencies of compandors. The operational principle of the B-Type system is complementary low-level compression and expansion in a frequency range which varies in bandwidth as the signal changes.

Most objectionable noise encountered in home listening is at middle and high frequencies, from about 500 Hz to the upper limit of audibility. In the interest of circuit economy, the action of the B-Type circuit has therefore been limited to this range. A feedback control circuit adjusts system parameters automatically as a function of signal level and spectrum, so that the system's action complements the psycho-acoustic masking of noise which occurs naturally in the course of the program. A block diagram of a Dolby type of noise reduction system is shown in Fig. 3. The circuits used for encoding (during recording or transmission) and decoding (during playback or reception) are quite similar and can be considered as the same circuit, switched to operate in either mode.

The compression and expansion characteristics of the Dolby B-System are fixed and are referred to Dolby Level, a specific internationally standardized reference level. In the case of cassette tape, Dolby Level is a flux of 200 nWb/m; in FM broadcasting, Dolby Level is  $\pm 37.5$  kHz deviation.

Figure 4 is a block diagram of a switchable (encode-decode) B-Type circuit. There are two paths which the input signal follows: a *main path* (at the lower part of the figure) in which no change other than linear amplification occurs, and a *secondary path*, a variable filter through which only low-level, high frequency components of the input signal are allowed to pass. To encode the signal, the output of the secondary path is combined with signal in the main path *additively*; this boosts low-level, high frequency portions of the signal. Decoding is accomplished by feeding the secondary path from the circuit output, which is opposite in phase to the input (note phase inverter in Fig. 4); the secondary path is then part of an a.c. negative feedback loop which reduces output, i.e., the output of the secondary path is combined with the main path *subtractively*. In the decode mode, therefore, the circuit reduces the level of precisely the same information which was increased in level during encoding.

\*Dolby Laboratories, Inc.

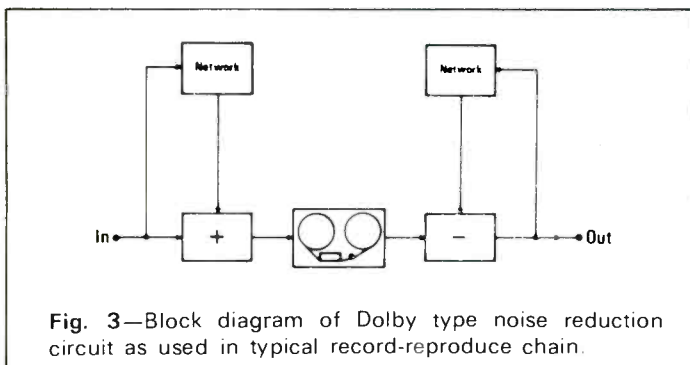

As Fig. 4 indicates, the action of the B-Type circuit is controlled by the output of the filter in the secondary path. Above a fixed threshold level, the bandpass of the filter, in turn, is modified by the d.c. feedback loop.

At very low levels, i.e., below the threshold, which at high frequencies is about 40 dB below Dolby Level, the output of the filter is not sufficient to generate d.c. feedback; consequently, the output of the secondary path is simply proportional to signal level within the filter pass band. The output of the circuit is then essentially as shown in Fig. 5.

As signal level rises above the threshold level, the rectified filter output is returned to the FET gate where it is applied as negative feedback, raising the filter cutoff frequency so that the output of the secondary path, while still increasing, no longer does so in proportion to the change in signal level. As signal level becomes even larger, the increasing d.c.

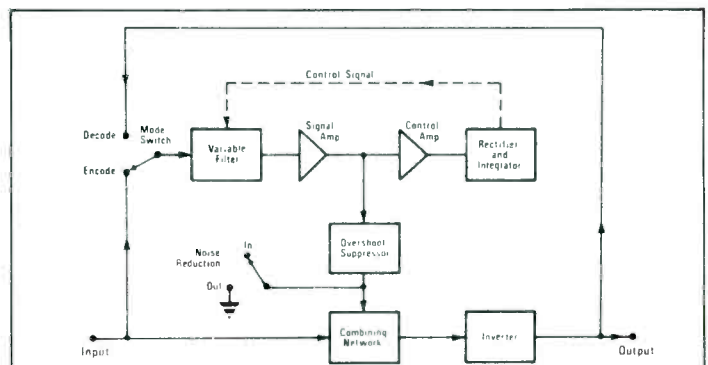

Fig. 4—Block diagram of Dolby B-Type noise reduction circuit. The configuration shown can be switched to encode or decode the signal.

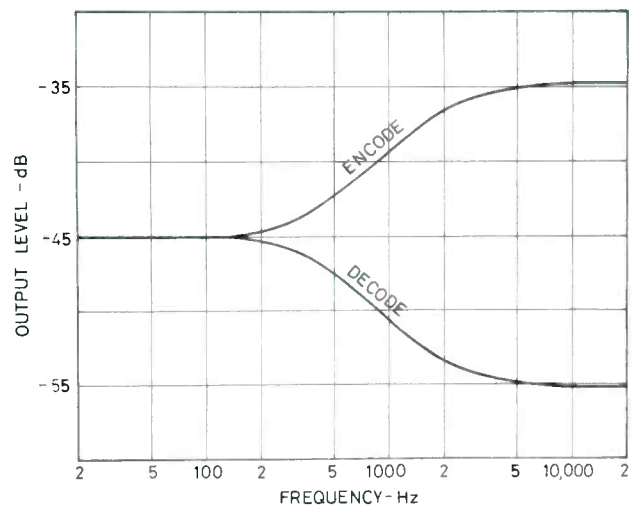

Fig. 5—Output of B-Type encoder and decoder circuits under low-level input signal conditions. The two operations are symmetrical and the result is an overall frequency response which is level.

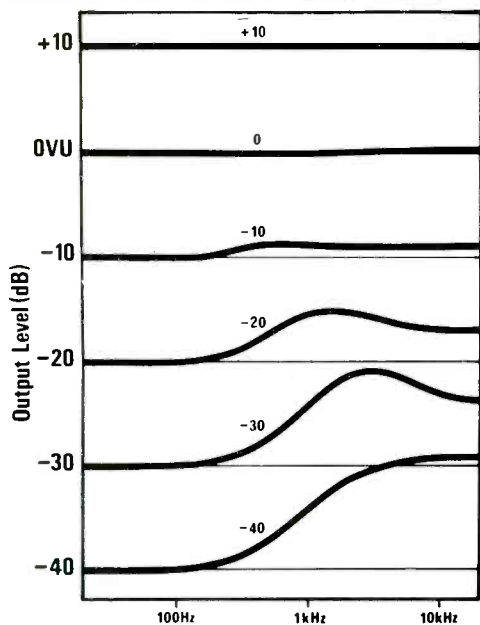

Fig. 6—Characteristics of encoding processor at several levels. The gradual reduction in boost with increasing level avoids possible tape overload.

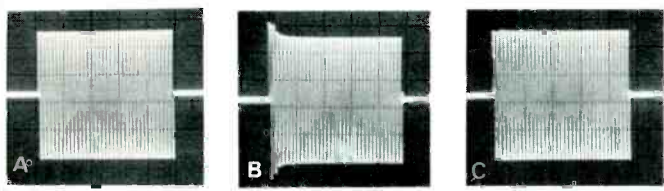

Fig. 7—Effect of the B-Type circuit on a tone burst; frequency = 3 kHz; burst duration, 12 milliseconds; low level = 40 dB; high level = +6 dB; (A) Input to system; (B) Encoded. (C) Encoded and Decoded.

feedback generated restricts the filter bandwidth further, and near Dolby Level the output of the secondary path remains relatively constant. The net effect is that the secondary path has no audible effect on output at low frequencies, and increasing effect with increasing frequency and decreasing level to about 40 dB below Dolby Level. At high levels, the effect of the extra signal is so small as to have no significance; at low levels, in the spectral region in which noise reduction is required, the increase during encoding is as much as 10 dB, and is of considerable importance.

The manner in which the secondary path changes from constant-gain to constant-output is determined by the adjustment of gain within the feedback loop. In addition, the exact variation in filter bandpass with changing level is set optimally by making the control amplifier frequency-dependent. The overall frequency response of a B-Type encoder circuit for different input levels is shown in Fig. 6.

A compander operating over a wide frequency range must be designed to take into account the problem of noise modulation discussed above. If some high-level passages in the program differ sufficiently in frequency content from the noise components present, the latter will remain audible during the program in many cases. However, these passages cannot be increased in level when encoded, because of the danger of overmodulation. Under these conditions, compression may be applied intermittently, and high-frequency noise modulated audibly by mid-frequency components of the signal. The B-Type circuit overcomes this problem because it continues to function when a high-level signal occurs within its operating range; instead the feedback control shifts the range upward in frequency. This avoids the danger of overmodulation, but retains full noise reduction at frequencies higher than those masked by the signal.

The attack time of the B-Type circuit is dependent on the amount and rapidity of the signal change, due to the non-linear design of the integrator, varying from about 100 milliseconds to as little as 1 millisecond. The recovery time of the rectifier-integrator is shorter than that of the human hearing system, about 100 milliseconds.

All compressors exhibit overshoot, including the B-Type

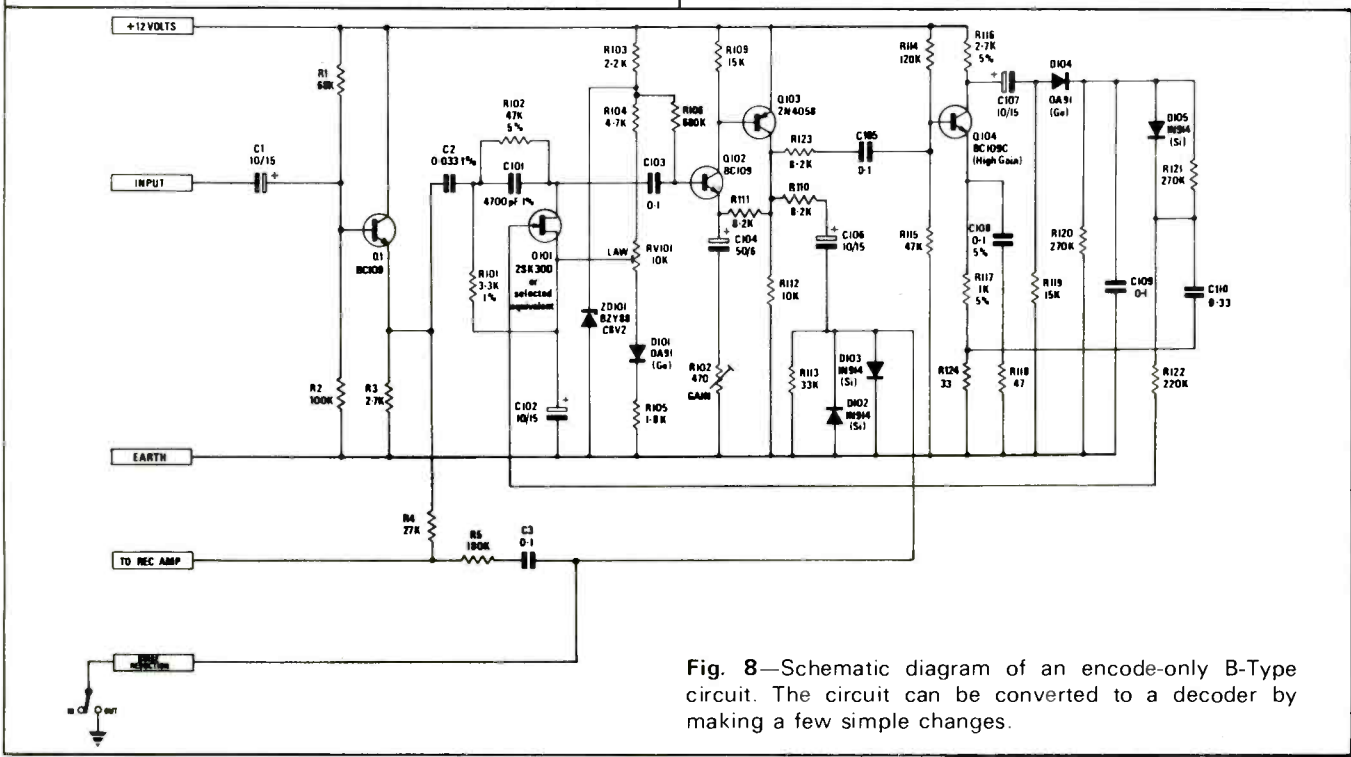

Fig. 8—Schematic diagram of an encode-only B-Type circuit. The circuit can be converted to a decoder by making a few simple changes.



circuit. However, the dual-path approach used makes it possible to reduce the amplitude of overshoots significantly. Overshoot, which can occur only in the secondary path (where it can be suppressed without affecting the main signal) is comparatively small, and essentially disappears when the signal is decoded again. When signal levels are low, or when changes in signal level take place slowly, there is no overshoot problem; when signal changes are large and rapid, diodes in the overshoot suppressor stage limit the peaks of the overshoot. Since this takes place in the secondary path, the result of the suppressor action is to limit overshoot to a relatively small fraction of the full-level main path signal. Further, by restricting overshoot suppression to the secondary path, it is possible to avoid introducing audible distortion to the encoded signal. Because a complementary action takes place during decoding, the small remaining overshoot in the encoded signal is eliminated, and as with other effects produced during encoding, the original signal is restored. Figure 7 shows the result of encoding and decoding a short burst of 3 kHz. which changes in level from -40 dB to +6 dB.

Figure 8 is a typical schematic diagram of an encode-only B-Type circuit; the circuit for decoding-only is similar. As can be seen, only five transistors plus an FET are required; the parts cost of the circuit is approximately \$2.40.

Figure 9 is the schematic diagram of a B-Type processor which has been designed to integrate noise reduction with other tape recorder electronics requirements as much as possible. The resulting circuit provides 26 dB of gain, whether or not noise reduction is in use, bias and multiplex filtering, and meter and monitor amplifiers. In fact, the only additional electronics needed to complete the recorder are a bias oscillator, recording amplifier (one transistor) and a

microphone and head amplifier (two transistors). With the active elements used in the record/play switchable processor shown (eight transistors and one FET), the total used in the recorder, for two channels, is 22 transistors and two FET's. The cost to a manufacturer of the components shown in Fig. 9 is about \$3.20, excluding the bias and multiplex filter components, which are, of course, necessary in the circuits of any properly designed tuner and recorder.

Dolby Laboratories and Signetics have collaborated in the development of an integrated-circuit version of the B-Type circuit. The IC is expected to offer manufacturers economy of assembly, elimination of adjustments, and somewhat smaller space requirement than the discrete-component version.

The characteristics of Dolby B-Type noise reduction can be summarized as follows:

1. Program recovery characteristics, with regard to frequency response, phase response, transients, and signal dynamics, are theoretically perfect; in practice, this ideal is attainable to any desired accuracy. Distortion in practical B-Type circuitry is considerably lower than that of the tape recorders or tuners with which it is used. Any type of program material can be encoded and decoded without audible loss.
2. The circuit is simple, inexpensive, and small in size, either in discrete-component or IC form.
3. The circuit is easy to manufacture and use because of the absence of critical components or adjustments. The circuit can be quickly and easily calibrated during manufacture, after which further calibration is not required. In use, only a simple level adjustment is necessary if tape of significantly different sensitivity is substituted for that formerly used.
4. No modification of broadcasting or duplicating practice is required to incorporate B-Type encoding. The use of the noise reduction system often makes worthwhile other im-

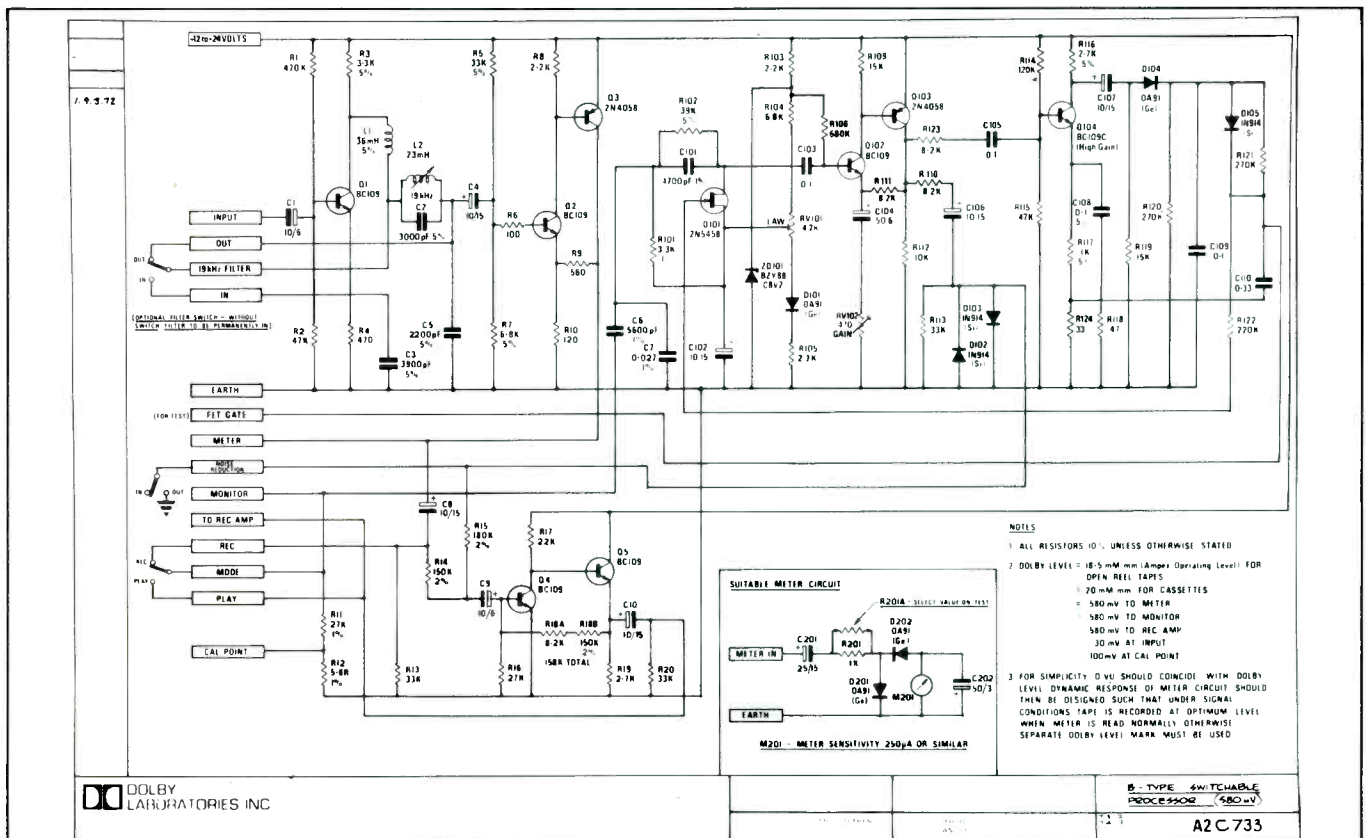

Fig. 9—Schematic diagram of complete switchable encode/decode circuit for use in tape recorder, including HF filtering, meter drive, monitor output and 26 dB of

gain. Only a few more parts need be added to make complete record/play electronics for one channel of the recorder.

provements, however, such as extension of frequency response and dynamic range, or reduction of distortion by use of lower modulation levels, or some combination of these.

### Effects Upon Noise Spectra

Figure 10 is a multiple exposure of the screen of a 1/3-octave real-time analyzer, allowing a direct comparison of the noise spectra at the output of a high-quality cassette recorder when different kinds of tape were used with and without the Dolby B-Type noise reduction circuit. Curve 1 is that produced by C90 ferric oxide tape; curve 2 is that of C90 chromium dioxide tape; curve 3 is produced by the same tape used for curve 1, but the B-Type circuit is switched "in;" and curve 4 represents the noise spectrum of the chromium dioxide tape with the circuit in. The tapes shown were biased before the measurements were made; no changes in gain or other control settings were made during the tests, other than to set equalization differently for the chromium dioxide tape from (70 microsecond). In fact, most of the improvement in noise level obtained when chromium dioxide tape is used appears to be due to the change in equalization; if this change is not made, there is little advantage in chromium dioxide tape from a noise point of view. On the other hand, the combination of chromium dioxide tape, 70 microsecond equalization, and B-Type noise reduction results in an excellent noise figure, 57 dB below Dolby Level in the example in the photograph (DIN 45405).

The advantages of B-Type noise reduction are also obtained when the system is used for FM broadcast transmission and reception, i.e., the improvement in signal-to-noise ratio obtained by use of the B-Type circuit is approximately the same as that produced by a 10 dB increase in field strength. The significance of this improvement can be appreciated when it is realized that such an increase would usually require an increase in transmitter power by a factor of ten. Considerable experimentation and broadcast experience in the USA have demonstrated, as one would expect, that the area in which listening is satisfactory is greatly extended by use of the B-Type noise reduction system. Several American classical music FM stations are already broadcasting full-time using Dolby B-encoding.

### Compatibility

When any improvement is made in a system as widely used as the compact cassette system, it is highly important that

the new development should be fully compatible with existing equipment. Improved cassettes must be playable on any machine which can play old-type cassettes, and fortunately this is true of Dolby B-Type cassettes. Such cassettes are subjectively compatible (i.e., generally pleasing to the listener) when played without decoding circuitry, to a great extent because of the unique approach taken in the B-Type circuit. Because most low-cost cassette machines are deficient in high-frequency response, the increase in low-level high frequency content in a B-Type cassette is usually welcomed by listeners with such equipment. Cassette recorders of higher quality, or the associated equipment with which they are used, contain tone controls which permit the balance to be adjusted to suit the taste of the listener. It is quite likely that many of the millions of B-Type encoded cassettes which have been made commercially are owned and played by listeners who are unaware of the special nature of the program material they hear. In any case, the subjective difference between encoded and other cassettes is sufficiently unobtrusive that none of the recording companies offering "Dolbyized" cassettes have found it necessary to offer old-type cassettes as an alternative.

It is worth noting that almost all pre-recorded cassettes are already compressed, for only in this way can the audibility of low-level passages be preserved in programs of wide dynamic range. B-Type cassettes differ mainly in that the listener now is able to remove the compression by pushing a button on his cassette machine restoring program dynamics and reducing noise. This is only possible because B-Type compression is standardized, while other types of compression vary considerably.

### Commercial Use

Within a few years of its introduction, the Dolby B-Type noise reduction system has been licensed to most major manufacturers of consumer tape recorders. At the present time there are more than 40 licensees manufacturing over 100 different B-Type products. Licensee payments for use of the circuit are on a sliding scale, based on quantity, from a maximum of 50¢ (U.S.) to 10¢ per circuit. Royalty charges are typically 60¢ per stereo unit for a major manufacturer.

In addition, most of the pre-recorded cassettes now made in the United States, the United Kingdom and Japan are "Dolbyized," and many of the largest recording companies issue their cassette output in this form, among them Ampeg and CBS in the United States, Decca and RCA in England, and CBS-Sony, Nippon Columbia, King, and Apollon in Japan. Pre-recorded open-reel tapes and 8-track cartridges are also becoming available. In the United States, a number of FM stations have already started to broadcast regularly in B-Type encoded form, and this procedure is under study in other countries as well. There is no royalty payable for encoding cassettes or other tape recordings, or broadcasts.

### Conclusions

The reduction of background noise by the Dolby B-Type noise reduction system has contributed importantly to the improvement in quality of home tape recording and playback. It has helped to make the extension of frequency response, the reduction of wow and flutter, and other improvements worthwhile, particularly in cassettes. The unique characteristics of the B-Type system permit excellent noise reduction without program losses, noise modulation and other drawbacks which have afflicted earlier attempts to solve the noise problem. The simplicity and economy of the B-Type circuit facilitate its use in consumer products at all price levels.

AE

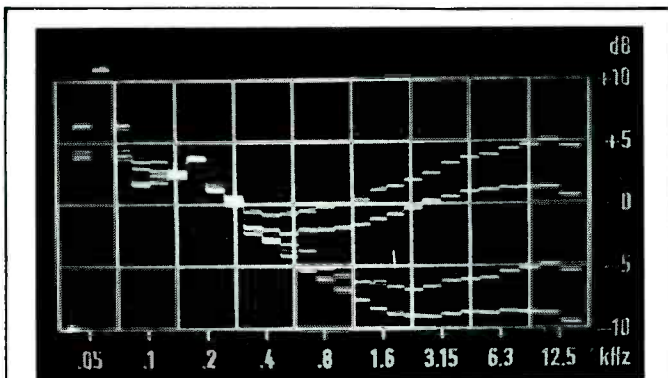

Fig. 10—Noise spectra at output of cassette recorder during playback of four kinds of tape. All tape was biased and control settings were the same for the four tests. (1) Ferric oxide C90 low-noise, -45.7 dB DIN 45405; (2) Chromium dioxide C90, -48 dB; (3) Same as (1) with B-Type noise reduction, -55 dB; (4) Same as (2) with B-Type noise reduction, -57.1 dB. All noise measurements referred to Dolby Level = 200 nWb/m.



# From The Lab

George W. Tillett

SEVERAL READERS have asked me what I thought of the recent Consumer Report's tests on loudspeakers using a computer to evaluate the results. Briefly, what CU did was to feed the speakers with a pink noise signal and then take power response readings at 10 degree intervals in two perpendicular planes. At each angle, 30 readings were made, representing the rms value of 1,000 measurements in each of 30 one-third octave bands. The computer converted the data from decibels to sones and then it was transposed into simple percentages. Frequencies below 110 Hz were excluded because of room variations and differences due to positioning.

Now, I must admit that I was horrified when I'd read this far. A speaker with several 2 dB peaks could be lumped together with one having an enormous 15 or 20 dB peak somewhere in the spectrum. There would be no distinction between a peak at 150 Hz and one at 12 kHz or 7 kHz. And how do you grade coloration? As all speaker engineers know, tiny 1 dB peaks—or even smaller at certain frequencies—can cause quite severe colorations. The density of the enclosure material plays a large part in these variations which can hardly be measured much less evaluated by a computer!

However, on reading further I discovered that a listening panel was also used, and it was claimed that they confirmed the computer analysis "to a reasonable degree." Looking at the list of speakers tested, I can well believe it. None were really bad, and I can think of several other systems which would score quite high on the percentage tests but would sound abominable. Incidentally, the CU listening tests involved comparisons with a reference laboratory speaker using tapes originally made with that loudspeaker in an anechoic chamber—a method of evaluation which allows a high degree of accuracy.

So all-in-all, I would say that I wouldn't disagree with the CU conclusions, although I have strong reservations about those computer-derived percentages. The highest score was 89 per cent; my guess is

that a speaker with a score of 100 per cent CU accuracy would still sound like a loudspeaker, that is it would still have some distortion and some coloration.

## Measuring Wow & Flutter

The article by Robert Berglas aroused a great deal of interest, and most people saw the snags I mentioned in the footnote. Gary Flynn, of Atlanta, Georgia, writes: "... an instrument of this type (Heath-Schlumberger counter) measures the *average* frequency during the sampling period, which in the Heath instrument is 1 second. The flutter modulation of the 1 kHz carrier, however, since it is an a.c. signal like any other, has an average value of 0, and therefore has no effect on the average frequency of the carrier as read on the frequency counter."

D. E. Peter, of Hollywood, Calif., says: "To determine a peak-to-peak wow component at 6 kHz, the counter must count for about  $\frac{1}{4}$  cycle of 6 Hz or  $\frac{1}{24}$ th second. Assuming a standard flutter tape is used, the counter will count  $3150 \text{ Hz} \times \frac{1}{24} \text{ second}$  or 131.25 Hz. The 0.25 Hz will cause the output sequence to be 131 ... 131 ... 131 ... 132 ... 131 ... The uncertainty in the last digit caused by the non-coherence of the counter clock and the counted frequency will cause a measurement uncertainty of  $\pm 0.760$  per cent. In other words, the wow measurement will be obscured by noise if the wow is less than about 0.5 per cent, rendering the technique useless." As Mr. Peter says, a computing counter, such as the Hewlett-Packard 5360 series, could measure wow and flutter combined but this seems like a complicated way of doing things.

A. R. Collins, of the Acoustical Company in England, comes up with some different figures. He writes: "Firstly, the plus-or-minus one count ambiguity in the counter dictates that, with a 1 kHz reference signal, the accuracy of the reading will be subject to an error of plus or minus 0.1 per cent, assuming the 1 second gate time which is common on counters measuring frequencies in the region of 1

kHz. ... To resolve wow components up to 6 Hz, the sample period shall be  $\frac{1}{12}$ th second or less, in which time the counter will indicate 83 cycles. The plus or minus one count uncertainty will degrade the accuracy to worse than plus or minus 1 per cent. The use of a higher test frequency to permit the use of short gate intervals will improve the accuracy." Mr. Collins goes on to say that a phase-locked loop method is inherently a better technique for wow and flutter measurements than a digital system and one such application was described in *Wireless World* for December, 1971. The author is R. Ockleshaw, and some of his remarks on manufacturer's specifications would agree with those made by Robert Berglas. In brief, the PLL system produces an output voltage which is instantaneously proportional to the difference between the incoming frequency and a reference frequency. Any phase/frequency error is transformed into a changing d.c. level. The complete circuit uses three ICs plus a single transistor and should cost no more than \$25.

## Control I

This is a handy gadget made by HR Manufacturing, of 1917 57th St., Sarasota, in sunny Florida. This company formerly made the Rabco turntables and arms, now made by Harman-Kardon. What does Control I do? It switches off the amplifier, receiver, tape recorder, or whatever in the absence of a signal. Two wires are connected to the speaker sockets and the equipment to be switched is plugged into a socket at the rear of Control I, which in turn is plugged into the power outlet. That's all. I found that signals as low as 50 milliwatts would keep the unit switched on so you could use Control I for very soft background music. (Some very interesting applications here!) Switch-off time depended on the signal level and it varied between a few seconds up to just over 9 minutes after the cessation of the signals. The circuit uses 3 transistors and a heavy-duty relay and there is an override switch as well as a manual on-off switch. Price is \$29.95. **A**

**901**  
**SERIES II**

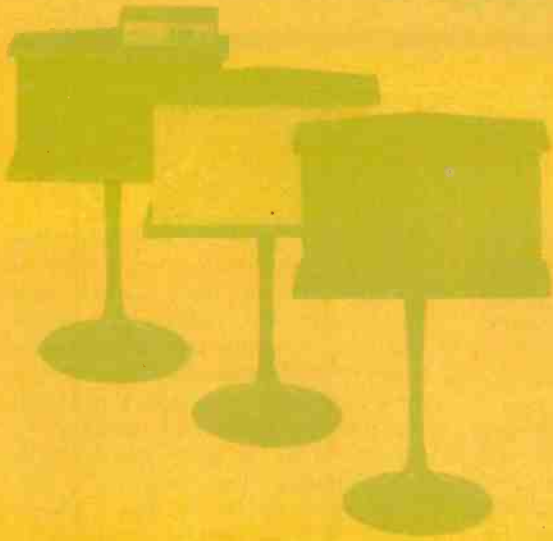

**Series II ...**  
**a new**  
**listening**  
**experience**

by **BOSE**<sup>®</sup>



**501**  
**SERIES II**





# Introducing the new...

## ***BOSE 901 SERIES II***

The original BOSE 901 was the product of a twelve year research program on acoustics.\* The large sales that have grown from the worldwide acceptance of the 901 now support what we believe is the industry's most sophisticated team of researchers, dedicated to improving home music systems. All forms of loudspeakers, new and old, are studied.

The concepts of direct and reflected sound, acoustically-coupled full-range speakers, active equalization, and flat power radiation have emerged from the research as fundamental for optimum music reproduction. We doubt that these will change.

However, what is changing is the accuracy with which we can realize these concepts in a producible speaker design and the adaptability of the design to a wider range of home environments. The 901 SERIES II represents the combination of all the technological advances that have emerged from our research department over the past five years.

The 901 SERIES II features a completely new equalizer design. It provides a type of equalization for program source variations not available on other speakers. The new equalizer also enables the 901 SERIES II to adapt to a much wider range of room environments. The 901 SERIES II can even

be played in front of drapes and still reproduce music with the proper frequency balance.

The new cone formulation in the 901 drivers provides an unprecedented uniformity of response. BOSE now employs a blue coloring and the BOSE logo to distinguish the basic cone material for special quality control measures, starting right with the manufacture of the cone material.

The 901 SERIES II represents a new height in precision control of audible performance in production speakers. This is thanks to the recent introduction of the SYNCOM™ II speaker testing computer, developed by BOSE specifically to measure performance parameters directly related to our aural perception of sound.

The 901 SERIES II carries a FIVE-YEAR warranty covering parts and labor on both the electronic active equalizer and on the speakers.

\*If you would like to know about the research that developed the 901, and about the state-of-the-art of sound recording and reproduction, you will want to read Dr. Bose's articles in the June and July '73 issues of TECHNOLOGY REVIEW. A 20 page combined reprint of these articles is available from BOSE for \$.50. Also we'll send you a complimentary copy of the 16 page, full-color 1801 amplifier brochure and information on the new BOSE 901 and 501 SERIES II speakers. Write Dept. OA and request the "complete literature package."

## ***BOSE 501 SERIES II***

### The Design Goals of the new 501 SERIES II:

- To duplicate as many of the sonic characteristics of the 901 SERIES II as possible, within the cost constraint that dictates the use of a woofer-tweeter approach.
- To match the frequency balance of the 901 SERIES II as closely as possible, so that the 501 and 901 can be used together to produce a Direct/Reflecting® QUADRAPHONIC system that represents a large advance over conventional, direct-radiating QUAD systems.
- To increase the high-frequency power handling capability beyond that of the original BOSE 501.

### How the goals were achieved:

- By designing a new tweeter that has *double* the magnet size of the original design.

- By using four additional circuit components in the crossover network.

- By 100% selection and matching of the woofers and tweeters with the SYNCOM™ II computer--the unique computer designed and constructed by BOSE CORPORATION and put into service in August, 1973, to achieve a new level of speaker performance.

### The Performance:

You must be the judge. If our efforts have succeeded, you will know immediately when you A-B the 501 SERIES II with any other speaker up to the price of the 901 SERIES II. (If you make the test in a store, be sure to clear at least 20 inches on each side of the 501, so that its reflected sound will be free to bounce off the rear wall.)

# ***BOSE***®

The Mountain, Framingham, Massachusetts 01701

# Cassette Tape Tests

**C**ASSETTE RECORDERS have improved enormously during the past two or three years and the best Dolbyized models pose a serious challenge to open-reel machines in the same price range. However, because of the slow tape speed and smaller track width, they are much more dependent on the quality of tape and correct matching for best results. And heads have to be clean too!

One of the bugbears of cassette recorders is *tape saturation* which restricts the amount of high frequency signal that can be recorded on the tape. Even the best tapes show some loss in maximum output above approximately 5 kHz, and this is why it is necessary to keep high frequency signal levels well below the 0 VU mark on the meter. If this is not done, the tape saturation will tend to cut peaks and the recorded sound will be dull and lifeless. But if levels are cut *too* far, signal-to-noise ratio will suffer. Here the Dolby system helps considerably, but even so, it is essential to choose a tape having a high Maximum Recording Level (MRL) for best results.

## Test Procedure

The machine selected for our tests was the Harman-Kardon 1000, which we included in our cassette recorder survey in August, 1972. We found it to be very suitable for our purposes because of its high standard of performance and because it is possible to measure both input and output signals without too much fuss. Both input and output controls are provided—this helps to select convenient reference points on the output meter. We used a Ferrograph Recorder Test Set which can measure distortion. Two other cassette recorders were used for cross-reference, a Pioneer CT-4141 and a JVC 1667.

Our first test was to measure the frequency response at 0 VU with a constant input. This was plotted in a graph and then we measured the distortion and output level, also at 0 VU level. Then we checked signal-to-noise ratio and finally made frequency measurements at -20 dB level. Frequencies below 400 Hz are not shown in the graphs as deviations were not significant.

## Output

The Maxell UD was taken as a standard; the output was identical to the Scotch Highlander and TDK KRO. The

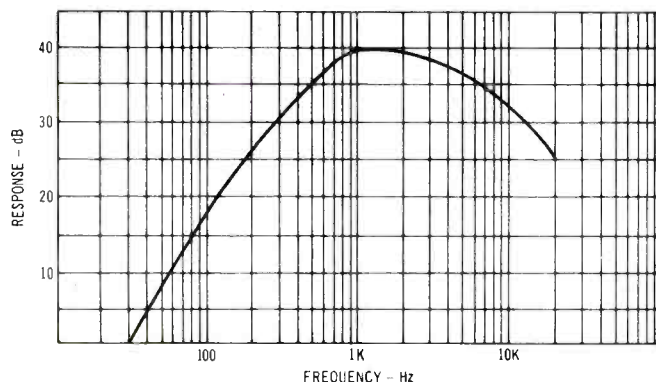

Fig. 1—ASA weighting characteristics.

actual figure for the Harman-Kardon 1000 was 480 mV for 0 VU recording level. So a tape having an output of -1 dB would produce about 415 mV; -2 dB, 390 mV, and -6 dB, only 240 mV.

## 3 dB Point

This is the frequency where the response has fallen by 3 dB. In general, the higher the frequency at which this occurs, the better the tape. However, distortion, signal-to-noise ratio, and headroom all must be taken into account.

## Signal-To-Noise Ratio

Some authorities consider that a weighted noise factor is more accurate as it corresponds to what a person really hears. We wanted to isolate some of the noise due to the electronics of the record-replay amplifier so we used the ASA weighting characteristics as shown in Fig. 1. The reference figure is the standard 3% distortion level.

## Distortion

Tapes having a low distortion at 0 VU will obviously have a greater headroom at mid-frequencies. However, variations among the tapes tested were not great.

## Chromium Dioxide Tapes

As we have noted before, CrO<sub>2</sub> tapes are much more consistent—the variations between makes are quite small.

## How To Choose The Best Tape

Recorders are factory adjusted to suit a particular tape and it is almost impossible to change bias current or equalization. But you may find a particular tape is deficient in treble response and so it is possible to improve matters by changing to one with a rising or extended high frequency response. If you do not have a Dolby or other noise reduction system, choose a tape with a high signal-to-noise ratio—plus adequate headroom. If you are using a tape with a low MRL, watch that VU meter!

## Dropouts

With only two samples of each cassette (three at most), it was not possible to make a reliable estimate of dropout probability. For example, Sample A of Irish 261 had three dropouts but Sample B had none at all! Two were considered to be more dropout prone than the others; they were the DAK LN and the TDK 180 LN. The latter is extra thin and the makers do stress that there is a need for special care in handling.

## Construction

Some cassettes were welded together; others used screws. Both methods have advantages. The welded construction—in theory—is more accurate and reliable, but the screw assembly does permit repairs to be made. Note that all cassettes tested were C-60's unless stated otherwise.



KLH is well into its second decade of manufacturing extraordinary high performance loudspeakers that don't cost an extraordinary amount of money. We've kept costs down by making every loudspeaker ourselves. And by selling a staggering number of them.

In short, we've had a lot of practice.  
And that's perfect for you.

For now you can own a pair of our new Model Thirty-One loudspeakers for just \$89.95<sup>†</sup>. Think of it. Two superb sounding full-range loudspeakers at a price you might consider fair for just one! A pair of Thirty-Ones deliver a truly inordinate amount of sound for their modest size. You can drive them to big listening levels

with virtually any decent amplifier or receiver. They're handsome, featuring a new sculptured acoustically transparent foam grille. Rugged. And best of all, incredibly inexpensive. With the money you save, you might even trade-up to a better turntable or receiver, perhaps even get into quadraphonic sound. The Thirty-Ones can help make it happen. A pair is at your KLH dealer now. Listen to them soon. We're sure you'll agree that no one has ever offered you a better value in sound.

And we've had a lot of practice.

For more technical information, write to KLH Research and Development, 30 Cross Street, Cambridge, Mass. 02139. Or visit your KLH dealer.

**What  
does it take to  
make an important new  
loudspeaker and  
sell it for  
\$89.95<sup>†</sup>  
a pair?**

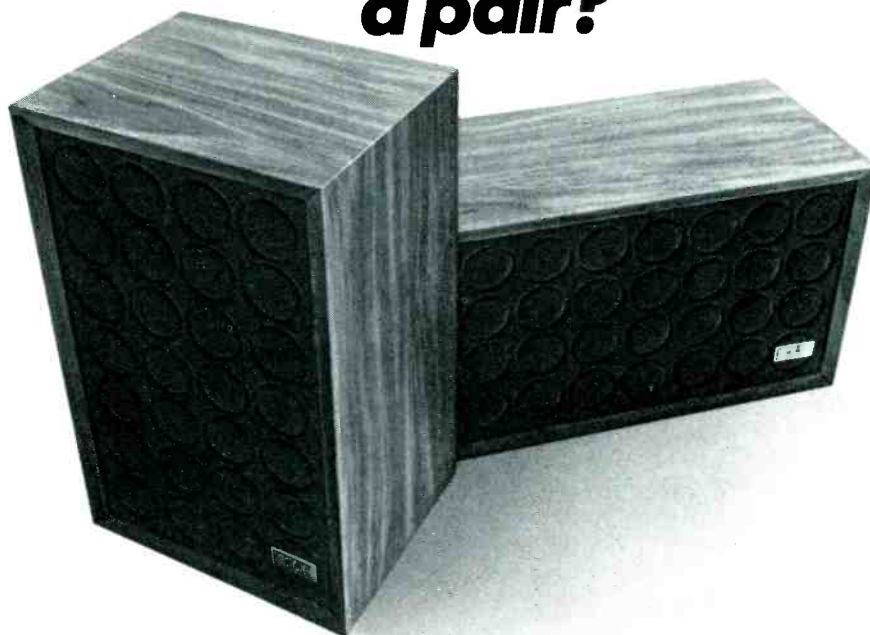

**Practice.  
A whole lot of practice!**

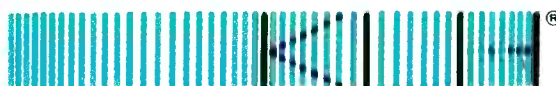

KLH RESEARCH AND DEVELOPMENT CORP.  
30 Cross St., Cambridge, Mass. 02139

<sup>†</sup>Suggested retail prices—slightly higher in the South and West.

Check No. 19 on Reader Service Card

# Chromium Dioxide (CrO<sub>2</sub>) Tapes

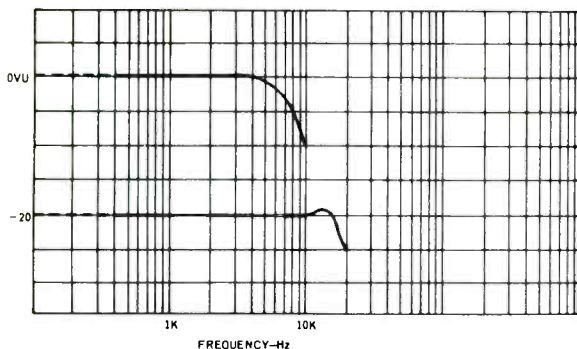

## Advocate (Advent) Crolyn

C-90, welded case. Output: -0.5 dB. Distortion at 0 VU: 2.5%. 3 dB Down Point: 16 kHz. S/N: 60 dB. Average headroom.

## Ampex Series 363

Welded case. Output: -0.3 dB. Distortion at 0 VU: 2.5%. 3 dB Down Point: 15.6 kHz. S/N: 60 dB. Slightly above average headroom.

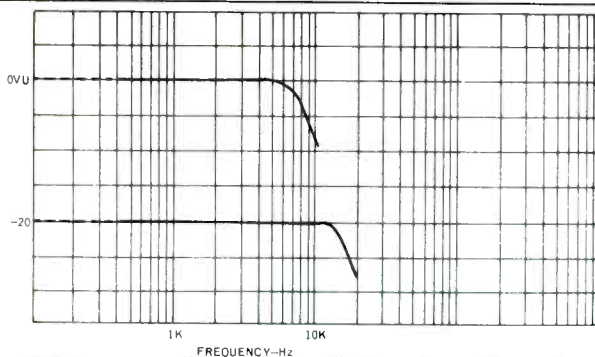
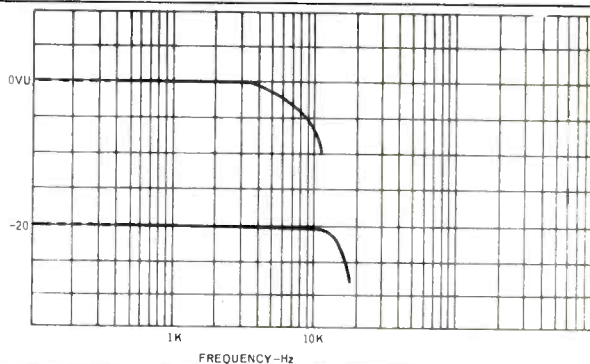

## BASF Chromdioxid

Screw-assembled case. Output: -2 dB. Distortion at 0 VU: 2%. 3 dB Down Point: 15 kHz. S/N: 60 dB. Average headroom.

## Norelco 400

Screw-assembled case. Output: 0.5 dB. Distortion at 0 VU: 2.3%. 3 dB Down Point: 15 kHz. S/N: 60 dB. Average headroom.

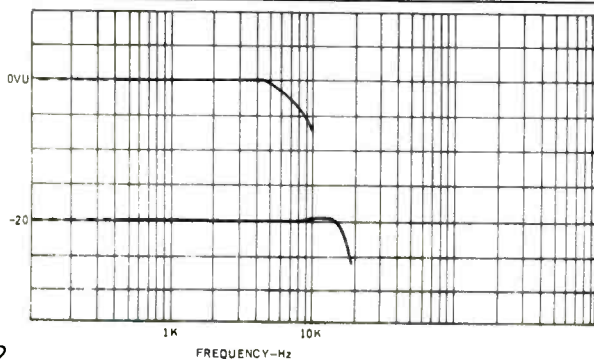
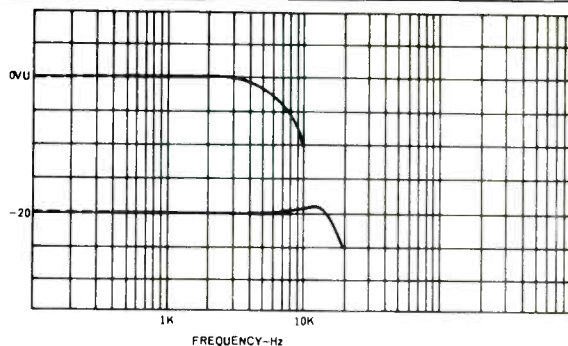

## TDK KROM-O<sub>2</sub>

Screw-assembled case. Output: 0 dB. Distortion at 0 VU: 2%. 3 dB Down Point: 16.5 kHz. S/N: 60 dB. Excellent frequency response.



# SONY 1055 and 5055

## One good Sony deserves another



Sony offers you ten individual choices in tuners, amplifiers and pre-amps, plus an infinite variety of combinations. For every listening requirement in every price range. We're going to tell you about two new low-priced models that offer all the traditional Sony performance and value.

The Sony TA-1055 delivers 20+20W RMS continuous power into 8 ohms per channel, from 40Hz to 20kHz. The power you pay for is the power you get, at every frequency from low, low bass (where you really need it) right up to the highest highs. And these Sony circuit features keep that power

clean and quiet—direct coupled differential output and wide range, integrated circuit phono preamp. It has all the operating features, including such luxury touches as two sets of tape output and monitor connections (use one for an SQ decoder) with direct dubbing, front panel Aux and MIC inputs and slide controls. \$169.50\*

The deserving tuner for the TA-1055 is Sony's ST-5055. Its sensitivity is 2.2µV IHF, moderate by today's standards, but when you combine it with a capture ratio of 1 dB, performance is outstanding. There's a high blend switch for quiet stereo reception of

weak signals, built in AFC, signal-strength meter and switchable muting. \$169.50\*

Each is the lowest priced tuner and amplifier offered by Sony. Imagine the performance and value offered by the eight other models. Sony's wide selection of deserving amplifiers and tuners goes right on up to the ultimate combination of the super-powered 3200F, deluxe 2000F preamp, and 5130 tuner. Visit your dealer and audition these Sonys. You deserve it.

Sony Corporation of America, 9 West 57th Street, New York, New York 10019.  
\* Suggested retail.

### Sony Tuners and Amplifiers: now 10 great choices

Check No. 36 on Reader Service Card



# Five disturbing facts about loudspeakers no other manufacturer has the guts to tell you.



## The Loudspeaker Jungle

**1.** There are approximately one hundred different makes of "high fidelity" speakers sold in the United States, confronting the buyer with an incredible clutter of names, types, claims and counterclaims.

Of the hundred, no more than twenty are relevant, in the sense that they represent some sort of serious engineering effort and manufacturing philosophy, whether successful or not.

The remaining eighty are opportunistic marketing ventures, big and small, responding to the merchandising needs of stores rather than to the listening needs of the public.

**2.** One reason for this commercial jungle is that anyone with no other qualifications than a few thousand dollars can go into the speaker business.

About nine out of ten speaker manufacturers, the good guys as well as the bad guys, buy their drivers (woofers, tweeters, etc.) from outside suppliers in the U.S., Europe and Japan.

There are only a handful of these "raw speaker" houses and they stand ready to make anything their customers specify, from the most sophisticated drivers to the cheapest, a hundred

thousand units or just five hundred.

The typical speaker manufacturer is therefore merely a contractor with practically no overhead; he throws a Gundersen woofer and a Furuhashi tweeter into a Gonzalez cabinet and sells it as the one and only original Astrodynamic speaker system. (The names have been altered to protect the innocent.)

There's nothing *inherently* wrong with this way of making speakers, as long as a talented and experienced speaker designer is in charge from beginning to end.

At Rectilinear, we buy our drivers only from the best suppliers, who make them to our own rigid specifications to match the system designs we've developed. We make our own cross-over networks and cabinets.

But not every manufacturer is like us.

**3.** Among the approximately twenty technologically and ethically respectable speaker brands, some six or seven are relevant only to a small coterie of dedicated audiophiles.

These are the exotic designs, utilizing electrostatic or other unconventional drive principles as well as diaphragms of unfamiliar shape and construction.

In most cases, these speakers require special, expensive amplifiers and compulsive owners who enjoy fussing and fiddling.

The small, avant-garde firms that specialize in making this type of product have always had a high mortality rate, usually because of wishful thinking about unsolved or only partially solved engineering problems.

Nevertheless, we have the highest regard for these brave

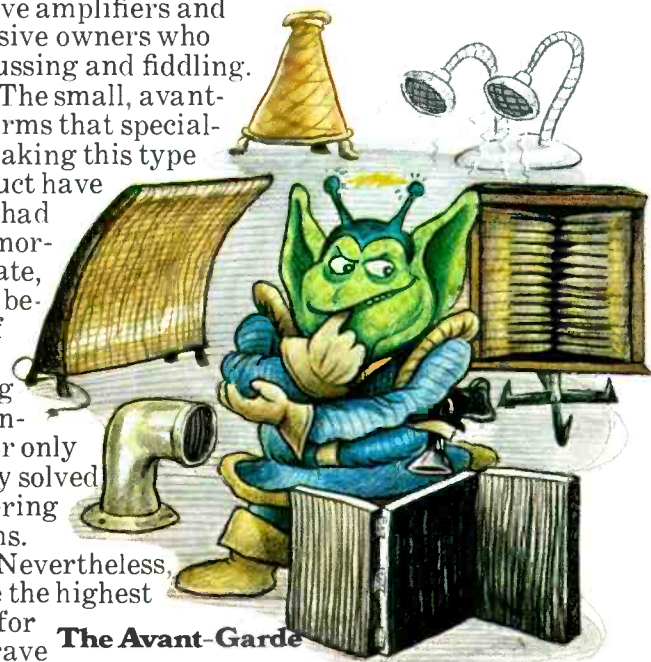

The Avant-Garde



experimenters and consider it entirely possible that the future belongs to one of them.

But which one?

(Will you buy the first electric automobile when it comes out?)



### The West Coast Sound

Some believe, and so far we're one of them, that a speaker should radiate sound only forward, over as wide an angle as possible. Others aim various drivers at the back wall or the ceiling, to bounce off the sound before it reaches the listener.

We feel that the arguments for the latter approach are unscientific and that the resulting sound is phony. No guitar is nine feet tall and twelve feet wide. (When somebody comes up with a reflective design that presents a correct spatial perspective, we may change our mind.)

As for personality or character, a speaker should theoretically have none, since it's a reproducer, not a musical instrument. *When two speakers sound different playing the same program material, at least one of them is wrong. Maybe both.*

But they do sound different, even in this heavily screened group.

There's the West Coast sound, for example, favored mainly by California-based firms and characterized by sizzling highs, a huge bass and lots of so-called presence. Everything a bit overstated and larger than life.

There's also the polite New England sound, with its origins in the Boston area. Nice and smooth, neutral, everything in its place, nothing shrill, but somehow muffled and less vivid than real life.

We believe that, despite their charms, both of these personalities are wrong. Only a totally characterless accuracy is right. What goes in must come out, no more and no less. Let the record producer create the type of sound you hear, not the speaker manufacturer.

Accuracy has a great deal to do with low

**4.** The thirteen or fourteen speaker makers who are both serious and reasonably conservative, and among whom we confidently number ourselves, are hopelessly split on the issues of sound dispersion and speaker "personality."



### The Polite New England Sound

time delay distortion, a much-neglected subject.

Electrostatic speakers excel in this area. We could summarize our position by stating that Rectilinear aims for the accurate, electrostatic type of sound without giving you the problems associated with electrostatics.



### The Accurate Sound

**5.** There's also a new impediment to accurate sound reproduction, in addition to the established schisms discussed above. We're referring to the epidemic of "three-dimensional" or "sculptured" speaker grilles made of polyfoam.

A speaker grille should be, above all things, acoustically transparent. There should be no audible, and virtually no measurable, difference in the output of the speaker with the grille on or off.

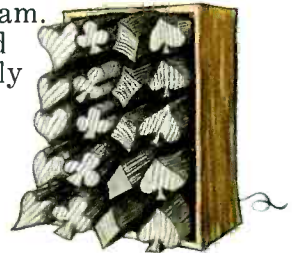

### The 3-D Grille

But the foam material these newfangled grilles are made of is the same as the appliance people use for muffling the mechanical noises of air conditioners!

How a reputable manufacturer can use a *sound deadener* for a speaker grille is beyond us, but everybody seems to be doing it.

Until acoustically transparent three-dimensional materials become available, our grilles will remain prosaically two-dimensional.

#### RECTILINEAR SPEAKER SYSTEMS

Rectilinear III floor-standing speaker (6 drivers, 3-way crossover)	\$299.00
Rectilinear III Lowboy (6 drivers, 3-way crossover)	299.00
Rectilinear XII bookshelf speaker (3 drivers, 3-way crossover)	149.00
Rectilinear Mini-III bookshelf speaker (3 drivers, 3-way crossover)	109.00
Rectilinear XIa bookshelf speaker (2 drivers, 2-way crossover)	89.00

**So.** Okay.

Besides Rectilinear, are there any sincere, serious, nonexotic speaker companies that make forward-radiating, personality-less, accurate-sounding systems without 3-D grilles?

We don't know of any.

In our own methodical way, we're unique.

### One more thing.

We aren't telling you all this just for laughs.

Next time you're in a hi-fi store, use these five facts to guide you through the loudspeaker jungle.

And remember who told you.

# RECTILINEAR®

Rectilinear Research Corp., 107 Bruckner Blvd., Bronx, N.Y. 10464  
Canada: H. Roy Gray Limited, Ontario

Check No. 30 on Reader Service Card

# Ferric Oxide Tapes

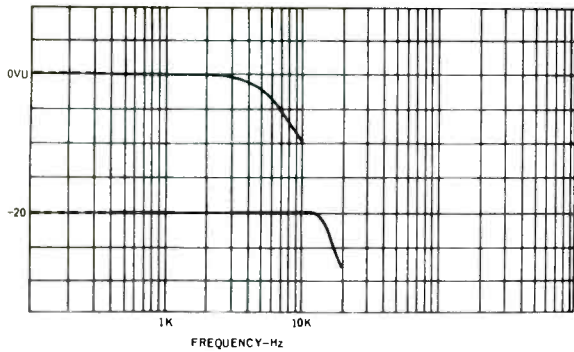

## Ampex 20:20+

Screw-assembled case. Output: +1 dB. Distortion at 0 VU: 2%. 3 dB Down Point: 14.5 kHz. S/N: 55 dB. Average headroom.

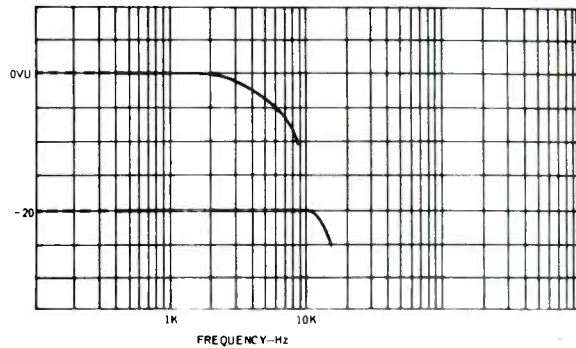

## BASF SK/LN

Welded case. Output: -2 dB. Distortion at 0 VU: 2.5%. 3 dB Down Point: 12.5 kHz. S/N: 56 dB. Headroom 5 dB down at 6 kHz.

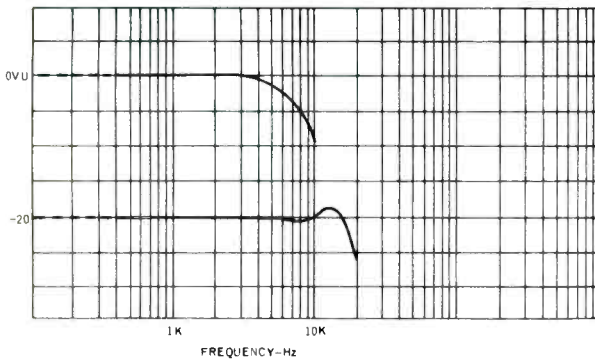

## Capitol LN

Screw-assembled case. Output: -0.3 dB. Distortion at 0 VU: 2.2%. 3 dB Down Point: 16.3 kHz. S/N: 56 dB. Excellent frequency response; better than average headroom.

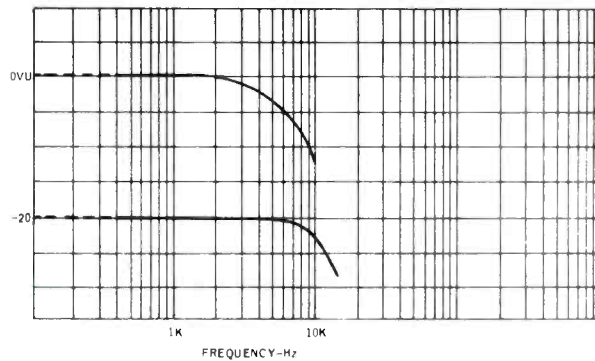

## DAK LN

Welded case. Output: -0.5 dB. Distortion at 0 VU: 2.5%. 3 dB Down Point: 10.5 kHz. S/N: 52 dB. Slightly below average headroom; inexpensive general purpose tape.

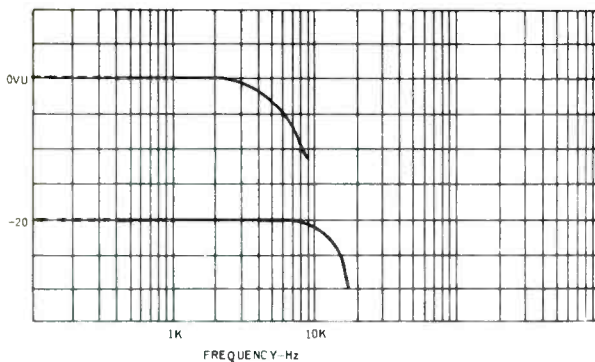

## Irish 261

Welded case. Output: -2 dB. Distortion at 0 VU: 2%. 3 dB Down Point: 14 kHz. S/N: 55 dB. Slightly lower than average headroom—down 5 dB at 6.5 kHz.

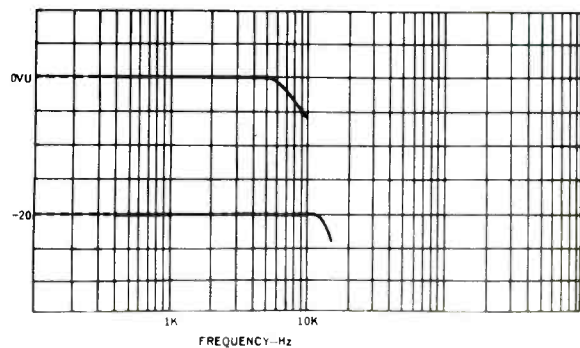

## Maxell LN

Welded case. Output: -0.3 dB. Distortion at 0 VU: 2%. 3 dB Down Point: 13.5 kHz. S/N: 56.5 dB. Excellent headroom; 5 dB down at 9 kHz.



# How Magnavox is helping to clear the air in Los Angeles.



The airwaves over Los Angeles are thick with signals from 78 FM stations, all squeezed into 20 MHz of spectrum.

Other urban centers are no better. But Magnavox has found a way through the sound smog, to help you find and pull in just the station you want—even if it's butted up against one that's lots more powerful.

Our bright idea: the 1500 Plus DTI, the first stereo FM/AM receiver with *digital* tuning. It counts, latches, decodes and displays in large glowing numerals the *exact* frequency you're tuned to—FM or AM—with the accuracy you'd expect from a digital computer. Which, in fact, is how we do it—after our MOSFET front end and ICs clear the air.

Once in, the scrubbed

signal is boosted by an amplifier stage that typically delivers 50/50 watts rms (into 8 ohms) at only 0.5% distortion. Direct-coupled output, of course, for full damping at any frequency.

Other goodies: linear phase lump-constant filters for minimum distortion on FM, an active tone-compensation network, full-function jack panel, 4-channel matrix decoder, and a thermal protection circuit that shuts the set off if it's ever overloaded—then *shows* you why it shut off.

What price pure air? \$399.95\* Other Magnavox high-performance receivers, with zero-center tuning meters, start at \$229.95\*

Your Magnavox dealer is listed in the Yellow Pages. Visit him today, and hear what clear air sounds like.

## Magnavox. You heard right.

Check No. 22 on Reader Service Card

\*Minimum retail price in fair-trade states. Optional with dealer in other states.

Free FM/AM Station Guide. Write to: The Magnavox Company, Stereo Components Dept., 1700 Magnavox Way, Ft Wayne Ind 46804



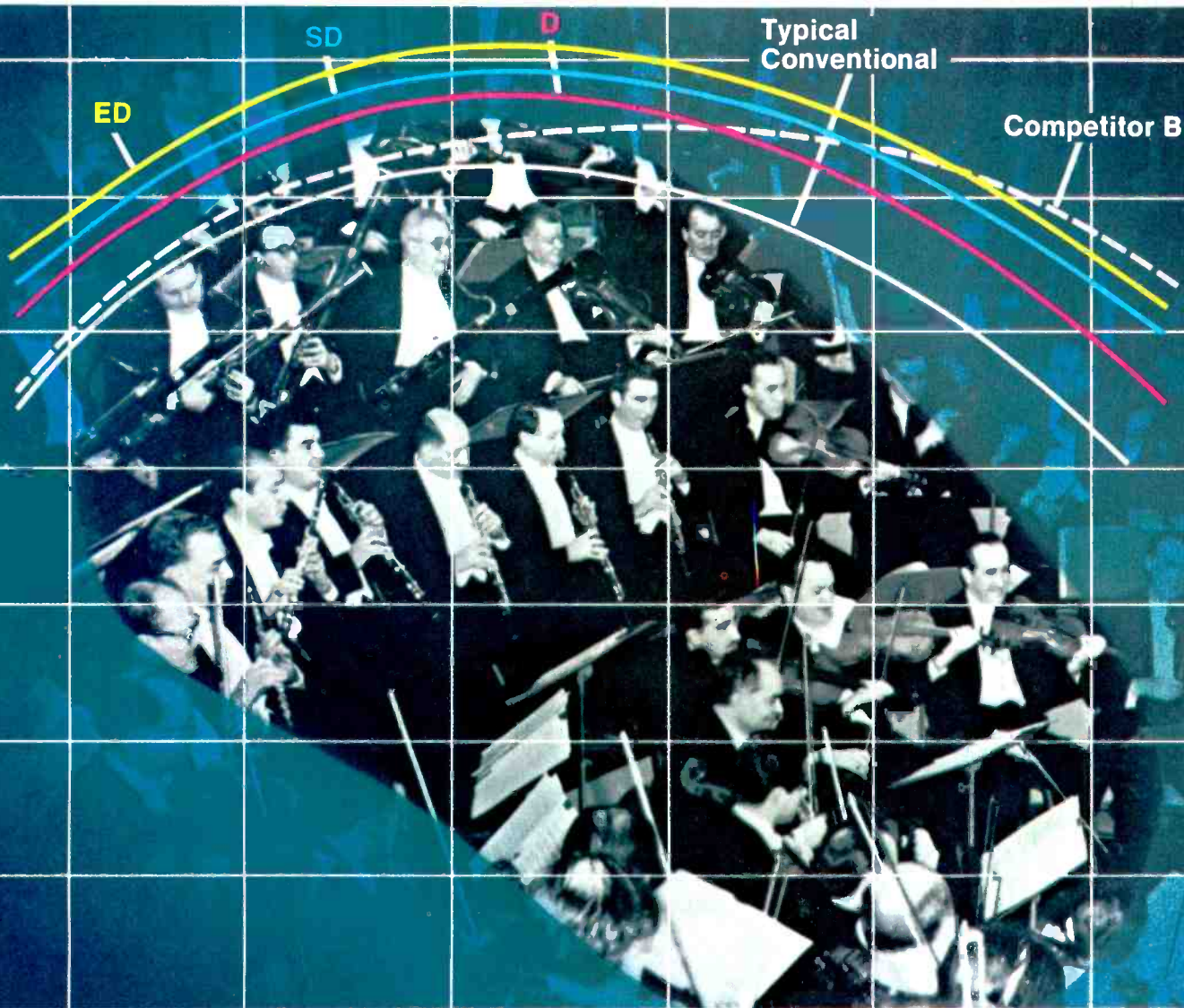

# capture all the sounds of life on TDK's high-MOL cassettes

MOL stands for maximum output level. It is a tape's most important measureable characteristic — the ability to faithfully reproduce the richness, fullness and warmth of the original performance. Only your own critical ear can be a better judge of a tape's overall hi-fi performance capabilities.

A tape with high MOL lets you capture the subtle overtones, transient phenomena and important harmonics of "real-life" sound. High MOL provides high saturation levels which means you can record at higher inputs and handle the loudest and softest passages without audible distortion or hiss. Because TDK cassettes have the highest MOL values of any cassettes on the market today, you can capture the total experience of beautiful music

and all the other sounds of real life.

TDK's EXTRA DYNAMIC (ED), SUPER DYNAMIC (SD) DYNAMIC (D) cassettes also offer the best-balanced characteristics of any cassettes (see facing page.) Add complete compatibility with any recorder, plus fully-guaranteed mechanical reliability, and you've got the world's finest cassettes — TDK.

Enter TDK's dynamic new world of cassettes, for a totally new and different experience in sound reproduction quality. TDK's DYNAMIC-series ED, SD and D cassettes, plus the BRILLIANT-series KROM(KR) chromium-dioxide cassettes are available at quality sound shops and other fine stores everywhere.

the new dynamic world of

**TDK**

TDK ELECTRONICS CORP.  
755 Eastgate Boulevard, Garden City, New York 11530





# TDK's circle of tape performance

## ....a whole new way to evaluate tape

A tape's ability to provide "real-life" sound reproduction depends not only on its MOL (maximum output level) values and the familiar frequency response characteristics, but also on the value and proper balance of a number of other properties. TDK has arranged the twelve most important tape characteristics on their exclusive CIRCLE of TAPE PERFORMANCE diagrams, shown below. Each of the radii represents one of the twelve factors, and the outer circle represents the ideal, well-balanced character-

istics of a "perfect" tape. The closer the characteristics of any cassette tape approach those of the ideal (the larger and more regular the pattern), the better the sound reproduction capabilities of the cassette. The goal is to reach the outer circle.

Compare TDK's well-balanced characteristics with those of the two leading so-called "hi-fi" competitive cassettes and a typical conventional cassette. Judge for yourself which provides the best characteristics for true high fidelity performance.

### ED

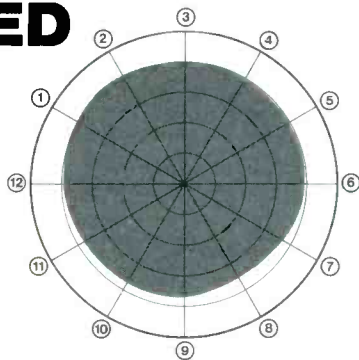

### SD

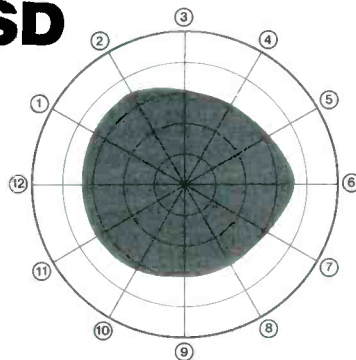

### D

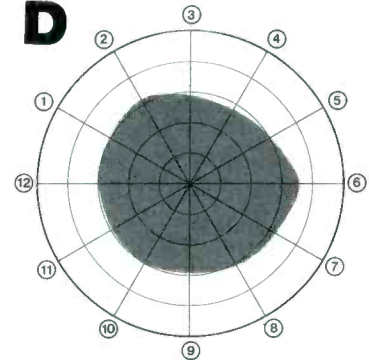

### Competitor A

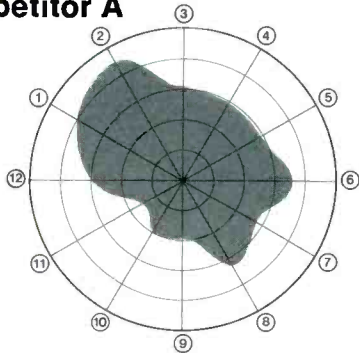

### Competitor B

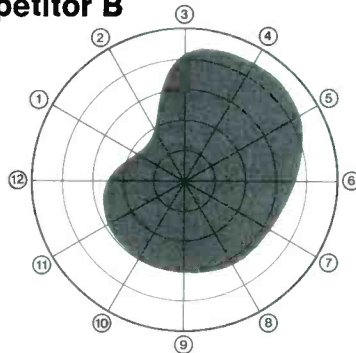

### Typical Conventional Cassette

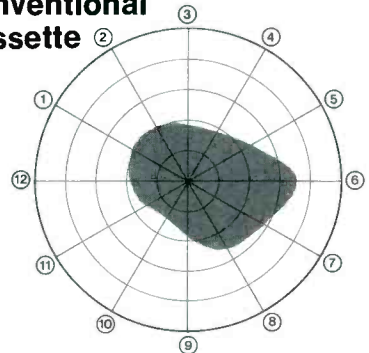

1-MOL @ 333Hz  
2-Sensitivity @ 333Hz  
3-Sensitivity @ 8kHz

4-Sensitivity @ 12.5kHz  
5-MOL @ 8kHz  
6-Erasability

7-Bias Noise  
8-Print-Through  
9-Modulation Noise

10-Output Uniformity  
11-Uniformity of Sensitivity  
12-Bias Range

### EXTRA DYNAMIC

for the discriminating audiophile, an entirely new dimension in cassette recording fidelity. Vastly superior to any other cassette, with unmatched performance on any deck. 45, 60 and 90-minute lengths.

### SUPER DYNAMIC

turned the cassette into a true high-fidelity medium. Outstandingly clear, crisp, delicate reproduction of the complex characteristics of "real-life" sound. 45, 60, 90 and 120-minute lengths.

### DYNAMIC

excellent hi-fidelity at moderate prices, with well-balanced performance characteristics superior to most "premium" cassettes. 45, 60, 90, 120 and 180-minute lengths — the world's only 3-hour cassette.

#### What is MOL?

MOL (maximum output level) is the output level obtained from an input signal of a given frequency which causes 5% distortion (average audible level) in the output. MOL varies with signal frequency.

#### What Does the MOL Diagram (facing page) Show?

The large closed-loop area on the facing page represents

a typical sound energy plot of high fidelity music; the curved lines represent the MOL characteristics of various cassettes. As long as the MOL curve is above the sound energy plot, no audible distortion occurs. Separation between the MOL curves and the energy plot is necessary to permit recording, without distortion, the occasional bursts of high-energy sound which periodically occur in musical passages.

Check No. 41 on Reader Service Card

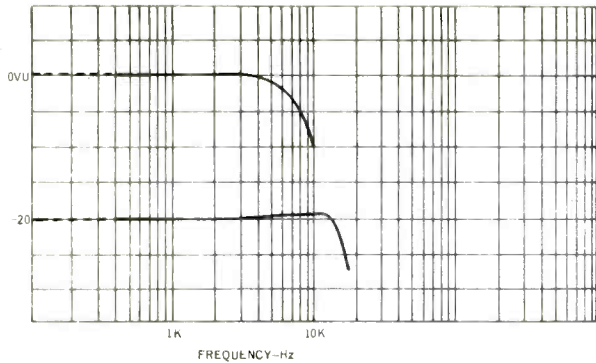

**Maxell UD**

Welded case. Output: 0 dB. Distortion at 0 VU: 2%. 3 dB Down Point: 13.5 kHz. S/N: 56 dB. Above average headroom.

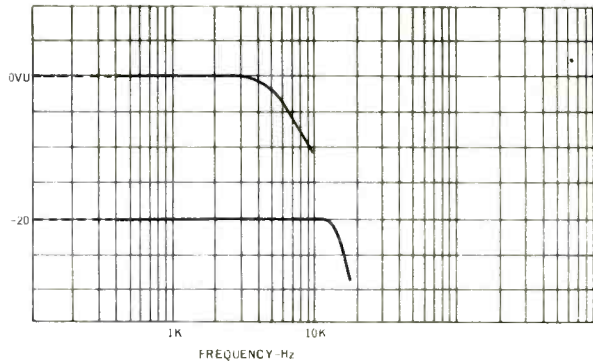

**Memorex MRX<sub>2</sub>**

Non-standard plastic box; welded case. Output: +0.5 dB. Distortion at 0 VU: 1.6%. 3 dB Down Point: 15 kHz. S/N: 54 dB. Slightly lower headroom—down 5 dB at 6.5 kHz; excellent frequency response.

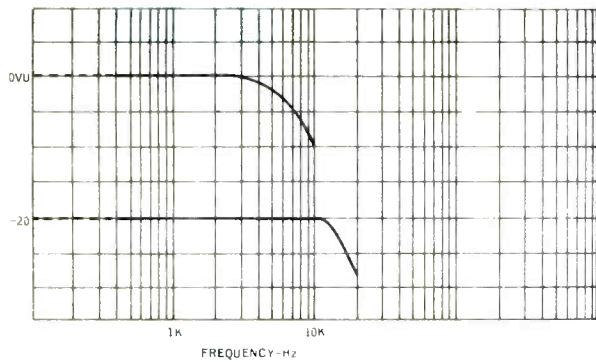

**Primus 30**

Welded case. Output: -0.5 dB. Distortion at 0 VU: 2.2%. 3 dB Down Point: 14.5 kHz. S/N: 52 dB.

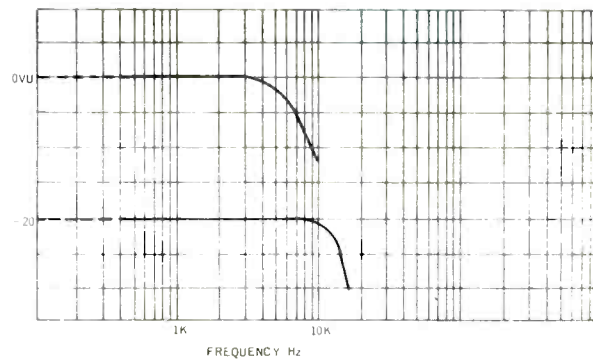

**Scotch Highlander**

Welded transparent-plastic case. Output: 0 dB. Distortion at 0 VU: 1.5%. 3 dB Down Point: 12 kHz. S/N: 56 dB.

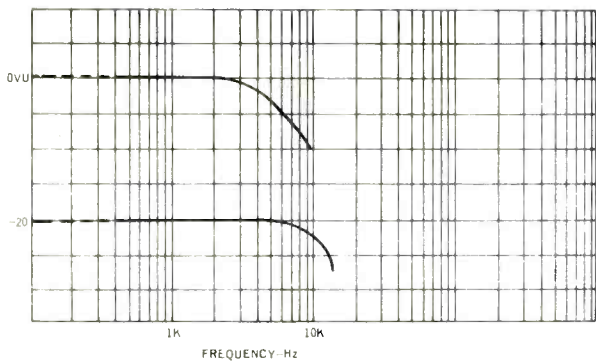

**Scotch LN/HD**

Welded transparent-plastic case. Output: -0.5 dB. Distortion at 0 VU: 1.5%. 3 dB Down Point: 11 kHz. S/N: 56 dB. Headroom slightly lower than average.

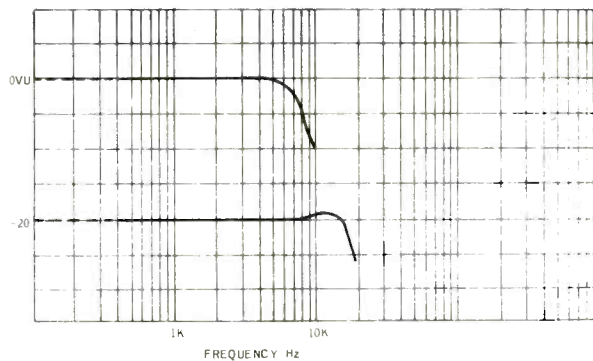

**Sony LN**

Welded transparent-plastic case, with auto-sensor. Output: -0.5 dB. Distortion at 0 VU: 2.1%. 3 dB Down Point: 15.5 kHz. S/N: 54.5 dB. Better than average headroom; excellent frequency response.



# New Avid Series 100 High Fidelity Speaker Systems.



From left to right: Model 100, Model 102, Model 103

An exciting new experience in accurate sound and imaginative styling...  
Avid Series 100 Speaker Systems.

Avid speakers are the premium quality products of extensive research from a company that has pioneered in quality audio components for over 20 years.



A-B any of the Series 100 models, with their unique user-changeable decorator grilles, now at better audio shops near you. From \$79.50 to \$139.50.

**AVID**  
CORPORATION

10 Tripps Lane, East Providence,  
R.I. 02914 Tel. (401) 438-5400.

Check No. 5 on Reader Service Card

### Sony UHF

Screw assembled case, with auto-sensor. Output: + 0.5 dB. Distortion at 0 VU: 1.6%. 3 dB Down Point: 13 kHz. S/N: 55.5 dB. Average headroom, excellent frequency response.

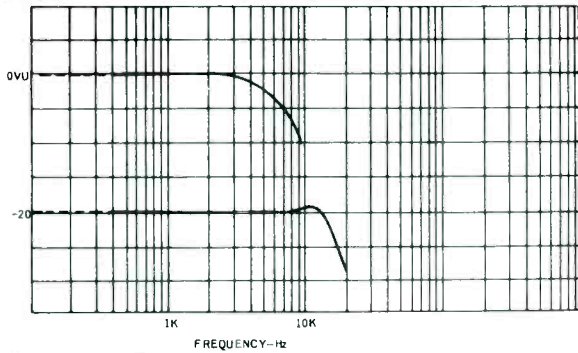
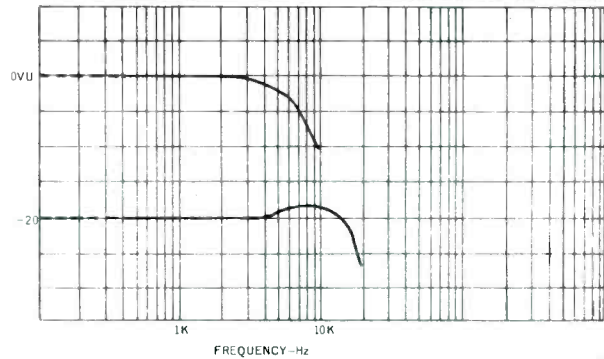

### TDK ED

Screw-assembled case. Output: -0.5 dB. Distortion at 0 VU: 2%. 3 dB Down Point: 15 kHz. S/N: 56.5 dB. Average headroom.

### TDK LN

Screw-assembled case. Output: -0.5 dB. Distortion at 0 VU: 2%. 3 dB Down Point: 13 kHz. S/N: 55 dB. Slightly below average headroom.

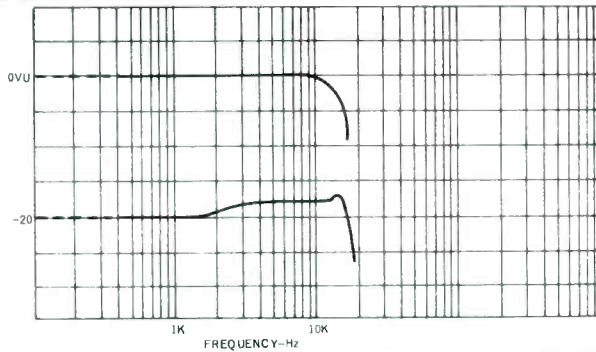
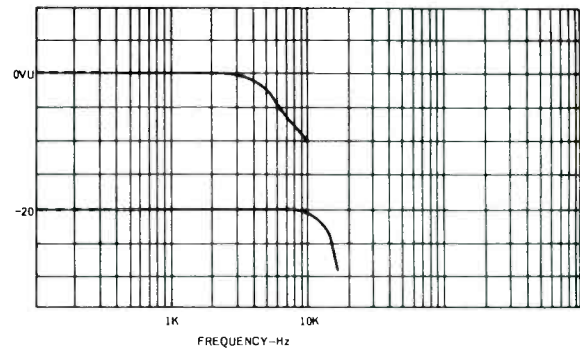

### TDK LN

C-180, screw-assembled case. Output: -11 dB. Distortion at 0 VU: 3%. 3 dB Down Point: 16.5 kHz. S/N: 52 dB. Playing time of 3 hours is achieved at the expense of output; thickness is less than 25 millionths of an inch; headroom is excellent.

### Tracs Plus

Screw-assembled case. Output: -0.5 dB. Distortion at 0 VU: 2.2%. 3 dB Down Point: 15.3 kHz. S/N: 55 dB. Average headroom.

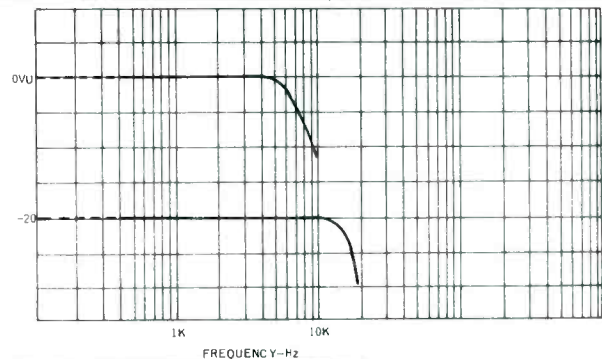





## The only Dolbyized<sup>®</sup> reel-to-reel recorder with GX heads on the market today...

One of a kind. And without competition. AKAI's new GX-285D.

The first—and *only*—Dolbyized reel-to-reel stereo tape deck with GX heads available in the U.S. today.

Here is unparalleled musical clarity. And the entire frequency spectrum dynamically reproduced. With dramatic improvements in the reduction of perceptible distortion and tape hiss.

All made possible by combining AKAI's exclusive GX (Glass and Crystal) heads with an integral Dolby<sup>®</sup> Noise Reduction System.

But the innovations don't end here.

AKAI has eliminated jamming and tape spills forever. Built into the GX-285D is an all solenoid-operated pushbutton control system that provides precise control of all functions, including AKAI's unique Automatic Reverse Playback System.

Other outstanding features include a Servo-Controlled Capstan Motor plus two Outer-Rotor Motors, Pause Control, Tape Selector Switch, Automatic Stop/Shut-Off, and a 4-Digit Tape Counter.

You'll find the AKAI GX-285D truly versatile... with professional capabilities that include Sound-On-Sound, Sound-With-Sound, and Sound Mixing.

Your nearest AKAI Dealer is waiting to show you the new GX-285D. And the added difference Dolby Noise Reduction can make in reel-to-reel performance.

Because you haven't really heard anything... yet.

Dolbyize and Dolby are Trade Marks of Dolby Laboratories, Inc.

From  
**AKAI**<sup>™</sup>  
The Innovators



# Equipment Profiles

Onkyo Model TX-555 AM/FM Stereo Receiver .....	54
BGW Model 500-R Stereo Amplifier .....	56
Hegeman Model H-1 Speaker System .....	66

## Onkyo Model TX-555 Stereo Receiver



### MANUFACTURER'S SPECIFICATIONS

#### FM TUNER SECTION

**IHF Sensitivity:** 2.0  $\mu$ V. **S/N:** 70 dB. **THD:** Mono, 0.2%; Stereo, 0.5%. **Capture Ratio:** 1.5 dB. **Selectivity:** 75 dB. **AM Suppression:** 50 dB. **Image Rejection:** 70 dB. **I.F. Rejection:** 100 dB. **Frequency Response:** 30-15,000 Hz  $\pm$  0.5 dB. **Stereo Separation:** 40 dB at 400 Hz.

#### AM TUNER SECTION

**IHF Sensitivity:** 40  $\mu$ V. **S/N:** 40 dB. **THD:** 0.8%. **Image Rejection:** 40 dB. **I.F. Rejection:** 40 dB.

#### AMPLIFIER SECTION

**Power Output:** 40 watts continuous per channel, 8 ohm loads, both channels driven. **THD:** 0.3% at rated power. **IM Distortion:** 0.4% at rated power; 0.3% at 1 watt output. **Power Bandwidth:** 15-35,000 Hz. **Frequency Response:** 10 Hz to 35,000 Hz  $\pm$  1 dB. **Damping Factor:** Over 100. **Input Sensitivity:** Phono, 2.5 mV; Aux, 100 mV. **Phono Input Overload:** 200 mV. **Equalization:** RIAA  $\pm$  0.5 dB. **Tone Control Range:** Bass,  $\pm$  10 dB at 100 Hz; Treble,  $\pm$  10 dB at 10,000 Hz.

#### GENERAL SPECIFICATIONS

**Power Requirement:** 120 VAC, 60 Hz, 250 Watts, max. **Dimensions:** 18 $\frac{3}{8}$  in. W. x 5 $\frac{1}{2}$  in. H. x 15 $\frac{1}{8}$  in. D. **Weight:** 28 lbs. **Price:** \$399.95.

This entry from Onkyo is the first receiver of theirs we have had a chance to test and we were at once impressed by the fine external styling of the unit as well as by its neat internal layout and construction. The front panel is a heavy pale-gold-anodized casting, with solid end-cap posts which give the unit a very trim look.

The framed dial scale area, which also contains a single signal-strength meter active for both AM and FM, is blacked out until power is applied, at which time it is illuminated in bright green, with separate red illumination applied to the tip of the translucent dial pointer. Illumination to the meter face is applied only when a radio position (either AM or FM) is selected. Controls located along the lower section of the panel include a speaker switch (with settings for one or two pairs of speakers and an off position for headphone listening), dual-concentric, clutch-operated bass and treble controls, balance control, volume control and program selector switch. In addition, there are six push-push buttons which control such secondary functions as high and low cut filters, stereo/mono mode, tape monitoring, loudness compensation and FM muting. The usual stereophone jack is located at the extreme left of the panel, while the large tuning knob is positioned to the right of the dial scale. The FM dial scale itself is perfectly linear, with equal divisions between each MHz and, probably for this reason, Onkyo elected not to include a logging scale.

A view of the rear panel is shown in Fig. 1. Speaker connection terminals are well spaced and are of the binding post type which permit the stripped ends of the speaker cable to be inserted in a small hole and retained in place by tightening a screw terminal. There are antenna connections for 300 ohm, 75 ohm, and "local" FM (used when attenuation of overly-close station signals is desired). There is also a terminal for connection of an external AM antenna in the event that the included ferrite bar antenna proves inadequate for weak-signal AM reception. Input jacks are provided for phono, and two sets of Aux equipment. An interesting innovation in the record-out system is the incorporation of two pairs of Rec Out jacks. The first set operates as expected, in conjunction with the front panel tape monitoring switch and the play-

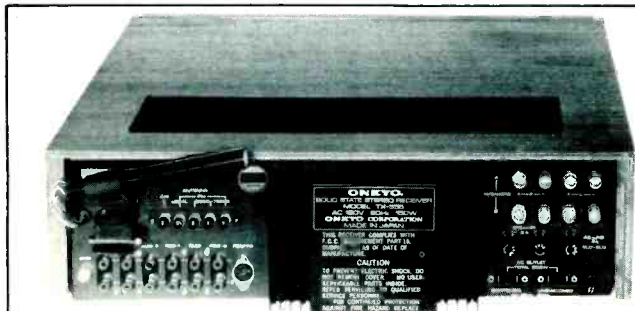

Fig. 1—Rear panel layout.

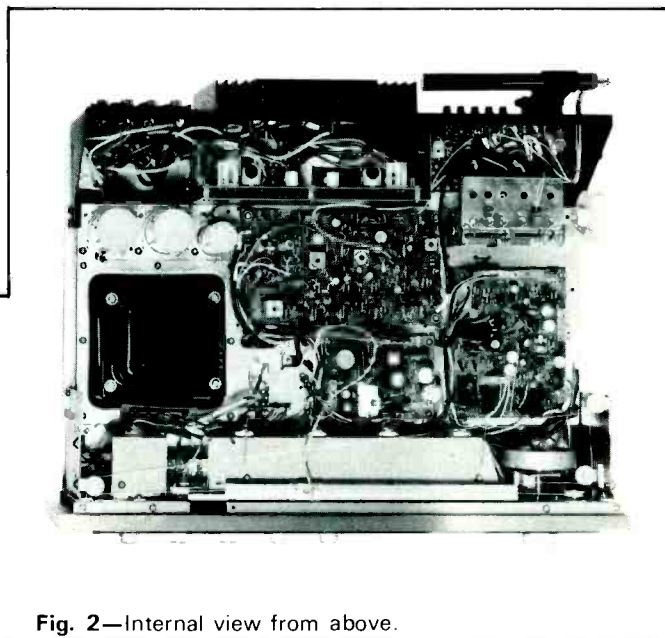

Fig. 2—Internal view from above.



back jacks on the rear panel. The second Rec Out jack set is located *after* the volume control and tone control circuitry, permitting the recordist to alter tone quality of the program prior to recording. This latter jack set does not permit tape monitoring, however. A DIN tape connector is also included, and it is wired in parallel with the Rec 1 and Playback jacks in the usual manner. A pair of speaker fuses, a line fuse and a switched and unswitched a.c. receptacle complete the rear panel layout.

Figure 2 shows a view of the inside of the chassis, and the modular construction is apparent. Several of the p.c. board modules are interconnected by multi-conductor plugs and sockets which permits easy servicing or replacement, if ever needed. The front-end features a four-gang tuning capacitor for FM (2 gangs for AM), double-tuned interstage circuitry and an FET r.f. amplifier. Three pairs of ceramic filters are used to set i.f. selectivity and a four-stage differential amplifier is used to achieve necessary gain and limiting functions. Negative-feedback type tone controls are used in the voltage amplifier section, while the power amplifier is completely direct-coupled right out to the speaker terminals. An electronic protection circuit is included to protect against short-circuits in addition to the speaker fuses already noted. Transients or "popping" sounds of turn-on and turn-off have been eliminated by another circuit which Onkyo calls a "transient killer circuit."

### Tuner Measurements

As indicated in Fig. 3, IHF sensitivity was achieved for an input of exactly 3.0 microvolts. Fairly steep quieting was observed, with a 50 dB S/N reached for a bit over 4  $\mu$ V input. Ultimate S/N reached 63 dB at just under 100  $\mu$ V, while mono THD reached a low of 0.25% for signal inputs above 100  $\mu$ V. Stereo THD reached a low of 0.28%, considerably better than the 0.5% claimed. Stereo threshold sensitivity is not adjustable on this receiver, and we found that it took some 30  $\mu$ V of signal before the receiver "switched over" to stereo operation. In view of the fact that THD at this input level was already below 1.0% and quieting was quite good, Onkyo would have been well advised to factory adjust the stereo threshold to a lower setting—say about 10  $\mu$ V or so—so that listeners might enjoy stereo reception for weaker signal strengths.

Stereo FM separation fell short of the 40 dB claimed by the manufacturer, as shown in Fig. 4. Mid-band separation ranged from about 30 dB to 33 dB, with separation decreasing to 25 dB at 50 Hz and about 24 dB at 10 kHz. Mono distortion at various frequencies is also shown in Fig. 3 and is seen to remain well below 0.5% for frequencies from 80 Hz to 9 kHz and below 1.0% over the entire useful audio range of FM transmission. Stereo THD is just a bit higher than mono THD (0.28% at mid-band frequencies) for most of the audio range, increasing because of non-harmonic related "beats" as higher frequencies were tested.

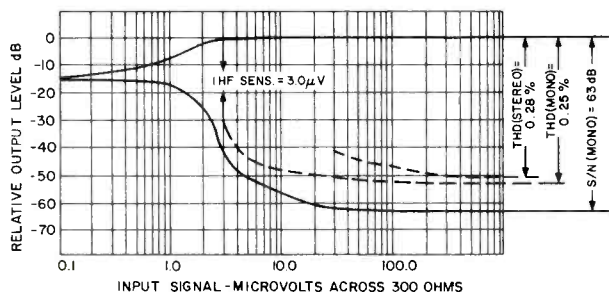

Fig. 3—FM performance characteristics.

Capture ratio measured exactly 1.5 dB with 1000  $\mu$ V input, as claimed, and rose to about 1.8 dB for signals of 100  $\mu$ V. Selectivity measured 70 dB, a very respectable figure even if short of the 75 dB claimed by the manufacturer. Frequency response was well within the  $\pm 0.5\%$  limits quoted by the manufacturer, indicating careful choice of de-emphasis components and i.f. design.

AM performance was typical of that attainable with two-section tuning (signal fed directly to converter), and the 40  $\mu$ V sensitivity claimed was confirmed.

### Amplifier Measurements

The Onkyo TX-555 power amplifier section is extremely conservatively rated and a winner in every sense. THD for all power levels right up to rated 40 watts per channel hovered just over 0.1% and did not reach rated THD of 0.3% until each channel was producing 46 watts, as shown graphically in Fig. 5. IM distortion remained below 0.1% for all power levels up to about 30 watts and reached its rated value of 0.4% at 49 watts output per channel. Based upon the manufacturer's rated output of 40 watts per channel into 8 ohm loads, power bandwidth extended from 10 Hz to 40 kHz, considerably better than claimed. Power bandwidth is plotted in Fig. 6. The power amplifier easily produced rated power

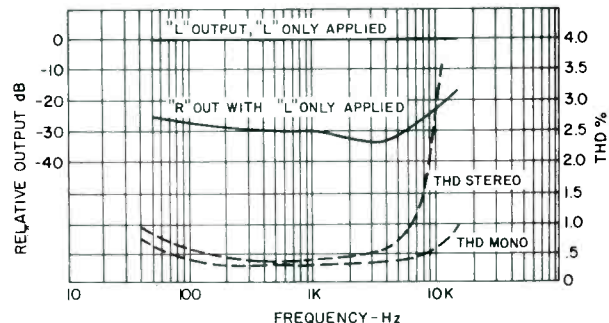

Fig. 4—FM separation and THD vs. frequency.

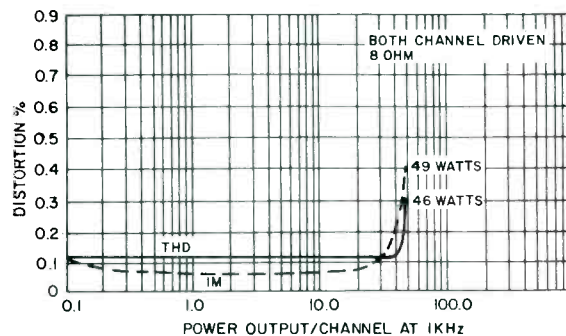

Fig. 5—THD and IM characteristics.

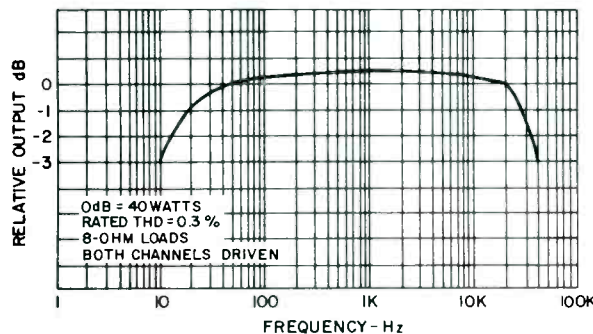

Fig. 6—Power bandwidth.

at all frequencies from 20 Hz to well over 20 kHz. Even at 20 Hz, THD measured 0.6%, as shown in Fig. 7. THD at half power and 1 watt levels was proportionately better at the frequency extremes as shown.

Phono input sensitivity was confirmed as 2.5 mV and, more important, the overload input signal capability was measured as 225 mV as against the 200 mV claimed. This is an extremely worthwhile feature, in that it insures absence of distortion when playing today's dynamically recorded discs with virtually any cartridge, regardless of its nominal output level. Phono hum and noise was measured as 60 dB below full output, with reference to a 2.5 mV signal input. Referenced to a 5 mV input signal (more typical), the hum and noise level becomes 66 dB and very acceptable. S/N ratio for the Aux input was 75 dB below rated output while residual hum and noise of the power amplifier was measured as 90 dB.

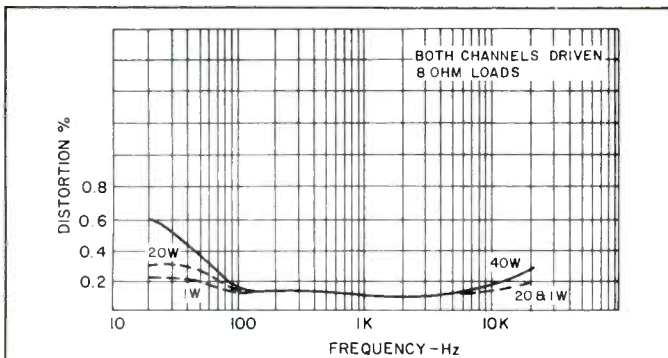

Fig. 7—THD vs. frequency.

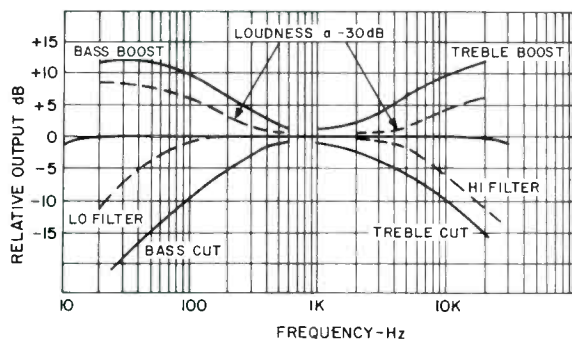

Fig. 8—Tone control, filter, and loudness control action.

Tone control range, filter action, and loudness control action with volume control set at -30 dB are all plotted in Fig. 8 and are seen to conform to manufacturer's claims and standard practice. The loudness control compensates both bass and treble extremes, with the treble emphasis being moderate. Overall frequency response, including low level amplification and tone control stages, extends from 9 Hz to over 30 kHz within 1 dB.

### Listening Tests

FM reception using the Onkyo TX-555 was highly satisfactory, with good quieting and distortion free performance on most all of the 45 stations we logged. We were not conscious that the IHF sensitivity and stereo FM separation measured less than some of the "super tuners" we have recently tested, which proves once more that these particular parameters are of lesser importance than we are led to believe. We were, however, aware of the high stereo threshold point, since some three or four stations (admittedly at great distances from our receiving site) were received in mono when we knew that they were broadcasting in stereo. Our field strength meter indicated a signal strength of 25  $\mu$ V for the strongest of these, confirming that it does take more than 30  $\mu$ V to "flip" this receiver into the stereo mode. Of course, most typical listening involves signal strengths greatly in excess of that figure—providing you use a reasonable FM antenna.

It was in the phono mode that this receiver really came into its own. Transient response seemed excellent and even our most dynamically recorded discs were heard without any discernible overload distortion or breakup. As for power output, it was more than adequate for our stereo pair of low-efficiency acoustic suspension systems which call for a nominal 20 watts of power per channel. Low-level listening was also very clean, sonic evidence of the low distortion figures observed during our lab measurements. Controls were smooth and easy to use, and volume control tracking was particularly accurate to below -60 dB from full volume.

At just under \$400.00, the Onkyo TX-555 represents good value for anyone interested in a receiver in the 40+ watt per channel power range. At \$469.95, the company offers another model (TX-666) which is reported to have somewhat better FM performance and 50 watts per channel output. If the higher powered set is as conservatively rated as this one, both receivers deserve serious consideration in their respective power classes.

*Leonard Feldman*

Check No. 50 on Reader Service Card

### BGW 500R Stereo Amplifier



#### MANUFACTURER'S SPECIFICATIONS

**Power Output:** 200 watts per channel into 8 ohms; 300 watts per channel into 4 ohms. **Distortion:** Less than 0.2% at 200 watts; typically 0.01%. **Hum and Noise:** Better than 100 dB below rated output. **Input Sensitivity:** 2.0 volts. **Damping Factor:** Greater than 1000. **Frequency Response:**

2 to 65 kHz +0 -3 dB. **Dimensions:** 19 in. W x 11 in. D x 5 1/4 in. H. **Price:** \$685.00.

The BGW 500R is a very professional looking piece of equipment with its chrome handles and rack-and-panel construction. Nothing is visible on the front panel except a tiny indicator light—and the BGW logo. The panel itself is very heavy, about 12 gauge I'd say at a guess, and the amplifier itself turns the scales at 42 lbs. No lightweight, this 500R! At the rear are two pairs of heavy-duty output terminals, two input jacks, and a circuit-breaker on-off switch. No fuses are used, which will not surprise our regular readers who will remember designer Brian Wachner's article in our February, 1973, issue. More about this later.

Under the black perforated metal shield, the layout is nice and clean. The output transistors are mounted on two heat-sinks, which run almost the whole length of the chassis across the middle. Behind them are two power transformers and the circuit boards are stacked vertically at the rear.



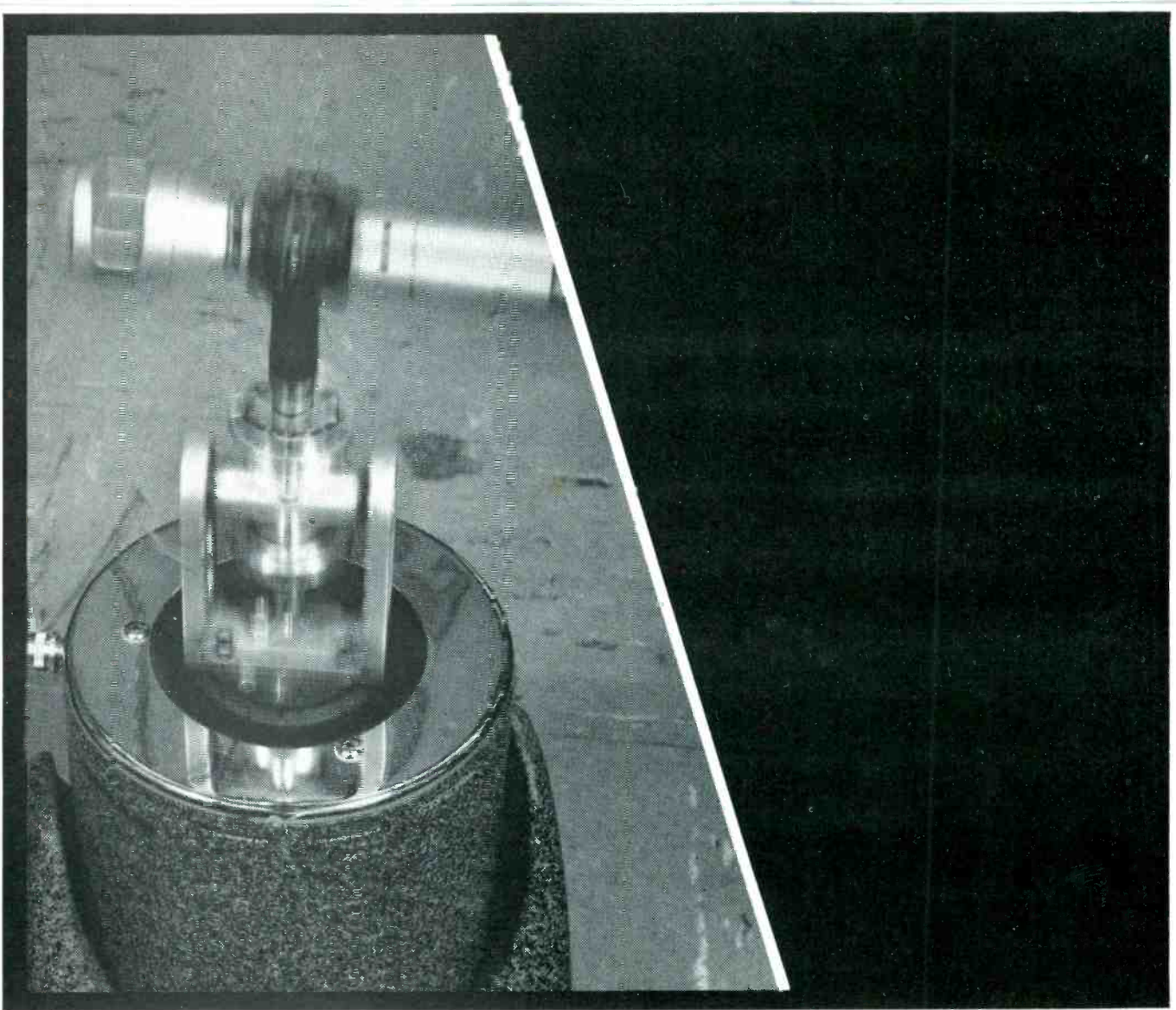

## shake. rattle & roll.



Welcome to our chamber of horrors. Inside the Shure Quality Control laboratory, some of the most brutal product tests ever devised are administered to Shure microphones. The illustration above shows a "shaking" machine at work on a Shure microphone and noise-isolation mount. It's only one in a battery of torturous tests that shake, rattle, roll, drop, heat, chill, dampen, bend, twist, and generally commit mechanical, electrical and acoustical mayhem on off-the-production-line samples of all Shure microphones. It's a treatment that could cause lesser microphones to become inoperative in minutes. This kind of continuing quality control makes ordinary "spot checks" pale by comparison. The point is that if Shure microphones can survive our chamber of horrors, they can survive the roughest in-the-field treatment you can give them! For your catalog, write:

Shure Brothers Inc.  
222 Hartrey Ave., Evanston, Ill. 60204  
In Canada, A. C. Simmonds & Sons Ltd.



Check No. 35 on Reader Service Card

Figure 2 shows the underneath view of one of the heatsinks, which incidentally are 14 inches long with a total radiating area of 560 square inches.



Fig. 1—Back panel.

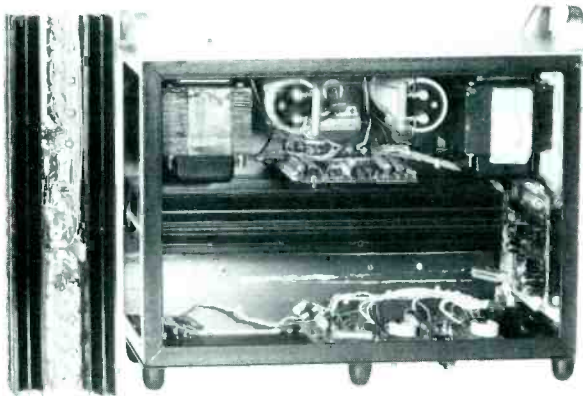

Fig. 2—Interior of the chassis with one output stage and heatsink removed.

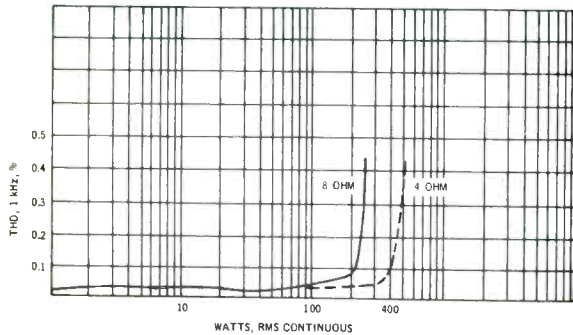

Fig. 3—THD versus watts at 4 and 8 ohms.

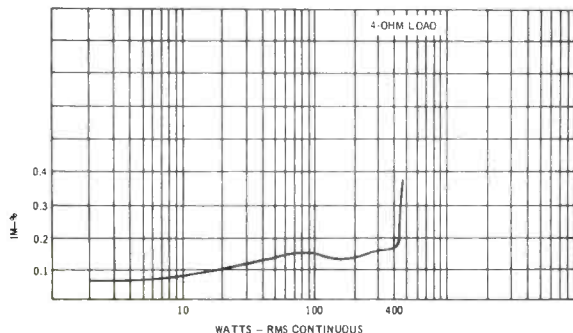

Fig. 4—IM versus watts with a 4 ohm load.

### Circuit Description

Input stage is an LM 318 IC, which has a large overall negative feedback loop around it and a NPN-PNP pair, which is then followed by the power driver and output stages. Each output stage uses three NPN silicon devices—a total of 12 for the two channels. The power supply arrangement is a little unusual as two power transformers are used in a series-parallel circuit. In other words, the inputs are in parallel but the secondaries are in series. The Crowbar protection circuit employs a thyristor to discharge the energy in the capacitors and turn off the supply in the event of a short circuit or high overload surges. Two transistors are used to limit the current in the output transistors. The d.c. supply measured 75 plus 75 volts, and this dropped to 63 plus 63 volts under full load. In series with the power transformer primary is a 4 ohm resistor and a relay shorts out this resistor after a one second delay, thus preventing switch-on surges.

### Measurements

Figure 3 shows the power output and THD for 8 and 4 ohm loads. Both channels were driven simultaneously, and it will be seen that the 500R delivers more than 225 watts at 8 ohms and over 400 watts per channel at 4 ohms. Nearly a kilowatt! IM distortion (60 Hz and 7 kHz, 4:1) is shown in Fig. 4. Full rated power is stated at 300 watts per channel into 4 ohms; this is a very conservative figure and we obtained nearly 400 watts per channel from 20 Hz to 20 kHz. Power bandwidth is quoted as being "less than 10 Hz to 20 kHz," but we found the 3 dB point to be above 40 kHz. Distortion versus frequency for 200 watts and 400 watts is shown in Fig. 5. Frequency response is shown in Fig. 6, the 3 dB points being 5 Hz and 90 kHz respectively. Square wave responses at 40 Hz and 10 kHz can be seen in Fig. 7. The high frequency waveform shows a slight rounding but there is no trace of overshoot—even with a simulated electrostatic loudspeaker load. Rise time is given as 5 microseconds. Hum and noise were not too easy to measure due to outside (Continued on page 66)

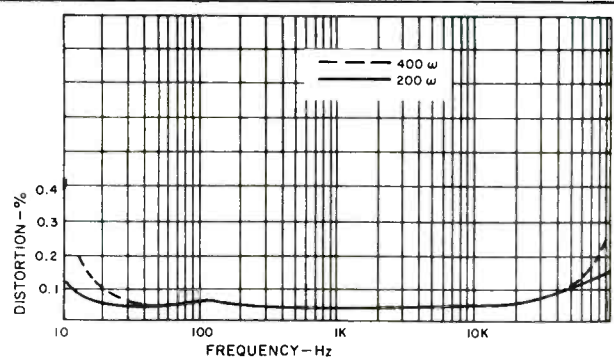

Fig. 5—Percentage distortion versus frequency at 200 and 400 watts output.

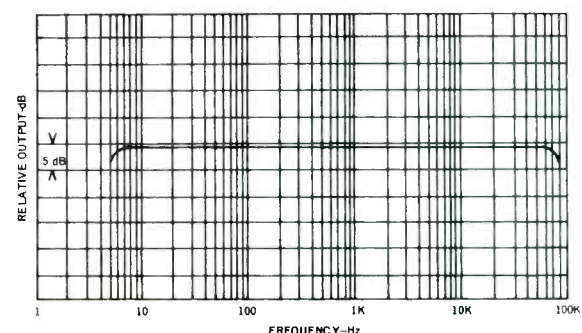
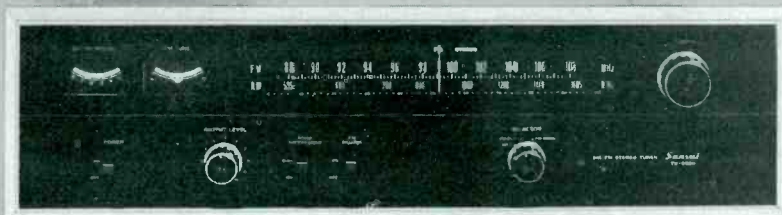

Fig. 6—Frequency response.





# can you match a Sansui tuner?

**Sansui can. With one of our new integrated amplifiers:**

**AU-7500** \$299.95  
40 watts RMS/channel



**TU-7500** \$249.95  
IHF sensitivity 1.9  $\mu\text{V}$

**AU-9500** \$519.95  
80 watts RMS/channel



**TU-9500** \$299.95  
IHF sensitivity 1.7  $\mu\text{V}$

**AU-6500** \$249.95  
30 watts RMS/channel



**TU-7500** \$249.95  
IHF sensitivity 1.9  $\mu\text{V}$

Sansui, world famous for the finest in components, can now be put together like a jigsaw puzzle and meet the musical needs, power requirements and budget of the choosiest component connoisseur. Designed to conform to each other in style and size the new Sansui TU-9500 tuner (with IHF sensitivity of 1.7  $\mu\text{V}$  and THD of less than 0.3% in stereo) matches the AU-9500 amplifier which delivers a massive 80 watts RMS per channel into an 8 ohm speaker.

The TU-7500 tuner (with IHF sensitivity of 1.9  $\mu\text{V}$  and THD of less than 0.5% in stereo) can be matched with either the AU-7500 amplifier with an output of 40 watts RMS per channel into an 8 ohm speaker or the AU-6500 which provides 30 watts RMS per channel into an 8 ohm speaker. Every match looks and sounds great because it has the unmatched engineering and design quality of Sansui.



**SANSUI ELECTRONICS CORP.**

Woodside, New York 11377 • Gardena, California 90247  
SANSUI ELECTRIC CO., LTD., Tokyo, Japan • Sansui Audio Europe S. A., Antwerp, Belgium  
Check No. 33 on Reader Service Card

# Advertising Index

ADVERTISER	PAGE	ADVERTISER	PAGE	ADVERTISER	PAGE
Acoustical Mfg.	81	Fairfax Industries	76	Rectilinear Research	44, 45
Quad Speakers		Loudspeakers		Loudspeakers	
Check No. 1 on Reader Service Card		Check No. 15 on Reader Service Card		Check No. 30 on Reader Service Card	
Akai	53	Harman/Kardon	23	Revox Corp.	74
GX-285D Recorder		High Fidelity Components		Tape Recorders	
Write Direct to Advertiser		Check No. 16 on Reader Service Card		Write Direct to Advertiser	
Audio Dynamics Corp.	7	Heath Company	11	Rhoads & Company	86
ADC-XT 10 Speaker		Current Catalog		Teledaptor	
Check No. 2 on Reader Service Card		Check No. 17 or Mail Postcard		Check No. 31 on Reader Service Card	
Audio Research Corp.	80	Jensen Sound Laboratory	73	Rogersound Labs	12
High Fidelity Components		Loudspeakers		Loudspeakers	
Check No. 3 on Reader Service Card		Check No. 18 on Reader Service Card		Check No. 32 on Reader Service Card	
Audio Warehouse	85	KLH Research & Development	41	Sansui Electronics	59
Mail Order Discounts		High Fidelity Components		Amplifiers	
Check No. 4 on Reader Service Card		Check No. 19 on Reader Service Card		Check No. 33 on Reader Service Card	
Avid Corp.	51	Lafayette Electronics	82	Saxitone Tape Sales	86
Series 100 Speakers		1974 Catalog		Magnetic Tape	
Check No. 5 on Reader Service Card		Check No. 20 on Reader Service Card		Write Direct to Advertiser	
BSR	65	Linear Design Labs	2	Schwann Record & Tape Guide	72
Turntables		749A Loudspeaker		Current Listings	
Check No. 6 on Reader Service Card		Write Direct to Advertiser		Write Direct to Advertiser	
Bose Corp.		Logic Newsletter	87	Sherwood Electronic Labs	13
901 Series II & 501 Series II	38, 39	Sample Copy		7200 Receiver	
800 Speaker	83, 87	Check No. 21 on Reader Service Card		Check No. 34 on Reader Service Card	
1801 Amplifier	Back Cover	Magnavox Company	47	Shure Brothers	57
Write Direct to Advertiser		Receivers		Microphones	
Bozak	25	Check No. 22 on Reader Service Card		Check No. 35 on Reader Service Card	
Loudspeakers		Marantz Company	Cover 3	Sony Corp.	43
Write Direct to Advertiser		Loudspeakers		High Fidelity Components	
British Industries	3	Check No. 43 on Reader Service Card		Check No. 36 on Reader Service Card	
Venturi Speakers		McIntosh Laboratory	79	Soundcraftsmen	79
Check No. 9 on Reader Service Card		Free Catalog		Equalizers	
Crown International	6	Check No. 23 on Reader Service Card		Check No. 37 on Reader Service Card	
IC150		Midwest Hi Fi	83	Southern Sound Wholesalers	86
Check No. 10 on Reader Service Card		Mail Order Discounts		Mail Order Discounts	
dbx, Inc.	70	Check No. 24 on Reader Service Card		Check No. 38 on Reader Service Card	
Decilinear Expander		PAIA Electronics	87	Superscope	17
Check No. 46 on Reader Service Card		Synthesizer Kits		Microphones	
Electro-Voice	70	Check No. 25 on Reader Service Card		Check No. 63 on Reader Service Card	
Condenser Mics		Phase Linear	15	TDK Electronics	48, 49
Check No. 11 on Reader Service Card		400 Amplifier		Recording Tape	
Elpa Marketing		Check No. 26 on Reader Service Card		Check No. 41 on Reader Service Card	
Thorens Turntables	69	Pickering & Co.	19	Technics by Panasonic	5
Check No. 12 on Reader Service Card		Cartridges		SA-5400X Amplifier	
Watts Parastat	71	Check No. 39 on Reader Service Card		Check No. 42 on Reader Service Card	
Write Direct to Advertiser		Pilot Radio	67	United Audio	31
Empire Scientific	21	Receiver		Dual Turntables	
Cartridges		Check No. 27 on Reader Service Card		Check No. 44 on Reader Service Card	
Check No. 13 on Reader Service Card		U.S. Pioneer Electronics	Cover 2, 1	Utah Electronics	16
Epicure	74	Stereo Receivers		Loudspeakers	
East Coast Dealers		Check No. 28 on Reader Service Card		Check No. 45 on Reader Service Card	
Write Direct to Advertiser		Rabco	75		
		Turntables			
		Check No. 29 on Reader Service Card			



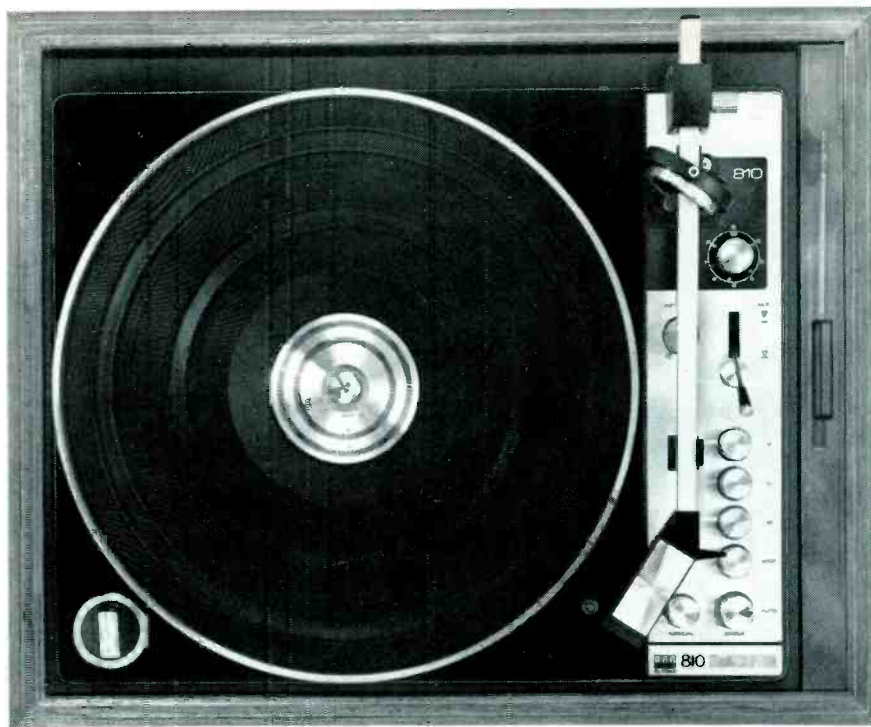

# We gave our best turntables the shaft.

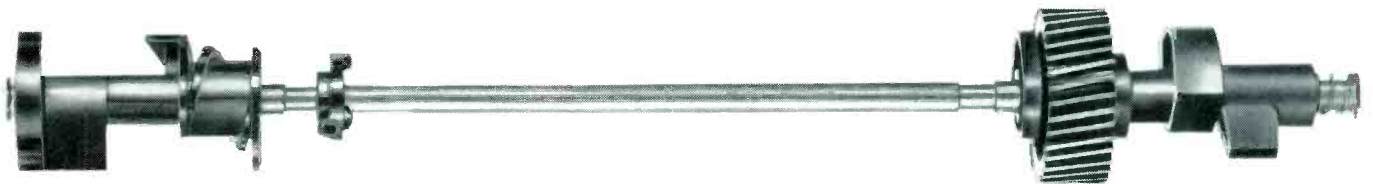

## And they're better because of it.

The BSR 810 and 710 have their brains in their shaft. A carefully machined metal rod holding eight precision-molded cams. When the cam shaft turns, the cams make things happen. A lock is released, an arm raises and swings, a record drops, a platter starts spinning, the arm is lowered, the arm stops, the arm raises again, it swings back, another record is dropped onto the platter, the arm is lowered again, and so on, for as many hours as you like.

Deluxe turntables from other companies do much the same thing, but they use many more parts—scads of separate swinging arms, gears, plates, and springs—in an arrangement that is not nearly as mechanically elegant, or as quiet or reliable; that produces considerably more vibration, and is much more susceptible to mechanical shock than the BSR sequential cam shaft system.

When you buy a turntable, make sure you get the shaft. The BSR 710 and 810. From the world's largest manufacturer of automatic turntables.

# BSR

BSR (USA) Ltd., Blauvelt, New York 10913

Check No. 6 on Reader Service Card

(Continued from page 58)

electrical interference, but it lies within 100 to 125 dB as claimed. Input voltage required was almost exactly 2.0 volts for full output.

### Listening Tests

How did it sound? In one word, neutral. Which is how it should be. After all, distortion was virtually unmeasurable and it did not increase at low levels. There was no sign of crossover distortion even at milliwatt outputs and overload

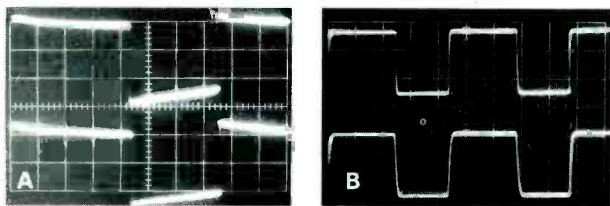

Fig. 7—Square wave response at A, 40 Hz, and B, 10 kHz.

### Hegeman H-1 Loudspeaker



#### MANUFACTURER'S SPECIFICATIONS

**System Type:** Two-way, coaxially mounted. **System Components:** 8-in. bass, 1-in. dome tweeter. **Crossover Frequency:** 5 kHz. **Frequency Response:** 30-20 kHz. **Recommended Amplifier Power:** 20 watts. **Nominal Impedance:** 8 ohms. **Dimensions:** 26" H. x 11" W. x 8¾" D. **Price:** \$114.00 ea.

The name Hegeman has been almost a legend in the high fidelity world for many years and such items as the Model 4 corner speaker and the original Citation amplifiers are still remembered with affection by older enthusiasts. As an innovator, Stu Hegeman is not satisfied with putting two or three standard loudspeakers in a box, juggling with the crossover

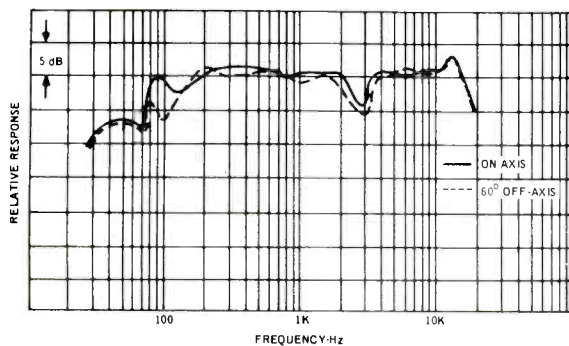

Fig. 1—Response measured with one-third octave pink noise, taken on axis and 60 degrees off-axis.

characteristics were excellent. Bandwidth and rise time were more than adequate; so was stability with complex loads.

Two preamplifiers were used, a Harman-Kardon Citation 11 and a Sony 2000F. Both gave first-class results. Bass was tight, treble smooth with no trace of stridency. Much of the program material consisted of master tapes and disc recordings of impeccable quality. Power was ample for a pair of AR LST's or EPI 400's. Unfortunately, we had to return our Magneplanar speakers just before we received the amplifier, so I missed the opportunity of comparing the 500R with the Audio Research 75+75 with those speakers. Perhaps later. . . .

Summing up: The BGW will unquestionably take its place among the top four or five high quality amplifiers. It is well made with the welded steel construction and all the components appear to be high grade. At \$685, it is not cheap, but, after all, this is only 80¢ a watt! My only criticism concerns the lack of VU meters. Yes, I know the answer, but I still like the idea! I almost forgot; there is no switching thump. That relay really works. G.W.T.

Check No. 51 on Reader Service Card

and calling the result *A Revolutionary New System*. His H-I is a little different, as we shall see.

It is a floor-standing column type of system measuring on 26 in. high by 11 in. by 8¾ in. deep. The finish is a teak vinyl and at the top is a charcoal plastic foam grille. The two loudspeakers are mounted underneath on an angled panel so the sound is projected upwards and forward. The bass unit is an 8-in. model with aluminum cone and 1-in. dome tweeter which also acts as a loading plug and diffuser for the low frequency unit. A small wooden dome is mounted under the grille just above the tweeter to improve dispersion. Crossover is mechanical—the bass speaker rolls off from 2 kHz so a simple capacitor is used to couple the HF unit. Input terminals and a level control are mounted in a recess at the rear. So far, the H-I is reasonably conventional—the unusual features of the design are concerned with the low frequency

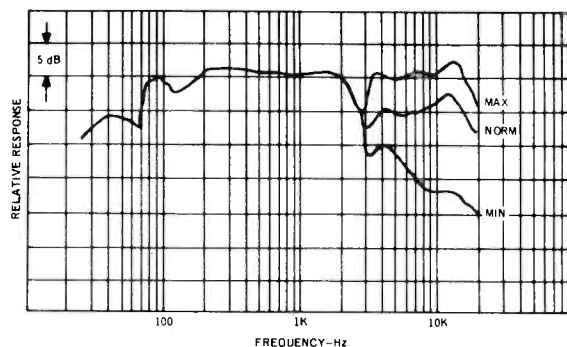

Fig. 2—Showing the effect of the level control.

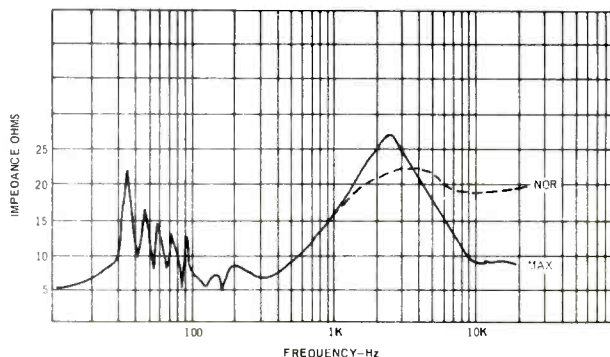
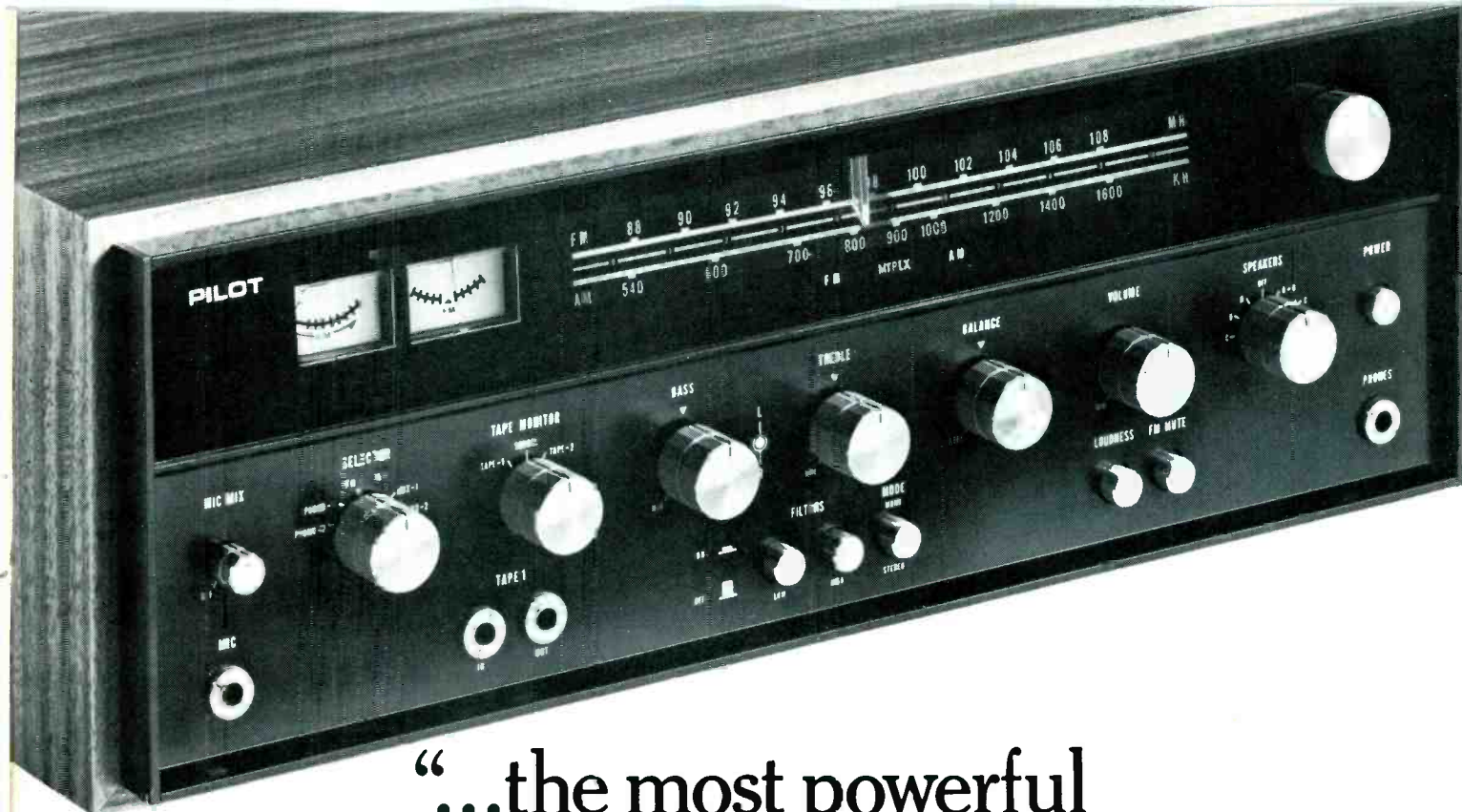

Fig. 3—Impedance characteristics. Note the influence of the tuned pipes.





“...the most powerful stereo receiver in its price class by a considerable margin...”

A challenging claim?

Not at all. Just a statement of fact by Hirsch-Houck Laboratories as published in Stereo Review, September 1973.

They're describing the new Pilot 254 and they go on to say, “Our test measurements clearly showed that the advertised specifications for the Pilot 254 are not only honest, but quite conservative.”

Separating verifiable fact from advertising fiction is a testing lab's specialty. Making sure that every Pilot product meets or exceeds every one of its specifications is our specialty.

How well we do our part, may be judged from the rest of the Hirsch-Houck report.

The Pilot 254 specifications read: 65 honest watts per channel, 8 ohms, both channels driven. The Lab finds, “At 1000 Hz, the outputs clipped (were overdriven) at 82 watts per channel...”

We rate harmonic and I.M. distortion at 0.4% and 0.5% respectively. They find, “At Pilot's rated 65 watts per channel output level, distortion was 0.1% to 0.15% from 20 to beyond 10,000 Hz, reaching a maximum of 0.25% at 20,000 Hz.”

In evaluating the FM tuner section, the Lab reports, “FM tuner performance was well up to the standards of the audio section.”

We rate IHF sensitivity at 1.8  $\mu$ V with harmonic distortion at 0.4% mono and 0.8% stereo. They find, “...a 1.7  $\mu$ V IHF sensitivity and only 0.16% harmonic distortion at almost any useful signal level with mono reception. The stereo distortion was about 0.5%.”

We list capture ratio at 1.5 dB. They find, “The capture ratio was an excellent 1 dB...”

And they go on to confirm the same outstanding performance figures for noise, stereo separation, image rejection and all the rest.

Finally, they sum it all up with, “...we could not fault this fine receiver in any respect.”

Listen to the Pilot 254 and you will agree.

For the complete text of the report and additional information write: Pilot, 66 Field Point Road, Greenwich, Conn. 06830.

The Pilot 254 Stereo Receiver \$429.00\*

\*Manufacturer's suggested retail price

**PILOT**  
performance is more than great specs

Check No. 27 on Reader Service Card

end. The enclosure is sealed, and it does not use a tube vent or any kind of port. In other words, it is *not* a reflex or an air-suspension system—it actually employs six stagger-tuned pipes which extend the low frequency response without introducing coloration. The principle has been used before but not, as far as I know, in a cabinet of this size.

### Measurements

Figure 1 shows the response measured with one-third octave pink noise. As might be expected, dispersion was very

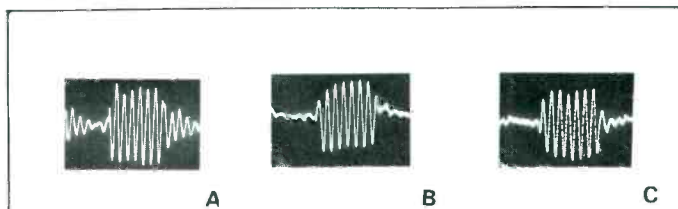

Fig. 4—Tone-burst characteristics at A, 100; B, 1000; and C, 5000 Hz.

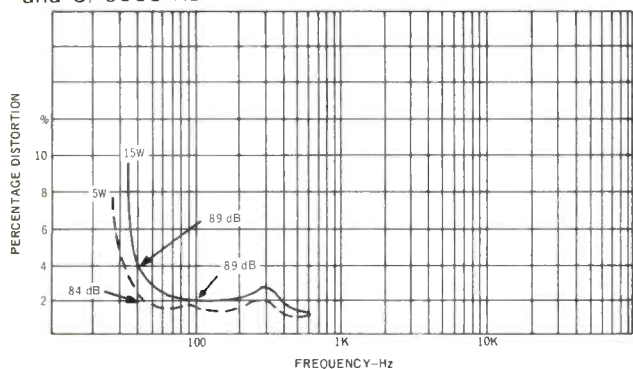

Fig. 5—Low-frequency distortion and some SPL figures for 5 and 15 watts.

good indeed—the variation at 60 degrees off-axis being quite small. Figure 2 shows the effect of the HF level control. Apart from a 5 dB dip at 3 kHz, the response between 100 Hz and 10 kHz was very smooth. There is a slight rise to 12 kHz, then falling off from 18 kHz. The impedance curve is shown in Fig. 3 and the influence of the tuned pipes can be seen quite clearly. Tone-burst responses are shown in Fig. 4. A is 100 Hz, B, 500 Hz, and C, 5 kHz. Figure 5 shows the low frequency distortion is exceptionally low for such a small enclosure. Power handling capacity was high—no less than 87 watts (continuous sine wave) at 40 Hz and 90 watts at 100 Hz. White noise confirmed the low coloration and wide dispersion.

### Listening Tests

Sensitivity is about average and a power of 15 to 20 watts per channel is recommended. The receiver used for most of the tests was a Pioneer 727, which delivers more than 35 watts per channel, so there was ample power to spare. Best positions for the speakers were near the corners, close to the walls which act as reflectors. Overall sound quality was rather distant and withdrawn due to the 3 kHz dip. Bass was solid and remarkably clean and uncolored for such a small enclosure and a useful output was obtained to below 35 Hz. Stereo image was stable with a wide listening area. In short, the dispersion was an excellent compromise between directional systems with a restricted listening area and omnidirectional systems which tend to produce a diffuse image. A Soundcraftsmen 20-12 equalizer easily compensated for the 3 kHz dip and the sound then had a more forward, lifelike quality, at least to my ears, but it is only fair to say that at least two people preferred the more distant, back row sound without the equalizer. *Chacun a son gout . . .* Summing up: the Hegeman H-I is an unobtrusive system with above average bass response and good dispersion. It will undoubtedly appeal to many people who want a floor-standing system of a reasonable size.

T.A.

Check No. 56 on Reader Service Card

## Encore to excellence.

Thorens proudly presents its TD-125AB Mark II Electronic Turntable with a new, unsurpassed transcription tonearm.

When the Thorens TD-125 first appeared on the scene, Stereo Review acclaimed it as . . . "unquestionably one of the elite among record players. It would be hard to imagine a unit that performs better."

While a host of refinements have been added to the Mark II, such as the new TP-16 tonearm with its own automatic magnetic anti-skating control,

all the advanced features of the original TD-125 have been retained.

Visit your Thorens dealer today and learn why this new Thorens is a must in any quality stereo and 4-channel system.

Elpa Marketing Industries, Inc.  
New Hyde Park, N.Y. 11040. West. Scottsdale, Ariz. 85253. Canada: Tri-Tel Assocs.,



# THORENS

Check No. 12 on Reader Service Card



# Jazz & Blues

Martha Sanders Gilmore

FOR TEN CONSECUTIVE days (June 29-July 8), the 20th annual Newport Jazz Festival/New York kept jazz fans humming and their feet tapping as over 1000 musicians performed in 56 events at 13 sites in and around New York.

On a rain-drenched Friday afternoon, the festival opened in the outdoor Wollman Amphitheater in Central Park, where fewer than 250 souls had gathered. It was a good beginning, said the 250, rising to their feet in applause of Gerry Mulligan's 17-piece ensemble. The Age of Steam. The Mulligan team broke right through the clouds with *A Weed in Disneyland*, "dedicated to the President of the U.S." Mulligan pumped out the steam on baritone, raising his leg in emphasis, while trombonist Bob Brookmeyer brayed in answer to him. Mulligan played a very stately *Waltzing Matilda*, treating it like an old southern

song, then whirled us around the maypole in a frolicsome *Mavrag*, which featured Jimmy Owens on a quick bristling trumpet solo.

Next up was vocalist Margie Joseph, all the way from New Orleans, who sang a rather lusty, slow-paced *Let's Go Where the Grass Is Greener*. Then the Newport Ensemble, which included producer George Wein on piano; Larry Ridley, bass; James Spaulding, reeds; Al Harewood, drums, and Roland Prince, guitar, played two modern sounding pieces, *Two Areas* and *Ginger Flower*, with Harewood setting the calypso pace in the latter. While Wein's solo was rather oblique, guitarist Prince played an effortless stream of notes that brought out the sun.

The quintet of Charles Lloyd then led fans down some rather beguiling paths, as Lloyd played tenor saxophone as if doing a rain dance. Lloyd, who doubled on flute, from which he got a

very full tone, was so enmeshed in his music that he couldn't bother to look up. The Latin American sound of Gato Barbieri closed the afternoon and set umbrellas to bobbing with strong urgent tones and grand churning rhythms.

The original Benny Goodman Four's Friday evening performance at Carnegie Hall was an understandable sell-out, with folks sitting onstage and packed up to the rafters of the great hall. It was an evening of pure nostalgia and the first time the group had appeared on this stage since 1938 as bassist Slam Stewart joined Teddy Wilson, piano; Lionel Hampton, vibes; Gene Krupa, drums; and Benny Goodman, clarinet. The smash evening of memories included *Moonglow*, *Memories of You*, the Andrew Sisters' winner *Bei Mir Bist Du Schoen*. As an encore, the inimitable *Sing, Sing, Sing* spotlighted Krupa with Hampton

Photo by George Gilmore



The Original Benny Goodman Four, including Teddy Wilson, piano; Benny Goodman, clarinet; Slam Stewart, bass; Lionel Hampton, vibes, and Gene Krupa, drums.

# Electro-Voice Condenser Microphones Meet the test

(and please the testers).

Hirsch-Houck Laboratories (reporting in the May, 1973 *Popular Electronics*) said, in part, "Best of all, their sound quality has a range and smoothness that we have not previously found except in much more expensive mikes".

And *Consumer Guide* magazine (Vol. 31) rated the E-V electret condenser microphones "Best Buys" on the basis of their tests.

Further proof that you can get studio-quality sound at moderate prices with an E-V electret condenser microphone. Prices start at \$39.75, suggested retail. See and hear them today at your E-V dealer. Or write for your useful FREE guide to the use of Electro-Voice condenser microphones. It has helpful information for every tape recording enthusiast.

a **Gulton** COMPANY  
ELECTRO-VOICE, INC., Dept. 1032A  
602 Cecil St., Buchanan, Mich. 49107

**Electro-Voice®**

More U.S. recording studios use Electro-Voice microphones than any other brand.

Check No. 11 on Reader Service Card

**dbx 117  
expansion  
gives your  
records  
20 db more  
dynamic  
range**

Ever wondered why records seem to have less dynamic range than live performances? Commercial record producers typically sacrifice as much as 20 db of dynamic range through compression (for reasons we explain in our literature)

The dbx 117 Decilinear Expander restores up to 20 db of the dynamics missing from records, tapes, and FM broadcasts. The Model 117 also lets you make professionally noise-free, full range recordings on even a modestly priced tape recorder.

The stereo dbx 117 is sold by better audio dealers at \$159. dbx, Incorporated, 296 Newton Street, Waltham, Massachusetts 02154



**dbx** inc.

Check No. 46 on Reader Service Card

scattering all over his vibes, while Goodman piped a happy tune.

Cornettist Ruby Braff and guitarist George Barnes preceded Goodman and crew in a very fine set, which evoked a light, tight, chamber music quality with Braff cutting the light fantastic in *Liza*.

Afterwards over at Philharmonic Hall, the B.B. King Blues Band was followed by Eddie "Cleanhead" Vinson playing a lean and sinewy alto saxophone, goateed and singing out in a raspy blues voice. Then Gatemouth Brown came on, a real cut-up who played a wailing harmonica, holding a high note an inordinately long time followed by Arthur "Big Boy" Crudup and son with some slow-moving guitar blues.

B.B. then brought the "master" on, none other than Muddy Waters who performed all sorts of pyrotechnics on guitar, projecting a stinging, waspish sound and receiving a standing ovation for *I've Got My Mojo Working*. But Willy May (Big Mama) Thornton was the evening's highlight, putting on a very commanding performance with her rendition of Janis Joplin's *Ball and Chain*. It was disappointing, however, that B.B. spent most of his time talking instead of playing.

A sunny afternoon with the odor of chestnuts wafting through the breeze brought fans out to hear the Guitar Explosion at the Wollman Amphitheater. The afternoon sessions under the sun truly recreated the feeling of the original festival and produced some of the best music of the entire 10 days although the crowds were regrettably small. Joe Puma and Chuck Wayne got the afternoon off to a roaring start with interwoven duets. In *Li'l Darlin'* Puma used a wah-wah and Chuck Wayne was all over his instrument with his busy-bee fingering, each obviously delighted in the other's company in a totally good-humored set.

The George Benson Quartet launched right into *So What* with Benson displaying much technical virtuosity, his fingers flying fleet as the wind. A rather contemplative *Summertime* was played by two contrasting guitarists, the restrained and cerebral Jim Hall and the more ebullient and outgoing Tal Farlow. Then Tiny Grimes, wearing a blue button hat for his first appearance at Newport, proved that he is a strong force in the guitar world with *I'll Remember April*. By striking contrast Pat Martino's young contemporary sound never went very far and was, in the final analysis, repetitive.



But Larry Coryell and Foreplay came on as redeemers. Coryell, who is known for his frenetic stop-and-go patterns, was joined by soprano saxophonist Steve Marcus on *Lolita*. Coryell played a mesmerizing solo on *Jovride* and it was a spellbinding experience indeed to hear his fusion of jazz and rock. Nonetheless, they saved the best for last in Roy Buchanan, an arresting, unforgettable stylist who, treating his guitar with great care, almost caresses his strings and draws out his notes.

Saturday night at Philharmonic Hall began with Sonny Rollins in superb form but who was unfortunately not permitted enough time. An imposing figure all in white, Rollins displayed his excellent intonation and ability in *There Will Never Be Another You* and *I've Never Been in Love Like This Before*, with Walter Davis playing a giddy piano. Then along came swinging Mary Lou Williams, who played with tremendous punch in a tongue-in-cheek *Autumn Leaves*, showing off her feverish left hand and getting a pretty sound out of the keyboard.

A very coherent set was played by Gil Evans' unorthodox and coloristic orchestra in which Evans exploited every member of his School for Scandal to their fullest. Shining lights, however, were Billy Harper, tenor saxophone; Marvin Peterson, trumpet; Trevor Koehler, soprano sax, and Howard Johnson, tuba. It was fascinating to watch percussionist Sue Evans go about her chores.

The icing on the cake was an absolutely devastating unaccompanied piano by Keith Jarrett who went on for 45 minutes. Jarrett incorporated strains of church music and cake-walk rhythms, as well as impressionistic and classical motifs.

Radio City Music Hall was filled to capacity for the midnight jam session which was broken down into three sets. The first featured some wild blowing by Howard Johnson on tuba and Freddie Hubbard on trumpet, but the trumpet duel between Jimmy Owens and Clark Terry in the second set brought the house down. The final set, featuring the more avant-garde jazz musicians, Don Cherry and Robin Kenyatta, was unfortunately only a futile attempt at music and resulted merely in noise.

On Sunday jazz buffs savored a boatride on the Hudson River to the tune of two Dixieland bands imported for the occasion. On the lower deck it was the Drootin Brothers from Boston while Percy Humphrey's Preservation Hall Band from New Orleans graced the upper deck, winding it all

up just as the ferry was about to slide into its slip with *When the Saints Go Marchin' In*.

On hand Sunday evening at Philharmonic Hall was Duke Ellington with his 19-piece orchestra, a skillfully polished organization if there ever was one. The "piano player" featured himself in *Rockin' In Rhythm*, vintage 1929, while Russell Procope took a clarinet solo in *Creole Love Call*, from 1927. After Paul Gonsalves, the recognized hero of the Newport Jazz Festival, walked all over the stage

playing *In a Sentimental Mood*, Harold Ashby submitted some graceful tenor sax in *Afro-Eurasian Eclipse*. A soprano all the way from Stockholm, Alice Babs, sang *Far Away Star* in an almost operatic voice with an incredible range. Mandrill, an incompatible second bill, depended more upon theatrics than sheer musicality.

*The Hallelujah Chorus: The Life and Time of Ray Charles* as written and narrated by James Baldwin was performed at Carnegie Hall. If there had been less of Baldwin and more of



## Caution: Cigarette smoking is hazardous to your records.

Cigarette ashes and smoke can ruin records. They can create a gritty film in the grooves that throttles the original sound. Restore the original brilliance with a Watts Parastat. Both new and old records respond to this

remarkable cleaning tool. It probes deep into record grooves, routing the toughest dust, dirt and anti-static sprays. Can't give up smoking? Get a Watts Parastat. Only \$16.50.

Watts record care equipment and kits are available at hi-fi dealers and record counters everywhere.

Elpa Marketing Industries, Inc., New Hyde Park, N.Y. 11040 / Scottsdale, Ariz. 85260



### PARASTAT

# STOP

## BEFORE YOU BUY THAT RECORD . . .

WAIT A MINUTE!

IS IT REALLY A BARGAIN?  
IS IT THE PERFORMANCE YOU REALLY WANT?

Check the other performances and recordings in the latest Schwann Record & Tape Guide.

If it saves you disappointment over one poor purchase, it's well worth the time to look in Schwann first.

**Schwann-1** Monthly. Special new listing section has latest releases: records, 8-track cartridge and cassette tapes. Nearly 45,000 total listings on 773 labels in classical, recent popular, rock, jazz, musical shows, country, opera, ballet, electronic, quadrasonic, etc.

**Schwann-2** Semi-annual catalog for specialized categories: pop more than two years old, classic jazz, older and re-released mono and reprocessed stereo classical recordings, classical on lesser-known labels, international pop & folk on domestic labels, spoken, educational, religious, etc.



### SPECIAL PRICE SAMPLE OFFER

If your favorite store doesn't carry Schwann, order samples by mail. Prices include postage and handling.

- Schwann Sampler one Schwann-1 (monthly) and one Schwann-2 (semi-annual) ..... \$2.25
- Latest Schwann-1 (monthly) ..... \$1.25
- Latest Schwann-2 (semi-annual) ..... \$1.25
- Newly revised Basic Record Library booklet.

Lists 1,000 suggestions in classical music by musical periods for your enjoyment. Send 15¢ for cost of handling, also 8¢ stamped self-addressed long envelope.

I enclose \$..... for the items checked above.

Name \_\_\_\_\_

Address \_\_\_\_\_

City \_\_\_\_\_ State \_\_\_\_\_ Zip \_\_\_\_\_

Dealer's Name & Address \_\_\_\_\_

**Schwann Record & Tape Guide**

137 Newbury Street, Boston, Mass. 02116

AU

Charles, the show would have been a success. The pomposity of Baldwin, who orated from a lectern, then came piano-side to ask Charles questions, was indeed a contrast to the engaging Charles who sang some of his hit songs such as *Eleanor Rigby*.

An afternoon of jazz for children and adults was decidedly designed for the latter, for what few children were present only came alive during the tap dancing portion with Baby Laurence, Buster Brown, Chuck Green, John McPhee, and L.D. Jackson who displayed their percussive talents foot-wise. Preceding them was Professor Longhair, a blues pianist from New Orleans, and the Milt Buckner-Jo Jones Duo. In *It's Three O'Clock in the Morning*, Buckner played only with his feet as Jones tapered it off to three cymbal knocks.

But the crowd truly woke up to the Charles Mingus Quintet as Mingus played his own bittersweet compositions with great gusto, emitting deep-throated solos in which he made his string bass fairly sing. His *Goodbye Pork Pie Hat* conveyed a Gershwin-esque quality, a very pretty piece instilled with all sorts of unexpected intervals.

Then, as though it were Halloween, Don Cherry and his Eternal Now came on, wearing all sorts of weird costumes and sporting colorful trappings. The music was likewise, geared to both the eye and ear as his troops spread themselves across the stage, ringing bells and gongs and blowing on conchs.

Jazz fans of all ages danced to the bands of Duke Ellington, Woody Herman, and Count Basie on Monday night in the Roseland Ballroom, while Tuesday afternoon was bright and clear with the crystalline tones of Marian McPartland's piano. In Ellington's easy-going blues *Things Ain't What They Used To Be*, Miss McPartland created some exquisite pianistic embroidery, then gave Roberta Flack's *Killing Me Softly With His Song* a simmering ballad treatment, finishing off with some boogie-woogie and ragtime in *Royal Garden Blues*.

The Modern Jazz Quartet, pristine and wearing pink shirts under black vests payed a tribute to the setting in *Skating in Central Park*, a subdued and restrained waltz in which pianist John Lewis played plenty of flatted fifths. Milt Jackson shone in *Bag's Groove* as bassist Percy Heath quoted from *The Hucklebuck*.

Much improved over last year, Stan Getz blew out a graceful *Spring Is Here* to honor the weather with mighty Jack DeJohnette managing his drums.



Then Mose Allison, that man from Mississippi, played some turbulent piano, singing and swinging in *Ain't That Just Like Living* and his crowd pleasing *Seventh Son*, full of wonders, witchcraft, and excursions into originality.

Ending the afternoon was the Horace Silver Quintet which featured the two Brecker brothers, Randy and Mike, on trumpet and saxophone respectively. Mike Brecker played a rather frantic sax solo in *In Pursuit of the 27th Man*, as Silver, with two adjacent notes together as is his custom, playing descending spaced-out runs that are his trademark in *Song for My Father* with the audience clapping along.

A unique concert, since it featured song writers rather than performers, was a Jazz Salute to the American Song performed by such artists as Stan Getz, Mabel Mercer, the Modern Jazz Quartet, Rahsaan Roland Kirk, Earl Hines, Art Hodes, Barbara Carroll, Dave Brubeck, and Gerry Mulligan playing the works of composers Duke Ellington, George Gershwin, Rogers and Hart, Harold Arlen, Fats Waller, Irving Berlin, Jimmy Van Heusen, and Alec Wilder (who was seated in the audience). For those who cannot find the melody in jazz, there could be no complaints as jazz artists winged their way from *Alexander's Ragtime Band* to *Come Rain Or Come Shine*.

The most enjoyable concert of the entire festival perhaps was Count Basie who introduced his present orchestra and that of the fifties. The roster read like a Who's Who in Jazz and the band sounded better than ever in *Speak Low*, *Sleep*, and *Poor Butterfly*. It was thoroughly spontaneous and uncontrived and the Count himself received a standing ovation.

At Louis Armstrong Memorial Stadium, about 100 jazz musicians payed a 4th of July tribute to the late Louis Armstrong before 8,000 people. The several trumpet men who played in honor of Satchmo included Clark Terry, Dizzy Gillespie, Erskine Hawkins, Jimmy Owens, Ray Nance, and Freddie Hubbard. Singers there in honor of Armstrong included Al Hibbler, Joe Williams, Helen Humes, and Ella Fitzgerald, who received the greatest round of applause. The four-hour show finally ended with a full-scale jam.

Conductor-arranger Michel Legrand put on a stunning performance at Carnegie Hall that evening with Stan Getz and Sarah Vaughan. Legrand conducted his slick orchestra with much enthusiasm in his own compositions such as *Shoes*, then teamed up

# We Call It Total Energy Response

At Jensen, the woofers, tweeters and purring mid-range speakers on our Model 6 are really sounding off.

They're part of our Total Energy Response design that gives every Jensen speaker a fuller, richer sound.

On Model 6, you hear Total Energy Response at its best. Because there just isn't a better four way, four speaker system on the market at \$198.

Model 6 holds a 15" woofer, 8" direct radiating mid-range, 5" direct radiating tweeter and Sonodome® ultra-tweeter.

It features our Flexair® suspension system, an exclusive crossover network, a 5 year parts and labor warranty, and walnut cabinet with base.

Power Rating—75 watts  
Frequency Range—27-30,000 Hz.  
Crossover—300/1,000/4,000 Hz.  
Dispersion—170.°

Take in a demonstration of Jensen's new Model 6. You'll get the maximum response.

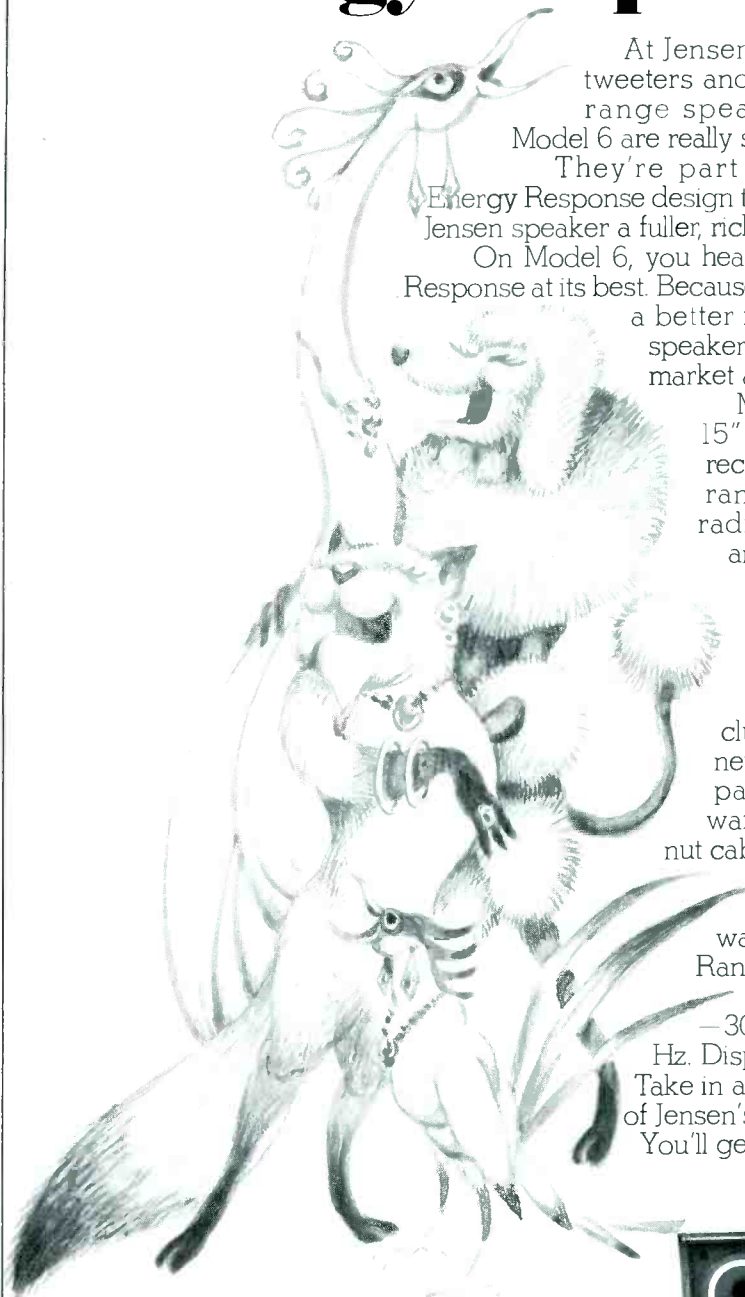

Model 6 Speaker System.



**JENSEN SOUND LABORATORIES**  
DIVISION OF PEMCOR, INC. SCHILLER PARK, ILLINOIS 60176

The best by far...  
because Revox delivers what  
all the rest only promise.



For complete details write: Revox Corp., 155 Michael Drive, Syosset, N.Y. 11791

## EPI'S LINEAR SOUND. HERE ARE SOME PLACES YOU CAN HEAR IT ON THE EAST COAST.

Arkansas Custom Audio, Little Rock Connecticut Klein's Camera & Hi Fi, Westport/Fred Locke Stereo, Avon/Sound Gallery, Greenwich Delaware Sound Studio, Newark Florida Cox's Appliance, Daytona Beach/Gibson Audio, Ft. Walton Beach/Hi Fi Associates, Miami/Henry Peerson Audio, W. Palm Beach/Sound Room, Tampa/Stereo Systems, Jacksonville/Swiff's Stereo & Camera, Key West/Tweeter, Etc., Coral Gables Georgia Canned Sound, Inc., Dalton/Hi Fi of Atlanta, Atlanta/N&W Camera Exchange and Hi Fi Center, Augusta/Sonic Stereo, Athens Illinois Albert Audio, Joliet/Appletree Stereo, DeKalb/Astro Sound Systems, Chicago/House of Sound, High Point/Lofgren Distributing, Moline/Playback, Inc., Chicago/Schnulle's Hi Fi Shop, Rockford/Stereo Studio, Arlington Heights/Stereo Trend, Arlington Heights Indiana Audio Specialists, South Bend/Hi Fi Shop, Evansville/Sound Productions, W. Lafayette Kentucky Tape Hut, Paducah Louisiana Quail Creek Stereo, Shreveport/Sound Salon, New Orleans Massachusetts Audio Components, Boston/Audio Designs, Lenox/DeMambo Hi Fi, Boston/Draper International, Hyannis/Hi Fi Listening Shop, Marlboro/Sound Ideas, Amherst/Tech Hi Fi, Boston/Tweeter, Etc., Boston Maryland Hi Fidelity Center, Baltimore/Gordon Miller Music, Pikesville/Sight & Sound Ltd., Belaire/Sirkis Music, Baltimore/Stereoland, Baltimore Maine New England Music Center, Portland/Frank Pomerleau, Inc., Augusta Michigan Adray Appliance, Dearborn/Audioland—Men of Music, Mt. Clemens/Douglass Sound, Ann Arbor/Electronic Sound Equipment Co., Grand Rapids/Marshall Music, Lansing/Michigan Teletronics, Flint/Tech Hi Fi, Royal Oak Ohio Bullet Dist., Bedford Heights/Channel I, Sylvania/Pioneer, Cleveland/Sound Associates, Bowling Green/Stereocraft, Parma Heights Pennsylvania Audio Warehouse, Pittsburgh/Barnett Brothers, Jenkintown/Bryn Mawr Radio, Bryn Mawr/Stereo Plus, Westchester/Tech Hi Fi, Philadelphia Rhode Island Stereo Sales, Providence/Tech Hi Fi, Providence South Carolina Kelley Enterprises, Greenville Tennessee Audio 747, Jackson/Opus 2/Lafayette, Memphis/Sound Gallery, Nashville/Southeastern Stereo, Knoxville Virginia Audio Specialists, Falls Church/Sound World, Virginia Beach/Stereo Design, Hampton West Virginia Custom Stereo, Charleston/Hi Fi Center, Huntington/Stereo Components Center, Morgantown Minnesota Schaak Electronics, Minneapolis North Carolina Audio Systems, Charlotte/Delta Enterprises, Charlotte/House of Sound, High Point/Troy Stereo Center, Durham New Hampshire Audio Lab, Keene/Rivers Camera Shop, Dover/Tech Hi Fi, Nashua New Jersey Audio Lab, New Brunswick/Conklins, Wycoff/House of Hi Fi, Trenton/Sound Associates, Cherry Hill/Stereo Center, Princeton/Stereo Mart, Middletown/Stereo Sound, Mahwah/Tech Hi Fi, Paramus New York Action Audio, Newburgh/Arnee Audio, Wappingers Falls/Audio Experts, Mamaroneck/Audio Unlimited, New York/Center Stage Stores, Albany/Curtis Stereo Four, New York/Dryden's Radio & T.V., Ithaca/Gracom Sound Stage, Flushing/Bob Hyatt's Rochester/Rosner Custom Sound, Long Island City/Sound Shop, Geneva/Stereo Plus, Kenmore/Stereo Center, Utica/Stereo Lab, Oneonta/Stereoland, Binghamton/Stereo Sound, Latham/Stereo World, Syracuse/Transcendental Audio, Buffalo/Willoughby—Peerless, New York Vermont Concert Electronics, Burlington

Next month: EPI's Dealers in the Central States.



with Miss Vaughan in his smash hit *Watch What Happens*. One of the new breed of saxophonists Tom Scott also joined Legrand. But Miss Vaughan, wearing a sequined dashiki, once again proved why she is considered one of the top jazz singers on today's scene, singing such numbers as *Summer of 42*, *Alfie*, and *Wave*.

Further along that evening it was back to Dixieland at Philharmonic Hall in a program of New Orleans Ragtime and Stride piano which featured pianist Wally Rose, the Turk Murphy Quintet, and the Bob Greene Orchestra which dedicates itself to the music of Jelly Roll Morton. The band roared through *Alabama Bound*, *The Smokehouse Blues*, and *Steamboat Stomp*, which the crowd really loved. Another pianist back in New York after 26 years was Joe Turner, a very accomplished musician who played a full, bluesy piano in *Willow Weep for Me* and *Poor Butterfly*.

Seated onstage there followed Percy Humphrey's Preservation Hall Jazz Band, the epitome of collective improvisation which began its set with *Somebody Stole My Gal*, screamed on *Ice Cream*, played *Basin Street Blues* featuring clarinetist Albert Burbank, and finished off with *When the Saints Go Marchin' In*.

Central Park on Thursday afternoon was taken over by some of the more experimental jazz groups, such as the Art Ensemble of Chicago who sported a reported 350 instruments from the four corners of the world. It was—in a sense—primitive, as though the players were performing in slow motion. Lester Bowie blew his trumpet over the shrieks, gongs, and clatters and drummer Don Moye brought his arms around like a windmill's in an expressionistic performance that went on non-stop for 50 minutes.

Sam Rivers followed on tenor saxophone in a wild and frantic session in which Rivers chanted in between switching to flute, then sang and hummed while blowing his flute. Another 50-minute non-stop set. Then in blew Ray Barretto and his group of Latin musicians like a fresh breeze who played an utterly palatable rendition of Thelonious Monk's *Round About Midnight*. The genius of Archie Shepp rounded out the afternoon, Shepp playing more understandably and more conservatively than usual, bending low under the weight of his art in J.J. Johnson's *Lament* and Calvin Massey's *The Peaceful Warrior* in which Joe Lee Wilson sang.

A salute to Ella Fitzgerald with the Chick Webb Orchestra under the direc-



tion of Eddie Barefield brought out that "First Lady of Song" in her own composition *A Tisket, A Tasket*, who then replaced the orchestra with the notable pianist Ellis Larkins. Ella sang several Gershwin tunes, such as *Nice Work If You Can Get It* and *I've Got a Crush On You*, which she gave a jewel-like treatment. In between sets a jam session ensued with Roy Eldridge, Tommy Flanagan, Keter Betts, Freddie Waits, Joe Pass, Al Grey, and Eddie "Lockjaw" Davis.

Following Ella at Philharmonic Hall was Chuck Mangione in a session imbued with great dignity and taste by the young flugelhornist. His group displayed a very high degree of musicianship in *Please Treat Her Well* which featured Gary Niewood with beautiful tone on alto flute and Mangione, a thoughtful, uncluttered player. Mangione fairly scatted on his horn in *Land of Make Believe*, one of his own compositions which had a child-like quality about it.

Wearing a flowing black cape, John Blair appeared onstage as an apparition playing an electronic vitar which appears to be a cross between a violin and guitar. Blair was both fascinating to watch and listen to, and finished off with a dance. John Mayall reincarnated the rock and roll of the fifties in *Move On Down the Line*, playing electronic piano and harmonica, his hair flying.

The entire Brubeck family appeared in Friday afternoon's concert at the Wollman Amphitheater. Darius on keyboard, Chris on trombone, and Danny on drums were joined by father Dave in the familiar *Take 5*. Then came on Carmen McRae looking resplendent, a salty songstress who really handles a lyric. Charmin' Carmen hit a very low note in *Spring Can Really Hang You Up the Most*, then gaye *Green Dolphin Street* a pure jazz feeling.

After blessing us all with a long stick adorned with rattles, Dizzy Gillespie commemorated the late Martin Luther King in *The Brother King*, with Mike Longo carving out a nice spot for himself on piano. The composition is comprised of lightly swinging passages interspersed by more pensive ones. Under the beautiful blue-skied canopy, Hubert Laws made an enthusiastic contribution on electric flute in John Coltrane's *Moment's Notice*. Laws then played *Amazing Grace*, stating it majestically and with great feeling and control.

Weather Report was good Friday evening with Joe Zawinul doing all sorts of miraculous things on electric piano and drummer Eric Gravatt com-

ing in like a locomotive, working up quite a head of steam. Wayne Shorter's work on tenor and soprano sax was notable and it is always nice to hear Miroslav Vitous on bass. Chick Corea's Return to Forever played five pieces from their suite *Hymn of the 7th Galaxy* which resulted in rather formless, space music in which one really couldn't hear Corea that well.

Over at Carnegie Hall was the reunion of the Cab Calloway Orchestra in which Cab jumped around leading his band for a fare-thee-well, but not for long. Instead Nellie Lutcher sang and

played piano. Louis Jordan sang and played alto saxophone, followed by a seemingly endless set by vocalist Esther Phillips. However, we did get to hear Cab sing *Hi-de-Ho!*

A midnight jam session at Radio City Music Hall featured some brilliant alto work by Eric Kloss and trombone work by Bill Watrous and veterans Art Farmer and Red Rodney in *I'll Remember April*. Ralph Towner played some lovely Spanish guitar followed by a real treat from Bill Evans, Eddie Gomez, Marty Morrell, and Gary Burton after which they accompanied

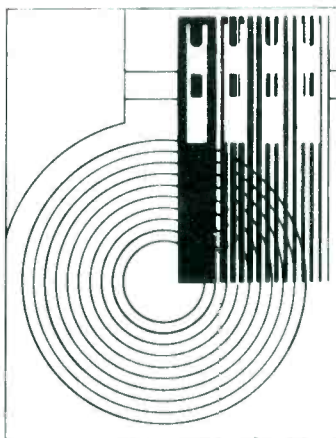

## We play it straight

Master records are made by machines that drive the cutting head in a straight line across the record. A playback system that moves across your

record in any other way, results in wear and distortion.

With a conventional pivoted arm system, the revolving groove "pulls" the stylus toward the center of the record. This is called, "skating force."

Skating force causes wear on the inner wall of the groove and the stylus, and results in a loss of separation as well as distortion levels simply not acceptable to the serious listener.

Most good pivoted arm systems do have anti skating devices. But they can only be set for average skating force, and an anti skating device that remains constant cannot fully compensate for all of the varying forces exerted during the playing of a record. Even the total elimination of tracking error does not eliminate the inherent problem of the pivoted arm — skating force.

The RABCO system plays it straight. The pickup moves in a straight line. The record is played precisely as it was originally cut. It has no anti-skating device for one reason. The RABCO system eliminates skating force.

We want to tell you more about how we eliminate both skating force and tracking error. Drop us a note and we'll send full information straight away.

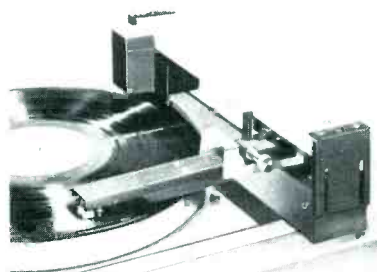

**The RABCO SL-8E**  
A straight tracking tone arm for your turntable



**The RABCO ST-4...**  
A professional turntable with the RABCO tone arm system

# RABCO

A division of Jervis Corporation

DEPT A  
55 Ames Court  
Plainview, New York 11803

Jeremy Steig on flute.

The evening continued with a set by Art Blakey, Larry Ridley, Barry Harris, Hank Mobley, Joe Farrell, Stan Getz, John Faddis, Cecil Payne, Dizzy Gillespie, and Curtis Fuller in Gillespie's *Night in Tunisia* with an extended coda by Diz. The jam session came to a close around 4:00 a.m. with Sonny Stitt, Blue Mitchell, Louis Jordan, Oliver Jackson, Milt Hinton, Tiny Grimes, Larry Coryell, Earl Hines, Al Grey, and John Mayall who, despite his youth,

lited in very nicely with the seasoned veterans.

Saturday afternoon was taken over by drummers. M'Boom with Max Roach surrounded us with a morass of percussion and a plethora of noise-makers. Art Blakey and his Jazz Messengers proved quite a contrast in a straight-forward set that featured tenor saxophonist Sonny Stitt blowing on a very fluid and light horn while Cedar Walton made multi-noted excursions on piano. Roy Haynes joined them in

*Night in Tunisia*, playing a duet with Blakey that was truly remarkable.

A series of Gretsch Greats included Tony Williams, Freddie Waits, Elvin Jones, Mel Lewis who played with his mallets, treating his drums like jungle drums, and Jo Jones, who did an exhibition on sock cymbal with grace and aplomb. What style he had! Finishing off the afternoon with a propulsive beat was Randy Weston's African Rhythms.

At Carnegie Hall Saturday evening there occurred a So-Lo Piano tribute to the late Art Tatum as performed by Dave McKenna, Brooks Kerr, Jimmy Rowles, Eubie Blake, Bill Evans, Art Hodes, Ellis Larkins, Billy Taylor, George Shearing, and Earl Hines. The concert was beautifully modulated all the way from Rowles' understated and controlled *Liza* to Blake's sprightly *Rhapsody in Ragtime* to Hodes' scintillating *Grandpa's Spells*, wherein his elbow got into the action, to Hines' *Boogie-Woogie on the St. Louis Blues* which ended the festival on a celebratory note for this writer.

\* \* \*

**Robin Kenyatta:** Gypsy Man

**Songs:** *Seems So Long; Another Freight Train; Werewolf; Reflective Silence; Gypsy Man; Melodie Chinoise; I've Got Dreams To Remember.*

**Atlantic SD 1633**, stereo, \$5.98.

This is a mish-mash of tunes of the soul-rock ilk by Robin Kenyatta. The recording never actually seems to go anywhere or lead us anywhere and bogs down into a kind of Purgatory or Never-Never land. It's as though Kenyatta has not quite been able to commit himself to anything. He plays alto, soprano sax, and flute here and arranges all but one of the tunes, *Werewolf*, which was arranged by Robert W. McPherson.

It's almost totally Kenyatta with no other individuals getting much solo space. Most together of all and one knows at once why they named the album after it is *Gypsy Man* which features Kenyatta on vocals and soprano sax with some electric piano by Larry Willis that fits in rather nicely.

In Stevie Wonder's *Seems So Long* Kenyatta is all soul, tearing at the heart strings, but *I've Got Dreams To Remember* is a heavy-handed and burdensome accomplishment that will put you to sleep.

The sound is super-slick and electronic as Kenyatta merely skims the surface of his art.

Performance: C+

Sound: B-



## The Finer Things In Life

Jaguar XJ-12—one of the finest cars made today. If you want to buy one, you have to find a Jaguar dealer. They're not on every corner, as are some car dealers. But when you want the best, you go out of your way to obtain it.

**Fairfax FX-300**—recently tested and top rated by one of the leading consumer reporting magazines among 20 of the most popular speaker systems in the \$85 to \$120 price range. Not every high fidelity dealer can sell you a **Fairfax FX-300** though. You'll have to visit the dealer we've selected to carry the Fairfax line. But then, isn't the best worth going out of your way for?

The **FX-300** is a two-way, two-speaker system with a ducted port. It uses a heavy-duty 10-inch bass driver and a 3-inch wide-dispersion tweeter. Frequency response is an honest 24 to 20,000 Hz, and power capacity is 40 watts rms (7 watts min.) into 8 ohms. The cabinet of selected walnut veneers—we do our own veneering—measures 22 x 14 x 10<sup>3</sup>/<sub>4</sub> inches and is 1-inch thick on all sides.

If we can build the top rated **FX-300** for only \$109.95, think of what our other seven models must sound like from \$69.95 to our \$399.95 Wall of Sound I. Visit a Fairfax dealer and let your ears judge for themselves.

To find out which dealer in your area has been chosen to carry the Fairfax line of speakers, call (201) 485-5400 or write for a full line catalog; Fairfax Industries, Inc., 900 Passaic Avenue, East Newark, New Jersey 07029.



the SUPERSOUND line **FAIRFAX**  
Made in U.S.A.





# A Perfect Gift for Giving

## A Subscription to AUDIO

Looking for the perfect gift for the hi-fi/stereo enthusiast in your life? Then give Audio . . . the gift that will be remembered all year through.

Now save money on multiple gift subscriptions to Audio. Order your first subscription at the

money-saving rate of **\$6.00** . . . and

pay just **\$3.00** for each additional subscription. That's a \$3.00 saving on each gift subscription!

Give the gift that's special—and save money when you buy two subscriptions or more.

*And your present subscription may be renewed or extended at these special holiday rates.*

*For the personal touch that says you care, give Audio this Christmas. With each gift subscription, we will send a beautifully engraved gift card telling who the gift is from. Take advantage of this special holiday offer by filling in the attached order form and mailing it today.*

### SPECIAL CHRISTMAS ORDER FORM

Total number of persons receiving gift subscriptions in your entire order

First subscription \$6.00 and each gift subscription at \$3.00 per year to the following:

One year

Two years

Name \_\_\_\_\_

Address \_\_\_\_\_

City \_\_\_\_\_ State \_\_\_\_\_ Zip \_\_\_\_\_

One year

Two years

Name \_\_\_\_\_

Address \_\_\_\_\_

City \_\_\_\_\_ State \_\_\_\_\_ Zip \_\_\_\_\_

One year

Two years

Name \_\_\_\_\_

Address \_\_\_\_\_

City \_\_\_\_\_ State \_\_\_\_\_ Zip \_\_\_\_\_

One year

Two years

Name \_\_\_\_\_

Address \_\_\_\_\_

City \_\_\_\_\_ State \_\_\_\_\_ Zip \_\_\_\_\_

One year

Two years

Name \_\_\_\_\_

Address \_\_\_\_\_

City \_\_\_\_\_ State \_\_\_\_\_ Zip \_\_\_\_\_

Gift card should read from \_\_\_\_\_

Send bill to:

Name \_\_\_\_\_

Firm \_\_\_\_\_

Address \_\_\_\_\_

City \_\_\_\_\_ State \_\_\_\_\_ Zip \_\_\_\_\_

Please renew my subscription for

1 year \$6.00

2 years \$10.00

# Weingarten Looks At Paul Simon

Sherwood L. Weingarten

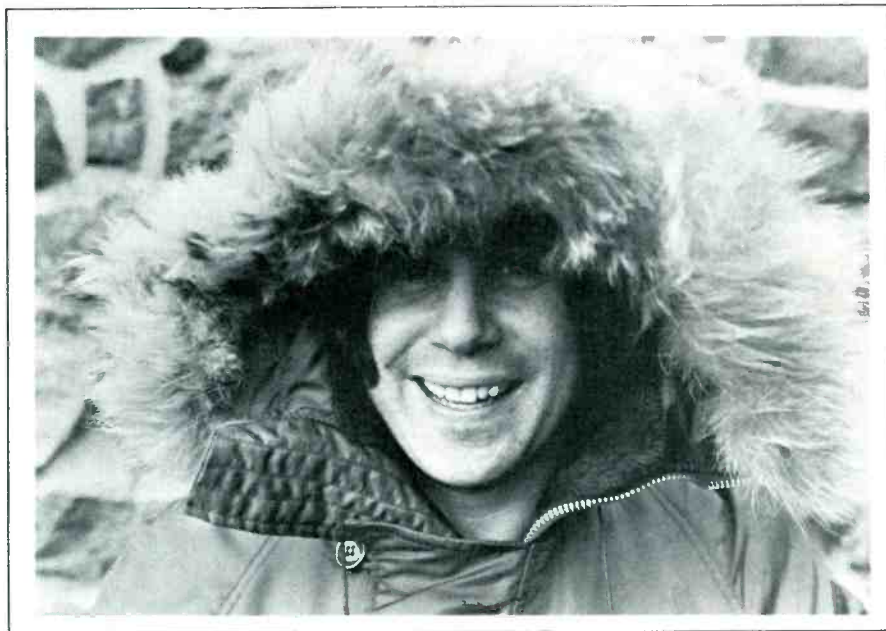

**THERE GOES RHYMIN' SIMON** (Columbia, KC 32280), includes the biggest hit of the summer, *Kodachrome*. Paul Simon's chartbuster deserves that status if only because of its bounciness and first few verses: "When I think back/On all the crap I learned in high school/It's a wonder/I can think at all." Other highlights from the 11 tracks are *Tenderness*, something that seems suited to the Ink Spots or Mills Brothers and includes the thought that "I know you see through me/But there's no tenderness/Beneath your honesty." *Something So Right*, with the notation that "Some people never say those words/I love you/But like a child they're longing/To be Told," and *Was a Sunny Day*, a breezy change-of-pace, pure Simon but superimposed on a calypso rhythm. Definitely a superior album.

**PARIS SESSIONS** (Vanguard, VSD-79328) is folk-rock from *Country Joe McDonald*, who continues to lace his material with biting humor and commentary. His words are still the kind that will offend many, but if you can get over what may be an initial shock, there's plenty of meaning. Of the 10 cuts, all but one his own mental exercises, there's no standout. Your own perspective will tell you what's best,

probably depending upon which of his themes (violence in reel and real life, death in life, the sexual revolution, dope paranoia on both sides of the fence) you best relate to. Joe's voice and acoustic guitar, not incidentally, were never better . . . even when he was trying to sing instead of deliver messages.

**20 YEARS OF ROCK N' ROLL** (Buddah, BDS 5133-2) places 30 original hits on two discs. The Dick Clark compilation is one of the best anthologies of nostalgia put on vinyl. Included are the Orioles' *Crying in the Chapel*, Curtis Mayfield's *Superfly*, the Crew Cuts' *Sh-Boom*, Jerry Lee Lewis' *Whole Lotta Shakin' Goin' On*, Joey Dee's *Peppermint Twist*, the McCoys' *Hang on, Sloopy*, Carl Perkins' *Blue Suede Shoes* and Otis Redding's *Dock of the Bay*.

**-ON STAGE** (London "Phase 4 Stereo," BP 44182/83) shows that, contrary to the adage, the more things stay the same, the more they change. Benny Goodman, who's been tooling around with his clarinet since swing was an infant, proves that the oldies *are* goodies and all they need is the slightest touch of modernization to improve them. This double-record album, re-

corded live in Copenhagen, puts Goodman in front of his sextet (that includes such jazz favorites as "Zoot" Sims on sax and "Bucky" Pizzarelli on guitar) for 22 superior cuts. Joys all. Among the winners are *I Want to Be Happy*, *Where or When*, *Honeysuckle Rose*, *My Funny Valentine*, *Oh Lady Be Good*, *Stompin' at the Savoy*, *The Sheik of Araby*, *After You've Gone* and *Moon-glow*.

**-HEAR & NOW** (United Artists, UA-LA018-F) is a lesson in longevity. Ferrante & Teicher, who here provide 13 cuts that lean heavily on hits, have been doing their thing on piano 100 albums' worth. They obviously must be doing something right. Actually, it's evident—for the sound is good for listening and/or background music. Backed by a lot of strings, they particularly do justice to Don McLean's *American Pie*, Neil Diamond's *Song Sung Blue* and a couple of their own compositions *Tranquillo* and *Oh to Be Young Again*. Missing is their usual adaptation of some classical themes, but the other tunes make you quickly forget that factor.

**CREAM OFF THE TOP** (Polydor, PD 5529) isn't the best material by one of the supergroups of the 60s, but even Cream's second best is better than most



others. These 11 re-releases, which were the forerunners of the so-called heavy metal sound, show that the ego trips the three went on were understandable. You don't have to get far into the LP to realize the artistry of Eric Clapton's guitar, or Jack Bruce's bass and vocals or Ginger Baker's drums. Best tracks are *Four Until Later*, a light blues entry; *NSU* and *Traintime*, two by Bruce, the latter featuring the composer on excellent, bluesy, gutsy harmonica; and Clapton's *Outside Woman Blues*.

**360 DEGREES OF BILLY PAUL** (Philadelphia International, ZQ 31793) spotlights a slick quadrasonic sound produced by Gamble-Huff. The disc, distributed by Columbia, is headed by the chartbuster *Me and Mrs. Jones*, and favored by smooth renditions of Carole King's *It's Too Late* and Elton John's *Your Song*. Paul is the kind of black singer who appeals to whites who don't like black singers.

**AUTUMN TO SPRING** (The Famous Charisma Label, CAS 1 0598) almost gets out of a rut. Keith Emerson's keyboard work causes flashes of interest as *The Nice* go at the business of entertaining for nine tracks.

There are, in fact, a few minutes that are actually positive listening experiences; the lion's share of the package, though, is filled with just plain noise, pretending, of course, to be creative rock.

The group sells a lot of records, so there's obviously a segment of the cash-plunking public that can accept the emphasis on gimmick effects rather than sound sound.

For those who want to hear influences of The Beatles and the Stones on one vinyl, this, as the comic intoned, must be the place. Reason? The tapes were made in '67 and '68, before the personnel shifting began.

Despite the uneven, up-and-down quality of the record, which is distributed by Buddah, the group can do a unique gig now and then, proven by records cut in a later time period. But this one? *Mush!*

**WHERE ARE YOU NOW, MY SON?** (A&M, SP-4390) is half entertainment, half documentary. Side one showcases the angelic voice of *Joan Baez* performing seven items, three self-penned and two by her sister, Mimi Farina. She also trades her guitar for piano on the lone instrumental, *Windrose*. Then, the propagandist takes over. The flip side is one cut, a ballad written about the U.S. bombing of Hanoi that covered the Yule, 1972 period. Sound quality is authentically horrible, because much of it was transferred from a hand-

**Soundcraftsmen** presents the new **RP10-12**  
**PROFESSIONAL EQUALIZER for RECORDING and PLAYBACK**  
PERFECT tailoring of octave-wide bands... Infinitely variable adjustment flexibility  
... Special Effects programming ... Instant re-setting  
via Computone-Charts

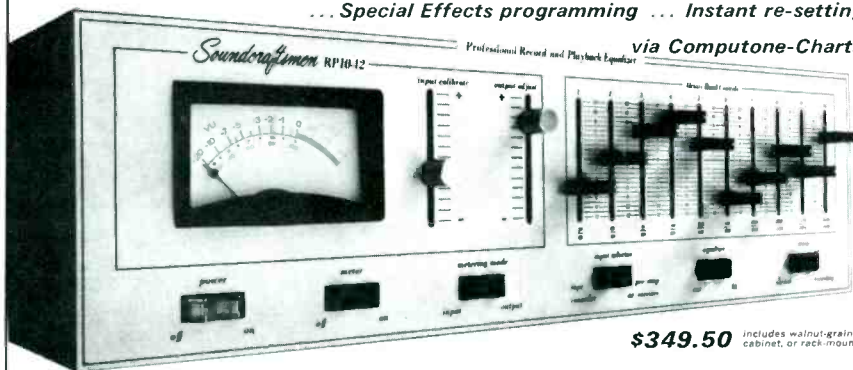

**\$349.50** includes walnut-grain cabinet, or rack-mount  
**Recording Studios • Audiophiles • Night Clubs • Performers • Theatres**  
**Churches • Gyms • Auditoriums • Hi-Speed Duplicating • Musical Groups**

**SPECIFICATIONS**

**FREQUENCY RESPONSE:**  $\pm 1/2$  dB from 20-20,480 Hz. 1dB down @ 10Hz, 1/2 dB down @ 100 KHz.  
**HARMONIC DISTORTION:** Less than .08% @ 2V, .05% @ 1V, Typ. .01% @ 1V.  
**IM DISTORTION:** Less than .08% @ 2V, .05% @ 1V, Typ. .01% @ 1V.  
**SIGNAL TO NOISE RATIO:** Better than 90 dB below 2V output, Typ. 95 dB.  
**INPUT IMPEDANCE:** 100K ohms — (Operable from any source up to 100K ohms: any Hi-Fi, Hi-Fi, Pre-amp, Receiver or Tape Recorder).  
**OUTPUT IMPEDANCE:** 600 ohms — (Operable into any Mixer, Hi-Fi Amp, Receiver or Tape Recorder).  
**INSERTION LOSS:** Zero (Slide controls centered, and "OUTPUT ADJUST" control set so that "input" equals "output").  
**MAXIMUM OUTPUT:** 7 V in to impedance, 3.5 V into 600 ohms — (13 dBm).

**SPECIAL FEATURES**

**VU METER:** Precision  $\pm .5\%$  meter movement provides an accurate visual display, to enable exact unity-gain input-output matching.  
**INDUCTORS:** Toroidal and shielded ferrite-core.  
**CIRCUIT BOARDS:** Military grade G-10 glass epoxy.  
**RESISTORS:** Low-noise selected carbon-film throughout.  
**SWITCH CONTACTS:** Gold-plated to assure low noise and reliability.  
**DEFEAT SWITCH:** Electrically removes the Equalizer from the circuit.  
**OUTPUT ADJUST:** Controls a continuously variable 18 dB range, from -12 dB to +6 dB, to match output to input.  
**RANGE:** 12 dB boost and 12 dB cut, each octave centered at 30, 60, 120, 240, 480, 960, 1920, 3840, 7680 and 15,360 Hz.  
**SIZE:** Walnut-grained wood case 5 1/4" x 18" x 11". Rack-panel 5 1/4" x 19".

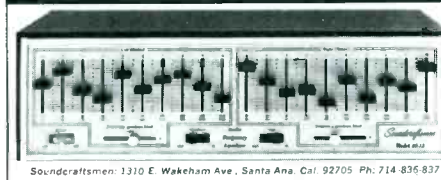

**STEREO 20-12 . . . . \$299.50**

**MASTER OUTPUT LEVEL:** "Frequency-spectrum-level" controls for left and right channels, continuously variable 18 db range, for unity gain.  
**HARMONIC DISTORTION:** Less than 1% THD @ 2 v, Typ. .05% @ 1 v.  
**IM DISTORTION:** Less than 1% @ 2 v, Typ. .05% @ 1 v.  
**SIGNAL TO NOISE RATIO:** Better than 90 dB below 2V output.  
**INPUT IMPEDANCE:** Operable from any source 100K ohms or less — (any Hi-Fi Amp, Receiver or Tape Recorder).  
**OUTPUT IMPEDANCE:** Operable into 3K ohms or greater — (any Hi-Fi Amp, Receiver or Tape Recorder).  
**SIZE:** Walnut-grained wood case 5 1/4" x 18" x 11", or rack-mount.  
**ALSO AVAILABLE, the 20-12-600, \$349.50**  
SAME AS 20-12 ABOVE, EXCEPT HAS 600 OHM OUTPUT

Soundcraftsmen: 1310 E. Wakeham Ave., Santa Ana, Cal. 92705 Ph: 714-835-8375

Check No. 37 on Reader Service Card

**FREE** **McIntosh CATALOG**  
**and FM DIRECTORY**

Get all the newest and latest information on the new McIntosh Solid State equipment in the McIntosh catalog. In addition you will receive an FM station directory that covers all of North America.



**MX 113**

**FM/FM STEREO - AM TUNER AND PREAMPLIFIER**

**SEND TODAY!**

McIntosh Laboratory, Inc.  
East Side Station P.O. Box 96  
Binghamton, N.Y. 13904  
Dept. 1

NAME \_\_\_\_\_  
ADDRESS \_\_\_\_\_  
CITY \_\_\_\_\_ STATE \_\_\_\_\_ ZIP \_\_\_\_\_

If you are in a hurry for your catalog please send the coupon to McIntosh.  
For non rush service send the Reader Service Card to the magazine.

Check No. 23 on Reader Service Card

recorder on the scene, and the message's impact is lost because the point-of-view is so heavy-handed.

**TRUE STORIES AND OTHER DREAMS** (Electra, 75053) finds *Judy Collins* less strident than some of her recent efforts. This time around the stress is on lyrical beauty, with more emphasis than usual on the melodies themselves. There are nine cuts, five of her own. But best are Stephen Stills' *So Begins the Task* and Tom Paston's *The Hostage*.

**CALL ME** (Hi-London, XSHL 32077) spotlights soul singer *Al Green*, who, finally, is beginning to grow on me. His arrangements are slicker now, and his voice somehow seems to better get across his meaning (without losing any of his soul). Listen, in particular, to *Call Me (Come Back Home)*, *I'm So Lonesome I Could Cry* and *Here I Am (Come and Take Me)*.

**ALADDIN SANE** (RCA, LSP-4852) contains nine more tunes penned and performed by *David Bowie*, singer and sexualist extraordinaire. In addition, Bowie does a number on Mick Jagger's *Let's Spend the Night Together*. Seems to me, however, he's getting worse on vinyl all the time. Whaddya say, Ziggy? How about it, Major Tom?

**ROUGH EDGES** (Mercury, SRM 1-655) shows that albums can be

well-named, for the phrase aptly describes what's inside the dustjacket. The music, by *Doug Sahn* with the Sir Douglas Quintet, goes back to '69 and some tapes that weren't worth releasing at the time. The dozen cuts, an amalgamation of ordinary rock, country, blues and whatnot, can't even be saved by Sahn's talent with guitar (he also sings, and fiddles, literally that is). And believe it or not, Sahn almost sounds like Louis Prima on the countrified *Colinda*. Get his later stuff instead.

**BACK TO THE WORLD** (Curtom, CRS 8015) is strictly soul, spotlighting the squeaky, hopeful and exciting voice of *Curtis Mayfield*. Pick any of the seven cuts on the Buddah-distributed disc and enjoy, baby, enjoy.

**THE BODY AND SOUL OF TOM JONES** (Parrot-London, XPAS 71060) plays up the hit *Letter to Lucille*, but Jones, still as good as any white soul singer around, is better yet on a pair of Bill Withers specials, *Ain't No Sunshine* and *Lean on Me*. And he does a creditable job on a country smash of a few years back, *Running Bear*.

**WE'RE ALL TOGETHER AGAIN FOR THE FIRST TIME** (Atlantic, SD 1641) merges three jazz Hall-of-Famers, *Dave Brubeck* and his piano, *Gerry Mulligan* and his baritone sax,

and *Paul Desmond* and his alto. Backed by Alan Dawson on bass and Jack Six on drums, the superstars offer six goodies recorded live in Berlin, Paris, and Rotterdam on tour. Brubeck does one solo gig, a one-minute run-through of *Sweet Georgia Brown*.

**PORTFOLIO** (Stormy Forest, SFS-6013) teams up the drivin' guitar and husky voice of *Richie Havens* with tunes by David Blue, Marvin Gaye, Leon Russell, Jim Rado, and Havens himself. Not his best outing, not his worst.

**NOW & THEN** (A&M, SP-3519) spotlights straight soft rock-pop from *Richard and Karen Carpenter*. Included are the chartbusters *Sing* and *Yesterday Once More*, plus the revival *Jambalaya (On the Bayou)*. The five cuts on the first side are newies, while the flip side contains a medley of "oldies" going all the way back to the '60s (my, ain't that prehistoric, dad). Pleasant ho-humms.

**NOWHERE ROAD** (London, XPS633) finds *Chris Youlden* alone again, unnaturally. The singer, who fronted for Savoy Brown on four LPs over three years and then went into hibernation, comes out of hiding with 11 cuts, all self-penned. All are okay blues with a heavy dose of rock. Be glad he's back. Æ

## the most revealing speaker made!

The MAGNEPLANAR\* Tympani speaker is a patented new method of sound reproduction hidden in a 1-inch thick folding floor screen. Sound from the Tympani is so revealing that everyone (not just 'Golden Ears') can hear the difference in source material and associated electronics.

The MAGNEPLANAR\* Tympani utilizes a low-mass Mylar diaphragm driven in a magnetic field. Bass detail is exacting with the 'tightness' found in live music other bass reproducers cannot match. Mid-range and treble detail is equally dramatic, with a transparency that yields an emotional impact formerly available only in the concert hall.

This speaker breakthrough must be heard to be believed. Visit your nearest Audio Research dealer for an unforgettable demonstration or write to us for complete details today.

\*TM, MAGNEPLAN, INC.



**audio research corporation** Box 6003 / Minneapolis, Minnesota 55406 / Tel: (612) 721-2961



# Reviews

Ball Canby

synthesizer can yet quite match the healthy complexity of natural wave forms and thus when a piano or violin, or what-have-you, is made to produce noises that fall into the synthetic sound area (rather than into their conventional modes of sound production) the results are unusual, and unusually good. Beat the synthesizers at their own game.

Lazarof is an internationally trained musician, out of Europe, now transferred to America, and his work is thus without special nationalistic sounds, which is precisely what is happening today—music and the arts being, as usual, ahead of politics. Here we have “ordinary” instruments, except for one tape, and yet the sounds are typically those of the new times in which we live. exotic squeaks, bumps, scratches, rings and so on—very expertly conceived. Forget about Classical Music—just listen to them as interesting effects. You can't help but enjoy, I say! (And the message of the music, as it should, will take care of itself in due time.)

Also typically of our age, this is music entirely without regular beat, a kind of randomness in time. Which, of course, represents—in the long view—a very healthy reaction to the relentlessly “Bach-jazz” beat of much early 20th century music of all sorts. Which, in turn, was a healthy reaction to the moony swelling and dying of much late 19th century music! So it goes on this earth.

Good to welcome back the Vox label, in its excellent mid-price Candide configuration—we will be having more Vox reviews in the near future. Haven't had a Vox release sent to us for many a long moon, more's the pity. For Vox's benefit, I note that one of the first reviews I ever wrote was of a pioneer ten-inch 78 rpm album on the Vox label, just after the War, entitled *Salzburg Serenade*. It marked the very beginning of the enormous flood of new labels and new records that have come forth since then.

Performances: A                      Sound: A-

**Bruno Walter conducts Schumann.**  
(Symphonies No. 3 “Rhenish,” No. 4 in D Minor.) Parnassus 8 (P.O. Box 281, Phoenicia, N.Y. 12464).

I can remember the hierarchy of conductors back before the war, when these two recordings were first made. Stokowski was, then as now, the man for flare; Koussevitsky brought flamboyant Russo-French Romanticism to Boston and Toscanini went all-out Italian temperamental in New York, the fiery Maestro. Bruno Walter was the good gray classicist, gently European, a true German soul, whose many recordings were treasured for their sane, beautifully balanced musicality. In his eighties, Walter still preserved that image and that ability, on into the stereo age.

The “Rhenish” symphony is here played by the New York Philharmonic in 1941, in the famed and tattered Liederkrantz Hall before it was converted to TV use. The D minor comes from London in 1938 with London Symphony. Musically, both are just superb—there is no other word for it. I wouldn't hesitate to say that these are definitive performances—so *right*, so marvelously easy and natural, so



The QUAD Electrostatic was the first full range electrostatic loudspeaker produced commercially and is still the standard by which all others are judged. Using closely coupled moving elements some two hundred times lighter than the diaphragms of moving coil loudspeakers and being entirely free of cabinet resonances and colouration, this loudspeaker overcomes the usual major problems of loudspeaker design and provides remarkably natural reproduction of sound. This explains why the QUAD electrostatic loudspeaker is used by broadcasting and recording organisations all over the world, in applications where quality is of prime importance, and as a standard of reference by the majority of loudspeaker manufacturers.

QUAD for the closest approach to the original sound.

# QUAD

is a registered trade mark

For details of your nearest dealer write to Acoustical Manufacturing Co. Ltd., Huntingdon PE17 7DB, England.

wonderfully phrased and shaped, so light and airy and yet so impressive and earnest in the louder parts. If you want to know Schumann, forget about the fi and get to know these versions first!

The 1941 New York recording is excellent, with the large Liederkrantz liveness of fond memory, the playing extremely accurate and well rehearsed. The 1938 London disc is less good, with that curious closed, ringing sound familiar in many orchestra recordings

of the time from Europe. And the London Symphony is less accurate than the New York Philharmonic. But the music is there, even so. (If you have oldie LPs you may own Columbia ML 4040, the "Rhenish" transferred to LP format around 1948, at the beginning. It must have been recorded on 16-inch transcriptions, as were many in the pre-tape era at Columbia.)

Performances: A Sound: C-

JOEL GREY/LIVE  
Columbia KC32252, stereo.

There's no Peppermint Room crooning in Joel Grey's style. Whether he's belting out a medley from *George M.*, the Broadway show that brought him to notice and eventually to *Cabaret*, or easing his and our way through *What Kind of Fool Am I?* or *Love Is Here To Stay*, he's got an almost primal simplicity. This freshness—one might almost say "vocal innocence"—must have nothing to do with his youthful appearance and boyish good looks. I've never seen him perform in person, but his engaging personality filled my living room easily from this record. *Joel Grey/Live* is a pressing of his Waldorf-Astoria show last year, and in it he depended on a stylish delivery that had an astonishing spontaneity to it.

Who'd ever think the Empire Room could itself take on the atmosphere of intimate cabaret? Joel Grey does it: in his light humor, which never tries too hard, his immediate establishment of rapport with his audience . . . this is one of those few discs that have a visual sense built right into them. You can almost see the Cheshire Cat grin breaking across his face.

*Lean on Me* has a poignance that stops mercifully short of the maudlin. *Happiness Is Just a Thing Called Joe* is sung, he tells us, to his wife Jo, and we believe the tenderness in his voice not in spite of but because of his casual attitude. He has to convince no one; he is secure in his devotion. He can also be secure in his talent.

I also like very much his brief delivery of *For All We Know*, which he performs as a coda and which is a lesson in the difference between sentiment and sentimentality. May others take notice.

Grey's *Wilkommen* is the best in the *Cabaret* medley. I doubt it can ever identify anyone else.

Occasionally the brass gets in his way. And the live audience reaction has been generally toned down in the final mixing. Incidentally, is it only American nightclub audiences who applaud when they like a joke? And who interrupts the start of a good song to show their recognition? I'd be grateful for explanations of these curious national traits.

Donald M. Spoto

Performance: A Sound: B+



# FREE

## LAFAYETTE 1974 CATALOG



### The World's Largest Consumer Electronics Catalog

The world's Foremost consumer electronics catalog is yours for the asking! Over 25,000 items . . . jampacked with illustrations and descriptions of the very latest in Hi-Fi, CB, Tape recorders, Radios, Television, Electronic Parts, Technical Publications.

## Your Complete Electronics Buying Guide

Electronics For Home, Business, Industry  
PLUS The Latest in 4-Channel Stereo!

LAFAYETTE 1974 CATALOG 740

Our 53rd Year Stores From Coast-to-Coast

MAIL  
THE  
COUPON  
TODAY

Lafayette Radio Electronics  
P.O. Box 10, Dept. 27103  
Syosset, L.I., N.Y. 11791

Send For Your Free Lafayette Catalog Today!

Send me the FREE 1974 Lafayette Catalog 740 27103

Name

Address

City  State  Zip

Check No. 20 on Reader Service Card



# Classified

Rates: 25¢ per word per insertion for noncommercial advertisements; 50¢ per word for commercial advertisements. Frequency discounts as follows: 3 times, less 10%; 6 times, less 15%; 12 times, less 20%. Closing date is the FIRST of the second month preceding the date of issue. *Payment must accompany all orders under \$10.00.* Use the handy self-addressed, postage paid card at the back of this issue. When replying to AUDIO box number ads, send letters c/o AUDIO, 134 No. 13th St., Phila., Pa. 19107. For more information about classified advertising, circle Reader Service Card #135.

## FOR SALE

**FIREWORKS NEWS**—Monthly magazine covering Fireworks, Construction, Sources of Supplies, New Firms—Products. FREE Fireworks Catalogs with Subscriptions \$9.00 per calendar year. Pyro Press, Box 1202P, Lexington, Kentucky 40501.

**ONE OF FLORIDA'S ONLY AUDIO RESEARCH DEALERS.** Complete Audio Research on demonstration. SP-3/Dual 75/Dual 51/Magneplanars and Bass Panel (Tri-amped). Plus Phase Linear, Crown, McIntosh, Hartley, Decca, Stax, S.A.E., Braun, Tandberg, Advent, B&O, Rabco, J.B.L., Thorens, E.S.S. (Heil). Complete audio counselling. Sound & Sight, 20 N. Federal Highway, Boca Raton, Fla. 33432 (305) 391-1843.

**CANADIANS:** Brand name audio at warehouse prices. FREE price list. Baltimore Audio Inc., 2385 Eglinton Ave. E., Scarborough, Ontario, Canada M1K 2M5.

**BLANK RECORDING TAPE** brand-new, top quality, splice-free. Open reel, cassettes and video tape. Acoustic Dynamics, Box 500, Hewlett, N.Y. 11557.

**SONY 850 TAPE DECK** Mint condition \$625, or best offer. Jeffrey Hall, 203 S. Bullock, Saginaw Mich. 48602. (517-799-6176).

**STELLAVOX SP7** for approximately 1/2 of original cost. As new with several deluxe accessories. Hyde, 301 Springdale, Wintersville, Ohio 43952 (614) 264-4987.

**CAPITOL STACK-PACKS.** Blank cassettes, cartridges, reels. Discount prices. Lawson's, Box 510, Livermore, Ca 94550.

**AUDIO RESEARCH, BEYER, B&O, BOZAK, BRAUN, CROWN, DECCA, KLIPSCH, HARTLEY, PHASE LINEAR, QUAD, RADFORD, REVOX, SAE, SENNHEISER MICS.** Others. Custom designed and constructed music reproduction systems for homes, musicians and auditoriums. Each component analyzed and optimized. Demonstration by appointment. Phone or mail consultations. **AUDIO SYSTEMS & DESIGN**, 5421 South 84th St., Lincoln, Nebraska 68516. (402) 489-9888.

**SEQUERRA TUNER, QUINTESENCE** preamp, PHASE LINEAR power amps, NORMAN acoustic equalizer, CONNOISSEUR turntables, JANSZEN electrostatics. Also, Soundcraftsmen, P&M electronics, B&O, ERA, CM Labs, Tannoy, Hartley, Design Acoustics and Braun components. More. Units shipped from stock prepaid freight. **ADVANCED ELECTRO ACOUSTICS** 1610 South Park Avenue, Buffalo, N.Y. 14220 716-826-5832.

## FOR SALE

**CANADIANS:** McIntosh loudspeakers: ML 1C, \$750/pair; ML 2C, \$1750/pair; MQ 102 bass equalizer, \$115; plus shipping. Offers considered. Dr. Les Leventhal, 192-1 Snow St., Winnipeg, Manitoba, R3T 2M4.

**THOUSANDS OF LIKE NEW** ips and pre-recorded tapes. Catalogue \$1.00 House of Records, Hillburn, New York 10931.

**SOUND SYNTHESIZER** kits imitate nature's background music. Surf \$11.95. Wind \$11.95. Wind Chimes \$16.95. Electronics Songbird \$6.95. Also electronic music accessories waa waa, sustain, many more. Catalog Free. PAIA Electronics, Box D14359, Oklahoma City, Okla. 73114.

**SPEAKER SPECIALIST TOBY** Corporation of America: 4620 Camp Bowie, Fort Worth, Texas 76107.

**AUDIO RESEARCH,** Magneplanar, Crown, McIntosh, Thorens, Decca, Stax, Revox on display. Free List used equipment. Stereo Shop, 107 3rd Ave SE, Cedar Rapids, Iowa 52401. 319-365-1324.

**SENSIBLE SYSTEMS & PRICES:** Hegeman, IMF, LTD, Celestion, ARP Synth AR-LST, JVC, Citation, Marantz, BGW, Thorens, B&O, Connoisseur, Equa, Akai, Dokorder, Tandberg, Revox-Beyer, Soundcraftsmen, BGW, Hartley, JansZen, 54 other makes. Trades, 89 Day Speaker Approvals. By appointment only (404) 252-8569. Write for famous "Blue Sheet" **ATLANTA AUDIO PROJECT** Ltd. Suite 106-108, 141 West Wieuca Rd. Atlanta, Ga. 30342.

**ATTENTION ALL SERIOUS CASSETTE ENTHUSIASTS**—At last—No nonsense cassette labels. Send for free samples. Joe Bly Enterprises, 339 W 88th St., N.Y., 10024.

**CYBERACOUSTIC AND EQUIPMENT TESTING** laboratory. CROWN tape recorders, amps, AURLINEARS, warranty service station, IMF and Infinity monitors, AKG, Rabco, Decca, UREI, Fairchild and more. Barclay, 503 Haverford Avenue, Narberth, PA 19072 (215) 667-3048 or 120 Villa Crest Drive, State College, PA 16801 (814) 466-6500.

**HI FI ENTHUSIASTS WANTED!!** Earn more than just spare money in your spare time. We need campus representatives to sell name brand stereo components at discount prices in your area. High commission, no investment required. Serious inquiries only, please. Contact: Mike Santillo, K&L SOUND Services Co., 264 N. Beacon St., Watertown, Mass. 02172.

## Why pay retail for hifi?

Buy direct from us, and you save money with our high-volume prices on more than 100 name brands. Order from the branch nearest you to save time and money on freight.



## Midwest Hifi Wholesale & MAIL ORDER DIVISION

Send for our free catalog!  
2455b Wisconsin Ave,  
Downers Grove, Ill 60515  
3309 E. J W Carpenter Frwy,  
Irving, Tex 75062

Check No. 24 on Reader Service Card

HOW GOOD SHOULD A REINFORCEMENT SYSTEM SOUND? SO GOOD YOU DON'T HEAR IT!

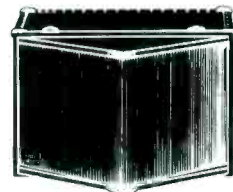

Listen to the remarkable

**BOSE 800™**

Portable Loudspeaker System and all you'll hear is the performance, without artificial coloration. After all, isn't the performance really what the audience comes to hear?

**Bose 800, The Unobtrusive One**

Please send complete information to:

Name \_\_\_\_\_  
Address \_\_\_\_\_  
City \_\_\_\_\_ State \_\_\_\_\_ Zip \_\_\_\_\_

Return to Bose Corp.  
The Mountain  
Framingham, Mass. 01701  
Dept. OAP

## FOR SALE

**AUDIO RESEARCH, SAE, CROWN, PHASE LINEAR, INFINITY, KLIPSCH, TANNOY, BRAUN, QUAD, DECCA, REVOX, STAX, TRANSCRIPTORS, RADFORD,** and many more. Factory authorized service on all brands sold. No appointment necessary. Hoffman's "House of Stereo", 5931 Smith Rd., Cleveland, Ohio 216-243-2772.

**FREE 64 PAGE CATALOG** offers hundreds of recordings of rare Renaissance, Baroque and Classical music. Some records priced as low as \$1.00 each! All late recordings. In stereo only. Musical Heritage Society, Box 932-AU, New York, N.Y. 10023.

**WORLD'S LARGEST, DEEPEST, MOST POWERFUL SUB WOOFER SYSTEM** can be had only at Music and Sound Ltd., 11½ Old York Road, Willow Grove, Pa. 19090. 215-659-9251. From \$1,000.

**INFINITY MONITORS.** IMF ALS40, EPI, Marantz (including 500), Philips turntables, Audio-Technica shibata, Ortofon, Discwasher. Stop in and chat. THE SOUND SHOP, 96 Seneca Street, Geneva, NY 14456 (315) 781-0215.

**DAYTON-WRIGHT ELECTROSTATICS**—used 3 months—Excellent condition. THE SOUND SHOP, 96 Seneca Street, Geneva, NY 14456 (315) 781-0215.

**SPEAKERS, SPEAKER KITS, CROSSOVER KITS.** Catalogue free. Crossover designs guide 25¢. SPEAKERLAB, 5500A - 35th NE, Seattle, Wash. 98105.

**LOADED MAXELL C-90UD** cassettes, 10 for \$15.00. \$1.65 each postpaid, private labeling and other custom lengths and tapes now available. MJS, 703 Menker Ave #1, San Jose, Calif. 95128.

**TRANSCENDENTAL AUDIO, LTD. BUFFALO, N.Y. 716-897-3984.**

**THE INVENTORS, ENGINEERS, COLLEGE INSTRUCTORS AND PROFESSIONAL MUSICIANS** at Music a Sound Ltd. offer their clients a new standard of technical competence, certain proprietary testing procedures, a mind boggling research laboratory, and a host of the most advanced professional services, including **hand picked** component matching/customization/assembly/alignment, room acoustical design and treatment, calibrated environmental equalization, total "A" warranty station service, **±1 db at your ears**, and the most flexible demonstration facilities anywhere for the distinguished array of products from: Sequerra, Dayton-Wright, Dahlquist, Infinity, Crown, Decca, I.M.F., Quad, Rogers, Spondor, B.B.C. Monitors, Stax, E.S.S., B&O, J.B.L. and Altec. **Professional**, Schoeps, S.S.I., Beyer, Custom Rabco, Gately, Otari, Braun, Tascam, **shipped pre-paid insured**. Music & Sound Ltd., 11½ Old York Rd., Willow Grove, Pa. 19090. 215-659-9251.

**AUDIO RESEARCH CORP'S** Magneplanars IA, II, and III, Woofer Screen\*, SP-3 Preamp\*, EC-2.3 and 4 Crossovers\*, Dual-51, 75, and 400 Amps. Tone Arm\* normally **shipped from stock, pre-paid insured** Music & Sound Ltd., 11½ Old York Road, Willow Grove, Pa. 19090. 215-659-9251.

**THOUSANDS OF OLD RADIO COMEDIES.** Dramas, Band Remotes, Mysteries, etc. \$6.00 for 6 Hour Reels. Catalogue: \$1.00 (Refundable). Cassettes also available. RADIOVOX 1756 Washtenaw, Ypsilanti, Michigan 48197.

**TWO (2) WHARFEDALE W-90** loudspeaker systems, a stereo pair. Must sacrifice, moving out of state. Very reasonable. Call (201) 941-1768—AM ONLY.

## FOR SALE

**MEMORIES SEMICONDUCTORS FREE FLYER,** UTI, P.O. Box 252, Waldwick, N.J. 07463.

**PROTECT YOUR LPs.** Poly sleeves for jackets 6¢ round bottom inner sleeves 5¢ Poly lined paper sleeves 12¢ White jackets 27¢ Postage \$1.00. House of Records, Hillburn, N.Y. 10931.

**ADVENT, B & O, EPI, FISHER, ORTOFON, PHASE LINEAR, REVOX, SANSUI, TANDBERG THORENS, HI-FI SHOP EVANSVILLE, IND. 47714.**

**MEMOREX TAPE LOWEST PRICES. WRITE FOR FREE INFORMATION.** SOUND DYNAMICS, Box M-3, FREMONT, CALIFORNIA 94537.

**CIZEK LOUDSPEAKERS** Lowest price in the country. Quotes on your favorite system. Sound Center, Box 1242, Bloomington, Indiana 47401, 812-332-4252.

**AUDIO RESEARCH, RADFORD, PHASE LINEAR, CROWN, QUAD, ALTEC, INFINITY, DECCA, GRACE, AKG, REVOX, BRAUN, PANASONIC SP-10, ESS, TANDBERG** and many more. Hartley Electronics (Audio Consultants) 1502 Butternut Richland, Wa. 99352. (509) 947-5026 after 5 p.m. weekdays, all day weekends.

**SPEAKERS CUSTOM BUILT** Folded or straight axis horns for the perfectionist. These horns will provide the finest sound in the world. Duluth Electronics Co., 24 East 1st, Duluth, Minnesota 55801, 218-624-4153.

**AUDIO RESEARCH, BRAUN, CERWIN-VEGA DECCA, ESS, HEGEMAN, IMF, MAGNUM OPUS, PHASE LINEAR, QUAD, QUINTESSENCE, RABCO, RADFORD, SAE, STAX.** Paul Heath Audio, 354 State Street, Rochester, N.Y. 14608. (716) 232-2828.

**FLORIDA AUDIOPHILES!** E.S.S. AMT 1; Phase Linear, Klipsch, Sony, Marantz, B & O, Quad, Revox, Barzilay. **INTERIORS PLUS SOUND** 3038 N. Federal Hwy., Ft. Lauderdale, Fla. 33306. (305) 566-3511.

**NEUMANN MICS & ACCESSORIES** Gately Pro kits and mixers. Most models in stock. Immediate prepaid shipment. Mastercharge. Write or call Dick McGrew Recording Service, 7027 Twin Hills, Dallas, Texas 75231. 214-691-5107.

**KLH-9 ELECTROSTATIC SPEAKERS.** Pair list \$1395.00. Pair absolutely factory sealed for \$990. New Pioneer electronic crossovers \$125. Also available: Rabco, Thorens, Ortofon, Marantz, Ohm, Soundcraftsmen, others. Park Radio, 202 W. Fayette St., Baltimore, Md. 21201. (301) 727-1134.

**DIAMOND NEEDLES** and Stereo Cartridges at Discount prices for Shure, Pickering, Stanton, Empire, Grado and ADC. Send for free catalog. All merchandise brand new and factory sealed. LYLE CARTRIDGES, Dept. A, P.O. Box 69, Kensington Station Brooklyn, New York 11218.

**ELECTROENCEPHALOPHONE:** brainwave monitor. Professional biofeedback instruments J&J Rt. 8, Box 8102, Bainbridge Island, Wash. 98110.

**CONNECTICUT AREA** Audio Research speaker and amps. Dyna-mod kit and Transcriber turntables. The Stereo Lab, 168 State St., New London, Conn. (203) 447-9802.

**HI FI FURNITURE?** See Toujay Designs at SEE 70, Hi Fi expo, 443-A, Park Ave. S., NYC, 10016, Tues. to Fri. 11-5, Sat. 11-4, Full line brochure 25¢.

**STEREO COMPONENTS** Lowest discounts \$1.00 for catalog. Defa Electronics, 2209 Broadway, N.Y., N.Y. 10024. Tel. 212-874-0900.

## FOR SALE

**PROTECT YOUR RECORDS.** Cardboard replacement covers, plastic lined sleeves, 78 and 45 heavy sleeves, hinged record set boxes, 12", 10", 7". Cabco, A-4, 89 East Woodruff, Columbus, Ohio 43201.

**PROTECT YOUR VALUABLE EQUIPMENT** with a professional security system. Low prices. No wires. Easy installation. Write: Electrodyne, P.O. Box 230, Brooklyn, N.Y. 11223.

**SCOTCH MAGNETIC TAPE,** discount Box 167A, Orwigsburg, Pa.

**10½" RECORDER SPECIALISTS:** Used boxed 10½" metal and fiberglass recording reels NAB center Metal \$2.00 each fiberglass \$1.25 each. New 1 mil quality tape on above metal reel 5 for \$24.00 on fiberglass 5 for \$19.00. Replacement content labels for 10½" tape box samples \$25. Sound Investment Co., POB 88338, Dunwoody, Ga. 30338.

**ROGERS B.B.C. MONITOR,** IMF, B&W Ltd., Celestion, Radford, Decca, ERA, Connoisseur, Audionics TL-90, Goldring, Revox, Beyer, Lamb and more. Custom design and modifications. SUFFOLK AUDIO, INC., 120 Boylston St., Suite 220, Boston, Mass. 02116. (617) 423-2051.

**PROFESSIONAL AUDIO EQUIPMENT:** Microphones, recorders, equalizers, limiters, turntables, lathes, cutterheads, disc mastering systems, portable mixers, consoles, alignment tapes. Package deals and installations. Request Flyer Wiegand Audio, Middleburg, Pa. 17842 717-837-1444.

**IMF MONITOR, STUDIOS,** and ALS-40 speakers stocked. Decca 4RC cartridges \$63.00. TEAC AC-7 automobile stereo cassette players, special \$110. Bang & Olufsen Beocord 1800 recorder, demo just \$375.00. SAE-MK 4B amplifier, mint \$260.00. Hadley 622 demo amplifier \$222.50. Advent large speakers, mint pair \$175.00. AR-3 speakers, big woofers, excellent, pair \$230.00. Grundig #505 Compact Receiver with DUAL changer \$445.00. We take trades. Audiocraft, South Rockwood, Michigan 48179. Telephone: (313) 379-9945.

**BUY FROM HI-FI WHOLESALERS.** List \$3.00. AudioSales, Box 39A, Bluepoint, N.Y. 11715.

**IMF SPEAKER SYSTEMS—ORDER DIRECTLY FROM PHILA.** Monitor, \$900; Studio, \$400; ALS-40, \$300; All models shipped immediately from stock, prepaid. Barclay, 503 Haverford Ave., Narberth, Pa. 19072. (215) 667-3048.

**CROWN CONSOLE—714C** Recorder plus Mus-O-Matic deck—including console w/cut outs for turntable—tuner amp. Also Sony ST 5000F tuner, TA2000 PreAmp, JBL 50/50 watt energizer. J. Barnett, 749 Rt. 35, Middletown, N.J. (201) 671-1161.

**TWO McINTOSH 3500 AMPLIFIERS.** SAE Mark I Preamplifier Excellent condition. Will ship anywhere. Roger Egan, Box 540, Sun Valley, Idaho 83353.

**BROADCASTER RELEASES COLLECTION** of OLD TIME RADIO SHOWS for sale for first time in 15 years. EIGHT TRACK or CASSETTES processed on PROFESSIONAL equipment. FORGET THE AMATEURS! ELECTRIC MEMORY, INC., BOX M BRYANT, ARK. 72022, Initial catalogue is FREE!

**CANADIANS—DYNACO COMPONENTS** AT TREMENDOUS DISCOUNTS. Write En-Jay Sales, Hornepayne, Ontario.

**KLIPSCHORNS AND CENTER BELL KLIPSCH** Speaker, Oil Walnut, Black Grill Cloth. Brand new, \$2825.00 retail. Asking \$2200.00. Leonard Gibbs, 1745 Mulmar St., Charleston, S.C. 29407.



## FOR SALE

**WORLD'S FINEST LOUDSPEAKERS** on DEMONSTRATION—AUDIO RESEARCH CORPORATION'S NEW T-1A, T-II, T-III; DAHLQUIST PHASED ARRAY, IMF MONITOR III, STUDIO III, ALS 40, ESS AMT-1, RTR 280DR, ESR-6, CERWIN-VEGA 320 MT—320C, HEGEMAN, QUAD BROCHURES AVAILABLE. PAUL HEATH AUDIO, 354 STATE, ROCHESTER, N.Y. 14608. (716) 232-2828.

**ULTIMATE SYSTEM:** RABCO ST-4, ADC ALM, CITATION 11A, PHASE LINEAR 700, DAYTON WRIGHT XG-8 Mk I Full Range Electrostatic Loudspeakers. ALSO: SAE Equalizer, McIntOSH MR-65 w/ mpX, ALTEC A7-500W Mk II, SCOTT 299F, RADFORD TRISTAR 50 Speakers. B. Hoffman c/o Council Opticians, 123 Gray St., E. Aurora, N.Y. 14052.

**TWO SENNHEISER MKH-105 MICROPHONES** with accessories as new. Stellavox SP-7. Both bargains. Hyde, 301 Springdale, Wintersville, Ohio 43952. (614) 264-4987.

**+ - x + CALCULATOR OWNERS:** Compute square roots, trigonometric functions, logarithms, exponentials and more! Quickly, accurately, easily! Manual \$2.00. Send Today—Unconditional money-back guarantee. Mallmann Optics and Electronics, Dept. A2, 836 South 113, West Allis, Wisconsin 53214.

**AR. KIH, ADVENT, DYNACO, RECTILINEAR, ADC OWNERS—**Our low cost electronic equalizer adds a full octave of new bass, provides three broadband tone controls. Three reviews, literature, from NORMAN LABORATORIES, 520 Highland Parkway, Norman, Oklahoma 73069.

**GATELY/PROKIT SM6A** six input stereo mixer; EQ6 equalizer for equalization on each input, and specially built pan-pot unit for panning on each input. All three units rack mounted, in portable case. Excellent physical and operating condition. Asking only \$575. Ken Newman, 38 Rolling Ridge Rd., Upper Saddle River, N.J. 07458. (201) 327-3677.

**CROWN CX824—**1969 model, 20 hrs. use, 10Z, remote, etc. \$1200 (cost) K. E. Ryan, 14538 Cortina Dr., La Mirada, Calif. 941-8464.

**MAKE A SOUND CHOICE.** Our switching equipment allows instant comparing of all our products. Audio Research, Magneplanar, B&O, Braun, Crown, DBX, Decca, Infinity, Phase Linear, Rabco, SAE, Soundcraftsmen, and many more.  
**SOUND SYSTEMS**  
Palo Alto, Calif. (415) 328-3761.  
Mill Valley, Calif. (415) 383-6556.

**FLAT FREQUENCY RESPONSE TO 18 Hz.** Sound Systems presents its new Earthshaker One woofer system. The system includes an electronic crossover variable from 20 to 300 Hz and 100 watt rms amplifier.

**SOUND SYSTEMS**  
Palo Alto, Calif. (415) 328-3761.  
Mill Valley, Calif. (415) 383-6556.

**DECCA MK V EXPORT—HAND SELECTED.** Custom lateral damping for SME tone arms (for maximum performance).

**SOUND SYSTEMS**  
Palo Alto, Calif. (415) 328-3761.  
Mill Valley, Calif. (415) 383-6556.

**REVOX 1222 HS, VARIPITCH.** Built-in Sel-sync, amps and speakers. Remote control. Less than 30 hrs. use. With full warranty, \$900. Also Sony 8000-B 4 speed servocontrol recorder w/less than 50 hrs. use, \$125. D. Torrey, 2798 Rose Hill Rd., Marietta, N.Y. 13110.

**SCOTCH 150 STUDIO TAPE—**1800' on 7" reel degaussed and boxed 12 for \$12 POSTPAID. Free price list. WIDE RESPONSE, 6114A SANTA MONICA BLVD., HOLLYWOOD, CALIF. 90038.

## FOR SALE

**ARE YOUR TAPES BEING SPOILED** by recording or playback on equipment that may be magnetized? The magnetic signal "printed" on tape is quite sensitive to subsequent magnetic field exposure. You can now actually measure such damaging residuals and really demagnetize offending components using an Annis Audiophile Han-D-Kit. Write for bulletin & copy of article "Notes On Demagnetizing", R. B. Annis Co., 1103 N. Delaware, Indianapolis, Ind. 46202.

**HAN-D-MAGS,** Audiophile Han-D-Kits and Magnetometers—Free Data. R. B. Annis Company, 1103 N. Delaware, Indianapolis, Indiana 46202.

**SONY 854-4S** (Sync) Quad Tape Deck \$1350 or make offer. Mint Condition.

**SONY 850-2** Stereo Tape Deck (1/2 Track, 3/4 ips, 7 1/2 ips, 15 ips; 10 1/2" reels) \$650 or make offer. Mint condition.

Appalachia Sound Recording Studios  
Route #8, Box 525  
Chillicothe, Ohio 45601  
Phone (614) 663-2544

**J.E. SUGDEN AMPLIFIERS—**Finally, a transistorized amplifier for the perfectionist, ideal for electrostatics. Linn Sondek Turntables, lowest rumble ever. Also Audionics, Braun, DBX, Decca, ERA, Integral Systems, Lamb Dolby, Ortofon, Quad, Quintessence, Radford, and more. **AUDIO-PHILE SYSTEMS,** 851 West 44th, Indianapolis, Indiana.

**THD MEASUREMENTS TO 0.01%** for under \$200. Fantastic Sugden Test Equipment. **AUDIO-PHILE SYSTEMS,** 851 West 44th, Indianapolis, Indiana.

**PHASE LINEAR 400 \$450, MARANTZ 7T \$175, MARTIN CRYPTON speakers \$400 pr., HARTLEY CONCERTMASTER VI \$500, CITATION 12 \$250, RADFORD SC-24 \$325, SPA50 \$290, QUAD 33 & 303 \$365, BRAUN TG 1000 \$735, GATELY Pro-Kit Mixer \$295, ALLIED 495 Receiver \$195, BOSE 901's \$365 pr., BRAUN 810 walnut \$595 pr., RABCO SL8E \$145, SAE Mark III \$440, DECCA London \$70. All above used equipment in excellent condition. **AUDIO SYSTEMS & DESIGN** 5421 South 84th St., Lincoln, Nebraska 68516 (402) 489-9888.**

**THE AUDIO RESEARCH ROOM.** The complete range of Audio Research equipment on display under ideal listening conditions. By appointment. C.M. Santmire, **AUDIO SYSTEMS & DESIGN** 5421 South 84th St., Lincoln, Nebraska 68516 (402) 489-9888.

**ELECTRONIC ORGAN KITS, KEYBOARDS** and many components. Independent and divider tone generators. All diode keying. I.C. circuitry. Build any type or size organ desired. Supplement your Artisan Organ. 25¢ for catalog. **DEVTRONIX ORGAN PRODUCTS,** Dept. A, 5872 Amapola Dr., San Jose, Calif. 95129.

**SME 3009,** used 18 months, \$50.00? Dudley, Box 284 Quilcene, Wash. 98376.

**MAGNEPLANAR, CELESTION, EPI, OHM, RTR,** Audionics (transmission line), ERA and Connoisseur perfection turntables, BGW, Sony, B&O, Crown, Transcriptor, Stax, Decca, Integral Systems, many others. Hear our Magneplanar & Audionics super speaker system for \$1,100. High definition Audio specialists, The Gramophone, Ltd., 757 Asp St., Norman, Okla. 73069, 405-364-9477.

**E. V. PATRICIAN 800 CONTEMPORARY PR MINT, EDMOND HAMMITT BOX 96 WILLISTON, OHIO 43468. 419-836-6011.**

**ORTOFON OWNERS—IMPROVE SOUND** with our Micro-Preamplifier, which replaces Ortofon transformer. Send for free literature. Huntington Electronics, Box 2009, Huntington, Conn. 06484.

**HUGE SAVINGS ON FAMOUS BRAND STEREO COMPONENTS**

**DISCOUNTS**

**ON NATIONALLY ADVERTISED**

**TURNTABLES • CARTRIDGES**

**COMPACTS • RECEIVERS**

**AMPLIFIERS • TAPE RECORDERS**

Wholesale Prices! Audio Warehouse Sales, One of the Capitol's largest stereo wholesalers will fill and deliver all your mail orders promptly in factory sealed cartons, at prices that will amaze you.

Write for quote on Famous Brand, Stereo Components. We guarantee satisfaction.

**AUDIO WAREHOUSE SALES**  
3310 NEW YORK AVE. N.E.  
WASHINGTON, D.C. 20002  
(202) 832-1616

Check No. 4 on Reader Service Card

## FOR SALE

**iiOUR RABCO SL-8E SOUNDS BETTER THAN YOUR SL-8E!!** For \$100 we'll convert "yours" to "ours". Professional Products Div., Music and Sound Ltd., 11 1/2 Old York Road, Willow Grove, Pa. 19090. 215-659-9251. Dealer inquiries invited.

**iiHAND-PICKED DECCA LONDON EXPORT SERIES & MK VI!!** At long last the ultimate cartridges, guaranteed from Music and Sound Ltd., 11 1/2 Old York Road, Willow Grove, Pa. 19090. 215-659-9251.

**JAPAN HONG KONG DIRECTORY.** World Products information. \$1.00 today. World Trade Inquiries, Hillvard, Washington 99207.

**IMF MONITOR MK II SPEAKERS,** 8 months old, pair \$950. FIRM, Pat Minichello, 2960 West 8th Street, Brooklyn, New York 11224, (212) 946-3572.

**RECORDING STUDIO AND TUNED ROCK PA'S,** 100's of professional products (J.B.L. and Altec Professional, Tascam, D.B.X., U.R.E.I., Gately, etc., etc.) and customized touring sound systems, including feedback suppression, narrow band (10HZ!) acoustic voicing/equalization ( $\pm 1$  db at your ears), room design/measurement/treatment. All shipped prepaid insured from Music and Sound Ltd., 11 1/2 Old York Road, Willow Grove, Pa. 19090.

**INVENTORS—ENGINEERS**

**SONY TA-3120A,** \$120. R.C. Nuebling, 519 Sixth, Ann Arbor, Mich. 48103.

**PRE-RECORDED EIGHT-TRACKS, CASSETTES.** Excellent condition, reasonable prices. Free lists. F. Pavar, 1234 Taylor Ave., New Kensington, Pa. 15068.

**ADVENT MODEL 100 NOISE REDUCTION UNIT,** Excellent condition. Cost \$250, sell for \$125. S. Keith, POB 92, Lyndon Ctr., Vt. 05850

**SCOTCH BRAND CASSETTES**

LOW NOISE/HIGH DENSITY (LN/HD)  
or HIGH ENERGY/COBALT (HE)

QUANTITY	1-9	10	48
SC-45-LN/HD, 45 min	1.35	1.21	1.15
SC-45-HE, 45 min	1.55	1.48	1.40
*SC-60-LN/HD, 1 hour	1.48	1.35	1.21
*SC-60-HE, 1 hour	1.65	1.57	1.49
*SC-90-LN/HD, 1 1/4 hrs	2.16	2.02	1.92
*SC-90-HE, 1 1/4 hours	2.48	2.32	2.22
SC-120-LN/HD, 2 hours	3.00	2.57	2.49

\*Buy 2, 60 or 90's. GET ONE FREE

**OPEN REEL TAPE RIOT**

NEW FACTORY FRESH SCOTCH LOW NOISE 212-R90; #207-R90 (7" REELS 1800 FT. 1 MIL POLYESTER); SCOTCH #203 (3600 FOOT 10-1/2" METAL REEL); OR AMPEX #641, 1800 FT. 7 INCH REEL

QUANTITY	1-9	10	36
#211-R90 SCOTCH 7"	3.32	2.92	2.77
#207-R90 SCOTCH 7"	3.83	3.34	3.17
#641-18 AMPEX 7", 1800 FT.	1.95	1.83	1.69
203-36 SCOTCH 10-1/2" METAL NAB	7.95	7.00	6.79

CASSETTES & REELS ASSORTABLE FOR BEST QUANTITY PRICE SHIPPING/HANGLING +10%, 7% OVER \$20.00, 5% OVER \$70.00

**SCOTCH MAGNETIC TAPE (USED)**

#150, 1800 ft. 7 inch reel. 1 mil polyester, recorded once, bulk erased (no box), 99c. plus 10% shipping & handling (min. order \$10.00) slightly used 10-1/2 inch fiberglass reels, 3/4" hole, 50c metal, NAB, \$1.00 each (plus shipping by weight and zone)



**SAXITONE TAPE SALES**

1776 Columbia Rd., N.W., Washington, D.C. 20009

**LISTEN TO TV THROUGH YOUR STEREO WITH TELEDAPTER!**



Works with any television & stereo. No wiring, just takes a minute to plug in. Now enjoy all TV programming with a full new sound. Complete and ready to use with instructions. 10 day money back guarantee. SEND ONLY \$2.00 for C.O.D. or save C.O.D. charges and send \$16.95 in check, cash or mastercharge No. to:

**RHOADES & CO.**

P.O. Box 817 Hendersonville, TN. 37075

—Dealer inquiry invited—

Check No. 31 on Reader Service Card

**We Don't Have Gimmicks Just Low Prices**

**Southern Sound Wholesalers**

Every Major Brand  
Mail Order Discount Prices  
Same Day Service

- Memorex
- Garrard
- Dynaco
- KLH
- Scotch
- Sherwood
- Koss
- ADC
- Shure
- Miracord

To Mention a Few!  
**"Ask For A Quote"**

P. O. Box 44  
Magnolia, N. J. 08049

Check No. 38 on Reader Service Card

**FOR SALE**

**LOUDSPEAKERS—BOSE 901 REPLACEMENTS.** \$6.98 postpaid. Quantity Discounts. Moneyback guarantee. Auratone, Box 580-1, Del Mar, California 92014.

**CROWN SX72Z IN CASE.** Excellent condition. S/N 72db!! \$725 or best offer. Reply Box 7494, Tulsa, Ok. 74105.

**CLASSICAL 78's (SOME LP'S):** Mengelberg, Fried, Levitzki, Caruso, Michaelowa, others Reasonable. Chatham Antiques, 228 Main Street, Chatham, N.J. 07928. (201) 635-1440.

**THE LARGEST OLDIES CATALOGUE.** Over 6000 records for sale 50¢ to \$150.00 covering years 1948-1972. Cost of 60 page catalogue is \$3.00 refundable with the first order. Send to Collectors Records, Box 44017 Dallas, Texas 75234.

**SAE MARK I PREAMP** in excellent condition with walnut cabinet for \$375. J. Coomes, 2800 N. Hamline Ave., St. Paul, Minn. 55113 or (612) 633-0886.

**LOWEST DISCOUNT PRICES ANYWHERE** on audio equipment. All major brands discounted. Write for quotes; K&L Sound Services, 264 N. Beacon St., Watertown, Mass. 02172.

**TRANSCRIPTORS, STYLUS SCALES, SWEEP ARMS;** each list \$15, now each \$8; Stylus Brushes list \$12, now \$6. Two Lowther PM6 drivers plus Acousta plans \$100. R. Goewey, 33-45 92nd St., Apt. 5G, Jackson Heights, N.Y. 11372.

**BUY DIRECT FROM ENGLAND'S HI FI MAIL ORDER SPECIALISTS!** SAVE ON SME, LEAK, DECCA, TANDBERG, REVOX, TANNOY, B & W, CELESTION, TRANSCRIPTOR, CAMBRIDGE, A & D, B & O, STAX, WHARFEDALE, ELECTROSTATIC SPEAKERS, ORTOFON, ETC. INSURED SHIPPING QUOTES FREE OR SEND \$2.00 BILLS TO INCLUDE LITERATURE. GOODWIN LIMITED, 7 BROADWAY, WOOD GREEN, LONDON N 22. VISITORS WELCOME TO SHOW-ROOMS. PHONE 888-0077.

**SCOTCH RECORDING TAPE,** lowest prices. TAPE CENTER, Box 4305B, Washington, D.C. 20012.

**QRK AND REK-O-KUT** professional turntables, tone arms, accessories. Isostatic Audio Systems, 66 Dale Drive, Tonawanda, New York 14150. (716) 695-1535.

**MELLOTRONS-ARP SYNTHESIZERS**—discounted. Shipped in factory sealed boxes. Shipping prepaid on synthesizers. Write Dan Keen, 219-19th Street, Avalon, N.J. 08202.

**MAGNEPLANAR® LOUDSPEAKERS** are extremely realistic sounding. Our top quality models are sold thru AUDIO RESEARCH dealers, some of which advertise on these pages. We now have two less expensive models for sale. They are the MG 1672-P Room Divider and the MG2167-F Floor Standing model. You may buy direct from the manufacturer until there is a dealer in your area. Write us for details. Magneplan Inc., P.O. Box 8642, White Bear Lake, Minn. 55110.

**MARANTZ 7 PREAMP.** Excellent Condition. Excellent Appearance, \$185.00. David Mason 1099 N. Jamestown Road, Decatur, Georgia 30033.

**JBL PARAGON**—oiled walnut; absolutely perfect condition, \$2100.00. Phone 203-929-5255 or write Howard Megee, 14 Poplar Drive, Shelton, Conn. 06484.

**AUDIO RESEARCH MAGNEPLANER** Speakers three months old \$900: Infinity Servo-Statik 1 Speakers-Walnut-\$1,400. R. Meyer, 2670 Cupid St. New Orleans, La. 70114. 504-361-3267.

**FOR SALE**

**CUSTOM DESIGNED** Four-way walnut finished corner horn enclosures, (only one of its kind). Electronic x-overs. Cit. A, 4-Cit. B's. Photo and technical report to interested parties. Blaine Irwin, 27046 Laverne Court, Highland, Calif. 92346. (714) 862-4356.

**NEW PHASE LINEAR 400 AND CROWN DC-300A.** Both unused condition. Warranty cards. Phase Linear \$445. Crown \$615. Farhat, P.O. Box 4322, Jacksonville, Fla. 32201. (904) 388-8955

**KARLSON**—Fantastic new line of patented advanced technology speaker systems for stereo, p.a., and music now available. Write Karlson Research & Mfg. Corp., Box 117, W Hempstead, N.Y. 11552.

**OPERA TAPES.** Historical performances of past 40 years. Unbelievable treasures and rarities. ALSO LP RECORDS. Free catalog Ed Rosen, Box 97, Freeport, N.Y. 11520.

**JBL SA600 STEREO AMP,** factory reconditioned, \$200. Box 314, Glenham, N.Y. 12527

**BOSE 1801 POWER AMP,** \$800 or best offer. Phone (601) 366-7452.

**AUDIO RESEARCH—DUAL 51** amplifier w/fan, and PC-1 crossover. Soundcraftsmen 20-12 equalizer. All components new in mint condition. Transferable warranties. Best offers.

D. Thompson  
2639 Moderna Court  
Rancho Cordova, Ca.  
95670.  
(916) 363-9054

**SERVICES**

**DON'T PAY** the high mail order prices. Thieves Warehouse is coming up to your area. Franchises available. Thieves Warehouse, P.O. Box 8057, Pensacola, Florida 32505.

**HIGH FIDELITY SPEAKERS REPAIRED AMPHRITE SPEAKERS SERVICE**

655 Sixth Avenue, New York 10, N.Y.  
212-CH3-4812

**BOSTON MASS. AREA** Authorized-Service for Panasonic-J.V.C.-Fisher-V.M.-Webcor-Magnavox-Lloyd's-Motorola-Juliette-Ross-York. "Where the faults go out and the quality goes in." All's Radio and TV. 1592 Columbus Ave., Roxbury, Mass. 02119. (617) 442-8850

**QUADRAPHONIC DUPLICATIONS.** Unsurpassed quality. High-speed CASSETTES REELS from your Quadtapes. NATIONAL TAPE DUPLICATORS 111 Valley Wilmington, DE 19804.

**NOW LOWEST PRICES FOR STEREO MASTERS** expertly cut on a Scully lathe with the Westrex 3D stereo cutting system. Stereo: 12"—\$33 per side 7"—\$14 per side Mono: 12"—\$22 per side 7"—\$9 per side. Trutone Records 6411 Bergenwood Ave North Bergen, N.J. 07047 201-868-9332.

**THE NEW YORK AUDIO SOCIETY** is a hi-fi club with a comprehensive activities program and numerous member benefits. Come and be our guest at one of our meetings and see what we have to offer. For details write N.Y. Audio Soc. Dept. A; Box 5889, Grand Central Sta.; N.Y., N.Y. 10017 or call M-Fri. 10AM-6PM (212) 242-3900.

**RECORDS MADE FROM YOUR TAPES** Also, editing and mastering. Send for free brochure. Nashville Record Productions, Inc., Dept. AM 204 19th Ave., So., Nashville, Tennessee 37203.

**TAPE RECORDER HEADS** brought back to spec. Wear removed. Brilliant finish. \$10.00 each. One day service. E. Maher, 5 Evans Place, Orinda, Calif. 94563.



## SERVICES

**CUSTOM RECORDING SERVICE** Tape and disc. Stereo and mono. Live and copies. Editing. Masters and pressings. High quality at reasonable rates. Joseph Giovanelli, Audio Tech Laboratories, 2819 Newkirk Ave., Brooklyn, N.Y. IN9-7134.

**PHYSICIAN** (otologist) interested in data or purchase of high fidelity 8-track tapes, or equipment applied to hearing testing and research. Call HE4-9132, Chicago, Ill.

**MULTI-CHANNEL TAPES** Processed from YOUR Mono Records Tapes. Demo Tape \$1.50. R. R. Faulkner, Box 26, Redondo Beach, Calif. 90277.

**EXCITING ANNOUNCEMENT—FANTASTIC NEW APPROACH TO AUDIO REPORTING!** Presenting AUDIO REVIEW, a unique publication featuring revealing, in-depth discussions of controversial issues, equipment reviews/ratings/recommendations, audio highlights and more. AUDIO REVIEW reports issues and ideas other magazines ignore by exposing factual "behind-the-scenes" information you'd otherwise never know about. Upcoming issues feature professional equipment reviews, exciting exposes, buyers discount service and so much more. Special subscription rate: \$7.50/year. Write AUDIO REVIEW for exciting details/information on many new services available to subscribers. AUDIO REVIEW, Box 175, North Branford, Conn. 06471.

**THE ABSOLUTE SOUND**, in its current issue, looks at the Audio Research SP-3; the \$1,750 Mark Levinson pre-amp; four Shibata-stylus cartridges from Japan (the Grace, the Satin, the Supex, the Audio Technica AT20SL); the Magneplanar 1A; the Quintessence pre-amp; the IMF bookshelf speaker and the Monitor III; the Heil AMT-1; the Dynaco 400; the Shure V-15 III and the Panasonic SP-10. If you haven't yet subscribed, this is some of what you've missed: the Dayton-Wright electrostatic; the double Advent system; Hegeman's Model One; the Magneplanar I. And if you do not subscribe, this is what you'll be missing: Magneplanar III; the Phase Linear pre-amp; the Dahlquist speaker; the Dayton-Wright pre-amp; the Jecklin-Float headphones; Radford's amp and pre-amp. By the way, we also tell you which records and tapes sound the absolute best. Nor is that all. (\$8 annually; four issues) THE ABSOLUTE SOUND, Box 115H, Sea Cliff, New York, 11579.

## HELP WANTED

### ASSISTANT EDITOR

Popular home entertainment magazine needs experienced editor with good background in audio or electronics. Send resume or call F. Nemeyer, 134 No. 13th St., Phila., Pa. 19107 (215) 564-5170.

**EPICURE PRODUCTS, INC.** is seeking quality applicants to meet expansion needs. Applicants must be willing to travel extensively four or five days per week, be knowledgeable of, or willing to LEARN all aspects of the hi fi industry—products, policies, and future developments. Position requires a professional approach to sales, and a person interested in rapid advancement into a growing management team. Base salary and monthly incentive. Epicure Products, Inc. Newburyport, Mass. 01950. Call: Robert Fuller, Personnel (617) 462-8191.

**SERIOUS RECORDISTS NEEDED** Excellent remuneration. We train and equip. Modest investment required. Write Box 278, Englewood, Ohio 45322.

## BUSINESS OPPORTUNITIES

**\$25 00 HUNDRED** stuffing envelopes. Immediate earnings. Beginner's Kit \$1.00 (refundable). Lewcard, A392 DU, Brea, California 92621.

## BUSINESS OPPORTUNITIES

**MAILORDER MONEYMAKING KIT** Home Business. Valuable lists, concrete information, detailed steps. Capital unnecessary. Free Details. Pictures. Meadows, Box 327-AU10, Boston, 02199.

**MONEY AVAILABLE NOW!** Both Personal, Business Uses . . . \$500 to Millions. Finance Anything . . . Get Rich Techniques . . . Thousands Actual Sources. Free Details. AIDS, Box 725-AUD, Holland, Michigan 49423.

**IMPORT-EXPORT OPPORTUNITY.** Profitable world-wide, mail order business from home, without capital or travel abroad. We ship plan for no risk examination. Experience unnecessary. Free report. Mellinger, Dept. G1539, Woodland Hills, California 91364.

**MAILORDER MILLIONAIRE** helps beginners make \$500 weekly. Free report reveals secret plan! Executive (1Q10), 333 N. Michigan, Chicago 60601.

**MECHANICAL ABILITY?** \$100.00 Daily Possible. Your Business. Send \$2.00 to: J. Perry, Box H-1, Somerville, Mass. 02145.

**\$10 DAILY WRITING SHORT ARTICLES** at home. Begin immediately! Copyrighted report reveals how and where. Send \$1.00. Specialty Merchandise Co., 7659 So. 42nd St., Omaha, Neb. 68147.

## AUTO ACCESSORIES

**SPEAKERS**—Acoustically designed and built for 1/4—3/4 cost of factory speaker systems. SAVARD 600 East Roosevelt Box 360, Baton Rouge, LA. 70802.

## MISCELLANEOUS

**HOW INTELLIGENT ARE YOU?** Self-scoring test reveals I.Q. in 45 minutes! Ljunghammar and Sayer Associates, Dept. AM1, 2132 North 122nd, Seattle, 98133.

**DON'T DIE WITHOUT A WILL.** Blank will form protects your family. Only \$2.00. Guaranteed. Order today. Southwest Sales, Dept. 24C, Box 1257, Las Vegas, Nevada, 89101.

## EQUIPMENT WANTED

**CASH FOR YOUR** unwanted stereo LP's and reel to reel tapes. Record House, Hillburn, New York 10931.

**WANTED: CROWN, R.O.M.** Write Jim Hollinger, Galen Hall Rd., Rt. #3, Wernersville, Pa. 19565.

**KLIPSCHORNS, USED.** State style and condition. C. C. Bonsell, 2201 Martin Ave., Dayton, Ohio 45414.

**WANTED FOR CONSIDERATION** and critical evaluation—Custom engineered audio components, amplifiers and preamplifiers, etc. I. David, 157 Coyne Pl., Belford, N.J. 07718.

**WANT ANGEL TAPE #3634,** Mahler 2nd. Klemperer/Philharmonica. D. Karsch, 1010 Fifth Avenue, New York City 10028. (212-744-2827 after 6 PM.)

**LOOKING FOR AN AMPEX MICRO 155** which came out last year (1972 model). Anyone owning one and willing to sell—must be in excellent shape—please call me. Willing to pay fair price for unit. A. Licata, 85 Livingston St., Apt. 56, Brooklyn, N.Y. 11207.

**WANTED: GRADO LABORATORY ARM,** with or without Grado turntable. Will pay top dollar if in excellent condition! C. Phillips, Box 487, Gibsonville, N.C. 27249.

HOW GOOD SHOULD A REINFORCEMENT SYSTEM SOUND? SO GOOD YOU DON'T HEAR IT!

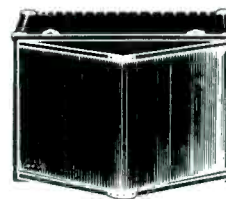

Listen to the remarkable

**BOSE 800™**

Portable Loudspeaker System and all you'll hear is the performance, without artificial coloration. After all, isn't the performance really what the audience comes to hear?

Bose 800, The Unobtrusive One

Please send complete information to:

Name \_\_\_\_\_  
Address \_\_\_\_\_  
City \_\_\_\_\_ State \_\_\_\_\_ Zip \_\_\_\_\_

Return to Bose Corp.  
The Mountain  
Frammingham, Mass. 01701  
Dept. OAP

DIGITAL:THEORY,DESIGN,  
CONSTRUCTION

**LOGIC NEWSLETTER®**

SAMPLE COPY \$1.00  
LOGIC NEWSLETTER  
POB 252AA  
WALDWICK,N.J. 07463

Check No. 21 on Reader Service Card

**PAIA** HAS...

**synthesizer KITS**



MODELS PRICED FROM \$139

FREE BROCHURE AND CATALOG  
OF THE COMPLETE PAIA LINE

PAIA ELECTRONICS  
BOX M14359, OKLAHOMA CITY, OK 73114

Check No. 25 on Reader Service Card

## EQUIPMENT WANTED

**HIGHEST CASH PAID FOR YOUR EQUIPMENT.** Quick action, full details to Box 4, Tennant, N.J. 07763.

**WANT ANGEL TAPE #3634.** Mahler 2nd. Klemperer/Philharmonica D. Karsch, 1010 Fifth Avenue, New York City 10028. (212-744-2827 after 6 PM.)

**WANT MERCURY RECORD #90449.** Hanson 3rd Symphony. Advise price/condition. D. Karsch, 1010 Fifth Avenue, New York City 10028.

**WANTED! LARGE ELECTRO-VOICE** Patrician Model IV or 600. Also E-V Georgian. J.C. Lucken, 1635 W. Onondaga St., Syracuse, N.Y. 13204. 1-315-479-5783

**WANTED—MARANTZ MODEL 9 AMPLIFIER.** Call Collect—317-546-4176 (days). Please ask for Bob Rudolph. Evenings 317-257-8895.

**WANTED! INFINITY 2000A,** pair like new. Price please. Dean Slindee, Box 55, Lansing, Iowa 52151.

**INFINITY SS1 OR SS2 OR SERVO-BASS UNIT** Dean Slindee, Box 55, Lansing, Iowa 52151.

**WANTED SCHEMATIC OF MOOG SYNTHESIZER** models 10, 12, IIc, Ic, IIIc, or portable models, and all ARP models. Write what you've got and price for original or copies to: B. Allan Taylor, 123 S. 65th Ave. W., Duluth, Minn. 55807.

**WANTED: PHASE LINEAR MOD. 400 & Mod. 700 AMPS.** WILL TRADE: Marantz Mod. 15 w/ walnut case, CM Laboratories Mod. 911 AMP, Thorens Mod. 124 w/SME Arm w/Shure V15 II Cart. w/walnut Base, Fairchild Comander (new) EVX4. (new). All these units in "superb" condition. Reason: Need more power. 203-367-0298. M.J. Rogersen, 160 Jeniford Rd., Fairfield, Conn. 06430.

## GOVERNMENT SURPLUS

**JEEPS** Typically From \$53.90 . . . Trucks from \$78.40 . . . Boats. Typewriters, Knives, Airplanes, Clothing, Multimeters, Oscilloscopes, Transceivers, Photographic Electronics Equipment, Wide Variety Condition 100,000 Bid Bargains Direct from Government Nationwide Complete. Sales Directory and Surplus Catalog \$1.00 (Deductible on Orders From Separate Included Catalog). Surplus Service, Box 820-AUD Holland, Michigan 49423

## INSTRUCTION & EDUCATION

**BIBLE** Degrees—Correspondence—Fundamental Bible Seminary. P.O. Box 942, Elk City, Oklahoma 73644.

**LOGIC** trainers catalogs 50¢. UTI, POB 252, Waldwick, N.J. 07463.

**TAPE RECORDING COURSE:** Taught by studio engineers. Free information, NNA, Box 721E, Rye, New York 10580.

**EARN COLLEGE DEGREES AT HOME.** Many subjects. Ministerial studies, high school equivalency diploma. Florida State Christian University, Post Office Box 1674, Fort Lauderdale, Florida, 33302.

## RECORDS

**CATALOGS** Broadcasts, soundtracks, Personalities of Thirties, Forties, Box 225, New York, N.Y. 10028

**RARE** Deleted Motion Picture Soundtrack and Show Albums. Steiner, North, Goldsmith, Waxman, Young, Bernstein, Styne, etc. "ONLY THE BEST." Send 25¢ for new quality catalog to ReCollections, P.O. Box 197, Roselle Park, New Jersey 07204.

## RECORDS

**SHOW ALBUMS**—Rare. Out of Print LP's. Free large list. Broadway/Hollywood Recordings Georgetown, Conn. 06829.

**FILM-STAGE SOUNDTRACKS.** Large free list. A. Lutsky, Box 7342, Miami, Fla. 33155.

**OLDIES—45 RPM** Original hits. Catalog 50¢ C&S Record Sales, Box 197, Wampsville, N.Y. 13163.

**RARE RECORDS**—Send wants. Box 410, Bronx, N.Y. 10469.

**FREE LP CATALOG**—Deleted Soundtracks, Shows, Nostalgia. A. Roseman, P.O. Box 16083, Phila., Pa. 19114.

**THREE GREAT JAZZ ALBUMS!** Write: Bountiful Records, 12311-A Gratiot, Detroit, Michigan 48205.

**FREE 200-PAGE CATALOG.** 1,400 New Stereo Recordings. Renaissance, Baroque, Classical, Romantic, Modern Music, Not sold in stores. Not listed in Schwann's. Highest quality! Budget label prices! Available only by mail. MUSICAL HERITAGE SOCIETY, Box 932 AU, New York, N.Y. 10023.

**SOUNDTRACKS**—O.C.—Personalities & Jazz Want lists to: Theo's Records, P.O. Box 4994, Panaroma City, Ca. 91412.

**SOUNDTRACK RECORD ALBUM** (new) and list—\$2.00. Whalon, 2321A Hill Lane, Redondo Beach, Calif. 90278.

**PILITA CORRALES**—Winner 1973 International Music Festival—Tokyo sings about "LOVE", Stereo \$6.00 AIRMAILED!! Record-Handicraft catalog \$1.00 (Refundable). ARABELL CO., PITOGO, QUEZON E-327, PHILIPPINES.

**SOUNDTRACK SPECIAL**—"The Train" (Jarre), "The Scalphunters" (Bernstein), "You Only Live Twice" (Barry). All three stereo—Mint—\$29.95 complete—(U.S. 4th Class). Other postage extra. Money orders only to: L and K, 3082 N. Elston, Chicago, Ill. 60618.

**RECORDS**—soundtracks, show, cut-outs. Send wants—we'll quote. Lesco, 2205 Marylane, Broomall, Pa. 19008.

**OPERAS, OPERETTAS, OPERATIC RECITALS.** Lieder, Chansons, Scandinavian, Spanish vocals, piano, etc. Many rare items from private collection. SIERLE, 80 Central Park West, NYC 10023.

## PHOTOGRAPHY

**12 EXPOSURE ROLL KODACOLOR FILM** developed-printed jumbo, \$1.50. Capri Color, Box 831, Laredo, Texas 78040.

## MUSIC

**BRAZILIAN**—Latest hits from Brazil. Not Sergio Mendes. Not available in the U.S. Write Braziliansound, Box 1280, Bellaire, Tx 77401.

## TAPE RECORDINGS

**RENT 4-TRACK** open reel tapes—all major labels, 3,000 different. Free brochure. Stereo-Parti, 55 St. James Drive, Santa Rosa, Cal. 95401.

**RENT ANY CASSETTE** or Open Reel Pre-recorded tape. All Labels, Catalog 75¢. Tape & Time, 1116 4th Ave., No. Sauk Rapids, Minn. 56379.

**KENNEDY/TIPPIT/OSWALD MURDERS!** Actual episodes & police recordings! Reels/cassettes: \$10. Majestic, 9651 Foxbury, Rico-Rivera, California.

**NEW TAPE EXCHANGE CLUB.** All Formats. Details 25¢. Bob Musial, Box 11907-A, Chicago, Ill. 60611.

## TAPE RECORDINGS

**OLD Radio Show Monthly Special Club**—TBOR, Box 1692A, F.D.R. Station, New York 10022.

**SPlice FASTER BETTER BY SHEARING.** Replaces razor. Specify ¼" or cassette, \$16.95; with attached splicing tape mechanism, \$24.95. Details—NRP, Box 289, McLean, Va. 22101.

**EVERYTHING ON OPEN REEL!** Thousands of prerecorded classical/popular tapes. Latest releases. Discounts. 96-page catalogue \$1. Barclay-Crocker, Room 333C, 11 Stone Street, NYC 10004.

### 8-TRACK TAPES \$1.75

By joining Star Tape Club. Buy as many as you want or none. No obligation. Big name hit tapes. Rock, Soul, Popular, Best of, Religious, Bluegrass, Classical, Country, Jazz, also Party. Join direct from this ad. Send \$4.00 to:

### STAR ENTERPRISES

35-AM Woodcrest Ave., Dayton, O. 45405

**UNIQUE INTRODUCTORY OFFER.** A \$22.50 value for \$8.95 on over 300 spoken word audio cassette tapes. Send for special order blank and complete catalog. Send to Superscope Tape Products Division, 455 Fox Street, Dept. A-1, San Fernando, CA 91340.

## RADIO PROGRAMS

**REMEMBER RADIO?** On cassettes or reels. Amos & Andy, Inner Sanctum, Jack Armstrong, Fred Allen, I Love a Mystery, Your Hit Parade, Grand Ole Opry, All your Favorites live again. High quality, low prices. Catalog only 50¢. Remember Radio, Inc., 2513-B, Norman, Okla. 73069.

**1930-1962 RADIO PROGRAMS ON TAPE** Huge catalog! Hour samples! \$1.24, refundable!! AM Treasures, Box 192M, Babylon, N.Y. 11702.

**DID YOU KNOW . . .** Radio tapes make unusual and appreciated Christmas gifts. Young people enjoy discovering a "new" form of entertainment. And the over-30 generation has memories of some favorite show. Catalog, details of Christmas specials, \$1.00 (refundable). **RADIO MEMORIES, 1033 GYPSUM, SALINA, KANSAS 67401.**

**RADIO PROGRAMS. CATALOGUE OF THOUSANDS:** \$1.00 (Refundable). THE RADIO VAULT. BOX 9032-TV, WYOMING, MICHIGAN. 49509.

**WANTED—"GRAND CENTRAL STATION"** radio dramas written by Roger Gallagher 1946-1950. Contact Gallagher, RFD2, Amherst, Mass. 01002.

**RADIO MEMORIES.** Custom recorded reels and cassettes. Professional quality equipment assures best sound, but at prices YOU can afford. Large catalog and supplement \$1.00 (refundable). 1033 Gypsum, Salina, Kansas 67401.

**NOSTALGIA RADIO PROGRAMS** traded. Private collection. Drawer 3226, Newport, Delaware 19804.

**OLD RADIO PROGRAMS** Large selection, sample tape and catalog \$1.00. Audio Antiques Box 6651, Cleveland, Ohio 44101.

## BOOKS AND PUBLICATIONS

**YOU'VE SEEN THE REPRINTS** of our nice equipment reports. If you want to read the nasty ones you'll have to subscribe. For free prospectus, write: STEREOPHILE, Box 49A, Elwyn, Pa. 19063.

## REAL ESTATE

**IDEAL 5-ACRE RANCH.** Lake Conchas, New Mexico. \$3,975. No Down. No Interest \$29/mo. Vacation Paradise. Good Investment. Free Brochure. Ranchos, Box 2006BB, Alameda, California 94501.





## Separation saved our marriage thanks to Marantz speakers.

"Where's the flute Henry?" my wife complained constantly. I was about ready to leave her. Then we saw a Marantz dealer. He told us that separation of sound is a true test of a speaker system. He suggested we put Marantz and other popular speakers to the test by listening to a familiar recording so we'd be able to hear for ourselves that it's the speaker and not the recording that makes the difference. Oh, what a difference Marantz made! What we thought were two oboes were clearly an oboe and a flute. And that barbershop quartet...well, they're really a quintet.

The proof is in the listening. And that's where Marantz design concepts come into play. The transducers in Marantz speaker systems are engineered to handle an abundance of continuous power, so you get distortion-free

sounds that are as pleasing as a nibble on the ear.

We bought the Marantz Imperial 5G Two Way Speaker for just \$99. Perfect for our budget and it delivers fine sound separation even with minimum power equipment. And there are five other quality Marantz speaker models starting as low as \$59 and all are available with the new Marantz acoustically transparent foam grill.

Whatever your power and budget requirements, keep this in mind. Marantz speaker systems are built by the people who make the most respected stereo and 4-channel equipment in the world.

To find out how much better they sound go to your nearest Marantz dealer and listen.

**marantz.**  
We sound better.

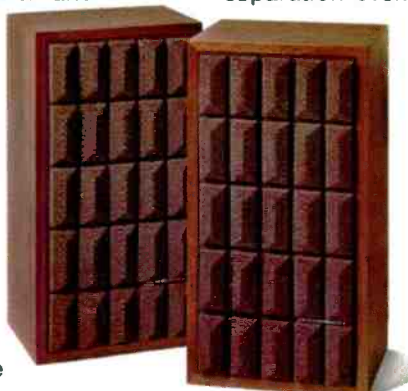

©1973 Marantz Co., Inc., a subsidiary of Superscope Inc., P.O. Box 99P, Sun Valley, Calif. 91352. In Europe: Superscope Europe, S.A. Brussels, Belgium. Available in Canada. Prices and models subject to change without notice. Consult the Yellow Pages for your nearest Marantz dealer. Send for free catalog.

Check No. 43 on Reader Service Card



# **BOSE 1801™** ... the definitive amplifier that's not for everyone.



No ordinary consumer product -- an amplifier that delivers 400 watts rms per channel, has calibrated light emitting diode (L.E.D.) level indicators as well as dual VU meters, weighs 82 pounds, and has a reliability that is backed by a FIVE - YEAR warranty on parts and labor. A precision instrument is a more accurate description of the 1801. And its price reflects it. So before you get too interested, be aware that it takes just under \$1000 to own one.\*

The technology, materials, and workmanship appropriate to amplifiers that deliver power greater than 100 watts rms per channel are more closely related to aerospace products than to consumer products. Being actively engaged in research on both types of products, we tapped our aerospace electronics staff for the design of the 1801.

For those who want all the facts, we have prepared a 16 page color brochure that describes the 1801 and discusses the relation of various amplifier measurements to aural perception of sound. You will find this brochure useful for selecting an amplifier in any price range. For a complimentary copy of this brochure, write Dept. OAA

\*The 1801 is also available without the L.E.D. and VU meter monitor display option for under \$800.



Integral Design™ - a BOSE first - enables a complete amplifier channel, from the low-level stages to the 14 silicon power output transistors, to be mounted on a single card with photo etched precision circuits. A complete channel can be replaced in less than ten minutes without a single adjustment!

## 60-DAY INTRODUCTORY OFFER

At participating BOSE dealers during October and November 1973, you will receive a FREE pair of add-on 901 Series II speakers when you purchase an 1801 amplifier with a 901 Series II speaker system. As described in the 1801 brochure, the "Super-Bose" system, comprised of an 1801 and two pair of 901s, handles 800 watts for a musical experience that must be heard to be believed.

# **BOSE**

The Mountain, Framingham, Mass. 01701