

BINAURAL  
SOUND

# AUDIO

NOVEMBER  
1972 60c

The Authoritative Magazine About High Fidelity

23602

Trials of the Novice Kit-Builder  
Equalization of Sound Reinforcement

CHRISTMAS BUYING GUIDE



ISSUE 119

# re of everything.

Four new and completely different AM-FM stereo receivers with increased performance, greater power, unsurpassed precision and total versatility.

SX-525 AM-FM STEREO RECEIVER — 72 WATTS IHF



SX-626 AM-FM STEREO RECEIVER — 110 WATTS IHF



# Pioneer has mo

SX-727 AM-FM STEREO RECEIVER — 195 WATTS 1+1/2



SX-828 AM-FM STEREO RECEIVER — 270 WATTS HF



# Critics Agree...

You'll be reading lots about the new Pioneer receiver line in a wide variety of publications. Acclaim and enthusiasm for these receivers is evident in reviews (reprints available) now appearing in many of these publications. Here are highlights from just a few.

## STEREO REVIEW

(Hirsch-Houck Laboratories)

"Pioneer's moderately priced SX-727 has a degree of operating flexibility and electrical performance previously found only in some of the most expensive receivers . . . in many areas of its measured performance it is somewhat better than much of the competition at its price level . . . stereo FM separation was among the best we have measured."

**AUDIO** "... (The SX-727) is a rugged, reliable instrument that certainly represents state-of-the-art receiver technology in its design and performance . . . FM performance equalled or exceeded specs in just about every area . . . selectivity was excellent."

## HI-FI STEREO BUYERS' GUIDE

"This (SX-828) excellent performer features full power output at all frequencies . . . excellent reception of weak FM signals . . . selectivity was excellent."

Long before the current wave of consumerism, Pioneer had established its reputation for superior quality craftsmanship. This reputation has been continuously augmented by our commitment to building high fidelity components with a measurable extra margin of value. Our four new receivers — SX-828, SX-727, SX-626, SX-525 — are designed to meet a wide range of requirements and budgets. Yet each unit incorporates a significant array of features and refinements built into the top new model — the SX-828. Regardless which new Pioneer receiver you finally select, you are assured it represents the finest at its price.

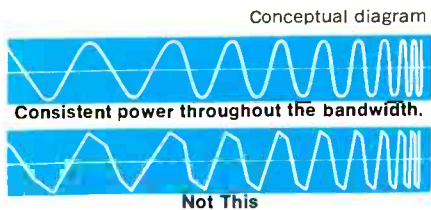

### More meaningful power.

When it comes to power, each model provides the most watts for your money. This is meaningful power. Power that is consistent throughout the 20-20,000 Hz bandwidth (not just when measured at 1,000 Hz.) Especially noticeable at the low end of the spectrum with improved bass response, the overall effect is greater frequency response and low, low distortion.

Model	IHF Music Power 4 ohms	RMS @ 8 ohms Both channels driven @ 1KHz
SX-828	270 watts	60+60 watts
SX-727	195 watts	40+40 watts
SX-626	110 watts	27+27 watts
SX-525	72 watts	17+17 watts

### Direct-coupled amplifier circuitry and twin power supplies improve responses.

Of course, having power to spare is important; but directing it for maximum performance is even more vital. In the SX-828 and SX-727, you will find direct-coupled circuitry in the power amplifier combined with two separate power supplies to maintain consistent high power output with positive stability. This means transient, damping and frequency responses are enhanced, while distortion is minimized. In fact, it's less than 0.5% across the 20-20,000 Hz. bandwidth.

### Ultra wide linear FM dial scale takes the squint out of tuning.

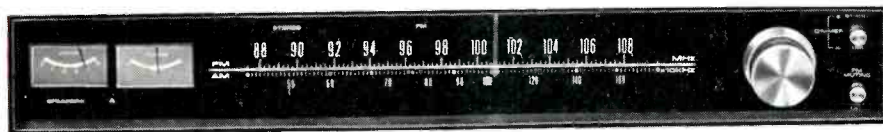

### You can't expect great music without great specifications.

Pioneer's reputation for high performance capability is thoroughly reinforced in these four receivers. Listening to them substantiates it; the specifications tell the reasons why. Since Field Effect Transistors increase sensitivity, they're incorporated into the FM tuner section of each unit. For example, the SX-828 uses 4 FET's. You get greater selectivity and capture ratio with Integrated Circuits and Ceramic Filters in the IF stage. Here's a mini spec list.

	SX-828	SX-727	SX-626	SX-525
FM Sensitivity (IHF) (the lower the better)	1.7uV	1.8uV	2.0uV	2.2uV
Selectivity (the higher the better)	+75dB	+70dB	+70dB	+45dB
Capture Ratio (the lower the better)	1.5dB	2.0dB	2.5dB	3.0dB
Power Bandwidth	All exceed by a wide margin the usable sound frequency spectrum			

### Inputs and outputs for every purpose including 4-channel sound.

Depending on your listening interests and desire to experiment in sound, each receiver provides terminals for a wide range of program sources.

#### Inputs:

	SX-828	SX-727	SX-626	SX-525
Tape monitor	2	2	2	2
Phono	2	2	2	Phono/Mic.
Auxiliary	1	1	1	1
Microphone	2	1	1	Phono/Mic. (as above)

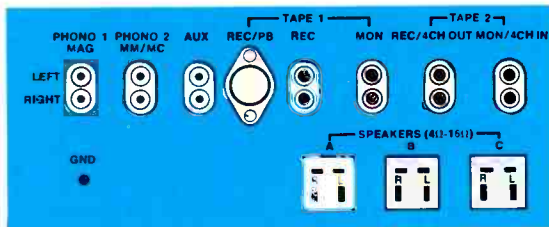

#### Outputs:

	SX-828	SX-727	SX-626	SX-525
Speakers	3	3	3	2
Headsets	2	1	1	1
Tape Rec.	2	2	2	2

Someday, if you want 4-channel sound, all models have 2 inputs and 2 outputs to accommodate a unit such as Pioneer's QL-600A Decoder Amplifier. With it, and two additional speakers, perfect 4-channel sound is simply achieved.



### Exclusive protector circuit for speakers.

Another example of Pioneer's advanced engineering is the automatic electronic trigger relay system designed into the SX-828 and SX-727. Since the signal is transmitted directly to the speakers because of the direct-coupled amplifier, this fail-safe circuit protects your speakers against damage and DC leakage, which can cause distortion. It also guards against short circuits in the power transistors. It's absolutely foolproof.

### Versatile features increase your listening enjoyment.

Our engineers have outdone themselves with a host of easy-to-use features. All four units include: loudness contour, FM muting, mode lights, click stop bass/treble tone controls with oversize knurled knobs, and an ultra wide linear FM dial scale that takes the squint out of tuning. Except for the SX-525, they all employ high and low filters. Enlarged signal strength meters make tuning easier than ever. Center tuning meters

are included as well in the SX-828 and SX-727. Further sophistication is offered on the top two models with a 20dB audio muting switch — the perfect answer to controlling background music. As the senior member of the family, the SX-828 is

endowed with speaker indicator lights (A,B,C,A+B,A+C) and a tuning dial dimmer for creating a more intimate lighting atmosphere.

Some day other stereo receivers will strive for this total combination of power, performance, features, precision and versatility. Why wait? Pioneer has more of everything now.

See and hear these magnificent receivers at your local Pioneer dealer. SX-828—\$429.95; SX-727—\$349.95; SX-626—\$279.95; SX-525—\$239.95 Prices include walnut cabinets.

U.S. Pioneer Electronics Corp.,  
178 Commerce Road, Carlstadt,  
New Jersey 07072

**PIONEER**  
when you want something better

**WE'VE MADE  
THE BEST  
EVEN BETTER**

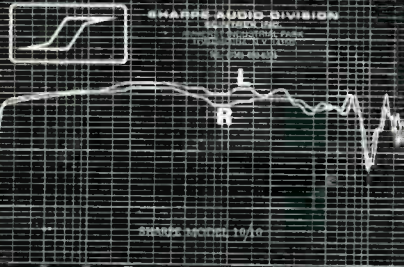

**...3  
NEW MODELS  
BETTER!**



**NEW MODEL 10/10**

The frequency curves are actual tracings from a new Sharpe production Model 10/10. Improved design of the famous top-rated Model 10A. Smooth, brilliant, full response. Striking new decor.

**NEW MARK III**

For new bright sounds to satisfy the highest standards of discriminating professionals and audiophiles alike. Smart new appearance with advanced acoustical designs.

**NEW MODEL 7/7**

See this new budget-priced version of one of Sharpe's most popular models. Price and quality make it a "best-buy." Lightweight stereo listening. Rich new ebony decor. Your Sharpe dealer will gladly demonstrate the complete Sharpe Stereo line.

**SHARPE  
AUDIO  
DIVISION**  
SCINTREX, INC.

Tonawanda, N. Y.  
14150

Export Agents  
**ELPA MARKETING  
INDUSTRIES, INC.**  
New Hyde Park,  
N. Y. 11040

Check No. 2 on Reader Service Card

# AUDIO

NOVEMBER 1972

Successor to **RADIO** Est. 1917

Vol. 56, No. 11

## FEATURE ARTICLES

- 18 Equalization of Sound Reinforcement Systems *Daniel Queen*
- 28 The Trials and Tribulations of the Novice Kit-Builder *Leonard Feldman*
- 34 Audience Involvement Through Use of Binaural Sound *Billy Brant*
- 42 Language of High Fidelity, Part VI—Coils *Martin Clifford*
- 52 Addenda to Annual Product Directory
- 54 Christmas Buying Guide
- 87 Audio ETC *Edward Tatnall Canby*

## EQUIPMENT REVIEWS

- 56 Revox Open-Reel Tape Deck *A-77 Dolby*
- 60 Sony Preamplifier *TA-2000F*
- 64 Empire Speaker System *7500M*
- 66 Fairfax Speaker System *FX-300*

## THE WORKBENCH

- 72 Russound/FMP Multiplay Switch *SQB-2*

## RECORD AND TAPE REVIEWS

- 74 Eugene List's Gottschalk Festival *Richard Freed*
- 84 Classical Reviews *Edward Tatnall Canby*
- 86 Canby's Capsules *Edward Tatnall Canby*
- 89 Weingarten Looks At *Sherwood L. Weingarten*
- 94 Recorded Tape Reviews *Bert Whyte*
- 95 Jazz & Blues *Martha Sanders Gilmore*

## AUDIO IN GENERAL

- 4 Coming In December
- 4 Audioclinic *Joseph Giovanelli*
- 6 Tape Guide *Herman Burstein*
- 8 Dear Editor
- 10 Behind The Scenes *Bert Whyte*
- 14 Tape Competition
- 16 Editor's Review
- 70 What's New In Audio
- 76 Advertising Index
- 100 Classified Advertising



EDITOR *George W. Tillet* PUBLISHER *Jay L. Butler*  
 ASSOCIATE EDITOR *Edward Tatnall Canby* MARKETING DIRECTOR *Sanford L. Cahn*  
 ASSISTANT EDITOR *Eugene Pitts* COVER DESIGN *John Kwasizur*  
 DESIGN *David Adams* SUBSCRIPTION MANAGER *Jean Davis*  
 ADVERTISING PRODUCTION *Sharon Mancini*

CONTRIBUTING EDITORS: *Herman Burstein, Martin Clifford, Leonard Feldman, Richard Freed, Joseph Giovanelli, C. G. McProud, Harry E. Maynard, Alexander Rosner, Sherwood L. Weingarten, Bert Whyte*

AUDIO (title registered U.S. Pat. Off.) is published by North American Publishing Co., Irvin J. Borowsky, President; Frank Nemeyer and Roger Damio, Vice Presidents; R. Kenneth Baxter, Vice President/Production; Nate Rosenblatt, Promotion Director; Mary Claffey, Circulation Director.  
**RATES**—U.S. Possessions, Canada, and Mexico, \$6.00 for one year; \$10.00 for two years; all other countries, \$9.00 per year. Printed in U.S.A. at Columbus, Ohio. All rights reserved. Entire contents copyrighted 1972 by North American Publishing Co. Second class postage paid at Philadelphia, Pa. and additional mailing office. Back issues, \$2.00 each.  
**REGIONAL SALES OFFICES:** Jay L. Butler, Publisher, and Sanford L. Cahn, Marketing Director, 41 East 42nd St., New York, N.Y. 10017, telephone (212) 687-8924.  
 Jay Martin, 15010 Ventura Blvd., Sherman Oaks, Calif. 91403, telephone (213) 981-7852.  
**REPRESENTATIVES, United Kingdom:** The American Magazine Group, 27 Maddox St., London, W 1, England.  
**Continental Europe:** John Ashcraft, 12 Bear St., Leicester Square, London W.C. 2, telephone 930-0525. For Benelux and Germany, W.J.M. Saunders, Mgr., Herengracht 365, Amsterdam, Holland, telephone 24.09.08.  
**Japan:** Japan Printing News Co., Ltd., No. 13, 2 Chome Ginza Higasi, Chuo-ku, Tokyo, telephone 541-5795.

AUDIO Editorial and Publishing Offices, 134 N. 13th St., Philadelphia, Penna. 19107  
 Postmaster: Send Form 3579 to the above address

# IMPROVE YOUR HEARING FOR \$200.

Sometimes high fidelity people lose sight of what it's all about: Sound.

The ultimate test of any piece of high fidelity equipment is what you hear.

That's why, of all the statements made by equipment reviewers about our Garrard Zero 100, the most significant were these:

"Using identical virgin records, and virgin styli in identical good cartridges, the Zero 100 on occasion sounded markedly 'crisper' than other turntables." *Rolling Stone*.

"A listening test proves to bring new life to many records, noticeably reducing distortion on the inner grooves." *Radio Electronics*.

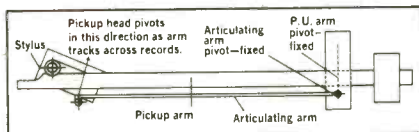

"From about 7 in. diameter to runout, the Zero 100 delivers considerably less distortion and greater definition than with the same pickup mounted in a standard arm. The improvement in sound quality is notably impressive."

*Elementary Electronics*.

"The articulated arm of the Zero 100 produced less distortion, and therefore greater definition, on high-level, musically complex passages, from the inner grooves."

*Hi-Fi Stereo Buyers' Guide*.

That's what reviewers actually

heard when they tested the first automatic turntable with Zero Tracking Error. This is, to our knowledge, the first time a turntable has been given credit for making records sound better.

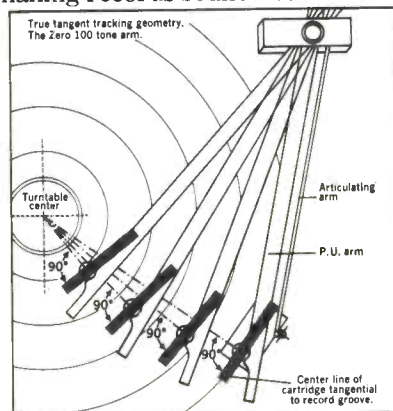

Cartridges and other components, yes. But never a turntable — until the Zero 100.

By this time you probably know how we achieve Zero Tracking Error. The principle of the articulating arm, continually adjusting the angle of the cartridge so it is always at a 90° tangent to the grooves, is a simple one. But the ingenious engineering and the development of the precision pivots to make the principle work, took several years.

But enough from us. Let's go back to what the reviewers say about the Zero 100.

"It probably is the best arm yet

offered as an integral part of an automatic player." *High Fidelity*.

"All of these features combined into one automatic turntable make news, even though some are found on other units. Only in the Zero 100 are they all put together." *Audio*.

When *Audio* talks about "all of these features" they're referring to such things as our magnetic anti-skating, variable speed control, illuminated strobe, viscous-damped cueing, 15° vertical tracking adjustment, patented Garrard Synchro-Lab synchronous motor and our exclusive two-point record support in automatic play.

But all of this gets back to our original point. It is the sound that makes the difference. After all, a \$200 record player should give you a really meaningful difference. And the high fidelity experts agree that people who own a Zero 100 will hear better than people who don't.

If you'd like to read the reviews in full detail, we'll send them to you along with a complete brochure on the Zero 100 and the Garrard line. Write to: British Industries Company, Dept. K12, Westbury, N.Y. 11590.

## GARRARD ZERO 100

The only automatic turntable with Zero Tracking Error.

Mfg. by Plessey Ltd. Dist. by British Industries Company



# coming in December

## Directory of Microphones

Microphones by Jim Long

The Language of High Fidelity, Part VII of Martin Clifford's Guide for Beginners

## Annual Index

The Care of Records by Percy Wilson

## Equipment Reviews Include

AR LST  
Small Advent



### ABOUT THE COVER:

Choosing Christmas presents can be very perplexing but if you are tired of ties and socks ask the Ms. to consider record or book tokens, tape recorder accessories, and so on. Better still, let her take a look at AUDIO—you may end up with a \$1000.00 tuner.

# audioclinic

Joseph  
Giovanelli

## Lightning Protection

*Q. I have some unrelated questions concerning lightning protection for the antenna mast.*

*I live in a rural area, dotted with villages and towns. Throughout this area, servicemen, who make antenna installations, seem to have no interest in grounding the antenna system for lightning arrest. The general consensus seems to be that it is not necessary to do so. They will perform the task upon insistence. I do not ask that you understand the psyche of the installers. I am curious, however, about the old tradition of grounding. Is it still timely and necessary? Is grounding the mast needed if only to avoid stealing "dB's" from the antenna?*

*All lightning rods I have ever seen have been pointed at the top. Is the point functional in meeting the bolt?—James D. Boltz, Fredonia, N.Y.*

A. If you are located in an open area, you are definitely a candidate for a lightning stroke. Grounding, therefore, is the only protection you have. When the mast is mounted at ground level, all that is required is to sink the mast a few feet into the earth and the job is done. I would locate the antenna away from the house. Further, I would make provisions at the bottom of the mast to disconnect the lead-in. By disconnecting this lead-in cable at the approach of a thunderstorm you will add an additional safeguard in terms of preventing lightning from entering your house, possibly damaging your audio gear or the house itself.

When the antenna is mounted on the roof, however, you must make your ground connections to the mast, using heavy gauge wire. If you should receive a direct hit from a lightning bolt, the grounding won't be adequate. You had better try prayer. The instantaneous peak current involved is more than any reasonable wire gauge can withstand.

If there is some signal loss introduced by the proximity of the mast to the antenna, that same loss will occur whether the mast is grounded or not. Remember that at the FM wave lengths, effective grounding cannot be established. There is so much inductance in the length of the mast, plus ground lines, that there is no real way to ground the system for r.f.

Lightning rods have points because it is well known that lightning is attracted to high, sharp objects. (This is why chimneys are struck more often than the rest of the house. If chimneys were a lot larger, the bolt would not jump to them.) Lightning rods, being of small diameter and higher than any other point on the structure to which they are mounted, will be a better attractant to lightning than any other portion of your home, including the chimney and the antenna system.

Lightning rods offer the best protection possible. In order to take maximum advantage of this fact, the rods must be installed by a professional in the field of lightning protection.

## Signal-to-Noise Ratio

*Q. Please define signal-to-noise ratio. I always thought the higher this ratio was, the better. Some companies claim that they have recorders with low signal-to-noise ratios, made even lower with the use of Dolby. Please clear this up for me.—Preston Schaffer, Brooklyn, N.Y.*

A. In addition to the desired signal information, any recording or reproducing system always contains a certain amount of background noise. The amount of desired information present, divided by the unwanted background noise yields the signal-to-noise ratio. By arithmetic, we can express this ratio in terms of dB. The greater the number of dB of signal-to-noise, the better is the device being considered, at least in this regard.

A manufacturer would strive for the greatest possible difference between the desired signal and the inherent background noise present in his device. He would, therefore, probably not advertise a low signal-to-noise ratio; he might, however, advertise his extremely low background noise or his high signal-to-noise ratio.

The use of the Dolby system would decrease unwanted background noise as compared to the wanted program, thereby increasing the signal-to-noise ratio.

If you have a problem or question on audio, write to Mr. Joseph Giovanelli, at AUDIO, 134 North Thirteenth Street, Philadelphia, Pa. 19107. All letters are answered. Please enclose a stamped self-addressed envelope.



# "Optimum stereo performance...

excellent dispersion. It has a big sound at any volume level. Completely free from harshness or stridency..." **Julian Hirsch, Stereo Review**

# "Superior transient response...

extreme clarity, will not break up under any normal or even super normal pushing..." **Larry Zide, American Record Guide**

# "What a speaker!..."

The sonic presentation was excellent; voices were natural with no coloration; orchestral music was balanced and full; transients came through cleanly; the organ sounded authentic. Indeed, for a system of its size and price, designed for home use the Gradiar strikes us as the best." **High Fidelity**

CONSUMER COMMENTS: **R. A., Portsmouth, N. H.**, The rich true sound of stereo • **W. S., Canoga Park, Calif.**, The style for my wife... the sound for me • **J. A., Hyattsville, Md.**, Superior sound over anything near it in price • **D. O., Vallejo, Calif.**, That's good sound • **T. F., St. Louis, Mo.**, Fantastic sound and the fine quality in the design • **R. G., New York, N. Y.**, I love it; you made it! • **D. D., Honeybrook, P. A.**, Fantastically good fidelity • **J. F., Vancouver, B. C.**, This speaker is truly a work of art!



Model 950CM

Model 7500M

Model 6000M



Empire Scientific Corp.  
Garden City, New York 11530



Mfd. U.S.A.  
World Famous Speaker Systems

CIRCLE NO. 90 ON READER SERVICE CARD

www.americanradiohistory.com

# The Tape Guide

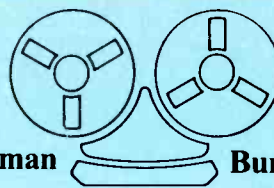

Herman Burstein

## Phones For Monitoring

*Q. I have a TEAC tape deck, model A-1200-U. To make use of the tape or source monitoring feature, headphones of 10,000 ohms impedance or better are required. The dealer whom I purchased the tape deck tells me that high fidelity phones are not made in this impedance range. I wrote to TEAC asking if they could suggest a source of supply for the required headphones, and they have not replied. I want to use the TEAC for recording without disturbing others in the room, and I am afraid to use my present 4-16 ohm phones for fear of overloading the outputs of the TEAC. Any suggestions you may have will be gratefully received.—J. Francis Hartmann, Glen Ellyn, Ill.*

A. You might write directly to headphone manufacturers for suggestions. Perhaps you can do something like the following. Connect the low-impedance (presumably high quality) headphones you have to the output of the power amplifier, and work out a switching arrangement that disconnects the speakers from the power amplifier. Since there should always be a load across the output of the power amplifier, either the switching arrangement should substitute a dummy load resistor, or you should leave a dummy load resistor (about 30 to 50 ohms) permanently connected to the output of the power amplifier. The resistors in question should be rated at 10 watts or more.

## Low Playback Level

*Q. I experience a drastic reduction in signal level during playback after a recording. (I am not recording at too low a level inasmuch as prerecorded tapes give me about the same playback level as tapes I have recorded.) If the volume control is set at 2 when monitoring the source, then it has to be moved to about 5 or 6 when monitoring the tape playback in order to get the same level. I will be grateful for any light you can shed on this problem.—Kohoh Ansah, New York, N.Y.*

A. Your problem in brief is that the playback level is substantially lower than the monitoring level. The fault lies either in the design of your tape recorder or in the misadjustment of an internal control (if there is such a control) which permits the playback and monitoring levels to be equated.

Further, keep in mind that for the same signal level applied to the tape, some tapes have higher output than do other tapes. Accordingly, if your machine contains a control of the type I have mentioned, it has to be set on the basis of the tape you are using.

## Cassette vs Reel Recorders

*Q. I have a mono open reel tape recorder. I am thinking of purchasing a stereo recorder. However, some people feel a cassette is better for what I want to use this machine for, mainly taping radio and TV programs. What do you advise? How would one connect the cassette to the radio or TV for recording?—Sam Gerfinkel, Yonkers, N.Y.*

A. For high quality reproduction you are probably better off with an open-reel machine. However, a cassette machine offers you a much more compact device. If you are planning to record mainly from radio (presumably mono) and TV (mono of course), I don't see why you want a stereo recorder. If the radio or TV has a tape output jack, you would connect this to the high-level input of your tape machine. If they lack such a jack, you can obtain the signal across the volume control of either unit. Third, but least desirable, you can obtain the signal across the speaker leads of the radio or TV. If you take the signal across the volume control, keep the cable from the unit to the tape recorder as short as possible and of minimum capacitance per foot.

## Background Noise

*Q. When I use my Ampex 601 in recording from FM station WNCN, during the playback of that program there is an annoying background noise that is present neither in the original broadcast nor in monitoring. What could cause it, and how can I eliminate it? Strangely, WNCN seems to be the only offender.—William E. Hlad, Bronx, N.Y.*

A. Possibly, very high frequencies—too high to be initially audible—are beating with the bias frequency of your tape recorder to produce audible noise. For example, harmonics of the multiplex 19,000 Hz signal could be doing this. In such a case the solution may be to insert a high frequency filter (cutting off sharply above 15,000 Hz) between the output of the FM tuner and the input of the tape recorder. Consult your audio dealer about such a filter.

## Mono Recording

*Q. Regarding the use of a mono open-reel tape recorder to record from a stereo radio: (1) Do I control recording volume with the volume control of the radio or with the volume control of the tape recorder? (2) Since the recorder is mono, should I use only one channel of the stereo radio? (3) To feed the tape recorder I use a patch cord with alligator clips. Is the best hookup to the speaker terminals inside the set or to the two screws in back of the set that are attached to the speakers?—Sam Gerfinkel, Yonkers, N.Y.*

A. Adjust the recording level of your tape machine by means of its volume control. Once you have found the proper setting for this control, do not change it while recording. Your tape recorder should be connected to the combined output of both channels. Otherwise you will not pick up all the program material. If your radio has a stereo defeat switch, this will supply a combined output in the defeat position. If it doesn't, you might try the following. Connect two resistors in series, each of about 16 ohms and two watts rating, between the hot terminals for each speaker. Connect your patch cord to (1) the midpoint of these two resistors and (2) ground. It doesn't matter whether connection is made to the speaker terminals inside the set or to the screws leading to the speakers.

## Input Matching

*Q. I have a tape deck whose output is 1 volt. I plan to buy an audio receiver with an input sensitivity of 170 mv. Would this receiver match my tape deck?—George S. Hatch, Jr., APO.*

A. The two should match well. The receiver requires a minimum of 170 mV and can probably accept a few volts before overloading. The 1 volt output of your tape deck fits well within this range.

If you have a problem or question on tape recording, write to Mr. Herman Burstein at AUDIO, 134 North Thirteenth Street, Philadelphia, Pa. 19107. All letters are answered. Please enclose a stamped, self-addressed envelope.



# if you are serious about music use the tape of the pro. TDK

Ask any artist or musician, any recording engineer or audiophile, chances are he uses TDK for his professional work. Unmatched in purity and fidelity over the full range of human hearing, crystal clear in its dynamic response and with complete reliability, TDK truly is the tape of the expert. Cassettes, 8-track cartridges or reel-to-reel, in the widest choice of formulations and lengths, including cassettes running as long as 3 hours.

## *Purity In Sound*



Ask your dealer for free copy of 48-page "Guide to Cassettes," or write us directly.

**TDK ELECTRONICS CORP.**  
23-73 48TH STREET LONG ISLAND CITY, N.Y. 11103 • 212-721-6881



# TDK



Check No. 7 on Reader Service Card

# Dear Editor



## Service vs. Features

Dear Sir:

In another leading hi-fi magazine an editor stated that frequency-of-repair records would be of little use in rating hi-fi products, and your articles—while informative and well-written—tend to stress the same attitude. I can understand this and agree, but only because present hi-fi practices make such analysis and comparison impossible.

Nowhere else in this country do I see such a high-turnover industry as yours. Products are obsolete in a matter of months as manufacturers bring out and advertise to death new products which have genuine improvements and added features. Service and reliability are hinted at but never stressed—it's always looks, performance, or features which come first.

And at the same time your industry seems plagued with service problems. I have YET to find a company which really considers service important. Their service centers are always understaffed with indifferent personnel who are overworked and frankly don't give a hoot about your product or your problems.

Indeed, why should they? The customer won't keep the product long anyway, the serviceman feels, since it gets obsoleted so quickly. In part, this is true. The mass advertising I get barraged with every time I pick up a hi-fi mag does nothing but make me miserable by telling me what a junk heap my present rig is. And it makes me even madder because it keeps promising things which the equipment simply cannot do no matter HOW good it is!

The result, Mr. Editor, is cynicism and distrust. I no longer believe what companies say; why should I? Friends and I never take our gear in for service. We either repair it ourselves or junk it wastefully for some "improved model" which dissatisfies us in some other way. Music is not important anymore; only the gear is important.

This practice does make comparisons of service and reliability impossible. But I wish you and other editors would challenge this wasteful practice instead of getting swept up into its very core.

K. Wiley  
Rochester, N.Y.

*There is some truth here, but the fact remains that manufacturers who make unreliable products do not remain in business. The dealer does not want to buy*

*products that eat up his profit in the service workshop! In my experience, present-day hi-fi equipment with plug-in circuit boards, modules, and so on is a lot more reliable than it was back in the days of high voltages with transformers burning up, capacitors breaking down—not to mention tube failures! Nevertheless, there is considerable room for improvement—too many designers work on the assumption that their products will never, never need servicing. Especially some tape recorders that need a can opener to get at the innards.—ED.*

## The Discography Predicament

Dear Sir:

As a collector of records since the late twenties, it is indeed frustrating to pay top dollar for discs, or tapes, and discover the omission of the composer, lyricist, artist, soloist, vocalist, orchestra, conductor, etc.: to say nothing of the "misleading" information on the label or jacket.

I must go back to the old 78 shellac days to find composer and lyricist listed on the label, together with the show, revue, or film the selection was written for, as well as the artist (orchestra, vocalist, or both). Some foreign labels, notably HMV, Odeon, Polydor and English Decca, even listed the publisher, recording date, and location.

With the advent of the LP, all of the above disappeared from the label, although the 45's (and 45 EP's) retained most of this for a few years; the LP introduced the beautiful and artistic jacket with less and less discography and more and more nonsensical patter, having absolutely no reference to the content, but rather about the LP title, cover, acoustic effects, or the supposed "mood" of the music.

With the introduction of prerecorded tapes, the situation became worse; open-reel (at the outset) was more like the old 78 rpm shellac labels (because adequate space was available on the label of 7 in. reels) but with the intercalation of 8-track cartridges and cassettes, practically everything disappeared from the labels (space?) and box or jacket (inventory?).

Complaints of quality control, both about discs and tapes, are increasing to the point that disc/tape manufacturers are starting to "listen," but still results are not forthcoming. Again, foreign-produced discs/tapes far exceed their American counterparts in quality

control, sonics, engineering, processing and discographies and at competing prices.

My interest now is centered on a recording catalog (disc/tape) that at least lists the entire selections on an LP, or tape, and not the present standard of simply stating a "few" selections, followed by the well-worn phrase "and 8 more."

This is not meant as being critical of the "so-called Bible" of the industry, the Schwann Record & Tape Guide, nor The Harrison Tape Catalog, Listen Magazine and others that are doing a creditable job. They are doing an excellent job on what they set out to do, namely a catalog listing of available discs/tapes and prices, when the manufacturers discontinued issuing their own catalogs. Now, with the voluminous number of discs/tapes being released, it is amazing the job they are doing. Schwann comes the closest to listing each selection, in their monthly "New Listings," but again it is inadequate. Miss a month and you've had it and Schwann catalogs are not easy to obtain.

I feel strongly enough about this dilemma to, with the encouragement of other readers and the disc/tape manufacturers themselves, encourage and promote the publication of a complete catalog/discography combination similar to the excellent RCA Victor Catalog circa 1940-41 which was of the type outlined above.

Your views may be expressed through this "Letters to the Editor" column, or the writer direct. Record/tape manufacturers' views and opinions are especially solicited, as their willingness and cooperation will be required, to make available their documented data for compilation of such a catalog.

A. F. McNaughton, Jr.  
22 Blake Street  
Keene, New Hampshire 03431

## Mechanical Minds?

Dear Sir:

Please write so women without mechanical minds can understand enough to buy the right equipment and how to use it.

Jane B. Cantor  
Montebello, Calif.

*But what would women's lib say about writing down to the ladies?—Ed.*

# The ADC-XLM "...in a class by itself."

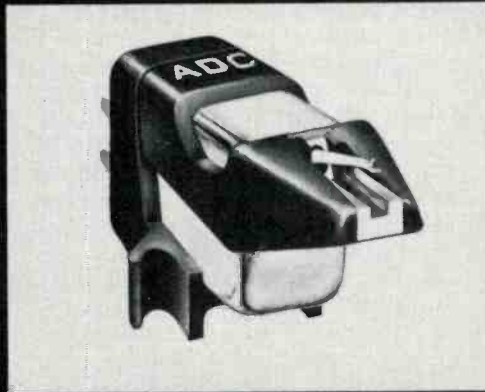

That's the way Stereo Review described our XLM. High Fidelity headlined their review, "Superb new pickup from ADC" and went on to say, "...must be counted among the state of the art contenders." And Audio echoed them with, "The ADC-XLM appears to be state of the art."

With the critics so lavish in their praise of the XLM, there's hardly any necessity to add anything. Far better to let the experts continue to speak for us.

**Frequency response** The CBS STR-100 test record showed less than  $\pm 1.5$  dB variation up to 20,000 Hz. *Stereo Review*  
...response is within  $\pm 2$  dB over the entire range. *Audio*  
Frequency response is exceptionally flat. *High Fidelity*

**Tracking** This is the only cartridge we have seen that is really capable of tracking almost all stereo discs at 0.4 grams. *Stereo Review*  
The XLM went through the usual torture test at 0.4 grams (some top models require more than a gram). *High Fidelity*  
The XLM is capable of reproducing anything found on a phonograph record. *Audio*

**Distortion** Distortion readings... are without exception better than those for any other model we've tested. *High Fidelity*

The XLM has remarkably low distortion in comparison with others. *Audio*  
At 0.6 grams the distortion was low (under 1.5 per cent). *Stereo Review*

**Hum and noise** The XLM could be instrumental in lowering the input noise from the first stage of a modern transistor amplifier. *Audio*  
The cartridge had very good shielding against induced hum. *Stereo Review*

**Price** This would be a very hard cartridge to surpass at any price. *Stereo Review*  
We found it impossible to attribute superior sound to costlier competing models. *High Fidelity*  
Priced as it is, it is a real bargain in cartridges. *Audio*

**The Pritchard High Definition  
ADC-XLM \$50.**

 **AUDIO DYNAMICS CORPORATION**  
Pickett District Road, New Milford, Connecticut 06776  
Check No. 9 on Reader Service Card

# Behind The Scenes

Bert Whyte

**A**UTUMN IN NEW YORK . . . it's the title of a popular song, and it is traditionally the beginning of the audio "season." It is when we have the fall convention of the Audio Engineering Society, this year being held at the prestigious Waldorf-Astoria, and when we have the "flagship" show of the Institute of High Fidelity, the venue this year being the Statler-Hilton. As I write this, the AES convention is but a few hours away, and I am feeling very frustrated. Most of the writers I know are great procrastinators. I admit that I am quite notorious in this respect. All of us who write for monthly magazines submit our material several months in advance of publication, and we have a tendency to "wait-for-the-latest-information" before we turn in our articles. Inevitably, we must face up to the inflexible tyranny of copy deadlines. Hence my frustration, as there are so many things of interest at the convention, that had I another day or so . . . Ah, well! I'll just have to keep things in my memory bank until next month.

With the growing importance of quadrasonic sound, there is unusual interest in the AES convention this year. Many people I know, who don't normally attend the technical sessions, are planning to go to them this time. The interest is understandable with an opening day session on quadrasonic sound chaired by my friend John Woram of Vanguard Records, with such provocative papers as Al Grundy's "Mathematics of Quadrasonic Matrices," friend John Eargle's "4-2-4 Matrix Systems: Standards, Practice and Interchangeability," Peter Tappan's "Can We Hear Four-Channels via Headphones?" Then there is Mark Gardner of Bell Laboratories with his "Some Single and Multiple-Source Localization Effects," Takeo Yamamoto of Pioneer describing a "Quadrasonic One-Point Pickup Microphone," and Rex Isom of RCA with "An Analysis of the Frequency Modulation of the Carrier in Discrete Four-Channel Records." As if this wasn't impressive enough, later on in the convention are such things as a panel on four-channel broadcasting, a paper on logic enhancement of matrixed quad, another on recording techniques for SQ quadrasonic discs, and the inventor of the Shibata stylus in person on the technical requirements of phono cartridges

for proper playback of CD-4 discrete four-channel records. As you can see, some pretty high-powered engineering talent is involved in many aspects of quadrasonic sound.

Speaking of the CD-4 discrete disc, there have been some new developments that warrant a progress report. I mentioned a couple of months ago that JVC and Panasonic were going to produce a new generation of demodulators for the CD-4 disc employing phase-lock-loop circuitry. Mr. Bob Dunn of Panasonic was kind enough to send me one of these new demodulators, along with a new semiconductor quadrasonic cartridge with Shibata stylus and, most importantly, technically updated versions of RCA discrete discs. The demodulator is more compact than the earlier JVC unit, with clean, simple styling. A selector switch on the front panel has a position for four-channel auxiliary input (i.e. discrete tape), another for the CD-4 disc, and one for stereo discs. There is a so-called "radar" light above the selector switch which goes on when the high frequency carrier is fed into the unit. The rear panel has various input and output receptacles for the PHONO and AUX front and rear, plus a sensitivity calibration control set at the factory. The output of the cartridge feeds into the demodulator, and the outputs of the demodulator into the high level inputs on a four-channel receiver, integrated amplifier or pre-amplifier. It is worth noting that in using the demodulator, the phono pre-amp section of the receiver, amp or pre-amp, is by-passed. With all due respect to Panasonic, whose phono pre-amp in the demodulator is clean and quiet, I don't think it would be as good as the phono section of really high quality pre-amps.

This raises the prospect that if the CD-4 discrete disc becomes a viable and stable market entity, the manufacturers of the high class units may have to build demodulator circuitry into their phono sections. The semiconductor cartridge is claimed to have response from 10 to 50 kHz. One takes a little time to get used to such an extended high end claim, but there is no question that it picks up the carrier with ease. Used with conventional stereo records, the cartridge gave excellent results.

RCA calls its discrete discs by the

trade name "Quadrisc." Two have actually been released, even though most of the new demodulators, or related equipment containing the new demodulator circuitry, will not be marketed until October of this year. The hi-fi press is quite familiar with these discs, having heard various versions of them at a number of demonstrations. The pop disc is APD1-0001, entitled "Hugo Montenegro/Love Theme From The Godfather," which is slightly misleading since there are eight other selections totally unrelated to the "Godfather." In any case, we are told that the album was specifically recorded for the quadrasonic format, and there is indeed clever and logical positioning and localization of the various instruments or groups of instruments on the four channels. The classical Quadrisc is ARD1-0002, with Eugene Ormandy and the Philadelphia Orchestra, entitled "The Fantastic Philadelphians, Vol. 1." Produced by my former RCA colleague, Max Wilcox, this features Chabrier's *España*, Dukas' *The Sorcerer's Apprentice*, Saint-Saëns' *Danse Macabre*, and Mussorgsky's *Night on Bald Mountain*. The important thing here is that this is a true four-channel ambient classical recording and it is a welcome relief from the hokey stuff RCA tried to foist on us in the classical Q8 cartridges.

Now follow this . . . until quite recently, all the sample Quadriscs were cut with the JVC CD-4 equipment in Tokyo. The recordings of Montenegro and Ormandy that I received were down 6-8 dB from standard stereo level. They were also variable in respect to noise. Some were not too bad, while others had a lot of ticks and pops as well as odd swishing and thumping sorts of noises. In addition to being down in level, the classical recording suffered from bass attenuation. In the face of these shortcomings, RCA installed the special CD-4 cutting equipment in its studios at 1133 Avenue of the Americas in New York, which is slightly amusing inasmuch as the cutting speed necessary to the process of putting the 30 kHz carrier on the lacquer is approximately 11.33 rpm! Now that the CD-4 cutting equipment is close to hand, RCA has evidently been doing extensive testing, for the updated Montenegro and Ormandy recordings I was sent are very significantly improved over the pre-

# Eight Exceptionally Clear Quotes from Reviewers on the Advent Model 201 Cassette Deck:



*"The Advent 201 easily met its specifications and established itself—at least for now—as the best cassette recorder we know of. Having used it to evaluate the forty types of cassette tapes in a survey report, we have a familiarity with, and a respect for, its capabilities."*

Julian Hirsch, *STEREO REVIEW*

*"Well, I have tested it and used it. And I can state categorically that it represents the finest cassette deck available—one that is not likely to be surpassed in the near future."*

Larry Zide, *STEREO & HI-FI TIMES*

*"In addition to the Dolby circuitry and the special bias and equalization control for Crolyn, the deck was the first we had come across in which a properly recorded cassette could be made literally indistinguishable from the sound source."*

*HIGH FIDELITY*

*"It is difficult to restrain our enthusiasm for the Advent 201. The unit came with a demonstration tape that had been dubbed onto Crolyn tape by that specific machine from a Dolby "A" master tape. The sound quality, especially with the finest playback amplifiers and speakers, was literally awesome, as was the total absence of hiss or other background noise."*

Julian Hirsch, *STEREO REVIEW*

*"The 201 is a superlative tape deck. That it is a cassette unit with these qualities is something that would not have been believed just one year ago."*

Larry Zide, *STEREO & HI-FI TIMES*

*"In making recordings from discs and FM—both at the time of preparing the original report and in the intervening months—we find that the 201 documents the premise that the sound of state-of-the-art cassette equipment need make no apologies whatever to the better open-reel decks."*

*HIGH FIDELITY*

*"Summarizing, the Advent 201 is a tape deck of superlative quality. It is difficult to imagine how its sonic performance could be substantially improved."*

Julian Hirsch, *STEREO REVIEW*

*"All told, the 201 represents the present state of the cassette art."*

Larry Zide, *STEREO & HI-FI TIMES*

The only important fact that those quotes (and a dozen more like them) don't fully indicate is the special, almost addictive, pleasure that cassettes provide when used with a tape machine as good as the 201. There is something just right about being able to put the latest Stones recording or a Beethoven symphony into your shirt pocket. And there is a real joy in knowing that locked in these little cassettes is music of unsurpassed quality that you can hear again and again—easily, conveniently, and without concern about scratches, loss of quality and the other ills that discs are heir to.

We believe the Advent Model 201 will give you more pleasure than any piece of equipment you have bought (or are likely to buy) for a long, long time.

If you would like more information, including a list of Advent dealers, please write us at the address below.

Thank you.

**Advent Corporation, 195 Albany Street, Cambridge, Massachusetts 02139.**

vious samples. RCA now claims that the Quadradiscs are cut at normal "plus three" stereo level. To check this I played the new discs at a comfortable room-filling level, and then without touching the gain controls, played the previous sample discs that had been cut in Tokyo. Sure enough, there was roughly an 8 dB difference in level.

Quadraphonic expert John Eargle was my house guest the day before the AES convention, and we did a lot of comparative listening to the New York

and Tokyo versions of these two CD-4 discs, as well as having a very stimulating discussion on various aspects of the discrete discs in particular and the quadraphonic scene in general. I can tell you that John and I were very impressed with the combination of the new phase-lock-loop demodulator, new cartridge, and the quadradiscs cut in New York. The Montenegro disc was really quiet. The master was Dolbyized of course, so no hiss intruded. But in addition, the record surfaces were astonishingly quiet, with only an infre-

quent tick or pop reminding you that you were listening to a record. This improvement is attributed to the use of harder record compounds and improved lubricants in the compound, plus the experience RCA has gained in pressing these new discs. John and I had the impression that the updated Ormandy recording was still slightly down in level, and the surfaces on the disc were a bit noisy. However, we also noted that the bass had been restored almost to normal, with bass drum in several parts of the music reproduced with solidity and impact. The sound we heard from these discs was for the most part nice and clean, and this plus the improved output and less noise, made for very pleasant listening. The separation between the four channels and the "discreteness" of the pop disc were beyond cavil. The same could be said of the classical disc with the rear ambience nicely handled and obviously kept within the fusion limits of the brain.

John and I feel that RCA has most of the parameters under control. The only claim not yet fully substantiated is that RCA statement that they can cut up to 26 minutes per side: neither of the discs we listened to had more than 20 minutes per side. One fly in the ointment, which might slow up marketing plans, is the availability of the Shibata styli, which, it is said, are very difficult to grind. However, it must be noted that the people at Pickering/Stanton recently gave a demonstration of their quadraphonic cartridge, which featured a modified version of the Shibata stylus, and it worked very well indeed. In fact, to me, their cartridge had a smoother, more "open" sound than either the JVC magnetic cartridge or the Panasonic semi-conductor cartridge.

John and I concluded that on the basis of what we heard, and assuming that sufficiently rigorous quality control was exercised by RCA to maintain a consistent level of excellence, the CD-4 discrete disc is an eminently marketable item. One by one, the problems of the discrete disc seem to have been resolved. This is the big leagues, and there is a great deal of money at stake. In light of present technology and the pressure that RCA is under to make the CD-4 disc succeed, it would be surprising if the remaining problems proved insurmountable.

I had thought I would be able to bring you the rest of the story on the upgrading of automotive stereo cartridge systems, but I have run into a few minor snags that must be resolved before committing the story to paper. Bear with me 'til next month. **AE**

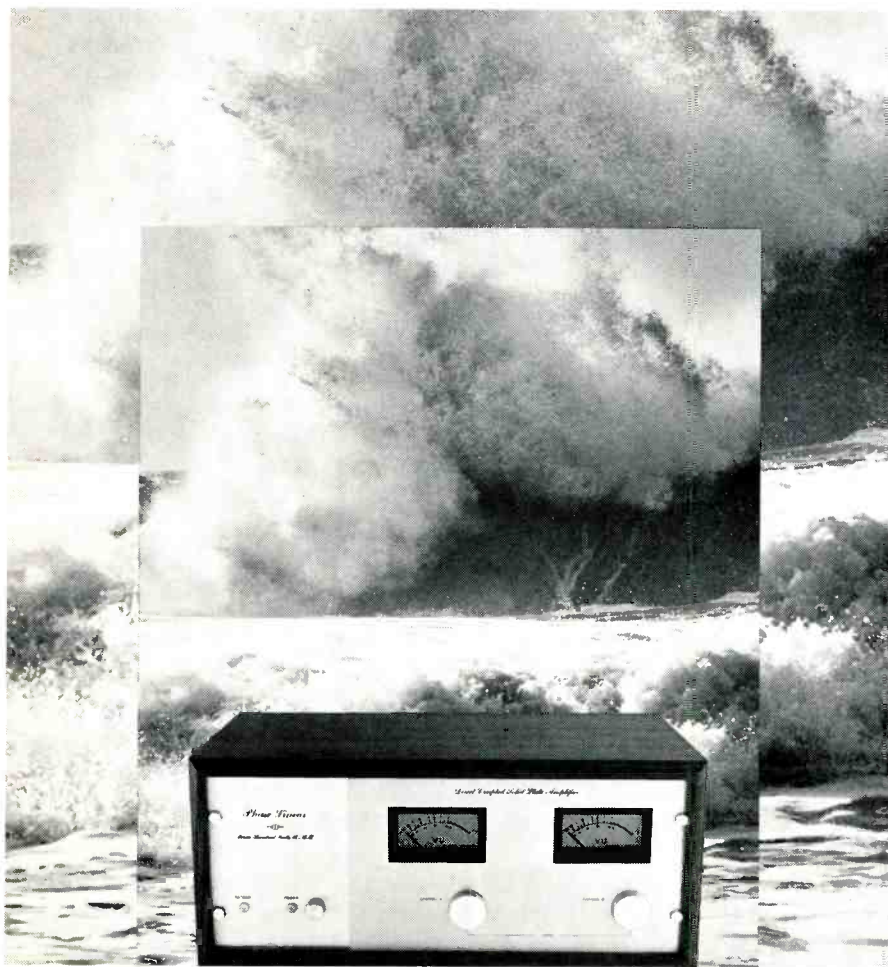

## As big as life: 700 watts RMS

Now you have the power to hear it like it was. The power to reproduce music at original volume levels with no clipping, no audible distortion during low frequency passages or musical peaks. This is what high fidelity is all about — this is the

unique and pleasurable experience of owning the Phase Linear 700. See your dealer or write us for full information. \$779.00

**Phase Linear**  
CORPORATION  
405 Howell Way, Edmonds, Wa. 98020

Check No. 12 on Reader Service Card



# Listen



## to the irresistible sound of Martin Speakers

The sound of Martin Speakers can be as quiet and irresistible as the gentle meeting of sand and surf. Or vibrant and deepthroated as the roar of thunder in the summer sky.

Martin Speakers, for people who are attuned to the irresistible sounds of the audible universe.



MARTIN SPEAKER SYSTEMS • A DIVISION OF EASTMAN SOUND MANUFACTURING CO., INC.

Harmony Road and Route 295  
Mickleton, New Jersey  
08056

Martin Speakers from \$44.50 to \$350.00

"A new standard of performance built  
by people who listen."



Check No. 13 on Reader Service Card

# TAPE COMPETITION

**T**HIS LIST was intended to be the final one in this series but tapes kept arriving by almost every mail, so we relented and yet another final list will be published next month. But this must definitely be the last one, so please hold those tapes until we announce the next competition.

First prize this time goes to *Fred Moldenhauer*, of Denver, for a series of jazz recordings—including the Queen City Jazz Band, Peanuts Hucko Quartet, Ralph Sutton Trio, and The Happy Jazz Band—all made in Denver. Sound is very clean with very natural brass definition. Mics were E-V RE-15's (for brass), 666's (for reeds), and 664's (for the rhythm section). Recorders were both Roberts—a 990 and a 720. The first was bought in 1963 and the second in 1967. Fred says he has learned to “nurse” them himself over the years—which may be the reason why he gets such good results. Incidentally, the last piece was described as “long hair stuff,” which is difficult to translate these days. As it happens, it turned out to be an innocuous piano recital.

Second prize of \$25.00 goes to *John Thomas*, of Boalsburg, Pa., for a recording made at Penn State Univ. The first selection on the tape is a performance of Stravinsky's *Suite for Small Orchestra*, and it was played by the Penn State Chamber Orchestra conducted by Douglas Miller. The second selection was Holst's *First Suite*, and this was played by the Penn State Symphonic Wind Ensemble with Smith Toulson. The last piece featured a small group and it was made in a living room. Recorders used were Revox A77's and microphones were AKG-12A's mounted as a coincident pair. These were supplemented by 202A vocal mics and 451's for guitars for the recording of the small group. Overall quality was very good with excellent stereo image (a tribute to the coincidental arrangement, which I also favor). Wind ensembles are not that easy to record, but the production of the PSSW ensemble playing Holst was very natural sounding—at least in my room.

Consolation prizes of BASF or TDK special low-noise tapes are being sent to the following, among others:

*Walton W. Dell*, of Jersey City, for a very ambitious tape using 13 tracks—or rather “over-dubs” as a mono Ampex was used to “pick up” three instruments—a piano, maracas, and foot stomping (well, Walton says three instruments).

The tape was made back in 1960, when Walton was attending American University in Washington, D.C. It seems that he was visiting a friend, who was working at a local recording studio, and they started to doodle away on the studio piano—experimenting with equalization, echo, and tape speeds, and eventually adding rhythm and so on. They were both so intrigued with the possibilities that they worked all night and best part of the next day. The final composition was called *Riff In C*, and while I agree it is debatable whether the piece is a masterpiece, the signal/noise is remarkably good in spite of all those dubs—and, of course, in 1960 there were no Dolby systems!

*Bob Katz*, of Hartford, Conn., sent in an interesting tape entitled *Divertimento For Violin and Drums*, recorded at the Hartford College radio station. The tape had to be made at night when the station was off the air because of FM radiation problems, and so the session was held from 2:00 a.m. to 11:00 a.m. by “two very tired musicians and one dreary-eyed engineer.” A Barcus-Berry pickup was used with the violin and the output was fed to a Univox equalizer-preamp. Mics were AKG D1000E's, RCA 77DX's, an E-V 635A, and a E-V 664. Recorder was a Scully 28-2, and preamps were made from a “canabalized” Ampex 601. An Ampex 351 was employed for tape delay and a DBX 117 range expander was used for the final dubbing. Bob thinks very highly of this DBX unit, which he says considerably reduced the hum from one of the tapes. As might be expected from this array of equipment, the tape was nicely recorded, with good signal/noise and balance. The stereo image was good too. I am now looking forward to testing a DBX unit which I received recently.

The next tape is entirely different; a Concert of Sacred Music from a program given in tribute to Dr. H. Alexander Matthews, a well-known organist and composer who retired early this year. The concert took place in Philadelphia's suburb of Drexel Hill at the United Methodist Church, and the organist was Edward Wetherill, who was accompanied by vocalists and two choirs. Cantatas and other works by Dr. Matthews were played. The tape was made by *Fred B. Davis* of Philadelphia, who used a Tandberg 62 and a 6021X recorders, two Synchron/Vega mics mounted on 15-foot stands, plus two Sony ECM-22's. The E-V mics were

used for the organ and choir, and the ECM-22's for the soloists. In general, the sound quality was excellent and the low organ pedal notes came over remarkably well.

*Howard Greenlee*, of Scottsdale, Arizona, sent in a recording of a caliope—a most difficult instrument to record. Howard used a Norelco Continental cassette recorder with the mics supplied (I believe they are crystal types) and then transferred the tape to a Crown 724, adding some bass and treble boost. Results were surprisingly good, although bass is somewhat attenuated.

*Daniel Premack*, of Minneapolis, Minn., is a musician as well as an engineer, and he devised his own electronic instrument, which he used to record a piece called “Ignatus,” being part of a film soundtrack. Daniel says for best results listen via a Dynaquad system, and if I wished to see the visual effects, use a 'scope. I must confess I did not use the 'scope (it was connected to some equipment on test), but I did listen to the tape using both two-channel and SQ modes. Listeners described the Premack in various terms but I thought it sounded like a cross between a Theremin and electronic bagpipes. . . . The recorder was an Ampex AX-50, and the dub was made on a Sony 230. Apparently the output was not taken directly from the instrument, as an RCA mic was employed.

*Justin Smith* is only 15, and he is very interested in mathematics and synthesis. His tape was made with Electrocomp and ARP synthesizers, Sony TC-630, 366, 110A, and 580 recorders, an Ampex 15 ips machine, two Sony MX-12 mixers, and a TEAC AN-180 Dolby unit. Mics were two RE-55 E-V's and two Sony F-26's. Justin also says he used “700 kilograms of splicing tape and several tons of Scotch 206.” He probably exaggerated a little bit. . . . Anyway the program included Bach's *Invention in D minor* and five original compositions—one entitled *Mary Had a Little Lamda*. The Bach *Invention* was recorded in two versions, one direct from the synthesizer and one from the back of the hall. Justin says he uses similar techniques to Walter Carlos—curiously enough, he writes just like Walter too! The sound was good—even better when played through an SQ decoder. Noise was low—especially when it is realized that some sections were dubbed 25 times!

# WE SPEAK SOFTLY

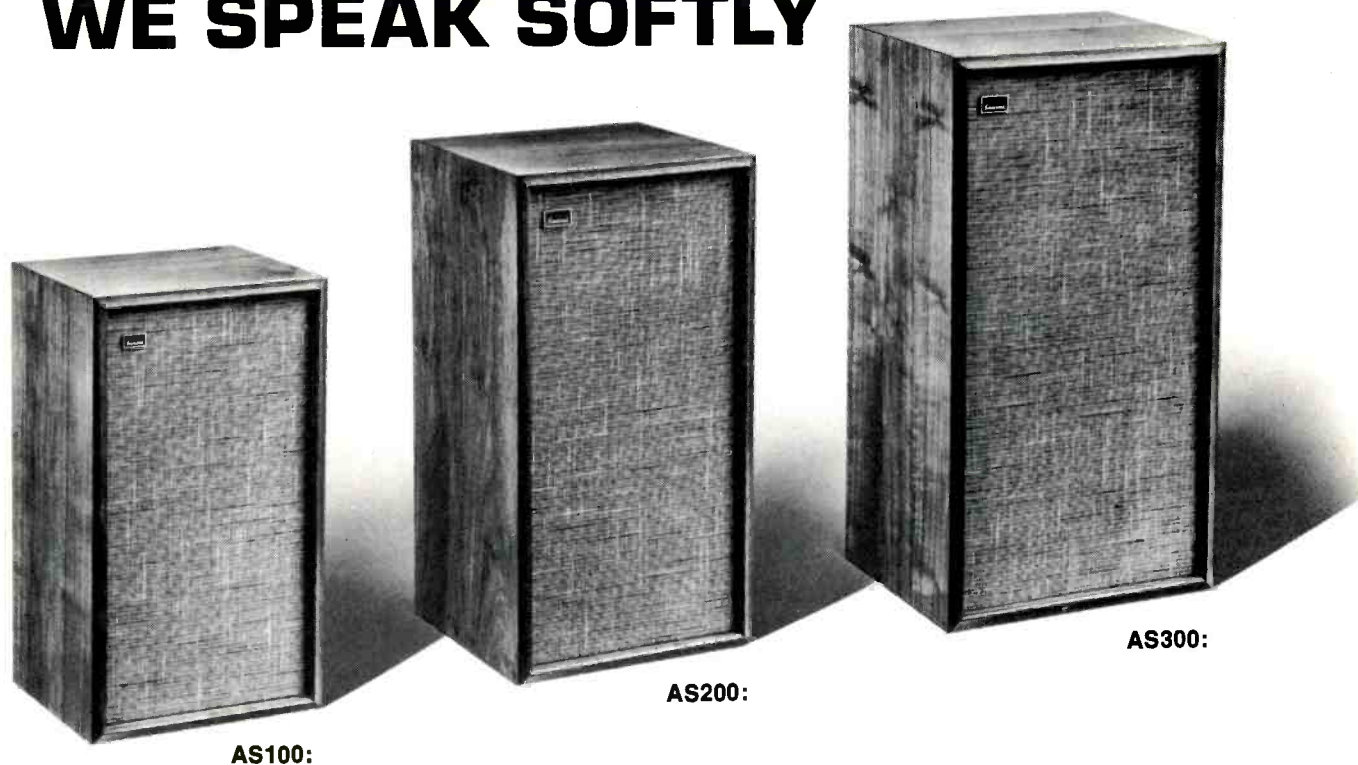

# AND CARRY A BIG SOUND

From the most delicate whisper to the thunder of a full orchestral climax, Sansui's new AS acoustic-suspension speakers reproduce the full dynamic range, distortion-free and with impartial precision.

Loud or soft—high volume setting or low—their special quality remains steadfast—and that quality will be a revelation to American ears. For the AS line was designed only after careful research into our listening preferences.

But traditional acoustic-suspension design was only the starting point. Next came new woofer cones blended of selected pulp and wool, then custom-impregnated for well-damped sound. Leakproof, mitred-joint cabinets. New wide-dispersion cone tweeters with excellent transient response. The results are lowered resonances, extended low-end response and smoother high-end performance. They add up to a new standard for reproduced sound, more natural yet more dramatic than anything you're accustomed to.

Listen to them yourself. You'll hear what we mean.

**AS100:** 2-way system with 10" woofer and 3" tweeter.  
Response: 45 to 20,000 Hz. Peak power: 40 watts. \$89.95.

**AS200:** 3-way system with 10" woofer, 6.5" midrange and 3" tweeter.  
Response: 40 to 20,000 Hz. Peak power: 50 watts. \$119.95.

**AS300:** 3-way system with 12" woofer, 6.5" midrange and 3" tweeter.  
Response 35 to 20,000 Hz. Peak power: 60 watts. \$149.95.

© COPYRIGHT 1972 BY SANSUI



## SANSUI ELECTRONICS CORP.

Woodside, New York 11377 • Gardena, California 90247  
ELECTRONIC DISTRIBUTORS (Canada), Vancouver 9. B.C.  
SANSUI ELECTRIC CO., LTD., Tokyo, Japan • Sansui Audio Europe S. A., Antwerp, Belgium

Check No. 15 on Reader Service Card

# Editor's Review



THE AES CONVENTION was held in New York's plush Waldorf-Astoria this year and the exhibition itself seemed rather less cramped in its new quarters. The usual elaborate studio equipment was on display—most of it beautifully styled with a superb finish. One large console by Rupert Neve attracted some attention because of the small sign reading "Delivery In 30 Days." In an industry where it is normal to wait for six to nine months for custom-made equipment, this is a revolution indeed! Upstairs, there were several demonstration rooms and both Sansui and CBS were showing off their respective quadraphonic systems. The former was using their new "Vario-Matrix" system I mentioned briefly in August, and CBS was using a logic system via a new Lafayette four-channel receiver. The Sansui room was crowded with studio equipment and they were emphasizing the separation characteristics of the system which they insist is *not* logic controlled. CBS was playing some of the new discs—including those made by EMI, and I am really looking forward to side-by-side A-B comparisons between the two systems—as well as with the RCA-JVC discrete. Electro-Voice was using their universal decoder with four of their new speaker systems which use a 6-in. bass unit and a slave radiator. Bass seems to be well maintained down to 40 Hz—maybe even lower. The enclosure is vented and is quite small—being less than a cubic foot. However, an equalizer is necessary to lift the response below 100 Hz or so. Bose was demonstrating their new 801 which is the performer's version of the 901. Well, not quite because all the eight speaker units are facing forward, but the equalizer is still required. The enclosures are about the same size as the 901's, but they are built into a portable case. Several can be stacked if required. Power handling capacity is quite high and the *Gramophone's* John Gilbert said it "was more than enough for English ears." JVC was demonstrating their discrete system—again emphasizing separation, and nearby DBX was showing off their professional noise-reduction unit. Some good sound was to be heard from the EPI room where some new column systems were featured—including the Microtowers which cost less than \$100.00 a pair.

## Schwann Likes

The *Schwann Record Guide*—sorry, *Record and*

*Tape Guide*—recently had a contest to find out what composers people liked least. As they put it, "music of a composer I would just as soon not hear for the next five years!" About 2200 replies were received, which astonished the Schwann people but they were even more surprised by the results—or so I would imagine. Would you believe the top 13 hates were Schoenberg, Wagner, Bruckner, Bartok, Stravinsky, Ives, Liszt, Berg, Hindemith, Webern, Mahler, Tchaikovsky, and Bach? Schoenberg, Webern, and Berg, yes—but Bach and Mahler? and Haydn, Vivaldi, Johann Strauss were not far behind on the un-preferred list either. Beethoven and Mozart collected quite a few votes too, so I am left wondering what composers *would* make the preferred list—perhaps Schwann could make another survey?

## Video-Discs

The Decca-Teldec Video-disc now has a formidable competitor in the just announced Video-disc from the Dutch Philips company. Turntable speed is 25 rpm and playing time is said to be 45 minutes for each side of a 12-in. disc. The system bears no resemblance to the Teldec as a neon-helium laser beam is used instead of a stylus. The signals are in the form of pits or microscopic indentations which modulate the laser beam. This is reflected to a photo-electric detector and converted to signals which are applied to the TV screen. The video image can be "frozen" if required but users cannot make their own discs. On the other hand, the laser disc players should be cheaper than tape units and they will have obvious applications in the industrial and educational fields.

## G-Ratings

A Japanese magazine has recently tested some of the new cassette tape recorders and I was intrigued to note that marks were awarded for "Gorgeousness." This desirable feature must be far more difficult to measure than signal-to-noise, for instance, and I was impressed with such items as recorder A having a G-rating of 61%, but recorder B made only 52%. I congratulate the engineers concerned on their perception. If they will let us into the secret, we will certainly include G-ratings in our list of specifications.

G. W. T.

# The right Pickering cartridge for your equipment is the best cartridge money can buy.



There's a "right" Pickering cartridge for every record player, and only Pickering has developed a way for you to be absolutely certain you select the "right" cartridge for your high fidelity music system.

It is a simple way for you to precisely match one of our XV-15 (100% Music Power) cartridges to whatever kind of record player you have or plan to buy. It's called Dynamic Coupling Factor—DCF for short.

We have taken virtually every record player and pre-analyzed the vital variables affecting cartridge design and those related to the engineering

features of the various turntables and changers. So, no matter what equipment you own or plan to purchase, there is a Pickering XV-15 cartridge exactly "right" for it. The DCF number enables you to select the proper Pickering XV-15 cartridge in relation to a particular type of playback equipment to achieve maximum performance.

If you're ready to buy your next cartridge, be certain you end up with the Pickering XV-15 cartridge that's best for your system. Have your Pickering high fidelity dealer show you our DCF Chart, or write Pickering & Co., Inc., Dept. , 101 Sunnyside Boulevard, Plainview, N.Y. 11803.



*"for those who can hear the difference"*

## The **100%** Music Power Cartridges

All Pickering cartridges are designed for use with *all* two and four-channel matrix derived compatible systems.

Check No. 17 on Reader Service Card

# Equalization of Sound Reinforcement Systems

Daniel Queen

**R**ECENT INTEREST in equalization of sound reinforcement systems has resulted in many terms being tossed about. Included have been broadband equalization, narrow-band equalization, notch-filters, one-third octaves, direct-to-reverberant ratio, etc.

There is much dispute now on the relative merits and effects of these various measures. Before a sound contractor decides on a particular measure, he should know exactly what that measure is capable of doing but more importantly, what it is *not* capable of doing.

The technology of using notch filters for room equalization was popularized by C. Paul Boner after studying church reinforcement systems which appeared to exhibit several sharp response modes. When these modes were removed by means of filters only a few Hertz wide, the capability of the system to provide gain before howlback was enhanced. Boner's studies showed that many of the rooms with which he worked could be improved using as many as fifty or sixty such filters. It should be noted that Boner advocated the use of such filters only after the system had been built with high quality components and after the system was broadband equalized.

Herein lies the rub: The difference between broadband equalization and notch filtering is sometimes confused. Broadband equalization is accomplished after making measurements of the room response, usually by means of third-octave filters, then correcting the response in each of these third-octave bands. The usual approach is to make the third-octave measurements at various points in the room. A noise source feeds the amplifier or microphone. The response at the various locations is averaged, then estimates are made about which are the most significant factors to be corrected.

The equalization filters used to correct the system in this process are no narrower than one-third octave. In the vicinity of 1 kHz such a filter is 200 Hz wide. In contrast, narrow-band equalization is achieved by increasing the gain of the sound reinforcement system until either ringing or howlback occurs. A notch filter is then inserted at the frequency of the ringing or howlback. Such a filter is typically about 5 Hz wide at its half-power points.

## Sources of Perturbations

Deviations from flatness in a sound reinforcement system, when in an actual room, are caused by characteristics of the room itself, of the electroacoustic components, and of the interaction between the room and the electro-acoustic components.

Every room acts somewhat like an organ pipe. For each major dimension, resonance frequencies occur at the frequency where the dimension is one-half wave length and at integral multiples thereof. Thus, a room 30 feet in length will have resonances at 15 Hz, 30 Hz, 45 Hz, etc. The other major dimensions will generate resonances at similar harmonic intervals. One can see that, as frequency increases, more of these resonance modes will occur (the "mode-density" will increase). In fact, in most rooms, the mode-density above 250 Hz is such that modes are separated by no more than 5 Hz, their Q is approximately equal, and they

are distributed evenly about the room, resulting in an essential flat amplitude vs. frequency response when excited. Only when rooms are unusually shaped or have a very uneven distribution of absorbing materials, can one expect the amplitude of any mode to exceed the average of all the modes—particularly within third-octave bands.

Thus, except at very low frequencies, the room itself contributes little to nonflatness due to individual modes. Instead the room characteristically shows greater absorption and therefore amplitude roll-off at the extreme ends of the band. The roll-off at the low end is mainly due to vibration of walls, causing sound to leave the room, and at the high end by the absorption of materials on the walls or in the room. The effect of such absorption is usually spread over a wide band, looking much like the effect of tone controls (Fig. 1).

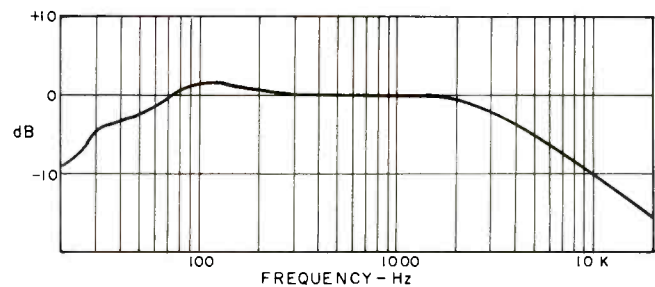

Fig. 1—The broadband steady-state response of a typical meeting hall (averaged over tenth octaves).

The equalization for it is broadband. However, an unusual effect is caused when a loudspeaker or a microphone is inserted into a room. If the loudspeaker is spaced away from a reflecting surface, it will produce a series of peaks and dips associated with the distance from the surface, as shown in Fig. 2. These peaks and dips go to a minimum when the speaker is actually put into the wall. Usually these peaks and dips are well inside the pass band of a third-octave filter and must be equalized by means of narrow-band filters.

A similar effect occurs with a microphone, the nearest reflecting surface being the floor or a lectern table top. Similarly the effect is minimized by moving the microphone close to or into the table top or if possible, close to the floor. The effect of floor reflections can be minimized by use of directional microphones provided they are truly directional in all planes (as we shall discuss later.)

## Amplifiers and Signal Processing Circuitry

The amplifiers and signal processing circuitry in a sound reinforcement system generally can be depended upon to be free of amplitude perturbations. However, care must be taken that, due to unusual tone control circuitry, etc., excessive phase shifts that could throw a system into positive feedback do not occur.

# All in the family.

In the space of a few short years, the critically acclaimed Revox A77 has established itself as the tape recorder of choice for the knowledgeable enthusiast.

Now, from the same dedicated design team that created the Revox A77 come two new meticulously engineered components, an FM tuner and a stereo amplifier, that extend performance to the limits of current technology.

Take the Revox A76 FM stereo monitor tuner. With its incredibly sensitive front end, unique dual action IF strip, specially developed discriminator circuit and two regulated power supplies, the A76 represents an entirely new approach to FM signal processing.

In fact, the Revox A76 sets new performance standards in a half dozen different categories.

But simply quoting a list of specifications, however fine, doesn't begin to describe the capabilities of this remarkable instrument.

For what distinguishes the Revox A76 from all the rest is its uncanny ability to capture the weakest signals with a clarity and a freedom from noise that is truly startling.

As for the Revox A78 stereo amplifier, it does everything a superb amplifier should do. And it does it just a little better.

Together or separately these remarkable components are a fitting addition to the Revox family and provide further proof of what we've said all along...

Revox delivers what all the rest only promise.



A76 FM  
Stereo Tuner

A77 Tape  
Recorder

A78 Stereo  
Amplifier

## Revox Corporation

155 Michael Drive, Syosset, N.Y. 11791. Calif: 3637 Cahuenga Blvd. West, Hollywood 90068. Canada: Revox Sales and Service, Montreal

Check No. 19 on Reader Service Card

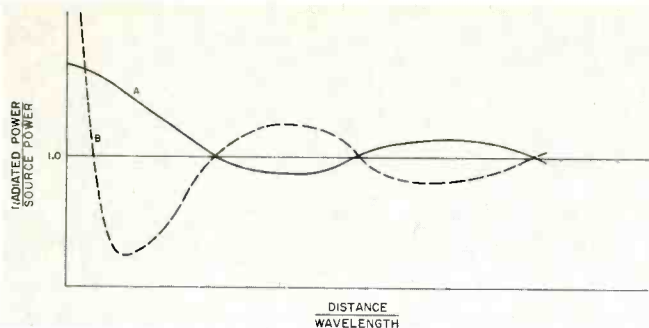

**Fig. 2**—The effect of locating a loudspeaker near a reflecting surface. Curve A is for a hard surface; curve B for an absorbent surface. For any fixed distance, the curves represent the amplitude-frequency characteristic of the radiation. The sensitivity-frequency characteristic of a microphone follows similar curves.

### Loudspeakers and Microphones

The characteristics most commonly specified for microphones and loudspeakers for sound reinforcement systems are frequency response and directivity. These should be the characteristics which would most affect the susceptibility of the system to howlback. The freer of peaks the response is, the less the chance of howlback at one of those peaks. The more directive the transducers can be, then the more direct sound from the talker and to the listener will be produced at a given gain setting of the system. Thus it would seem that a microphone specified with a flat response and with good directivity would be the best microphone to choose for the system. Unfortunately, the frequency response given with the microphone is usually the zero incidence response in a free field, that is, a non-reflective environment. If it is a directional microphone, the response at one or two other angles may be plotted. Loudspeakers are specified with the on-axis response supplemented by a polar plot of the loudspeaker at 4 or 5 frequencies. The polar plots are usually shown in two planes around the loudspeaker. This would be adequate to tell the performance if actual rooms had only the two planes measured in these response plots. Actual rooms, however, must be analyzed in three dimensions, so no single incidence or plot in a few discrete planes reveals the full performance of the transducer.

### Incident and Reflected Sound

The problem can be better appreciated through an examination of the different sound fields that exist in an actual room. The fields are defined by time and direction: 1. The sound that goes directly from the sound source to the receiver; 2. The sound that goes from the sound source to the receiver with one or two reflections, and 3. The sound that goes from the sound source to the receiver with an almost infinite number of reflections. These are called, respectively, the direct field, the early reflections, and the reverberant field (Fig. 3). In most of the literature the early reflections and the reverberant field are differentiated on the basis of the sensitivity of human hearing to the relative time of arrival of sounds. If the reflected sound is heard less than 65 milliseconds after the direct sound, the human hearing process fuses it with the direct sound. After 65 milliseconds the human hearing process hears it as an echo or a discrete sound.

Speech intelligibility is usually found in the direct sound and the early reflections. Recent studies have shown that a low ratio of direct-early to reverberant sound acts similarly to a low signal-to-noise ratio in reducing intelligibility. Con-

trariwise, musical quality is found in all fields. Thus a non-reverberant room, which sounds very good for speech, would sound dead for music.

One of the reasons for this lies in the transient characteristics of a room. The direct sound flows from the sound source to the receiver at the propagation velocity of sound in air, while dropping in amplitude 6 dB for each doubling of distance. The early reflections travel similarly, although the distance, naturally, is greater. However, the reverberant field acts like a capacitor being charged. In fact, its rate of build up is very similar to the exponential charging rate of a capacitor.

Thus the rapid transient sounds of speech will not excite the reverberant field as much as the continuous sounds of music. A room, which in combination with a loudspeaker, is found to have a direct-early to reverberant energy ratio at the center seats of 0 dB, when measured by steady state methods, may actually have a 10 dB direct-early to reverberant energy ratio for speech.

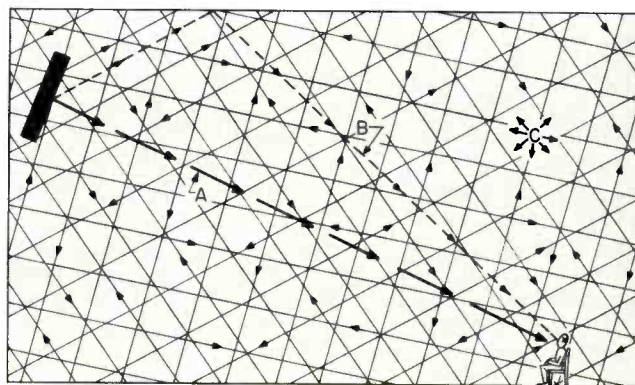

**Fig. 3**—The sound fields excited in a room by a loudspeaker. A is the direct sound; B, the early reflections, and C, the reverberant field.

Therefore, for speech intelligibility, one would be most concerned with the response of a loudspeaker and microphone in the direction that would be normally between the sound source and the receiver. This would seem in concurrence with the specification of the microphones and loudspeakers in terms of frequency response at zero incidence.

### The Acoustic Feedback Loop

However, good response in the direct field is meaningless if one cannot turn the gain up without getting howlback. Howlback occurs because, in the feedback loop shown in Fig. 4, the gain between the output of the loudspeaker and the input of the microphone becomes greater than one and in-phase at a particular frequency. If the phase and amplitude characteristics show some non-linearities, which they usually do, the system can ring without howling. It is obvious that this howlback causing path is not in the on-axis direction, since a microphone is usually not placed directly in front of and facing the loudspeaker.

### Direct-To-Reverberant Ratio

As shown in Fig. 3, the amplitude in the direct field drops in half with every doubling of distance. In contrast, when the sound source is continuous, that is steady state, the amplitude of the reverberant field is almost the same throughout the room (although peculiar shapes and unusual reflecting



# before you select a speaker look into all the Fax.

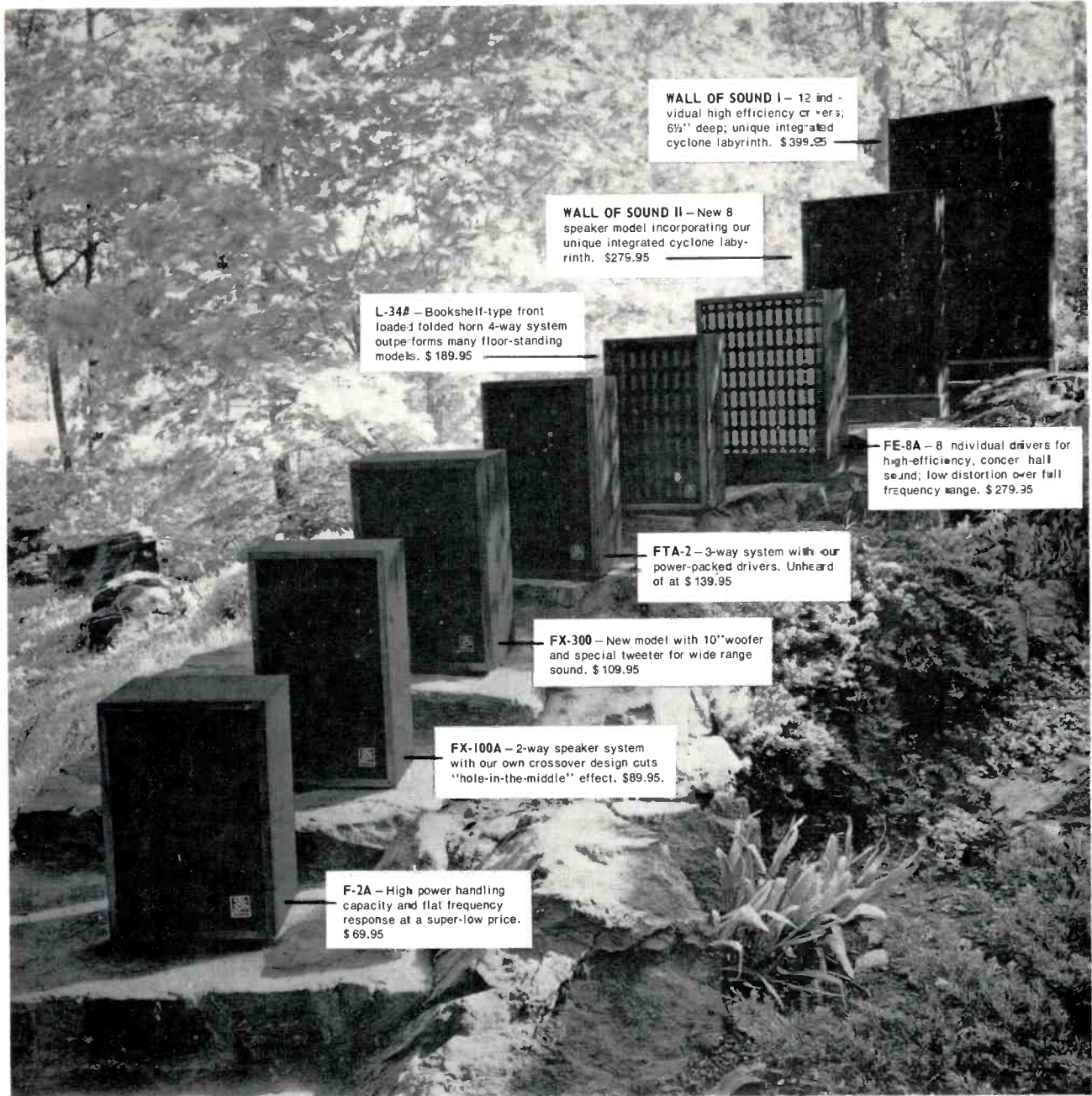

**WALL OF SOUND I** - 12 individual high efficiency drivers; 6 1/2" deep; unique integrated cyclone labyrinth. \$399.95

**WALL OF SOUND II** - New 8 speaker model incorporating our unique integrated cyclone labyrinth. \$275.95

**L-34#** - Bookshelf-type front loaded folded horn 4-way system outperforms many floor-standing models. \$189.95

**FE-8A** - 8 individual drivers for high-efficiency, concert hall sound; low distortion over full frequency range. \$279.95

**FTA-2** - 3-way system with our power-packed drivers. Unheard of at \$139.95

**FX-300** - New model with 10" woofer and special tweeter for wide range sound. \$109.95

**FX-100A** - 2-way speaker system with our own crossover design cuts "hole-in-the-middle" effect. \$89.95.

**F-2A** - High power handling capacity and flat frequency response at a super-low price. \$69.95

Model for model, we put more into them. So you get more out of them. See and hear for yourself how true pitch and zero overlap engineering are incorporated into our entire line. Check out the advanced electronics responsible for distortion-free reproduction of the widest possible range of sound. See the special sound chambers. Even bigger-and-better baffles for improved sound dispersion. You won't see the quality control testing we give every component in every speaker. But you'll hear the super-sound results.

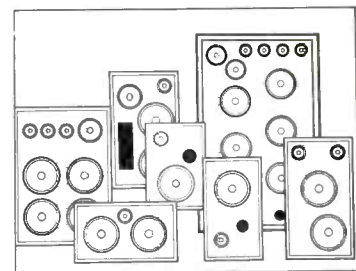

**FAIRFAX, of course.**  
the *SUPERSOUND* line

**FAIRFAX**  
INDUSTRIES INC.  
900 PASSAIC AVE. EAST NEWARK, N.J. 07029

Check No. 21 on Reader Service Card

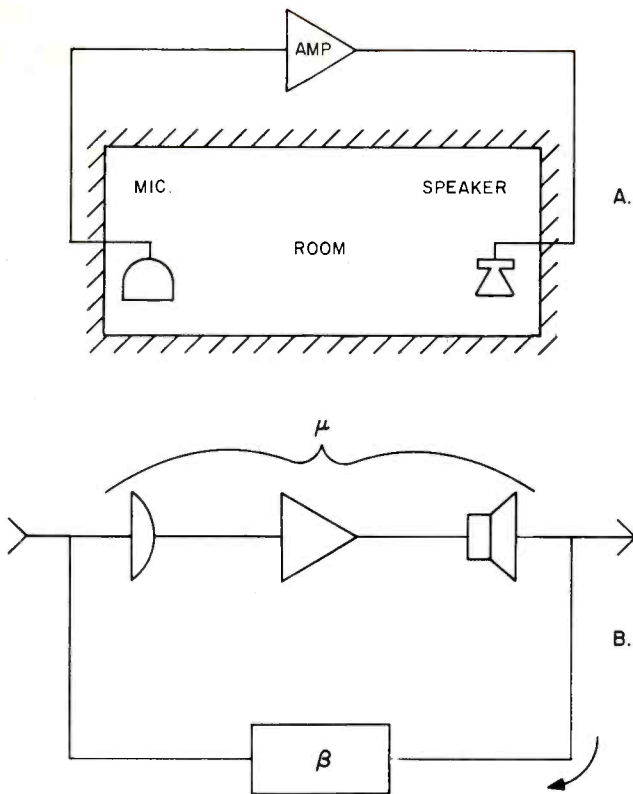

Fig. 4—Sound reinforcement system, A, and its electrical analog, B.

or absorbing surfaces can cause some variations). Thus, as one moves away from the sound source the amplitude of the direct field approaches that of the reverberant field (Fig. 5).

Where the microphone and loudspeaker are completely directional, so that the loudspeaker radiates only in a forward direction and the microphone gathers only from its front, then, if the microphone and loudspeaker are not facing each other, the only path between the microphone and loudspeaker would be the reverberant field. It would be only the peaks in the reverberant response of the room that would cause howback problems (provided we selected microphones and loudspeakers with flat response). Yet, we have shown that above about 250 Hz the room should be essentially flat (except for broadband variations). Why then is it still found necessary to use narrow-band filters? The answer can be seen by examination of the off-axis characteristics of the transducers.

### Random Incidence Versus Axial Response of Microphones

The directional patterns are commonly designed into microphones as shown in Fig. 6. Although the figure shows them in two dimensions, they actually exist in three dimensions. The omnidirectional pattern is ideally a sphere with the microphone at its center; the cardioid pattern roughly the shape of a cherry with the microphone at the stem; the bi-directional pattern, two spheres end to end with the microphone between them; and the ultra cardioid pattern roughly the shape of a cucumber with the stem projecting behind the diaphragm. Ideally, these patterns are the same at all frequencies. However, just as there are no point sources in the real world, there are no ideal patterns in actual microphones.

There are two ways to measure the response of a microphone. One is the free-field response, in which a source closely simulating a point-source is placed at a fixed angle to the microphone in a room free of reflections at a distance many times the largest dimension of the microphone. Using this method, the actual frequency-response is measured at various angles to the microphone. Thus its directivity pattern can be plotted.

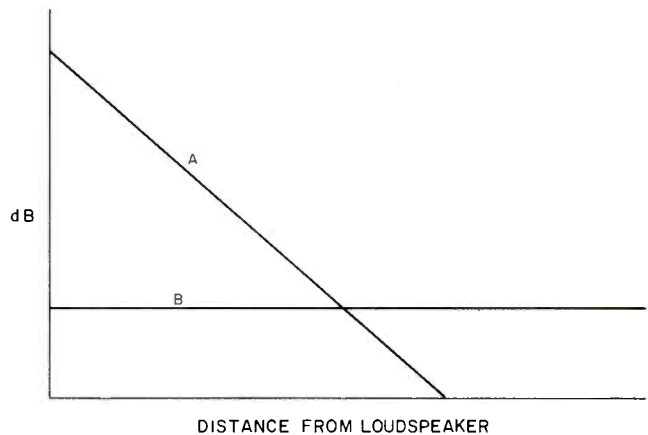

Fig. 5—The relation of sound fields to distance from the loudspeaker; A, the 6 dB loss per doubling of distance for the direct sound, and B, the reverberant field.

The second method is the random-incidence (sometimes called pressure) response. In this method the microphone is placed in a highly reverberant room at a point where it will receive very little direct sound from a source but will receive an infinite number of waves from an infinite number of angles to it. Using the random-incidence method, all the free-field responses from every angle are averaged. The difference in sensitivity level of a microphone between perpendicular incidence and random incidence is a measure of the perpendicular incidence directivity-factor of that microphone. It is obvious that a true omnidirectional microphone would have a directivity factor of 1, whereas the directivity factor of an ultra-cardioid microphone would be higher than that of the other types. However, for a microphone to respond to vibrations in the air, it must have a large enough diaphragm to absorb sufficient energy to create an electrical signal sufficiently above the thermal noise of the microphone structure to result in a useful signal-to-noise ratio.

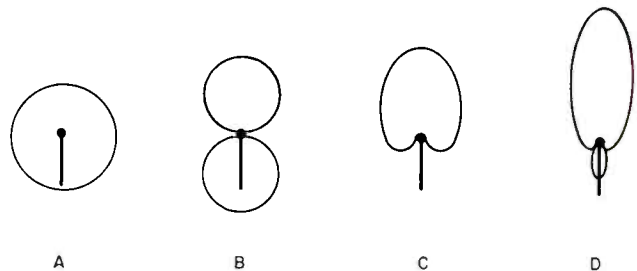

Fig. 6—Ideal microphone directivity patterns: A, nondirectional; B, bidirectional; C, cardioid, and D, super-cardioid.

# There's more behind the BOSE 901 than just a reflecting wall.

## Research

The 901 DIRECT/REFLECTING® speaker system is the result of the most intensive research program that has been conducted into the physical acoustics and psychoacoustics of loudspeaker design. The research that gave birth to the 901 in 1968 began in 1956 and continues today to explore the frontiers of sound reproduction. Copies of the Audio Engineering Society paper, 'ON THE DESIGN, MEASUREMENT AND EVALUATION OF LOUDSPEAKERS', by Dr. A. G. Bose, are available from the Bose Corp. for fifty cents.

## Technology

As might be expected, the product that emerged from 12 years of research is technologically quite different from conventional speakers. Some of the major differences are:

- 1) The use of a multiplicity of acoustically coupled full-range speakers to provide a clarity and definition of musical instrument sounds that can not, to our knowledge, be obtained with the conventional technology of woofers, tweeters, and crossovers.
- 2) The use of active equalization in combination with the multiplicity of full range speakers to provide an accuracy of musical timbre that can not, to our knowledge, be achieved with speakers alone.
- 3) The use of an optimum combination of direct and reflected sound to provide the spatial fullness characteristic of live music.
- 4) The use of a totally different frequency response criterion—flat power response instead of the conventional flat frequency response—to produce the full balance of high frequencies without the shrillness associated with conventional Hi-Fi.

## Quality Control

It's a long way from a good theoretical design to the production of speakers that provide you with all the musical benefits inherent in the design. To this end BOSE has designed a unique computer that tests speakers for parameters that are directly related to the perception of sound. There is only one such computer in existence—designed by us and used for you. In January alone it rejected 9,504 speakers that will never be used again in any BOSE product. It is the speakers that survive the computer tests that provide your enjoyment and our reputation.

## Reviews

The BOSE 901 DIRECT/REFLECTING® speaker is now the most highly reviewed speaker regardless of size or price. Read the complete text of reviewers who made these comments:\*

Julian Hirsch STEREO REVIEW.  
"... I must say that I have never heard a speaker system in my own home which could surpass, or even equal, the Bose 901 for overall 'realism' of sound."

e/e HIGH FIDELITY. "It is our opinion that this is the speaker system to own, regardless of price if one wants the ultimate in listening pleasure."

Irving Kolodin SATURDAY REVIEW.  
"After a time trial measured in months rather than weeks, this one can definitely proclaim Bose is best, big or small, high or low."

## Performance

You alone must be the judge of this. Visit your BOSE dealer. Audition the 901 with your favorite records. We make only one request. Before leaving, ask him to place the 901's directly on top of the largest and most expensive speakers he carries and then compare the sound. You will know why we make this request when you have made the experiment.

\*For reprints of the reviews circle our number on your readers service card.

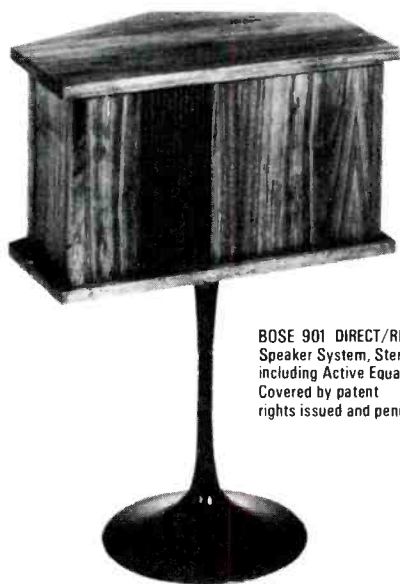

BOSE 901 DIRECT/REFLECTING®  
Speaker System, Stereo Pair,  
including Active Equalizer.  
Covered by patent  
rights issued and pending.

You can hear the difference now.

**BOSE**®

NATICK, MA. 01760

"It has not been publicized and it is little known to the general public that BOSE Corporation for many years, has been involved in the research and design of the most advanced electronic systems under contracts from NASA, the Department of Transportation and other government agencies. It has long been rumored that BOSE Corporation's top flight team of scientists and engineers has been devoting significant research to consumer electronics. We have it on reliable information that sometime this fall they will introduce their first electronic product to the consumer market—a highly sophisticated power amplifier."

Check No. 31 on Reader Service Card

Therefore, most omnidirectional microphones have diaphragms with diameters in the order of an inch. Figure 7 shows that when a wave having a length close to that of the diameter of the diaphragm falls on the front of the diaphragm it will respond the same as a wave having a length much larger than the diaphragm. However, if the wave comes in parallel

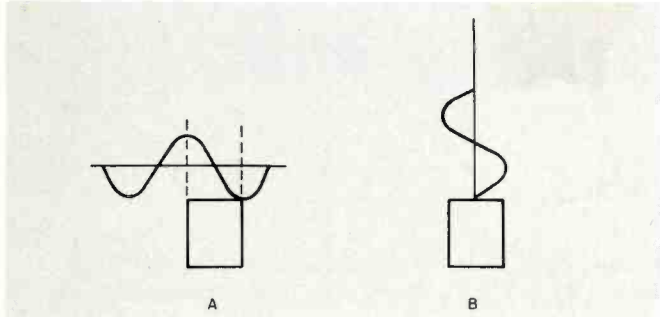

**Fig. 7**—A, a wave striking a microphone diaphragm with parallel ( $90^\circ$ ) incidence; B, a wave striking the same diaphragm with perpendicular ( $0^\circ$ ) incidence. In case A, simplified for illustration, the diaphragm sees equal negative and positive pressure, causing a null. However, in case B, the perpendicular incidence, the diaphragm sees only the wavefront, so no null occurs at any wavelength.

to the diaphragm, it will tend to cancel itself out as it passes over the diaphragm. Thus, a microphone which is designed to be flat on-axis actually must have a hole in its response off-axis. If, on the other hand, it is designed to be flat in its random-incidence response, it will have a peak somewhere around 5 kHz on-axis. In one case, the microphone can be seen to have a non-flat response in the reverberant field, aggravating the howlback; in the other, the direct-early sound will be peaked and raspy.

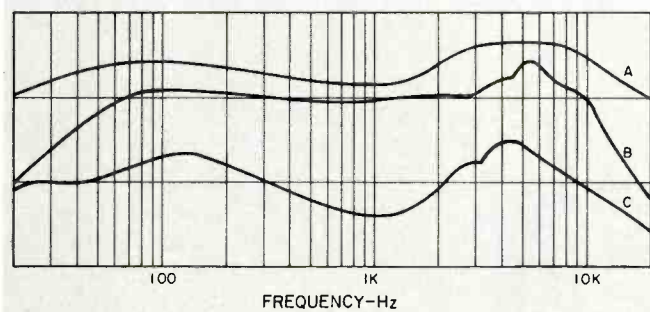
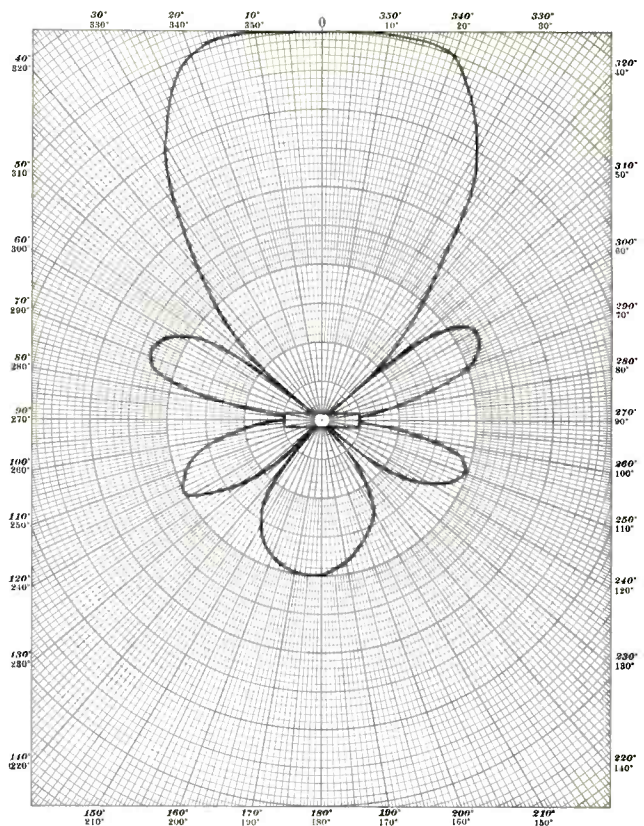

**Fig. 8**—Sensitivity-frequency characteristics of a cardioid microphone. A, random noise incidence; B, on-axis ( $0^\circ$ ) incidence, and C, rear axis ( $180^\circ$ ) incidence.

Figure 8 shows the response of a typical, high-quality cardioid microphone. The on-axis response is shown to be very flat. The off-axis response at  $180^\circ$  shows some variations including peaks near 200 Hz. It is this off-axis characteristic which distorts the response in the reverberant field. It is possible, in fact, that the peak in the off-axis response of a directional microphone can be sufficient to put the loudspeaker into the direct field of the microphone, that is at that frequency, the signal directly from the loudspeaker can be louder than the signal that flows to the microphone from the loudspeaker through the reverberant field.

### Loudspeakers

The directivity patterns of loudspeakers are even more subject to this type of inconsistency in directional pattern. Because loudspeakers need radiating surfaces which are large

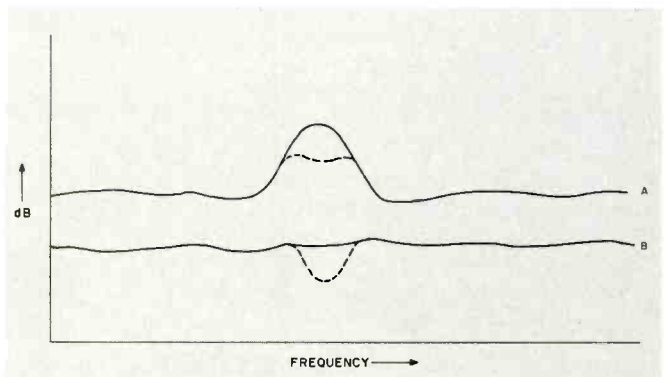

**Fig. 9**—Polar plot of loudspeaker radiation at one frequency on one plane.

compared to the shorter wave-lengths they must radiate, their radiation can be made consistent only by approximate methods. Thus every loudspeaker, even if its individual elements are nearly ideal, has many finite lobes as shown in Fig. 9.

### Equalization for Defects

The peaks, which cause howlback at a lower gain than could be accomplished with ideal transducers, can be reduced with narrow band filters—but care must be used when doing so. Figure 10 shows the effect of a 10 Hz filter on a peak 30 Hz wide. Since the filter is placed in the signal processing circuitry of the sound system it also affects the direct sound that is delivered to the listener. The audible effect of the 10 Hz filter is very small and would probably not change the sound heard by the listener. Figure 11 shows the result of adding additional filters to reduce the peak even more.



**Fig. 10**—Effect of a 10 Hz wide notch filter on A, reverberant field, and B, direct-early sound field.

# AKAI



**YOU BET!**



**Reel-to-Reel  
and Cassette ...  
AKAI eliminates  
the choice ...  
You get them both  
in the exciting new  
GX-1900D  
stereo tape recorder.**

It's a sound combination!

AKAI's remarkable GX-1900D Stereo Tape Recorder combines reel-to-reel and cassette in the same unit. With full record and playback capability.

What's more, an exclusive AKAI feature permits Both-Way Transfer between reel and cassette. So you'll have all the advantages of two complete recorders.

The GX-1900D is superbly engineered with 4 heads—Hysteresis Synchronous Motor—Tape Speed Equalizer—Automatic Stop and Shut-off—Fause Lever with Start Button. And the cassette unit is built with AKAI's GX (glass and crystal ferrite) Head. To provide you with sound quality paralleling that of the finest open reel recorders.

So you can stop trying to decide between reel and cassette. Get them both in the AKAI GX-1900D. At your AKAI dealer.

## AKAI™

**THE SWITCH  
IS ON  
TO AKAI**

AKAI America, Ltd. / P. C. Box 55055 - Los Angeles, California 90055

For your nearest AKAI dealer call 800-243-6000 Toll Free. In Connecticut, 1-800-882-6500.

In Canada: Pro-Sound Distributors, Ltd., Vancouver, B. C. In Mexico: Mexico International Imports, S.A., Apartado Postal 66-672, Mexico 12, D. F.

Check No. 25 on Reader Service Card

As these additional filters are added, a hole begins to develop in the direct field response causing deterioration in the quality of the sound at the listener. It is for this reason, among others, that acousticians strongly warn against beginning narrow band equalization until one has carefully chosen and carefully installed the best transducers.

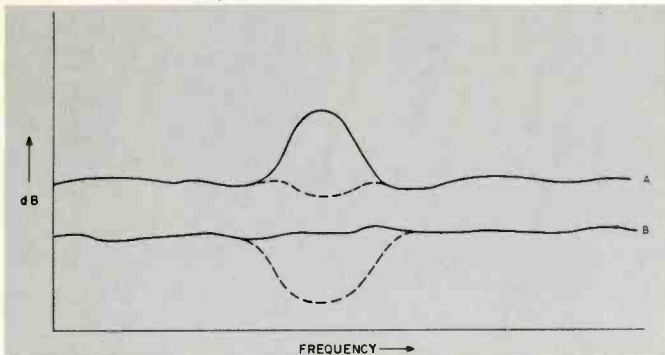

Fig. 11—Effect of additional filters on A, reverberant field, and B, direct-early sound field.

### Directivity Pattern Defects

As with microphone response, the response of loudspeakers can be measured in two ways. A test microphone may read the response from different angles to the loudspeaker in a free field. Similarly, the loudspeaker may be used to excite a reverberant room with a microphone placed so it picks up the reverberant field without receiving the direct field of the loudspeaker. The first method measures the free field response of the loudspeaker. The second measures the reverberant or power response of the loudspeaker. The power response is the characteristic that excites the reverberant field in an actual hall. Frequently, due to the lobes in the loudspeaker polar response or due to problems in the placement of the loudspeaker in the room, the power response of the speaker is very different from the direct field response. If, when measuring the response of a sound system preparatory to broadband equalization, the microphone is placed in the reverberant field of the loudspeaker and equalization is applied, the direct field of the loudspeaker may be severely distorted affecting the quality of the sound. (Fig. 12).

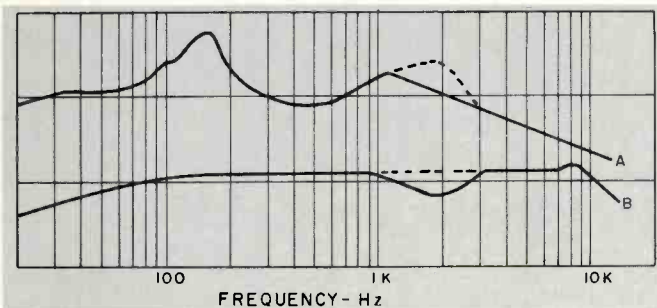

Fig. 12—Possible effect of equalization of the direct-early sound field (B) on the reverberant field (A).

If, on the same loudspeaker, the microphone is placed close to the loudspeaker, in the direct field, then the reverberant field may be distorted to such a degree as to aggravate the howlback of the system (Fig. 13).

### Effectiveness of Equalization

Thus, it can be seen that a system with severe transducer problems, that is, a substantial difference between the free field and reverberant field responses of the transducers cannot successfully be equalized unless that equalization can be applied separately to the reverberant and direct fields—a condition which is rarely practical and is difficult to achieve.

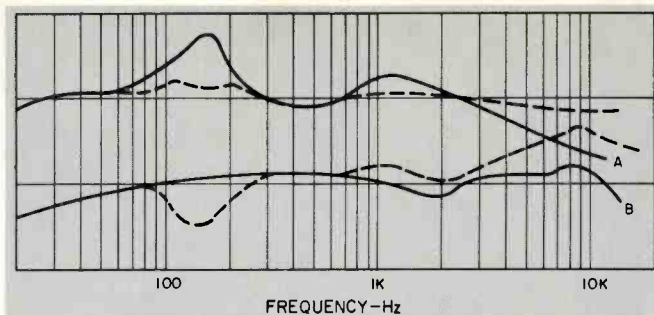

Fig. 13—Possible effect of equalization of the reverberant field (A) on the direct-early sound field (B).

To produce a system capable of high gain before howlback, the sound system designer must first obtain representative off-axis response curves for his transducers and compare these with the reverberant field and with the on-axis response. He must be sure that the combination of microphone and loudspeakers he chooses will not cause severe peaking in the reverberant field.

Secondly, the designer must take care in the placement of his microphones and loudspeakers so that he does not cause peaking due to reflective surfaces. He may then proceed to broadband equalization.

Broadband equalization may be achieved by placing the system microphone in the direct field of the loudspeaker, that is, close enough to the loudspeaker so that it will be mainly direct sound that is measured. Third-octave or broader filters are then inserted to flatten the response curve. Note that because the high frequency response in the reverberant field usually falls off as in Fig. 1, flattening the response with a microphone in this field will cause high frequency emphasis in the direct field resulting in a raspy sibilant sound.

Having thus flattened the direct field of the sound system, the system gain should be increased until howlback occurs. Narrow-band notch-filters are then inserted to reduce the susceptibility to howlback. Such filters should be inserted until they begin to reoccur around the same frequencies. At this point the designer should go back to the direct field and see that his broadband equalization has not been distorted by the insertion of excessive narrow-band filters.

### Conclusion

Sound system equalization should only be used as a last step in the design of a sound system and should never be used when care has not been taken in the selection and placement of loudspeakers and microphones. For speech reinforcement an effort should be made to place the direct sound of the talker at the ears of the listener. To accomplish this, microphones and loudspeakers should be as directional as possible, provided their off-axis response is as uniform as their on-axis response. If this is achieved, the improvement in gain before howlback achievable with directional loudspeakers and microphones will be proportional to the directivity factors of the loudspeakers and microphones. Improvements of gain in excess of 20 dB over systems commonly in use can be achieved by proper selection and placement of loudspeakers and microphones. The next step, the process of equalization, can achieve additional gains in the order of 6 to 15 dB.

### References

1. C. P. Boner and C. R. Boner, "A Procedure for Controlling Room-Ring Modes and Feedback Modes in Sound Systems with Narrow-Band Filters," *J. Audio Eng. Soc.*, Vol. 13, No. 4 (1965).
2. C. P. Boner and R. E. Boner, "The Gain of a Sound System," *J. Audio Eng. Soc.*, Vol. 17, No. 2 (1969).



it really comes alive...

and it's under \$100...

True to the Bozak Tradition of "best in its class", our new **Sonora** (Model B-201) delivers dramatically clean sound at far higher levels than other speakers under \$100 — and many costlier ones.

The secret of **Sonora** is our unique 8-inch Bass/Midrange driver. Its aluminum diaphragm radiates a solid, true-pitch Bass and a transparent, breakup-free Midrange, while serving as a heat-sink for the voice coil. As a result, it can easily handle the output of any amplifier up to 60 Watts RMS rating, with freedom from overloading.

**Sonora** is a two-way system, with an LC Crossover linking the 8-inch driver with a single-section of B-200Y, the tried-and-true Treble Speaker used in all Bozak systems.

The enclosure is a sturdy, resonance-free tightly-sealed box of  $\frac{3}{4}$ -inch compacted-wood material, covered with walnut-grain vinyl.

Be it rock or traditional, in stereo or quad, Music Really Comes Alive with **Sonora!**

Hear them at your Bozak Dealer's.

11 $\frac{3}{4}$ " x 20 $\frac{1}{4}$ " x 10" deep;  
walnut-grain vinyl.  
8 Ohms; 12.5 to 60 Watts RMS.



Bozak, Darien, Connecticut 06820 / Overseas Export by Elpa Marketing Industries, Inc. / New Hyde Park, New York 11040, USA

Check No. 27 on Reader Service Card

# the trials and tribulations of the novice kit-builder

Leonard Feldman

**I**N THE COURSE of testing and reviewing various high-fidelity products for AUDIO Magazine over the past several years I have, from time to time, had to review various electronic products which are offered to the consumer in kit form. I've watched as construction manuals of various manufacturers have become increasingly "easy to follow" and as recently as two years ago I would have stated positively that kit-building manuals had reached a level of perfection such that even an unschooled chimpanzee could, "in just two evenings of spare time," assemble a stereo receiver using only "simple tools such as a screwdriver, cutters, long-nose pliers and a low-wattage soldering iron." I would have taken this position, that is,—until I got involved in offering a kit product to the general public myself!

The kit product that I offered was, from my point of view, as uncomplicated as could be. There was only one printed circuit board to worry about, some 20 or so resistors and an equal number of capacitors, a few transistors and an IC, some coils, parts for a power supply, a single chassis plate for mounting everything, and a plastic cabinet. I wrote a detailed, 8-page construction manual, replete with "helpful hints," line drawings, check lists, step-by-step instructions and (for the more technical user) a schematic of the finished product. After all, I had the benefit of having read many "professional" kit-manuals in the course of my work and could borrow the tried-and-tested techniques of the best of them! I started to ship my kits with justifiable pride, offering to help "trouble shoot" any unsuccessful efforts for a flat \$5.00 fee. Since then, I had the deflating opportunity to examine about 100 "unsuccessful efforts"—and I've rewritten the manual no less than three times! Now admittedly, in any true "cross section of the buying public" I knew I'd find a few weird interpretations—but some of the fiascos that were returned to us are worth describing, not so much for the amusement of the experienced kit-builder (though we'll admit that we very often were doubled up in laughter), but for the forewarning of the neophyte who is about to take "the plunge."

## The Parts List versus Taking Your Chances

Most kit manuals start out by stressing the importance of opening up every package of parts and comparing the contents with the accompanying parts list. True, really elaborate kits usually subdivide the contents into individual envelopes or packages, but even the contents of one of these individual packages can resemble the panic-producing melange shown in the photo of Fig. 1. If I were a kit builder embarking upon a first project, I'd rather skip the parts list check and take my chances on everything being there when I need it—still neatly packaged. I haven't run into a missing part for years, and if this misfortune should befall me in the future, I'll write to the manufacturer who would, I am sure, promptly make up the shortage. I find this approach much more practical than the piles of parts laid out on a workbench or table, especially since many electronic and hardware parts seem to be equipped with miniature motors which invariably propel them to the floor and don't shut off till the parts have rolled into a dark corner or under an immobile piece of furniture. The only caution I would offer is that you *not* throw away the shipping carton until

all parts have been used up—as there may be one last envelope hidden amidst the packing material.

## Timing Estimates

Some kit producers insist upon providing the kit builder with an estimate of the time required to put together their product. Obviously, the intent is to sell kits by assuring the potential customer that he is not in for an endless task and I'm sure that in each such factory there is one (or more) technician who has the job of putting together a kit at breakneck speed so that the advertising agency can vociferously proclaim, "... build it in just one evening!" I've run into kits that would have to be transported to northern Greenland in the dead of winter to meet that requirement! Awake, kit manufacturers! DON'T start out by intimidating your potential customers. They're going to try to equal or beat your time estimate and in doing so, you'll find yourself with more kits improperly wired or incomplete and your trouble-shooting staff will soon be larger than your instruction manual writing staff! Awake, kit builder! The finished product you're trying to complete will probably give you good service for years to come—don't push it!

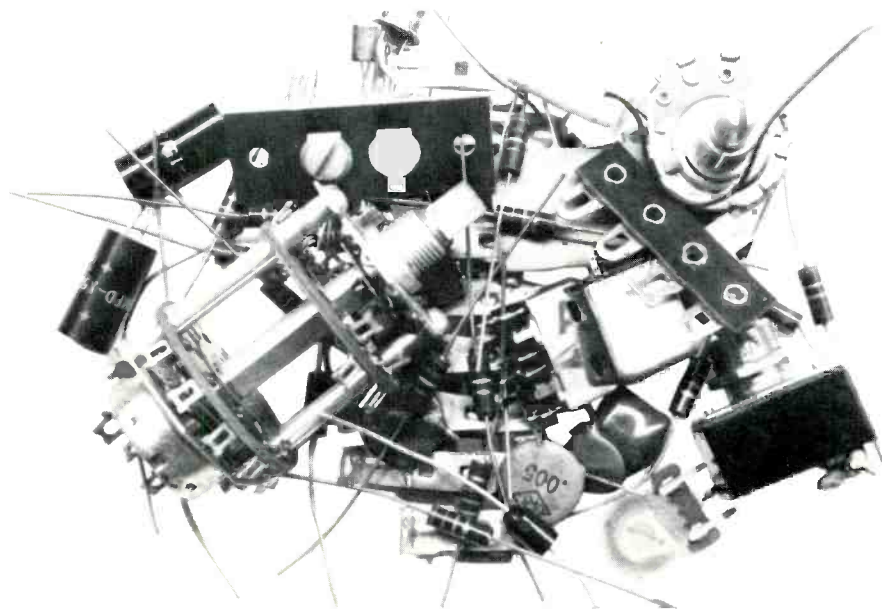

Fig. 1—HELP! Where do I begin?





TEAC AN-80 Dolby noise reduction unit

# TEAC 3300: the strong, silent type

If you've been shopping the field for a semi-pro deck with studio-size reels, you've probably had to cut your way through a lot of noise about silence. And you've probably wondered why you haven't heard TEAC blowing its horn on the subject. The answer is simple—we didn't feel we had to. Long before the dawning of Dolby,\* TEAC perfected the kind of electronics that lets you use the most advanced low-noise/high-output tapes on decks like the 3300 with startling results. We effectively reduced tape noise and hiss below audible levels. And let Dolby take it from there. But we wanted to keep the 3300 a truly versatile semi-pro deck for the audiophile. So instead of building Dolby in, we outboarded it, as you can see—in the AN-80 Dolby Noise-Reduction Unit. Now you could get better signal-to-noise than was dreamed of in your ratio. Not only on your 3300 but on any other existing deck.

At the same time, we addressed ourselves to making the 3300 transport (already world-renowned for its superlative quality and unmatched reliability) a near-perfect mechanism. By manufacturing all critical components in-house—and to specs and tolerances we wouldn't dare impose on anyone else. By quality control tantamount to paranoia—for example, we adjust, check, and readjust our heads as many as 17 times during manufacture. Over and above this, we provide audiophile conveniences overlooked on other decks. Like a bias-level switch that lets you select the proper bias for your tape. And the famous Edi-Q symmetrical control that allows smooth one-hand operation in editing and cueing. Two full-size VU meters with wide-excursion, expanded scales. Now would you really expect a machine as strong as all this to be anything but silent?

## TEAC®

Check No. 29 on Reader Service Card

\*Dolby is a trademark of Dolby Laboratories, Inc.

# AURALINEAR SPEAKERS

## NEW from CROWN

Introducing the first speakers worthy of the Crown name — Auralinear Speaker Systems. Four models of unique electrostatics that are as far ahead of ordinary speakers as the DC 300 was ahead of all other amplifiers when it was introduced.

The electrostatic design has potential for the finest response and lowest distortion, but previous electrostatic speakers suffered from three major weaknesses: (1) inability to deliver realistic sound pressure levels, especially at low frequencies (2) fragile, unreliable elements (3) poor dispersion.

All of these problems have now been beautifully resolved in the Crown Auralinear Speaker Systems, by uniting radically new extended-range electrostatic radiators with special acoustic suspension woofers. One result is accurate reproduction of clear, high frequencies with none of the crackling, frying sounds that characterize many of today's electrostatics. We call it honest sound.

For the location of your local Auralinear dealer, write Crown, Box 1000, Elkhart, Indiana, 46514.

model  
ES-224

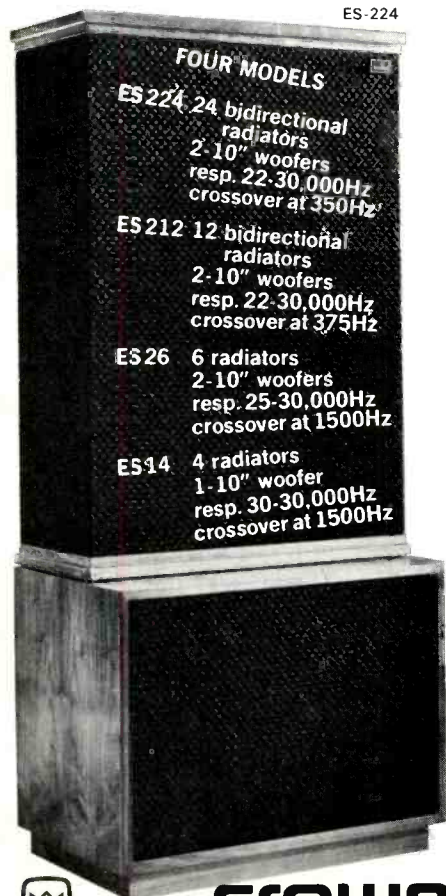

Check No. 22 on Reader Service Card

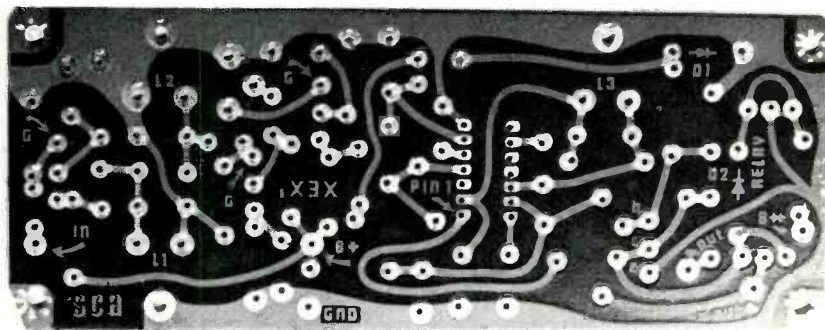

Fig. 2—The soldering side of a p.c. board.

### “Only a Few Simple Household Tools . . .”

Many kit manuals approach the subject of a soldering iron apologetically. The presumption, I suppose, is that most “households” are not normally equipped with a proper soldering iron for kit building. They therefore try to imply that a single 35 or 45 watt iron is all you need. Some even imply that a “soldering gun” can successfully be used for the multiple kinds of soldering required to put most kits together. Nothing could be further from the truth. The very way in which a “gun” works will *destroy* the fragile copper patterns of a printed circuit board.

Heavier, chisel-shaped tips should be used for soldering directly-wired connections, such as wires to terminal strips, wires to socket terminals, etc. If there is any “chassis grounding” to be done (soldering of electrolytic capacitor mounting tabs to chassis, etc.), an even larger tip may be required and, in some cases, a higher wattage iron may be required (65 to 90 watts).

Before we leave the subject of soldering as related to printed circuits, we must tell you about one of the kits that was returned to us about a year ago. Upon opening the carefully packed unit, we discovered, to our utter shock and disbelief, that the novice kit builder had

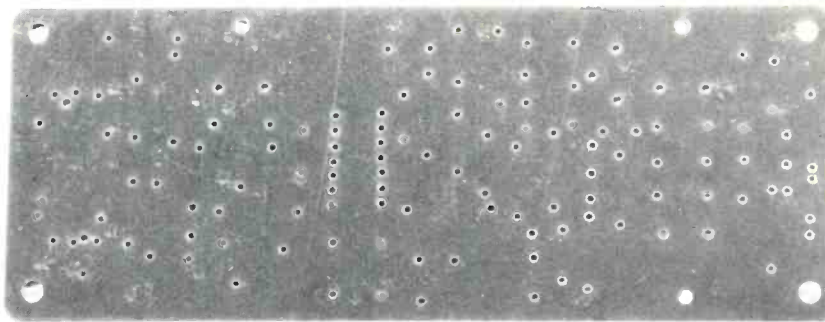

Fig. 3—The parts-insertion side of the same p.c. board.

Proper soldering of components on a printed circuit board involves the speedy but concentrated application of heat to the junction between the copper pattern and the component lead end emerging from the printed circuit board hole. A gun cools off quickly and reheats so slowly when the trigger is pulled that you end up holding the oversize “business end” of the gun against the printed circuit board for an agonizing length of time—often just long enough to separate the copper pattern from the base material of the board itself. We have found that a single, pencil-tip iron *can* do the entire soldering job for kits, *providing* you have more than one tip for it. Soldering of p.c. boards should be done using a pointed tip which flares to a diameter no greater than 1/8 inch.

inserted *every single part* in the p.c. board from the *wrong side*. That is, resistors, capacitors, transistors and IC's were all sitting nicely on the *copper pattern* side of the board. With all due respect to this kit-builder, we must say in his defense that he had somehow managed to *solder* every part from that side, by leaving a bit of exposed lead above each hole entry point. Needless to say, the board had to be scrapped. We offered to replace the board and all associated parts at our cost, but I suspect the customer was too embarrassed to accept our offer and may, to this day, be carefully unsoldering each part and installing it from the correct side. The story may sound incredible, but when you stop to think about it, some manufacturers show board layouts as viewed

from the copper side of the board, while others show layouts from the component side, with an X-ray view of the copper below, for purposes of "clarification." Make sure you understand the presentation in your kit manual before you start or it could happen to you. The really funny thing about this catastrophe is the fact that if we were dealing with passive parts alone (resistors, capacitors, coils, etc.), the board might actually have worked, but since there were three-lead transistors and an IC involved, "bases" quickly became "collectors" in the mirror-image situation that resulted. Without belaboring the point, Figs. 2 and 3 show the P.C. board involved and parts are normally inserted with the Fig. 3 view facing you.

The list of tools usually recommended besides the controversial soldering iron consists of a screwdriver, cutting pliers, needle nose pliers (sometimes called "long nosed pliers"), and a ruler (for measuring prescribed wire lengths). It usually comes as somewhat of a shock to discover that most household screwdrivers have blades which are far too thick and broad to get into the slots of the miniature screws which usually accompany most kits. Often, Phillips-head screws are supplied, and these usually stop the kit-builder dead in his tracks. I have found myself using no fewer than four different sizes and types of screwdrivers in building the average kit and having a variety of types and sizes on hand is a great convenience. I find, too, that the tool which I use more than any single screwdriver is one which is hardly ever mentioned—the "nut driver" (also popularly known by its trade name of Spin-tite). This handy gadget (shown in Fig. 4) does for a nut what a screwdriver does for a screw. In mounting parts using machine screws and nuts, it is far easier to hold the screw stationary (with the blade of the screwdriver) while turning the nut with the nut driver than to rotate the screw with the screwdriver while trying to hold the nut stationary with oversize finger tips that never can get into the tight places required. A 1/4 inch and a 5/16 inch nut driver will cover most requirements, both dimensions referring to the distance between the parallel "flat" sides of the nut in question.

Although much of the work of kit building has been reduced to insertion of parts into p.c. boards, there still remain a goodly number of loose wires that are used to interconnect from one p.c. board to another or for interwiring of such sections as power supply, power output stages in an audio amplifier, and other sections which do not

## Stanton Quality is a very special quality... in all 6 headsets.



Stanton headsets — all of them — are designed just like a fine loud-speaker system for your head. Yet there are many different models because we know there are many needs and tastes to satisfy.

Although there is a great variety of features and price ranges, two things are constant in all Stanton headsets — their exciting "presence" and their equally exciting sense of styling that makes them the handsomest headsets a head ever wore.

At the top of the Stanton Dynaphase dynamic headset line, our brand new Dynaphase Seventy-Five (\$74.95) reigns supreme. It employs a true two-way system (separate woofer and tweeter) and an L-C crossover network in each earpiece, plus a remote control station for volume and tone adjustment, as well as stereo and mono mode selection.

This same exceptional system is offered in the Stanton Dynaphase Model Sixty (\$59.95) without remote control station. You can always add this unit as an accessory (Model 5741, \$19.95) at a later date.

Three other Dynaphase models feature a special high-performance, Stanton wide-range single-speaker system at a popular price — Model Forty and Model Forty 600 ohm and Model Fifty with balance level controls on each earpiece (\$49.95).

And for the most discriminating audiophile, we offer the incomparable Stanton Isophase Electrostatic Headset (\$159.95) complete with Polarizer unit.

See your Stanton franchised dealer or write Stanton Magnetics, Inc., Terminal Drive, Plainview, L. I., N. Y. 11803.

Check No. 23 on Reader Service Card





Fig. 4—A nutdriver used *with* a screwdriver helps assembly of hard-to-get-at screws and nuts.

lend themselves readily to p.c. board layout. What kit builder has not dreaded the familiar phrase, “strip  $\frac{3}{8}$  in. insulation from each end of a 12 in. piece of wire”? I must confess that I have been “stripping the ends” of wires with cutting pliers for nigh on to 20 years and every now and again, the wire in question becomes, successively,  $1\frac{1}{8}$  in.,  $1\frac{1}{4}$  in.,  $1\frac{3}{8}$  in.,  $1\frac{1}{2}$  in., etc. as the sharp tips of the cutting pliers bite into the wire itself instead of just “stripping the insulation.” A \$1.98 solution to this problem is shown in Fig. 5. It’s called (as you might have guessed) a wire stripper, and while there are varieties of this product that sell for several dollars, the type shown not only strips all sizes of wire you are likely to use (it’s adjustable), but it doubles as a wire cutter too. About the only time I find I need cutting pliers now is for trimming the component leads of parts I have inserted into p.c. boards, where the pointed

step instructions. Results have varied from the relatively mild punishment of having to unsolder several well-soldered connections (to insert additional parts that were destined to go to the same terminal) all the way to having to unwire and remove a 12-lead power transformer because I just couldn’t squeeze a fuseholder past its bulky mass to mount it on the back chassis flange. Let’s face it, friends, despite fragmentary evidence to the contrary, most kit products have actually been assembled by their designers at some time or other and the printed assembly and wiring manuals are an outgrowth of that experience.

#### “Now for Alignment and Test . . .”

There is nothing quite so sad as completing a high fidelity component kit, checking all connections, turning it on, obtaining what seems like satis-



Fig. 5—A handy tool for stripping and cutting hook-up wire and reducing kit-building frustrations.

tip of the cutting pliers lets me get in close enough to cut off excess lead lengths so they don’t “spill over” to adjacent copper patterns.

#### “Never Skip Ahead Of The Instructions . . .”

Here, at last, is the one admonition given by kit-manual writers with which I must fully concur. I must confess that I too have been guilty of the cardinal sin of kit building—jumping ahead of the given order of step-by-

factory performance and then proceeding to louse things up by second-guessing the alignment and test procedure. (Actually, I suppose an even sadder result is turning it on and having *nothing* happen at all. No, in the last analysis, I guess the most tragic event is turning it on and having something happen that isn’t supposed to happen—like smoke pouring forth from the innards, or fuses blowing—or—well, let’s not even pursue this any further . . .)

#### “It Doesn’t Look Factory Wired . . .”

Unless you want to invest thousands of dollars in automatic wave-soldering units, automatic terminal connecting machines, riveting and eyeleting machines, solderless terminal connecting machines, tension wire-wrap machines, and the like, don’t be surprised if your “end product” still looks a bit crude compared to the “factory wired” job. The somewhat archaic methods of wiring and assembling detailed in kit-manuals persist not because kit-designers are oblivious to manufacturing progress, but rather in recognition of the limitations imposed by the needs of the “home builder” who is not expected to “capitalize” his kit building endeavors to the degree that a manufacturer might.

Happily, most kits today can be aligned with *no* test equipment at all. If that’s the case, go to it, treating each successive step as if it were still part of the assembly and wiring process. If a voltmeter or ohmmeter *is* required, don’t proceed without one. If scopes and generators are required, don’t try to bypass their use—even if it means taking your finished masterpiece to a friend who has such equipment. To salvage your “pride of having done it yourself” (one of the main selling features of kits), perhaps he’s a good enough friend to let *you* do the test and alignment, albeit with *his* equipment. If he insists on being the “engineer,” that’s still better than the thought of destroying your “one evening’s work” (or one week’s work, or one month’s work) over a few minutes of checking and testing.

At the risk of further intimidating the faint-hearted (an outcome hardly initially planned for this otherwise helpful treatise), I’d like to conclude by quoting a paragraph from the section of my most recently acquired kit-manual entitled:

#### “In Case of Difficulty”

After dealing with a host of troubleshooting hints, measurements that can be made and areas that can be visually checked and re-checked, the section concludes (as do I) with this immortal thought:

*NOTE: In an extreme case, where you are unable to resolve a difficulty, refer to the service and warranty section of the “kit builders guide” and to the “factory repair service” information on page 143 of this manual.*

# The best time to upgrade your component system is before you buy it.

If you're a typical reader of this magazine, you most likely have a sizeable investment in a component system. So our advice about upgrading might come a little late.

What you might have overlooked, however, is the fact that your records are the costliest and most fragile component of all. As well as the only one you will continue to invest in.

And since your turntable is the only component that handles these valuable records, advice about upgrading your turntable is better late than never.

Any compromise here will be costly. And permanent. Because there is just no way to improve a damaged record.

If the stylus can't respond accurately and sensitively to the rapidly changing contours of the groove walls, especially the hazardous peaks and valleys of the high frequencies, there's trouble. Any curve the stylus can't negotiate, it may lop off. And with those little bits of vinyl go the high notes and part of your investment.

If the record doesn't rotate at precisely the correct speed, musical pitch will be distorted. No amplifier tone controls can correct this distortion.

If the motor isn't quiet and free of vibration, an annoying rumble will accompany the music. You can get rid of rumble by using the bass control, but only at the expense of the bass you want to hear.

Experienced component owners know all this. Which is why so many of them, especially record reviewers and other music experts, won't play their records on anything but a Dual. From the first play on.

Now, if you'd like to know what several independent test labs say about Dual, we'll send you complete reprints of their reports. Plus a reprint of an article from a leading music magazine telling you what to look for in record playing equipment. Whether you're upgrading or not.

Better yet, just visit your franchised United Audio dealer and ask for a demonstration.

You'll find Dual automatic turntables priced from \$109.50 to \$199.50. That may be more than you spent on your present turntable, or more than you were intending to spend on your next one.

But think of it this way. It will be a long, long time before you'll need to upgrade your Dual.

**Dual**<sup>®</sup>

Dual 1215 S, \$109.50



Dual 1218, \$155.00

Dual 1229, \$199.50

United Audio Products, Inc., 120 So. Columbus Ave., Mt. Vernon, N.Y. 10553  
Exclusive U.S. Distribution Agency for Dual.

Check No. 33 on Reader Service Card

# Audience Involvement Through Use of

## BINAURAL SOUND



**Billy G. Brant**

ONE OF THE most challenging aspects of dramatic presentation, whether on the stage or through the electronic media, is attaining a high level of audience involvement. Those performing in stage productions have found a partial answer in audience participation, where the audience actually takes part in the play. Those in the electronic media have a larger obstacle to overcome because they must rely upon emotional and imaginative involvement. A few television and film producers have considered a device such as Aromarama and Smell-O-Vision that would produce odors of the scenes flashed on the screen thus adding to the realism of the picture and involving the audience in that manner. Some public (non-commercial) radio stations are now returning to the dramatic art form with a series entitled "Binaural Theater" which is designed to totally involve the audience with sound.

"Binaural Theater" is a series produced by the National Center of Audio Experimentation, a project of the Corp. for Public Broadcasting and the Univ. of Wisconsin, for distribution to stereo-capable public radio stations in the U.S. This series of plays combines contemporary radio drama with the newly applied technique of binaural sound. In fact, it is the use of binaural sound that separates this series from those plays produced in the early years of American broadcasting or those currently being produced in other countries.

Donald Voegeli, Technical Director of NCAE, explains, "Binaural, which means 'relating to or used by both

ears,' is a system of microphone placement and receiving or playing back through stereo or two-channel headphones, audio information to which your own binaural hearing can apply sense of direction, distance, movement, and other important aspects of natural human hearing. In binaural we attempt to take you to the event where the recording was made. You become a participant in the event. Your relationship to the event is much more intimate, much more real."

Binaural sound engulfs the listener, stimulating him to the point of actually experiencing the situation or scene as if he were there watching it. This realism places the listener continually at the focal point of all the action,

forcing him to be involved with the action. With binaural sound the listener can be in a rain storm or a riot, in the middle of an argument or directly in the path of an oncoming car. At times the sound effects in "Binaural Theater" are more impressive than the plot or the acting. However it is the acting and the production techniques associated with the acting that complete the realistic approach to drama that binaural sound provides.

The acting and actions performed before the microphones demand as much of a binaural director as of a stage director. Blocking must be as carefully planned as on the theatrical stage. In fact, acting in binaural sound is similar to acting on the stage. In



NCAE Director Ed Burrows demonstrates binaural recording with "Herman."

FM-5  
\$159.95 kit  
\$249.95 assembled



PAT-4  
\$94.95 kit  
\$159.95 assembled



STEREO 120  
\$159.95 kit  
\$199.95 assembled

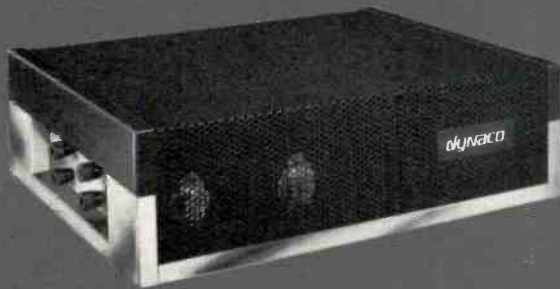

you  
can't beat  
the *dynaco*  
system

Assemble this superlative Dynaco system yourself, and enjoy the significant savings the kits afford, the fun of doing your own thing, and the satisfaction of phenomenal sound quality from this versatile, coordinated music ensemble.

The key to the system is the new Dynaco A-35 speaker—the ultimate in sonic accuracy at reasonable cost. The amp, preamp and tuner are easily built in a week of spare time. Each has earned a world-wide reputation for excellence and unequalled value—the assurance of continued "state of the art" performance year after year after year.

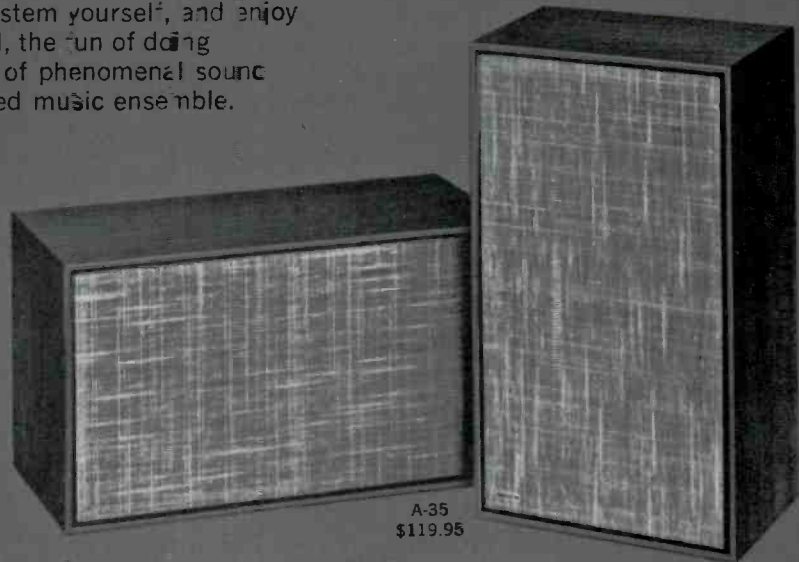

A-35  
\$119.95

**dynaco inc.**

Division Tyco

3060 JEFFERSON ST., PHILADELPHIA, PA. 19121

In Canada write DYNACO OF CANADA LTD., Montreal, 760, Quebec, Canada

binaural sound the listener can tell if an actor is "far left" or "down center" or "up far right." Like the stage, the actors' movements can have almost any variation. Interestingly enough, the actors must perform with even greater realism than they do on the stage because the audience does not have the advantage of a visual image to reinforce what is spoken. This is a vast change from the early radio dramas like "The Green Hornet" or "The Shadow," where the actors were required to stand in one place before a microphone and speak their lines. If they move from that spot, they would either not be heard or be heard only faintly. With binaural sound recording, the director has the opportunity to allow his actors almost unrestricted natural movement.

Most of the action of the plays in this series was recorded on location to abet the total realistic sound picture. Scenes were recorded in moving cars, in homes and on street corners. As fate would have it, some on-location recording was impossible so the director and the actors did their scenes in a studio while the appropriate sound beds (the total ambient sound of the location) were added at the proper time. The scenes were then edited and placed in order to form a smooth sounding, exciting dramatic production. Many hours of production went into the twelve plays that make up the "Binaural Theater." The result can be seen in the appreciation of this newly applied technique called binaural sound.

The recording of binaural sound is accomplished with a U-shaped device affectionately dubbed "Herman" by those at NCAE. Two microphones are placed about eight inches apart with a piece of foam rubber separating them. This foam acts as a barrier to isolate the two microphones. With a little imagination, Herman would be the human head because Herman is designed to approximate the position



Mary Jane Kimbrough and Charles Kimbrough of the Milwaukee Repertory Theater record a scene from "The Genuine Plastic Marriage" by Julian Dickon. (Photos courtesy NCAE.)

and accoustical properties of the ears on a human head. And, this indeed is the whole idea—to record sound as the human ears would hear it.

This type of recording adds the natural realism to "Binaural Theater." To fully appreciate these effects the listener has to wear stereo-headphones. The headphones direct all of the variations of the sounds to the ears of the listener.

"Binaural Theater" is just one product of the research of the National Center for Audio Experimentation. NCAE is interested in other uses of audio besides binaural and is concerned with audio's role in other media as well as radio. Yet binaural sound experimentation at NCAE has resulted in a number of other universities, colleges and radio stations doing their own experimentation. Recently, the Univ. of South Florida began a binaural drama script competition. This is a direct outgrowth of NCAE's efforts, according to E.G. Burrows, the Director of NCAE.

It will be interesting to see how the drama public reacts to this new and unique presentation of contemporary drama. Many who have heard these plays say that they are very good. Don Voegeli goes one better. "If radio's most glorious attributes are the stimulation of the imagination and the personal sound in the ear, here is radio at its best!"

The "Binaural Theater" is currently being aired by approximately 77 public radio stations around the country. The following are plays in the "Binaural





# If you want to be completely surrounded by music you need a 4-channel receiver that completely adjusts to your surroundings.



Since JVC wants to give you nearly perfect sound, we also have to give you a nearly perfect listening area.

The JVC 5445 4-channel receiver does just that.

A special sound effects amplifier (SEA) takes discrete and matrix 4-channel sources, plus stereo and monaural sources, and breaks them up into five frequency ranges, instead of just the usual bass and treble.

So you can bring up any frequency that's absorbed or tone down any one that's reflected too much. You can bring up any instrument. Or push any down. That's sound control you'd expect only

in a professional studio.

And the separate SEA control for the rear speakers lets you adjust for any future 4-channel sound system.

This receiver also makes your present stereo records, tape and FM stereo broadcasts sound better than ever by picking up previously hidden sounds through the rear speakers.

Naturally, this receiver is completely compatible with your present equipment. And the equipment you'll probably buy in the future. It even has optional remote control and 4-channel headphones.

JVC also makes a top-quality inte-

grated 4-channel amplifier, the 280 watt Model 990. And if you have a really good stereo amplifier, you can convert your system to 4-channel instantly with JVC's add-on amplifier, the 5101.

The JVC receiver, amplifier and add-on amplifier. They can take a beautifully arranged room and help you orchestrate it.

**JVC**

JVC America, Inc.  
58-75 Queens Midway Expressway  
Maspeth, New York 11378

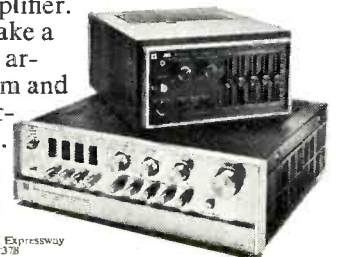

Check No. 37 on Reader Service Card

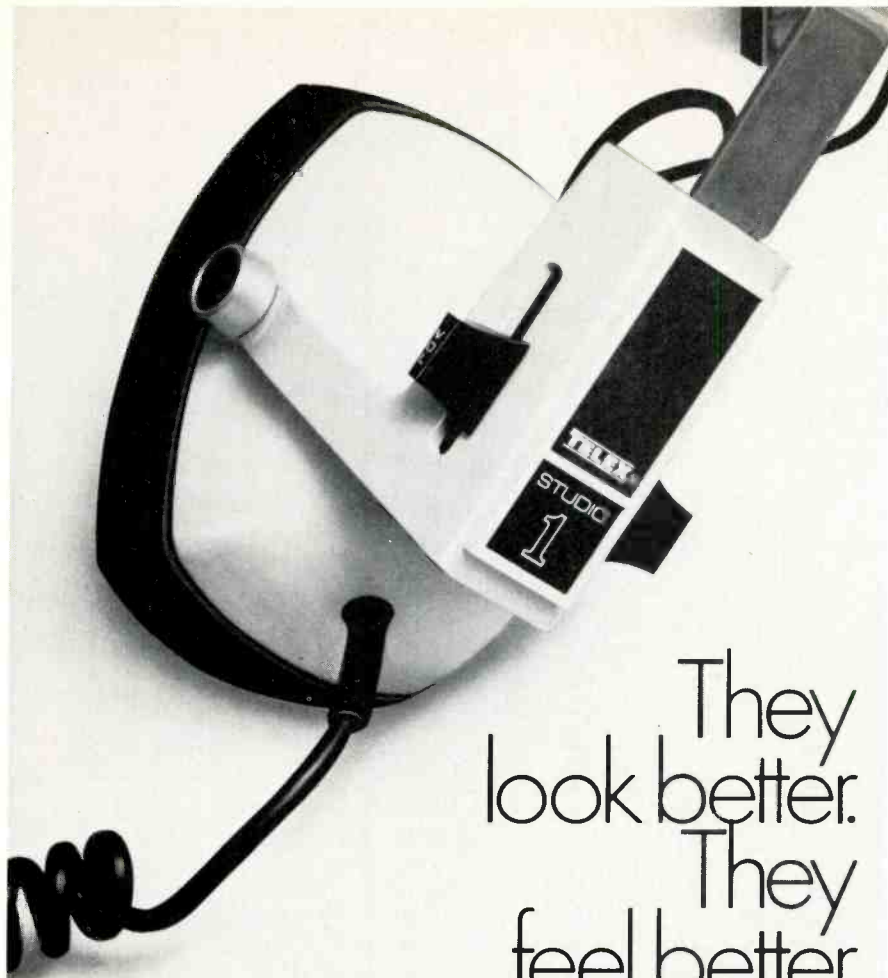

They  
look better.  
They  
feel better.  
They  
sound better.  
Studio stereophones by  
Telex.

Don a pair of Studio stereophones, the best looking stereophones made. They feel better because surgical silicone ear cushions comfortably conform to your head, even if you wear glasses. The real test is listening. A unique audiometric-type driver faithfully delivers all the sounds from a disc, tape or receiver. Choose either the Studio 1 with volume and tone controls, or the Studio 2.

The proof? Try them yourself at a better hi-fi dealer.

products of sound research

**TELEX**<sup>®</sup>

COMMUNICATION DIVISION

9600 Aldrich Avenue South / Minneapolis, Minnesota 55420

Studio stereophones are made by the world's largest manufacturer of aviation and educational headsets, stereophones, and other listening devices. Write for catalog.

CANADA: DOUBLE DIAMOND ELECTRONICS, LTD., Scarborough 4, Ontario  
EUROPE: ROYAL SOUND COMPANY, INC., 409 North Main Street, Freeport, N. Y. 11520 U.S.A.  
INTERNATIONAL: TELEX EXPORT DEPT., 9600 Aldrich Ave. So., Minneapolis, Minn. 55420 U.S.A.

Theater" series. The public is advised to check with their local public radio station to see if that station is carrying "Binaural Theater."

*Before Tomorrow*, by Colin Finbow. A romantic comedy in which a young, newly engaged couple discover they really have little in common.

*Nathan and Tabileth*, by Barry Bermange. A warm and sympathetic portrait of two old people whose dialogue is echoed by internal monologue. A visitor, possibly their nephew, disrupts the routine of their day.

*Life by Misadventure*, by Julian Dickon. A dying man in his hospital bed relives the traumatic episodes of his life involving wife, daughter, son, and mistress.

*Enchanted Night*, by Slawimor Mrozek. Two "commercial travelers" share a seedy hotel room and find themselves competing for the affections of a lady who is the creation of their mutual fantasies.

*Guardian Angel*, by Vaclav Havel. In this black comedy of contemporary life, a successful playwright is given unwelcome help from a mysterious stranger claiming to be his "guardian angel."

*Echoes*, by Rhys Adrian. Through a series of "echoes" like snapshots in an album, an elderly couple review the trivia of their past and present lives.

*The Genuine Plastic Marriage*, by Julian Dickon. In this "normal" marriage characterized by boredom and disillusion, self-revelation leads only to a widening of the gap between husband and wife.

*Timepiece*, by Stanley Eveling. A clock plays a key role in a man's gradual but not entirely unpleasant descent into madness.

*All Night Store*, by E.G. Burrows. One woman's nightmare walk down a lonely road at night. This play was written especially for binaural presentation.

*The Yellow Room*, by Donald Hall. The author reads this collage of love poems taken from his book, *The Yellow Room*.

*The Mortification*, by Barry Bermange. A corporation employee finds himself a victim of the system as he is mysteriously transferred to subterranean offices.

"Binaural Theater" is new and exciting. This series might begin a Renaissance of radio drama in the United States.

AE

# From the guys who brought you the world's best tape recorders... The world's newest and finest receiver.

Take a second look and you'll begin to see some of the things that make this receiver extraordinary. Like two tuning meters . . . three tape facilities . . . eight function-indicator lights. All of which do more than meets the eye.

That left-hand meter is a field-strength indicator when you're tuning FM. Pull out the speaker-selector knob and it becomes a power effect indicator—a built-in early warning system that will avert amplifier clipping and speaker overload.

Tapes 1 and 2 control standard rear-panel jacks for two decks—reel-to-reel, cassette, cartridge—so you can copy and convert as well as play and record. Tape 3 is a typical Tandberg

touch. It's jacked into a preamp circuit that lets you use the amplifier controls to modify the output signal. With Tape 3, you can tone down, brighten up, boost and rebalance worn discs and imperfect tapes when you re-record.

As for the pilot lamps, they're the visible indicator of eight function controls hidden under a flip-down cover. Two scratch/hiss filters for moderate or extreme high-frequency attenuation, rumble filter, loudness contour, Tape-3 preamp, mono left, mono right, and stereo.

What meets the ear in the TR1020 comes from the same no-compromise

electronics that have made Tandberg tape recorders *the* industry standard.

To cite just a few points, there's the true complementary output stages, a MOSFET front end for both AM and FM, separate power supplies, fully encapsulated electronic tuning, FM sensitivity typically 1.7 uV, and a capture ratio of 1.8 dB.

In sum, the TR1020 is pure Tandberg. An AM/FM stereo receiver that delivers about \$600 worth of performance for \$429.90.

Including the hardwood cabinet.

Don't just look at it. Look into it. With your nearest Tandberg dealer.

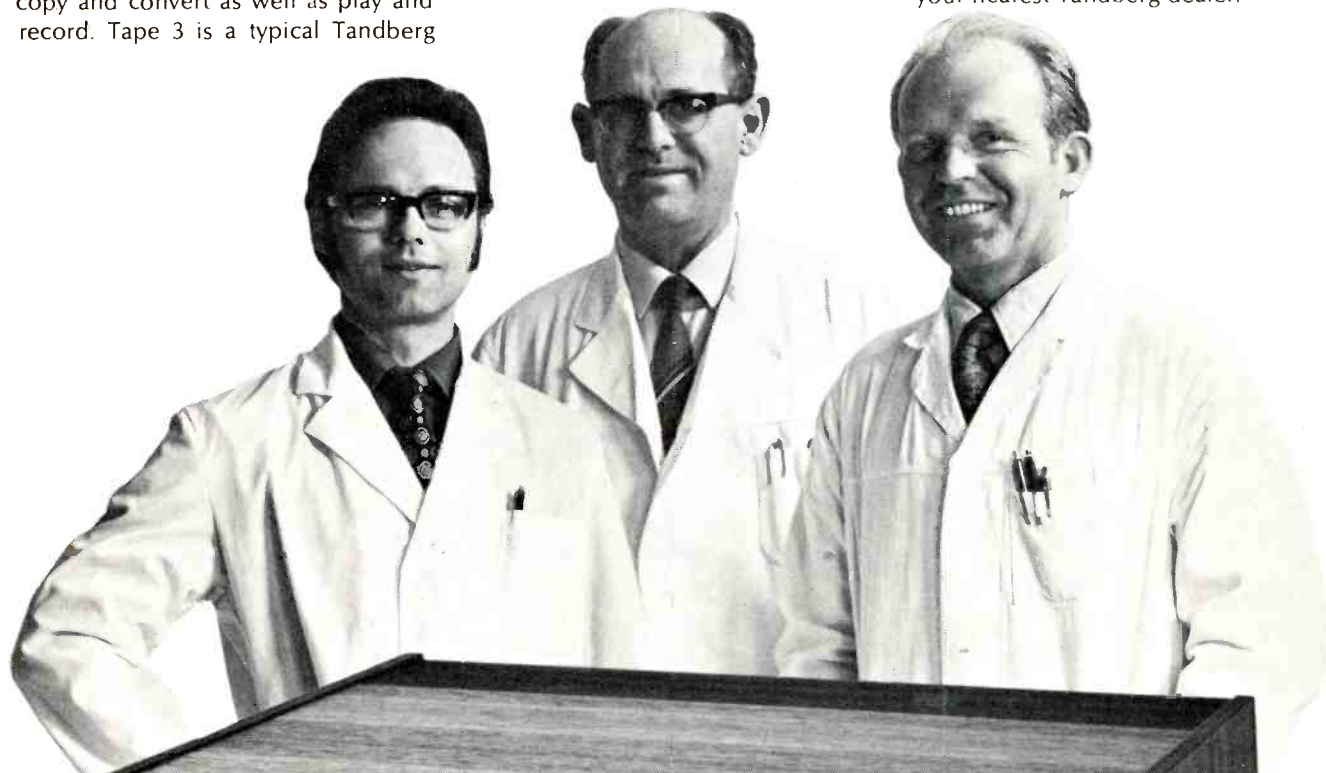

## TANDBERG TR1020

When you make the finest tape decks in the world, you don't settle for second best in anything.  
TANDBERG OF AMERICA, INC., 8 THIRD AVENUE, PELHAM, NEW YORK 10803  
Check No. 39 on Reader Service Card

*Sansui*

**QS**

REGULAR MATRIX

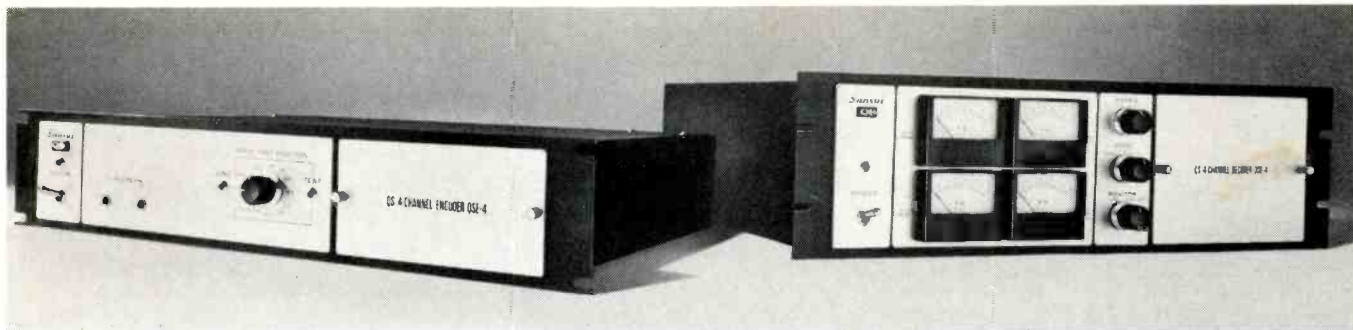

QS Professional Encoder/Decoder

# SANSUI QS

## the unique four-channel system that's already widely accepted around the world.

Sansui is a world-wide manufacturer of four-channel home equipment that has also designed its own advanced system of four-channel encoding.

The Sansui QS matrix system offers so much separation and four-channel depth that many professional recording engineers and producers are acclaiming it as the world's first discrete matrix.

The QS system provides greater separation among all four channels than the human ear can discern. For all practical purposes, the system's total effect is identical to that of discrete recording techniques.

*Major advantages of the Sansui QS system:*

- "Regular Matrix," based on the QS system, is an industry standard in Japan. The result: most Japanese-made equipment manufactured since April, 1972 contains QS-type decoding circuitry.
- More and more record companies have committed themselves to QS encoding—after trying the other available systems. Let their experience save you the time and money you might waste experimenting.
- Sansui QS is the advanced system that permits decoding in a way that produces full-circle as well as dead-center sound localization. The results are entirely indistinguishable from discrete four-channel sound sources.
- QS does not degrade any aspect of high-fidelity reproduction. System specifications for noise, distortion, dynamic range and frequency response are all maintained at optimum levels.
- QS provides truly outstanding synthesized sound-field reproduction from two-channel sources. This lets you enjoy the four-channel effect with existing two-channel recordings.
- QS lets you enjoy full sound-field playback records using other matrixing methods.

*ENJOY your favorite artists in QS sound right now on these record labels world-wide:*

**A&M, ABC/Command, ABC/Dunhill, Audio Treasury, Barclay, Black Jazz, Impulse, Ode, Ovation, Project 3, Pye, Toshiba, Vanguard (Japan) and others.**



*For full details,  
contact your nearest Sansui office now.*

**SANSUI ELECTRONICS CORP.**

**Sansui Electronics Corp.**

**New York**

55-11 Queens Blvd., Woodside, N.Y. 11377. Tel.: (212) 779-5300. Cable: SANSUILEC NEWYORK  
Telex: 422633 SEC UI.

**Sansui Electric Co., Ltd.**

**Los Angeles  
Tokyo**

333 West Alondra Blvd. Gardena, Calif. 90247. Tel.: (213) 532-7670.  
14-1, 2-chome, Izumi Sugunami-ku, Tokyo 168, Japan. Tel.: (03) 323-1111. Cable: SANSUIELEC.  
Telex: 232-2076.

**Sansui Audio Europe S.A.**

**Belgium**

Diacem Building Vestingstraat 53-55. 2000 Antwerp. Tel.: 315663-5. Cable: SANSUIEURO ANTWERP.  
Telex: ANTWERP 33538.

**Germany, W.**

6 Frankfurt am Main, Reuterweg 93. Tel.: 33538.  
Check No. 15 on Reader Service Card

# THE LANGUAGE OF HIGH FIDELITY

Martin Clifford

TAKE AN ORDINARY inoffensive pedestrian, put him in the driver's seat of a sports car and you sometimes get a complete personality change. The pussycat becomes a tiger. Take an ordinary length of wire and loop it into a number of consecutive circular turns (Fig. 1) and you go from an ordinary current carrier to an electromagnet, a

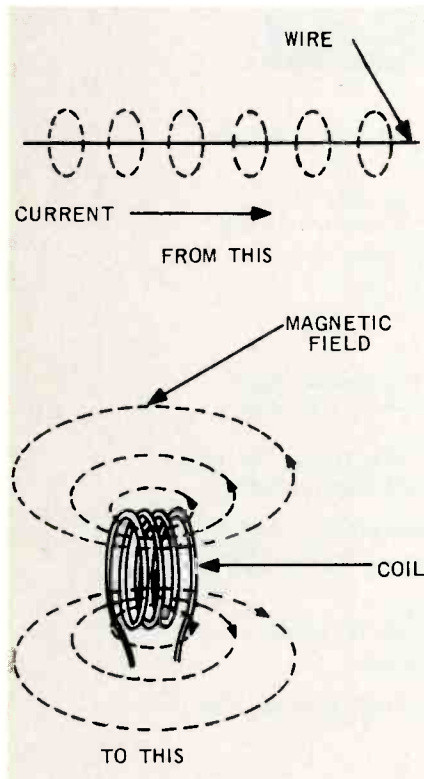

Fig. 1—The magnetic field surrounding a current-carrying wire becomes stronger when the wire is wound in the shape of a coil.

device whose varying magnetic field easily leaves its own confines and, busybody-like, tries to interfere with everything within its reach. Almost like removing the cork from a newly unearthened bottle only to find the thin wisp of smoke coalescing an evil genie. With a difference, though. The magnetic field surrounding the turns of wire of a

coil carrying current can be controlled. And even more. The magnetic field can be harnessed, tamed, made to do useful work, even if that work results in the rasping sound of a cheap transistor pocket radio.

## Away From The Straight And Narrow

The Dr. Jekyll-Mr. Hyde transformation of a straight wire into a coil is a basically simple changeover, from straight to round. But round is capable of many ingenious engineering interpretations. A fundamental coil consists of circular turns of wire placed adjacent to each other, wound on some kind of supporting form (Fig. 2) made of wax or plastic impregnated paper, cardboard or plastic. Offhand, we might say there is nothing inside the form, but in this space age we are conscious of air, or its lack, and so this first coil is an air-core type. A more complete name would be a single-layer air-core. And, to keep adjacent turns from shorting against each other, the wire is covered with an insulating material such as cotton, silk, nylon, rayon, glass or some plastic. Or else the wire can be insulated with a paint-like substance such as enamel or some special formulation described by an assigned trade name. If cotton insulation were used, the basic coil might now be identified as a single-cotton covered single-layer air-core type. This is still the same coil, but now the labeled accompaniment tells us a great deal more about its physical characteristics. As you can see, the electrical characteristics have been kept in abeyance.

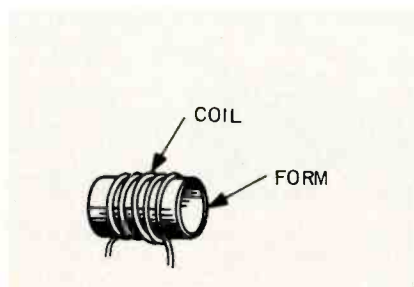

Fig. 2—The basic coil—turns of wire wound on a support called a form.

A single insulating layer, or single cotton covered, can be abbreviated as SCC. Add another layer and you have double cotton covered, or DCC. Cotton, silk, and nylon coverings, though, have been largely supplanted by plastic types.

## Coil Types

Successive turns of a single-layer wound coil can ultimately result in a component whose length is somewhat embarrassing and so a solution is to wind one layer on top of another. To keep the turns from falling apart, the coil can be sprayed with some plastic substance, varnish, lacquer or synthetic material or dipped in hot wax. But whether a single layer is used or many,

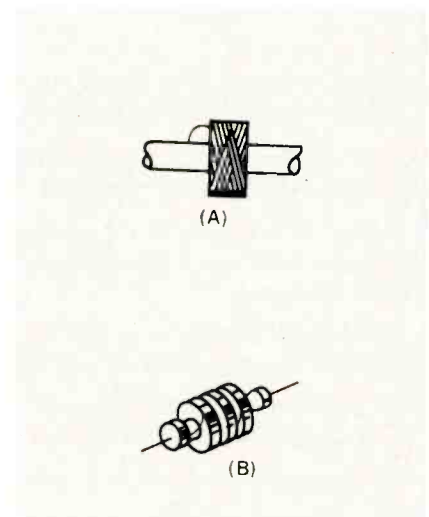

Fig. 3—Universal single pi (a) and triple pi (b) windings.

the coil is sometimes called an inductor or solenoid or incorrectly referred to as an inductance.

During winding, the wire can be put down in a basket-weave pattern, a type of construction called a universal winding. A single winding, as shown in Fig. 3-a is a pi. It is possible, of course,

(Continued on page 44)

**This is it.  
Everything you've  
been listening for.**

There is no ultimate in sound electronics.  
There are only new achievements.  
Because electronics is not a pure science. But a blending  
of science and art.

The Sherwood 8900 receiver introduced in 1969 is a  
case in point.  
By the measure of every leading consumer testing  
publication, it led the industry.

Not because of its features. Or numbers.  
But because of the total effect that can only come when  
technology has been advanced by artists.  
Which brings us to 1972. And the reason for bringing out  
a new model (8900A with FM) (7900A with AM/FM).  
We've redesigned it not just to incorporate the new  
features or circuitry.

(Twice the RMS power of the S8900.)  
(The 4-gang tuning condenser.)  
(Front panel control of 4-channel decoder which can  
double as a 2nd tape monitor.)  
(Or even the Dynaquad 4-channel matrixing circuitry.)  
As important as these additions are, they're not important  
at all.  
What happens to you when you hear it is.

Sherwood Electronic Laboratories, Inc.  
4300 North California Avenue, Chicago, Illinois 60618

**The  
Sherwood  
Experience.**



Check No. 42 on Reader Service Card

(Continued from page 40)

to have more than a single pi, series connected as in Fig. 3-b. Other types of windings are variously called basket weave, spider web, etc.

### Coil Names

Coils can also be identified by their electrical characteristics. A filter, as the name tries to suggest, separates currents of different frequencies. A choke, a somewhat more violent designation, does the same work. A tuned coil is one that is made to resonate at a particular frequency, comparable in a physical way to adjusting a violin string to a desired pitch. A voice coil is that part of a speaker responsible for moving the cone. These are just a few of the assigned jobs.

### Inductance

An auto at rest likes to stay at rest, a condition many owners deplore. Similarly, a car in motion likes to stay in motion, a fact which led to the early invention of brakes. This stubborn behavior on the part of cars, or all other masses, is known as inertia. Coils have inertia, too, but of an electrical kind. They oppose any change in the amount of current flowing through them, an electrical characteristic called inductance. The basic unit of inductance in

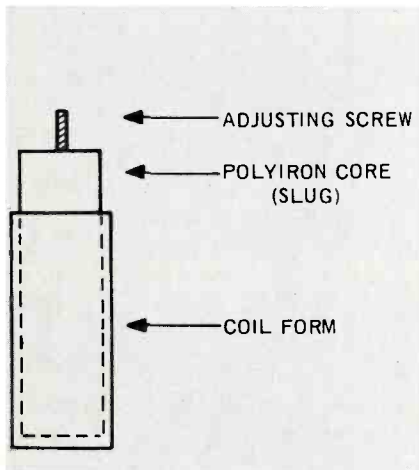

Fig. 4—The inductance of a coil can be varied by moving a poly-iron core in or out of the form on which the coil is wound.

the henry, with commonly used sub-multiples such as the millihenry, or thousandth of a henry, and the microhenry, or millionth of a henry. The amount of inductance of a coil is based on the way it is made: the number of turns, how wound, and the kind of material stuffed inside the coil form.

A large amount of inductance isn't necessarily better than a small quantity. A locomotive has more inertia than an auto, but car owners will challenge its superiority as a mode of transportation.

### Fixed And Variable Coils

A coil can be fixed, that is, its inductance is a permanent feature and cannot be changed. Or, a coil can be variable and its inductance modified

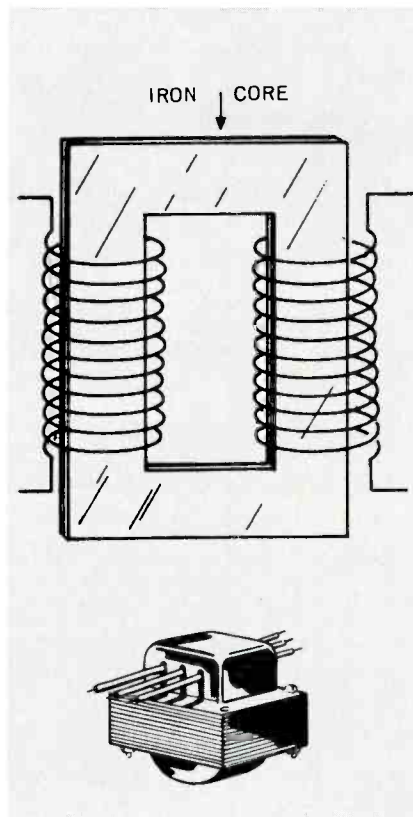

Fig. 5—Fixed iron core coil. The core consists of thin sheets of steel.

at will. This is ordinarily done by inserting a poly-iron slug (made of powdered iron and held together with a binder) into the coil form (Fig. 4). The presence of iron increases the inductance of the coil, and conversely, removing it lowers inductance, and so a variable coil can be made by having movable iron cores. Since a coil without a core is called an air-core type, one with a ferrous core material is an iron-core type. Iron-core types can be fixed or variable. Fixed coils (Fig. 5) often have thinly sliced sections of iron (laminations) as their core material.

### Inductive Reactance

The inductance of a coil isn't the only factor involved in opposing any change of current. The frequency of

the current flowing through the coil must also be considered. The frequency, in Hertz, multiplied by the inductance in Henrys, further multiplied by a constant, 6.28, supplies the current-flow opposition known as inductive reactance, ordinarily abbreviated as  $X_L$ . Inductive reactance, like resistance, is measured in ohms, a reasonable assumption since both reactance and resistance are implicated in current flow opposition. The vectorial combination of resistance and reactance, or total opposition to current flow, is called impedance, a word you will find in the spec sheets of just about all hi-fi manufacturers. The impedance of a voice coil of a speaker, for example, is a combination of reactance and resistance. The resistance of a coil is a fixed amount, depending directly on the wire used, its length, and the surrounding temperature. The reactance of a coil is frequency sensitive. The higher the frequency, the greater the reactance, a form of electrical behavior that is precisely opposite that of a capacitor. And so, voice coils have 4 ohms impedance, or 8 ohms, or 16 ohms, but only at a particular spot frequency. At some other frequency, the voice-coil impedance "is a whole 'nother story."

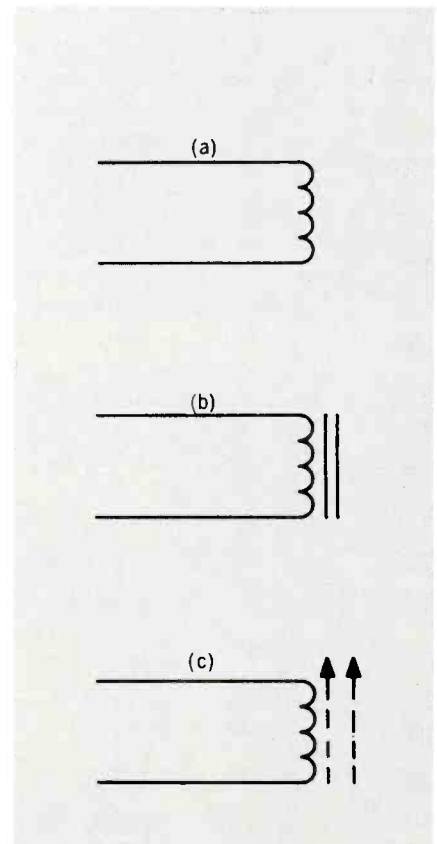
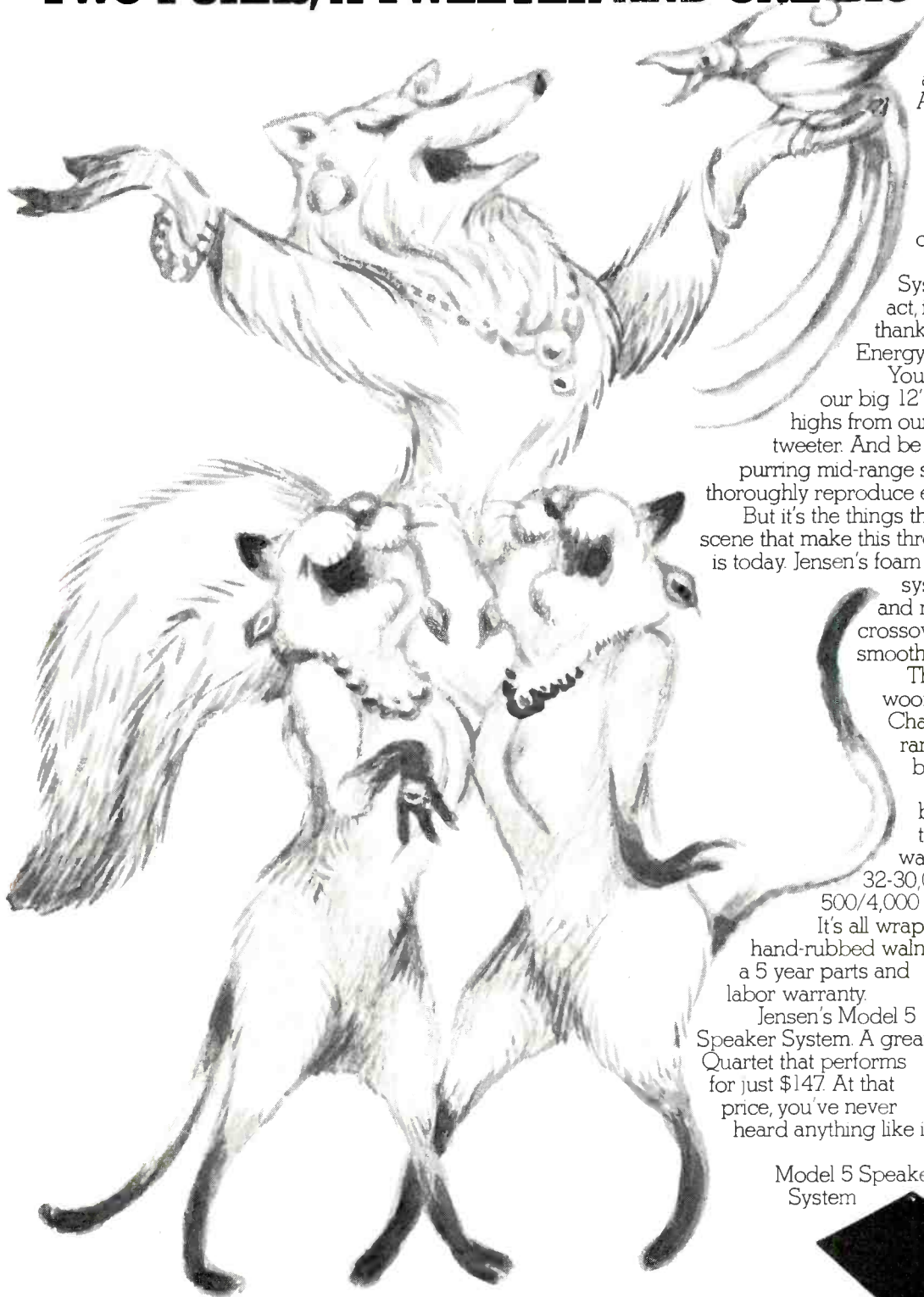

Fig. 6—Electronic symbols for coils. Air-core (a); fixed position iron core (b) and variable poly-iron slug type (c).



# THE MODEL 5 QUARTET. TWO PURRS, A TWEETER AND ONE BIG WOOFER.



Two things make a great quartet. Voices. And balance.

When you have both, you get near perfect sound. And that's exactly what you hear from this Quartet of Jensen speakers.

The Model 5 Speaker System. A great balancing act, if there ever was one, thanks to Jensen's Total Energy Response design.

You'll thrill to the lows from our big 12" woofer. Marvel at the highs from our Sonodome® ultra-tweeter. And be soothed by a duo of purring mid-range speakers, that thoroughly reproduce every sound in between.

But it's the things that go on behind the scene that make this three-way System what it is today. Jensen's foam Flexair® suspension system gives sound clarity and realism. The unique crossover networks provide smoothness and tonal blend.

There's a four layer woofer coil. A Tuned Isolation Chamber on each mid-range. And two rear panel balance controls.

This Quartet has a brilliant technical record, too. Power Rating: 60 watts. Frequency Range:

32-30,000 Hz. Crossover: 500/4,000 Hz. Dispersion: 170°

It's all wrapped up in a luxurious, hand-rubbed walnut cabinet. And carries a 5 year parts and labor warranty.

Jensen's Model 5 Speaker System. A great Quartet that performs for just \$147. At that price, you've never heard anything like it.

Model 5 Speaker System

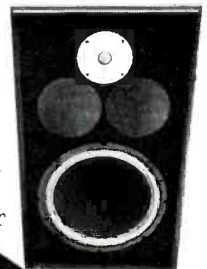

## JENSEN SOUND LABORATORIES

A DIVISION OF PEMCOR, INC. SCHILLER PARK, ILLINOIS 60176

Check No. 49 on Reader Service Card

## Coil Symbols

As in the case of resistors and capacitors, electronic symbols are used for coils. The basic symbol for a coil (Fig. 6a) consists of a small succession of loops. In the absence of any further information, the symbol represents an air-core type. A pair of solid parallel lines (drawing b) adjacent to the coil indicates the coil has an unmovable, laminated-iron core. Fig. 6c is the symbol for a coil having a powdered-iron core. The arrow means the core is adjustable.

## The Magnetic Field

Every wire, no matter what its geometry, becomes a magnet when current flows through it, whether that current is d.c. or a.c. The wire becomes a magnet, not because it is made of copper, or some other material, but simply be-

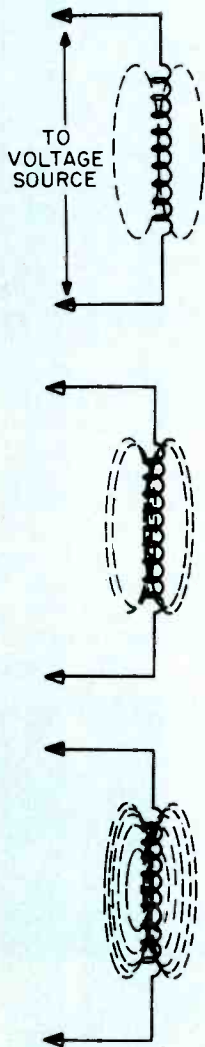

Fig. 7—The greater the current flow through the coil, the larger the magnetic field around that coil.

cause the current is itself surrounded by a magnetic field or magnetic lines of flux or force. That same current, flowing through a vacuum, would still be accompanied by magnetic lines of force. With no current flowing through it, a coil simply becomes a series of circularly arranged wires. Because of this ephemeral behavior, coils are called temporary magnets or electromagnets (EM) in contrast to magnets which remain rather fixed and are called permanent magnets (PM). A speaker voice coil is an EM and is surrounded by a PM, and so the arrangement is called a PM speaker.

Magnets, like people, can be weak or strong. The stronger the current, that is, the greater the amount of current flow, the stronger will be the magnetic field around it. When a magnetic field is concentrated it performs better since there is more of it in a smaller space. And that's the great advantage of a coil over a straight length of wire—its ability to concentrate the magnetic field (Fig. 7).

## Controlling Magnetic Fields

Magnetic fields are the Peck's Bad Boy of electronics. Uncontrolled, they can create havoc in the form of oscillation, quite capable of transforming a domesticated amplifier into a miniature generator. The various techniques used for taming magnetic fields are to keep coils widely separated, mounted at right angles to each other or, most commonly, a form of imprisonment known as shielding. In hi-fi systems, shields are not used to protect coils against inclement weather, but to ensure good behavior.

## The Transformer

We have a transformer when two coils are placed within reasonable proximity of each other. The magnetic field of the first coil, identified as the primary winding or simply primary (Fig. 8), reaches across to the turns of wire in the second coil (or secondary). This has a very disturbing effect on the electrons resident in the turns of wire of this adjacent coil. It forces them out of their lethargy, compelling them to move to one end of the coil or the other. But this disequilibrium of electron quantity produces an electrical pressure, since there are now more electrons at one end of the coil than the other. This electrical pressure is actually the transfer of electrical energy through space,

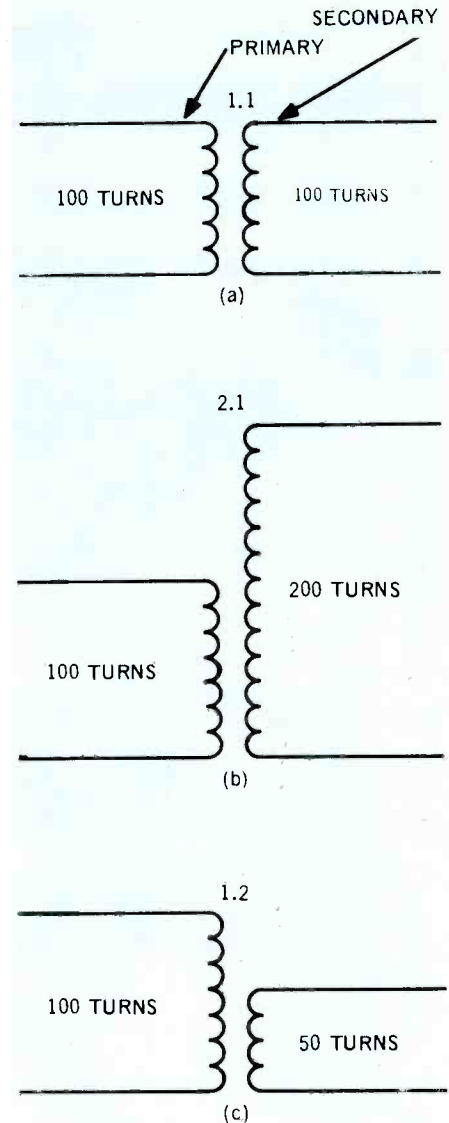

Fig. 8—A transformer may have the same number of turns for both secondary and primary windings (a), have more turns on the secondary (b) or fewer turns (c).

from the primary to the secondary winding, even if that space is measured in fractions of an inch. The electrical pressure across the secondary winding, produced by the magnetic field of the primary, is called an induced electromotive force or EMF.

Since a transformer consists of two or more coils sharing a common core, all of the previously named coil designations still apply. A transformer can be air core or iron core, and either fixed or variable.

(Continued on page 50)

# Don't you wish you could start all over again?

You can. In 4-channels. With a Panasonic discrete system. Panasonic chose discrete as its 4-channel standard for a lot of reasons. First, it has the highest degree of speaker separation and steady sound positioning of any type of 4-channel system. And in addition to playing discrete 4-channel tapes and records, a Panasonic discrete system enhances the sound of stereo tapes, records, and radio. Because of our Quadplex™ circuitry.

Start with one of our 4-channel receivers. Like Model SA-6800X. It has Panasonic's Acoustic Field Dimension. That lets you adjust the speaker separation electronically. Plus a full 300 watts of power (IHF).

You'll also need a tape deck. For 8-track cartridges, there's the RS-858US. It plays and records 2 and 4-channel cartridges. With four separate input level controls. And 4 VU meters. If you want all that in reel to reel, there's our 4-channel deck, Model RS-740US. It has Hot Pressed Ferrite heads, noise suppressor systems and other features. That add up to a frequency response of 30-23,000 Hz at 7½ ips. And an S/N ratio of better than 50 dB.

If you want records, you'll want the SL-1100 direct-drive turntable. With wow and flutter of less than 0.03% WRMS. And the SE-405 demodulator for Compatible Discrete 4-channel (CD-4) records. Like RCA Quadradiscs.

As well as matrix 4-channel, stereo and monaural records.

And our speakers, Model SB-750 are 3-way air-suspension systems. With 5 speakers in each enclosure. Two domed tweeters. Two domed midranges. And a 12" woofer.

We can also let you see 4-channel sound. On our 4-channel audio scope. Model SH-3433. The screen will show you how much sound you're getting from each channel.

You can see our discrete 4-channel components at your franchised Panasonic Hi-Fi dealer. The man who can make your wishes come true. But this time in 4 channels.

FOR YOUR NEAREST FRANCHISED PANASONIC HI-FI DEALER, CALL TOLL FREE 800 243-6000. IN CONN., 1-800 882-6500

## Panasonic® Hi-Fi Discrete 4-Channel System



Check No. 47 on Reader Service Card

www.americanradiohistory.com

(Continued from page 46)

### Transformer Turns Ratio

A transformer can have the same number of primary and secondary turns and is then called a 1 : 1 (one-to-one unit). If the transformer has more secondary than primary turns, it is a step-up type, and if the secondary has fewer turns, it is a step-down type. The arithmetic ratio of the number of secondary turns to the number of primary turns is the turns ratio. A step-up transformer produces a voltage increase, that is, there is more voltage across the secondary than across the primary. There is a price to be paid, however. The current through the secondary becomes less than that through the primary. The step-down transformer has more secondary current flow than the primary, but again at a price. The voltage across the secondary is less than that across the primary.

In the 1 : 1 transformer the secondary and primary voltages are identical. Theoretically, the secondary current should be the same as that in the primary, but nature takes its toll. There are various losses due to heat and magnetization of the core material. Nature never supplies anything for nothing. Would-be inventors of perpetual motion machines should realize this and take note that it isn't nice to fool Mother nature.

### How To Read Simple Circuit Diagrams

Coils can form poly-conjugal relationships with other components described in previous articles—with resistors, capacitors, tubes, transistors, and voltage sources such as batteries. The whole purpose of these arrangements is to help convert sound energy to its electrical equivalent, obtain a magnified replica, and then to reconvert to sound once again. But in so doing to have an amplified, completely faithful reproduction, a process known as high-fidelity.

In one of the simplest applications (Fig. 9-a) two widely separated frequencies (one frequency is much higher than the other), move along the conductor with the direction of movement indicated by the arrow. The lower frequency will go through the coil rather readily since the electrical opposition of the coil, its reactance, is smaller for low frequencies. The higher of the two frequencies will encounter much more opposition. This doesn't mean there will be complete separation between the two frequencies, simply that at the output there will be a much higher ratio of low-to-high frequency

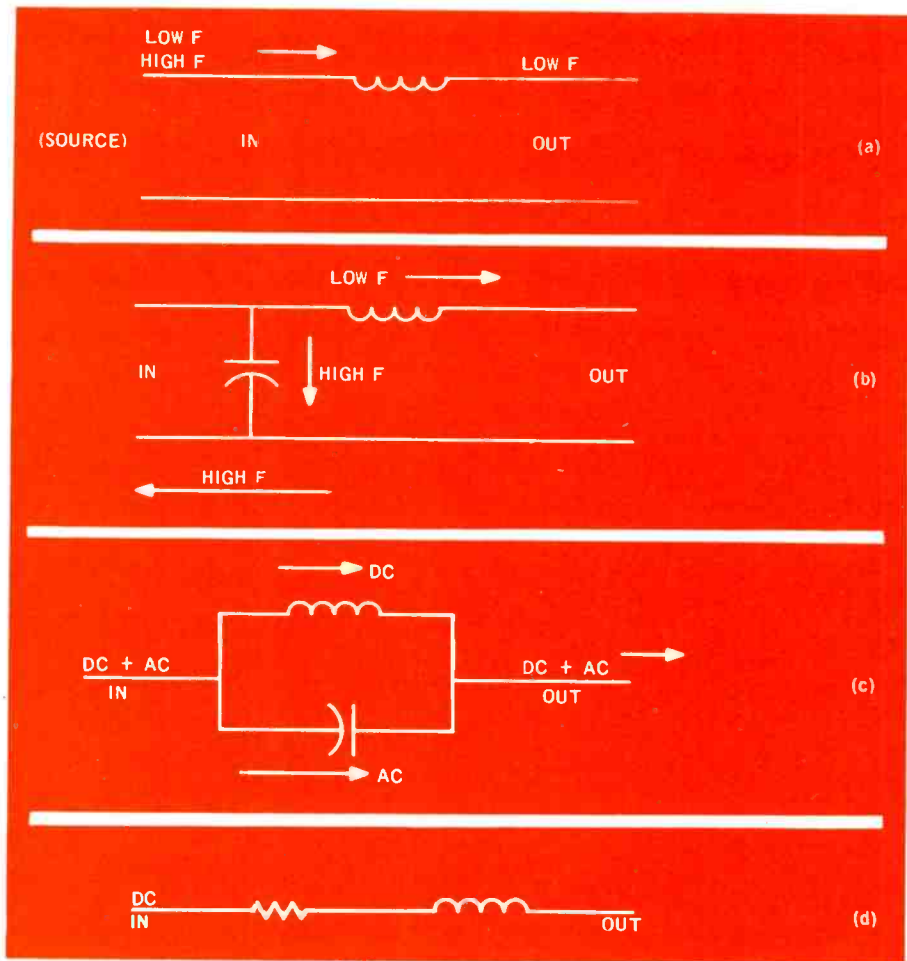

Fig. 9—Coils are used in conjunction with other components to form circuits for doing specific jobs. Although coils are normally used in a.c. circuits, drawing (d) shows a d.c. application to keep the direct current from reaching an immediate maximum value.

signal than existed at input.

Fig. 9-b shows a modification with a capacitor shunted across the connecting wires. Coils and capacitors behave in opposite ways. For a low frequency the capacitor has a high reactance, the coil a much lower one. And so the low frequency has every reason to continue through the coil toward the output. For this low frequency the capacitor offers very little encouragement as a possible current path. However, the higher frequency finds relatively easy passage through the capacitor, returning to the source.

A combination coil-capacitor circuit, similar to this one, is a filter, often used as a circuit arrangement for frequency separation, possibly at the input to a speaker system.

In some circuits it may be necessary to separate, momentarily, d.c. (actually a zero frequency current) from a.c. The d.c. and a.c., both moving along the same wire are separated by the coil connected across the capacitor (Fig. 9-c) referred to as a shunt circuit. The capacitor has its maximum opposi-

tion to d.c., and so the d.c. is compelled to move through the coil. For a.c., the coil will have a high reactance, the capacitor much lower, and so the a.c. will use the capacitor as a path. Naturally, some a.c. will also flow through the coil, but the separation can be made more complete by repeating the circuit.

In still another arrangement, a resistor is wired in series with the coil. The purpose here is not to stop the current from flowing but rather to delay it from reaching its peak value for a fraction of a second. The amount of time delay will depend on the value of inductance and resistance.

### And So Into The Future

So much for components. There aren't many of them—just resistors, capacitors, coils, tubes, transistors, and voltage sources. But with this handful we can now settle down to the serious business of understanding hi fi system components, starting with the tuner. Not now, of course. In the next issue.

(To be continued)

# Now Marantz adds full 4-channel to any stereo system.

Got the urge to go 4-channel, but don't want to give up your great stereo system? Well, Marantz ends your dilemma with the new Model 2440 adaptor/amplifier.

Rated at 40 Watts continuous RMS power with less than 0.3% distortion, the Model 2440 converts virtually any stereo receiver to full 4-channel capability.

But that's not all. Marantz components synthesize 4-channel sound from any stereo source (including your stereo records and tapes), decodes any matrix-

encoded 4-channel disc or FM broadcast, and accept optional SQ\* matrix decoders and CD-4\*\* demodulators. This Marantz-exclusive decoder feature provides built-in snap-in, snap-out adaptability to any future 4-channel matrix development. So you'll never have to worry about your system becoming obsolete.

The Marantz Model 2440 is another member of the Marantz family of 2 or 4-channel receivers, amplifiers and adaptors starting at just \$149.95. See your Marantz dealer now.

**marantz.**  
We sound better.



**OPTIONAL MARANTZ MODEL SQA-1 DECODER** (shown) is just one of a variety of optional matrix decoders which snap instantly into *exclusive SQ\** decoder pocket found on all Marantz 4-channel equipment.

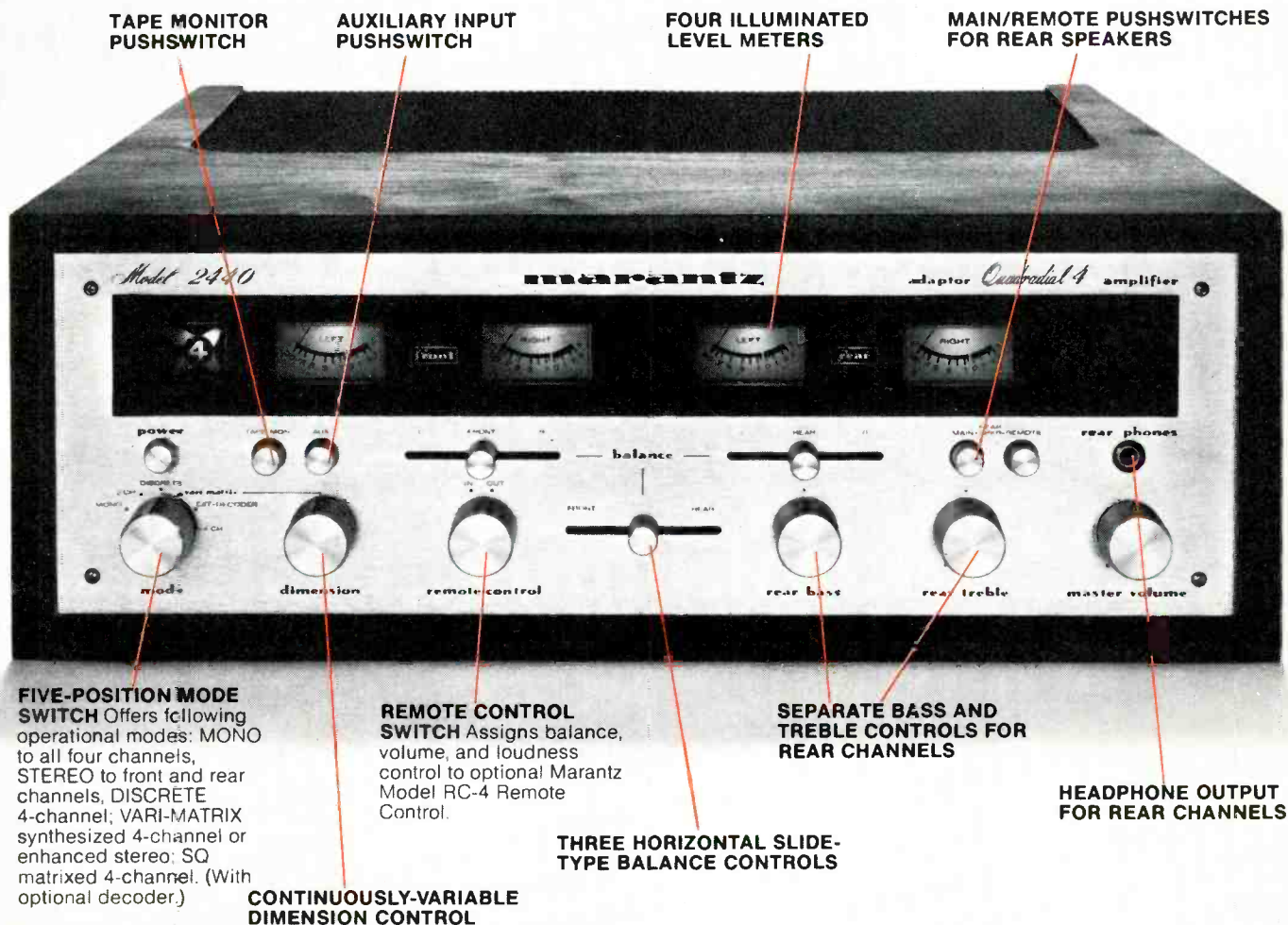

**TAPE MONITOR PUSHSWITCH**

**AUXILIARY INPUT PUSHSWITCH**

**FOUR ILLUMINATED LEVEL METERS**

**MAIN/REMOTE PUSHSWITCHES FOR REAR SPEAKERS**

**FIVE-POSITION MODE SWITCH** Offers following operational modes: MONO to all four channels, STEREO to front and rear channels, DISCRETE 4-channel; VARI-MATRIX synthesized 4-channel or enhanced stereo; SQ matrixed 4-channel. (With optional decoder.)

**CONTINUOUSLY-VARIABLE DIMENSION CONTROL**

**REMOTE CONTROL SWITCH** Assigns balance, volume, and loudness control to optional Marantz Model RC-4 Remote Control.

**THREE HORIZONTAL SLIDE-TYPE BALANCE CONTROLS**

**SEPARATE BASS AND TREBLE CONTROLS FOR REAR CHANNELS**

**HEADPHONE OUTPUT FOR REAR CHANNELS**

\*SQ is a trademark of CBS Labs, Inc.  
\*\*CD-4 is a trademark of Victor Co. of Japan

Check No. 43 on Reader Service Card



## Don Giovanni, Eleanor Rigby, Bill Bailey

There are 57 FM stations in New York, 73 in Los Angeles, 41 in San Francisco and 37 in Chicago—all crammed between 88 and 108 MHz. With so many stations, and so little space, there's bound to be a bit of pushing and shoving. Now and again, an unfortunate overlap. A receiver with ordinary sensitivity and selectivity just won't cut it.

But Sony doesn't make ordinary receivers. It gives you a choice of six

models—all with extra ordinary tuner sections. The FET front ends, solid-state IF filters, combine to bring in even the weakest stations with an unusual immunity to overload from strong ones. Station selection on the long linear dial is razor sharp. Interference and noise have been reduced to where they can't intrude on your listening pleasure.

And the amplifier sections are equally extraordinary. They feature Sony's dual-

power-supply, direct-coupled approach. There's no coupling capacitor to stand between you and the music.

The only problem you might have is in making up your mind as to which Sony is best for you. Power and price might be a good criteria.

The top-of-the-line 6200F has 245 watts of power, \$699.50. The 6065 delivers 220 watts at \$429.50. The 6055, 100 watts at \$319.50, and the 6045,

# SONY® keeps them separate and beautiful



## & Second Hand Rose make a poor medley

75 watts at \$249.50. The 6036 is a frill-free, receiver with 44 watts of power (it does not have direct coupling) at \$199.50. The new Sony SQR-6650 provides virtually every form of 4-channel (SQ, matrix and discrete) as well as excellent stereo performance, only \$329.50. The best way to make up your mind is to visit your Sony dealer for a demonstration. Sony Corporation of America, 47-47 Van Dam Street, Long Island City, N.Y. 11101. Prices: Suggested retail. Power ratings: IHF standard constant supply method into 8 ohms.

Check No. 51 on Reader Service Card



# Annual Directory Addenda

MANUFACTURER	MODEL	RMS power/chan., W, 8 ohms	THD at rated power, %	IM at rated power, %	IM at 1 watt, %	Power bandwidth, Hz-MHz	Freq. resp. at 1 watt, Hz ± 2 dB	Rated output S/M, phono, dB	Damping factor	Dimensions, W x D x H, in.	Weight, lbs.	Price	SPECIAL FEATURES
DUNLAP-CLARKE	2000A 4-chan.	250	0.075	0.1	0.075	10-50k	5-250k ± 3	100	500	18 x 16 x 7	55	1295.00	Fans; short-proof meters; level conts.; meter range switch.
	1000	250	0.075	0.1	0.075	10-50k	5-250k ± 3	100	500			680.00	As above. Less meters, \$680.00.
	500	125	0.075	0.1	0.075	10-50k	5-250k ± 3	100	500			450.00	Without meters.
	1600	400	0.075	0.1	0.075	10-40k	5-100k		800			1095.00	Air-cooled; meters.

## Amplifiers

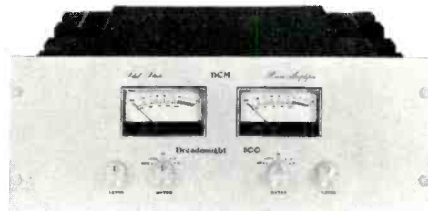

Dunlap-Clarke-McMorrow 1000

### Manufacturer's Addresses

David Clark Co., Inc.  
360 Franklin St.  
Worcester, Mass. 01604

Garrard  
c/o British Industries, Inc.  
South Service Road  
Westbury, N.Y. 11590



Clark 300/Red Baron



Sennheiser HD414

## Headphones

MANUFACTURER	MODEL	Type	Frequency response, Hz ± 2 dB	Impedance, ohms	Sensitivity mW input for 100 dBm out	Maximum input, mW	Distortion, %	Cord length, ft.	Weight, oz.	Price	SPECIAL FEATURES
DAVID CLARK	100A	Dyn.	20-18k	17	105	1000	1.2	9	16	50.00	Also available in 300 and 600 ohms.
	200	Dyn.	30-16k	8	100	500	1.5	9	16	29.00	
	250	Dyn.	30-16k	8	100	500	1.5	9	16	34.00	With vol. contl.
	300	Dyn.	40-14k	8	100	500	2.0	9	16	21.00	
SENNHEISER	HD414	Dyn.	20-20k	2k	1 mW for 102 dB		1 at 122 dB	10	5	36.95	Detachable cord.



# At last a serious rival to the KLH Model Fifty-One.

## The new KLH Model Fifty-Two.

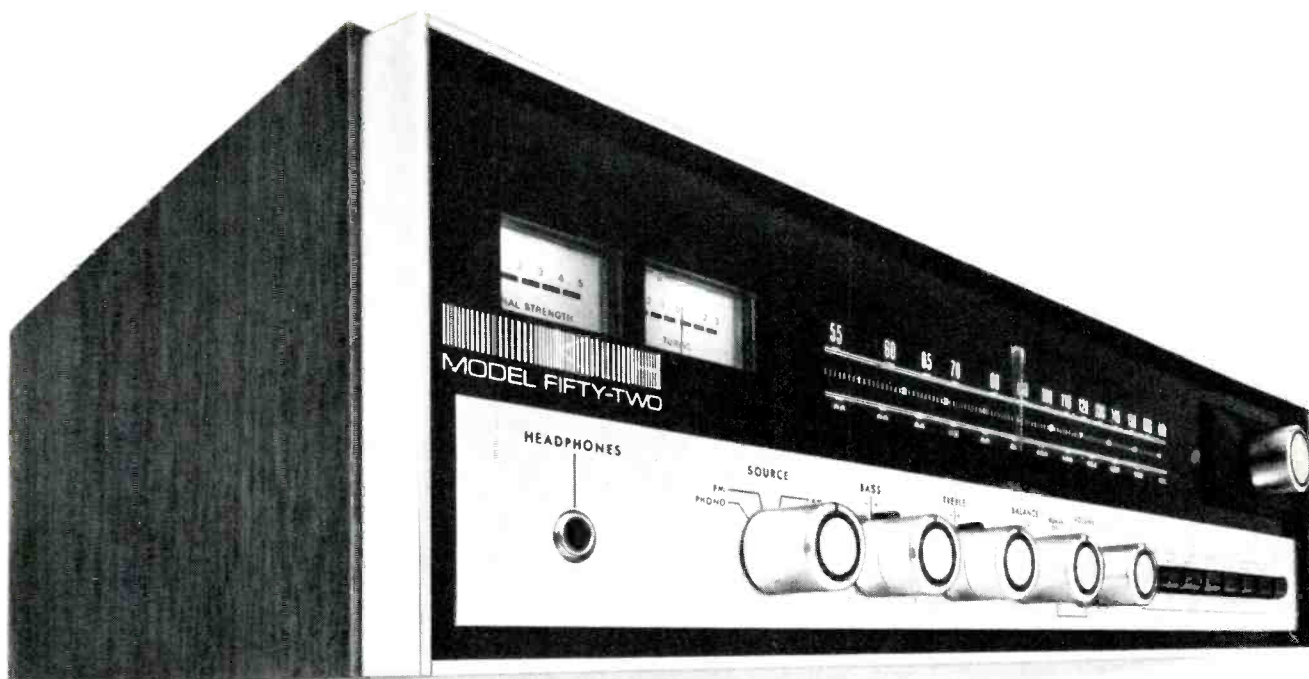

When it comes to power, performance and overall product integrity, KLH's classic Model Fifty-One is a tough stereo receiver to beat. At \$259.95†, it literally wipes out its competition. We just could not make a better AM/FM stereo receiver for the money.

So we've made a more expensive one.

It's called the Model Fifty-Two. And it costs \$289.95†. The additional thirty dollars buys you additional power (30 watts per channel RMS compared with the Fifty-One's 20 watts per

channel RMS). The Fifty-Two also has a new KLH look, dual tuning meters, and a host of new convenience features. Now we know the Fifty-Two will never replace the Fifty-One; we never intended it to. But if you have a special need for somewhat more power than the Fifty-One offers, but you want the same dependability, precision engineering and super quality, we have a new receiver for you. The Fifty-Two... the Fifty-One's serious, but friendly rival.

See the Fifty-Two at your KLH dealer now. Just \$289.95† (including

Check No. 45 on Reader Service Card

walnut-grain enclosure). Also see the rest of the KLH receiver line, especially KLH's newest and lowest priced AM/FM stereo receiver, the Model Fifty-Five. Powerful. Dependable. And very special for just \$199.95†. For more information, write to KLH Research and Development, 30 Cross Street, Cambridge, Mass. 02139.



KLH RESEARCH AND DEVELOPMENT  
A Division of The Singer Company

†Suggested retail price. Slightly higher in the west.  
\*A trademark of The Singer Company

# Christmas Buying Guide

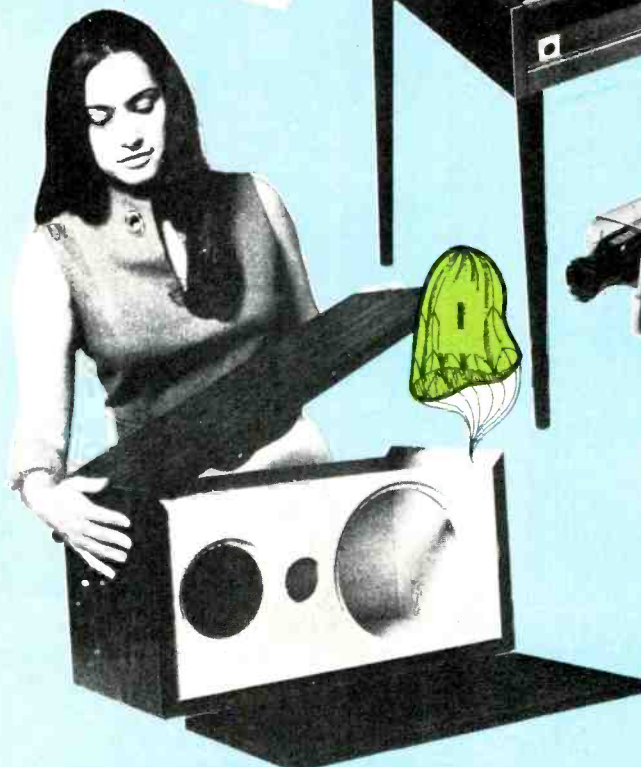
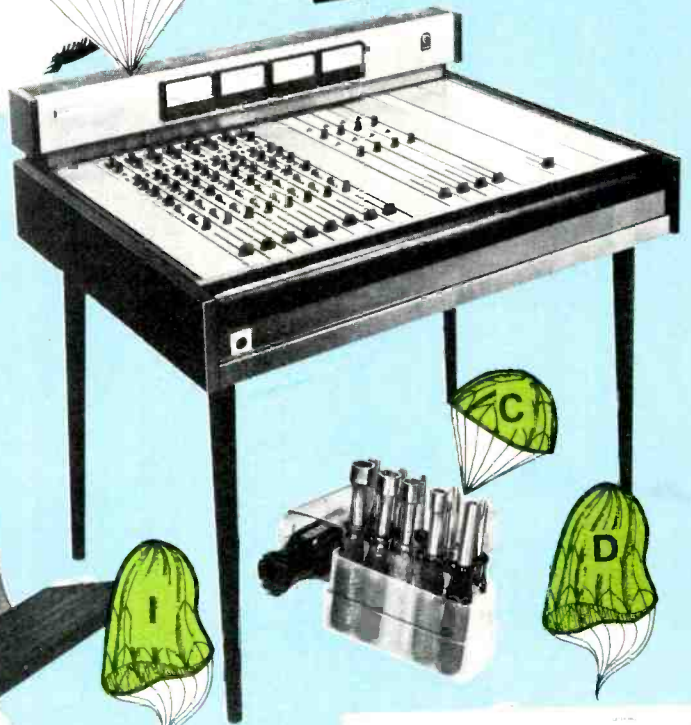
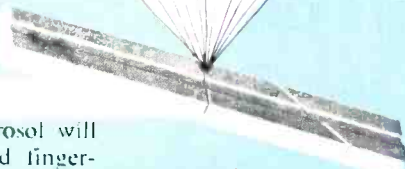

## Under \$10.00

**A.** Dirty discs? **Clean-Jet** aerosol will clean them of dust, lint, and fingerprints, and will do the same for styli, tapes, and recorder heads as well. Long flexible nozzle and pressure-control button help get the right amount where you want it. A can holds more than 1000 blasts and costs only \$1.50.

**B.** Would you believe 20 second rewind of a C90 cassette? On batteries, no less? That's what **Edsearch** claims for their cassette winder. It's \$6.45, less batteries, from Edsearch, Dept. A, 6 East 43rd St., New York, N.Y. 10017.

**C.** Tired of hunting around for the proper sized nutdriver or screwdriver? Here's a set from **Xcelite** that's quite complete, and has an injection-molded case with stay-closed locks and stand-up base. Contains 5 nutdrivers, 3 slot-head screwdrivers, and 2 Philips type drivers. About \$6.00.

**D.** There's nothing like the right tool for a tough job, as anyone who's fought with a retaining ring will tell you. You may not come up against one of these very often, but you'll probably save one or more fingernails and a lot of time if you have **Jensen's** retaining-ring plier set. It will handle rings from  $\frac{3}{8}$  to  $1\frac{1}{2}$  in., both internal and external. Interchangeable tips come in three sizes and in straight, 45°, and 90° angles. Just \$7.95, postpaid, from Jensen Tools, Dept. A-11, 4117 No. 44th St., Phoenix, Ariz. 85018.

## Under \$20.00

**E.** Every tape enthusiast needs a tape splicing block. Here are professional models in duraluminum from **Nortronics**—QM-311 for  $\frac{1}{4}$  in. tape, QM-312 for 0.150 in. cassette tape, and QM-313 for  $\frac{1}{2}$  in. video and audio tape. A single-edge stainless steel cutting blade and 10 splicing tabs are included with each block. \$12.00. A welcome gift, though not pictured, is Dr. Harry F. Olson's *Modern Sound*

*Reproduction*, from Van Nostrand, which shows today's newest and most important elements, systems, and accessories used in high quality sound reproducing equipment, along with methods and applications that help achieve high levels of excellence and performance in sound reproduction.

## Under \$100.00

**F,G.** Headphones assure good listening without disturbing others. The **Suporex PRO-B VI** dynamic phones feature a two-way system in each earcup and a clothing clip, for attachment to belt or pocket, to take up the strain if you move too far from the receiver. The **Telex Studio I** phones are also dynamics and have slide volume and tone

controls in each cup. Both have adjustable cushioned headbands. **Suporex**, \$60.00; **Telex** \$69.95.

**H.** Designed with the busy executive in mind, the **3M/Wollensak Model 4350** cassette recorder features memory rewind and built-in condenser microphone. It will operate on D cells, car or boat battery, or household current. Other features include automatic shut-off, remote control, and pause. Price: \$99.95.

**I.** Fold a speaker together is what **National Tel-Tronics** wants you to do with its pre-fab speaker enclosures. Two and three-way systems are available and response is specified as 20 to 20,000 Hz. Assembly time for the kit is said to be just 12 minutes. Prices



are \$69.95 for the three-way and \$59.95 for the two-way.

**Over \$100.00**

**J.** A great present for the student away at college, **STAK** modular audio components can also solve a space problem at the vacation cottage or a decorating problem at home. The basic sound system consists of four stackable 18-in. cubes and includes an AM/FM stereo receiver, an 8-track player, BSR changer, and two speaker systems. Price is \$275.00. Also available are a three-piece coffee table sound system at \$300; lighted module, \$40.00; book module, \$19.95, and three-drawer unit for \$44.00.

**K.** A new, low-priced addition to the **Marantz** receiver line is the Model

2010 AM/FM stereo receiver which boasts 20 watts rms power over a 40 to 16,000 Hz bandwidth with 8 ohms load. Both IM and THD are specified as below 0.9%. Features include tape monitoring and main/remote speaker switching. Price: \$199.95.

**L.** A super gift for the professional sound man is the **Brüel & Kjaer 2209** impulse sound level meter, which has *everything* desirable in a single, portable precision measuring instrument. Complies with all existing standards for impulse and precision meters. Has 20 scales, four weighting scales or linear response, slow, fast, impulse, impulse hold, or peak hold response adjustment, plus many other features. \$1450.00.

**M.** If you professional recordists are

thinking about buying yourself a present this year, take a look at **TEAC-TASCAM'S Model 10** mixing console, an eight-in., four-out unit. Includes 8 input modules, 4 sub-master modules, a master module with straight-line fader, and four 4-in. VU meters with fast-acting peak indication. Each input has a 3-position input pad, a feedback-type mic attenuator, a line attenuator, a 3-position input selector, hi- and lo-pass filters, hi-, mid-, and lo-band equalizers with frequency selection, plus other features. The board is wired to accept four additional input modules, and optional plug-in modules include talkback, remote transport control, quad panner with joystick controls, and headphone monitor panel. Price: \$1,890.00.

# Equipment Profiles

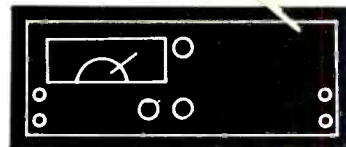

Revox A77 Dolby Tape Recorder .....	56
Sony TA-2000F Preamplifier .....	60

Empire 7500M Speaker System .....	64
Fairfax FX-300 Speaker System .....	66



## Revox A77 Dolby B Stereo Tape Recorder

### MANUFACTURER'S SPECIFICATIONS

**Tape Speeds;** 7½ and 3¾ ips, ± 0.2%. **Motors:** Three, electronically governed capstan motor, electronic speed change. **Wow and Flutter** (weighted): Max. 0.08% at 7½ ips; max. 0.1 at 3¾ ips. **Operating Position:** Horizontal or vertical. **Frequency Response:** 30-20,000 Hz +2, -3 dB at 7½ ips; 30-16,000 Hz +2, -3 at 3¾ ips. **Distortion at Full Modulation, 1000 Hz:** Max. 1½% at 7½ ips; 2% at 3¾ ips (with Dolby). **Signal to Noise Ratio:** Better than 58 dB at 7½ ips, better than 56 dB at 3¾ (w. Dolby) **Oscillator Frequency:** 120 kHz. **Power Supply:** Electronically stabilized. **Tape Spool Diameter:** Max. 10½ in. **Dimensions:** 16¼ in W, 14¾ in. H, 8¾ in. D, (over controls). **Weight:** 34 lbs. **Price:** \$859.00.

Whatever we said about the original Revox A77 in October, 1968, could well be repeated here, except that this model is better—being Dolby equipped. There are a few minor differences in appearance and a few in the mechanism itself. The upper portion of the unit—behind the tape reels—now has a stainless steel front over the plastic main panel, whereas the original was dark gray plastic. The lower portion of the first model was brushed stainless steel, while the current model has a dark gray plastic panel. There are two toggle switches below the controls—the one on the left switches the Dolby circuit in or out in both record and play modes, and the one at the right switches in or out a filter to eliminate interference from stereo multiplex circuitry.

The original machine had a pair of push-push switches to cut off power to the spooling motors and to disconnect the input to the power amplifiers (when included). These have been eliminated and in their place are the two Dolby calibration controls. The monitor-selector switch formerly had three positions for INPUT, tape (NAB) and tape (TEC). The TEC position has been replaced by a CAL position which turns on the calibration oscillator for the Dolby circuitry and enables the adjustment of the proper levels for correct Dolby operation.

The solid tape guide post has been replaced by a spring-loaded guide post to further eliminate flutter due to varying tape tension in the feed reel, and the left tape guide—formerly a solidly fixed non-rolling roller—is now actually a roller. The right tape guide is still fixed.

The space provided in the earlier model for plugging in the two output amplifiers is now occupied by the Dolby processors, so the unit can not be used to drive speakers, and of course, the cut-off switch is not needed. Brake tension has been reduced to permit editing while the machine is in the stopped position.

But enough of this comparison with the older machine—most readers will not have access to the October, 1968 issue, so it is desirable to start from scratch in describing the machine.

Transport operation is controlled by five pushbuttons at the left side of the control panel—FAST REWIND, FAST FORWARD, PLAY, STOP, and RECORD, the latter a red button which must be depressed at the same time as the PLAY button to put the machine into the record mode. Below these are two controls combined with concentric switches. The left knob controls playback level, the right one the balance. The left switch, actuated by a clear plastic disc at the base of the knob, has four positions—STEREO, CH I, CH II, and MONO. The right switch is marked TAPE, INPUT, and CAL.

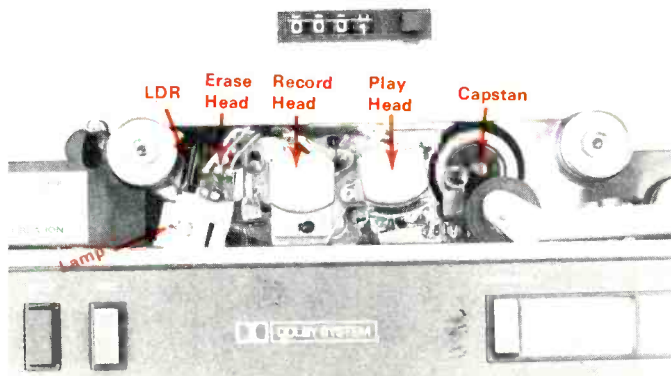

**Fig. 1**—Head assembly, with unshielded erase head, record head, and shielded playback head. No pressure pads are used, but the shield in front of play head is raised when machine is in record and play modes. Light-dependent resistor and illuminating lamp are visible just to the left of the erase head.

# BASF jamproof cassettes.

Now all BASF cassettes feature jamproof special mechanics.\* The most significant design breakthrough in the cassette marketplace today. Prevents jamming of invaluable recordings. Eliminates wow and flutter. Prevents tape edge dropouts.



Finally, a cassette with 100% mechanical reliability. Buy BASF Cassettes with jamproof special mechanics.

For the BASF dealer nearest you, write BASF SYSTEMS INC, Bedford, Massachusetts 01730.

Tension spring in C120's prevent jamming due to tape looping.

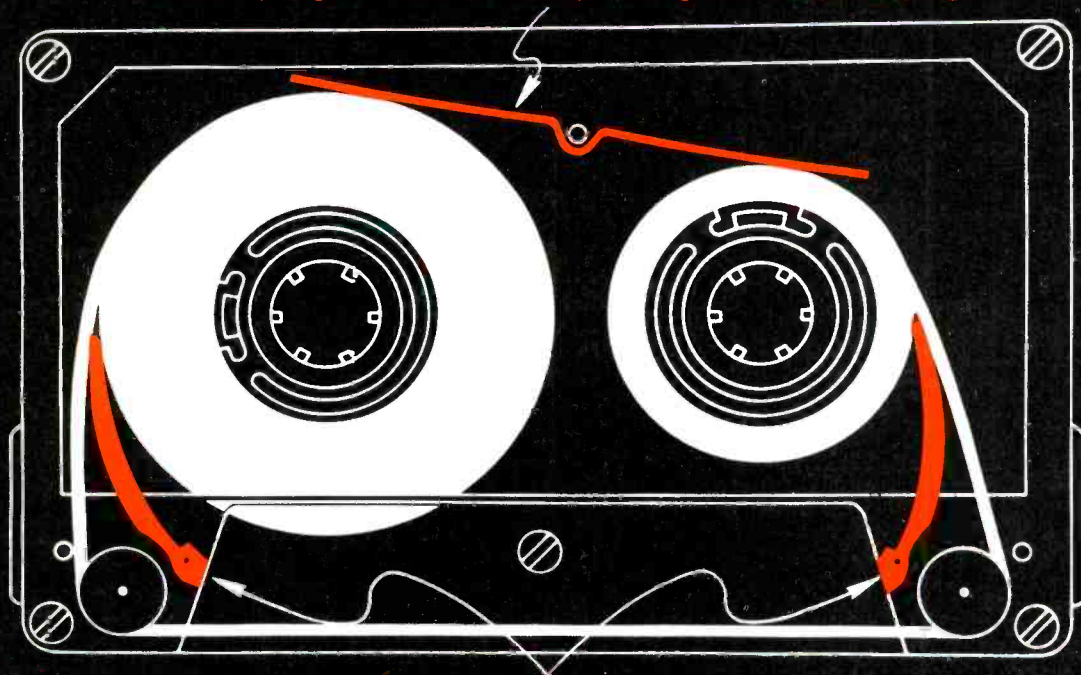

Two precision guide-arms insure smooth precise winds to eliminate jamming.

\*Patent Pending

Check No. 57 on Reader Service Card

Audio/Video Products



At the right are the two VU meters, flanked by two red push-push switch buttons to select the channel to be recorded, and below the meters are two more knob/switch combinations. The knobs control the recording levels for the two channels while the five-position switches select the source—two impedances for microphones, radio, auxiliary, and a cross-feed position for introducing echo or for sound-on-sound recording. To the far right is a switch operated by a bar knob to control power and speed, with two positions for each speed to compensate for different reel sizes. Above this switch is a power-on pilot light, not actually necessary since the meters are illuminated continuously when power is on, with a red light in the meter scale to indicate the channel(s) recording.

Between the two sets of controls are three phone jacks—one for headphone monitoring with conventional (but high impedance) phones, and the other two for microphones for the two channels. Above the control panel is the tape-path shield—a plastic strip which swings down out of the way for threading. The reel turntables are at the upper part of the front panel, with spring-loaded sleeves which hold the reels in place on the spined spindles. Between the reels is a 4-digit counter, which resets by a pushbutton.

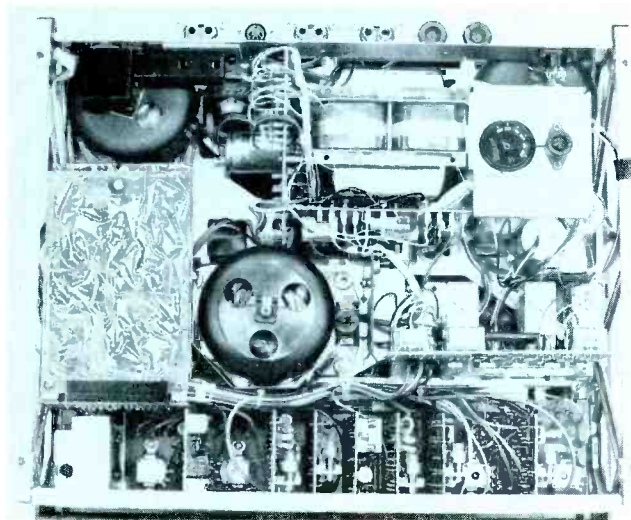

**Fig. 2**—Rear view of the Revox A77 removed from its case. Fuse and line-voltage selector switch are at upper right. The Dolby PC boards are at center left, next to the capstan motor with the tachometer head immediately to the motor's right.

Along the top at the rear are the connectors for inputs and outputs—a 10-terminal DIN socket for the remote control, with its dummy plug, two holes where the speaker jacks were in the original model, a pair of phono receptacles for AUX inputs, another pair for microphone inputs, (duplicating the phone jacks on the front panel), a 5-terminal DIN socket for RADIO input and output for direct connection to many amplifiers and receivers, and another pair of phono receptacles for outputs. These are followed by a receptacle for the power cord.

The unit is constructed on two cast end trusses which provide a remarkable solidity to the chassis. The several modular plug-in boards are secured along the lower part of the rear with all adjustable controls accessible from the bottom through a cover plate in which all the holes are punched for access, but covered by a paper on which the controls are labeled. The playback modules each have two adjustments—one for output level, and one for the bias trap. The record amplifiers each have five adjustable controls—equalizations for the two speeds, level, meter cali-

bration, and bias trap. The oscillator module has four adjustments—bias for the two speeds on channel I, and the same for channel II.

Above the electronics modules is the relay panel on which are located the three relays which control tape motion. The capstan motor is further to the left (viewed from the rear), and the Dolby processing circuit boards are at the left of the motor. Above are the two spooling motors and the brake system, and between them is the power transformer and the regulating panel. One additional relay is located on the module which contains the dummy load that replaces unused heads to maintain a proper load on the oscillator when recording on only one channel. The Dolby processing circuit boards apparently have no servicing adjustments.

### Operation

The tape is threaded over the spring-loaded post and under the guide roller, then between a light and a light-dependent resistor. When the tape is in place, the light is shaded from the LDR and operation is normal. When the end of the tape is reached, the light energizes the cell and that acts on a two-transistor circuit which opens the holding circuit for any relay that happens to be energized. The complete relay circuit is rather complicated, but well protected against noise getting into the signal circuits (from making or breaking contacts) by numerous diodes.

The record switching makes it possible to mix two inputs onto one channel in mono, or to record on either channel alone, or on both in stereo. In addition, the output from one channel may be fed to the input of the other for sound-on-sound recording or for echo effects if desired. The output switching provides for the output of either track onto both outputs, or of both tracks onto both outputs (mono), or with the two tracks separate, for stereo. The machine is thus exceptionally flexible in operation and all controlled from the front panel.

The electronic speed control for the capstan motor employs nine transistors. The last stage—a power type—varies its shunting effect across a bridge rectifier in the a.c. line feeding the motor depending on the frequency of a signal picked up by a tachometer head (similar to a recording head) which "reads" the frequency of a series of notches milled into the external rotor of the capstan motor. This frequency is 1600 Hz at 7½ ips (800 at 3¾) and feeds a discriminator controlling the power transistor, which varies the motor voltage from about 60 to 100, and thus acts to maintain exact speed by this very fast-acting servo arrangement. (It requires one and a half pages in the service manual, together with three small diagrams and a two-page full schematic, to describe the operation of the motor control circuitry. Suffice that it does work, and that the motor voltage can be traversed between 0 and 130 volts with only a 3-Hz change in the 1600-Hz tachometer frequency. Line-voltage variations of 20 per cent will cause a speed change of less than  $\pm 0.04$  per cent, and changing the supply frequency from 60 to 50 Hz will cause a motor-speed change of less than 0.05 per cent.

The spooling motors operate on 55 volts in the large-reel position of the power switch, and on 42 volts in the small-reel position. (The feed reel actually operates on 6 volts less than those values.) Both operate on 105 volts in the fast-wind positions.

### Performance

The average recorder user knows little and cares less about the "innards" of his machine, but this more or less detailed description of the Revox is given to show the reader the precision with which the machine has been engineered and

# FREE RECORDS...

Give Audio Magazine this Christmas and we'll send you a FREE stereo album for every subscription you order.



It's Christmas #10040. A medley of popular holiday songs featuring Liberace, George Wright, Anita Kerr Singers, and more.

Now's the time to take advantage of this special one-time offer. Because from now until Christmas we'll give you a free record album of your choice when you give a gift subscription to Audio Magazine.

Order one gift subscription—get one record!  
Order two gift subscriptions—get two records!

ORDER AS MANY AS 7 GIFT SUBSCRIPTIONS AND GET ALL SEVEN OF THESE GREAT HOLIDAY ALBUMS RECORDED BY THE COUNTRY'S TOP ENTERTAINERS.

If you already subscribe to Audio then just extend your subscription for one more year to be eligible for your free record.



LOOKING FOR THE PERFECT CHRISTMAS GIFT THIS YEAR... LOOK NO FURTHER, IT'S AUDIO BY FAR!



Tis the Season #10874. Original renditions of holiday favorites by Mahalia Jackson, Charlie Byrd, Bobby Vinton, Robert Goulet, Jerry Vale and more.

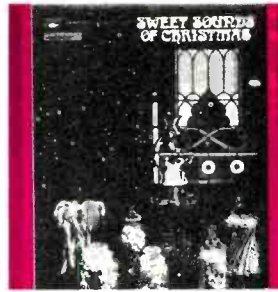

Sweet Sounds of Christmas #10875. Soft and gentle Christmas favorites with Pat Boone, Eddie Fisher, Billy Vaughn, The Mills Brothers and more!



Country Christmas Favorites #10876. Good listening holiday melodies with Ray Price, Tammy Wynette, Marty Robbins, Johnny Cash, Lynn Anderson and more.



Christmas Greetings #1433. The best of Christmas in one great album with the Mormon Tabernacle Choir, The Philadelphia Orchestra, Ken Griffin and Eddie Layton to name a few.



A Country Christmas #1434. Old favorites, country style by leading artists. Burl Ives, Jimmy Dean, The New Christy Minstrels, Stonewall Jackson and more.



Have a Happy Holiday #1432. Featuring the New York Philharmonic, Ray Conniff, Andre Kostelanetz, Steve Lawrence and Eydie Gorme, Percy Faith and more greats in popular holiday tunes.

Renew my subscription for 1 year. \$6.00.

Send me FREE Record # \_\_\_\_\_

Name \_\_\_\_\_

Address \_\_\_\_\_

City \_\_\_\_\_ State \_\_\_\_\_

Zip \_\_\_\_\_

Check or money order enclosed.

Charge Credit Card # \_\_\_\_\_

American Express  Diners Club

Master Charge Bank # \_\_\_\_\_

Exp. Date \_\_\_\_\_

Bill me.

(Avoid delays with your subscription. Gift records will be shipped when subscription payment is received.)

## Send gift subscriptions to:

AU112

Name \_\_\_\_\_

Address \_\_\_\_\_

City \_\_\_\_\_ State \_\_\_\_\_ Zip \_\_\_\_\_

Send FREE Record # \_\_\_\_\_

With Gift Subscription  To me.

Name \_\_\_\_\_

Address \_\_\_\_\_

City \_\_\_\_\_ State \_\_\_\_\_ Zip \_\_\_\_\_

Send FREE Record # \_\_\_\_\_

With Gift Subscription  To me.

Name \_\_\_\_\_

Address \_\_\_\_\_

City \_\_\_\_\_ State \_\_\_\_\_ Zip \_\_\_\_\_

Send FREE Record # \_\_\_\_\_

With Gift Subscription  To me.

Name \_\_\_\_\_

Address \_\_\_\_\_

City \_\_\_\_\_ State \_\_\_\_\_ Zip \_\_\_\_\_

Send FREE Record # \_\_\_\_\_

With Gift Subscription  To me.

AUDIO MAGAZINE 134 N. Thirteenth Street Philadelphia 19107

built. But still, perfection in design and construction must be reflected in performance or the user will not be satisfied with his purchase.

As we said about the original A77, it was one of the finest machines we had ever encountered. We could also say that about the Dolby B model. We ran a number of frequency-response curves on the machine at levels from 8 dB below indicated "0" to 40 dB below. (It is standard practice to run frequency response curves at least 20 dB below the indicated 0 to avoid overloading at the frequency peak of the recording equalization.) This variation was done to determine how the Dolby system functioned. At none of these levels did the deviation from "flat" exceed the specifications—a remarkable feat, in our opinion. With the Dolby and filter switches off, the response at 7½ ips was within  $\pm 1.5$  dB from 20 to 20,000 Hz at the -20 recording level. At -8, there was a definite rolloff above 15,000 Hz, but only to 5 dB at 20 kHz. With Dolby and filter switches in, response was equally flat at -20 except for a rolloff above 17,000 Hz, probably due to the action of the filter. With only the Dolby switch on, there was never a variation more than  $\pm 2$  dB from flat from 20 to 20,000 Hz at any level from -15 to -40. Superb performance in frequency response. Since the machine was indicated as being adjusted for Scotch 203, that is the tape we used for all measurements.

Wow and flutter were measured, both from a standard tape and on a record-and-play basis. Wow—that below 6Hz—measured less than 0.02%, while flutter—between 6 and 250 Hz—was 0.06% at 7½ ips and 0.08% at 3¾ ips. Signal-to-noise measured 53 dB unweighted, and 62 dB weighted below the 3% distortion point, which was at +8 recording level (for 1000 Hz). We also measured distortion at several other frequencies and found the same figure throughout. These figures were at 7½ ips, with only slightly differing figures for 3¾.

Using the Heathkit IB-101 frequency counter, we measured the bias oscillator frequency and found it to 122,508 Hz—close enough to the specified 120 kHz. Crosstalk between the two channels in mono was 62 dB, and in the stereo connection, 48 dB.

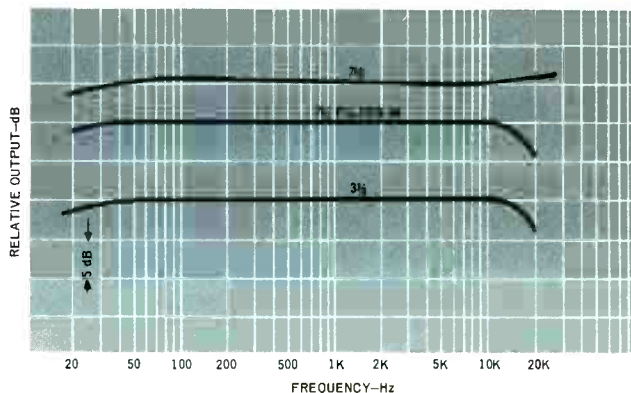

Fig. 3—Frequency response curves for the Revox A77 Dolby B. There was no difference in response between Dolby and non-Dolby operation over a wide range of recording levels. Response drops off slightly above 15 kHz when the filter switch is on.

Input signals required for 0 recording level were noted as follows: AUX, 15 mV; LO Mic (impedance 50 to 600 ohms) 0.15 mV; HI Mic (up to 100k ohms) 2 mV; Radio, 2 mV (33,000 ohms). Outputs were measured at a maximum of 2.5 V from a source impedance of 600 ohms at the output phono jacks, and 1.22 V from the radio receptacle with an impedance of 2500 ohms.

While the Revox A77 Dolby B is not inexpensive, it must be admitted its performance is exceptional, and if one wants quality, one must expect to pay for it. There is no doubt that the machine is well designed and well crafted. And there is no doubt that its performance is close to that of professional machines. In fact, many are in use in applications where the expense of the professional machines could not be met, and their performance has been uniformly excellent. From this description it must be discerned that we like the new Revox. Try it; you, too, will like it.

C. G. McProud

Check No. 60 on Reader Service Card



### Sony TA-2000F Preamplifier

#### MANUFACTURER'S SPECIFICATIONS

**Maximum Output Voltage** (less than 0.1% THD): 4.5 volts at 100k, 3.0 volts at 5k. **Harmonic Distortion:** Less than 0.03% at rated output. **IM:** Less than 0.05% at rated output. **Tone Controls:** Bass,  $\pm 10$  dB in 11 two-dB steps at 50 Hz; treble,  $\pm 10$  dB at 10 kHz in 11 two-dB steps. **Turnover Frequencies:** 250 and 500 Hz; 2.5 kHz and 5 kHz. **Filters:** High, 12 dB per octave above 9 kHz; low, 12 dB per octave below 50 Hz. **Sensitivities:** PHONO 1, 1.2 mV and 0.06 mV; PHONO 2, 1.2 mV; MIC 0.5 mV; high level inputs, 110 mV. **S/N Ratios:** PHONO, 73 dB (IHF "A"); high level input, better than 90 dB. **Headphone Output:** 0.5 V at 8 ohms, 5 V at 10 kilohms. **Main Outputs:** 1, 1 volt at 3 kilohms or higher; 2, 0.3 volts into 6 kilohms or higher. **Power Consumption:** 23 watts. **Dimensions:** 15¾ in. W, 5¾ in. H, 12¾ in. D. **Weight:** 19 lb., 8 oz. **Price:** \$549.50.

There are not too many top-quality preamps available these days, but the Sony TA-2000F must certainly be included among them. This is a later version of the TA-2000 which we reviewed back in December 1968. This is a very handsome looking unit with quite an array of controls. Reading along the top from left to right, these are as follows: volume control, then the two large VU meters, bass and tre-

ble switches, function selector, a lever switch for tuner and phono 1, and at the extreme right, the main input selector switch for two tape inputs, three auxiliaries, phono number 2 and microphone. The bottom row of controls include a lever switch for power on/off, three controls for headphone level, balance, and meter level, followed by three switches for the tone control turnover frequencies and a cancel posi-



# When Radio Shack features a stereo system on network TV and on the cover of their new catalog

... it  
better  
be  
good!



*Save \$50 On Our TV Special!*

We're showing off this all-Realistic system to millions upon millions of viewers this fall on NBC and CBS pro football telecasts. With that kind of exposure, every component in it had to be selected with painstaking care to deliver what we feel is best-for-the-money performance, style and features. We call it our "TV Special" on our 1973 catalog cover and it's very special indeed! Heart of this system is our STA-18 AM/FM Stereo Receiver, rated at 25 watts and boasting some very special features for its price — center-channel FM/signal-strength AM tuning meter, tape inputs and outputs with monitor, dial pointer that *changes color* to show FM stereo broadcasts. The bookshelf-perfect MC-1000 speaker systems have acoustic-suspension design, full 20-20,000 Hz response. Our LAB-12A 4-speed turntable handles your records with gentleness and precision. It is complete with a factory-installed base and diamond magnetic stereo cartridge. The cabinets are made of oiled walnut wood; everything supplied for instant easy hook-up. Stop in, see it and hear it at any one of our over 1600 stores in all 50 states. **Reg. Sep. Items Price \$279.90** **System Price 229<sup>90</sup>**



### FREE '73 Catalog

See What's Really New in Stereo, Communications, Hobby, Parts, Kits, Antennas, Tools, Much More. At Your Nearby Store or Write Dept.: AIX.

# Radio Shack

and ALLIED RADIO STORES  
A TANDY CORPORATION COMPANY  
P. O. Box 1052, Fort Worth, Texas 76107  
Check No. 61 on Reader Service Card

tion. Next is the high- and low-pass filter switch, a microphone input mixing control, and a lever switch for tape monitor. On the left side of the panel is the headphone jack, and on the right is an auxiliary input jack. The rear panel, shown in Fig. 1, has 25 input and output jacks with five separate input level controls, a two-position output level switch,



Fig. 1—Showing the rear panel.

and a phono impedance selector which gives a choice of 33, 47, or 82 kilohm impedances as well as 10 and 30 ohms at a higher sensitivity. Also on the rear panel are four a.c. outlets and a DIN socket.

In spite of the number of controls, the front panel does not look over-crowded—probably because of the use of lever switches. The tone controls are both step types and bass turnover frequencies are 250 and 500 Hz. These are selected by a lever switch mentioned above. The advantage of a 250 Hz turnover is the fact that the extreme bass can be lifted without affecting the 150 Hz to 300 Hz range, thus avoiding that “chesty” coloration on speech. Treble turnover frequencies are 2.5 kHz and 5 kHz which makes a very flexible arrangement when used in conjunction with the filter switch. This gives a 12 dB per octave roll-off above 9 kHz. The low frequency filter attenuates below 50 Hz—also at 12 dB per octave. The rest of the controls are fairly conventional—although few preamps boast the luxury of a headphone level control! The original 2000 had a simple two-position meter level switch but the new model has a three-position control, plus independent adjustment for microphone inputs. Probably more important innovations are the tone control turnover switches and the use of FETs for the “front-ends.” The other transistors are special high-voltage types, as a 150 volt line is used. The total number of transistors is no less than 96 of which 26 are FETs. And there are 15 diodes—a far cry indeed from the old tube amplifiers!

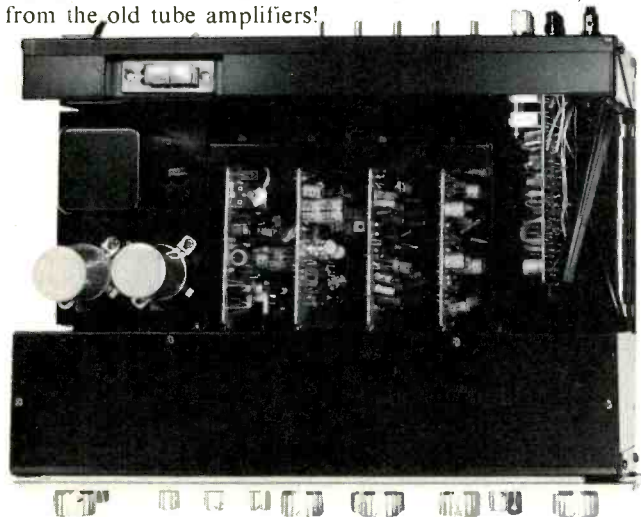

Fig. 2—Inside view.

## Measurements

Figure 3 shows the output voltage and distortion and it will be noticed that the distortion is insignificant below an output of four volts. Variation in the range from 40 to 10,000 Hz was negligible. Figure 4 shows the effect of the high- and low-pass filters and Figs. 5A and 5B show the tone control characteristics. The steps are approximately 2 dB each. Overall response with the controls at flat positions was 1 dB down at 10 Hz and 3 dB at 80 kHz. The square wave response, as might be expected, is excellent and the 40 Hz, 1 kHz, and 20 kHz waveforms are shown in Fig. 6. Phono input was just over 1 mV for 1 volt output, and the overload point was 280 mV—which is exceptionally good. One of the advantages of a high line voltage is the greater permissible voltage swing.

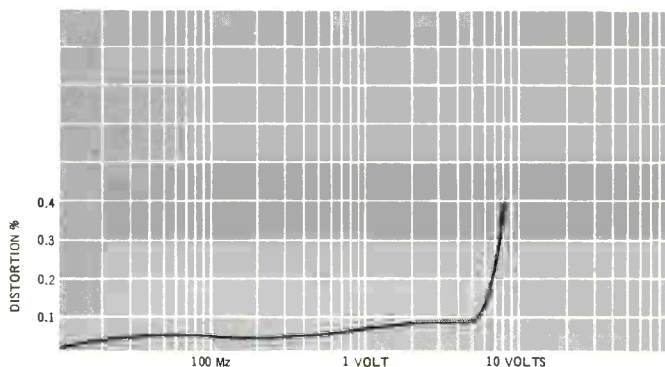

Fig. 3—Output voltage and distortion.

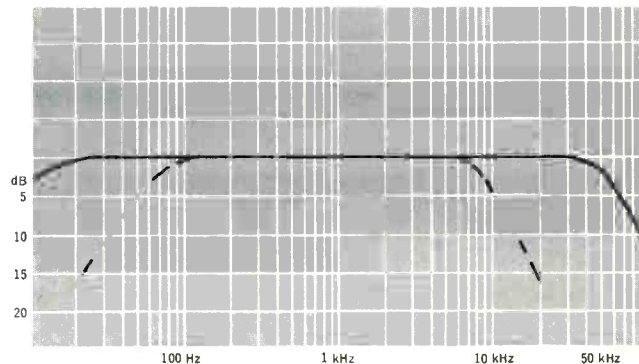

Fig. 4—High- and low-pass filter characteristics.

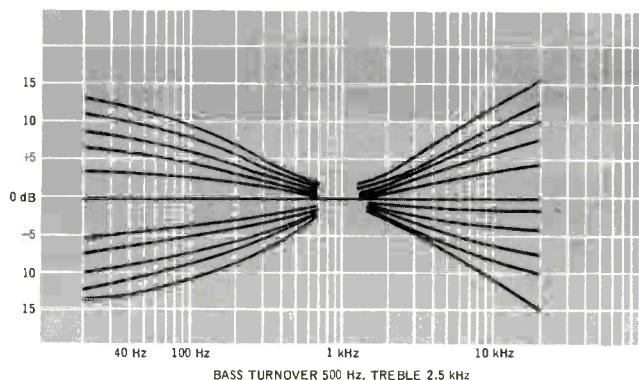

Fig. 5A—Tone control characteristics, bass turnover 500 Hz, treble 2.5 kHz.

Noise and hum, using the IHF “A” weighting, was -72 dB with input shorted. Tuner and other high level sensitivities were 85 mV for 1 volt output and noise level was -96 dB with inputs shorted and -76 dB unweighted. Microphone sensitivity was 1.4 mV and the noise level was -55 dB—rather better than the specification. So much for the measurements.

**"When EPI first asked me to endorse their speakers, I asked EPI to go take a walk."**

*- Buddy Rich*

"I'm not the kind of a guy that goes around endorsing every product somebody asks me to endorse. But when I heard an EPI speaker, I knew it was different. My drums sounded like my drums, instead of like a recording of drums. A sax sounded like a sax. The bass was a real bass. Trumpets were crisp and sharp. Cymbals were bright and clear. EPI loudspeakers are the best I've ever heard for true-to-life music. I own them and listen to them. I recommend them to my friends. If I were you, I'd buy them."

*Buddy Rich*

The true-to-life sound Buddy's talking about comes out of eight linear speakers, from \$55 to \$1000, made only by Epicure Products, Inc., Newburyport, Mass. 01950.

**The True-to-Life Sound of EPI.**

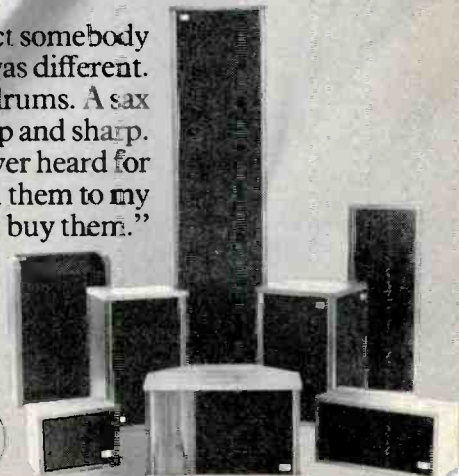

Check No. 62 on Reader Service Card

[www.amaadacradatistisortov.com](http://www.amaadacradatistisortov.com)

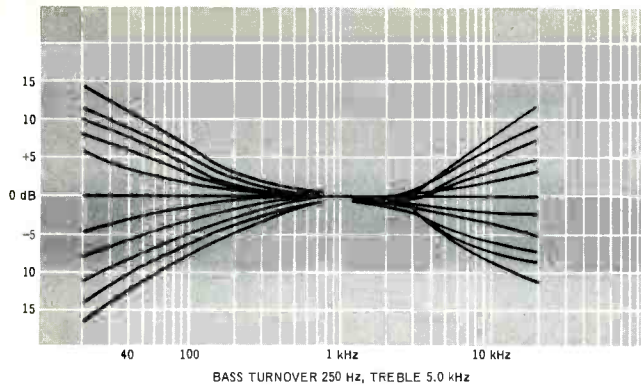

Fig. 5B—Tone control characteristics, bass turnover 250 Hz, treble 5 kHz.

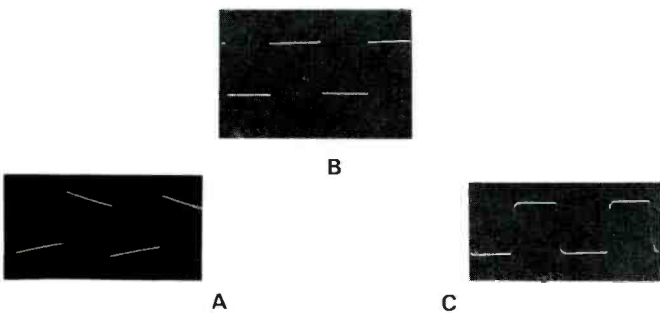

Fig. 6—Square wave response at A, 40 Hz; B, 1 kHz, and C, 20 kHz.

### Listening Tests

For most of the listening tests, the 2000F was paired with a Sony TA-3130, although some larger amplifiers were also used on occasion. Phono cartridges were an ADC 25 and a Decca Mk-5—one connected to each phono input. The three-way lever selector switch is featured in other Sony amplifiers, such as the 1130, and it enables a quick change to TUNER input, PHONO, or whatever is selected by the main switch. This was found to be most convenient and the output from a tape recorder was taken to one of the auxiliary inputs. Output from the tape monitor sockets was taken to a Sony 1000 decoder which, in turn, was connected to another amplifier supplying the rear channels. A Soundcraftsmen equalizer was connected between the preamp and main amplifier for some of the tests.

I must say the 2000F was a pleasure to use—in particular the choice of tone control turnover frequencies (something I have advocated for many years) is a most useful refinement. As a collector of old 78 records, I must confess I like a continuously variable low-pass filter but for most people the 9 kHz cut is a satisfactory compromise. The effects of tracing distortion, etc. can be minimized without sacrificing too much of musical value in the process. Incidentally, the “cancel” position for the tone controls produced no measurable effect on distortion—neither was there any discernible effect on square wave performance as high as 20 kHz but I suppose there are always those purists who feel there *must* be some kind of distortion or phase shift in a tone control system—even at a “flat” position. Summing up then, the Sony 2000F is recommended to those discriminating people who want a versatile, high performance preamplifier which can be used with a top quality power amplifier without degrading the result. It is a most complex piece of equipment, nicely styled and well made. It is not particularly cheap, but this kind of engineering just *has* to be expensive! T.A.

Check No. 64 on Reader Service Card

### Empire Model 7500M Loudspeaker System



#### MANUFACTURER'S SPECIFICATIONS

**System Type:** Three way; acoustic suspension. **System Components:** 15-in. woofer, 5-in. dome mid-range, 1-in. dome tweeter. **Crossovers:** 450 and 5,000 Hz. **Frequency Response:** 25-20,000 Hz. **Power Handling Capacity:** 100 watts. **Nominal Impedance:** 8 ohms. **Dimensions:** 20-in. diameter, 27-in. high. **Weight:** 75 lbs. **Price:** \$184.95 with imported marble top; \$169.95 with walnut finish top.

The Empire 7500M Grenadier loudspeaker system repeats the now familiar cylindrical column shape, topped off by a heavy imported marble disc, which makes the speaker look like a piece of fine furniture. Hidden behind a decorative bronze panel are the mid-range and high frequency radiators. The cast acoustic lens in front of the mid and high frequency domes helps to increase the normally excellent dispersion of these drivers.

The massive 15-in. woofer is mounted close to the floor and faces downward into a funnel-shaped loading plug. Bass frequencies radiate through eight roughly oval-shaped slots at the bottom of the cabinet. Crossover points are at 450 and 5,000 Hz, and a three-position slide switch, marked DECREASE, NORMAL, and INCREASE, is located next to the polarized speaker input binding posts on the bottom of the cabinet. The system is available in either walnut or oak finish and the marble top is optional, so the speaker can be purchased in an all wood finish at a savings of \$15.00 per speaker.

#### Measurements

For our measurements as well as the subsequent listening tests, we placed the treble switch in the INCREASE position. Measurement of impedance confirmed the manufacturer's

# HERE'S WHAT OUR CONSUMERS REPORT TO US!

Please list any suggested improvements, changes, or other comments:

One Hell of an improvement TO what I thought was a good sounding system. Purchased from HI-FI World City Mt. Pleasant State Ill. 60076

I thought my system was the best sounding system going, but this equipment makes it sound un-real. (Keep up good work) Purchased from Lafayette radio pennsauken State N.J. P.S. send any literature that you may have.

Winters Dictionary has a word that describes the 20-12 - SUPERLATIVE SYSTEM! Purchased from SOUND EX City WILLOW State PA

WOW!!! WHAT A CHANGE IN MY SYSTEM! EVEN MADE A REVIEW OUT OF IT Y'WIFE! Purchased from [unclear] City [unclear] State Co.

An excellent device - what my system needed for total versatility with son. Purchased from Frankfort Audio Club City Frankfort

Great device for... Purchased from [unclear] Shop City Dallas

IRRESISTIBLE! EVERY SYSTEM SHOULD HAVE ONE. Purchased from LEONARD RADIO City NYC

LEAVE IT ALONE - IT'S PERFECT! Purchased from J & J ENGINEERING City KOKOMO



**Soundcraftsmen** presents

the new component that is a "must" with every fine stereo system...

## the new Audio Frequency Equalizer guaranteed to improve any fine stereo system!

Now, in a few minutes, you can accurately "tune" the frequency response of your stereo system and room environment to a flat  $\pm 2$  db! All you need are your own ears and the 20-12 (with its step-by-step instruction record) to transform any stereo system and room environment into an acoustically-perfect concert hall! Or, to provide any special acoustical effects you desire! The 20-12 enables you to instantly compensate for frequency response variations, in system and room.

**\$299.50** includes walnut cabinet or rack mount for commercial installations

PATENT-PENDING design combines the best features of expensive commercial equalizers: Toroidal and ferrite-core inductor passive circuitry, plus active transistor circuits and active master level control circuits, provide accurate linear response in "problem" listening areas. Allows a full 24 db range of equalization for each of the 10 octave-bands per channel, plus an additional 18 db range of full-spectrum boost or cut to compensate for acute response non-linearities in the entire recording-reproducing process.

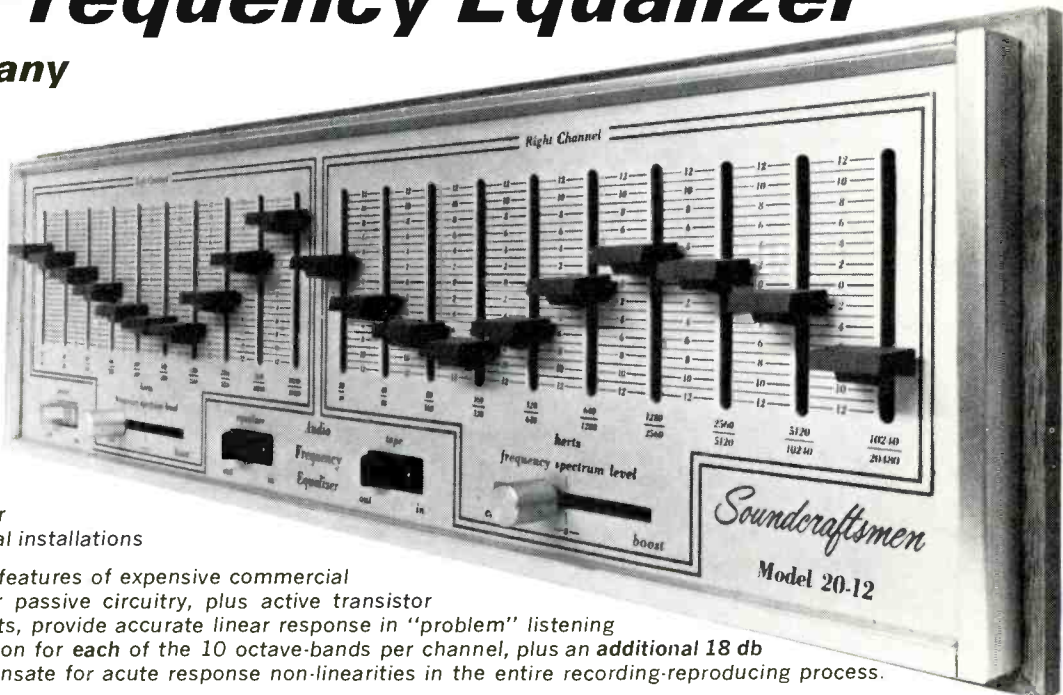

### ROOM EQUALIZATION, SPECIAL EFFECTS, PLAYBACK and RECORDING

**EQUALIZING FOR ROOM CHANGES:** For example, here are some factors that would call for definite changes in your Equalizer settings: (1) Draperies open or closed. (2) Sliding glass door open or closed. (3) Room full of people. (4) Seating arrangements changed. (5) Major changes in furniture arrangement. (6) Relocation of speakers. . . . **EQUALIZATION OF RECORDS:** You can compensate for old 78 record deficiencies (surface noise, absence of highs or lows, etc.) or favorite recordings that have never sounded quite the way you felt they should sound. . . . **COMPENSATING FOR RADIO STATIONS:** Some stations are noted for excesses in either low or high frequencies. Make out a Computone Chart for each of your favorite stations so that you can easily achieve the ideal tonal response each time you change stations. . . . **EQUALIZING TAPES:** Compensating for pre-recorded, or home-recorded, tapes that are under or overemphasized in certain frequency areas. . . . **CHANGING OVERALL BALANCE:** You can make up for many deficiencies in recordings to more

accurately duplicate the sounds of the original performance, or shape each curve to your own listening interests to greatly enhance your enjoyment of your recordings. . . . **SPECIAL EFFECTS:** You can boost or cut the loudness of a specific instrument or groups of instruments to obtain more pleasing instrumental balance or to add presence to a solo. . . . **IMPROVING RECORDING OF TAPES:** Use the Equalizer for tape dubbing, to create a near-perfect tape out of one that may have serious deficiencies. (Make your own corrected recording of records, station programming, or other tapes, and no further adjustment of the Equalizer will be needed for playback.) (See Operating Instructions). . . .

**COMPUTONE CHARTS:** After you have achieved the equalization of sound that you prefer use the Computone Charts, supplied with each Equalizer, to mark the settings, so that you can duplicate the settings easily.

## SPECIFICATIONS and SPECIAL FEATURES

**TOROIDAL** and ferrite-core inductors, ten octave-bands per channel.  
**FREQUENCY** response:  $\pm 1/2$  db from 20-20,480 Hz at zero setting.  
**HARMONIC DISTORTION:** Less than .1% THD @ 2 v., Typ: .05% @ 1 v.  
**IM DISTORTION:** Less than .1% @ 2 v., Typ: .05% @ 1 v.  
**SIGNAL-TO-NOISE RATIO:** Better than 90 db @ 2v. input.  
**INPUT IMPEDANCE:** Operable from any source 100K ohms or less - (any Hi-Fi Pre-amp, Receiver or Tape Recorder.)  
**OUTPUT IMPEDANCE:** Operable into 3K ohms or greater - (any Hi-Fi Amp, Receiver or Tape Recorder.)  
**CIRCUIT BOARDS:** Military grade G-10 glass epoxy.  
**RESISTORS:** Low-noise selected carbon-film.

**RANGE:** 12 db boost and 12 db cut, each octave.  
**MASTER OUTPUT LEVEL:** "Frequency-spectrum-level" controls for left and right channels, continuously variable 18 db range, for unity gain compensation from minus 12 db to plus 6 db.  
**MAXIMUM OUTPUT SIGNAL:** variable Master "frequency spectrum level" Controls allow adjustment of optimum output voltage for each channel, to exactly match amplifier capability, up to 7 v.  
**SIZE:** designed to coordinate with receivers, comes installed in handsome walnut-grained wood receiver-size case, 5 1/4" x 18" x 11", or rack-mount  
**WARRANTY:** 2-year parts and labor.

Soundcraftsmen: 1310 E. Wakeham Ave., Santa Ana, Cal. 92705 Ph: 714-836-8375  
 Check No. 65 on Reader Service Card

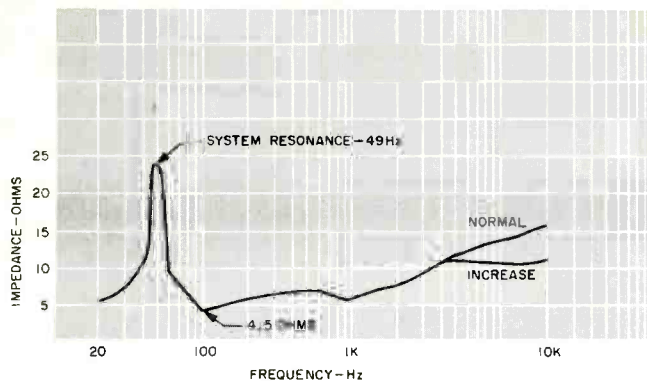

Fig. 1—Impedance of the Empire 7500M.

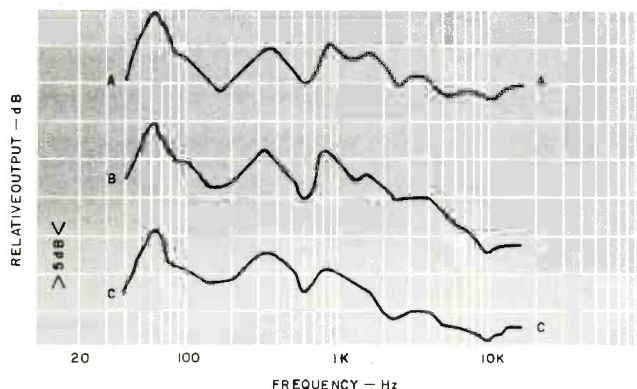

Fig. 2—Frequency response at A, on axis; B, 45 degrees off axis, and C, average of five positions.

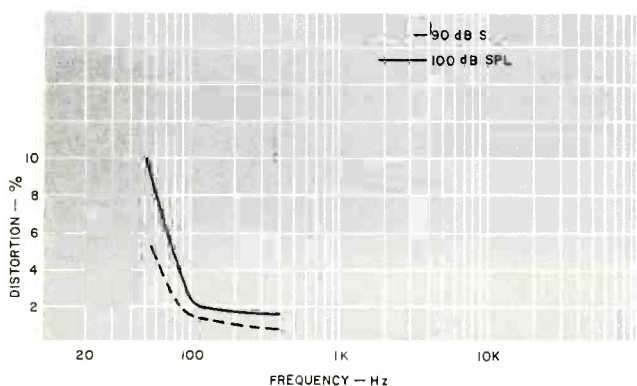

Fig. 3—Second and third harmonic distortion at two sound pressure levels. An input of 2.8 volts gives 90 dB.

specification of 8 ohms for the 7500. As Fig. 1 shows, impedance is 8 ohms or more throughout most of the range and dips only briefly to 4.5 ohms. Three frequency response curves are shown in Fig. 2; the bottom one, C, shows the total energy that the speaker radiates and is fairly smooth. The low frequency rise at 65 Hz is partly speaker and partly due to room effects. Figure 3 shows that distortion, even at high sound pressure levels, is quite low. As efficiency is on the high side, a rather modest 20-watt amplifier or receiver will do an excellent job of driving the speaker to levels approaching 100 dB. For rock fans, however, the speaker will take 100 watts and more in peak loads without complaints. The tone bursts of Fig. 4 show excellent transient response by this speaker.

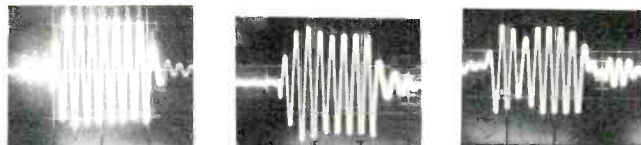

Fig. 4—Tone burst response at A, 100 Hz; B, 1000 Hz, and C, 10,000 Hz.

### Listening Tests

With the treble switch in the INCREASE position, most of the boost takes place in the region above 6000 Hz. The overall sound can best be characterized as being robust, with the mid-range on the full side. Treble is well dispersed and holds up quite well to 16,000 Hz. Low frequency performance can best be characterized as clear and very deep. The range and power of this speaker are certainly most impressive for a system of this size. Performance in the bass region is somewhat affected by the floor material. In our room we preferred standing the speaker on a deep pile carpet, well away from any wall. Since the speaker performs well under this condition and with its cylindrical shape and convenient height, it becomes a natural candidate for use as an end table, flanking a free-standing couch. Another advantage of the column form is that the speaker can be rotated to direct the high frequency energy either towards or slightly away from the listening area, as acoustics or personal preference dictates.

In conclusion, we might note that the Empire 7500M, in addition to being a rugged, efficient performer that blends into a variety of listening rooms, is something of a bargain at \$169.95 (without marble top) and merits serious consideration.

*Alex Rosner*

Check No. 60 on Reader Service Card

### Fairfax FX-300 Speaker System

#### MANUFACTURER'S SPECIFICATIONS

**System Type:** Two-way, ducted port. **Speaker Components:** Two; woofer, 10-in. cone type; tweeter, 3-in. cone type. **Nominal Input Impedance:** 8 ohms. **Frequency Response:** 24-20,000 Hz. **Maximum Input Power:** 40 watts. **Minimum Input Required:** 10 watts. **Dimensions:** 14 in. W., 10<sup>3</sup>/<sub>4</sub> in. D., 22 in. H. **Weight:** 26 lbs. **Price:** \$109.95.

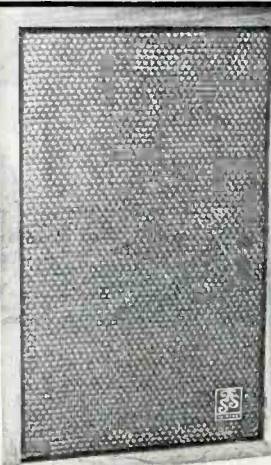

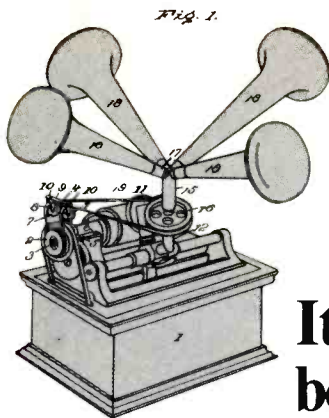

## It was 72 years before Frederick Myers' dream would become a reality.

Back in 1900, Frederick Myers dreamed that he could fill a room with dramatic music. But, he faced the same problem that plagued inventors for 70 years thereafter: the standing wave phenomena.

When placed in your home, every conventional speaker produces a fixed emission pattern of sound waves. These waves reflect from your walls to "add and subtract" from the true original signals. In this way, standing waves alter the true dynamics and reduce the "live qualities" of the music.

In 1971, the Leslie Speaker group of CBS applied for patents on special designs which—for the first time—effectively dealt with the standing waves. These patents are used exclusively in the Leslie Plus 2 Speaker system.

Here is what this breakthrough means to you. Now, you can hear music with a realism that is unmatched. You literally feel that you're in third row center of your favorite concert hall—no matter what part of the room you are sitting in.

Also, you can achieve this effect with either stereophonic or quadraphonic recordings!

For further information on this unique system, just send in the coupon below, or visit your authorized Leslie dealer. Sixty seconds of hearing the Leslie Plus 2 Speaker system will prove everything we say about it is true. Hear it for yourself ... soon!

**Leslie**  
SPEAKERS

Leslie is a registered trademark of CBS, Inc.



LESLIE PLUS 2 MODEL 430



LESLIE PLUS 2 MODEL 450

Electro Music  
CBS Musical Instruments, A Division of  
Columbia Broadcasting System, Inc.  
56 West Del Mar Boulevard, Pasadena, California 91105

Please send me additional information about the Leslie Plus 2 systems.

NAME \_\_\_\_\_

ADDRESS \_\_\_\_\_

CITY \_\_\_\_\_ STATE \_\_\_\_\_

There is now a wide choice of good loudspeakers in the \$100.00 class and one of the most recent contenders is the Fairfax FX-300 which costs \$109.95. It measures 22 by 14 by 10 $\frac{1}{4}$  inches and is finished in an oiled walnut veneer with an attractive matching grille cloth of brown and gold fabric. The bass unit is a 10 inch with half-roll surround and 1 $\frac{1}{2}$  inch voice coil. Magnet is a 8.5 ounce Alnico. The tweeter is a 4 inch cone type with closed back. Actual cone size is 3 inches as the flexible surround is quite wide. Crossover is about 1500 Hz but the variable HF level control begins to function at 700 Hz. Input connectors are binding-posts which are mounted on a recessed panel at the rear. The cabinet is well made and solidly constructed of 1 inch stock instead of the more commonly used  $\frac{3}{4}$  in. board. Unlike most systems

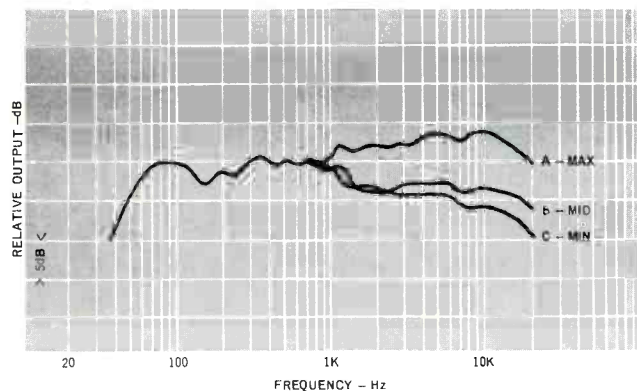

Fig. 1—Frequency response to one-third octave pink noise. A, high frequency control at maximum; B, at center, and C, at minimum.

in this category, the FX-300 is not totally enclosed but functions as a bass-reflex with a 4-by-2 $\frac{1}{2}$  inch tube vent placed at the front. The enclosure itself is filled with fiberglass.

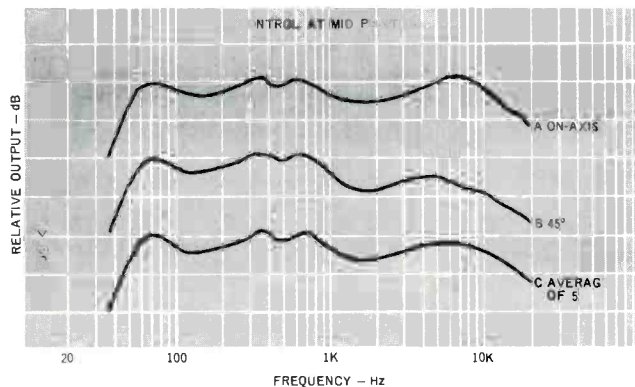

Fig. 2—Response at A, on axis; B, at 45 degrees, and C, an average of five positions.

### Measurements

The frequency response taken with one-third octave pink noise is shown in Fig. 1. Curve A is the response with the high frequency level control at maximum; Curve B with the control at center, and Curve C with it at minimum. Figure 2 shows the response on-axis, at 45 degrees, and an average taken at 5 positions. System resonance is 74 Hz and frequency doubling occurred at 60 Hz but only when driven hard with 12

watts input—above average. Distortion is shown in Fig. 3. 96 dB SPL corresponded to an input of 5 watts. Response to tone bursts was very good and can be seen in Fig. 4. The impedance curves are shown in Fig. 5, and it will be seen that the average value is around 15 ohms with the low point at 7.5 ohms. White noise performance was good with a slight mid-range coloration.

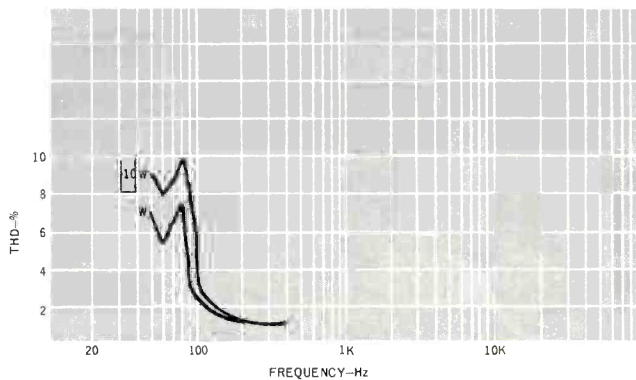

Fig. 3—Distortion at 5 and 10 watt inputs.

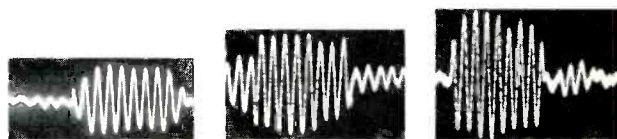

Fig. 4—Tone-burst response at A, 100; B, 500, and C, 5000 Hz.

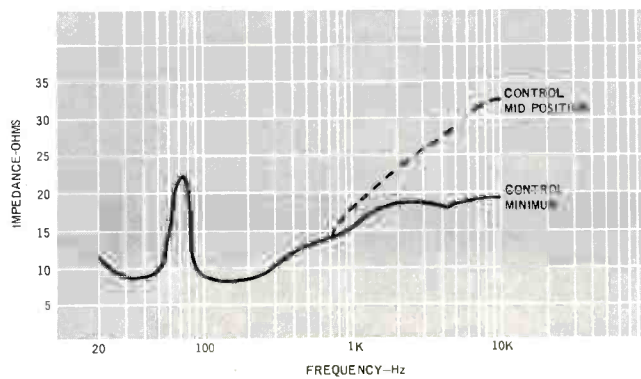

Fig. 5—Impedance curve. Low point is 7.5 ohms.

### Listening Tests

For our listening tests, we found the center position of the level control gave the best balance. Overall sound was clean and rather forward compared with our laboratory standard. Bass was sufficient for realistic organ reproduction in a medium-size room, and speech—always a good test—was relatively uncolored. Sensitivity was above average and a 20-20 watt amplifier would be more than adequate for most people. All-in-all, the Fairfax FX-300 shows a creditable performance and at its modest price, it is very good value for the money.

T.A.

Check No. 71 on Reader Service Card



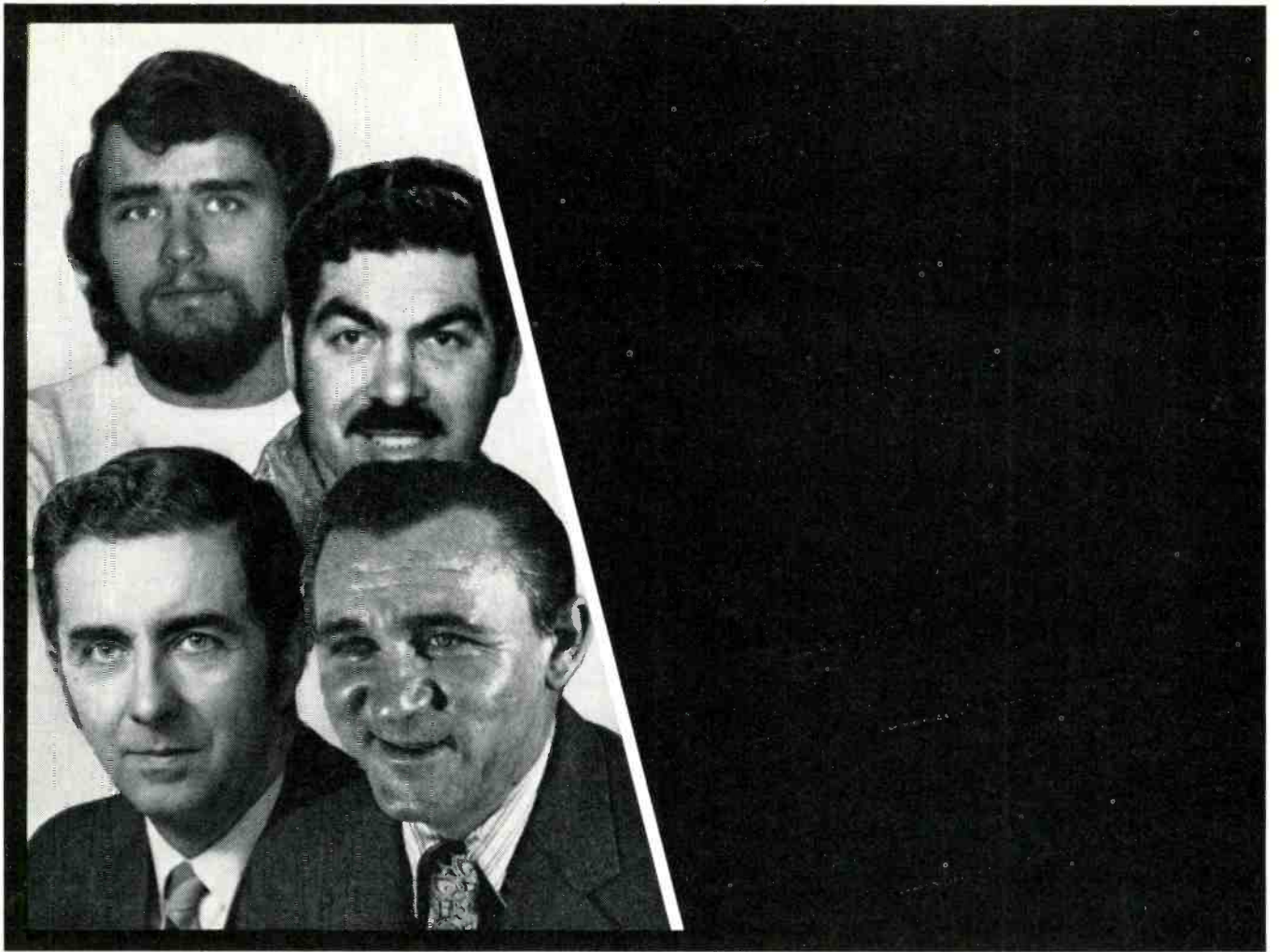

## Ask Bob. or Jerry. or Harry. or Harry



Meet four of the sound industry's most knowledgeable and authoritative "technical directors": Bob Kiernan, Jerry Grollnek, Harry McCune and Harry Warner. Their jobs? To raise the quality of sound reinforcement installations to the highest possible levels before today's super stars take the stage. And while Bob, Jerry, Harry and Harry each has his own special sound reinforcement techniques, they all have one thing in common: an absolute unwillingness to settle for anything less than *superb sound*—and, accordingly, an unreserved professional reliance on Shure microphones for all their assignments. Shure microphones, such as the *Unisphere* and *Unidyne*, provide *performance consistency* and natural sound. Their ruggedness is unsurpassed . . . their reliability is almost legendary.

Shure Brothers Inc.  
222 Hartrey Ave., Evanston, Ill. 60204  
Check No. 59 on Reader Service Card



# What's New in Audio



## Duotone SHP-1 headphones

This dynamic stereo headset comes complete with an 8-ft. cord and uses a standard 3-circuit plug. Padded cushion ear cups are featured. Price: \$14.95.

Check No. 110 on Reader Service Card



## Pilot 210 amplifier

This stereo amp offers 25 watts (rms) per channel (8 ohms, 0.5% THD). Response is 20 to 20,000 Hz  $\pm 1$  dB, and IHF power bandwidth is 20 to 25,000 Hz. Design features include complimentary symmetry, fused outputs, center channel output and out-board connection of main amp and preamp. Inputs include two each for phono and AUX. There are separate switches for main, remote, and reverse speaker operation. Also included are a front panel headphone jack and switched and unswitched a.c. receptacles. with walnut veneer cabinet. Price: \$159.90.

Check No. 112 on Reader Service Card

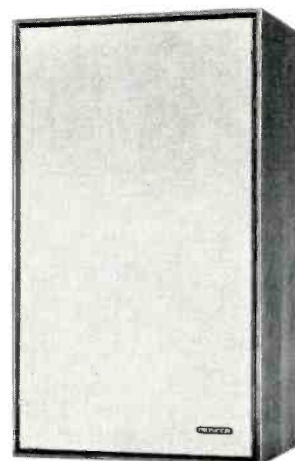

## Pioneer CS-E700 speaker system

Incorporating a 12-in. woofer, a 5-in. midrange, and a multi-cellular horn tweeter, this system is said to have a frequency response of 35 to 20,000 Hz. Separate level controls are located on the front baffle panel, behind the snap-out grille. Each control has three positions, each in 3 dB steps. Finish is oiled walnut. Price: \$189.00.

Check No. 114 on Reader Service Card



## Turner microphones

The new TC series of multi-port cardioid pattern dynamic microphones are designed for use in broadcast, recording, entertainment, and high quality PA applications. Top of the line is the TC10 (shown) which has a dual system of rear entry ports said to provide improved low frequency response together with a decrease in handling noise. Response is specified at 50-15,000 Hz, with a front-to-back ratio of -26 dB, and output is -55 dB ( $0=1$  mM/10  $\mu$  Bars). Impedance is 150 ohms. Price: \$225.00; other mics in the TC series are priced from \$130.00.

Check No. 111 on Reader Service Card



## Astrocom tape deck

The Model 407A open reel tape deck features relays, rather than solenoid-operated switches, for quieter operation, greater dependability, and longer life. The design incorporates three motors, with a hysteresis-synchronous type for capstan drive, four heads, erase, record, play, and reverse play. Automatic reverse play uses add-on conduction strips for sensing. Effects include sound-on-sound, sound-with-sound, and echo. Speeds are 7½ and 3-¾ ips. S/N is specified at 50 dB. Price: \$459.95.

Check No. 113 on Reader Service Card

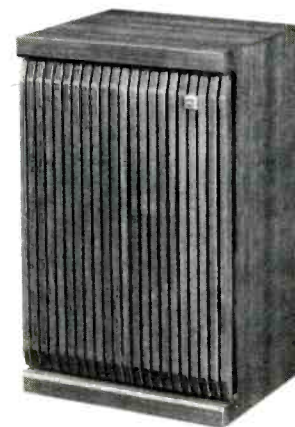

## Olson S-132 speaker system

This three-way acoustic suspension system features an acoustic lens built into the removable wood grille. Components are a 10-in. woofer, 5-in. midrange, and a 2-in. tweeter, coupled through an L-C crossover. Specified frequency response is 25 to 20,000 Hz; power capacity, up to 60 watts; impedance, 8 ohms. Price: \$159.98 each, \$300.00 per pair.

Check No. 115 on Reader Service Card

# sound as clear as light

An adventure in sound clarity is the promise of ESS. Clean, clear, transparent sound that brings a new awareness of the detail encoded in modern recording mediums.

Acceleration is the decoding key. The more rapidly a speaker diaphragm initiates motion the less information is lost in transfer, and ESS loudspeakers are designed for highest acceleration. From thunderous bass through delicate highs ESS acceleration recreates sound as clear as light.

All ESS models embody this exciting purity of definition, from the uncompromised TRANSTATIC through the bookshelf TEMPEST. Discover ESS clarity—your ESS dealer will be happy to shed all the necessary light on the subject.

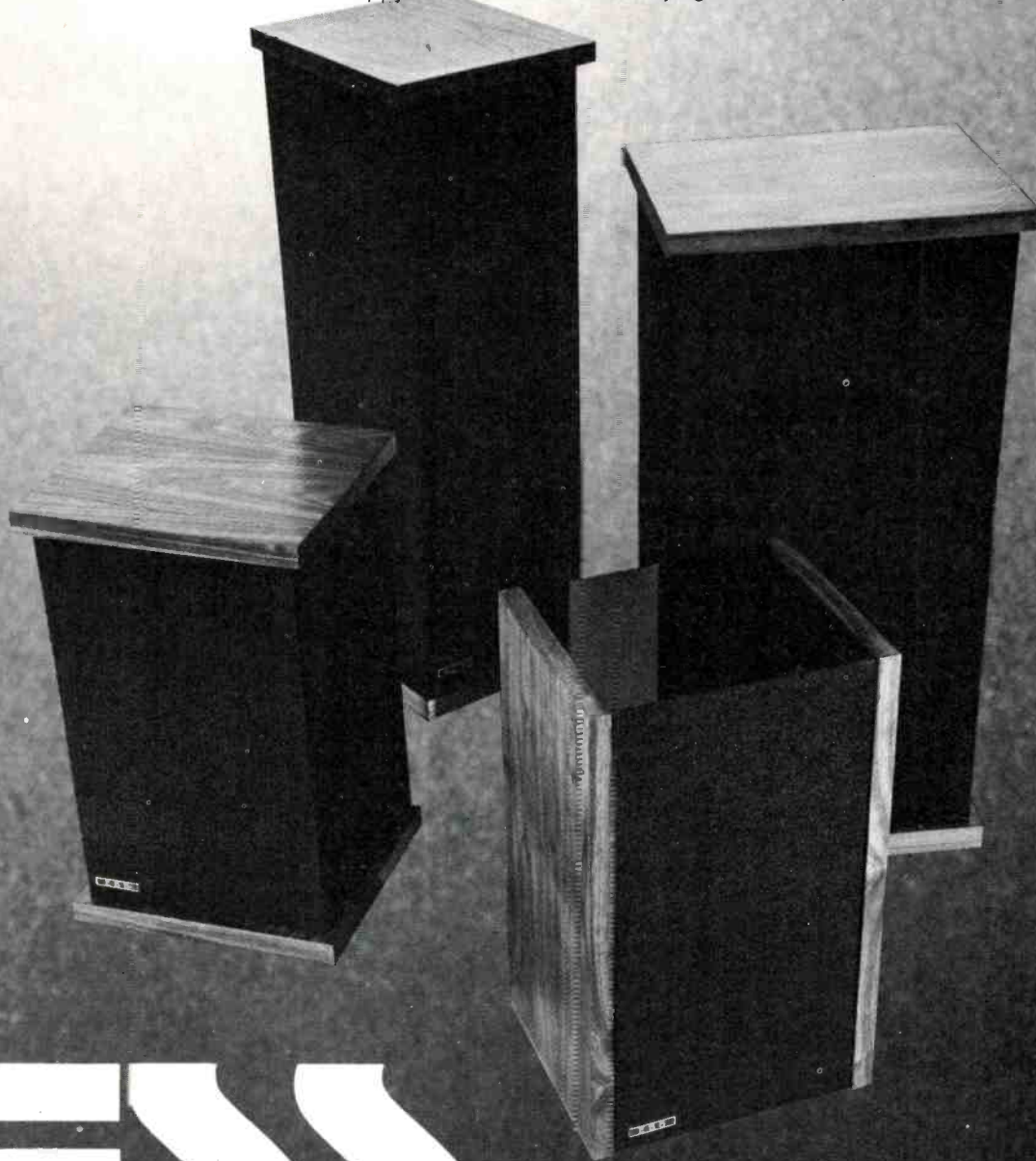

# ESS

**ELECTROSTATIC SOUND SYSTEMS, INC.**  
sacramento, california

Check No. 69 on Reader Service Card

# THE WORKBENCH



**Russound/FMP SQB-2**  
**Multi-Play switch**

Many older receivers and amplifiers don't have facilities for remote speakers, and when they do a good proportion present the user with a MAIN versus REMOTE choice so that loading is always high enough to be tolerable to the amplifier. But the enthusiast will quickly find that he wants to have both main and remote speakers playing—and if he doesn't, his wife will. To complicate matters, she may want to have another set playing in still a third location. (We won't discuss the amplifier's reaction to this idea!)

It's easy enough to hook up two speaker systems in parallel or series/parallel, but with a third set things start to become a little sticky. Even if you stick to two sets, there really isn't much latitude for switching ON and OFF, and it really doesn't make much sense to have the patio speakers on with a foot

of snow out there. And if you just pull the speakers out of the hook-up, you've destroyed that impedance balance you wanted.

To handle these problems, the SWB-2 has its circuitry arranged so that it can handle any combination of three sets of speakers at once and still present the amplifier with at least a four ohm load. In addition, this black box has a dual input system allowing two amplifiers to be hooked up to it. This can be used for A-B tests of two receivers (or amplifiers), switching between separate sources (a simple way to bring the TV output into the system), etc.

The back of the SWB-2 has the 10 two-screw terminals necessary to accommodate the wiring up of three pairs of speakers for output and two amplifiers for input. In practice, these terminals are somewhat closely spaced and would benefit

from a barrier strip since, as the instruction sheet mentions, "a short circuit at the switchbox . . . could cause damage to the power amplifier." Marking the various terminals as to Amp A or B, Left or Right speaker system, and signal or ground would speed installation, as would use of screw-type or spring-loaded posts rather than terminals which require a screwdriver.

After checking for possible shorts, we put the SWB-2 through its paces and it worked "as advertised." Controls were juggled to switch back and forth between a moderately powerful integrated amplifier and a "lightweight" receiver—no problems. Speaker pairs were switched from completely off to all three on and again there was no trouble. Switching was positive—click on, click off. If you need a switch box, consider this one: it works. Price: \$13.20 postpaid. *E.P.*

Check No. 72 on Reader Service Card

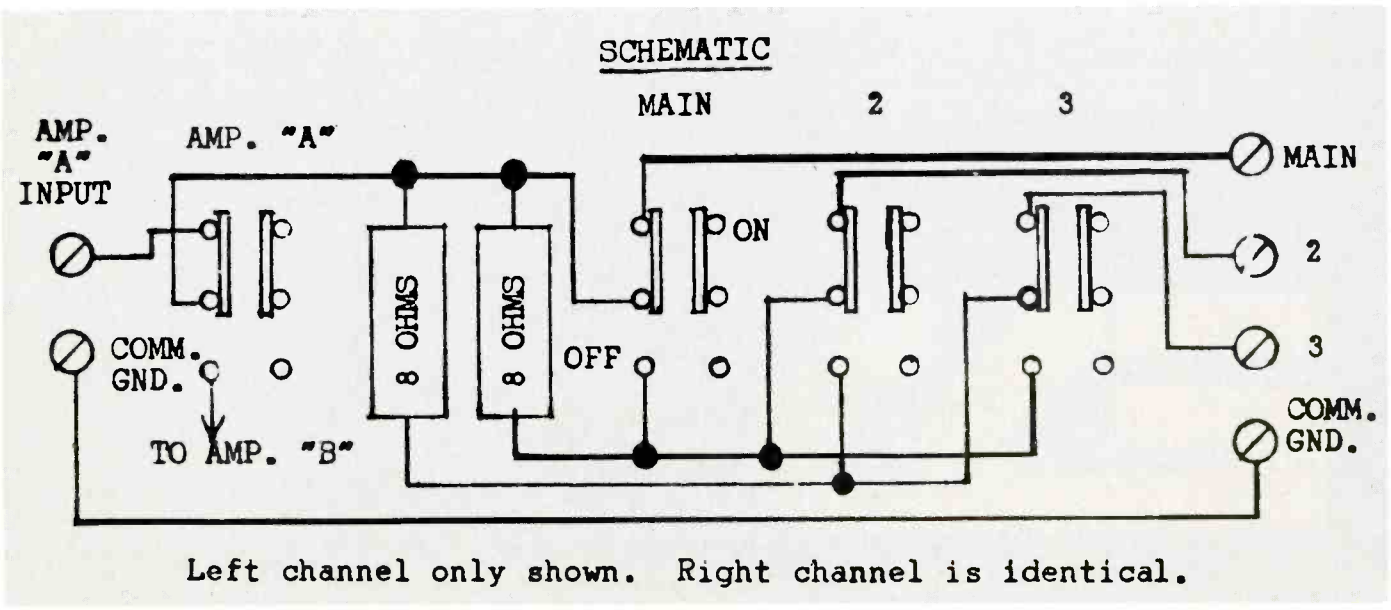

# STUDIO 4

Enjoy the 4-channel sound of "STUDIO 4" hosted by Skitch Henderson . . . on these FM/Stereo Stations:

- Asbury Park **WADB** 95.9
- Atlanta **WLTA** 99.7
- Buffalo **WBNY** 96.1
- Cincinnati **WLQA** 98.5
- Detroit **WOMC** 104.3
- Ft. Worth/Dallas **KFWD** 102.1
- Ft. Lauderdale **WMJR** 100.7
- Indianapolis **WFMS** 95.5
- Kansas City **KMBR** 99.7
- Los Angeles **KPSA** 107.5
- Louisville **WSTM** 103.1
- Milwaukee **WBKV** 92.5
- Newark **WVNJ** 100.3
- Oklahoma City **KFNB** 101.9
- Phoenix **KXTC** 92.3
- Pittsburgh **WKJF** 93.7
- Portland **KJIB** 99.5
- Providence **WPJB** 105.1
- Sacramento **KCTC** 96.1
- San Diego **KYXY** 96.5
- San Jose **KPSJ** 106.5
- Seattle **KIXI** 95.7
- Toledo **WCWA** 104.7
- Tulsa **KRAV** 96.5
- Washington, D.C. **WJMD** 94.7
- Youngstown **WQOD** 93.3

Consult your local FM listing or favorite hi-fi dealer for exact program times.

Studio 4 is brought to you by

**TELEX**®

COMMUNICATIONS DIVISION  
9600 Aldrich Avenue South  
Minneapolis, Minnesota 55420

*The World's Largest Manufacturer of Stereophones, Aviation Headsets and other Listening Devices.*



Check No. 73 on Reader Service Card

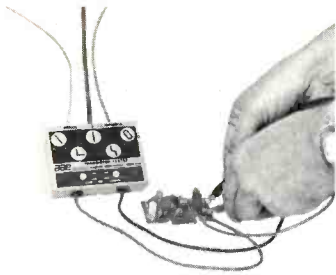

### Component Checker

This is a novel device which tests transistors, resistors, and capacitors in circuit. It is used with a scope and the graphic symbols on the tester panel show the appropriate scope patterns. Price: \$29.95.

Check No. 50 on Reader Service Card



### Gotham meters

A new range of wow and flutter meters has just been announced by Gotham Audio Corp. Three units are available: Type ME104 at \$365.00; Type ME102B at \$475.00, which has a switch for 3 KHz as well as the DIN3150 standard, and Type ME301, costing \$780.00, a precision wave analyzer capable of determining the actual flutter frequency. Makers are Woelke of West Germany and brochures can be had from Gotham.

Check No. 48 on Reader Service Card

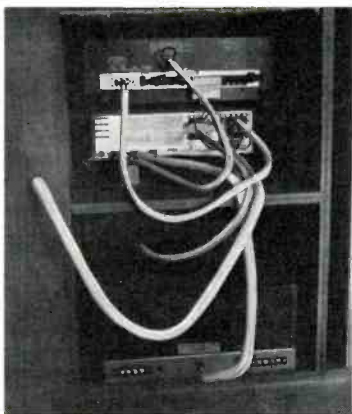

### Zipertubing

These wiring covers help keep cords and connectors dust free, protect them from damage, and provide insulation. To apply, the covers are wrapped around the wires being bundled and zipped together with finger pressure. ID sizes are 3/8, 1/2, 5/8, 3/4, and 7/8 in. Price: \$2.95 per 10-ft. roll.

Check No. 52 on Reader Service Card

### Mellotone Change-A-Grille kits

Worn or unsightly grille cloths are quickly changed with these replacement grille cloth kits, which include acoustic fabric mounted on perforated baffle board. The new grille is simply cut to the correct size and affixed with the included self-stick tape. Available in a variety of bright, decorative weaves.

Check No. 53 on Reader Service Card

### Maxell endless tapes

These 8-track endless blank cartridge tapes are available in two recording lengths—the 8T-200 in 40 minute and the 8T-300 in 60 minute. They are said to have a frequency response of 40 to 12,000 Hz and produce 3 dB greater S/N than conventional tapes. Prices: 8T-200, \$2.35; 8T-300, \$2.65.

Check No. 6 on Reader Service Card

### Microphone Kit

Here is a condenser microphone in kit form. Frequency response is quoted as 50 to 15,000 Hz with a sensitivity of -66 dB re: 1v/μ bar. Output impedance is 250 ohms, unbalanced. The capacitor unit itself is preassembled and the kit price is \$79.50, including preamp and power supply. A battery model costs \$49.50.

Check No. 54 on Reader Service Card

### Sony CRO-60 cassettes

Chromium dioxide tape is used in these cassettes to provide extended frequency response, a higher saturation point, and higher output at high frequencies.

Check No. 55 on Reader Service Card

### Piano Transducers

These are special sensors for recording the piano. In operation, one is fixed to the soundboard and the other to the metal "harp" plate and the outputs suitably mixed by adjustment on the preset controls. The standard studio model has a minimum matching load of 10,000 ohms and the *Studio* and *Artist* series have low impedance output as well. The units are powered by built-in 9-volt batteries, and it is claimed that the sensors have many advantages over conventional microphones.

Check No. 56 on Reader Service Card

# Eugene List's Gottschalk Festival

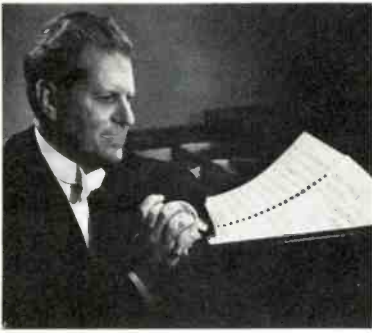

Eugene List



Richard Freed



Louis M. Gottschalk

THE MIDDLE of the nineteenth century was the heyday of the piano virtuoso-composer, that species of showman who thrilled and amazed audiences with his keyboard Prowess, traditionally made the ladies swoon, and composed much (in many cases most) of his own material. Chopin lived into this period, but died in 1849. Among the Titans who survived him were Franz Liszt, Sigismond Thalberg, Henri Herz, Anton Rubinstein, and the American Louis Moreau Gottschalk, to whom Chopin himself had said "I predict that you will become the king of pianists."

Gottschalk, who was indeed so proclaimed on the occasion of his American debut in 1853 and many times thereafter, was 20 when Chopin died. He was born in New Orleans in 1829 and at 13 was sent to Paris for musical training. He was not accepted at the Conservatoire, whose director held that Americans were barbarians who made locomotives, not music, but within three years he received Chopin's accolade at a private performance, and four years after that his formal debut was hailed as a triumph by Victor Hugo and Théophile Gautier as well as his fellow musicians. What electrified the Parisians was not only Gottschalk's playing but

his compositions, especially his Louisiana dances based on Negro and Creole music remembered from home. He had been composing piano pieces since he was 15, and many of them had already circulated by the time he first played in public; one of them, in fact, *Bamboula*, had been made a test piece for pianists at the very Conservatoire to which its composer had been denied admission, and the young "*pianiste-compositeur louisianais*" sat on the jury with the director who had barred him.

In Paris Gottschalk had a fascinating circle of friends—Bizet, Saint-Saëns, Offenbach, Meyerbeer, Berlioz. He was admired by Liszt and Rossini, and actually assisted Berlioz in producing some of his mammoth concerts. The association with Berlioz undoubtedly gave him the idea for the "festivals" he was later to stage himself in the Caribbean and South America, actually monster concerts for which he composed his own orchestral and operatic works calling for hundreds of performers.

After the Paris debut, Gottschalk toured in Switzerland and Italy and spent a year-and-a-half at the Spanish court, where he was given lavish honors by the queen, before returning to America at the age of twenty-four. In New York, Boston and Philadelphia, he was no less an "exotic" than he had

been in Europe, for his Louisiana dances were as new to those cities as to Paris and Geneva. He had brought with him a number of works reflecting his exposure to Spanish music, and he now spoke with a pronounced French accent; he lost no time, though, in beginning to compose pieces in which he quoted American national and patriotic airs, much as Charles Ives was to do a half-century later. When he toured the Caribbean he absorbed new influences that were to bring forth some of his most colorful and distinctive compositions: Latin and Afro-Cuban rhythms which had not been exported before.

The flair, the bearing, and even the compound romantic involvements that went with the classic image of the virtuoso-composer were attributes Gottschalk had in abundance (in the romance department, we note that he was literally carried off the stage and abducted by an Amazonian admirer at the end of a recital in Geneva, and that his open affair in New York with the actress-writer Ada Clare, who bore him a son, was chronicled by the lady herself in her newspaper column and a novel), but he also enhanced the image with his musicianship and his genuine uniqueness.

Few of the virtuosi were significant as composers. Liszt, of course, was a



Eugene List



Eugene List with President Nixon and Emperor Haile Selassie at the White House during a State Dinner and Musicale in honor of Selassie.

great composer, and not only for the piano, but the music of Thalberg and Herz is not heard today and they are remembered, in that category, only as concocters of display-pieces for their own use. Gottschalk was not a great composer, but he was nevertheless America's first great musician. He was an original, an unpretentious but significant innovator whose influence on succeeding generations has only recently begun to be recognized.

He also happened to be an exceptionally keen and passionate observer of humanity. From the beginning of his five-year sojourn in the West Indies, early in 1857, until December 1868, just a year before his death, Gottschalk kept a remarkable journal, subsequently published in book form as *Notes of a Pianist*. It is one of the most valuable of musical diaries, not only for its autobiographical material (there are no references to his amatory adventures, an omission which may be taken as an indication that Gottschalk was a true gentleman—and that he intended his journal to be published), but even more for the insightful observations on the mores and personalities of the time, and most especially for those on America during the Civil War.

Like the other virtuosi, Gottschalk composed for his own purposes as a

musical showman; he never took himself too seriously as a composer, but his music has enough substance to continue delighting the ear long after it has served to display his own powers as a performer. He wrote more than piano music, too: among his works were some grandiose affairs for orchestra, some works for piano and orchestra and at least three operas as well as several multi-piano stunt pieces involving as many as 30 pianists. While it would be a gross exaggeration to compare Gottschalk with Liszt, it might not be at all unreasonable to regard him as the closest we had to an American Glinka, paving the way for Ives, one might say, as Glinka did for Mussorgsky. Tchaikovsky once said that all Russian music had grown from Glinka's *Kamarinskaya* as an oak from an acorn, and one might almost make similar claims for such Gottschalk works as *The Banjo*, *Bamboula*, and *The Union* as having borne the seeds of what made American music American—including anticipations of ragtime and jazz.

If Glinka, the father of Russian music, profited from his trip to Spain, so did Gottschalk, who wrote operas on Spanish and Portuguese themes and even made use of some of the same tunes used by Glinka in his two "Spanish overtures," most notably the celebrated

*Jota aragonesa* (also used by Liszt in his *Spanish Rhapsody*), which turned up in Gottschalk's "grand symphony" for 10 pianos, *The Siege of Saragossa*. But Gottschalk drew really astonishing riches from his last years in the Caribbean and Latin America. He was, in fact, our first conspicuously successful ambassador of good will between the Americas. It was entirely fitting that the speaker at his funeral in Rio de Janeiro, where he died on December 18, 1869, saluted Gottschalk as the man who had "linked with his name the two continents," for he had, on his own, provided "cultural exchange" in both directions (and, indeed, in more than two). It might be in order to outline his inter-American peregrinations before proceeding to more specific matters.

After his return from Europe in 1853, Gottschalk made a brief visit to Cuba the following year, continued to perform in the United States, and then returned to the Caribbean in 1857 for a two-year concert tour with the soprano Adelina Patti, who was then only 14. When the tour ended Patti and her father returned to New York, but Gottschalk chose to remain in the islands for another three years, soaking up local color and producing the first in his series of

(Continued on page 78)

# Advertising Index

Advertiser	Page	Advertiser	Page	Advertiser	Page
Acoustical Mfg. Co.	90	Fairfax Industries, Inc.	21	Sansui Electronics	15, 40, 41
Quad speakers		Speakers		Electronic Components	
<b>Check No. 11 on Reader Service Card</b>		<b>Check No. 21 on Reader Service Card</b>		<b>Check No. 15 on Reader Service Card</b>	
Advent Corp.	11	Finney Co.	95	Saxitone Tapes	104
Model 201 cassette deck		Antennas, filters, amplifiers		Magnetic tape at a discount	
<b>Please Write Direct To Advertiser</b>		<b>Check No. 94 on Reader Service Card</b>		<b>Check No. 105 on Reader Service Card</b>	
AKAI America, Ltd.	25	Institute of High Fidelity	79	Schwann Record and Tape Guide	96
GX-1900D tape recorder		Industry association		Guide to current tapes and discs	
<b>Check No. 25 on Reader Service Card</b>		<b>Write Direct to Advertiser</b>		<b>Write Direct to Advertiser</b>	
Audio Dynamics Corp.	9	JVC America, Inc.	37	Scott, Inc., H.H.	Cover III
XLM phono cartridge		Four-channel receiver and amplifier		High fidelity components	
<b>Check No. 9 on Reader Service Card</b>		<b>Check No. 37 on Reader Service Card</b>		<b>Check No. 100 on Reader Service Card</b>	
BASF Systems, Inc.	57	Jensen Div., Pemcor	45	Sharpe Audio Div., Scintrex	2
Cassettes		Model 5 speaker		Headphones	
<b>Check No. 57 on Reader Service Card</b>		<b>Check No. 49 on Reader Service Card</b>		<b>Check No. 2 on Reader Service Card</b>	
BSR-McDonald	83	KLH Research and Development, Inc.	53	Sherwood Electronics Corp.	43
Model 810 turntable		Model 52 receiver		Model 8900 receiver	
<b>Check No. 83 on Reader Service Card</b>		<b>Check No. 45 on Reader Service Card</b>		<b>Check No. 42 on Reader Service Card</b>	
Benjamin Electronic Sound Corp.	89	King Karol	103	Shure Bros., Inc.	69
Lenco turntables		Discounts on tapes and discs		Microphones	
<b>Check No. 87 on Reader Service Card</b>		<b>Check No. 103 on Reader Service Card</b>		<b>Check No. 59 on Reader Service Card</b>	
Bose Corp.	23	Lafayette Radio Electronics Corp.	80	Sony Corp. of America	50, 51
Speakers		Catalog		Receivers	
<b>Check No. 31 on Reader Service Card</b>		<b>Check No. 80 on Reader Service Card</b>		<b>Check No. 51 on Reader Service Card</b>	
Bozak Co., The R. T.	27	Linear Design Labs	82	Sony/Superscope, Inc.	Cover IV, 81, 83
Speakers		Speakers		High Fidelity Components	
<b>Check No. 27 on Reader Service Card</b>		<b>Write Direct To Advertiser</b>		<b>Check No. 63 on Reader Service Card</b>	
British Industries Corp.	3	Linear Devices, Inc.	92	Soundcraftsmen	65
Garrard Zero 100 turntable		B&W speakers		Equalizers	
<b>Check No. 3 on Reader Service Card</b>		<b>Write Direct To Advertiser</b>		<b>Check No. 65 on Reader Service Card</b>	
Crown International	30	Marantz Co.	49	Southern Sound	104
Aurilinear speakers		2440 four-channel adaptor		Components and systems	
<b>Check No. 22 on Reader Service Card</b>		<b>Check No. 43 on Reader Service Card</b>		<b>Check No. 104 on Reader Service Card</b>	
DeCoursey Engineering	97	Maximus Sound	78	Southwest Technical	97
Filters and dividing networks		Speakers		Amplifiers	
<b>Check No. 98 on Reader Service Card</b>		<b>Check No. 78 on Reader Service Card</b>		<b>Check No. 97 on Reader Service Card</b>	
Design Acoustics	81	McIntosh Laboratory, Inc.	92	Stanton Magnetics, Inc.	31
D-12 speaker system		MX-112 tuner-preamplifier		Headphones	
<b>Check No. 81 on Reader Service Card</b>		<b>Check No. 92 on Reader Service Card</b>		<b>Check No. 23 on Reader Service Card</b>	
Dynaco, Inc.	35	Midwest Hi-Fi	103	Stereo Component Center	104
High fidelity components		Wholesale price list & catalog		Discount Price List	
<b>Write Direct to Advertiser</b>		<b>Check No. 102 on Reader Service Card</b>		<b>Check No. 106 on Reader Service Card</b>	
Eastman Sound, Inc.	13	Panasonic	47	TDK, Inc.	7
Martin speakers		Four-channel systems		Cassettes	
<b>Check No. 13 on Reader Service Card</b>		<b>Check No. 47 on Reader Service Card</b>		<b>Check No. 7 on Reader Service Card</b>	
Electro-Music Div., of CBS	67	Phase Linear, Inc.	12	Tandberg, Inc.	39
Leslie speakers		Model 700 amplifier		TR-1020 receiver	
<b>Write Direct To Advertiser</b>		<b>Check No. 12 on Reader Service Card</b>		<b>Check No. 39 on Reader Service Card</b>	
Electrostatic Sound	71	Pickering & Co., Inc.	17	TEAC Corp. of America	29
Speakers		Phono cartridges		Open-reel tape recorder	
<b>Check No. 69 on Reader Service Card</b>		<b>Check No. 17 on Reader Service Card</b>		<b>Check No. 29 on Reader Service Card</b>	
Electro-Voice	88, 91	Pioneer (USA), Inc.	Cover II, I	Telex	38, 73
4x4 receiver		Receivers		Studio 1 headphones	
<b>Check No. 96 on Reader Service Card</b>		<b>Write direct to advertiser</b>		<b>Check No. 38 on Reader Service Card</b>	
4169 and 4170 speaker units		Radio Shack	61	Studio 4 headphones	
<b>Check No. 88 on Reader Service Card</b>		Catalog		<b>Check No. 73 on Reader Service Card</b>	
Elpa Marketing Industries	98	Revox, Inc.	19	United Audio	33
<b>Check No. 68 on Reader Service Card</b>		Tuner, amplifier, receiver		Dual turntables	
Empire Scientific Corp.	5	<b>Check No. 19 on Reader Service Card</b>		<b>Check No. 33 on Reader Service Card</b>	
Speakers		Rogersound Labs	95	Utah	85
<b>Check No. 90 on Reader Service Card</b>		Speakers		Speakers	
Epicure Products, Inc.	63	<b>Check No. 95 on Reader Service Card</b>		<b>Check No. 70 on Reader Service Card</b>	
Speakers		Rotel of America	97		
<b>Check No. 62 on Reader Service Card</b>		RX-154A receiver			
		<b>Check No. 99 on Reader Service Card</b>			



## and at these leading hi-fi dealers

- Ia.,** Cedar Falls, Sampsons, 307 Main St.  
Dubuque, Faber Music, 1157 Central  
Iowa City, Stereoland, 700 S. Dubuque  
Waterloo, Farnsworth Electronics, 201 Mullan
- Kan.,** Wichita, McClelland Sound, 121 N. River St.  
**Ky.,** Louisville, McDonalds Sound, 4129 Shelbyville Rd.
- La.,** Baton Rouge, Lafayette Radio, 2610 Florida Blvd.
- Me.,** Lewiston, Stroboli, 180 Lisbon St.  
**Md.,** Bethesda, Audio Associates, 10217 Old Georgetown Rd.  
Baltimore, E. J. Korvette, 1955 E. Joppa Rd.  
Baltimore, Lafayette Radio, Catonsville  
Cumberland, TV & Radio Parts Co., 138 N. Mechanic St.  
Glen Burnie, E. J. Korvette Inc., Govnor Plaza-Ritchie Hwy.  
Glen Burnie, Lafayette Radio,  
Gaithersburg, Stereo Corner, 19140 Montgomery Vlg. Av.  
Mt. Tanier, Lafayette Radio, 3189 Queens Chapel  
Rockville, E. J. Korvette, 11800 Rockville Pike  
Towson, Lafayette Radio, 815 Taylor Ave.
- Mass.,** Boston, Lafayette Radio, 584 Commonwealth Ave.  
Boston, Lafayette Radio, 899 Boylston St.  
Cambridge, Minute Man Radio, 30 Boylston  
Chicopee, Custom Electric, 32 Center St.  
West Roxbury, Lafayette Radio, 1530 V. F. W. Parkway
- Mich.,** Ann Arbor, Douglas Sound, 617 E. William  
Ann Arbor, Hi-Fi & TV Ctr., 3731 Washtenaw  
Ann Arbor, Hi Fi Buys, 618 S. Main  
Ann Arbor, Pentronics Inc., 3386 Washtenaw  
Birmingham, Nutronics Inc., 315 Hamilton  
Detroit, Barton Electronics, 1326 Broadway  
Detroit, E. J. Korvette Inc., Telegraph Rd.  
W. Chicago  
Grand Rapids, The Sound Room Inc., 3635 28th St. S.E.  
Kalamazoo, Kaltronics, 214 N. Rose St.  
Kalamazoo, The Sound Room Inc., 1228 S. Burdick  
Livonia, Robbie Electronics, 33760 Plymouth Rd.  
Marquette, Sound Center, 429 N. 3rd St.  
Oak Park, Eric Electronics, 10721 W. Ten Mile Rd.  
Port Huron, Stereo Sound Shop, 703 Huron Ave.  
Roseville, E. J. Korvette, 28800 Gratiot  
South Gate, E. J. Korvette, Ford St. & Penn Ave.  
Sterling Hts., Lafayette Radio, 34208 Van Dyke  
Stevensville, Tri County Audio Visual, 5792 St. Joseph Ave.  
Traverse City., Walker's Music, 118 S. Union  
Warren, Audio Tech, 29088 Van Dyke  
Clarksdale, Sound Center, 3rd St.
- Miss.,** Jennings, Lafayette Radio, 8976 Jennings Stat  
**Mo.,** St. Louis, Best Sound, 1131 S. Brentwood  
St. Louis, Hi-Fi Fo-Fum, 3659 N. Lindbergh  
St. Louis, Hi-Fi Fo-Fum Inc., 1155 Big Bend  
St. Louis, E. J. Korvette, Florissant Rd.-Evans  
St. Louis, E. J. Korvette, 281 U.S. Highway 66  
St. Louis, Hi Fidelity Showroom, 6383 Clayton  
Springfield, Hurd's House of Sound, 2718 S. Glenstone
- Mont.,** Helena, Marshall Electronics, 428 N. Main  
**Neb.,** Grand Island, Lombard-Leschinsky, 109 E. 3rd St.  
Omaha, Custom Electronics, 4448 S. 48th St.
- N.H.,** Keene, Melody Shop, 102 Main St.
- N.J.,** Audubon, E. J. Korvette, Bik. Horse Pke./Nicholson Rd.  
Cherry Hill, Franklin Music, 158 Echelon Mall  
East Brunswick, Lafayette Radio, Route 18  
Paramus, E. J. Korvette, Rte. 4 & Spring Valley Rd.  
Plainfield, Lafayette Radio, 139 W. Second St.  
Totowa, Lafayette Radio, 410 Route 46  
Trenton, E. J. Korvette, Olden & Princeton  
Watchung, E. J. Korvette, Blue Star Shop Ctr.,  
W. Orange, E. J. Korvette, Prospect Ave.-Eagle Rk. Rd.
- N.M.,** Albuquerque, Hi Fi House, 3001 Monte Vista N.E.  
Gallup, Terrys World of Sound, 106 W. Coal  
Las Cruces, Mannie's, 802 S. Solano Dr.
- N.Y.,** Binghamton, Stereoland Inc., 168 Water St.  
Bronx, E. J. Korvette, 1998 Bruckner Blvd.  
Brooklyn, E. J. Korvette, 485 Fulton St.  
Brooklyn, Laco Electronics, 4924 Fourth Ave.  
Brooklyn, Lafayette Radio, 2265 Bedford Ave.  
Buffalo, F. M. Sound Equip., 1241 Main St.
- Buffalo, Lafayette Radio, 3600 Sheridan Dr.  
Buffalo, Purchase Hi Fi, 747 Main St.  
Carie Place, E. J. Korvette, Glen Cove Rd.  
Westbury Av  
Eggersvie, F. M. Sound, 4510 Bailey Ave.  
Hempstead, Lafayette Radio, 120 N. Franklin  
Huntington Sta., E. J. Korvette, 350 Route 110  
Jamaica, Lafayette Electronics, 165-08 Liberty  
Lawrence, E. J. Korvette, Rockaway Tpk.  
Peninsula Blvd.  
Little Neck, E. J. Korvette, Douglaston Pkwy.-61st Ave.  
Massapequa, Lafayette Radio, 5288 Sunrise Hwy.  
Mattydale, Superior Sound, 1801 Brewerton  
Nanuet, E. J. Korvette, Route 59 & First St.  
New York, Lafayette Radio, 49 W. 45th St  
New York, Grand Central Radio, 124 E. 44th  
New York, Harvey Radio, 2 W. 45th St.  
New York, E. J. Korvette, 575 Fifth Ave.  
New York, Liberty Music, 76th & Madison  
New York, Lyric Hi-Fi, 1221 Lexington  
New York, Midway Radio, 60 W. 45th St.  
New Rochelle, Lafayette Radio, 218 North Ave.  
Port Chester, E. J. Korvette, 431 Boston Post  
Rego Park, Lafayette Radio, 9518 Queens Blvd.  
Rochester, Hyatt's, 171 S. Goodman  
Rochester, Lafayette Radio, 3330 Monroe Ave.  
Scarsdale, Lafayette Radio, 691 Central Ave.  
Schenectady, Stereo Sound, 169 Jay St.  
Staten Island, E. J. Korvette, 2795 Richmond  
Syosset, Lafayette Radio, 111 Jericho Tpk.  
Syracuse, Audio World, 2910 Erie Blve. E.  
Syracuse, Lafayette Radio, 2544 Erie Blvd.  
Syracuse, Lafayette Radio, 3948 W. Genesee  
Wappingers Fls., Arnee Audio Design, Nine  
Mall Route 9  
West Seneca, Lafayette Radio, 3001 Ridge Rd.  
Woodbury, Harvey Radio Co., 60 Crossways  
Pk. W.
- N.C.,** Asheville, Hi-Fidelity Sales, 180 Baltimore Ave.  
Raleigh, Womack Elect, 417 N. Salisbury St.  
**Ohio,** Ashtabula, Morrison Radio, 331 Center St.  
Cincinnati, United Radio, Summit & Reinhold  
Cincinnati, Hi Fi Audio, E. McMilliam &  
Woodburn  
Cleveland, Lafayette Radio, 6425 Pearl Rd.  
Parma Hts.  
Cleveland, Hoffmans, 5931 Smith Rd.  
Cleveland, Audio Craft Co., 3915 Carnegie  
Columbus, Univ Audio, 1604 N. High St.  
Columbus, Custom Stereo, 1391 S. Hamilton  
Columbus, Lafayette Radio, 3395 Cleveland  
Columbus, Lafayette Radio, 856 Hamilton Rd.  
Columbus, Palmer Electronics, 3560 N. High  
Columbus, Jimmy Rea Electronics, 540 W.  
Broad St.  
Columbus, Lafayette Radio, 4676 W. Broad St.  
Dayton, Custom Elect, Van Burne Shopping  
Ctr.  
Dayton, Stotts-Friedman, 108 N. Jefferson St.  
Eastlake, Allied Service Center, 34545 Vine  
Lancaster, Commerical Music, 303 Cedar Hill  
Mentor, Lafayette Rad, 75 Bi Mentor Ave.  
Parma, Winteradeo Elec, 5373 Ridge Rd.  
Toledo, Lafayette Radio, Miracle Mile Shpg.  
Ctr.  
Warren, Valley Electronics, 264 W. Market St.  
Warrensville, Lafayette Radio, 21907 Emery
- Okla.,** Oklahoma City, Capitol Electronics, 6500  
North May  
Oklahoma City, Lafayette Radio, 2220 S.W.  
74th St.
- Ore.,** Portland, Hunters Video Sonic, 4059 N.E.  
Sandy  
Portland, Oregon Hi Fi & Recorder, S.W. 5th &  
Washington  
Portland, Wassons Electronic, 631 N.E.  
Grand Ave.  
Pa., Ambridge, Central Radio, 1194 Merchant St.  
Bridgeville, Lafayette Radio, Great Southern  
Shpg. Ctr.  
Camp Hill, C & S Distributors, 7 N. 21st  
Camp Hill, Radio Shack, Camp Hill Shopping  
Ctr.  
Cornwells Hts., Franklin Music, 720 Neshaminy  
Mall  
Eynon, Eynon Drug Store, Rt. 6  
Erie, House of Records, 1787 W. 26th St.  
Greensburg, Wander Sales, Greengate Mall  
King Prussia, E. J. Korvette, Route 202 &  
Missile Rd.  
King Prussia, Lafayette Radio, King of Prussia  
Plaza  
Lancaster, Lafayette Radio, 2153 Lincoln Plaza  
Meadville, Ott's Radio, 164 Park Avenue Plaza  
McKeesport, Wander Sales, 325 Fifth Ave.  
Monroeville, Lafayette Radio, 4045 William  
Penn Hwy.
- Pa.,** Monroeville, Wander Sales., Monroeville Mall  
Natrona Hts., Sound Shack, 911 Dallas Ave.  
New Brighton, Television Parts Co., 518 5th  
No. Versailes, Wander Sales Co., Eastland  
Shopping Ctr.  
Philadelphia, Sam Goody, 1125 Chestnut St.  
Philadelphia, Tech Hi Fi, 4034 Walnut St.  
Pittsburgh, Audio Warehouse, 3916 Saw Mill  
Run Blvd.  
Pittsburg, A F C Electronics, 5924 Penn Mall  
Pittsburgh, Camera Radio Company, 2801  
Liberty  
Pittsburgh, Horne Music Ctr., 510 Market St.  
Pittsburgh, House of Audio, 929 Liberty Ave.  
Pittsburgh, House of Audio, 2967 W. Liberty  
Pittsburgh, House of Audio, 6027 Broad Street  
Mall  
Pittsburgh, House of Audio, Allegheny Center  
Mall  
Pittsburgh, House of Audio, Pines Plaza  
Shopping Ctr. 1130 Perry Highway  
Pittsburgh, Lafayette Radio, 4801 McKnight  
Pittsburgh, Listening Post, 5500 Walnut St.  
Pittsburgh, Record-Rams, 639 Butler St.  
Pittsburgh, Opus One, 3519 Forbes Ave.  
Pittsburgh, Opus One Inc., 400 Smithfield St.  
Pittsburgh, The Soundpiper, 1835 Murray Ave.  
Pittsburgh, Wander Sales, 7901 McKnight Rd.  
Pittsburgh, Walks Kamera, 312 Forbes Ave.  
Plymouth Mtg., Franklin Music, Plymouth  
Meeting Mall  
Reading, Electronics TV Dist, 201 S. 4th St.  
State College, High Fidelity House, 101  
Heister St.  
Uniontown, TV & Radio Parts, 19 W. Fayette  
Wyncote, E. J. Korvette, Cheltenham Ave.-  
Easton Rd.  
Wyncote, Lafayette Radio, 8156 Ogontz Ave.  
Cranston, Sound-O-Rama, 758 Reservoir Ave.  
Chattanooga, College Hi-Fi, 5768 Brainerd  
Kingsport, Watkins Stereo Ctr., 1019 Center  
St. E.  
Memphis, Stuber's, 1523 Union Ave.  
Nashville, Electra Dist., 1914 W. End Ave.  
Nashville, Miller Clinic, 602 Gallatin Rd.  
Nashville, Nicholsons, 115 19th Ave. So.
- Tex.,** Amarillo, Appliance Center, 3309 Bell  
Amarillo, Capitol Electronics, 1800 Washington  
Austin, Home Entertainment Ctr. 7530 Burnet  
Austin, High Fidelity, 1710 Lavaca St.  
Dallas, Discount Records, 4003 Northwest  
Pkwy.  
Dallas, Hillcrest High Fidelity, 6307-09 Hill-  
crest Ave.  
El Paso, Howell Electronics, 2873 Pershing  
Houston, B & M Electronics, 3717 S. Shep-  
herd Dr.  
Houston, Home Entertainment, 5310 Kirby By.  
Houston, Home Entertainment, Nassau Bay  
Shppg. Ctr. 10091 Upper Bay Rd.  
Lubbock, Hi Fidelity, 2217 34th St.  
McAllen, McAllen Radio, 415 S. Broadway  
Midland, Barton Elecs, 1023 N. Midkiff  
Midland, Midland Camera, 317 N. Colorado  
Richardson, Electronics Unlimited, 61 Richard-  
son Hts. Vlg.  
San Antonio, Case Sound, 3522 Broadway  
Tyler, Cole Electronic, 335 S. Bonner  
Salt Lake City, House of Music, 156 S. Main  
Arlington, Audio Associates, 3441 Fairfax Dr.  
Baileys Crsdrds., E. J. Korvette, 1335 Leeburg  
Pike  
Blacksburg, Audio-Tronics, 113 N. Main St.  
Blackburn, Carver's, 153 College Ave.  
Falls Church, Lafayette Radio, Wilson &  
Roosevelt Aves.  
Hampton, Stereo Designs, Mercury Plaza Mall  
Norfolk, Lafayette Radio, 1730 E. Little Creek  
Norfolk, Sound Shop, 7862 Tidewater Dr.  
Richmond, Audio Fidelity, 6521 W. Broad St.  
Roanoke, Audio Fidelity, 3032 Trinkle Ave N.W.  
Virginia Bch., Lafayette Radio, 5112A Virginia  
Bch. Blvd.  
Woodbridge, Lafayette Radio, 14402 Jeff Davis  
Hwy.
- Wash.,** Seattle, Electricraft Stereo Ctr., 5030 Roose-  
velt Way N.E.  
Spokane, Hai's Stereo, N. 2514 14 Div. St.  
Spokane, Huppins Hi Fi, 419 W. Main Ave.
- W.Va.,** Morgantown, Stereo Component Ctr., 465½  
High St.
- Wis.,** Appleton, Consumer Electr., 518 N. Appleton  
Janesville, TV Hi Fi Center, 117 W. Milwaukee  
Milwaukee, Discount Records, 434 W. Wisconsin  
Ave.  
Milwaukee, Hi-Fi Fo-Fum Inc., 2532 W.  
Wisconsin Ave.  
Milwaukee, Hi Fi Salon, 7204 W. Greenfield  
Whitewater, Golden Ear, 112 First St.

(Continued from page 75)

"festival" extravaganzas. It was during this period that he wrote his Cuban dances for piano duet, his one-act opera *Escenas Campestres* ("Cuban Country Scenes," for a cast of three unnamed characters), and his First Symphony (*Night in the Tropics*, for large orchestra, full band and Afro-Cuban percussion instruments), the finale of which is nothing less than a grand *samba*, surely the first one in a symphonic setting.

In 1862 Gottschalk took the oath of

allegiance to the Union at the American Consulate in Havana and sailed back to New York. For the next three years he toured the Union, and his programs emphasized patriotic fantasies, his biggest success being one called *The Union*. He played that work at a Washington recital attended by Lincoln, an event recorded in *Notes of a Pianist* with a poignant and frequently quoted description of the President. A few months later Gottschalk played *The Union* again as part of a memorial service for Lincoln, when news of the

assassination was received aboard the ship carrying him to California. From California he proceeded in 1865 to Mexico, Panama, and South America, where he spent the last four years of his life.

Wherever he traveled, this "king of pianists" was received with the honors usually reserved for royalty and with a good deal more enthusiasm. A merchant in Guadeloupe had all the partitions in his house torn out to provide Gottschalk with a concert hall. The Emperor of Brazil welcomed him in 1869 by immediately placing all of his country's musical resources at his disposal, and Gottschalk used many of them in his last "monster concert," less than a month before his death. The program, which involved 650 performers, included a specially composed *Marche solennelle* on Brazilian themes for orchestra and brass bands, with offstage cannon in the triumphant coda. During the previous year he had composed his Second Symphony, *Montevideo*, in which he combined patriotic tunes from both Uruguay and the United States. The musical cross-pollination he effected between the United States, Europe, and other lands of the Western Hemisphere was to prove productive on a scale Gottschalk himself could not have dreamed of. Whether or not his music actually served as a model, he clearly anticipated styles and devices used later by such diverse creators as Ives, MacDowell, Milhaud, and Copland.

When Gottschalk died there was wrangling between his relatives in the States and his associates in Brazil over who was authorized to take his scores, and apparently all of his orchestral works and operas were lost at that time. In any event, none of them was available for performance again until the last few years. Hershy Kay's marvelously sympathetic orchestration of several of the piano pieces for the ballet *Cake-walk* became a popular item, both with and without the stage action, more than 20 years ago, but it was not until 1955, when Howard Shanet conducted the *Symphony Night in the Tropics* (in reduced orchestration) at Columbia University, that any of Gottschalk's own orchestral music was heard in the United States.

There were more North American premieres as recently as 1969, in observance of the centenary of Gottschalk's death, and still more rediscoveries were given their first performances in more than 100 years at recording sessions during December 1970 in Berlin. The recordings were released just a year ago in a three-disc Turnabout set called "A Gottschalk Festival"

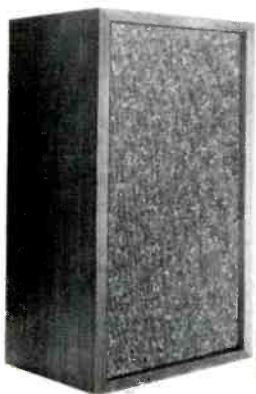

Look for the Maximus Hallmark (M) but...

# don't mention our name!

Maximus loudspeaker systems are tailored to their hi-fi dealer's standards and to yours. These systems may be recognized in most cases by the manufacturer's Hallmark on the back of the equipment and the MAXIMUS Hallmark banner displayed in the store. When you see it... you don't have to mention our name - but you should listen to the speakers that bear his. You are about to save money on the particular system that suits you best and with complete assurance of its quality.

Why? Simply because MAXIMUS expertise is acknowledged by audio industry experts and music lovers alike. They, like your dealer, are certain of MAXIMUS dedication to the highest principles and latest technology of sound reproduction. You can rely on the trouble-free performance of MAXIMUS Hallmark products...

(Your dealer signs his name to that!)

And - all MAXIMUS speaker systems are fully guaranteed by this "recognized" manufacturer.



MAXIMUS headsets are designed, developed and engineered to meet the same high standards of all MAXIMUS speakers and speaker systems.



**MAXIMUS SOUND**

CORPORATION 5 South Street, Garden City, N.Y. 11530 (516) 248-6404  
MAXIMUS WEST, 1900 West 135th Street, Gardena, Calif. 90249 (213) 770-1284



It began as a  
simple idea.

(Then competition started)

Ideas like products start in the humblest of ways. Particularly great ideas. But it takes more than an original genius to make these ideas grow into something big. It takes the lively competition among nationally advertised brand names. The kind that has changed the sound of music to what it is today.

Brand names are what manufacturers call their products. They put their names right on the package so you can see who they are. They work hard to make these products better. Offer brighter developments. Innovations. Consistent quality. This is how they try to outdo other brands. And they let you know about these improvements through advertising. But if they don't live up to these claims it's good-bye to their reputations. That's how competition works.

Nationally advertised brands are what we take for granted.

But we'd soon know the difference if they weren't around.

When brand names compete, products get better.



BRAND NAMES FOUNDATION INC.

Ever notice?



INSTITUTE OF HIGH FIDELITY

Works known under more than a single title are meticulously cross-referenced. A limited number of copies of the Offergeld catalogue were distributed free, and now there are no more. This is a document which simply must be kept available. (The numbers assigned to the respective works by Offergeld are used, by the way, in the annotation and label copy for the Turnabout album.)

Harold C. Schonberg, music critic of *The New York Times*, has been an enthusiastic drum-beater for the Gotts-

chalk cause. He has written several articles about Gottschalk, mentioned him prominently in his book *The Great Pianists* (Simon and Schuster), and he betook himself to New Orleans in February 1969 to cover the anniversary concert in which Werner Torkanowsky conducted the New Orleans Philharmonic in the North American premieres of *Montevideo*, the *Marcha triunfal*, *Escenas Campestres*, and the original piano-and-orchestra version of the *Portuguese Variations*. Eugene List was the soloist in the *Variations*, and

also in the *Grande Tarantelle*, and, as already mentioned, it was he who made all these works available for performance.

List's first major encounter with Gottschalk came in the mid-Fifties, when he made his celebrated recording of a dozen solo pieces for Vanguard (VRS-485, now a collector's item). He was intrigued by the Gottschalk lore he acquired from Vanguard's famous staff musicologist Sidney Finkelstein, and it occurred to him that any pianist-composer with Gottschalk's flair must have written works for piano with orchestra; he determined to look for them, and first armed himself with a well-worn copy of the 1881 edition of *Notes of a Pianist* (the Behrend edition was then still eight or nine years in the future), which he all but memorized. His first big catch was the *Grande Tarantelle*.

After trying various sources in Brazil and Paris, List succeeded in obtaining the two-piano score of the *Tarantelle* from the British Museum and he took it at once to Hershy Kay, whose feeling for the Gottschalk idiom had been demonstrated so brilliantly in the *Cakewalk* score—and who had also developed an interest in restoring "lost" works. Kay produced his now-standard reconstruction of the *Tarantelle* in 1957 and List gave the first performance the same year, with Richard Korn conducting, in Carnegie Hall.

Ten years later, when several Gottschalk manuscripts were offered for sale by Abrahão de Carvalho of Rio de Janeiro, List bought them as a gift for the Americana Collection of the New York Public Library's Lincoln Center Library and Museum of the Performing Arts. The scores were those of the two marches recorded in the Turnabout album, the original piano-and-orchestra version of the *Portuguese Variations*, the *Symphony Montevideo*, *Escenas Campestres*, and a sketch for the *Tarantelle*. Having already brought the *Tarantelle* into currency, List lost no time in arranging for performances of the other works. All but one were introduced in the 1969 centennial concert in New Orleans; the *Marche solennelle* needed more attention in the way of reconstruction, and List arranged to have a performing version prepared by Donald Hunsberger, band authority and conductor of the Eastman Wind Ensemble, in time for the recording sessions.

It was List's own idea to have *The Union* and the *Brazilian Fantasy* set for piano and orchestra. He felt *The Union*, in particular, "practically cried out for a larger frame," and indeed

# The \$300<sup>00</sup> Concert Hall

With all the "great", "new", "fantastic", "innovative" things everyone's claiming, how do we prove we've got something remarkable?



Lend us your ears. And eyes.

Walk into an authorized LDL high fidelity dealer with a favorite record or tape—hopefully, a demanding one. Ask him to hook up your present (or future) amplifier or receiver and a pair of LDL 749 reflecting speakers. And listen.

Listen to the "speakerless" clarity of a multiple-transducer crossoverless system using the finest components. If your record's got fundamental bass, the fundamental's what you'll hear, up to and including the *attack* of drums and strings. And as for highs, you won't just listen to them—you can pick them apart: violins, trumpets, piccolos and more—each clearly defined.

But good stereo (or quad) is more than

frequencies and transients put in their place: it's a spatial phenomenon. Which is where the LDL 749 really excels. Precisely combining forward-radiated sound from the front of the enclosure with panoramically-reflected sound from the rear. Result: the kind of acoustical environment you used to need a concert hall to get.

Need more convincing? A-B LDL 749's against other speakers—even the \$1000-a-pair variety. We honestly think you'll prefer ours.

Where do your eyes come in? To appreciate the speakers' compact size and elegant looks. Beginning with the \$299.95 pricetag ... for the pair. Now, where can you get a concert-hall for that?

For the name of your nearest dealer, write or call:

**LDL** LINEAR DESIGN LABS, INC.  
114 Wilkins Avenue, Port Chester, N.Y. 10573 •

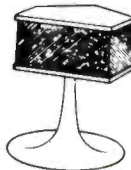

Dealer inquiries invited



\$300.  
**Not For One... For Both!!!**

Gottschalk himself had written "Tam-bour," "Trombe," etc. over various sections of the piano score. *The Union* includes an unusually effective harmonization of *The Star-Spangled Banner*, and the *Brazilian Fantasy* is strikingly similar in its overall construction. Samuel Adler has captured the Gottschalk spirit beautifully in his arrangements, which might well become as popular as the Hershey Kay orchestration of the *Tarantelle*.

Naturally, List was involved in several of the special events which marked the Gottschalk centenary in 1969: he performed with the New York Philharmonic and New Orleans Philharmonic, participated in a memorial recital with fellow-pianists at Lincoln Center, played various other Gottschalk programs, and even appeared on the Ed Sullivan television show with nine of his pupils in a performance of the *Jota aragonesa* from *The Siege of Saragossa* (another reconstruction he had commissioned, this one from another of his pupils, Victor Savant). He had hoped to stage a full-scale Gottschalk "monster concert" on the anniversary of Gottschalk's death, and thought it might be done at the Eastman School (where he, Hunsberger and Adler are all faculty members), where something like the 650-performer complement of Gottschalk's own last concert in Brazil might have been assembled. Unfortunately, that did not happen: the Gottschalk commemorative concert at Eastman was, instead, a brief multi-piano program given by List and his pupils. But the Gottschalk Festival did take place in recording studios in Vienna, Berlin, and Rochester, and now the fun of it may be repeated at will by anyone who cares to make the ridiculously modest investment required for the Turnabout album.

The charming introductory remarks with which List opened the commemorative concert at Eastman, by the way, were recorded and are included in the Turnabout set. As he reminds us in those comments, in his biographical essay in the printed insert, and most pointedly in the performances themselves, fun was a quality Gottschalk held in high regard. One famous example of his sense of humor was his publication of several works under the pseudonym "Seven Octaves" with the dedication "To my dear friend L.M. Gottschalk." That same dedication, not pseudonymous but proudly signed "Eugene List," is unmistakably evident (even if not in writing) throughout this recorded "Gottschalk Festival."

# Sony's quintessential deck.

The top of the Sony stereo line. Without question, the finest component 3-motor stereo tape deck you can buy. No true stereo buff should be without the Sony TC-850, (\$895.00). See the entire line of Sony reel-to-reel tape decks starting at \$159.95 at your Sony/Superscope dealer.

**Giant 10½ inch Reels.** For maximum record and playback time.

**Three-Heads.** For Tape/Source monitoring and wider-frequency response.

**Automatic Program Scanner.** Locates and plays individual segments to music.



**Three Motor Transport.** With Servo-Control Capstan motor. Assures powerful torque, accurate and stable tape tension.

**SONY SUPERSCOPE**

You never heard it so good.®

©1972 Superscope, Inc., 8142 Vineland Ave., Sun Valley, Calif. 91352. Prices and models subject to change without notice. Consult the Yellow Pages for your nearest Sony/Superscope dealer. Send for free catalog.

Check No. 63 on Reader Service Card



From its Sequential Cam System that antiquates the conventional noisy cam gear and swinging plate to its Synchronous Power Unit, the BSR McDonald 810 is designed to match or exceed the performance of any automatic turntable currently available. Some other highlights include a Variable Pitch Control, a 12" dynamically balanced turntable platter, a viscous-damped cue and pause control with exclusive friction Cue Clutch to keep the tone arm cued over the exact groove. An automatic tone arm lock to eliminate accidental damage to the stylus or record. A Concentric Gimbal Arm Mount and featherweight push-button operation featuring the widest selection of operating modes.

Your BSR McDonald dealer will be happy to audition the 810 for you.

The price for this unbelievable performer? \$149.50. From BSR. The world's largest manufacturer of automatic turntables.

**BSR**  
**McDONALD**

BSR (USA) Ltd.  
Blauvelt, N. Y. 10913

## Introducing the BSR McDonald 810 Transcription Series Automatic Turntable.

Check No. 83 on Reader Service Card

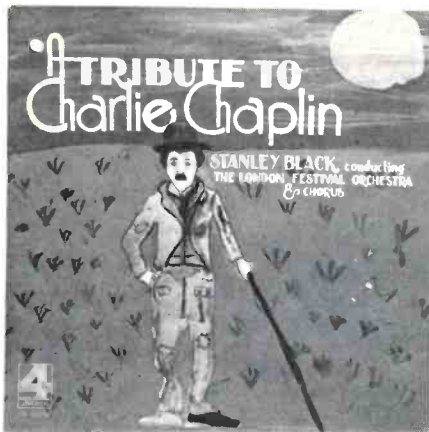

**A Tribute to Charlie Chaplin.** London Festival Orch. and Chorus, Black. London Phase 4 SP 44184, stereo, \$5.98.

Charlie Chaplin, the visible film star, continues to make such an immediate and lasting impact on us that C. Chaplin, composer of virtually all the music you ever hear with the Chaplin films (not counting the silent ones with local pianist in the house) is scarcely ever noticed. He's there, the whole time.

The Chaplin music is decidedly film stuff and no two ways about *that*, as you'll find when you play this record. Old fashioned? Of course—much of it dates from the early sound-picture era. But the newer music is pretty much indistinguishable. Content? Well, how can one put it? The Chaplin style is skillfully omnivorous, a bit of everything (except modern), to suit every (film) occasion. The writing is slick and expert—assuming that Charlie isn't ghosted by a host of able assistants. The content is memorable in a certain extremely limited sense: Yes, you will hum the tunes now and then. They catch. Other than that, it all slips in and out of the ears, leaving scarcely a trace, just a mood. That was the idea.

You will pardon me if I suggest that since Charlie's producing heydays our film music has considerably widened and deepened. The norm is now far more modern. Electronic music, dissonance, far-out "classical" (like the "Elvira Madigan" Mozart piano concerto), all have their place in our film consciousness. Film music still has the same end, as a vital but secondary element in the total presentation. But our film-music language has expanded. It can say and do more these days.

Yet the barrage of "oldie" films forever on TV and in the theaters

# Classical Record Reviews

Edward Tatnall Canby



keeps the earlier and more conventional musical styles alive in our ears, concurrently with the new ways. We can "read" both. Thus Charlie's music fits right into the TV background—and no matter when he composed the notes, early or late. Whether you'll want to listen to straight Chaplin, minus foreground, is a question, unless it brings back the scenes for you.

It probably won't do that because, if I am right, a lot of this music has yet to be heard around town. "A King in New York," for instance, or "A Countess from Hong Kong," plus something called "Chaplin Revue." The rest is from the big old talkies and semi-talkies, "Modern Times," "Dictator," "City Lights." Oh yes—and a few items are by somebody else, though from Chaplin films. L. Daniderff, J. Padilla. You won't really know the diff.

Performances: OK      Sound: B

**Franz Liszt's Greatest Hits of the 1850's.** Jorge Bolet, piano. RCA LSC 3259, stereo, \$5.98.

"Transcriptions," they called these—we'd be more likely to call them freely composed Fantasies; for they do not in any way tend towards faithfulness to the Original! That idea didn't arrive for a hundred years. Instead, old Liszt, the super-showman pianist (who could be heard *only* in the concert hall, or in some very exclusive social salon, or in his own studio) took then-familiar airs, arias, hunks of heavyweight opera, and re-composed his own special version of the music, in the Liszt style. Of course! Why not? Liszt was the guy who played them after all. They were vehicles for his public spectacles and they *had* to sound like him.

So we have Donizetti, Schubert, Verdi, Wagner, Chopin, Schumann, a galaxy of different talents, all sugared

up into the expert Liszt confection, ultra-musical always, covered with glittering masses of pianistic ice, incredibly difficult to perform and sounding easy—that is, when played the way Liszt undoubtedly played them. Some pianists fail miserably. All you can hear is the glitter and the icing. The music gets lost in the fingerwork.

Not here. Jorge Bolet has a big rep for Liszt playing and rightly so. His style is a bit dry and pointed in the finger ends, perhaps not as smoochy as Liszt himself could well have been, back around 1850. But no matter—for the musical sense gets through in all senses. Melody, harmony, the style and intent of the original composer, even the imaginative rendering of the original "instrumentation," everything from a solo aria or solo piano piece to a vast opera chorus with big orchestra.

Performance: A-      Sound: B+

**Monteverdi: *Il Ritorno D'Ulisse in Patria* (1640).** Concentus Musicus Wien, Harnoncourt. Telefunken "Das Alte Werk" SKB-T-23 (4 discs), stereo, \$23.92.

This is one of those superb evening-long album-experiences that requires as much from you, the absorbed listener, as you do from the recording. You get your money's worth, if only in sheer quantity of material presented, via the sound itself, via the vast booklet with background essays, text, and so on. I found the seldom-heard Monteverdi opera a great experience but it isn't easy. No set pieces, no arias, no symphonic interludes—just, deliberately, a steady flow of half-spoken musical recitative, the entire sense of the music concentrated in the actual vocal expression of the various solo voices. A marvelously reconstructed contemporary-style accompaniment, however, adds greatly to variety and interest.

Only the early Monteverdi opera

*Orfeo* has precise and detailed instructions as to performance. This later opera and *Poppea* (better known) have come down in sketch-like copies, scarcely more than the vocal line and words plus bass. Not even the later conventional figures are there—so even the harmonies are no more than implied by the bass and must be guessed from the musical context. But the biggest question is whether the sketch indicates a “chamber” style with the simplest of accompaniments or was simply a conductor’s boiling-down for convenience, like a piano score of a symphony. Who knows? Maybe there was a large orchestra of contemporary instruments? Scoring was still in this period left to local imagination and seldom indicated on the written-out music.

This vast and absorbing musicological solution to the problem of performance has the typical quality of the Viennese *Consensus Musicus* group—*incredibly careful musicology plus utterly musical performance, never for a moment dry or stodgy.* The realization, with a wealth of carefully utilized instruments of Monteverdi’s own time, has a Germanic thoroughness and believability. The actual performance has an Italian intensity, though the cast is international, from Sweden to England to Germany or Austria. The booklet tells all in English, German and French, the individual instruments are described in detail with pictures, the complete text is set out in parallel columns in four languages and there is even a stereo diagram so you can locate the trombones, piffari, lute, chitarrone, regal, recorders, harp, strings and so on. So—go to it!

Performance: A      Sound: B+

**Adolph Busch, violin; Rudolph Serkin, Piano. Perennial Records 2006, mono. P.O. Box 437, New York 10023.**

Perennial does a fine job of reviving famed old recordings not likely to reappear on major labels but they must be getting hysterical; this one has labels reversed and no notes included. (Usually, if I am right, they do a fancy job of documentation and evaluation.)

We older musicians were brought up on the music of Adolph Busch and his son-in-law Rudolph Serkin, both in concerts and on disc—but that was in the last days of Busch, when his violin had become somewhat raucous and inaccurate in tone, though ever full of intensity and enthusiasm; Busch had then expanded his activities into conducting his own orchestral ensemble. The recordings refashioned on this LP date are older: the earliest a brief acoustic Bach disc of 1924, the others from 1930 and 1931. Busch is younger, his

tone clean, the notes accurate—quite another player from the familiar rough-edged Busch of those somewhat later years. As for Serkin, he is of course still very much with us, if occasionally now confused with his own son, Peter Serkin. In these recordings he furnishes an expert old-fashioned accompaniment on the piano for works that now would be heard on the harpsichord—Bach, Geminiani, Vivaldi. Also a movement of Reger, always a Serkin favorite. An addition is a Schubert song, *Sei mir gegrüsst*, with Heinrich Rehkemper,

baritone, and Manfred Gurlitt, piano.

Performances: A-      Sound: C+

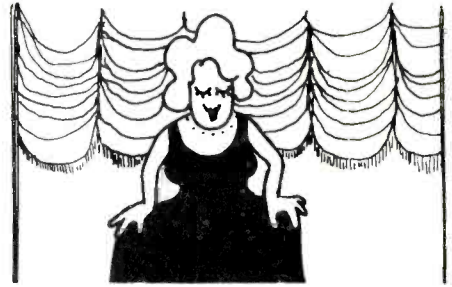

## 3 of the World's Best Sellers!

*Utah*  
sells more  
speaker systems  
than anyone else

Chances are very good that you have heard our sound. In fact, if you listen to many great speaker systems, you couldn't miss us. We haven't promoted the name too much, since engineering, sound technology and manufacturing techniques are our real forte. All this means to you is **incomparable** sound for astonishingly low prices. IT'S NO WONDER, WE ARE NUMBER 1! Here are three examples of quality systems that sell by the thousands.

**FINISH: (ALL MODELS)** Genuine Walnut Veneer, handsome hand-rubbed, oil finish.

Please write to UTAH ELECTRONICS for detailed information on Model or Models of your choice.



HUNTINGTON, INDIANA

Check No. 70 on Reader Service Card



AS-2A 8" 2-WAY  
\$49.95 NET

WD-90-12" 3-WAY  
\$89.95 NET

HSI-C-12" 3-WAY  
\$99.95 NET

### UTAH SPECIFICATIONS

**AS-2A: 8" 2-WAY ACOUSTIC SUSPENSION SYSTEM—\$49.95 NET** (8" Woofer, 3½" Tweeter, Weight—22 pounds, Size—11" x 18" x 9")

**WD-90: 12" 3-WAY ACOUSTIC SUSPENSION SYSTEM — \$89.95 NET** (12" High Compliance Woofer, 8" Midrange, 3½" Tweeter, Weight—33 pounds, Size—14" x 23" x 10")

**HSI-C: 12" 3-WAY SPEAKER SYSTEM—\$99.95 NET** (12" Heavy Duty Woofer, Midrange Compression Horn, 5" Tweeter, Weight—46 pounds, Size—15" x 25¼" x 14")

# Canby's Capsules

Edward Tatnall Canby

**Brahms: Piano Concerto #2.** Rubinstein; Phila. Orch., Ormandy. RCA LSC 3253, stereo, \$5.98.

*"Performance of a Lifetime! A Magnificent Recording!"*

Believe it or not, RCA's self-pat is true and the continuing Rubinstein series is surely definitive—for awhile anyhow. Grand old pianist, and Ormandy is in his best role as orchestral accompanist.

**Jochim Raff: Piano Concerto Op. 185. A. Dreyschock: Concert Piece, Op. 27.** Frank Cooper; Nürnberg Symph. Orch., Deaky. Genesis GS 103, stereo \$5.98.

More of the Romantic piano revival—and there's plenty more to come. For every famed Concerto at least 100 are sitting around unplayed, and you can never be sure what wonders (or boredom) you'll find. Of these, the Rheinberger hits me as the most alive and attractive on discs. Raff seems forced and harmonically amateurish in structure, if skillful in piano and orch. writing. Dreyschock, a super piano virtuoso, wrote nicely and not as noisily here as his rep would indicate. All in all—the verdicts of recent history on these second-best composers can safely be ignored. Just listen. Pleasant music, if long-winded and, in the large, all pretty much alike.

**Rheinberger: Piano Concerto.** Andrian Ruta; Nürnberg Symph. Orch., Deaky. Genesis GS 104, stereo, \$5.98.

**Prokofiev: Peter and the Wolf; Classical Symphony; March, Scherzo, Love for Three Oranges.** George Raft, narrator; London Symph. Orch., Black. London Phase 4 SPC 21084, stereo, \$5.98.

Phase 4 strains hard to be real Pop here and doesn't make it. The orchestral music is played in fine classical style, fluently and with feeling, the tempi slow and melodic—excellent Prokofiev. Along comes George Raft with a gangster-style version of Peter (that low-down, yellow-bellied punk), a couple of birds (chicks), and that upstanding Mafia character, the wolf himself. If you ask me, the mix with Prokofiev's gentle, imaginative music is terrible.

**Efrem Kurtz conducts Prokofiev's Peter and the Wolf; Classical Symphony; March, Love for Three Oranges.** Michael Flanders, narrator; Philharmonia Orch. Seraphim S-60172, stereo, \$2.98.

A low-priced alternative: Same music, different sound. Flanders' Peter is elegantly British, a bit condescending to listening kiddies; the music is distant, the pace slow with too-long pauses after narration, for a flat impact. The stereo sound is mainly at fault—very distant and unrounded. The "Classical" too is so-so, with the conventional too-fast last movement and the same distant sound. No bargain, even at half price.

**Four Concertos of the Neapolitan School** (Paisiello, Durante, Auletta, Mancini). R. Gerlin, hps.; Jean-Pierre Rampal, fl.; G. Ales, P. Doukan, vls.; L'Orch. de L'Isleau-Lyre, Froment. L'Ois.-Lyre OLS 129, sim. stereo, \$5.98.

Another brave London reissue in this pioneer "rediscovered Baroque" series, this one 1953. Brave because the music is important but the sound is ancient, the soft parts OK but loud parts buzzy. No matter—four worthwhile and revealing concerti, from Baroque Mancini to almost-Mozart Paisiello, with a crackerjack French solo team. Styling is musically a bit old-fashioned, but performance is vital and fiery.

**The Fabulous Philadelphia Sound Series—Ed. Elgar/Vaughn Williams: Enigma Vars., Cockaigne Ov., Tallis Vars.** Philadelphia Orch., Ormandy. Columbia M 31074, stereo, \$5.98.

The "fabulous" series necessarily antedates RCA's take-over of the Philadelphia several years back—a lot of extra tapes were piled up before the changeover. Predictable Columbia sound, good but un-mellow and over-accented, for the type of music. RCA does a milder, softer, more luminous job on the same orchestra. The usual smoothly proficient Philly show-playing, under Ormandy.

**Tchaikovsky: Piano Concerto No. 1.** Horowitz; NBC Symphony, Toscanini (1941). Victrola VIC 1554, mono, \$2.98.

Amazing—the famous recording now sounds harsh, tinny, bass-less, the loud parts unbelievably distorted. But remember—it was played on tubby home consoles with boom bass and no highs, sounded good that way. As intense and driving as ever.

**Flamenco Themes in Concert.** Manuel Cano, solo guitar. Musical Heritage MHS 1191 (mail order: 1991 Broadway, N.Y.C. 10023).

An excellent Spanish-made recording of a dynamic Spanish guitarist, close-up and hi-fi, a cross between the formal concert sound and the more usual wandering improvisations on many flamenco discs (with thumps of feet, an occasional olé . . .). A clear cut and well-shaped and styped program, ornamenting specific and well-known melodies, dances.

**Anthony Newman: Music for Organ** (Bach, Dandrieu, Franck, Liszt). Columbia M 31127, stereo, \$5.98.

Never a dull moment with this intense and original young organ genius. He turns tables here—plays Romantic Franck and Liszt—at what a pace!—on a Baroque orientated organ, an experiment in texture and clarity. It works, though organists will pale. His Baroque Bach and Dandrieu is first-rate too, rhythmically driving, brightly colored.



# Audio ETC

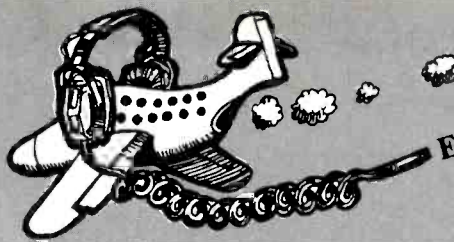

Edward Tatnall Canby

GET AWAY from it all! That's good advice sometimes. So I did. It was my own advice to me. For some two years I hadn't been off for more than a couple of weeks where I could honestly say that the name AUDIO would be totally unknown—or almost. Not to mention the name Canby. That new 45-day round trip to Europe by air came along and with it my opportunity—I got home on the 44th day with hours to spare. Six whole weeks, and now I'm back at the old post to orate on things that haven't happened, audio and musical. I didn't listen to a single LP in six weeks, though I did hear half of one, once, in France. And my gleanings on audio in Yerp, in spite of a brave batch of addresses I took with me, were marvelously nil. What a pleasure, if I may be so bold as to say so! I am a new man.

Well, not quite nil. I still have a pair of ears and a lot of curiosity, *en passant*, as the French say. For instance, I had never been on a 747 before, nor had I sampled the much-advertised stereo fare, plus movies, which I hear of 20 times per day in New York via the ads on my radio in the kitchen. So why not try? I plunked down that outrageous \$2.50, required (as they keep telling you) by international agreements or something, and in due time—very due—a pretty gal came along with what looked like a basket of gray spaghetti and tossed me a hunk of same. Headphones?

Now keep in mind that I still ply my binaural hobby and I like headphones. Moreover, I am steadily impressed by the improvements in headphone fi which have been coming our way during these last few years. I still have a whole piece to write on binaural listening too. So the headphone, to mix the metaphor once again, is my dish, especially in two-channel format. I am quite prepared to go along in principle with those heady ads which claim that today's phones give us truer sound, hi-er in fi than most loudspeakers and just about as wide in tonal range if not wider. (Wider than *some* speakers anyhow.)

So I took the gray spaghetti and tried to figure out which end was which. Where, for goodness' sake, were the transducers? All I could find were tubes. (Yes, I know, you flying commuters from one coast to the other know all about such things, but remember, I'm a neophyte and so are a few of our more stationary readers.) Tubes that went from the ears, via a most uncomfortable (sorry—my personal impression) sort of a squishy plastic thing that squashes into the orifice, down to a pair of holes in the seat control panel. Push 'em in, at both ends, switch around the channel selector until something happens, and you're in business, sonically speaking.

Well, I do declare, it was a shock. In fact, in moments I was quite fascinated by the extraordinary degree of non-communication provided by those dual spaghetti tubes. I am an inveterate telephone user and have been ever since I began with the old two-piece apparatus with the tall column on a base for the mouthpiece and the removable heavyweight ear unit on the end of a cord that we used to dangle expertly between a finger and thumb an inch or so away from the receiving ear. Limited frequency range was then the norm, but you could understand. My science teacher explained that, though there was no bass response, you could recognise a male voice; your ear had the ability (provided by the Creator aeons before Bell) to reconstruct low-frequency intelligence via the overtone content in the middle-high range which the telephone communicated successfully. You could even understand music over the phone minus any real bass. To any musical ear, as we all know, the harmonic sense of a passage of music is entirely intelligible via phone—or for that matter via miniature transistor radio. You can indeed "hear" the bass line at the bottom of the music though, technically, it isn't there.

But, do you know, I could not even recognise the music I was hearing in full stereo over the spaghetti tubes! Unbelievable. I knew it had to be Dvořák because the classical music

program said so and I caught a note or two, in the loudest parts, that identified the sound as in fact Dvořák or a sampling of a tiny corner of Dvořák, a sort of biopsy in sound. But as for hearing or reconstructing any sort of bass, I simply could not do so. For minutes at a time I would lose the thread of the music, though it was not unfamiliar to me. The basic harmony of Dvořák, and of a Tchaikovsky symphony too, was totally missing. How could it be? Only last month some exmembers of the Canby Singers worked up a madrigal among themselves, out in Buffalo, and then phoned me long distance in New York to sing it. Perfect. I got every note and could even recognise the voice of the bass singer, whose name was Jeff. A telephone reconstruction and better than any computer could do, I'll bet. But Tchaikovsky on a 747? Meaningless jargon.

Well, I don't want to knock the spaghetti makers unnecessarily. They have a job to do and it isn't an easy one. You don't go around passing out massive hi-fi headphones to hundreds and hundreds of passengers in any case. And there's the matter of sanitation, which accounts for the sticky plastic earpieces and the lack of any other contact with the human head and skin, presumably covered with unmentionably varied germs. So the spaghetti stuff is undoubtedly a workable and practical solution for a mighty difficult problem of communication. And I think I know why there wasn't any bass, not even reconstructed bass. A matter of massive masking.

Yes, the inside of a 747 in flight is relatively quiet. A lot quieter than some planes I've been in, both pure jet and prop jet. But if you start to apply good old living room hi-fi standards, you run into some figures that need not be quoted—they can be sensed. Without a suitcase full of equipment, I could only use my ears. But my guess is that the flying ambience in a 747 or noisier equivalent comprises a white noise spectrum—maybe I should say a dark gray spectrum—that runs from the subsonic up into the midrange at levels which must reach rather enormous heights down in the very bottom and

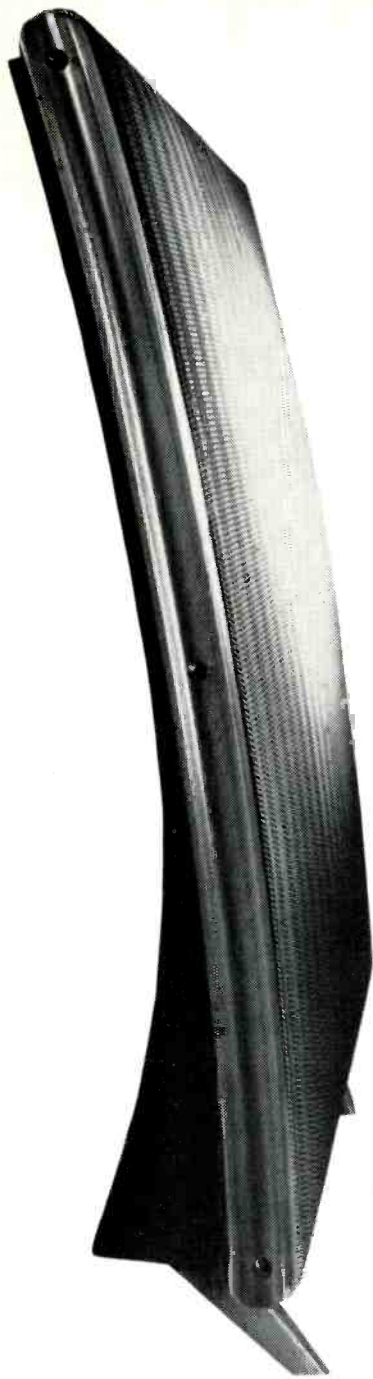

# QUAD

## Electrostatic Loudspeaker

—you simply have to listen to it.

QUAD for the closest approach to the original sound.

QUAD is a registered trade mark.

To have further details of your nearest dealer write to

Acoustical Manufacturing Co. Ltd.,  
Huntingdon, PE17 7DB, England.

Check No. 11 on Reader Service Card

**HONKY CHATEAU** (Uni, 93135) spotlights *Elton John* with too many sounds that could have been produced a decade ago. Best of the 10 cuts, all penned by John and Bernie Taupin, is the hit single, *Rocket Man*. The music, thankfully, is frequently soft enough to enjoy.

**VINEGAR JOE** (Atco, SD 7007) is a sextet (aided by another six, plus a background vocal trio) that offers a variety of now sounds, all pretty good. Considering some of the garbage I've heard recently, change that to nearly very good.

**RADIO DINNER** (Banana/Blue Thumb, BTS 38) by various performers under the auspices of *National Lampoon* is the funniest LP of the year. It starts with a marvelous spoof, *Deteriorata*, (with Norman Rose doing a sim-voice of Les Crane), moves through a parody of vidiot game shows, socks it to Philadelphia Mayor Frank Rizzo, and does the Beatles' *Magical Misery Tour*, a Joan Baez tragicopus, and *Concert In Bangle Desh*. Best for under-30s, in body or mind, but straights can dig it too.

**FACE THE MUSIC** (Decca, DL-75353) is a misnomer, the "music" part of the title anyhow. The seven-man blues-rock outfit, *Sod*, which delves into an electric sound that's more brassy than most, is average, average, average—at best, non-musical at worst. Eight cuts you can do without.

**NATURALLY** (Wheel, WLS-1002, distributed by RCA) features *The Rock Flowers*, a faded carbon copy of The Supremes in style and sound. This, the trio's second LP, has 11 cuts; the missing 12th was the good one.

**DREAM NUMBER TWO** (MGM, Verve MV-5085) puts Ken Tobias on an up-bound musical elevator, accompanying himself on guitar, the folksinger, who looks a bit like Ringo Starr and whose musical creations remind one of Gordon Lightfoot, glides through 10 of his own pieces. Highlight is *Stay Awhile*, a tune that's bounced around the charts a bit. He should have a bright future, if handled properly.

**MOUSETRAP** (United Artists, UAS-5580) presents *Spencer Davis*, one of the most underrated performers of modern music, with an integrated,

warm, and melodic sound. There's country-rock and plain rock on a dozen entries, five of which Davis originated. Best are the lead number, *Rainy Season*, combining rock with a pinch of hillbilly; *What Can I Be*, a simple yet poignant exercise in now; *Tried*, slow but moving in an emotional sense, and the traditional *Easy Rider* and *Ella Speed*.

**LOVE MUST BE THE REASON** (Polydor, PD 5509) is middle-of-the-road music by *James Last*, his orchestra and chorus. If schmaltz is your bag, fill up on the 11 pastels. Highlights are Last's own *There Is Love*, Carole King's *It's Going to Take Some Time*, David-Bacharach's *Close to You*, the title tune and *I Don't Know How to Love Him* from "Jesus Christ, Superstar."

**Fearless** (United Artists, UAS-5562) features the five-man *Family* on 10 cuts (including the instrumental, *Crinkly Green*). It's hard rock, mostly drivin' stuff, professional in every respect. Music and vocals are together both in the colloquial and "now" senses of the word. The linear notes contend, rightly, that the group offers an "atmosphere of contained violence"—except that sometimes it's not contained too well.

**NANCY & LEE AGAIN** (RCA Victor, LSP-4645) reunites the *Sinatra* gal with the *Hazelwood* guy and a heavy country sound. Highlights of the LP, which is spotty and not as good as their earlier duets, are *Arkansas Coal* (Suite), *Big Red Balloon*, and *Down From Dover*. *Got It Together* is a mish-mash of spoken, amateurish reminiscences, however.

**KENNETH MCKELLAR'S PEOPLE** (London International, SW 99538) includes folk music from around the globe. This is the tenth album by McKellar, whose trained voice sometimes seems ill-fitting, too slick, for his material. Smooth orchestral arrangements, with heavy use of violins and flute, helps the product, though. Highlights are "Scarlet Ribbons," "Shenandoah," "Scarborough Fair-Canticle" and "The Wild Mountain Thyme."

**A LONG TIME** (Ashe, AHS 850) is filled with spirituals, gospel, work songs, blues and freedom songs. The recording, featuring the operatic-trained voice of Joseph Brewer and the gospel sounds of Ella Jenkins and Brother John Sellers, is one folk buff's shouldn't miss. Or those who care about the black plight, bigotry in general, or injustice in the world at large. There are 16 cuts.

**LIVING GAME** (Decca, DL 75318) marks the debut of Mick Greenwood, vocalist and acoustic guitar player, who is backed by four others in combo (plus a handful of sidemen). There are 11 cuts, all his own making; his lyrics are good but his voice has a nothingness quality. Two pieces are worth hearing for the overall effect, "Taxi," on which Lynn Dobson is great on flute, and "Situation Number Four," with good guitar pickin'.

**ED AMES** (RCA Victor, LSP-4634) stays contemporary by borrowing from the best. His 10 vocal choices, all "now" hits, include John Denver's "Take Me Home, Country Roads," Les Crane's "Desiderata" and Neil Diamond's "I Am . . . I Said."

**DENNY GUY** (Daybreak, DR 2008), 26-year-old Nebraskan transplanted in Hawaii, has an uncanny vocal resemblance to folksinger Glenn Yarbrough. But his soul is his own, evidenced by his debut LP, an 11-tune outing distributed by RCA. Guy's music is simplistic, yet eminently hummable; his lyrics direct and meaningful. Accompanying himself on guitar, he sticks mainly to the folk idiom, inserting touches of rock and country. Highlights are an anti-war treatise, "Marching Song;" a pro-humanity, anti-scapegoat piece, "My Lai Lad," and the one tune he didn't pen, "The Trouble Maker," which portrays Jesus in that role, at least from an Establishment standpoint.

**TO LIVE ANOTHER SUMMER, TO PASS ANOTHER WINTER** (Bud-dah, BDS 95004) is a two-disc package containing the music from the original Broadway cast of the Israeli show. It's not exactly a "Fiddler on the Roof," but it's damned good anyway. The theme is based on the idea of a new nation carved out of desert and despair (what did you expect?).

**LET'S STAY TOGETHER** (Hi-London, SHL 32070) features the heavily-promoted Al Green, a 23-year-old soul singer from Arkansas. Despite the ballyhoo, however, he's nothing special. Heavy on a falsetto approach, Green offers nine tunes (including the hit title single, an indication that record-buyers can get sucked into anything).

**OF MUSE AND MEN** (RCA, LSP-4573) spotlights Jose Feliciano as he tries to expand his horizons by delving into more than the soul bag he's been in. He sings country ("My Last Farewell"), rock ("The Spirit," with its electric sound and over-dubbing), and his own brand of gospel ("Come Down, Jesus," a potent statement that resulted in a hit single).

# Either way you get the world's first universal four-channel decoder.



**EVR-4X4 Four-Channel AM/FM Receiver \$249.95**

**EVX-44 Universal Four-Channel Decoder \$99.95**

Now Electro-Voice offers our new universal decoder circuit built into both a stereo receiver and a 4-channel decoder.

The EVR-4X4 Receiver has every needed feature for 2- and 4-channel sound. Yet it costs no more than many 2-channel units that offer half the pleasure. And it will properly decode any matrix 4-channel input without switching. Ideal for playing SQ\*, Stereo-4†, or any other matrixed records, tape or FM sources.

The EVX-44 Universal Decoder creates a 4-channel control center for existing stereo equipment. Just add a second stereo amp and two more speakers. Unique separation enhancement circuit automatically adjusts front-back separation as required by program material.

Both the receiver and the decoder are also designed to accommodate 'discrete' inputs like 8-track tape if you wish. Hear the finest in four-channel sound at your Electro-Voice showroom. Where the excitement is!

E-V 4-channel products are produced under U.S. Patent No. 3,632,886  
\*T.M. CBS, Inc. †T.M. Electro-Voice, Inc.

*Electro-Voice*

a **Gulton**  
COMPANY

ELECTRO-VOICE, INC., Dept. 1124A, 602 Cecil Street, Buchanan, Michigan 49107  
In Europe: Electro-Voice, S.A., Römerstrasse 49, 2560 Nidau, Switzerland In Canada: EV of Canada, Ltd., Gananoque, Ontario



DON'T MISS B&W's NEW DM2A shelf speaker, \$300! John Gilbert, eminent critic has this to say about it: "...I have no reservation in placing this speaker in the top echelon of modern high quality systems."\* For your nearest dealer contact us: Linear Devices Inc. 143 French Street, New Brunswick, New Jersey 08901. Or call (201) 846.7777. \*Gramophone May 24, 1972

## FREE McIntosh CATALOG and FM DIRECTORY

Get all the newest and latest information on the new McIntosh Solid State equipment in the McIntosh catalog. In addition you will receive an FM station directory that covers all of North America.



### MX 113

FM/FM STEREO - AM TUNER AND PREAMPLIFIER

**SEND TODAY!**

McIntosh Laboratory, Inc.  
East Side Station P.O. Box 96  
Binghamton, N.Y. 13904

NAME \_\_\_\_\_  
ADDRESS \_\_\_\_\_  
CITY \_\_\_\_\_ STATE \_\_\_\_\_ ZIP \_\_\_\_\_

If you are in a hurry for your catalog please send the coupon to McIntosh.  
For non rush service send the Reader Service Card to the magazine.

Check No. 92 on Reader Service Card

**MY HEAD, MY BED & MY RED GUITAR**, (Roulette, SR 3007) is a study in mediocrity as Tommy James sings a dozen of his own works, with a countrified aura this go-'round. His target on the 12, as well as on the one tune he didn't write, must be totally unsophisticated teens, for anyone else will blanch at the nonsense.

**LOVE, LUCK N' LOLLIPOPS** (Polydor, PD 5503) peppers middle-of-the road stuff with jazz and country. The Bells, a sextet that frequently puts its one female out front, are best on "Kris Collection," a Kristofferson medley including "Sunday Morning Coming Down," "Help Me Make It Through the Night" and "For the Good Times." But also worth a mention are Paul Simon's "Homeward Bound" and Phil Spector's "To Know You Is to Love You."

**ANOTHER SHADE OF BLACK** (Roulette, SR 3005) puts a three-man rhythm section and a string quartet behind the voice of *Don Crawford*, who also strums a guitar. He has a solid, deep voice that he uses to punch his way out of the soul bag.

**THE GODFATHER** (Paramount, PAS-1003) is the original soundtrack of the Brando-starrer. There are a dozen tracks, including one vocal ("I Have But One Heart," sung by Al Martino). Most of the cuts are unimaginative background garbage, but "The Godfather Waltz," the main title music which is reprised later on the LP, and the "Love Theme" are worth hearing. The success of the movie ensures the success of the disc even though the latter is merely adequate.

**HOW DO YOU DO?** (Philips, PHS 700-000) showcases a Dutch duo, *Willem Duyn*, age 30, and *Maggie MacNeal*, 21. They have adopted the name *Mouth and MacNeal* and diddle with pop sounds on a dozen tracks. Range is from rhythm and blues days (via such as Ivory Joe Hunter's "I Almost Lost My Mind") to now (via John Lennon's "Isolation"). Okay, but nothing spectacular in their vocalizing.

**SWEET COUNTRY SUITE** (Verve Forecast, FTS 3090) finds Larry Murray, who has a good folksy voice, doing seven originals as part of 11 tracks. It's all countrified and fairly simple, with a soft rock sound added. "All I Need is a Friend" is best; on it, Murray, who penned the piece, sounds much like Dylan, as do his lyrics. Background vocals are by Swampwater (a quartet) and The Blackberries (a trio).

**THE BEST OF THE 50 GUITARS OF TOMMY GARRETT, VOL. 2** (Liberty, LST-35001) is a two-disc package, with 22 tracks, filled with soft, Muzak-type, middle-of-the-road pop instrumentals. Unfortunately, many of the tunes are badly edited, the engineers cutting off endings in mid-air. Much of the material, also, is slowed down, with the lagging tempos becoming an annoyance. Best numbers are those that are Latin-oriented, including "The Mexican Shuffle," almost an imitation of Herb Alpert and The Tijuana Brass; "The Lonely Bull," and "Tequila." Also worth hearing are "Lara's Theme from 'Dr. Zhivago,'" the best ballad, and "A Man and a Woman," a copy of the hit version.

**SURRENDER** (Motown, MS 723) spotlights the sauciness of Diana Ross, ex-Supreme now supreme in the field, the one that appeals to both middle-of-the-road and hip audiences. She sings (rather than screeches) on 11 cuts, including the hit title tune and two other chartbusters, "Remember Me," and "Reach Out, I'll Be There." Meanwhile, her former partners, The Supremes, are alive and well and still living in Successland. Witness **TOUCH** (Motown, MS 737,) with its 10 goodies, including "Here Comes The Sunrise" and Laura Nyro's "Time And Love," and **RETURN OF THE MAGNIFICENT SEVEN** (Motown, MS 736), on which they are joined by The Four Tops for 11 melodies, including "You Gotta Have Love In Your Heart" and "Call Me."

**GUITARS PURE AND HONEST** (A&R, ARL 7100-007, distributed by Mercury), presents an unusual recording duo, George Barnes and Bucky Pizzarelli, a pair of guitarists. They offer pure jazz, sometimes cocktail stuff and now and then a bit of commercial nonsense. But mostly it's superb. A dozen cuts utilize a sound separation technique that allows the listener to easily find Pizzarelli (who plays a guitar with an extra bass string) on the right and Barnes on the left. Best are "Honeysuckle Rose," "Spinning Wheel," "Blue Skies," and Pizzarelli's own "Slow Street."

**KIDS ARE PEOPLE TOO!** (Roulette, SR 42064) stars Bob McAllister, mainstay of video's "Wonderama." McAllister, who penned all 10 tunes with Sharon Kaplan, makes use of two oblique items: a kazoo and a kid's chorus. The disc's good for tots (there's still a lot of silliness) but probably will drive parents up the nearest wall. One instrumental offers a break in the vocal chaos, "Abracadabra."

**LOVE MEANS . . .** (Stax, STS 2044) a dozen songs to Carla Thomas, another soul thrush who emphasizes softness instead of screaming. Highlights are a trio of tunes she aided in penning, plus Jimmy Webb's "Didn't We," and "Cherish." The latter being de-souled by means of a glossy chorus and heavy use of strings.

**AIR** (Embryo, SD 733) is a quartet—one gal, Goggie Coppola, and three guys—who are heavily into jazz modes on all 11 cuts. Naturally! The LP was produced by Herbie Mann. Goggie wrote all but two of the tunes, and she also plays piano, organ, and harpsichord. Her vocals, also jazz-oriented, contain a potent soulful quality.

**SONGS** (Uni, 73103) features a trio led by Orville Stoeber (who sings, plays guitar, and wrote most of the lyrics and music for the dozen cuts). Harry Palmer is on guitar and Ray Barrett plays organ and piano. It's folk, a bit of rock, and lots of classical overtones, mostly ballad format. Stoeber's voice, often resembling that of Jose Feliciano, has a bluesy quality and stays in high registers. Best tune is "Seventh Avenue," which tells of a prostitute and asks: "She stands up straight, she's never late, and she makes love the whole day through. Do You?"

**GREEN BULLFROG** (Decca, DL 75269) is a nine-man group that toys with blues-rock. Mostly it's loud, noisy, and unoriginal. The eight cuts include Joe South's "Walk a Mile in My Shoes." Urrrrp!

**LOVEJOY** (Stax, STS-2040) spotlights heavy blues, superimposed on a heavy gospel sound, by Albert King, who is a wild man with a guitar. King's vocals are supported by Jeanne Greene and The Mt. Zion Singers. Highlights: "Corina, Corina," "For the Love of a Woman," and the Mick Jagger-Keith Richards opus, "Honky-Tonk Woman."

**BLESS THE BEASTS AND CHILDREN** (A&M, SP 4322) is a soundtrack album helped immeasurably by the presence of The Carpenters (the pop duo excels on the title tune, which, not incidentally, is reprised twice instrumentally). Of the 11 tunes, though, only the vocals are noteworthy (the others are "Down the Line," sung by Barry De Vorzon, lyricist and co-producer with Perry Botkin Jr., who did the arrangements, and "Lost," sung by Renee Armand).

**CALYPSO CARNIVAL** (RCA Victor, LSP-4521) finds Harry Belafonte trying, unsuccessfully, to go home again. A throwback to the '50s, despite the bits of rock superimposed on the offbeat calypso strains, it's all outdated in motif.

## Statement of Ownership, Management, And Circulation

STATEMENT OF OWNERSHIP, MANAGEMENT AND CIRCULATION, Act of October 23, 1962; Section 4369, Title 39, United States Code.

1. Date of Filing, Sept. 20, 1972; 2. Title of Publication, AUDIO; 3. Frequency of Issue, Monthly; 4. Location of Known Office of Publication, 134 N. 13th Street, Philadelphia, Penna. 19107; 5. Location of the Headquarters or General Business Offices of the Publishers, 134 N. 13th Street, Philadelphia, Penna. 19107.

6. Names and Addresses of Publisher, Editor, and Managing Editor: Publisher, Jay L. Butler, 134 N. 13th Street, Philadelphia, Penna. 19107; Editor, George W. Tillett, 134 N. 13th Street, Philadelphia, Penna. 19107; Managing Editor, none.

7. Owner, North American Publishing Company, 134 N. 13th Street, Philadelphia, Penna. 19107; I.J. Borowsky, 134 N. 13th Street, Philadelphia, Penna. 19107.

8. Known Bondholders, Mortgagees, and Other Security Holders Owning or Holding 1 Percent or More of Total Amount of Bonds, Mortgages or Other Securities: None.

9. Paragraphs 7 and 8 include, in cases where the stockholder or security holder appears upon the books of the company as trustee or in any other fiduciary relation, the name of the person or corporation for whom such trustee is acting, also the statements in the two paragraphs show the affiant's full knowledge and belief as to the circumstances and conditions under which stockholders and security holders who do not appear upon the books of the company as trustees, hold stock and securities in a capacity other than that of a bona-fide owner. Names and addresses of individuals who are stockholders of a corporation which itself is a stockholder or holder of bonds, mortgages, or other securities of the publishing corporation have been included in paragraphs 7 and 8 when the interests of such individuals are equivalent to 1 percent or more of the total amount of the stock or securities of the publishing corporation.

10. This item must be completed for all publications except those which do not carry advertising other than the publisher's own and which are named in Sections 132, 231, 132, 232 and 132, 233 Postal Manual (Sections 4355a, 4355b, and 4356 of Title 39, United States Code).

	Average no. copies each issue during preceding 12 months	Single issue nearest to filing date
A. Total no. copies printed (Net Press Run)	104846	117640
B. Paid circulation		
1. Sales through dealers and carriers, street vendors and counter sales	16634	20256
2. Mail Subscriptions	75168	81988
C. Total paid circulation	91802	102244
D. Free Distribution by Mail, Carrier or other means		
1. Samples, complimentary, and other free copies	1236	1364
2. Copies distributed to news agents, but not sold	11152	12934
E. Total distribution (Sum of C and D)	104190	116542
F. Office use, left-over unaccounted, spoiled after printing	656	1098
G. Total (Sum of E and F—should equal net press run shown in A)	104846	117640

I certify that the statements made by me above are correct and complete.

JAY L. BUTLER, Publisher



# Recorded Tape Reviews

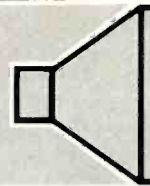

**Ravel: Fanfare from *L'Eventail de Jeanne*. Franck: Symphony in D Minor.** Leopold Stokowski cond. the Hilversum Radio Phil. Orch., **Ampex/London L75061**, open reel, 7½ ips, \$7.95.

London Records decided to celebrate the 90th birthday of my dear friend Leopold Stokowski by issuing a spate of new recordings by the Maestro. This Franck D minor symphony and the snippet of Ravel is one of that group, and in several respects it is an extraordinary recording. The Ravel *Fanfare* is new to me, and it can be summed up as an amusing bit of musical fluff. The *Fanfare* precedes the symphony on the tape, and I must warn you that you will think you have a blank tape on your machine, since a full half-inch of tape must be wound onto the take-up reel before the music commences! If I am correct it has been a great many years since Stokowski recorded the Franck symphony. His performance here is unabashedly romantic in concept. His tempi and phrasing are geared for maximum dramatic effect, and in fact many a purist will consider the reading on the "schmaltsy" side. Be that as it may, the Maestro makes this old warhorse (which has sometimes been called a "study in redundancy") newly interesting, and he gets fine playing from the Hilversum musicians. The Hilversum orchestra most likely is considered a Dutch "provincial" orchestra, but you would never believe this semi-epithet from the polish and precision of their playing. This was recorded at the Hilversum Radio Studios, and I am most impressed with the splendid acoustics. If supplementary reverb chambers were used, they must be awfully good, as I hear no evidence of them. The sound is broad and spacious, yet good orchestral definition is maintained and balances between orchestral choirs are evenly weighted. The overall sound is quite clean, with an especially sonorous bass line adding to the solidity of the sound. Most fantastic of all is the fact that there was almost no tape hiss! And this with playback at good room-filling level! The original master was A type Dolby, of course, but this is not a Dolby B type processing (at least not yet) so I don't know what

happy circumstances gave us such a quiet tape. I have heard rumors floating around that Ampex is now duping their open reel tapes at a mere 2-to-1 ratio. Perhaps so . . . in any case we are grateful for the low noise which makes this fine recording all the more desirable.

**Tchaikovsky: Symphony #2** (Little Russian). Leonard Bernstein cond. the New York Philharmonic, **Columbia MT31195**, Dolby cassette, \$6.95

Another fine cassette, with excellent range sound, with the quieter passages coming through unsullied by tape hiss thanks to the fine Dolby processing. Bernstein's performance is spirited and in fact almost frenetic in some moments. He essays a faster pace than the recent Thomas/Boston Symphony version, but nonetheless manages to be convincing in the lyrical sections. Fine playing from the N.Y. Philharmonic, especially in the first strings and the cellos. A little modulation noise noted, but not enough to mar the overall production.

**Scriabin: Poem of Fire, Piano Concerto in F Sharp Minor:** Vladimir Ashkenazy, piano; Lorin Maazel cond. the London Philharmonic Orch., **Ampex/London M10251**, Dolby cassette, \$6.95.

Scriabin is in the throes of a mild revival, and there have been several recordings lately of his lush tone poem *Prometheus*. This effort by Maazel is among the top choices by virtue of his deft handling of this sprawling work. He keeps everything cohesive, but gives full rein to the soaring climaxes, and the result is exciting music-making. The piano concerto is rarely heard, and truth be told it's not a particularly engaging work. But after you have recorded all the warhorses . . . where do you go from there? One can't know the depth of Ashkenazy's involvement with this piece; all the notes are played in his precise, articulate fashion, but he doesn't seem to be making a very inspired effort. The cassette rates high marks for sound quality . . . all is clean, balances are good, modulation noise a little in evidence in the concerto, nice acoustic framework. Piano sound again consid-

erably enhanced by the Dolby tape processing. Once you know how nice and quiet a pianissimo passage can be, it is awfully hard to listen to the same thing overwhelmed by the tape hiss typical of most non-Dolby recordings.

**London Phase Four Classical Sampler, Ampex/London L66007**, open reel, 7½ ips, \$7.95

This is one of those classical potpourris that Ampex and London are occasionally inspired to issue. I am told they are very popular, and if they are all as good as this tape, it is no wonder. The tape processing here is exemplary . . . tape hiss is quite low considering the multiplicity of recordings from which the numbers were culled . . . virtually no crosstalk or print-through, sound levels high and everything quite clean. The music ranges from a rousing performance of Moussorgsky's *Night On Bald Mountain* by Stokowski and the London Symphony, Dvorak's *Slavonic Dances*, *Light Cavalry Overture*, *Clair de Lune* and several other familiar works, and including the damndest transcription of the great Bach *D Minor Toccata and Fugue* by Camerata and the Kingsway Symphony Orchestra you have ever heard. Organ is combined with orchestra in a stupendous display of sonorities. It is overblown, it is cornball, but that is perhaps an injustice, because the transcription is really done quite well, and purists' howls aside, a thrilling sonic experience.

**London Phase Four Sampler: Various Artists. Ampex/London L66006**, open reel 7½ ips, \$7.95.

Another London sampler, this time of the pop genre, and a good one, albeit with a glaring error in the listing of material. You have everything here from Benny Goodman and a cool version of *String of Pearls*, Bernard Herrmann's effective music from *Psycho*, to Stan Kenton's roaring *Peanut Vendor*. The error is that sure as hell Mozart never wrote *Song of Joy*, that sleazy take-off on the *Ode To Joy* from Beethoven's *9th Symphony*. Really, fellas! Generally nice clean sound, good tape processing. Good tape to go with a tall drink on a hot day!

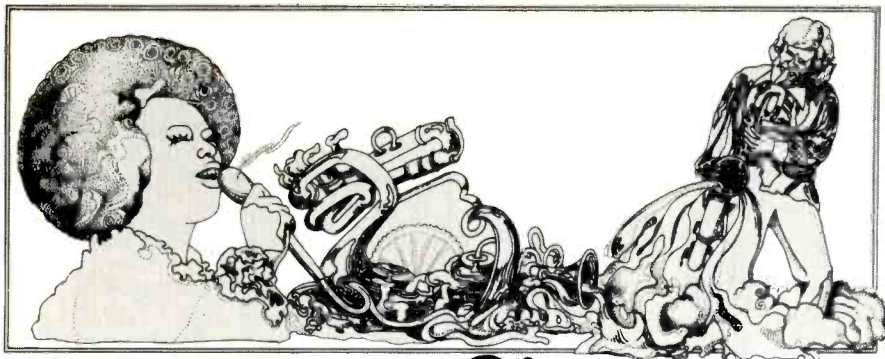

# Jazz

# &

# Blues

**Martha  
Sanders  
Gilmore**

**Mike Seegar: Music From The True Vine.**

**Musician:** Mike Seegar, guitar, banjo, dulcimer, autoharp, fiddle, harmonica, jew's harp.

**Songs:** *Birmingham Tickle; I've Rambled This Country Both Earlye And Late; The Sailor And The Soldier; Don't Let Your Deal Go Down; Old Gray Mare; Rattlesnake Daddy; Buckdancer's Choice; Old Blind Drunk John; In And Around Nashville; Little Betty Ann; Black Is The Color Of My True Love's Hair; Gambling Man; Roving Cowboy, and Lost Indian.*

**Mercury SRM-1-627, stereo, \$5.98.**

This LP of country tunes, mountain music, and folk songs has an authenticity that is refreshing. Appropriately titled, the friend of the earth is in this case Mike Seegar, an offspring of the famous Seeger family of songsters. Here, Seegar plays a galaxy of stringed instruments and sings with a kind of haunting, mountain-country twang that resembles a cross between a fiddle and a jew's harp.

In this rustic material out of the folk tradition, much of which Seegar arranged and re-arranged, he plays guitar, banjo, dulcimer, autoharp, jew's harp, harmonica, and fiddle. Thus the recording is a good introduction to the genre although, in its lack of commercialism, it may not have mass appeal. And the sound matches the material in naturalness!

It is every bit Seegar, this earth music, salty songs with humor and punch, a sea chanty, anecdotal tales of cowboys, lost love, and gamblers. In his approach, Seegar simulates the people who originated these tunes such as in *Lost Indian*, embellished with an owlish "who-who", *Roving Cowboy* featuring Seegar's plaintive voice against the



tormented sound of the fiddle, and *Black Is The Color Of My True Love's Hair*, an unaccompanied minor-keyed version that Seegar delivers like a strolling street crier. Seegar, the actor, accomplishes all, sometimes singing his song with his mountain accent, other times projecting radically different intonations, thereby proving extremely versatile vocally.

*Birmingham Tickle* is my favorite, a guitar instrumental with a lithesome melody in which the guitar boasts a full resonant sound. And it's interesting to compare Seegar's versions of *Don't Let Your Deal Go Down* and *Rattlesnake Daddy* with those of John Jackson, a fellow singer from Virginia. Everybody puts his stamp on these tunes!

Nonsense abounds in *Old Gray Mare* and *Old Blind Drunk John* performed by Seegar on a droning jew's harp, Seegar interjecting "buh-buh-

**GET  
MORE and BETTER  
FM Stereo Multiplex  
BROADCASTS**

WITH  
**FINCO**  
Award Winning FM Components

FM ANTENNA  
Model FM-4G

\$28.60 list

FM BAND  
PASS FILTER  
Model 3007  
\$8.05 list

FM INDOOR  
AMPLIFIER  
Model 65-7  
\$26.20 list



Write Dept. A-11 - for Catalog 20-213

**THE FINNEY COMPANY**  
34 W. Interstate St., Bedford, Ohio 44146

Check No. 94 on Reader Service Card

## The World's Greatest Speakers?

Every week some manufacturer claims that his speakers are the best. Where then do Rogersound Labs come in?

**We make truly great speakers like other people do, only our bag is price. We sell for 50% less because you buy direct from the factory.**

Columbia Records, Warner Bros., Reprise, and loads of other professionals use RSL studio monitors.

For full information on how you can get more speaker per dollar than you'd ever dream could exist, write or call:



**Rogersound Laboratories**

5706 Lankershim Boulevard  
North Hollywood, California 91601  
Phone: (213) 763-0855 • 877-1420

Check No. 95 on Reader Service Card

# NOW SCHWANN IS 14



To give you all you want to know about all kinds of records and tapes, Schwann now publishes 14 issues per year. The monthly **Schwann-1** carries all new listings and available classical and popular. The semi-annual **Schwann-2** catalog lists more specialized categories, also older and re-released music.

You need both **Schwann-1** and **Schwann-2** because each is part of the complete Schwann. Look for the dealer who displays this sign.

**Schwann-1** Monthly. Special new listing section has latest releases: records, 8-track cartridge and cassette tapes. Nearly 45,000 total listings in classical, recent popular, rock, jazz, musical shows, opera, ballet, electronic, quadrasonic, etc.

**Schwann-2** Semi-annual supplement. Expands coverage of Schwann-1 in specialized categories: pop more than two years old, classic jazz older and re-released mono and reprocessed stereo classical recordings, classical on lesser-known labels, international pop & folk on domestic labels, spoken, educational, religious, etc.



## SPECIAL PRICE SAMPLE OFFER

If your favorite store doesn't carry Schwann, order samples by mail. Prices include postage and handling.

- Schwann Sampler one Schwann-1 (monthly) and one Schwann-2 (semi-annual) .....\$2.00
- Latest Schwann-1 (monthly) .....\$1.25
- Latest Schwann-2 (semi-annual) .....\$1.00
- Newly revised Basic Record Library booklet.

Lists 1,000 suggestions in classical music by musical periods for your enjoyment. Send 15¢ for cost of handling, also 8¢ stamped self-addressed long envelope.

I enclose \$.....for the items checked above.

Name \_\_\_\_\_

Address \_\_\_\_\_

City \_\_\_\_\_ State \_\_\_\_\_ Zip \_\_\_\_\_

Dealer's Name & Address \_\_\_\_\_

### Schwann Record & Tape Guide

137 Newbury Street, Boston, Mass. 02116

AU

wuh-buh" instead of the usual "do-dee-oh-do"! *Little Betty Ann* has a curious tenor about it with intriguing lyrics against Seeger's banjo. It is appreciated that Mercury listed song sources.

There's no pretense here. Seeger's vine is ripe.

Sound: A-(natural) Performance: B+

**Bing Crosby, Louis Armstrong: Bing and Satchmo**

**Musicians:** Bing Crosby and Louis Armstrong, vocals, Armstrong, cornet, with chorus and orchestra.

**Songs:** *Way Down Yonder In New Orleans; Brother Bill; Little Ol' Tune; At The Jazz Band Ball; Rocky Mountain Moon; Bye Bye, Blues; Muskrat Ramble; Sugar; Preacher; Dardanella, and Let's Sing Like A Dixieland Band.*

**MGM GAS-137**, stereo, \$4.98.

This reissue proves a delight, albeit superficial, after just hearing the first few bars. This collection of tunes from the '30's and '40's from MGM's Golden Archive Series features two shining lights in the entertainment world during the mid-century, Bing Crosby and the late Louis Armstrong. Traces of Bing's experience in vaudeville emerge in his approach which contains a wealth of word plays and onomatopoeic blurts while Satchmo is the perennial personality-entertainer cum actor-musician cut-up that we all remember. Fans may recall the 1936 Decca recording *Pennies from Heaven* and the film by the same name where these two merged their mountain-high talents.

The material is appropriately out of the "High Society" ilk, admittedly schmaltzy, corny, and commercial at times but pleasantly nostalgic. We are treated to two Johnny Mercer tunes which stand utterly apart: his *Little Ol' Tune* and *Rocky Mountain Moon* which remind one of a midnight dance on Long Island, both melodic gems.

The sound is sweet swing and remarkably good although rechannelled for stereo. The balance is fine, and it is all full of fun and downright intoxicating to hear such pros.

Of interest is the contrast between Bing's smooth, slippery voice which croons and dips about the scale and Louis' bullfrog-in-the-well intonation, his timing as precise as St. Petersburg architecture.

Their time-sharing is about equal throughout, the two submitting musical dialogue that at times resembles a debate, but both contributing ear-bending rebuttals such as in *Way Down Yonder In New Orleans* and *Bye Bye, Blues*. The latter enjoys a



bit of the refreshing art of improvisation as they quote from *Pop Goes the Weasel*.

Although at this point in Louis' career he was short on improvising, he plays some stellar sounds on cornet as demonstrated in *Muskrat Ramble* and *Sugar*, which is a honey.

There's a chorus and an unidentified band, on cue always, which execute some tripping arrangements with above-average ensemble work and there's a well-conceived clarinet solo in *At the Jazz Band Ball*.

But MGM would have done better to provide some essential information. A long distance call to the company proved wasteful with still no information given. Nonetheless, *Let's Sing Like a Dixieland Band* is precisely what they do!

Sound: A- Performance: A-

**Dick Wellstood: From Ragtime On Musician:** Dick Wellstood, piano.

**Songs:** *Scott Joplin's New Rag; Pork And Beans; Yesterday; Kitten On The Keys; Three Little Oddities; Chicago High Life; Keepin' Out Of Mischief Now; Sunday Morning Blues; Fucallia; Handful Of Keys, and Put On A Happy Face.*

**Chiaroscuro 109,** 17 Terrace Place, Sea Girt, N.J. 08750.

In listening to this totally musical recording by pianist Dick Wellstood, it immediately becomes apparent that the virtuoso pianist can play just about anything "from ragtime on"—hence the title!

One in a spate of recordings emerging in this long overdue ragtime renaissance, this disc captures the spirit and intricacy of the genre in *Scott Joplin's New Rag*, a classic example of ragtime, as were nearly all of Joplin's rags, "Luckey" Roberts' *Pork And Beans*, and in a couple of Fats Waller compositions, *Handful of Keys* and the droll *Keepin' Out Of Mischief Now*, which Wellstood takes at a spare stride.

In addition, Wellstood serves up a couple of the late Zez Confrey's works—Confrey passed away only recently—his immortal *Kitten On The Keys*, which could easily supplant Czerny exercises, and *Three Little Oddities*, which are indeed that since one would never know they were by the same composer. They resemble études of impromptus and are like poetic children's play songs: winsome, Debussyesque, with a "Girl With the Flaxen Hair" quality, and played ethereally here by Wellstood, whose dynamics are superb throughout.

A favorite is *Chicago High Life*, written by Earl Hines in the twenties and played by Wellstood with marvellous

• NOVEMBER 1972

# A FOUR-CHANNEL RECEIVER FOR \$239.95?



HERE IT IS . . . THE ROTEL RX-154A

"Versatile performance and unbeatable value! That's the NEW ROTEL RX-154A Four Channel Receiver with "SQ" matrix system. The RX-154A has been designed to enable you to enjoy 4-channel realism in three different ways. . . . 4-channel reproduction of 4-channel tapes (discrete), 4-channel enhancement of your existing stereo library of tapes and records (derived) and . . . "decoding" capabilities for specially encoded FM broadcasts, records and tapes. . . . Any way you look at it . . . the NEW ROTEL RX-154A has all the answers . . . and at a price that is easy to live with! Only \$239.95, walnut finished wood cabinet included!" **RMS Power in Quad 10Wx4, RMS Power in Stereo 20Wx2.**

## Rotel of America, Inc.

2642 CENTRAL PARK AVE. YONKERS, N.Y. 10710

Check No. 99 on Reader Service Card

### ACTIVE DIVIDING NETWORK FILTERS

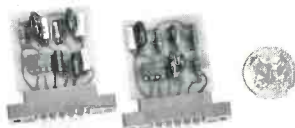

These are matched pairs of Butterworth filters made to order for the desired frequency. Attenuation—3 db. at cutoff frequency; filters can be supplied with either 6 db., 12 db, or 18 db. per octave. Construction—as illustrated, except that filters are dipped in a tough epoxy coating for protection against moisture and handling. Sockets are supplied.

### DIVIDING NETWORK FILTERS

TYPE	OUTPUT	THD & NOISE MAX.	PRICE PER PAIR
A	2.5 volts	10 Hz. to 10 KHz.—.1% 10 KHz. to 20 KHz.—.3%	\$29.50
B	9 volts	10 Hz. to 10 KHz.—.1% 10 KHz. to 20 KHz.—.2%	\$33.00
C	9 volts	10 Hz. to 60 KHz.—.1%	\$35.50

Prices FOB Factory.

## DeCoursey

ENGINEERING LABORATORY  
11828 WEST JEFFERSON BOULEVARD,  
CULVER CITY, CALIFORNIA 90230  
(213) 397-9668

Check No. 98 on Reader Service Card

## NOTHING FANCY



### JUST LOTS OF GOOD CLEAN POWER

Our 75 Watt RMS basic amplifiers are not the most beautiful available, but if it is performance you want and at a very reasonable cost, perhaps you can find a place to hide them. Harmonic distortion is typically less than .05% up to rated output and IM less than 0.1% at any level up to full output.

The circuit features differential inputs, current drive to complementary outputs with complete volt-amp protection. Circle the number on the reader reply card and we will send you a schematic, a copy of the Hirsch Lab. report, and our complete catalog of audio products.

UT-MA Single channel  
75 watts . . . . . \$90.00  
UT-M Kit. . . . . \$60.00

plus postage & insurance 14 lbs.

**SWTECH** SOUTHWEST TECHNICAL  
PRODUCTS CORPORATION  
219 W. Rhapsody, San Antonio, Tex. 78216

Check No. 97 on Reader Service Card

understatement and *élan*, his left hand inscribing deft punctuation.

Wellstood's repertoire ranges far and his approach at times recalls the talented Don Shirley. He explores the various faces of *Put On a Happy Face* tempo-wise, bringing out the very best of its optimistic qualities. Wellstood is gloriously unpredictable in the Beatles' *Yesterday* and his own *Fucallia* in which he quotes from *Laura*. And his synopsis of *Sunday Morning Blues* stands tall in musicianship, a haunting, suspenseful blues that is lovely harmonically even though the boogie insert seems a bit out of place.

One side of *From Ragtime On* is more than your money's worth. Dick Wellstood plays a very full keyboard and does not fall into the mechanical pit that swallows up many exponents of ragtime. He needs no accompaniment, is truly inventive, and also writes very amusing liner notes. The overtones of the piano are reproduced well and one cannot find fault with the sound quality.

Find Chiaroscuro at your local record store or write: Richard Wellstood, 17 Terrace Place, Sea Girt, N.J. 08750.

Sound: A- Performance: A+

# Dust buggin' you?

Dust and dirt are the number one record killers. With today's featherweight tracking cartridges and elliptical styli, the need has never been greater for impeccably clean records. Whether sitting still or playing on the turntable, records attract and hold dirt.

The solution is a Watts Dust Bug. Simply attached to any transcription or automatic turntable, its dust-seeking brush penetrates the deep crevices a split second before the stylus tracks the groove, and lifts the

dirt for removal by a downy soft plush roller. At the same time it applies anti-static fluid to inhibit static build-up. The result: reproduction is sharper; surface noise is reduced and record and stylus life is substantially increased.

The Dust Bug, along with other Watts Record Care Equipment and Kits, is available at leading hi-fi dealers. Send for Watts Record Care Book. Enclose 25c for postage and handling. Elpa Marketing Industries, Inc., New Hyde Park, N.Y. 11040



## Get a Dust Bug.



Check No. 68 on Reader Service Card

### Earl Hines: My Tribute to Louis

**Musicians:** Earl Hines, solo piano.

**Songs:** *When It's Sleepy Time Down South*; *Struttin' With Some Barbecue*; *A Kiss To Build A Dream On*; *Pennies From Heaven*; *Confessin'*; *Muskrat Ramble*; *Blueberry Hill*, and *Some Day You'll Be Sorry*.

**Audiophile S III, Stereo, \$5.95.**

"July 6, 1972, was the saddest day in the history of jazz," lamented pianist Earl Hines, winner of *Down Beat* Magazine's International Critics' Poll for the past two years and one of the most inventive and influential keyboard artists alive today. It was the day Louis Armstrong passed away and it holds special significance to Hines who was associated with Louis off and on since they met in Chicago in 1925, playing together from 1948-51 and sharing in a genuinely mutual musical respect.

Such was Louis' influence upon Hines that Hines has been dubbed the "trumpet style pianist," echoing Louis' brilliance and melodic intensity pianistically in linear, single-note horn lines in the treble cleff counter-balanced by strident ragtime chords in the bass, which together set up a rhythmic turbulence the likes of which you've never heard. Indeed, it is as though Hines' hands are independent of one another but they create Cezanne-like constructions with the architectonics, originality, and pzazz of a Frank Lloyd Wright coupled with the natural curvaceousness of a Le Corbusier.

This LP, recorded only twelve days after Louis' death, is a personal tribute to Satchmo by Hines and contains eight of the tunes Hines associated with his musical comrade and champion. It includes two takes of Armstrong's theme song, *When It's Sleepy Time Down South*, the first gracefully lilting, the last a beautifully reflective recapitulation of Louis' genius—a kind of poignant legato sign-off by the master.

Hines' superb technical prowess never lapses in his rhythmically bright tremolos and galloping glissandos. He colors his text with vivacious marks of punctuation and underlinings as crisscrossed as wigwams. One is constantly aware of his extemporaneous creativity, his laudable inability to play the same thing twice. One of the most interesting tunes in this collection is the familiar *Kiss To Build A Dream On* which Louis and Hines recorded in 1951. Hines infuses it with an insinuating, sidling motion, a crab-like

and saucy soft-shoe in the left hand which acts as a foil to the tune's serene melodic character in the right and embellishes it with astonishing cascading runs down to the cellar.

Hines' wit is ever present in an effortless, easy-going *Muskrat Ramble* which Louis recorded with trombonist and composer Kid Ory in 1926. Hines casts a droll glance at New Orleans, contriving a melodically swinging mid-section that is akin to Sousa's *Stars and Stripes Forever* and countless other marches of the early twentieth century. His harmonics are notable.

Hines gives a slow-moving, sing-song reading to *Blueberry Hill*, an all-vocal hit that Louis made in 1949, slithering into it subtly and instilling it with some touches of Erroll Garner and quoting from *The Tender Trap* which allows a Beethovenesque tag to escape.

*Struttin' With Some Barbecue*, which Armstrong recorded in 1927, is an inevitable entrée with a boogie-woogie stop-and-go left hand and a fanciful use of syncopation. It is as if Hines' left hand is a springboard for his right: one is caught up in swirling musical pools that finally flow into a waltz—Niagara Falls flowing into Walden Pond! Neatly cut, the corners squared, edges turned under, *Struttin'* is an amazing feat by "Fatha."

Regrettably, my cut of *Confessin'* is badly scratched for it's one I would like to play over and over. *Confessin'* was one of Armstrong's big hits of the thirties. Here, Hines fashions umbrella twirls and whirl-a-gigs in a relaxed treatment, his interpolative skills multifarious.

The sound quality of this recording is bright and sparkling with only my own aforementioned scratch as a blemish. Hines was loaned a Steinway concert grand for the date and he enhanced its unique instrumental properties by his rhythms that ricochet like boomerangs.

Pianist Hines here reincarnates the sunny, smiling spirit of Louis Armstrong and their very amiable affiliation. Hines takes Satchmo out like a full-blown New Orleans funeral parade—an Olympia Brass Band all rolled into one Steinway Concert Grand which serves Hines' talents well and where accompaniment would be superfluous.

If you are not able to obtain this from your local music dealer, write to Audiophile Records, Box 66, San Antonio, Texas 78291, or, even better, suggest that he stock this very fine catalog.

Sound: A-

Performance: A-

# Do Something Nice for a Friend Today

## Introduce him to Audio Magazine at our expense!



We'll send your friends a copy of Audio Magazine at absolutely **NO COST**, so they can get a glimpse of one of the best read, well written magazines about hi-fi, stereo . . . **AUDIO MAGAZINE**, of course!

We want to show your friends what they're missing every month.

And, we want to tell them how valuable Audio is for stereo enthusiasts, do-it-yourselfers, music lovers and even audio engineers and professionals.

Each and every month Audio carries dozens of stories and columns devoted to new products, record reviews and new equipment—practically everything new and exciting that's happening in the audio spectrum.

**So, do something nice for a friend today!**

Let us send him a **FREE** copy of Audio. I guarantee you he'll be grateful for your thoughtfulness.

Please list the names and addresses of friends you think would enjoy Audio Magazine. We'll send them FREE copies of Audio and a gift card inscribed with your name.

My name is \_\_\_\_\_

Address \_\_\_\_\_

City \_\_\_\_\_ State \_\_\_\_\_ Zip \_\_\_\_\_

(fill-out or attach subscription label from cover)

Please send FREE copies of Audio to my friends listed below.

Name \_\_\_\_\_

Address \_\_\_\_\_

City \_\_\_\_\_ State \_\_\_\_\_ Zip \_\_\_\_\_

Name \_\_\_\_\_

Address \_\_\_\_\_

City \_\_\_\_\_ State \_\_\_\_\_ Zip \_\_\_\_\_

# Classified

Rates: 25¢ per word per insertion for noncommercial advertisements; 50¢ per word for commercial advertisements. Frequency discounts as follows: 2 times, less 15%; 6 times, less 20%; 12 times, less 30%. Closing date is the FIRST of the second month preceding the date of issue. *Payment must accompany all orders under \$10.00.* Use the handy self-addressed, postage paid card at the back of this issue. When replying to AUDIO box number ads, send letters c/o AUDIO, 134 No. 13th St., Phila., Pa. 19107. For more information about classified advertising, circle Reader Service Card #135.



## FOR SALE

**FREE 64 PAGE CATALOG** offers hundreds of recordings of rare renaissance, baroque and classical music. Some records priced as low as \$1.00 each! All late recordings. In stereo only Musical Heritage Society, Box 932-AU, New York, N.Y. 10023.

**SOUND SYSTEM INTERNATIONAL** presents a revolutionary radial track tone arm and turntable. Brochures available. Paul Heath, 81 Big Tree St., Livonia, N.Y. 14487 (716) 346-5630.

**SHURE V15-11** improved. \$47 and old cartridge. shipped prepaid STEREO Shop, 1209 1st Ave. SE, Cedar Rapids, Iowa 52402.

**"OVERSEAS MUSIC & NEWS** Hallicrafters S-240 shortwave receiver w/tuner output \$99.95 ppd USA AMRAD 1025 Harrison St., Oakland, Ca. 94607"

**LOUDSPEAKER KITS**, complete or cabinet only, original and published designs. Amplifier kits. Factory direct at great savings. Catalog 25¢. R.C.S. Co., P.O. Box 30312, Santa Barbara, Cal. 93105.

**ACOUSTIC SUSPENSION SPEAKER KITS**. Build your own . . . Save. 10¢. AudioCessories, 320 W Edmonston Rockville, Maryland. 20852.

**FREE 4-TRACK** Stereo Tapes, 8-Track Cartridge, Cassette. Write Music, Box 27815, Los Angeles, Calif. 90027.

**THE FINEST STEREO SOUNDS**—On demonstration, Audio Research's Magneplanar speakers and Dual 75 amplifier, QUAD ESL's, Infinity, Stax, Decca, Transcripitor, Thorens, Revox—"DS" Audio, 410 East Evergreen Road, Lebanon, Pennsylvania 17042 (717) 273-6314.

**WORLD'S LARGEST, DEEPEST, MOST POWERFUL SUB WOOFER SYSTEM** can be had only at Music and Sound Ltd., 11½ Old York Road, Willow Grove, Pa. 19090: 215-659-9251. From \$1,000.

**!!OUR RABCO SL-8E SOUNDS BETTER THAN YOUR SL-8E!!** For \$100 we'll convert "yours" to "ours". Professional Products Div., Music and Sound Ltd., 11½ Old York Road, Willow Grove, Pa. 19090: 215-659-9251. Dealer inquiries invited.

**SEND FOR LATEST STUDIO CLEARANCE** sale list featuring microphones tape recorders, equalizers, limiters, turntables, lathes, cutter heads, loudspeakers, mixing consoles, organs, and pianos. Only professional studio equipment listed. Wiegand Audio Laboratories, RD #3, Middlesburg, Pa. 17824 (717) 837-1444.

## FOR SALE

**BUY DIRECT FROM ENGLAND'S HI-FI MAIL ORDER SPECIALISTS!** Save on SME, Leak, Goldring, Decca, Tandberg, Revox, Gold Speakers, Garrard, Wharfedale, KEF, Celestion, Transcripitors, Cambridge etc. Insured shipping quotes free or send \$2.00 bills for catalog (\$4.00 air post) credited on first purchase over \$100. Goodwin Ltd. 7 Broadway, Woodgreen, London N22. Visitors welcome to showrooms.

**ENGLAND'S LEADING MAIL ORDER AND DISCOUNT SPECIALIST OFFER:**—SME IMF RADFORD QUAD TANNOY B & W TEAC KEF DUAL SANSUI AT VERY COMPETITIVE PRICE. PLEASE SEND FOR QUOTES. REPLY BY AIRMAIL. SHIPPED IMMEDIATELY. FREIGHT COLLECT. SOUTHERN AUDIO SERVICES LTD. 43, HIGH STREET, KINGSTON-ON-THAMES, SURREY.

**BASF, MEMOREX, SCOTCH** reels, cassettes, 8-tracks. Lowest prices. Satisfaction guaranteed. S&S Audio, Box 2065, Champaign, Ill. 61820.

**PROTECT YOUR LPS**. Poly sleeves for jackets 5¢ Inner sleeves 4¢ Poly lined paper sleeves 10¢ White jackets 25¢ Postage \$1.00 House of Records, Hillburn, N.Y. 10931.

**KLIPSCH, TANNOY, JBL, MARANTZ, THORENS, RABCO**. No discounting. Superior Sound, 2780 Erie Boulevard East, Syracuse, New York 13224.

**NAB HUB ADAPTERS**—Fit Revox, Crown, TEAC, Roberts. \$3/pair postpaid. No C.O.D. Quantity prices available. John Kountz, 1065 Van Dyke Dr., Laguna Beach, Calif. 92651.

**"PERFECTIONISTS"** and discerning people can now get the amplifier that's "wiping out" all other amplifiers at test clinics across the country and is better than test equipment! Kit only \$60. Send for Free Catalog SWTPC, Box 32040B, San Antonio, Texas 78284.

**AMPEX PRO TAPE** by the carton. Send for prices. BKM Associates. Box 22 Wilmington, Mass. 01887.

**INFINITY AND CROWN SYSTEMS**—Aurelinear speakers, AKG microphones, UREI limiting, Fairchild equipment, RABCO, Decca Mark V. All laboratory tested. Barclay, 503 Haverford Ave. Narbeth, Pa. (215) 667-3048.

**ON DEMONSTRATION**—Trans-static electrostatic transmissionline monitors, Super Quad speaker system, Audio Research Corp. D-75 amplifier. Phase Linear 700 and 400 amplifiers. Sound System International arm-turntable combination. Paul Heath, 81 Big Tree St., Livonia, N.Y., 14487 (716) 346-5630.

## FOR SALE

**AUDIO RESEARCH, RADFORD, S.A.E., PHASE LINEAR, BRAUN, KLIPSCH HARTLEY, REVOK, B&O, DECCA**, others. Custom designed and constructed music reproduction systems. Each component checked and adjusted. Demonstration by appointment. Phone or mail consultations. C.M. Santmire, Audio Consultant, 1340 S. 20th St., Lincoln, Nebraska 68502. (402) 477-8469

**RARE STAMPS!** 101 Old United States 1861-1935 \$1.50. Approvals. J. Cuddihy, 80 Lexington Ave., Jersey City, New Jersey 07304.

**POCKET MAGNETOMETERS** enable serious recordists to determine when & if their equipment needs demagnetizing. The Han-D-Mag enables you to really do something about it. New Audiophile Han-D-Kits are now available. Includes Magnetometer, clip-on probe, Han-D-Mag with sensor strips, instructions and list of experiments. Price 20/B5 Kit \$29.75. Order direct or ask for data and bulletins—R. B. Annis Company 1103 N. Delaware St. Indianapolis, Ind. 46202.

**Phase Linear, Crown, Radford, B&O, Braun, Klipsch, SAE, & Hegeman**. Audio Labs, Inc. 2204 Ingersoll, Des Moines, Iowa 50312.

**SCOTCH RECORDING TAPE**, lowest prices, TAPE CENTER, Box 4305B, Washington, D.C. 20012.

**AUDIO RESEARCH, INFINITY, SAE, BRAUN, TRANSCRIPTORS, DECCA, ESS, STAX, QUAD, EPI**, and others. THE STEREO SET, 1737 Wisconsin Ave., Washington, D.C. 20007. (202) 338-1493

**AUDIO RESEARCH DEMONSTRATION THE STEREO SET**  
1737 Wisconsin Ave., N.W.  
Washington, D.C.

**VISITING WASHINGTON D.C.? THE STEREO SET** specializes in the world's finest audio equipment. Relax in one of our 3 sound rooms. 1737 Wisconsin Ave., (202) 338-1493.

**DAYTON WRIGHT, E.S.S., RADFORD, INFINITY, I.M.F., B&W LTD. QUAD E.P.I., BRAUN, B&O, CITATION, HEGEMAN, KEITH MONK: "ELF", SPENDOR, A&D ARMS, ADC, RABCO, DECCA, PHASE LINEAR, OTARI TRANSCRIPTORS, SINCLAIR, JANZEN, SSI**. We have the best demonstration "rooms" on the East Coast. TRANSCENDENTAL AUDIO, 1214 WALDEN AVE. BUFFALO, N.Y. 14211. 716-897-3984

## FOR SALE

**+STEREO PLUS.** The Store owned by engineers. All items lab tested, data supplied. Best makes, keen prices. Free advice by experts. Stereo Plus, Parkway Center, South High St., West Chester, Penna. 19380

## FOR SALE

**CHICAGO'S AUDIO PERFECTIONISTS** offer state-of-the-art equipment. NO APPOINTMENT REQUIRED to hear and buy: **Audio Research** (Magneplanar, Dual 75, SP-3), **B&O** (full line), **Decca**, (both "London" and Mark IV cartridges, International tone arm, Deccalifts, Microlifts, Kelly Ribbon Tweeters), **E.S.S.**, **Infinity Systems**, **Phase Linear**, **Quad**, **Revox**, **Sheffield** (both records), **Spendor** (monitors and speakers), **Stax** (SR-3 electrostatic headphones, the UA-7 Tone arm, Headphone amplifier), **Transcriptor** (both Hydraulic Reference and Saturn turntables, tone arms, accessory brushes, stylus-pressure gauge), and the **Syantific Audio Record Cleaning Machine**, at \$595. OPEN DAILY, 10-6 (Mon. & Thurs. to 9 p.m.), and Tues., Wed., Fri. or Sat evenings, by appointment. Ten minute walk north of Chicago's Loop. BankAmericard, MasterCharge, American Express, Welcome. **THE AUDIOPHILE**, at 8 East Erie St., Chicago 60611. Telephone (312) 787-0750.

**GET "MUSIC ONLY" FM Programs** SCA Adaptor fits any FM tuner or receiver. Free list of Stations with order. Kit \$14.50 (with Squelch \$19.50) Wired and Tested \$25.00 (with Squelch \$29.95) All plus postage & insurance. Thousands Sold. SWTPC, Box 32040A, San Antonio, Texas 78284.

**SCOTCH MAGNETIC TAPE**, discount Box 167A, Orwigsburg, Pa.

**STEREO SYSTEMS, LOW PRICES!** Write or call: Purchase Radio Co., 747 Main St., Buffalo, N.Y. 14203 (716) 854-2124.

**BUY IRISH TAPE** at discount prices, get Free leaders trailers. Write for catalog and order form. Also ask for pre-recorded specials. Direct Mail Cassette Corp., Box 71, Plainview, N.Y. 11803.

**HEGEMAN SPEAKERS**, \$99.50 each. Superbly reviewed "ROLLING STONES" 1/14/71. **CREIGHTON AUDIO LABS.**, 740 Haven Pl., Linden, N.J. 07036 (201) 925-1020.

**BUYING PHOTOGRAPHIC AND HI-FI/STEREO EQUIPMENT IN HONGKONG, JAPAN, AND SINGAPORE.** 96-page comparative pricing guide lists prices and available discounts of more than 1,170 items. Covers all well-known makes of cameras, lenses, and accessories; all popular models of hi-fi/stereo components. All prices in local currency and converted into U.S. dollars. Send \$1.50 for current issue (updated quarterly)! **HK Media Corporation**, P.O. Box 368, Pelham, N.Y. 10803.

**JBL PARAGON**—Walnut. Beautiful condition \$1700.00 JN Hartley 1502 Butternut, Richland WA 99352 509 947-5026

**FM BACKGROUND MUSIC** without commercials available on many FM stations! **MUSICON** Adaptor plugs into your FM Tuner, delivers continuous music thru your amplifier and speakers. Line cord operated. No adjustments or tuning, ever. New design breakthrough guarantees optimum performance (15-day refund for any reason). Lowest price ever—\$39 postpaid to **K-LAB**, Box 572A, S. Norwalk, Conn. 06856.

## FOR SALE

**NEW LOW PRICES ON COMPONENTS, SYSTEMS! SAME DAY QUOTES! FAST, LOW-COST GUARANTEED DELIVERY! YOU'LL HEAR MORE FROM REDWOOD STEREO! R.S.C.,** PO Box 2794, SAN RAFAEL, CA. 94901. (415) 472-2255.

**VALUABLE RECORDED TAPES** lose highs and become progressively noisier each time they are played on equipment that is not thoroughly demagnetized. You can measure damaging magnetic residuals with the Pocket Magnetometer and really demagnetize recorder components with the powerful Han-D-Mag. Now available, complete Audiophile Han-D-Kits including: Magnetometer, Probe, Han-D-Mag, experimental sensors and "Notes". Kit 20/B5 \$29.75, Kit 25/S5 \$51.00, postpaid U.S.A. Literature available. **R.B. Annis Company** 1103 North Delaware, Indianapolis, Indiana 46202.

**SONY 854-4 QUAD TAPE DECK** Mint Condition. \$975 Appalachia Sound Recording Studios Rt #8, Box 525; Chillicothe, Ohio 45601 (614) 663-2544 Old Route 23 South Road.

**LARGEST QUAD DEALER IN U.S.A.** offers experienced sales and service plus free freight (in continental USA) on all Quad equipment. (New FM3 usually in stock). **THE AUDIOPHILE**, 8 East Erie, Chicago, ILL. 60611. Telephone (312) 787-0750.

**BROCINER Transcendents**—two in excellent condition—classic speakers with Klipsch bottom and Lowther top—J. Kameron, 247-02 41 Ave., Little Neck, N.Y. 11363—(212) 631-1578.

**TEAC 4070SL** \$475; Lamb mixer (4/2, full eq. echo limiting), \$425; Sony MX112 mixer, \$65. (203) 322-2995

**TEAC TAPE RECORDER, SONY COMPONENT DEALER CLOSING SHOP.** ALL ITEMS VERY LATEST AT LESS THAN DEALER'S COST. SAVE 30% TO 50%. STATE NEEDS. BOX A02-1

**OTHER LOUDSPEAKERS WILL BORE YOU** after you own two or four Quad Electrostatics. Their incredible definition and transparency have made them a monitor standard for Deutsche Gramophone, Philips, the B.B.C., and many others. We strongly recommend Quad 303 power amp for guaranteed results. Immediate delivery of all Quad components from stock (we pay freight in continental USA) and complete service from **THE AUDIOPHILE**, 8 East Erie, Chicago, ILL. 60611. Telephone (312) 787-0750.

**FREE** Electronics plans and kit catalog. **McCord Electronics**, Box 41, Sylvania, Ohio 43560.

**SAVE AT LEAST 35%** on high-quality 8-track stereo tapes with 30 of the top country western songs, or 25 of the top pop songs as listed in Billboard each month. Send for information today: **Mildred's Gifts P.O.** Box 7253 Portsmouth, Va. 23707

**THE SPENDOR BC-1 MAY BE THE BEST BOX** speaker ever made. British critics have raved over it. Requires only 25 watts. Available in Rosewood, Teak, or Walnut at \$320, including "trolley" base. (Available without at \$295). **THE AUDIOPHILE**, 8 East Erie, Chicago, ILL. 60611.

**OLD, ACOUSTICALLY RECORDED** sounds your grandparents danced to—jazz, waltzes, vocals, comedy, etc.—Lauder, Whiteman, Sousa and many others. Only \$3.00 for sample 60-minute cassette sent first class mail. **The NITSUA Co.**, P.O. Box 96, Garden City, N.Y. 11530

**MARANTZ 10B TUNER, MINT CONDITION.** ASKING \$500. Box #A02-3

## FOR SALE

**JAPAN HONG KONG DIRECTORY.** World products information. \$1.00 today. Sekai Shogyo Annai, Hillyard, Washington 99207.

ii **DECCA MK. VII, Repeat MK. V.** This is not a misprint. At long last the ultimate cartridge hand picked and guaranteed from Music and Sound Ltd., 1 1/2 Old York Road, Willow Grove, Pa. 19090: 215-659-9251

**Kenwood, Sansui, JVC, Nikko, Akai, Crown, JansZen, PL, IMF, Citation, ESS, SAE, LDE, JBL, Beyer-Revox, Tandberg, Hegeman, Phasel, Braun, Others.** US PX Pricing No catalog, quotes only, immediate domestic delivery. **Audiifax**—District of Columbia, Box 7961 Atlanta, Ga. 30309.

**DECCA MK-V CARTRIDGES SHIPPED FROM STOCK.** Both the regular "London" model (\$99.50) and the "Export" version (\$125, not sold in England) shipped Air Parcel Post if you send certified check or Money Order. (If using BankAmericard, Master Charge, American Express send complete number, expiration date, YOUR SIGNATURE). For ultimate performance from these cartridges we strongly recommend the Decca International tone arm (\$117.50), and we also stock the superb "London" ribbon tweeters (\$125 each, including 1 kHz crossover), Microlift (\$8.95) and Deccalift (\$35) cueing devices. **THE AUDIOPHILE**, 8 East Erie, Chicago, ILL. 60611. Telephone (312) 787-0750.

**Music & Sound Ltd. presents FACSIMILE REPRODUCTION**, starring Audio Research Corp's Magneplanar Loudspeaker, High Definition Electronics & Xovers. Continuous performances. 1 1/2 Old York Road, Willow Grove, Pa. 19090. —215-659-9251

**SAE Mk. IVB** power amp. 1 year old, perfect. \$295. Novak, 9391 W. Outer Drive, Detroit, Mich., 48219. (313) 534-6964 eves.

**JAZZ & BLUES** Records & Books—new & out-of-print. Send for lists. Traditional Jazzland, Box 366-E, Dayton, OH, 45401

**REVOX A-77** \$400.00 Decca 4RC \$40.00 Both excellent. **Douglas Robinson**, Waterloo, Nebraska 68069 (402) 779-2589

## ELECTRO-ACOUSTIC DESIGN ENGINEER

We desire to engage for mutual benefit someone who has the urge to create and see produced elegant loudspeakers and loudspeaker systems. You can satisfy your urge for creativity and our needs simultaneously.

**Prime requisites** are imagination and a love of music coupled with a background in physics, an engineering discipline or mathematics. A degree in one of these fields is desirable but not mandatory, as we also treasure the supremely self-educated individual.

**Experience** in the field of applied musical acoustics is of high value.

Send resume and salary requirements in complete confidence to

Harold Boyce, V.P. Industrial Relations  
Electro-Voice, Inc., 600 Cecil St.  
Buchanan, Michigan 49107

An Equal Opportunity Employer

## FOR SALE

**STAX SR-3 HEADPHONES SHIPPED FROM STOCK.** Send \$115. Check or money order for overnight air parcel post delivery. **The Audiophile**, 8 East Erie, Chicago, ILL. 60611.

**FERROGRAPH** Series 7 Recorder New, with warranty and metal reels \$380. R. Stuehler 645 Darrell Rd. Hillsborough Ca. 94010 (415) 344-8824

**MACINTOSH INDUSTRIAL 200 WATT Tube Mono Amp** in Rack. ALTEC 290 Drivers on 311-90 Horns Pair WHW P.O. Box 1073 Carbondale, Ill. 62901

**8 Track Holder**—Compact, attractive walnut finish wood and masonite construction. Holds 48 cartridges. Lazy susan swivel base. 9½" X 9½" X 12½" high. Also available for cassettes. Regular price \$14.95. Now reduced to \$9.95 Postpaid. House of the Swanson, Box 808A, E. Norwich, N.Y. 11732.

**DIAMOND NEEDLES** and Stereo Cartridges at Discount prices for Shure, Pickering, Stanton, Empire, Grado and ADC. Send for free catalog. All merchandise brand new and factory sealed. **LYLE CARTRIDGES**, Dept. A P.O. Box 69, Kensington Station, Brooklyn, New York 11218.

**SOUNDTRACKS**—O.C.—Personalities & Jazz Want lists to: Theo's Records, P.O. Box 4994, Panorama City, Ca. 91412

**MATTES-MARTIN AMPLIFIERS** preamps, integrated units; manufacturer's closeout of used units and demos all in excellent condition. Savings of 50% and more from new. Mattes-Martin Electronics Corp., 909 Pitner Ave., Evanston, Ill. 60202. Phone (312) 869-7800.

**TANDBERG 6000X**, 4 Track. Excellent Condition, Warranty, \$395.00. Rick Moulton, 220 Briggs, Roodhouse, Illinois 62082 (217) 589-4321. Days 1:30—4:30. Will Ship Postpaid.

**FREE TECHNICAL ASSISTANCE + ACOUSTICAL CONSULTATION** with purchase of individually hand picked, guaranteed lab tested and aligned custom components from Infinity, Crown, Decca, I.M.F., Quad, Rogers, B.B.C. Monitor, Stax, Transtatic, J.B.L. PROFESSIONAL, Schoeps, Sound Systems International, Beyer, custom Rabco, Gately, Otari, dozens more. We save you \$\$\$ with **FACSIMILE REPRODUCTION** at Music and Sound Ltd., 11½ Old York Road, Willow Grove, Pa. 19090—215-659-9251 Engineers, College Instructors, Inventors, Musicians.

**TEAC #A-4070**, new tape deck, auto, reverse, bi-directional recording, bias switch, pause control, 4 ferrite heads, w/accessories. \$350 Hugh Tompkins (703) 282-5918

**THE ONLY ULTRA HIGH POWER HANDLING (400 Wt), ULTRA LOW DISTORTION, HIGHLY RELIABLE, TRULY LINEAR, FULL RANGE ELECTROSTATIC SPEAKER IS THE DAYTON WRIGHT XG-8. FEW PEOPLE ARE READY FOR THEM. TRANSCENDENTAL AUDIO, 1214 WALDEN AVE. BUFFALO, N.Y. 14211. 716-897-3984**

**QUAD MODEL 303 POWER AMP IS A 20TH CENTURY CLASSIC.** Units purchased from us optimized for immeasurable IM and HD. Has uncanny overload characteristics and is absolutely unconditionally stable into any load above 3 ohms or into open or short circuit. Also available from us as 90-watt mono amp with same specs. **QUAD MODEL 33 PRE-AMP** with equal specs and perfect (within ½ db.) RIAA equalization is ideal combination. Freight prepaid, from stock (and complete service facilities) at **THE AUDIOPHILE**, 8 East Erie, Chicago, ILL. 60611.

## FOR SALE

**Store your cassette tapes!** Beautifully designed compact unit holds 25 cassettes, turns for ready access. Guaranteed! **Rohe Company**, Box 13096-AG11, Columbus, Ohio 43213.

**Ampex FR1100**—\$475.00, 600—\$225.00; 620—\$75.00; GR-736A—\$200.00; GR-1210C—\$100.00; GR-1932A—\$175.00; HP-400L—\$90.00; HP-211A—\$125.00; HP-201B—\$125.00; HP-410B—\$75.00. Box A02-4.

**Cizek Loudspeakers**, lowest price in the country—free literature. Quotes on your favorite system. **Sound Center**, Box 1242, Bloomington, Indiana. (812) 332-4252.

**Connecticut Area.** Audio research speaker and amps, Dyna-mod kit and transcriber turn tables. **The Stereo Lab**, 158 State St. New London, Conn. (203) 447-9802.

**HI FI FURNITURE?** See Toujay Designs at SEE 70, Hi Fi Expo, 443-A, Park Ave. S., NYC, 10016. Tues to Fri 11-5, Sat 11-4. Full line brochure 25¢.

**McINTOSH 1700**, \$500 or best offer. Also Sony 630-D. Ed Willner, Box A202-Teter, Bloomington, In. 47401.

**IMF SPEAKERS; DECCA CARTRIDGES; PML** ultimate microphones; Mattes-Martin, Teac, and C/M Labs electronics. Mint Grado laboratory turntable with ESL arm \$95.00; Grundig tubed receiver—new \$150.00; Fisher X-100-C control amplifier \$135.00. We take trades. **Audiocraft**, South Rockwood, Michigan 48179. Telephone: (313) 379-9945.

**McIntosh 1700 Receiver**, \$415.00; Superex "Pro" phones, \$22.00; Revox accessories.

**WATERBEDS.** Buy kit, build frame. Kit contains mattress, liner, pad, frame plans, five year written guarantee. Details. **Classic Waterbeds**, R.D.#1 Box 319A, Lititz, Pa. 17543

**ELECTRONIC ORGAN KITS, KEYBOARDS** for music synthesizers and organs. Every component for organ circuitry. 25¢ for catalog. **Devtronix Organ Products**, Dept. A, 5872 Amapola Drive, San Jose, Calif. 95129.

**FLORIDA AUDIOPHILES!** Phase Linear, E.S.S. Transtatic I, Rabco, Klipsch, Bozak, Revox, Marantz, Sony, B&O, Barzilay, Interiors Plus Sound, 3038 N. Federal Hwy. Ft. Lauderdale, Fla., 33306. (305) 566-3511.

**B&W 70CA, PHASE LINEAR, THE WORLD'S FINEST SPEAKER AMPLIFIER COMBINATION.** JVC 5011 super preamp. Transcriber, EPI Tower, Quad, Electrostatic specialists. Finest, best equipped laboratory in the country. Formerly supplying to professionals only. Now you can benefit from the unique services of **THE AUDIO-LAB**, 146 French St., New Brunswick, N.J. 08901 (201) 249-9191.

**ALPHAPHONE®** headset—brainwave trainer. Free literature. **Aquarius Electronics**, Box 627-S, Mendocino, Ca. 95460.

**QUAD**, Radford, Bang & Olufsen Audio components of superb quality for the connoisseur. **Audio Imports**, 5557 Versaille Dr., Indianapolis, Ind. 46227.

**LOW, LOW, PRICES,** on Audio Equipment and Blank Tape. All factory fresh, 1st quality items. Write for **FREE CATALOGS** to Mr. A. Dept. AMO at **SMG DISTRIBUTORS, INC.**, 46-35 54th Road, Maspeth, N.Y. 11378.

**A.E.A. WILL BUILD** to your specifications or ours, any cabinet used for audio. Send plans for quote. **ADVANCED ELECTRO ACOUSTICS** 1610 South Park Avenue, Buffalo, N.Y., 14220 716-826-5832

## FOR SALE

**E.R.A. PERFECTIONIST TURNTABLES!** Phase linear\* Quad\* Hartley\* C.M. Janszen\* B&O\* Tannoy\* Acoustical\* Hadcock\* Grace\* Hopkins\* Decca\* Hegeman. **ADVANCED ELECTRO ACOUSTICS** 1610 South Park Avenue, Buffalo, N.Y. 14220 716826-5832

**SYNTHESIZERS:** E.M.S. of London Voltage-controlled synthesizers featuring computerized sequencing, touch-responsive keyboard, and compact, foolproof matrix-board patching available in U.S. at prices far below American makes. Ultimate stability, infinite sound generation, and English-made quality in a comprehensive studio, or live-performance instrument. For full information, contact: **Electronic Music Studios** of Western New York, 489 Birr St. Rochester, N.Y. 14613 or phone 1-716-458-7653 **WE SHIP NATIONWIDE.**

**CONDENSER MICROPHONES** in easy to build kits. Free details. Write **Electronic Enterprises**, 3305 Pestana Way, Livermore, Calif. 94550.

**We give consultation** on stereo equipment: Braun, Benjamin, Transcriber, E.S.S., Quad, S.A.E., and many others. Also, classical and English released labels, jazz and rock albums. Mail orders accepted: **Flip Side Systems, Inc.** 300 W. Market St. Louisville, Ky. 40204 phone (502) 584-3334

P.S. Write to us about our all new record club!  
**Audio Research**, Radford, Phase Linear, Crown, Quad, Stax, Infinity, JBL, Braun, ESS. Information available. **Hartley Electronics**, 1502 Butternut, Richland, Wa. 99352 (509) 947-5026 after 5 pm weekdays, all day, weekends.

**EXCLUSIVELY IN USA "Satin" Moving Coil Cartridges.** Impedance matches magnetic input. M14LE (Eliptical) \$99.95, M14LX (Shibbata) \$129.95. Send Check to: **Michael-Scott Enterprises**, Room 24, 6056 West Broadway, Minneapolis, Minnesota 55422

**AUDIO RESEARCH, SAE, CROWN, PHASE LINEAR, INFINITY, KLIPSCH, TANNOY, BRAUN, QUAD, DECCA, REVOX, STAX, TRANSCRIPTORS, RADFORD**, and many more. Factory authorized service on all brands sold. No appointment necessary. **Hoffman's "House of Stereo"** 5931 Smith Rd. Cleveland Ohio. (216) 243-2772

**RECORDING** tape Dozen 2400' reels \$14.00, Dozen 1200' reels 7.00 900' sample 25¢, guaranteed. **Mitchell Box 444A, Flushing, N.Y. 11367**

**ELECTROENCEPHALOPHONE:** brainwave monitor. Professional biofeedback instruments. **J&J**, 8102-A, Bainbridge, Wash. 98100.

**TUBE** Headquarters of World! Send 10¢ for Catalog (tubes, semiconductor, equipment) **Barry**, 512 Broadway, N.Y.C. 10012.

**WHOLESALE!** Professional Amplifiers, PA Systems. Guitars. Free Catalog. **Carvin**, Escondido, Calif. 92029.

## PLANS & KITS

**INTEGRATED CIRCUIT KITS**—Free catalog. **FRAZER & ASSOCIATES**, 3809 Surfwood Road, Malibu, California 90265.

## AUTHORS

**PUBLISH** your book! Join our successful authors: All subjects invited. Send for free appraisal and detailed booklet. **Carlton Press (Dept. VRK)** 84 Fifth Avenue, New York 10011.

## SERVICES

**DON'T PAY** the high mail order prices. Thieves Warehouse is coming to your area. Franchises available. Thieves Warehouse, P.O. Box 8057, Pensacola, Florida 32505.

**RENT STEREO TAPES** \$1.50 week. Catalog 25¢ Tape Library, Box 8126, Washington, D.C. 20024.

**CUSTOM RECORDING SERVICE.** Tape and disc. Stereo and mono. Live and copies. Editing, Masters and pressings. High quality at reasonable rates Joseph Giovanelli, Audio-Tech Laboratories, 2819 Newkirk Ave., Brooklyn, N.Y. IN 9-7134.

**LEARN** Electronic Organ Servicing at home. All makes including transistors. Experimental kit—trouble-shooting. Accredited NHSC. Free Booklet. Niles Bryant School, 3631 Stockton, Dept. 1D, Sacramento, Calif. 95820.

**TRADE STEREO TAPES**, \$1.25 each postpaid. Minimum three. Tapetrade, Box 2181, La Jolla, Calif. 92073.

**HIGH FIDELITY SPEAKERS REPAIRED**  
AMPRITE SPEAKER SERVICE  
655 Sixth Avenue, New York 10, N.Y.

**RECORDS MADE FROM YOUR TAPES.** Also, editing and mastering. Send for free brochure. Nashville Record Productions, Inc., Dept. AM, 204 19th Ave., So., Nashville, Tennessee 37203.

**CUSTOM STYLUS** and cartridge re-tipping, repairing. (Weathers, Ortofon, Edison, Shure, etc.) Box 322A, Tuckahoe, N.Y. 10707. 914-SP 9-1297.

**WHAT'S YOUR I.Q.? FIND OUT HOW INTELLIGENT YOU ARE WITH AUTHENTIC SELF-SCORING I.Q. EXAM.** \$3 M. FINKELSTEIN BOX 159 BROOKLYN, NEW YORK 11204

**MID-AMERICAN RECORDING** Ent., Inc., Custom Recording & Stereo Concert Systems 1-319-3995

**TAPE RECORDER HEADS** refinished like new, \$10.00 each. Fast service. E. Maher, 5 Evans Place, Orinda, Calif. 94563.

**PROFESSIONAL RECORDING SERVICE** at low-low rates. Demos, pressings, tape duplication—to say nothing of our fabulous location recording service. Send for brochure. Trutone Records, Box 830, Saddle Brook, N.J. 07662 201-868-9332

**ACOUSTECH AMPLIFIER REPAIR.** Original performance or improved specifications. BKM Associates, Box 22, Wilmington, Mass. 01887.

**GET EXCELLENT CREDIT** in 30 days WITHOUT INVESTIGATION, no matter what previous credit has been. RESEARCH, Box 4487-A, Jacksonville, Florida 32201.

**LEARN TAPE RECORDING FROM STUDIO ENGINEERS.** Free Literature. Write: NNA, Box 721E, Rye, New York 10580.

**SPEAKERS** rebuilt, Hi-Fi foreign instrument amplifier. Speakers, 2409½, W. Colorado, Colorado Springs 80904.

## COLOR SLIDES

**SLIDES, ART-EDUCATIONAL-TRAVEL**, 50,000 individually sold. Samples-Catalog \$1.00 refundable. Visuals D21 440 N.W. 130 Street, Miami, Florida 33168.

## TUBES

**TUBES** receiving, factory boxed, low prices, free price list. Transletronic Inc., 1306 40th Street, Brooklyn, N.Y. 11218. Telephone: 212-633-2800.

## BUSINESS OPPORTUNITIES

**MAILORDER MILLIONAIRE** helps beginners make \$500 weekly. Free report reveals secret plan! Executive 1Q11 333 North Michigan, Chicago 60601

**MAILORDER MONEYMAKING KIT.** Home Business. Valuable lists, concrete information, detailed steps. Capital unnecessary. Free Details. Pictures. Meadows, Box 327-AUA, Boston 02199.

**MAILORDER**—Carry no stock. Companies will pack, ship under your label. One-man operation capable of \$10,000—\$20,000 year. Details Free! Distributors, Box 9—M, East Rockaway, New York 11518.

**PIANO TUNING LEARNED QUICKLY AT HOME!** Tremendous field! Musical knowledge unnecessary. GI Approved. Information Free. Empire School, Box 327, Miami, Florida 33145

**1000% Profit** Bronzing or Chinakoting Anything. Free Literature. NBC Box C-4—AM, Coral Springs Fla. 33065.

**15,000-WORD ENCYCLOPEDIA** MANUAL about mailorder, plus custom answers bonus, only \$3.00. Free details. SOUNDS, 854 Glencoe, Denver, Colorado 80220.

## GOVERNMENT SURPLUS

**JEeps** Typically From \$53.90 . . . Trucks From \$78.40 . . . Boats, Typewriters, Knives, Airplanes, Clothing, Multimeters, Oscilloscopes, Transceivers, Photographic, Electronics Equipment. Wide Variety. Condition 100,000 Bid Bargains Direct from Government Nationwide. Complete Sales Directory and Surplus Categories Catalog \$1.00 (Deductible On Orders From Separate Included Catalog). Surplus Service, Box 820-AUD, Holland, Michigan 49423.

**NO CATCHES** Buy any surplus direct from U.S. gov't. All information \$2.00. Bridgeworth, P.O. Box 2292-B, Vancouver, Washington 98661.

## INVENTIONS WANTED

**FREE "DIRECTORY OF 500 CORPORATIONS** Seeking New Products." For information regarding development, sale, licensing of your patented/unpatented invention. Write: Raymond Lee Organization 230-AM Park Avenue, New York City 10017.

## HELP WANTED

**ELECTRONICS/AVONICS** Employment Opportunities. Report on jobs now open. FREE details. Aviation Employment Information Service. Dept. A, Box 240, Northport, N.Y. 11768.

**Serious recordists** to make and distribute records for major companies. We train and equip. Modest investment required. Send resume to Mr. Bloch, 418 N. Main St., Englewood, Ohio 45322.

**Sales/Marketing Manager.** Manufacturer of Sharpe high fidelity headphones with plant in Buffalo needs manager for total U.S. market with a minimum of 5 years experience marketing audio products to dealers and distributors via sales representatives. Salary and bonus commensurate with experience and performance. Send resume and earnings record in complete confidence to: Mr. Gerald Stork, Scintrex Limited, 222 Snidercroft Rd., Concord, Ontario, Canada.

check with the  
East-Coast Stereo  
Discounters...  
...then BUY from

**MIDWEST  
HI-FI  
WHOLESALE**

Box 567  
Ellsworth Industrial Park  
Downers Grove, Ill. 60515  
312/852-5885

Write for our new  
WHOLESALE price list  
& catalog. You'll  
be glad you did!

OVER 50 NAME BRANDS  
FACTORY - SEALED CARTONS  
WHOLESALE PRICES  
\* SAVE ON TIME  
& FREIGHT CHARGES

Check No. 102 on Reader Service Card

Now YOU can buy ANY  
**RECORD or TAPE**  
on ANY LABEL!  
WORLD'S LARGEST SELECTION  
AT LOWEST DISCOUNT PRICES

### SPECIAL MAIL ORDER PRICES

List Prices	Year Price
1.98	1.70
2.50	2.00
2.98	2.40
3.98	3.00
4.98	3.75
5.98	4.75
6.98	5.50

**25% OFF LIST PRICES!**  
ANY TAPE  
OPEN REEL, 8-TRACK OR CASSETTE!

**BUY MORE — SAVE MORE!**

**BUY ANY**

5 ITEMS DEDUCT	5%
6 ITEMS DEDUCT	6%
7 ITEMS DEDUCT	7%
8 ITEMS DEDUCT	8%
9 ITEMS DEDUCT	9%
10 OR MORE ITEMS DEDUCT	10%

**MORE**

Schwann Catalog \$1 PPD.  
Free With First Order.

**FREE Shipping Anywhere in USA, APO & FPO**  
Addresses! (Add 15% for Foreign Shipments — Min. charge \$1.50) Send check or M.O.

**KING KAROL RECORDS** Dept A-11  
P.O. Box 629, Times Sq. Station, New York, N.Y. 10036

\*N.Y. State residents please include local Sales Taxes  
OUR RETAIL STORES STOCK EVERYTHING!  
OUR NEW STORE: 609 Fifth Ave. at 49th St./KLM Bldg.  
460 West 42 St. 111 West 42 St. 940 3rd Ave.  
at 10th Ave. at 6th Ave. at 57th St.  
Flushing, Queens: 40-4C Main Street  
SPECIALISTS IN OPERA RECORDINGS  
Check No. 103 on Reader Service Card

## EQUIPMENT WANTED

**CASH FOR YOUR** unwanted LP's and pre-recorded tapes. Record House, Hillburn, New York 10931.

**WANTED**—Mint condition AMPEX 351-2 or 350 converted to 2 Track stereo w/or w/out modifications. Reply to Box #AA2-1.

**INFINITY** Preamp, 2000A Speakers, Marantz SLT-12U, Playboy before 1964. Dean Slindee, Lansing, Iowa 52151.

**Australian Enthusiast** wants used McIntosh and Marantz tube preamps and main amps. Maurice Taylor, P.O. Box A122, Sydney South, N.S.W. 2000, Australia.

## STEREOS

**COMPLETE LIST OF PRICES** FOR top manufacturers of stereo equipment. Write for quotations on all major brands of stereos.

### STEREO COMPONENT CENTER

465 High St.,  
Morgantown, West Virginia 26505

Check No. 106 on Reader Service Card

### OPEN REEL STEREO TAPE BUYERS

At last! An open reel compilation, including titles, songs, etc. of 95 long play, 1½-3 hour albums by American Airlines, Continental Airlines, and Ampex 4 track stereo tapes (includes a group of "sound effects" tapes by Audio Fidelity). Send \$1.00—and we will also mail you a 140-page Harrison stereo tape catalog—so you'll get both for \$1.00—and this \$1.00 is refundable on your first \$10.00 purchase of open reel stereo tapes at our 30% discount!



**SCOTCH MAGNETIC TAPE (USED)**  
±150, 1 mil polyester, 3600 foot on 10½ inch fiberglass reels, used once, \$1.99, 1800 foot, 7 inch reels, 99¢—guaranteed to perform as good as new or money refunded. (Bulk no box). Used 10½ inch fiberglass reels (small hole) 50¢. New hinged boxes: 10½ inch, 39¢, 7 inch, 9¢. (All plus postage by weight and zone.)



### SAXITONE TAPE SALES

1776 Columbia Rd. N.W.  
Washington, D.C. 20200

Check No. 105 on Reader Service Card

**We Don't Have Gimmicks  
Just Low Prices**

# Southern Sound Wholesalers

Every Major Brand

Mail Order Discount Prices  
Same Day Service

- Memorex
- Garrard
- Dynaco
- KLH
- Scotch
- Sherwood
- Koss
- ADC
- Acoustic Research
- Harmon Kardon

To Mention a Few!

**"Ask For A Quote"**

P. O. Box 44  
Magnolia, N. J. 08049

## CARTOONING

Learn Cartooning at home. Free booklet. V.A. approved. Cartooning, Box 7069A0 Colorado Springs, Colorado 80907

## RECORDS

**OLDIES—45 RPM** original labels and represses over 5,000 from personal collection for sale. Reasonable prices. Try me for the ones you've given up hope in finding. Call or write, Robert Fenster, 1503 Ave. J, Brooklyn, N.Y. (212) 258-5121.

**OLDIES—45 RPM.** Original hits. Catalog 50¢. C&S Record Sales, Box 197, Wampsville, N.Y. 13163.

**CATALOGS.** Broadcasts, soundtracks. Personalities of Thirties, Forties. Box 225, New York, N.Y. 10028.

**DELETED L.P.'s?** Get on my sales list. Vincent Scaparro, 904 Allerton Avenue, Bronx, N.Y. 10469.

**THE GREATEST R&R ALBUM.** Two years in compilation. Available only thru the mail and released in the original mono form. 19 songs including Bopalena, House of Blue Lights, Guitar Boogie, Strange Love, Mr. Engineer and more. All songs are stylistic landmarks in R&R. Send \$5.00 to Album, POB 1301 Studio City, Calif. 91604.

**MOVIE, TV, Stage shows, specials.** Soundtracks etc. Box 345 Evanston, Ill. 60204

**HOBBY RECORDS** list. Send addressed, stamped envelope 1312 N. 18th, Monroe, La. 71201

**COLLECTORS JOURNAL—VALUABLE DATA RECORD MART** 12 issues \$3.00—Record Research, 65 Grand Ave., Brooklyn, New York, 11205.

**RARE** soundtracks, list 16¢ Establishment, Box 5645A Milwaukee, Wisconsin 53211

**CLASSICAL LP'S, BUY-SELL-MIDWEST CLASSICAL RECORD EXCHANGE, BOX 10997, MIDWEST CITY, OKLA. 7310**

**SOUNDTRACKS** rare, send to: Show Music, Box 12, Wood River, Illinois 62095.

**Show Albums**—Rare, Out of Print LP's. Free large list. Broadway/Hollywood Recordings, Georgetown, Conn. 06829.

**UNUSUAL CLASSICAL RECORDS** unavailable elsewhere. 90PP free catalogue. Box 83K, Irvington NY 10533.

**Soundtrack Record Albums** from films, original, rare, free list. Whalon, 2321—N Hill, Redondo Beach, Calif. 90278.

## MUSIC BOXES

**Swiss Music Boxes.** Finest. Tunes to Order. Spielman, 55 West 42nd. New York 10036.

## REAL ESTATE

**CARIBBEAN!** Only \$25,000 buys 1 sq. ft. land plus equivalent interest in luxury hotel building scheduled construction thereon. Posh new international resort, dazzling tropical Honduras, C.A. Easy terms: only \$1.00 per sq. ft. month. Unprecedented option, quadruple acquisition without increase monthly payment. Good income in leaseback to hotel co. Tax and maintenance free with fabulous vacation benefits. McEvoy, Box 2483, Dallas, Texas 75221.

## RADIO PROGRAMS

**RADIO RERUNS,** Complete broadcasts. 8¢ stamp for free catalog. Box 724-A, Redmond, Wash. 98052.

**OLD RADIO PROGRAMS.** Reels or cassettes. Free catalog. Fred Berney, 5931 S.W. 8 Street, Miami, Fla. 33144.

**OLD RADIO PROGRAMS** at low prices yet a large selection. Catalog 50¢. The Best of Radio, P.O. Box 1692, F.D.R. Sta., New York, N.Y. 10022.

**OLD RADIO PROGRAMS, CATALOG \$1.00** (refundable). The Radio Vault, Box 9032, Wyoming, Michigan. 49509

**FREE CATALOG.** Radio Mysteries. Detective House, 218 Orangeview Lane, Lakeland, Fla. 33803.

**MOST AMAZING SHOW** ever produced for Radio, Ken Nordine, narrator, network cast. Introductory notes by show's creator-producer. Complete series, 19 Cassettes. Volume One, \$3.98; subsequent releases, 3 for \$10.00. Postpaid. Guaranteed. "Incredible, But, True!", Sawyer, Michigan 49125.

**OLD Radio Shows, Jazz/Big Band** remotes, over 7000 selections, 650 reels, \$8.00 for 6 hrs. Plus bonus reels for accumulated orders, \$1.00 for catalog (refundable) McCoy's Recording, 1228 Lincoln Drive, Pasco, Washington 99301.

## INSTRUCTION & EDUCATION

**FREE D.D.—B.D.—M.D.—**With Lifetime Ordination. Box 333 PM, Rillton, Pennsylvania 15678.

**SIMPLIFIED**—Typing Course. 25¢. Tri-publications. 270—52nd St., Brooklyn, New York 11220.

## TAPE RECORDINGS

**RENT 4-TRACK** open reel tapes—all major labels, 3,000 different. Free brochure. Stereo-Parti, 55 St. James Drive, Santa Rosa, Cal. 95401.

**MEMOREX** recording tape, audio & video lowest prices, write for free information BERGETZ SYSTEMS CO., Box 1181, Melrose Park, Ill. 60161.

**TAPE**—Ampex, BASF, Sony, TDK, Memorex. From 52¢. Catalog 10¢. AudioCessories, 320 W. Edmonston, Rockville, Maryland 20852.

**PROFESSIONAL LARGE ALUMINUM SPLICING BLOCK** Two precision Dove-tail grooves splices quarter-inch or cassette tapes. Unconditionally guaranteed. 6.95 postpaid. Details NRP Box 289, McLean, Va. 22101

**"8" TRACK TAPES**—400 Current Rock-Country Western—Soul—Jazz. (\$3.49 Postpaid) Catalog-Details—25¢ (Distributorships Available) Royaltone Distributors POB141AM Carrollton, Illinois 62016.

**8-Tr. Blank Cartridges** \$1.25 80 Minute, Scotch Tape, Atlas Electronics, PO Box 522 Dept. C, Blackwood, NJ 08012

**USED Mylar Tapes** 1800 50 reels \$35.00 postpaid. Send check with order. Fremmerman, 4041 Central, Kansas City, Missouri 64111.

**CASSETTES**—60-minute stereo/monaural rentals (90 days): \$21 Majestic, 9651 Foxbury, Pico Rivera, California

**Rent any Cassette** or Open Reel Pre-recorded tape. All Labels. Catalog 75¢. Tape & Time, 1116 4th Ave., No., Sauk Rapids, Minn. 56379.



# Scott audio systems are fully integrated to deliver the best sound

## New Scott fully integrated audio component systems

AM-FM stereo receiver	IHF sensitivity	*Watts per channel	Matching speaker	Frequency response	Power handling capacity, watts
357B	2.5 uV	28	D-41	35 Hz to 20,000 Hz	35
377B	1.9 uV	42	D-51	30 Hz to 20,000 Hz	60
387B	1.9 uV	57	D-51	30 Hz to 20,000 Hz	60
477	1.9 uV	78	D-61	30 Hz to 20,000 Hz	75
525	1.7 uV	100	D-71	28 Hz to 20,000 Hz	100

\*Rated with both channels driven into 8 ohms

One superiority of Scott component audio systems over others is that our amplifiers, receivers and speakers are designed from the drawing board up to complement each other precisely in dynamic impedance and power transfer characteristics. This means that when you buy one of the receivers listed above with its matching controlled impedance speaker system, you know the ensemble will reproduce sound better than a component system selected at random. In each Scott integrated system the components are carefully

selected so that the receiver has sufficient power to drive its matched speaker pair to more than adequate listening levels, yet not so much as to cause damage to the speaker or drive it into serious distortion.

You'll know the implications of this after you've visited your Scott dealer to hear the fully integrated Scott audio systems he has on display. Or you may receive complete product information by circling our number on the reader response card.



**SCOTT**<sup>®</sup>  
where innovation is a tradition

H.H. Scott, Inc., 111 Powdermill Road, Maynard, Mass. 01754

Check No. 100 on Reader Service Card

# Superscope stereo products fulfill the American dream.....quality stereo components everyone can afford.

**A pledge from the company which brings you Sony/Superscope tape recorders and Marantz stereo equipment.**

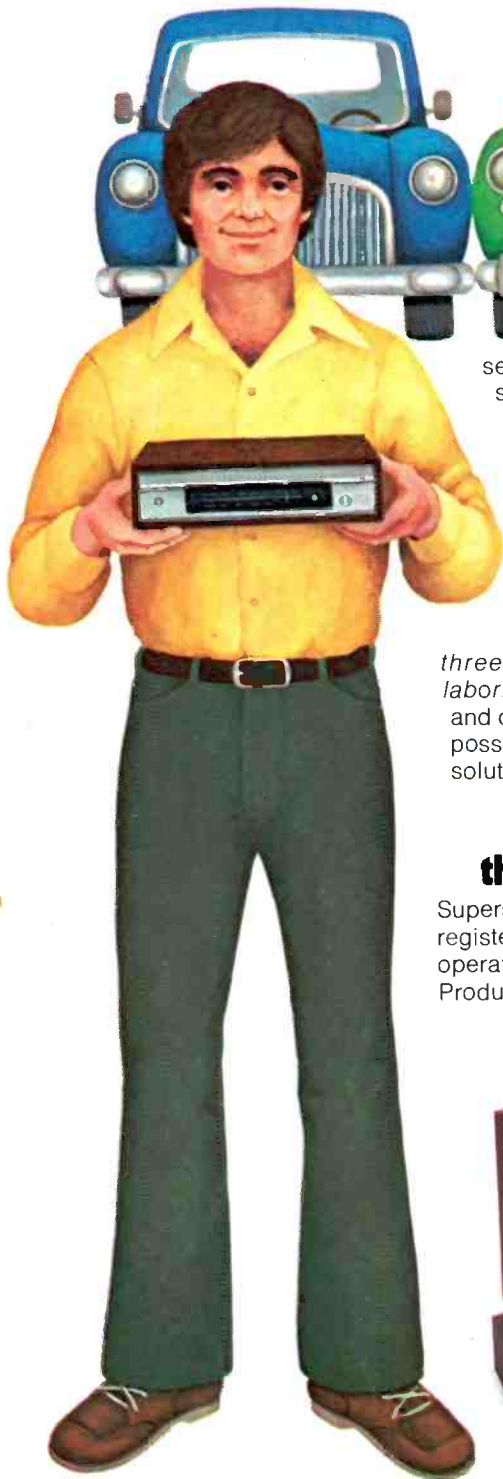

Two cars in every garage. And a chicken in every pot. There's no reason today why everyone who listens to music shouldn't enjoy stereo in his home the way it was meant to be heard. The way the professionals and buffs do. With a stereo system made up of separate components (which can be as basic as a receiver and two speakers).

But up to now, components have been beyond the reach of the average budget. Now, however, Superscope combines its knowledge and years of experience in the audio field to bring to every music lover, high quality, solid-state stereo components at a modest price. Whether it's your basic AM/FM receiver and two speakers, or a

separate tuner, amplifier and speakers, Superscope offers an exciting new line of quality stereo components starting as low as \$79.95 for our amplifier.

Not only are these new Superscope components brilliantly engineered, but they're beautifully styled with handsome walnut cabinets (an option with most other brands). Most important, each Superscope stereo amplifier, tuner and receiver carries a *three-year guarantee on parts and labor*. Is the high degree of reliability and quality at so modest a price an impossible dream? Not at all. It's an absolute reality at your Superscope dealer.

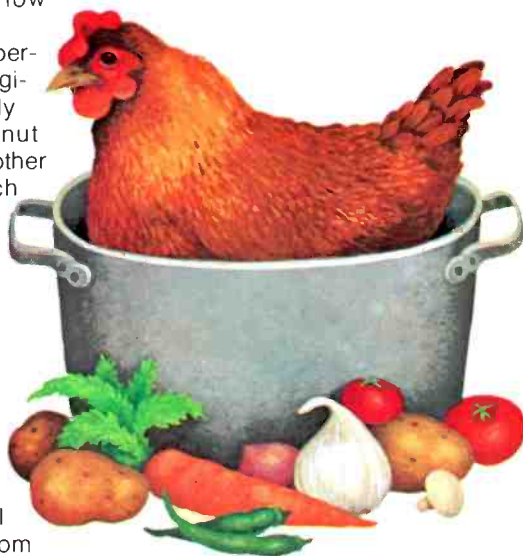

## The Superscope three year guarantee.

Superscope, Inc. guarantees the original registered owner that all parts are free from operating defects for three years from purchase date.

Products are repaired or replaced free of charge subject to the following: if purchased in U.S.A. from authorized dealer; if registration card transmitted within ten days of purchase; if serial number not altered/removed; if connected/operated subject to instructions; if not repaired by unauthorized parties; if not altered/repared so as to affect stability/reliability; if shipped with shipping charges fully prepaid; in original package from within U.S.A. Return shipment to points in U.S.A. is prepaid if foregoing met. Owner has responsibility to proving date of purchase at time service sought.



**SUPERSCOPE**

You never heard it so good.®

©1972 Superscope, Inc. 8150 Vineland Ave., Sun Valley, Calif. 91352. Send for free catalog.

Check No. 63 on Reader Service Card