

The Authoritative Magazine About High Fidelity

CANBY

*Moog and
Moondog*

AUDIO

AUGUST
1970

60¢

Sound Installations by Computer

DOPPLER EFFECT IN LOUDSPEAKERS

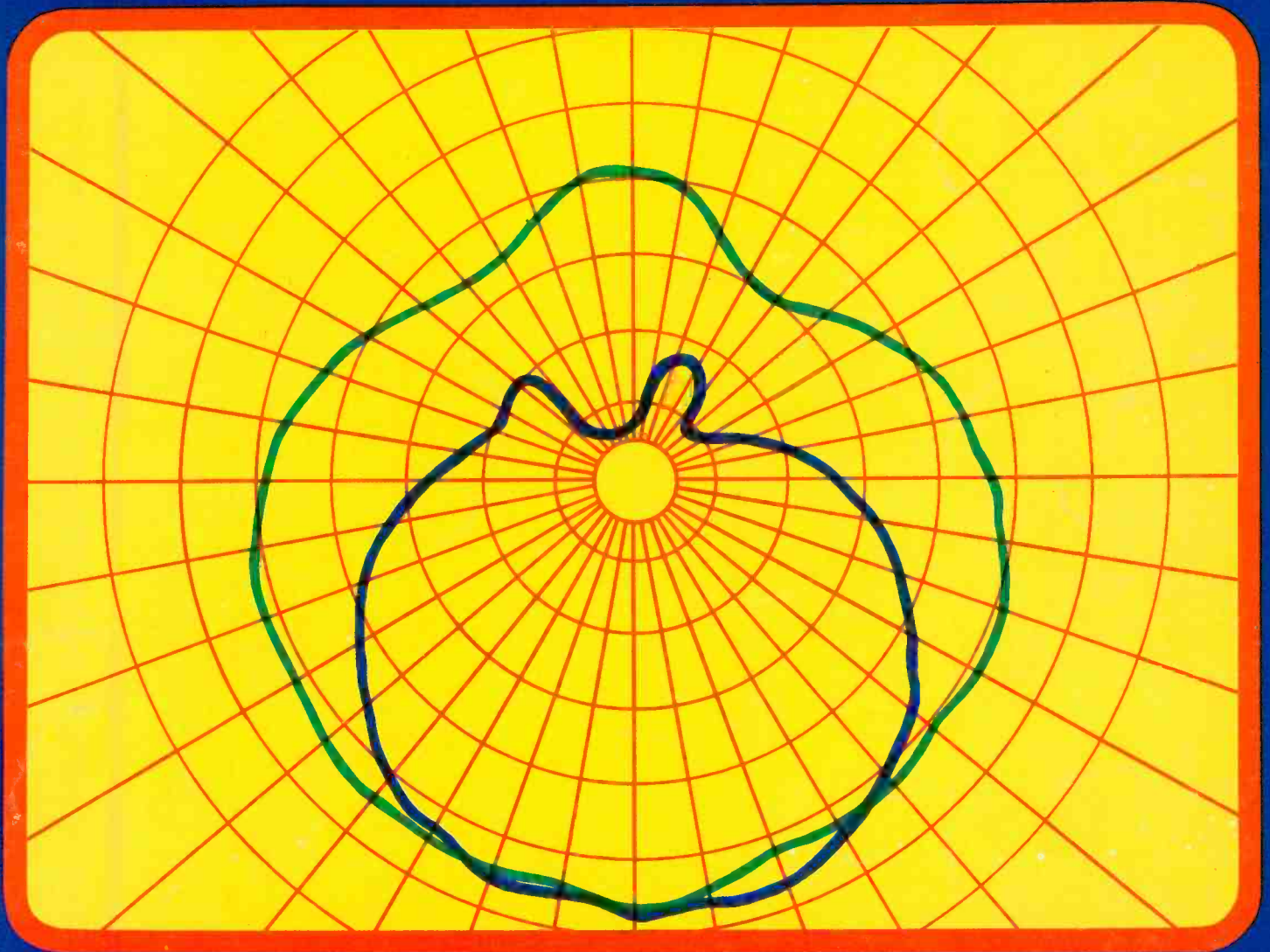

ELECTRONICS FOR PUBLIC ADDRESS

POWER

and purpose are implicit
in its every distinctive line...



Never before has there been a receiver like the 387.

Power and purpose are implicit in its every distinctive line...

from its bold new high-visibility dial face to the sweep of its comprehensive control panel.

And just wait until you experience the 387's effortless

performance! A new kind of receiver power is yours to command — instantaneous, undistorted, unmatched for flexibility and responsiveness.

Inside, the 387 justifies its advanced exterior. Here are tomorrow's electronics...

Integrated Circuits, Field Effect Transistors, solderless connections, and electronic safeguard systems to keep the 387's 270 Watts of power totally usable under all conditions.

Decades of manufacturing experience and engineering skill have gone into the 387. But to really appreciate how its designers have totally rejected the ordinary, you must see it and hear it.

SCOTT 387 AM/FM STEREO RECEIVER



Computer-activated "Perfectune" light: Perfectune computer decides when you're tuned for the best reception and lowest distortion, then snaps on the Perfectune light.

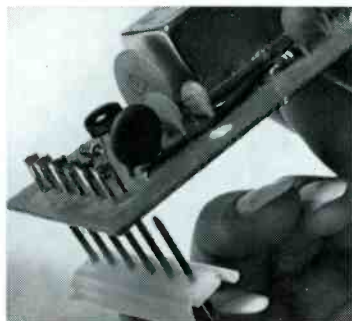

New Modutron Circuit Board Exchange Policy: Takes over after your warranty expires; insures quick, inexpensive replacement of any plug-in printed circuit board for as long as you own your Scott unit.

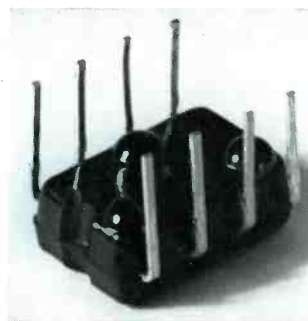

Ultra-reliable Integrated Circuits: Seven IC's are included in the 387... totalling 91 transistors, 28 diodes, and 109 resistors.

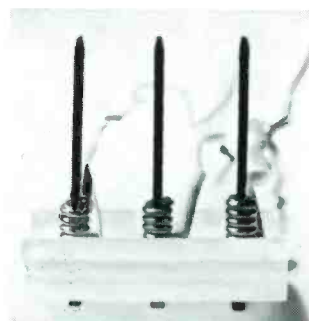

New solderless connection techniques: Tension-wrapped terminal connections plus plug-in circuit modules result in the kind of reliability associated with aerospace applications.

387 SPECIFICATIONS

AMPLIFIER SECTION: Total power (± 1 dB) 270 Watts @ 4 Ohms; IHF music power, 220 Watts @ 4 Ohms; 140 Watts @ 8 Ohms; Continuous output, with one channel driven, 100/100 Watts @ 4 Ohms; 63/63 Watts @ 8 Ohms; Continuous output, with both channels driven, 85/85 Watts @ 4 Ohms; 55/55 Watts @ 8 Ohms; Harmonic distortion, 0.5% at rated output; IHF power bandwidth, 10 Hz — 38 kHz; Hum and noise, phone, -70 dB. **TUNER SECTION:** (FM); Usable sensitivity (IHF), 1.9 μ V; Stereo separation, 40 dB; Capture ratio, 2.5 dB; Signal/Noise ratio, 65 dB; Cross modulation rejection, 80 dB; Selectivity, 42 dB. **TUNER SECTION:** (AM); Sensitivity (IHF), 4 μ V @ 600 kHz; Selectivity (IHF), 32 dB.

Price: \$449.95 Accessory case, extra.

Prices and specifications subject to change without notice.

SCOTT®

For detailed specifications, write:

H. H. Scott, Inc., Dept. 35-08

111 Powdermill Road, Maynard, Mass. 01754

Export: Scott International, Maynard, Mass. 01754

© 1970, H. H. Scott, Inc.



Discovery in the art of performance

Find *your* sound! The Sarmaker collection not only includes microphones for many different applications, but—even more important—microphones to enhance the personal techniques of professional performers as well.

You can choose characteristics like "flat" frequency response. Tapered low-frequency response. Switchable Bass Roll Off. A host of others. To make "today's" sound come alive—close up or far out.

That's the way it goes up and down the Sarmaker

line (at optional list prices from \$12 to \$93). For pop, rock, and classical performers. At concerts, theatres, night clubs. In reel-to-reel and cassette home recordings. For discussion/panel, paging, P.A., CB, and ham applications...you name it.

To get specific, ask for the new Sarmaker brochure 1S1056 at your RCA microphone distributor or, write: RCA Electronic Components, Commercial Engineering, Section 14 H/J10, Harrison, New Jersey 07029.

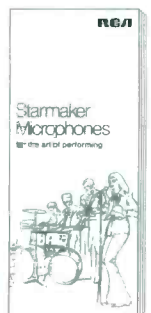

And, remember, for further professional needs, RCA also produces the renowned BK and SK microphone lines.

RCA

Check No. 1 on Reader Service Card

the pros
depend on
SHARPE
headphones
for the
complete
sound —

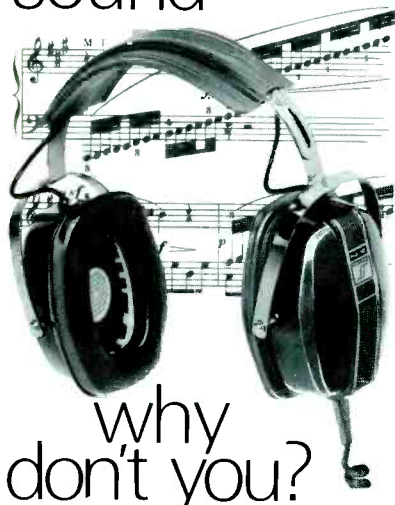

why
don't you?

SHARPE Stereophones MKII with the smoothest frequency response from 15-30,000 Hz (30-15,000 ±3.5 dB) are the choice of the professionals. After all, the pros know. That's why they're top rated.

Audiometric laboratories have proven **SHARPE** Headphones to be superior in sound reproduction, utterly free of distortion (less than 1%) and ambient noise, no matter what your application... professional or home stereo.

Only **SHARPE** offers the maximum in comfort in the patented liquid filled ear cushions, and true reproduction, whether you choose the new Model 7 at \$19.95 or the 770 at \$100.00... the quality standard of the professionals. Sound them out today at your franchised **SHARPE** dealer. Use the reader service card for the one nearest you. Ask him to demonstrate

SHARPE Stereo Central, a new concept in remote listening control and headphone storage.

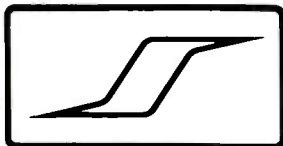

SHARPE
AUDIO DIVISION
SCINTREX INC.

390 Creekside Drive, Amherst Industrial Park
Tonawanda, N. Y. 14150

Export Agents:
Elpa Marketing Industries Inc
New Hyde Park, N. Y. 11044

ALSO AVAILABLE IN CANADA

Check No. 2 on Reader Service Card

AUDIO

Successor to **RADIO**, Est. 1917

AUGUST 1970

Vol. 54, No. 8

George W. Tillett
Editor

Jay L. Butler
Publisher

Contributing Editors

Edward Tatnall Canby
Associate Editor

C. G. McProud
Consulting Publisher

Herman Burstein
Leonard Feldman
Richard Freed
Joseph Giovanelli
Alexander Rosner
Bertram Stanleigh
S. L. Weingarten
Bert Whyte

Marlyn Rentschler
Designer

Sanford L. Cahn
Marketing Director

Ruth E. Napp
Advertising Production

Jean Davis
Subscription Manager

FEATURE ARTICLES

- | | | |
|----|---|-----------------------------|
| 12 | Line Radiators for Public Address | |
| 14 | Moogs and Moondog | Edward Tatnall Canby |
| 20 | The Computer in Sound Reinforcement System Design | Don Davis |
| 26 | Doppler Distortion in Loudspeakers | Roy V. Childs |
| 36 | Electronics for Public Address | Norman H. Crowhurst |

EQUIPMENT PROFILES

- | | | |
|----|------------------------------------|---------------|
| 44 | Heathkit AM/FM Stereo Receiver | AR-29 |
| 48 | Dynaco Integrated Stereo Amplifier | SCA-80 |
| 50 | Sony Stereo Tape Deck | TC-366 |

RECORD/TAPE REVIEWS

- | | | |
|----|----------------|-------------------------------|
| 54 | Classical | Edward Tatnall Canby |
| 56 | Canby Capsules | Edward Tatnall Canby |
| 58 | "NOW" Music | Sherwood L. Weingarten |
| 60 | Jazz | Bertram Stanleigh |
| 62 | Tape Reviews | Bert Whyte |

AUDIO IN GENERAL

- | | | | | |
|----|---------------------|--------------------------|----|-------------------|
| 4 | Audioclinic | Joseph Giovanelli | 28 | Dear Editor |
| 6 | What's New in Audio | | 64 | Classified |
| 16 | Tape Guide | Herman Burstein | 66 | Advertising Index |
| 18 | Editor's Review | | | |



AUDIO (title registered U. S. Pat. Off.) is published by North American Publishing Co., I. J. Borowsky, President; Frank Nemeyer, C. G. McProud, and Roger Damio, Vice Presidents; R. Kenneth Baxter, Production Director; Nate Rosenblatt, Promotion Director; Mary Claffey, Circulation Director. Subscription rates—U.S. Possessions, Canada, and Mexico, \$5.00 for one year; \$9.00 for two years; all other countries, \$8.00 per year. Printed in U.S.A. at Philadelphia, Pa. All rights reserved. Entire contents copyrighted 1970 by North American Publishing Co. Second class postage paid at Phila., Pa.

REGIONAL SALES OFFICES: Jay L. Butler and Sanford L. Cahn, 41 East 42nd St., New York, N.Y. 10017; Telephone (212) 687-8924. Jay Martin, 15010 Ventura Blvd., Sherman Oaks, Calif. 91403; (213) 981-7852.

REPRESENTATIVES: United Kingdom: H. A. Mackenzie and Peter E. Holloway, 4a Bloomsbury Square, London W.C.1. Tel. HOL-3779.
Continental Europe: John Ashcraft, 12 Bear St., Leicester Square, London W.C. 2. England. Tel. 930.0525. For Benelux & Germany: W. J. M. Sanders, Mgr, Herengracht 365, Amsterdam, Holland. Tel. 24.09.08.
Japan: Matsushita Inc., Highness Takawawa, Room 405, 8-33 Takawawa 4-chome, Minato-ku, Tokyo, Japan 108.

AUDIO Editorial and Publishing Offices, 134 N. 13th St., Philadelphia, Pa. 19107
Postmaster: Send Form 3579 to the above address



To maintain the uncompromising standard of Garrard automatic turntables, we mass produce them.

Garrard of England is the world's largest producer of component automatic turntables.

A mass producer, numerically speaking.

Especially curious, since Garrard remains a staunch foe of mass production methods.

At our Swindon works, final assembly of the Garrard SL95B is in the hands of nineteen men and women.

Hands, not machines.

A modest record

As Brian Mortimer, Director of Quality Assurance, sees it, "In top form they turn out twenty units an hour. A rather modest record in these days of mechanized production lines.

"But if we were to speed it up, we'd pay for it in quality. And, in my book, that's a bad bargain."

At Garrard, we insist that each person who assembles a part test that finished assembly. If it isn't up to standard, it's corrected on the spot—or set aside to be made right.

And then we test our tests.

Four of our nineteen final "assemblers" do nothing but testing.

Before each unit is packed in its carton, it must pass 26 final checks that cover every phase of its operation.

Is all this fussbudgetry really necessary?

By hand.

Brian Mortimer answers it this way. "It would be sheer folly to give up the precision we'd achieved in manufacture through imprecise assembly."

The case for fussbudgetry

Of the 202 parts in a Garrard automatic turntable, we make all but a handful ourselves.

And we do it for just one reason. We can be more finicky that way.

For instance, in the manufacture of our Synchro-Lab motor we adhere to incredibly fine tolerances.

Bearings must meet a standard of plus or minus one ten-thousandth of an inch. Motor pulleys, the same.

To limit friction (and rumble) to the irreducible minimum we super finish each rotor shaft to *one micronch*.

And the finished rotor assembly is automatically balanced to within .0008 in.-oz. of the absolute.

So, in the words of Brian Mortimer,

"We indulge our fussiness with a certain amount of conviction."

From Swindon, with love

For fifty years now Garrard has been important to the people of Swindon, and they to us.

Many of our employees are second and third generation. (Mortimer's father hand-built the first Garrard.)

And 256 of them have been with Garrard for more than 25 years.

We've been in good hands.

Today's SL95B is the most highly perfected automatic turntable you can buy, regardless of price.

Its revolutionary two-stage synchronous motor produces *unvarying* speed, and does it with an ultra-light turntable.

Its new counterweight adjustment screw lets you balance the tone arm to within a hundredth of a gram.

And its patented sliding weight anti-skating control is permanently accurate.

\$44.50 to \$129.50

There are six Garrard component models from the 40B at \$44.50 to the SL95B (shown) at \$129.50.

Garrard standards, nonetheless, do not vary with price. Only the degree of refinement possible.

The choice is yours. However, your dealer is prepared to help.



Garrard
British Industries Co.

Check No. 3 on Reader Service Card



Coming in September

Audio's Annual 1970-1971 Directory of Stereo Hi-Fi Com- ponent Equipment

Here, in one issue, you get a truly comprehensive view of what's available in the latest hi-fi component models:

■ Amplifiers ■ Preamplifiers ■ Tuners ■ Receivers ■ Record Changers ■ Turntables & Tone Arms ■ Phono Cartridges ■ Loudspeaker Systems ■ Open-Reel Tape Recorders ■ Cassette and 8-Track Cartridge Tape Recorders ■ Microphones ■ Headphones.

In addition to this authoritative, year-long equipment buying guide, the September issue of AUDIO Magazine will include regular features and departments.

ABOUT THE COVER: This shows the polar diagram of a line source speaker system, to be precise—the Bozak CM-200-10. Polar charts are made in a similar manner to normal speaker response curves but the loudspeaker is mounted on a synchronized turntable and rotated in front of the microphone. It could be accomplished the other way round but it would be a lot more complicated...

Audioclinic

JOSEPH GIOVANELLI

An Interesting Hiss Problem

Q. While evaluating receivers, I came across one which I liked very well except for a "hiss" which is heard while listening to recorded tapes, records, and radio. It is still heard when both the high-pass and the low-pass filters are switched in. Could you tell me the reason for this?—SP/5 Michael J. Bass, APO S.F.

A. All electronic circuits generate some noise. We hope that this noise is well below the signal level, so much so that it is not noticeable. Most of the noise produced by today's equipment is produced by the phonograph preamplifier circuitry, but not all of it. When the phonograph circuitry is the dominating noise source, the noise will be affected by volume controls, tone controls, and filters. This is because this source of signal must pass through these portions of the equipment on its way to the loudspeaker. There is a considerable number of additional circuit elements between the filters and the loudspeakers, all of which will generate some noise. Because this noise, or "hiss" is produced at points located in the chain after the volume control, this control will not be effective in reducing it. Similarly, if the noise is generated after the filters, you can see that they can't have any effect either.

I will have to digress just a moment so that you can gain the rest of the picture.

Loudspeaker systems vary in efficiency. One type of speaker system might produce room-filling volume with one or two watts fed into it. Another speaker might require 30 watts to produce the same amount of sound. These are the extremes, but what I am now coming to is that if the amplifier is producing noise in stages which are located after the filters and volume control, this noise will be heard more when listening to some speakers than with others. If you heard the receiver under discussion through relatively high-efficiency speakers, it is quite likely that if you use low-efficiency speakers the noise would not be apparent. If the noise was heard when listening to relatively low-efficiency speakers, there is probably something wrong with the particular receiver. This would be especially obvious if you heard the hiss from only one channel.

Listen to a second sample of the product. If the noise is absent, you will know that there definitely was something wrong

with the first sample. Of course, you must listen to the receiver with the same speaker. If the speaker is of low efficiency and the noise is still apparent, then we can only conclude that there is a design fault in the receiver, and you should pass it by, even though it is good in other particulars.

Reproducing Pathe Records

Q. I am a Pathe Record Collector. How can I play these records on my high fidelity music system?—Robert Moenning, San Pablo, California.

A. Some of the earlier Pathe records, black with no center paper label, start from the inside and are vertically cut. Their nominal speed is 90 rpm, but they do vary in speed. Therefore, you will need a way to determine when the record is being reproduced properly. One guide could be the key in which the piece was written. You would have to hope that it was not transposed by the performer. The speed of later records was reduced to 80 rpm.

From their initial recordings up to at least 1917, the stylus tip radius used for playing back these records was 8 mils spherical. I was not able to learn just how long after 1917 this tip size was used. I would assume, however, that, for as long as the disks were vertically cut, the standard of groove size did not change.

You need considerable force in order to prevent the stylus from skating out of the record grooves. Because the average stereo pickup does not track at heavy forces, you will need to obtain an extra stiff stylus assembly for this application. You must also have this stylus tipped with an 8-mil diamond or sapphire.

The cartridge must be wired for monophonic operation, but with one channel reversed, so that only vertical motion will be reproduced. Failure to reverse this channel will result in the almost complete cancellation of the desired program.

If you have a problem or question on audio, write to Mr. Joseph Giovanelli at AUDIO, 134 North Thirteenth Street, Philadelphia, Pa. 19107. All letters are answered. Please enclose a stamped, self-addressed envelope.

"High quality pressings begin with quiet lacquer masters"—

John Eargle, Chief Engineer of Mercury Records.

"We should never forget the impact that a low-distortion, low-noise master tape can have on the sound of a well made pressing. Recent studies* have shown that pressings benefit from the use of the Dolby System even under the ideal conditions of cutting master lacquers from original low-noise tapes. Under more usual conditions the cutting is done from tapes once and even twice removed from the original, and in these cases the benefits of noise reduction are all the more apparent."

*John M. Eargle, "Performance Characteristics of the Commercial Stereo Disc," *J. Audio Eng. Soc.* 17, 416 (1969).



Write for full technical details and advice on how the Dolby System can be of value in your own professional audio recording or transmission application.



DOLBY LABORATORIES INC

333 Avenue of the Americas New York N Y 10014
telephone (212) 243-2525 cables Dolbylabs New York

for international inquiries:

346 Clapham Road London S W 9 England
telephone 01-720 1111 cables Dolbylabs London

*Contact us for the name
and address of your
nearest professional
Dolby System dealer.*



LSB-2 Linear Stereo Booster. A symmetrical push-pull preamplifier that can be used with your stereo pre-amp to improve the volume characteristic of your system without introducing any noise or distortion of your frequency response. It is designed primarily to be used in conjunction with a component that does not put out enough power. This can be either a low level device like a microphone or tape deck, or one that does not match your pre-amp properly. In either case, the LSB-2 can up to quadruple the volume of your system. Separate volume controls will allow great flexibility if you wish to mix two unmatched different level devices such as a microphone and phonograph.

LSB-1 Performs exactly as the LSB-2 except it has a fixed gain of 4 and no volume controls.



(Also available at your retail music or hi-fi store)

STEREO TONE EXPANDER Designed for the stereo buff who wants that extra dimension of tone control on his system. If you find that your stereo doesn't give you enough highs even when the treble control is turned to maximum, or enough lows when the bass control is turned to maximum, then the stereo tone expander should be used in conjunction with your preamp. This unit is housed similarly to the LSB-2 except with two tone controls. Utilization of these controls will have the effect of extending your pre-amp controls virtually one extra rotation.

All mail order sales are on a two week money back guarantee. Buy it and try it. If you don't think it's the greatest return it for a full refund. Enclose a check and Electro-Harmonix will pay shipping. Or, if more convenient, order C.O.D. for cost plus shipping.

electro-harmonix

15 West 26th St., New York, N. Y. 10010

Please ship:

LSB-1	\$15.95	<input type="checkbox"/>
LSB-2	22.95	<input type="checkbox"/>
STEREO TONE EXPANDER	24.95	<input type="checkbox"/>

Enclosed is check for \$ _____
 Please ship C.O.D.

Name

Address

City State Zip

Check No. 6 on Reader Service Card

What's New in Audio

Fisher 4-channel receiver

This is model 701 mentioned in our July issue. Features include 5-way 4-channel mode selector, Auto-Scan electronic tuning, sliding front and rear channel volume



controls, illuminated mode selector lights and 3 FETS in the tuner section. Rated output is 40 watts (RMS) per channel. Price, \$700.

Check No. 81 on Reader Service Card

Pioneer automatic turntable

This unit, model PL-A25, uses a 4-pole motor which is a hysteresis synchronous type with outer rotor. A separate motor is employed for the automatic devices and provision is made for manual play.



The tone arm is equipped with a lateral balancer and an oil-damped lifting device. The PL-A25 comes complete with an induced-magnet type stereo cartridge. Price \$129.95 complete with cartridge, base, and cover.

Check No. 82 on Reader Service Card

Weltron 8-track player

Weltron model WTR-800 is an 8-track recorder-player with automatic level control, cartridge ejection and a special signal indicator warns the user of unsatisfac-

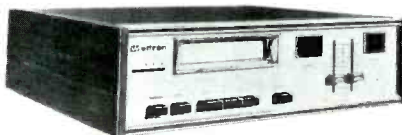

tory input level. It is specially designed for use with high quality stereo receivers or amplifiers. Price \$139.95.

Check No. 83 on Reader Service Card

Norelco model 1570 cassette player

This machine includes a built-in AM-FM radio permitting direct off-the-air recordings. It features a dual-motor tape transport system, automatic level control and

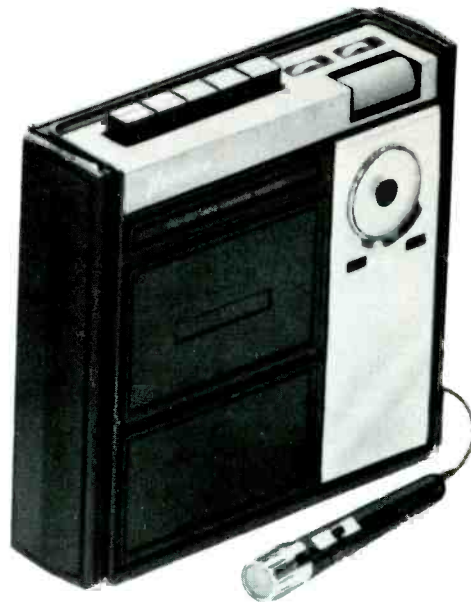

dynamic microphone. Power is supplied by four "C" cells and a detachable line cord is included. Price \$90.

Check No. 84 on Reader Service Card

New Fisher speaker system

Model WS-70 is an omnidirectional system using a 6-inch bass speaker with a 3-inch cone treble unit. Dimensions are

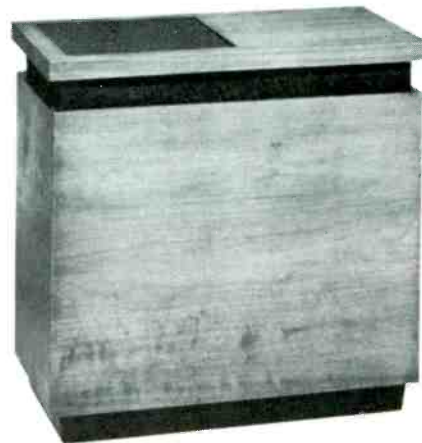

15½" wide by 9½" deep and 16½" high. It is finished in walnut and the weight is 16 pounds. Price, \$79.95.

Check No. 85 on Reader Service Card

JVC introduces the New Super Naturals

Fabulous new features plus Advanced SEA* add up to the ultimate listening experience — Super Natural Sound! Yours to enjoy in four exciting new models from JVC. Check them out at your dealer today. Or write us direct for color brochures and the name of your nearest dealer.



JVC Model 5010. Moderately priced AM/FM multiplex stereo. Has Advanced SEA with knobs that click up or down in 2db steps within a range of ± 12 db, just like the more expensive models. 40 watts total dynamic power. Five IF stages. New FET reaches out for distant FM stations. 1% IM distortion. Accommodates 2 speaker systems simultaneously. Wood cabinet.

JVC Model 5020. Superb AM/FM stereo with Advanced SEA. Automatic FM. 75 watts dynamic power. FM linear scale dial. FET ultra-reliable circuitry. Separate pre-and main amplifier sections. 1% IM distortion at rated power. 30-30,000 Hz bandwidth for crisp, clean sound. Wooden cabinet at no extra cost.



JVC Model 5030. Sophisticated beauty. AM/FM multiplex stereo with automatic FM and Advanced SEA. Brilliant 140 watts output. FM linear scale dial pinpoints stations on crowded FM band. IC modules plus new ultra-sensitive FET frontend. 15 to 30,000 Hz bandwidth. Infinitesimal 0.8% distortion. Built in pre-and main amplifiers. Wood cabinet.

JVC Model 5040. 200 watts concert hall quality AM/FM stereo. Advanced SEA. 0.8% distortion at full output. Handles 3 stereo speaker systems. Automatic FM. IC modules for near perfect reliability. Separate pre-and main amps. Computer designed FET. 10 to 30,000 Hz bandwidth. Hand rubbed wood cabinet.



*Stereo Review acclaims JVC's exclusive Sound Effect Amplifier (SEA) as "the most effective tone control system ever devised." Advanced SEA divides up the sound spectrum into 5 channels, gives you control of each for out of this world sound.

JVC Catching On Fast

JVC America, Inc., 50-35, 56th Road, Maspeth, New York, N.Y. 11378

Check No. 7 on Reader Service Card

The greatest record and tape offer in our history... FOR EVERYONE - EVEN THOSE

Free... ANY 3 STEREO LP's or WITH ABSOLUTELY NO OBLIGATION



31787 MAMAS & PAPAS—16 Great Hits
Dunh LP, 8TR, CASS



42665 CROSBY, STILLS & NASH
Atlan LP, 8TR, CASS,



33077 JOAN BAEZ—
One Day At A Time
Vangu LP, 8TR, CASS



42673 LED ZEPPELIN
II
Atlan LP, 8TR



49706 B.B. KING—
Completely Well
Blues LP, 8TR, CASS



44368 PAUL MAURIAT
—Midnight Cowboy
Phil LP, 8TR, CASS



30602 JACKSON FIVE
—I Want You Back
Motow LP, 8TR, CASS



42693 KING CRIMSON
Atlan LP, 8TR



33032 IAN & SYLVIA
—Nashville
Vangu LP, 8TR, CASS



17317 CASALS—
Plays Beethoven
Phil LP



34525 HELLO DOLLY
TwenCen LP, 8TR,
CASS



42638 HERBIE MANN
Memphis Underground
Atlan LP, 8TR, CASS



33495 BLIND FAITH
Atco LP, 8TR, CASS



33252 WES
MONTGOMERY—Best
River LP, 8TR, CASS



31799 THREE DOG
NIGHT—It Ain't Easy
Dunh LP, 8TR, CASS



15116 HANDEL—
Jephtha
Vangu LP (3 records)



17263 GREGORIAN
CHANT
Phil LP



44365 JACQUES BREL
—If You Go Away
Phil LP

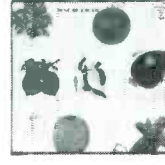

33486 CREAM—Best
of Cream
Atco LP, 8TR



42577 RASCALS—Great
Hits Time Peace
Atlan LP, 8TR, CASS



44373 HARR: French
Original Cast
Phil LP



16759 TCHAIKOVSKY
—1812 Overture
Mercu LP



67503 SMITH—
Minus—Plus
Dunhi LP, 8TR, CASS

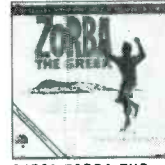

34506 ZORBA THE
GREEK—Soundtrack
TwenCen LP, 8TR, CASS



33065 JOAN BAEZ—
David's Album
Vangu LP, 8TR, CASS



30606 TEMPTATIONS
Psychedelic Shack
Gordy LP, 8TR, CASS



33078 WEAVERS—
On Tour
Vangu LP, 8TR, CASS



17042 BEETHOVEN:
Piano Sonatas
Richter Phil LP



33083 COUNTRY JOE
& FISH—CJ Fish
Vangu LP, 8TR, CASS



66546 RARE EARTH—
Get Ready
RarEa LP, 8TR, CASS



44369 MYSTIC MOODS
—ORCH. Stormy Weekend
Merc LP, 8TR, CASS



17238 BERLIOZ—
Te Deum—London Sym.
Phil LP



31795 RICHARD
HARRIS—Love Album
Dunhi LP, 8TR, CASS



48782 APPLAUSE
—Original Cast
ABC LP, 8TR, CASS



33487 BEST OF BEE
GEES
Atco LP, 8TR, CASS



42703—ARETHA
FRANKLIN—This Girl's
In Love With You
Atlan LP, 8TR, CASS



17049 SIBELIUS
—Sym 2 Concert-
gebouw/Szell
Phil LP, 8TR, CASS



33443 IRON
BUTTERFLY—In A
Gadda-Da-Vida
Atco LP, 8TR, CASS



31781 THREE DOG
NIGHT—Suitable
for Framing
Dunhi LP, 8TR, CASS



15113 MAHLER
Sym 3 Utah Sym
Vangu LP (2 records)



43793 SPANKY AND
OUR GANG—Greatest
Hits
Mercu LP, 8TR, CASS



30609 SUPREMES—
Right On
Motow LP, 8TR, CASS



17064 MOZART: Sym
Nos. 25, 29, 32—
Lon. Sym, Davis
Phil LP



33029 BUFFY
SAINTE-MARIE
—Gonna Be A
Country Girl Again
Vangu LP, 8TR, CASS



42704 CROSBY,
STILLS, NASH &
YOUNG—Deja Vu
Atlan LP, 8TR, CASS



44195 FOUR
SEASONS—Gold Vault
of Hits
Phil LP, 8TR, CASS



31973 JOHN COLTRANE
—Selflessness
Impul LP



30601 DIANA ROSS
& SUPREMES
—Greatest Hits 3
Motow LP, 8TR, CASS



67500 STEPPENWOLF
—“Live” (2 records)
Dunhi LP, 8TR, CASS

PEOPLE WHO SWORE THEY WOULD NEVER JOIN ANOTHER RECORD OR TAPE CLUB!

ANY 1 TAPE Cartridge or Cassette **SHOWN HERE** Worth up to \$20.94 TO BUY ANYTHING EVER!

Yes, take your pick of these great hits right now. Choose any 3 Stereo LP's (worth up to \$20.94) or any 1 stereo tape (worth up to \$6.98) FREE . . . as your welcome gift from Record Club Of America when you join at the low lifetime membership fee of \$5.00. We make this amazing offer to introduce you to the only record and tape club offering guaranteed discounts of 33 1/3% to 79% on all labels—with no obligation or commitment to buy anything ever. As a member of this one-of-a-kind club you will be able to order any record or tape commercially available, at savings up to 79%—guaranteed never less than 33 1/3%. No automatic shipments, no cards to return. We ship only what you order. Money back guarantee if not satisfied.

See for yourself why over 3/4 million record and tape collectors paid \$5 to join Record Club of America when other record or tape clubs would have accepted them free.						
Compare Clubs and See	Columbia Record Club (as advertised in Playboy February, 1970)	Capitol Record Club (as advertised in Playboy April, 1970)	The RCA Cassette Club (as advertised in Sports Illustrated May 4, 1970)	Columbia Stereo Tape Cartridge Service (as advertised in TV Guide April 25, 1970)	RCA Stereo 8 Tape Club (as advertised in Playboy April 1970)	RECORD CLUB OF AMERICA
CAN YOU CHOOSE FROM ALL LABELS? LP'S OR TAPES INCLUDING CARTRIDGE CASSETTE AND REEL-TO-REEL TAPES?	NO	NO	NO	NO	NO	YES! Choose any LP or tape on any label! No exceptions! Hundreds of different manufacturers including Columbia, RCA, Capitol, Angel, London, etc.
MUST YOU BUY A "MINIMUM" NUMBER OF RECORDS OR TAPES? HOW MANY?	10	12	6	12	6	NONE! No obligations! No yearly quota! Take as many as few, or none at all if you so decide!
HOW MUCH MUST YOU SPEND TO FULFILL YOUR LEGAL OBLIGATION?	\$49.80 TO \$59.80	\$59.76 TO \$71.76	\$35.70 TO \$41.70	\$83.76 TO \$95.40	\$41.70 TO \$47.70	ZERO DOLLARS! You don't have to spend a penny, because you're not "legally obligated" to buy even a single record or tape!
CAN YOU BUY ANY RECORD OR TAPE YOU WANT AT A DISCOUNT?	NO	NO	NO	NO	NO	ALWAYS! You get discounts up to 79% off. Guaranteed never less than 33 1/3% off. No exceptions.
DO YOU EVER RECEIVE UNORDERED RECORDS OR TAPES?	YES	YES	YES	YES	YES	NEVER! There are no cards which you must return. Only the records and tapes you want are sent and only when you ask us to send them.
HOW LONG MUST YOU WAIT FOR SELECTIONS TO ARRIVE?	5 to 6 weeks	5 to 6 weeks	5 to 6 weeks	5 to 6 weeks	5 to 6 weeks	NO LONG WAITS! Your order processed same day received. No shipping on cycle.

TYPICAL "EXTRA DISCOUNT" SALE			
Savings of 50% And More From Recent Club Sales . . . Savings up to \$3.49 per LP			
	Label	List Price	Half Price
Simon & Garfunkel—Bridge	Col	5.98	2.99
Over Troubled Water	A&M	4.98	2.49
Joe Cocker	War	4.98	2.49
Peter, Paul & Mary—Album 1700	A&M	4.98	2.49
Herb Alpert—Greatest Hits	Fant	4.98	2.49
Creedence Clearwater Revival—Willy & Poorboys	Apple	6.98	3.49
The Beatles—Let It Be	RCA	5.98	2.99
Hair—Original B'way Cast	Parrot	5.98	2.99
Tom Jones—Tom	Apple	5.98	2.99
Paul McCartney—McCartney	RCA	4.98	2.49
Jose Feliciano—Fireworks	Cap	5.98	2.99
Glen Campbell—Oh Happy Day	Col	5.98	2.99
Barbra Streisand—Greatest Hits	Col	6.98	3.49
Miles Davis—Bitches Brew	RCA	6.98	3.49
Leontyne Price—Verdi Heroines			

Your \$5.00 membership fee entitles you to buy or offer gift memberships to friends, relatives, neighbors for only \$2.50 each, with full privileges. You can split the total between you—the more gift members you get—the more you save! Special Note: gift members do not receive any FREE records or tapes.

AT LAST A RECORD AND TAPE CLUB WITH NO "OBLIGATIONS"—ONLY BENEFITS!

This is the way you want it—the only record and tape club with no strings attached! Ordinary record or tape clubs make you choose from just a few labels—usually their own! They make you buy up to 12 records or tapes a year—usually at list price—to fulfill your obligation. And if you forget to return their monthly card—they send you a record or tape you don't want and a bill for \$4.98, \$5.98, \$6.98 or \$7.98! In fact, you may be charged almost double for your records and tapes.

But Record Club of America Ends All That!
We're the largest all-label record and tape club in the world. Choose any LP or tape (cartridges and cassettes) . . . on any label . . . including new releases. No exceptions! Take as many, or as few, or no selections at all if you so decide. Discounts are GUARANTEED AS HIGH AS 79% OFF! You always save at least 33 1/3%. You never pay full-price! You get bestsellers for as low as 99¢, plus a small handling and mailing charge.

No Automatic Shipments
With Record Club of America there are no cards which you must return to prevent shipment of unwanted LP's or tapes (which you would have to return at your own expense if you have failed to send written notice not to ship). We send only what you order.

How Can We Break All Record and Tape Club Rules?
We are the only major record and tape club NOT OWNED . . . NOT CONTROLLED . . . NOT SUBSIDIZED by any record or tape manufacturer anywhere. Therefore, we are never obliged by company policy to push any one label, or honor the list price of any manufacturer. Nor are we prevented by distribution commitments, as are other major record or tape clubs, from offering the very newest records and tapes.
Join Record Club of America now and take advantage of this special INTRODUCTORY MEMBERSHIP OFFER. Choose any three LP's or any one tape

shown here (worth up to \$20.94) and mail coupon with check or money order for \$5.00 membership fee (a small handling and mailing charge for your free records or tapes will be sent later). This entitles you to LIFETIME MEMBERSHIP—and you never pay another club fee. You are never obligated to buy another record or tape ever. Your savings have already MORE THAN MADE UP FOR THE NOMINAL MEMBERSHIP FEE.

- Look What You Get**
- FREE Lifetime Membership Card—guarantees you brand new LP's and tapes at discounts up to 79% . . . Never less than 1/3 off.
 - FREE Giant Master LP Catalog—lists readily available LP's of all labels! Thousands of listings; hundreds of labels.
 - FREE Giant Master Tape Catalog—sent on request. Lists readily available tapes (cartridges and cassettes) on all labels.
 - FREE Disc & Tape Guide—The Club's own Magazine, and special Club sale announcements which regularly bring you news of just-issued new releases and "extra discount" specials.
 - FREE Any 3 Stereo LP's or any 1 Tape shown here (worth up to \$20.94) with absolutely no obligation to buy anything ever!

Guaranteed Instant Service
All records and tapes ordered from Disc & Tape Guide and special sale announcements are shipped the same day received (orders from the Master Catalogs may take a few days longer). ALL RECORDS AND TAPES GUARANTEED—factory new and completely satisfactory or replacements will be made without question.

Money Back Guarantee
If you aren't absolutely delighted with our discounts (up to 79%)—return items within 10 days and membership fee will be refunded AT ONCE! Join over one million budget-wise record and tape collectors now. Mail coupon to: Record Club of America Club Headquarters, York, Pa. 17405

40-R4 © 1970 RECORD CLUB OF AMERICA, INC.

RECORD CLUB OF AMERICA
CLUB HEADQUARTERS
YORK, PENNSYLVANIA 17405 **X799**

Yes—Rush me a lifetime Membership Card, Free Giant Master LP Catalog (check box below if you also wish a Master Tape Catalog) and Disc & Tape Guide at this limited Special Introductory Membership offer. Also send me the 3 FREE LP's or 1 FREE TAPE which I have indicated below (with a bill for a small mailing and handling charge). I enclose my \$5.00 membership fee. (Never another club fee for the rest of my life.) This entitles me to buy any LP's or Tapes at discounts up to 79%, plus a small mailing and handling charge. I am not obligated to buy any records or tapes—no yearly quota. If not completely delighted I may return items above within 10 days for immediate refund of membership fee.

Also send Master Tape Catalog

3 FREE LP'S

or 1 FREE TAPE

8 track
 cassette

Also add _____ Gift Memberships at \$2.50 each to my request. (Attach separate sheet with names and addresses. Indicate Master Catalog request.)

I enclose \$ _____ covering my \$5.00 lifetime membership and any gift memberships at \$2.50 each.

CASH CHECK MONEY ORDER

Make a check or money order payable to Record Club of America.

Mr. _____
Miss _____
Address _____
City _____ State _____ Zip _____

Check No. 9 on Reader Service Card

Line Radiators For Public Address



BMC P-1

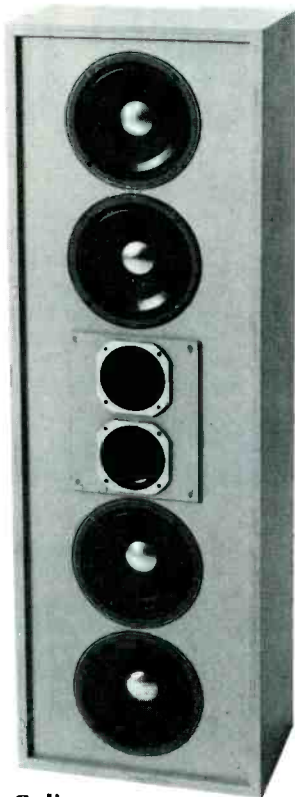

JBL Colinear

The **BMC model P-1** column at the far left has an array of six 4½-inch speakers fitted with dispersion domes. Response is said to extend down to 40 Hz and the dimensions are 33½ by 8¼ by 5 inches wide. Model P-2 is a smaller version JBL's **4380** is called a 'Colinear' array and it uses four 8-inch speakers with two 5-inch high-frequency units. Horizontal radiation is 120 deg. and 20 deg. vertical. The **University CSO-6G 'Uniline'** is completely weatherproof and constructed to withstand severe environmental conditions. It uses six 8-inch speakers and the two middle units have 'whizzer' cones to increase h.f. response. Dimensions are 60½ by 11 by 7½ deep and the frequency response is given as 65 Hz to 14 kHz. The small system is a **Geloso model 10T/98** which employs three 5-inch speakers. The ball-type swivel permits a wide range of adjustment and among the other features is a variable thumb-type impedance selector. This 'mini-column' is ideal for low-level background music or paging systems. Dimensions are 19¼ by 4 by 3 inches deep. The large curved system is an **Electro-Voice LR7** which has no less than nine 5-by-7-inch speakers plus two compression tweeters. Frequency range is 50 Hz to 17 kHz and dimensions are 60½ by 11 by 14 inches deep.

Line-source, or sound-column systems consist of several speakers mounted vertically and spaced as close as possible in an enclosure. Such systems project the sound forward in a horizontal beam with minimum side and rear radiation. Reflections from walls and ceilings are reduced

making for better intelligibility, and the sound pattern allows a greater latitude in microphone placement to avoid feedback. Usual lengths are 4 to 7 feet which to some extent determines the low-frequency response in accordance with the following formula

$$l = \frac{720}{f_1 \sin \theta} \text{ ft}$$

Where f_1 lowest working frequency
 θ angle at which intensity is -6 dB at f_1

In order to maintain a uniform high-frequency response, i.e. to prevent undue beaming effects, it is customary to tailor the response of the units or use series inductors for the top and bottom units. To arrive at the required wave shape with a minimum of side-lobes, input should be distributed with full power applied to the middle units and tapered off at each end. This is usually accomplished by using taps on the input transformer as shown in Fig. 1. In outdoor systems where reflections from walls do not reinforce the sound, it is worth remembering that doubling the distance from speaker to listener reduces the sound pressure by 6 dB. To make this up, amplifier power would have to be increased by a factor of four.

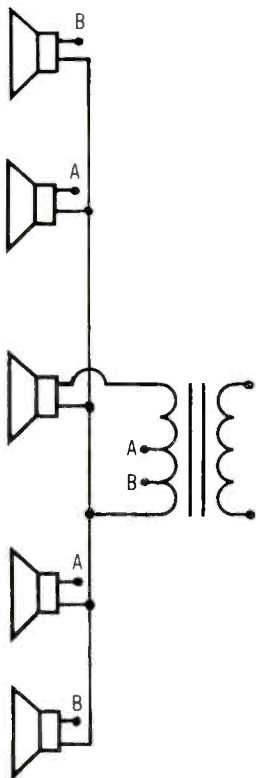
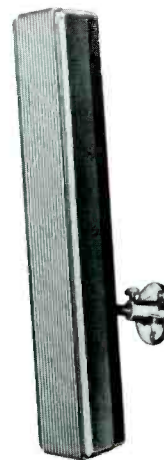

Fig. 1—Showing one method of power 'tapering.'



University CSO-6G



Geloso 10/98

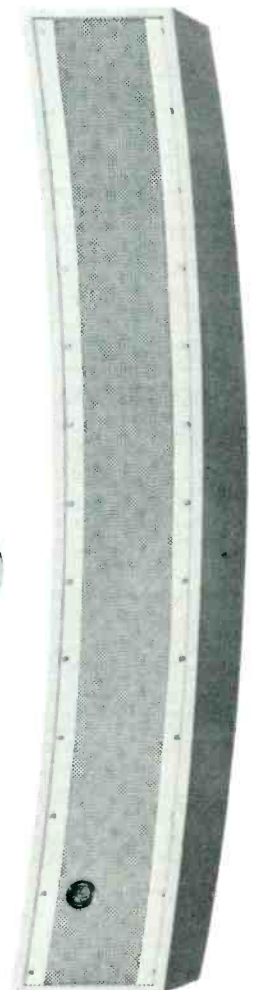

Electro-Voice LR7



Second to one...

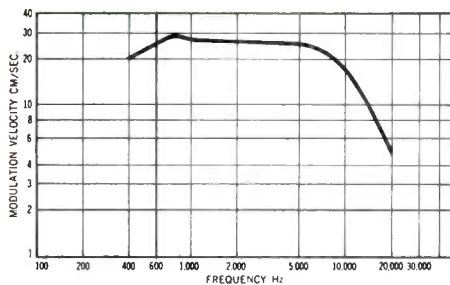

TRACKABILITY CHART FOR M91E
Measured At One Gram

If it were not for the incomparable Shure V-15 Type II (IMPROVED) Super-Track, the Shure M91E Hi-Track would be equal or superior to any other phono cartridge in trackability . . . regardless of price! The astounding thing is that it costs from \$15.00 to \$50.00 less than its lesser counterparts. And, it features an exclusive "Easy-Mount" design in the bargain. Trade up to the M91E now, and to the V-15 Type II (IMPROVED) when your ship comes in. Elliptical Stylus. $\frac{3}{4}$ to $1\frac{1}{2}$ grams tracking. \$49.95. Other models with spherical styli, up to 3 grams tracking, as low as \$39.95.



M91E HI-TRACK PHONO CARTRIDGE

© 1969, Shure Brothers Inc., 222 Hartrey Ave., Evanston, Illinois 60204

Line Radiators (cont'd)



Jensen TXC-56

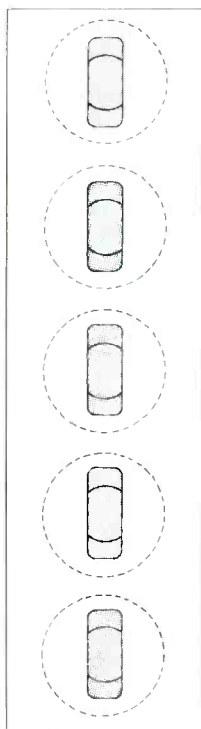

Fig. 3—Method of slot-loading.

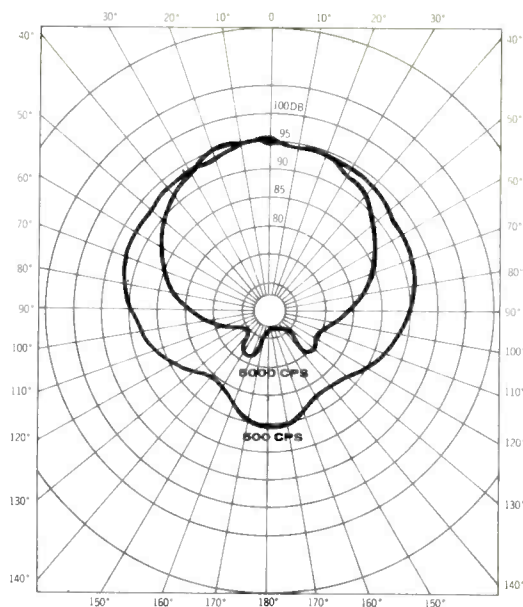
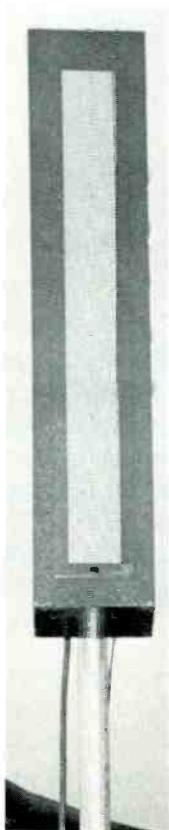
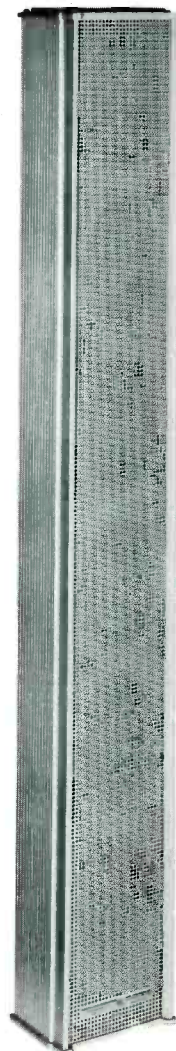

Fig. 2—Horizontal dispersion of Bozak system.



Bozak CM-200-10

Electro-Voice LR4SA



At the upper left of the page is the **Jensen TXC-56** system which uses six 5¼-inch speakers. Frequency response is quoted as 100 Hz to 10 kHz, and the dimensions are 40½ by 9½ by 5½ inches deep. **Model TXC-84** is similar in styling, but is fitted with four 8-inch units, and the frequency response is extended down to 50 Hz and up to 15 kHz. Dimensions are 52½ by 13¾ by 7½ inches deep. At the right is the **Electro-Voice LR4SA**, which is described as an all-weather line radiator. It comprises six 5- by 7-inch speakers, and the frequency response is given as 200 Hz to 10 kHz. Dispersion is 120 deg. horizontal and 30 deg. vertical. The enclosure—which is made from extruded aluminum—is 48½ by 6½ by 4 inches deep. At the left is a **Bozak CM-200-10** mounted on a pole. This system is intended for areas with severe reverberation problems and the bass response rolls off below 200 Hz. It comprises two 6-inch speakers with eight 2-inch treble units. The polar diagram shown in Fig. 2 is the horizontal dispersion pattern at 500 Hz and 5 kHz. **Model CM-109-18** is a larger system with a low-frequency response going down below 100 Hz, and it uses six 8-inch speakers plus twelve 2-inch treble units. It is somewhat larger, measuring 57 by 15½ by 10 inches deep.

The diagram of Fig. 3 is that of a slot-loaded enclosure as used by Bozak. These are very popular in Europe and are used extensively for airport installations. Care has to be used in design to avoid cavity effects. The majority of enclosures are sealed, but reflex loading with narrow ports is sometimes used in the larger systems.

Why most hi-fi speaker manufacturers demonstrate with the Crown

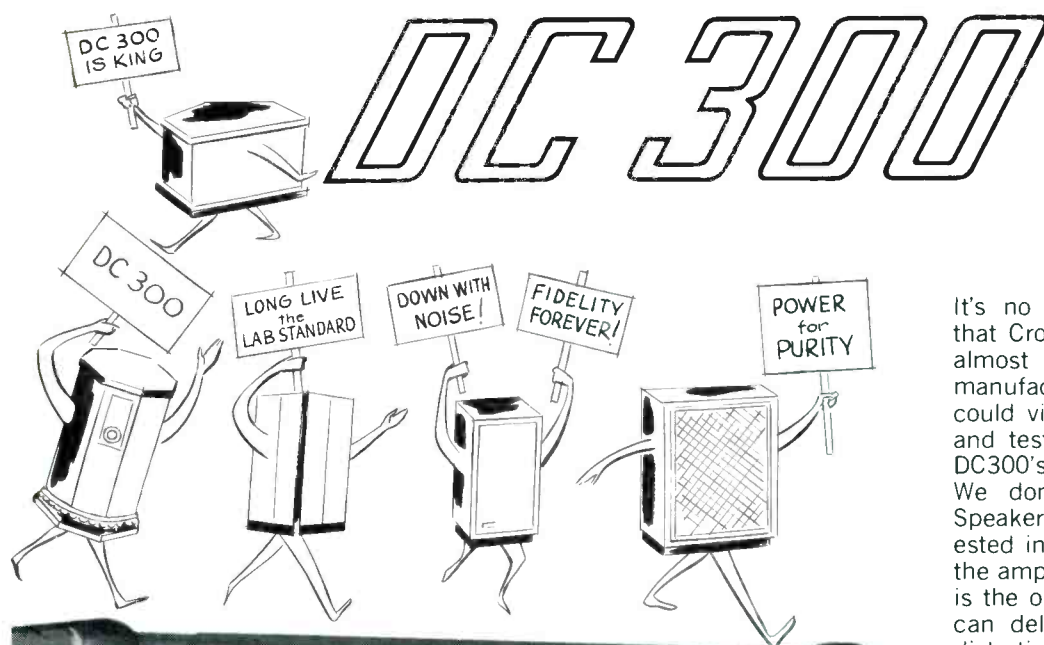

It's no secret to hi-fi show goers that Crown DC300's are at work in almost every independent speaker manufacturer's exhibit. And, if you could visit their factory design labs and test chambers, you would see DC300's in nearly every plant too. We don't have to tell you why. Speaker manufacturers are interested in hearing their speakers, not the amplifier. And the Crown DC300 is the only amp in the world which can deliver a signal so pure that distortion is practically unmeasurable, at any listening level. Plus adequate power to reproduce all of the critical transient signals without overload. Does that tell you something about how your system could sound with a DC300?

300 watts/channel RMS into 4Ω
 IM distortion under 0.05%, 1/10 watt to 300 watts
 S/N 100db below 150 watts RMS into 8Ω
 3-year warranty on parts and labor
 damping factor greater than 200
 Send for lab test reports from Audio, Stereophile and Hi-Fidelity.



BOX 1000, DEPT. A-8, ELKHART, INDIANA 46514

Check No. 13 on Reader Service Card

www.americandisbistory.com

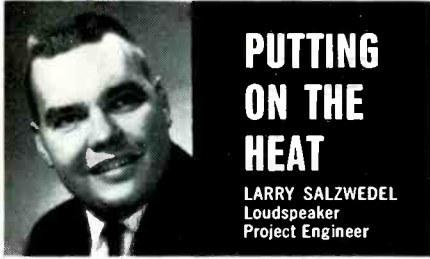

Because two basic characteristics—material fatigue and heat dissipation—limit the ability of a transducer to withstand high acoustic power levels, the design of a new class of high-reliability, high-power drivers was centered on these two areas.

While the voice coil of the new drivers is of conventional copper, it is protected by a new polyester insulation that is unaffected by temperatures in the neighborhood of 300°F, typical of continuous high-level operation. The coil is mounted on a coil form of Kapton polyimide plastic (described in an earlier article [#72] in this series) and then cemented to a heavy-duty phenolic diaphragm. Centering of the entire assembly with unusually high accuracy is the result of precision fixturing, plus a system of automatic thermal compensation.

Of special interest is the magnet structure, which employs a cast, one-piece ductile iron pot structure. This permits better heat transfer than conventional bolted or glued assemblies. A series of radiating fins are cast into the structure to increase the surface area, and serve to reduce the gap temperatures as much as 40°F. The elimination of multiple parts also improves production uniformity by decreasing cumulative "stack ups" of tolerances.

The driver design eliminates the usual decorative outer cover, since this was a source of trapped air that held heat inside the structure. The pot structure is also painted black to further increase prompt radiation of heat generated inside.

While some of these measures may seem extreme, rigorous testing has provided proof of the validity of this approach. A standard Model 1825 high-power driver easily withstands 300 hours of continuous operation in siren service with an input of 75 watts square wave. This compares with a typical life of 16 hours for all other similar drivers tested to date. For sine wave input, maximum power is 90 watts.

In addition to the availability of the new E-V Model 1825 driver for use on conventional reentrant, multicell, and sectoral horns, two special horns (Model AR400 and Model AR500) have been developed. These horns are expressly suited to siren applications for vehicular service (either exterior or concealed) and can be used on emergency vehicles, in audio warning systems, for marine fog horns, etc. Full information on horns and drivers for inclusion in high-power systems is available on request.

For reprints of other discussions in this series,
or technical data on any E-V products, write:
ELECTRO-VOICE, INC., Dept. 803A
602 Cecil St., Buchanan, Michigan 49107

Electro-Voice®

A SUBSIDIARY OF GULTON INDUSTRIES, INC.

Check No. 14 on Reader Service Card

MOOGS & MOONDOG

E. T. CANBY

It's always fascinating to me that in both our arts and our engineering—music and hi-fi, for instance—we thrive so well on adversity, even in this age of abundance. We're always forging ahead against limitations that by rights should have us crying "uncle" every other minute. Instead, we just get obstinate and push on even harder. It's a way of life and it goes 'way beyond any differences between artists and engineers.

Whether it's in music or in engineering, we do our best in the face of limitations—we call them challenges—and very seldom when things are shoved at us on a platter. We get our kicks, and our successes, by setting up millions of little Mt. Everests and climbing them; because there they are, staring us in the face. We work out compromises, so that somehow or other 2 plus two adds to 5. Are we proud! They said it couldn't be done. Perhaps it's only a couple of dB of signal-to-noise that we've picked up against all reason. Or a successful pop tune when they said all the good tunes had already been written (and copyrighted). Sometimes we do big things, but it's the little ones that really add up.

Parsimony is best. We *never* start from scratch—that's just rhetoric. We start with whatever we have, what's in front of us—tools, materials—and we build on what has already been built, solving a few more problems that couldn't be solved. Music is that way. So is engineering. Improved tape recorders grow out of earlier improved tape recorders. New music comes out of the old, even if it's all-electronic. A "totally new" tape recorder? A "totally new" musical language? Hogwash. We each add our parsimonious bit. And all because we insist on denying the common-sense verdict that enough is enough and there isn't any more to be done. Not on your life! Hope of financial reward, by the way, is merely an excellent excuse.

How, then, do young composers come to write their music? The same way young engineers come to designing a tape recorder. Don't think that you can walk up to a burgeoning musician with a couple of Moogs and say, look! *Compose any-*

thing you want! It doesn't work out that way. Instead, the good young composers go around listening, learning, observing; and then they try their hand at whatever music happens to be around—whether it's for a Moog or a mouth organ. Might be either. Limitations? Of course. The mouth organ plays only two chords. The Moog has great tangles of patch cords, to confuse the budding muse. (Mr. Moog is probably doing something about that.) Some synthesizers, remember, synthesize only one note at a time, after vast settings of dials and feeds and sliders and switches. (Whereas any old harpsichord can play you dozens of complex wave forms in seconds.)

Music comes out, you see, the way it goes in. You start from where you are and with what you have. Tape recorders are the same. And tone arms. You set out to improve the unimprovable—otherwise why bother?

To get down to cases (and this is how I got started here . . .), I'm interested in a new recording of piano music by a youth of 25, who wrote the stuff a few years back, when he was 20. Funny—it sounds straight out of the pre-war days, say, 1925-1935. He wasn't even born then. Andrew Zatman. Then there's music by a Prince Consort, composed at the same age though some 130 years ago. Prince Albert. Good musician. And there's Moondog, a statuesque creature with a vast white beard and hair, dressed in a Viking-style costume. He writes European-type classical, though he comes from Hurley, Mo. and also Kansas, Wyoming, and points West. It's what *he* heard. What he likes, where *he* started.

Then, too, there's Paul McCartney of the Beatles, who might have been Schubert if he'd been around at the right place and time. He wasn't. So, perforce, he's Paul, an absolute master of melody. What melody? The kind he heard in Liverpool, out of America. He, too, manages to improve on earlier models. And with no more than those same seven familiar notes of the ordinary scale plus a few extras on the side. Economical, yes?

(Continued on page 32)

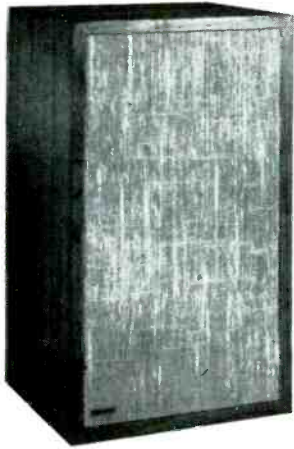

"...quite probably the best buy in high fidelity today."

—the Dynaco A-25 speaker (\$79.95 assembled only)

from THE STEREOPHILE, Box 49, Elwyn, Pa. 19063

"...(sonically) we cannot see how any preamp, present or future, could surpass the PAT-4."

(\$89.95 kit, \$129.95 assembled)

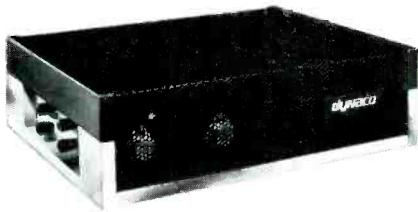

"...makes most loudspeakers sound better."

The Dynaco Stereo 120 power amplifier
(\$159.95 kit, \$199.95 assembled)

These opinions from **The Stereophile** are even more meaningful since it is the most respected journal in the audio field, whose sole source of revenue is from its subscriptions.

Over the years Dynaco has proved faithful to its philosophy of providing outstanding per-

formance at a most moderate cost. Proper initial design eliminates the need for model changes. The savings achieved are passed on to you. What is "state-of-the-art" when you acquire it will still meet contemporary performance standards years later.

Send for literature or pick some up at your dealer where you can see and hear Dynaco equipment.

DYNACO INC.

3060 JEFFERSON ST., PHILA., PA. 19121
IN EUROPE WRITE: DYNACO A/S, HUMLUM, STRUER, DENMARK

BASF

BASF

the
"more"
tape

Every time you choose BASF, you get more for your money . . . more than you get with any other quality tape.

First, you get superlative recording quality. BASF is made with a special formulation that creates superb sound reproduction with extra-low tape noise.

and there's more . . .

BASF tape is ageless. Your recordings will last a lifetime, unaffected by temperature, humidity or time.

and there's more . . .

BASF tape reels are packaged in the exclusive plastic "Perma-Store" box . . . the one that makes your tape library look as good as it sounds.

and there's more . . .

BASF tape reels come with color-coded leads and switching foils at both ends.

and there's more . . .

Now BASF cassettes, with the same superior tape quality, come in handsome mini versions of the Perma-Store Box, for looks, convenience and protection.

and there's more . . .

BASF tape reels and cassettes cost no more than other quality recording tapes. Ask to see BASF tape at your favorite dealer's today.

BASF SYSTEMS INC

Crosby Drive
Bedford, Massachusetts 01730



Check No. 16 on Reader Service Card

Tape Guide

HERMAN BURSTEIN

Splicing

Q. I have read that a reel of tape that has been spliced is not considered a permanent link due to eventual drying-out. It was suggested that the spliced reel be duplicated on a fresh, continuous reel for permanent storage and use. Is this true? Many of my recordings are spliced because of editing, etc.—John Eshia, New Britain, Conn.

A. Of course it is preferable that a reel of recorded tape have no splices in it. On the other hand, using high-quality splicing tape, the splice is apt to last many years if correctly made. The question really boils down to how fussy one is. Occasionally one of my splices made years ago (perhaps when I was less expert at making a splice or when splicing tape was not as good as today) does come apart. But I have not found the inconvenience so great or frequent as to warrant re-recording all the reels containing a splice. Moreover, you have to balance the inconvenience of a splice coming apart against the deterioration in signal-to-noise ratio—about 3 dB—when making a copy of the reel in question.

More Volume

Q. My tape recorder cannot make recordings with sufficient volume. Prerecorded tapes play back with all the volume I need. But I cannot get satisfactory results on home recordings. Recording either from a phonograph record or from FM, I cannot get the needles on the VU meters to deflect sufficiently, no matter how far up the volume controls of the tuner and the tape recorder are turned. Could this be a problem in impedance matching. My tuner is part of a General Electric phonograph Model 4000

—Ernest J. Oresik, Madison, Indiana.

A. I doubt that yours is an impedance matching problem. It appears to be one of insufficient signal fed into the tape recorder, or else something faulty in the record amplifier of your tape machine. Can you borrow a tuner from a friend and see if you then drive your tape recorder

adequately? If your friend's tuner drives your tape machine to full recording level, as shown by the VU meter, it is unlikely that the trouble is in your tape machine.

If the fault is in your GE unit, perhaps you can get more signal by picking it up at a later stage of amplification. If this isn't feasible, you can buy an inexpensive preamplifier in most audio stores, and this may solve your problem. Such preamps are customarily sold for accepting the signal from a tape playback head or from magnetic phono cartridges; and they provide the necessary extra amplification and the required equalization. Some of these preamps also have a flat position (no equalization), and this is the type you want. Presumably the signal you are feeding out of your GE unit is already equalized and therefore the flat position of the preamp should be used.

Frequency Response Measurements

Q. I am rather mystified by a statement in an AUDIO PROFILE. It stated that a tape recorder's overall performance (record-playback) was ± 2.5 dB from 20 to 20,000 Hz. The playback response of this machine was measured by the reviewer as being ± 2.5 dB from 50 to 15,000 Hz. Assuming that these figures are correct, why would the playback response be inferior to the overall record-playback response? (Robert Pearson, Chicago, Illinois)

A. The reason for rating playback response only between 50 and 15,000 Hz is that this is the compass of the test tapes in accepted use. Further, it is possible for a machine to have better record-playback response than playback response alone if the machine contains equalization in the record amplifier to make up for deficiencies in the playback process (deficiencies in the head, playback amplifier, and so on.)

If you have a problem or question on tape recording, write to Mr. Herman Burnstein at AUDIO, 134 North Thirteenth Street, Philadelphia, Pa. 19107. All letters are answered. Please enclose a stamped, self-addressed envelope.

The new Sony savings plan: \$134.95

A Really Spectacular Buy. The new solid-state stereophonic Sony model 252-D is loaded with exciting quality features including sound-with-sound! Handsomely mounted in a low profile walnut wood cabinet. Here is the most tape deck recorder for the money. And it's a Sony!

Scrape Flutter Filter. Special precision idler mechanism located between erase and record/playback heads eliminates tape modulation distortion. This feature formerly found only on professional studio equipment.

Sound-with-Sound. A versatile feature that enables you to record on one channel while listening to the other. Ideal for learning or teaching foreign languages as well as perfecting diction, singing and instrumental music.

Vibration-Free Motor. An important new Sony development utilizing "floating" shock absorber action to isolate completely any motor vibration from the tape mechanism.

Four-Track Stereophonic and Monophonic Recording and Playback. Seven-inch reel capacity provides hours and hours of stereo enjoyment. Stereo headphone jack for private listening. Automatic sentinel shut-off. Two VU meters. Pause control. Three-digit tape counter. Record interlock. Separate record selector buttons. Vertical or horizontal operation.

Non-Magnetizing Record Head. Head magnetization build-up—the most common cause of tape hiss—has been eliminated by an exclusive Sony circuit which prevents any transient surge of bias current to the record head.

Instant Tape Threading. Exclusive Sony Retractable pinch roller permits simple one-hand tape threading. An automatic tape lifter protects heads from wear during fast forward and rewind.



Sony Model 252-D. Just \$134.95! For your free copy of our latest tape recorder catalog, please write to Mr. Phillips, Sony/Superscope, Inc., 8144 Vineland Avenue, Sun Valley, California 91352.

SONY SUPERSCOPE The Tape Way to Stereo

You never heard it so good.

Editor's Review

Much of the space in this issue is devoted to Commercial Sound and the article by Don Davis on the uses of a computer-calculator in system planning is of particular interest. Computers are going to be employed more and more in this field and I note that Bell Telephone Laboratories have been using one to measure room characteristics. The computer traces the paths of 300 rays which radiate from an omni-directional sound source in a simulated room. Each ray is tracked by the computer as it bounces off the ceiling, floor, and walls. Each time a ray hits an absorbing material its energy is reduced and the computer keeps an account of the energy remaining in each of the rays. So far, the studies have shown discrepancies with reverberation time calculations taken by conventional methods—and quite large ones at that. Readers who are interested can find further details in the February issue (Part I) of the JASA (The Journal of the Acoustical Society of America)

One day we may be able to use computers for the accurate evaluation of loudspeakers: with the present state-of-the-art there is no way to evolve a set of specifications which will guarantee that the sound produced by system A will sound identical to system B. In other words, it is possible to have two loudspeakers which will give identical results from conventional tests in terms of frequency, distortion, transient response with tonebursts, dispersion, and so on—but will still *sound* different. One reason is phase differences and another is the presence of small resonances that do not show up on the normal frequency runs. Yet another possibility is Doppler distortion—easy enough to measure with a spectrum analyzer but much more difficult to evaluate in terms of *relative* distortion.

* * *

What will the Hi-Fi setup of the future be like? This idle speculation was prompted by a demonstration of new prototype radio and TV models by Panasonic recently. Among the fascinating products was a tiny portable 1½-inch screen TV with built-in AM/FM radio, a battery operated portable Color TV set, a direct-drive phono turntable using an 'electronic commutator' motor and an AM-FM radio with digital clock. This is a clock with a dif-

ference—you don't even have to *look* at it. Just press a switch and a voice announces the time. . . . In the mornings it can be programmed to give the time for two minutes, then switching on the radio. It can be set to play radio programs with time announcements every hour if so desired. How is it done? Not by tape as I had supposed—but with two magnetic discs, one for the hours and the other for minutes. When the call switch is pressed down, a motor drives the magnetic head to the correct position. Very ingenious. . . .

And then there is the neural hearing concept. Two doctors in New York have evolved a system whereby sound is transmitted direct to the nervous system, bypassing the ears entirely. Small disks called 'transdermal devices' are placed each side of the head and these are fed with a modulated r.f. signal. The head becomes in effect the dielectric element between two plates of a capacitor and the signal is detected by a complex process involving the coclea and the nerves themselves. The coclea normally converts a mechanical signal into an electrical one, but here its function is reversed. The r.f. carrier is usually in the 30- to 100-kHz range and the actual power is quite low. I heard the system some months ago and although frequency range went above 20 kHz and down to 30 Hz, the quality of reproduction was not up to Hi-Fi standards. However, work is still going on and who knows what impact such ideas may have in the future?

* * *

Two High Fidelity Shows have been announced by the IHF, the first to take place at the Westbury Island Inn from September 15 to 22 and the second at the Newton Marriott Motor Inn (near Boston), from October 29 to November 1. The German High Fidelity Institute also announced a Hi-Fi Show and I must confess I found their description more picturesque. Says the information leaflet "Chaotic bedlam is completely erased by the use of sound-proof listening studios . . . it is a rich and pure part of Hi-Fi '70 and not as it so often happens regrettably, a pseudo-cultural Show."

No danger of pseudo-culture here, not even in Boston—but we certainly have a lot of bedlam to erase!

G.W.T.

THE CARTRIDGE KILLER.



This man doesn't have time to baby the tools of his trade. Not with a commercial, a traffic report and time check breathing down his neck. He's got to keep those records spinning fast and furious. And, if he kills a cartridge or two along the way, well—that's how it goes

Until now.

Meet the Stanton 500AL—the cartridge that's tougher than disc jockeys. Here is the workhorse of the broadcast industry. We designed the entire stylus assembly to withstand the rugged demands of back cueing and the kind of handling that would quickly ruin ordinary pick-ups. Yet its high restoring force and tracking reliability is accomplished without sacrifice of professional standards for frequency response, output, channel separation, etc.

The Stanton Model 500AL is just one of many cartridges engineered by Stanton for the varied and critical applications in the fields of broadcasting and recording. For nothing less than Stanton performance and reliability would meet the needs of the engineers who have made Stanton—The Professional Standard.

For free literature write to Stanton Magnetics, Inc., Terminal Drive, Plainview, L.I., New York 11803



STANTON

Scott Muni
WNEW-FM, New York

Check No. 19 on Reader Service Card

The Computer in Sound System Design

DON DAVIS*



As we enter the decade of the Seventies more and more professional sound contractors are becoming capable of truly engineering a sound reinforcement system. They think of rooms in terms of shape, average absorption coefficients, critical distance; and of loudspeakers in terms of efficiency, directivity, and uniformity of dispersion. It is refreshing to hear engineering discussions rather than salesman's platitudes regarding equipment performance. This article stresses universal performance parameters that must be met.

AN ACCURATE KNOWLEDGE of a room's size and shape, its reverberation characteristics, and its ambient noise level allows the modern sound contractor to evaluate quickly the advantages and disadvantages of using one of the three basic approaches to sound system design, namely:

1. High-level single-source system.
2. High-level overhead distributed system.
3. Combinational system.

The sound contractor first measures or calculates the following parameters:

1. Reverberation decay time.
2. Average absorption coefficient.
3. Ambient noise level.
4. Room constant.
5. Critical distance.
6. Distance between the performer and the most remotely located listener.
7. Equivalent acoustic distance.
8. Needed acoustic gain
9. Potential acoustic gain.
10. Electrical power required.
11. Time delay.
12. Distribution requirements.

He is then fully equipped to predict accurately and precisely what can be done with the sound system (and even more important, what should not be done) and is capable of delivering what he predicts.

How Sound Behaves Outdoors

In outdoor conditions sound essentially follows the inverse-square-law attenuation rate:

*Director of Commercial Sound Products, Altec Lansing Division of LTV Ling Altec.

$$20 \log_{10} \frac{D_a}{D_f} = -dB \text{ loss} \quad (1)$$

Where D_a = the starting point
 D_f = the distant point

By arranging the distances so as to produce a fractional number of less than 1, the negative sign is automatically inserted when used in a computer. Figure 1 illustrates the inverse-square-law attenuation rate of sound with increasing distances.

How Sound Behaves in a Room

As a listener moves away from a loudspeaker in a room he becomes aware of several phenomena: First, the sound initially drops in loudness with increasing distance and then reaches a relatively steady loudness. When near the loudspeaker it is easy to localize it, but at a distance, location of the loudspeaker can be difficult if the listener closes his eyes. Finally, at a distance from the loudspeaker, high frequencies drop off rather rapidly. For any given listener position, then, this means that we require a reasonably accurate calculation of:

1. The attenuation of sound between the loudspeaker and the listener.
2. The ratio of direct sound to reflected (reverberant sound) at the listener's ears.
3. The expected change in signal balance due to humidity, air absorption, etc., at the listener's position compared to some closer reference distance.

When the loudspeaker or other sound source is moved indoors, several other parameters must be taken into consider-

ation simultaneously. The directivity of the loudspeaker will, in a large part, determine how much sound is concentrated on the audience and how much strikes other surface areas first. How much each of the surface areas reflects becomes of importance as well as the distances involved in the reflections. So in addition to our knowledge of inverse-square-law attenuation we need to add:

1. The loudspeaker's directivity factor known as Q .
2. The room's acoustical characteristics known as the Room Constant (R).

Loudspeaker Directivity

Loudspeaker directivity is defined either as the directivity index (D_i) or the directivity factor (Q). To visualize the basic meaning of these parameters let's examine three basic directivity situations:

1. A point source with a perfect spherical radiation pattern.
2. A point source with a perfect hemispherical radiation pattern.
3. A point source with a radiation pattern that is 90° in the vertical axis and 90° in the horizontal axis.

We will, in all three cases, assume that the point source is 100 per cent efficient (e.g., 1 electrical watt produces 1 acoustic watt) and that all SPL measurements are to be taken at 4 feet from the source).

In the first instance, we can visualize a perfect sphere and as we intrude a small measuring microphone into its four-foot radius from any angle we would expect to read:¹

¹ Michael Rettinger: *Practical Electro-Acoustics*, Chemical Publishing Co. Inc., New York, 1955.

$$20 \log_{10} \left(\sqrt{\frac{1 \text{ watt}}{142.24 r^2 (1 - \cos \frac{\theta}{2}) 10^{-7}} \cdot \frac{1}{0.0002 \text{ dynes/cm}^2}} \right) \quad (2)$$

= dB SPL for 100% efficient source at 4 ft.

where 142.24 = a constant derived from a density of air times the velocity of sound in air times 2π (English units)—assuming $T = 20^\circ\text{C}$, atmos. pressure = 760 mm of Hg)

r = distance from sound source

θ = angle subtended by the spherical surface area.

Therefore:

$$20 \log_{10} \left(\sqrt{\frac{1 \text{ watt}}{142.24 \times 16 \times (1 - \cos \frac{360}{2}) 10^{-7}} \cdot \frac{1}{0.0002 \text{ dynes/cm}^2}} \right) = 107.40 \text{ dB SPL} \quad (3)$$

If we apply the same formula to the hemispherical sound source we find that at 4 feet anywhere on the surface of the hemisphere, we can measure:

$$20 \log_{10} \left(\sqrt{\frac{1 \text{ watt}}{142.24 \times 16 \times (1 - \cos \frac{180}{2}) 10^{-7}} \cdot \frac{1}{0.0002 \text{ dynes/cm}^2}} \right) = 110.41 \text{ dB SPL} \quad (4)$$

We are now in a position to define the directivity index (D_i). A quick inspection reveals that simply by confining the radiated power (1 acoustic watt) to a smaller radiated angle (from a spherical radiation pattern to a hemispherical radiation pattern) we benefit by a 3.01-dB increase in our SPL. This increase is the D_i . Therefore, a sound source with a perfect spherical radiation pattern would exhibit a D_i of 0 dB, and a sound source with a perfect hemispherical radiation pattern would exhibit a D_i of 3.01 dB.

Once again, let's use the formula to examine the 90-deg. subtended angle

$$20 \log_{10} \left(\sqrt{\frac{1 \text{ watt}}{142.24 \times 16 \times (1 - \cos \frac{90}{2}) 10^{-7}} \cdot \frac{1}{0.0002 \text{ dynes/cm}^2}} \right) = 115.74 \text{ dB SPL} \quad (5)$$

$$115.74 - 107.40 = 8.34 \text{ dB} = D_i$$

The directivity factor (Q) is found by the formula

$$\text{Antilog}_{10} \left(\frac{D_i}{10} \right) = Q \quad (6)$$

As can be seen, Q is simply the power ratio of the directivity index.

We can now list these parameters in a table, plus other angles of interest. See Fig. 2. It is of interest to sound system engineers that the devices he deals with have the following range of D_i and Q . See Fig. 3.

The Room Constant

When the internal volume (V) of an enclosed space, the total surface area of the boundary surfaces (S), and the reverberation decay time for 60-dB RT is known, it is a simple calculation to obtain the average absorption coefficient (a) of the total room:

$$1 - \epsilon - .049 V/S(RT) = a^{(7)}$$

⁷ Sound Systems Design, Section B, *Manual of Sound Systems*, Western Electric Co., 1949.

a can also be calculated, as it must be in the case of the building still on the drawing board, by considering each individual surface area (s) that consists of a different surface material. By means of well established list of absorption coefficients (a), each surface area may be multiplied by its absorption coefficient. The individual surface areas times their individual absorption coefficients can then be summed. With the addition of other objects in the space in terms of sa , the complete total can be divided by the total boundary surface area to obtain a . One such table is shown in Fig. 4.

$$\frac{s_1 a_1 + s_2 a_2 + s_3 a_3 \dots + s_n a_n}{S} = a \quad (8)$$

At this stage, if it is a building on the drawing board, the sound contractor cal-

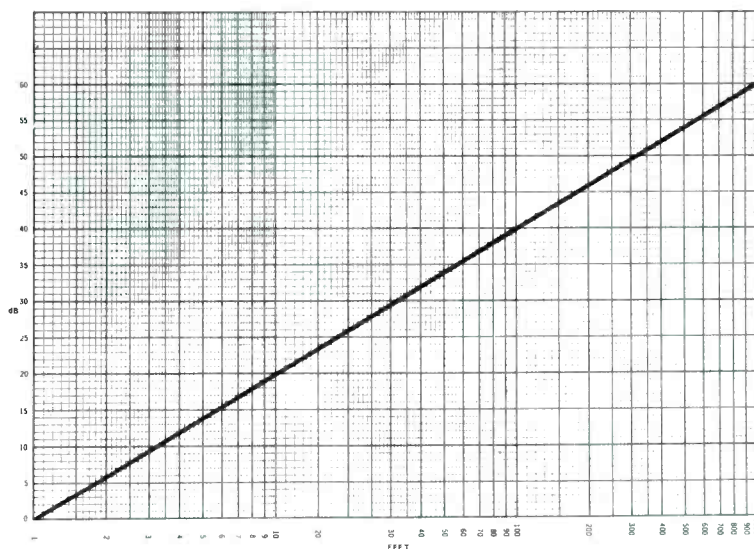

Fig. 1—Inverse-square-law attenuation from 1 to 1000 ft.

Angle	dB-SPL	D_i	Q
360°	107.40	0 dB	1.00
180°	110.41	3.01 dB	2.00
160°	111.24	3.84 dB	2.42
120°	113.42	6.02 dB	4.00
106°	114.41	7.01 dB	5.00
90°	115.74	8.34 dB	6.82
60°	119.14	11.74 dB	14.92
45°	121.59	14.19 dB	26.26
30°	125.08	17.68 dB	58.66
15°	131.09	23.69 dB	233.65
10°	134.60	27.20 dB	525.30
5°	140.62	33.22 dB	2100.21
1°	154.60	47.20 dB	52,497.21

Fig. 2—SPL in dB at 4 feet from a speaker of 100% efficiency at 1-watt level, radiating into various angles.

calculates the RT for each of the frequencies for which he has an accurate a by using:

$$\frac{.049V}{-S \log_e (1-a)} = RT \quad (9)$$

He also calculates the room constant:

$$\frac{Sa}{(1-a)} = R \quad (10)$$

It can be seen that R is a handy one-number value indicating the "liveness" or "deadness" of an acoustic environment.

Attenuation of Sound with Increasing Distance in an Enclosed Space

Using the information developed above, the formula for the attenuation of sound with increasing distance in an enclosed space is not difficult to comprehend or utilize.

$$10 \log_{10} \left[\left(\frac{Q}{4\pi r^2} \right) + \left(\frac{4}{R} \right) \right] = \text{dB loss} \quad (11)$$

where Q = the directivity factor
 r = the distance from the source
 R = the room constant

For the purpose of illustration, let's examine an auditorium where the

$$\begin{aligned} V &= 500,000 \text{ ft}^3 \\ S &= 100,000 \text{ ft}^2 \\ a &= 0.12 \end{aligned}$$

And the loudspeaker's directivity factor $Q = 5$.

$$\begin{aligned} RT &= \frac{.049V}{-100,000 \times \log_e (1-0.12)} \\ &= 1.92 \text{ sec.} \end{aligned} \quad (12)$$

$$R = \frac{100,000 (0.12)}{1-0.12} = 13636.36 \quad (13)$$

We can therefore plot for each increase in r of one foot, the difference between the readings as shown in Fig. 5.

$$10 \log_{10} \left[\left(\frac{5}{4\pi \times 1} \right) + \left(\frac{4}{13636.36} \right) \right] = -4.0 \text{ dB} \quad (14)$$

$$10 \log_{10} \left[\left(\frac{5}{4\pi \times 4} \right) + \left(\frac{4}{13636.36} \right) \right] = -10.01 \text{ dB} \quad \text{difference } 6.01 \text{ dB}$$

$$10 \log_{10} \left[\left(\frac{5}{4\pi \times 9} \right) + \left(\frac{4}{13636.36} \right) \right] = -13.52 \text{ dB} \quad 3.51 \text{ dB}$$

$$10 \log_{10} \left[\left(\frac{5}{4\pi \times 16} \right) + \left(\frac{4}{13636.36} \right) \right] = -15.99 \text{ dB} \quad 2.47 \text{ dB}$$

Type of Sound Source	D_I	Q
Person talking (no sound system)	3 dB	2
Coaxial loudspeaker in infinite baffle	7 dB	5
Cone woofers	7 dB	5
Multicellular horns	7-12 dB	5-15
Sectoral horns	7-9 dB	5-9.5

Fig. 3— D_I and Q rating for typical sound sources.

SOUND ABSORPTION COEFFICIENTS OF GENERAL BUILDING MATERIALS AND FURNISHINGS

Complete tables of coefficients of the various materials that normally constitute the interior finish of rooms may be found in the various books on architectural acoustics. The following short list will be useful in making simple calculations of the reverberation in rooms.

Materials	Coefficients					
	125 Hz	250 Hz	500 Hz	1000 Hz	2000 Hz	4000 Hz
Brick, unglazed	.03	.03	.03	.04	.05	.07
Brick, unglazed, painted	.01	.01	.02	.02	.02	.03
Carpet, heavy, on concrete	.02	.06	.14	.37	.60	.65
Same, on 40 oz. hairfelt or foam rubber	.08	.24	.57	.69	.71	.73
Same, with impermeable latex backing on 40 oz. hairfelt or foam rubber	.08	.27	.39	.34	.48	.63
Concrete block, coarse	.36	.44	.31	.29	.39	.25
Concrete block, painted	.10	.05	.06	.07	.09	.08
Fabrics						
Light velour, 10 oz. per sq. yd., hung straight, in contact with wall	.03	.04	.11	.17	.24	.35
Medium velour, 10 oz. per sq. yd., draped to half area	.07	.31	.49	.75	.70	.60
Heavy velour, 18 oz. per sq. yd., draped to half area	.14	.35	.55	.72	.70	.65
Floors						
Concrete or terrazzo	.01	.01	.015	.02	.02	.02
Linoleum, asphalt, rubber or cork tile in contact with wall	.02	.03	.03	.03	.03	.02
Wood	.15	.11	.10	.07	.06	.07
Wood parquet in asphalt on concrete	.04	.04	.07	.06	.06	.07
Glass						
Large panes of heavy plate glass	.18	.06	.04	.03	.02	.02
Ordinary window glass	.35	.25	.18	.12	.07	.04
Gypsum board, 1/2" nailed to 2 x 4's 16" o.c.	.29	.10	.05	.04	.07	.09
Marble or glazed tile	.01	.01	.01	.01	.02	.02
Openings						
Stage, depending on furnishings			.25	—	.75	
Deep balcony, upholstered seats			.50	—	1.00	
Grills, ventilating			.15	—	.50	
Plaster, gypsum or lime, smooth finish on tile or brick	.013	.015	.02	.03	.04	.05

ABSORPTION OF SEATS AND AUDIENCE

Values given are in sabins per person or unit of seating

	125 Hz	250 Hz	500 Hz	1000 Hz	2000 Hz	4000 Hz
Audience, seated, depending on spacing and upholstery of seats	2.5-4.0	3.5-5.0	4.0-5.5	4.5-6.5	5.0-7.0	4.5-7.0
Seats, heavily upholstered with fabric	1.5-3.5	3.5-4.5	4.0-5.0	4.0-5.5	3.5-5.5	3.5-4.5
Seats, heavily upholstered with leather, plastic, etc.	2.5-3.5	3.0-4.5	3.0-4.0	2.0-4.0	1.5-3.5	1.0-3.0
Seats, lightly upholstered with leather, plastic, etc.			1.5-2.0			
Seats, wood veneer, no upholstery	.15	.20	.25	.30	.50	.50
Wood pews, no cushions, per 18" length			.40			
Wood pews, cushioned, per 18" length			1.8-2.3			

Finding the Ratio of Direct to Reverberant Sound

It can be seen clearly that initially every time the distance is doubled, the difference is approximately 6 dB until the distance begins to approach 34 feet. Beyond 34 feet, even if we go to 340 feet we will not encounter any more significant attenuation.

Why does sound behave in this manner? What happens at 34 feet? What happens is that the reflected sound at 34 feet is equal in energy to the direct sound. In acoustical terms the distance from the loudspeaker to 34 feet is called the "free field" and the distance beyond 34 feet is called the "reverberant field." See Fig. 6.

The distance at which this occurs and at which the direct sound energy from the loudspeaker is equal to the reflected sound energy is called the "critical distance" (D_c).

Fortunately, there is a much easier way to get D_c than by incrementing the formula above:

$$0.14 \sqrt{QSa} = D_c^{(3)} \quad (15)$$

where Q = the familiar directivity factor.

S = the total boundary surface area.

a = the average absorption coefficient.

If D_c by definition is the distance at which the direct sound energy equals the reflected sound energy, and if the direct sound energy (by definition, not undergoing reflection) continues to follow the inverse-square law while the reverberant sound energy tends to remain at a constant level relative to the direct sound level at D_c , then we can state that at $2 D_c$ the ratio of direct-to-reverberant sound is -6 dB and at $4 D_c$ the ratio of direct-to-reverberant sound is -12 dB.

While the human ears coupled to that marvelous real-time analyzer, the human brain, can and does differentiate between the direct and reverberant sound long after the ratio becomes less than 1 to 1, even they can not accurately do so after the ratio exceeds -12 dB. In literally hundreds of high-quality sound reinforcement installations it has been proven that $4D_c$ is the *maximum* distance any loudspeaker should attempt to project sound if the listener is expected to understand it.

It is also interesting to consider that if the sound system microphone and the sound system loudspeaker are separated by D_c , then the microphone can be car-

(Continued on page 61)

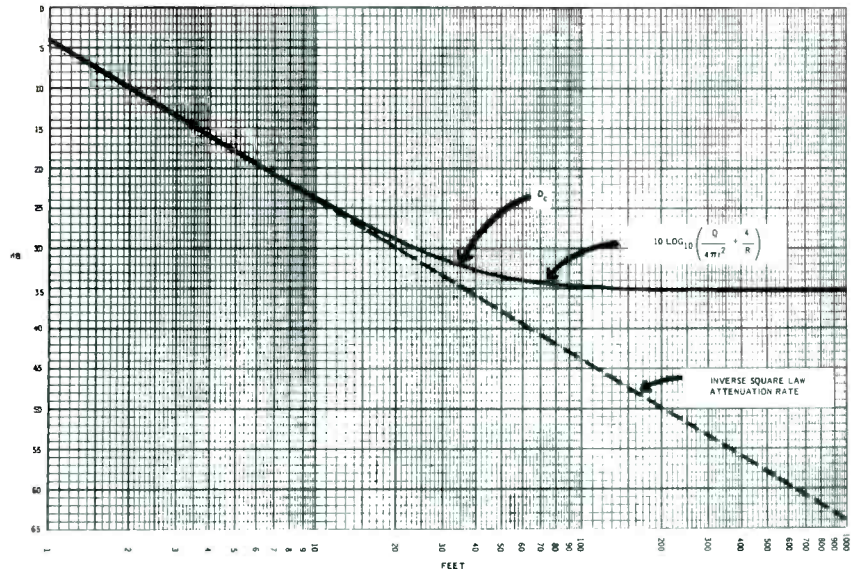

Fig. 5—Increments of R in feet.

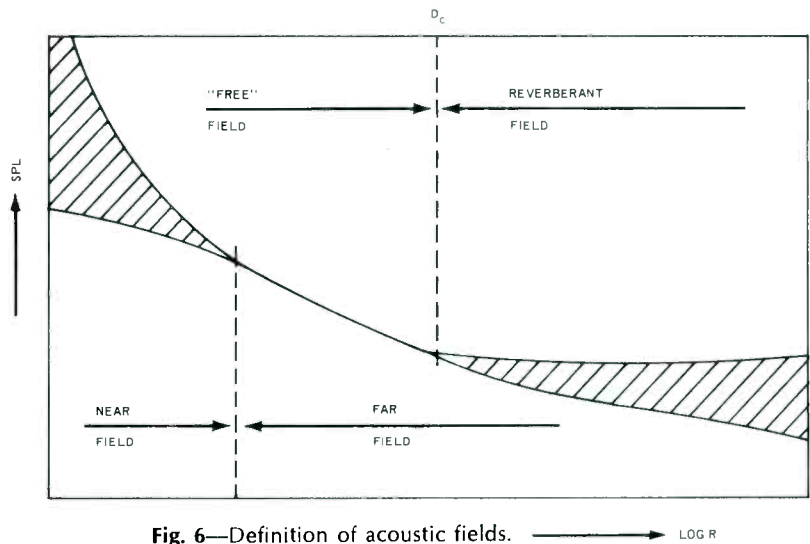

Fig. 6—Definition of acoustic fields.

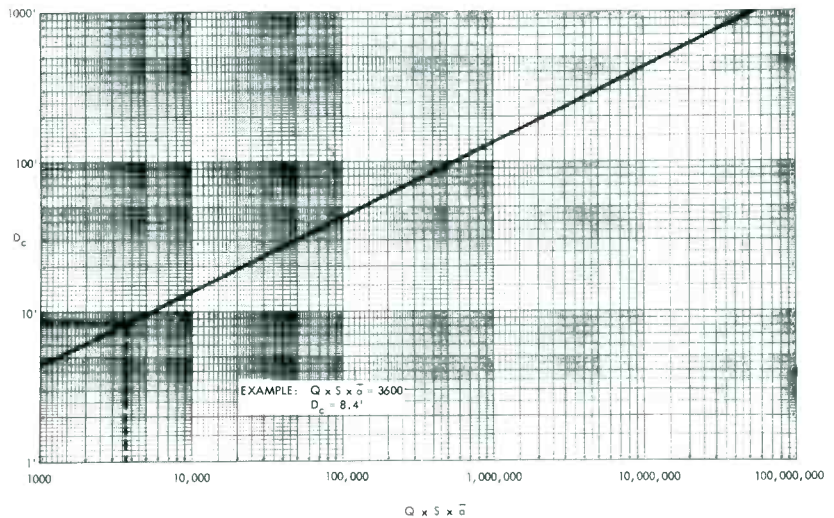

Fig. 7—Nomograph for finding critical distance (D_c)

³ Hewlett Packard, *Acoustics Handbook*, Application Note 100, Nov. 1968.

HEARD THE LATEST?



- 4-track, 2-channel stereo
- All-silicon transistor pre-amps
- Pause control
- Digital counter
- Dual VU meter
- Fast winding
- Automatic stop at end of tape
- 0.2% wow and flutter (RMS)
- Frequency response: 40 to 12,000 Hz
- S/N ratio: 45 dB or more
- Crosstalk: 40 dB between adjacent tracks at 100 Hz
- Microphone optional

A-24

This is what happens when a big name thinks small. It's the TEAC A-24, and it's making cassette history. This deck is powered by a unique hysteresis synchronous outer rotor motor for compact convenience, powerhouse performance. And it comes complete with all the craftsmanship it takes to make a TEAC.

More exclusive features: a special end-of-tape sensing circuit which not only stops the cassette, but completely disengages the mechanism – releasing pushbuttons, pinch roller and idlers – to avoid “flats” and deformation of critical drive components. Two specially-designed heads for outstanding frequency response. Just about the lowest wow and flutter that ever came out of a cassette.

Of course, no sound system is really complete without cassette capability. So if it's time to round out your equipment, it's time to sound out our A-24.



TEAC

TEAC Corporation of America • 2000 Colorado Avenue • Santa Monica, California 90404

Check No. 24 on Reader Service Card

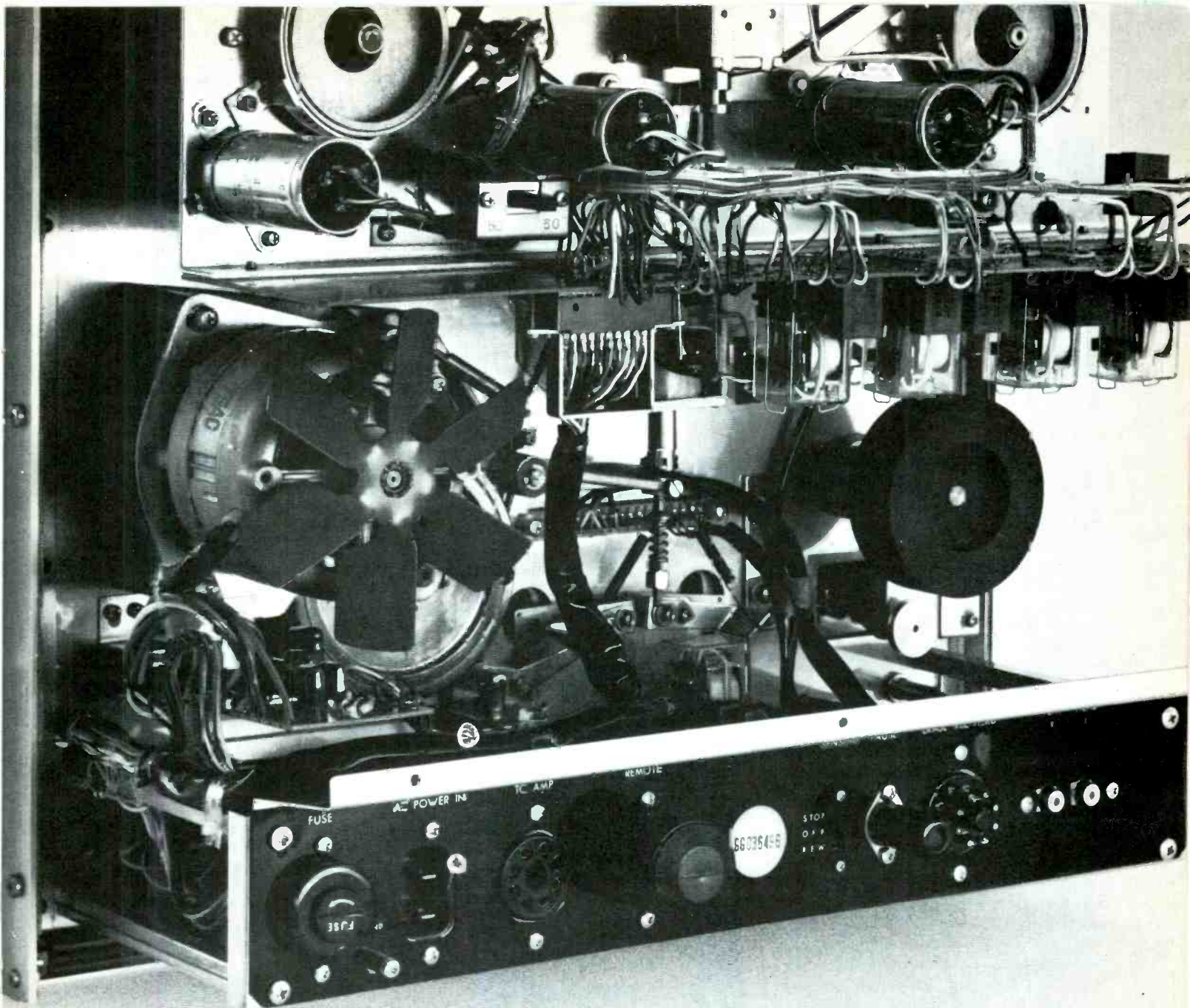

BACK TALK

When it comes to building sound equipment from the inside out, you could call us the component company. You see, we're one of the few tape deck manufacturers who make all our own critical components – from heads to motors and most of the electronics. After all, who knows better than we do what it takes to make a TEAC?

For instance, our heads are hyperbolic, not conventionally rounded. This means more intimate tape contact, less tape tension, better sound reproduction. Hyperbolic heads are the shape of things to come – and the only kind we'd think of using.

Meanwhile, we still buy outside parts for certain purposes. The ones we buy, we buy because they're the best. The ones we make, we make because they're the best.

And most of the time, we've got it made.

TEAC

TEAC Corporation of America • 2000 Colorado Avenue • Santa Monica, California 90404

Check No. 25 on Reader Service Card



DOPLER DISTORTION IN LOUDSPEAKERS



ROY V. CHILDS

CHRISTIAN DOPPLER, an Austrian physicist and mathematician, in his paper, *Über das farbige licht der Doppelsterne*, published in 1842, described the apparent change of frequency of a wave-type phenomenon due to the relative motion between the emitter and the detector. The wave-type phenomenon includes sound waves, and in this article has to do specifically with apparent change in frequency due to the relative motion between the loudspeaker cone and the listener's ear.

The classic example of the train whistle which decreases in pitch as the train passes is probably well known to most readers. Similarly, a loudspeaker operating simultaneously at two frequencies will, under certain conditions, exhibit the effect because the low-frequency movement of the voice coil, which can be of large amplitude, will "carry" the high-frequency source to and from the listener's ear.

Originally this author felt that the amount of distortion due to the Doppler effect was negligible compared to other problems encountered in audio reproduction; however, when an experiment which is quite easy to perform suggested itself, the following equipment was set up. Utilizing a 6½-in. high-compliance speaker, a wooden stand, an amplifier, a simple resistive mixer, two audio generators, and a certain amount of patience, the experiment is well within the capabilities of many audiophiles. The wooden stand shown in Fig. 1 is merely a platform for stability with two upright arms set into the edges. Spacing must accommodate the speaker used. A depth gauge (Fig. 2) was made from a thick sheet of aluminum for a bracket through which a hole was drilled and tapped for a 0-80 screw. The screw itself had a thin aluminum disk divided into eight equal segments affixed to the underside of its head with a nut and would indicate depth in increments of 1/640 in. Interpolation to 1/1280 in. (.00078 in.) was quite easy. A small compression spring was used between the bracket and the disk to take up play in the threads.

Lack of a baffle allowed considerable

low-frequency excursion without appreciable power radiation. Only the low-frequency movements of the effect upon the high frequency could be detected, which was exactly as desired. Figure 3 shows a block diagram of the set-up.

According to Doppler, the apparent change in the high frequency depends upon the velocity of the relative motion between the emitter and detector. The maximum velocity is the peak-to-peak amplitude multiplied by π times the frequency. For example, a speaker operating at 40 Hz with a total excursion of

¼ in. will reach a maximum velocity in each direction of approximately 31.4 inches per second or about 1.784 mph. This author felt it was somewhat ridiculous to expect an effect from such a low velocity, but continued with the experiment.

A series of high frequencies was used with 40 Hz as the modulating frequency. Each high frequency was selected and its amplitude adjusted for ease of hearing. The low-frequency amplitude was increased from zero to the point where the high frequency was observed to change and then the high frequency was turned off so the amplitude of low-frequency cone movement could be measured with the gauge and noted. Each frequency combination was used, and then the low frequency was changed to 15 Hz so the new combinations could be recorded. The assistant changed places with the listener and the entire test was run and recorded again. The table (with the dimensions rounded off to two significant figures) and the graph show the results.

The most noticeable feature of the results is that the detectable level of amplitude varies widely for both people. One person's ability seems fairly consistent with a modulating frequency of 40 Hz, but there seems to be no pattern to the other runs. Probably background noise level plays an important part. Furnace, traffic, and people noises vied with the test tones, making it necessary to try again in some cases; however, the results may be more typical of home reproduction as a consequence. Homes don't normally feature anechoic chambers.

Maximum velocity is reached at two points during the low-frequency cycle where the cone speeds (1) through the rest positions on its way to or from the listener's ears. Since it is supposed to be reproducing a sine wave it should translate a circular cyclical motion to a reciprocating cyclical motion. Therefore its maximum velocity is the same as the speed of a point revolving at a constant radius around a center at a given frequency.

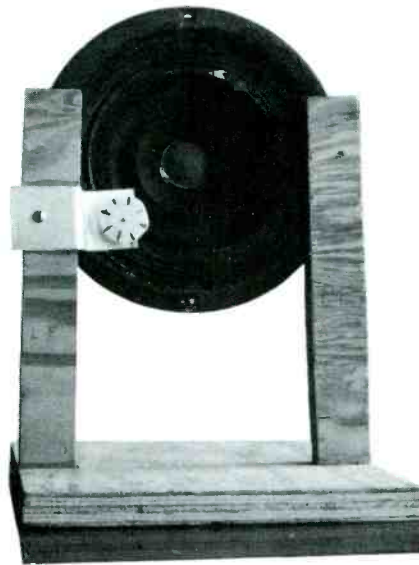

Fig. 1—Loudspeaker set-up used by the author for measuring the Doppler effect.

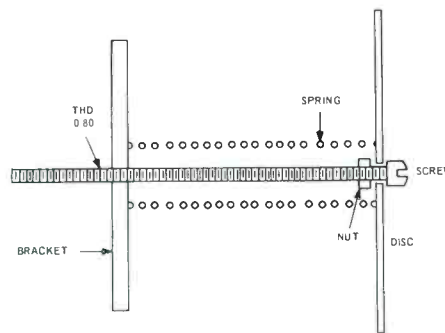

Fig. 2—Detail of "micrometer" bracket shown in Fig 1.

Thus:

$$V = C / \text{unit of time}$$

where V = maximum velocity

$$C = \text{circum.} = \pi D$$

$$D = \text{diam.} = \text{peak to peak amplitude of cone}$$

$$\text{By substitution: } V = A_{p-p} \pi f$$

At the peaks the velocity reaches zero. At other points in the cycle the velocity changes the high frequency accordingly. The effect is an apparent sweeping below and above the high frequency. A type of warble tone results which, under some circumstances, is quite distinctive. The upper and lower sideband limits of the resultant channel caused by the modulation (note the similarity to a FM carrier in radiotelephony) can be determined by the formula:

$$S.B. = f_i \frac{1129}{1129 \pm V}$$

where f_i = high, modulated frequency

f_s = low, modulating frequency

$$V = A_{p-p} \pi f_s$$

A_{p-p} = peak to peak amplitude at f_s in feet.

We can consider f_i being multiplied by a "modulation factor" which leads to the conclusion that the actual frequency of f_i is immaterial because the modulation causes a ratio change which our hearing mechanism detects. If the modulation factor were ± 2 , the warble tone would span a channel two octaves wide, and if the M.F. were ± 1.0595 the warble tone would span a channel one whole tone wide. One would expect to hear this much difference. The highest amplitude for detection was 0.18 in. with frequencies of 15 kHz and 15 Hz. This represents worst-case conditions and would not, with the typical speaker systems, be significant. It would take a single-voice-coil type of speaker in an enclosure where the speaker load decreases drastically at the very low frequencies so as to allow easy cone movement at 15 Hz—for instance, a phase inversion enclosure of the large-port type. In addition, the input would have to contain frequencies in the 15-Hz region. Much more realistic are the results of the frequency combination of 40 Hz and 400 Hz. One person detected the modulation caused by an amplitude of .094 in. The 400-Hz signal was modulated by a factor of less than 1.0009! It becomes obvious that the amplitude of a low frequency can be very low and still cause detectable change in the high frequency.

It must be remembered that a listener who enjoys large-scale musical works

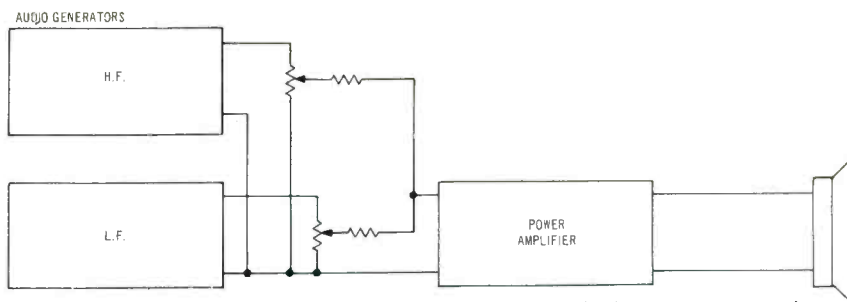
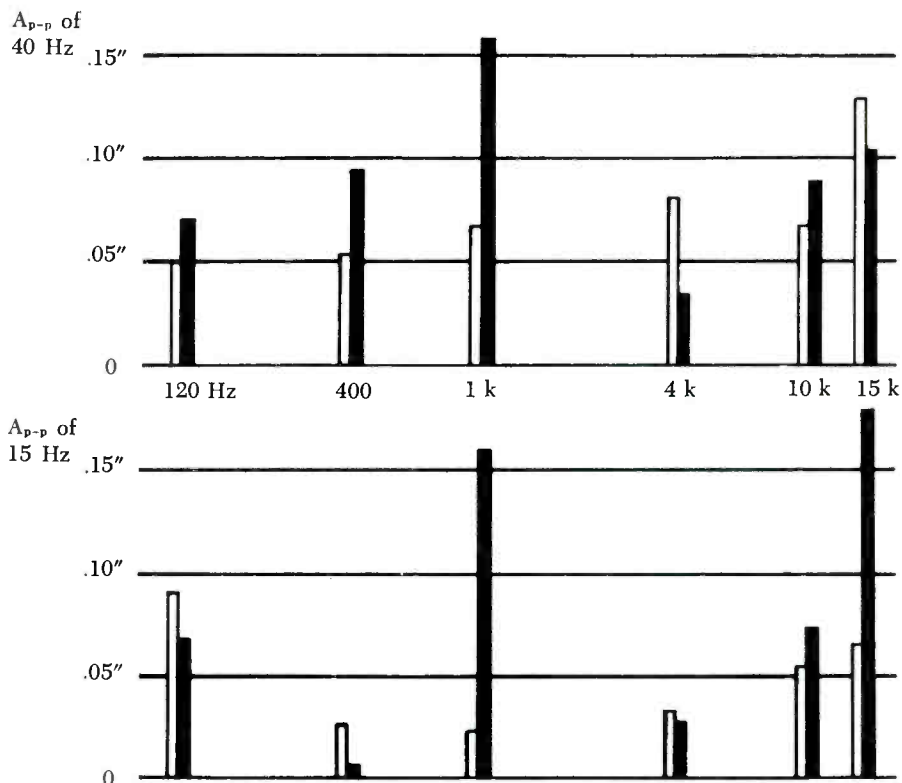

Fig. 3—Simple mixer arrangement for feeding low- and high-frequency signals to the test loudspeaker.



TABULATED RESULTS

$f_{i0} = 40 \text{ Hz}$ $f_{i1} = 120 \text{ Hz}$ 400 Hz 1 kHz 4 kHz 10 kHz 15 kHz

A_{p-p} (in.) at detection

1st person	.05	.053	.068	.08	.066	.13
2nd person	.069	.094	.16	.031	.087	.1

$f_{i0} = 15 \text{ Hz}$

A_{p-p} (in.) at detection

1st person	.091	.027	.022	.031	.053	.066
2nd person	.069	.0031	.16	.028	.072	.18

reproduced at super realistic SPL's will be operating speakers so that peak-to-peak amplitudes in the bass region will be of the order of 1/4 in. or more for even 15 in. speakers. The point is that amplitude of even 0.18 in. as shown in the table are entirely within the realm of normal operation, unless we talk about flute or violin or other instrument without appreciable output in the bass range.

One thing helps the listener: Little in the way of steady-state tones such as were used in this experiment are found in music. The closest to a steady-state tone is probably an organ pedal note. Perhaps the normal variability helps mask the Doppler-effect distortion.

(Continued on page 28)
(with Editorial comment)

The author wishes to encourage the carrying out of this and similar experiments by others and would appreciate questions, comments, suggestions, corrections, and speculations on this article.

Æ

Arguments about Doppler distortion in loudspeakers have been going on for some years now. Many early writers did admit its existence but remained sceptical about the actual effects. In *Loudspeakers*¹ published in 1958, Gilbert Briggs said "Some writers still claim that the dividing network avoids Doppler effect but they never furnish proof of having heard the effect or seen evidence of it in a loudspeaker. It seems, on examination to be quite innocuous. If a train passes close to you at 60 m.p.h. with its whistle blowing at about 550 Hz, the pitch will change from about 600 Hz down to 500 Hz to your ear. An airplane travelling at 600 m.p.h. will produce a much greater change of pitch. But the maximum velocity attained by a voice coil moving $\frac{1}{2}$ inch at 50 Hz (which it rarely ever does) is equal to only 4.45 m.p.h., and any resultant change of pitch could not be detected by the human ear. There is actually very little tendency for the Doppler effect to be produced in a moving-coil speaker for the fundamental reason that the velocity of the voice coil goes down with frequency. Thus a movement of $\frac{1}{2}$ inch at 25 Hz—where it would be more likely to occur—results in half the velocity produced by the same movement at 50 Hz." Writing in the same book, Raymond

Cooke (now of KEF) has this to say "... the Doppler effect with the engine whistle depends on its rapid approach towards and departure from the observer. The listener to a speaker would therefore have to be directly on axis to receive any pitch variation, which would diminish to zero at the sides, i.e., 90 degrees off axis. Merely standing up or sitting down would destroy much of the effect if it had any audible existence—which seems to be more than ever phantasmagorical." Lovely word that. However, in 1967, following a lecture by James Moir to the British Sound Recording Association², Geoffrey Horn wrote³ "... Mr. Moir's apparently scientific investigations lead us along nicely, until he comes to subjective assessment when he is on less sure ground. The first part of his article is beyond dispute; certainly there is a Doppler effect, we are all familiar with it; certainly it must apply to loudspeaker cones and obviously it can be measured; but when and under what circumstances can we call it distortion? Mr. Moir sets up his two-tone tests and finds a threshold beyond which he detects unpleasantness but his results are almost unbelievable—in terms of frequency change alone—0.001% error in a watch for example is less than a second a day!... I have spent some interesting hours in a softly-furnished room of about 2000 cubic feet with a selection of pairs of loudspeakers of different sizes and some suitable Doppler-provoking disks. Organ proved to be the most illuminating as might be expected; other music provided only occasional examples of the

effect, except for a short extract (which goes a long way) by a 'group' where the mightily powerful bass-guitar beat produced a decidedly 'new' sound. In general, the effect of the distortion was not as 'dirty' as had been expected but it was an obviously added noise. From these ever-so-loose and ever-so-subjective tests, I should say that most full-range units of 8 inches and below can be expected to produce some signs of this distortion unless they are horn or column loaded in such a way that the diaphragm movement is lessened at low frequencies. I conclude, then that Mr. Moir is correct in saying that quantities of this type of distortion are present in the output of our loudspeakers, but they remain undetected as such because of a number of mitigating or disguising circumstances. Therefore, Briggs was right to dismiss its effect on listening to music and his judgment remains true today. Experiments I carried out myself at Wharfedale in 1965 and at Fisher in 1966 confirmed this point of view. However, if we let Geoffrey Horn have the last word "... the problem is not so far below the surface as we might previously have been inclined to believe, particularly with the development of small 'long throw' loudspeaker units."

G. W. T.

1. *Loudspeakers*, by Gilbert Briggs, 1958 Edition. (Cahners Publishing Co., 221 Columbus Ave., Boston, Mass. 02116)
 2. *Hi-Fi News*, January, 1967
 3. *Hi-Fi News*, May, 1967
- See also:
"Modulation distortion in loudspeakers" by Paul Klipsch, *AES Journal*, February, 1970
"Loudspeaker performance," *Wireless World* February, 1970

Dear Editor.....

Dear Sir:

I noted with interest your comments in the May issue equipment report on the AR receiver. I would like to point out that although the MPX measurements were "better than your test equipment" your measurements can be interpreted in a more meaningful way. The AR MPX design is characterized by the fact that residual cross talk is almost entirely residual distortion. (Most good MPX detectors share this characteristic). Since you measured 0.5% distortion this implies that at that frequency separation should be -46 dB. We have actually seen units with 0.1% distortion and a separation of -60 dB, and have even approached this through the complete FM signal chain. Since amplifier performance is generally

better than 0.25% harmonic distortion, a comparable standard of MX stereo quality is obviously needed for overall system performance. Our experience proves with care it can be obtained with added separation as an additional side benefit.

ROBERT GRODINSKY
Consulting Engineer
Acoustic Research, Inc.

In my experience, most MPX distortion is due to non-linearity of some kind but in a well-designed detector, crosstalk would then become a significant factor. A distortion of 0.1% is incredibly low and up to now, figures of this order have only been achieved by special 'counter' circuits. I would certainly agree that stereo receiver distortion ought to be comparable with that attained by the amplifier. In fact, I would go further and say that broadcast transmission quality should be comparable too. Unfortunately, with few exceptions it is not.—Ed.

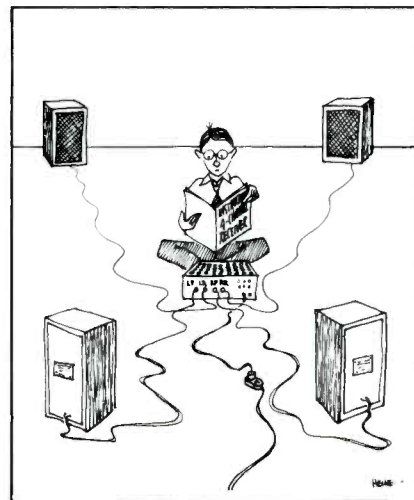

"If left-front is out of phase with right-rear, switch leads on one speaker. If right-rear and left-rear are out of phase with left-front..."

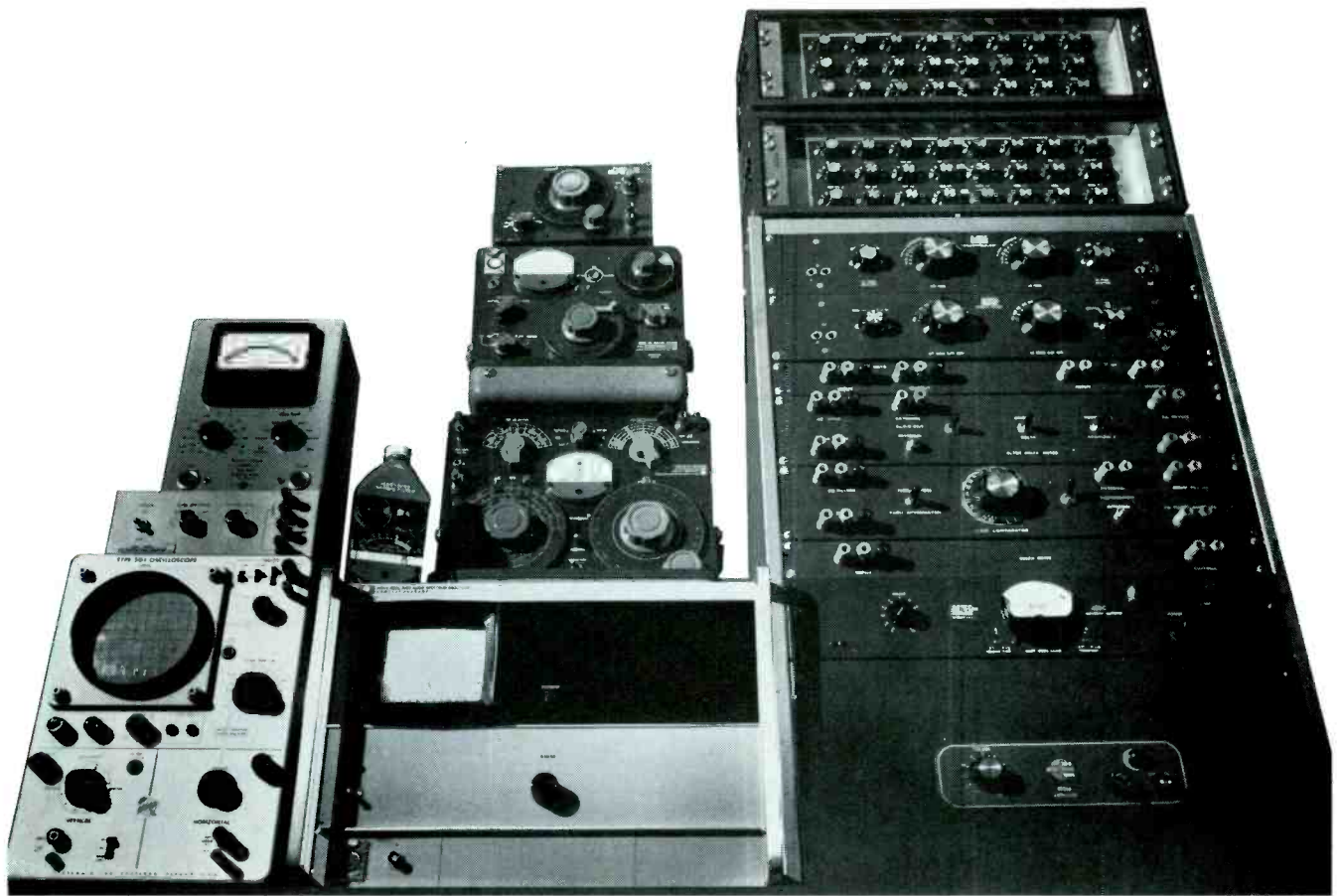

Learn why Altec Acousta-Voicing[®] towers over other equalization methods

Why go through expensive experimentation?
 Altec has more than 100 fully equipped and trained
Acousta-Voicing contractors
 with over two and a half years of experience
 and a *thousand* successful installations.

No one else can make this statement.
 Ask for a demonstration in your studio and learn
 about real time analysis where it counts —
your studio!



A QUALITY COMPANY OF LTV LING ALTEC, INC.

To: Altec Lansing, 1515 South Manchester Ave., Anaheim, California 92803.

I'd like to have a free demonstration of Altec Acousta-Voicing in my studio—including a frequency response curve that will show me all the ups and downs. Please have an Altec Sound Contractor contact me to set up a demonstration date.

Please send me your free Acousta-Voicing literature.

NAME _____

POSITION _____ STUDIO _____

ADDRESS _____ PHONE _____

CITY _____ STATE _____ ZIP _____

Check No. 29 on Reader Service Card

The simple things in



life.

Sometimes, they're the most enjoyable. Like the Sony 6040 FM stereo, FM-AM receiver.

The amplifier delivers a simple 30 watts—that's 30 watts *continuous* power measured the hard way; with *both* channels operating. More than enough to drive even relatively inefficient "book shelf" size speakers to room-filling volume without distortion. That should simplify your speaker shopping.

The tuner is sensitive enough to bring in the weak stations. But it's insensitive to strong signals that might overload weak ones (even with stations sandwiched together on the dial).

And though the 6040 is stripped of unessentials, it does have several essential extras that we felt you simply shouldn't be without: a filter for noisy programs and recordings, a tuning meter, a headphone jack, and a monitor and output for one tape recorder, plus auxiliary inputs for two or more (one of them on the front panel, for convenience).

The Sony name, Sony quality, and an un-Sony-like, under \$200 price tag. The Sony 6040. Just another of those simple things that help make life enjoyable. Sony Corporation of America, 47-47 Van Dam Street, Long Island City, New York 11101.

Frill-free fidelity by SONY®

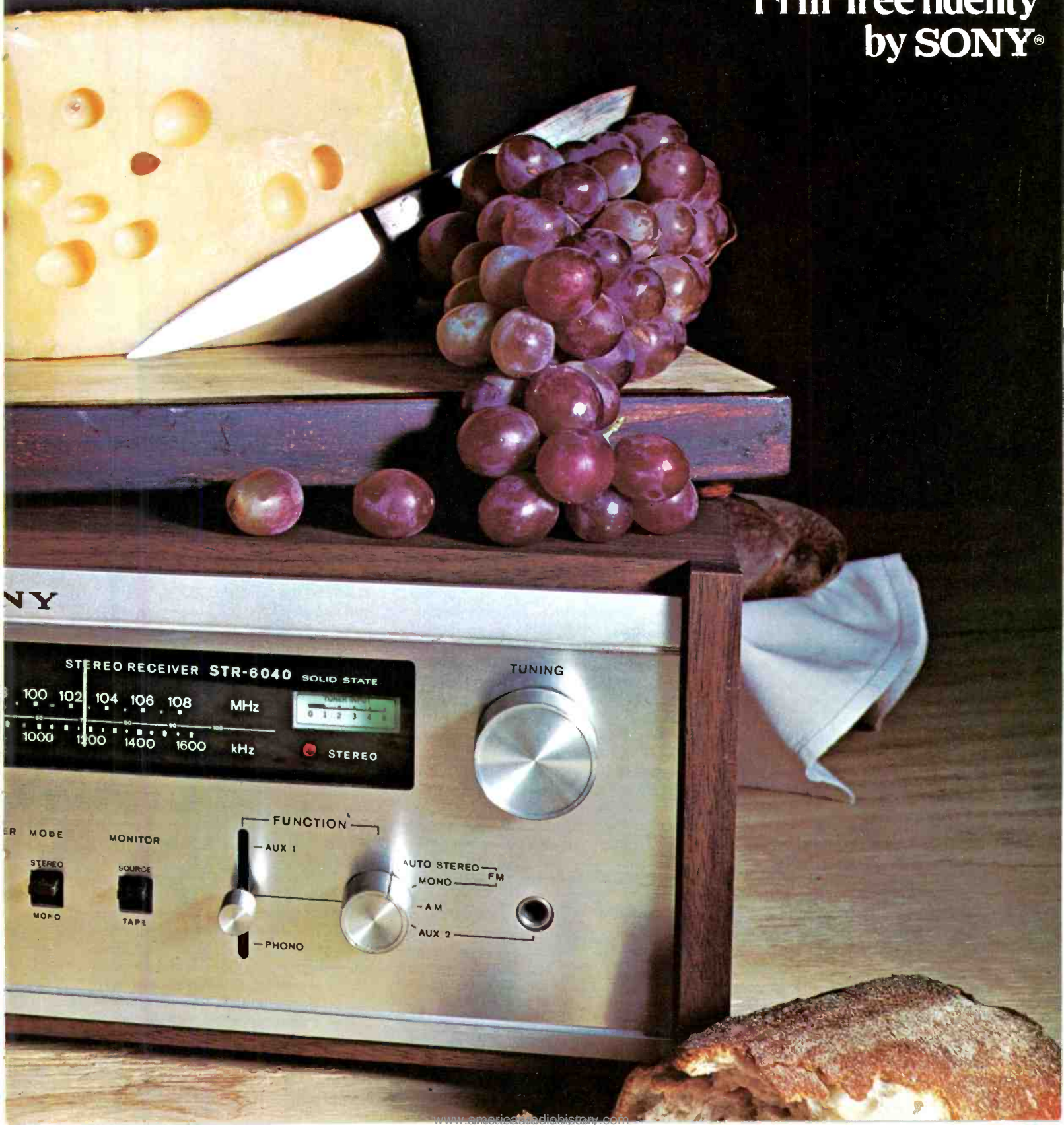

Moogs and Moondog

(Continued from page 14)

Finally, I'm interested in the new KLH Model Forty-One tape recorder (their hyphen), the one with the built-in Dolby "B" circuit. If ever a "totally new" machine proved my point, this one does. Namely, that if you start where everybody else is you can always squeeze some more out of a configuration already squeezed a million times. KLH does, with Dolby's cooperation. Yep, they do the "impossible."

Andrew Zatman's 24 Preludes for piano, composed at age 20, are very much influenced by Shostakovich, Stravinsky, and Poulenc, as the composer himself admits. I'd add a few more, to his credit, including Prokofiev, Bartok, Hindemith. OK! So that's what he's been hearing, back in Washington, D.C. If it had been Gershwin, I suppose he'd now be composing a new-model Rhapsody in Blue. If so, it would be good, for this boy has marvelous talent. His little Preludes (and a Sonata) are on an Orion disk (*Contemporary Music for Piano, ORS 6909 stereo*) and they are astonishingly well written and entertaining. He even plays them in the typically dry, brittle piano style of the 1930s—before he was born. Why not? As I say, one starts where one starts, with good models. Frankly, I prefer Zatman to Shostakovich, who gets long-winded at the drop of a note.

Prince Albert, Queen Victoria's husband and a mainlander German, was a brain and—who knew it?—a first-rate trained musician if technically an amateur, since his business was helping run the Queen's empire. He wrote mostly songs. Again, the kind of songs he heard around him circa 1840. They are often Schubert-like, or Mendelssohnian (M. was a musical lion in England at the time), more expressive than Mendelssohn, yet not as personal in tone as Schumann, who was having his "song year" at about this same date. The Prince's songs are altogether pleasing and beautifully written, to German text mostly, in the German *Lied* tradition. A "find" for those of us who thought Prince Albert was a kind of tobacco or a cutaway tailcoat, or that the Prince did nothing but beget royal children (including Edward VII) and open the Great Exhibition of 1851. His music is gracefully recorded by five different voices, out of the Purcell Consort, to the fluent piano of Jennifer Partridge. *Argo ZRF 597 stereo*.

As for Moondog, he is an anomaly, a self-taught blind musician who goes for the classical sound to the tune of plenty-big symphony orchestras. He has a plenty-big one on his current Columbia LP



KLH MODEL FORTY-ONE

(*Moondog, Columbia MS 7335 stereo*). Fifty-odd performers—wow! Somebody must pay. His scores are curiously folk-like, as though he might belong with such as Blind Lemon Jefferson and the sort, but they come out a sort of untutored Brahms or maybe Rheinberger or Weinberger or Castelnuovo-Tedesco—who knows? He, too, has been listening. His orchestra is weird, a handful of strings and a battery of brass and wind, from flügelhorn to flutes, bass trumpet to baritone sax. I didn't find much cohesion in the Moondog sound in spite of fugues and canons and themes galore but the sonic experience is, to say the least, unique.

By the way—isn't there a personage remarkably like Moondog who stands motionless, year after year, on a busy New York corner just outside Columbia Records, dressed in a Viking outfit that could come straight from the Met costume department? That might have a bit to do with this recording.

McCartney? Go listen to any Beatle record including the new ones, pirated or legit. Only trouble is, you can't always tell McCartney from Lennon. They're like Fletcher and Munson, or Glaser-Steers, or KLH. Or Bach-Stokowsky.

Oh yes—that Model Forty-One from KLH. It's wholly new in the KLH line, which means of course that it isn't new but in basic respects takes off properly from earlier machines of its sort. What distinguishes this model is its unique built-in Dolby "B" circuitry, for noise reduction.

Dolby "A" is the now-familiar professional noise reducing system widely used for the tape masters from which our current LP disks are derived. The "B" circuitry is a much simplified version designed for consumer uses including tape recorders. It's supposed to do the very same job—reduce the accretion of back-

ground noise in the record/playback process—without affecting the signal itself. A big order.

Best news I have is that it works. Noise does go down, as compared with a non-Dolby recording and playback. Signal, as far as I can hear, is wholly unaltered. No swishings, pulsings, volume changes, just music and a super-quiet background. I wouldn't have believed it possible. But Ray Dolby is a very clever engineering mind working in a familiar area, compression-expansion, where others have fallen flat on their faces. All it takes is the right circuit parameters. Dolby has 'em. Columbia and the egg.

The KLH Forty-One was long in gestation and seems to have offered some problems en route; all I can say is my current model works just fine and my only objection is to the somewhat clumsy controls, stiff and angularly sharp, and to the difficulty in editing—you must go through "play" to get to the manual-tape-rocking "pause" position, and hence you lose your cue point. The Dolby circuit boost tends to overload some hissy sibilants and piano-type percussives at the slow 3¾ ips speed, but at 7½ they are entirely clean. (Could have been the tape I used, I should add.) Dolby "B" will soon be appearing in other areas. Advent has separate "B" units for existing tape recorders; there could be Dolby-ized LP disks some day, for noise-reduced playback through the "B" circuitry.

What you should do, I expect, is to go right out and get all of this music I've described, apply it to the KLH Forty-One, and as you play back the tapes (without a trace of added noise), think hard about improving the unimprovable and the desirability of starting off with what you have, the better to climb Mt. Everest. Whether you're a musician or an engineer, that's the proper procedure. **AE**

We made the world's fastest bookshelf speaker a little faster.

Until recently, the world's fastest bookshelf speaker was the **Rectilinear X**.

Now it's the **Rectilinear Xa**, which is our new model number for the identical system with some minor modifications.

This model change isn't an exercise in planned obsolescence, just as our eccentric use of the word fast isn't an advertising gimmick. They both express our deep concern about *time delay distortion*, a phenomenon blithely ignored by most speaker designers and taken seriously only by a few egghead engineers.

Time delay distortion occurs when a speaker doesn't "speak" the instant a signal is fed into it but remains silent for a tiny fraction of a second. This tends to blur the reproduced signal, especially in a speaker system with several drivers, each of which has its own different time delay. Typically, the woofer is slower to speak than the midrange, which in turn is slower than the tweeter. Crossover networks further complicate the problem. The overall result is an audible loss of clarity.

Our solution in a three-way system such as the **Rectilinear Xa** is to use a 5-inch midrange speaker with exceptionally low time delay (one that speaks exceptionally fast in response to an input signal) and let it carry nearly all of the music. The woofer contributes only to the extreme bass (below 100 Hz) and the tweeter only to the extreme treble (above 8000 Hz). Thus the time delay

differences are kept out of the range where most of the audible information is. The greatest benefit is that the critically important upper bass and lower midrange are reproduced by a fast midrange driver rather than a slower woofer, as in other bookshelf speakers. That's what makes our design the world's fastest.

Now, the main difference between the **Rectilinear X** and the new **Xa** is that the relatively unimportant time delay in the woofer (below 100 Hz) was further reduced by certain changes in the crossover network. This makes the speaker faster still, and some very small irregularities in the frequency response were also flattened out in the process. It's a small improvement, but we feel that

anyone who pays \$199 for a bookshelf speaker is entitled to our latest thinking.

How does the new **Rectilinear Xa** sound? We're hopelessly prejudiced, so we'll quote Hirsch-Houck Laboratories instead (Equipment Test Reports, *Stereo Review*, June 1970):

"... We preferred the **Rectilinear Xa** in the areas of clarity and definition. In fact, we have heard few systems capable of comparable sonic detail, and most of them lack the bass of the **Rectilinear Xa**."

In other words, one of the leading authorities in the business is telling you that if you want supreme transparency *plus* bass, you're just about reduced to the **Rectilinear Xa**.

Arguing with that is like fighting city hall.

(For more information, including detailed literature, see your audio dealer or write to Rectilinear Research Corp., 107 Bruckner Blvd., Bronx, N. Y. 10454. Canada: H. Roy Gray Co. Ltd., Markham, Ont. Overseas: Royal Sound Co., 409 N. Main St., Freeport, N. Y. 11520.)

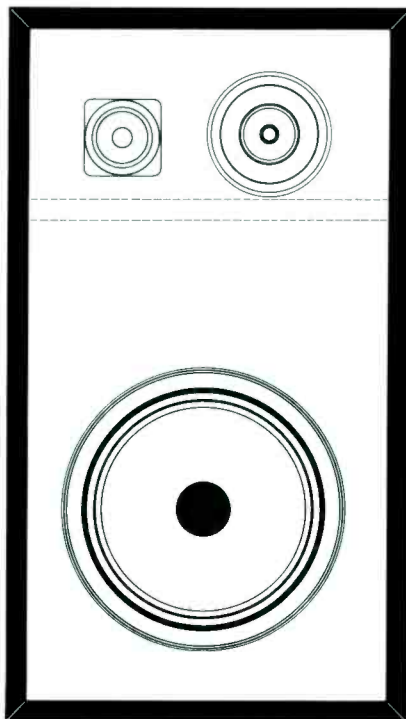

Check No. 33 on Reader Service Card

Rectilinear Xa

The Marantz Speakers.

Now everybody can afford them.

Not long ago, if you owned Marantz components and wanted a speaker system equal to the caliber of your Marantz equipment, you had to pay through the nose to satisfy your ears.

No more.

Today, Marantz builds their own line of speaker systems—Marantz Imperial Speaker Systems—and at prices that begin well within the reach of even the most modest budget. And these speaker systems not only match the traditional quality of Marantz stereophonic equipment, they also enhance the sound of any other brand of quality equipment in your system.

The reason: Marantz Imperial Speaker Systems deliver honest sound—natural, true-to-life, believable sound. Unmarred by beefed-up tones and artificial coloration.

And because Marantz Imperial performance is so clean and crisp, you can enjoy music for hours on end

without experiencing “listener fatigue.”

Marantz bookshelf-size speaker systems, the Imperial III, IV, and V are engineered for maximum power handling capabilities. For example, the Imperial III can handle over 100 watts of continuous RMS power, has a 12” acoustic-suspension woofer, separate midrange, and high frequency dome-type speakers.

All Marantz Imperial Speaker Systems not only provide superb stereophonic performance, they are also distinguished by elegant cabinetry, handsomely finished in fine hard-woods. As beautiful to the eye as they are to the ear.

And here’s the best part: Marantz Imperial Speaker System prices start as low as \$69.00!

Visit your nearby franchised Marantz dealer for a demonstration. He’s listed in the yellow pages. Then let your ears make up your mind.



marantz[®]
Components • Speaker Systems • Receivers

©Marantz Co., Inc., 1970. A subsidiary of Superscope, Inc., P. O. Box 99A, Sun Valley, Calif. 91352. Send for free catalog.

Electronics for Public Address

NORMAN H. CROWHURST

PUBLIC ADDRESS SYSTEMS are the story of overcoming acoustic problems. From the earliest days, this consisted of using one or more microphones with one or more loudspeakers to make the program sound—someone speaking or a musical performance—more audible to the audience.

If acoustics are not very bad, a relatively simple arrangement of microphone, amplifier, and loudspeakers does the trick. But then, when the acoustics are not bad, possibly the auditorium does not really need reinforcement in the first place, except maybe for the speaker or vocalist who has always used one and cannot be heard without. Apart from this, sound reinforcement is more generally needed where the audience cannot hear without it, which means the acoustics are not good, one way or another.

So various tricks were used fairly early in the game to help the system do a better job than the simple microphone, amplifier, and loudspeaker combination could do, with no trimmings. The recurrent problem has always been acoustic feedback, from the loudspeakers to the microphone, before adequate 'gain' could be obtained to make the program more audible to the audience.

Transducers

Before we turn to the purely electronic devices, it will be well to emphasize something that time and again has been found to be very important concerning the electroacoustic devices—microphones and loudspeakers: they must be as flat as possible in their frequency response—free from peaks and dips.

Acoustic feedback always occurs first at some specific frequency: that is where the trouble begins. In a good system, feedback should be almost ready to start at many frequencies at the same time, over a fairly wide frequency band. The presence of marked peaks in either the microphone or the type of speakers used, will result in a tendency to start a feedback howl at one of these peak frequencies while the general reproduction of adjacent, non-peak frequencies is still quite inadequate.

Auditoriums also exhibit frequencies at which feedback more readily starts, often due to natural resonances associated with the dimensions of the building. But in few instances are these peaks nearly as difficult to manage as are those peaks that occur in microphone or loudspeaker response. When an acoustic howl starts, it sets up a standing wave pattern in the room, and this pattern is usually related in some way to the dimensions of the room.

If the system, from acoustic input to the microphone to acoustic output from the loudspeakers, is close to flat, the correction needed to minimize the effect due to building acoustics is usually not serious, but it can be very helpful.

Acousta-Voice

This is the approach used by Altec Lansing's "Acousta-Voice" method. Acousta-Voice is not so much a system as an approach to doing the job. The Acousta-Voice engineer, trained by Altec's people, visits the auditorium and conducts a real-time analysis of the building's acoustics, to find where its peaks and valleys are.

These are carefully and precisely analyzed and then a permanent filter is adjusted to offset the acoustic deviations from flat response. When the Acousta-Voice filter is inserted into the system, the overall response of the system, *in that auditorium*, is flat.

This enables the system to be operated at notably more gain than is possible without the correction, and the performance is more free from noticeable coloration at the level where it is operated.

Perhaps Acousta-Voicing can be regarded as a refinement of the older methods that employed tone controls and notch filters. The main difference is that the old method used controls that were available on a specific system, or some components thrown together by a man with a good "ear" for such things, and thus matched the performance, as well as possible, to the needs of the moment. To a considerable extent, this method depended on, and was limited by, the skill

of the operator. Acousta-Voicing is more precise, scientific, not subject to trial and error, or hit and miss.

Frequency Shifting

Another approach that seems to have fascinated many because of its sophistication, is the frequency-shifting principle. Every input frequency is shifted a few hertz up or down, so the frequency content in the output from the loudspeakers differs from that going into the microphone, although the intelligible content of the program is virtually unchanged.

This method has proved successful, if expensive, on speech, but for obvious reasons, it is not good for music. Shifting frequency, say 5 Hz, in the upper register may make little enough difference that only a highly skilled musician would notice it. But down in the bass register, the same 5 Hz could be a change in pitch of a semitone or two, which would be disastrous to the musical effect, even as discerned by a musically untrained ear.

Possibly frequency shifting would have proved far more popular for situations where speech-only is a reliable expectation, if it were not for the fact that, being highly sophisticated, it is also costly.

Acoustic Nulling

Another approach to the acoustic feedback problem is worth noting, and putting in perspective relative to other efforts, so confusion between different methods is avoided. This has been the subject of some experiments conducted by Electro-Voice in collaboration with Brigham Young University.

While it involves additional electronics to do the job, it relies on acoustic nulling of the feedback signal. If two loudspeakers are connected anti-phase and a microphone is placed precisely equidistant from them, as in Fig. 1, and their levels are adjusted so the intensity received from each is equal at the microphone, the acoustic field at the microphone is a null, and much more gain can be used.

Acoustic Research designed "Big Horn" to show the size of a horn-type speaker system that could match the bass response of the AR-3a.

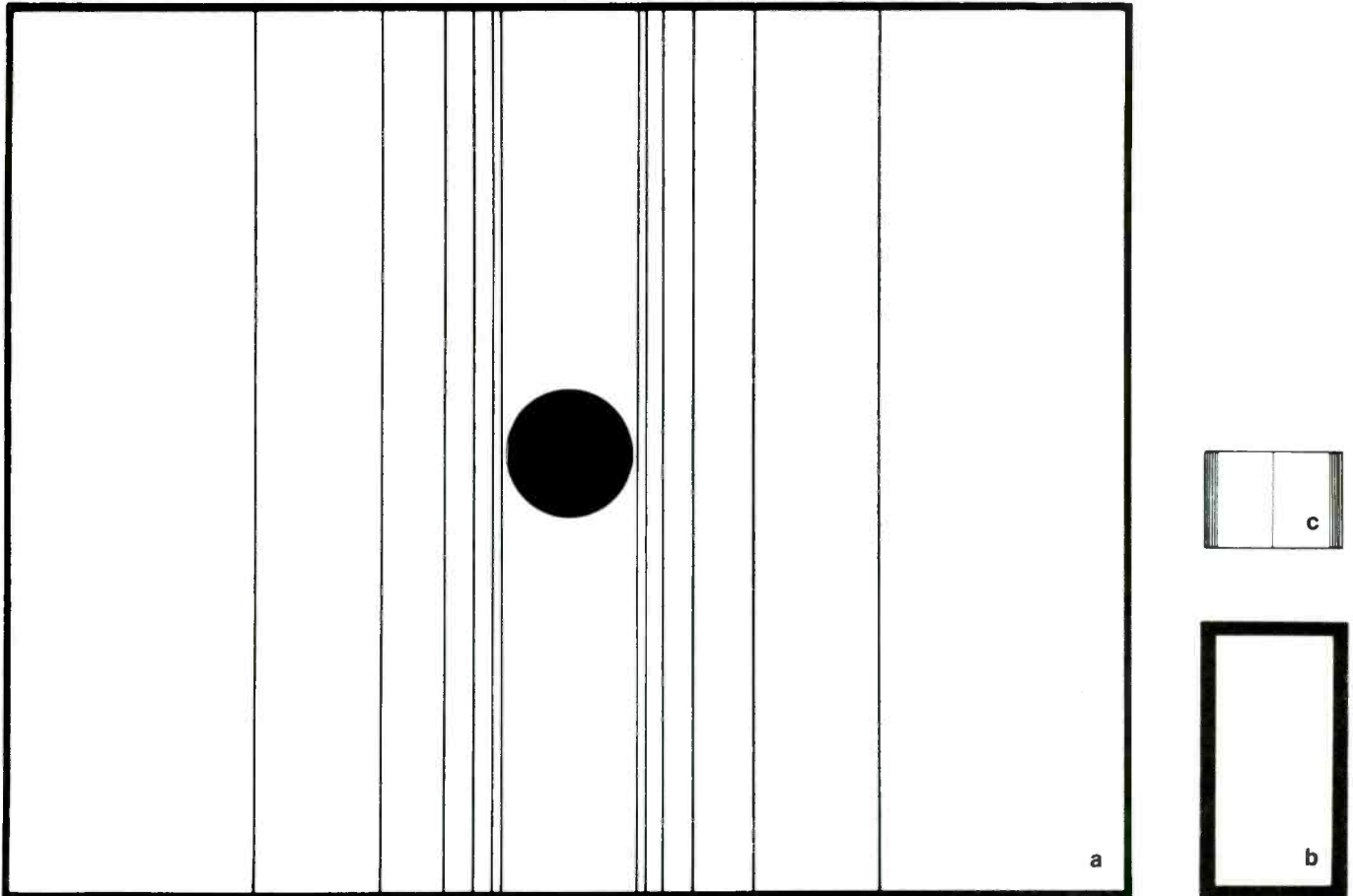

a Big Horn; **b** AR-3a; **c** *Acoustics* by Beranek; all drawn to the same scale.

When the AR-3a is placed against a wall, its frequency response is flat to below 40 Hz, and continues even at lower frequencies with very low distortion. To design Big Horn, we turned to page 268 of the standard text, *Acoustics* by Leo Beranek*, to find the equation used to calculate the size of a horn with a cutoff frequency of 40 Hz.

As shown in the scale drawing above, Big Horn is 7 feet high and 9 feet wide; its depth would have to be greater than either of these dimensions. A pair for stereo would take up slightly more space in a living room than two VW buses. Yet, played at the same loudness, the only audible difference between them and a pair of AR-3a systems would be the slightly rougher response of the Big Horns due to reflections inside them. Other than that, the Big Horns should sound excellent; they would simply be not quite as good, and much more costly than AR-3as.

Complete technical data for the AR-3a is available free on request.

*McGraw-Hill, \$14.50.



Acoustic Research, Inc.

24 Thorndike Street, Cambridge, Massachusetts 02141

Check No. 37 on Reader Service Card

One's first reaction to this will probably spring from observations in earlier systems when speakers were accidentally connected out of phase: the auditorium coverage is poor, because of dead spots where signal cancels and listeners at these points receive only reverberated signal, highly confused. But the Electro-Voice approach goes two steps beyond this to overcome the defect.

Instead of using just one microphone on one acoustic null point, a multiple system is used, such that each microphone is at a null point for the speakers fed by that microphone's amplifier system as in Fig. 3. Now every individual system can be operated at a higher gain than any system can be operated in that auditorium without using this trick, and no listener is going to be located at a null point for more than one of the multiple systems used.

An important part of the successful application of this method is that the microphone on each system must be equidistant from the two loudspeakers on the same amplifier that are connected antiphase, *by direct path*. Feedback of the conventional type occurs due to standing wave patterns building up. The usual practice of avoiding direct-path feed from loudspeakers to microphone means the first howl frequency occurs using a complicated path, rather than the simple direct one. (Fig. 2).

So placement of speakers needs to be quite different to utilize this approach. There must be a deliberate direct feedback path from each, or the cancellation will not occur uniformly over the frequency range. But the completeness of cancellation means that gain can still be elevated, in comparison with the more usual arrangement. And the multiple system use means that each system carries only part of the total sound conveyed to the average listener, and thus each can be operated at a level lower than the normal, single-channel system.

The system has another bonus. In most conventional systems, the performer or speaker hears his own performance or voice come back to him only by reverberation. With this method, he hears the system direct, just as the audience does.

Another difference should be noted. In conventional systems, microphone placement is not usually highly critical. In the Electro-Voice system, the microphone must be located very accurately in relation to the two loudspeakers connected to the output of its amplifier. Any movement of the microphone, not along the line of cancellation, will invalidate the cancellation very quickly and cause trouble.

The Electro-Voice people use omnidirectional or cardioid mikes with this

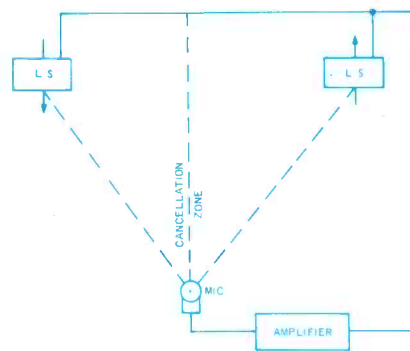

Fig. 1. The basic arrangement developed by Electro-Voice.

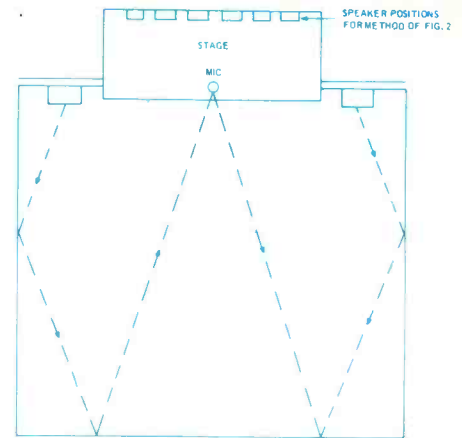

Fig. 2. For comparison, a more conventional system tries to avoid direct-path feedback from loudspeakers to microphone, so that acoustic feedback at a frequency starting a howl may take the paths shown here by the dashed lines.

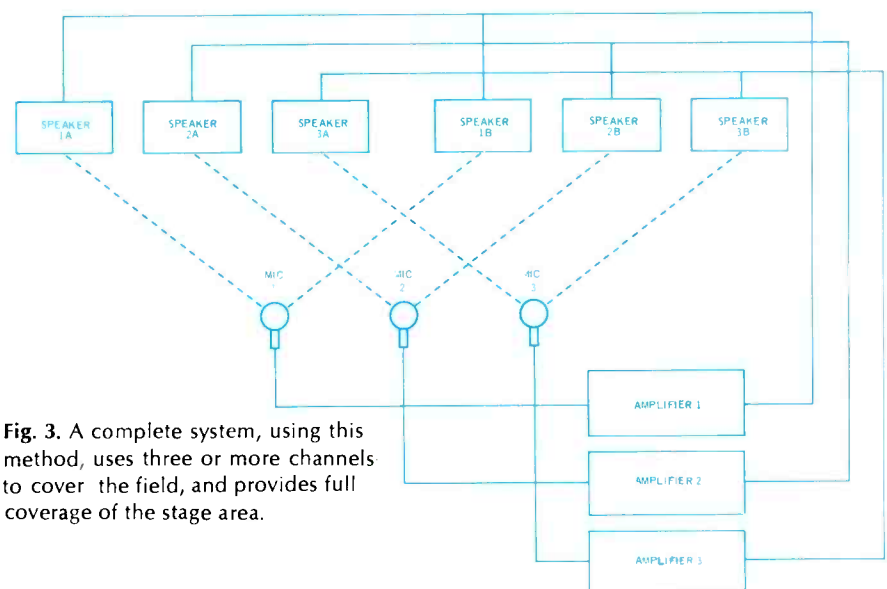

Fig. 3. A complete system, using this method, uses three or more channels to cover the field, and provides full coverage of the stage area.

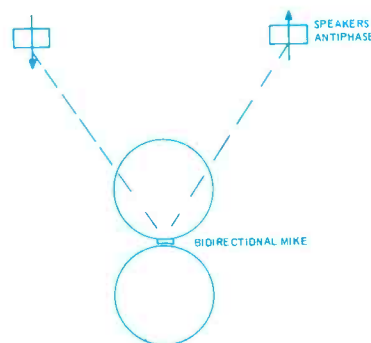

Fig. 4. A bidirectional mike could also use this system, although Electro-Voice does not recommend it.

system, never bidirectional types. It would be theoretically possible to use bidirectional mikes, except that now the mike must not only be kept in the same place, it must not be rotated at all. The system must be kept completely symmetrical (Fig. 4).

Another possibility, similar to the Electro-Voice in principle, has been used with bidirectional mikes, long before the

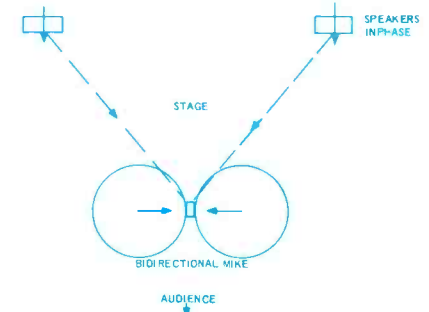

Fig. 5. An alternative way of using a bidirectional mike with similar effect, with the loudspeakers in phase and the microphone pickup from them antiphase. This was actually used long before this new development.

loudspeaker antiphase method was used. This uses the bidirectional mike so its position and orientation neutralizes feedback by antiphase at the mike, rather than the loudspeakers, thus avoiding the need for a multichannel system (Fig 5).

(Continued on page 42)

Small news from Sony.

The World's Most Versatile Tape Recorder! The Model 124-CS portable stereo Cassette-Corder® lets you record your favorite music and play it back in glorious stereo. When there's work to be done, you can use it as a functional tape recorder. Compact, lightweight, the 124-CS weighs just five pounds with batteries and measures just 6 $\frac{1}{16}$ " x 2 $\frac{1}{16}$ " x 9 $\frac{3}{4}$ ".

Full-Range Extension Stereo Speakers.

Ideal for desired stereo separation. In addition, recorder also features its own built-in speaker, which cuts off when extension speakers are used.

AC or Battery. Cassette-Corder® plays off house current, car or boat battery, four flashlight batteries, or optional rechargeable battery pack, providing use-anywhere versatility.

Constant-Speed Motor for True-Fidelity Sound. Regulated-speed DC motor ensures constant tape speed for pitch accuracy. Signal-to-noise ratio: 45 db or better. Frequency response: 50 to 10,000 Hz.

Recording-Level, Battery-Level Indicator. Extremely accurate meter for monitoring proper input level. Meter also continuously indicates battery condition during playback mode. Sony-matic level control automatically controls recording level.

Push-Button Tape-Transport Controls. Just push a button for forward, record, rewind, fast-forward, or stop. Safety interlock prevents accidental erasure of recorded tape. Separate controls permit continuously-variable stereo balance, tone, and volume. Stereo or mono mode switch.

Lid & Cassette Pop-up Button. Push the button, the lid flips up, the cassette pops out. Snap a new cassette into place in seconds. Use Sony C-90 cassettes and get 1½ hours' playing time.

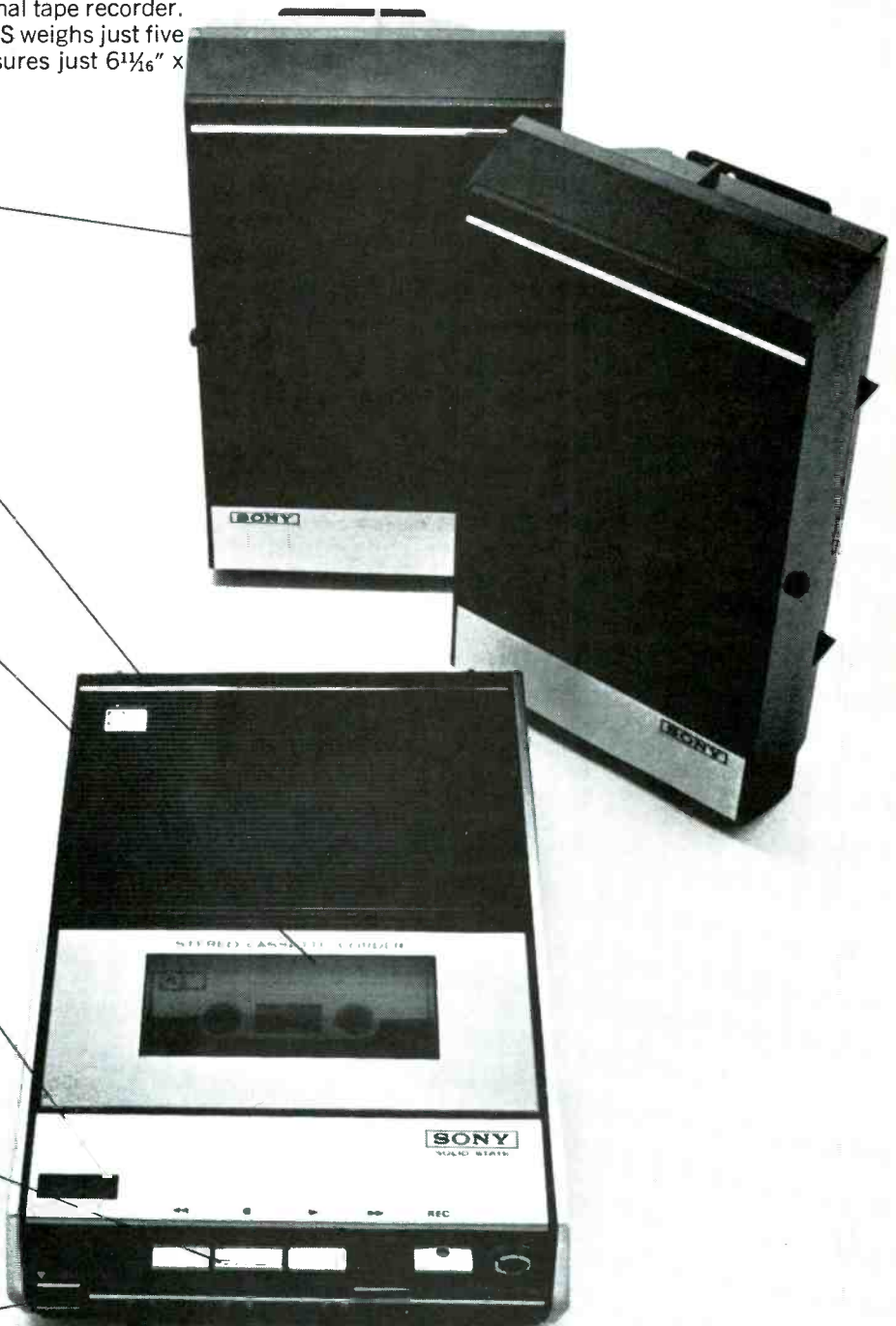

Sony Model 124-CS Portable Stereo Cassette-Corder®. Less than \$199.50, complete with carrying case for recorder, speakers, and accessories. **Also available:** Sony Model 110, Easy-matic Cassette-Corder®, priced at only \$109.95. For your free copy of our latest catalog, please write Mr. Phillips, Sony/Superscope, 8144 Vineland Ave., Sun Valley, California 91352.

SONY SUPERSCOPE The Approach to Stereo.

You never heard it so good.®

An audio the new



Murray Allen owns one of the world's keenest ears. He played sax and clarinet with big name bands like Skitch Henderson's and Bobby Sherwood's before becoming an engineer. And has done sessions for Bobby Melton, The Hi-Lo's, Julie London and many other famous names. Murray was one of the first to experiment in multi-track recording and recently pioneered in the use of 16-track. He is now with Universal Recording Studios where he engineers records and commercials, including the Schlitz and United Air Lines television campaigns which are currently on the air. He was also Audio Consultant to Science Research Associates.

"The VM professionals are really worthy of the name. I've never seen so much professional control in home-type equipment."

"The VM 1521 receiver, for example, does a lot of things even more expensive units I've played with can't."

"The bass and treble controls really give you a lot of room. And it's got a high and low filter you can switch in and out. The separation is terrific, too."

"I mean you can take something like a bass and clarinet duo and completely isolate the bass on one channel, then completely isolate the clarinet on the other."

"Another thing, I live in an area where FM is very Rfy. The VM 1521 has a new filter that handles it better than anything I've heard."

"The speakers are something else, too. VM calls them the Spiral Reflex System. Built on the twin wave theory. That's very efficient. And clean. Really clean. Especially the percussions. Even the transients don't get distorted. It even gets those low guitar sounds."

"And I really like the VM 1555 automatic turntable. The cueing. The belt-driven platter. The extra length on the tone arm. The photo-electric tripping mechanism. All of them are terrific."

"And the spindle gently lowers records all the way down to the stopped platter. Really takes good care of them."



The VM PROFESSIONAL 1521 Semiconductor complement: 49 transistors, 30 diodes, 3 ICs, 2 MOSFETs • FM circuit: four ganged front end with 2 dual gate MOSFETs for lower cross modulation, greater sensitivity and overload; 5 pole phase linear toroidal filters and 2 ICs for selectivity, sensitivity and limiting that surpasses all previous standards in this price range • AMPLIFIER: Power output/bandwidth: 40 watts RMS/channel power at less than 0.5% distortion; bandwidth 9-30 KHz • IM distortion: less than 0.5% • Frequency response: ± 1 db 20 Hz - 20 KHz • TUNER: Sensitivity: 1.9 uv for 30 db quieting • Signal to noise ratio: -75 db • Capture ratio: 1.8 db • Selectivity: -75 db • SM 100% MOD distortion: less than 0.5% • Stereo separation: 40 db at 1 Hz • Image rejection: -90 db • IF rejection: -100 db • Spurious response rejection: -100 db • Comes complete with cabinet of oiled walnut veneer hardwood at no extra cost. (Model 1520, same as above except 25 watts RMS/channel power.)

Check No. 41 on Reader Service Card

engineer talks about VM professionals.

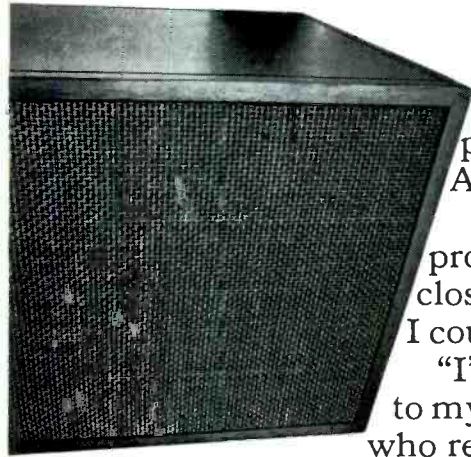

"You know how hard it is to reproduce a clean piano or harp. Well, the 1555 does a beautiful job. Absolutely no wow."

"I listened to an album I engineered on a VM professional rig, and I can honestly say it was closer to the master tape than I'd ever heard. I could even hear tape noise which is really rare."

"I've decided to take my VM professional outfit to my office. Every day I deal with people who really know a good sound when they hear it."

"And it always pays to make a good impression."

THE VM PROFESSIONAL "SPIRAL REFLEX SYSTEM" 84

The speakers' back waves are channeled through a spiral configuration acoustical tunnel so that the back and front waves blend in phase and the high frequencies of the back wave are completely eliminated; the result is exceptionally clean frequency response with extended bass and high efficiency • Speakers: high compliance, air-suspension type 8" woofer, 3 1/2" core type tweeter • Response: 35-20,000 Hz • Power Rating: 80 watts peak, 40 watts RMS • Cabinet is Pecan solids and veneers with inlays of Carpathian Elm Burl.

THE VM PROFESSIONAL 1555
Two synchronous motors - 24-pole for turntable, one for changer mechanism
• Belt driven, completely isolated, low mass, dynamically balanced turntable • Gentle lowering spindle
• Automatic record size sensor system • Photo cell cycle-change sensor eliminates side pressure and trip noise • Piston-damped 2-way cue control
• 9 1/2" tone arm (from pivot to stylus); the longest on any automatic turntable • Piano-key control center isolated from turntable and pick-up arm • Built-in anti-skate system • Detachable head
• Tracking error: 1 1/2 degrees maximum over entire record • Rumble: -52 db (CBS weighting)
• Comes complete with Shure magnetic cartridge and attractive walnut base with dust cover.



For engineering specs on the complete VM Professional Series write

VM CORPORATION

Dept. 74, P.O. Box 1247, Benton Harbor, Michigan 49022
or call direct, Area Code 616-925-8841. (Ask for Dept. 74.)

Electronics for Public Address

(Continued from page 38)

This arrangement is particularly good for interview or dialog, with one person on each side of the mike from the audience's viewpoint, so the mike does not obtrude between the participants and the audience.

The Electro-Voice multichannel system is intended for wide-field (full-stage) coverage, rather than just single-person pickup. And for this purpose it simplifies the system. To use a conventional system for this purpose requires a number of mikes and, for best results, mixing and gain riding is necessary. With the system just described, the system is set up, correctly nulled acoustically for each amplifier, and the amplifiers need no gain riding during a program.

The important thing to realize, in comparing systems, is that a completely different approach is used. A conventional system cannot be changed to the Electro-Voice system just by altering a few connections. A completely different speaker placement must be used. Low-level speakers throughout the auditorium, as used by some other systems, will not work where this method is used.

For the conventional approach, the P.A. system serves a function that can be considered as modified "relay." True, the loudspeakers may be in the same room with the microphone, but they work because they are removed as far as possible—trying to be in a different 'part' of the room, to which sound is thus 'relayed'.

For the Electro-Voice approach, the P.A. system is essentially a reinforcement system, as was never the case with conventional systems. It reinforces the sound level, right where it starts, on stage, or wherever the program originates. This is the important difference.

Amplifiers

Now for a few differences in public address amplifiers. Tubes are almost, if not quite, passe. Solid state provides complete freedom from microphonics, as well as greater compactness and efficiency. The one weak point about transistors is their susceptibility to blowing if they are accidentally overloaded, which is easier to do with them than with tubes.

Mismatching the output, for example, can result in transistors trying to deliver many times their normal rated output audio current, which will not take long to blow them if it is allowed to happen. The first step toward protection was the insertion of current-limiting circuits that cut back the input when output current reached a predetermined maximum, of which Fig. 6 is a sample.

Transistors Q1, Q2 are the output, driven by complementary pair Q3, Q4. Resistors R1, R2 produce a voltage drop due to output current from their respective output transistors. When this exceeds the contact potential of either protection transistor Q5 or Q6, the latter starts to conduct, bypassing the base current to Q3 or Q4, and holding output current to that required to produce the contact potential for Q5 or Q6. Q7 provides the voltage swing. D1 and D2 prevent Q5 or Q6 from conducting in reverse on the half-wave of signal for which they are not intended to be operative. D3 and D4 provide the contact potential to maintain a quiescent output current.

This kind of circuit prevented output transistors from being blown by excess audio output current. But then another possibility showed up: excessive dissipation. If output current reaches its maximum into a load whose impedance value

is only slightly lower than nominal, the voltage drop across the output transistors at this maximum current will be small and safe.

But suppose the impedance connected to the amplifier output is much nearer to a short-circuit than that: now the voltage across the load when maximum current is reached will be almost zero, which means all the supply voltage is being dropped across the transistors, which are working at maximum current already. This situation will certainly exceed the transistors' permitted dissipation.

There just is no way to hold both these quantities in bounds at the same time. Voltage drop across the transistors could be reduced by allowing output current to rise, but the transistor is going to be overrated whatever you do, until a correct load is connected to the output, by which time it may be too late to save the output transistors.

So the protection circuit devised against this possibility cuts off the input when a dangerous condition of this kind presents itself (Fig. 7). Zener diodes, D7, D8 sense when the voltage drop across an output transistor is too great, at the time current limiting comes into action, causing Q5 or Q6 to conduct.

When the protection triggers, Q10 charges C3, which causes the clamp circuit to ground the signal output from input transistor Q15. Resistors R5 and R6, in conjunction with capacitors C1 and C2 allow greater overloads of very short duration, but act if the overload lasts long enough to cause damage at a lower dissipation level. Q8 is a feedback transistor, sampling the output through R3, R4; Q9 combines feedback with input at this point.

(Continued on page 61)

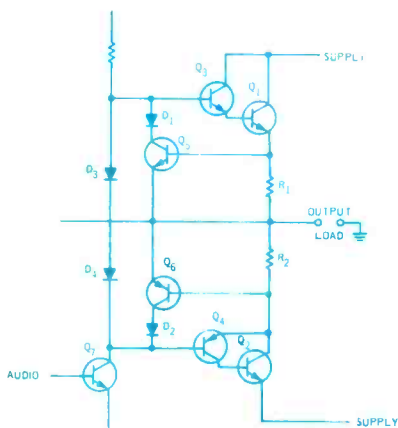

Fig. 6. A typical protection circuit to provide maximum current protection for output transistors.

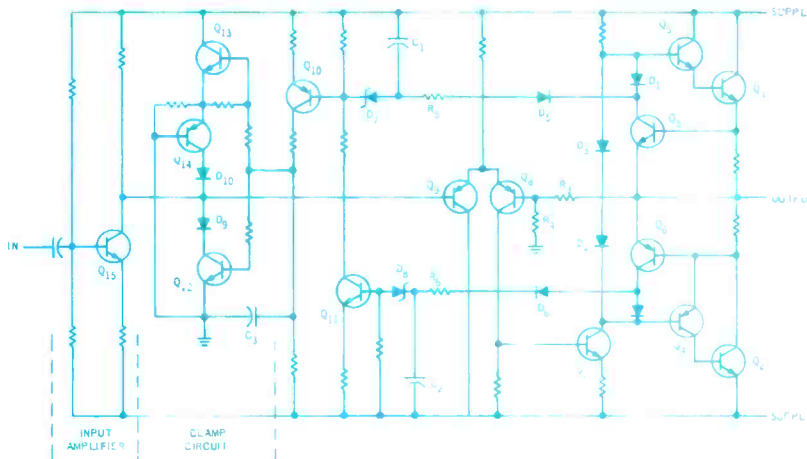

Fig. 7. One version of a more complete circuit that adds dissipation protection. Parts serving the same function are numbered the same as in Fig. 6.

FABULOUS SUCCESSOR TO THE FABULOUS SANSUI 2000



THE NEW SANSUI 2000A

AND STILL AT THE SAME PRICE

\$299.95 can still go a long way in purchasing top notch high fidelity equipment. The exciting new 2000A has a wide dial FM linear scale plus a sensitivity of $1.8 \mu\text{V}$ (IHF) for pin-point station selectivity with a clean crisp signal from even distant stations. Its powerful 120 watts (IHF) will easily handle 2 pairs of stereo speaker systems. The Sansui 2000A has inputs for 2 phonographs, tape recording and monitoring, headphones and auxiliary; and for the audiophile, pre- and main amplifiers may be used separately. Hear the new Sansui 2000A at your franchised Sansui dealer.

Sansui®

SANSUI ELECTRONICS CORP.

Woodside, New York, 11377 • Los Angeles, California, 90007

SANSUI ELECTRIC CO., LTD., Tokyo, Japan • Frankfurt a.M., West Germany

Electronic Distributors (Canada), British Columbia

Equipment Profiles

- Heathkit AR-29 AM-FM Receiver 44
- Dynaco SCA-80 Amplifier 48
- Sony TC 366 Tape Deck 50

Heathkit Model AR-29 AM-FM Stereo Receiver

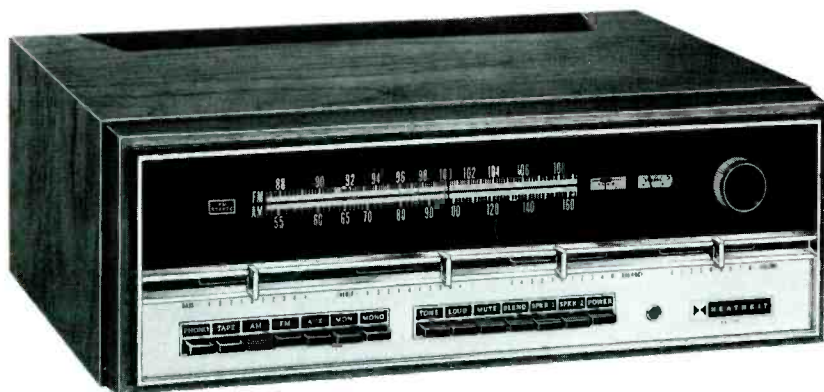

MANUFACTURER'S SPECIFICATIONS:

FM TUNER SECTION: IHF Sensitivity: 1.8 μV (1.5 μV typical). S/N: >60 dB; **Capture Ratio:** 1.5 dB; **THD (Mono)** 0.5% or less; **Selectivity (Alternate Channel):** >70 dB; **Image Rejection:** 90 dB; **I.f. Rejection:** 90 dB; **Spurious Response:** >90 dB; **Stereo Separation:** 45 dB typical at 1000 Hz.

AM TUNER SECTION: Sensitivity: 30 μV at 600 kHz, 20 μV at 1400 kHz, with external antenna; **Antenna:** Built-in rod type, adjustable; **THD:** 2%; **Hum and Noise:** -35 db.

AMPLIFIER SECTION: **Power Output:** 100 watts total IHF music power, 8-ohm load; **RMS Power Output/Channel:** 35 watts, 8-ohm load; **THD:** 0.25% at rated output; **Power Bandwidth:** 5 Hz to 30 kHz. **Hum and Noise (IHF):** High Level Input: -75 dB; Phono: -65 dB; **IM Distortion:** 0.2%; **Input Sensitivity:** Phono: 2.2 mV; Tape Monitor and Aux: 180 mV; **Frequency Response:** Aux: (1-watt level) 7 Hz to 60 kHz ± 1 dB; **Damping Factor:** 50.

GENERAL: **Power Requirements:** 110-125 or 210-250 V, 50/60 Hz, 55 watts idling, 240 watts at full output; **Dimensions:** 16 $\frac{3}{4}$ " wide, 5 $\frac{1}{8}$ " high, 14 $\frac{1}{2}$ " deep; **Cabinet:** AE-19 pecan finished, or custom mounted. **Weight:** 26 $\frac{1}{2}$ lbs. **Price:** \$285.00; AE-19 Cabinet: \$19.95.

The Heathkit AR-29 is a worthy companion to the famous AR-15—somewhat easier to build, somewhat lower in power, somewhat less expensive—but nevertheless a superb receiver in its own right. After a thorough study of the instructions, we built it, got it to working perfectly, and then enjoyed its performance for some time before making the usual measurements required to complete a report on the unit.

In external appearance, the AR-29 seems simpler than the AR-15, inasmuch as it has only one "knob," and that is the tuning control. Volume, bass and treble tone, and balance are all handled by slide controls which move horizontally just under the back-lighted front panel. Function and source selection are controlled by fourteen push buttons, and the only other component on the front panel is the stereo headphone jack. On the rear are the barrier-type output connector strip, the center-speaker switch, two convenience outlets—one switched and the other unswitched—and the line fuse. Openings in the bottom plate provide for adjusting the signal levels from all sources so that outputs from whatever input are of equal level. The input phono jacks are all mounted on the flat surface of the chassis top, with a portion of the rear cover shielding them from the internal

circuitry. These jacks, incidentally, are permanently mounted to the input pre-amplifier circuit board, which also accommodates the level-adjusting pots, all the electronic components, and at its front end the pushbutton assembly, which is the source selector.

The construction of the receiver is of a new design which employs eight printed-circuit boards, resulting in relatively few components being mounted on the chassis itself. These circuit boards are fitted with receptacles which mate with six-pin Molex plug assemblies which are mounted in several places on the chassis in their nylon snap-in bodies. After they are installed, the wiring is made to the plugs with cable harnesses, resulting in a simplified wiring procedure.

The individual circuit boards are completed separately so the builder has a number of small projects to finish, rather than one large and cumbersome assembly. Thus he has the feeling that something has been accomplished with the completion of each of the boards. Actually, there is a lot of work in putting these boards together, and the overall construction time for the receiver is likely to be around 35 hours—very similar to that for the AR-15, although much simpler for the constructor. After all the circuit boards are completed, they are installed one at a time in the chassis and tested in accordance with the instructions. No external test equipment is required, since there is a test panel with a pair of switches mounted inside the chassis, and the signal meter is used as a voltmeter to test supply voltages at various points through the chassis, and also as an ohmmeter for other measurements that ensure correct wiring. On the whole, the construction and final testing is a short course in electronics, well done as is usual with Heath instructions, and effective enough that it is not necessary to give a final alignment with instruments to get the receiver operating in accordance with its specifications.

Circuit Description

The circuit, which employs 65 transistors, 42 diodes, and four integrated

circuits, differs considerably from the AR-15. The output amplifiers employ positive and negative supply voltages, eliminating the need for output coupling capacitors and thus improving the response in the very-low-frequency region. Starting with the r.f. section, the FM front end is embodied in a tuning unit which has two r.f. amplifier stages, a mixer, and an oscillator. The input accommodates either 75- or 300-ohm antenna lead-ins, and feeds the primary of a transformer whose secondary is tuned by the main tuning capacitor, and which feeds the gate of an FET. Its output is coupled to the second r.f. stage—a bipolar transistor—which is in turn coupled to the base of the mixer transistor, which is also coupled to the oscillator. The a.f.c. voltage is fed from the detector to a voltage-variable-capacitance diode which alters the oscillator frequency to hold the stations in tune.

The AM tuner employs two FETs as r.f. amplifier and mixer, and a third as oscillator. The AM antenna is a ferrite rod, which is encased in a plastic housing and is adjustable in position over a wide range. The i.f. stages follow the mixer, then the diode detector, and another FET that serves as the AM meter amplifier. A 10-kHz filter eliminates interchannel squeal, and an emitter follower feeds the remaining circuitry.

The FM i.f. amplifier employs an integrated circuit, followed by a nine-pole passive filter—which must be fairly complicated since its replacement cost is listed at \$18.00—followed by two more ICs, the last one feeding the ratio-detector transformer, followed by the two-stage direct-coupled audio amplifier, and by the FET which provides the a.f.c. voltage back to the oscillator. There is also an a.g.c. amplifier, a signal-meter amplifier, a signal-differential amplifier, and a muting-voltage amplifier. The output of the FM/AM i.f. amplifier chassis is then fed to the multiplex circuit board where it is fed to an elaborate IC which performs practically all of the demodulating functions for the stereo-signals. Its two stereo outputs are fed to separate two-stage amplifiers, filtered, and thence to the control preamplifier circuit board. Two switches are provided on the MX board for alignment of the 19- and 38-kHz circuits separately.

The input preamplifier circuit board provides the necessary gain and equalization for the phono inputs, with low-noise transistors being used in the first stage. Supply voltages are sufficiently high that, along with the circuit design, the overload at the phono input is a comfortable 155 mV, which should take care of any cartridge likely to be used with this receiver.

Fig. 1—Rear view.

Note input jacks and AM antenna.

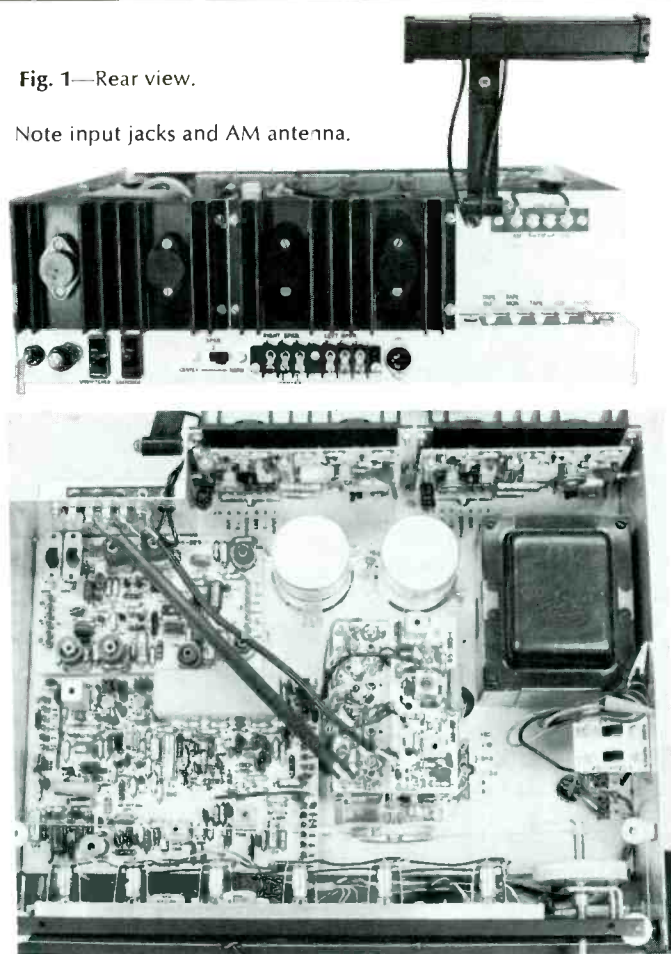

Fig. 2—Top view of chassis.

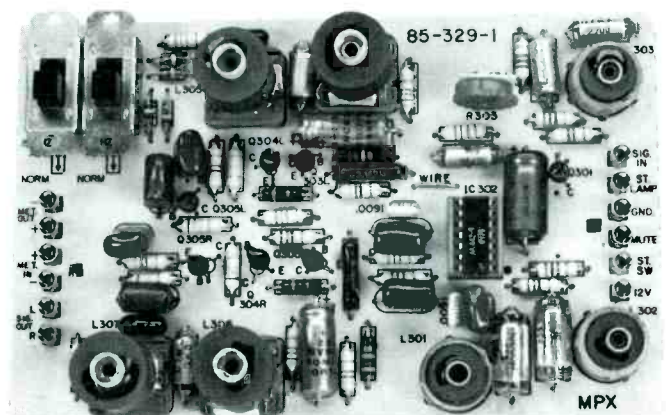

Fig. 3—Multiplex circuit board.

The control preamplifier is the section which provides the tone controls, balance control, and the volume control. A single-unit, two-transistor Darlington device is used in each channel to provide sufficient gain for the tone controls, and when the TONE button is depressed, the tone-control circuitry is bypassed, providing flat response throughout the entire range.

The output amplifiers are constructed on printed-circuit boards which are integral with the heat sinks when completed.

The input is fed to a pair of transistors operating as a PNP differential amplifier. The input is fed to one base, while the feedback is applied to the other one. A pre-driver stage furnishes amplification to the PNP driver on one side of the circuit, with the NPN driver supplies the signal to the other side. A complementary pair of transistors is used as a dissipation limiter, with a total of seven diodes maintain control against overdrive of the two 2N3055 output transistors.

The power-supply section provides regulated voltages of 12 and 50 to the circuits requiring regulation, and a separate bridge rectifier furnishes the positive and negative 35-volt supplies to the output stages. Dual primaries on the power transformer permit connection for operation on either 117 or 220 volts (nominal) when required.

Performance

Figure 4 depicts the FM characteristics of the AR-29, which show the excellent sensitivity, as well as the fine quieting of the receiver. Channel separation is shown in Fig. 5. All of these curves put the AR-29 in the category of most of the high-quality receivers on the market—that is to say there are few which can outperform it. Figure 6 shows the effect of the tone controls at full and half positions. Boost at 20 Hz is shown to be about 15 dB, and cut about 22 dB. On the high-frequency end, the boost and cut are more moderate, +10 and -20 showing as the response at 20 kHz. The dashed line on the same figure shows the effect of the loudness button when depressed, raising the response at 20 Hz by 10 dB, and at 20 kHz by 8 dB. Distortion figures are plotted in Fig. 7, with a measured distortion of 0.15 per cent as typical over most of the audio range, even though the specifications rate the receiver at a distortion of 0.25 per cent.

As a check on the effectiveness of the signal meter, we measured the signal required to move the pointer to the five points on the meter scale. A signal of 36 μV would cause a deflection to the first division, 60 μV to the second, 85 μV to the third, and 125 μV to the fourth division. An input of 160 μV would deflect the signal meter fully to the fifth position on the scale. With the MUTE button depressed, a signal of 6 μV would silence the set, but even then, the S/N was some 56 dB. Once silenced, a signal of 21 μV was required to disable the mute circuit. We noted a power output of 36 watts per channel at a distortion of 0.15 per cent, with both channels driven, and at the rated distortion of 0.25 per cent, we measured an output of 42 watts per channel. Power bandwidth also exceeded specifications, extending from 7 Hz to 43 kHz at the half-power point. Frequency response at the 1-watt level was from 7 Hz to 62 kHz, ± 1 dB, and from 4 Hz to 110 kHz ± 3 dB, also exceeding specifications. Full limiting occurred at an input signal of 1.4 μV , while IHF sensitivity measured 1.8 μV .

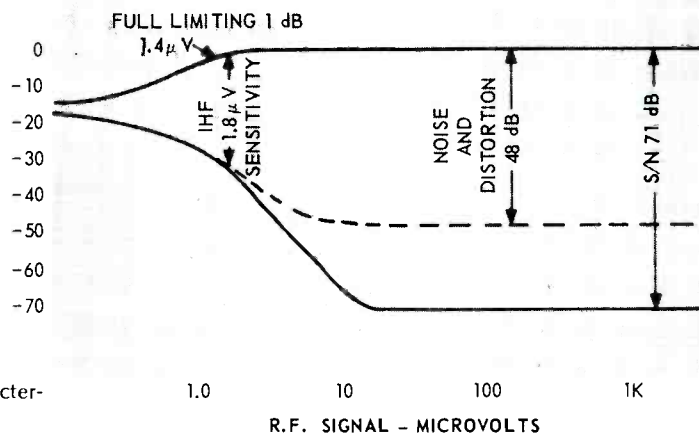

Fig. 4—FM characteristics

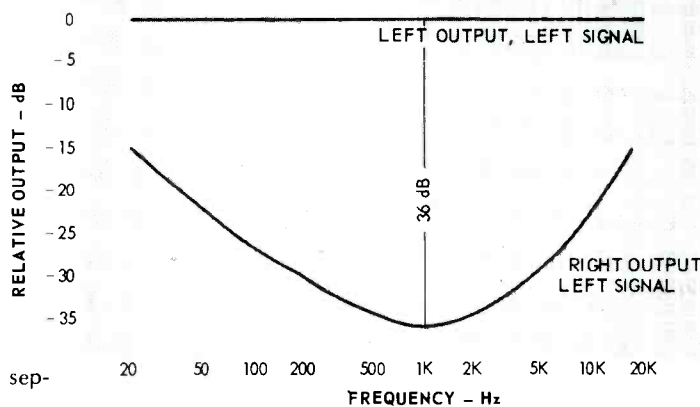

Fig. 5—Showing separation

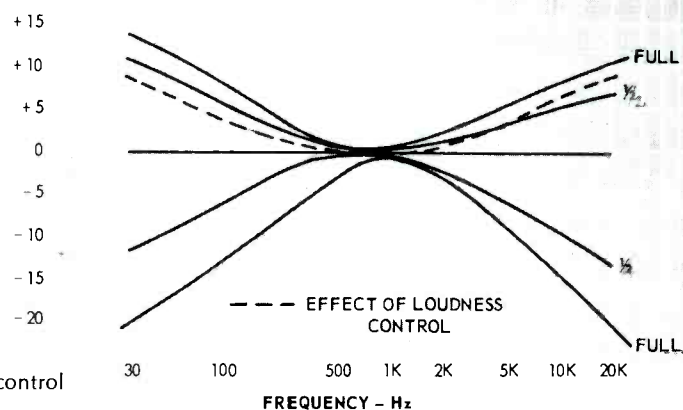

Fig. 6—Tone control curves

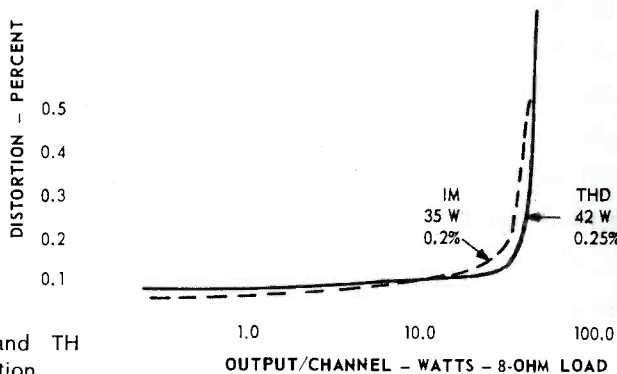

Fig. 7—IM and TH distortion



HOW TO LISTEN TO SUPERIOR MUSIC... ...listen on a TDK cassette

Finally – and fortunately for all music lovers – there is now a tape cassette available that will make your cassette music sound virtually as good as your finest records. Pop, jazz, rock or classical – a TDK SD™ cassette will make your recorder sound instantly better.

The TDK SD cassette gives you clear, crisp, life-like fidelity with an incredible frequency response of 30 to 20,000 Hz, a SN ratio of better than 55dB, an extremely wide dynamic range and practically no hiss.

TDK cassettes work smoothly and efficiently, no jamming, tearing or other little tragedies. Just ask for TDK – “the cassette that is in a class by itself”.

TDK SD tape is available in 30, 60 and 90 minute cassettes. At fine audio, music, department and camera stores everywhere.

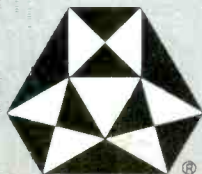

TDK

World's leader in tape technology since 1932.

TDK ELECTRONICS CORP.

NEW YORK • LOS ANGELES • CHICAGO

Listening Test

After such an impressive set of measurements, we could only hope that listening tests would bear out what we had measured, as indeed they did. We first found that we could pull in 26 stations with only our finger on one of the FM antenna terminals, which was impressive in itself. After we connected the antenna, we brought in 43 stations, with 32 of them in stereo. These figures should not be compared with others reported, since our location does not provide the enormous number of stations available to the New York area, but to date we have never pulled in over 41 stations heretofore with any receiver, and not all of them were listenable. One effect we noticed as a result of the a.f.c. circuitry—as we tuned up to a station and it snapped in, it would then remain in tune for a short distance of the dial pointer, shutting out a station adjacent to the strong one. However, if we approached the desired weak station from the other side, it could be tuned in successfully.

Even the AM reception was excellent—after we corrected an error in connecting the a.g.c. diode which was originally in reverse. This created a funny effect, since the weak stations were very weak, while the strong ones were *awfully* strong. But the ease of removing the i.f. circuit board

made changing the diode a very simple operation, and then performance was excellent, even with the built-in rod antenna. We did not connect an external AM antenna, since we had no intention of trying for a long-distance reception record—the built-in antenna furnished all the stations we wanted in the AM band.

With reasonably efficient loudspeakers, the AR-29 should suffice for even the most hardened and critical listener. Its 35 watts per channel is more than adequate

for most loudspeaker systems, and far more than could be used in an apartment of the usual construction.

The ease of construction and the completeness of the instructions make the assembly a pleasant procedure, and the completed receiver is a handsome piece of equipment. Its performance should satisfy the most serious audiophiles thoroughly.

C. G. McP.

Check No. 48 on Reader Service Card

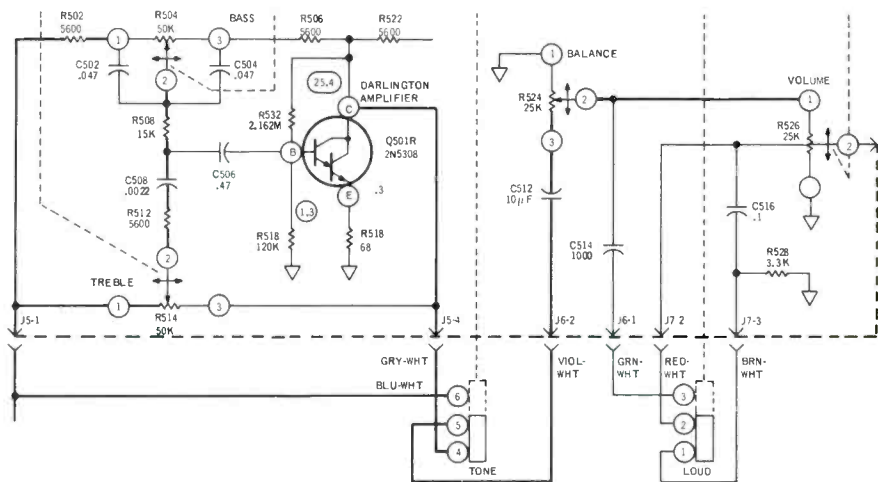

Fig. 8—Showing Darlington tone control circuit.

Dynaco SCA-80 Integrated Stereo Amplifier

MANUFACTURER'S SPECIFICATIONS:

Frequency Response: (at 1-watt output) High-level inputs, ± 0.5 dB from 15 to 50,000 Hz. **Power Output:** 40 watts per channel into 8 ohms with less than 0.5% THD from 20 to 20,000 Hz. **Power Bandwidth:** 8 Hz to 50 kHz at less than 0.5% distortion. **IM Distortion:** Less than 0.1% at any power level up to 40 watts per channel with any combination of test frequencies. **S/N:** High-level inputs, 80 dB below rated output; Phono, 60 dB below rated output. **Inputs:** RIAA magnetic phono, 47k ohms, 3 mV; Special low-level (2nd phono), 47k ohms, 3 mV; High-level (tuner, tape amp, spare) 100k ohms, 0.13 V. **Outputs:** Main and remote speakers, 4 to 16 ohms; tape, 600 ohms, same level as high-level input; Headphone (front-panel jack), 8 ohms or higher. **Semiconductors:** 20 transistors, 10 diodes. **Damping Factor:** greater than 40. **Dimensions:** 13½" wide, 4¼" high, 10" deep. **Weight:** 16 lbs. **Price:** \$169.95 in kit form; \$249.95 wired.



The name DYNACO has long meant a quality product in the kit field, and the current project is one of a long line of products that have given their builders a practical device on which they could expend their desires to "build something" and which when completed could well take its place among the best in hi-fi equipment. The SCA-80 is a combination of the PAT-4 preamplifier (reported in

these pages in December, 1967) and the Stereo 80 (which was reported in February, 1970). It utilizes a relatively simple circuit, and still simpler construction, since there is no "chassis" in the accepted sense, and since there are no transistor-equipped circuit boards to assemble—they are all completely assembled at the factory, so all the builder has to do is install them in the proper places in the

unit and make the necessary connections. The actual assembly requires only the putting together the few components on the power supply circuit board, assembly of the front and rear panel components, and the building of the two output-stage sections on their heat sinks—a comfortable twelve or thirteen hours of pleasant construction. None of the work is difficult, nor does it require any special talents in soldering, wiring, or even in the assembly.

Circuit Description

The preamplifier section is prefabricated on one circuit board for each channel, and consists of the feedback pair used for the phono preamp, followed by an additional feedback pair to provide the necessary gain for the tone-control circuits. These two sections are interconnected by the selector switch. The phono preamp pair consists of two Telefunken BC109B NPN transistors, with the first selected for low-noise characteristics. The tone-control pair uses two more BC109B transistors, and both sections have combined d.c. and a.c. feedback. A unusual feature of the input selector switch is the provision of a "special" position which the user may customize to accommodate a second phono input or a tape-head input for those installations where those functions are desired. The selector switch provides all the usual positions in addition to the *special* position mentioned—PHONO, TUNER, TAPE, and SPARE. Directly under the selector switch is the MONITOR rocker switch which permits listening either to the source signal or to the output of the tape recorder.

The next knob controls volume, and under it is the LOUDNESS rocker switch, which introduces an RC combination across the lower portion of the volume control to increase bass response at low levels. The BALANCE control is next on the panel, and under it is the FILTER switch, which has three positions—OFF, RUMBLE, and NARROW. The rumble position rolls off the low-frequency response starting at about 100 Hz, and reaching a 20-dB droop at 20 Hz. In the narrow position, the rumble filter is in, and an additional section rolls off the high end starting at about 6000 Hz, and reaching 18 dB at 20 kHz.

The BASS tone control knob is next, and under it is the MODE switch, also with three positions—MONO, BLEND, and STEREO. In the former, both channels are paralleled, and in the latter both operate separately. The blend position places a resistor between the two channels to reduce separation to 6 dB, a condition used when the Dynaco three-speaker system is

Fig. 1—Inside view

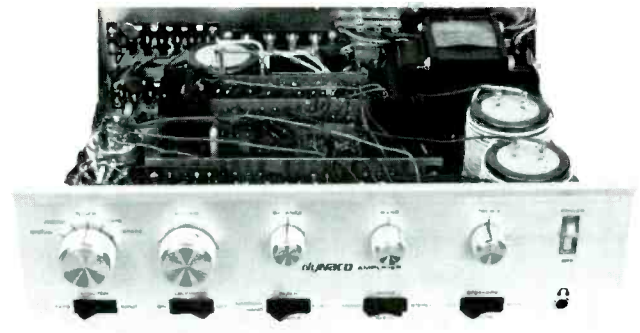

Fig. 2—Rear panel

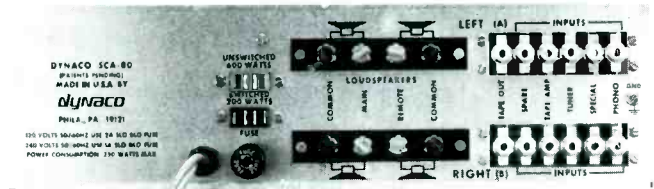

Fig. 3—Power Output Watts RMS (One ch)

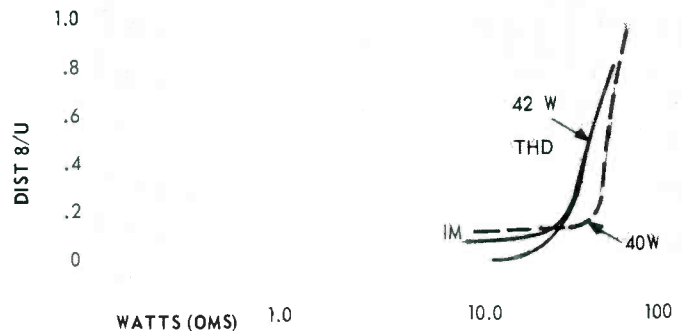

Fig. 4—Loudness -30 on Vol. control

Rumble & Narrow band filters

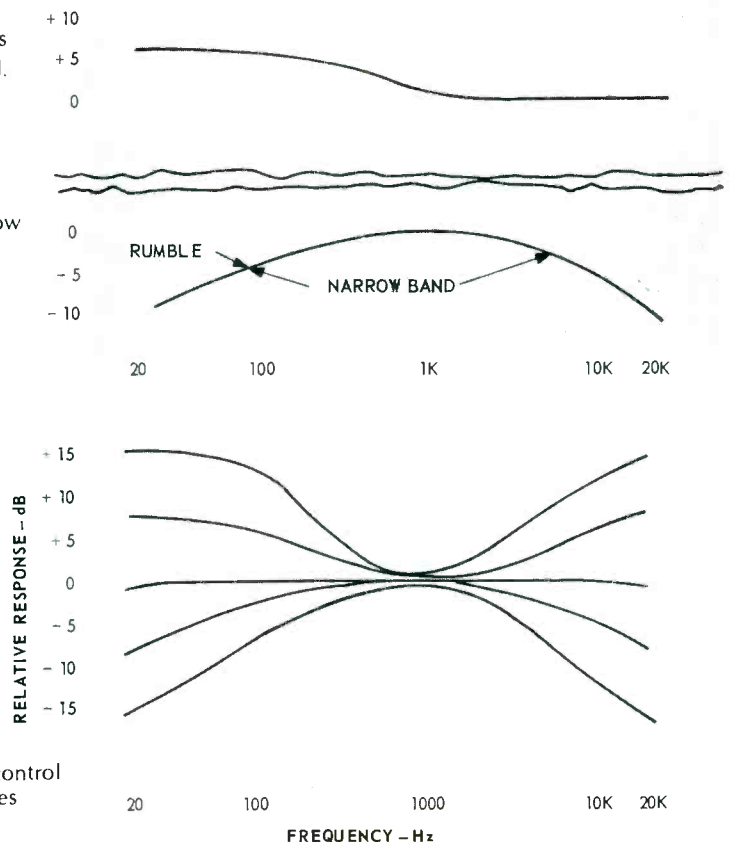

Fig. 5—Tone control Curves

employed for a center fill, or for remote mono speakers. The TREBLE tone control knob is next, and under it the speaker switch which has three positions—OFF, REMOTE, and MAIN. The tone-control circuitry is of the patented Dynaco arrangement which takes them out of the circuit when they are in the center position. This eliminates the possibility of unwanted phase shift or effect upon the performance, and with the specially designed controls, they are actually out of the circuit when centered. This is one of the features that the perfectionist looks for in his amplifier, since he wants to make sure that there is no effect on frequency response when the controls are "flat." In most amplifiers, this condition is met only by using switches for the tone controls.

The power switch is next in line with the knobs. It is of the push-push type, and is illuminated when the amplifier is on. The headphone jack is directly below the power switch, and accommodates the usual 8-ohm stereo headphones, fed from the outputs through 120-ohm resistors.

The power amplifier section consists of a pair of factory assembled printed-circuit boards, each of which accommodates four transistors and three diodes. The first transistor is a 40233, which drives a 2N5320, with both d.c. and a.c. feedback applied. The second transistor feeds the

driver pair—2N5320 and 2N5322—in the usual complementary-pair configuration, and they feed the output transistors, a pair of 2N3055's mounted on the heat sink. An interesting construction of the complete output amplifier involves a pair of slots in the heat sinks, and the printed-circuit boards slip into these slots when the heat sinks are mounted. Feed to the output terminals is through 5000- μ F computer-grade electrolytics and the r.f. choke which is wound around the capacitors to provide the 3-mH of inductance to roll off the response in the r.f. region so as to reduce interference and to afford stability.

The power supply uses a transformer with two primaries, both tapped, so as to accommodate line voltages of 100, 120, 220, and 240. The secondary—approximately 54 volts—is fed to a bridge rectifier consisting of four separate diodes, filtered by another 8000- μ F capacitor, then further filtered and fed to the preamplifier section. The junction between the output transistors is fed stabilizing voltages from the power supply.

Performance

While we have heretofore reported on the PAT-4 and the Stereo 80 independently, we also measured the SCA-80 for its performance figures. Power bandwidth measured from 7 Hz to 47 kHz at a distortion of 0.5 per cent.

Frequency response of the RIAA-equalized phono preamp was within 1.5 dB from 20 to 20,000 Hz, and the tone-control curves are of the usual configuration, as shown in Fig. 5. Loudness equalization is a mild 7 dB at the -30-dB setting of the volume control, and is shown in Fig. 4, along with the effect of the filter switch in the RUMBLE and NARROW positions. Distortion measured less than 0.15 per cent at a 1-watt output, and at rated distortion of 0.5 per cent, the output was 42 watts per channel, both channels operating. Separation was 37 dB at 40 Hz, 35 at 1000 Hz, and dropped to 31 dB at 20 kHz, all of which are good figures.

Signal-to-noise ratio measured 83 dB on the high-level inputs, and an average 61 dB on the phono inputs.

For those audiophiles who build just for enjoyment or those who want to economize in their systems, the SCA-80 will give them the desired pleasure in the construction part of the project, and the performance of the finished amplifier will satisfy them completely. The name Dynaco has been synonymous with quality products having a minimum of "gimmicks" which add up in cost to satisfy the presumed requirements of the ultimate user.

C.G.McP.

Sony Model TC-366 Three-Head Stereo Tape Deck

MANUFACTURER'S SPECIFICATIONS:

Speeds: $7\frac{1}{2}$, $3\frac{3}{4}$, and $1\frac{7}{8}$ ips. **Maximum reel size:** 7 in. **Motor:** One, vibration-free induction. **Heads:** Three—erase, record, play; quarter-track. **Semiconductors:** 27 transistors, 4 diodes, 1 Zener. **S/N:** 55 dB (with SLH tapes), 52 dB (with standard tapes). **Frequency Response:** 20-25,000 Hz at $7\frac{1}{2}$ ips; 30-17,000 Hz at $3\frac{3}{4}$ ips; 30-9,000 Hz at $1\frac{7}{8}$ ips. **Wow and Flutter:** .09% at $7\frac{1}{2}$, 0.12% at $3\frac{3}{4}$, 0.17% at $1\frac{7}{8}$. **Inputs:** Microphone, low impedance, 0.19 mV; **Auxiliary,** 100k ohms, .06V. **Outputs:** Line, 0.775 V, 100k ohms impedance; headphone, 8 ohms, 30 mV. **Dimensions:** $16\frac{7}{8}$ " wide, $8\frac{5}{16}$ " high, $14\frac{13}{16}$ " deep. **Weight:** $22\frac{1}{2}$ " lbs. **Price:** 229.95.

The new model TC-366 replaces the well-known 355, which has long been a popular deck. The new features of the 366 should ensure even greater acceptance than its predecessor. Among these



features are its ability to accommodate both microphone and line inputs simultaneously with mixing between them, an automatic total-mechanism shut-off, tape-equalization selector switch, faster forward and rewind spooling, and the absence of pressure pads—always a decided advantage. Another of its plus features is the unique cabinet which provides for either vertical or horizontal mounting of the chassis to the user's choice.



Fig. 1—The 366 remounted in its cabinet for horizontal operation

Physically the TC-366 is in a slant-front case which can be used in the vertical position, or if the user wants to place it in the horizontal position he removes it from the case and turns the deck around and remounts it, with a slanting front panel in a position which makes it easily accessible in addition to being attractive in appearance. The upper section of the molded plastic panel is fitted with the two reel hubs flush with the satin-finished aluminum surface. The panel is stiffened on all four sides by extruded aluminum trim strips. An aluminum strip across the center of the front serves as a divider, and accommodates the four-digit counter at the left. Centered on this strip is the removable head cover, finished in dark gray trimmed with aluminum. The base of the head assembly is finished in polished chrome. To the left of the head cover are the pause lever (which can be operated momentarily, or locked in the stationary position), and to its right the speed-control knob. On the other side of the head cover is the operating control with its REWIND, STOP, FORWARD, and FAST FORWARD positions.

Below this section to the far left is the noise reduction switch, followed by two RECORD levers in a bright red, the left channel record-level controls—one for microphone and one for the auxiliary input. Next comes the two VU meters, with a red indicator light showing when recording, or when setting levels before starting the tape motion. To their right are the two record-level controls for the right channel. Next comes the tape selector switch and then the two monitor

You pay for what Thorens leaves out.

And you'll never miss them. Like rumble. Or wow and flutter. Irregular turntable speed. Damaged records, chipped stylus.

The Thorens TD-150 Mark II is for people who take their music seriously. People who refuse to accept the many imperfections of ordinary sound reproduction. This is how Thorens has championed their cause.

Record wear reduced . . . Stylus life extended

Several Thorens features provide this. Positioned at the front is the Cueing Synchronizer. It lowers the tonearm gently and precisely into the groove. The Anti-Skate Control then makes certain the stylus is positioned exactly on both walls of the groove. And when you change turntable speeds (33 $\frac{1}{3}$ and 45 rpm) the Speed Glide Adjustment does it rapidly and smoothly without jolting the stylus.

Rumble, wow and flutter are eliminated

The flywheel action of the 12-inch, precision balanced, non-magnetic platter absorbs the slightest variations in speed and eliminates wow and flutter. The long and resilient drive belt system of the synchronous motor in combination with a unified suspension system for the

tonearm mount and turntable assembly routs rumble effectively.

Constant Turntable Speed

Dance of the Hours never sounds like Danse Macabre. The double 16-pole synchronous motor always maintains its speed regularity, providing constant, smooth, in-phase precise speed.

Plays records the way they were recorded

Records are cut at a 15° tracking angle. The best performance is achieved when they're played back at this angle. The low-mass plug-in shell permits you to adjust the tracking angle of a cartridge accordingly. You're always assured perfect tracking force since the tonearm can be adjusted to track as low as $\frac{1}{2}$ gram, and is always in perfect balance.

So you see, when you pay for what Thorens leaves out, you receive superb performance and reliability. But then you expect unexcelled quality from Thorens. And you get it.

TD-150 Mark II, complete with tonearm and walnut base . . . Only \$130.00. For more details, see your Thorens dealer, or write to:

ELPA MARKETING INDUSTRIES, INC.
New Hyde Park, New York 11040



THORENS

switches, one for each channel, which permit monitoring on either channel from the source or the tape. To the far right is a power indicator light just above the white rocker-type power switch. At the far left corner is the stereo headphone jack.

The auxiliary input and line output phono jacks are accessible through an opening on the left side of the wood case, and the power cord comes out a similar opening on the right side. The microphone(s) are plugged into miniature phone jacks located just below the two record levers. When the tape is stationary, the deck can be put in the record mode in either or both channels to permit setting levels before starting the recording. This operation requires that the monitor switches be in the source position. After starting the recording, both monitoring and VU meter indication can be furnished by source or tape, at the operator's discretion. Headphone monitoring is fed from an emitter follower through a step-down transformer which matches the transistor to 8-ohm phones—the ones most likely to be readily available to the user of the machine.

The transport mechanism is of the proven type used in many of the Sony models. The resiliently mounted induction motor drives the capstan by an idler between the three-step motor shaft and a two-step flywheel. The highest speed uses the largest diameter of motor pulley and the smaller diameter on the flywheel. For the two slower speeds, the idler contacts the larger diameter of the flywheel, thus ensuring a larger motor-shaft diameter. The take-up spindle is driven from the flywheel by a rubber belt, and for fast forward and rewind, the spindles are driven by idlers, one of which gets its power from a pulley on the motor shaft. The motor is resiliently mounted to eliminate vibration, and the effectiveness of this mounting is shown by the low flutter-and-wow figure. There is a brake on the feed spindle which is released by tape tension across an arm in the tape path.

The tape passes under the brake release arm and under a tape guide fitted with a tapered entryway which directs the tape into the guide accurately, then past the automatic shutoff lever which actuates a switch for the motor as well as a trigger which releases the operating knob unless the tape is threaded through the machine. The tape then passes over the erase head and the scrape-flutter filter—which is a precision idler roller that eliminates modulation distortion. It then passes the non-magnetizing record head, the tape lifter bar, then the well-shielded play head and finally the capstan. Before being wound onto the takeup reel, it

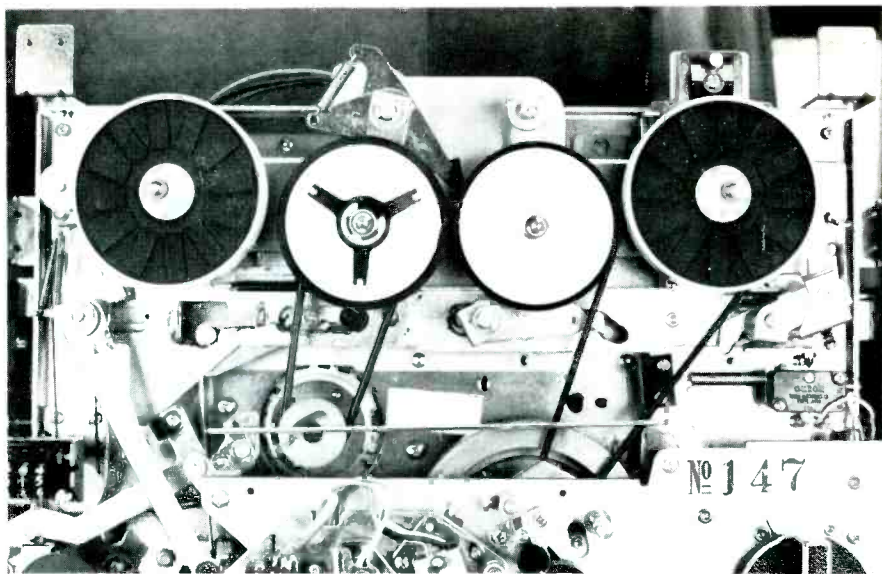

Fig. 2—Drive Mechanism. Lever at left controls drag on feed reel, applies brake on runout or tape breakage. Note two-stepped flywheel.

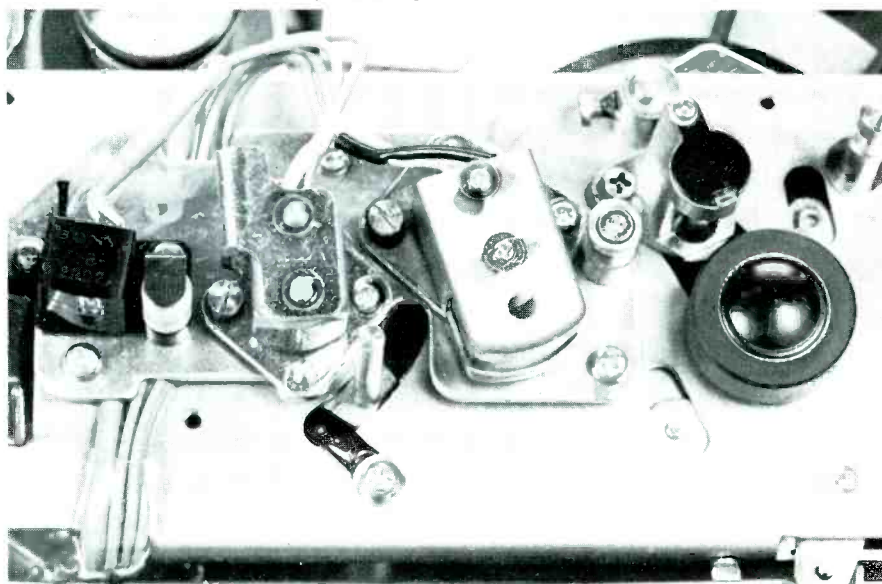

Fig. 3—Close-up of head assembly.

passes another guide, ensuring clean wind.

Circuit Description

The electronics of the 366 are relatively simple. The record amplifier uses five transistors per channel—two as a feedback pair for the microphone preamplifier, followed by the *MIC* level control. The *AUX* input level control and the *MIC* level control feed an emitter follower through isolating resistors, and the output of the follower is fed to the source/tape monitor switch, and to the equalized two-stage record amplifier. Bias and erase current are supplied by a self-balancing push-pull oscillator. Supply voltage to the oscillator is fed by the channel record switch to the selected record and erase heads, and through two additional switches actuated by the operating lever for safety. Oscillator output builds up slowly due to a delay network in the supply circuit, and bias is adjusted by a variable capacitor and an

equalizer switch which reduces the bias in two steps for the lower speeds.

The playback amplifier utilizes six transistors—the first three as a feedback-equalized preamp ending up with an emitter follower which feeds a level-adjusting pot that balances source and tape levels.

Following the source/tape selector switch is a two-stage amplifier which accommodates the noise suppressor circuit—simply a roll-off, with the effect shown in Fig. 3—and a compensating adjustment for the type of tape used, normal or low-noise-high-level. Additional compensation is provided in the record amplifier to ensure flat response on either type of tape. If you record on low-noise tape with the normal setting, you will have a response which rises in the upper mid-range frequencies. The equalized two-stage amplifier is followed by another emitter follower which drives the headphone transformer and the record-level meter.

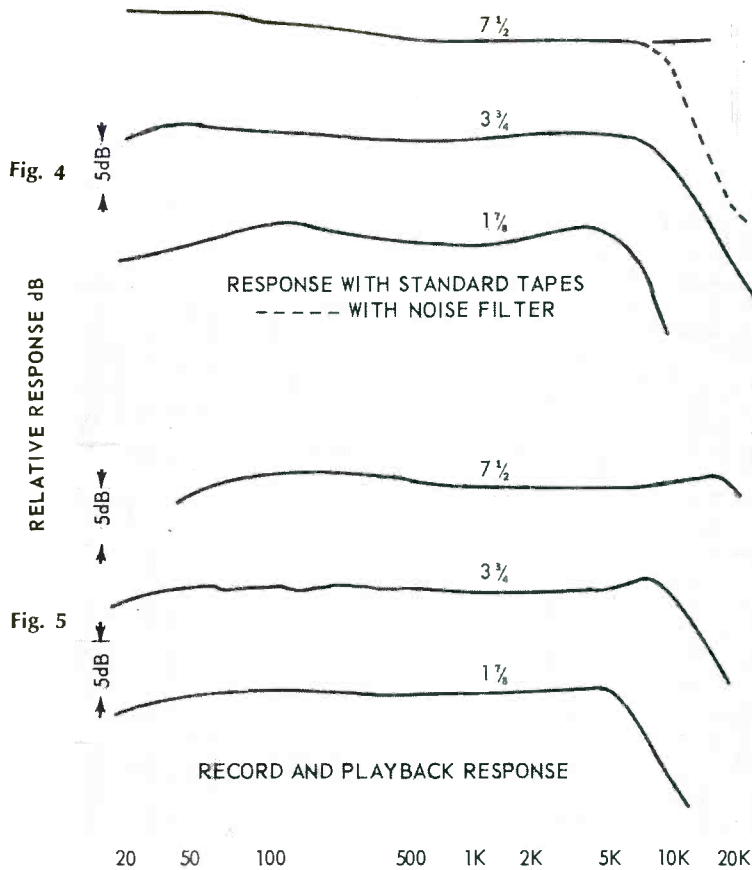

The power supply provides a 2-volt winding for the indicator lights, as well as a center-tapped 52-volt winding feeding a full-wave diode pair, followed by a three-transistor regulating circuit to supply 25 V to the amplifiers and the bias oscillator.

Performance

Figure 4 shows the response to standard tapes for the three speeds, and Fig. 5 shows the record/replay response, using the sample of Sony Low-Noise-High-Output tape that is furnished with the machine. We measured wow-and-flutter at .07 per cent at 7½ ips, with most of the contribution in the 6- to 250-Hz region. At 3¾ ips, wow-and-flutter measured 0.1 per cent, and at 1¾, it was 0.14 per cent, all being below specifications. Bias frequency was noted as being 160 kHz, common to most recent Sony models, and an excellent assurance of complete absence of any interference with pilot or switching frequencies when recording from FM stereo. Distortion measured 1.0 per cent at indicated 0 VU at 1000 Hz, 0.4 per cent at 10,000, 5000, and 100 Hz, with an increase to 0.8 per cent at 50 Hz. The 3 per cent distortion point was reached at an indicated recording level of +4.5 dB, resulting in a signal-to-noise ratio of 54 dB with standard tape and 57 with the low-noise product.

An input signal of 0.1 mV at the microphone jack was sufficient to give a 0-dB recording level, as was an auxiliary input of 0.32 V at the maximum settings of the record-level controls. Line output for a 0-dB recording level was 0.78 V, and the level difference between source and tape was less than half a dB. Rewind time was a very fast 110 seconds for 1800 feet of tape, and fast forward was clocked at 115 seconds, both extremely fast for a consumer-type machine. Channel separation was almost identical with the signal-to-noise figure—54 dB with standard tapes, and 56 with low-noise tape.

There is no question that the TC-366 is a worthy successor to the long accepted 355, and after several hours of various types of recording, we found no tape spillage and no broken tapes, no matter how hard we tried. The enforced delay between fast wind and ordinary recording or playing with the capstan drive prevents any of these undesirable happenings. The "retractomatic" pinch roller, which rises and moves toward the capstan as the machine is started makes it exceptionally easy to thread the tape, since the roller is well out of the way during this operation. We could sum up by saying that the 366 is simple and uncluttered, but that it has all the functions necessary to the average recordist.

C. G. McP.

ADC: WORLD'S MOST PERSNICKETY SPEAKER MAKER.



We make 303AX speakers for fussy audiophiles. Each one is crafted by hand and contains a two-way acoustic suspension system that's accurate enough to please even the most discriminating listener. The ADC 303AX lacks the distortion and coloration often found in speakers in its price range. Which makes it a superb value in a full-sized bookshelf speaker.

Of course, there's only one way to find out how really accurate our speaker system is. Go to your nearest ADC dealer and compare it to other models. After all, hearing is believing!

SPECIFICATIONS

- Type . . . Bookshelf.
 - Cabinet . . . Oiled Walnut.
 - Dimensions . . . 23¾" H x 13" W x 11¾" D.
 - Weight . . . 37 lbs. each.
 - Frequency Response . . . 33Hz—20kHz ± 3 db (measured in average listening room).
 - Speakers (2) . . . High accuracy, wide dispersion tweeter with Hi Flux Magnet and 10" high compliance woofer.
 - Nominal Impedance . . . 8 ohms.
 - Power Required . . . 10 watts min.
 - Price . . . \$100 suggested resale.
- Write for details about other ADC speaker systems. From \$55-\$350.



AUDIO FOR AUDIOPHILES

Check No. 53 on Reader Service Card

Classical Record Reviews

EDWARD TATNALL CANBY

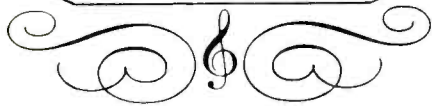

The Sound of the Mozart Piano. Jorg Demus and Norman Shelter, pianists. RCA Victrola VICS 1495 stereo (\$2.98).
Chamber Music by Beethoven on Original Instrumentals 1792-1800. Assorted instrumentalists (Dutch). Telefunken SAWT 9547 stereo (\$5.95).

Here are two fascinating recordings for those who wonder how Beethoven and Mozart sounded in their own day—when really well performed.

Too many so-called “authentic” performances, we have found these last years, sacrifice imagination and artistry to exact authenticity in the instruments. Better a good performance on the wrong instruments, is the common conclusion. But these disks are of the new generation where, at last, first-rate artistry and authenticity have come together.

There is no more thoroughly satisfying Mozart performer today than Jorg Demus, whose Mozart and Schubert recordings with Paul Badura-Skoda years ago were an early ornament in Westminster's pioneer LP catalog. Here, with a new team-mate, Norman Shelter, he has mastered the art of the Mozart piano itself, which is no mean feat. *Two* Mozart pianos! Both of the period, by Anton Walter of Mozart's own Vienna,

one instrument 1785, the other 1795. The familiar two-piano Sonata in D, K. 448, is a revelation in this brilliant, clattery sound, seemingly much bigger and more orchestral than the music ever can be on two modern grands. Matter of tone color and bright overtones. This is precisely as the music must have sounded when Mozart and his sister Nannerl played it together. Equally telling is the (one-piano) D minor Fantasia, K. 397 and the little “Twinkle, twinkle, Little Star” variations (*Ah, vous dirai-je maman*) K. 265. The record is capped by the superb and unfamiliar four-hand (one piano) Andante and Variations, K. 501, a late and profoundly rich work of keyboard coloration, wonderfully revealed by the Mozart piano.

Beethoven? Yes, even Beethoven can benefit by “old instruments.” Here we have a variety of chamber works, all via period instruments. First, the Trio Op. 11 for piano, clarinet, and cello with a Broadwood fortepiano of 1825 (slightly late for the music but plenty “early” even so), a clarinet of 1800 and a cello of 1835. (Many cellos are much older, of course, but are variably modernized.) Excellent performance! Lively, knowing, technically perfect. The clarinet is a bit hoarser than ours but otherwise like today (though without the modern key system). The piano compares interestingly with the Mozart instruments, still rather twangy, with a trace of the harpsichord in its bass but otherwise fuller and more precise. A brief “WoO” work fills out the side, an Allegro and Minuet for two (old) flutes, wooden, with six and seven keys.

Side 2 is technically spectacular. First a Sonata for piano and horn, Op. 17, played on a valveless natural horn. Astonishing—no fingers! Except for odd tone-color changes for the muted in-between notes, the performance of the complex melodic lines is quite as good as with a modern valved instrument. All done via breath and lip, plus a hand in the bell. Then an unlikely piece, a Quintet for *three* natural horns, an oboe, and a bassoon, this one minus even a “WoO” designation. Excellent oboe, 1820, and bassoon, 1795, and the three horns, with not a valve between them, play the most elaborate tissue of often-chromatic harmony and melody without a blooper. It was done in Beethoven's day; now it can be done again. Once more, excellent and imaginative playing in all these works.

These two disks are worth a month of study, and you can forget all the rest of the month's output.

Performances: A

Sound: A

J. M. Kraus: Funeral Cantata for Gustave III of Sweden (1792). Soloists, Clarion Concerts Orch. and Chorus, Newell Jenkins. Vanguard Cardinal VCS 10065 stereo (\$3.98).

F. W. Rust: Four Sonatas. Vladimir Pleshakov, piano. Orion ORS 7023 stereo (\$5.98).

One of the finest things that is happening in “old” music today is the rediscovery of some of the unknown classic and Romantic composers of the post-Baroque era, from Haydn on through Beethoven. We have had immense doses of minor Baroque music including far too many unimportant exercises by such as Vivaldi; there is more discrimination being shown in these later revivals—if only because, perhaps, the music is bigger, longer, and more costly to present. Good.

Newell Jenkins, of New York, has specialized in late 18th century unknowns—this discovery, while not quite as earthshaking as the liner notes (by Jenkins) would have it, is certainly an interesting one. Kraus was a well trained German composer resident in Sweden at the highly musical court there. Gustave's assassination, which furnished the plot for Verdi's *Ballo in maschera*, led to this funeral cantata, on the spot. (Verdi's opera had political overtones for his own time and had to be disguised, though originally called *Gustavo Terzo*.) The music is reminiscent of that Catholic church style so characteristic of Haydn and, especially, Mozart—operatic, but full of rather special church-style harmonies, augmented-sixth chords and the like, which were reserved for sacred music. Kraus is a good melodist and a thoroughly professional craftsman but he overdoes the augmented sixths as Mozart never would have, nor Haydn. All in all, this is precisely what it ought to be, a competent, informed, skilled and expressive work by a well trained musician in a fringe-area European court. What else?

Mr. Jenkins' orchestra plays as it always does, with finesse, fine phrasing and close attention. Excellent! But his soloists in the work are unfortunate, though three of them hail from the Swedish Royal Opera, which ought to qualify them, somehow. The soprano (American born) sings with a tight, strangled delivery wholly out of place in such graceful music, though her intentions are musical enough. The tenor is weak and quavery. The basso, Finnish Kim Borg, is merely sepulchral, which is not enough. As for the chorus, it is an inattentive bunch of (New York?) professionals, full of nasty wobbles and operatic power, unblended.

For pros they are singularly sloppy, Mr. Jenkins is an orchestra man. Period.

F. W. Rust, of the generation of Haydn, writes really excellent piano sonatas, with much of Haydn in them but even more of the early Beethoven period. He is more introspective and far less flamboyant than Beethoven, of course, nor is he as formally circumspect as Haydn. But he has a fine ear for ornamental melody and a keen sense of harmonic contrast. The sonatas are well built early-Romantic and should add a very useful perspective to the present Beethoven Anniversary Year. Vladimir Pleshakov plays with grace and naturalness. Even his piano seems to have a certain authentic sound, as though of the period. Bet it's no Steinway concert grand. Good record.

Performances: B-, A- Sound: B+, B+

La Reine des Coeurs. Couperin: Ordres 8, 14, 21. George Malcolm, harpsichord. Argo ZRG 632 stereo (\$5.95).
Sylvia Marlowe plays Couperin le Grand. (harpsichord). Decca DL 710174 stereo (\$5.98).

Two recordings of the French master of the harpsichord, and very different though the differences are not easily described in so many words. Both recordings are worthwhile if you enjoy the silvery, highly ornamented, stylized French music of the time of Louis XIV and his great-grandson successor, Louis XV. You have your choice here of an English or American view.

George Malcolm plays his Couperin fluently and brilliantly, as always with him; he has a show-biz flair, if you can imagine such a thing applied to the harpsichord. He plays fast—too fast, I'd say, for this music. Driving, but without enough breathing space, the millions of finger ornaments played so glibly that the ear does not hear the individual notes. Considering that this was a subtle art, full of nuances and suggestions, a more leisurely sort of intensity would seem to be right, if shades of meaning are to be conveyed. Tension, yes. But a measured tension? The music is never dull in Malcolm's version—no chance of that!

Is it his harpsichord, or the recording technique, that gives a certain coarseness of sound, as though he were belaboring the small instrument for more than it could take? I suspect the instrument. It does not sing as it should.

Sylvia Marlowe's Couperin is of an opposite sort. Her versions (including one whole *Ordre*, or Suite, the same: No. 8) are the product of exhaustive study, in every detail of ornamentation and regis-

tration. Here there is leisure and gravity. And here also there is a fine, singing harpsichord tone, beautifully recorded. (Hers is a William Dowd instrument.) Sylvia Marlowe's ornamentations are precise and always correct, where Malcolm's have a certain slapdash quality and his rhythms, notably the "double-dotted" figures, seem . . . well, absent minded. Not Marlowe! She is never dull or plodding—far from it—but, in contrast to Malcolm, her music has just a faint

smell of the lamp, as the old pre-electricity phrase goes. Always has, to my memory.

All in all, even so, I think I prefer the Marlowe version, for the studied care with which it is prepared. Malcolm seems to say, look! It's easy. It isn't, and shouldn't sound so.

Performances: B, B. Sound: B-, B+

(Continued on page 57)

"Scotch" Brand, the professional recording tape.

In disguise.



This innocent-looking little cassette is no teenybopper's toy. It's loaded with "Dynarange" recording tape, the overwhelming choice of professional sound engineers—and serious hobbyists.

On reel-to-reel equipment, "Dynarange" offers flawless full-fidelity performance. High S/N, superb sensitivity across the whole sound spectrum. And this tough polyester tape has permanent silicone lubrication for maximum tape life plus minimum head wear.

Yet cassette systems need all these qualities even more. And they get it. With the same dependable "Dynarange" tape in cassettes carefully engineered for smooth, jam-free performance. "Scotch" Brand Cassettes deliver the highest possible fidelity at cassette speed.

There's the same quality combination in "Scotch" Brand 8-Track Cartridges, too.

Professional savings:

Get up to 40% off on tape-related premium items with tabs from "Scotch" Magnetic Tape products. Ask your dealer for free catalog, plus helpful booklet of recording tips. Or send 25¢ in coin to:
3M Company, P.O. Box 3146, Saint Paul, Minn. 55101.

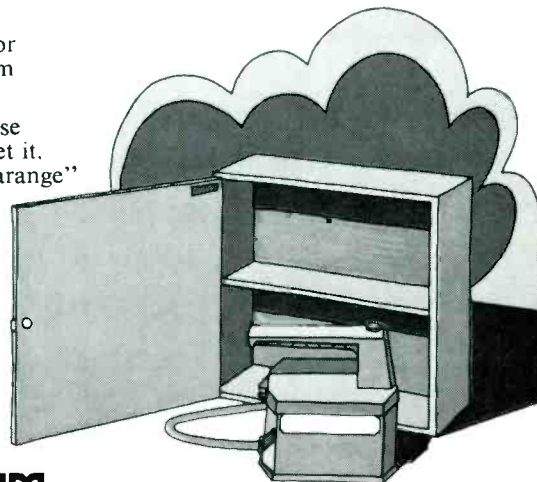

Magnetic Products Division **3M** COMPANY
"SCOTCH", "DYNARANGE" AND PLAID DESIGN ARE REGISTERED TRADEMARKS OF 3M CO.

Canby's Capsules...

TITLE	CONTENT	RECORDING TECHNIQUE
<p>Grofe: Grand Canyon Suite. A. Kostelanetz & His Orch. Johnnie Cash Narrates "A Day in the Grand Canyon." Columbia MS 7425 stereo (\$5.95).</p>	<p>Big fuss here over not very much—J. Cash telling story of descent into canyon to get sound effects. Some are mixed with the music—insignificant. Cash is OK himself as a story teller, even so, though Grofe's own "effects" are much better than the real ones.</p>	<p>The 1941 K. original was a hi fi miracle—this one is fancier but similar in impact. The portable sound effects—via 250 lbs. of equipment!—are mere fragments. Could as well have used a cassette portable. Silly, I'd say.</p>
<p>Bernard Shaw. Some of his Broadcasts. Westminster WBBC 8001 mono. (\$5.98).</p>	<p>The grand old man in five of his humorous and prophetic broadcasts 1934-46, including 90th birthday TV talk. Wonderfully pithy, Irish-slanted accent. Note: sides reversed in my copy.</p>	<p>BBC did a splendid job in the '30s—relatively wide-range sound with clean sibilants, even in '34. Compare with our own dismal "air checks"—CBS's <i>Morrow</i>, for instance.</p>
<p>Allen Ginsberg. William Blake. (Songs of Innocence and Experience, tuned by Ginsberg). MGM FTS 3083 stereo (\$4.98).</p>	<p>Hard to know what to say—Ginsberg's nasally sung amateur tunes, to Blake words, are sincere, convinced—but musically pathetic. Dismally out of tune, dull, repetitive. Poor Blake.</p>	<p>Ginsberg is a good poet and a lousy musician—he records that way, for all of MGM's care and expertise in hi fi sound. Somebody put much work and money into this album. Nicely done up.</p>
<p>This Cantata Kit includes Vocal Score and Record. (Webber: Joseph and the Amazing Technicolor Dreamcoat.) Singing Hurricanes, Univ. Miami, Fla. (Belwin, Rockville Center, N.Y.) (\$3).</p>	<p>Confusing? Inside, 1 LP and 1 printed score, pop shorthand style. A vaguely rock-ish version of the Joseph story, vigorous and banal, the water-thin musical content done with enthusiasm and vigor to a rock beat. Nice if you like "musicals" of this sort.</p>	<p>Technically not bad—pop-style recording with synth. reverb, good balance of vocal and instr. forces. Stereo, though it doesn't say so. Score publ. by Novello, record done by Belwin. Tape?? Doesn't say.</p>
<p>How to stop smoking without using will-power. Howard Loy. RCA LSP 4311 stereo (\$5.98).</p>	<p>Look—I have no Problem; I don't smoke. And Mr. Loy says don't skip ahead, do the exercises on the indicated day... this is mainly a train-the-subconscious deal, via "relax, relax" messages, plus film star testimonials. If it works—then fine! Might as well try.</p>	<p>Well, it says stereo though the monologue voice hardly needs it. Too much trouble to do a genuine mono recording these days! Probably'd cost extra.</p>
<p>Russian Choral Music of the 18th century. U.S.S.R. Russian Chorus, Yurlov. Melodiya-Angel SR-40116 stereo. (\$5.98).</p>	<p>Oddly, the old Russian church music has mainly been recorded outside of Russia; but now the Russians are coming back to it themselves. Good. The music, sung in big Romantic style by enormous voices, has the harmonies of Mozart and Haydn—curious, intriguing style! Splendid singing, a cappella.</p>	<p>A big, rather distant stereo spread with good blend. But typically, the Russian recording still is edgy and uncomfortable in the loud parts. IM distortion mainly, I'd guess. Fine in soft portions.</p>
<p>Chinese Classical Music. Recording, notes, photos by John Levy. BBC Radio Enterprises. Westminster WBBC 8003 (mono) (\$5.98).</p>	<p>Not easy to get at Chinese music these days—except the flimsy, semi-Westernized pop and opera. This disk features the expected twangy, whining type of sound, mainly the Ch'in but also Cheng, P'ipa, Hsaio, etc... nice for atmosphere and excellent if you know anything about the vast traditional literature of this art.</p>	<p>Don't know where BBC recorded this—photos suggest the job is first-hand, not a Chinese-made reissue. In any case the (mono) sound is very good, entirely modern.</p>
<p>Wound-up opera. A Music-Box Spectacular! Great Hits from the Opera. Rita Ford Collection. Columbia MS 7338 stereo (\$5.95).</p>	<p>Rita Ford's mainly-big music boxes have been on disks before—this one is excellent of the sort. Much variety, numerous machines with diff. sounds and varied musical techniques. Music ranges from Rossini to Verdi plus Mozart, Meyerbeer, Gounod, etc. Some more successful than others—Wagner's shifting harmonies are amusingly impossible but Rossini's decorative style is perfect for the box. Nicely recorded, with incidental sound effects—winding up, etc.</p>	

BEETHOVEN EDWARD TATNALL CANBY

Beethoven: Three "Elector" Sonatas, WoO 47; Eight Variations, WoO 67 and Sonata in D, Op. 6, for piano duet. Jörg Demus, piano; Demus and Norman Shetler. Deutsche Grammophon 139 448 stereo \$5.98.

In this Beethoven year of plenty we will not often hear really new and unfamiliar music by the composer. This collection of early piano music, mostly from before the official Op. 1, is unexpectedly interesting. The music is virtually unknown and one wonders how it could have been so long ignored. Superb playing and recording bring out its best qualities.

The intriguing "WoO" items are part of the large quantity of youthful music that has come to light only recently and is now beginning to reach into our musical consciousness. "WoO" stands merely for "without opus number" but it represents a new body of Beethoven material, well worth the listening. The three "elector" sonatas were composed at approximately the age of 12 and published in 1783, when Mozart was just 27. (They were hopefully dedicated to the local

ruler, the Elector at Koln.) For a child of that age they are extraordinary, even beyond Mozart and Schubert. The style is familiar enough and astonishingly mature; one hears Mozart first, but also Haydn and, perhaps, C.P.E. Bach—though these influences of course were filtered through more-immediate composers, Beethoven's teacher Neefe, and others who wrote in the current style of the time. But what is most surprising is the remarkable suggestions of Beethoven himself, in phrase after phrase—the gruff, competent, brilliant pianist of later years already foreshadowed even to hints of the "Pathétique" and many other familiar works.

There are, to be sure, many too-easy figurations, a few clumsy moments and some pretentiousness—youth trying to sound grown up. But generally the composing technique is faultless and the works are consistently and beautifully built in their own terms; Beethoven had already learned to solve specific musical problems in the methodical fashion that was to be characteristic of his later life.

The Sonatas are immeasurably well

served by Jörg Demus, whose strong, beautifully phrased and sympathetic pianism is a joy to hear. It is hard to imagine them played with a better sense for their innate values.

The two works for piano duet are not far apart in style, though one is "WoO 67" and the other Op. 6. The Variations are forthrightly built on an interesting theme by Count von Waldstein, he of the later Waldstein Sonata and a long-time Beethoven patron; it is curiously advanced, with an almost sentimental, turn-of-the-century sound already scented with Chopinesque lights and colors. They do not bother the young Beethoven a bit. The Sonata Op. 6 is out of the "recognized" early Beethoven period, not very different in style from the "WoO" works but more suavely polished and better shaped, with fewer of the youthful experimental flashes of the earlier music. Grown-up, but for our ears perhaps less interesting.

The piano recording is the finest I have heard for a long time, an absolutely superb rendition of one of those mellow, woody sounding central European instruments, so unlike our brilliant Steinways. Why, why, can't we all make piano recordings like this?

Performances: A

Sound: A

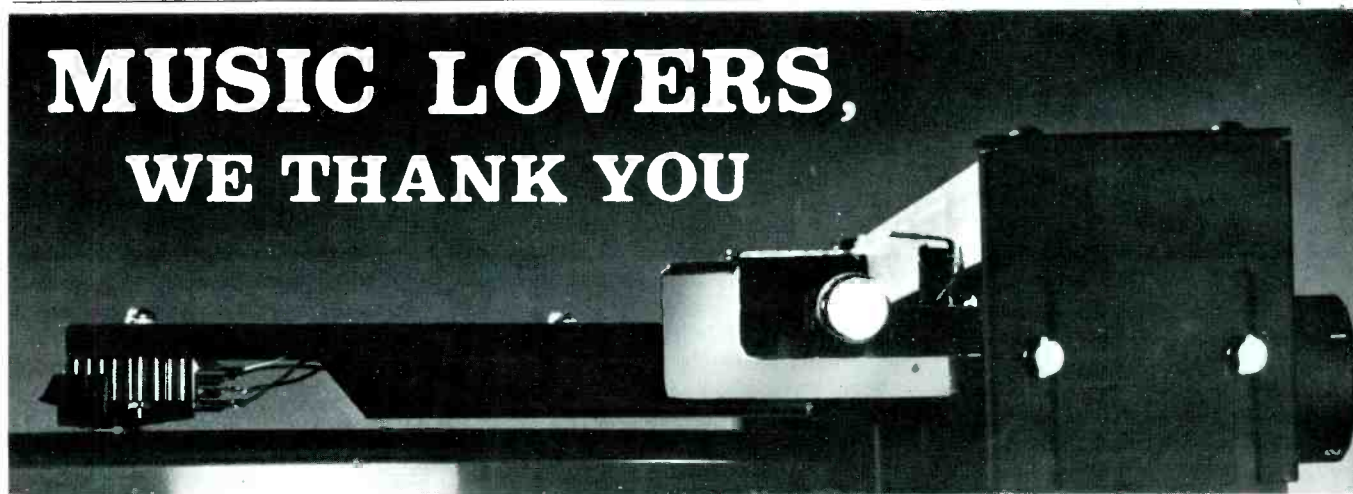

We thank you for your overwhelming interest; We thank you for the tens of thousands of inquiries; We thank you for your world-wide purchases; Above all else- We thank you for your praise, criticism, and your many kind suggestions.

In compliance with your most frequently expressed desire, our new SL-8E is equipped with an electrically-powered lowering and lifting mechanism. The touch of a button gently lowers the arm to the record. Another touch gently raises it.

We have, of course, incorporated this gentle action into the automatic trip at the end of play.

In all other respects, the SL-8E is the same superb record-playing mechanism as the SL-8.

Gratefully, RABCO

The makers of the only servo-driven straight line arm. Price in the USA - \$169.50

RABCO

11937 TECH ROAD, SILVER SPRING, MARYLAND 20904

Check No. 57 on Reader Service Card

NOB MUSIC

Sherwood L. Weingarten

Woodstock!

The name cannot fail to evoke a mental montage, flashing pictures of half a million youngsters basking in a sea of music, bodies, pot, and mud.

Peace!

Here, too, the mind's eye is filled with a sharp collage. But this brain-mural more than likely depends on which side of the political fence you sit, on which side of the generation gap you live.

Both Woodstock and peace have been much maligned. Both, according to some extremists, are obscenities—the former because of its hedonistic tone, the latter because it's a term that fits neatly into the so-called Communist conspiracy.

But there's another viewpoint, one to which I subscribe. Woodstock and peace become synonymous, and according to the new American Heritage Dictionary of the English Language, peace is "freedom from quarrels and disagreement; harmonious relations."

Gather half a million Establishment types anywhere and try to obtain the same sense of brotherhood achieved at that farm in New York state. It probably can't be done. Certainly it would be impossible given the shortages of food and water, the massive traffic tieups the shaggy-haired youngsters suffered.

Why was Woodstock so peaceful? Historians may argue that question forever, but most participants would agree with Max Yasgur, on whose farm the rock festival was held, when he said that the rock buffs proved to the world they could get together for just fun and music. A meeting of the minds, a communion with nature and the cumulative talent that appeared.

Woodstock, of course, is now fodder for gray-haired sociologists. But its effects—and commercial aftermath—linger. The recent film based on the festival gave millions a closeup of harmony—as well as those sparse moments of "anti-social behavior," the nude romps, the marijuana-puffing, the sprinkling of four-letter epithets. (Oddly, the movie code requires that parents must accompany "underage" youngsters, despite the fact that many of

these same music buffs attended in person what is being viewed on the screen.) And Cotillion has released a three-disk set of "music from the original soundtrack and more."

The WOODSTOCK recording (SD 3-500), which requires more than two hours of listening time, runs the gamut of contemporary pop music. As could be expected, the compendium is uneven—both musically and acoustically. Recognizing this, producer Eric Blackstead explains on the liner notes: "The music and sounds . . . were selected from 64 reels of 8-track tape recorded over a period of three and a half days in three continuous 18-hour sessions. Technical flaws, resulting from equipment failure as well as human overload, are inevitable in a venture of this size . . . Consider them like the scars in fine leather, proof of the origin and authenticity of the material in which they are found."

Regardless of the flaws, the album captures the feel of the festival, the mood of the audience, the excitement of the performers. Audiophiles may be disconcerted at times by microphone feedback, auto horns, audience cheering and/or clapping that interferes with musical interludes, seemingly non-pertinent announcements, and sounds of a rainstorm, but all that can add to the mood if one lets it.

Each listener, naturally, will have his own favorites. Highlights for me include tunes by John B. Sebastian, Richie Havens, Country Joe, Joan Baez, and Crosby, Stills & Nash.

The Sebastian original, "I Had a Dream," is a ballad that sets the theme for the festival—love, communication, and hope. The message of the song, first in the LP, is strong enough to overcome the fact that the composer-guitarist-singer really has no voice. The performer later offers "Rainbows All Over Your Body," prefaced by a statement alluding to the tent city that sprang up: "A flophouse is all you need if you've got love."

Havens adapts "Freedom," a soulful extravaganza that is perfect for his raspy

voice, from "Motherless Child." His heavy (in the colloquial sense) guitar work and roots vocal are met with wild applause.

Country Joe (McDonald) grooves with his background group, The Fish, on "Rock & Soul Music," an up-tempo mover—but he is even better on his own. "I-Feel-Like-I'm-Fixin'-to-Die Rag," his best known original, is probably the strongest anti-war statement in the package. A venomously sarcastic entry, his solo evidently turns on the youthful audience, which starts to sing along. The tune, not incidentally, is preceded by "The 'Fish' Cheer," a parody of your old high school or college yell—this time, however, utilizing one of the no-no cuss words.

Folksinger Baez, whose crystal tones seem almost out of place on a rock-oriented stage, offers two winners. "Drug Store Truck-Drivin' Man," a duet with Jeffrey Shurtleff, is a countrified success featuring pointed, understandable words. Shurtleff, who dedicates the song to the War Resisters Movement (which he says "has no enemies") and to "Gov. Ronald Rea-guns," has a pleasant voice that is particularly easy on the ears. The second Baez number, "Joe Hill," is the story of a union organizer carrying a theme that a man's ideals do not necessarily die when he does. Softly revolutionary, the tune apparently casts some sort of spell over the throng, for the audience is duly respectful and silent while it is rendered. Not incidentally, the raven-haired singer notes the tune is a favorite of her husband, David, jailed as a draft resister.

The Crosby, Stills & Nash combo deserves accolades for "Suite: Judy Blue Eyes," an eight-minute, eleven-second opus reminiscent of the Simon & Garfunkel sound. Though this was only the trio's second live performance (they refer, crudely, to their fear), it comes across flawlessly. Neil Young, who subsequently made the group a quartet, joins later for a pair of melodies in the country-rock mode, "Sea of Madness" (marred by what

seems a muffled sound) and "Wooden Ships."

Another highlight of the album is the beginning of Side Four, with a 2:20 segment of "Crowd Rain Chant," an improvisation (during the downpour) of what sounds not unlike Afro tribal rhythms. This is followed by still another peak, "Soul Sacrifice," by Santana, the innovative group that superimposes rock on a Latin backdrop.

Also spotlighted on the set are Arlo Guthrie, "Sha-Na-Na" (with a throwback to the '50s, "At the Hop"), "The Who" (with "We're Not Gonna Take It," from their rock opera, "Tommy"), Joe Cocker (with a frenzied version of the Lennon-McCartney tune "With a Little Help from My Friends"), "Ten Years After," Jefferson Airplane; Butterfield Blues Band (with "Love March," that in soft spots sounds as if the group's practicing); and Sly & Family Stone (with a hard soul medley of three, totaling 13:16).

Plus Jimi Hendrix doing his souped-up version of "Star Spangled Banner" (electric noise, at best).

Some listeners will be offended by the verbal pyrotechnics, others by lyrics that are anti-Establishment, pro-integration, and anti-war. But these are only parts of the total experience the LPs offer. For the package, which some will consider a collector's item as a snatch of history, has much to say to those who will listen. And if the album's symbol (a guitar with a hand on its strings and a dove on its neck) doesn't say enough, perhaps this quote from one of the announcers will:

"The man next to you is your brother and you damn well better treat each other that way because if you don't, you're gonna blow the whole thing."

A sharp contrast to the imperfect live reproduction of Woodstock is the studio-produced slickness of THE CORE OF ROCK (MGM SE-4669), another anthology. Looking backward a few years, the LP includes tunes that stress soul (Richie Havens), blue (The Enemies and The Blues Project), folk-rock (Tim Hardin), art-rock (Janis Ian), jazz (The Blues Project again), and pop-rock (Van Dyke Parks).

Best of the 11 songs (all but Miss Ian spotlight two) is Havens' "Handsome Johnny," a catalogue in song of American war history. Although an effective peace tune (which includes a racial note, mentioning the "War of Birmingham"), it is somewhat outdated by its not being able to include Nixon's expansion of the Indo-Chinese conflict into Cambodia. Havens also sings Bob Dylan's "Just Like a Woman."

Other melodies worth noting are Hardin's "If I Were a Carpenter" and "Reason to Believe," Miss Ian's "Society's Child," the Blues Project's jazz instrumental "Flute Thing," and Parks' "Come to the Sunshine."

All, however, are worth hearing—not only as a sampling of "golden oldies," but as good modern music.

CAPSULE CRITIQUES

... THE LAST SWEET DAYS OF ISAAC (RCA Victor, LSO-1169), an original cast recording (book and lyrics by Gretchen Cryer and music by Nancy Ford). Disappointing. Although pegged as a "rock musical," it is watered down to be commercial; the life, death, art, truth, and love themes it purports to display, furthermore, are victims of hit-and-run attempts. The principals' voices are merely adequate; only a secondary role, sung by C. David Colson, stands out.

... WALKIN' SHOES (Mine-MGM, MSG-1100), with country singer Joe South offering 10 tunes. This is a fast-buck re-release to capitalize on the new popularity of the writer-singer of "Games People Play." It's early rock 'n' roll here, backed by The Believers (South's voice often isn't distinguishable from the rest). Originally entitled "The Joe South Story."

... AARON LIGHTMAN (Poppy, PYS 40010), with lyrical emphasis on wanderlust and natural beauty. A classical-pop combination that soothes the armchair listener. Reflection is the keynote, softness the byword. An interesting concept LP, too, in that the music runs together without a noticeable break.

... LET THE SUNSHINE IN/MID-NIGHT COWBOY/AND OTHER GOODIES (Philips, PHS 600-337), with Paul Mauriat and his orchestra's breezy instruments (and wordless vocal chorus that is sweetness personified). Among the 10 tunes are "Sweet Charity" and "Square Party," which resembles a square dance thrown by Arthur Fiedler and the Boston Pops.

... PORTRAIT (Bell, 6045), showing that the Fifth Dimension is greater as a whole than individual parts. Group efforts such as the smash single "Puppet Man," plus "A Love Like Ours," "Save the Country" and a tri-tuned medley are marvelous; solo ventures, however, lack that certain spark to take them above the mediocre. THE 5TH DIMENSION GREATEST HITS (Soul City, SCS-33900) is a bargain set in that the package contains the Grammy-winning "Aquarius/Let the Sunshine In," "Stoned



WE GUARANTEE YOU'LL GET STONED !!!

At last Electro-Harmonix has developed a device that can literally get you stoned electronically. This revolutionary accessory, the **STEREO PULSE MODULATOR** can be conveniently attached to any stereo system be it components, console or a compact set.

Two pulses of existing music are continuously re-generated per channel, each with a separately adjustable speed and volume control. It is the mix of these 4 pulses with their intermittent beat frequencies that will give you a new high or reinforce one you already have.

The master volume control aids in balancing these stereo pulse pairs with your existing music.



(also available at your retail music or hi-fi store)

Every object and sub-object has a resonant frequency. The high achieved by the **STEREO PULSE MODULATOR** is a result of tuning in to your own resonant frequency.

All mail order sales are on a two week money back guarantee. We absolutely guarantee you'll get stoned using the **STEREO PULSE MODULATOR**. Buy it and try it. If you don't think it's the greatest return it for a full refund.

Enclose a check for \$49.95 and Electro-Harmonix will pay shipping. Or, if more convenient order C.O.D. for cost plus shipping.

electro-harmonix

15 West 26th St., New York, N.Y. 10010

Please ship **STEREO PULSE MODULATOR**

- Enclosed is check for \$49.95
 Please ship C.O.D.

NAME

ADDRESS

CITY STATE ZIP

'Now' Music

Soul Picnic," Up-Up and Away" and half a dozen more chartbusters.

... 33% REVOLUTIONS PER MINUTE (Stormy Forest, SFS-6006), starring a folk-rock singer-guitarist, Bruce Murdoch, who's trying too hard to be a combination of Bob Dylan, Richie Havens, and Phil Ochs. The baker's dozen tunes are mostly a plea for change, peppered with dissatisfaction with present-day society. Lowlight is "Che Guevara," a paean to the slain guerilla fighter that starts with poetic narration and contains

such oversimplifications as "Nazi rulers" when referring to Establishment leaders. A symptom of our times, but is the cure worse than the disease?

... MANCE LIPSCOMB VOL. 5 (Arhoolie, 1049), with the 75-year-old black blues singer from Texas providing authenticity on 11 songs. Heavy, tough guitar work is showcased in addition. For aficionados in particular.

... STARS OF THE 1960-1970 MEMPHIS COUNTRY BLUES FESTIVAL (Sire-London, SES 97015), with more authentic blues from the back country. Not live from the event, however, because it went untaped—but recreated in studios with the participants, Mississippi

Fred McDowell, Bukka White, Champion Jack Dupree, Furry Lewis and the late Joe Callicott (who was scheduled to appear but died before the festival was held).

... LENA & GABOR (Skye, SK15), with Miss Home singing with the exquisite clarity of voice that's become expected of her, and Szabo playing soft jazz guitar as well as ever (but not in the foreground often enough to make much of a dent here). Lots of Latinized, jazzy, bluesy numbers, thanks to Gary McFarland arrangements. Among the best; "Everybody's Talkin'," "In My Life," "Message to Michael" and "The Fool on the Hill."



Jazz Super Hits, Volume II Atlantic Stereo SD 1559

John Coltrane's *Equinox*, Charles Lloyd's *Sombrero Sam*, Hank Crawford's *Whispering Grass*, Ray Charles' and David Newman's *Hard Times*, Herbie Mann's *Philly Dog*, Jack McDuff's *A Change is Gonna Come*, and Yusef Lateef's *Russell & Elliot* are all distinguished achievements of the last decade of jazz recordings. Each was originally well recorded by Atlantic, a label that has always been one of the most proficient at the engineering level, and the new stereo tape-to-disk transfers are even better than the originals. For those who like a variety of moods and personalities on a platter, and for those who only want a few outstanding examples of modern jazz, this record is eminently worthwhile.

Performance: A Sound: A

Wes Montgomery—Eulogy Verve Stereo V6-8796

Clearly Verve intends to keep reshuffling and reissuing its collection of Montgomery recordings on the theory that new combinations of the old material will result in greater sales. Included are *Little Child (Daddy Dear)*, *Matchmaker*, *Mi Cosa*, *Sun Down*, *Boss City*, *Theodora*, *Tear It Down*, *Golden Earrings*, and *Moca Flor*. In spite of some rather ponderous orchestral backgrounds, the

Montgomery guitar speaks out clearly in some of the most agreeable, happily uncomplicated music making that one is ever likely to encounter. Verve can hardly be taken to task for increasing its availability.

Performance: A Sound: A

Erroll Garner Everest Simulated Stereo FS-245

Reissues of ten tunes cut with his trio a half dozen years before his celebrated *Concert by the Sea*, these Erroll Garner recordings offer sprightly performances, indifferently recorded, of *She's Funny that Way*, *Stormy Weather*, *Sunny Side of the Street*, *This Can't be Love*, *Somebody Loves Me*, *Moonglow*, *I'm Confessin'*, *Can't Believe that You're in Love with Me*, *Stompin' at the Savoy*, and *Red Sails in the Sunset*. The transfers from shellac pressings are of variable quality, and Everest's electronic re-recording technique adds a bit of fuzz to the sound without materially improving the directional effect. But Garner's magnificent stride style is infectious, and even when John Simmons' bass and Alvin Stoller's drums are indistinctly heard in the background, their pacing is felt in the swinging rhythms that have not always been present in this pianist's recent work.

Performance: A Sound: C

Earl "Fatha" Hines Everest Simulated Stereo FS-246

Seven first-rate recordings with Hines' piano backed by Gene Redd, trumpet, Leroy Harris, alto, Hank Milo, drums, Dickie Wells, trombone, Jerome Richardson, flute, and Paul Binnings, flute, are coupled with three oddities that find Hines matched with Morris Lane, tenor, Eddie South, violin, Bob Wyatt, organ, and unspecified performers on drums, guitar, and bass. The three strange items, recorded in Chicago in 1947, are *Honeysuckle Rose*, *Blues for Garroway*, and *Dark Eyes*. The last of these actually finds Hines playing a subordinate role to Eddie South, whose introduction is part of the cadenza from the last movement of the Tchaikovsky violin concerto. While the dated sound is not improved by Everest's electronic manipulations, the performances are splendid, and Hines is worth acquiring for his performances of *Nice Work if You Can Get It*, *The Web*, *If I Had You*, *Hollywood Hop*, *A Jumpin' Something*, *Gone With the Wind*, and *Humoresque*.

Performance: A Sound: C

The Coltrane Legacy Atlantic Stereo SD 1553

Just when everyone thought that the bottom of the barrel had been scraped and there was no new Coltrane material left, Atlantic offers a half dozen previously unreleased recordings made between 1959 and 1961. Two of the numbers are original compositions by Coltrane, 26-2 and an untitled piece played with McCoy Tyner, piano, Steve Davis, bass, and Elvin Jones, drums. Another untitled composition, a ballad by Billy Frazier, is the gem of the collection. Nearly nine minutes in length, it features

Eric Dolphy, flute, Freddie Hubbard, trumpet, and McCoy Tyner, piano, with Art Davis, bass, and Elvin Jones, drums. Everything is sweetness and delicate filigree. No message is in these graceful tunes, nor is there any in *Centerpiece*, *Stairway to the Stars*, and *Blues Legacy* that make up the balance of this set. The last three titles were performed with a group that included Milt Jackson, vibes, Hank Jones, piano, Paul Chambers, bass, and Connie Kay, drums. None of the performances throws any new light on Coltrane, but they are all well-performed, well-recorded, highly musical expressions.

Performance: A Sound: A

The Best of Charles Lloyd
Atlantic Stereo SD 1556

As in the earlier releases in its "Best of" series, Atlantic has made a serious effort to select important landmark recordings in the artist's career. This fine set contains material derived from live performances at the Monterey Jazz Festival of September 1966, at San Francisco's Fillmore Auditorium in 1967, and from a session in 1966 at Atlantic's New York Studio. Included are Lloyd's familiar two-part *Forest Flower—Sunrise and Sunset*, *Sombrero Sam*, *Dream Weaver*, and *Love-In*. It is convenient to have so many of the important Lloyd compositions available on a single set, particularly when the sound is as bright and crisp as on this very welcome reissue.

Performance: A Sound: A

The Best of Ornette Coleman
Atlantic Stereo SD 1558

Selected from Atlantic recordings made from 1959 to 1961, the half-dozen pieces here presented represent highlights from the early recording career of a major artist. Included are *Una Muy Bonita*, *Embraceable You*, *Blues Connotation*, *Lonely Woman*, *Ramblin'*, and *C & D*. Playing with Coleman are Don Cherry, trumpet, and Charlie Haden or Scott LaFaro, bass, and Ed Blackwell or Billy Higgins, drums. This is leaner music than Coleman's more recent work, and it has little of the warmth that he later achieved through richer instrumentation, but it effectively exposes the clarity of thought and the sound structure of this artist. The sound compares favorably with the present state of the art. It is hard to believe this material was taped a decade ago.

Æ

Performance: A Sound: A

The Computer in Sound System Design

(Continued from page 23)

ried anywhere in the reverberant field without danger of encountering an increased level that will cause acoustic feedback.

Further, it can be seen that in a given room where S remains fixed the only way to change D_c is to change either a or Q .

One of the easiest ways to change the Q of a loudspeaker is to stack two of them in a vertical line. If cones are used, the Q will shift continuously with frequency. If horns are used, it is possible to find wide frequency areas where Q is relatively under control. One of the real indications of a professional sound contractor is his knowledge and use of the loudspeaker's Q in designing complex loudspeaker arrays.

To change a requires increasing the total number of sabins (sa) in the space. The D_c formula allows the sound engineer to examine this change in detail for each space he works in. Figure 7 allows the quick calculations of D_c from Q , S , and a .

To be continued

Electronics for Public Address

(Continued from page 38)

The signal stays clamped until C3 discharges, allowing Q12 and Q13 to return to their normal non-conducting mode. In normal operation, all transistors Q5, Q6, Q10, Q11, Q12, Q13, and Q14, used for protection are non-conducting. The remaining transistors serve the normal amplifying functions.

The time constants associated with C1, C2, and C3 are chosen to provide guaranteed protection, with minimum unnecessary interference with signal. This is one variation of a whole range of new circuits that are making transistors as "foolproof" as tubes.

FREE!
Product Information

Simply complete the Reader Service Card (back of issue), noting the reader service number on advertisements and editorial material. We'll handle the rest.

The all new PE-2040
PERfection in PERFORMANCE



Your inevitable choice among automatic turntables. Sooner or later other automatic turntables will incorporate the exclusive features now available on the new PE-2040: Dial-a-Matic vertical tracking angle adjustment for all records . . . Independent, ultra-gentle, fingertip cueing control . . . Fail safe stylus protector . . . Automatic record scanner . . . Single lever control for all modes of operation . . . Continuous record repeat. These are just some of the exclusive features. Stop by at your PE dealer for the complete story and a demonstration of PERfection in Performance. PE-2040—\$145.00; PE-2038—\$115.00.

Elpa Marketing Industries, Inc., New Hyde Park, N.Y. 11040



PERfection in PERFORMANCE



please
write
for a
free

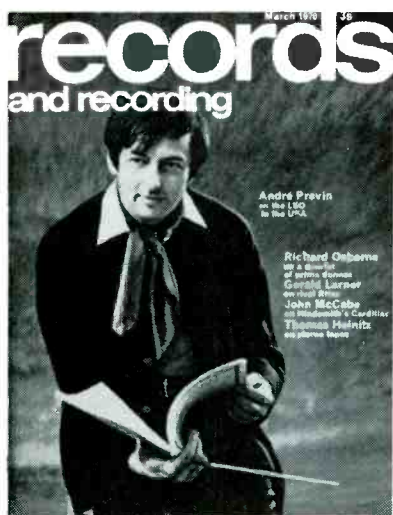

introductory
copy

WRITE YOUR NAME & ADDRESS HERE.
CUT & POST THIS COUPON or write a
separate letter to

RECORDS AND RECORDING,
75 VICTORIA STREET, LONDON, SW1.

name _____
address _____
city _____ state _____

Check No. 62 on Reader Service Card

Recorded Tape Reviews

BERT WHYTE

CASSETTES

Orff—Carmina Burana. Eugene Ormandy conducting the Philadelphia Orchestra. Columbia cassette 16 11 0152, \$5.95

Stravinsky—Le Sacre du Printemps. Pierre Boulez conducting the Cleveland Orchestra. Columbia cassette 16 11 0154, \$5.95

These two cassette recordings are quite extraordinary, from the standpoint of both musical performance and sonic excellence. The Ormandy treatment of the Orff work is now considered near-definitive. His sense of balance and proportion in this essentially rhythmic work is quite remarkable and the playing of the orchestra and the choral work are superlative. The Boulez performance of "Le Sacre" is still being weighed and evaluated and he has his full measure of supporters and nay-sayers. It is certainly close to Stravinsky's own ideas and is even more detailed. Admirers of the work will probably want to acquire this "different" version for its uniqueness. My own feeling is that it may be a little too lean and astringent for most tastes. You know, I can easily quibble about certain inadequacies in the sound quality of these recordings. Even though the hiss level on these cassettes is quite low for this medium, there is still too much to ignore. There is also some occasional overload distortion, and some print-through. But when one considers that the tape speed is a snail's pace 1½ ips, the overall quality is quite astonishing. Had we heard these recordings in the monophonic era of not too many years ago, their *low noise and distortion and their great presence* would have been considered miraculous! Listen to these cassette recordings though a really top-quality wide-range system, and you will be surprised by the good high-frequency response, clean transients, fairly wide dynamic range. If your speaker is one of the few that can really reproduce 30 hertz, you will hear bass drums in "Le Sacre" with a solidity and impact you will find hard to believe. It must be said that extended low-frequency response is actually aided by slow tape speeds. Nonethe-

less, this quality of bass reproduction is a real plus for this medium. Don't misunderstand me... good as they are these cassette recordings are by no means the equivalent of a good open-reel tape or top-quality disk. But for many people, their quality is acceptable *right now*. For the serious audiophile, it is obvious that the cassette needs technical improvements in a number of parameters. With the use of the Dolby System imminent and advanced new tape formulations waiting in the wings, the high-quality cassette may be a reality sooner than anyone thought possible just a few months ago. This will spur the development of a really high-quality cassette deck, which with few exceptions, is something that has been sadly lacking in the hi-fi market.

Wagner—Tannhauser (Overture and Venusberg Music); Richard Strauss—Suite from Der Rosenkavalier. Erich Leinsdorf conducting the London Symphony Orchestra Ampex/London L75037, open reel, 7½ ips, \$7.95

This is one of London's "Phase Four" recordings which I always approach with some trepidation. Experience has taught me that I can expect a good recording as far as distortion and signal-to-noise ratio are concerned, but in matters of balance and acoustic perspective one never knows whether there will be some gross exaggerations or a reasonably straightforward treatment. In this recording there are a few places where some instruments are dynamically blown up far out of proportion to their normal values, but for the most part instrumental balance, stereo perspective, and directional information are not exaggerated.

Erich Leinsdorf is a conductor who has done a great deal of recording, and knows how to work with engineers to achieve his desired objectives. In these two sturdy warhorses he manages to combine a finely detailed view of the inner aspects of these complex scores, with equal regard for the essential lyricism of the works. The Venusberg Music soars with passion and excitement and Leinsdorf elicits some quite extraordinary string playing from the London Symphony. In the suite from Der Rosenkavalier, the very Viennese Mr. Leinsdorf is at his best and in his loving performance, he shows us how the waltz sections should be played—gay, frothy confections that are the echo of a bygone era. A special tip of the hat to the french-horn players of the London Symphony, who traversed the many lip-busting horn passages in this work with seeming ease and consummate beauty of tone. All in all, a very pleasing recording.

"APPLAUSE"—Original cast Album with Lauren Bacall Ampex/ABC, L11, open reel, 7½ ips, \$7.95

In a somewhat dismal Broadway season, this new musical was one of the few productions which opened to critical acclaim. I haven't seen it yet, but friends who have tell me the rave reviews are more than justified. Based on the movie "All About Eve," this play makes a successful transition from drama to musical with the benefit of witty, sophisticated lyrics and a score that is an admixture of the big, bright, punchy, Broadway production numbers, romantic ballads, and a couple of songs with a touch of the bittersweet. There is little question that Lauren Bacall is the star of this vehicle. In the role played by Bette Davis on the screen, Lauren is just simply marvelous. She quite dominates the production and in the numbers I heard on this recording, she sings them in a fascinating blend of gusto and insouciance, in that inimitable "whiskey baritone" of a voice. The rest of the cast seemed to handle their roles quite well, and on an overall basis what I heard in this recording would indicate a visit to the theatre . . . if I can ever get hold of a ticket! (better make that plural, or my wife will kill me). The sound on this tape is generally nice and clean, with good intelligibility in the vocals. However, there is an impression that everything seems a bit "cramped" acoustically and a smidgen more reverb might have helped to create a better sense of liveness.

8-TRACK

Henry Mancini and Orch.—Theme from "Z" and other film music RCA-P8S1583, 8-track cartridge, \$5.95

As the title indicates, here is a sampling of music from recent films such as "The Adventurers," "Airport," "Patton," and an oldie from "Casablanca." A good deal of the music could be dismissed as trite and trivial. Even so, Mr. Mancini has an uncanny ability to make the music attractive with his superior arrangements and the excellent playing he gets from his orchestra. As an example, the love theme from "Airport" is dressed up with a trombone solo that is both tenderly beautiful, yet the essence of sophistication. The theme from "The Molly Maguires" is a study in clever orchestration and once heard, sticks in your mind. The overall sound is bright and clean, with wide dynamics and just the right amount of reverb for good presence. Very realistic tympani sound in the "Patton" theme. Good tape processing here with no audible crosstalk or print-through. Hiss level moderate at room-filling playback.

We put a little more feature into each feature.

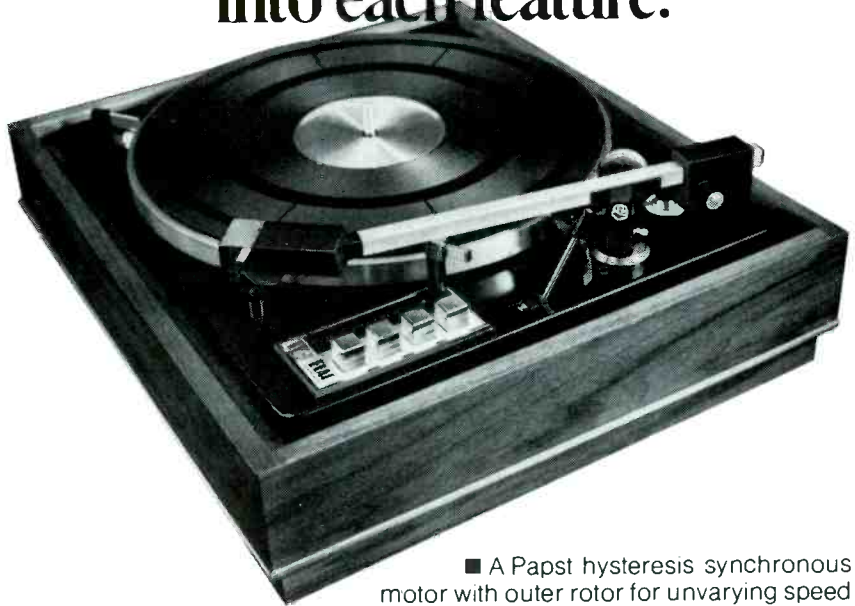

■ A Papst hysteresis synchronous motor with outer rotor for unvarying speed accuracy. ■ Precise stylus overhang adjustment with built-in gauge—no shifting, no guesswork, no templates. ■ Silicone-damped cueing in both automatic and manual play. ■ And, those exclusive light touch pushbuttons to make it easy to enjoy all those other wonderful 50H features \$169.50 at your hi-fi dealer. Benjamin Electronic Sound Corp., Farmingdale, N.Y. 11735, a division of Instrument Systems Corp.

MIRACORD 50H

Check No. 20 on Reader Service Card

FREE

McIntosh CATALOG and FM DIRECTORY

Get all the newest and latest information on the new McIntosh Solid State equipment in the McIntosh catalog. In addition you will receive an FM station directory that covers all of North America.



MX112

FM STEREO/AM TUNER PREAMPLIFIER
— ALL SOLID STATE

SEND TODAY!

McIntosh Laboratory Inc.
2 Chambers St., Dept. AE11
Binghamton, N.Y. 13903

NAME _____

ADDRESS _____

CITY _____ STATE _____ ZIP _____

CLASSIFIED

Rates: 25¢ per word per insertion for noncommercial advertisements; 50¢ per word for commercial advertisements. Frequency discounts as follows: 2 times, less 15%; 6 times, less 20%; 12 times, less 30%. Closing date is the FIRST of the second month preceding the date of issue. *Payment must accompany all orders under \$10.00.*

SERVICES

**HIGH FIDELITY SPEAKERS REPAIRED
AMPRITE SPEAKER SERVICE**
655 Sixth Ave., New York, N.Y. 10010
CH 3-4812

RENT STEREO TAPES \$1.25 week. Catalog 25¢, Tape Library, Box 8126, Washington, D.C. 20024.

CUSTOM STYLUS and cartridge re-tipping, re-pairing. (Weathers, Ortofon, Edison, Shure, etc.) Box 322A, Tuckahoe, N.Y. 10707, 914-SP 9-1297.

FREE — FREE — FREE — FREE — FREE
Send in for your FREE one year subscription to Olson Electronics' fantastic value-packed catalog—unheard of low, low prices on brand-name speakers, changers, tubes, tools, stereo amplifiers, tuners, CB, and other values. Credit plan available. If you have a friend interested in electronics, send his name and address for a FREE subscription also. Olson Electronics, Dept. AH 260 S. Forge St., Akron, Ohio 44308.

RECORDING for radio producers, agencies, musicians. Mono & Stereo. Evening and weekend sessions available. DEMOVOX SOUND STUDIO, 1038 Bay Ridge Avenue, Brooklyn, N.Y. (212) 680-7234.

SURPRISED? You will be with the contents of The Hi-Fi Newsletter. Free information or \$1 sample issue (refundable) with subscription. Box 593, Hialeah, Fla., 33011.

CUSTOM RECORDING SERVICE. Tape and disk. Stereo and mono. Live and copies. Editing. Masters and pressings. High quality at reasonable rates. Joseph Giovanelli, Audio-Tech Laboratories, 2819 Newkirk Ave., Brooklyn, N.Y. IN 9-7134.

LEARN Electronic Organ Servicing at home. All makes including transistors. Experimental kit—trouble-shooting. Accredited NHSC. Free Booklet. Niles Bryant School, 3631 Stockton, Dept. 1D, Sacramento, Calif. 95820.

FREE LITERATURE: Address labels, business cards, printing, rubber stamps. JORDAN'S, 552 West O'Connor, Lima, Ohio 45801.

MAKE FRIENDS WORLDWIDE through international correspondence. Illustrated brochure free. Hermes, Berlin 11, Germany.

PROTECT YOUR LP's. Poly sleeves for Jackets 5¢, Inner sleeves 4¢, Poly lined paper 10¢, White Jackets 25¢ Minimum order \$5.00. House of Records, Hillburn, N.Y. 10931.

SERVICES

ACOUSTECH Amplifier Repair under direction of personnel originally in charge of servicing these units. Original performance with added reliability or improved specification modifications. For information, write BKM Associates, Box 22, Wilmington, Mass. 01887.

ACOUSTIC RESEARCH, Dyna, Koss, Shure discount specialists. Write for free catalog. SCS Corp., 95 Vassar St., Cambridge, Mass. 02139.

FOR SALE

STEREO TAPE TRANSPORT. Made for leading manufacturer, two-speed, pause control, 7" reel, 50-15,000 Hz, 0.25% wow and flutter, with record/play and erase heads. Without case. Send money order or check for \$19.50 to Stereo Center, 218 Columbia Street, Utica, New York 13502. Add \$2.50 for prepaid shipping & insurance.

Professional Stereo Tonearm — similar to Shure M232 or Rek-O-Kut S320. Plug-in shell, finger lift, adjustable counterweight, no springs, heavy connecting cables with pin plugs, beautifully balanced. One-year warranty. Made by famous turntable-arm manufacturer in Switzerland. Send check or M.O. for \$9.50 plus \$1.50 for shipping and insurance. Stereo Center, 218 Columbia Street, Utica, N.Y. 13502.

HOBBYISTS, experimenters; black and white television converted to color by means of a new patented color converter adaptor circuit. Installation all do-it-yourself. Write for free brochure. Bele Electronics Corp., 111 N.E. Second Ave., Miami, Florida 33132.

AMAZING DISCOUNTS on famous brand high fidelity stereo components. No small wonder that we have set new sales records each year since 1959. Write. Arkay Electronics, 1028-05 Commonwealth, Boston, Mass. 02215.

TAPE TIMERS: The professional way of synchronizing tape movement with timing accuracy. PRO Model 15-7½ ips \$99.95. Standard Model 7½-ips \$49.95. Write for catalog. TIMEKEEPER, Box 762, Mineola, N.Y. 11501.

HI FIDELITY CABINETS? Ask your dealer about Toujay designs or visit our factory showroom. 146 E. 53rd St. N.Y.C. 10022.—Tues. thru Sat. 10 to 5:30. Full-line brochure & colored chart. Send 25¢.

FOR SALE

FLORIDA AUDIOPHILES!
REVOX specialists in S. E. Florida. Special deals on Scotch 203 and Audiotape Formula 15 with purchase. Exclusive regional dealer for state-of-the-art S.A.E. equipment, reviewed in **The Stereophile**. Beyer, Thorens, Ortofon, P.E., Stanton, Sony, K.L.H., Bozak, Dyna, others, and imported English brands. Special package deals. Interiors Plus Sound. 2400 E. Las Olas, Ft. Lauderdale, Fla. 33301.

SCULLY Professional Tape Recorders, from 1 to 24 tracks, complete recording studio package designed to order featuring W.A.L. console systems and other leading professional audio products. Phone (201) 681-6443, Weigand Audio Laboratories, 3402 Windsor Road, Wall, N.J. 07719.

ARM/cartridge performance kit. Includes: Tracking Error Gauge, Tonearm Positioning Gauge, Cartridge Positioning Gauge, Alignment Mirror, and complete instructions. \$15.00 P.P. **ADVANCED ACOUSTICS/DESIGN** 4175 Neil Rd., Reno, Nev. 89502. Dealers invited. More coming!

CONSUMERS CASSETTES and Accessories. Blank Cassettes as low as C-30 . . . 50¢, C-60 . . . 54¢, C-90 . . . 99¢, C-120 . . . \$1.22. All Cassettes licensed quality control by North American Philips. Lifetime guarantee. **WRITE FOR FREE CATALOG!** **CONSUMERS ELECTRONICS CO.,** 103 Park Avenue, Dept. AM, New York, N.Y. 10017.

Western Electric 594A drivers with multicellular 26A matching horns; 713C, 555 drivers and horns. Real collectors item: Bell Labs cornucopia shaped 60-Hz horn with matching 60-6000-Hz driver. JBL 375, LE-85, LE-75, 130B, D130. Electro-Voice Patrician IV bass horns, Centurion. Marantz electronic crossovers. Dyna Mark III, Stereo-70, Fisher 200B, Revox A77, Ampex 601-2, Thorens TD-124, SME arm. Paul Lambidakis, 7213 Cedar Ave. Takoma Park, Maryland 20012.

Tandberg 164lx, with carrying case, dustcover, like new, \$200.00. Rectilinear III's, \$400.00. KLH-9's, stands, \$850.00. Bozak B-4000 Symphonies (Modern), \$750.00. Marantz 20 tuner, \$425.00. Ampex 2160 deck, \$275.00. Heath GR-180 TV, \$225.00. All guaranteed excellent condition; will consider all offers. Box 54, Fayetteville, Arkansas 72701 or 501-521-5374.

SHERWOOD crossover sale. Brand new factory sealed cartons 12 dB per octave—8-16 ohms, 800 Hz—\$6.50. 3500 Hz—\$4.50—guaranteed. Cash with order. Musicraft—48 E. Oak Street, Chicago, Illinois 60611.

AMPEX 350: electronics \$250.00; ¼-track stereo head assembly \$80.00. **BERLANT BR-1** full track 10"-reel recorder with spare amplifier \$375.00. Ronald Beery, 178 W. 15th, Holland, Mich. 49423.

PATENT RIGHT for sale—Tonearm. Servo-controlled straight-line tracking. U.S. inquiries. J. Jeles, Box 182, Chemainus, B.C., Canada.

Ampex 800 recorder \$150. J.B.L. SE400S basic amp. \$150. H-K Citation I preamp. \$110. Like new in cartons, E. Toby, 1950 N. Nashville, Chicago, Ill. (312) 889-0656.

REL PRECEDENT FM Tuner, excellent condition, will mount perfectly in McIntosh 2105 walnut case. \$175 firm. R. Levin, 26 Swan Place, Arlington, Mass. 02174.

INFINITY SYSTEMS—the finest reproduction possible today. Paul Heath, 81 Big Tree Street, Livonia, N.Y. 14887

Name Brand Audio Equipment; Tape At Wholesale Prices; Free Catalog. **TONES,** 3719 Elm, McHenry, Ill. 60050.

FOR SALE

Viking Studio 96 professional tape transport with ¼-track stereo record, erase, play heads. No electronics. Accepts 10" reels. Used less than 5 hours. \$250. JBL Speakers: complete S7R complement, LE-15A \$90; PR-15 \$18; LE-85 \$100; HL-91 \$28; LX-5 \$50—or will sell entire package for \$250. All in superb condition. (Prices F.O.B. Centerport, N.Y.) W. G. Wohleking, 10 Cranbrook Drive, Centerport, N.Y. 11721.

MICROPHONES—Condenser, Ribbon, Dynamic. Precision-built in West Germany, top value, performance, and appearance. Write for distributor costs, catalog and FREE booklet, "How To Choose and Use Microphones." Stanford International, San Carlos, CA. 94070.

1-inch Scotch (1 ROB-10½M) empty NAB reels and boxes. New, unopened, cartons of 5; \$3.50 per reel. Cash, money order, check. Minimum order 10 reels prepaid. Sample, prepaid: \$4.20. Picture free on request. Helffrich Recording Labs., R.D. #2, Allentown, Pa. 18103.

COMING SOON! The world's most complete collector's catalogue of radio programs on tape, with fabulous original illustrations and rare photos from the world's foremost radio library of RADIO'S MEMORABLE YEARS. Don't miss out. Reserve your copy today. Only \$2.00 postpaid (refundable). Send bank draft, check, or money order (no cash) to RADIO'S MEMORABLE YEARS, INC. Box 686, Allentown, Pa. 18105.

TEAC A-4010 Tape Deck. Mint Condition. \$375. Lt. J. Bradwell, USS Bon Homme Richard, FPO San Francisco, Calif. 96601.

NEUMANN U-87 mics (pair) with power supply and cables, as new, \$700.00. Bill Hagara, 2003 Spruce, Duncan, Okla., 73533. (405) 255-6805.

ADVENT Frequency Balance Control stereo equalizer, \$225 Prepaid with free Stereo LP "Seven Steps to Better Listening." Advent Dolby systems, \$250 Prepaid. Radex Electronic Studios, Freeport, Illinois 61032.

CUSTOM SPEAKER CABINETS to your specs., and duplication of any discontinued enclosure. Price list available. Custom sound systems installed in Wash. D.C. area, Custom Audio Components, 3921 Lantern Drive, Wheaton, Md. 20902. 942-8540.

FISHER Dynamic-Noise-Suppressor amplifier. Perfect working order. New tubes, schematic. \$225. Arthur Shifrin, Box 5, Flushing, N.Y. 11364.

MODULES FOR ALL TYPES of applications. Discrete to thick-film IC devices, Preamplifiers to power amplifiers. New Catalog with schematics, \$1.00. PM Electronics, Inc., Box 46204, Seattle, Washington 98146.

McIntosh 250 Stereo Amp., \$260.00; Fisher TFM1000 S. S. Tuner, \$275.00; AR3's with stands, \$300.00. All Practically New. LONG, 79 Chittick Rd., Hyde Park, Mass. 02136.

FOR SALE: One McIntosh MR-71 Tuner, original carton, like new, \$225.00. John Donmoyer, 2635 Parkway Blvd., Allentown, Penna. 18104.

BUY-SELL-TRADE: AR, Altec, Advent, Marantz, Sony, Dynaco. SHURE V15-II improved, \$47 and old cartridge, shipped prepaid. STEREO Shop, 1201 Ellis, Cedar Rapids, Iowa 52405.

McIntosh Mc-2105 power amplifier, brand new, \$460. Warranty. H. D. Smith, 310 S. 3rd Avenue, Lebanon, Pa. 17042. Call evenings (717) 273-6314.

SPECIAL PRICES on ROBERTS equipment—writer, Starlite Photographic Company, 14578 Tuller, Detroit, Mich. 48238.

FOR SALE

FM BACKGROUND MUSIC without commercials available on many FM stations! MUST-CON Adapter plugs into your FM Tuner, delivers continuous music through your amplifier and speakers. Line-cord operated. No adjustments or tuning, ever. New design breakthrough guarantees optimum performance (15-day refund for any reason). Lowest price ever—\$35 postpaid to K-LAB, Box 572A, S. Norwalk, Conn. 06856.

TEST RECORD RRM-002 for precise evaluation of disk-playback equipment. Measure Frequency and Phase Response, Noise and Distortion, Speed Variation. \$7.50 Available only from TIMEKEEPER, Box 762, Mineola, N.Y. 11501.

KLIPSCH, TANNOY, BOZAK, MARANTZ, THORENS, RABCO—No Discounting—Superior Sound, 1801 Brewerton Rd. (Rt. 11) Syracuse, N.Y. 13211.

FILIGREE WOODWORK. Custom-made precision product for speaker cabinets, etc. Send 50¢ for sample to the Winchester Co., Box 937, Pacific Palisades, Calif. 90272.

FREE LP and other extra savings. Send for your low, low quotation today. DISCOUNT SPECIALISTS, Box 2576, Hialeah, Florida 33012.

Crown CX-822 tape recorder, Lo-24. Also Crown SX-724 tape recorder. Call evenings. (609) 854-3448.

PROTECT YOUR RECORDS. Cardboard replacement covers, plastic lined inside sleeves, 78 and 45 covers and sleeves, multiple record set boxes, 12", 10", 7". Cabco A-1, 89 East Woodruff, Columbus, Ohio 43201.

SAVE OVER 33½% on a pair of one of the world's best speaker systems shipped direct to you from factory. Try them in your home for thirty days. Write KGLL, Inc., Water St., Lewiston, Maine 04240.

DISK RECORDING EQUIPMENT: Complete mono and stereo cutting systems featuring rebuilt Scully, Neumann, Van Eps, and Fairchild lathes and new W.A.L. amplifiers. Priced from \$2500.00. Wiegand Audio Laboratories, 3402 Windsor Road, Wall, N.J. 07719

FREE Catalog: Low-priced, high-performance subminiature listening devices direct from manufacturer. Dealers welcome. Audiotronix Adm. 7, 156 Fifth Avenue, New York, N.Y. 10010.

BLANK 8-TRACK CARTRIDGES. Do Your Own Recording on 8-Track Cartridges. Write Stereo Shack, Box 794, Miami, Florida 33143.

IMPROVED SHURE V15-II, \$47.00 and your old cartridge, shipped prepaid. The Stereo Shop, 1201 Ellis, Cedar Rapids, Iowa 52405.

WORLDS BEST TAPE, Box 18026, Seattle, Washington 98118.

FREE CATALOG offers high fidelity speaker systems at manufacturer's prices. CTAL, Box 543, Newark, Calif. 94560.

BACK DATE MAGAZINES! Send needs. Midtown, Box 917-AU, Maywood, N.J. 07607.

COMPONENTS at rock-bottom discounts. Write for quotes. StereoCom, Box 38582, Dallas, Texas 75238.

OLDIES—45 RPM. Original hits. Over 4000 available. Catalog 50¢. C & S Record Sales, Box 197, Wampsville, N.Y. 13163.

REVOX RECORDERS, Box 18026, Seattle, Wash. 98118.

FOR SALE

Klipschorns, plus Heresy speakers; Acoustech X system, Tannoy Autograph Professional speakers, McIntosh C-24, MR 71, Thorens 125, Dual 1019, 1219, others, all mint, sacrifice, Paul Heath, 81 Big Tree St., Livonia, N.Y. 14887

Two Ampex AG-440-2U Tape Recorders, mint condition, \$1900.00 each. Elvis Hughes, 401 Fifth St., Carmi, Ill. 62821.

Crown 714C 2-chan., 4-tr. Recorder with Ampex hub adaptors. Excellent condition. Highest bid. Will answer all inquiries. Paul A. Wittosch, 16305 Kenwood, South Holland, Ill. 60473.

EQUIPMENT WANTED

WANTED: Recording of Lily Pons's San Francisco La Traviata. Please write to Phillip Polite, 950th Ninth, San Diego, California 92101.

CASH FOR YOUR unwanted LP's and pre-recorded tapes. Record House, Hillburn, New York 10931.

Viking RP-120 Record/Reproduce Amplifier. W. G. Wohleking, 10 Cranbrook Drive, Centerport, N.Y. 11721.

Marantz 7 or 7C . . . L. Berggren, Helmfeltsg. 7, S-211 48 Malmö, Sweden.

CROWN CX-822 w/Lo-Z inputs. David Schultz, RFD 2, Storrs, Conn. 06268.

HELP WANTED

SERVICE TECHNICIAN. One of the country's foremost professional equipment importers seeks ambitious lab technician with enough imagination and ingenuity to handle the repairs on a wide variety of equipment under the supervision of a European graduate engineer. Salary open. Contact Mr. Delamater, Gotham Audio Corporation, 2 West 46th Street, New York, N.Y. 10036 (212) 265-4111.

SERIOUS RECORDISTS to make records by largest manufacturer. We train, equip, and provide protected franchised territories. Modest investment required. Send resume to Mr. Bloch, 418 N. Main St., Englewood, Ohio 45322.

WORKERS needed. Go to work immediately! Information send stamped, self-addressed envelope: Box 67, Rising Star, Texas 76471.

ADDRESSERS (Commission Mailers) Wanted. Everything Supplied. Details 25¢. Smyre's, Box 953-D, Newark, N.J. 07101.

RECORDS

"HARD To Get" records—all speeds. Record Exchange, 842 Seventh Avenue, New York, N.Y. 10019.

BUSINESS OPPORTUNITIES

MAKE BIG MONEY raising chinchillas, rabbits, guinea pigs for us. Catalog—25¢. Keeney Brothers, New Freedom, Pa. 17349.

SELL—LEASE—BUY

AMPEX AG-350-1 portable for lease. Best offer. Ken Robinson, General Delivery, Williamsburg, Va. 23185.

STOLEN

MA5100 S/N 53 H 92 Pgh., Pa. on 2/6/70 Contact B. R. McAvoy (412) 621-2791.

**GET
MORE and BETTER
FM Stereo Multiplex
BROADCASTS**

WITH
FINCO[®]

Award Winning FM Components

FM ANTENNA
Model FM-4G

\$28.50 list

FM BAND
PASS FILTER
Model 3007
\$7.30 list

FM INDOOR
AMPLIFIER
Model 65-7
\$24.95



Write Dept. AM-8 - for Catalog 20-213

THE FINNEY COMPANY
34 W. Interstate St., Bedford, Ohio 44146

Check No. 21 on Reader Service Card

Advertising Index

Acoustic Research, Inc. 37
Altec Lansing 29
Audio Dynamics Corp. 53

BASF Systems, Inc. 16
Benjamin Electronic Sound Corp. ... 63
British Industries Corp. 3

Classified 64
Crown International 13

Dolby Laboratories, Inc. 5
Downtown Audio 66
Dynaco, Inc. 15

electro-harmonix 6, 59
Electro-Voice, Inc. 14
Elpa Marketing Industries 51, 61

Finney Company, The 66

Garrard Sales Co. 3

Hi-Fidelity Center 66

JVC America, Inc. 7

3 M Company 55
Marantz Company 34-35
McIntosh Laboratory, Inc. 63

Pickering & Company, Inc. ... Cover III
Pioneer Electronic U.S.A. Corp. Cover IV

RCA Magnetic Products 1
Rabco 57
Record Club of America 8-9
Records and Recording 62
Rectilinear Research Corp. 33

SCA Services 66
Sansui Electric Company, Ltd. 43
Scott, H. H. Inc. Cover II
Sharpe Instruments, Div. of
 Scintrex, Inc. 2
Shure Brothers, Inc. 11
Sony Corporation of America 30-31
Sony/Superscope 17, 39
Stanton Magnetics 19

TDK Electronics, Inc. 47
TEAC Corporation of America ... 24, 25

VM Corporation 40-41

**Enjoy Relaxing
Background Music at Home
with NO COMMERCIALS!**



Our SCA-1 Decoder makes possible reception of this "private" musical programming, transmitted by nearly 400 FM stations around the country. YOUR FM tuner or receiver can recover this "hidden" music with the simple addition of an SCA-1.

Hook-up in minutes—full instructions supplied. SCA-1 is self-powered . . . uses all solid-state circuitry (FET's, IC's, NPN's). Works with *any* quality FM Tuner or Receiver.

Send check or m.o. for either . . .
SCA-1 (Wired, ready to use) \$64.50
SCA-1K (Kit, all needed parts) \$49.95
Etched, drilled P.C. Board plus special IC & full construction plans \$12.50
"New York Residents add appropriate sales tax"

*One year parts guarantee
Prohibited for commercial use*

**Free National SCA station list
supplied with every order**

SCA Services Co., Inc.
Box 601, Port Washington, N.Y. 11050

Check No. 22 on Reader Service Card

*We Own The
Sharpest Pencils
In Town!*



**YOU SAVE MORE
ON HI-FI COMPONENTS
& TAPE RECORDERS**

- We invite your test of our "We Will Not Be Undersold Policy."
- 15-day money-back guarantee.
- 2-yr. unconditional guarantee parts & labor no charge, at local warranty station or factory.
- Trade-ins—highest allow. Send your list.
- Most items shipped promptly from our \$250,000 inventory, fully insured.
- Our specialty—APO & Export.
- 23rd yr. dependable service—world wide.

Rated #1 service—satisfaction according to nationwide survey.

Write for Our Price First!
You'll Be Glad You Did!

HI-FIDELITY

CENTER

"The House of Low Low Prices"

239-V East 149th St.
New York, N.Y. 10451

Check No. 66 on Reader Service Card

HEAR HERE

FOR THE UTMOST IN

DISCOUNTS

ON NATIONALLY
ADVERTISED

**HI-FI STEREO
COMPONENTS**

WRITE FOR OUR QUOTE

**All Merchandise Shipped
Promptly Fully Insured From
Our Warehouse.**

**DOWNTOWN
AUDIO, INC.**

17 WARREN ST.
NEW YORK, N.Y. 10007
267-3670-1-2
DEPT. A

Check No. 23 on Reader Service Card

READER INQUIRY CARD

AUGUST 1970 ISSUE

Use this FREE Post Paid Card for more facts on the products described and advertised in this issue.

THIS CARD EXPIRES OCTOBER 31, 1970

CHECK BOX A or B beside each coupon number

A to help me make an immediate decision to purchase.
 B to explore a new method or to keep my files on the subject up to date.

#	A	B	#	A	B	#	A	B	#	A	B	#	A	B	#	A	B	#	A	B						
1			16			31			46			61			76			91			106			121		
2			17			32			47			62			77			92			107			122		
3			18			33			48			63			78			93			108			123		
4			19			34			49			64			79			94			109			124		
5			20			35			50			65			80			95			110			125		
6			21			36			51			66			81			96			111			126		
7			22			37			52			67			82			97			112			127		
8			23			38			53			68			83			98			113			128		
9			24			39			54			69			84			99			114			129		
10			25			40			55			70			85			100			115			130		
11			26			41			56			71			86			101			116			131		
12			27			42			57			72			87			102			117			132		
13			28			43			58			73			88			103			118			133		
14			29			44			59			74			89			104			119			134		
15			30			45			60			75			90			105			120			135		

My Comments On This Issue _____

DETACH HERE AND MAIL

Name _____
 Firm _____
 Address _____ Office Residence
 City _____ State _____ Zip _____

OPTIONAL INFORMATION:

Are you a subscriber to AUDIO Magazine? Yes No

I am a:

- 1 High Fidelity Enthusiast
- 2 Home Recordist
- 3 Professional Recordist
- 4 Broadcast Engineer/Manager
- 5 Audio Service Technician
- 6 Audio Manufacturer or Dealer
- 7 Other _____

I have purchased the following equipment after seeing it advertised in AUDIO Magazine. _____

I am planning to purchase the following equipment in the next year. _____

I have advised the following number of people on their Hi-Fi purchases over the past two years.

- under 5 5 to 10
- 10 to 20 over 20

DETACH HERE AND MAIL

BUSINESS REPLY MAIL

No Postage Necessary if Mailed in the United States

FIRST CLASS
 Permit No. 22,489
 Philadelphia, Pa.

POSTAGE WILL BE PAID BY:

AUDIO

the authoritative magazine about high fidelity

134 North Thirteenth St.

Philadelphia, Pa. 19107

CLASSIFIED
 ORDER CARD

Fill in other side to
 order a classified ad

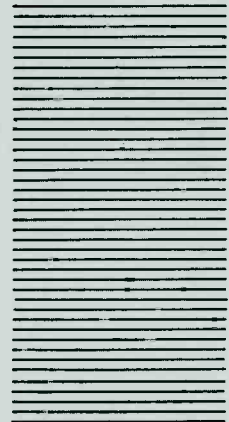

SUBSCRIPTION ORDER CARD

Don't wait until your subscription runs out. Renew now and insure uninterrupted service. The remaining issues on your current subscription will be added.

GENTLEMEN:

PLEASE ENTER MY SUBSCRIPTION TO **AUDIO**

Name _____

Address _____ Office Residence

City _____ State _____ Zip _____

- New Subscription
- Renewal

1 YEAR—\$5

 (Foreign - \$8)

2 YEARS—\$9

 (Foreign - \$13)

3 YEARS—\$12

 (Foreign - \$17)

BILL ME
PAYMENT ENCLOSED

FOR OFFICE USE

DETACH HERE AND MAIL

FIRST CLASS
Permit No. 22,489
Philadelphia, Pa.

BUSINESS REPLY MAIL
No Postage Necessary if Mailed in the United States

POSTAGE WILL BE PAID BY:

AUDIO
the authoritative magazine about high fidelity

P.O. BOX 8671
PHILADELPHIA, PA. 19101

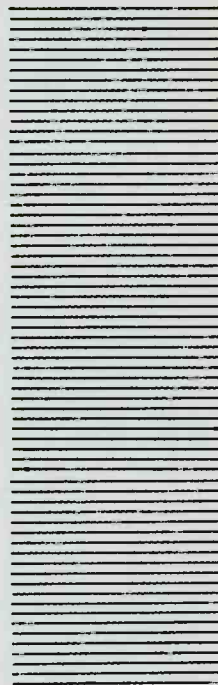

READER INQUIRY CARD

Fill in other side to get more information on advertised products

CLASSIFIED ORDER CARD

COPY FOR YOUR AD

Want to buy, trade or sell components? Looking for a rare piece of equipment? Want to offer or buy a service? Want a job in the audio field? If your answer is "yes" to any of these questions, your ad belongs in Audio Classified. Rates are comfortably low —readership is astoundingly high. Use this handy order form to include your message in the next issue.

PLEASE CHECK ONE:

- For Sale
- Wanted to Buy or Trade
- Situation Wanted
- Help Wanted
- Services
- Insert in next issue
- Insert in next 2 issues
- Insert in next 6 issues
- Insert in next 12 issues
- Assign box number (additional cost \$1)

RATES: Commercial, 50¢ per word; situation wanted or non-commercial, 25¢ per word. We reserve the right to determine classification as commercial or non-commercial. Payment must accompany all orders under \$10.00.

Name _____

Address _____ Office
 Residence

City _____ State _____ Zip _____

BUSINESS REPLY MAIL
No Postage Necessary if Mailed in the United States

FIRST CLASS
Permit No. 22,489
Philadelphia, Pa.

POSTAGE WILL BE PAID BY:

AUDIO
the authoritative magazine about high fidelity

134 North Thirteenth St.
Philadelphia, Pa. 19107

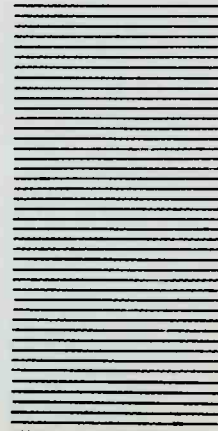

**SUBSCRIPTION
ORDER CARD**

Fill in other side to order a new subscription

A lot of people don't know that a cartridge that's great for one high fidelity system could be disastrous for another.

That's why Pickering has done something fantastically simple.

We've developed *Dynamic Coupling Factor*—henceforth known as *DCF*.

All it is is a complicated name for an uncomplicated way to select the best cartridge for your system. It is your guide to the selection of that cartridge based on its intended application in playback equipment—just as horsepower is the guide to the proper engine for a vehicle.

It works like this. You own an XYZ model record changer. What cartridge do you pick? Not the \$29.95 model because it isn't designed for the capability of your XYZ player. Not the \$60.00 cartridge either, for its quality cannot be realized in that unit.

Our chart—available to you free—reveals that you need our model XV-15 with a *DCF* rating of 400 for optimum performance. This means that you will get

100% of the music from your records. Not 50% or 75% but *all* of the music capable of being obtained from your particular playback unit.

Technically, what we've done is taken virtually every high fidelity record player and pre-analyzed the vital variables for you; those affecting cartridge design and those related to the engineering features of the various turntables and changers.

So now all you need to be well informed on cartridges is to send for our *DCF* application guide containing our recommendations for what cartridge you use with which record player.

And next time you walk into a high fidelity salon, tell the man: "I'd like a Pickering XV-15 with a *DCF* of 400." Or whatever.

Pickering cartridges are priced from \$29.95 to \$60.00. For your free *DCF* chart, write *DCF*, Pickering & Co., 101 Sunnyside Blvd., Plainview, N.Y. 11803.



PICKERING

"for those who can hear the difference"

Check No. 103 on Reader Service Card

You can pay a lot more to get a lot less.



If you know any 2-speed manual turntable that costs \$129.95 and also gives you automatic operation . . . two motors . . . belt drive precision . . . drift-free plug-in shell tonearm . . . lateral tonearm balancer for equalized stereo

sound . . . high compliance magnetic cartridge with diamond stylus . . . oiled walnut base . . . hinged dust cover . . . 12" dynamically balanced platter . . . automatic stylus protection lead-in device . . . automatic

stop, return, repeat . . . oil-damped cueing . . . adjustable stylus tracking force — then buy it.

Pioneer Electronics U.S.A. Corp.
140 Smith Street, Farmingdale,
New York 11735

 **PIONEER**® PL-A25

WEST COAST: 1335 WEST 134TH ST., GARDENA, CALIF. 90247 • CANADA: S. H. PARKER CO., 67 LESMILL RD., DON MILLS, ONTARIO

