

AUDIO

JUNE / 1966

60¢

...the original magazine about high fidelity!

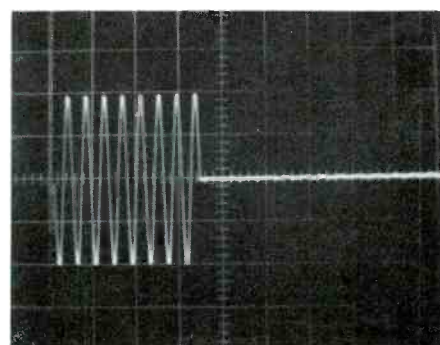
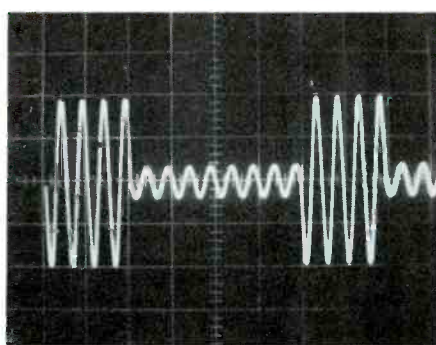
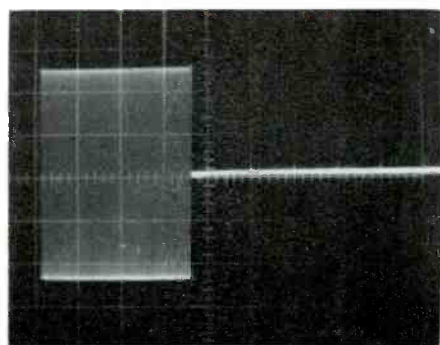

HOW MUCH POWER DO YOU NEED?

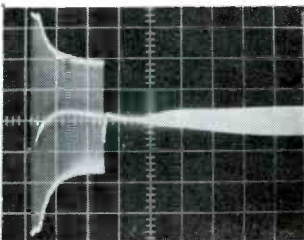
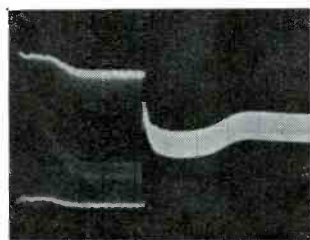
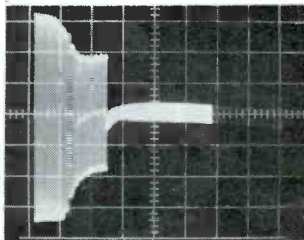
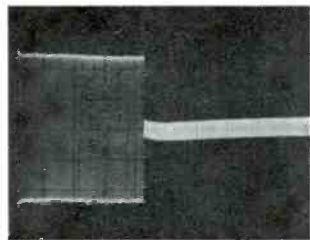
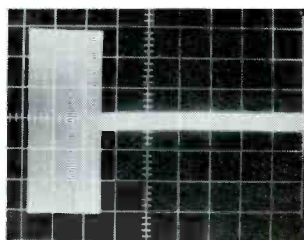
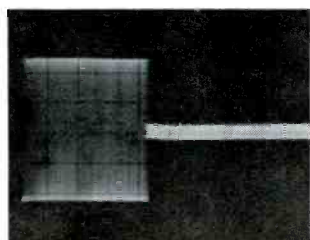

HOW DOES YOUR AMPLIFIER OVERLOAD? HOW DOES IT RECOVER?

See Page 19

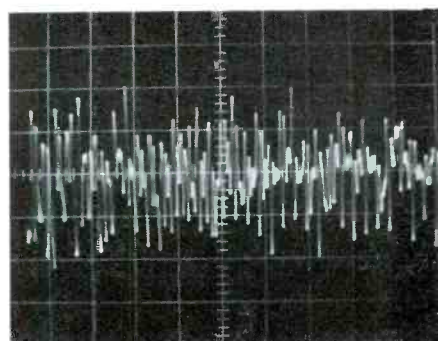

AL BROWDY
1962 SO STEARNS DRIVE
LOS ANGELES 34 CALIF
SEPT 67 3C-11

Space-age Scott FET design improves AM as dramatically as it does FM



New Scott 382 Receiver lets you hear more stations, more clearly! 65-watts/Space-age FET circuits in both AM and FM/Only \$339⁹⁵

Scott engineers are constantly on the search for new developments to continually improve a near-perfect product.

After experiencing the miraculous improvements FET's brought to FM, Scott engineers applied amazing new FET circuitry to Wide-Range AM. The result — the new 382 AM/FM stereo receiver — incorporating, for the first time anywhere, a Field Effect Transistor AM circuit along with Scott's astonishing FET FM front end. Introduction of this new model marks the first real improvement in AM circuitry design in more than a decade.

AM Comes of Age

Recent improvements in AM broadcasting equipment, plus the Federal Communication Commission's decision to split AM and FM programming, have given audiophiles renewed interest in superior AM reception. Introduction of the new 382 now brings Scott FET sound to the exciting news, sports, current events and music broadcasts available only on the AM band.

Scott AM Has Advanced FET Circuits

Advanced Scott 382 circuitry incorporates Automatic Variable Bandwidth, a unique feature which automatically adjusts tuner bandwidth to the quality of the incoming signal. The bandwidth automatically narrows for best reception of weak, distant stations, blocking out noise and interference. When tuned to stronger stations, the bandwidth automatically broadens, providing full frequency wide-range reception. In addition, the new Scott Automatic Gain Control circuit, which increases tuner sensitivity when incoming signal decreases, also increases resistance to cross modulation as the signal gets stronger.

Field Effect Transistor FM Lets You Hear More Stations, More Clearly

The 382 utilizes revolutionary new Field Effect Transistor circuitry for maximum FM sensitivity with virtually no cross modulation, no drift, no more problems caused by changing tube characteristics. Scott is the first, and only, manufacturer to use this important advance in solid-state design.

Scott's all silicon IF strip provides three stages of true IF amplification for strong as well as weak signals plus three additional stages of IF limiting action, giving optimum selectivity and stereo separation.

Direct-Coupled Silicon Output Amplifier Section

Output and driver transformers, major causes of diminished power and distortion, are eliminated from Scott's radically new direct-coupled solid-state amplifier design . . . allowing more power over a wider frequency range, with virtually no distortion.

The 382 includes these popular features found in the most expensive Scott components: Tape Monitor switching, Speaker switching with provision for remote speaker selection, switched front panel stereo headphone output, front panel stereo balance switch, separate-channel clutched bass, treble, and volume controls, fully automatic stereo switching with indicator, and precision tuning meter.

382 Specifications: Usable sensitivity, 2.5 μ v; Harmonic distortion, 0.8%; Drift, 0.02%; Frequency response, 18-25,000 cps \pm 1 db; Music Power rating per channel (4 ohms), 32½ watts; Cross Modulation Rejection, 85 db; Stereo separation, 35 db; Capture ratio, 6.0 db; Selectivity, 40 db. Price \$339.95.

Scott . . . where innovation is a tradition



For complete information and specifications, circle Reader Service Number 100.
H. H. Scott, Inc., 111 Powdermill Road, Maynard, Mass. Dept. 35-06. Export: Scott International, Baynard, Mass.
Prices and specifications subject to change without notice. Prices slightly higher west of Rockies.

Circle 100 on Reader Service Card

AUDIO

June, 1966 Vol. 50, No. 6

Successor to **RADIO**, Est. 1917

LARRY ZIDE
Associate Editor

HAROLD D. WEILER
Roaming Editor

JANET M. DURGIN
Production Manager

Contributing Editors

EDWARD TATNALL CANBY
JOSEPH GIOVANELLI
HAROLD LAWRENCE
CHESTER SANTON
HERMAN BURSTEIN
BERTRAM STANLEIGH

Representatives

James C. Galloway,
9220 Sunset Blvd.,
Los Angeles, Calif. 90069
Warren Birkenhead, Inc.,
No. 25, 2-chome, Shiba Hama-
matsu-cho,
Minato-ku, Tokyo, Japan

C. G. McPROUD
Editor and Publisher

SANFORD L. CAHN
Advertising Director

EDGAR E. NEWMAN
Circulation Director

Power Amplifier Overload Characteristics and their Importance	19
A Switch-Type Tone Control	24
The Finite Approach to the Infinite	25
Solid-state Flutter Meter—Conclusion	38

Light Listening	10
Jazz and All That	14
Record Revue	42

Marantz 7T Solid-State Stereo Amplifier	34
Synchron Condenser Microphone	34
Euphonics Cartridge System	35
Thorens Integrated Turntable	36
Thorens Turntable	36

Audioclinic	2
Letters	6
Audio ETC	12
Editor's Review	16
Sound & Sight	31
New Products	40
Tape Guide	44
About Music	48
New Literature	51
Advertising Index	56

AUDIO Articles

R. A. Greiner
Marshall K. Steele
Norman H. Crowhurst
Arthur E. Gladfelter

AUDIO Reviews

Chester Santon
Bertram Stanleigh
Edward Tatnall Canby

AUDIO Profiles

7T
Model S-10
CK-15-LS
TD150
TD124 II

AUDIO in General

Joseph Giovanelli
Edward Tatnall Canby
Harold D. Weiler
Herman Burstein
Harold Lawrence

Number 34 in a series of discussions
by Electro-Voice engineers



**STEREO
SIMPLIFIED**

PAUL E. VANDE KOPPEL
Cartridge Engineer

Mass-produced phonograph cartridges must meet a number of criteria to be accepted by the phonograph industry. Among them are high performance, a high degree of uniformity, and low cost. Yet the complexity of past cartridge designs made the attainment of these goals a constant struggle. At Electro-Voice, a basic program of re-evaluation of cartridge design has resulted in a drastic reduction of complexity for a modern stereo ceramic cartridge.

Comparing the new cartridge* with the old, we find it composed of just five assemblies, as opposed to the 12 parts needed in previous designs. This simplification resulted in no degradation of performance, but did contribute to a significant improvement in uniformity and a sharp reduction in assembly time and cost.

A key achievement of the program was an improved element assembly. In the past, hundreds of rubber back pads and yokes were molded at once, then each pad was assembled to a ceramic element. Finally, a pair of elements were joined by a yoke before insertion in the cartridge body. The hand assembly, plus the multitude of dies made variations in mechanical positioning inevitable.

With the new design, both ceramic elements are loaded into an eight-station rotating die that permits molding the thermoplastic yoke and back pad assembly directly to the ceramic elements in one operation. No additional assembly is needed, and the lower number of dies reduces variations in size and positioning.

The external case design has also been simplified, and snaps together without the use of fasteners. Perhaps more dramatic, however, is the simplification of electrical contacts. Normally a set of external contacts press against the sides of the elements to provide output termination.

With the new design, however, the ends of the elements themselves extend from the back of the cartridge. A mating plug, wired directly into the tone arm, is supplied with spring-loaded wiping contacts. When the cartridge is inserted, the plug terminals make direct, positive contact with the sides of the elements, thus eliminating all intermediate contact surfaces and reducing the incidence of intermittents.

In keeping with today's designs, the new cartridge is quite small, and well suited to a variety of mounting schemes. Final proof of design success is in the ready acceptance of this new concept by phonograph manufacturers. Nevertheless, work continues on even more sophisticated approaches to phono transducer design.

*Patents applied for.

For technical data on any E-V product, write:
ELECTRO-VOICE, INC., Dept. 663A
602 Cecil St., Buchanan, Michigan 49107



Circle 105 on Reader Service Card



AUDIO (title registered U. S. Pat. Off.) is published monthly by Radio Magazines, Inc., C. G. McProud, President; Henry A. Schober, Secretary. Executive and Editorial Offices, 204 Front St., Mineola, N. Y. Subscription rates—U. S., Possessions, Canada, and Mexico, \$5.00 for one year, \$9.00 for two years; all other countries \$6.00 per year. Single copies 60c. Printed in U.S.A. at Blanchard Press Inc., Garden City, N.Y. All rights reserved. Entire contents copyrighted 1966 by Radio Magazines, Inc. Second Class postage paid at Mineola, N.Y. and additional mailing offices.



RADIO MAGAZINES, INC., P.O. Box 629, MINEOLA, N.Y., 11501
Postmaster: Send Form 3579 to AUDIO, P.O. Box 629, Mineola, N.Y., 11501

COMING

Articles:

Walter G. Wohleking makes his first appearance with An FM Antenna Primer, a thoroughly documented guide to the basic theory and practical aspects of antennas for reception of FM stereo broadcasts.

Norman H. Crowhurst resumes his Audio Measurements Course.

Thomas J. Celi presents an article on Tracking Error Determination and Minimization.

Profiles:

Acoustech X1 and PM Add-a-Kit.

University Mediterranean Speaker System

Viking 880 Tape Recorder

In the July Issue

On the newsstands, at your favorite audio dealer's, or in your own mailbox.

AUDIO CLINIC

Joseph Giovanelli



Send questions to:
Joseph Giovanelli
2819 Newkirk Ave.
Brooklyn, N. Y.
Include stamped, self-addressed envelope.

The Use of Test Records

Q. Recently I purchased a CBS ST-101 test record. While playing the stereo frequency response band, I noticed that frequency tones appeared at relatively the same loudness level, except for the 5000 and 4000-Hz tones, where there was a marked decrease in the sound level. The 5000 Hz tone could be heard, but at a marked reduction in volume. The 4000 Hz tone was just barely audible, and could be heard only when I stood directly in front of the speakers. From 3000 Hz down, volume level once again became loud and clear.

What could cause such a marked drop in sound level at these two specific frequencies? Is it possible that my hearing apparatus has trouble in picking these two tones? Perhaps my speaker system, for some strange reason, cannot accurately reproduce these specific test tones. Is it possible that the test record itself is not reproducing them at the correct sound level? David A. Taylor, Braintree, Massachusetts.

A. There have been occasional instances in which the ear, for some mysterious reason, discriminates against certain discrete frequencies while transmitting others above and below them to the brain.

It is possible, however, that your tweeter has a null in that range or that the crossover network nulls out those frequencies in particular. This is especially likely when these frequencies fall in the area of transition between the midrange and the tweeter or woofer and tweeter (depending upon the nature of your speaker system).

It is possible that your cartridge has trouble with those frequencies because of some anti-resonant efforts associated with the disc, and the cartridge and the arm's secondary resonance.

It may be that there are standing waves in your room which are nulling certain frequencies.

I do not believe that your trouble lies with the disc proper because the disc is considered to be a good one.

If you are to find out just where your problem occurs, you must use the test disc as it is intended to be used, to measure the output of your cartridge and the remainder of your system—using test instruments. The ear is a very amazing piece of test equipment, but when quantitative

measurements are involved, the ear cannot be relied upon. If you have a good a.c. VTVM or a 'scope, connect this to the output of your cartridge and see if it is flat. I am not sure whether this test disc has a flat characteristic on any of its cuts or whether the only cuts on the disc are RIAA. If RIAA is used, the treble will appear to rise. 4000 and 5000 Hz will not be lower than the frequencies below them. To check for true flatness over the RIAA curve, you should use your preamplifier. Make sure that your preamplifier's tone controls are set to their flat positions. Do not go by the flat indications on the front panel. They are only indications of approximately flat response. Use an audio oscillator to determine where the tone controls should be set in order to obtain a perfectly flat response with the oscillator feeding a high-level input.

If the cartridge and RIAA compensation are then correct, you should have no null in the response. If you see a null, you will know that the cartridge is involved in the trouble. It is unlikely that the input circuitry of your preamplifier could cause the trouble unless it employs inductances in the equalizer network. Their use is doubtful.

If the outlet of your system is relatively flat, you probably can suspect your speakers.

As a shortcut, try moving the speakers to different parts of the listening room and note whether or not the same null effect still takes place. This test will rule out standing waves in the room as the possible culprit.

Test Records

Q. Though high fidelity has been my hobby for many, many years, I have not used or even heard a test disc until recently.

What should a test disc tell me? How can such a disc help me to improve the performance of my system? Charles Towne, New Rochelle, New York

A. Test discs are made for specific purposes; no one disc, therefore, will contain every test in which you might be interested.

Some discs feature test for room resonances and arm resonances. The manner by which these tests should be conducted is explained in the instructions which accompany the discs.

Other tests which can be found on some test discs indicate the presence or absence of turntable rumble. Even the type of rumble can be revealed by such discs; that is to say, if the turntable itself is at fault, if an idler needs replacing, if there is hum transmitted mechanically, if lubrication is in order or if the turntable simply is poorly mounted.

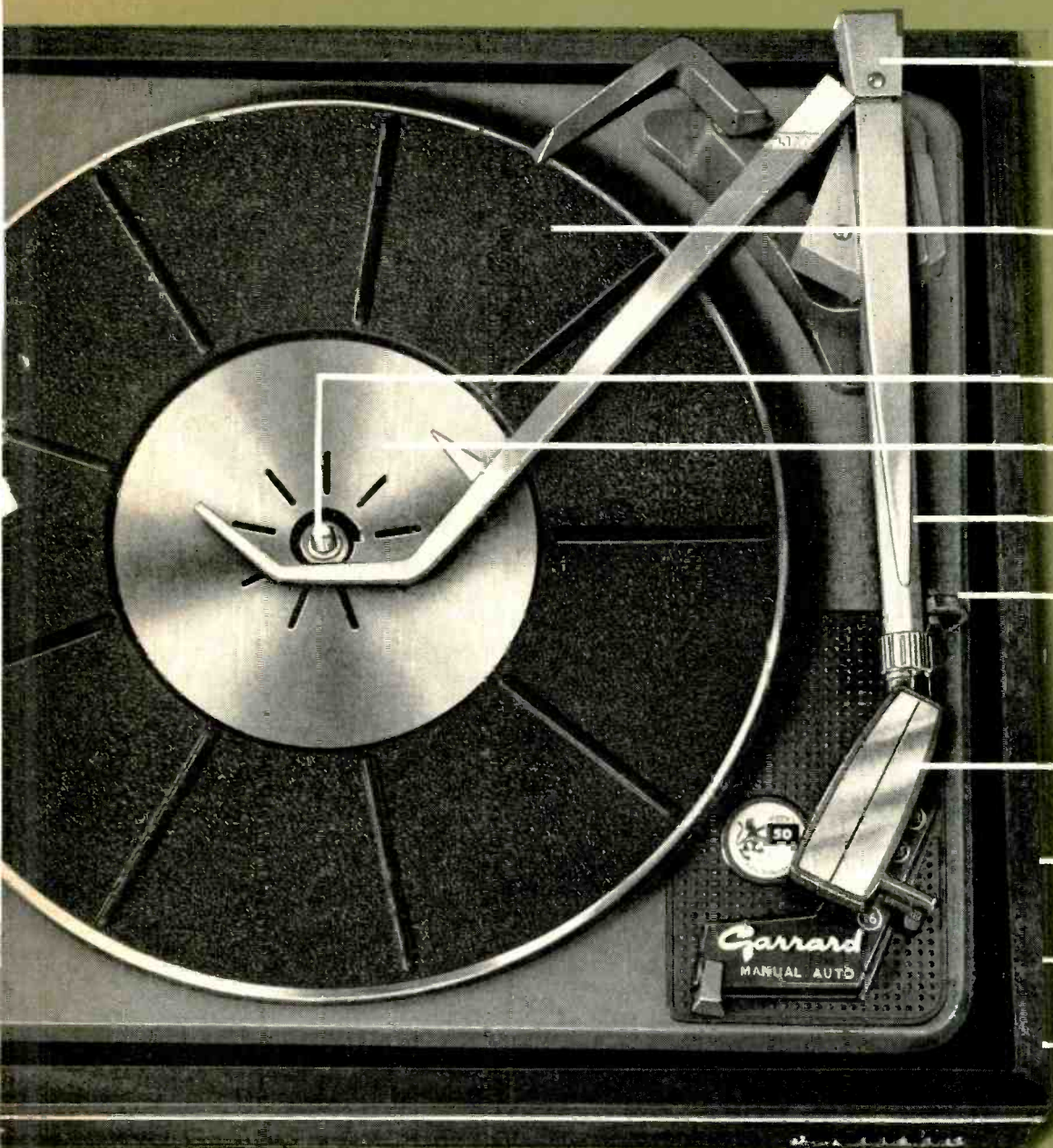

Graceful cast aluminum tone arm is counterbalanced—first time this type of arm has been available in a popular priced unit. This feature alone gives the Model 50 particular significance—an automatic in the economy field which can track high quality cartridges for finer sound reproduction.

Oversized turntable with handsome mat is reminiscent of previous Garrard models in a considerably higher price echelon.

Two spindles—a convenient short spindle for playing single records manually; an interchangeable center drop spindle for automatic play when desired. Spindles remove for safety and convenience when taking records off the turntable.

In automatic position, Model 50 intermixes records of any size or sequence.

Stylus pressure adjusted with simple, accessible finger touch device, for correct tracking force, according to the cartridge manufacturers' specifications.

Super sensitive trip, with Dupont Delrin® to offset friction, operates with any high compliance pickup at correct minimal tracking force.

Shell is lightweight cut away type with extended finger lift for safety in handling. It plugs in... accommodates your widest personal choice of cartridges... can be removed from the arm instantly to change cartridge or service stylus.

Garrard 4-pole shaded "Induction Surge" motor, with dynamically balanced rotor, shielded from hum. Constant speed assured, free from vibration.

Ultra-compact—fits easily into any record changer space. Only 14 7/8" left to right, 12 1/2" front to rear, 4 3/8" above and 2 7/8" below motor board.

Simple installation. Fully wired for stereo, with a 4-pin, 5-wire system utilizing separate connection for ground, to eliminate hum. Leads connect to the changer with a built in Amplok plug (for AC) and a female twin phono socket mounted on the unit plate (for audio). Simply plug in at the player!

Important reading: 32-page Comparator Guide detailing all Garrard models. Write for complimentary copy to Garrard, Dept. GF-18, Westbury, New York 11591.



This is the Model 50 Garrard's most compact manual/automatic turntable. Despite its modest price of only \$44.50, dealers large and small, in every part of the country, think enough of this unit to include it in the overwhelming majority of advertised systems which they pre-select. The dealer knows he can combine the Model 50 with the finest, most expensive brand name amplifiers, receivers, and speakers, and offer them to his most discriminating customers assured that it will be compatible and an enduring credit to his reputation. The dealer's recommendation is important to you. It is every bit as significant as the impressive list of features on this page, which the Model 50 incorporates. This is the lowest priced Garrard automatic... but all Garrards meet exactly the same strict standards of quality. Therefore, you can buy a Model 50 with complete assurance, and you will use it with pride as well as pleasure, for years to come.

Garrard®
WORLD'S FINEST

Circle 193 on Reader Service Card

For your sound approach to quality...

look!



listen!



compare!



Other test discs contain information useful in determining a tonearm's ability to track a groove. These tests for cartridge-tonearm tracking and tracing are of various types. With some, the ability or inability of the cartridge to reproduce high frequencies cleanly is indicative of good tracking. Such tests may indicate that a stylus is worn, that the tracking force is too light, that there is tracking error because of improper tonearm mounting, or that the cartridge itself is defective or deficient. Another tracking test involves the use of various levels of mid-band energy. As I have said before, complete details on the use of these tests will be found in the literature accompanying the particular test disc you may have.

Other test discs determine the total intermodulation distortion present in a home music system. Other tests which are sometimes found are those for square-wave response, cartridge channel balance, and last, but not least, is the familiar frequency-response checks.

These latter checks are arranged with or without RIAA compensation.

While it is true that some tests can be conducted with the unaided ear, most tests must be made using instruments in conjunction with the test disc. The instruments to be used will, of course, depend upon the particular test.

Phonograph Volume Loss

Q. I have a record player which employs a crystal cartridge and a three-tube amplifier—12BA6, 35W4 and 50C5 tubes. Now, even though none of the components has been changed, I must turn the volume control all the way up in order to get sufficient volume.

What can be the cause of this? Kenneth A. Bush, Rutherford, New Jersey

A tube, especially the 35W4, can be responsible for your reduced volume.

The cartridge, however, is often responsible for this volume loss. To determine if the cartridge is responsible, try this test. With the gain set to its maximum, touch the "hot" pickup lead. See if you obtain a substantial amount of hum from the speaker. If you do, you can be almost 100 per cent certain that your cartridge must be replaced. As time goes on in the life of a crystal cartridge, changes take place within the crystal element which result in decreased output. Often the crystal breaks up into many pieces.

If the rectifier tube is weak, there is often distortion accompanying the loss of volume. Such distortion is not likely to occur when the cartridge is defective, except for a lack of lower frequencies.

Of course, other factors can enter into the picture. Perhaps the plate bypass for the 50C5 has become partially shorted. The excess current flow will reduce the voltage to all tubes. Further, the output transformer will carry more current than it should, and this will cause saturation of the iron core—leading to reduced output, especially at the lower frequencies.

The coupling capacitor between the 12BA6 and the 50C5 may have opened or shorted.

It is possible that the filter capacitor has become partially shorted. AE

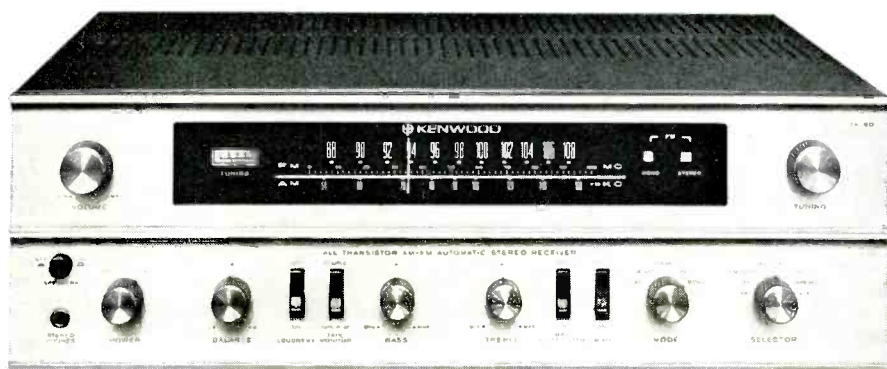

KENWOOD SOLID STATE STEREO RECEIVERS

Once you've seen and heard the wonderful SOUNDS OF KENWOOD you'll want to make comparisons with other units. Listen to the unusual quality of KENWOOD. Compare total music power...sensitivity...wide frequency range produced by silicon power transistor amplifiers...and many more important engineering features that add up to outstanding musical performance and trouble-free reliability. Only by making comparisons for quality, features and price will you find that KENWOOD provides a truly superior selection of hi-fi stereo receivers. Visit your nearest KENWOOD franchised dealer, and he'll be glad to demonstrate your sound approach to quality. Or write us for free, colorful brochure.

...the sound approach to quality



3700 So. Broadway Pl., Los Angeles, Calif. 90007, AD 2-7217 • 212 Fifth Avenue, New York, N.Y. 10010, MU 3-1115

Circle 106 on Reader Service Card

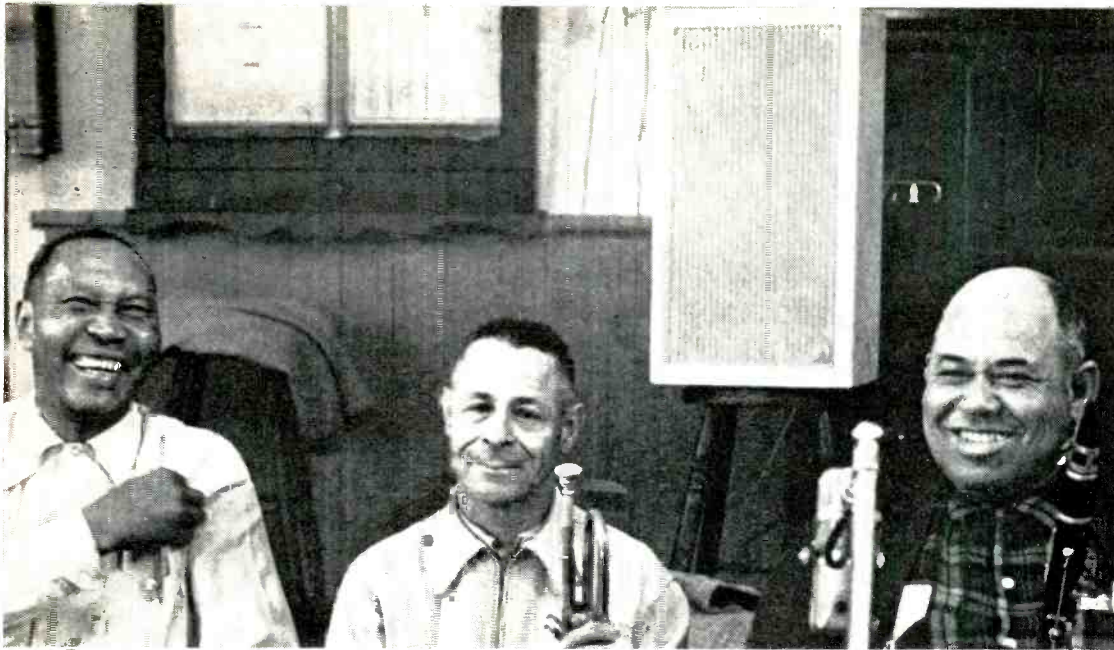

COURTESY RIVERSIDE RECORDS AND HI-FI/STEREO REVIEW

Jazz Group

Jim Robinson, Ernie Cognolotti, and Louis Cottrell participate in a Riverside Records recording session in New Orleans. The AR-3 in the background (one of a stereo pair) is being used to monitor recording quality.

AR-3 LOUDSPEAKERS ARE USED ALONGSIDE THE LIVE INSTRUMENTS THEY REPRODUCE.

AR-3 (one of a stereo pair)



COURTESY SAN DIEGO SYMPHONY ORCHESTRA

Symphony Orchestra

During rehearsals the San Diego Symphony Orchestra pauses now and then to listen to a taped recording of the passage they have just played. AR-3 loudspeakers were chosen for the stereo playback system because of their lifelike, uncolored reproduction of orchestral timbres.

COURTESY CONCERTAPES CONCERTDISC



String Quartet

Members of the Fine Arts Quartet listen to the first playback of a Beethoven Quartet, checking both their performance and the fidelity of the recording. The AR-3 speakers being used as monitors were chosen by the musicians themselves, who felt that AR-3's would create musical carbon copies of the live performances, free of hi-fi gimmick effects.

AR speakers (\$51 to \$225) are often used professionally as shown here, but they are primarily designed for natural reproduction of music in the home. Literature will be sent on request.

ACOUSTIC RESEARCH, INC., 24 Thorndike Street, Cambridge, Massachusetts 02141

Circle 107 on Reader Service Card

NEW... Concertone 800 Series



WITH "3 PLUS 3" REVERSE-O-MATIC®

New from Concertone—a complete line of professional bi-directional stereo recorders, featuring totally automatic "3 Plus 3" Reverse-o-matic®.

- **Two separate three-head systems** provide erase, record, play, and off-the-tape monitoring in both directions.
- **Fool-proof reverse programming** . . . reverses precisely where you want it . . . when you want it.
- **Assures uncompromised stereo balance**, levels and response, distortion, and signal-to-noise ratio in play and record modes in both directions automatically.

PLUS Self-adjusting Band Brakes • Dual Automatic Shut-off and Tension Arms • Record Level Pre-Set • Add-Echo • Multiple Sound-On-Sound • and many other outstanding functional features.

Model 804 Professional Tape Deck — heart of the new 800 series — available for less than \$400.

Model 803 Professional Portable — completely self-contained, with stereo monitor amplifier and speaker system, less than \$470.

Model 815 Real Wood Designer Portable — with built-in powerful Norton Amplifier; including separate speaker system, less than \$700.

Model 814, The Audio Composium — a complete stereo home entertainment center, with AM/FM multiplex Norton receiver, record changer; available in four distinctive cabinet styles, less than \$950.

Norton Amplifier — less than \$150.

Write today for complete details on the new Concertone 800 series.

CONCERTONE

A DIVISION OF ASTRO-SCIENCE CORPORATION
9731 Factorial Way • South El Monte, California 91733



Circle 109 on Reader Service Card

LETTERS

Erratum

SIR:
Permit me to draw your attention to a typo in the text of my article "Room Design for Stereo Music." The end of the first sentence in the third paragraph should read: ". . . the ratio of length to width is in the order of 1.4," (not "1:4" as printed).

M. RETTINGER,
5007 Haskell Avenue,
Encino, Calif. 91316

"Bingo" Cards

SIR:
I'm sure you will be interested in knowing that I have only received one reply from seven inquiries made on the March card and five made on the April card. One supplier told me to contact a Montreal firm.

R. F. MERRILL,
47 Baby Point Road,
Toronto 9, Ont., Canada

(Most advertisers insist on our offering reply ("bingo") cards, and of course we are glad to oblige. Some do not want to be included, so we do not code them. However, we think the advertiser should furnish the requested information promptly when he receives the inquiry. Ed.)

Hertz vs. Cycle

SIR:
Regarding the recent change in your text whereby you have concurred in honoring the name of Mr. Hertz by using that term in lieu of the cycle, it is interesting to note that the concerted action has not escaped the notice of a lay reader. The *Chicago Tribune* of April 20 carried a letter from such a reader who has chosen to deal with the subject in a jocular vein. Hope it is sufficiently interesting to warrant mention in the magazine.

FREDERICK C. BERLINGEN,
1649 N. Mozart Street,
Chicago, Ill. 60647

(The letter by Tribune reader Frank Hughes, comments on the adoption of the new terminology by the IEEE, the ISO, and the IEC, as well as the Conference Generale des Poids and Mesures, then concludes with:

So now, instead of 60-cycle current in your house, you have 60-hertz, and WGN broadcasts on 720 kilohertz instead of 720 kilocycles.

And if you want to climb up on the handlebars, I'll ride you to work on my bihertz. So that's what comes from teaching science to laymen. Ed.)

Unreadable Page

SIR:
I have just received the May issue of *AUDIO*. Unfortunately, the insert appearing between pages 24 and 37 had its back page glued to page 37, making it impossible to continue reading the article. I don't object to the advertisement, but can you send me another copy of page 37?

ARTHUR M. CARTON,
150 East 28th Street,
New York, N.Y. 10016

(We have done so. Ed.)

Perfection results from CHOICE...NOT CHANCE

Since no single phono cartridge can be all things to all people, we earnestly recommend that you employ these individual criteria in selecting your personal cartridge from the broad Shure Stereo Dynetic group:

YOUR EAR: First and foremost, listen. There are subtle differences in tonality that beggar description and are quite unrelated to "bare" specifications—yet add immeasurably to your personal listening pleasure.

YOUR EQUIPMENT: Consider first your tone arm's range of

tracking forces. Too, keep in mind that the cartridge ordinarily represents the smallest monetary investment in the system, yet the ultimate sound delivered depends *first* on the signal reproduced by the cartridge . . . "skimping" here downgrades your *entire* system.

YOUR EXCHEQUER: Shure cartridges cover the entire economic spectrum. And they are ALL Shure in quality, all Shure in performance. Even the least costly has received copious critical acclaim.

BEST SELLER



MODEL M3D

Where cost is the dominant factor, the M3D provides extremely musical and transparent sound at a rock-bottom price. The original, famous Shure Stereo Dynetic Cartridge . . . with almost universal application. Tracks at pressures as low as 3 grams, as high as 6 grams. For any changer. Only \$15.75

MUSICAL BEST-BUY

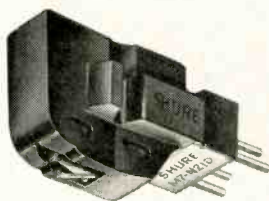

MODEL M7/N21D

Top-rated cartridge featuring the highly compliant N21D tubular stylus. Because of unusually clean mid-range (where most music really "happens") it is especially recommended if your present system sounds "muddy." For 2-gram optimum tracking (not to be used over 2½ grams). Only \$17.95 (Also, if you own an M3D or M7D, you can upgrade it for higher compliance, if tracking force does not exceed 2½ grams, with the N21D stylus for only \$12.50.)

ALL THE MOST WANTED FEATURES



M55E

15° TRACKING, ELLIPTICAL STYLUS

Professional performance at a modest price. Compares favorably to the incomparable Shure V-15, except that it is produced under standard Shure quality control and manufacturing techniques. Remarkable freedom from IM, Harmonic and tracing distortion. Will definitely and audibly improve the sound of monaural as well as stereo records. A special value at \$35.50. Upgrade M44 cartridge (if you can track at 1½ grams or less) with N55E stylus, \$20.00

THE "FLOATING" CARTRIDGE

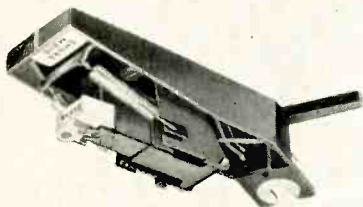

**M80E GARD-A-MATIC®
WITH ELLIPTICAL STYLUS**

Bounce-proof, scratch-proof performance for Garrard Lab 80 and Model A70 Series and Dual 1009 automatic turntables. Especially useful where floor vibration is a problem. Spring-mounted in tone arm shell. Stylus and cartridge retracts when force exceeds 1½ grams . . . prevents scratching record and damaging stylus.

Model M80E
For Garrard turntables. \$38.00
Model M80E-D
For Dual 1009 turntables. \$38.00

THE ULTIMATE!

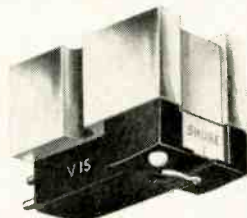

**V-15
WITH**

BI-RADIAL ELLIPTICAL STYLUS

For the purist who wants the very best, regardless of price. Reduces tracing (pinch effect), IM and Harmonic distortion to unprecedented lows. 15° tracking. Scratch-proof, too. Produced under famed Shure Master Quality Control Program . . . literally hand-made and individually tested. In a class by itself for mono as well as stereo discs. For manual or automatic turntables tracking at ¾ to 1½ grams. \$62.50

"THE BEST PICK-UP ARM IN THE WORLD"

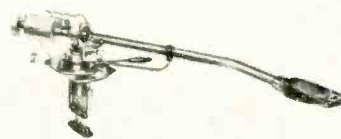

SHURE SME

Provides features and quality unattainable in ANY other tone arm. Made by British craftsmen to singularly close tolerances and standards. Utterly accurate adjustments for every critical factor relating to perfect tracking . . . it realizes the *full* potential of the cartridge and record. Model 3012 for 16" records \$110.50; Model 3009 for 12" records \$100.50

SHURE

Stereo Dynetic®

High Fidelity Phono Cartridges . . . World Standard Wherever Sound Quality is Paramount
Shure Brothers, Inc., 222 Hartrey Ave., Evanston, Illinois

Circle 110 on Reader Service Card



MAXIMUS 7 - Illustrated without grille cloth.

The MAXIMUS 7 is \$189 Audiophile net. Size: 24" x 14" x 12"

An important new development of particular significance

MAXIMUS 7 SMASHES THE SOUND BARRIER

Until now, you couldn't buy a speaker system like the MAXIMUS 7 . . . at any price. Now, all at once, here are six sophisticated design developments in a single new system — a bold breakthrough that offers uncompromising performance to the most discriminating listener. Read why dealers call the MAXIMUS 7 the freshest, most creative speaker system to come along in many years.

Here is the incredible MAXIMUS 7, the ultimate expression of advanced design and luxury performance. There is no other speaker system, at any price, that matches it.

What makes it so different? For the first time, all six of today's most sophisticated design features are incorporated into a single speaker system, creating an instrument so lavish in sound, so elegant in craftsmanship, that it challenges any speaker system to direct comparison, regardless of name. Here's what the magnificent MAXIMUS 7 offers you:

1. BROADEST FREQUENCY RANGE

MAXIMUS 7 delivers a frequency range of 25 to 35,000 cps at fantastically low distortion levels—virtually flat throughout the entire spectrum. No other system comes close, even at five times the price. It takes this kind of broad range capability to reproduce the harmonics that are present in the original sound. The result is a richness and roundness of sound such as you never heard before.

2. EXTREMELY LOW DISTORTION LEVELS

MAXIMUS 7 delivers its full range of sound at less than ¾% distortion from

50 cps to 35,000 cps; less than 3% at 30 cps, and provides superior performance even down to 20 cps. What other speaker system can make that statement?

3. ASTOUNDING POWER HANDLING ABILITY

A speaker system's true function is to reproduce sound faithfully without injecting its own personality. Frequently, a sudden clash of cymbals, a roll of kettle drums, and a speaker system loses its control, injecting extra, undesirable sounds of its own. Not so with the MAXIMUS 7. Its 9½ lb. ceramic magnet structure is among the most powerful ever used in a speaker system. It completely controls the magnetic field, which controls the sound output. This power handling ability is reflected in the rich, pure, luxurious sound of the MAXIMUS 7.

4. ADJUSTABLE ACOUSTIC CONTROLS

MAXIMUS 7 features two continuously variable KONToured ACOUSTIC controls, one for mid-ranges, one for treble. Both controls are located on the front panel, accessible in a moment. With them, you can adjust the sound precisely to your own individual taste.

You get perfect personal control of the sound you want to hear.

5. (CAPS®) CUSHIONED AIR PNEUMATIC SUSPENSION

MAXIMUS 7 features a heavy duty 12" pneumatic suspension woofer, based on the famous CAPS principle, an exclusive development of UTC Sound. In addition, it incorporates two shielded, back-loaded, bi-polar, mid-treble wide dispersion lens radiators and a dome lens compression type multi-cellular ultra-high treble horn. The resulting sound quality is simply superb.

6. SNAP-OFF DECORATOR GRILLE

MAXIMUS 7 provides the convenience of a distinctive, decorator-styled front grille that complements any style of decor. Snap off the grille instantly for easy access to front panel controls. Replace grille cloth with fabric of your choice. Cabinet is fully finished on all six sides in exquisite oiled walnut. Here is unquestionably the most distinguished of speaker systems, in an elegant, compact, book-shelf enclosure. Test it yourself very soon, at your favorite audio dealer. MAXIMUS 7 — designed for those who demand nothing less than the Finest.



MAXIMUS

MAXIMUS — a design product of UTC SOUND DIVISION • 809 Stewart Ave., Garden City, New York

Creative Engineering for the Sound of tomorrow

Circle 112 on Reader Service Card



Coming to your
hi-fi dealer soon
following its spectacular
West Coast premiere

the all-new,
feature-packed

MIRACORD 50H

the finest automatic
turntable ever produced

Use this coupon for details:

Benjamin Electronic Sound Corp.
40 Smith St., Farmingdale, N.Y. 11736

Send complete details about your
new Miracord 50H. Also notify me
when dealers near me receive
first deliveries.

Name _____

Address _____

City _____

State _____ Zip _____

Circle 113 on Reader Service Card



LIGHT LISTENING

Chester Santon

One Stormy Night

Philips PHS 600-205

I really got sidetracked while reviewing this one. In the case of a normal recording, it's pretty easy to gauge how long it will take to get through both sides of an LP. Once I got started on this one I soon found myself rummaging through earlier recordings of a similar nature—just to see what my present stereo pickup would do with sound-effects discs I hadn't played in recent months. What makes this Philips release unusual is the sound effects that have been mixed with the music. When it was decided to embellish some mood music on hand, Philips consulted our old friends on the West Coast specializing in train sounds, Mobile Fidelity Records. The idea was to present music as it might sound on a stormy night with Philips' Mystic Moods Orchestra supplying the instrumental sound and MF taking care of the storm and its by-products. As soon as the record begins, a large home sound system will immediately reveal that the music is to be heard with all the storm windows of the house wide open. If you want the sound of a real liquid downpour with freshly-washed presence in every groove, this record has it. The rain continues throughout both sides of the record, spiraling away merrily between the bands of the disc while the orchestra takes a few seconds to brush the flood out of its eyes. At regular intervals in the musical selections, a roll of thunder surges through one's speakers, at times almost drowning out the orchestra. On the next to last band of Side Two, the orchestra gives up for a time while Mobile Fidelity's steam locomotives (don't ask me why) take over in the storm. After checking some of my other sound-effects records devoted to similar material, I'm prepared to give Philips a clean bill of health in a fairly exacting form of record making. There are other thunder recordings of greater impact with no distraction of mere music, but the rainfall here is exceptionally realistic if you can take a whole record of it. This release won't convert sound fans into raging lovers of mood music but it may well encourage the layman to investigate some of the stereo recordings listed in the catalog under "Sounds—Miscellaneous."

Edmundo Ros: Latin Boss

London Tape LPL 74073

It takes little effort to persuade me to listen to a recording by London's famous

12 Forest Ave., Hastings-on-Hudson, N.Y.
10706

Edmundo Ros. His past releases have won a knowledgeable following among audio buffs who appreciate fine sound with a piquant Latin beat. Quite apart from any personal pleasures involved, there is further excuse for consideration of this tape release. It's been some time since this corner has devoted attention to a London Records Phase 4 production in either tape or disc form. The sound of this type of London multi-channel recording is so predictable that it is hard to imagine any technical change in its character from one month to another. Re-acquaintance with the formidable amount of gimmickry in the Phase 4 process still leaves me lukewarm despite the acknowledged merits of the Edmundo Ros performing skills. Anyone with a vague recollection of the wonderful sound Ros once enjoyed on the London label in pre-Phase 4 days will feel let down in this release. Certainly the instrumental talent was on hand in the recording studios. It simply could not work its way through the mountain of equipment Phase 4 involves and still register as it used to in the living room of the listener.

There are other labels aplenty using some form of multiple channeling in their pop recordings but few if any have gone to the extremes of Phase 4 process. The mere fact that London Records has been able to keep Phase 4 alive is a somewhat disconcerting tribute to the deficiencies of the average stereo phonograph in use today. In this latest Edmundo Ros recording, the producers are still gambling on the fact that the average American home has little of the presence in playback that you and I take for granted in our systems. How else can one explain a recording process that crams sections of the orchestra into small compartments so that it unfolds into the living room as a series of disjointed segments spread from speaker to speaker. The effect in this release is similar to the one I objected to in earlier Phase 4 efforts. In an attempt to gain maximum instrumental presence, mikes feeding each channel are right on top of the players and subsequent channel isolation is the most rigorous in the industry. When the muted brasses, an important ingredient in the Ros arrangements, speak up at the far right of the stereo listening area you can measure with a yardstick exactly where their segment of the "stereo wall" ends and where another section of the band takes over. Multiple channeling works best in the quieter tunes. This sounds like a different tape when the level drops in going from *One Note Samba* to *The Girl from Ipanema*.

(Continued on page 47)

A MARK TO REMEMBER

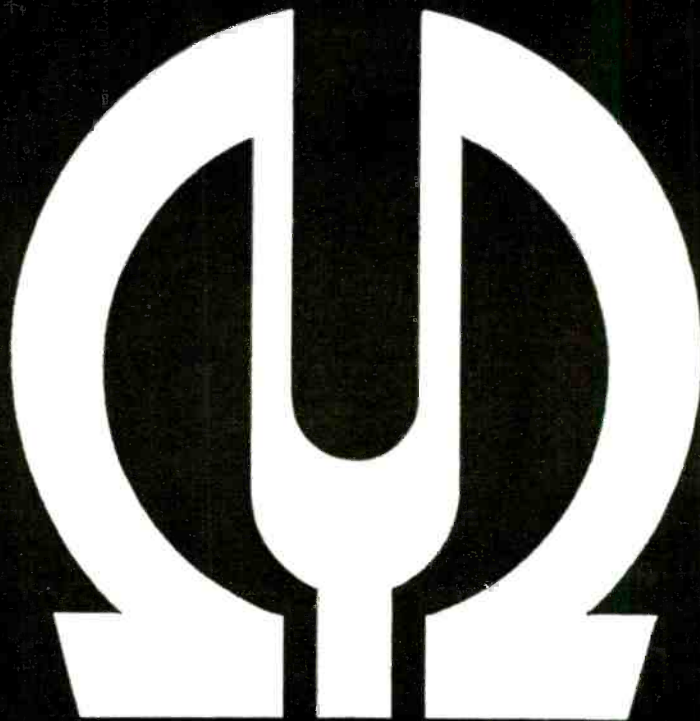

Reg. U.S.-T.M.

The faithful re-creation of sounds and music by man-made means, as close to the original sounds as possible, using the power of electricity has always been our guiding principle. The PIONEER trademark was conceived from this basic principle, by combining a tuning fork, that generates the standard waveform of sound, and the standard electrical symbol for the ohm.

As a major producer in one of the largest markets in the world the name PIONEER is synonymous with quality.

We will soon introduce some of our new Receivers at the better Hi Fi dealers. Ask them to demonstrate Pioneer equipment. REMEMBER THE MARK of the tuning fork and the ohm.

PIONEER ELECTRONICS U.S.A. CORPORATION

350 FIFTH AVENUE, NEW YORK, N. Y. 10001

Phone: (212) 524-1757

Circle 114 on Reader Service Card

AUDIO ETC.

Edward Tainall Canby



Prelude in 8-Track Major

I am observing the progress of the 8-track tape cartridge with the greatest of calm, on the sidelines.

I find this a very handy place to be, particularly in respect to 8-track. Judging from the mass of publicity which silently wends its way to me via the P.O., auto-tape, and especially 8-track auto-tape, is making a perfectly stupendous noise, or is about to make it. So far, I haven't heard a peep. Maybe it's just as well. But my ears and eyes are open. It's coming, all right.

The furor about 8-track began on paper a whole year ago, around June of '65 as I remember. It came from RCA and Lear-Jet. Natch. They launched it. Of course, after XXX years in this business, I tend to take such advance publicity with tablespoons of salt. And so I figured I'd better wait a few months for the billions to materialize.

'Long about September—was it?—I actually received an 8-track cartridge. I didn't get to hear it. Wouldn't play on my one-track Ampex and they didn't send me an 8-track player. Then, comes the autumn Hi-Fi Show in New York. At the RCA Victor showroom there were, indeed, some 8-track cartridge boxes. Also some tape machines. Reel-to-reel. Meanwhile I had written a tentative article on 8-track implications, a prelude to this prelude here. I decided (it was now October) that maybe I was still a bit premature, and so I didn't even bother to send it in to the editor. Thought I'd wait.

I rather suspect it is still too early to say very much. Hence this is only a prelude to 8-track. But don't think this is an abnormally long delay for a major new product! Not at all. As we should know, big publicity always waxes enthusiastic much too soon, never waiting for Engineering and Production, not to mention Distribution. The real merit of a major development, its likely failure or success, is not to be measured in a few days or weeks. If the thing takes years to develop behind the scenes, there'll be more years before solid conclusions can be drawn about it.

Disc

Meanwhile (as the broadcast news announcer say . . .) there are plenty of clues in the present wind, even if most of us haven't set eyes on any automobile tape cartridge, 4-track variety or 8. It seems abundantly clear that there is now a fire

going on behind all the 8-track smoke, at long last, after a full year. Not only in 8-track, not only in autos, either. This introduction of 8-track cartridge tape has in an odd way served to clarify and strengthen the position of the older tape types, which now show strong signs of settling down to a real (reel?) permanency. I think I can almost see how tape is going to go, in these next few years, along-side disc.

Ah yes! Who was it said that tape was going to take over from disc, because disc recording was an obsolescent system? 'Bout fifteen years ago, that rumor started. Luckily, I had the sense not to fall for it. Right now, disc is rather healthy, and going strong towards its centennial celebration. Yep, 100 years of disc. Not too far off. I'm willing to bet that NO form of magnetic tape is ever going to replace the disc record. So there. Only when we manage to combine the two—on maybe a magnetic disc—and then replace a billion or so phonographs, or equip 'em with new-type pickups, will we find the present disc really obsolete.

And so tape, for all its generally excellent sound, still finds itself winding in and out and around the disc market. It's a tough job to do so. Disc has itself strategically placed in almost any old area you can mention. Only two areas are really, positively, clearly for tape, with disc thoroughly pushed aside.

Pro Tape

One is the professional-commercial inside area. Background music, for instance. And all the related fields, except where sound on film still takes priority because of the associated picture. (Videotape? Coming up.) But also, of course, in all phases of master recording of sound-for-entertainment within the record company. Disc used to be supreme there, first on 78 and then, for a long while, on 33 transcriptions. Gone. All tape. Broadcasting is tape everywhere (audio or video)—except, of course, that major professional area, the broadcasting of recorded music. Strangely, the disc still holds on there, in all its millions, in spite of tape's better quality! (Well, not really strange at all. The disc persists there for the same reasons it hangs on with the public. Remarkably high quality, considering, plus reliability, simplicity and ease of operation. Plus, of course, availability.)

Sadly, from the engineer's viewpoint, a great deal of broadcast tape derives from

discs. That's really a stab in the back! But it's awfully convenient.

Vibrational Situation

The other major area where tape has the field pretty much to itself is in what we may call the vibrational situation. That is, where the disc is apt to be jostled, and grooves skipped. There is disc's Achilles heel, its most disastrous weakness! Quality—to heck with it. Scratchability—who cares. The disc is OK wherever it can be set down on a solid, immovable foundation. And hence—somebody has brightly seen—the automobile is a natural for tape. It vibrates, it moves.

Look. People nowadays live 45 per cent of their lives at home and in the office, and the other 45 per cent in the car. I'm leaving out 10 per cent—that goes for shopping centers and elevators and planes and trains (commercial background music)—and vacation. (Bed doesn't count, ear-phones and pillow speakers notwithstanding.) So, if we hafta have music all the time, then for Pete's sake, *put it in the car!* Imagine it, 45 per cent of 190 million American lives wasted on sleazy car-radio music! Where has everybody been, all these years, leaving that enormous gap in the business of selling records???

Well, as we all know, somebody tried to make automobile disc players for awhile. It didn't work. Sure, the system was a technical success, I guess; but the inherent odds were against it, and nobody cared anyhow. It just didn't go over.

So now comes vibration-immune tape, pushbutton style. And the billions start rolling. Or do they? Anyhow, tape has the field to itself. Disc is OUT, for that 45 per cent. No wonder tape is huffing and puffing and churning out big publicity! Somebody's gotta do something about it. We can't afford to have any more silent cars, with the loudest noise the annoying, utterly boring tick of an obsolete mechanical clock. We must fill every vehicle with the proper amount of recorded noise—I mean music, pardon me. Tape is the answer.

Stereo? Well, I wouldn't have believed it. I haven't tried, but some guy tells me it works, it really works. In your automobile interior, stereo is like being inside a set of earphones with a Bauer circuit included. That's the 8-track gimmick! To have stereo, and lots of music, too, you need 8-track. Well, now we have it, and we've got 8-way stereo.

The Bandwagon

It looks like a success, from here. Not because of any sales figures I've seen. (Have you?) But because of a very simple and easily observable phenomenon—the bandwagon. Watch the bandwagon and you'll see the combined up-to-the-minute judgments of some of the canniest minds in the industry. It's like looking over the shoulders of the stock-market pros as they buy into General Motors.

All last summer, RCA and its associated cartridge-and-player manufacturer, Lear-Jet, sat it out with 8-track in lonely magnificence, to the tune of hundreds of fat pages of ecstatic press releases in huge kits you could scarcely lift. I got 'em all.

(Continued on page 49)

Small Speaker

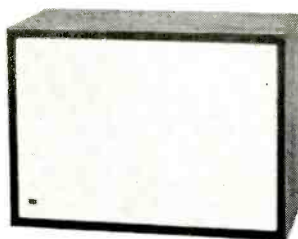

Big Flexibility

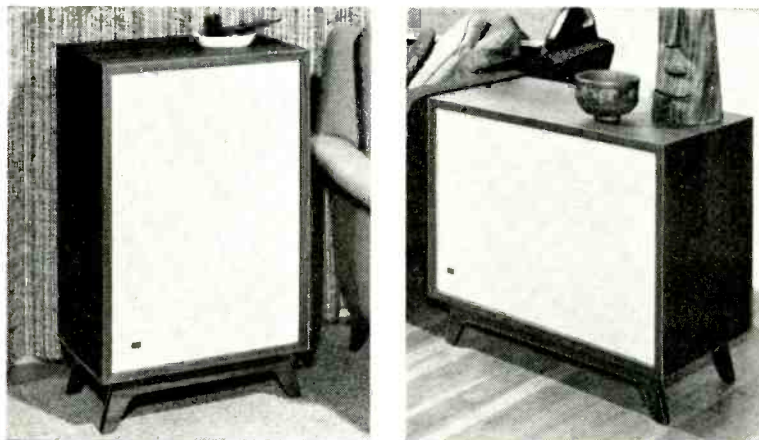

Bozak Quality

The Bozak Concerto III / Model B-313

If you want the realistic reproduction that only Bozak loudspeakers can bring to your home music system but your room won't accommodate full-sized speakers, where do you turn?

To the Bozak B-313.

Three-Way System, Compact Enclosure

It's a full-sized three-way Bozak system in a compact enclosure. The speaker complement is identical to the famed B-302A system—bass, midrange and two treble-speakers along with the same crossover network used in all full-sized Bozak systems. Each component is identical to those used in Bozak's Concert Grand, the world's finest speaker system.

Real Bozak Performance

The performance, too, is identical to the B-302A, except the low-range frequency response extends only to an honest 45 cycles, rather than to 40 cycles. We're sorry about that,

but the laws of physics won't permit 40-cycle notes to be reproduced in such a small enclosure.

There's even a small bonus in the slightly foreshortened frequency range. When you move to larger quarters, just transfer the components to a larger Bozak enclosure, and you automatically extend the bass response.

About The Enclosure

Measuring just 24½ x 17¼ x 12¼ deep, it's slightly larger than so-called "bookshelf" speakers, but it can be used on a shelf. It's also slightly smaller than the usual free-standing speaker, but it can be used on the floor, either vertically or horizontally. Used with the available floor stand, it becomes a handsome end table.

The classic simplicity of the cabinet design permits its use with any decor. Naturally the wood surfaces are genuine walnut. The matte finish is hand rubbed in the true Bozak tradition of craftsmanship.

You can't find a better speaker for a small room.



Box 1166, Darien, Connecticut
Circle 115 on Reader Service Card

SOUNDMEN GET SOUND ANSWERS FROM FAIRCHILD!



NEW! FAIRCHILD COMPATILIZER

An automatic approach to the production of compatible stereo records. Unit rejects low frequency information automatically above a predetermined level. COMPATILIZER also permits increase in high level recording time on discs and provides maximum separation on stereo records above 100 cycles.

NEW! FAIRCHILD BASS-X

A dynamic low frequency roll-off filter—that can roll off high level low frequency information, starting at 500 cycles, with a maximum obtainable attenuation of 12 db at 30 cycles. Device is automatic, is in use only when needed—therefore it does not alter overall apparent low end response to the ear. THE FAIRCHILD BASS-X allows higher levels to be maintained in disc recording, and particularly assists AM stations in increasing their effective signal by automatically controlling the often troublesome low end response.



FAIRCHILD CONAX

The world-accepted way to control high frequency spillovers in FM due to pre-emphasis. Lets your station maintain real high levels even with brass and crashing cymbals and still avoid FCC citations.

THE REVERBERTRON

The new compact reverberation system which gives your station that real big voice. With the Reverbertron you can have that Carnegie Hall effect as close as the gain control on the Reverbertron. And there's the added plus of an increase in apparent loudness of your station sound due to reverberation, as originally described by Dr. Maxfield.



Write to FAIRCHILD — the pacemaker in professional audio products — for complete details.

FAIRCHILD

RECORDING EQUIPMENT CORPORATION
10-40 45th Ave., Long Island City 1, N. Y.

Circle 116 on Reader Service Card

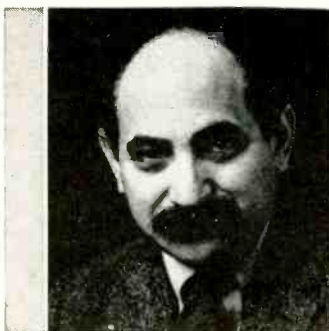

JAZZ and all that

Bertram Stanleigh

Les McCann: Spanish Onions

Pacific Jazz Mono PJ-10097

There has been a wealth of new McCann waxings lately, and one can only marvel at this versatile pianist's ability to keep coming up with new and different material. From the title tune and album cover with Les in one of those black, broad-brimmed, flat-crowned Spanish hats, it seemed reasonable to expect this new set would have an Iberian flavor. But only *Spanish Onions* (shouldn't this really be called *Spanish Chestnuts*?) is in the form of an Andalusian improvisation. More's the pity, for this number is nearly nine minutes of sheer masterpiece, combining all of the familiar clichés of Flamenco, corrido band, and zarzuela with Les's familiar bounce and wit. But even if the remainder of the platter is in a more commonplace style, the performances are served up with the enthusiasm and originality that make McCann such a satisfying performer. As usual, Victor Gaskin, bass, and Paul Humphrey, drums, round out the trio. Recorded "live" at the Empire Theatre in Los Angeles during an after-hours concert, the sound isn't up to the superb level of Pacific Jazz's studio recording with the same group, but it's still quite adequate, and the audience participation is confined to short bursts of applause at the end of each selection.

Lucky Thompson: Lucky is Back!

Rivoli Records Stereo LPR 40

Since Lucky Thompson's tenor and soprano sax were recently heard with the latest aggregation of Art Blakey's Jazz Messengers in *Soul Finger* on Lime-light, we were unaware that Lucky had been away. But the cover of this new Rivoli recording shows him, complete with luggage, disembarking from the France, so he's evidently been sharing his talents with the fortunate Europeans. Even if we failed to note his absence, we're delighted to learn of his return on this very welcome platter. He's in great shape as he rambles through a quartet of original compositions: *Evil Eva*, *Passionately Yours*, *Slow Dough*, and *Tippy Top*. Three standards: *Love*, *Willow Weep for Me*, and *My Old Flame* make up the balance of the collection. The rest of the participants are Tommy Flanagan, piano, Willis Ruff, bass, and Walter Perkins, drums.

Della Reese: I Like it Like Dat!

ABC Paramount Mono ABC 540

The versatility, vivacity, and abundant talent of Della Reese are all very much in evidence in this blues collection that features arrangements by trumpeter Bobby Bryant. Della manages to project each of a dozen numbers with a style of its own, delivering every set of lyrics with clarity and emotional conviction. But the accompaniments are brash and overly contrived, and the

otherwise worthwhile record is seriously impaired by a tasteless abundance of echo and a balance between singer and band. This is fine when Miss Reese is backed by a solo instrument but it makes a noisy blur of the instrumental contribution in the fully-orchestrated sections. Della Reese is an artist who deserves more considerate treatment from the sound engineers.

Skip James, Greatest of the Delta Blues Singers

Melodion Mono MLP 7321

Born in Yazoo County, Mississippi in 1902, Nehemiah James had been a performing musician and blues and gospel singer from his late teens until about 1938. In 1931 he had cut a notable group of masters for the Paramount label, and now, after an absence of thirty-five years, Skip is back on discs with his first recordings since his rediscovery in 1964. Of the eight numbers in this collection, five are James compositions that he had originally cut on Paramount: *Hard Time Killin' Floor Blues*, *Cherry Ball Blues*, *Devil Got my Woman*, *Illinois Woman*, and *All Night Long*. The remaining three tunes are also by James: *I Don't Want a Woman to Stay Out All Night Long*, *Sick Bed Blues*, and *Washington D. C. Hospital Center Blues*. The last two were written in 1964 during an illness, at about the time of his rediscovery. Throughout this record James shows himself as a skillful guitarist with a wonderfully sustained rhythm and an eloquent way of projecting the despair of the traditional blues. There is quite sufficient voice left to convey his message, and the recording does an excellent job of presenting voice and guitar in a proper perspective.

The Stanley Brothers—Their Original Recordings

Melodion Mono MLP 7322

Ralph and Carter Stanley are classed among the greatest of bluegrass musicians. Their recordings, made in the late '40s and early '50s for small record labels with only local distribution in the southeastern states, have long been out of print and the subject of great interest for collectors. Fourteen of their 78 rpm waxings are reissued on the present platter, and their availability should be cause for rejoicing on the part of the new crop of urban bluegrass performers and all country music aficionados. While the recorded quality of the originals is uneven, the transfers to LP have been accomplished with skill. It's particularly hard to put into words the special quality to be found in these classic performances. Their full depth can be appreciated, however, by comparing some of these original performances with those of the city-bred bluegrass groups of the last few years. Just listen to their *Rambler's Blues* or *Little Glass of Wine* to discover what's missing in the work of the young country music makers. Æ



PHOTOGRAPHED AT CAPITOL RECORDS BY FRANZ EDSON

Good records start with Stanton.

A professional needs to know for sure. When he listens to a test pressing, he needs a cartridge that will reproduce exactly what has been cut into the grooves. No more, no less. Otherwise he would never be able to control the final product. The record you buy in the store.

That's why the professionals keep using Stanton. It tells them the whole truth, and nothing but.

In the photograph above, studio engineers are shown listening to

a test pressing. This is a critical stage in record making. The stereo playback system they are listening through is fronted by a Stanton 581 EL Calibration Standard. (The turntable also happens to be a Stanton. Other fine turntables will work, too.) They're getting the whole message. You'll get it, too, in an upcoming release.

Each Stanton Micro FLUX-VALVE® Calibration Standard is custom made. That means that

each will perform exactly as the original laboratory prototype. We laboriously adjust them until they do. It also means that you will get the same accuracy that the professionals get. Guaranteed.

Stanton Calibration Standards are hard to make. And the price reflects it. \$49.50. But that really isn't much to pay for uncompromising accuracy.

STANTON Magnetics, Inc.
Plainview, L. I., N. Y.



Circle 117 on Reader Service Card

EDITOR'S REVIEW

THREE HI-FI SHOWS IN TWO WEEKS?

Sounds implausible, doesn't it? But that is exactly what could—and did—happen this April. First the U. S. Department of Commerce exhibit at the Trade Center in London. Concurrently for the first four days was the International Audio Fair and Festival at the Hotel Russell, also in London. And just over a week later another show was held at the Bitburg Amateur Radio Club at the Bitburg Air Force Base in West Germany. Details of all three shows will have to wait until next month, but we did evolve an idea which we believe is worth presenting to our readers and to the industry for what it is worth.

LET'S MAKE COMPARISONS SIMPLER

The idea of which we speak came about following our listening to a demonstration in one room at the London Audio Fair shortly after having heard one in another room. The first was a popular rendition, something like Hugo Winterhalter, for example. The second was a classical guitar. Assuming both reproducing systems were equally good, how could one possibly compare them?

We are fully aware, of course, of the desire of each exhibitor to select music which will show off his equipment to its best advantage. If a system does best with solo instruments, that is the type of music used to demonstrate it; if the system is capable of fine reproduction of a full symphony orchestra, by all means choose that music to show it off; if it does especially well on vocals, select them; if the brass and wire brushes of a latin-type ensemble, pick a good one of those. Most people have a preference for a specific type of music, although they are certain to hear more than one type over the course of a listening day. Yet if we were to select a system which sounded good with a chamber music ensemble, must we assume that it will sound equally good on the other types of music?

One example of a loudspeaker designed for a particular type of music is the "tone chamber" (electronic organ term for loudspeaker) usually heard with organs. These speakers are designed for a certain kind of music, and do a most creditable job with it. But most of them are not suitable as general-purpose loudspeaker systems. On the other hand, a good general-purpose loudspeaker might do just as well on organ music, but it would most likely cost three or four times as much as the organ-type "tone chamber."

The same principles apply to a complete system. One which performs to our satisfaction with one type

of music may not be equally satisfactory with another. Yet if the system works best with a specific type of music, that is just what the exhibitor will select to demonstrate with, naturally enough.

Our proposal is simply this: The IHF would produce—or solicit from one of the record manufacturers—a special record for the show. This record should consist of the particular recording company's best demonstrable recordings in a number of different types of music—preferably classical on one side, and popular on the other. The selections should probably be chosen by a committee (perish the thought), and the recording company rotated from year to year. The record itself—as well as a tape of the same material—should then be packaged in suitable jackets and boxes and made available at a reasonable price to those who attend the show or anyone, for that matter. This part of the proposal is not new—it has been in effect at the Festival du Son in Paris since 1962, although we do not know if they make tapes available in the same fashion.

Each exhibitor would be required to have the demonstration record on hand to play for any of the visitors who requested it, thus making it possible to make a more valid comparison of the equipment on display. We doubt that the exhibitors would take kindly to the idea that they use this record or tape *exclusively*, but it would suffice if they had it available for the edification of those who wanted to hear it.

Undoubtedly this plan would give the visitors an opportunity to hear the same recording on several different systems to the end that their judgment could be valid.

Everyone knows that any demonstration depends on the listener's familiarity with the number being played as well as the particular recording. It's as simple as any A-B test—at least one element must remain constant. If you are comparing loudspeakers, you do not change amplifiers or source, but change only the speaker. If you are comparing amplifiers, you do not change the source—either the record or the cartridge, for example. If you are comparing complete systems, the music must remain the same.

Furthermore, everyone knows that the average person does not have a reliable audio memory—only a highly trained person can be expected to be so favored, and even he is likely to be most doubtful of it. But we believe that this proposal would help the inexperienced listener make a satisfying choice.

We don't expect 100 per cent acceptance of the idea, but we've proposed it and we're glad.

Nine out of ten musicians prefer the natural sound of Pickering.

PHOTO BY FRANZ EGGON



Microgroove discs are recorded by magnetic processes. Naturally they sound better when reproduced with a Pickering Micro-Magnetic™; there's a natural compatibility. From the tiniest peep of a piccolo to the mightiest roar of an organ, Pickering produces sound as natural as the original performance. That's why musicians prefer Pickering. And so does everyone else who can hear the difference.

Pickering makes it easy to get natural sound in any stereo installation. There are four Pickering Micro-Magnetic pickups, each designed for a specific application. The V-15AC-2 is for conventional record changers, where high output and heavier tracking forces are required. The V-15AT-2 is for lighter tracking in the newer automatic turntables. The even more compliant V-15AM-1 is ideal for professional-type manual turntables. And the V-15AME-1 with elliptical stylus is the choice of the technical sophisticate who demands the last word in tracking ability.

No other pickup design is quite like the Pickering Micro-Magnetic. The cartridge weighs next to nothing (5 grams) in order to take full advantage of low-mass tone arm systems. Pickering's exclusive Floating Stylus and patented replaceable V-Guard stylus assembly protect both the record and the diamond.

But the ultimate test of a cartridge is the human ear. Find out for yourself. Listen carefully to a Pickering. You'll hear the difference.

For those who can **hear** the difference.

Pickering
Pickering & Co.
Plainview, L.I., N.Y.

Compare these new Sherwood S-8800 features and specs! ALL-SILICON reliability. Noise-threshold-gated automatic FM Stereo/mono switching, FM stereo light, zero-center tuning meter, FM interchannel hush adjustment, Front-panel mono/stereo switch and stereo headphone jack, Rocker-action switches for tape monitor, noise filter, main and remote speakers disconnect. Music power 140 watts (4 ohms) @ 0.6% harm distortion. IM distortion 0.1% @ 10 watts or less. Power bandwidth 12-35,000 cps. Phono sens. 1.8 mv. Hum and noise (phono) -70 db. FM sens. (IHF) 1.6 μ v for 30 db quieting. FM signal-to-noise: 70 db. Capture ratio: 2.2 db. Drift \pm .01%. 42 Silicon transistors plus 14 Silicon diodes and rectifiers. Size: 16 $\frac{1}{2}$ x 4 $\frac{1}{2}$ x 14 in. deep.



Now, look at the *NEW* Sherwood specs!

Model	V-Vacuum Tube S-ALL-SILICON T-Germanium Transistor	Power (IHF) 2 channels 4 ohms Watts	FM Sensitivity Microvolts	Price	Dollars/Watt
Sherwood S-8800	S	140	1.6	\$ 359.50	\$ 2.57
Altec 711A	S	100	2.2	378.00	3.78
Bogen RT8000	T	70	2.5	319.95	4.57
Dyna FM-3, PAS-3 & S-70	V	90	4.0	394.85	4.38
Fisher 600T	V&T	120†	1.8	459.50	3.82
Fisher 440T	T	70	2.0	329.50	4.70
Harman-Kardon SR-900B	T	100	1.85	449.00	4.49
McIntosh 1500	V&T	85	2.5	499.00	5.87
Marantz 8B 7, & 10B	V	75*	2.0	1170.00	15.60
Scott 348	V&T	120	1.9	479.95	4.00
Scott 342	T	65	2.5	299.95	4.61

References "T" or "V&T" (above) may include some silicon transistors.
 Figures above are manufacturers' published specifications except (*) which are published test findings.
 †(at 8 ohms), 4-ohm rating not specified



S-8800 140-watt FM ALL-SILICON Receiver
 \$359.50 for custom mounting
 \$368.50 in walnut leatherette case
 \$387.50 in hand-rubbed walnut cabinet

Sherwood

Sherwood Electronics Laboratories, Inc., 4300 North California Avenue, Chicago, Illinois 60618. Write Dept. A6

Circle 118 on Reader Service Card

Power Amplifier Overload Characteristics and their Importance

R. A. GREINER*

The search for a clue as to why amplifiers sound different with differing sound sources and with various loudspeakers never seems to cease. This should show the reasons in a manner readily understood by everyone, since the actual effect can be shown pictorially.

PERHAPS BECAUSE it is the one element in the audio reproduction chain most easily built, measured, and analyzed, the audio power amplifier has been the subject of much discussion over the years by amateur and professional alike. However, these discussions were often subjective and opinionated and not founded upon fact or objective measurement. Sometimes heated arguments were waged about such things as triode sound-*vs.*-pentode sound, desirability of .001-per cent distortion-*vs.*-.01-per cent distortion and on ad infinitum. One might have expected that the transistor-*vs.*-tube controversy would arise with even greater vigor in more recent years, as it indeed has.

While I do not wish to get in the crossfire of a continuing argument, I present here the results of some interesting experiments. The purpose of this paper is not to settle the power amplifier controversy but rather to shed some light on the relative merits of several amplifier types and how these amplifiers may be expected to perform in certain types of audio systems. Included are some of my personal conclusions as to the relevance of these test results in terms of desirable amplifier speaker/listening-room combinations and in good amplifier-design criteria.

I would like to take this opportunity to point out my neutrality in this controversy. My main interest from a professional standpoint is in semiconductor devices, and I have written a college textbook on this subject. However, my large audio system, parts of which have been described in *AUDIO* in past years (Nov.-Dec. 1960) con-

sists mainly of vacuum tube electronics. Some transistor equipment is employed where its use seems definitely advantageous. This situation will most likely change as I anticipate complete conversion to solid-state devices in the next few years.

Introduction

The present investigation was initiated when it became apparent that some high-quality tube and transistor amplifiers *do in fact sound different*, especially when used with some modern low-efficiency acoustic-suspension speakers. That this should be the case even when only the *best* quality amplifiers, rated at 30 watts or more, are used, is difficult to rationalize at first. It becomes even more mysterious when the amplifier with the lowest measured sine-wave distortion figures clearly sounds the worst under some circumstances. There should really be no difference in the sound of a system when any of several high-quality am-

plifiers are substituted in the system and all used *within their rated power*. After all, the sine-wave distortion in the poorest amplifier tested was conservatively one-half to one-fourth that generated in the tape, pickup, and speaker systems. In fact, the distortion generated in any reasonable electronics is generally negligible compared to the source and speaker distortion.

We are faced with the fact, however, that some power amplifiers sound good when pushed to high listening levels and some sound simply terrible. The clue needed to explain this latter fact lies in the statement, "within its rated power." Or to be more specific, the sound of the amplifier seems to be associated with how the amplifier behaves when it is used at a good fraction of its rated power and *occasionally overloaded*. There are two main factors involved in this discussion. One has to do with the statistical nature of musical signals, the second with the relative demands made on the power amplifier by the audio system and operator. Each of these factors is discussed briefly below and a few terms and listening situations are described so the reader may establish a reference for the system and listening levels used in the tests.

The Nature of Musical Signals

The nature of musical signals is something like that of random noise. In fact, some music is only slightly organized noise. Basically, music signals differ from sine waves, which are used for much testing. Sine waves are large in amplitude during much of their cycle and small only during the short time interval when they cross the zero axis. Their peak-to-average power ratio is small. Music signals on the other hand are small in amplitude most of the time and very large occa-

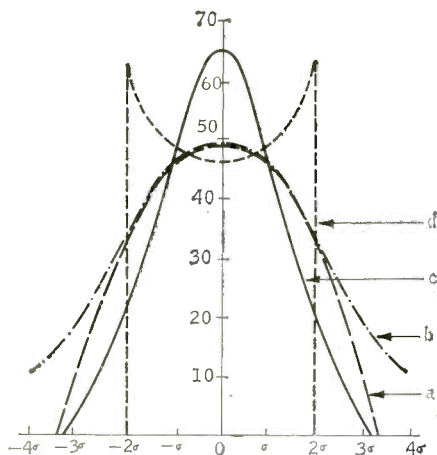

Fig. 1. Amplitude density curves for sinusoidal and typical noise and music sources. Ordinate gives the density and abscissa the amplitude.

Professor, College of Engineering, Dept. of Electrical Engineering, University of Wisconsin, Madison, Wis. 53706

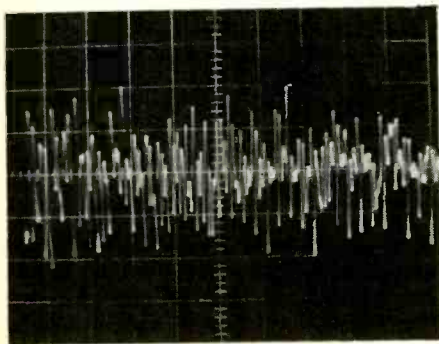
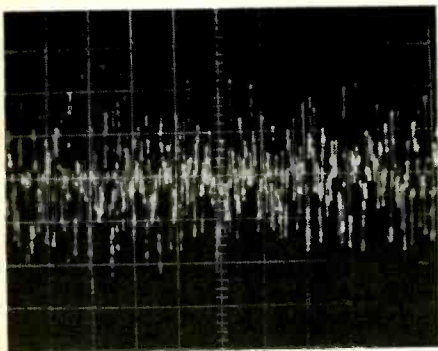
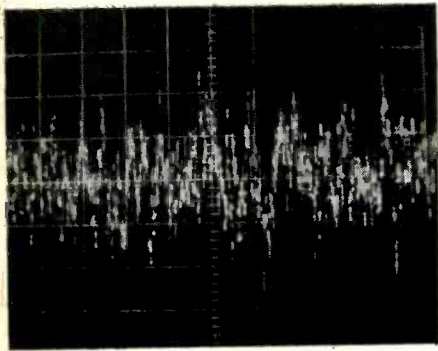

Fig. 3. Tone burst of 128 cycles "on" (top), 8 cycles "on" (middle), 4 cycles "on" and 8 at reduced amplitude, shows the versatility and excellent waveforms of the tone-burst generator.

sionally. They have a large peak-to-average power ratio. This feature is shown in Fig. 1.

There we see a set of amplitude density curves for several types of signals. Clearly that of the sine wave is different from the rest. The most significant factor is that the skirts of the distribution are missing completely for the sinusoid. The peak-to-average ratio for all sound sources is much greater than for the sinusoid. A better way to evaluate the difference in these signals is to consider that the difference between the peak power and the average power in a sine wave is only 3 dB. That is, a 50-watt-average-power sine wave reaches a 100-watt peak each half cycle. Music on the other hand will typically have a peak-to-

short-time average-power ratio of 14 to 18 dB. Thus the music signal will have a 25 or even 50 to one peak-to-average ratio. This means that in a low-level musical passage where the average power may be 0.02 watt, the peaks may reach 1.0 watt. While in a very loud passage the average power may be 2 watts and the peaks 100 watts. These electrical power levels are only examples and may be much lower or higher in a given audio system.

The main point in the above discussion is that the music signal puts entirely different demands upon an amplifier than does sine-wave testing.

Because of the statistical nature of the musical signal there will always be peaks which greatly exceed the average. While they may not occur often, they usually will overload the power amplifier rather than some other link in the system. Typical signals from orchestral music, jazz, and pink noise are shown in Fig. 2.

One can be sure that average power-vs.-distortion curves and frequency-response curves measured with sine waves do not tell the whole story about amplifier performance. So-called transient testing with square waves or pulses gives no additional information since it is entirely equivalent to frequency phase-response tests. Pulses are sometimes easier to use for quick tests but usually harder to interpret than frequency-phase tests.

We want to use a test signal which is highly controllable and still has some of the important characteristics of the music signal. The most convenient signal is a tone burst. In Fig. 3 we see such a burst. The relative amplitudes of the "on" and "off" portions can be controlled. The signal starts at the zero crossing and switches to the new level at another zero crossing after a specified number of cycles.¹ A General Radio Tone Burst Generator was used to perform the tests along with other oscillators, meters, oscilloscopes, and so on, as required. The signal from the tone-burst generator is essentially perfect as far as distortion, sharpness, freedom from transients, and the like are concerned at all frequencies of interest.

This can be seen in the several examples shown in Fig. 3 which look identical at 20 Hz or 20 kHz on the equipment used.

The advantages of using a tone burst are very great when it comes to evaluating the overload characteristics of any amplifier as will be seen in the following data. A signal of this type is quite realistic when used to represent a music signal since a controlled burst quite reasonably represent a loud drum

beat or similar burst of sound followed by the normal-level background instruments. This sort of event is common in most forms of music. The tone burst represents the large peak-to-average power ratio demanded of a typical amplifier much more accurately than does a continuous sine wave and it enables one to overdrive the amplifier for short intervals without overloading the power supply or destroying power transistors. Ideally one would use noise bursts for testing and this has been tried. However, the results are at present too difficult to interpret to be of great value.

The Demands of the System

The second factor which must be considered is that of the demands which the listening situation and loudspeakers make upon the power ampli-

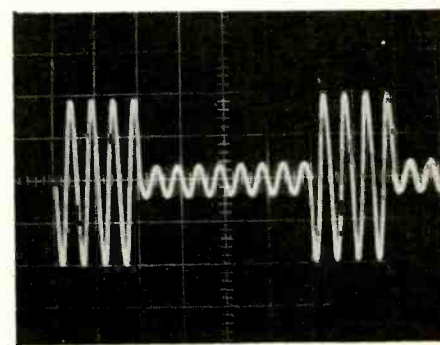
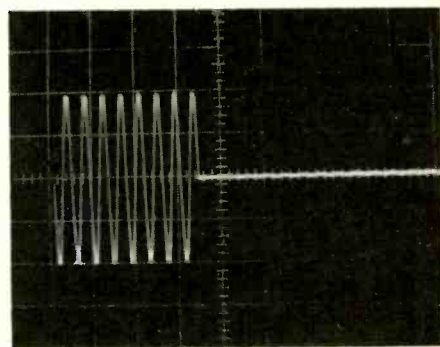
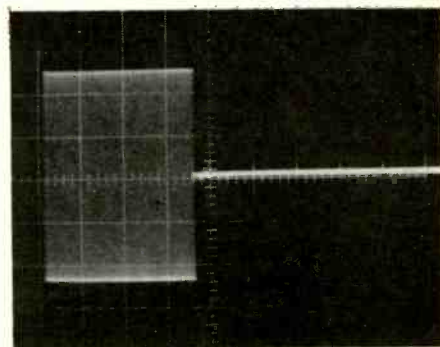

Fig. 2. Typical examples of pink noise (top), jazz band (middle), orchestra (bottom).

DECIBELS

RE 0.0002 MICROBAR

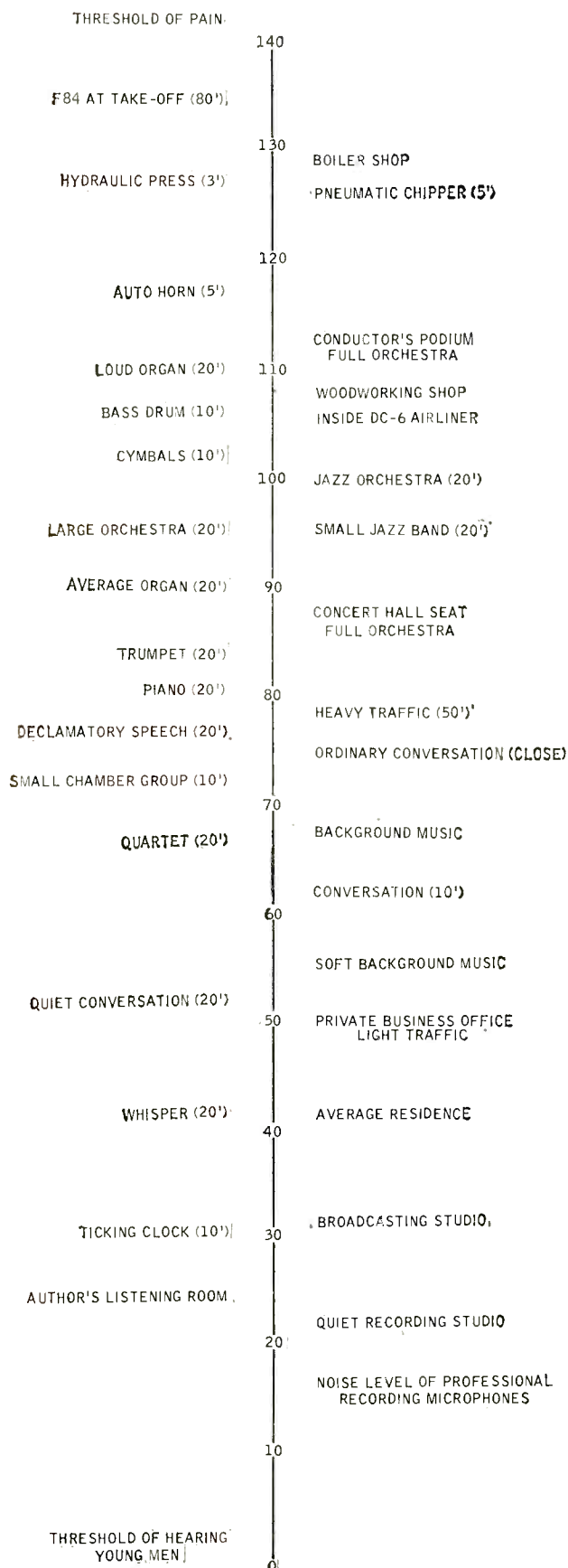

Fig. 4. Sound pressure levels (SPL) in decibels with respect to 0.0002 microbars.

fier. This factor is much more complicated to evaluate because it is highly dependent upon the individual audio installation. The extremes may vary from small, live rooms with efficient speakers to large, dead rooms with inefficient speakers. To demonstrate the immense variations which may occur, consider the following examples. A realistic sound level for listening to orchestral music is about 86 dB SPL (referred to .0002 dynes/cm²), we will use SPL for all acoustical levels since this is a standard scale. Typical sound levels on this scale are shown in Fig. 4.

This chart is compiled from a great variety of sources including measurements made by the author.

For a small room, say about 1000 cubic feet, of average liveness we then calculate an acoustic output from the speakers of about 0.008 watts average. For a large room, say 4000 cubic feet, we require 0.03 watts average for the same sound level. Using a modest figure of 14 dB peak-to-average ratio, we require 0.2 acoustic watts peak and 0.75 acoustic watts peak respectively. An efficient direct-radiator loudspeaker may convert about 2 to 4 per cent of the electrical input into acoustic output. An inefficient speaker may convert only 0.2 to 0.4 per cent of the electrical power to acoustic power. Thus the efficient speaker in the small room may require a peak power of 10 watts and the inefficient speaker in the large room may require 225 watts peak power. These are extreme examples of course, but certainly show the great demands that the inefficient speakers make on the power amplifier. Table 1 summarizes the situation for two room sizes and two speaker efficiencies. A level of 96 dB SPL average is *very loud* but may be the *actual* level used when listening to a close up jazz-type group.

From the table we must estimate the requirements of a particular installation. In the author's case a room of 3500 cubic feet with rather dead characteristics is used. Two large (24 cu. ft.) multiple-cone, direct-radiating speakers are used. These speakers are moderately efficient at about 3 per cent. The room requires 0.02 acoustic watts average for a level of 86 dB SPL. The electrical power required is about 0.7 watt average. If one again allows 14 dB peak-to-average ratio for the program material we find acoustic peaks of 0.5 watts or electrical peaks of 17 watts. At an average level of 96 dB SPL we require 0.2 acoustic watts or 6.7 electrical watts average. The electrical peaks reach 170 watts at this level if we allow again a 14 dB peak-

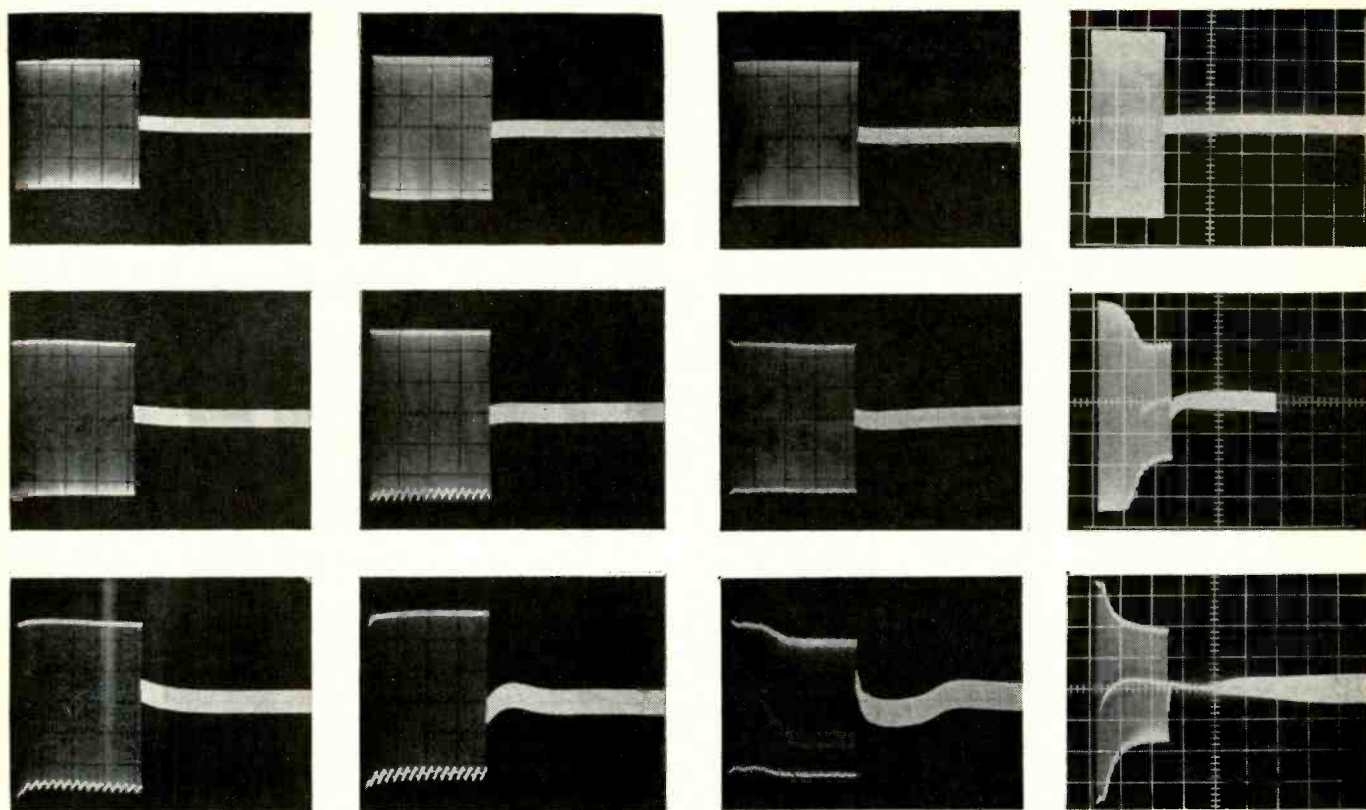

Fig. 5. Overload characteristics for amplifiers A, B, C, and D from left to right. No overload (top), 2-dB overload (middle), 5 dB overload (bottom).

to-average ratio. The system actually uses four 50-watt amplifiers which are very conservatively rated and have reasonably good overload characteristics. Thus the system is adequate for the room and realistic listening levels at which it is expected to perform.

It is worthwhile to note that several inefficient acoustic-suspension speaker systems were driven with an amplifier rated at 60 watts per channel, but with modest overload characteristics, and it was found that the amplifier could be overloaded easily, with severe distortion resulting, at normal to loud listening levels in the same room. Note that we are not suggesting that it is necessary to generate the same acoustic power from the speakers as the orchestra would generate. This would be a ridiculous 75 acoustic watts for a full orchestra and would demolish the listener in even a very large listening room. However, we are demanding that the system generate the same sound pressure level at the listening position in the listening room as would be heard by the same listener in a typical concert hall, or in a typical jazz concert, or in a chamber performance.

In summary of this second factor in system power requirements, we may note the following. The range of required power from the amplifier may vary by 100 to 1 or more in different

systems. It must be carefully evaluated for each individual room/speaker set and expected listening level. Listening levels vary with individual taste and since the ear responds logarithmically a small apparent loudness change can mean a factor of 2 or more in required power level.

We must also recognize that we do not listen at realistic levels all of the time. Usually we listen at 5 to 10 dB lower levels. However, for a system which must, on occasion, produce realistic levels and not only background music, these power requirements are reasonable.

The required peak power depends upon the peak-to-average ratio of the source material. This is much larger for some sources than others and in general, increases as the quality of the program source improves. The figures given are typical and indicate that even a good system may overload on peaks occasionally and many inefficient-speaker systems, even with high-power amplifiers, may overload frequently.

In fact, most inefficient acoustic-suspension speaker systems in medium to large listening rooms often require peak powers in excess of those obtainable from commonly available amplifiers. We now will investigate the results of some overload tests on typical amplifiers.

Tone Burst Tests on Typical Amplifiers

The series of tests described below is only one of many possible tests of a similar sort that could be performed using tone bursts. The particular levels and frequencies are the experimenter's personal choice. The results are generally valid however, and show that there are serious limitations in some highly regarded amplifier designs and that apparently identical amplifiers on a basis of frequency response and sine-wave average-power rating are in fact quite dissimilar in performance under more realistic test conditions. While many amplifiers were tested, only four are presented here. At least two of each were tested with similar results. They were selected to show the range from the worst to the best of those tested. All four are high-quality, well regarded high-power amplifiers. One is very inexpensive and one very expensive. They are designated A, B, C, and D in Table II at this time so as not to confuse the issue with emotion.

One main test was used to give an over-all picture of the overload performance. This was to apply a tone burst of 128 Hz at a 1000-Hz rate and then reduce the level by 25 to 30 dB and observe the way the amplifier recovered. The signal was adjusted to a level 0.5 dB below clipping which was in all cases clearly defined. This level was considered the "no overload" case.

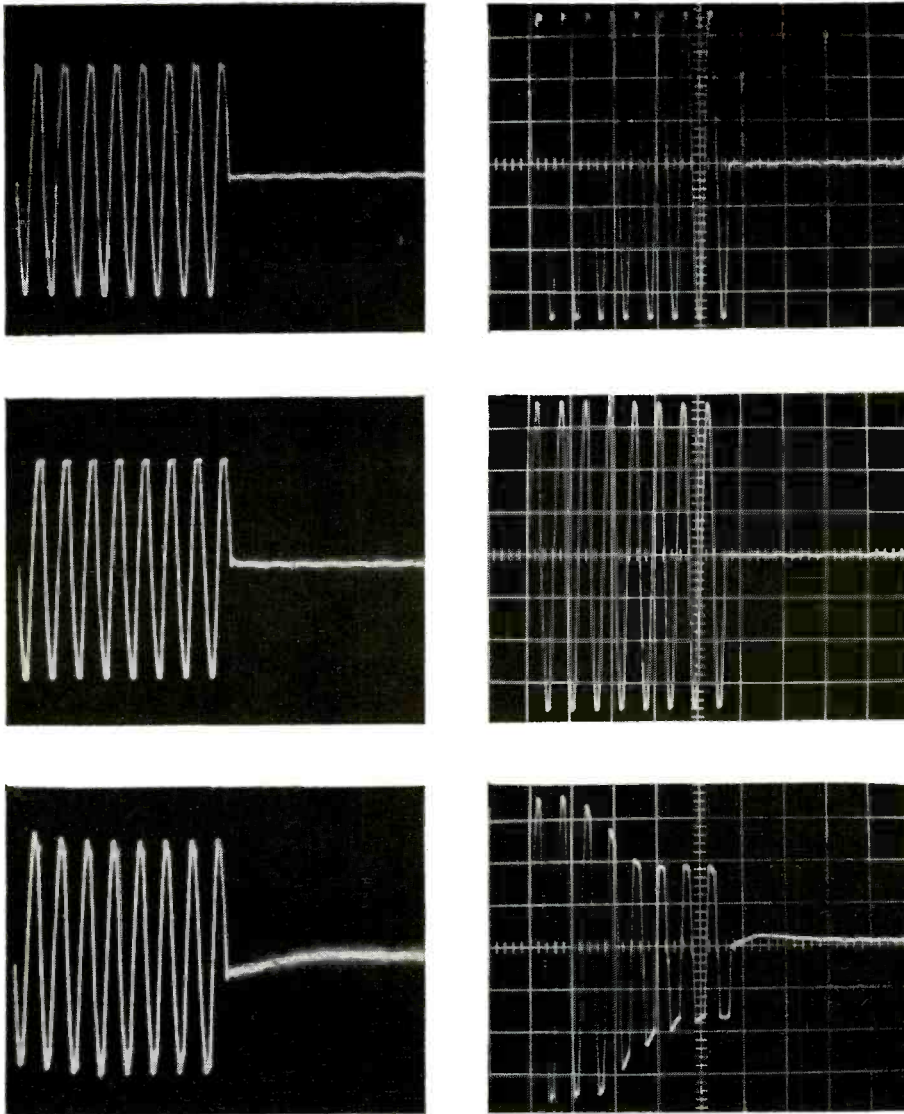

Fig. 6. Overload waveforms for amplifiers A, left, and D, right. Overload 2 dB in all cases. Frequency of 10 kHz at the top, 1000 Hz in the middle, and 100 Hz at the bottom.

The amplifier was then driven to 2-dB overload and 5-dB overload. The period between tone bursts was 5 seconds to allow all transients in amplifier and power supply to dissipate.

The results of this test are presented in Fig. 5. Clearly the four amplifiers are different in behavior. The best amplifier was A and then followed B, C and D in that order. Amplifier D was terrible as is clear in the figure. It is interesting to note that medium-power-level distortion measurements placed the amplifiers in the order D best, C second, A and B poorest. These distortion figures were all under 1 per cent THD, however. Pertinent data on the amplifiers are given in Table II. A second point aside from the tests is that all amplifiers sounded good with a medium-efficiency speaker at 86 dB SPL in the author's room. But, A sounded good and D terrible with low-efficiency speakers at the same sound

level. Amplifiers B and C sounded the same.

The conclusion must be that ampli-

fiers do sound different and that this difference can not be evaluated in terms of small-signal harmonic distortion, or if tubes or transistors are used, or if transformers are used or not, or in terms of most of the other alleged differences in design specifications. But rather the way any good modern feedback amplifier will sound depends on how adequate it is in handling the occasional overloads which occur in typical program material.

A somewhat more detailed look at the results shown in Figs. 5 and 6 lends some insight into what may be the trouble with the poorer amplifiers. At the 5-dB overload drive level all four amplifiers have a low-frequency "thump" immediately following the overload condition. Amplifier A is very quick to recover and does not attenuate or distort the low level signal at all. While amplifier D not only has a severe low-frequency "thump" but completely cuts off the low level signal and recovers only after an additional 100 to 200 milli-seconds. Since amplifier A and B are direct coupled for the most part there are very few capacitors to charge during overload and recovery is quick and clean. Amplifier C is a very simple standard tube design but does have driver capacitors to the final power stage which charge on overload and delay recovery. Amplifier D is a very sophisticated design which makes great demands on the driver stage. When the output limits and the feedback is lost, the driver charges the coupling capacitors to such an extent that the output tubes are completely cut off for an appreciable period.

Figure 6 shows two amplifiers, the best, A, and the worst, D, in a slightly different test. The test is as follows: A tone burst of 8 cycles "on" and 128 cycles "off" is applied at a level of

TABLE I

Average Acoustic Level db SPL	4% efficiency		0.4% efficiency	
	1000 cu. ft.	4000 cu. ft.	1000 cu. ft.	4000 cu. ft.
86	0.008	0.03	0.008	0.03
	.2	.75	2.0	7.5
96	0.08	0.3	0.08	.3
	2.0	7.5	20	75
106	0.8	3	0.8	3
	20	75	200	750

Upper figure Average Acoustic Watts
Lower figure Average Electrical Watts

TABLE II

Amplifier	Single Channel Rating	Measured Rating	Distortion at 1/2 power
A	40 W	40 W	0.6%
B	40 W	36 W	0.4%
C	35 W	36 W	0.2%
D	30 W	40 W	0.1%

2-dB overload. This is a very slight overload. The pictures show this test for a basic frequency of 10 kHz, 1,000 and 100 Hz. Note that 8 cycles of 10-kHz tone are passed without difficulty. The 1000-Hz tone burst starts to de-

(Continued on page 54)

A Switch-Type Tone Control

MARSHALL K. STEELE *

Tone control circuits are always of interest to the habitual experimenter, and this one offers a solution to one of the problems encountered when using commercially available dual controls—that of tracking in both channels. With selected components, both channels can be made to track accurately.

TONE CONTROLS are considered a necessity on all high-quality audio systems in use today, but they do present certain difficulties in use, particularly in stereo systems. The popular Baxendall circuit, using variable resistors, suffers from either an undue number of controls—four in all for both treble and bass control—or, if the potentiometers are ganged, from a probable inequity of tracking, making simultaneous uniform control impossible.

A psychological factor has also been noted, especially in the use of the treble control. While initial installation may be done with the aid of a square-wave generator and subsequent adjustment with a plumb bob, there is never real assurance of returning to a given position accurately.

It was felt that these problems could best be beaten by the use of switch-type controls, which may be ganged for stereo, the response curves being controlled by fixed capacitors and resistors. By using a feedback-type circuit, variations in individual tube gain could be eliminated as a source of tone-control error. The writer has found from experience that it has never been necessary to use differing amounts of boost or cut in either channel of his stereo system.

*1604 Grove St., San Diego, California 92102

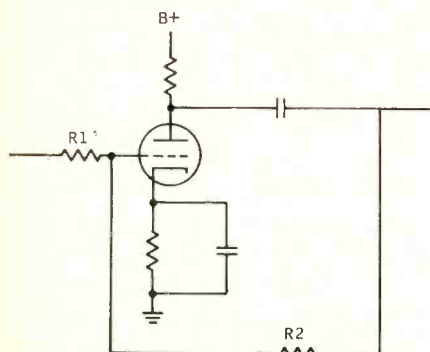

Fig. 1. Simplified representation of the anode follower.

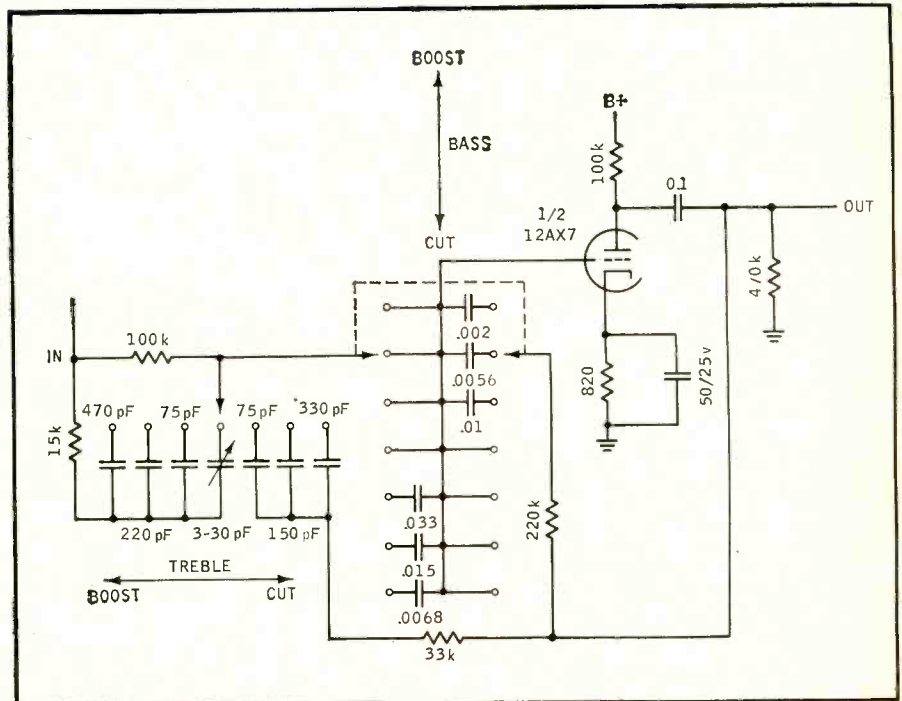

Fig. 2. Schematic of the author's switch-type control.

The control finally arrived at is based on the anode-follower configuration, a very handy circuit and much used in computer operation. To understand the operation it is only necessary to know that the gain of the stage is controlled primarily by the ratio of R^2 to R^1 , as illustrated in Fig. 1, the actual gain of the tube having little effect on the output voltage, assuming the basic gain of the tube to be sufficient at the extremes of the ratio. To change the gain relative to frequency, is it only necessary to control the ratio of the reactances of R^1 and R^2 by using series or parallel capacitance.

The final design of the control, shown schematically in Fig. 2, has proved to be an excellent one, having a mid-band gain of 5 dB, low distortion, more-than-adequate control range, and a low-impedance output. For bass boost, a series capacitor is used with R^2 so as the frequency drops, reactance of R^2 increases. Treble cut results from

a lowering of the effective impedance of R^2 at increasing frequency by use of a series R-C network paralleling R^2 . Treble boost and bass cut are accomplished by controlling the impedance of R^1 in similar fashion.

In constructing the control, a shorting-type switch is necessary for the bass control; otherwise during the momentary opening of the feedback loop the gain would jump an uncomfortable 25 dB or so. The treble control need not be of the shorting type. Both input source and output must be at d.c. ground potential since otherwise the grid return of the tube could be open to d.c. depending on the position of the bass-control switch, so with all switching at ground potential; no clicks are in evidence. With the large amount of feedback used, hum has proved to be no problem and it is not necessary to take more than normal care about lead length and placement.

(Continued on page 46)

The Finite Approach

NORMAN H. CROWHURST*

to the Infinite

Theory and practice do not always follow exact parallels. In this feature, the author examines some accepted theories relating to the infinite and arrives at some realistic conclusions.

IN MANY AREAS OF ENGINEERING, particularly as related to audio, we encounter theory and design approaches that utilize a theoretical infinite something-or-other, and approximate it in practice by taking only so many—a finite part of the infinite. Usually the infinite is considered valid, because mathematical theory has shown it to be; therefore, it is presumed, the finite part taken is as valid as the degree to which it approaches the infinite.

Over the years, we have adopted alternative approaches in these situations that have proved more accurate as well as simpler, once we had made the decision to abandon a theoretical infinite as the "goal" and to settle for something that is exactly realizable. In this article we want to show the philosophy that runs through all these areas, to be adopted when this kind of situation is encountered.

As examples of this situation already encountered, we will list square-wave analysis (the well-known Fourier series), filter design (as an approximation to an infinite line)⁷⁻⁷ and the theory of FM modulation (as Bessel functions giving rise to an ultimately infinite series of sidebands)⁸. We will treat the square-wave example rather completely, with all the necessary math in the appendix, and show qualitatively how the same philosophy applies to the other two areas.

Square-Wave Analysis

The traditional analysis of a square wave, by Fourier series, results in an infinite number of odd-harmonic terms, each proportional to the reciprocal of its order: one-third of third harmonic, one-fifth of fifth harmonic, one-seventh of seventh harmonic, and so on; if you have this whole series (which converges more slowly the further you go) extended out to infinity, which is an awful long way, you theoretically finish up with a perfect square wave.

The facts of life limit us to the

finite. We have to terminate, usually after not very many of these harmonics in the series. If we even take 20 harmonics (up to the 41st harmonic), that seems a lot of harmonics, but the ripple it leaves on the resulting "square" wave is still quite measurable. Approaching it that way, we eventually realize that the road to infinity is an awful long way.

How Fourier Approaches Square

Let's take another look at what this series does, step by step (*Fig. 1*): adding the third harmonic to the fundamental puts a dent in the wave and pushes it up to a steeper slope where it crosses the zero line. The steepness at this crossover is directly proportional to the number of harmonics (including fundamental) included in the series, because each wave added has the same slope at the crossover point.

Now adding the fifth removes the dent made by the third, reverses it and puts in two more dents, as well as adding its increment to the crossover slope. Adding the seventh reverses the dents produced by the third and fifth, adds two more and further increases the slope. Each time a harmonic is added, the magnitude of the dents is reduced slightly and their number increased. The further you go, the slower the change in magnitude and relative number of dents (each extra harmonic only adds two more dents).

True, in theory, if you can go on like this forever, the slope at crossover eventually gets infinitely steep, the depth of the dents gets infinitely small, and their number infinitely large, so the space between crossovers becomes, in theory, a perfect horizontal straight line.

I think we've said enough to show that, with this approach to a square, we'd stand precious little chance of ever seeing anything even remotely resembling one. Yet we've all seen something looking creditably good on a cathode-ray-tube screen—something our eyes told us was substantially a perfect square wave. It certainly couldn't have been created by Fourier synthesis.

The More Realistic Approach

So let's start over, with a different basis for our synthesis: let's make our objective the removal of "ringing," with the maximum crossover slope and the best approach to top flatness, for any particular number of harmonics we choose to include. First we add third to fundamental. Then we add fifth, changing third as this permits, and so on.

The easiest way to derive a series is to first find an equation for the requisite transfer characteristic (which Fourier doesn't even bother with). For simplicity, we use a unit concept in the equation for the transfer characteristic: the maximum amplitude of fundamental is 1, so the equation always

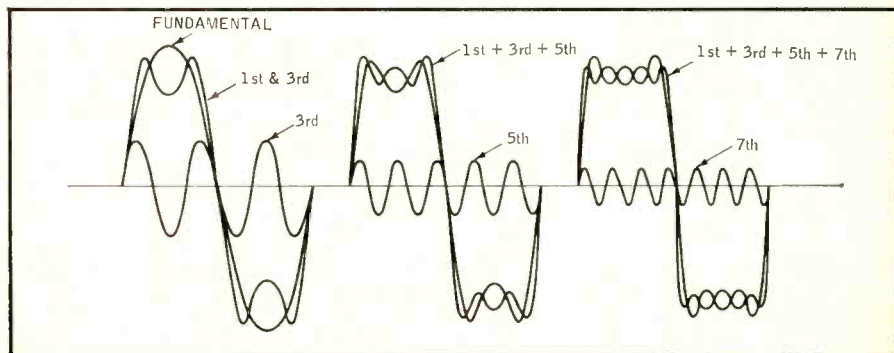

Fig. 1. Successive steps in building up a square wave by Fourier synthesis: left, fundamental and third; center, fifth added; right, seventh added.

*Box 651, Gold Beach, Ore. 97444

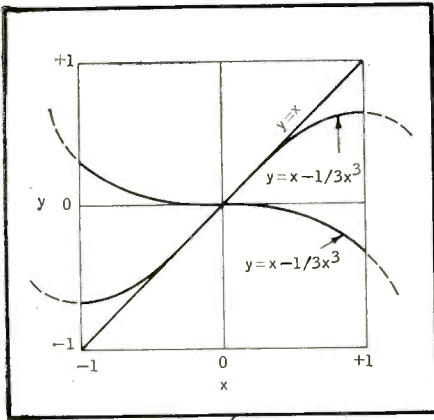

Fig. 2. Transfer characteristic for maximum flattening without denting, using added third-order term.

takes the form, $y = x - ax^3 + bx^5 \dots$ etc., as we add as many harmonics as we are considering at the moment.

Adding third-order distortion must add a negative curve to the slope of the straight transfer characteristic. To meet the condition of maxima at $x = \pm 1$, we substitute in, as we have in the appendix, the condition for a stationary point (level) at $x = \pm 1$, with none before that (Fig. 2).

When we put a sine-wave function into this transfer characteristic, we find that the third-order transfer term generates some negative fundamental and some third harmonic (Fig. 3), which does two things: it changes the amplitude of fundamental and adds third harmonic. For just the third-order term added, the amplitude of fundamental is reduced to $\frac{2}{3}$ and a further $\frac{1}{12}$ (of the original fundamental amplitude) is cut from peak height.

If we change our point of reference to the peak height of the wave, this means the fundamental is increased to $\frac{12}{8}$ or $1\frac{1}{2}$ times its original magnitude, so its slope at crossover must increase in the same ratio. The harmonic is $\frac{1}{9}$ the resultant fundamental amplitude (instead of $\frac{1}{3}$ as in the Fourier series), which is the relationship that just doesn't dent the wave.

Note that in approaching it this way, we do not add the slope due to third harmonic at crossover, as we did in the Fourier approach. This is because the third-order term (not harmonic) also adds (in negative phase, so it really subtracts) a component of fundamental, whose slope at crossover is precisely equal and opposite to that due to the third harmonic it also adds (Fig. 3).

Having gone through that, we will try adding another term and its associated harmonic, by the same process. We start with a fresh transfer characteristic (Fig. 4) which also has its

first stationary point at $x = \pm 1$. It could have further stationary points beyond $x = 1$, but these would not use the maximum possible amplitude of fifth-order term. So we equate the derivative of the resulting expression with that representing a curve with two coincident stationary points (a point of inflexion) at $x = \pm 1$.

Putting the sine-wave function into the transfer characteristic again, we find the third-order term again generates fundamental, of opposite phase, and third harmonic, while the fifth-order term generates another fundamental component, this time in phase with the original, plus a third harmonic, out of phase with the original third, plus a fifth harmonic (Fig. 5). Note how much smaller the fifth is than it was in the Fourier series.

Adding all this together, we find the fundamental is now reduced to $\frac{5}{8}$ of its original amplitude by the third- and fifth-order terms, while the peak amplitude is now reduced by a factor of

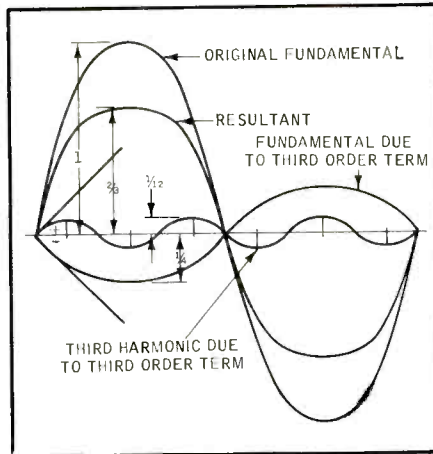

Fig. 3. Waveform synthesis represented by the transfer characteristic of Fig. 2.

$\frac{64}{75}$ below this by the third and fifth harmonic components. This means the same peak height will be reached by starting with a fundamental of amplitude $\frac{15}{8}$ times the original, which is the factor by which crossover slope is now increased.

In the appendix we have pursued matters further, using the same technique of equating all the stationary points of the transfer characteristic to $x = \pm 1$, to get expressions for the series for further-order terms and harmonics added. The results we have tabulated below. First the successive transfer series:

Basic: $y = x$

With third order: $y = x - \frac{1}{3}x^3$

With fifth order: $y = x - \frac{2}{3}x^3 + \frac{1}{5}x^5$

With seventh order: $y = x - x^3 +$

$$\frac{3}{5}x^5 - \frac{1}{7}x^7$$

With ninth order: $y = x - \frac{4}{3}x^3 +$

$$\frac{6}{5}x^5 - \frac{4}{7}x^7 + \frac{1}{9}x^9$$

Finding the increased crossover slope is easier from these equations direct, by adding up the coefficients when $x = \pm 1$: this gives the amplitude at the stationary points. The successive fractions resulting from this addition are: 1, $\frac{2}{3}$, $\frac{8}{15}$, $\frac{16}{35}$, $\frac{128}{315}$. Changing the coefficients to give the same maximum amplitude at the stationary points results in multiplying the crossover slope by the reciprocals of these factors: 1, 1.5, 1.875, 2.1875, 2.4609375. Note that the seventh order term slightly more than doubles crossover slope, while ninth multiplies it by almost 2.5.

The harmonic series generated by the resultant transfer characteristics is interesting. Normalizing to peaks of the same height, these are:

Fundamental only: $\sin \omega t$

Add third order: $\frac{9}{8} \sin \omega t + \frac{1}{8} \sin 3\omega t$

Fifth: $\frac{75}{64} \sin \omega t + \frac{25}{128} \sin 3\omega t + \frac{3}{128} \sin 5\omega t$

Seventh: $\frac{1225}{1024} \sin \omega t + \frac{245}{1024} \sin 3\omega t + \frac{49}{1024} \sin 5\omega t + \frac{5}{1024} \sin 7\omega t$

Ninth: $\frac{19845}{16384} \sin \omega t + \frac{2205}{8192} \sin 3\omega t + \frac{567}{8192} \sin 5\omega t + \frac{405}{32768} \sin 7\omega t +$

$$\frac{35}{32768} \sin 9\omega t.$$

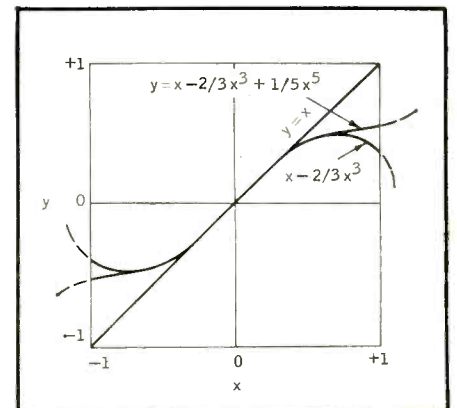

Fig. 4. Transfer characteristic for maximum flattening without denting, using fundamental, third- and fifth-order terms.

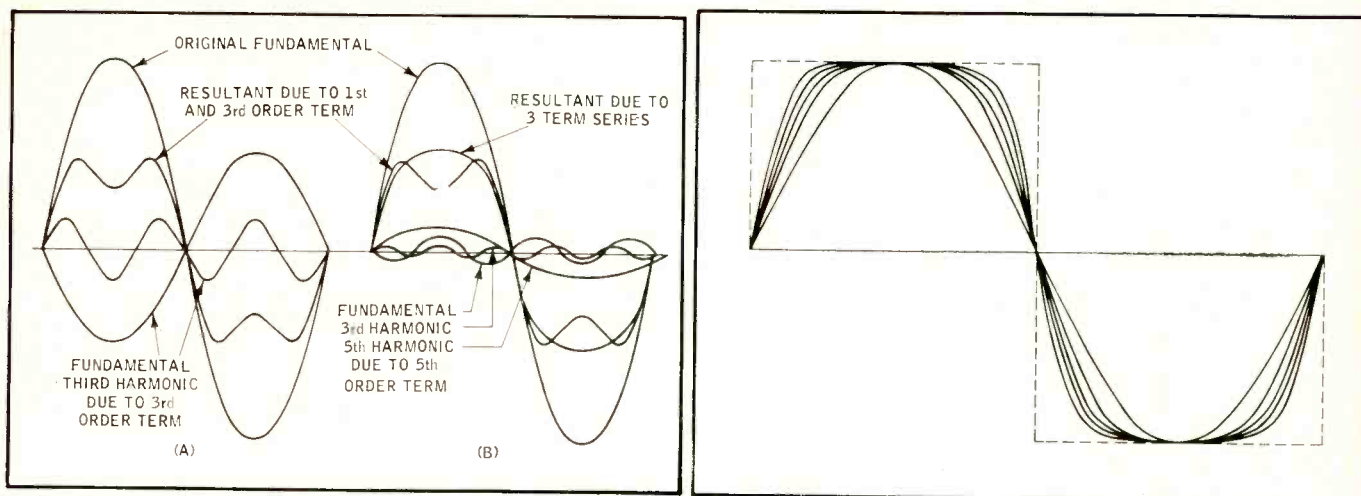

Fig. 5, (left). Waveform synthesis represented by the transfer characteristic of Fig. 2: (A), fundamental and third-order term; (B), addition of fifth-order term. Fig. 6, (right). Waves produced by the first five successive approaches to a square wave by this method, starting with simple sine wave and going as a series up to the ninth-order term.

Or using approximate decimals, so the magnitudes are more readily compared,

Fundamental only:

$$\sin \omega t$$

With third:

$$1.125 \sin \omega t + 0.125 \sin 3\omega t$$

With fifth:

$$1.172 \sin \omega t + 0.195 \sin 3\omega t + 0.0234 \sin 5\omega t$$

With seventh:

$$1.195 \sin \omega t + 0.239 \sin 3\omega t + 0.0478 \sin 5\omega t + 0.0049 \sin 7\omega t$$

With ninth:

$$1.210 \sin \omega t + 0.269 \sin 3\omega t + 0.0693 \sin 5\omega t + 0.01237 \sin 7\omega t + 0.00107 \sin 9\omega t.$$

In either of those forms, the coefficients may not be easy to compare with Fourier, so we'll take out the fundamental expansion factor, so each series starts with $\sin \omega t$ of coefficient 1:

With third: $\sin \omega t + \frac{1}{9} \sin 3\omega t$

and fifth: $\sin \omega t + \frac{1}{6} \sin 3\omega t + \frac{1}{50} \sin 5\omega t$

and seventh: $\sin \omega t + \frac{1}{5} \sin 3\omega t + \frac{1}{25} \sin 5\omega t + \frac{1}{245} \sin 7\omega t$

and ninth: $\sin \omega t + \frac{2}{9} \sin 3\omega t + \frac{2}{35} \sin 5\omega t + \frac{1}{98} \sin 7\omega t + \frac{1}{1134} \sin 9\omega t$

Note that the relative coefficients are always smaller than those in the Fourier series. By the time the ninth is added, the third is doubled, as compared with third only. Fifth doubles

when seventh is added and increases by about another 50 per cent when ninth is added. Seventh is multiplied by a factor of 2½ when ninth is added. Figure 6 shows the five successive approaches, from the pure sine wave to the one with ninth-order term, to show how adding terms brings the approach closer to a square wave.

This set of series differs from Fourier in that it is complete with the last term in each case. It is not an approximation. Each of these series produces something like a square wave, without any ripples on it. The more terms in the particular series, the better the approach to a square wave. This is a far

more realistic approach than Fourier and, we believe, one that is easier to understand, as well as being more useful.

It is apparent that taking enough terms in transfer response with this approach, and putting in corresponding harmonics to the waveform, can result in a square wave as good as you want, which the Fourier series never can, in practice. Based on this analysis, the waveform content of a square wave of any desired "goodness" can be calculated.

Filters

We have gone into this subject at length and with mathematical support,

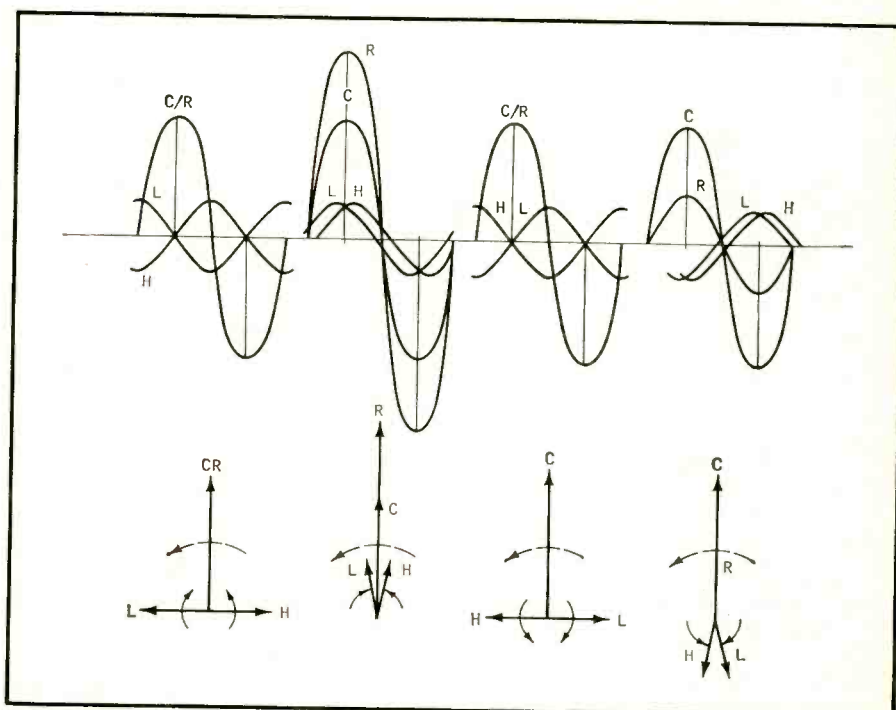

Fig. 7. Amplitude modulation represented by vector diagrams (bottom) and waveforms to correspond (top), to illustrate technique applied to FM modulation subsequently.

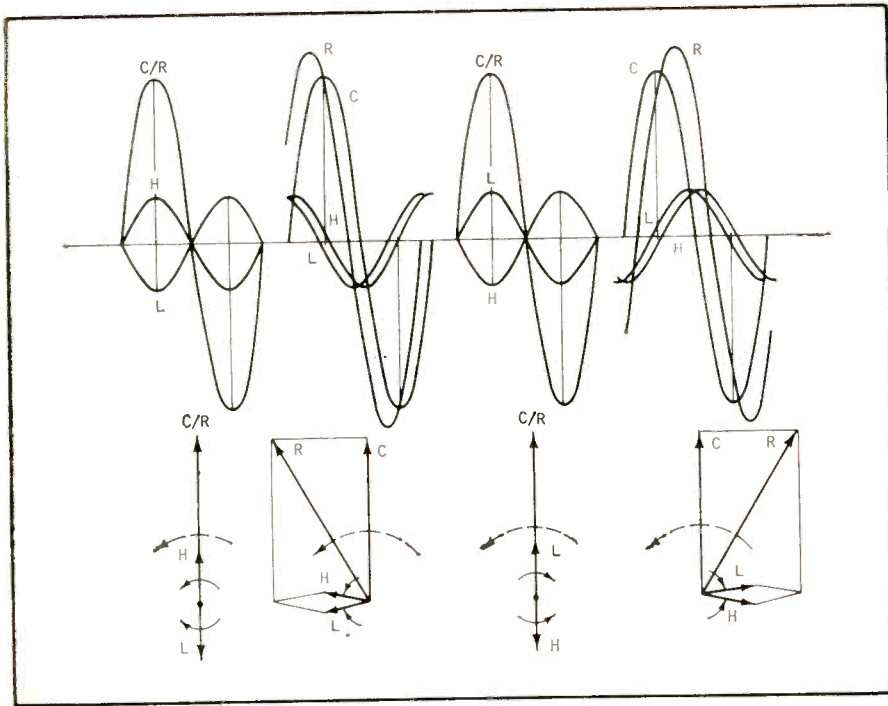

Fig. 8. Changing the phase relation of the sidebands (from Fig. 7) results in predominantly phase modulation, but amplitude varies as well, as double frequency.

in previous articles¹⁻⁷. First there was the extension of the "constant-resistance" principle, which does use an accurate, finite approach, rather than an approximation based on infinite line theory¹. Among developments of particular interest was the design of different types to approximate linear phase response, or constant time delay⁶. This used a successive approximation approach, that came closer to the desired objective with fewer elements, because the approximations used were accurately calculated.

Filters based on infinite lines, and image-impedance theory, cannot be accurate in their performance, even though they are based on minimum mismatch. The constant-resistance approach is based on actual termination, not on an impedance that can only approximate what is really an unrealizable image-impedance characteristic.

And more complicated filters, like the

linear-phase type, are based on an assumed "characteristic" or iterative impedance, while the approach we gave in detail enables any desired combination of real terminating impedances to be used—at least within the capabilities of the basic requirements.

FM Sideband Analysis

We will conclude this with another approach that illustrates a different technique for application⁸. This starts with representation of modulation by vectors. In each case the carrier is represented by a vector, assumed to be rotating in the usual counter-clockwise direction. The sidebands are other vectors rotating slightly faster and slower than the carrier vector. For analysis it is easier to consider the carrier vector as stationary, or as if we were going round with it, in which case the upper sidebands rotate counter-clockwise at a speed determined by their difference

frequency, while the lower sidebands rotate clockwise.

Amplitude modulation is represented by two vectors that start at right angles to the carrier, one on each side, and rotate in opposite directions, producing the fluctuation in resultant amplitude quite accurately with only the two sidebands (Fig. 7). In the waveforms at the top and the corresponding vectors below, C identifies carrier, L the lower sideband, H the higher sideband and R the resultant of all three. Comparing the four different time points shows how a carrier with two sidebands appropriately phased, can produce an amplitude-modulated wave with no phase deviation of the resultant.

Small degrees of frequency or phase modulation can be represented in the

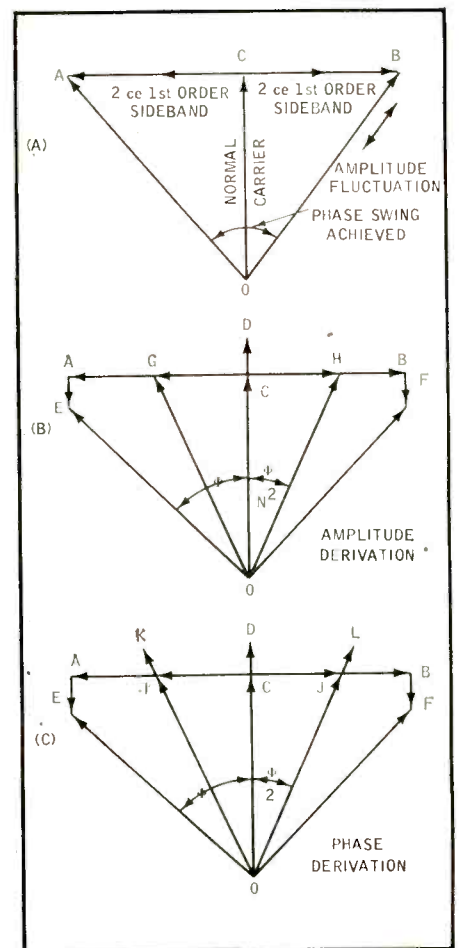

Fig. 10. Vector diagrams for FM, including second-order sidebands: (A) basic, with only first order (composite of diagrams of Fig. 8); (B) including second order, with intermediate vectors (OG, OH) introduced to investigate amplitude linearity when OD, OE and OF are made equal; (C) with alternative intermediate vectors (OK, OL) to investigate amplitude linearity when phase linearity is introduced by making $\theta = 2(\frac{\phi}{2})$.

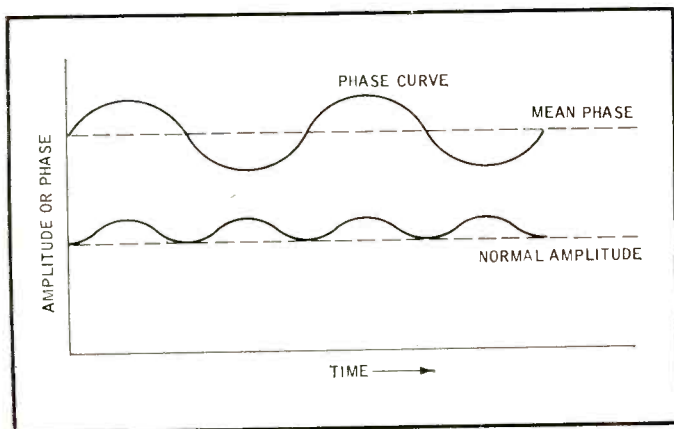

Fig. 9. Phase and amplitude variation achieved by carrier and sidebands of Fig. 8.

Announcing

TWO
NEW
MICROPHONES

THAT
CONTROL

"POP,"

"BOOM,"

WINDNOISE &

FEEDBACK

SHURE



UNISPHERE^{T.M.} UNIDIRECTIONAL MICROPHONES

Now! All the superb, world-renowned feedback control and uniform pickup pattern features that have made the Unidyne family of microphones the industry standard for solving difficult public address problems — with added problem-solving features afforded by spherical filter assemblies that effectively control explosive breath sounds ("POP") and wind noise in outdoor locations. They are particularly recommended for close-talking applications and permit superior utilization of space on small stages or studios. They facilitate speaker, vocalist and orchestral placement and provide practically complete rejection of unwanted audience noises. They control echoing in partially filled halls ("BOOM"). And, the shape's the greatest for pop singers and combos! For hand or stand.

UNISPHERE A — Model 585 SA High Impedance; 585 SB Low Impedance. Budget priced for use in low-budget systems. List Prices: Model 585 SA \$65.00; Model 585 SB \$58.00

UNISPHERE I — Model 565. Premium quality spherical filter version of the incomparable Unidyne® III. Multi-impedance, small size for maximum handability. List Price: \$95.00

SHURE MICROPHONES — WORLD STANDARD WHEREVER SOUND
PERFORMANCE AND RELIABILITY ARE PARAMOUNT

SHURE BROTHERS, INC.
222 Hartrey Avenue, Evanston, Illinois 60204

Circle 120 on Reader Service Card

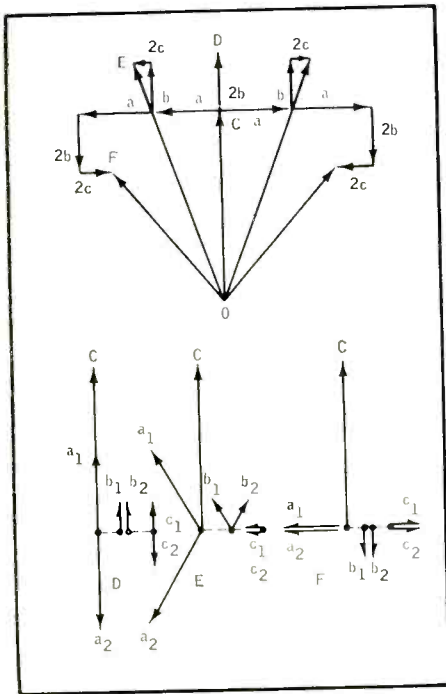

Fig. 11. Vector diagrams for FM including second and third order sidebands: left, composite construction to show geometry on which calculations are based; right, three sets of vectors to represent phase relations of sidebands at positions of vectors OD, OE and OF.

same way, by shifting the phase of the sidebands, so they shift phase, rather than amplitude of the resultant vector (Fig. 8). But as soon as more than a little phase shift is produced in this way, amplitude fluctuates as well, at twice the frequency: amplitude is a minimum each time the signal passes through its zero and a maximum at each maximum phase shift (Fig. 9).

This amplitude fluctuation can be corrected by introducing second-order sidebands, separated from the carrier by twice the difference frequency of the first-order ones. Using this approach, equations can be developed (as shown in the appendix) to give the sideband relationships for either constant amplitude (between mean or zero deviation, and the full or extreme deviation) or for linearity of phase modulation, as indicated by comparing mid-deviation with full deviation (Fig. 10).

If the amplitude at full deviation is held equal to that at zero deviation, it will drop below this "constant" amplitude at intermediate deviation points. If the phase linearity is maintained, by making half-amplitude (30 deg. of modulating signal) half phase on the final deviation, then amplitude is at a minimum for zero deviation, rising to a maximum at full deviation value.

As the amount of phase modulation is increased, the divergence between constant-amplitude requirements and

those for linear phase modulation becomes greater and a third-order term is necessary to correct the difference. The third-order term is derived by adding the conditions that amplitude is the same at zero and extremes, and phase is correct at mid-deviation point (Fig. 11). Again, this addition is only good for a further extension of phase swing, before there is deviation in either amplitude or phase linearity at points between the critical ones where proper coincidence has been obtained.

The same method can be pursued to obtain linearity, or best approach to it, with any given number of sidebands on either side. But to conclude this article, we may show qualitatively how relative amplitudes of carrier and sidebands vary as the extent of modulation is increased (Fig. 12). As rotation of phase increases, carrier amplitude decreases, as shown by C_0 for zero signal and C_1 , C_2 for successively larger signals, and more energy goes into the sidebands. As the higher-order sidebands come into play, the carrier will actually go through zero and reverse its original phase, and later on the lower-order sidebands will start to go through similar reversals. But when this stage is reached, we are involved in something that begins to look like an infinite series.

The valuable thing about this approach is that it shows some insight into the functioning of an FM system. The more modulation used, the more sidebands become necessary. But less than the theoretical may sometimes be used, at some sacrifice. Usually phase-linearity will be the more important parameter, in the interest of freedom from audio distortion in the over-all transmission chain. So amplitude will have to modulate a little, to keep within the allowed number of sidebands and maintain phase linearity.

In practice this may be achieved by the use of over-all negative feedback that corrects phase-linearity after the unwanted higher sidebands have been filtered off, with the result that the cor-

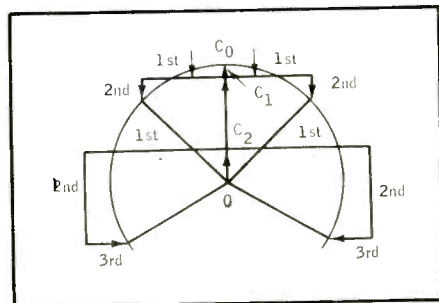

Fig. 12. Demonstration of variation of amplitude of relative sidebands and carrier, from zero signal (C_0), through intermediate value (C_1) to larger value (C_2).

rect amount of amplitude fluctuation to compensate is forced into the system.

This kind of analysis is very useful for finding out what can be done. Electronic feedback circuits may do the job, but whether they can, and to what extent, can best be determined by this kind of analysis.

Æ

References

1. Norman H. Crowhurst, "Basic design of constant resistance crossovers." *AUDIO*, Oct. 1953, p. 21.
2. Norman H. Crowhurst, "Feedback filters for 2-channel amplifiers." *AUDIO*, Oct. 1954, p. 32.
3. Norman H. Crowhurst, "The RC crossover compromise." *AUDIO*, July, 1957, p. 17.
4. Norman H. Crowhurst, "The use of twin-T networks," *AUDIO*, May, 1958, p. 19.
5. Norman H. Crowhurst, "Electronic crossover design." *AUDIO*, Sept., 1960, p. 19.
6. Norman H. Crowhurst, "Filters for FM stereo." *AUDIO*, Aug., 1961, p. 26.
7. Norman H. Crowhurst, "Crossover designs." *AUDIO*, Sept.-Oct., 1963.
8. Norman H. Crowhurst, "Mathematics for Electronic Engineers and Technicians" (Sams), p. 209-B.

APPENDIX

Using the form, $y = x - ax^2$ (1)

as basis for deriving the transfer characteristic shown in Fig. 2, the condition required is that its stationary points be at $x = \pm 1$. The derivative of Eq. (1) is

$$\frac{dy}{dx} = 1 - 3ax^2 \quad (2)$$

Equating this to zero for $x^2 = 1$ requires

$$a = \frac{1}{3} \quad (3)$$

which is the value used in Fig. 2.

Adding a term, the transfer form becomes,

$$y = x - ax^3 + bx^2 \quad (4)$$

The derivative of this is

$$\frac{dy}{dx} = 1 - 3ax^2 + 5bx^4 \quad (5)$$

For this to have a pair of double roots $1 - x^2 = 0$, the coefficients must have values such that

$$\frac{dy}{dx} = 1 - 2x^2 + x^4 \quad (5a)$$

whence values for the coefficients are:

$$a = \frac{2}{3}, b = \frac{1}{5} \quad (6)$$

Substituting these into Eq. (4) gives the equation used for Fig. 4:

$$y = x - \frac{2}{3}x^3 + \frac{1}{5}x^2 \quad (7)$$

(Continued on page 45)

Sound & Sight

HAROLD D. WEILER

A Portable VTR System

At the recent National Association of Broadcasters Convention in Chicago we saw a video recorder which may well change the broadcasters' concept of field recording.

The world's first portable video recorder—hand carried and battery powered for shooting half hour long TV recordings with sound—was demonstrated there for the first time.

At a press conference, Mr. William H. Butler, Broadcast Applications Director of the Westel Company, gave this description of its practical applications in recording programs for later broadcast.

"A television station cameraman went out on a most unusual assignment. In two days time, he took pictures of a new addition to the Steinhart Aquarium . . . and of another addition to the Fleishbacker Zoo. He recorded the Mayor's weekly press conference.

"He took pictures from a helicopter . . . from the top of the Mark Hopkins Hotel . . . and from an excursion boat in the harbor and surfers riding the Pacific's breakers."

The cameraman, he said, also recorded on his two-day venture a ride from the front seat of a roller coaster, took pictures from an open convertible moving down Montgomery Street, then across the Golden Gate Bridge . . . and from the glass elevator on the outside of the Fairmont Hotel."

"All of the pictures he took were broadcastable—complete with sound—and they required no processing. Most were taken in situations where only an essentially unencumbered person could move and act.

This is a battery-powered, record-only device with integrated camera head, and the entire weight is only 30 pounds complete with an 8-inch reel of 1-inch tape and a set of rechargeable nickel-cadmium batteries. It will make up to 33 minutes of continuous broadcast-quality video recording complete with a channel of high-quality sound, without reloading, and has sufficient extra power for an additional 30 minutes of preview, plus 60 minutes of standby operation.

The camera head accounts for less than 7 pounds of the total system weight. With its detachable pistol grip the camera head forms a well-balanced, easily-handled unit. It may also be mounted on any standard tripod head with or without the pistol grip. A CRT viewfinder is mounted on the side of the camera head, and may be adjusted and locked at a convenient viewing angle. It also serves as a hand grip. The CRT can either be used as a normal viewfinder or switched to function as an A-scope during set-up. The camera head will accept any standard C-mount lens.

The new Westel Recording Camera being used to record a celebrity's arrival for later TV news broadcast.

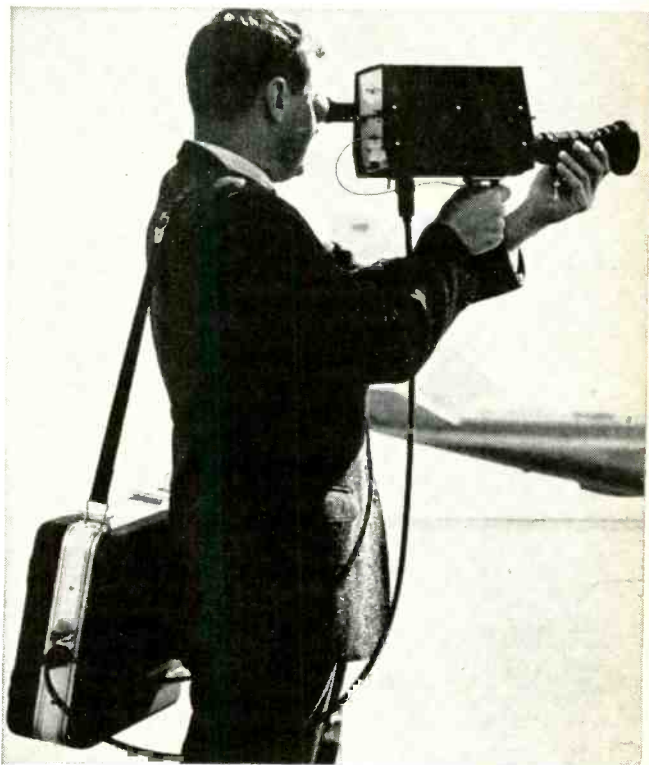

All operational and set-up controls and indicators are conveniently located at the back of the camera head. These include an Off-Preview-Standby Switch, Audio Gain Control, Audio Level Indicators, Battery Level Indicator, Electrical Focus, Mechanical Focus, Target Control, Manual-Automatic Target Control Selector Switch, CRT Function Switch, and Record Button. When the pistol grip is in place, the Record Button is actuated by a trigger on the grip.

The recording module, connected to the camera head with a flexible cable, measures 15 by 11 by 7 inches. Weight is approximately 11½ pounds without batteries and tape—only 23 pounds with two batteries and a full reel of tape. It uses a sync generator and the same scanning assembly, drum servo and signal processing electronics as are used in Westel's companion studio recorder—and uses 1-inch tape on standard 6½ or 8-inch NAB reels. In the interest of light weight and compactness, fast-forward and rewind functions have been eliminated, and only one audio record channel is provided. Audio input circuitry is designed to allow a wide variety of microphones to be plugged into the recording module.

The entire unit has been made sufficiently rugged to withstand the rigors of normal field use without special handling considerations. Provisions have been made, for

example, to assure that slack tape cannot be generated in the unit by movement or vibration in either an operating or non-operating condition. Start time is less than 1 second from dead stop to complete lock-in.

We can see many applications for the Westel Recording Camera in industrial, scientific, and educational fields.

With the recording camera a school district's audio/visual coordinator will be able to enrich curricula by interviewing community resource people such as judges, police chiefs, authors, etc. He may show vocational students actual machine shop practices and techniques, record driver-education theory based on actual community traffic conditions, broaden science enrichments material with the results of actual field trips, and further teacher training by recording intern teachers' classroom experiences.

Advertising agencies and departments will find numerous uses including consumer research studies, talent auditions, preparation of story boards for television commercials, and many other marketing research applications.

The Westel Recording Camera should also find a great many industrial applications such as management conferences, industrial security, training programs, sales conferences, products field testing, personnel interviews, and so on. Æ

Circle 121 on Reader Service Card ▶



Imagine.

**Instant Movies in Sound
(produce your own
or tape them off the air)**



The new Sony Videocorder[®] is a complete Home TV Studio: a video tape recorder, built-in monitor, and optional camera outfit. Takes TV pictures and sound right off the air, and puts them on tape. And with the TV camera attached, and microphone plugged in, you can do the same with live action.

When you're done—presto, switcho, rewind, playback! And there, on the TV monitor screen, is the same picture with the same sound, as easy as operating an ordinary tape recorder.

First unit ever designed for the home. There's nothing really new about taping sight and sound. TV stations have been doing it for years. But the equipment costs tens of thousands of dollars. That's a long way from home.

But, when you can bring the complete system—recorder and monitor—down to under \$1,000, plus an optional \$350 for the camera outfit, you're home. And that's exactly what Sony did. They achieved the most exciting home entertainment concept since television.

How did Sony do it? Know-how, that's how! The same imaginative know-how that has innovated all kinds of new things for people to enjoy: pocket transistor radios, incredibly small, personal TV sets, and high fidelity tape recorders—many of them memorable firsts.

Best known as a pioneer in transistor developments, Sony is also one of the foremost producers of tape heads, tape transports and the tape itself. Sony also manufactures TV picture and vidicon tubes. Sony drew from this specialized experience to create this all-new, all-Sony TV tape system for the home.

New recording/playback technique. It was out of this same resourceful know-how that the ingenious idea of alter-

nate-field recording and repeat-field playback was conceived. Combining it with helical tracking, it made possible the development of a unit that would use standard ½-inch video tape at conventional 7½ ips speed, yet capable of storing more than 60 minutes of program material on a 7-inch reel. The dream of a home TV tape recorder became a reality.

How it works. The Videocorder has a rotating 2-head assembly. Only one head is used for recording. It picks up every other field—30 fields per second. For "playback," both heads are used. As one head completes scanning a recorded field, the second takes over and rescans the same field. This reproduces 60 fields per second on the screen as completely interlaced 525-line pictures.

Similar to movie technique. The principle is very much the same as in movies, where the camera operates at, let us say, 24 frames per second. The movie projector also shows the film at 24 frames per second, but projects each frame twice. Thus, the observer receives 48 image impressions per second.

This is done to minimize "flicker" and enhance the illusion of smooth, uninterrupted motion. The Videocorder records 30 fields per second, and double-scans each field to produce 60 impressions each second.

Complete tape interchangeability. So precise are the sync constants provided by the circuitry and by the mechanical speed controls, that any tape recorded on one Sony Videocorder can be played back on any other Sony Videocorder.

The rotating heads are belt-driven by a hysteresis motor. The head assembly, in turn, is servo controlled to maintain locked-in 30 rps speed accuracy and correct angular orientation with relation to the recorded track.

The same motor also drives the tape capstan via a coupling idler wheel. The combined effects of the

capstan-mounted flywheel and the self-speed-regulating characteristics of the motor provide smooth, unvarying 7½ ips tape movement.

Unlimited Applications. The Sony Home Videocorder adds a thrilling new dimension to home entertainment. Want to relive some telecast event? Watch a space launch again? A ball game? A presidential speech? Some selected program? Tape it with your Sony Home Videocorder.

You can even use a timer attachment to record a program while you're out. For, once it's on tape, you can watch it at any time. And you can erase the recorded material, and re-use the tape over and over again.

And with the optional camera outfit, you can also record picture and sound of live events—family functions, social shindigs, community activities—you name it. You can also apply it to your business or profession or your hobby interests.

Playback versatility. Moreover, you're not limited to watching playback on the built-in Sony 9-inch screen monitor. You can connect the Videocorder to any monitor, regardless of size. A competent TV technician can even adapt your Videocorder to work with your TV set.

Now available. Prices start at under \$1,000. The basic Sony Home Videocorder (model TCV 2010) is priced at \$995 complete with 9-inch screen monitor/receiver. A deluxe version (model TCV 2020) in oiled walnut cabinet, and equipped with built-in timer for taping programs in your absence, is priced at \$1150. Optional camera outfit including tripod, microphone and cable, is \$350. A 7-inch reel of tape, a full hour of recording, costs only \$39.95.

Visit your Sony dealer today for an unforgettable demonstration. For free booklet describing the many uses for your Sony Videocorder, write: Sony Corporation of America, 580 Fifth Ave., N.Y., N.Y. 10036

SONY[®] VIDEOCORDER[®]

EQUIPMENT

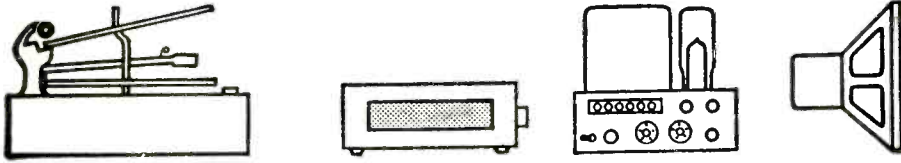

PROFILE



Fig. 1. Marantz 7T Solid-State Preamp

MARANTZ 7T SOLID-STATE STEREO PREAMPLIFIER

Here are the manufacturer's published specifications on this new unit:
Frequency response—20-20,000 Hz \pm 0.1 dB.
Total Noise: 80 dB below 10 mV input.
I. M. Distortion: 0.15 per cent at 10 volts equivalent output.
Dynamic range: up to 100 mV at less than 0.15 per cent IM distortion.

Our tests proved every Marantz claim conservative. But that is what we have come to expect from this firm.

The Marantz 7T is all solid-state. This would seem then to be the successor to the Model 7 vacuum-tube preamplifier. All of the established virtues have been kept in this new version; in fact, there are some interesting innovations.

Exterior appearance is unchanged in this model except for the addition of three jacks on the front panel. These are for headphones (600 ohms or higher), stereo tape recorder in, and stereo recorder out. These last two functions are duplicated on the rear panel. With the front-panel inputs it is now possible to use the preamp as a dubbing go-between with two recorders.

Other innovations include a center-channel output with a separate level control.

As with the earlier tube unit, the preamp will accept a wide variety of input sources. There are direct low-level inputs for two magnetic-phono systems, high-impedance microphone, and tape head. In the phono positions a three-position front-panel switch chooses OLD 78, RIAA, or OLD COLUMBIA LP equalizations. The tape-head

input (high impedance) has a rear panel trim pot to adjust high-end response.

The tone-control action along with the high-and low-cut filters remains unchanged from the earlier models (except, of course, that transistors are now used). Low-cut positions are at 50 or 100 Hz, while high-cut points are called out at 5 and 9 kHz. In each case, the position marked is (accurately) the three-dB-down point.

The tone controls themselves are step-type, offering accurately contoured and repeatable positions of boost and cut.

As we said at the beginning, our bench

measurements proved the published specs conservative. Frequency response is, in fact from 5 to 50,000 Hz \pm 0, -1 dB. IM distortion measurements through the full preamp were 0.12 per cent at 3 volts rms out. RIAA equalization is within 1 dB of RIAA specification, and that includes extension to the 20-20,000 Hz range.

We could go on. We did not find a test that proved this unit less than it is claimed to be. Moving on to listening tests showed that this 7T takes a sonic back seat to nothing. It operates with very-low-level cartridges without noise, and very-high-level cartridges without distortion. It has six a.c. convenience outlets on the rear panel. It still has a husky power on/off switch that won't give up under a heavy a.c. load. In fact, removing the top cover reveals a level of construction that is consistent with that which we have come to expect from Marantz. And, lest there be any misunderstanding about what that level is—it is a good cut above that which is usually seen in home componentry.

There is, thus, every reason to believe that trouble-free longevity is another virtue of this unit. Marantz is asking \$295 for the 7T with an additional \$24.00 for the walnut cabinet. We feel that it is worth every penny.

Circle 201

SYNCRON S-10 CONDENSER MICROPHONE

We often speak of the individual character of transducers, mentioning phono cartridges and speakers as typical, and completely forgetting that microphones too belong in that class. They have every bit as much individual personality as any product. And, as is true of all transducers, it is difficult (if not impossible) to laboratory test them and come out with a firm knowledge of what the product will sound like.

Condenser microphones have built a reputation for quality that has set them apart from other systems. If they have become the Rolls-Royce of the recordists; they have also demanded equivalent image pocketbooks. And, they have been bulky, with their need of separate power supplies.

Fig. 2. The S-10 Synchron condenser microphone. It is shown in a shock mount.

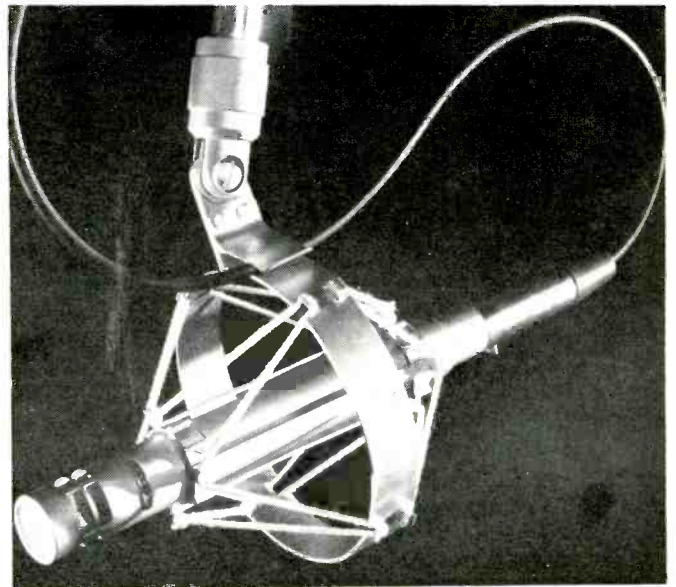

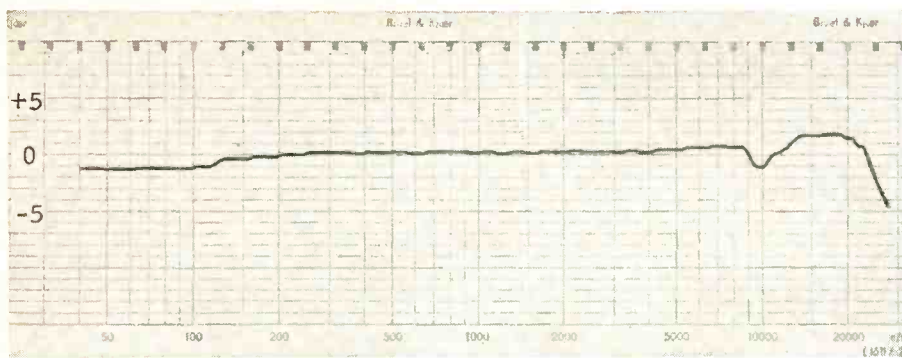

Fig. 3. The B & K frequency response curve of the S-10 Synchron.

Transistors have done much for the bulk, reducing the power packs to manageable size and to independence from power lines.

This microphone is not the first to be issued that is completely self-contained, but it certainly is the most manageable in that it is no larger than many a dynamic. Perhaps even this is not a "first" as such. What is dramatic is that the S-10 offers a degree of reliability and dependability that was not available in a portable before. A single replaceable Mallory TR-126 battery is contained within the slim lines of the microphone. Also within is the impedance matching circuitry. It uses a field-effect transistor.

The Mallory battery is only called upon to power the FET. Buried well within the casing is a separate power source that gives the needed 62 volts of polarization to the condenser element. This is a lifetime item. And it should be just that since no current is actually being drawn.

The replaceable Mallory is guaranteed for 1000 hours of operation. We suspect that this figure is conservative by a factor of many times. Longevity can be further enhanced by simply removing the 4-conductor XLR plug between the microphone and the 20 feet of cable. This breaks the battery circuit.

Other mechanical virtues of the S-10 are a weight of 9 ounces and a 7/8-inch diameter by 7 1/2-inch length. The patterning of the microphone is cardioid, the diaphragm material is Mylar, output is -53 dBm re 10 dyne/cm² into 200 ohms, and the microphone can be operated into any load from 30 ohms to high impedance.

This Synchron handles like a real pro. We were supplied with accessories which include a windscreen (\$14.95), a vibration suspension (\$29.95), and a desk stand (\$19.95). The microphone itself with a battery, carrying case, and swivel mount, and with 2-wire shielded cable, sells for \$240.00.

Tests

The best way to test a microphone is to use it. This becomes even more meaningful if it is compared against established favorite units. Frequency-response measurements require extraordinarily sophisticated equipment. So, we are reproducing the B & K curve tracing that was done by Synchron on this sample. We have no reason to believe that it is anything but accurate.

As would be expected from such a curve, the S-10 is neutral in sonic effect. It certainly doesn't have that bright rising top end that was so characteristic of the earliest condensers. When we first heard playbacks of recordings made with the S-10 we were struck by the general lack of microphone coloration. At the same time, there is no feeling of masking dullness. Rather, the S-10 comes through as a crisp and transparent performer.

With the feeling of independence that the self-contained aspect of this microphone offers, it is easy to forget that you are working with a condenser. It goes anywhere with ease. The result for us, has been some outstanding field recordings with a clarity and depth that we have found inappreciable indeed. Under the most exacting music applications, the S-10 is easy to get to like. And we do.

Circle 202

EUPHONICS CK-15-LS CARTRIDGE SYSTEM

Most of the phono cartridges on the market today share a common operating principle in that they are electrical generators. As transducers they convert the mechanical motion imparted by the stylus in the record groove into electrical energy.

This is not the only way to derive sound from a disc. An alternative, of course, is to create a cartridge that uses stylus motion to *modulate* an existing external voltage.

The problem of generators has been that when element size is reduced sufficiently for needed mass reduction requirements, voltage output suffers. So the theory behind a modulator device is that it is an attack from a different direction. Obviously, if you use an external voltage there need not be a direct correlation of output vs. element size.

This is the case with these Euphonics cartridges. They are not generators. Rather they use a tiny silicon element (two for stereo). Each is called appropriately, a Pixie. The stylus motion is directly transmitted to these elements causing them to twist slightly. This motion varies the electrical resistance of the Pixie. Voltage from a separate power supply is thus modulated in accordance with the undulation of the record groove.

The power supply itself derives its voltage from the household a.c. The supply is entirely transistorized; it runs cool and should go on indefinitely. During our tests there was never a hint of performance change due in any way to environmental effects on these components. The circuit is simple; it ought to be rock-stable at all times.

With such a system it would be expected that the designers could place output at most any level they choose. What they have, in fact, evolved is most interesting.

The power supply has a top-mounted slide switch. In one position, the output is like that of a magnetic cartridge. It needs RIAA equalization. Output to the preamplifier measured 11.2 mV on the left channel and 11.8 mV on the right. (From a 1 kHz recorded velocity of 3.54 cm/sec per channel.)

The alternate position of that top switch changes the output to an RIAA equalized high level. This will directly feed an AUX amplifier input.

Our tests were all performed in the low-output position.

The frequency response graph in Fig. 5 is indicative of the facilities of this approach. Neither this sweep nor square-wave observation detected an obvious resonant peak below 20 kHz.



Fig. 4. The Euphonics CK-15-LS Phono Cartridge and its power supply.

Dynamic-compliance figures obtained were quite high. Lateral compliance is 4.5 and vertical compliance is 6 ($\times 10^{-9}$). Remember that this is *dynamic* compliance measured under actual playing conditions; not in a static test jig.

rear, to throw the balance weight in the opposite direction from the offset. The result is an approximate torsional balance (depending on the weight of the cartridge) around the pivot.

The shell offers an interesting feature

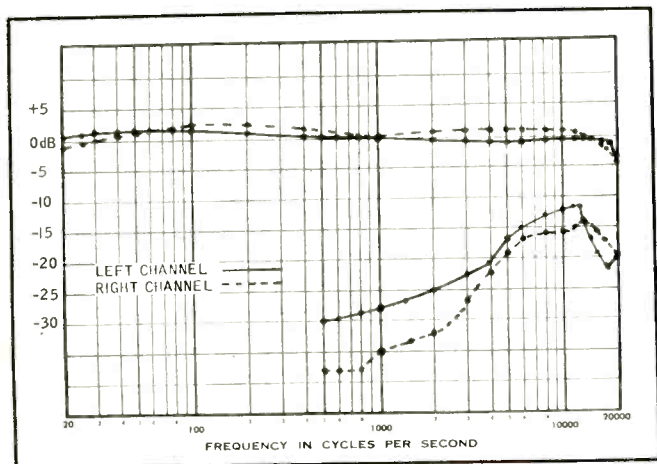

Fig. 5. Frequency response and channel separation of the Euphonics CK-15-LS cartridge. The test record is the CBS STR-100.

IM distortion measurements of the Euphonics were quite respectable, though not the best we have seen. The +9dB band of the CBS STR-111 was 3.8 per cent lateral and 3.0 per cent vertical distortion. Lest you think these figures *bad*, the best we have ever seen was about 2.5 per cent horizontal or vertical, and never have we both figures from the same cartridge. Therefore, this Euphonics must be considered a low-distortion product.

Required tracking force in a good arm can be held to 1.5 grams. This force includes an adequate protective factor to safely see the stylus through high-modulated discs.

As can be guessed, the Euphonics produces a faultless sound. Given a good source, the adjectives that come to mind are: *shimmering, bright, clean*. The flat frequency response makes this cartridge sound unspectacular. But that is as it should be. A cartridge's job is to extract what is in a record groove. This the Euphonics does with a great deal of truth.

Circle 203

THORENS TD-150 TURNTABLE

This latest entry from the Swiss firm of Thorens is available as a complete arm/turntable/walnut base package. These components may not be had separately.

The TD-150 system is of that type where the arm mount and turntable sub-assembly are linked solidly together while this combination is isolated (by three springs) from the base. The justification for this approach is that there is a significant reduction in sensitivity to acoustic feedback and a lessening of reaction to external vertical shock.

In any case, the TD-150 package is formed around a two-speed turntable. Drive is from a unique double synchronous motor and is via a belt to an inner platter. 33 or 45 is selected by the one control knob. That same knob is also the power on/off. Push it down for *off*; pull up for *on*.

The arm is of low-mass construction. The metal tube is double canted: up forward to achieve an offset angle; in the

we have not seen before. In addition to the now common forward/rear slide of the cartridge for correct overhang, there is a tilt adjust to allow the correct stylus tracking angle to be set. This is commonly 15 degrees but should be set in accordance with the instructions provided by the cartridge manufacturer.

The arm as a whole is of the type that achieves stylus force by adjusting the counterweight. There are no springs. A clever metal template fits over the rear section of the arm. It contains slots calibrated for each quarter gram of force. With this in place the rear weight is adjusted to balance the arm. (There are coarse and fine movement controls.) With the template removed, stylus force is correctly set to an accuracy of 0.1 gram.

There is need to also mention a damped arm-lift mechanism. This is a particular aid to butter-fingered operators (like us).

Tests

Total unweighted rumble measured -35 dB below 1kHz at 3.54 cm/sec. lateral and

vertical, or lateral only. Weighting with a 50 Hz chop-off gave a figure of -45 dB. The practical results of these numbers are to be heard when music springs forth from a velvety silence (when there is no rumble on the disc itself, that is).

Total flutter and wow was measured at 0.05 per cent. Arm resonance is below 10 Hz. Speed accuracy under load was consistently 0.5 per cent fast—well within specifications.

There is a multiple-spindle adapter. Used one way, it is the standard spindle. Used reversed, it is the large hole adapter. It is also the gauge against which correct stylus overhang is set.

All in all, this Thorens shows much that is clever and good. Certainly, it performs well. It gives every promise of being durable. At \$99.75 it makes a very attractive package. It is recommended without reservation.

Circle 204

THORENS TD-124 SERIES II

There are some products that seem to go on indefinitely. The TD-124 is one of them. We have had one in almost daily use for over six years. The only service has been a one time change of the belt.

The Series II designation is indicative of some real improvements on a product that was already excellent. Some of these are visible in a restyled knob and rubber mat. Most, however, are below the surface.

The TD-124 uses a drive system that is like no other. The shaft of a four-pole motor has a pulley which drives a small belt. This, in turn, is wound around a second pulley that drives a large puck. The second pulley is stepped to offer the range of four speeds that are available. The puck is in contact with the rim of a heavy inner turntable. On top of that platter lies a light aluminum one. A clutch arrangement places them in contact or separation. When separated, the inner table spins while the outer one (with the disc) is stationary. Thus, slip-starts may be made easily.

There is a magnetic eddy brake that is operative around the four nominal speeds. This allows a vernier adjustment of speed

(Continued on page 51)



Fig. 6. The Thorens TD-150 System.

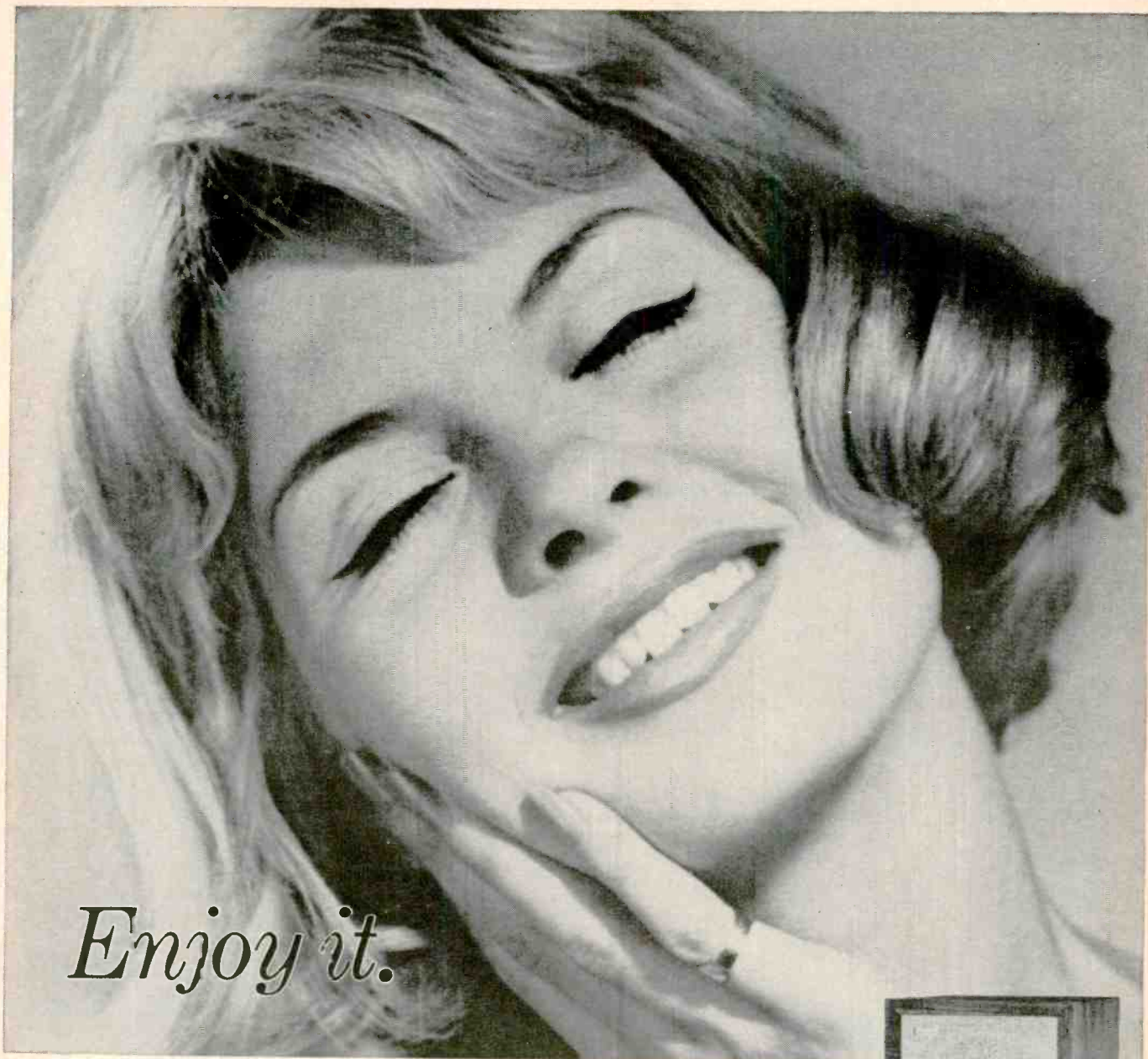

Enjoy it.

The lively sound! The more-than-you-pay-for big speaker performance of University's lively new Ultra-D.

Enjoy it — *the lively sound.* Put it anywhere — everywhere! No matter where, the Ultra-D fits!

Enjoy it — listen to *the lively sound* of the Ultra-D at your University dealer today. Bring your favorite record, too! Listen to something you know — you'll agree *University Sounds Better!*

Send for the all-new catalog of the world's largest (and liveliest) selection of high fidelity speakers and systems. It's FREE, and we'll also include "P-S-E Technigrams" University's master blueprint for superior stereo speaker systems. Address inquiries to desk F63

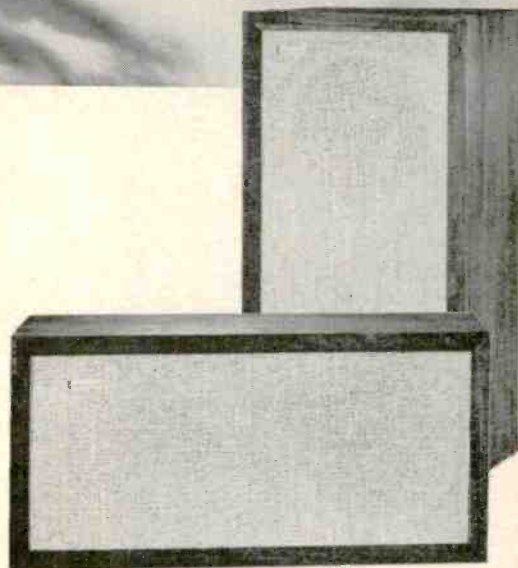

UNIVERSITY
SPEAKERS/MICROPHONES
A DIVISION OF LTV-LING ALTEC, INC.

9500 W. Reno Oklahoma City, Oklahoma

ULTRA-D SPECIFICATIONS: Components — 10" ultra-linear high compliance woofer, 4" direct radiator mid-range, 3½" direct radiator tweeter. Response—35 to 19,000 cps. Size—23 13/16" h. x 11 7/8" w. x 9 3/4" d. Finish Oiled Walnut.

Circle 122 on Reader Service Card

Build your own

Solid-State Flutter Meter

ARTHUR E. GLADFELTER

Conclusion

In this final section the author makes his acknowledgements and offers his references. Also included is a box of corrections on what has already transpired.

WHILE designing the flutter meter and also while preparing the article, I was given assistance by one particular individual, I would like to thank Edward J. Gleeson, Principal Engineer with The Bendix Corporation, York, Pa. for his help in the design of the detector, discriminator, and low-pass filter. He has also reviewed the written portion of the manuscript.

References

¹IRE Sound Recording and Reproduction Committee. "I.R.E. Standards on Sound Recording and Reproduction: Methods for Determining Flutter Content, 1953, *Proc. I R E*, March, 1954. page 537.

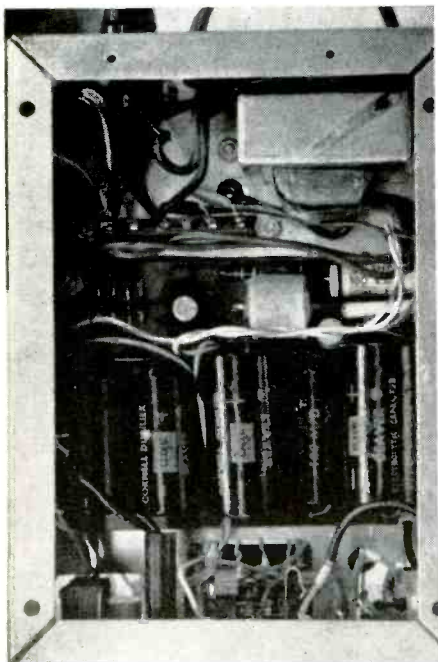

Fig. 3. A bottom view showing the parts layout of the completed flutter meter.

²N. M. Haynes, "Flutter, its Nature, Cause and Avoidance." A pamphlet published by Amplifier Corporation of America. Original source, "Elements of Magnetic Tape Recording," by N. M. Haynes.

³R. L. Riddle and M. P. Ristenbatt, "Transistor Physics and Circuits," Chapter 14, Transistor Oscillators and Multivibrators. page 331. Prentice-Hall (1958).

⁴J. A. Walston, J. R. Miller and the Staff of Texas Instruments Incorporated, "Transistor Circuit Design." Schmitt trigger, page 381. McGraw-Hill (1963)

⁵L. B. Arguimbau, "Vacuum-Tube Circuits and Transistors." Discriminators, Pages 491 to 495. John Wiley & Sons, Inc. (1956)

⁶Louis Weinberg, "Network Analysis and Synthesis." Chapter 13, Handbook Tables of Element Values and Explicit Formulas, Page 600. McGraw-Hill (1962)

⁷ASA-IRE Standards on Sound Recording and Reproduction, "Method of Determining Flutter content," A.S.A. Report Z57.1-1954.

⁸D. E. Morgan, "Flutter measurements by the American Standard method." *J. Audio Eng. Soc.*, 9:232, 234, 238, July 1961.

⁹J. A. Moore, "NAB reel-to-reel tape standards," *Broadcast Engineering*, September, 1965, Pages 30 and 32.

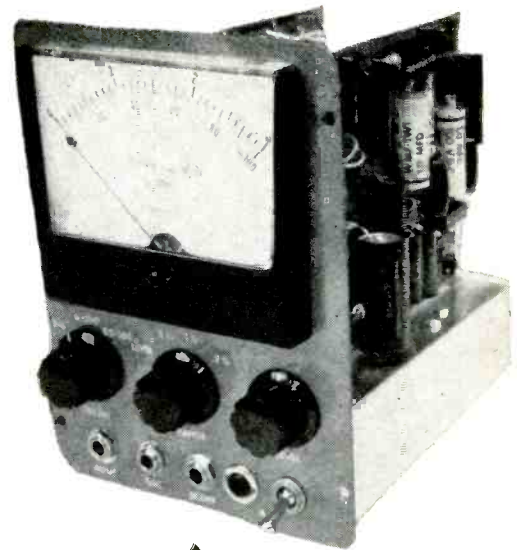

Fig. 1. The completed flutter meter with its protective case removed.

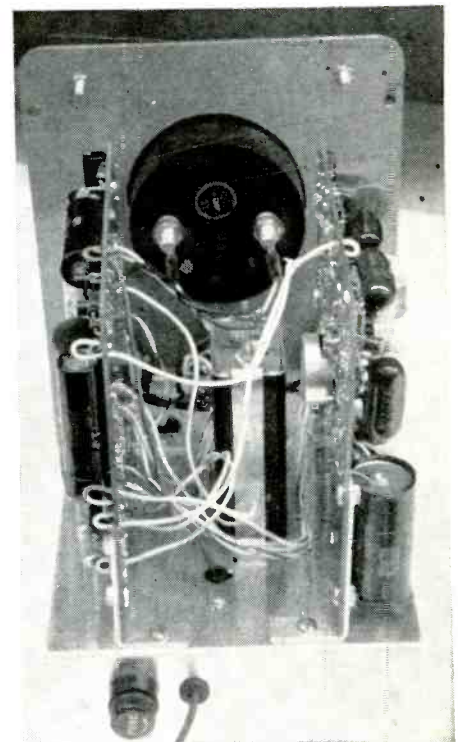

Fig. 2. (Above) A direct rear view of the flutter meter. The two circuit boards and associated wiring may be seen.

Department of (error) Amplification

In a complex story errors will sometimes creep in regardless of our watchfulness. The following summarizes corrections to this series. All save the last, are in the March issue.

Page	Column	Line	Article Reads	Correction
21	3	22	-32 deg.	+32 deg. F
22		Schematic	R72 500	R72 560
26	3	7	(0.22uf)	(0.022uf)
26	3	9	(0.47uf)	(0.047uf)
26	3	17	+5%	±5%
22 April	1	4-6	An extra line crept in here. "... and the frequency will represent the flutter rate." is the correction.	



PROFESSIONAL PLAYMATES



The new Sony Solid State 350 adds professional performance to home entertainment systems

Selecting the brilliant new Sony Solid State 350 to fulfill the stereo tape recording and playback functions of your professional component music system will also enduringly compliment your impeccable taste and passion for music at its finest. With an instant connection to your other stereo components, the versatile two-speed Sony 350 places at your pleasure a full array of professional features, including: 3 heads for tape and source monitoring. Vertical or horizontal operation. Belt-free, true capstan drive. Stereo recording amplifiers and playback

pre-amps. Dual V U meters. Automatic sentinel switch. Frequency response 50-15,000 cps \pm 2db. S.N. ratio plus 50db. Flutter and wow under 0.15%. Richly handsome gold and black decor with luxurious walnut grained low profile base. This remarkable instrument is yours at the equally remarkable price of less than \$199.50. Should you want to add portability to all this, there's the Model 350C, mounted in handsome dark gray and satin-chrome carrying case, at less than \$219.50. For information write Dept. 17, Superscope, Inc., Sun Valley, Calif.



Portable Model 350C

Circle 123 on Reader Service Card

NEW PRODUCTS

● **Dynamic Microphone.** Sonotone's new dynamic microphone is the model DM-10. It is available in four versions; each identical except for impedance. 50,000, 10,000, 600 or 200 ohms are the choices available. The casing of these mikes is die-cast metal and finished in brushed chrome with a raised wire grille. Accessories include a table stand made of metal and finished in matching brushed



chrome. Diaphragms are made of rugged polyester film and can withstand high temperature and humidity conditions. Patterns are omnidirectional and frequency response is a minimum of 80-15,000 Hz. High-impedance models come with seven feet of single-conductor shielded cable. Low-impedance units are supplied with two-conductor shielded wire. Cost is \$32.50 in the high impedance and \$37.50 low. Circle 211

● **Gloves.** It is normal to consider gloves as a protection for the hands when something difficult or hazardous is to be handled. These cloth gloves from Sioux Croix take quite a different approach. They are to be worn so that phonograph records to be handled will be properly protected. They are of a soft stretch cloth that has been impregnated with Dow Corning silicones and an anti-static compound. Dubbed the "Disc Jockey" (sic), they are



claimed to be effective in removing static electricity, dust and fingerprints from records. Also, their use quite naturally precludes the damaging effects of skin contact with disc grooves. The gloves are bright red with black trim, are available in ladies' or men's sizes, and list at \$1.50. They are available by mail-order from the firm, Sioux Croix, P.O. Box 2101, Sioux City, Iowa 51104. Circle 212

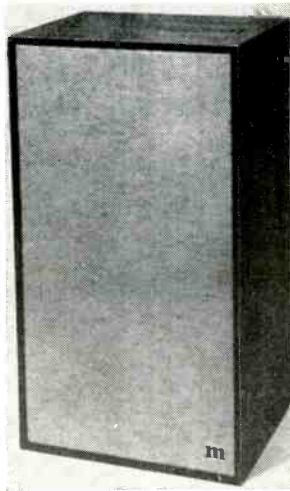

● **Compact Speaker System.** New damping techniques and infinite baffle loading are claimed to be responsible for the 40-18,000 Hz response that is stated for the Martin M 390 system. This is a small bookshelf-type enclosed system that is 18" wide x 10" high x 9" deep, weighs 12 lbs. and has a 3/4-inch hand-rubbed walnut cabinet. Power handling capability is claimed to be 5-25 watts and impedance matching is non-critical at 4-8 ohms. As an aid to integration into living quarters, the M-390 is available with grill cloth colors of cloud white, indigo, tangerine or sienna. Inside the box is a closed-back tweeter of 3-inch diameter and an 8-inch diameter extended-range woofer with 1 1/2-inch voice coil. The unit is totally filled with glass fiber and is hermetically sealed. List price is \$39.95. Circle 213

● **UHF Antenna Addition.** Owners of new-type television sets that tune all 82 channels, who also have good VHF antennas installed will welcome this new line. These are outdoor UHF antennas that may be quickly attached by special brackets on the same pole holding the present antenna. Of course, a separate lead-down must be run to the

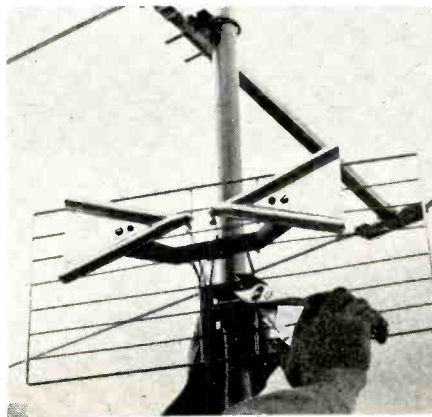

UHF terminals on the rear of the set. Model UHF-5 shown is made up of a 9 1/4 by 18 inch zinc-plated steel wire reflector and rust-resistant aluminum dipoles with a black plastic insulator. The pole bracket can be affixed to a pole under the regular antenna in just minutes. Retail price of the antenna is \$2.95. There are also two other versions, the UHF-3 at \$1.95 and the UHF-6 at \$4.95. Circle 214

● **Versatile Tape Portable.** Here is a battery portable recorder that permits recording in both forward and reverse directions by a turn of a single lever. Called the "Reverse-A-Track" the Model 300 is being distributed by Concord. By eliminating reel changes, continuous recording and playback time can be three hours or more. The solid-state electronics of the Model 300 also include a



new automatic record control compression circuit which eliminates the need for manual adjustment of recording levels. It automatically records sounds from different distances at the same level. Also featured is an automatic power selector circuit that disconnects the batteries when the unit is used with household current. Other features include fast wind in both directions, 3 3/4- and 1 7/8-inch speeds, a built-in speaker, and a remote-control dynamic cardioid microphone. A voice-control mike is available as an accessory. 4-inch reels are accommodated on the unit which weighs 6 1/2 lbs. The power source is two type "C" batteries or a.c. List price is \$125.00. Circle 215



● **Tape Cartridge Player.** A compact 4-track auto cartridge player has just been introduced by Craig Panorama. This unit illustrated is the Model C-503. It is being made by Pioneer of Japan. The Fidelipac 4-track cartridge is used. A companion home model, the model C-516, being introduced at this same time, is a recorder as well as a playback machine. The C-516 features a special sensing device that will stop the endless-loop cartridge before it can erase the previously recorded tracks. Circle 216

The Sound of Marantz is the Sound of Music at its Very Best.

SLT-12 Turntable, with Straight Line Tracking—a revolutionary development from Marantz. Finally, the art of tracking a record precisely duplicates the art of cutting a record. The Marantz SLT-12 Straight Line Tracking System exactly conforms to the angle, posture and the tracking used in the cutting of an original master stereo record. This perfect compatibility eliminates inherent deficiencies of conventional swing arm record player systems and gives incredibly perfect reproduction. It is the only system available which faithfully reproduces sound as it was originally recorded.

10B FM Stereo Tuner—rated by Hi Fi/Stereo Review magazine, “I have never seen a tuner to compare with it...so outstanding that it is literally in a class by itself.”

7T Solid State Stereo Console—a solid state component unequalled in performance, versatility and flexibility.

8B Dual 35 Stereophonic Power Amplifier—American Record Guide magazine says, “The Marantz 8B is a logical choice for ears that demand the best sound for now and for the future.”

marantz

MARANTZ, INC. SUBSIDIARY OF **SUPERSCOPE** INC.
25-14 BROADWAY, LONG ISLAND CITY, NEW YORK

Model 7T Stereo Pre-Amplifier

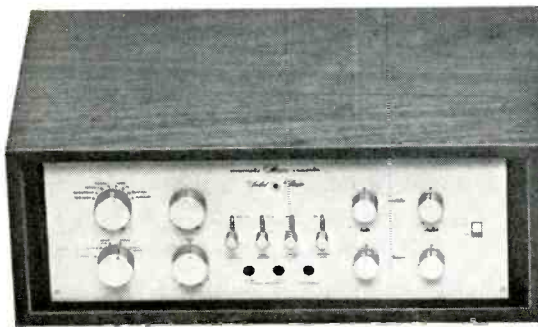

Model 8B Stereo Amplifier

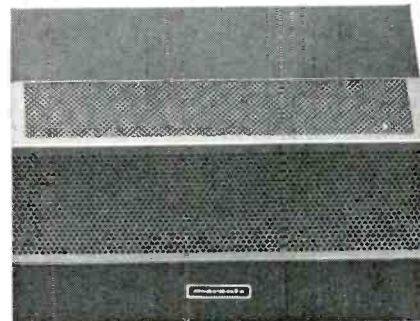

Model SLT-12 Turntable



Model 10B Stereo Tuner

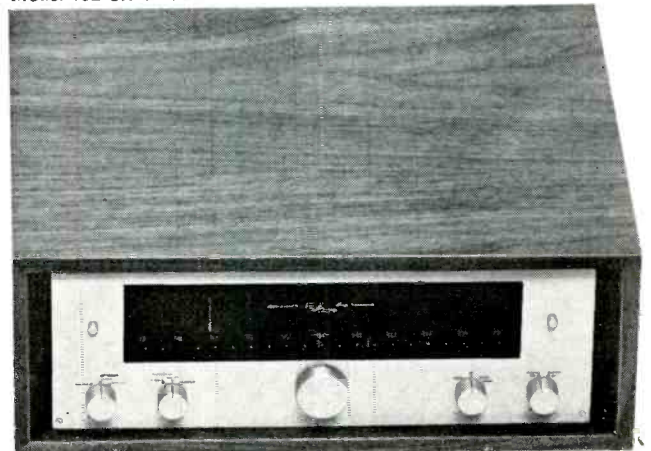

A wonderful adventure in sound awaits you with your discovery that the sound of Marantz is the sound of music at its very best. You, too, can own an incomparable Marantz system. Ask your dealer about the easy finance plan.

Circle 124 on Reader Service Card

RECORD REVUE

Edward Tatnall Canby *

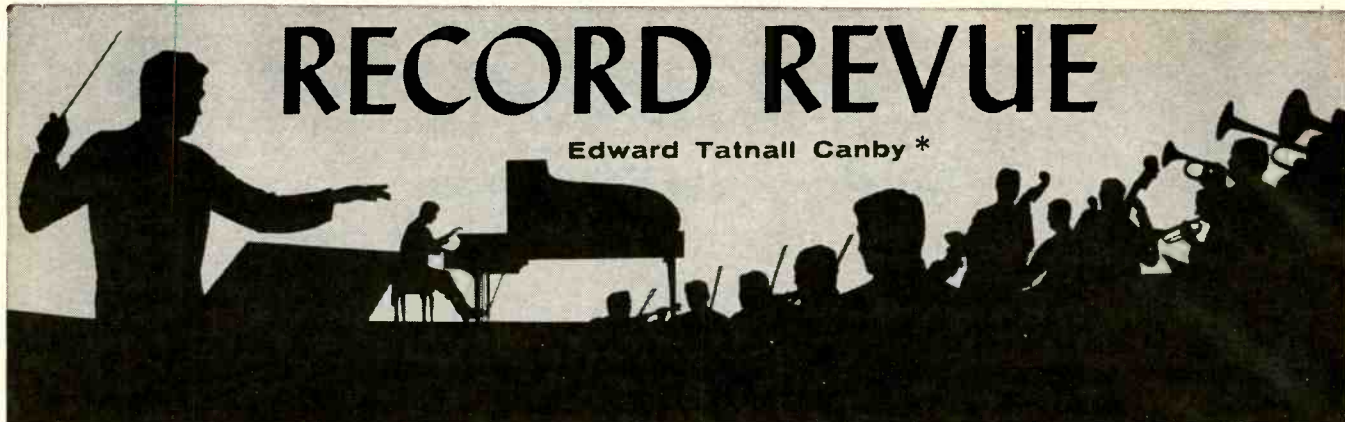

BIGGEST REVERB IN HISTORY

Music of Bologna, 16th-18th century. Instr. Ens. of Bologna, Tito Gotti.

Music Guild MS-130 stereo

Here's the darndest stereo reverb you've ever heard. The excellent selection of short works for various kinds of instruments, almost all in double-chorus format (including music for two organs) is played in the Basilica of San Petronio at Bologna, the place where most or all of it was first heard, 'way back then. If you want to count time, you'll discover that this incredible building has a reverb decay of something between eight and 15 seconds—I could never be quite sure how long that stupendous "echo" persists!

The engineers have done a very clever job in this huge space; the music is as clear as a bell, the separation between "choirs" of instruments, and between the two organs, is excellent, and yet the feeling of space is undiminished. We are standing close to the players, and beyond them is the big reverb. Often, one choir is closer than the other for an added depth-sense (and perhaps for good mono contrast).

The music, over two centuries, is varied nicely, and includes trumpets and oboes as well as strings and organs.

BIG STUFF

The First University Choral Festival. (Live from Philharmonic Hall.)

RCA Victor LSC 7043 (2) stereo

Well, there isn't anything of much value or importance musically here—but who cares. It's a great album!

Hundreds of college students, well over a dozen (I didn't count) choruses, from countries all over, and they joined in this festival with, so to speak, flags flying. It sounds that way. Massed chorus for the opening show—a thrilling international pageant. Massed again for the final program, a grand fuzzy sound, inspired as all get-out.

In between, the various choirs sing their chosen stunt pieces, chorus by chorus, and that is the bulk of this expert recording. What is so fascinating is the differences in national "personality" that show up, as we go through the list—Argentina, Brazil, Canada, Chile, Columbia, France, Germany, Great Britain . . . and so on, to Yugoslavia. There is a certain truthfulness here that is revealing and perhaps unintended—that music for unaccompanied singers like

this shows its true colors, it cannot be "faked."

The U.S. and Great Britain, for instance, both tried to inject some high-brow music, classicalish, into the proceedings; both of the choruses fall flat. High ideals, poor musical understanding. Lack of communication between the modern composer and the singer.

Whereas most of the other countries put on the inevitable tricked-up folk song arrangements that glee clubs have always sung—and they do them to perfection. Much better than the classical!

Well, that's life, and my only objection here is to the publicity which sort of implies, without saying so, that this was a great musical culture-bath. It certainly wasn't—though, as RCA says, it was indeed "an unforgettable experience in music-making!"

It was an unforgettable get-together of enthusiastic young people of many nations. Isn't that plenty?

BRAHMS: A German Requiem; Alto Rhapsody; Fest' und Gedenksprüche. Stich-Randall, Pease, Hogman, Chorus, Orch. Norddeutscher Rundfunk, Hamburg, Bamberger.

Nonesuch HB 73003 (2) stereo

Bach: St. John Passion, Giebel, Matthes, Lewis, Reh fuss, Bach Chorus, Orch. Amsterdam Philharmonic, Vandernoot.

Nonesuch HC-73004 (2) stereo

With these (and the Beethoven *Missa Solemnis*—I haven't heard that one yet —) Nonesuch branches into big works. No room to list all the performers, nor to evaluate each—but it's enough to say that these are superb bargains, not because they are very low in price (with extra discounts sometimes available, they are ridiculously cheap!) but simply because here you have some of the finest European performances imaginable.

Stars—yes, to an extent. James Pease, Grace Hoffman, Teresa Stich-Randall, are very well known, if not sensational publicity-luminaries. More important, though, is the over-all integrity, unity, and understanding of these large ensembles; the very high level of endeavor and dedication of the whole.

The *Requiem* is given a wonderfully "dark-brown" performance, just exactly right for the music's sincere, middle-19th century Romanticism. (And excellent solos—Stich-Randall is one of the finest singers alive.) In the contralto *Alto Rhapsody*, Grace Hoffman is superb—another fine job. And, for a dividend, there are the three great double-chorus movements of the *Fest' und Gedenksprüche*, little-known but top-quality Brahms, sung by a boys' choir superbly if perhaps a bit child-like in the feeling.

The Bach *St. John Passion* is similarly a well-integrated, understanding European-type performance, by people who have obviously lived in and around such music. Being Dutch, it is just a trace more chunky in vocal sound than the lean North-German music of the Brahms album, but—wonder of wonders—it has a good evangelist (he's the tenor who tells the story, and he is vital). Which is two thirds of the musical battle.

As the phrase goes, you can't go wrong here. You can go very *right*. Better try the Beethoven *Missa Solemnis* too. And the Beethoven opera, *Fidelio*, part of the same reprint series, while you're at it.

The Mormon Pioneers.

Columbia LS 1024 stereo

Whee! Look at this. What a marvelous picture book.

I should write *two* reviews of this one. I've been so absorbed in the big book itself that I haven't got around to the inconspicuous single record that is lost somewhere inside one of the book covers. Maybe I never will. Might be an anticlimax.

A superb book, this, from the striking silver cover photo of Mormons, standing on winter ice, reflected in some sort of icy pool of water, through the superb big illustrations inside, the articles on the Birth of the Mormon Church (Carl Carmer) and the Mormons on the Frontier (LeRoy R. Hafen), the big pictorial maps of Mormon cross-country progress from the East to the West, all the way through to the biographies and credits on pp. 46-47. Notes on the music, too (Thomas E. Cheney), but I haven't got to those yet.

The whole Mormon experience is intensely interesting as Americana, especially when it is so beautifully documented as here (in both senses—good scholarship and decorative "document" illustrations). If Mormon music wasn't exactly the highest of cultivated art, Columbia isn't at fault, nor the Mormons—what do you expect from people living and building on the roughest of frontiers?

In fact, Columbia's main problem in all of these U.S. historical documentary albums is just that—the music. It is almost bound to be an anticlimax (even as folk music) alongside such superb pictorial and written material. Maybe they should forget the record part and just go into publishing—big, foot-square books full of wonderful pictures.

You could still sell them through record dealers, even so. Why not?

(Continued on page 54)

Industry Notes...

●The appointment of **Roland M. von Sacken** as national marketing manager was announced this week by Pioneer Electronics USA Corp., the recently formed subsidiary of Pioneer Electronic Corp., the Japanese high fidelity equipment manufacturer.

Von brings to Pioneer 19 years of broad marketing experience, mainly in home-entertainment products, with the General Electric Company; and five years of experience with ELPA Marketing Industries where his duties included marketing, advertising, and sales.

●Amperex Electronic Corporation has made a number of executive promotions in Marketing and Sales, according to an announcement by Mr. John Messerschmitt, Vice-President.

Al Katz, Product Manager for Communication Tubes, has been promoted to the newly created post of Market Manager, R. F. Products. In his new position, Mr. Katz will supervise sales and marketing of Special Purpose Tubes, Microwave Tubes, and Industrial Tubes.

Allen Merken, Product Manager of the Digital Products Group, has been appointed Market Manager of the Component Division. Mr. Merken's new responsibilities will encompass the complete correlation of the Division's sales activities and long-range planning.

●**Leon Kuby** has re-joined Harmon-Kardon, Inc. as Merchandising Manager for High Fidelity, it was announced by Milt Dienes, High Fidelity Sales Manager.

In announcing Mr. Kuby's appointment, Mr. Dienes said, "It's a pleasure to have Lee Kuby back home again at Harman-Kardon. He was with the company from 1956 to 1964, and is well known throughout the industry as one of the most experienced men in the high fidelity field."

●**John M. Conly**, former editor of High Fidelity magazine and music editor of Atlantic Monthly, was appointed this month Public Relations Director of Audio Advertising Associates (A-3), nationwide agency for Sony and Marantz audio equipment. The announcement was made by Joseph S. Tushinsky, president of Superscope.

●**Avery Fisher**, President of Fisher Radio Corporation, has just announced the appointment of **Harold J. Schulman** as Executive Vice President, to succeed the late Ben Arons. Mr. Schulman brings to his new position 25 years of experience in the electronics field. In his past associations he has been Director of Marketing Services for Allen B. Dumont, Inc., Assistant to the President of CBS Columbia, Vice President and General Manager of Knight Electronics, and Marketing Manager of Allied Radio.

Mr. Fisher also announced the appointment of **George W. Tillett** as a member of the Fisher engineering management group, with special responsibilities as head of the speaker manufacturing division.

Mr. Tillett brings to his new position over thirty years of experience in the electronics industry in Great Britain. He is widely known for his articles on high-fidelity subjects, having contributed over three hundred articles to many publications.

Before joining Fisher Radio Corporation, he was, in turn, Chief Engineer of the English subsidiary of Heathkit and Technical Director of Wharfedale, Bradford, England.

Why tailor your needs to a standard console when you can tailor a console to your needs with Altec Audio Controls?

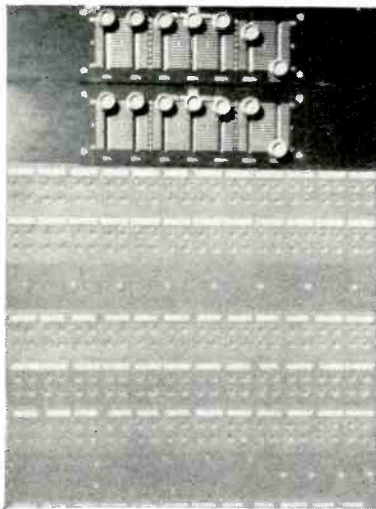

Like the clean, functional console above, which Ancha Electronics of Chicago built for the University of Illinois. There was simply *nothing* available in standard console that

would fit into a narrow space, provide complete graphic equalizers plus variable high-low-pass filters for *each* channel, and have all-silicon preamplifiers.

Using Altec audio components, Ancha Electronics, an authorized Altec Sound Contractor, custom-designed this beautifully flexible console, whose performance would be tough to match. The University of Illinois is using its new console both for stereo recording and as a master for rerecording.

A good representation of Altec audio control components can be found in the installation, including straight-line mixers, rotary attenuators, stereo pan pots, mixing networks, and fixed-loss pads.

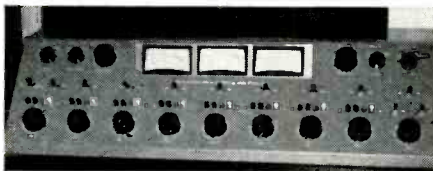

45-STEP MIXERS IN THIS CUSTOM CONSOLE FOR WEFM, CHICAGO!

After scrutinizing all the standard equipment available, WEFM decided that only a custom Altec console could meet their needs. After all, where else

could they get a standard console with 45-step, 1db-per-step, mixers?

Now WEFM not only has mixers capable of very fine level control, but also *all-silicon* preamplifiers and various other Altec audio controls components that add up to flat response, low noise, and rugged reliability for day-in, day-out operation.

LET ALTEC PROVIDE THE COMPONENTS FOR YOUR DREAM CONSOLE

Your console's going to be around for a long time. Why not make sure it's *exactly* what you want? Send on your letterhead today for special professional discounts (available to bona fide broadcast and recording studios *only*). We'll send you the name of your nearest Professional Altec Distributor and our new studio-equipment catalog. Write Dept. _____



ALTEC LANSING
A Division of **GE** Ling Altec, Inc.
ANAHEIM, CALIFORNIA
© 1966 AL

Circle 125 on Reader Service Card



The Tape Guide

HERMAN BURSTEIN

Recorder Service Stations

*Q. I own a **** tape recorder. Can you suggest a good service organization in New York State for servicing my recorder?*

A. I feel that the recommendation as to a tape recorder service agency should properly come from the manufacturer of your machine. I cannot recommend a specific agency for the same reason that I am prohibited from recommending specific audio components.

Loss of Highs

Q. My problem is basically the loss of high frequencies on tape recordings. By this I mean that when I record snare drums and cymbals, these instruments in playback appear as though they have moved far into the background. I have checked tape speed and head azimuth, but everything appears all right here. Can I do anything to get the better high-frequency response that I desire?

A. Do commercially recorded tapes have adequate high-frequency response when played on your machine? If so, the playback head in your machine is not responsible for the treble loss. The most likely cause is excessive bias supplied to the record head. Other possibilities include faulty record equalization, a dirty record head, or a magnetized record head.

Recorder Service Stations, Again

*Q. Originally I owned a **** tape recorder, and for three years had no trouble. Then I noticed wow and took the unit to the manufacturer's authorized service agency in my city. They changed the pressure pads and replaced several tubes, but when I got the machine home the wow was worse than before. I took the recorder to the only other authorized agency in the city, which gouged the capstan drive badly, explaining this would prevent tape slippage, and replaced the oscillator coil (no explanation). Later I learned that increasing the pressure of the pressure roller would have been sufficient to prevent slippage. By this time my recorder was in such poor condition that I purchased a new one. But I had trouble with this one from the start, and the original tape amplifiers had to be replaced. My new machine requires servicing, but I cannot trust either of the two authorized service agencies in my city, so I have written to the manufacturer. Although I have followed up this letter three times, I have yet had no answer from*

the manufacturer. What can I do? Can I bring my machine to you for servicing?

A. I am sorry to hear of your troubles with your tape recorders and the service agencies in your city. Unfortunately, I cannot help you because I am not set up to service tape recorders. If you truly feel you have been unfairly dealt with, I suggest that you contact the Better Business Bureau in your city, and that you write to the Institute of High Fidelity, 516 Fifth Ave., New York, N. Y., 10036. State your complaint clearly, briefly, and calmly.

Standards

Q. Can you please give me sources of information on the NAB and MIRA playback equalization curves, standards for determining signal-to-noise ratio, and other standards and tests concerning tape recorders.

A. These sources include: National Association of Broadcasters (1771 N St., N.W., Washington 6, D. C.); Institute of High Fidelity (516 Fifth Ave., New York, N. Y., 10036); Magnetic Recording Industry Association (care of Audio Devices, 235 E. 42nd St., New York City); RCA; Ampex; and the 3M Company.

Speed Accuracy

Q. I have just discovered to my dismay that my tape recorder runs 2 per cent fast. Not only did I check this with a stroboscope, but I also timed a recording available both on disc and tape; the tape took 2 per cent less time; I know that my turntable is running at exact speed. I have recorded over 100 tapes on my present machine. What's going to be when I buy my next recorder? Will I notice the result of a speed difference of 2 per cent? Will I have to find one that also runs 2 per cent fast?

A. Whether you can notice a 2 per cent difference in speed depends on your individual acuity. Some persons can hear differences of less than 0.5 per cent, while others can't hear differences until they reach 5 per cent or even more. Try playing your tapes on friend's machines that you have checked with your stroboscope and that vary in speed from your machine by 2 per cent more. If you really notice the difference, then the next time you buy a recorder you'll have to look for one that runs about the same speed as your present unit. That means shopping with the aid of your stroboscope, although I am dubious that any audio store will open up a number

of sealed cartons in order to let you pick the machine you want. However, you might get your pick of units already on the dealers shelf. The lesson here is that persons sensitive to pitch variation have all the more reason to invest in a high-quality recorder, where deviations from correct speed are usually kept to a minimum (0.5 per cent or less in a first-rate home machine). It is some years since I voiced the expectation that tape machines, like turntables, would some day provide a fine adjustment for speed, but I have proved a very wrong prophet in this respect.

Bias Frequency

Q. I have checked the frequency response of my tape recorder, using an audio generator and VTVM and have found that the response is down only 1 dB at 15,000 Hz and only 3 dB at 19,000 Hz. Inasmuch as the bias frequency should be at least five times the highest recorded frequency, according to what I read, then the bias frequency of my tape recorder should be around 100,000 Hz. But the nominal bias frequency of my recorder is only 65,000 Hz. I have tried checking the actual frequency by tuning the signal generator from 50,000 to 150,000 Hz and listening for a null. I do get a null at 65,000 Hz, but I also get nulls at other frequencies, indicating harmonics or subharmonics. What is the proper procedure for determining bias frequency? (I don't have an oscilloscope.) If bias frequency is too low, what kind of distortion results? Would raising the bias frequency be likely to improve performance materially?

A. The most direct way of checking frequency is with a frequency meter, a rather expensive instrument. The next best way is to use an oscilloscope and signal generator, adjust the generator to display the same number of waveforms as when the scope is connected to the bias oscillator, and read the frequency on the generator's dial. In your case, since you don't have an oscilloscope, I think you can safely assume that the bias frequency is 65,000 Hz, since you did get a null there.

If bias frequency is too low, there may be audible beats between the bias frequency and the highest harmonics of your audio signal. Distortion is not involved. I don't think that raising the bias frequency above 65,000 Hz will materially improve performance, unless you are in fact hearing beat notes. Raising the bias frequency would entail the problem of maintaining sufficient erase current through the erase head. Also, you would have to adjust the bias current fed to the record head in order to get the optimum combination of low distortion and extended treble response. Leave well enough alone.

Tape Hiss

Q. When recording, is the tape hiss caused by the erase head or the bias in the record head?

A. The noise added during recording is caused by distortion in the waveform of the bias current fed to the record head. There is also modulation noise: in the presence of an audio signal recorded on the tape, variations in the magnetic coating appear as noise recorded on the tape. \AE

from page 30

Continuing, to add a 7th-order term, the form is $y = x - ax^3 + bx^5 - cx^7$ (8)

The derivative of this is

$$\frac{dy}{dx} = 1 - 3ax^2 + 5bx^4 - 7cx^6 \quad (9)$$

For this to have three double roots $1 - x^2 = 0$, the coefficients must have values such that

$$\frac{dy}{dx} = 1 - 3x^2 + 3x^4 - x^6 \quad (9a)$$

whence values for the coefficients are:

$$a = 1, b = \frac{3}{5}, c = \frac{1}{7} \quad (10)$$

Substituting these into Eq. (8) gives the equation for the required transfer characteristic,

$$y = x - x^3 + \frac{3}{5}x^5 - \frac{1}{7}x^7 \quad (11)$$

Adding the 9th-order term, the form is $y = x - ax^3 + bx^5 - cx^7 + dx^9$ (12)

The derivative of this is

$$\frac{dy}{dx} = 1 - 3ax^2 + 5bx^4 - 7cx^6 + 9dx^8 \quad (13)$$

For this to have four double roots $1 - x^2 = 0$, the coefficients must have values such that

$$\frac{dy}{dx} = 1 - 4x^2 + 6x^4 - 4x^6 + x^8 \quad (13a)$$

whence values for the coefficients are:

$$a = \frac{4}{3}, b = \frac{6}{5}, c = \frac{4}{7}, d = \frac{1}{9} \quad (14)$$

Substituting these into Eq. (12) gives the equation for the required ninth-order transfer characteristic,

$$y = x - \frac{4}{3}x^3 + \frac{6}{5}x^5 - \frac{4}{7}x^7 + \frac{1}{9}x^9 \quad (15)$$

Into these successive transfer characteristics, to get the harmonic composition, requires the substitution

$$x = \sin \omega t \quad (16)$$

and to get results in the form of harmonics further requires the conversion formulae:

$$\sin^3 \omega t = \frac{1}{4}(3 \sin \omega t - \sin 3\omega t) \quad (17)$$

$$\sin^5 \omega t = \frac{1}{16}(10 \sin \omega t - 5 \sin 3\omega t + \sin 5\omega t) \quad (18)$$

$$\sin^7 \omega t = \frac{1}{64}(35 \sin \omega t - 21 \sin 3\omega t + 7 \sin 5\omega t - \sin 7\omega t) \quad (19)$$

$$\sin^9 \omega t = \frac{1}{256}(126 \sin \omega t - 84 \sin 3\omega t + 36 \sin 5\omega t - 9 \sin 7\omega t + \sin 9\omega t) \quad (20)$$

Putting these substitutions into Eqs. (1), (7), (11), (15) in succession yields:

$$y = \frac{3}{4} \sin \omega t + \frac{1}{12} \sin 3\omega t \quad (21)$$

$$y = \frac{5}{8} \sin \omega t + \frac{5}{48} \sin 3\omega t + \frac{1}{80} \sin 5\omega t \quad (22)$$

$$y = \frac{35}{64} \sin \omega t + \frac{7}{64} \sin 3\omega t + \frac{7}{320} \sin 5\omega t +$$

$$\frac{1}{448} \sin 7\omega t \quad (23)$$

$$y = \frac{63}{128} \sin \omega t + \frac{7}{64} \sin 3\omega t + \frac{9}{320} \sin 5\omega t +$$

$$\frac{9}{1792} \sin 7\omega t + \frac{1}{2304} \quad (24)$$

In the main text, we have changed the coefficients of these expressions twice, to use different references. The first set is normalized so the value of $\sin \omega t = 1$ always makes the whole expression unity (taking into account the relative signs of the higher order terms). The second set is changed so the coefficient of the first term ($\sin \omega t$) is unity.

For the FM sideband analysis, refer to Fig. 10. Writing C for amplitude of carrier, a, b, and c for amplitude of first, second, and third-order sidebands (each sideband) respectively, we can derive three expressions for the resultant amplitude in (B) of Fig. 10:

$$\text{From OD,} \quad R = C + 2b \quad (25)$$

$$\text{From OE, OF,} \quad R = C - 2b + j2a \quad (26)$$

$$\text{From OG, OH,} \quad R = C + j\sqrt{2}a \quad (27)$$

Squaring each of these expressions, to eliminate operator j:

$$R^2 = C^2 + 4Cb + 4b^2 \quad (25a)$$

$$R^2 = C^2 - 4Cb + 4b^2 + 4a^2 \quad (26a)$$

$$R^2 = C^2 + 2a^2 \quad (27a)$$

Equating (25a) and (26), which makes amplitude equal at mean and extreme positions of swing,

$$2Cb = a^2, \text{ or } b = \frac{a^2}{2C} \quad (28)$$

Substituting (28) into (27a) yields

$$R^2 = C^2 + 4Cb \quad (29)$$

which manifestly can never be identical with (25a).

Equation (27) was derived on the assumption that vectors OG, OH represent the resultant vector when the phase shift is $1/\sqrt{2}$ of its maximum, which represents a phase angle of 45 deg. of a sinusoidal modulating signal. Thus we have assumed constant amplitude at mean and extremes and linear phase modulation, and found that amplitude is not the same, but reduced, at the vector point representing 45 deg. of the modulating sine wave.

To show what happens when phase linearity is held, it is easier to use the vectors OK, OL, representing 30 deg. of the modulating sine wave ((c) in Fig. 10). Equations (25), (26) and (25a), (26a) still apply. For vectors OK, OL,

$$R = C + b + ja \quad (30)$$

$$\text{and } R^2 = C^2 + 2Cb + B^2 + a^2 \quad (30a)$$

As vectors OK, OL represent a modulating amplitude of $\sin^{-1} 0.5$, we can check to see whether the angles marked ϕ and $\phi/2$ are in that ratio. From the vector diagram,

$$\tan \phi = \frac{2a}{C - 2b} \quad (31)$$

and

$$\tan \frac{\phi}{2} = \frac{a}{C + b} \quad (32)$$

Substituting

$$\tan \phi = \frac{2 \tan \frac{\phi}{2}}{1 - \tan^2 \frac{\phi}{2}} \quad (33)$$

into (32) gives

$$\tan \phi = \frac{2a(C + b)}{(C + b^2 - a^2)} \quad (34)$$

Equating (31) and (34),

$$a^2 = 3(Cb + b^2) \quad (35)$$

Substituting (35) into (26a) and (30a), we can compare the expressions:

$$R^2 = C^2 + 4Cb + 4b^2 \quad (25a)$$

$$R^2 = C^2 + 8Cb + 16b^2 \quad (26b)$$

$$R^2 = C^2 + 5Cb + 4b^2 \quad (30b)$$

Expressed in this form, it is evident that these cannot be equal, and that the amplitude grows progressively toward maximum swing, if phase linearity is held.

In Fig. 11, expressions for vectors OD, OE and OF are, respectively:

$$R = C + 2b \quad (36)$$

$$R = C + b + j(a + 2c) \quad (37)$$

$$R = C - 2b + j(2a - 2c) \quad (38)$$

Equating (36) and (38) (after squaring) yields

$$b = \frac{(a - c)^2}{2C} \quad (39)$$

Setting this relationship ensures that amplitude is the same at mean (OD) and extremes (of which OF is one). From here two solutions are possible: use this result with Eq. (37) to obtain a solution based on equal amplitude at this point also; use the Eq. (33) to establish phase linearity at this point and produce another solution. The solutions are not identical, but close, until the deviation angle gets large. \AA

FAIRCHILD

REVERBERTRON

REVERBERTRON

REVERBERTRON

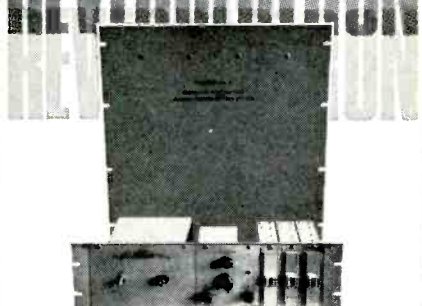

An electro-mechanical reverberation system that adds dimension and extra listening level to your sound.

For complete details write:

FAIRCHILD

RECORDING EQUIPMENT CORPORATION
10-40 45th Ave., Long Island City 1, N. Y.

TONE CONTROL

(from page 24)

The trimmer capacitor in the flat position of the treble control is an added nicety to compensate for the normal high-frequency Miller-effect loss in a triode and its adjustment is best done with a 10-kHz square wave. If a slight rounding can be tolerated, the trimmer may be left out, or a fixed capacitor of about 12 pF can be used.

For accurate control of two channels the resistors and switch-selected capacitors should be either matched or of 1 per-cent accuracy. Equal value, rather than accurate specific value, is the aim.

Harmonic distortion of the circuit was not checked but intermodulation distortion as read on a Heathkit audio analyzer runs about 0.1 per cent at an output of 2 volts. Intermodulation is strongly affected by the bias used on the tube, and the value of bias resistor here was chosen for minimum distortion. A slightly higher value of resistance will increase distortion a small amount; a lower value will permit grid current to flow and increase the distortion markedly. Bypassing has little effect on the total distortion, but increasing the gain of the stage permits more feedback at the frequency ex-

tremes. The output impedance is quite low—about 5000 ohms with the controls in flat position in this case—so the circuit may be used as an output stage in a preamplifier in place of the usual cathode follower. The B-voltage requirements are flexible and any voltage from 200 to about 400 will be satisfactory, but due to the large boost available at low frequencies careful decoupling may be necessary to avoid motorboating if the B voltage is taken

from the power amplifier.

One characteristic of the anode follower is that the input impedance is about equal to R' (Fig. 1), in this case a mid-band impedance of 100k ohms. As the treble boost is increased, however, this impedance drops and at the highest frequencies with maximum boost a minimum impedance of 15k ohms is seen, so for best performance a low-impedance source is required. A cathode follower does nicely; but if the source used is a low-impedance one, the control may be fed directly. Be sure there is a ground return at the control input. If none exists, a ½-meg.

Fig. 3. Response curves obtainable with the control.

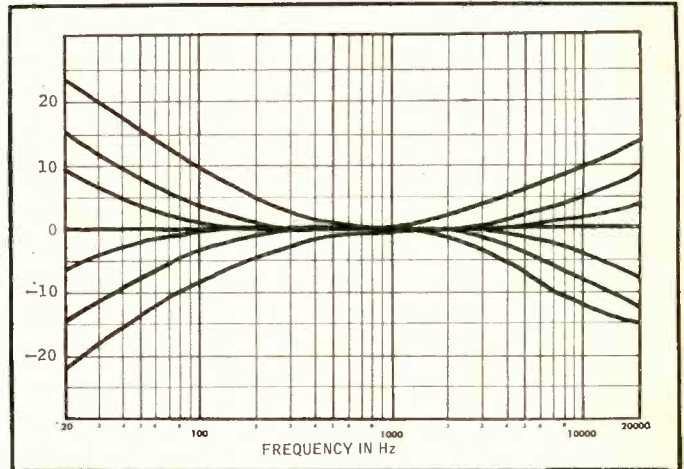

AUDIO

an eye opener for those who seek NEUMANN quality...

but think they
can't afford it!

(NEW NEUMANN LINEAR ADMITTANCE CAPSULE)

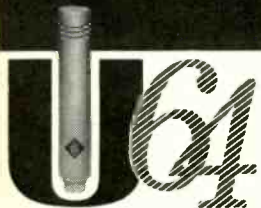

NEUMANN CARDIOID CONDENSER MICROPHONE

Once again, NEUMANN proves its leadership! The linear admittance capsule... a new condenser element concept two years in development ends usual cardioid mid-range deficiency for non-centered sound sources. This important innovation is enhanced by another exciting feature... NEUMANN quality at new lower prices. Six U-64's from 6-way power supply—\$260 per mike, dual/stereo system—\$310 per mike, single system—\$360. For any cardioid application the U-64 is the best answer and your best buy! Ask your franchised dealer for a demonstration or contact:

GOTHAM
AUDIO CORPORATION
2 WEST 46 STREET, NEW YORK, N.Y., 10036 • 212-CO-5-4111



© 1965 GAC

Circle 127 on Reader Service Card

resistor may be included from the junction of the 100k and 15k resistors to ground.

The response curves, shown in Fig. 3, are typical of feedback-type tone controls, being of a variable crossover with an ultimate constant slope, and their action sounds modest since the major effect is at the frequency extremes. Curves shown have proven to be quite adequate; the first cut position making an effective rumble filter if one is necessary, and the first boost position giving a solid bass foundation with no trace of boominess. Additional bass boost at low listening levels compensates well for normal hearing loss. A wider variety of curves may be had easily by using switches with additional positions and intermediate size capacitors, but the maximum boost and cut available will be about the same as shown.

A detailed discussion of the anode follower by Charles P. Boegli will be found in *Audio* for December, 1960. **Æ**

LIGHT LISTENING

(from page 10)

Salute to our Fighting Men in Vietnam

RCA Victor LSP 3600

RCA is really zero-ing in on the war in Vietnam. A few months ago it hit the bestseller charts with the songs of Sgt. Barry Sadler of the Green Berets. Now another green-hued album cover introduces a recording by Paul Lavalle and the Band of America with an assisting chorus. This is a more ambitious production than the Sadler release with a mixture of old military favorites ("The U. S. Air Force," "Anchors Aweigh" and "I Am an American") and songs spawned directly by the Vietnam engagement. The Lavalle band doesn't pack its usual weight in the low end of the bass spectrum but its nimble gait is a real asset in the brighter-paced songs. The chorus delivers the Elliot Lawrence arrangements with telling effect in a release that is sure to appeal to the same audience that went so heavily for the Sadler disc.

Harold Bradley: Guitar for Lovers Only

Columbia CL 2456

Joe Harnell: Golden Piano Hits

Columbia CL 2466

Every now and then, though the intervals are becoming farther apart, I check back to see what's doing in mono discs used by "Light Listeners." The exact mono sales figures being racked up (or down) these days in relation to stereo discs probably don't prove too much. The guy looking for the type of accompanied one-instrument background music found on these two records is well apt to settle for mono, particularly in the case of labels still charging a dollar extra for the stereo version of a given disc. (Remember when that extra dollar started as a "temporary" measure to pay for the development and installation, not to mention the upkeep of the first stereo

cutters?) Looking at the other side of the coin, it is possible that the dollar "advantage" enjoyed by mono could be the main reason why a less well-known artist can wangle a contract with a major label and keep working in today's highly competitive market. The names of Bradley and Harnell, by themselves, are hardly enough to pull a record dealer out of a serious slump in business but, at mono prices, both albums represent more than adequate value. Prior to his first album for Columbia ("Misty Guitar") Harold Bradley spent most of his time as accompanist for singers such as Anita Bryant, Patti Page, Connie Francis and Brenda Lee. Now he finds him-

self accompanied by a group of mixed voices and strings led by Bill McElhiney in an attractive list of standard tunes.

Joe Harnell has been moving his piano into a brighter spotlight with each change of record labels. Originally a Kapp artist, he then transferred to the Epic label and now has made the grade with its parent. He has a sure style, solid rhythm and a tonal color that gives some evidence of his study with classical composers Darius Milhaud, Aaron Copland and Leonard Bernstein. Strings, woodwinds and adroit use of trombones and Flügelhorn provide good backing in both the swinging and reflective Harnell arrangements. **Æ**

(advertisement)

\$500 OFFERED FOR PREAMPLIFIER

\$500 in cash awaits the first person who can supply Bob Tucker (Dyna-Kit's Sales Director) with a stereo preamplifier which can outperform Tucker's present unit, a Dyna PAS-3X.



Bob Tucker

When asked about his offer, Tucker explained: "Like most hi fi fans, I have always wanted to have the best equipment available. Over the years, as a hobbyist, a dealer, and now as a manufacturer, I've owned or had access to virtually all of the high-priced name brands; and on comparative listening tests as well as laboratory checks, the Dyna still comes out on top. Over 6 years ago I first made a personal offer of \$300 on the same basis, and while I met a few "bounty hunters", none of the units submitted could outperform my Dynakit. Now, with inflation sending the cost of audio equipment up, and with the latest improvement to the PAS-3X, I've upped the ante to \$500."

Queried on the criteria for choosing a preamp, Tucker gave the following:

- * Harmonic distortion and spectrum analysis
- * Intermodulation distortion
- * Flatness of frequency response
- * Accuracy of equalization
- * Gain
- * Signal-to-noise ratio, both audible and inaudible

* Transient performance, including square waves and tone bursts

* Thermal stability

* Channel separation

* Ability to maintain performance specs at any setting of the volume control

Freedom from switching transients
Convenience and flexibility of controls

Freedom from control interaction

Service accessibility

Conservative operation of components

Listening comparison

He further explained, "I'll be glad to supply more details to anyone who wishes to pursue this, but to save needless correspondence, I suggest that some preliminary test results be submitted so that those units which obviously do not measure up can be eliminated. An offer like this is feasible only because a preamplifier is the only audio component whose performance can be effectively defined by such established, easily reproducible criteria as the (*) items above. The last one is the simplest and most significant test, though—a listening test which anyone can perform: reproducing a "live" tape, using a first-class recorder, power amplifiers, and speakers; first through the preamplifier, and then bypassing it, going directly from the recorder to the power amplifiers. A truly fine preamplifier, like the PAS-3X, will be undetectable."

Circle 128 on Reader Service Card

Up- grade your sound !

Whatever your receiver or amplifier is capable of doing, EMI loudspeakers have a unique way of making it sound better.

Perhaps it's the ease with which EMI loudspeakers project sound. So smooth and natural, it seems to float on the air in all its concert hall glory. Filling the room.

Or perhaps, it's the deep bass, the incomparable realistic midrange and the full, silky highs.

Or it could be the subtle detailing of their transient perfect response that catches you unawares.

So, for better sound from your receiver or amplifier, come on up to EMI loudspeakers.

There's an EMI loudspeaker to meet any requirement and budget. From \$49.95* to \$395.00*

*Slightly higher in South and West

EMI / SCOPE

Scope Electronics Corporation
470 Park Avenue South
New York, New York 10016
Also available in Canada.

Circle 129 on Reader Service Card



ABOUT MUSIC

Harold Lawrence

Fighting the Noise Explosion

A young woman recently moved into a gleaming new apartment house on New York's Fifth Avenue. On her first evening at home she sneezed while taking a bath. A man said "God bless you." Startled, she looked up; was it the bathroom scene from *Thunderball* all over again, with James Bond leering at the girl in the tub?

Amusing? Not to the unhappy tenant, or to the World Health Organization, psychologists, noise-abatement societies, and individuals like Vance Packard, author of *The Naked Society* each of whom regard intruding noise as the most obvious invasion of our right to privacy. More aggressive noise makers than the toilet flush and the telephone are the trailer-truck engines, *Varoom* scooters, transistor radios, bull-horns, campaign sound trucks, jet airplanes, helicopters, jackhammers, and power shovels; each pollutes our aural life.

Until the spring of 1964 Robert Alex Baron, a New York theatrical manager, was simply another victim of the city's sound pollution. In April the Transit Authority installed five air compressors outside his apartment overlooking Sixth Avenue where the city was building a subway spur. The noise level shot up to 103 decibels, seven below that of an airplane. The assault began at 7:45 in the morning and continued until 4:30 in the afternoon. Like most of his neighbors, people who labor in television, radio, and the theatre, Mr. Baron was unaccustomed to waking so early. But losing sleep was a trivial matter compared to suffering the relentless barrage of rock drills, cement trucks, air compressors and chain saws. He decided to fight City Hall.

Several weeks of inquiries at the Board of Health, telephone calls to the police, and letters to the Mayor revealed that (1) the city has no prohibition on construction noise between 7 A.M. and 6 P.M., (2) the Noise Code exempts public utility construction from any restraint, and (3) construction noise is regarded as "temporary."

Baron and his family began wearing ear plugs and ear muffs at home, and had a supply on hand for daytime guests. The noise level inside the apartment rose to between 70 and 80 dB. "We had to shout at each other," Baron said. "And have you tried brushing your teeth with ear muffs on? It's like scratching chalk on a blackboard." It was when a ringing in his ears drove him to consult a physician that Baron decided to look for help.

Baron collected 500 signatures from people who lived in the immediate area.

Doctors who signed complained that they had trouble using their stethoscopes because of the din. NBC-TV covered the opening of the drive for signatures. In May, 1965, Baron formed the Upper Sixth Avenue Noise Abatement Association.

Baron and his anti-noise boys met with the Transit Authority, saw the Borough engineer, and enlisted the aid of Theodore Kupferman, then a City Councilman. The legislator sympathized with the aims of his neighbors; he proposed bills to establish the principle of quantitative noise levels, rather than the vague definitions on the pages of the Noise Code, such as the phrase "unreasonably loud." Kupferman also introduced a bill that would make it a violation to operate any machinery in or over any street unless it is equipped with a muffler which is to prevent noise in excess of 90 decibels at the source."

Since forming Upper Sixth Avenue Noise Abatement Association, Baron has gone on to launch a crusade against noise pollution. To learn more about the subject he joined the British Noise Abatement Society and the Acoustical Society of America, talked with officials of the U.S. Public Health Service in Washington, D. C., and went to Germany as the unofficial American representative to the International Conference on Noise Abatement. He found that the United States generally lags behind other nations in reducing noise but that the attention currently being focused on air and water pollution probably will swerve in the direction of noise pollution . . . if we apply pressure.

What can be done about noise pollution? A few possible solutions can be mentioned. (1) Set a 90-dB limit on construction noise. Silencing devices exist or can be manufactured to reduce noise. Residential-quality mufflers, for example, costing about \$100 can be used to cut the noise of air compressors. (2) Establish fines for noise violators, the fines being graded according to the number of decibels by which a citizen exceeds the limit. (3) Set standards for construction that would eliminate millimeter-thin walls in apartment houses and other buildings.

According to the World Health Organization, excessive noise can lead to cardiovascular problems, high blood pressure, nervous tension, fatigue, and ultimate hearing loss. Some dispute the W.H.O.'s assertion, claiming there's no proof. Baron says that by the time we get the proof, we'll all be deaf and insane. Æ

AUDIO ETC.

(from page 12)

But in the last few months, some much less imposing releases have been trickling out elsewhere which are enormously more significant.

A page or so, for instance, says that Ampex, with all its associated record companies feeding master tapes into the Ampex tape library, will be putting out 8-trackers. And even adapters of some sort. Then, wasn't there something from Columbia? Maybe I'm imagining things . . . anyhow, the bandwagon is rolling. People are getting on board.

Of course Ford has been making big noises for a long while about how nearly everybody buys his Mustang with a tape machine built in. (I'm mildly wondering how many actually got them—but that's neither here nor there.) And *wham!*—Mercurys'll be full of tape soon, too. You'll be hearing other small, significant voices mumbling apologetically about optional stereo via plug-in cartridges. A tiger in the tank and a tape in every slot? And wouldn't you rather have tape and a Buick-Buick-Buick, too? And jet-smooth stereo from Chevy?

Yep, these are the signs that count. 'Course the public hasn't got its oar in for fair, yet. The noise is still coming mainly from 8-track's proponents. But the public *must* be saying something, all over the place, to have set off such a bandwagon as this.

So auto-stereo, 8-track, is here and it only remains for me to mutter a few words as to how I feel about it, myself.

Watch Your Driving, Mister

8-track isn't really my business in any musical way. In my music, there are still some 30,000 titles listed in Schwann which are potentially interesting to me. On 8-track there's mostly background auto-soothing-syrup. Just look at the catalogues. A few exceptions, notably through the newer entries in the field. Not many.

And look at the 8-track system! Push-button, made for listening automation. Do you want the *second* movement of a symphony, not the beginning? Just try. You're meant to begin at the beginning and keep right on going. If you want to get to the last part in a hurry, you've got a problem. You aren't supposed to want to. Choice is not assumed to be your interest, except in a general background way.

What you want (it is taken for granted) is soft music by the yard, hours of it, just music. Does anybody try to "change the record" in a restaurant background installation? Or airport and elevator music? Bank music? Supermarket music, Nope. You take what comes, if you hear it at all.

That's what auto-stereo is designed to be like, as far as I can figure it. You plug in your cartridge and let it play whatever it will, choosing merely a whole "program," two programs for each direction

of play. It plays, and you mind your driving. Driving requires primary attention, after all. You shouldn't *want* to change your programs in mid-stream.

I suspect, anyhow, that if cartridge auto-music gets too much attention, the Feds will step in, on the grounds of safety, and condemn the whole idea as interference with interstate commerce, or maybe income tax evasion.

Myself, I'm just not interested in 8-track for the car. I don't even have a car radio. When I get bored, or sleepy, I use chewing gum.

I have long since found that as a driver I *cannot* listen seriously to any music in an automobile if there is the slightest conflict for my attention. Like, say, a red

light, or somebody trying to pass me, or a tail-gater three feet behind at 55. At such moments I simply do not hear the music. My mind turns it off. Matter of fact, I don't even hear conversation; I ignore direct questions asked by my "live" passengers, at the slightest hint of driving concentration. For me, after thirty years, accident-free, driving is instinctive. So is music listening; but it must give way. Driving comes first, automatically.

So—no car music for *me*. But I am not *you*. And I suggest that 8-track, nevertheless, is on the way "in" on a fair scale and if you aren't tempted now you might as well get ready to be soon. Just don't even try to resist. Before you know it, you'll have it.



S-10
SYNCRON
SOLID STATE

**CONDENSER
MICROPHONE**

Self Contained Convenience

FET circuitry eliminates external power supply • Permanently polarized
Powered by 1000-hour battery • Frequency Response: 40 — 20,000 Hz
Pressure gradient • Mylar diaphragm • Cardioid Pattern • 20 db discrimination
• No overload protection needed • Low noise (less than 23 db)
High output (-53 dbm) • Connector is on-off switch • Beautiful satin
nickel finish • Only 9 ounces with battery • Full accessory line • Wind
screen • Elastic suspension • Desk stand • Fully guaranteed • \$240 complete
(with battery, case, swivel mount, 20-feet of cable) • Made in U.S.A.

SYNCRON CORPORATION
WALLINGFORD, CONN., U. S. A.

Circle 130 on Reader Service Card

Made to run outside and play...

The "CARNIVAL/FESTIVAL" BY JBL. Now you can enjoy full bass, distortion-free sound from a portable precision unit that weighs only 20 pounds. Resists rust, rain, even salt spray, and loves to play outside!

For complete information on JBL products write Dept. AM
James B. Lansing Sound, Inc., 3249 Casitas Avenue
Los Angeles, Calif. 90039

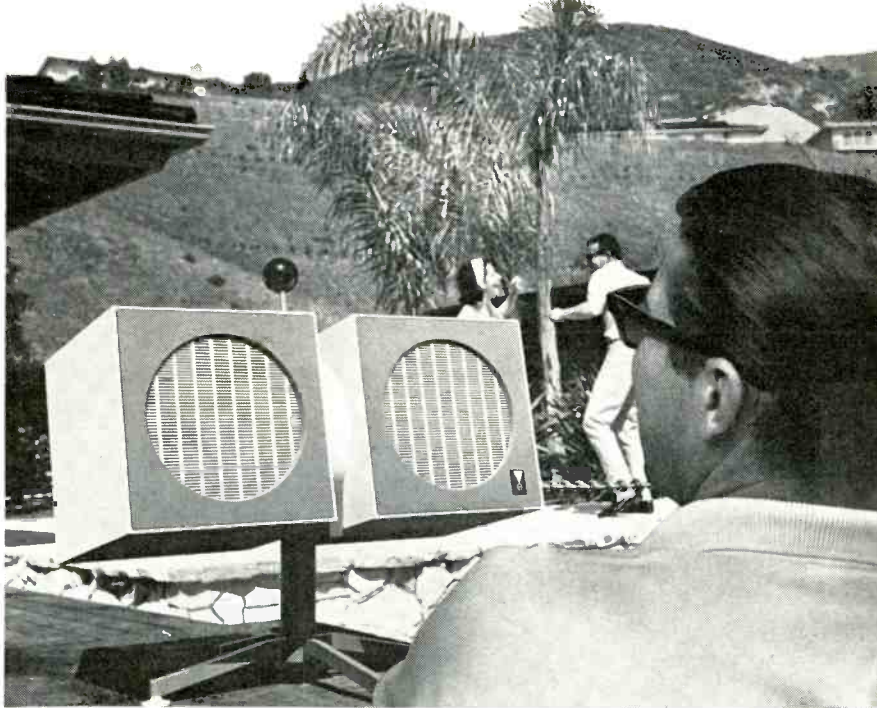

Circle 150 on Reader Service Card

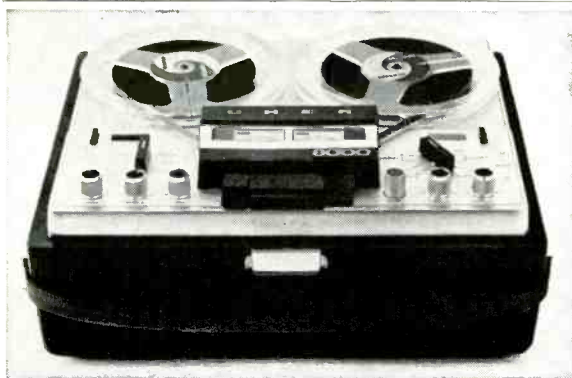

With just a flip of a switch, the new Uher 8000E tape recorder offers you 4 track stereo, monaural recording and playback, 4 speeds, 4 heads, synchronous sound on sound, multiplay sound with sound, echo effects, exclusive built-in automatic slide synchronizer (Dia-pilot), optional sound activator, (whew) and a host of other fantastic features. (You'll also flip over its all new solid state circuitry.)

If the above isn't enough reason to switch to Uher, you should listen to its concert hall sound.

For a demo visit your hi-fi dealer or write for literature. Martel Electronics, Los Angeles: 2356 South Corner, New York City: 1199 Broadway, Chicago: 5445 North Lincoln Avenue. End wasted tape. Send for the new Martel "Tape Tabulator" for the timing of classical repertoires (\$2.75 value). Dept. B. California office. Enclose 25 cents for postage and handling. Sound begins and ends with a Uher Tape Recorder.

MARTEL
SOLE IMPORTER FOR
UHER TAPE RECORDERS.

Circle 131 on Reader Service Card

4-track?

What about 4-track cartridge car stereo? Well, I fear that the enterprising outfits who started that deal, and who created the pioneer demand for auto-tape mostly on the West Coast, are going to have to join up with 8-track or quit. With RCA at the top, 8-track isn't going to be easy to push around. These 4-tracker outfits might as well convert and get it over with. As for purchasers who already have the 4-track cartridge units in their cars, they'll have to get along somehow. Probably the 4-track cartridges will be available for awhile, while demand lasts. In a couple of years you'll have a new car. And then you'll go 8-track.

(Copy your tapes onto 8-track cartridges? There's something in the wind, there, from Ampex, I think. Keep ears open.)

Reel to Reel?

Reel-to-reel tape? Well, there's a point. Reel-to-reel is another story altogether. It looks to me to be in fine shape now, having made a solid, if modest place for itself alongside of disc. Now, via the painlessly easy addition of 3 $\frac{3}{4}$ ips tapes to the prevailing 7 $\frac{1}{2}$ ips, it has widened its coverage very usefully. Those who like semi-background can now get it cheaply on the slower speed. On standard 7 $\frac{1}{2}$ ips, there is now a good cross section of solid classics, a modest number, but plenty for those people who do like top quality in their sound and yet whose modest musical know-how and tastes aren't yet quite up to exploring those 30,000-odd LP discs. Enough is enough! For many people, one or two Beethoven symphonies is a lot, plus a half dozen or so other serious classics. The huge LP disc catalogue makes things unnecessarily complicated for such listeners, with its choice of say 25 to 30 different versions of each well-known symphony and literally thousands of other works to spare.

Same thing with disc record stores—so much! *Too much.* The relatively tiny reel-to-reel library of music is easy to approach, offers just a nice amount of good music and is for sale in small corners of special stores, far from the maddening rush of the disc record emporium. Excellent idea.

So reel-to-reel has a tight and secure place for itself now. It sells, cannily, via mostly quite different outlets than disc, to suit its rather special type of buyer-appeal. You'll find reel-to-reel tapes in lots of hi-fi stores that won't touch disc. Disc is too rough, too big. Reel-to-reel is just right, on a small scale. People enjoy buying reel-to-reel tape, in places where they can get it without confusion and in reasonable quantity.

Is reel-to-reel on the way out, thanks to 8-track? Now don't start asking silly questions! Of course not.

Just as disc has persisted, in spite of tape, so reel-to-reel will persist, in spite of 8-track. Each of these three media has its own place; each is tailored to fit its clientele. Disc and reel-to-reel have settled
(Continued on page 53)

(from page 36)

NEW LITERATURE

● **Service Technician's Aid.** Sprague's popular Electrolytic Capacitor Replacement Manual is now ready in a new expanded and up-to-date edition. It now contains nearly 100 more set suppliers that were not to be found in earlier editions. All told, 389 different makes are featured, going from Acme to Zephyr, including TV sets as well as home, auto, and portable radios, tape recorders and antenna rotators manufactured from 1947 up to November, 1965. The 64-page manual lists original part numbers for each manufacturer, followed by ratings, recommended Sprague replacements, and list prices. More than 2500 electrolytic capacitors are included in an effort to ensure exact replacement. This is Manual K-108 and is available free of charge from Sprague's distributors or directly from the company. Circle 206

● **MATV Distribution Systems.** A new booklet by Blonder-Tongue describes system components which give any existing or future MATV system full 82-channel capability. Included are full architects and engineers specifications. High-lighted in the publication, titled "Don't get Caught in the TV Traffic Jam", is a new system to permit high-level distribution of UHF signals without the necessity for conversion to VHF. Also shown are the advantages of this system to such users as schools, hotels, apartment house developments, and TV dealer showrooms. There is no charge for the booklet. Circle 208

● **Magnetic Tape Specifications.** Irish Magnetic Tape has recently released a brochure outlining the technical specifications on its 190 and 200 series recording tape. The specifications cover a total of seventeen magnetic properties and fifteen physical ones. Also offered are characteristics that are general to the entire Irish line. The brochure is offered free of charge. Circle 209

● **Magnetic Films.** A brochure issued by Reeves Soundcraft Division of Reeves Industries describes new microplated magnetic films. The four-page bulletin provides illustrations, physical characteristics, and price information on the Soundcraft line of 35mm and 16mm full-coated and 35mm Magna-Stripe magnetic films, available in lengths from 400 to 2000 feet. The publication also describes Reeves' Magna-Striping service for 16mm prints and raw stock. Copies are available at no charge. Circle 207

● **Tape Cartridge System.** KRS Instruments, Division of Datapulse, Inc., has just released a two page sheet that describes their STACTape stackable, continuous-loop, magnetic tape cartridges, that offer editing reversibility, 1200-foot tape capacity, and maximum tape protection. This is KRS Instruments Technical Bulletin S-1. Circle 210

of about ± 3 per cent. It may be accomplished while a record is playing.

Other niceties include a built-in illuminated strobe that shows dots for the 33 speed. The inner weighted platter is now non-ferrous. So it can be used to better advantage with certain magnetic cartridges that are sensitive to such things.

There is a built-in leveling bubble. And, most useful to a tinkerer is the fact that the arm-mounting plate is readily removable and interchangeable. There are boards and bases for 12- or 16-inch arms.

Total rumble measured 31 dB below a 1-kHz signal of 3.54 cm/sec recorded velocity. A 50-Hz cut off reduced rumble to -43. These figures are better than they appear to be. The prime rumble frequency is 15 Hz. This is a practical situation of inaudible rumble.

Flutter is 0.08 per cent. Our experience with the original unit makes us think that this figure will stay that way. The same is true of the other characteristics.

The Thorens TD-124 is for the music lover with the need for a dependable-quality unit. As a completely separate component, it is ideal as the foundation upon which to build a complete system. Certainly, we consider this table to be in a class by itself. \$125 may seem a lot to spend for a turntable—but then this is what you must pay for the construction involved. We said this about the original TD-124. The Series II has only added emphasis to that belief. Circle 205

ACOUSTICAL REARGUARD



D-12

Range: 40-15,000 cps
Response: ± 3 db over entire range
Dimensions: 5 $\frac{1}{8}$ " x 2 $\frac{1}{2}$ " x 2 $\frac{1}{8}$ "
Data sheet available on request

Insensitive to sound reaching this dynamic microphone from the rear...An exceptionally pronounced cardioid pattern produces an acoustical shield of approximately 180° that effectively isolates unwanted sounds originating from noisy audiences, feed-back or reflection.

FOR SUPERIOR SOUND



C-60

Range: 30-18,000 cps (cardioid)
30-30,000 cps (omni-directional)
Response: ± 2.5 db over entire range
Dimensions: $\frac{3}{4}$ " Dia. x 4"
Data sheet available on request

A high quality condenser microphone for music and speech. Its characteristics provide truest fidelity for reproduction and recording. The C-60's many uses and users attest to the unusual versatility of this microphone. Available with either cardioid or omni-directional capsule.

CONDENSER • DYNAMIC MICROPHONES

MADE IN AUSTRIA BY AKG GMBH.

Norelco®
PROFESSIONAL
SOUND PRODUCTS

NORTH AMERICAN PHILIPS COMPANY, INC.
Professional Products Division, 100 East 42nd St., New York, N.Y. 10017

Circle 132 on Reader Service Card

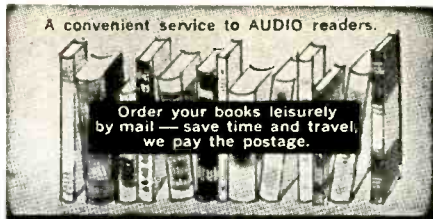

A convenient service to AUDIO readers.

Order your books leisurely by mail — save time and travel, we pay the postage.

Maintaining Hi-Fi Equipment

Joseph Marshall

A valuable reference for anyone whose living or hobby is servicing hi-fi equipment. Outlines the professional approach for servicing all types of hi-fi components. Covers trouble-shooting of electronic, mechanical and acoustic problems. 224 pages.

No. 58 Paperback \$2.90*



Designing and Building Hi-Fi Furniture

Jeff Markel

Written by a professional hi-fi furniture designer who has taught furniture design at leading colleges, this book is an authentic reference of value to the hi-fi fan and professional custom builder. Covers everything from types of woods to furniture finishing for the mechanically adept; design principles, styles and arrangements for the decor minded. 224 pages.

No. 79 Paperback \$2.90*



HI-FI TROUBLES

By Herman Burstein

HOW YOU CAN AVOID THEM HOW YOU CAN CURE THEM

Just published! At last, a book which deals directly with the problems you face in maintaining your audio system in peak condition. Tells you how to locate troubles, what to do about them and how to do it—and, just as important: what NOT to do. Helps you to achieve the best in listening pleasure from your equipment.

No. 120 \$3.95

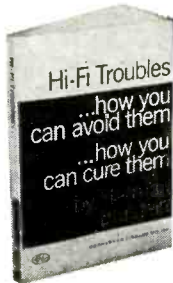

McProud High Fidelity Omnibook

Prepared and edited by C. G. McProud, publisher of AUDIO and noted authority and pioneer in the field of high fidelity. Contains a wealth of ideas, how to's, what to's, and when to's, written so plainly that both engineer and layman can appreciate its valuable context. Covers planning, problems with decoration, cabinets and building hi-fi furniture. A perfect guide.

No. 115 \$2.50*

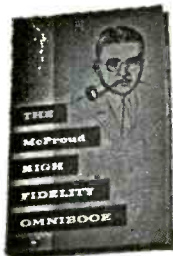

The 5th AUDIO Anthology

Edited by C. G. McProud, publisher of AUDIO. An anthology of the most significant articles covering: stereo recording and reproductions; stereo multiplex; measurements; stereo technology, construction and theory — which appeared in AUDIO during 1958 and 1959. The 5th is truly a collectors' item and a valuable reference for the professional engineer, teacher, student, hobbyist and hi-fi fan. 144 pages.

No. 125 \$3.50



"the best of AUDIO"—
edited by C. G. McProud

A new compendium of AUDIO knowledge. Here is a collection of the best of AUDIO — The AUDIO Clinic by Joseph Giovanelli — noted audio engineer and the original high fidelity answer-man — EQUIPMENT PROFILES edited by C. G. McProud — Editor of AUDIO. Here is a wealth of hi-fi and audio information. Answers to the most important issues in high fidelity and a valuable reference.

No. 124 Volume I \$2.00*



Tape Recorders and Tape Recording*

Harold D. Weiler

A complete book on home recording by the author of *High Fidelity Simplified*. Easy to read and learn the techniques required for professional results with home recorders. Covers room acoustics, microphone techniques, sound effects, editing and splicing, etc. Invaluable to recording enthusiasts.

No. 112 Paper Cover \$2.95*



The 6th AUDIO Anthology

Edited by C. G. McProud, publisher of AUDIO. Includes articles on the two most significant milestones in the field of high fidelity: FM STEREO and TRANSISTORS IN AUDIO EQUIPMENT. A meaningful reference for everyone in the fields of audio engineering, recording, broadcasting, manufacturing and servicing of components and equipment. A necessary book for the high fidelity enthusiast. 144 pages.

No. 130 \$3.95



"The AUDIO Cyclopaedia"

Howard M. Tremain

- 1280 pages
- 3400 topics
- 1600 illustrations

Here is one single volume with the most comprehensive coverage of every phase of audio. Concise, accurate explanations of all audio and hi-fi subjects. More than 7 years in preparation—the most authoritative encyclopedic work with a unique quick reference system for instant answers to any question. A vital complete reference book for every audio engineer, technician, and serious audiophile.

No. 123 \$19.95*

• MONTHLY SPECIAL! SAVE \$5.00

Save almost 50% with this collection of AUDIO books.
"best of AUDIO" (\$2.00) 5th AUDIO ANTHOLOGY (\$3.50)
McProud High Fidelity Omnibook (\$2.50) and
Tape Recorders & Tape Recording (\$2.95)

TOTAL VALUE ALL FOUR BOOKS . . . \$10.95

Your cost only . . . \$5.95 Postpaid

CIRCLE OS400

This offer expires June 30, 1966, and is good only on direct order to the Publisher

High Fidelity Simplified

Harold D. Weiler

3rd Edition

The complete hi-fi story — answers all questions about tuners, changers, amplifiers, tape recorders, speakers, record players, etc. Lots of ideas for custom installations. Tells how to achieve concert hall reception in your home. 216 pages.

No. 142 \$3.30



AUDIO Bookshelf—RADIO MAGAZINES, INC.

P. O. Box 629, Mineola, New York 11501

*All U.S.A. and Canadian orders shipped postpaid.

Please send me the books I have circled below. I am enclosing the full remittance of \$..... (No C.O.D. or billing.)

58	79	112	115	120	123
124	125	130	142	251	OS400

NAME _____

ADDRESS _____

CITY _____ STATE _____ ZIP _____

Getting The Most Out Of Your Tape Recorder

Herman Burstein

Written in "plain talk" for the man who has, or wishes to buy, a tape recorder. It answers the myriad questions raised by tape recording enthusiasts. Its chapters cover every phase of operation and maintenance—from adding a tape recorder to the hi-fi system, to a thorough dissertation on microphones. Lots of practical information on how to buy. 176 pages.

No. 251 \$4.25



AUDIO ETC.

(from page 50)

down handsomely in their respective niches. I expect that 8-track will find its place handsomely in the same fashion. Automobile music, à la Muzak. That's the big 8-track pitch, I'm guessing.

Soft Music

8-track in the home? They do keep talking about fancy 8-track adapters, consoles, decks and what-not, for home use. I say, forget it.

Maybe they'll make them. But these items are going to be too much like the early 45 rpm classical albums which RCA put forth, and then forgot. I always figured it was just to say they'd done it. Prestige. (They knew 45 was for jukeboxes and for millions of \$\$\$.) And that "traveling crane" record changer, the Seeburg Selectomatic, which was originally launched as a plushy classical home model (I was there), then quickly settled into a million juke boxes, where it belonged. They launch these things with classical éclat, for a good effect. Understandable.

So I say, forget 8-track in the home. Unless you want it for the same reason you'll buy it for the car. Automated, Muzak-style long-play. You can plug it in and it'll play and play, without the aid of human hands. Or ears. It fills up silence with sound, most admirably, and keeps right on filling it up, if you aren't too particular as to which sounds you get, so long as they are sweet and discreet. For this, 8-track ought to be superb, even in the home. I surely don't want to stand in the way of hopeful sales, and you certainly have a right to install 8-track *chez vous*, if you so desire.

So if that is your idea of taped heaven, go get a home player and start buying cartridges, wherever you can find them. Nice, long sequences of show tunes, for instance. Well-tailored discotheque and Latin-American. Maybe Frankie, Bing and Co. Perhaps even a good sequence of standard classics, for a well-bred musical background. (There will be some of this—quite a bit. More as time goes on.)

Maybe in this case the thing for you to do is to take a leaf from the professional background-music-man's book and install your 8-track somewhere out of sight, in the hall closet or down in the cellar. Then wire the whole house for soft 8-track stereo.

Put speakers in the kitchen, the laundry, in the bedrooms, out on the patio, in the johns and maybe underwater in the swimming pool. (A few technical complications there—more on *that* subject later on, I hope . . .) Another pair of speakers for the outside workshop and a pair for the garage. Big pair in the rumpus room and a tiny pair to baby-sit for the baby in stereo. (He'll snooze the day 'round.)

In this fashion, I dare suggest, you'll really be fulfilling the 8-track potential in terms of home usefulness. Music everywhere, in every background! Almost as good as a supermarket, or a bank.



Some people aren't ready for up-to-date sound in an up-to-date way.

We don't expect everyone to fall in love with a "round" speaker system. The Grenadier 8000P is unique. (Aren't most new things?) We didn't design it to be different. We designed it to be better. By creating a cylindrical shape we were able to face the woofer downward close to the reflecting floor surface. This provides 360 degree dispersion of the phenomenal stereo sound and virtually lets you sit anywhere—hear everything.

For them we dress differently.

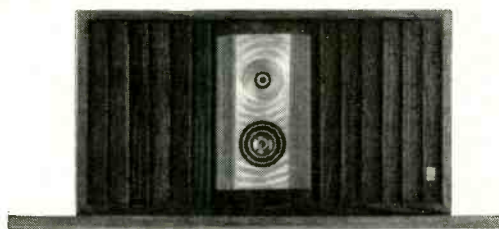

Our new 8400 convertible. Same great Grenadier Sound. Same great technical features. We just felt that for some people we better play it square. For color literature and nearest dealer, write:

EMPIRE

845 STEWART AVE., GARDEN CITY, N.Y.

Circle 142 on Reader Service Card

Green boxes... full of magic



WITH ferro-sheen® PROCESS



Well, almost magic. You'll hardly believe your ears the first time you play back a reel of Irish Tape. Beautiful sound—crisp, clear, response. Friends will think you've turned "pro" but you'll know how smart it is to demand Irish Tape—in the green box. (And Irish costs no more!)

FREE—Send for catalog describing the complete Irish line—sizes and technical specifications.



IRISH MAGNETIC RECORDING TAPE

458 Broadway, New York, N. Y. 10013

Circle 133 on Reader Service Card

CAVEAT EMPTOR!

*LET THE BUYER BEWARE

The Roman phrase "Caveat Emptor" cautions the purchaser to examine the article he is buying, and act on his own judgment, and at his own risk! We print it here as a reminder to you, hopefully a happy owner of a Shure Stereo Dynetic® cartridge, that the superior performance of all Shure cartridges depends upon the Shure Stereo Dynetic Stylus assembly—and alas, there are indeed imitations.

May we caution you that an inferior replacement stylus can audibly detract from and significantly reduce the cartridge's performance, and increase record wear. Obviously, if an imitation Stereo Dynetic stylus is used, we cannot guarantee that the cartridge will perform to published specifications. Accept no substitute.

LOOK FOR THIS
WORDING ON THE BACK
OF PACKAGE

THIS DYNETIC
STYLUS IS PRECISION
MANUFACTURED BY
SHURE BROTHERS, INC.

It is your assurance that the stylus you buy will enable your cartridge to perform up to Shure standards . . . *incompatible* Shure standards, that is.

INSIST ON
SHURE
REPLACEMENT STYLUS

SHURE BROTHERS, INC.
222 Hartrey Ave., Evanston, Illinois 60204

Manufactured Under One or More of the Following
U. S. Patents and Other Patents Pending.
2,993,516, 3,055,988, 3,077,521, 3,077,522,
D 163,366, D 185,168, D 187,229, D 187,230,
D 189,144, D 193,006, D 193,007, D 193,854,
D 193,934.

Circle 134 on Reader Service Card

Come to think of it, you might even fix up an extension cord and run music out to the car when it's just standing there at the curb, not going anywhere. Might as well have parking music, too. **Æ**

RECORD REVUE

(from page 42)

The Great Symphonies of Dvorak. (Nos. 7, 8, 9, new numbering). Cleveland Orch., Szell.

Epic BSC 155 (3) stereo
Here is the familiar "New World" Symphony, now correctly numbered 9 (it used to be called No. 5) and the two preceding ones, both relatively well known today. They are really marvelous works in the highest of high Romantic styling, full of lovely Bohemian melody, flashing happiness and sadness, uncomplicated in emotions but full of tricky harmonies. The "faults" of these works, that they are less rigorously organized than, say, the music of Brahms, no longer really matter much. We are not all Germanic listeners, after all.

The Szell performances are what is usually called authoritative—he comes from that part of the world. Also, they are extraordinarily well disciplined; his Cleveland Orchestra plays with an exactitude that matches the top U.S. outfits like Boston and Philadelphia (and beats the New York Philharmonic all-out, if you ask me). But—the inevitable *but*—there is a certain steely quality, a modern no-nonsense way of striding straight ahead, that to me somewhat dampens the Dvorak ardor. It's cool, all right. OK cool, if you wish.

POWER AMP

(from page 23)

generate slightly near the end. The 100-Hz tone burst starts to collapse after 2 cycles and distorts seriously. The good amplifier however shows no deterioration of the tone burst and only a slight "thump," due to a small bias shift, with quick recovery. Thus it would seem sensible to avoid low-frequency overload of the amplifier. Using two amplifiers in each channel with electronic crossovers is an excellent scheme to minimize the effect of low-frequency overload on the upper part of the spectrum and greatly improve system distortion (intermodulation particularly).

The severe cut off experienced with amplifier D is not due to power supply collapse but to bias shift. In amplifier A and B there is a ragged look on one side of the signal due to inadequate control of the power supply voltage. Slight differences in the oscilloscope pictures are due to the use of several different instruments over a several-month period of testing. **Æ**

MORE CLASSIFIED

AUDIO SALES SPECIALIST

Custom audio-equipment manufacturer has immediate opening for Audio Sales Specialist who knows complex audio systems and is familiar with the latest in transistorized equipment. Excellent salary and complete company benefits. An equal-opportunity employer. Send resume to Box CF-1, Audio.

CLASSIFIED

Rates: 10¢ per word per insertion for noncommercial advertisements; 25¢ per word for commercial advertisements. Rates are net, and no discounts will be allowed. Copy must be accompanied by remittance in first of the month preceding the date of issue.

HIGH FIDELITY SPEAKERS REPAIRED
AMPRITE SPEAKER SERVICE
168 W. 23rd St., New York, N. Y. 10011
CH 3-4812

HARPSICHORD: Same as owned by Philadelphia Orchestra and RCA Victor. In kit form for home workshop assembly, \$150. Clavichord kit, \$100. Free brochure. Write: Zuckermann Harpsichords, Dept. R, 115 Christopher St., New York, N. Y. 10014.

HI-FI SPEAKERS EXPERTLY REPAIRED
USED SPEAKERS BOUGHT
AUDIO SPEAKERS TECHNICUS
22 Astor Place, New York, N. Y. 10003
AL 4-2140

PRESSINGS FROM YOUR TAPES. WHOLESALE PRICES. SPECIALIZING IN SMALL QUANTITIES. DUBLE DUBLXU RECORDINGS COMPANY, 221 Carlton Avenue, Neptune, N. J. 07753.

ANY RECORD PUT ON TAPE: Single, LP, stereo. Quantity prices, 1 or 100. Write John G. Ellis, Box 15852, Del Valle, Los Angeles, California 90015.

FREE! Send for money saving stereo catalog A5M and lowest quotations on your individual component, tape recorder, or system requirements. Electronic Values, Inc., 200 West 20th St., New York, N. Y. 10011.

STEREO REVERBERATORS for experimental application, \$7. Mono, \$5. Cal's, Box 234, Dearborn, Michigan 48211.

5-YEAR INDEX TO STEREO EQUIPMENT TEST REPORTS appearing in 15 American and British periodicals. 1700 reports (1961-65) listed by type of equipment, \$2.00. J. B. Woy, P. O. Box 4216, Philadelphia, Pa. 19144.

AMPEX EQUIPMENT

2	New Bodine 300 Motors	\$125. each
7	1/4" Full Track Head Sets	150. each
2	1/2" Two Track Head Sets	275. each
1	300 Amplifier and Meter Panel	250.
2	300 Capstan Assemblies	50.
1	Four Input Mike Mixer	50.
2	350 Capstan Motors	100. each
4	300-350 Torque Motors	80. each
1	New Neumann SM2 Stereo Mike	475.
1	Sennheiser Impedance Meter	100.

INTERNATIONAL RECORDING CO.
333 Sixth Avenue
New York, New York
CH 2-1455 WA 9-8364

Lowest prices on new LP jackets. White-Colors. Samples, 50¢. Record Supplies, Hillburn, P. O. Box 323, Hillburn, New York 10931.

15% off list price of Ampex and Viking tape decks. Mail deposit with order to Singer Electric, 101 Lenox Road, Brooklyn, N. Y. 11226.

CONCERTONE Reversamatic recorder model 505 4R. Like new. Case, mikes, 30 tapes. Apt. 207, W1812 Riverside Ave., Spokane, Washington 99201.

SELL: Ampex 960, \$250. Citation III-X, \$140. Stereo records, send stamp for list. RDD, 40022 Medford, Huntsville, Alabama.

WANTED: Rek-O-Kut Auto-Poise AP-320 automatic tone arm. Wille, 3015 Kalakaua, Hawaii 96815.

Solid-state flutter meter parts, punched panel, cabinet, meter, coils, resistors, transformers etc. Spera Electronics, 32-20 37th Avenue, Long Island City, New York.

WANTED: Partridge T/CFB, 5-7 k pri, or CFB, 4000 k pri; On or Off chassis. Describe and state price. Cane, 2400 Capers Ave., Nashville, Tenn. 37212.

BROADCAST AUDIO DESIGN

Outstanding opportunities in broadcast audio circuit design. Leading manufacturer of broadcast audio equipment. BSEE degree and at least 3 years' related experience with solid-state circuits.

Excellent salary and complete benefits. Located in a progressive medium-size Midwest city with the finest of schools and family living.

Send resume or call Robert T. Fluent, Employment Manager, (217) 222-8202; or evenings (217) 223-7949.

Gates Radio Company
A subsidiary of Harris-Intertype Corporation
Quincy, Illinois 62301
An equal-opportunity employer (M&F)

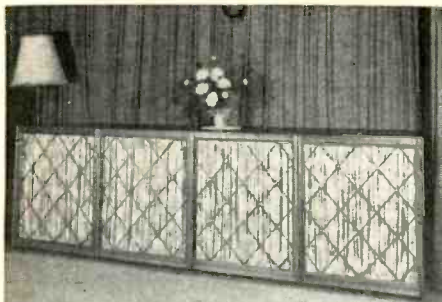

New MAESTRO, an all-horn-loaded, compression-operated uni-bass system, the world's first for home installation, gives crisp, clean and clear bass unobtainable by any cone-type woofer.

Other models: Orchestra, Concert, Symphonia and Symphonietta.

For further details, contact:

Provo High Fidelity
P.O. Box 204, Batavia,
N.Y. 14021



YL ACOUSTIC CO., LTD.

No. 34-6, 2-chome, Nishi-Shimbashi
 Minatoku, Tokyo, Japan.

Circle 136 on Reader Service Card

CANADA
High Fidelity Equipment
 Complete Lines • Complete Service
 HI-FI Records — Components
 and Accessories

ELECTRO-VOICE
SOUND SYSTEMS

126 DUNDAS ST. WEST, TORONTO, CANADA

Circle 137 on Reader Service Card

SAVE MORE

On HI-Fi
COMPONENTS & TAPE RECORDERS

- Easy-Pay-Plan—Up to 24 mos. to pay.
- 15 day money-back guarantee.
- 2 yr. unconditional guarantee parts and labor no charge, at local warranty station, factory or our service dept.
- Most items shipped promptly from our \$250,000.00 inventory.
- Trade-ins—Highest allow—Send your list.
- Shipments double packed & fully insured.
- Special consideration—Export & APO inquiries.
- 21st yr. dependable service—World Wide.

Write for our price first. You'll be glad you did.

"We own the sharpest pencils in the U.S.A."

HI-FIDELITY
 CENTER
 "The House of Low Low Prices"

239 U. East 149 St.,
 New York, N.Y. 10451

Circle 138 on Reader Service Card

AUDIO • JUNE, 1966

There are several criteria which should be followed when using feedback amplifiers (and that means essentially all modern amplifiers). These can be demonstrated by detailed analysis but are simply stated here. One: The input to the amplifier should be limited to prevent overload because when the amplifier output stage overloads the feedback is lost and earlier stages in the amplifier overload so severely that the bias is upset. Two: The frequency range of the input program material must not exceed the open loop band width of the power amplifier since feedback is lost at the extreme ends of the band and overloading results.

There is a tendency to make pre-amplifiers with excessive bandwidth because this is easy to do. However such a practice is folly because the extra-aural signals from rumble and noise only tend to overload the power amplifier. In fact, it would seem that much of what is said and done with amplifier and preamplifier design is done for advertising effect rather than as a result of rational engineering design.

Amplifier A and B were the best transistor amplifiers tested while D was the poorest tube amplifier tested. The best tube amplifier of commercial design tested was C. The author's tube amplifiers were more like B.

It is possible then to make tube amplifiers similar in overload capability to B and possibly even better. However, it is difficult and I know of none. On the other hand, it is possible to make transistor amplifiers even better than A. I have one such under test at this time. Other commercial amplifiers tested fell between B and C for the most part with some tube amplifiers falling between C and D.

It is abundantly clear that particular care must be exercised in selecting a power amplifier to drive low-efficiency speaker systems. The amplifier must be adequate in power-handling capacity and most of all must have excellent overload and recovery characteristics. Even careful selection does not remedy the fact that there will be clipping of the peaks on some occasions but at least gross distortion will be avoided.

The conclusion one might reach is that a really well designed transistor amplifier can be better than anything available in past years. But, that there can also be bad transistor amplifiers using bad designs and poor-quality devices. As with any equipment we must trust the manufacturer who stands behind his product.

BOYNTON HAS IT!

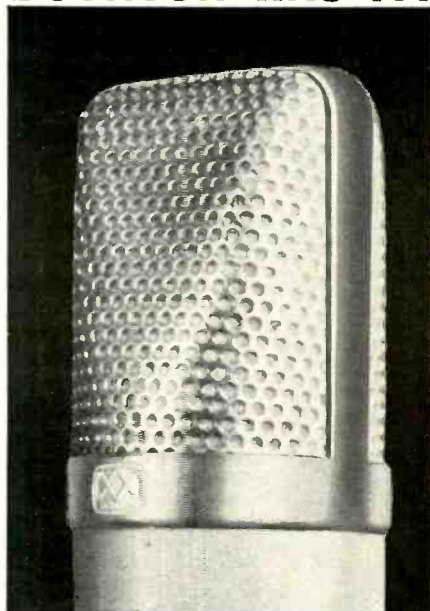

THE NEW SYNCRON AU-7a CONDENSER MICROPHONE

FOR PREMIUM SOUND PICKUP
 AT A FRACTION OF USUAL COST!

At last! An American made quality condenser microphone in a self-contained 9 3/4" unit that is reshaping the recording industry.

Now . . . P. A. engineers, broadcasters, studios and audiophiles can utilize the full potentials of "condenser" sound without the bulk and expense of conventional condenser mikes.

Connect the cable and it's ready to go. Over 2500 hours transistor battery life with low cost mercury cells.

Frequency range: ± 3 db 40-20,000. Directional characteristics: cardioid, with front to back ratio of better than 20 db.

Output level: -50 db. Distortion: less than 0.5%. Rugged diaphragm provides broad, smooth frequency response with total absence of annoying peaks. Maximum sensitivity, outstanding clarity of sound. **PRICE \$169.50**

ONLY SYNCRON MAKES IT. ONLY BOYNTON SELLS IT.

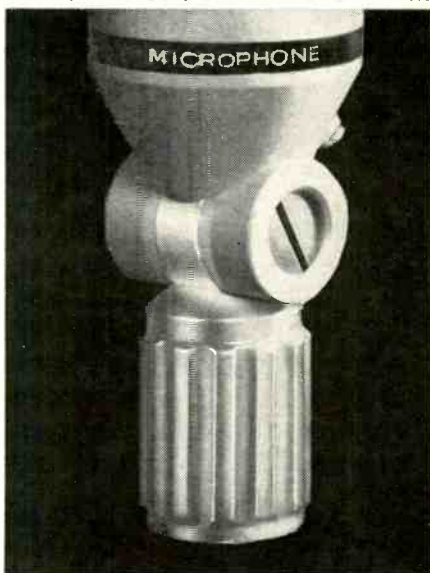

BOYNTON STUDIO DEPT. A10
 295 Main St., Tuckahoe, N.Y. 10707 Tel. (914) SP 9-5278
 SOLE DISTRIBUTOR FOR
SYNCRON AU-7a CONDENSER MICROPHONE
 Dealerships available

Circle 135 on Reader Service Card

FREE STEREO INFORMATION

FM station directory . . . covers FM stations in U. S. and Canada. Factual equipment test reports. Test reports on tuners, preamps, poweramp/preamps. Find out what the experts think. A complete 36 page catalog tells about tuners, power amplifiers, preamplifiers, preamp/power amp combinations, and tuner preamp.



ALL FREE — JUST WRITE TO:

McIntosh Lab, Inc. 6 Chambers St.
Binghamton, N. Y. 13903

NAME _____
STREET _____
CITY _____
STATE _____ ZIP _____

Circle 139 on Reader Service Card

LEVELING AMPLIFIERS

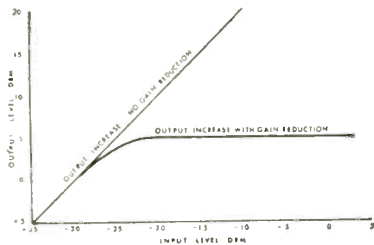

Typical gain-reduction plot

- NO LAG
- FLAT RESPONSE
- REPLACES EXISTING LINE AMPLIFIERS
- LOW NOISE LEVEL

OVER 500 IN USE BY MAJOR NETWORKS
INDEPENDENT STATIONS & RECORDING
STUDIOS

Our 8th Year Of Service To Industry

TELETRONIX ENGINEERING CO.

manufacturers of
FM Broadcast Transmitters and RF Amplifiers
Audio Relays, Solid State Remote Station Controls
Volume Levelers, FM Broadcast Antennae
308 Monterey Road, South Pasadena, Calif.
EXPORT: GOTHAM AUD. DEV. CORP.
2 West 46 Street, New York, N.Y. 10036

Circle 140 on Reader Service Card

Advertising Index

Key No.	Page No.
107	Acoustic Research, Inc. 5
125	Altec Lansing Corporation 43
	Audio Bookshelf 52
113	Benjamin Electronic Sound Corp. 10
135	Boynton Studio 55
115	Bozak 13
103	British Industries Corporation ... 3
141	Cabasse 56
	Classified 54
109	Concertone 6
104, 105	Electro-Voice, Inc. Cov. IV, 1
137	Electro-Voice Sound Systems 55
129	EMI/Scope 48
142	Empire Scientific Corporation 53
116	Fairchild Recording Equipment Corporation 14, 45
103	Garrard Sales Corporation 3
127	Gotham Audio Corporation 46
138	Hi Fidelity Center 55
133	Irish Tape 53
106	Kenwood Electronics 4
150	Lansing, James B., Sound, Inc. .. 50
124	Marantz, Inc. 41
131	Martel Electronics 50
139	McIntosh Laboratory, Inc. 56
132	Norelco—Professional Sound Products 51
119	Pickering & Company, Inc. 17
114	Pioneer Electronic Corporation .. 11
	RCA Electronic Components & Devices Cov. III
100	Scott, H. H., Inc. Cov. II
118	Sherwood Electronic Laboratories, Inc. 18
110, 120	& 134 Shure Brothers, Inc. 7, 29, 54
117	Stanton 15
121	Sony Corporation of America . 32, 33
123	Sony/Superscope 39
130	Syncron Corporation 49
140	Teletronix Engineering Company 56
122	University Sound 37
112	UTC Sound 8, 9
136	YL Acoustic Company, Ltd. 55

DANS le

MARCHE COMMUN

la

haute fidélité

c'est



Haut — Parleurs

Loudspeakers

Lautsprecher

Altavoce



TECHNIQUE Internationale

SAVOIR FAIRE français

Usine: Kergonan—29 N—

BREST FRANCE—

Tél: 44-64-50 +

Bureaux: 182, rue La Fayette

—PARIS 10è

FRANCE—

Tél: NORd 85-86



la chambre sourde

Circle 141 on Reader Service Card

AUDIO • JUNE, 1966

The 12th Reason Why You Should Look to RCA as the No. 1 Source of Silicon Transistors for AF Amplifiers

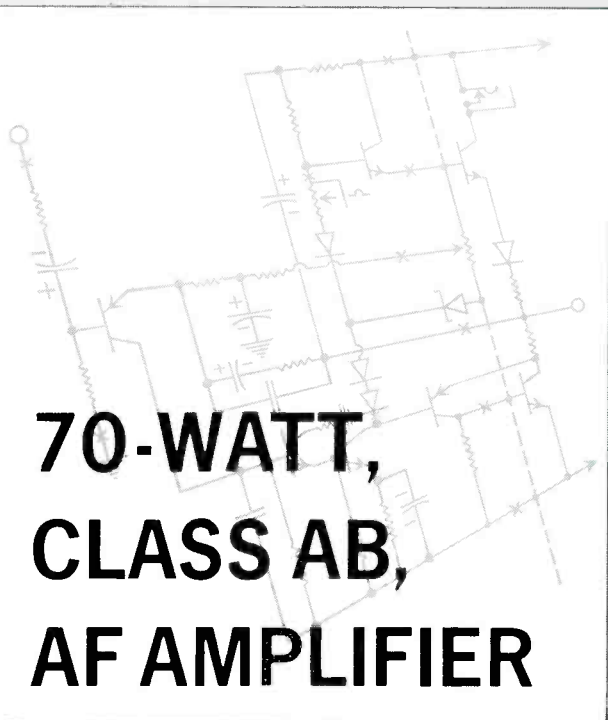

**70-WATT,
CLASS AB,
AF AMPLIFIER**

This high-performance, direct-coupled circuit is designed with RCA n-p-n and p-n-p transistors 40409 and 40410 which are complementary drivers for a pair of 40411's, series-connected in the output stage.

- Amplifier is short- and open-circuit proof
- 5 c/s to 25 kc/s (1 dB frequency response)
- 68 dB power gain
- 100,000-ohm input impedance
- Hum and noise down more than 60 dB from 1 W
- No output or driver transformers
- Less than 0.25% Total Harmonic Distortion at 1 kc/s and 70 W output

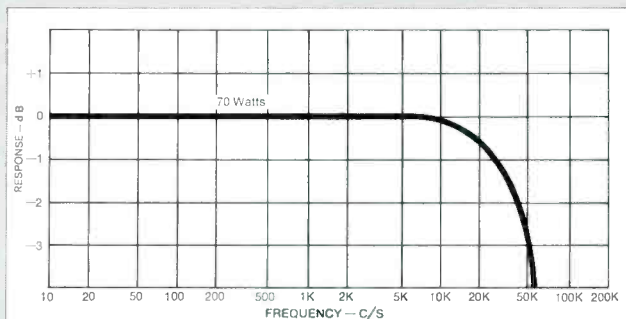

THE OTHER REASONS INCLUDE ELEVEN CIRCUIT DESIGNS FROM 12 TO 150 VOLTS...FROM 2 TO 50 WATTS

Now a total of 12 circuits—with practical price tags—add up to the RCA Silicon Audio Power Program which sets a new standard for high fidelity in performance and reliability. With RCA silicon, you can increase the efficiency of your circuit and save the cost of the power transformer. Your design benefits from compactness, savings in weight, and the advantages

of direct coupling—not to mention thermal stability, less critical biasing, less need for heat sinks, and more power. Yes, it is a fact! RCA economy silicon transistors for AF amplifiers offer performance and total reliability.

For more information on the new 70-watt amplifier as well as the other 11 circuits making up the RCA Audio Power Program, see your

RCA Representative. An application note (SMA-41) on the 70-watt amplifier is available, as well as a booklet (ATC-408), giving circuit specifications and performance data. For your copies, write, RCA Commercial Engineering, Section 12C6, Harrison, N.J.

RCA Electronic Components and Devices

Also Available Through Your RCA Distributor

See demonstration of RCA Audio Amplifiers at Chicago Spring Conference, June 13-14, O'Hare Inn, Desplaines, Ill.



The Most Trusted Name in Electronics

If the
Electro-Voice
Model 666
picks up
sound here...

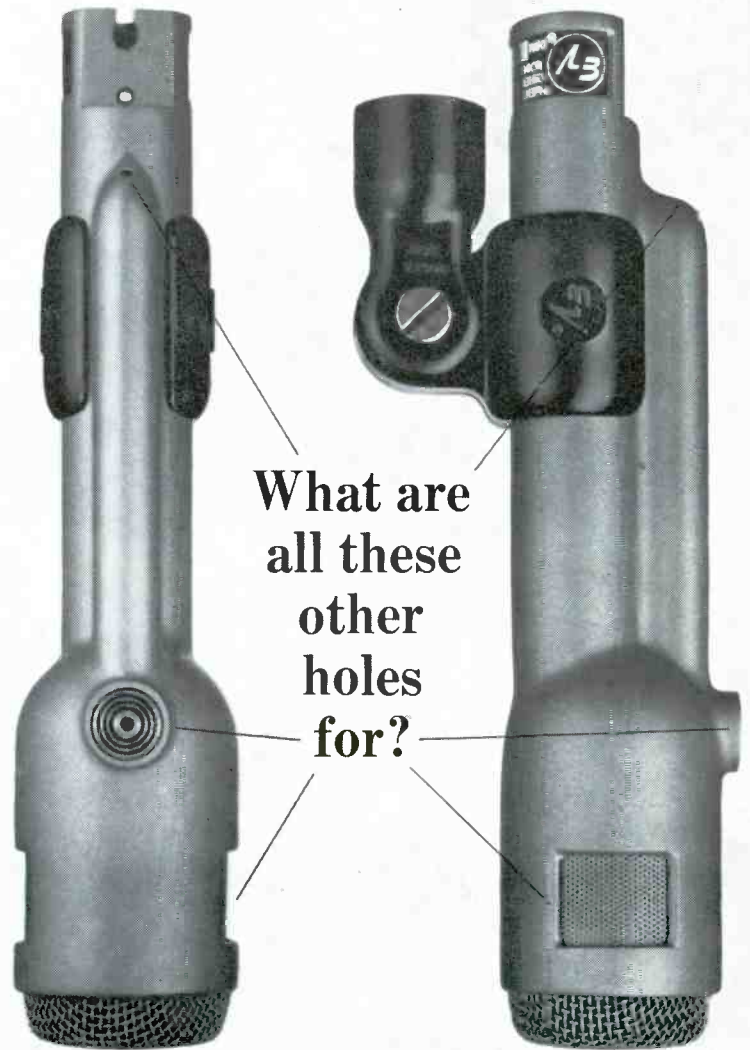

What are
all these
other
holes
for?

ⓔ The holes in the top, sides and rear of the Electro-Voice Model 666 make it the finest dynamic cardioid microphone you can buy. These holes reduce sound pickup at the sides, and practically cancel sound arriving from the rear. Only an Electro-Voice Variable-D® microphone has them.

Behind the slots on each side is a tiny acoustic "window" that leads directly to the back of the 666 Acoustalloy® diaphragm. The route is short, small, and designed to let only highs get through. The path is so arranged that when highs from the back of the 666 arrive, they are cut in loudness by almost 20 db. Highs arriving from the front aren't affected. Why two "windows"? So that sound rejection is uniform and symmetrical regardless of microphone placement.

The hole on top is for the mid-range. It works the same, but with a longer path and added filters to affect only the mid-frequencies. And near the rear is another hole for the lows, with an even longer path and more

filtering that delays only the bass sounds, again providing almost 20 db of cancellation of sounds arriving from the rear. This "three-way" system of ports insures that the cancellation of sound from the back is just as uniform as the pickup of sound from the front—without any loss of sensitivity. The result is uniform cardioid effectiveness at every frequency for outstanding noise and feedback control.

Most other cardioid-type microphones have a single cancellation port for all frequencies. At best, this is a compromise, and indeed, many of these "single-hole" cardioids are actually omnidirectional at one frequency or another!

In addition to high sensitivity to shock and wind noises, single-port cardioid microphones also suffer from proximity effect. As you get ultra-close, bass response rises. There's nothing you can do about this varying bass response—except use a Variable-D microphone with multi-port design* that eliminates this problem completely.

Because it works better, the E-V 666 Dynamic Cardioid is one of the most popular directional microphones on the market. Internal taps offer 50, 150, or 250 ohm impedance output. Frequency range is peak-free from 30 to 16,000 Hz (cps). Output is—58db.

To learn more about Variable-D microphones, write for our free booklet, "The Directional Microphone Story." Then see and try the E-V 666 at your nearby Electro-Voice professional microphone headquarters. Just \$255.00 in non-reflecting gray, complete with clamp-on stand mount. Or try the similar Model 665. Response from 50 to 14,000 Hz (cps), \$150.00 (list prices less normal trade discounts).

*Pat. No. 3,115,207

ELECTRO-VOICE, INC., Dept. 661A
602 Cecil Street, Buchanan, Michigan 49107



Circle 104 on Reader Service Card