

# AUDIO

CDC

®

APRIL/1966

60¢

*...the original magazine about high fidelity!*



AL BROWDY  
1962 SO STEARNS DRIVE  
LOS ANGELES 34 CALIF  
SEPT 67 3C-11

# Only the new Scott S-8 is designed for solid-state components!

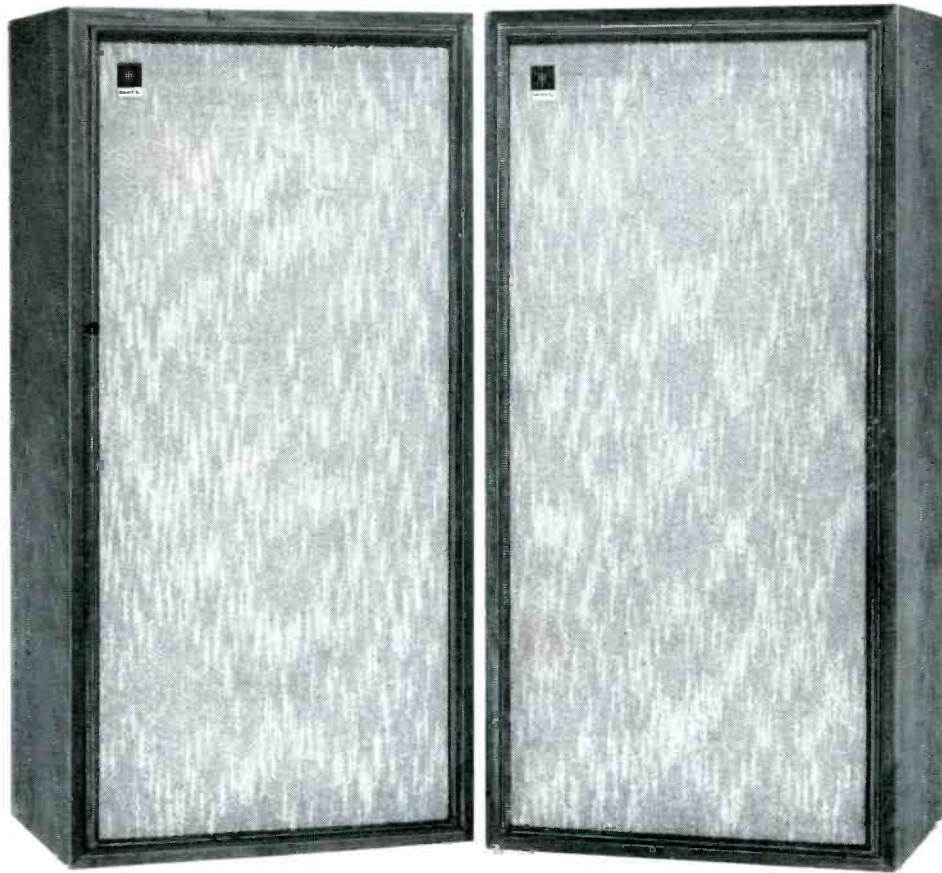

## Only the new Scott S-8 is designed with Controlled Impedance!

Scott engineers have developed a new kind of speaker system, specially designed for finest performance from solid-state components. Of all speakers now on the market, regardless of price, only the S-8 is completely compatible with new solid-state equipment. Here is why:

Solid state amplifiers and receivers give best performance over a fairly narrow range of load impedance. The impedance of ordinary speakers, however, varies considerably as the frequency changes. With increased impedance, available power is reduced. Lowered impedance may overload the amplifier output circuits.

Even the most expensive speakers available today were designed for tube equipment where impedance is controlled by output transformers. These speakers do

not offer, for example, 8 ohms impedance to the amplifier at all frequencies. In fact, the impedance can vary from as little as 2 ohms to as much as 20 ohms at different frequencies.

Now, Scott has designed an 8-ohm speaker system specifically for use with transistor components. The impedance range is controlled by integrated engineering development of both speakers and crossover to match the capabilities of today's solid-state equipment. The S-8 gives you the kind of sound you wanted when you bought transistor components. What more could you ask? The price? Only \$69.95, each. *Complete system, including S-8 speakers, Scott 342 solid-state FM stereo receiver, and automatic record changer, well under \$500 at most dealers.*

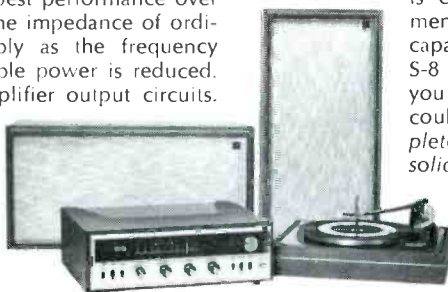

Scott... where innovation is a tradition

**SCOTT®**

For further information and specifications on the new Scott S-8 speaker system, write:  
H. H. Scott, Inc., Dept. 35-04, 111 Powdermill Road, Maynard, Mass. Export: Scott International, Maynard, Mass.

Circle 100 on Reader Service Card

# AUDIO

April, 1966 Vol. 50, No. 4

Successor to RADIO Est. 1917

LARRY ZIDE  
Associate Editor

HAROLD D. WEILER  
Roving Editor

JANET M. DURGIN  
Production Manager

## Contributing Editors

EDWARD TATNALL CANBY  
JOSEPH GIOVANELLI  
HAROLD LAWRENCE  
CHESTER SANTON  
HERMAN BURSTEIN  
BERTRAM STANLEIGH

## AUDIO Articles

Arthur E. Gladfelter  
Carolyn Howard Johnson  
Michael Rettinger  
Norman H. Crowhurst  
George Fletcher Cooper

## AUDIO Reviews

Light Listening 8  
Record Revue 54  
Chester Santon  
Edward Tatnall Canby

## AUDIO Profiles

Pilot Solid-State Stereo Receiver 42  
Empire Speaker System 44  
Uher Stereo Tape Deck 44  
R1100  
Grenadier 8000P  
9000

## AUDIO in General

Audioclinic 2  
Letters 6  
Audio ETC 12  
Editor's Review 16  
Tape Guide 48  
New Products 50  
New Literature 51  
Sound & Sight 52  
This Month's Cover 61  
Advertising Index 66  
Joseph Giovanelli  
Edward Tatnall Canby  
Herman Burstein  
Harold D. Weiler

Number 32 in a series of discussions  
by Electro-Voice engineers

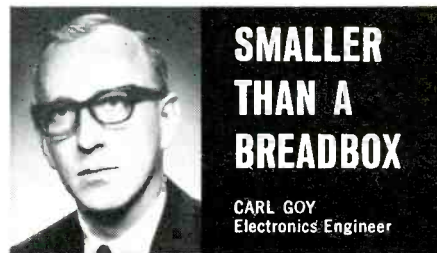

The advent of etched circuitry and transistors has laid the groundwork for a revolution in the appearance of high fidelity amplifiers, tuners and receivers.

In the past, all tube-type equipment tended to look alike, with a boxy chassis that had tubes sticking up on top (where cooling air could reach them), knobs stick out the front, and connectors on the back. The passive components were hidden inside this box. The shape was dictated primarily by the heat dissipation requirements of tubes.

With transistors, heat sinks replace the massive quantities of cooling air. It is actually possible to use the chassis itself as a more than adequate heat sink, thus eliminating one more component restriction. A case in point is the new model E-V 1144 50 watt amplifier. At idle, this amplifier consumes only 6 watts, of which 3 watts is accounted for by the pilot light and power transformer losses!

With this new design freedom, one must consciously reject any upside-down, inside-out, and wrong-end-to orientations or philosophies left over from the tube and box chassis days. In short, anything goes!

For convenience in design, each major circuit function of the Electro-Voice electronics was considered as a separate "building block". Preamp, power amplifier, and power supply could each be refined separately, then combined as needed into the complete unit without regard for orientation.

The final form of the equipment was free to take shape as dictated by convenience to the user and ease of service (a minor point considering the reliability of solid-state, etched circuitry). Height and width were defined by the need for room around switches and controls for easy operation.

Depth of the cabinet was based on normal shelf sizes. The actual amplifier depth is less than external appearance might imply, since the confusion of connectors normal to stereo amplifiers has been shrouded by a decorative screen.

This design, while small by past tube-type standards is far from the ultimate reduction in size achievable with present-day techniques. It is estimated that the Electro-Voice amplifier could be reduced in volume by over one third, using existing techniques and conservative engineering standards, without loss of performance or reliability. And new materials and techniques now on the horizon promise even greater progress toward achieving the ultimate packaging of high fidelity electronics.

For technical data on any E-V product, write:  
ELECTRO-VOICE, INC., Dept. 463A  
602 Cecil St., Buchanan, Michigan 49107



Circle 105 on Reader Service Card

C. G. McPROUD  
Editor and Publisher

SANFORD L. CAHN  
Advertising Director

EDGAR E. NEWMAN  
Circulation Director

## Representatives

Bill Pattis & Associates,  
4761 West Touhy Ave.,  
Lincolnwood, Ill. 60646  
James C. Galloway,  
9220 Sunset Blvd.,  
Los Angeles, Calif. 90069  
Warren Birkenhead, Inc.,  
No. 25, 2-chome, Shiba Hama-  
matsu-cho,  
Minato-ku, Tokyo, Japan

Solid-State Flutter Meter—In Four Parts—  
Part 2 19  
Warning for Wives in Stereophonic Sound 23  
Room Design for Stereo Music 24  
Audio Measurements Course—Part 4 26  
Intimations of Irresponsibility: Circuits  
for Speculation 36

Pilot Solid-State Stereo Receiver 42  
Empire Speaker System 44  
Uher Stereo Tape Deck 44



AUDIO (title registered U. S. Pat. Off.) is published monthly by Radio Magazines, Inc., C. G. McProud, President; Henry A. Schober, Secretary, Executive and Editorial Offices, 204 Front St., Mineola, N. Y. Subscription rates—U. S. Possessions, Canada, and Mexico, \$5.00 for one year, \$9.00 for two years; all other countries \$8.00 per year. Single copies 60¢. Printed in U.S.A. at Blanchard Press Inc., Garden City, N.Y. All rights reserved. Entire contents copyrighted 1966 by Radio Magazines, Inc. Second Class postage paid at Mineola, N.Y. and additional mailing offices.

RADIO MAGAZINES, INC., P.O. Box 629, MINEOLA, N.Y., 11501  
Postmaster: Send Form 3579 to AUDIO, P.O. Box 629, Mineola, N.Y., 11501

# COMING

## Articles

George S. Lehsten returns with a follow-up on his earlier article on the "Evaluation and Application of Artificial Reverberation to Conventional Sound Installations."

Arthur G. Johnson presents a "Servo Groove Tracker," in which he proposes a novel method of reducing tracking error to zero.

## Profiles

Heathkit GR-25, the 25-inch color TV receiver.

Scott 342 stereo FM receiver and the S-8 speaker systems.

Dual 1019 automatic turntable/record changer.

Sony 2010 Videocorder and VCK-2000 Video Camera Kit.

In the May Issue  
On the newsstands, at your favorite audio dealer's, or in your own mailbox.

# AUDIO CLINIC

Joseph Giovanelli



Send questions to:  
**Joseph Giovanelli**  
2819 Newkirk Ave.  
Brooklyn, N. Y.  
Include stamped, self-addressed envelope.

### Using Old Recording Blanks

*Q. Perhaps you can suggest a solution to a problem which has been "bugging" me for some time.*

*I have a considerable supply of aluminum-based recording discs which are several years old. Do you know of a process that I might use to rejuvenate these so that I can record on them? E. O. Seveland, Kennewick, Washington.*

A. I have some old, glass-base discs, made during World War II. I can record on them even with a cold stylus. I have a hot stylus arrangement, however, and anticipate no difficulty when I finally get around to using these discs as test blanks.

In my experience, lacquer does get hard after a time. It can be engraved, but the recording stylus does not last as long as it would with fresh blanks. I have found that placing the old disc over boiling water helps. The disc should not be inserted into the water, but should be allowed to come into contact with the steam rising from the boiling water. This steam treatment has resulted in better cuts on such old discs. Surface noise is lower than without treatment, and stylus wear is decreased.

### Advantages of Fixed Bias

*Q. I would appreciate your advising me as to what advantage fixed bias has over cathode bias for the purpose of output stages. I notice that the majority of quality high fidelity power amplifiers use fixed bias. Stanley Kaplan, Peabody, Massachusetts.*

A. Before entering upon any discussion of this sort, it is always a good idea to have a common understanding of our terms.

When we refer to cathode bias, we mean a circuit such as that shown in Fig. 1. The grid is at D.C. ground potential through  $R_g$ . Remember that no grid current flows in typical audio amplifier circuits, and hence the resistance in the grid circuit is not a factor. (Remember that only when current flows in a resistance can there be a voltage drop across the resistor.) When a tube is operated as in the circuit of Fig. 1, plate current flowing through the cathode resistor,  $R_k$ , makes the cathode positive with respect to ground. Because the grid is at

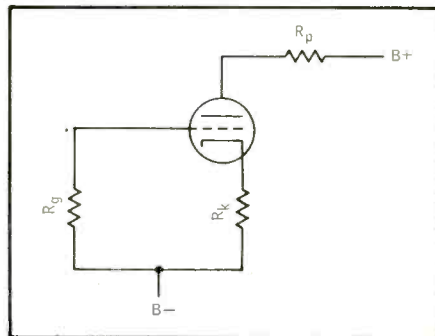

Fig. 1

ground potential, the grid must be negative with respect to the cathode, and is therefore biased in the proper manner.

A typical fixed-bias arrangement is shown in Fig. 2. Here, the cathode is directly connected to the ground, but the low side of the grid resistor is connected to the negative end of a power supply, and the positive side of this supply grounded. This makes the grid negative with respect to ground, and since the cathode is grounded directly, the grid is negative with respect to cathode.

When using fixed bias, all the plate voltage is used to develop power in the stage under consideration. As you know, the effective voltage applied to the plate circuit of a tube is taken as between the plate and cathode. If the cathode is ungrounded, as is the case with cathode bias, there will be about 20 volts between cathode and ground in the typical output stage used in medium-power amplifiers. This 20 volts comes, obviously, from the power supply. The voltage between plate and cathode will be 20 volts less than it would be if the cathode were grounded as it is in fixed-bias circuits.

This is probably the most important consideration about the use of fixed bias.

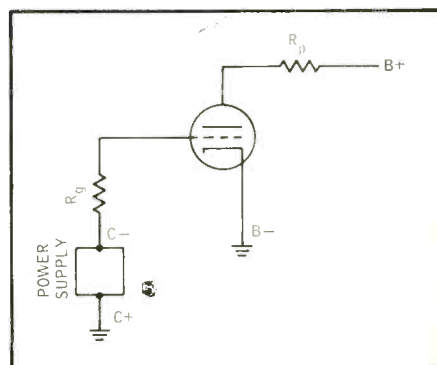

Fig. 2

# RC 80

# 1949



**The Garrard  
pusher platform  
record changing  
principle  
for automatic play  
when desired**

Consider that over 2 million of the Garrard units sold in this country alone, have featured this exclusive device. It is a smooth, silent, totally reliable mechanism which drops records gently over a polished removable spindle containing no levers or moving parts.

**The Type A70...**

At \$84.50, it is a classic example of the Garrard philosophy... to retain unsurpassed proven features, combining them with the newest advancements, including adjustable anti-skating control and a precision counterbalanced tone arm.

Read below and you will understand why a legion of Garrard owners—many of them still using their original RC 80's—insist upon this magnificent, newest version of the most successful, most satisfactory series of record playing units ever developed.

**Adjustable anti-skating control.** The natural side pressure on the stylus, which frequently causes distortion or rapid record wear, is eliminated.

**Dynamically balanced, counterweight-adjusted tone arm.** Needle pivots set into miniaturized ball bearings provide frictionless motion, flawless tracking.

**Calibrated stylus pressure gauge** with precise 1/4 gram click adjustments for accurate audible/visible settings.

**2-piece, full size, heavy cast turntable** for perfect torque and flywheel action. Noise and vibration damped out by resilient foam barrier.

**Low mass, cut-away shell** with extended finger lift, compatible with the most advanced cartridge designs.

**Super-sensitive trip** with Dupont Delrin® to offset friction — performs perfectly with highest compliance pickups at correct minimal tracking force.



# TYPE A70

# 1966

**Garrard**  
WORLD'S FINEST

Important Reading: Write for 32-page Comparator Guide detailing all Garrard models. Address Garrard, Dept. GD-15, Westbury, New York 11590.

CIRCLE NO. 103 ON READER SERVICE CARD

If "a picture is worth ten thousand words" then the

**SOUND OF KENWOOD** 

is worth at least twenty thousand words!

KENWOOD solid state stereo receivers have a sleek, handsome look, featuring automatic mono/stereo indicator with illuminated pinpoint tuning. Automatic silent switching to proper mode indicating instantly the reception of FM stereo broadcasts. Direct tape monitor system. Front panel stereo headset jack.

But it's the SOUND OF KENWOOD that proves our claim of peak performance with real dollar-for-dollar value.

Compare KENWOOD models for total music power... sensitivity... silicon power transistor amplifiers that provide wide frequency response... channel separation... I.F. stages... exclusive transistor protection circuit... and many more top-quality, engineering features that add up to the magnificent sound of KENWOOD. Compare prices, too. You'll find ours are extremely moderate.

There's a KENWOOD receiver to satisfy all your needs from high quality, economy models to luxury solid state. Write for illustrated brochure and the name of your nearest KENWOOD franchised dealer.



*the sound approach to quality*

**KENWOOD**

3700 So. Broadway Pl., Los Angeles, Calif. 90007, ADams 2-7217  
212 Fifth Avenue, New York, N.Y. 10010, MUrray Hill 3-1115



The complete line of KENWOOD models will be on display at Los Angeles Hi-Fi Music Show, Ambassador Hotel, Room 128H San Francisco Hi-Fi Music Show, Civic Auditorium, Room 304

Circle 106 on Reader Service Card

cathode bias. However, there are some other things to consider, especially when we are dealing with single-ended stages. While it is true that the average amplifier used in home music systems has a push-pull output stage, I think for the sake of a complete understanding of what happens with cathode and fixed bias, we shall consider their operation more deeply.

If we wish to operate a push-pull stage in Class B, we can not do so with cathode bias. No matter how much cathode biasing is used, the tube cannot be cut off. In a Class-B stage there is no plate current flowing. Therefore, there is no current flowing in the cathode resistor. Naturally, there is no voltage drop across the cathode resistor and of course, no bias voltage can be developed across it. If there is no bias, the grid will not be negative with respect to cathode and the tube will conduct. You can see that no matter how large a cathode resistor we use, some current will always flow. Further, the voltage between cathode and ground will become very high, leaving little plate swing for the stage.

Another thing to consider in a discussion of bias is that the bias voltage is supposed to vary in accordance with the signal presented to the tube's grid. In a stage employing cathode bias, however, the signal does not cause so complete a change as takes place in a fixed-bias stage. Think of it this way. Let us assume that signal applied to the grid is going in a positive direction. This tends to decrease the bias on the stage. Remember that when the bias falls, plate current rises. This increase in plate current results in an increased current flow in the cathode biasing resistor. Here, the cathode becomes more positive with respect to ground. The grid will become increasingly negative with respect to cathode. This effect results in degeneration and decreased output from the stage. The use of a cathode bypass capacitor decreases this degeneration, but there must always be a slight loss in stage gain under cathode-bias conditions.

The next obvious question is how does the bypass capacitor work to eliminate most of the degenerative effects described above. The reactance of the cathode bypass capacitor is low compared to the ohmic resistance of the cathode resistor. Therefore, when the cathode resistor is operating under static conditions, the capacitor will charge to the voltage developed across the cathode resistor. Again, let us say that the grid of the stage is driven positive. The cathode resistor would now like to become more positive, but the capacitor across it will charge up more than under static operating conditions. The charging current holds down the voltage across the resistor and allows the grid bias to more nearly follow the grid voltage swing. When the grid goes more negative, the voltage across the cathode resistor tends to be reduced, but the charge on the capacitor acts to maintain the voltage at its static level, and again the bias is more or less maintained.

You've probably observed that cathode bypass capacitors are used much more in single-ended stages than in push-pull stages and you may have wondered why

(Continued on page 49)



## PROFESSIONAL PLAYMATES



The new Sony Solid State 350 adds professional performance to home entertainment systems

Selecting the brilliant new Sony Solid State 350 to fulfill the stereo tape recording and playback functions of your professional component music system will also enduringly compliment your impeccable taste and passion for music at its finest. With an instant connection to your other stereo components, the versatile two-speed Sony 350 places at your pleasure a full array of professional features, including: 3 heads for tape and source monitoring. Vertical or horizontal operation. Belt-free, true capstan drive. Stereo recording amplifiers and playback

pre-amps. Dual V U meters. Automatic sentinel switch. Frequency response 50-15,000 cps  $\pm$  2db. S.N. ratio plus 50db. Flutter and wow under 0.15%. Richly handsome gold and black decor with luxurious walnut grained low profile base. This remarkable instrument is yours at the equally remarkable price of less than \$199.50. Should you want to add portability to all this, there's the Model 350C, mounted in handsome dark gray and satin-chrome carrying case, at less than \$219.50. For information write Superscope, Inc., Sun Valley, Calif.

**SONY** **SUPERSCOPE** *The Tapeway to Stereo* <sup>®</sup>

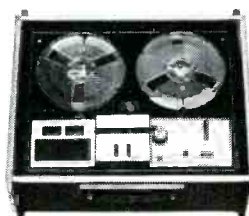

*Portable Model 350C*

Circle 117 on Reader Service Card

# SOUNDMEN GET SOUND ANSWERS FROM FAIRCHILD!



## FAIRCHILD DYNALIZER MODEL 673

The newest approach for the creation of "apparent loudness"—the Dynalizer is an automatic dynamic audio spectrum equalizer which redistributes frequency response of the channel to compensate for listening response curves as developed by Fletcher-Munson. Adds fullness and body to program material.

## NEW! FAIRCHILD BASS-X

A dynamic low frequency roll-off filter—that can roll off high level low frequency information, starting at 500 cycles, with a maximum obtainable attenuation of 12 db at 30 cycles. Device is automatic, is in use only when needed—therefore it does not alter overall apparent low end response to the ear. THE FAIRCHILD BASS-X allows higher levels to be maintained in disc recording, and particularly assists AM stations in increasing their effective signal by automatically controlling the often troublesome low end response.



## FAIRCHILD CONAX

The world-accepted way to control high frequency spillovers in FM due to pre-emphasis. Lets your station maintain real high levels even with brass and crashing cymbals and still avoid FCC citations.

## FAIRCHILD LIMITER MODEL 670

Fast attack stereo limiter (50 microseconds) with low distortion and absence of thumps. Sum and difference limiting position eliminates floating stereo image. Includes regular channel A and B limiting. Dual controls, dual meters provided. Used throughout the world. (Mono model available).

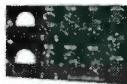

Write to FAIRCHILD — the pacemaker in professional audio products — for complete details.

# FAIRCHILD

RECORDING EQUIPMENT CORPORATION  
10-40 45th Ave., Long Island City 1, N. Y.

Circle 109 on Reader Service Card

# LETTERS

## Those \*#\$(?) Abbreviations

SIR:

I am pleased to note from the December issue that you have switched over, in general, to the *Système Internationale* of terminology which involves using capital letters for abbreviations of units named after people, as in dB, V or mV, Hz and so on, as you are now doing. I did not see you use the full term "hertz," but I presume that when you do you will spell it with a small letter initially, as the names of units should be.

The only remaining point for you to conform to would be to shorten those long numbers you tend to use by expressing audio frequencies in kHz rather than in Hz, as in 15 kHz rather than 15,000 Hz. The long numbers look so awkward, particularly when you get up to 800,000 Hz, as was done in the EICO 250 PROFILE. The prefixes of the SI allow choice of less cumbersome numbers, and are there to be used. Why not use them?

PHILIP N. BRIDGES,  
17910 Pond Road,  
Ashton, Md. 20702

*(It is quite a chore to change a system to which we have become accustomed over many years, and we still miss one or two, it seems. As to "kHz," we so often encounter in audio literature the expression, for example, of "15 to 25,000 Hz." Under the new system, this would be "15 Hz to 25 kHz," which looks even worse. We feel the 800,000 Hz was really a bad mistake, we must admit, and we shall try to avoid that one anyhow. Ed.)*

## Antenna Systems

SIR:

I wish to express my strong agreement with the sentiments regarding poor antenna systems coverage expressed by the reader whose letter appeared in the November issue. The indifferent response you gave the letter is also typical of the attitude existing on this subject among publications in the fields of hi fi and TV. The reason for this escapes me because, good tradesmen, there is money to be made here. Gross neglect of the antenna problem has been, in my opinion, the biggest stumbling block to color TV sales (*if there is one*. Ed.) How often does a potential buyer see a satisfactory color TV picture in an appliance store? Hardly ever. The problem is not as acute in the FM field, but it is there, particularly with the advent of stereo FM.

Realistically, the problem is this: The usual household which is buying hi fi equipment also owns and watches a good TV set. The hi fi enthusiast is probably a fairly knowledgeable type, and his attitude regarding audio quality will also apply to the quality of the TV picture (*Amen*. Ed.) Realizing that TV and FM antenna systems and requirements are

closely related, he will logically wish to spend his money in a manner which will benefit both. Several antenna manufacturers are now offering highly sophisticated all-channel antennas. The rotator is receiving much-deserved new attention. Reception of UHF TV is also now a requirement in most areas, and the idea of installing antenna distribution systems during construction of new homes has great appeal. Co-axial cable is receiving growing attention as a means of improving the quality of both FM and TV reception. In short, the subject is getting pretty complex, and precious little guidance is available.

As an individual, my specific questions on this subject follow:

(1) When using an all-channel antenna, what sort of transformer is needed to convert the UHF-VHF-FM signal into a combined 72-ohm signal in a single co-axial cable down lead?

(2) What type of splitter is needed in the attic to separate 72-ohm FM signal from the UHF-VHF TV signal efficiently? In most homes the high fidelity equipment and the TV set are located in different rooms which serve different purposes.

(3) When installing 72-ohm co-ax distribution systems which do not employ electronic boosters, what is required to tap off the cable efficiently?

(4) What specific type of transformer is needed at the backs of the FM and UHF-VHF TV sets to re-convert the 72-ohm signal efficiently to 300 ohms?

(5) What are the signal losses and compromises inherent in the use of splitters, transformers, couplers, and so on, as opposed to separate antenna systems?

(6) What sort of hardware is available for neat co-ax cable runs and connections? There seems to be a variety advertised. Is there a standard type?

(7) What about lightning protection when using co-axial cable?

(8) What is meant by "stub effect" when dealing with signal distribution systems? Certain antenna wall receptacles are advertised as the "anti-stub-effect type."

I hope that the above questions and comments will assist some contributor in preparing a badly needed article for your pages. Certainly the perusal of a parts catalog will not suffice.

REN D. SMAYLIE,  
LCDR, USN,  
USS OXFORD (AGTR-1)  
Fleet Post Office, San Francisco

*(We have commissioned an article on this entire complex subject and it should appear starting in the June issue. We can only hope that the author will have answered this reader's questions completely by the time his paper is finished, and to this end, we shall show him this letter. The article will likely be in two parts, and we shall insist that it be complete and accurate. Ed.)*



# Let's Look Inside The Dynamic Microphone

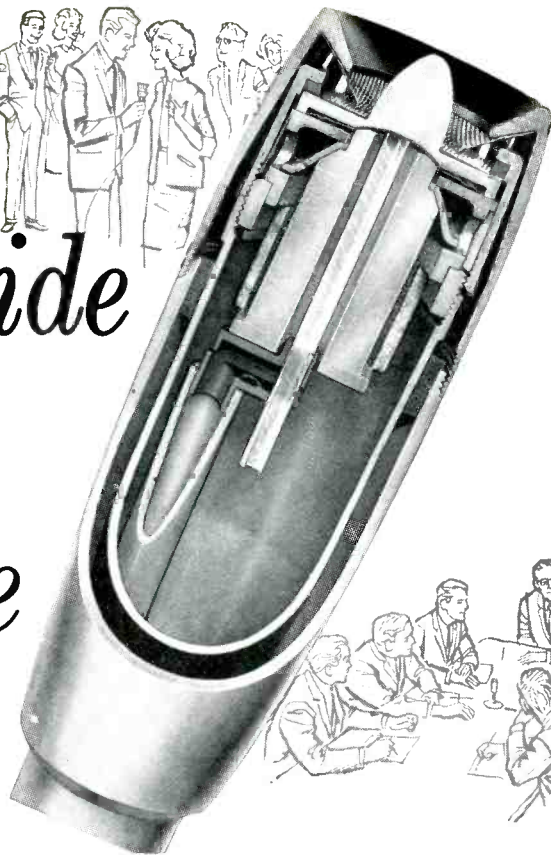

**T**HIS is no ordinary microphone. It's a University Dynamic. Its manner of working is no less complex than a modern day computer. Its system of elements is a carefully integrated electromechanical network in a critical acoustical area. Without showing it, it's really quite a bit more than it appears to be — you have to listen to know the results of its performance.

For example — you move toward a flurry of activity on a busy street corner and witness a man-on-the-street interview. To you and other observers the conversation is barely audible above the noise of people and traffic. But to radio listeners the conversation is clear and unaffected by the sounds of the city . . . They are remote . . . in the background where they belong. This is the distinct advantage of a microphone with a good directional pick-up pattern.



Model 8000  
Directional  
(Cardioid)  
Shock Mounted

Both are University Dynamic Microphones, but they are different in design, to serve different applications. The first is a highly directional (cardioid) dynamic microphone, sensitive only to the areas of sound intended for radio transmission or recording . . . proportionally attenuating sounds emanating from adjacent unwanted areas. The second is a highly omni-directional dynamic microphone sensitive to sounds in all surrounding areas, specifically designed to pick up all sounds.

University makes only dynamic microphones, and they have the precision and reliability of modern day computers. Look at the inside to confirm this. The bullet shaped dome of the directional cardioid is a precise and significant component of the system. It smoothes the vital mid-range to provide a more dynamic, natural quality of sound. Filters, in a special configuration, soften sudden bursts of sound, minimize sibilants and protect the inner components from dust, dirt and the elements. A series of ducts further extends the performance of the microphone's transducer element providing gross and fine tuning (similar to the bass ducts of a speaker system) to sharpen the directional characteristics and reinforce the bass response.



Model 2040  
Omni-  
Directional  
With Switch

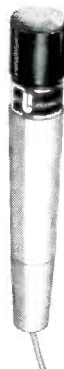

Model 2000  
Omni-  
Directional



Model 2050  
Omni-  
Directional  
With Switch  
& Switch

The unusual, rugged, yet highly sensitive characteristics of the exclusive University UNILAR diaphragm are responsible for the remarkable high frequency performance of the University Dynamic Microphone—sharp, bright, clear and transparent. The UNILAR diaphragm is not easily seen in the precision cut-a-way shown above. It is extremely light and sliver thin, rugged and virtually indestructible. It could easily withstand torturous bursts of sound and vibration, even without the "extra-measure-of-protection" blast filter screen in the assembly. This feature alone guarantees continued distortion-free and trouble-free performance . . . and, it is only one of many features that make the University Dynamic Microphone the choice of professionals and recording buffs. No matter

what the nature of sound, University captures the live natural quality that makes the difference right from the start . . . better than other microphones costing \$10, \$15 or even \$20 more. And, the exclusive University warranty gives you five times as long to enjoy this "lively sound." Stop at a franchised University Dealer today and try for yourself. Get more info too! Write to Desk C62M, UNIVERSITY SOUND, P. O. Box 1056, Oklahoma City, Oklahoma 73101 . . . we'll send you a FREE copy of "Microphones 66."



Attache' 5000  
Miniature  
Directional  
(Cardioid)  
With Lavalier



Model 8100  
Directional  
(Cardioid)  
With Switch  
Shock Mounted

To demonstrate another case in point — Imagine yourself an unseen observer in a conference room of a large organization. A tape recorder, fed by a single microphone in the center of the conference table, is in use to store all that is said. Many speak at once; some face away from the microphone; it appears that all that is said may never be recorded, but every word is captured on the magnetic tape for later review.

# SONY® First Again!



## NEW "Easy Threader" Tab



... makes every tape  
reel self-threading!

2 "Easy Threader" Tabs — FREE  
— in each box of 7" and 5" (1800' and  
900') of Sony Magnetic Recording Tape.

Other good reasons for buying Sony Magnetic Recording Tape with "Easy Threader" Tabs are: **Convenience** — instant take-up, no fumbling with tape ends. **Performance** — Lubri-Cushion, Permatizing, Oxi-Coat, are exclusive Sony tape features for everlasting performance.



**Don't Lose Your Heads Over Price!**  
Recorder heads, that is

It's false economy to buy cheap tape. Bargain brands — white box tape — are no bargain in the end! Magnetic Recording Tape MUST contain lubricants to minimize costly wear on your recording and playback heads. Cheap recording tape lubricants — if they use any — quickly wipe off. The tape becomes abrasive, causing pits in the heads which trap shedding oxide and form gummy film. You lose high frequencies and ultimately mute all sounds. In the end, expensive recording and playback heads must be replaced and damaged tape-feeding mechanisms repaired.

For TRUE ECONOMY, full range fidelity and lasting performance, buy Sony tape. The heavy Oxi-Coat used on Sony Magnetic Recording Tape is impregnated with LUBRICUSHION, an exclusive silicone lubricant which can never wear off!

**SONY SUPERSCOPE®**

Sun Valley, California

Circle 111 on a Reader Service Card



## LIGHT LISTENING

Chester Santon

### The Duke at Tanglewood

RCA Victor LSC 2857

A glance at the jacket of this album could easily lead one to believe that jazz has taken over at the concert hall that is the summer home of the Boston Symphony Orchestra. From the darkened auditorium pictured on the cover the eye travels to the well-lit stage occupied by Arthur Fiedler and the Boston Pops. At the very front of the stage is a concert grand piano with Duke Ellington relaxing at the keyboard while bassist John Lamb, in the employ of Mr. Ellington, stands by his instrument midway between Mr. Fiedler and the first chair of the string section. It's obvious that something a bit different from the usual concert routine was afoot when the picture was taken in the course of a special Pops Pension Fund concert. Despite the formal dress of the participants, some informal music making was on the agenda. As it turns out, the little old ladies who summer quietly in the Berkshires and make up a good part of the audience for the Tanglewood series were probably left quite unruffled by this Ellington appearance with the Pops. The end result is far more in the direction of popular music than in the rich vein of jazz so brilliantly worked by the Duke in the past.

A dozen standard Ellington tunes have been taken into the richly furnished workshop of noted Pops arranger Richard Hayman and there transformed into vehicles for a large orchestra. Piano and rhythm embellishments have been left to Ellington, Lamb on bass, and Louis Bellson on drums. The up-front placement of the visiting trio gives the album more than enough flavor to set it apart from other Boston Pops releases. Ellington fans with long memories will find their hero in somewhat diluted form here. This shouldn't surprise them because they realize, far more than does the general public, how long the dilution of the Ellington talent has been going on. What does emerge from this concert is fresh affirmation of the twenty-year streak of inspiration Ellington has had in the creation of popular songs as well as exceptional dance tunes. Along with perennials such as "Solitude," "Mood Indigo," "Caravan," and "Sophisticated Lady," the bill of fare includes several items heretofore in limited circulation. There is a stage march called "Timon of Athens" used in the Shakespeare production of that name at a Stratford Festival in the summer of 1963. The newest Ellington effort in words and music is represented by "Love Scene" currently being featured by Tony Bennett and other singers. The sound in this album is great. To the reasonably

\*12 Forest Ave., Hastings-on-Hudson, N.Y. 10706.

practiced ear, even the audience applause at the outset identifies this as a full range, hang-the-limiters, non-Dynagroove recording.

American Airlines Popular Program #14

Mercury, Philips, Smash Tape W 14

Some months prior to the appearance of this particular tape release, I encountered my first reel offering the home listener, at a price, the same musical entertainment he gets gratis on the longer flights of the leading airlines. At first blush the idea of airline tapes catching on as a home-listening medium seemed a bit farfetched. It just didn't seem possible that passengers would be so struck by what they had heard on headphones in flight that they would then purchase the same three-hour program for home use. Yet, according to the numbering of this release, thirteen earlier programs have already been issued and moved off store shelves in sufficient quantity to merit a fourteenth. The wide use of tape on board planes has certainly been stimulated with the introduction of 3 3/4"-ips as a regular commercial speed for use in the home. It is much simpler for Ampex to supply the airlines with a variety of material if it doesn't have to go to the bother of dubbing 7 1/2" releases to a slower speed. The listener with headphones in regular home use should certainly find these reels just as useful as he did in flight.

In the course of three hours, quite an armload of Mercury, Philips, and Smash albums are sampled in Program Number 14. Vocals alternate with instrumental numbers in a manner calculated not to take too much of your attention away from the scenery or the American Airlines hostesses. For optimum listening results, a tray balanced on the knee might help. I tried to get into the proper mood for this reel but I discovered that the flight could not be completed because of foul weather. My driveway needed shoveling.

### An Evening with Belafonte/Mouskouri

RCA Victor LSP 3415

Harry Belafonte has never been one to stand still while there were still new areas of folk song left to explore. Accepted and known in more parts of the world than most of our famous singers, Belafonte got the idea for this international album a long time ago while on a world tour. By the time this particular recording project was completed, he was to find himself singing Greek in the company of one of Greece's leading entertainers, Nana Mouskouri. In September of 1960, while appearing in Athens, Harry Belafonte visited a typical small club just outside the city to check at first hand the bouzouki music we now take for granted after seeing the film "Never



PHOTOGRAPHED AT CAPITOL RECORDS BY FRANZ EDSON

## Good records start with Stanton.

A professional needs to know for sure. When he listens to a test pressing, he needs a cartridge that will reproduce exactly what has been cut into the grooves. No more, no less. Otherwise he would never be able to control the final product. The record you buy in the store.

That's why the professionals keep using Stanton. It tells them the whole truth, and nothing but.

In the photograph above, studio engineers are shown listening to

a test pressing. This is a critical stage in record making. The stereo playback system they are listening through is fronted by a Stanton 581 EL Calibration Standard. (The turntable also happens to be a Stanton. Other fine turntables will work, too.) They're getting the whole message. You'll get it, too, in an upcoming release.

Each Stanton Micro FLUX-VALVE® Calibration Standard is custom made. That means that

each will perform exactly as the original laboratory prototype. We laboriously adjust them until they do. It also means that you will get the same accuracy that the professionals get. Guaranteed.

Stanton Calibration Standards are hard to make. And the price reflects it. \$49.50. But that really isn't much to pay for uncompromising accuracy.

**STANTON** Plainview, L. I., N. Y.



Circle 112 on Reader Service Card

# ROBERTS CROSS FIELD 770 STEREO TAPE RECORDER

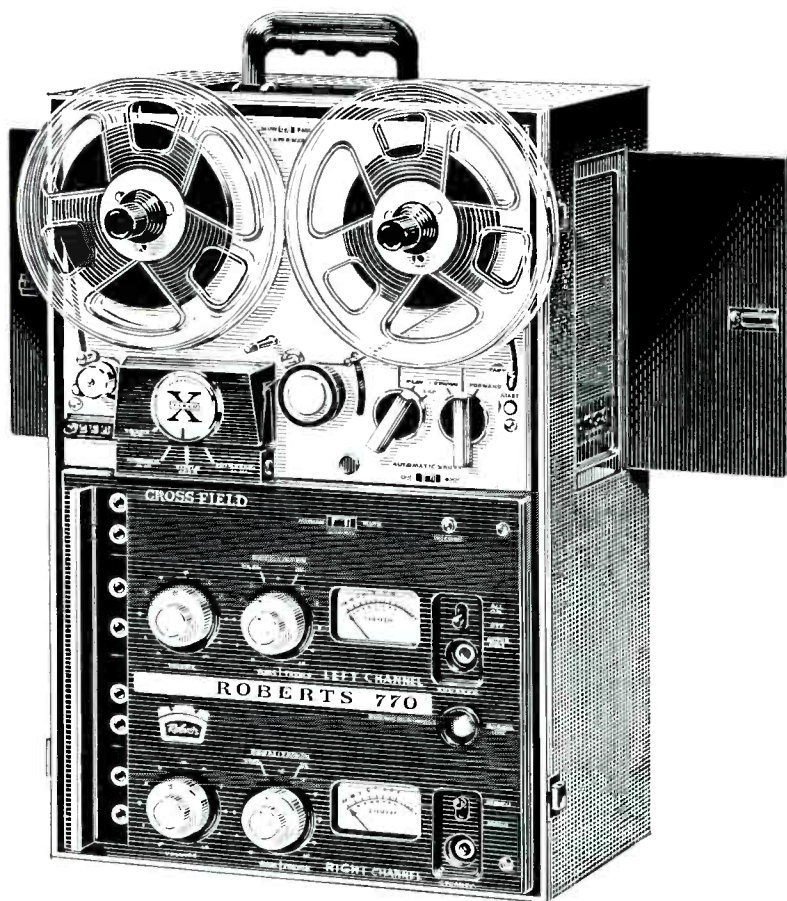

PLAYS THE NEW LP STEREO SPEED OF TOMORROW— $17\frac{1}{8}$ IPS  
PLAYS ALL 4 STANDARD SPEEDS

- |   |   |
|---|---|
| <input type="checkbox"/> 22,000 Cycle<br>Cross Field Response | <input type="checkbox"/> Sound-with-Sound, Track Adding |
| <input type="checkbox"/> Two 7" Speakers                      | <input type="checkbox"/> FM Multiplex Ready             |
| <input type="checkbox"/> 20 Watts of Flawless Stereo          | <input type="checkbox"/> Electrical Speed Control       |
|   | <input type="checkbox"/> Automatic Shut-off             |

**\$449.95**

THIS SUPERB INSTRUMENT IS A HALLMARK OF TAPE RECORDED  
ENJOYMENT IN THE HOME.



**ROBERTS**

5922 Bowcroft St., Los Angeles, Calif. 90016

28R

A DIVISION OF RHEEM MANUFACTURING, AN INTERNATIONAL COMPANY WITH OVER 75 PLANTS AROUND THE WORLD

Circle 113 on Reader Service Card

On Sunday." In addition to bouzoukis, he encountered Miss Mouskouri, a graduate of the Athens Conservatoire Hellenique and already a leading practitioner of Greek popular and folk songs. Cognoscenti already know her fine work on the Fontana label. If her voice was as ingratiating in 1960 as it is now, it's easy to see why Belafonte began plans to bring Nana Mouskouri to this country. By the time she arrived here in September of 1964, her fame as a recording artist has spread to other European countries north and west of Greece. Miss Mouskouri immediately joined Belafonte in a tour he had organized of American colleges, making her U.S. debut in the hardly Hellenic surroundings of Burlington, Vermont. The acclaim of today's folk-oriented college audiences led to a tour of the major theatres of the United States and Canada. The actual selection of the songs for this album began in Montreal following conferences with Manos Hadjidakis, composer of "Never On Sunday." Eight songs featured here are Hadjidakis creations based on Greek folklore. The other two were written by Miss Mouskouri's accompanist. If the Greek language gave Belafonte any difficulty during the learning process, there is no sign of it in his smooth treatment of the lyrics. He handles most of the love songs while Nana Mouskouri relives, in her satiny style, some of the Greek struggle against oppression. Their duets, particularly the light-hearted "Irene," exhibit a remarkable dovetailing of styles that usually comes with decades of joint effort. Put this one down as one of the freshest Belafonte releases to come along in some time.

Les and Larry Elgart: Elgart au Go-Go  
Columbia CS 9155

New Christy Minstrels: Chim Chim Cher-ee  
Columbia CS 9169

These two recent Columbia releases have one point in common: the artists featured have been forced to make sizable concessions to the demands of today's young crowd of record buyers. The transformation of the Elgart's dance band is more pronounced than that of the Christy vocal group, but neither is allowed to pursue the musical approach that first brought it to fame. If you take the trouble to listen carefully to the Elgart discotheque stylings you can occasionally detect some of the Elgart sound of old. The rest of the time the personality of the brothers is submerged in the beat of the moment that seems to level the individuality of any band using it. There is probably no permanent harm in all of this and I daresay the Elgarts could return to straight dance music if it ever regains its full popularity.

The New Christy Minstrels have a problem similar to the Elgart's. They too have a rent bill to meet every month. If a new slant has to be taken to continue selling records in quantity, they certainly take it here. The Minstrels' distinctive arrangements have given way to pop stylings in current vogue with the Award-winning "Chim Chim Cher-ee" from "Mary Poppins" leading the way. The unique blend of Christy harmony appears only fleetingly ("Kisses Sweeter than Wine" will remind you of their earlier releases) in a program aimed pretty much at the teen-age market

AE

# Harman-Kardon components look like this too!



Turn it on and hear true component sound. The brilliant sound you expect from Harman-Kardon. This is a complete music system of matched quality components. It's the SC-440, engineered around a powerful Harman-Kardon AM/FM solid-state receiver. There's a built-in Garrard AT-60 automatic turntable with magnetic cartridge and diamond stylus. Unique air-suspension speaker systems (10" hi-compliance woofer and 3½" curvilinear tweeter) give you dramatic stereo pleasure wherever you sit in the room. Amazing bass! Extraordinary power bandwidth and flat frequency response. Sound so lifelike you must hear it to believe it. Controls are up front, including D'Arsonval tuning meter, speaker balance, contour, and headphone jack. Tape input and output on back. Beauty? Take a look at its sculptured, hand-rubbed walnut styling. The SC-440 is the

new look in today's component music systems — at \$449\*.

**3 models to choose from.** The SC-430, same AM/FM control center as the SC-440, with 'bookshelf' speakers that sound a lot bigger than they are—\$419\* complete. Model SC-330 gives you FM stereo with a Garrard *Fifty* automatic turntable and 'bookshelf' speakers—just \$389\*.

Ask your Harman-Kardon dealer for a demonstration. You'll like them on sight—you'll buy on sound. *Harman-Kardon, Inc., 401 Walnut St., Philadelphia, Pa. 19106.*

\*Prices slightly higher in the West. Dust cover optional.

**harman kardon**

A subsidiary of The Jerrold Corporation

**LEADER IN SOLID-STATE STEREO COMPONENTS**

Circle 114 on Reader Service Card

# AUDIO ETC.

Edward Tattall Canby



## Pitch and Tempo II

The new-model Eltro MLR Tempo and Pitch Changer officially went on sale hereabouts this last February. Allowing for normal commercial optimism, I'd expect this means the new units are about now really beginning to get around—to those who can afford them. The new price is "unchanged"—ugh—a mere \$3950, including pedestal. (That's merely a thing to stand the machine on, next to your tape recorder.) Nevertheless, this gadget is worth a good, long look and think-spell for a lot of very different kinds of potential users.

The Eltro is the "WHAT?? Now wait a minute!" gadget I described at length and with, I hope, gusto, in last month's issue. It does the impossible. It changes the pitch of a played-back tape without changing the speed. Or, even more startling, changes the speed, faster or slower, without changing the pitch. It works, too. And for that reason alone I'd say it was easily worth the price, for whomsoever has the 4 kilobucks.

Now just what can you do with this gadget, once it is set up next to your own tape player, in such a fashion that tape can be played off your machine and onto the Eltro, then back again to the regular tape reel? Well . . . lotsa things. Some of them sort of silly (but not half as silly as the things a good many of us do with our fancy home gadgetry). Some of them anything but silly.

The earlier model, I should note right here, played only at 15 ips and was a strictly a one-channel or mono device (though some trick special models had been worked up, on special order). Now, the new model is convertible to 7½ ips—which will open it up to a large quantity of broadcast use, I suspect, as well as even greater potential in a thousand and one educational areas (and maybe a handful of millionaire private homes). And by this time a two-track "stereo" model will be available, to play tricks on the million-odd two-track tapes we have in use in our fair country every day of the year. (No four-track—yet.) So—versatility is now greatly increased. Wider usefulness.

### Music

Well, you can think of a few obvious uses for the Pitch/Tempo Changer. (Note a slight change in its official name, since last month's installment.) There's music. There's speech. And there's general noise. Look at music first. It would seem to be the obvious thing. Raise its pitch or lower it, to need. Speed up the music, or slow it down, pitch remaining precisely fixed.

Just for fun, you can, for example, play a good, thumpy pops recording (on tape, of course—no discs in this system), one of those with a solid rhythm bass, and by simply turning the Eltro knob, speed up the beat astonishingly, or slow it 'way down—and the music just plays right along. A most uncanny sensation! Same pitch, same key. Or you can do a super-uncanny version of the variable-speed turntable trick, familiar in numerous quality record players. Put on your (tape) record, turn the knob, and the pitch goes up—not just a little but a lot, say from C major up beyond E major—and yet the *speed*, the tempo, the steady beat, stays precisely the same. Or slow the stuff down, even further down, miles down. Until the instruments groan out low in the bass, like a 78 played at 33. And still the monotonous beat goes right on, absolutely unchanged! Phew. It's hard to believe as you listen.

That's just for kicks; nobody would have a practical use for such extremes. But minor adjustments—yes. There, we get into really useful things.

Readjust the pitch of a piece somehow recorded slightly too low, or too high, leaving the timing, the duration, unchanged. Speed up a piece that seems to drag, shortening its playing time, pepping up the styling, yet leaving its pitch, and hence *tone color* too, precisely the same.

Now you begin to see "commercial" applications. Wow! But, you'll say, not many people will want deliberately to re-style an already-recorded piece. Unethical. *Oh yes??*

Fifteen years back, they might have said that about tape editing of music. Or after-the-session mixes, from three or four or a dozen separately recorded tracks. Now, after-the-session dickering is an aesthetic part of the recording process, accepted by musicians (grudgingly, shall we say—can't blame them) as well as by recording technicians. Even classical music gets it, and plenty of it.

And so, here's one more alter-the-session tool, with wholly new and unprecedented capabilities. I can even imagine a conductor who might say, "Let's see now: I should have maybe done that scherzo just a shade faster. HEY, JOE! (*technical side-kick*)—play that back through the Eltro, will you? Speed it up just a bit . . . no, not that much . . . there! That's it! That's perfect. Let's do it again that way . . . or may be you could just run it through the machine, just like that."

(Ah, Musicians' Union! Another technical headache to figure out.)

It could be just that way. Maybe it is, already. As I heard the Eltro (the earlier model), the sound quality seemed plenty good enough. The pitch, above all, was steady as a rock. That, of course, is the one absolute necessity. Well, you could use it, if not for mastering, then for sampling, as per above.

But there are more elementary reasons for using Eltro on taped music. One of them is a dead-positive must, if I know my radio.

### Radio Time

I'll never forget my surprise, back in the 1940's, when I first looked into the timing catalogue in a radio station record library. The entire recorded collection is filed on neat cards not by composer but by time. Want a piece that's 7:23 long? Just look under 7, sub-head :23. For a couple of years I made up nightly classical symphonic programs out of that catalogue, and what a useful gadget it was, considering the rigidity of radio scheduling! Just patch together the right combination of minutes and seconds and it all adds up to, say, the required 58:30 (allowing for commercials and so on) or 25:45, or what have you. You could even pull out emergency "fill" music in a hurry, when a "live" program came out short. Need 4 minutes and 5 seconds? Quick, get out so-and-so disc, second band, first side. And it comes out triumphantly, right on the button.

But even this convenience isn't enough, sometimes. Like when you work up a program with some sort of coherence and shape. (You do, if you have any sort of conscience). Say, all-Brahms. Well, darn it, you sit down and juggle times until you're dizzy, but there just isn't any combination of Brahms that times out right. It's always either too short or too long. Only a measly minute or so—but a *minute!* On radio? Unthinkable.

You see what I'd be doing today. Just plug in some of the Eltro (having run off the stuff on some of that used tape lying around). Brahms First Symphony—30 seconds too long? Simple. Turn the tempo control down a bit, just a tiny bit. The scale is marked in percentages, 50 per cent to 180 per cent. (100 per cent, of course, is normal playback speed.) With a bit of quick figuring, you can set the thing up for the right time correction and, spread over all that expanse of symphony, it won't affect the music for anybody's listening ear. Not even the conductor who put it down in the first place would know the difference.

(But just in case you miscalculated, you can get a stupendously brilliant ending out of any old musical warhorse just by moving the Eltro indicator forward a bit during those last few moments—when you see timing is still too tight. Phone calls by the dozen—What version of the Brahms Symphony did you say *that* was? I want to *buy* it, quick!)

Well, just possibly I'm exaggerating. I haven't tried the unit under such exacting circumstances, on the commercial air. I am sure, though, that a more cautious approach such as, perhaps, copying the entire program ahead of time via the Eltro with adjustments completed previous to

## RECENT PROFESSIONAL INSTALLATIONS OF AR SPEAKERS

### AR-2<sup>x</sup>

(\$89-\$102, depending on finish)

Aeolian-Skinner reverberation system corrects excessively dead acoustics in the chapel of Choate School, Wallingford, Connecticut. Duncan Phyfe, musical director of the school, describes the effect on live pipe organ and chorus as "so natural one is not aware of an electronic reverberation system."

Similar Aeolian-Skinner installations are operating in Christ Church, Cambridge, Massachusetts, and in St. John's Episcopal Church, Washington, D.C. AR speakers were chosen because of their lack of coloration, their undistorted, full-range bass, and their reliability.



### AR-2ax

(\$109-\$128)

Sound reinforcement system for the summer jazz concerts in the sculpture garden of New York's Museum of Modern Art. Live music had to be amplified without giving the sound an unnatural, "electronic" quality; AR speakers were chosen after testing many brands.

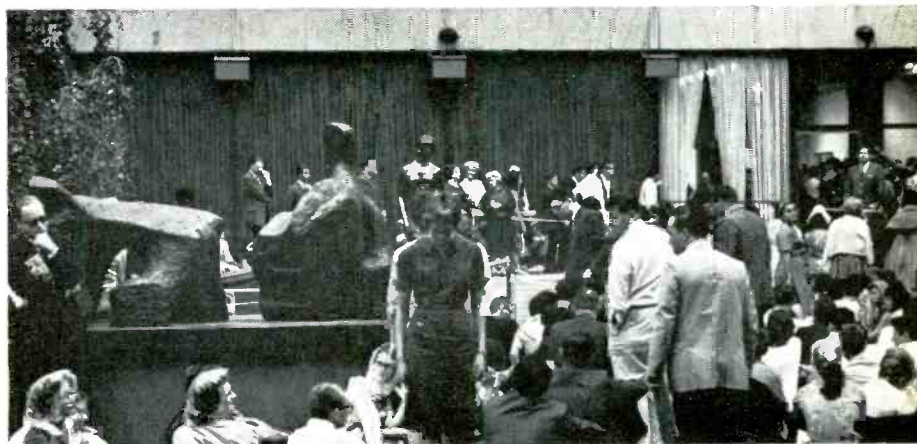

©1965, LINCOLN CENTER FOR THE PERFORMING ARTS

### AR-3

(\$203-\$225)

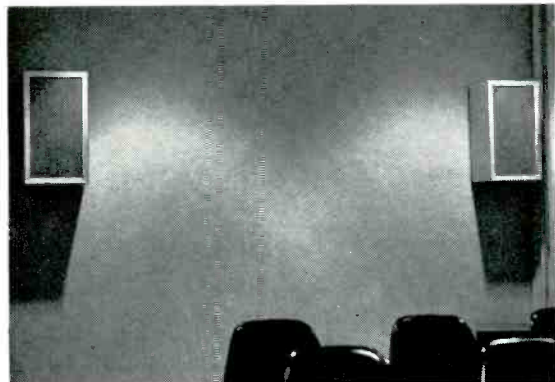

One of the listening rooms in the Library & Museum of the Performing Arts at Lincoln Center in New York City. AR-3's were chosen for these rooms to achieve an absolute minimum of artificial coloration.

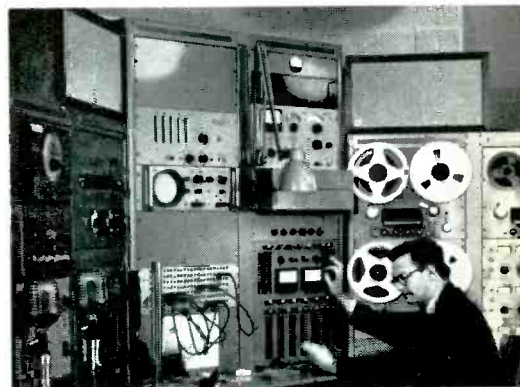

Experimental Music Studio of the University of Illinois. Dr. Hiller (seated) writes about the AR-3's, used as monitor speakers: "I wish all our equipment were as trouble free."

AR speakers and turntables are often used professionally, but they are primarily designed for natural reproduction of music in the home. Literature is available for the asking.

**ACOUSTIC RESEARCH, INC.,**

**24 Thorndike Street,**

**Cambridge, Massachusetts 02141**

Circle 115 on Reader Service Card

## BOYNTON HAS IT!

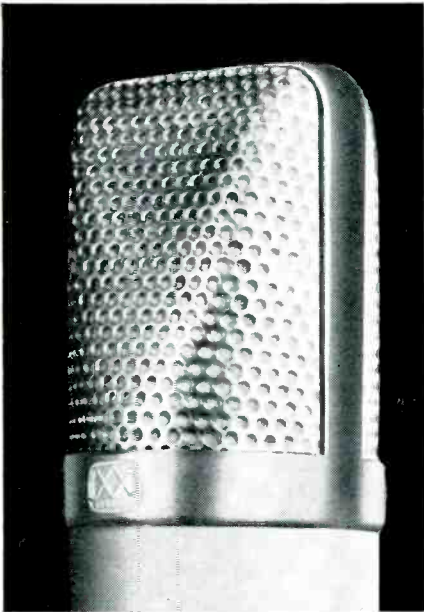

### THE NEW SYNCRON AU-7a CONDENSER MICROPHONE

FOR PREMIUM SOUND PICKUP  
AT A FRACTION OF USUAL COST!

At last! An American made quality condenser microphone in a self-contained 9¾" unit that is reshaping the recording industry.

Now . . . P. A. engineers, broadcasters, studios and audiophiles can utilize the full potentials of "condenser" sound without the bulk and expense of conventional condenser mikes.

Connect the cable and it's ready to go. Over 2500 hours transistor battery life with low cost mercury cells.

Frequency range:  $\pm 3$  db 40-20,000. Directional characteristics: cardioid, with front to back ratio of better than 20 db.

Output level: -50 db. Distortion: less than 0.5%. Rugged diaphragm provides broad, smooth frequency response with total absence of annoying peaks. Maximum sensitivity, outstanding clarity of sound. **PRICE \$169<sup>50</sup>**

ONLY SYNCRON MAKES IT. ONLY BOYNTON SELLS IT.



**BOYNTON STUDIO** DEPT. A10  
295 Main St., Tuckahoe, N.Y. 10707 Tel. (914) SP 9-5278  
SOLE DISTRIBUTOR FOR  
**SYNCRON AU-7a CONDENSER MICROPHONE**  
Dealerships available

Circle 116 on Reader Service Card

broadcast, would bring excellent results. Like any tool, including tape editing, this one can easily be mishandled and its functions made aesthetically unethical. But it has no ethics of its own—your skill and understanding alone can give it reasonableness, within its capabilities. So much for music.

#### Selling Adjuster

So you thought music was the main idea? Not at all, though the machine is accurate enough to use upon musical material (and its frequency range and electrical signal characteristics are good enough). Speech is a much more important application.

Some people speak slow, others fast. Some recorded radio programs, especially those that are taken down "live" at assorted public functions, drag along unmercifully. Wouldn't it be nice if you could speed up some of those draggy speech-makers, after the fact? That is—speed them up *without changing the tone quality of their voices?* You can, now.

And how about the guy who talks too fast, too nervously? If he slurs his syllables and is sloppy, you can't do much, other than tape-edit a few of the slips of speech. (I do this to myself all the time. Hence my unrivalled reputation for good diction on the air!) But you can increase his basic intelligibility by slowing him down, stretching out his words and sentences, until the listening mind can keep pace with his racing ideas.

Then we have the usual commercial bit. How about the "perfect" take of the one-minute ad, the one that has just the right once-in-a-hundred persuasiveness of voice, and yet comes out five seconds too long? 1:05. Use it! Just speed it up by a small, inaudible percentage (and just maybe, increase its persuasive punch in the process.) Or stretch out the one that ran too short and sounded sort of nervous. Don't oversell OR undersell, now. Use the Eltro Selling Adjuster. Ugh. (I'll bet somebody does, too.)

#### French by Ear

Let's get into education and related areas. I'll by-pass such intriguing matters as the readjustment of speech speed for a thousand spoken dramas, poets reading their works, story tellers on records, Presidents making addresses to the Nation (they tend to move slowly), correspondents' battlefield reports via short wave, etc. All that is just more of the same. But what of the Frenchman who talks so "fast" that you, the student of French language, just can't follow him? It isn't really fast—just good, normal French. Little that helps *you*.

Well, with an Eltro in tow (assuming a well-feathered educational nesting place), you can start your Frenchman's spoken stuff at a snail's pace, *Escargot*, with garlic. Every word slow and clear, perfect in tone quality and coloration. Terrific! You got it *all*? Now try again—and just a bit faster. Still get it? Well, now, let's try 95 per cent . . . 100 per cent. Done! Your French-by-ear is learned, cold.

(Again, the more cautious educators will prepare alternative tapes ahead of time, ranging from very slow up to normal, to be used in Educations' favorite graded format.)

Don't tell me this isn't a superb idea. With the new alternative Eltro models, two-track and at 7½ ips, the educational language conversion should be easy, even to those tapes where the student records himself on the second track, erasable, after listening to the permanent recording on the first.

#### Speech Speed-Up

That's not all. (I've got to start being brief—there's no end to the Eltro possibilities for the imaginative user.) Some very interesting studies and experiments have been made recently on ear-comprehension of speech. How *fast* can we hear speech? Can we, ideally, take in more words per minute than the average speaker gives us? Remember that we can *read*, with the eyes, normally much faster than we can pronounce the words we are reading. Can we hear similarly, given the chance? What is a workable maximum aural intake, given idea clarity of diction?

And—most interesting—*Can we be trained* to hear even faster?

All this from a reprint that Stephen Temmer of Gotham Audio (Eltro's U. S. agent) gave me when I "auditioned" the Pitch/Tempo Changer. Read it for yourself (as fast as you wish) in the JEP, (*Journal of Ed. Psych.*), June 1965, Vol. 56 No. 30. Or get a reprint from the Am. Psych. Assoc. Or—even better—from Gotham Audio.\* I won't give you all the dope; I'm merely planting an idea. But theory does suggest that since thought, inside the head, seems to race along at around 400 wpm (words per minute) for most of us with reasonable IQ's, we should be able to pick up spoken sense at this rate, through sound via the ears the way we read with our eyes. That is, *if speech itself can somehow be produced that fast, intelligibly.*

You see the implications. The Eltro Speeder-Upper is the essential ingredient. What else? Unless we develop a new sort of human breed whose jaws and tongue rattle away at 180 per cent of normal! No need for it. Just speed up normal recorded speech, via the Eltro machine. An incredible diversity of possible applications here, both for normal listeners (since we *can* hear faster than we usually do) and, beyond that, for *specially trained* hi-speed listeners.

In fact this might be a whole new adjunct to the universal teaching of reading and writing in schools. Why not? Isn't most of the speech we hear these days straight out of a loudspeaker?

(I can also see Mommy recording bedtime stories for the kids in the morning, then speeding 'em up to 180 per cent for quick home delivery to the kiddies' ears that night—but leave all that . . .)

\* \* \*

From here, the speech speed-up story spreads out so fantastically that I can follow it no further. You do it. Just sit down for five minutes and ruminate. Worth it.

#### Speech Pitch

So you were thinking that the other Eltro function, the adjustment of pitch (with—  
(Continued on page 60)

\*Gotham Audio Corp., 2 West 46 St., New York, N.Y. 10036



**90-WATT OF AMPLE POWER!  
AUTOMATIC STEREO SWITCHING!  
AMAZING VERSATILITY!**



**MODEL SX-1000T**

**NEW 90-WATT SOLID STATE FM MULTIPLEX STEREO RECEIVER  
MODEL SX-1000T**

The above-mentioned are but a few of the superb features of PIONEER'S handsome new stereo receiver, the SX-1000T, a feature-packed receiver for the discerning listener who wants true professional performance at a practical price.

Large power by 2SD-45 transistors  Sensitive protective transistorized switch and relay for protecting transistorized circuits  FM circuitry: cascode front-end using 4 nuvistors, 4 dual-tuning IF stages, with muting circuit  Tuning range: 88~108 Mc  FM sensitivity (IHF): 2 microvolts  Multiplex circuitry: time-switching circuit, with automatic mono/stereo switch  Audio circuitry:

single-ended pushpull circuits using silicon power transistors, direct-coupled output to loudspeakers  Frequency response:  $\pm 2$  db, from 20 to 20,000 cps (overall)  Protection circuit: electronic switching  Line requirements: 115/230 volts, 50/60 cycles AC  Music power output: 90 watts (IHF), with 16 ohms loads  Dimensions: 17-1/2" (W) x 5-7/8" (H) x 15-1/8" (D).

**NEW 40-WATT SOLID STATE AM/FM MULTIPLEX STEREO RECEIVER  
MODEL SX-600T**

AM frequency range: 535~1605 kc  AM sensitivity (IHF): 16 microvolts  AM antenna input: built-in ferrite loopstick with terminal for external antenna  Music pow-

er output: 40 watts (IHF), with 16 ohm loads  Dimensions: 17-1/2" (W) x 5-7/8" (H) x 16-15/16" (D). All other specifications are the same as for Model SX-1000T.

**MAIN PRODUCTS:**  Hi-Fi Speakers  Stereo Hi-Fi Amplifiers  Hi-Fi Speaker Systems  Stereo Hi-Fi Turntables & Record players.



**PIONEER ELECTRONIC CORPORATION**  
15-5, Nishi 4-chome, Omori, Ota-ku, Tokyo, Japan  
Cable Address: PIONEER TOKYO  
NEW YORK OFFICE: 350 Fifth Ave., New York, N.Y. 10001  
Telephone: (212) LA-4-1757/8

Circle 126 on Reader Service Card

# EDITOR'S REVIEW

---

Due to circumstances beyond our control—as they say in broadcasting circles—the Elpa Marketing Industries advertisement on page 79 of the March issue inadvertently—and incorrectly—listed the new Thorens TD-150AB turntable as carrying a price of \$75.00, whereas it should be \$99.75, as every knowledgeable audio buff knows. The error was caused by a change from \$99.50 to \$99.75. In the change, the 99. was omitted, leaving only the \$75. While it is not likely that the difference of only \$24.75 would upset any Audio reader's budget appreciably, we sincerely regret the error.

## COLUMNIST CATASTROPHE

Readers and fans of Harold Lawrence's column ABOUT MUSIC will be disappointed in not finding this department this month. Mr. Lawrence was at a recording session with harpsichordist Rafael Puyana in a 17th Century mansion which is now a music school in Breukelen (dodge that if your memory is long enough) when he was stricken with an appendicitis attack. He was taken to a hospital in Utrecht, Holland, where the offending appendage (and apparently his April column) was removed. He is back at work by now, and presumably his column will resume in the May issue.

## AHEAD OF OURSELVES?

It appears that we were so excited at the idea of having a "bang-up" construction article again after months of hiatus that we got ahead of ourselves and carried the text beyond the figures. Consequently we have repeated the constructional text and provided the required figures. Seems that we got so involved with making our own version of the flutter meter that we overlooked them. In our case we made coil forms as described by the author, but instead of cutting out discs for the side walls we used plastic buttons which are readily available at notion counters. The author undoubtedly had more shop facilities at his disposal than we do or than we would expect most of our readers to have, and we *try* to make sure that contributors' projects will work before we give them our "stamp of approval" by running them in the magazine.

There is little fault in repeating part of an article—it is much worse to omit some of it.

## AUDIO ENGINEERING SOCIETY ACTIVITY

We are genuinely pleased to see some activity by the New York Section of the AES. For too many years the NY group seemed content to write the rules for all the other sections without actually showing the way for their possible activities. In this instance, the Section has organized a field trip for Saturday, April 2 which will consist of an inspection tour and lecture describing the laboratory and production facilities of H. H. Scott, Inc. in Maynard, Massachusetts. The plant is located at 111 Powder Mill Road (Mass. Route 62) about 25 miles west of Boston, and the tour starts at 1:00 p.m. In addition to AES members, Audio readers are also invited to attend. If sufficient interest is shown, the Society will provide a chartered bus from New York, to leave at 8:00 a.m. and return at 8:00 p.m. at a cost of \$5.75 for the round trip. Since reservations are limited to 45, it is suggested that those interested telephone their reservations as soon as possible to (212) MU 9-5518. Hermon H. Scott and Daniel R. von Recklinghausen will be your hosts. This is a real opportunity to see a modern hi-fi plant in action. The New York Section will provide for driving from either New York or Boston.

## THE LOS ANGELES SHOW (and others)

Every so often a show gets spotted on the calendar right on the "cusp" of the magazine's appearance date, and this year's show in Los Angeles is one of those occasions, as is the U.S. Department of Commerce Exhibition at the Trade Center in London. Consequently we have little advance publicity on what we can expect to see at L.A., but what we do see we will tell our readers about in the May issue. The San Francisco show is in almost the same category, but anything shown at L.A. will also be at S.F., so one show review will suffice for both of these domestic affairs. As to the London show, we plan to review it—as well as the International Audio Festival, the British show—in the June issue.

# Nine out of ten musicians prefer the natural sound of Pickering.

PHOTO BY FRANZ EDSON



Microgroove discs are recorded by magnetic processes. Naturally they sound better when reproduced with a Pickering Micro-Magnetic™; there's a natural compatibility. From the tiniest peep of a piccolo to the mightiest roar of an organ, Pickering produces sound as natural as the original performance. That's why musicians prefer Pickering. And so does everyone else who can hear the difference.

Pickering makes it easy to get natural sound in any stereo installation. There are four Pickering Micro-Magnetic pickups, each designed for a specific application. The V-15AC-2 is for conventional record changers, where high output and heavier tracking forces are required. The V-15AT-2 is for lighter tracking in the newer automatic turntables. The even more compliant V-15AM-1 is ideal for professional-type manual turntables. And the V-15AME-1 with elliptical stylus is the choice of the technical sophisticate who demands the last word in tracking ability.

No other pickup design is quite like the Pickering Micro-Magnetic. The cartridge weighs next to nothing (5 grams) in order to take full advantage of low-mass tone arm systems. Pickering's exclusive Floating Stylus and patented replaceable V-Guard stylus assembly protect both the record and the diamond.

But the ultimate test of a cartridge is the human ear. Find out for yourself. Listen carefully to a Pickering. You'll hear the difference.

**For those who can hear the difference.**

**Pickering**  
Pickering & Co.  
Plainview, L. I., N. Y.

Circle 118 on Reader Service Card

Compare these Sherwood S-7800 features and specs! ALL-SILICON reliability. Noise-threshold-gated automatic FM Stereo/mono switching, FM stereo light, zero-center tuning meter, FM interchannel hush adjustment, Front-panel mono/stereo switch and stereo headphone jack, Rocker-action switches for tape monitor, noise filter, speakers (A) and (B) disconnect. Music power 100 watts (8 ohms) @ 0.3% harm distortion. IM distortion 0.1% @ 10 watts or less. Power bandwidth 12-35,000 cps. Phono sens. 1.8 mv. Hum and noise (phono) -70 db. FM sens. (IHF) 1.6  $\mu$ v for 30 db quieting. FM signal-to-noise: 70 db. Capture ratio: 2.4 db. Drift  $\pm$ .01%. AM sens. 2.0  $\mu$ v. AM bandwidth 7.5 kc. 43 Silicon transistors plus 16 Silicon diodes and rectifiers. Size: 16½ x 4½ x 14 in. dp.

# Did you miss our last ad\*?



\*If you missed our previous ad comparing Sherwood's new S-8800 ALL-SILICON FM receiver with many other receivers, write for your free copy.

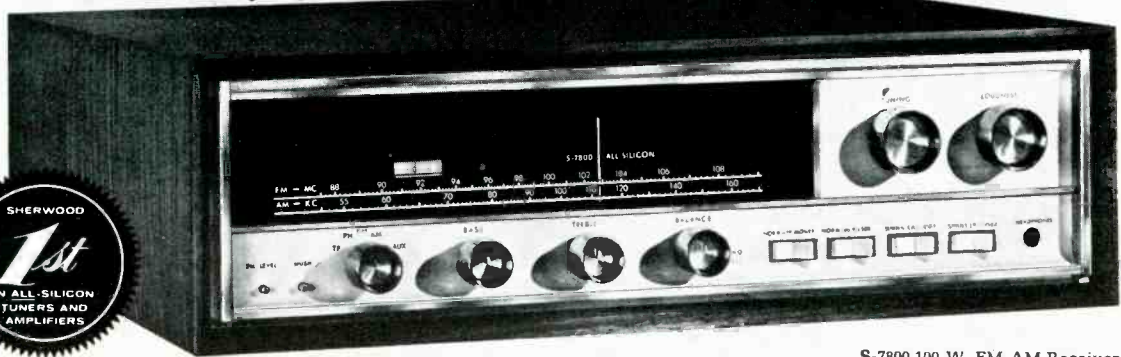

S-7800 100-W. FM-AM Receiver  
Chassis: \$399.50  
Wal. Cab. 28.00

Now we've added AM...and the industry's longest warranty —3 years—to our ALL-SILICON 100-watt FM receiver.

How can Sherwood offer this long warranty? Only because we said "No!" to both ordinary Germanium Transistors and old-fashioned tube Nuvisitors, insisting on ALL-SILICON reliability. No other receiver has its pacesetter 1.6 $\mu$ v FM sensitivity, its remarkable 0.1% distortion rating, for the most true-to-life sound.

*Sherwood*

Sherwood Electronic Laboratories, Inc., 4300 North California Avenue, Chicago, Illinois 60618 Write Dept. A4

Circle 119 on Reader Service Card

# Solid-State Flutter Meter

ARTHUR E. GLADFELTER

Inasmuch as the construction part of the first part of this article ran a little ahead of the figures, we cover again the complete construction of the printed-circuit boards and continue with the preliminary testing of the boards, then proceed with the calibration in this installment.

## IN FOUR PARTS—PART 2

**N**OW THAT YOU HAVE SECURED all the parts and wound the four coils, you are ready to proceed with the assembly of the boards. *Figure 9* shows the lead position on 2N3710 transistors. In *Figs. 10* and *11*, the holes for these small devices are shown in an obtuse triangle form, with the collector at the apex in every case, but with the base and emitter locations indicated by letters B and E respectively. Note that two pieces of wire are shown to make connections where it was not possible to provide crossings of the foil pattern—always a problem in laying out printed circuits.

### Making the Printed Circuit Boards

The printed-circuit board layouts for all three boards are shown in *Figs. 10*,

*11* and *12*. The board layouts are reproduced full scale, so that no intermediate steps are required to reduce the size. Boards 1 and 2 are 5 in. square, and board 3 is 3 1/4 by 4 3/4 in. These measurements are also specified in the parts list and can be verified by measurement of *Figs. 10* through *12*.

To show how the printed-circuit boards are made, board No. 3 will be used as an example. This is the easiest board to make and contains the least number of components. After the board has been cut to size, the copper clad side should be cleaned to remove any dirt or film that has accumulated. Cleaning is most easily accomplished with crocus cloth. Ajax cleanser or a large eraser. The board is then laid on the

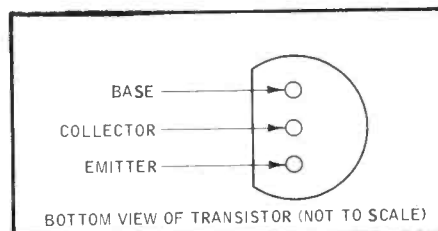
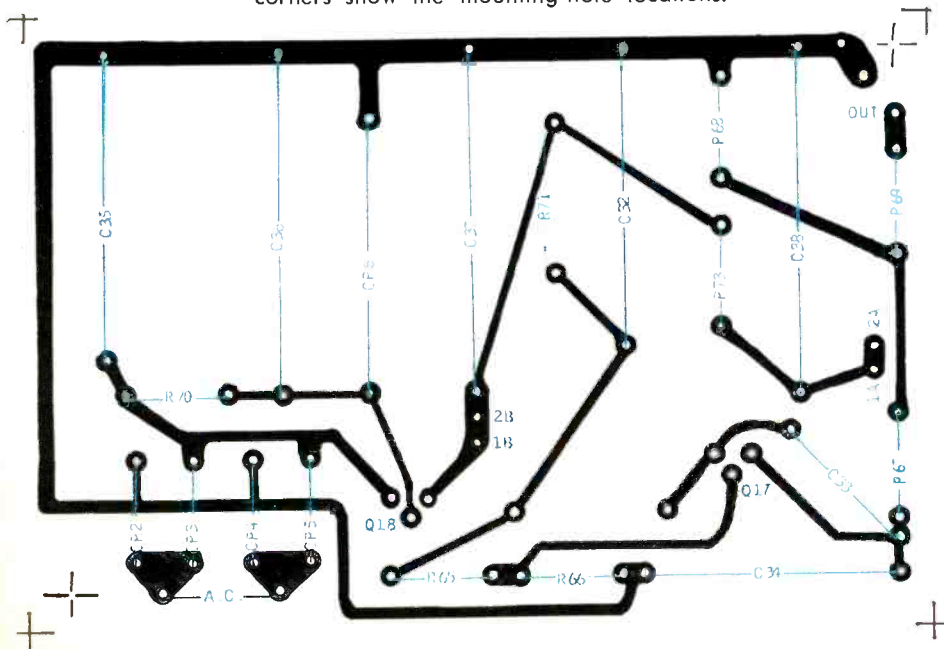

Fig. 9. Terminal arrangement of the 2N3710 transistors.

workbench or flat surface, with the copper side up. SCOTCH or masking tape is used on alternate corners to hold the board in position. The sketch of board No. 3 (*Fig. 10*) is then placed squarely on top of the printed-circuit board. A center punch, with a very fine tip is used to locate all holes. Alternately, if you do not wish to have a series of small "pinholes" on the magazine pages, *Figs. 10* through *12* must be retraced, and the tracing used as a template to locate the holes. The various connections are then made by placing 1/16 in. printed-circuit tape resist on the printed-circuit board.

The two most common etching solutions for printed circuit boards are ferric chloride and ammonium persulfate. Ferric chloride is normally bought in solution form, and one pint is more than enough to etch all three boards. Ammonium persulfate is a powder, and to make a solution, 2.5 pounds of Ammonium Persulfate are added to one gallon of water. In addition, a minute amount of mercuric chloride (a poisonous powder) is added, as a catalyst, in the amount of 26.7 milligrams of mercuric chloride to one gallon of water. Both of the etching solutions just described have their advantages and disadvantages. Rather than elaborate more, I suggest those who are undecided use the ferric chloride solution.

Fig. 10. Full-scale layout of board No. 3—the power supply and 3000-Hz oscillator unit. The component locations are identified by the colored lettering. The corners of the board are indicated, while the crosses at the upper right and lower left corners show the mounting-hole locations.



A plastic or glass tray can be used to hold the solution to etch the boards. The boards are then submersed in the solution, and to speed up the etching process, the tray can be heated (to about 160° F) and agitated. The time to etch a board will vary, but with heat and agitation, the time will range from about 15 to 30 minutes. After etching, the boards should be washed with water and the printed circuit tape resist removed. The boards can then be cleaned (as described previously) and appropriate holes drilled for the various components.

When soldering the components to the boards it is a good idea to heat-sink the 1N126 germanium diodes and also the resistors associated with the resistive divider in the range switch. All components, except the 2N3710, are mounted flush against the printed circuit boards. Because of the close spacing of the leads on the 2N3710, no attempt was made to have the printed-circuit board layout coincide with the wire leads on the 2N3710. The outside leads are spread apart and the 2N3710 is mounted about one-eighth of an inch above the board. Most of the other parts should fit on the boards fairly well; however, because the boards were originally laid-out using a 1:1 scale (as opposed to a 4:1 that is often used) some of the parts may not fit as well as a commercial board. The layouts should suffice, however, and are by far easier to use than point-to-point wiring.

#### Preliminary Printed Circuit Board Tests

After the parts are mounted on a printed circuit board, it is advisable to perform some preliminary electrical tests on each board before it is fastened to the chassis. The reason for this is that if a circuit is not functioning normally, it is easier to isolate troubles on the board level.

To test board No. 3, the output leads from the power transformer,  $T_1$ , can be soldered temporarily to the bridge rectifier,  $CR_1$  thru  $CR_4$ . The voltage at the emitter of  $Q_1$  should be about 33 V d.c., indicating the regulator is functioning.  $Q_1$  should oscillate at 3 kHz and the output amplitude at  $R_{60}$  (or  $J_1$ ) should be 0.75 V rms.

To test board No. 1, +33 V d.c. from board No. 3 can be used to supply the d.c. voltage. The d.c. biasing on the stages can be checked with the aid of the voltage readings on the schematic. The voltages were measured with no signal input. Note that the measurements at the collectors of the Schmitt trigger may be reversed, depending on the states of  $Q_4$  and  $Q_5$ . The discriminator-detector can be checked as follows: the d.c. voltages measured across  $R_{26}$  and  $R_{27}$  should be close to zero, with a

maximum upper limit of about 50 millivolts. This measurement will assure that neither  $Q_7$  or  $Q_8$  is leaky. A 3-KHz, 0.1-V rms minimum signal is then applied to the input. The d.c. voltage across  $R_{26}$  should increase to 1.1 V d.c. and across  $R_{27}$  the voltage should be about 1.6 V d.c.

Board No. 2 can be given a preliminary test by measuring d.c. voltages. Except for the voltages at the collector of  $Q_{10}$ , which depend upon the setting of  $R_{60}$ , most measurements should be within about  $\pm 10$  per cent of the values shown on the schematic.

#### Calibration

After determining that all circuits are functioning normally, the unit is ready for calibration. Three potentiometers are used to calibrate the unit.  $R_{11}$  is the first pot to be adjusted. With  $R_1$  in the maximum gain position a 3-kHz signal of about 0.1 V rms is applied to the input. Then,  $R_{11}$  is adjusted so that the square wave observed at the emitter of  $Q_1$  is symmetrical. Alternately, if an oscilloscope is not available,  $R_{11}$  can be adjusted with a d.c. voltmeter. The philosophy behind this method of adjustment is that  $Q_1$  (or  $Q_2$ ) will be conducting 50 per cent of the of the time. With this in mind—and assuming a collector-to-emitter saturation voltage of about 0.3 v.d.c.—the calculated average voltage at the collector of  $Q_1$  will be about 16.5 v.d.c. Using a d.c. voltmeter,  $R_{11}$  is then adjusted so the voltages at the collector of  $Q_1$  is 16.5 v.d.c.

$R_{60}$ , the second potentiometer to be adjusted, controls the gain of the voltmeter circuitry. It is adjusted with the RANGE switch in the 0.3 per cent position. To show the reasoning behind the setting of  $R_{60}$ , it will be necessary to take a second look at the basic definition of flutter, Eq. (1). Rearranging Eq. (1) in terms of  $df_o$  will give:

$$df_o = \frac{\sqrt{2}(f_{avg.})(f_k)}{100}$$

where:  $f_k$  = per cent Flutter

$df_o$  = Maximum deviation from the average frequency

$f_{avg.}$  = Average frequency (3000 Hz)

With  $f_{avg.}$  = 3000 Hz,  $f_k$  = 0.30 per cent,  $df_o$  corresponding to full-scale deflection is:

$$df_o = \frac{\sqrt{2}(3000)(0.3)}{100} = 12.73 \text{ Hz}$$

Now, 12.73 Hz is the peak deviation from the average frequency and peak-to-peak deviation on the discriminator curve will be twice the peak deviation

or  $2 \times 12.73$ , or (12.73) 25.46 Hz, for a full-scale reading of 0.30 per cent rms flutter.

After knowing the peak-to-peak deviation in frequency for a given percentage of flutter, a corresponding amplitude can then be determined from the slope of the discriminator S curve, Fig. 5. Assuming arbitrary frequencies of 3200 Hz and 2800 Hz (on Fig. 5) the corresponding d.c. voltages will be + 0.310 V d.c. and -0.310 V d.c. respectively. The rate of change in frequency ( $\Delta f$ ) with respect to the rate of change in voltage ( $\Delta V$ ) will then be:

$$\begin{aligned} \frac{\Delta f}{\Delta V} &= \frac{3200-2800}{0.310-(-0.310)} \\ &= \frac{400 \text{ Hz}}{0.62V} = 650 \text{ Hz/volt} \end{aligned}$$

Or, stated another way, the incoming frequency will have to change 650 Hz for a voltage change of 1.0 volt peak-to-peak at the discriminator output. It is, at this point, more convenient to convert the amplitude directly to an rms reading, that is, 1.0 volt peak-to-peak =

$$\begin{aligned} \frac{1}{2\sqrt{2}} \text{ V rms} &= 0.3535 \text{ V rms} \\ &= 353.5 \text{ mV rms.} \end{aligned}$$

As a result, 650-Hz peak-to-peak deviation will correspond to 353.5 mV rms. The voltage  $v$  corresponding to 25.46 Hz or 0.30 per cent flutter will be:

$$\begin{aligned} v &= \left[ 25.46 \text{ Hz} \right] \left[ \frac{353.5 \text{ mV rms}}{650 \text{ Hz}} \right] \\ v &= 13.8 \text{ mV rms} \end{aligned}$$

This means the rms voltage at the discriminator output will be 13.8 mV rms when the input frequency deviation represents 0.30 per cent rms flutter.

To set  $R_{60}$ , the input signal is removed and  $R_1$  is adjusted to the minimum gain position. The FILTER switch is placed in the 0.5-to-250 Hz position, and the RANGE switch in the 0.30 per cent position. The output signal from a sine-wave generator is then coupled to the base of  $Q_9$  via about a 10- $\mu$ f capacitor. An rms meter is also connected to the base of  $Q_9$ . With the frequency between 22 and 28 Hz, the oscillator output amplitude is increased until the meter indicates 13.8 mV rms.  $R_{60}$  is then adjusted so the meter indicates full scale, or 0.30 per cent rms flutter.

$R_{52}$ , the last potentiometer to be adjusted, calibrates the 1.0 per cent range.  $R_{52}$  must be adjusted after  $R_{60}$ . For a full-scale reading of 1.0 per cent rms flutter, the discriminator output voltage will be 3.33 times the voltage for the 0.30 per cent full-scale reading. Know-

Fig. 11. Full-scale layout of circuit board No. 1. Crosses at sides of panel are centers of holes for mounting brackets, made of  $\frac{3}{8}$  in. wide .064 aluminum strips.

ing this, and with the same set-up as described previously, it is only necessary to turn the RANGE switch to the 1.0 per cent position and increase the oscillator output amplitude so the external meter reads  $3.33 \times 13.8 = 46.1$  mV rms.  $R_{52}$  is then varied so the meter indicator reads full scale or 1.0 per cent rms flutter.

The input amplitude (from the recorder output) although not critical, should be at least 0.10 V rms. The fixed resistors,  $R_{43}$  and  $R_{76}$ , determine the meter deflection when the RANGE switch is in the LEVEL SET position.  $R_{43}$  and  $R_{76}$  have been selected so the meter will indicate about 85 per cent of full-scale deflection, when adjusting the input potentiometer  $R_1$  for the correct LEVEL SET amplitude. A line can then be placed on the meter scale at about 85 per cent of full-scale deflection to indicate the LEVEL SET position. (This marking was omitted on the writer's unit)

#### Performance

The preceding calibration is all that is necessary to calibrate the flutter meter. In order to evaluate the basic design however, a transistorized flutter simulator was made. This simulator can also be used to calibrate other existing flutter meters.

The flutter simulator, Fig. 13, is a bistable multivibrator (flip-flop), with a nominal repetition frequency of 3 kHz. The deviation in performance from a basic flip-flop can be explained as follows: Normally the base-bias resistors ( $R_{80}$  and  $R_{81}$ ) would be returned to ground, and the frequency would be relatively independent of any variation in supply voltage. In Fig. 13 however, the base-bias resistors are returned to ground through a 100-ohm resistor,  $R_{82}$ . A voltage from a sine-wave generator is then impressed across  $R_{82}$  via  $R_{83}$ . The varying voltage appearing across  $R_{82}$  will not affect the actual base circuit R-C time constants, but will change the ultimate or peak voltage to which the base capacitors can charge. Now, for a given voltage "trip-point" on an exponential R-C charging waveform, an increase in the peak charging voltage will cause a decrease in charging time. Thus, when a negative voltage is impressed across  $R_{82}$ , the peak charging voltage will increase and cause the frequency to increase. Similarly, a positive voltage impressed across  $R_{82}$  will cause a decrease in the peak charging voltage,

Fig. 12. Layout of board No 2. 3A and 3B indicate connections to power supply; input is to top end of  $C_{18}$ . Connections to switches are indicated as S1-1, S2-3%, etc.

AUDIO • APRIL, 1966

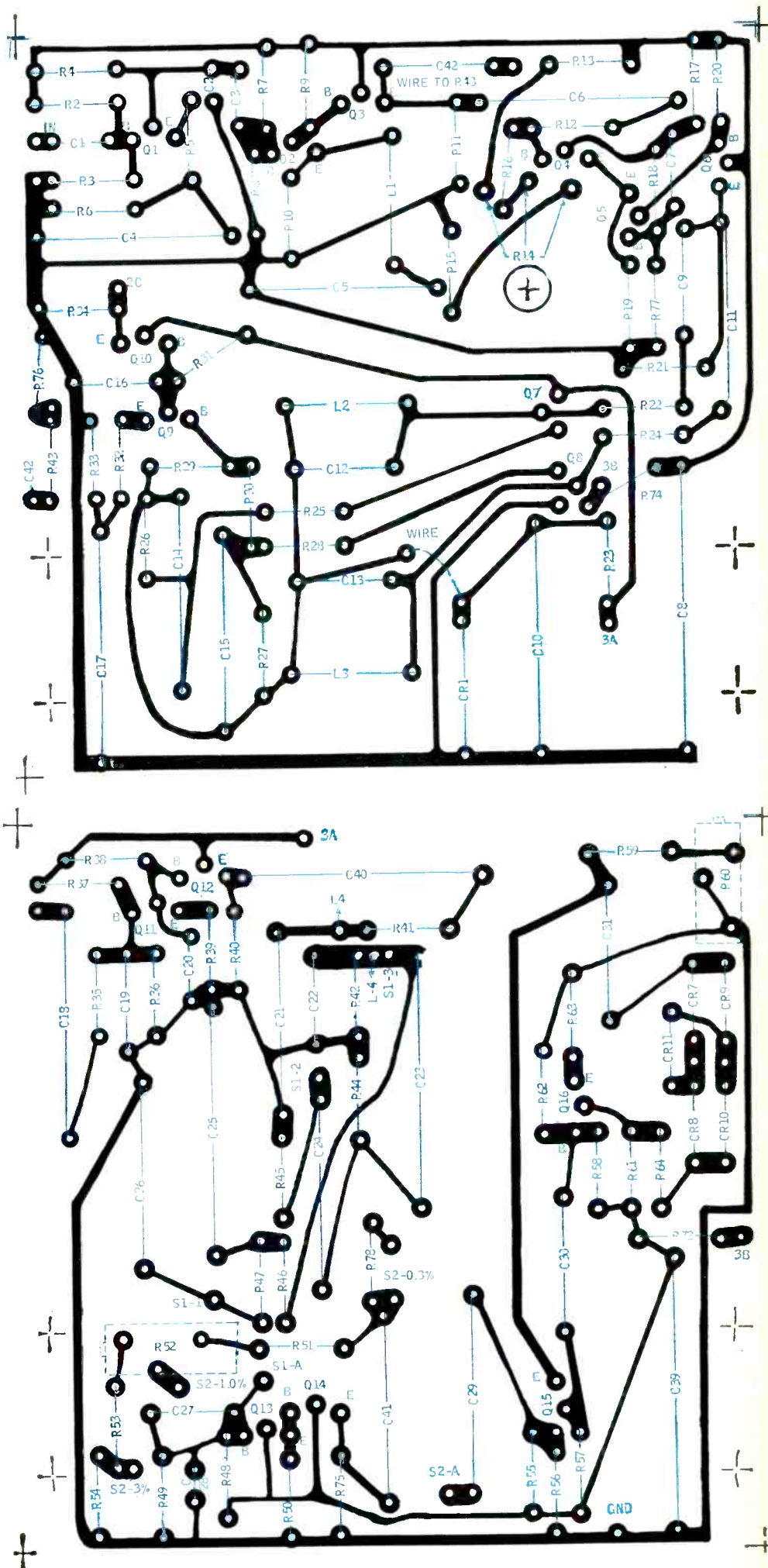

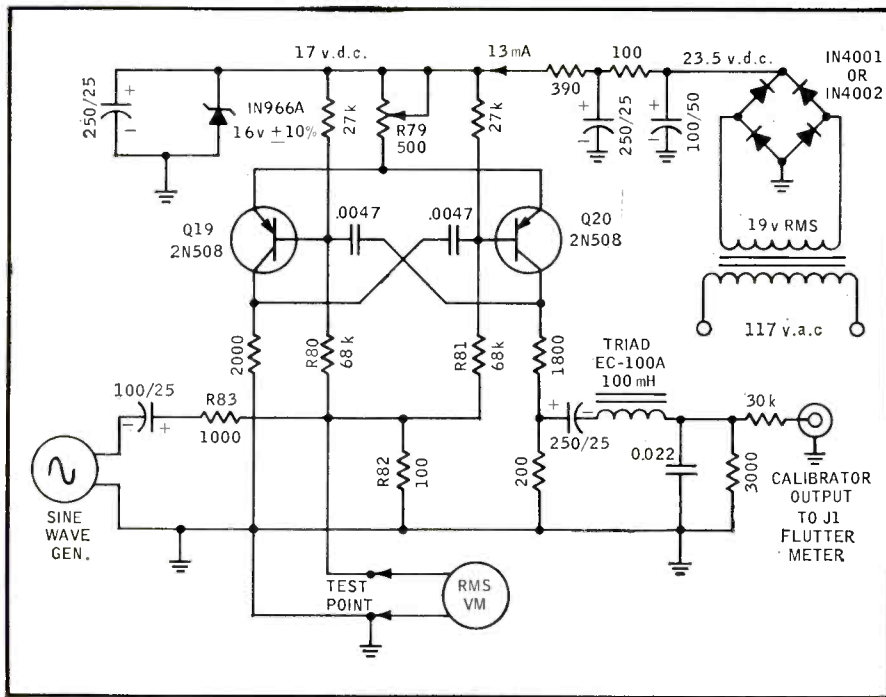

Fig. 13. Schematic of flutter simulator used to calibrate meter.

In fact, uniform response up to 120 Hz is adequate, except for the most critical tests.<sup>1</sup>

The second test was to evaluate the flutter meter tracking error. This was done by injecting various known percentages of flutter into the flutter meter. The flutter meter actual readings and that represented by the rms meter connected to the flutter simulator were then recorded. These results are summarized as follows:

Range	Flutter meter should read	Flutter meter actual reading
0.3%	0.30%	0.30 %
0.3%	0.15%	0.14 %
0.3%	0.10%	0.093%
0.3%	0.05%	0.04 %
1.0%	1.0 %	1.0 %
1.0%	0.8 %	0.795%
1.0%	0.6 %	0.59 %
1.0%	0.4 %	0.37 %

Thus, on the 0.30 per cent range and for readings greater than about 0.05 per cent, the absolute accuracy should be within 0.01 per cent flutter. The error does increase on the lower portion of the 1.0 per cent range; that is, where the reading was 0.37 per cent for 0.40 per cent. The tracking error at the low-scale readings is due, to a large extent, by the nonlinear characteristics of the diodes in the meter-bridge-rectifier circuitry. The tracking error could be reduced by providing more open loop gain in the meter amplifier,  $Q_{15}$  and  $Q_{16}$ . Along with the greater gain would be the possibility of low-frequency instability or motorboating. For this reason, the slight tracking error was accepted.

Although the flutter meter will probably be used at room temperature, a temperature test was performed on the entire flutter meter. The meter was placed inside a test chamber and the flutter simulator was used to provide a reference of 0.25 per cent rms flutter at  $+75^{\circ}\text{F}$ . With the temperature increased to  $+122^{\circ}\text{F}$ , the flutter decreased to 0.23 per cent, or a change of 0.02 per cent of flutter. Similarly, reducing the temperature to  $+32^{\circ}\text{F}$ , increased the flutter to 0.26 per cent, or an increase of 0.01 per cent flutter.

*To be continued*

and the frequency will decrease. Consequently, the generator output amplitude will correspond to a percentage of flutter and the frequency will represent the flutter and the frequency will represent the flutter rate. The frequency of the multivibrator may be adjusted to exactly 3000 Hz with potentiometer  $R_{79}$ .

The multivibrator output is taken from the collector of  $Q_{20}$ , attenuated by the 200-ohm and 1800-ohm resistors, and applied to a two-pole 12 dB/octave low-pass filter. This filter, which has an upper half-power frequency of about 4.5 Hz, removes the odd harmonics from the multivibrator square-wave output and provides a waveform that is essentially sinusoidal at the calibrator output.

To calibrate the flutter simulator it was necessary to measure the deviation in frequency ( $\Delta f$ ) vs. the change in voltage ( $\Delta V$ ). These results are plotted in Fig. 14. Using the frequency deviation corresponding to 0.30 per cent rms flutter and converting this to an rms voltage, the level across  $R_{82}$  will be about 0.067 V rms when the flutter simulator is generating 0.30 per cent rms flutter. When the rms meter indicates 0.223 V rms, the output frequency deviation represents 1.0 per cent rms flutter. Note the rms readings just given were measured across  $R_{82}$  and do not indicate the sine-wave generator output amplitude. This amplitude will be about 11 times that indicated by the rms meter.

The first item to be evaluated with the flutter-simulator was the over-all frequency response. If the detector charge and discharge time constants

( $R_{25}$ ,  $R_{26}$ ,  $R_{27}$ ,  $R_{28}$ ,  $C_{14}$ , and  $C_{15}$ ) were not chosen correctly, the flutter meter would not have provided uniform frequency response to the higher flutter rates. Using the calibrator, the over-all frequency response is down 1.0 dB at 170 Hz and down 3 dB at 240 Hz. At the low flutter rates the circuitry is flat to well below 0.5 Hz; however, at flutter rates below about 4 Hz, because of the damping characteristics of the meter movement, the indicating meter tends to follow the flutter peaks rather than the rms values. For very low flutter rates, the reading can be approximated by using the average of the high and low meter indications. Actually, if very low flutter rates are to be observed, it is better to use a d.c. oscilloscope, pen recorder, or any other suitable indicator that has response to d.c. Any of these instruments can be connected to the oscilloscope output jack  $J_2$  on the flutter meter. Based on the tests just described, the flutter-rate frequency response should be sufficient.

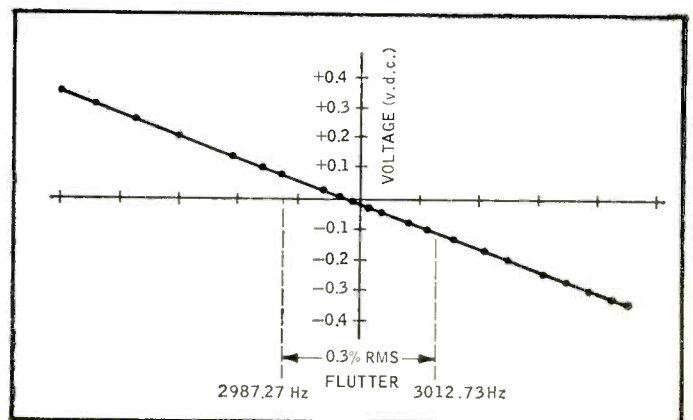

Fig. 14. Calibration of simulator in frequency deviation vs. voltage.



# A Warning for Wives in STEREOPHONIC soUND

CAROLYN HOWARD JOHNSON\*

Nearly every audio hobbyist has heard complaints from his "better half" occasionally. Here are some comments from a wife who has "seen the light"—obviously a woman who has enough perspicacity to recognize the better things in life.

SINCE THE JONESSES built a stereo set themselves, nothing in our neighborhood is the same. The old status symbols, like a mild 300 horsepower under the hood of the family car, have given way to the dangerous blast of a 100-watt amplifier. Contrary to what commercials would have you believe about wives, the ladies on our block aren't concerned with white tornados or 10-foot washing machines—but the unassuming innards of an FM radio are something else again. And the neighborhood gossip isn't the least impressed if a housewife's hands are so well tended that she must be having the heavy work hired; it's walnut stain imbedded in the cuticles that is of interest to the bridge group.

Not a woman on our street would deny that the stereo craze is the best kind of hobby. She will tell you that she doesn't mind scrimping and saving for a "stereo"; the family will benefit more than she would have from a pair of pearl earrings (sigh!). She also knows that a stereo is more valuable than a second car for shopping ever would be, and that music speeds the housework along far more effectively than a new electric floor polisher or automatic dishwasher.

Most of the ladies have done some reading on the advantages of a stereo system. Electronic-minded husbands have a way of leaving such beneficial literature near the cook book or under the bed where she is sure to find it.

From these leaflets they have learned that a stereo is an aid to family educa-

tion; how else could you afford to hear so many hours of "live" concerts? The Beatles "Yeah, yeah, yeah" would be at least \$5. for a single performance—with a stereo you can hear it every day from four to nine p.m. for no more cost than the electricity and some frayed nerve endings.

Any proud stereo owner will tell you that family arguments become rarer under the influence of the 1812 Overture played at top volume; they'll tell you that individual thought is stimulated, too. Of course, when communication with others becomes impossible, it's only natural for one to turn to his own thoughts.

If I had been aware of all these advantages, I would naturally have welcomed a do-it-yourself stereo with open arms. But I didn't know, so what might have been ecstasy bordered on lunacy.

You see, no one ever mentions the disadvantages and to learn of these and the advantages all at once would be too much for anyone. For instance, no one ever told me that building a stereo piece by piece is like buying yarn one skein at a time and hoping the sweater will come out all one color. I was told that building your own speaker system saves on labor costs but no one ever said a word about the money you save on mundane things like dinner out, movies, or bowling when your husband is up to his ears in woofers, tweeters, and soldering irons.

No one ever explained that component parts fill book cases, tables, and floor and finally the only easy chair in the house. Not until then does the electronics nut (who's so possessive of that chair that even the dog avoids it like

the plague) see that a cabinet to house the assortment must be the next item on the agenda.

No one ever warned me that the day HE brings home a mish mash of transistors and printed circuits, SHE might as well begin boning up on the techniques for finishing wood. No one ever told me that HIS hobby would ruin HER hands, that HIS tubes and wires would crowd HER sewing out of the back bedroom, that HIS sound system would probably be paid for out of HER household budget.

In fact no one ever tells you anything but, "We built it ourselves." That's why stereos have become status symbols, the anesthetics of the Let's-Go-Somewhere-Crowd.

When you begin to consider building a stereo—sometime in the first two minutes after you've repeated the marriage vows or seen the Joneses' new set—stop to think of the ulterior motives these enthusiasts must have. Remember that they *want* to addict you to discussion of ohms and response so you'll avoid dull topics like politics, and mink, and the space race. They *want* to put you in a position where you'll need their expert advice. They *want* you to be surrounded by stereophonic sound so you won't know they're playing their's too loud. They *want* company in their misery.

I realize that knowing these things won't keep you from taking the inevitable step but at least you'll be content in the knowledge that you knew what you were getting into. That knowledge is the secret to enjoying the misery. And it will help if you just like doing crazy, impossible, messy, wonderful things . . . just like my husband, the electronics nut, and I do. Æ

\*1528 E. McLellan, Phoenix, Ariz. 85014

# Room Design for Stereo Music

MICHAEL RETTINGER\*

Originally part of a letter in reply to one from a reader in the November issue, the author has expanded his suggestions for loudspeaker placement so as to introduce some other valuable considerations. The problem of speaker placement arises every time we move or rearrange the listening room.

**L**OUDSPEAKER POSITIONS for a stereo system often are chosen to fit the room dimensions, usually because the house is bought first, and then the stereo equipment. In some cases a good compromise is achieved in this manner—but not always. Frequently the results are mediocre, and on occasion downright inadequate, and one wonders whether the architect gave any thought at all to architectural acoustics in general and the reception of stereo music in particular. This writer has seen newly constructed homes in the \$50,000, and even \$100,000, class, in which considerable alteration work would have been necessary to achieve adequate music reproduction.

And yet, it is no more costly to plan and to build a new house for satisfactory music reception than it is to plan and build for satisfactory lighting

\*5007 Haskell Avenue • Encino, Calif. 91316

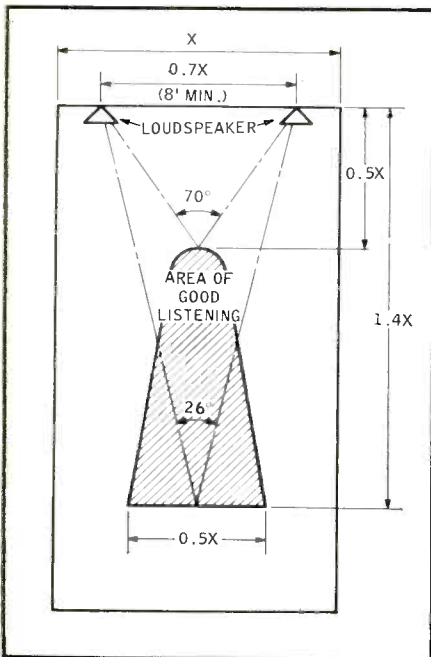

Fig. 1. Recommended loudspeaker positions for high-fidelity stereo reproduction.

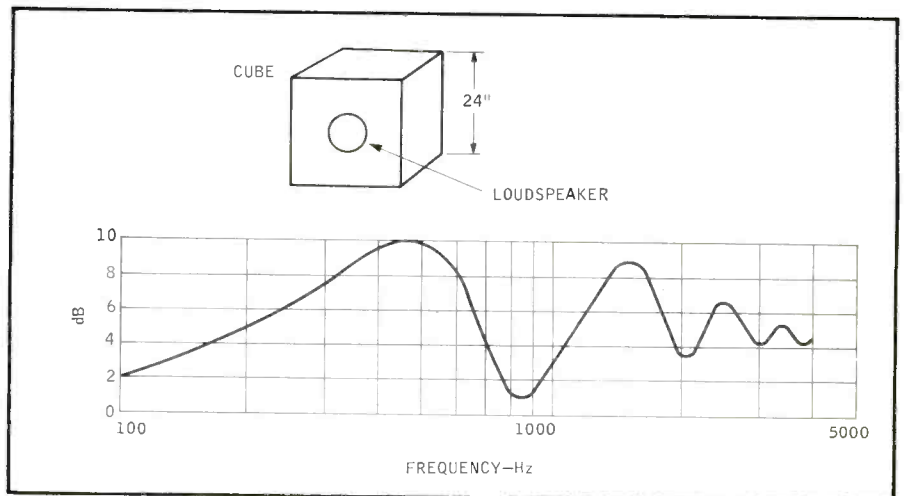

Fig. 2. (A), Placement of a loudspeaker in a cubical enclosure, and (B), response characteristic of such an enclosure showing the diffraction of sound by a cube.

conditions, warmth, room accessibility, and so on.

Figure 1 shows the area of good listening in a rectangular room. Note that a much wider or much longer room would be no better than one in which the ratio of length to width is in order of 1:4. Indeed, a wider or a longer room represents not only a waste of space, but also one in which the hearing conditions will become inferior. This is so because one may readily become positioned outside the area of good listening, and thereby become annoyed by the poor results; also because the room acoustics become unsatisfactory, leading to delayed reflections and non-uniform sound distribution, not to mention excessive acoustic power requirements on account of the larger room volume.

Figure 1 represents the composite of several curves, but is based chiefly on the work of Dr. Harry F. Olson, "A Review of Stereophonic Sound Research" (RCA Publication). It should be noted, however, that there are limitations in reproducing with two loudspeakers what originates on the concert stage over a large area. Loudspeakers resemble point sources in comparison to the surface sources of a band, for ex-

ample. For this reason "research" listening tests are generally carried out by placing the loudspeakers behind a light-opaque but sound-transmissive curtain, as was done by Dr. Olson. This argues, in the home, for mounting the speakers concealed behind a wall (see also next paragraph) rather than permitting the speakers to be placed conspicuously in the room. As long as a listener can see the sources of the signal, he is tempted to ascribe the direction of the lateral sound as that of one or the other of the two emitters—thus enhancing subjectively the "ping-pong" effect of certain stereophonic programs. When the positions of the loudspeakers are not known to the listener (hard to achieve for a home-owner but not for his guests) the sources appear to be far more diffused, and hence the music gains in realism and appeal. For this reason (to avoid the "ping-pong" effect) many home-owners have installed in their listening room a third, central speaker which may be used not only for the reproduction of stereo records and tapes, but also for monophonic voice programs, when it is desired to imitate the point source which a vocalist might represent.

(Continued on page 64)

# Perfection results from CHOICE...NOT CHANCE

Since no single phono cartridge can be all things to all people, we earnestly recommend that you employ these individual criteria in selecting your personal cartridge from the broad Shure Stereo Dynetic group:

**YOUR EAR:** First and foremost, listen. There are subtle differences in tonality that beggar description and are quite unrelated to "bare" specifications—yet add immeasurably to your personal listening pleasure.

**YOUR EQUIPMENT:** Consider first your tone arm's range of

tracking forces. Too, keep in mind that the cartridge ordinarily represents the smallest monetary investment in the system, yet the ultimate sound delivered depends *first* on the signal reproduced by the cartridge . . . "skipping" here downgrades your *entire* system.

**YOUR EXCHEQUER:** Shure cartridges cover the entire economic spectrum. And they are ALL Shure in quality, all Shure in performance. Even the least costly has received copious critical acclaim.

## RUGGED AND RESPONSIVE

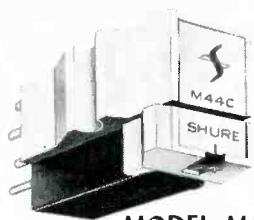

**MODEL M44-C**

An exceptionally rugged cartridge that tracks at forces up to 5 grams. Ideal for older model, heavier-tracking turntables, or where children or guests have access to your system. Retractable stylus prevents record damage. 15° tracking for minimal IM and Harmonic distortion. Truly musical sound. Only \$17.95

## ECONOMICAL TREND-SETTER



**M44 SERIES**

Premium quality at a modest price. 15° tracking angle conforms to standard adopted by major record companies. Remarkably low IM and Harmonic distortion . . . excellent channel separation, providing superlative stereo effect. Scratch-proof retractile stylus. M44-5 with .0005" stylus for 3/4 to 1 1/2 gram tracking. Only \$21.95. M44-7 for 1 1/2 to 3 grams, .0007" stylus. Only \$19.95

## ALL THE MOST WANTED FEATURES

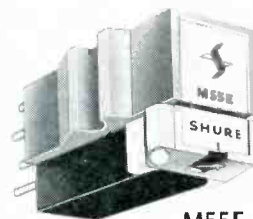

**M55E**

15° TRACKING, ELLIPTICAL STYLUS

Professional performance at a modest price. Compares favorably to the incomparable Shure V-15, except that it is produced under standard Shure quality control and manufacturing techniques. Remarkable freedom from IM, Harmonic and tracing distortion. Will definitely and audibly improve the sound of monaural as well as stereo records. A special value at \$35.50. Upgrade M44 cartridge (if you can track at 1 1/2 grams or less) with N55E stylus, \$20.00

## THE "FLOATING" CARTRIDGE

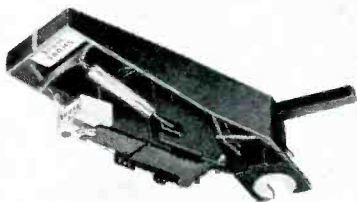

**M80E GARD-A-MATIC® WITH ELLIPTICAL STYLUS**

Bounce-proof, scratch-proof performance for Garrard Lab 80 and Model A70 Series automatic turntables. Especially useful for applications where floor vibration is a problem. Spring-mounted in tone arm shell. Unique safety feature retracts stylus and cartridge when force exceeds 1 1/2 grams . . . prevents scratching record and damaging stylus. \$38.00

## THE ULTIMATE!

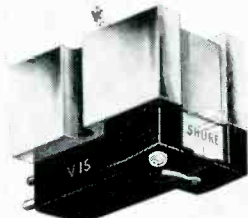

**V-15 WITH**

BI-RADIAL ELLIPTICAL STYLUS

For the purist who wants the very best, regardless of price. Reduces tracing (pinch effect), IM and Harmonic distortion to unprecedented lows. 15° tracking. Scratch-proof, too. Produced under famed Shure Master Quality Control Program . . . literally hand-made and individually tested. In a class by itself for mono as well as stereo discs. For manual or automatic turntables tracking at 3/4 to 1 1/2 grams. \$62.50

## "THE BEST PICK-UP ARM IN THE WORLD"



**SHURE SME**

Provides features and quality unattainable in ANY other tone arm. Made by British craftsmen to singularly close tolerances and standards. Utterly accurate adjustments for every critical factor relating to perfect tracking . . . it realizes the full potential of the cartridge and record. Model 3012 for 16" records \$110.50; Model 3009 for 12" records \$100.50

**SHURE**

*Stereo Dynetic®*

High Fidelity Phono Cartridges . . . World Standard Wherever Sound Quality is Paramount  
Shure Brothers, Inc., 222 Hartrey Ave., Evanston, Illinois

Circle 120 on Reader Service Card

# Audio Measurement Course

In Five Parts, Part 4

NORMAN H. CROWHURST

In this installment, the author points out the advantages and disadvantages of the various types of distortion measurement, what defects they show up, and the effects of hum and noise in the evaluation of the measurements.

IN THE PREVIOUS INSTALLMENT, when discussing the different possible ways of rating power, we omitted one factor in making the choice. This same factor will appear in other measurement and specification areas, so we will discuss it briefly here. When the fact that music-handling ability is related to peak, rather than average power, was first recognized, there was a move to change amplifier power ratings from average to peak.

## On Music Power Rating

At the time, few audio "engineers" and fewer manufacturers had any engineering or scientific background: it was an outgrown hobbyist's profession. So the 2:1 relationship between peak and average power of a sine wave was quickly grasped as an easy way to convert from one rating to the other. If an amplifier was rated at 25 watts on the average power in a sine wave, then it gave 50 watts peak, during the same test, due to the fundamental relationship for a sine wave.

The same amplifier might have given more power on the instantaneous test, which maintains the supply voltages artificially, long enough to measure power (Fig. 4-1). But the 2:1 substitution was so easy to make and few were equipped to measure true instantaneous

\*Box 651, Gold Beach, Ore. 97444

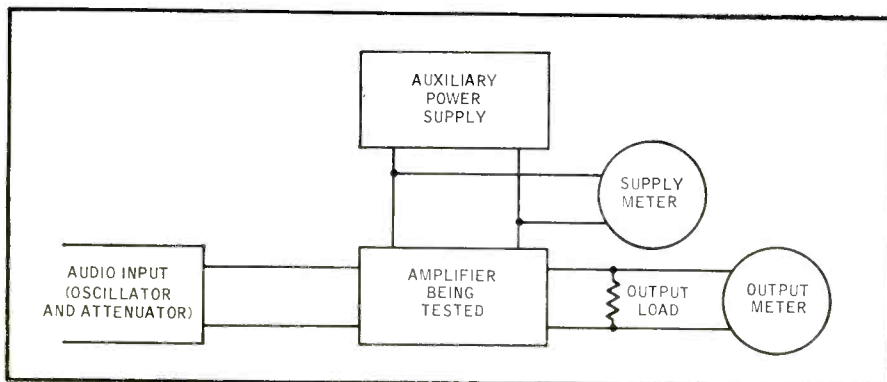

Fig. 4-1. Method of connecting an auxiliary power supply to measure music power rating.

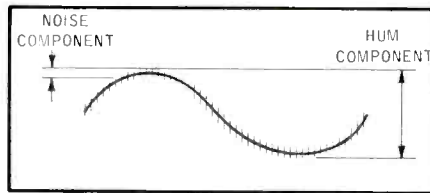

Fig. 4-2. Mixture of hum and hiss, where the hum looks bigger; but the hiss could sound the louder of the two.

or short-duration peak (which could be a higher figure yet).

So some just switched from 25 to 50 watts as a rating for the same amplifier, and so on throughout their product line. Those who realized that this was nothing more than a change in numbers felt the switch was "cheating." So the latter group continued to use the average power rating, insisting that theirs were "honest watts." After that, for a long while, power ratings reverted to the simple average value of a steady sine-wave signal. Impugning a man's honesty is a powerful form of persuasion!

But the fact is there really is more logic to using the peak figure, for the reasons we discussed in the previous installment. However, when IHF committee on amplifier measurement standards were discussing their projected Music Power Rating measurement, they were still influenced by the prejudice thrown up earlier.

The committee recognized that an instantaneous peak figure has more direct bearing on performance with program. But they decided to stay with the instantaneous average for their choice. After all, the 2:1 argument can cut both ways and it is a fixed relationship—on a simple sine wave.

## Noise

A similar psychological problem arises in the measurement of amplifier noise, which includes the thermal noise, generally recognized as hiss, and various forms of hum. If you measure the noise level of some amplifiers and also look at it, the result will be as at Fig. 4-2. The level shown on the meter is more due to hum than to random noise. Yet when you listen to this amplifier, you may not hear the hum at all, only the hiss. If you can hear the hum at all, it is probably much quieter than the hiss.

This is because the reproduced sound is at low level, not far above the threshold of audibility, so the hum frequencies are lost due to the insensitivity of human hearing at the low-frequency end. Further, if the hum is pure induced 60 Hz, it is far less likely to be audible than if it is 120 or 180 Hz, due to poor smoothing on a full-wave rectified supply, or magnetic induction from a saturated power transformer, respectively.

These facts suggest that a weighted characteristic should be used with the meter, so the reading is more closely indicative of what is likely to be heard. The problem with doing this is that people who have gone to great trouble to meet noise specifications, using a "flat" (unweighted) meter will cry "foul."

Output noise is specified relative to either a standard power level, or to the maximum power of the amplifier. Whichever is used should be stated, to avoid ambiguity. Both are justifiable, under different circumstances. Suppose you have a 50-watt amplifier, of which you only use about 2 watts: then absolute power level of the noise is most

# The Sound of Marantz

## is the Sound of

### Music at its Very Best.

**SLT-12 Turntable**, with Straight Line Tracking—a revolutionary development from Marantz. Finally, the art of tracking a record precisely duplicates the art of cutting a record. The Marantz SLT-12 Straight Line Tracking System exactly conforms to the angle, posture and the tracking used in the cutting of an original master stereo record. This perfect compatibility eliminates inherent deficiencies of conventional swing arm record player systems and gives incredibly perfect reproduction. It is the only system available which faithfully reproduces sound as it was originally recorded.

**10B FM Stereo Tuner**—rated by Hi Fi/Stereo Review magazine, “I have never seen a tuner to compare with it...so outstanding that it is literally in a class by itself”

**7T Solid State Stereo Console**—a solid state component unequalled in performance, versatility and flexibility.

**8B Dual 35 Stereophonic Power Amplifier**—American Record Guide magazine says, “The Marantz 8B is a logical choice for ears that demand the best sound for now and for the future.”

## marantz

MARANTZ, INC. SUBSIDIARY OF **SUPERSCOPE** INC.  
25-14 BROADWAY, LONG ISLAND CITY, NEW YORK

Model 7T Stereo Pre-Amplifier



Model 8B Stereo Amplifier

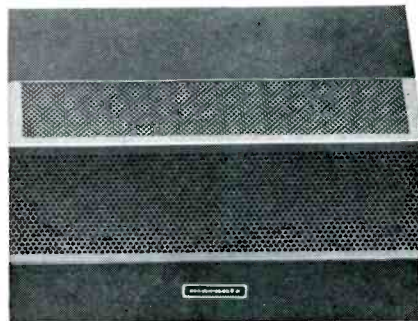

Model SLT-12 Turntable



Model 10B Stereo Tuner



*A wonderful adventure in sound awaits you with your discovery that the sound of Marantz is the sound of music at its very best. You, too, can own an incomparable Marantz system. Ask your dealer about the easy finance plan.*

Circle 121 on Reader Service Card

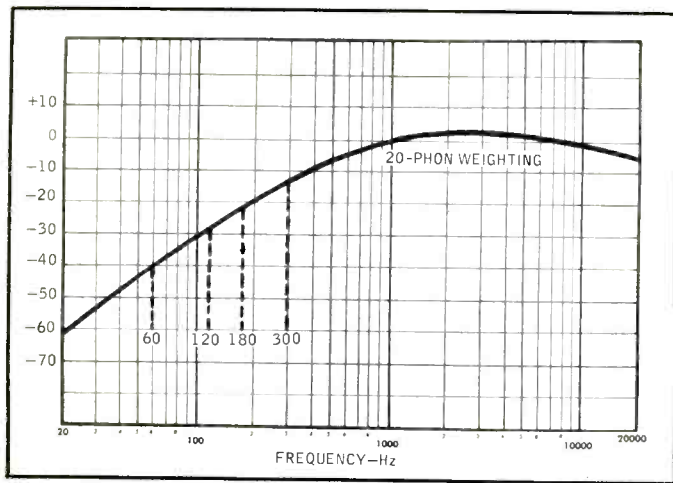

Fig. 4-3. Weighting for measuring noise (20 - phon level).

meaningful, because the 50-watt level is some 14 dB higher than you ever use. On the other hand, an amplifier where the same 50 watts is distributed between a number of speakers, so 50 watts is the peak level actually used, the maximum power output could be used as the reference more meaningfully.

**Weighted Measurements**

Now suppose we consider a typical case to illustrate weighting. Using a 20-phon weighting (Fig. 4-3, threshold-of-audibility weighting, is even steeper) 40 Hz is 40 dB less sensitive than 1000 Hz, 120 Hz is 24 dB down and 180 Hz is 10 dB down. Assume we have a noise level, exclusive of hum, that measures +20 phons and that we have a variable amount of hum, of different frequencies. We list the different quantities and their effect, writing the final combination in a column to indicate which dominates, hum or hiss (in-between indicates they are equal).

Much as that appears to present an argument for using weighted measurements, imagine the case where an engineering department has worked hard to achieve a noise level equivalent to +20 and a hum level to match, without weighting—this might read -70 dB in electrical terms—and then to find a manufacturer whose hum level is 40 dB higher who lists the same figures! You have to admit, it does seem a bit like cheating, from their vantage point. But on the other side of the argument, for most audio applications, relative audibility has more practical significance than absolute level.

**Intermodulation Distortion**

The main argument for turning from the harmonic to intermodulation distortion measurements was that the latter are more representative of the kinds of distortion that happen to program material (in terms of audible effects). To understand the significance of measurements made, we need to think a little

more about the mechanics by which distortion occurs in amplifiers.

The most obvious form of non-linearity is that of the transfer characteristic. Most amplifiers have a low-frequency cut-off as well as a high-frequency cut-off, and thus cannot handle d.c., to measure step-by-step increments

Actual hum level	Actual hum frequency	Weighted reading due to hum only	Hum domt.	Combined effect	Hiss domt.
+50	60	+10			+21
+30	60	-10			+20
+50	120	+26	+28		
+30	120	+6			+20
+50	180	+40	+40		
+30	180	+20		+23	
+20	180	+10			+21

of input and output. However, non-linearity of transfer characteristic can best be understood by imagining increments of signal, which may best be thought of as steps of d.c. change, such that each step may be measured as a separate entity.

Thus, if we plot changes of input voltages or current horizontally, we

mental is nulled out, as in the input/output bridge method, the vertical will receive only the harmonic residue and, by increasing the vertical input gain by a known amount, a harmonic-distortion reading can be obtained directly from what started as a transfer characteristic display.

If the nulling resistors from input and

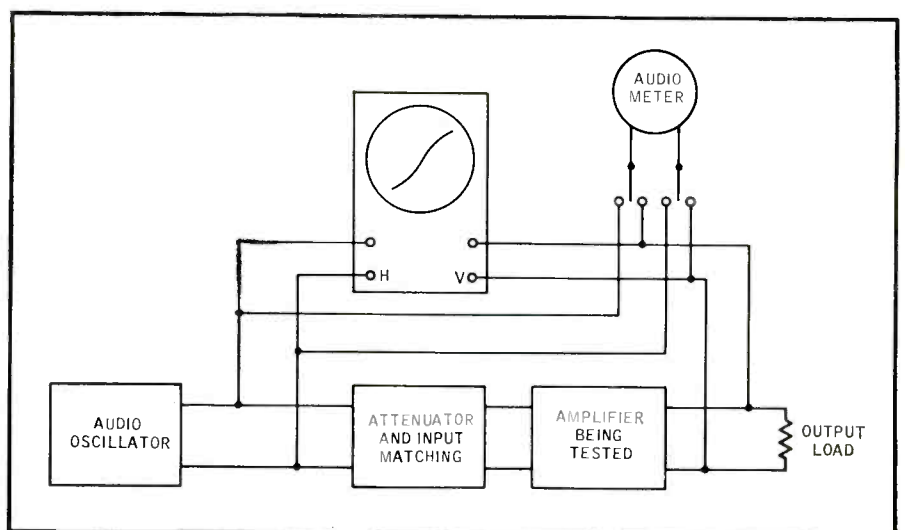
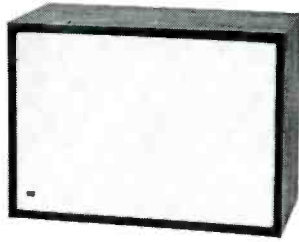
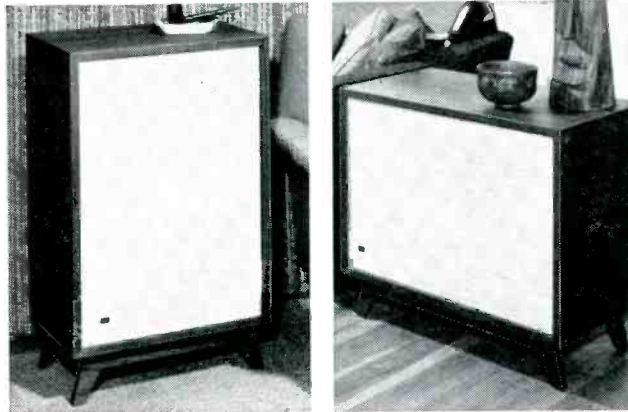

Fig. 4-4. Presentation of amplifier transfer characteristic, by adjusting trace to approximate a 45-deg line (how straight depends on how good the transfer characteristic is).

## Small Speaker'



## Big Flexibility



## Bozak Quality

# The Bozak Concerto III / Model B-313

If you want the realistic reproduction that only Bozak loudspeakers can bring to your home music system but your room won't accommodate full-sized speakers, where do you turn?

To the Bozak B-313.

### Three-Way System, Compact Enclosure

It's a full-sized three-way Bozak system in a compact enclosure. The speaker complement is identical to the famed B-302A system—bass, midrange and two treble-speakers along with the same crossover network used in all full-sized Bozak systems. Each component is identical to those used in Bozak's Concert Grand, the world's finest speaker system.

### Real Bozak Performance

The performance, too, is identical to the B-302A, except the low-range frequency response extends only to an honest 45 cycles, rather than to 40 cycles. We're sorry about that,

but the laws of physics won't permit 40-cycle notes to be reproduced in such a small enclosure.

There's even a small bonus in the slightly foreshortened frequency range. When you move to larger quarters, just transfer the components to a larger Bozak enclosure, and you automatically extend the bass response.

### About The Enclosure

Measuring just 24½ x 17¼ x 12¼ deep, it's slightly larger than so-called "bookshelf" speakers, but it can be used on a shelf. It's also slightly smaller than the usual free-standing speaker, but it can be used on the floor, either vertically or horizontally. Used with the available floor stand, it becomes a handsome end table.

The classic simplicity of the cabinet design permits its use with any decor. Naturally the wood surfaces are genuine walnut. The matte finish is hand rubbed in the true Bozak tradition of craftsmanship.

You can't find a better speaker for a small room.



Box 1166, Darien, Connecticut  
Circle 122 on Reader Service Card

# EXPERTS' CHOICE:

The editors whose job it is to know—recommend DYNACO

## STEREOPHILE

In this perfectionist magazine's selection of Recommended Components in each issue, Dyna preamps, amplifiers, and the Dynatuner have consistently dominated Groups B and C in all applicable categories. In their own words: "Component categories are as follows: Class A — Highest in price and prestige value, top quality sound; Class B — Sonic quality about equal to that of Class A components, but lower in cost; Class C — Slightly lower-quality sound, but far better than average home high-fidelity; Class D — Good, musical sound, better than the average component system but significantly less than the best sound attainable."

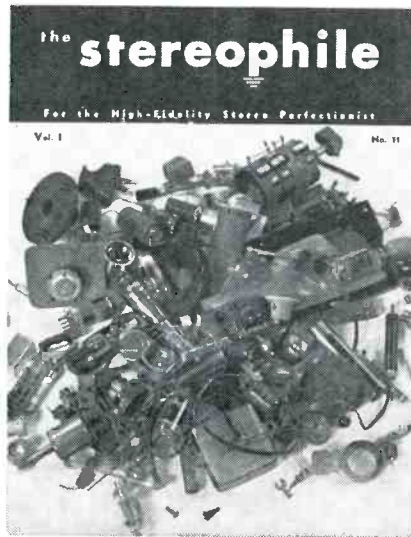

**HI-FI BUYERS GUIDE 1966**  
The top three Shoppers Special recommendations are clear:

- Maximum Fi — PAS-3, 2 Mark IIIs, FM-3
- Music Lovers — PAS-3, Stereo 70, FM-3
- Most Fi Per Dollar — SCA-35 and FM-3

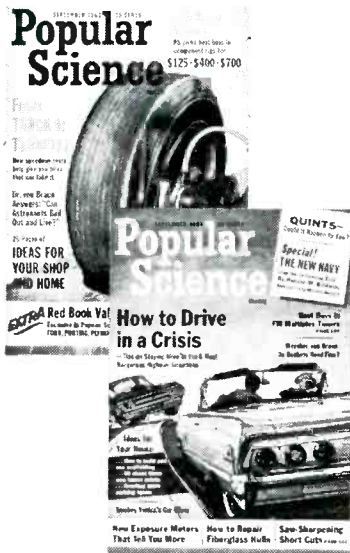

## POPULAR SCIENCE — 1963 and 1964

"The Low-Down on Hi-Fi Stereo" in September 1963 picked the Dyna PAS-2 preamp and the Stereo 70 amplifier for their top-most system at \$700 "selected to please the true hi-fi buff" with the further comment "It was the unanimous opinion of the panel that you could spend well over \$1000 and not get any better sound from your records."

The "Low-Down on Hi-Fi Stereo Tuners" in September 1964 picked the Dyna FM-3 in both major categories. It was one of the three assembled tuners over \$150 selected as "outstanding buys," and one of two tuners which were ranked as "definitely the best of the under-\$150 kits."



**FM-3**  
Stereo  
FM Tuner  
Kit  
\$99.95



**SCA-35**  
Stereo  
Amplifier  
Kit  
\$99.95



**PAS-3X**  
Stereo  
Preamplifier  
Kit  
\$69.95

Complete specifications and test reports are available on request.

**DYNACO INC.** 3912 POWELTON AVENUE, PHILADELPHIA 4, PA



# DYNACO IS BEST

for quality, performance and value!

**Modern Hi-Fi & Stereo Guide '64**  
*"Experts Choose The Most Sound For The Money" with the Dyna SCA-35 in 3 out of 6 systems, and the PAS-3 with 2 Mark IIIs, and the FM-3 separately picked in two other systems.*

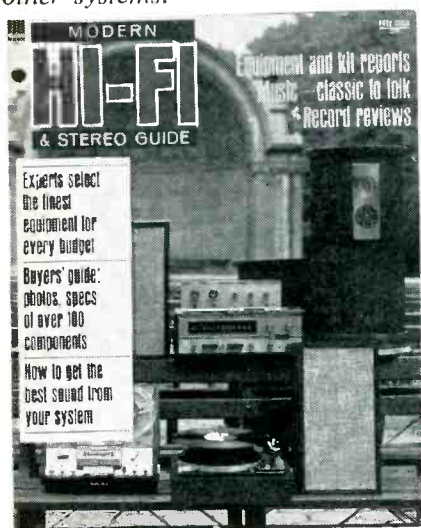

## HI-FI TAPE SYSTEMS 1964

"Editor's Choice Of Hi-Fi Systems": "Maximum Fi — The Dyna . . . (FM-3, PAS-3 and 2 Mark IIIs) . . . is the least expensive way to obtain state-of-the-art performance. Music Lovers — The Dyna . . . (FM-3, PAS-3 and Stereo 70) . . . has been recommended by more experts, and their nephews, than any other hi fi system. We don't hesitate to join the parade knowing that we run no risk whatever that anyone will be unhappy with the expenditure. Most Fi Per Dollar—This makes it three in a row for Dyna but we won't apologize. The SCA-35 is the finest low powered amplifier on the market, delivers 16 watts from 20 to 20,000 cycles at less than 1% distortion and below 3 or 4 watts the distortion is unmeasurable."

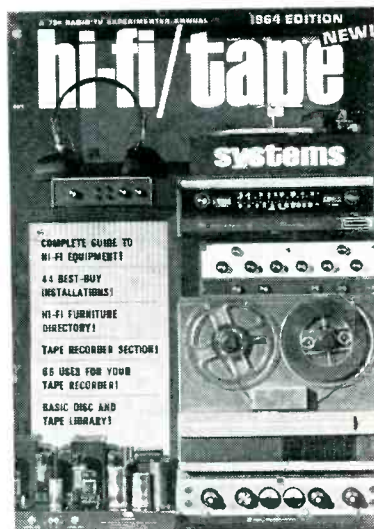

## CHANGING TIMES—The Kiplinger Magazine

The July, 1965 issue of Changing Times, the Kiplinger Magazine, makes recommendations for 5 fine stereo systems in its article 'The Best Stereo Your Money Can Buy'. A copy of this article is available on request.



2 Mark IIIs  
60 watts/  
channel  
Kits  
\$79.95 each



Stereo 70  
35 watts/  
channel  
Kit  
\$99.95



Stereo 35  
17.5 watts/  
channel  
Kit  
\$59.95

In Europe write Audiodyne a/s Christian X's vej 42, Aarhus, Denmark

**DYNACO INC.** 3912 POWELTON AVENUE, PHILADELPHIA 4, PA.

Circle 123 on Reader Service Card

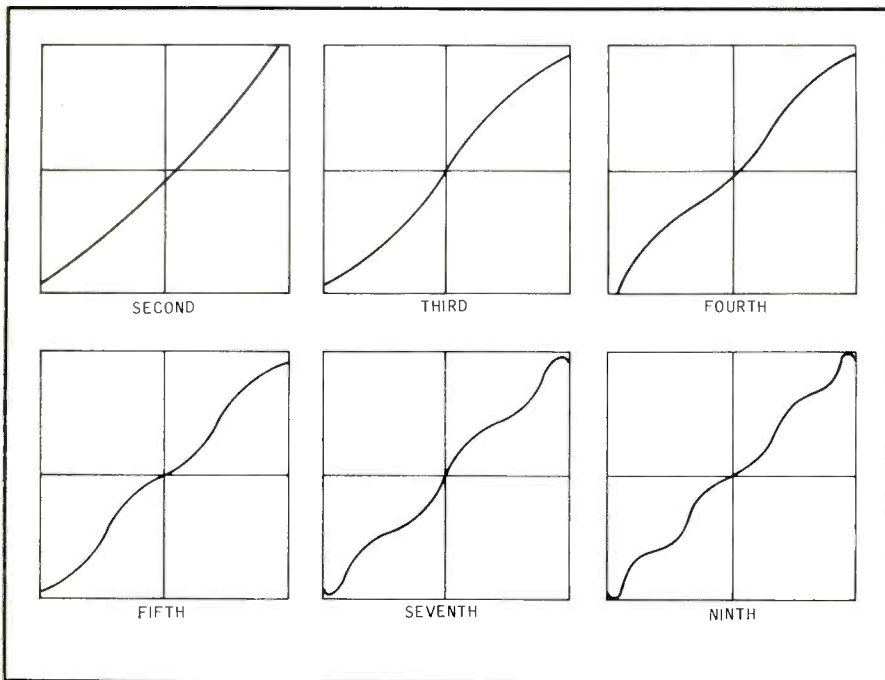

Fig. 4-5. A selection of transfer characteristics, each containing 5% distortion, representing one harmonic only. The harmonic is identified under each.

output have equal value, the harmonic residue at the null point, when balance is achieved, is half that at the output end, because it is zero at the input end. So, if increasing the gain of the vertical input 100 times causes the trace to have the same vertical height as was the direct output before increasing gain, this means there is 1 per cent distortion at null point, or 2 per cent at the output.

Incidentally, this method of reading automatically gives a peak-against-peak reading. But, to continue with our discussion of the significance of non-linearity of various forms, we have learned that the effect of distortion depends on its *order*, which means not the *amount* by which the line deviates from straight, so much as the *rate* at which it deviates.

Five per cent harmonic content, of whatever order (multiple frequency) will represent a regular deviation in the vertical that is 1/20th of the vertical height due to fundamental (Fig. 4-5). Examination of these transfer lines will show quickly that—particularly near the ends of the lines—the higher the order of the harmonic, the more radical the “bentness” of the transfer line, as well as the more noticeable the distortion it causes. There should be some way to get a reading that reports this “bentness,” instead of merely deviation.

“Bentness” of the line shows up better as a derivative than as direct deviation. As Fig. 4-5 shows, the higher the order of harmonic, the more the *slope* of the line has to change to achieve the same total deviation. So we need a test to explore the change

in slope of the transfer characteristic. This is what the SMPE form of intermodulation test aims to do. The low frequency moves the signal point back and forth, slowly, along the “curve,” while the high frequency rapidly scans a short part of it.

The change in output amplitude of the high-frequency signal is a direct indication of the change of slope over the part explored. But the effectiveness with which this is achieved depends on the relative magnitudes of the two signals. If the high-frequency signal is as big, or almost as big, as the low-frequency signal, higher-order curvature effects will be swamped by the amplitude of high frequency “scan.”

For example, assume we have a transfer characteristic that goes, not suddenly, but quite rapidly, into clipping, so it could be analyzed as pure 7th order curvature (not harmonic, but transfer curvature, Fig. 4-6). A harmonic analyzer would find about 5.1 per cent 3rd, 1.7 per cent 5th and 0.24 per cent 7th in the output this produces, which make up a true rms combination of 5.4 per cent. An average-reading meter will give somewhat less than 5 per cent reading. A peak-indicating comparison would read about 7 per cent. This is not to be confused with the even bigger peak/average ratio a sudden clipping would give, in which case the reading would be about 14 per cent peak and less than 2 per cent average.

Where the curvature flattens completely (horizontal dashed line construction, Fig. 4-6) the slope is zero. If the high frequency is totally within

such a flat part, it momentarily vanishes from the output. So using a very small high-frequency signal would cause its amplitude to fluctuate between a maximum in the middle of the low-frequency wave, and zero at the extremes. Average modulation on this particular wave, with a very small high-frequency wave, would be about 50 per cent.

#### The SMPE Test

In the SMPE test, basic test circuit for which is shown in Fig. 4-7, two standards were set down, with one preferred. One used equal signals, low and high frequency. The preferred one made the high-frequency one-fourth the magnitude of the low frequency. While still smaller relative amplitude would make the test better for detecting higher order components, this relationship gives a good compromise, by not making the high frequency too small for measurement with reasonable accuracy.

Reverting to our example of 7th-order curvature, for which the rms harmonic was 5.4 per cent, and using the one-to-one ratio SMPE IM test, the result would read about 7.3 per cent—quite similar, in this instance, to the peak/peak harmonic. Using the four-to-one ratio, this jumps to 21 per cent. Using a theoretical 9:1 ratio (low being 9/10th of total amplitude and high being 1/10th) the reading goes up to 39 per cent. With sudden clipping, instead of merely curvature the change is even more dramatic.

#### CCIF Test

The other kind of intermodulation test uses two higher-frequency signals, spaced apart by a fixed frequency, usually 100 Hz. The test has the advantage of simplicity, because all that is needed to detect the distortion product is a simple 100-Hz filter. But this also means

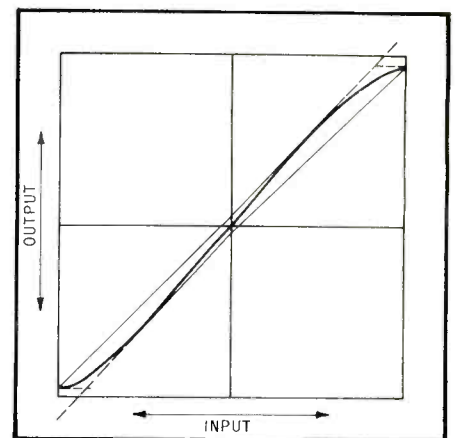

Fig. 4-6. Transfer characteristic with pure 7th order curvature, discussed in text, as basis for hypothetical case.

The new Empire Grenadier is the world's most perfect speaker system. If there is any doubt in your mind, take a seat and listen...



 **EMPIRE**

CIRCLE NUMBER 108 ON READER SERVICE CARD

You're on the threshold of an entirely new concept in sound, a voyage into startling reality, a sense of presence never before achieved in speaker systems.

Close your eyes, think performance only. Hear the penetrating thunder of the kettle drums... resounding clamor of the cymbals, and the soft, sweet brilliance of the reed section. This is the Empire Grenadier, the only speaker that lets you sit anywhere—hear everything. Now open your eyes. Take a close look at some of its amazing features:

A revolutionary die-cast divergent acoustic lens assures fuller frequency and separation, plus broader sound propagation (over 50% more sound dispersion of its highs and mids than conventional speakers).

Exclusive dynamic reflex stop system allows you to adjust the bass and treble response to suit your individual acoustics.

A 12" woofer faces downward, close to the reflecting floor surface, feeds through a front loaded horn with full circle aperture throat. This provides 360 degree sound dispersion and prevents standing waves from developing in the room.

The world's largest (18 lbs.) speaker ceramic magnet structure, an ultra-sonic domed tweeter, full presence mid-range radiator, and complete symmetry of design with terminals concealed underneath... and the most classic looking, elegantly styled chassis 'round.

Out of sight but never out of sound—the Empire Grenadier—world's most perfect speaker system.

No less perfect than the Grenadiers are the incomparable Troubadors — complete playback systems.

The famous Empire 398 and the Empire console 498.

The Troubadors consist of the Empire 3-speed professional "silent" turntable... 980 dynamically balanced arm with sensational dyna-lift... and the new Empire "Living cartridge", featuring the exclusive magnetic cone stylus. Empire has built its home around a family of quality products, years ahead in design and performance. For complete color brochure write to Empire—for a sound demo go 'round to your local Hi Fi showroom.

**EMPIRE** SCIENTIFIC CORP.  
845 STEWART AVE., GARDEN CITY, N.Y.



**MODEL 3000P**

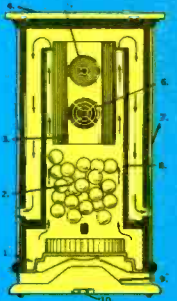

- OUTSTANDING FEATURES**
- 12 inch mass loaded woofer with floating suspension, four inch voice coil and world's largest (18 lbs.) speaker ceramic magnet structure.
  - Sound absorbent rear loading.
  - Die-cast acoustic lens.
  - Imported marble top.
  - Ultra-Sonic domed tweeter
  - Full presence mid range radiator.
  - Damped enclosure
  - Dynamic Reflex Stop System.
  - Front loaded horn.
  - Complete symmetry of design with terminals concealed underneath.

CIRCLE NUMBER 108 ON READER SERVICE CARD

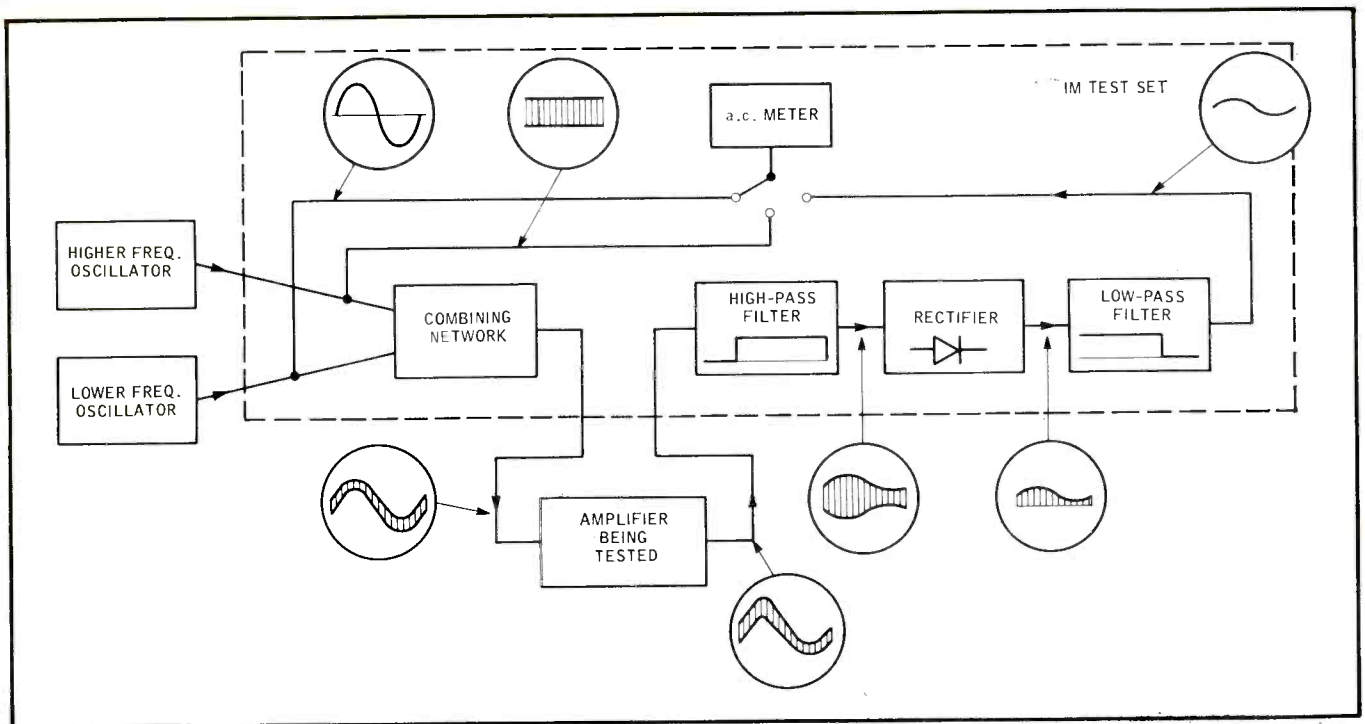

Fig. 4-7. The complete set-up for making the SMPE intermodulation test.

that the only distortion it detects is even-order, or asymmetric types.

Both types of test set include means for measuring input signal, which includes a calibrating procedure. By setting the gain of the volt-meter amplifier, when measuring input, to a predetermined mark on the scale, the same gain-setting will read off distortion percentage directly, when the meter-function switch is turned to the appropriate position.

For second harmonic only, the CCIF method will give a proportionate reading. For other even order (asymmetric) distortion terms, there will also be a 100-Hz component, with multiples thereof as spurious tones. Fig. 4-8 shows an example of distortion occurring with fourth-order curvature, such as could result due to poor matching of push-pull active elements (tubes or transistors). The addition of filters to find the multiples of 100 Hz would find some of these other forms, or their generated components, relatively simply. But odd-order terms, due to symmetrical distortion, will not register with this test, because they will maintain symmetry about the center line.

Unfortunately, odd-order harmonics (especially 5th and 7th) are more objectionable than even-order, because many of them are non-musical, or discordant. But the prime cause of distortion with multiple high frequencies is the generation of beat tones that are non-musical, which this test does discover quite effectively, by direct simulation. Incidentally, it may find distortions of this type that direct harmonic tests, even at this higher frequency, would not find, for two reasons:

(1) At the higher frequencies, the roll-off of the amplifier may attenuate the harmonics caused by the non-linearity, but it would not attenuate the beat tones;

(2) Whether or not the steady non-linearity (the transfer characteristic for a steadily maintained signal) produces any asymmetrical distortion, this test signal fluctuates the effective high frequency being handled at the lower, beat frequency. So if the supply circuit should "respond" to the 100-Hz rate of fluctuation, it may modulate the higher frequencies in a way that would not occur with a steady tone of higher frequency, causing the kind of asymmetrical distortion which this test detects, but in a different way.

#### Deficiencies of IM Tests

So much for what these respective tests do "catch." The dissatisfaction with them arises from the fact that there are distortions they don't "catch."

We have already mentioned that the CCIF test does not catch symmetrical distortion, under any circumstances. But what of its kind of distortion, does the SMPE test miss? And is it possible a test could be devised that would not miss the various components missed by these tests? How important are the components that they do miss?

In our introductory installment, we mentioned that the SMPE test will only detect *amplitude* fluctuation of the higher frequency. Which leaves frequency or phase fluctuation (which are the same thing, using different terms of reference) that it will not detect. Is this form of distortion at all common? When you've tried to think out this possibility, look in the panel for our answer.

Frequency or phase intermodulation is more common than you would expect. The only way to find whether it is present or not is to test for it. It usu-

(Continued on page 46)

Fig. 4-8. Distortion of CCIF signal by transfer characteristic with 4th order distortion.

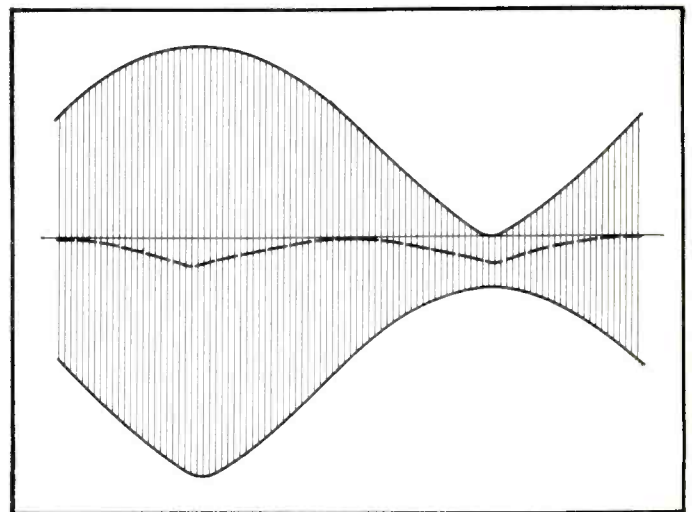

# Intimations of Irresponsibility: Circuits for Speculation

GEORGE FLETCHER COOPER

The first difficulty confronting the experimenter is the decision as to the subject of the experimentation. After that, everything should come easier. Here are several problems which might be worth solving, and which could well provide some hours of profitable experimentation.

**M**OST ENGINEERS MUST FIND themselves at times with an idea which they cannot apply at the moment and which may not work, anyway. Very often you discover that it will not work as soon as you settle down to describe it, but this usually means that you have an application round the corner. Sometimes you give a good deal of pleasure to junior engineers by letting them see the fallacy first; sometimes you give a good deal of pain to yourself by discovering in the last part of the design that you need some completely unrealistic component. Then there are the occasional winners. If you are unlucky you have them in a notebook, waiting for some spare time and someone else comes along with them; if you are lucky you find you have one of those circuits which seems to be bug-free and which you use for years before boredom makes you look for something else.

I propose to describe in this article some audio systems which may not work or which may not be worth-while even if they do work. Let us be quite clear about this from the beginning. *Caveat emptor, cave canem*, nobody asked you to volunteer. If you build a machine along the lines I describe and all you get when you switch on is a cloud of smoke or a pillar of fire you are assured of my sympathy, but of nothing more.

The first circuit I want to consider is a class-B amplifier, using transistors, based on the duality principle. We have seen this in the text-books but always with the provision that this is the sort of circuit used for submarine cable repeaters but quite unsuitable for everyday use. Is this really true?

The use of duality in the design of transistors circuits was meant to be a painless way of converting our tube circuits into transistor circuits without actually thinking. I do not believe that it was widely used because I suspect

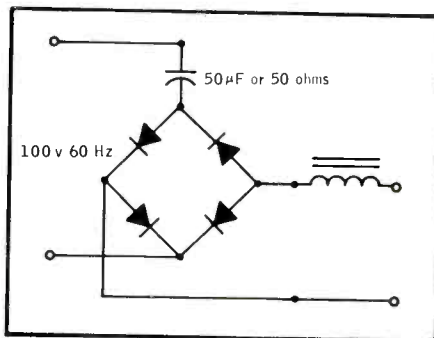

Fig. 1. Constant-current, 2-amp power supply unit.

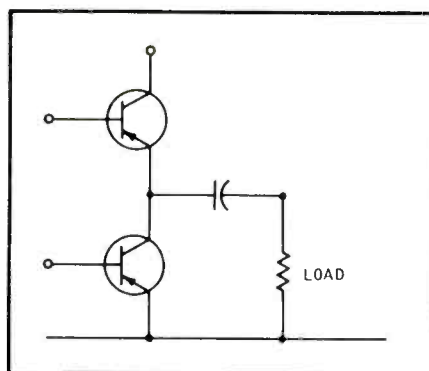

Fig. 2. A not unfamiliar circuit used in an unfamiliar way.

that there are a good many people who fall into confusion when they have to write down the dual of any but the simplest circuit. Or even, when I think again, of any circuit. Let us just clear the ground. We say that a tube is a voltage device while a transistor is a current device. Whenever a tube is cut off we make the transistor bottom and whenever the tube is bottomed we make the transistor cut off. If we use a high impedance in the tube circuit we use a high admittance, a low impedance, in the transistor circuit. Shunt capacitances become series inductances, and so on.

All this is quite logical and simple until we want to build a circuit and make it work. Our tube circuit is operated from a battery, a constant-voltage source and so quite clearly our transistor must be operated from a constant-current source. Long, long ago this idea was proposed for lighting our homes: to switch off a lamp you simply put a short-circuit across it. The technique is used for the strings of lamps used on Christmas trees, and you know the problem you have if a lamp fails: if two lamps fail at the same time your behaviour will be grounds for divorce.

The cable engineers like constant-current working. They cannot maintain

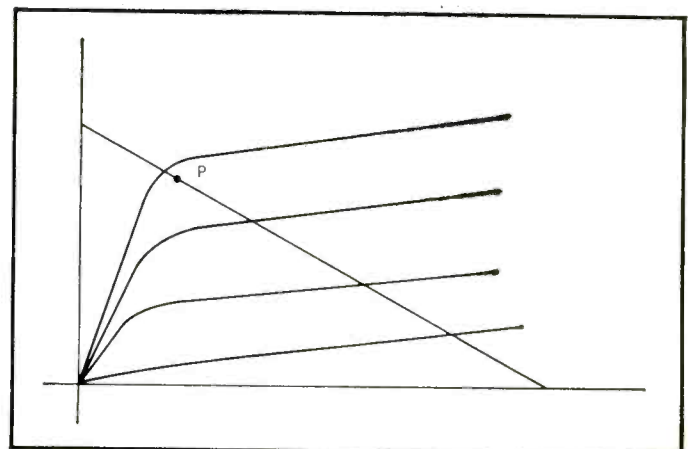

Fig. 3. Characteristic curves of the transistor circuit of Fig. 2.

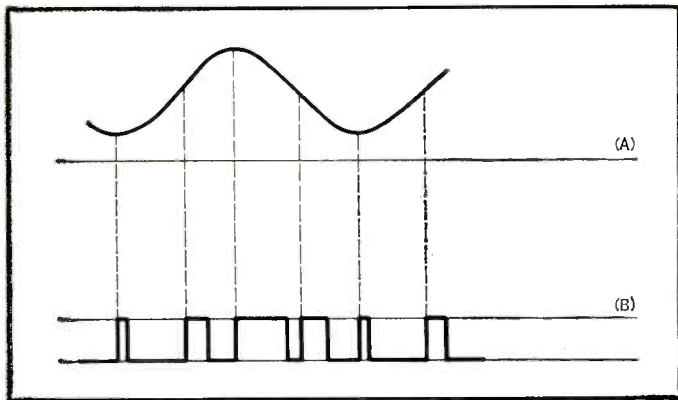

Fig. 4. Method of converting a sine wave to pulse-length modulation.

the voltage at the distant parts of the cable, but they can be sure of not losing any current. Anyway, unless all their repeaters are working, they are completely out of business. They build themselves special constant-current supply units which drive the right current into the cable and which are themselves pretty complex pieces of equipment. If we have to do this we might as well give up.

If you live in Aden you will have a 230 v., 50 Hz supply coming into your home; in Yugoslavia it is 220 V. 50 Hz (the U.S. Department of Commerce reference does not list Zanzibar or Zululand). They do not know about my own college supply, which was 40 volts but they think that everywhere in the world you can expect to get at least 110 volts and possibly 220-240 volts at 50-60 Hz. For a transistor amplifier you will probably be content with something of the order of 20 volts. Designers' views differ on this as you can see by looking at my survey in the May, 1962, issue of *AUDIO*. In order to operate a conventional amplifier from the power mains we use a transformer to give us this 12 or 24 or whatever voltage supply.

Electric power is not particularly cheap, if you compare the cost per kilowatt-hour with the cost of power produced by burning oil, but you can still get quite a lot for a dollar. Suppose that we consider a transistor output stage which will peak up to 2 amps and we decide to put a steady 2-amp load on the outlet. We shall get the best part of 5 hours operation from the 110 volt supply for the consumption of one kilowatt-hour. How many cents will that cost you?

We may therefore consider supplying our transistor amplifier directly from the power line through a high impedance which will give us what is virtually a constant-current source. Let us assume, to make the arithmetic easy, that we are to take 2 amps from a 100-volt line at a frequency of 50 Hz. We need a resistance of 50 ohms at  $\omega = 300$ , or do we? Why should we not limit the current with a capacitor? Then we shall have  $1/\omega C = 50$  for  $\omega = 314$ , or  $C = 1/15000$ , which is about  $66\mu\text{F}$ . I just do not know if you can get a  $66\mu\text{F}$  capacitor which will carry 2 amps of alternating current at a reasonable price. After all, I said I was just discussing

systems I have never explored fully. In any event we can usually find something to do with 200 watts, even if we have to use lamps or a resistor.

The power supply unit for our amplifier takes the form shown in Fig. 1. Note that there are no capacitors in the smoothing system, for they would give us a low impedance, which we most certainly do not want. The inductance must keep the current flowing in a load of about 10 ohms at a frequency of, say, 40 Hz, and so it must be at least 50 mH. This value will probably leave too much ripple on the current and I feel we should probably move up to at least 1H. I must say that this choke may be the major problem in the whole design because a 1-H, 2.5-A choke will weigh about 20 lbs., while a 100-mH, 2.5-A choke weighs only

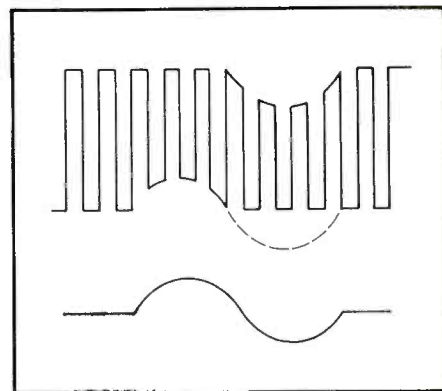

Fig. 6. Waveforms encountered in a single-transistor Class-B circuit.

4½ lbs. This second figure is about the weight we should find for the mains transformer we are eliminating.

The obvious configuration to use for the amplifier is the well-known half-bridge form shown in Fig. 2. The unusual thing will be the biasing of the transistors, which must be brought to the quiescent point P in the diagram of Fig. 3. This will be, perhaps, 2A, 0.5 volts, so that the quiescent transistor will be dissipating 1 watt. Used in the conventional way we should set the transistor to pass 100-200 mA, but with 10-20 volts applied to it, so that we should have anything from 1 to 4 watts of transistor dissipation. In general we can say that the higher the voltage to which we can swing the transistor the greater is the improvement under this heading. I do not propose to examine the biasing arrangements because these will be tied up with the driver circuit. We shall probably use a Darlington compounded pair or one of the p-n-p/n-p-n equivalent systems and the biasing to the quiescent point will probably be arranged in the driver or pre-driver stage.

There are, of course, a lot of loose

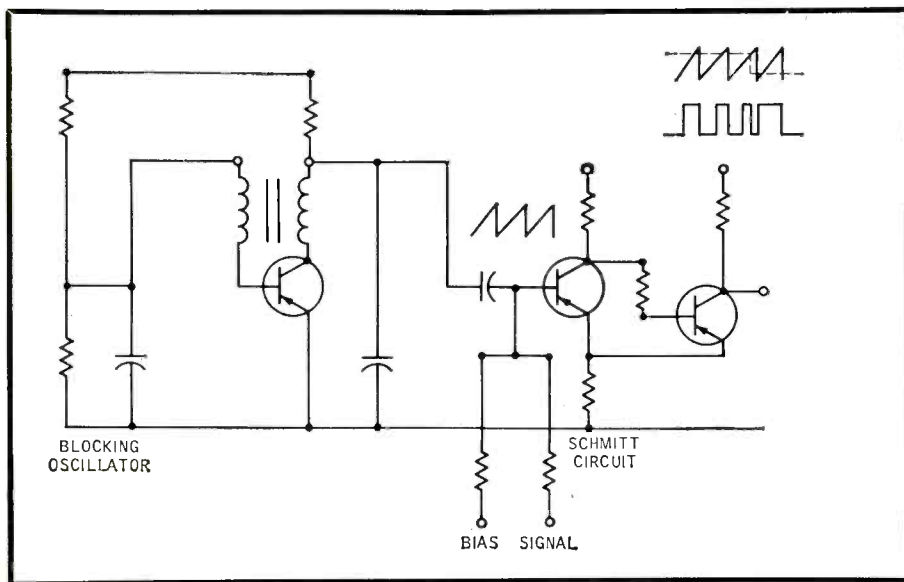

Fig. 5. General form of a pulse-length-modulator circuit.

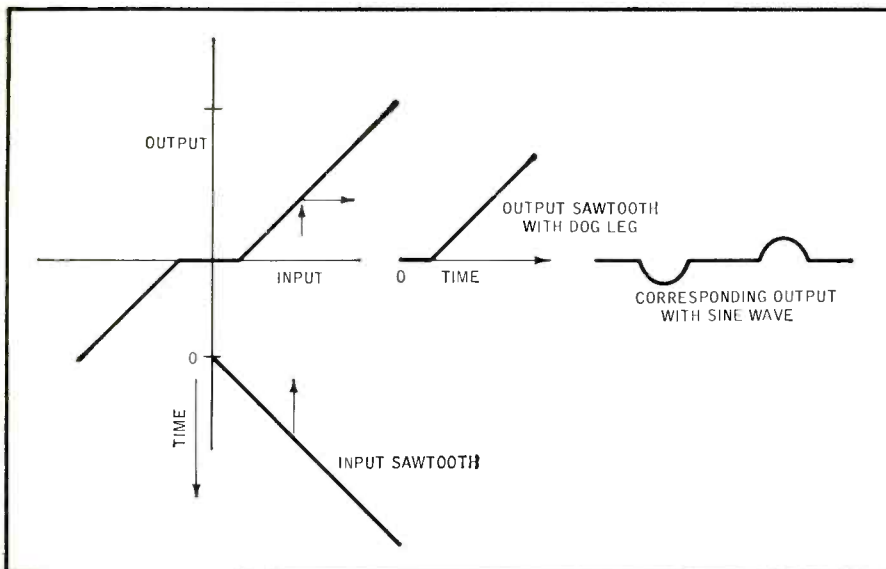

Fig. 7. Stylized push-pull characteristic using a sawtooth-wave input, with a sine-wave input added to observe the result.

ends which can only be made tidy by getting down to a full-scale design and that is just the point: it may be a waste of time. One aspect which may give a little trouble is putting the feedback on. I suspect that the logical thing to do here is to put on feedback from the load current, which means that an overdamped speaker system is desirable. I cannot justify this suspicion, which is related to the use of the feedback to keep down the supply hum, but it is a point for the designer to keep in mind.

#### Another Power Amplifier

The second type of circuit is again a transistor power amplifier, although it started out in my mind as a thyatron system. We need to go back about 15-20 years: just how far back depends on what you were doing around that time. There was quite a lot of excitement in the earlier part of the period but apart from all else it was a period when pulse modulation systems of this kind and that were being hailed as the systems of the future. It was around this time, too, that a British politician (the leaders of

my party are statesmen, the leaders of your party are politicians) announced that there was a completely new system of modulation, but as he was turned out of office not much later and had not revealed the new system to his technical advisers, this has joined the song the sirens sang and the name Achilles took when he hid among the women.

We are only concerned with the least interesting form of pulse modulation, pulse-length modulation. Interest is a subjective value, of course, but I think any engineer will recognize the sort of scale of interest which ranges upwards in complexity and then shows sharp leaps as sophistication produces simplicity. In my rating Wagner stands higher than Weber, but Mozart stands way out above Wagner. Pulse-length modulation is the direct way of coding a signal into pulses and is very easily explained. We take the waveform shown at (A) in Fig. 4 and we sample it at regular intervals. This is just the procedure we follow when we draw a graph from tables: we might put in points every 15 deg. or even every 30

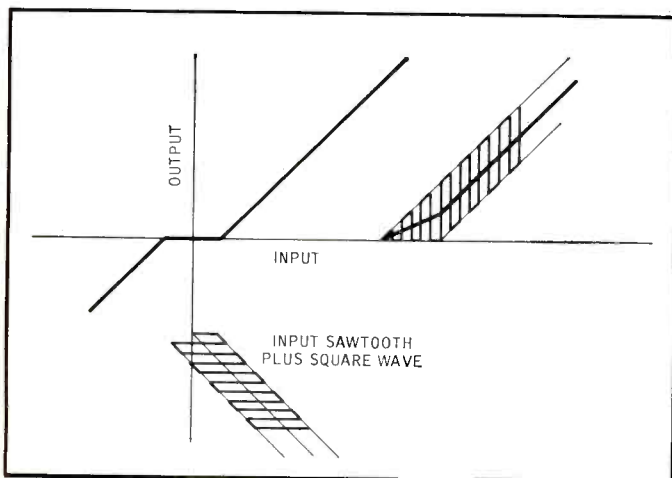

Fig. 8. Similar push-pull characteristic with a square wave added to the input sawtooth.

deg., to draw ourselves a fine wave. Having measured the size of the wave at each sampling point we generate a pulse which has a duration proportional to the size of the wave at the sample point and which has a constant amplitude. This is the waveform shown at (B) in Fig. 4.

The important feature of pulse-length modulation is the fact that the original signal can be recovered just by passing the pulses through a low-pass filter. The pulse rate must be at least twice the highest audio frequency to be handled. A system of this kind will probably be chiefly of interest for public address work, where we want a lot of sound, and here we might get away with telephone quality, which means that we might work with a pulse rate of 10 kHz. We need to be able to switch our transistors on and off in very few microseconds, but there are plenty of fast-switching power transistors nowadays. The important point is that the transistors are operating as they are in inverters, either cut off or bottomed, and consequently the dissipation is pretty low.

The construction of a system operating on this principle depends on the production of a pulse-length-modulator circuit. For this we have two essential parts, the pulse generator, which produces a regular train of pulses which will generate the leading edges of our modulated signal and will operate at the chosen frequency, and the triangular-wave generator and switch, which will generate the trailing edge of our signal at a time fixed by the amplitude of the signal voltage. A blocking oscillator can be used as a pulse generator and one way of proceeding is to allow the blocking oscillator to generate a saw-tooth and to combine this with the signal to control a Schmitt circuit. The general line is indicated in Fig. 5. There are some much more linear triangular wave-form generators which have been developed for time bases and which are based on the gated Miller feedback amplifier circuits. These are fired on by a pulse and the square wave is ended by the combination of triangle and signal. A full analysis of this kind of wave is rather complex, because the signal is not sampled regularly in accordance with the simple theory but is sampled at the moving edge of the pulse.

This principle has been used to provide a 1-kW d.c. amplifier controlling 50 volts and 20 amps with two 2N174 transistors. These have rather too low a cut-off frequency to be operated at the sort of frequency needed for audio amplification: the audio application is still wide open.



**1. With 1 Finger Of Your Right Hand, Pick Out Key A, Key F, Etc.**

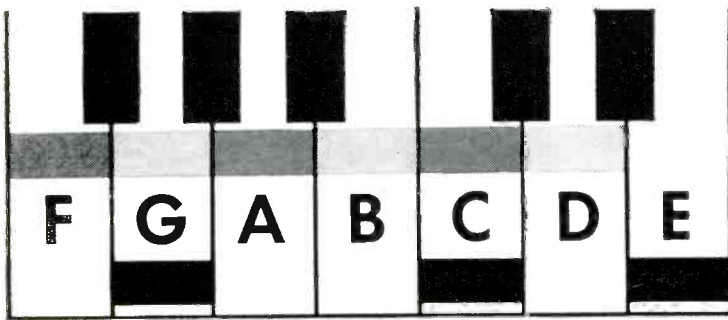
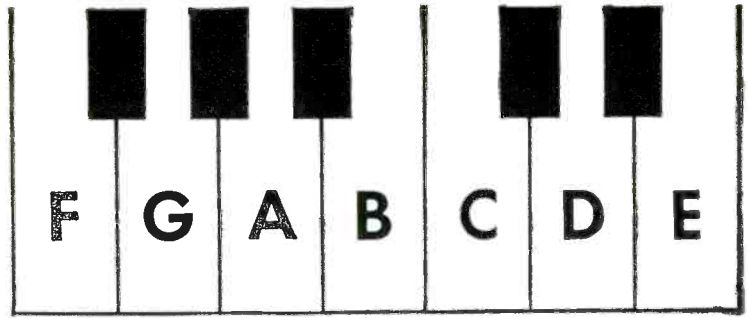

**2. Now Put 2 Fingers And A Thumb Of Your Left Hand On The Red Keys... The Green Keys... Or The Black Keys.**

**3. That's All It Takes To Play Complete Songs On The New Heathkit®/Thomas COLOR-GLO Organ**

Play Complete Songs In Minutes . . . Instead Of Months! Color-Glo key lights on this new Heathkit/Thomas Transistor Organ show you the correct notes and chords. You play melody, harmony and bass notes *instantly* . . . even if you've never played an organ before!

Switch On The Color-Glo, And You're Ready To Play! Each key on the upper keyboard lights up with a letter. You simply match the key's letters with the letters on the music to play melody. For harmony, there are 3 red keys, 3 black keys and 3 green keys on the lower keyboard. Just press and hold the notes that match the background color in the Thomas Color-Glo music book (included). To add the bass, press the pedal that's marked with the same color as the harmony notes. That's all there is to it. Touch the switch again, and the Color-Glo keys disappear, leaving a beautiful spinet organ.

All Genuine Thomas Factory-Fabricated Parts! Other features include ten organ voices; repeat percussion; two 37-note keyboards; 13-note heel & toe bass pedals; variable expression pedal; 2 levels of vibrato; balance control; 12" speaker; 50-watt EIA peak music power amplifier; and hand-crafted walnut cabinet. The transistorized tone generators, the heart of the organ, are warranted for 5 years.

Build It In About 50 Hours! Takes no special skills or knowledge . . . you even tune the organ with a pretuned tone generator. Easy credit terms available, too. Get the full story . . . use the coupon to send for demonstration record and the FREE Heathkit catalog.

Kit GD-325 Organ, 153 lbs. . . . . \$349.95  
 GDA-232-1, matching walnut bench, 18 lbs. . . . . \$ 24.95



Kit GD-325  
**\$349<sup>95</sup>**  
 (less bench)

**Hear It Perform Yourself!**



Send 50c for 7", 33 1/3 rpm demonstration record (see coupon). For full details on this, plus over 250 other Heathkits, mail coupon or write Heath Company, Benton Harbor, Michigan 49022 for FREE Heathkit Catalog.

Heath Company, Dept. 41-4  
 Benton Harbor, Michigan 49022

Enclosed is \$ \_\_\_\_\_, plus shipping.

Please send model(s) \_\_\_\_\_

Enclosed is 50c. Please send Organ Demonstration Record No. GD-232-5.

Please Send FREE 1966 Heathkit Catalog.

Name \_\_\_\_\_

Address \_\_\_\_\_

City \_\_\_\_\_ State \_\_\_\_\_ Zip \_\_\_\_\_

Prices and specifications subject to change without notice.

CL-238

Circle 124 on Reader Service Card

Some years ago Dome described, I think in *Electronics*, a most ingenious way of using class-B operation with a single transistor. As I remember the arrangement—and if there is something wrong blame my memory and not the man to whom I have attributed the circuit—it used the following basic principle: A p-n-p transistor biased to cut-off will amplify negative-going signals applied to the base: if it is biased to bottoming it will amplify positive-going signals. Now apply a large high-frequency square-wave drive which will just cutoff and just bottom the transistor. The result will be that for half the time the transistor will be ready to amplify negative going signals and for the other half of the time it will amplify positive going signals. The behavior of the circuit is indicated by the waveform of Fig. 6. If you care to plot out the average current you can confirm that the audio-frequency component is still there and if you care to do some mathematics, or to hunt up the original paper, you can confirm that the transistor dissipation is a good deal less than it would be for a class-A stage.

I do not feel too enthusiastic about this circuit. The transistor must be a fast switching type and will need a fair amount of drive. It will cost a fair amount to generate that square wave. Above all, I am worried by the cross-over distortion, because we must bias the transistor to just the right points near cut-off and near bottoming. Even so, we will not get that easy matching which we have with a selected pair of transistors biased and degenerated in the most suitable way. There is, however, another square-wave operation which I have not seen described but which may work out well. It is directed toward reducing cross-over distortion in class-B push-pull amplifiers.

When I first met tape recorders they were not very much like the type with which most readers will be familiar. There was none of this modern business of using plastics, for example. The tape was steel tape carried in drums which were of cast aluminum and must have been at least 25 inches in diameter. Getting this lot moving, sometimes at 30 ips, was a job which took brute force and nice timing through the gear-box. The interesting thing was that at this time the tape was operated, as it were, in class A. The bias was a steady current bias, not the high frequency a.c. bias we use nowadays. If no bias were used we could record a larger signal but we got distortion of just the kind we associate with crossover mis-match in a push-pull amplifier stage.

Can we not use a.c. bias for a class-B stage? That is, of course, not the right

question to ask, because we want to know what advantage will be gained by doing so. The answer seems to be that it is a good thing to do, at least a rough sketch of waveforms suggests this. There are several ways of drawing a convincing figure and there are, indeed, two ways of applying the bias. Where do we start?

First of all let us assume that the high-frequency a.c. bias is to be a square wave. For reasons which I shall mention later this is not the best bias waveform to use, and in fact we shall always find it convenient to use an ordinary sine wave. It is, however, very much easier to demonstrate what happens with a square wave and the effect of rounding it becomes quite obvious. This bias can

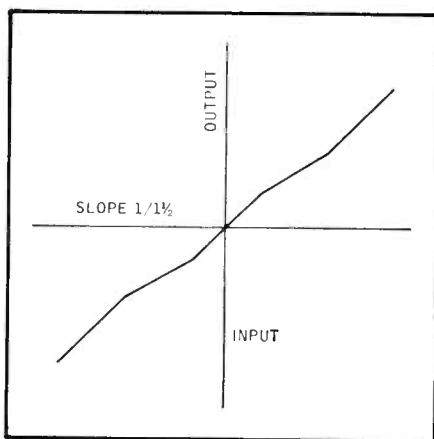

Fig. 9. Transfer characteristic obtained with a larger square-wave bias applied to the circuit of Fig. 5.

be applied to the push-pull stage either as a push-pull bias to be added to the signal or as a push-pull bias, acting like the carrier input of a Carson modulator.

We are interested in the over-all linearity of the system. Usually we sit down and draw diagrams with sine waves and my first sketch was just such a diagram. It is, however, much easier to draw a saw-tooth input and much easier to see how distorted the output has become. From such a characteristic one can even calculate the distortion without too much difficulty. Figure 7 shows an ordinary stylized push-pull characteristic with a very bad fit at the origin, the sort of characteristic which gives atrocious quality due to cross-over distortion. A typical output for a sine-wave input is added rather roughly just to remind you what happens in a circuit of this kind.

Now let us add a square wave to the input sawtooth and see, in Fig. 8, what will happen. The size of the square wave chosen is just large enough to bridge the central gap and there is a period

during which only half the signal is being amplified. The output waveform can be averaged to show a ramp or sawtooth which starts right back at the origin but begins at only half the final slope. The two regions of half slope and full slope are quite distinct.

This kind of characteristic will still produce some distortion but it is important to notice that its nature has changed. We now have distortion due to a change of gain with signal level, but there is still a good deal of gain left. We are not dealing with one of those true clipping situations where the familiar feedback equation  $\mu / (1 - \mu\beta)$  means nothing because  $\mu$  has fallen for the moment to zero.

Suppose that we use a sine-wave bias. The effect will be to soften off the corner of the average transfer characteristic but there will be little effect on the lower-order harmonics which are our main problem. If we try to draw this we just hide the fact that we have made this assumption by putting it in the drawing without saying anything. This rounding-off becomes particularly important if a larger bias signal is used. In drawing Fig. 8, I have used the smallest bias which would make sure that the system never fell into the zero-gain region and in consequence the low-slope area is centered on the origin. With a larger square-wave bias we should get an over-all transfer characteristic of the form shown in Fig. 9 as you can prove for yourself by drawing the corresponding version of Fig. 8. With a sine-wave bias the corners will, of course, be rounded and the characteristic will look much better.

A practical amplifier, of course, does not have this clean linear slope and the total cut-off we have shown. This, we might say, adds an order of rounding. The result will be to improve matters by averaging the slope over a greater length.

It would appear that very much the same kind of result will be obtained if the bias supply is applied in push-push to the two transistors. This may be a better way of operating, although while the output no longer contains a term of the bias-signal frequency it will contain terms of  $f$  (bias)  $-f$  (signal), since the circuit is a modulator. We must use quite a high frequency, say 50 kHz or more. The bias amplitude must be big enough to lift the circuit over the step, but if it is too large the amount of room left for the signal will be inadequate.

None of the circuits described in this article is guaranteed to work. They are offered to you simply as matters of speculation and if you care to try them, good luck. I am sure that some of them will be of value, somewhere.  $\text{\AA}$

# Perfectionist's guide to record playing equipment

You can do all this with both the DUAL 1009 and the DUAL 1019

1. Track flawlessly with any cartridge at its lightest recommended tracking force . . . even as low as 1/2 gram.
2. Play all standard speed records — 16, 33, 45 and 78 rpm.
3. Vary pitch of any record with 6% Pitch-Control.
4. Achieve perfect tonearm balance with elastically damped counter-balance that offers both rapid and fine-thread adjust.
5. Dial stylus force with precision of continuously variable adjust from 0-grams up, plus the convenience of direct reading gram-scale.
6. Start automatically with either single play or changer spindle . . . and start manually at any position on either rotating or motionless record.
7. Remove records from changer spindle or the platter without having to remove the spindle itself.
8. Change turntable speed and record size selector at any time during cycling or play.
9. Install in just 12 3/4" x 11 1/2" area with only 6 1/2" clearance above for changer spindle.
10. Mount, secure and demount from base or motorboard . . . all from above.
11. Even restrain the tonearm during cycling without concern for possible malfunction or damage.

... And to all this, the new DUAL 1019 adds

1. Direct-dial, continuously variable anti-skating compensation for any tracking force from 0-grams up.
2. Feather-touch "stick shift" Cue-Control for both manual and automatic start.
3. Single play spindle that rotates with your records exactly as with manual turntables.
4. Cartridge holder adjustable for optimum stylus overhang.
5. "Pause" position on rest post for placing tonearm with out shutting motor off.

Equipment reviews in every leading audio publication—and by consumer testing organizations—have placed Dual Auto/Professional Turntables in a class by themselves as the equal of the finest manual turntables. And these findings have been confirmed repeatedly by experienced audiophiles, many of whom have actually traded in their far more costly manual equipment for a Dual.

This unprecedented approval has been earned by Dual's precision design and engineering, relentless quality control, quiet operation and matchless performance . . . notably, flawless tracking as low as 1/2 gram.

For all these reasons, the only choice today for the perfectionist rests with either the world-renowned DUAL 1009, or the even more advanced DUAL 1019. Just some of the design and operating features of both models are presented here, to help you decide which one best meets your own requirements. If you had been considering anything but a Dual, we suggest you bring this guide with you to your authorized United Audio dealer. There you will find the comparison even more enlightening.



**DUAL 1009**  
Auto/Professional Turntable  
... closed the gap between  
the manual and the  
automatic turntable. **\$99.50**

**DUAL 1019**  
Auto/Professional Turntable  
... newest, most sophisticated  
record-playing instrument  
in the world today. **\$129.50**

united  
audio **Dual**

535 MADISON AVE. NEW YORK, N. Y. 10022

Circle 125 on Reader Service Card

# EQUIPMENT

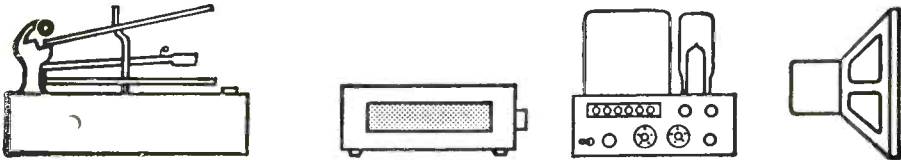

# PROFILE

## Pilot R1100 Solid-State Stereo Receiver

Pilot Radio represents one of the original group of manufacturers that made equipment available to those of us hungry for better music systems. A perusal of component catalogs of the fifties will reveal considerable representation by Pilot. More recently, however, Pilot seemed to abandon the component market to concentrate on marketing a line of consoles. Now they are back in the fold. And if this new component receiver is typical of their renewed outlook, we can predict that Pilot will again be a name to reckon with.

This is an all-transistor receiver. As such it is quite large—as large, perhaps, as a vacuum-tube unit of similar characteristics might be. Pilot has chosen to follow the path of designing for maximum coolness and spaciousness, rather than compactness. We can find no quarrel with this. Too often, we have seen the institution of miniaturization in a component at the expense of durability and/or serviceability. This Pilot receiver appears to have been built to last.

Then too, a high-power amplifier using transistors has eliminated heavy and bulky output transformers. But if it is after maximum power, it will require light but equally bulky heat sinks on the output transistors. Such is the case here. There are four hefty vertically-finned sinks toward the rear of the chassis. Each contains a pair of power transistors.

The net result of this care in construction is to be seen in the power response graph. These ratings were made with 8-

ohm loads and with both channels being driven simultaneously. 4- or 16-ohm loads will result in a power output derated by a maximum of 2.5 dB.

The front panel layout of the 1100 is forceful. It gives the feeling of machined massiveness (because of solid-metal knobs and a well-finished escutcheon). There are all the controls that any gadget-happy doodler would want. Not that this receiver is over-endowed. Rather, it is a deluxe unit that is making a serious effort to overcome the general feeling that a receiver must leave something out by virtue of its all-in-one design. Every sort of control is there; included beside the usual is a separate three-position contour control and a remote-local-all stereo speaker selector.

A row of rocker switches control power on/off, FM muting, low cut, high cut, and

Fig. 2. Frequency- and power-response curves.

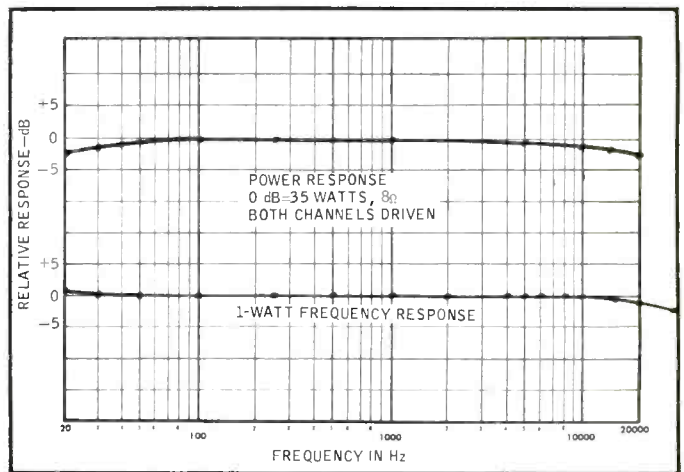

Fig. 3. IM Distortion curves for the R-1100.

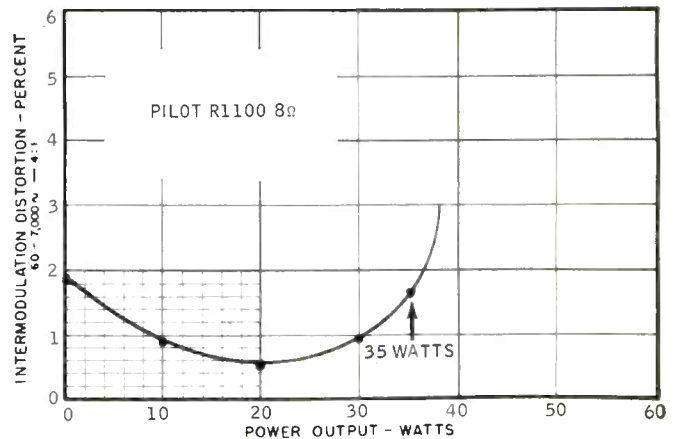

Fig. 1. The Pilot R-1100 Solid-State Stereo Receiver.

tape monitor. In conjunction with that last named switch, there is a front-panel tape-recorder output. This is designed to accept a three-contact stereo plug of the same type usually used for stereo earphones. Yes, there is also a front-panel earphone output. That aforementioned speaker selector switch also has a position that silences all for private listening.

There are two phono inputs and a tape-head input that feed the preamplifier section. The two phono inputs are both designed to accept a magnetic cartridge. A very real problem with solid-state preamps has been (as has been reported in these



E35  
Expandule  
takes  
bookshelf  
W30



E45  
Expandule  
takes  
bookshelf  
W40

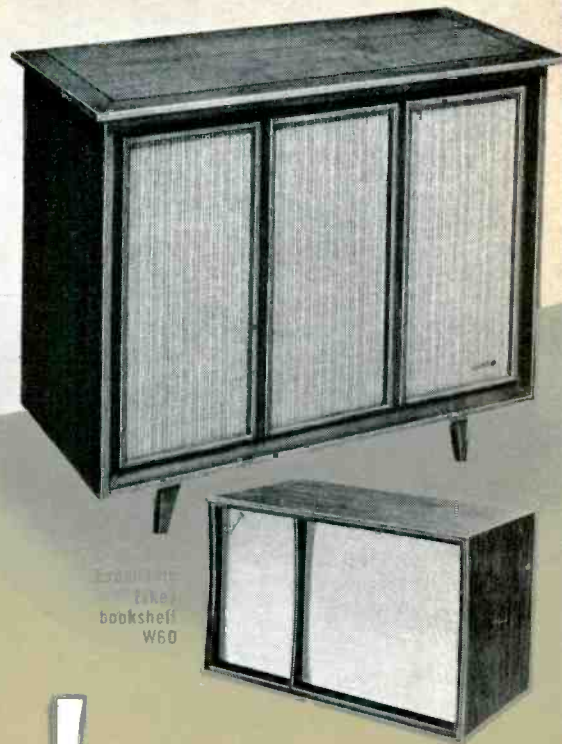

E65  
Expandule  
takes  
bookshelf  
W60

# Wharfedale

*gives small speakers big futures with new, investment-guarding*

## **E-X-P-A-N-D-U-L-E-S**

See how you can convert your present bookshelf speaker to a full-size system in three simple steps.

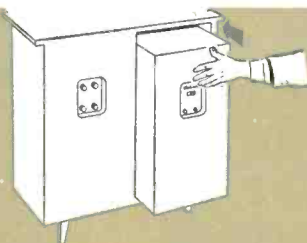

1. Slip bookshelf speaker into back of Expandule.

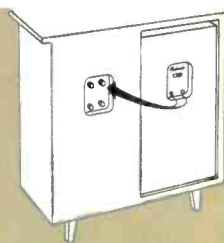

2. Connect leads from bookshelf speaker to Expandule.

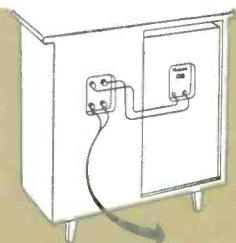

3. Connect leads from Expandule to amplifier.

Wharfedale's exclusive Expandules convert bookshelf speakers into magnificent-sounding floor models, preserving your investment when you are ready to improve upon the original speakers in your music system. Each Expandule contains a high-compliance, low-resonance woofer of appropriate size, plus the correct matching network to extend bass response and improve sound projection into the room... complementing the performance of the original bookshelf speaker. Expandule enclosures are table-top (30" height, and of slim-line, de-

sign. Finished in oiled or polished, walnut, they blend perfectly with present home-decorating trends. The handsome appointments and tasteful styling completely conceal the fact that the Expandule also contains the bookshelf speaker. Matching legs are optional.

Wharfedale is a smart investment, because you can start your music system with Wharfedale Achromatic bookshelf units (W30, W40, W60) and add the Expandules (E35, E45, E65) when you are ready... or now! Of course, we also offer the splendid W90 and W70 integrated floor-standing models for the finest realization of the Wharfedale sound, at highly attractive prices.

Mail this coupon for the Wharfedale Comparator Guide, a description of the Expandules, and a list of other speaker systems which they accommodate. Write Wharfedale, Dept. WD-16, Westbury, New York 11590.

Name.....  
Address.....  
City..... State..... Zip.....

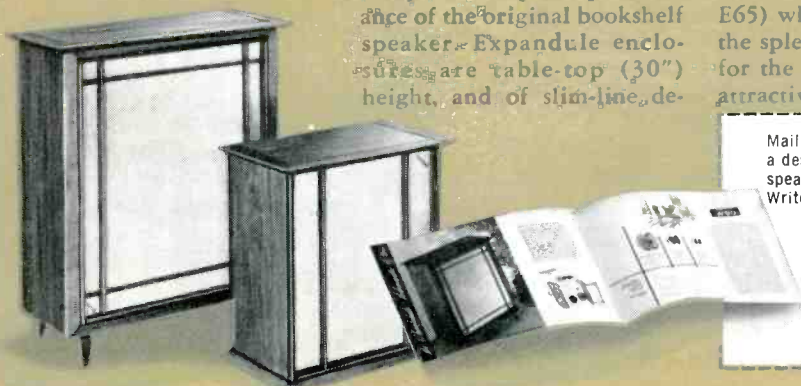

W90

W70

CIRCLE NO. 101 ON READER SERVICE CARD



pages) the input dynamic swing. What with cartridges having outputs as low as 1 mV or as high as 15 mV *steady-state*, an input designed to accommodate all cartridges would need sufficient sensitivity for the lowest and, at the same time, sufficient dynamic capability to handle musical peaks from a high-output cartridge. These peaks could require an input that will not overload with as much as 80-100 mV peaks.

The two inputs for phono are different. One (phono 2) has maximum sensitivity—3.2 mV for full output. But it will overload with signals that exceed 44 mV. So if you have a high-output cartridge, use phono 1. Now you need 14 mV for full output but you can pump in 178 mV before clipping and breakup. (There is a second benefit. A high-output cartridge in a hot input will be at ear-splitting volume with the gain control just cracked open. A reduced-sensitivity input makes it possible to operate the gain settings at optimum positions both for convenience and to take advantage of loudness compensation circuits.)

The tuner portion of this R1100 is FM—stereo and mono. Tuning is positive through a flywheel-balanced knob. Both signal strength and center-of-station meters are provided. Happily, they did coincide—best reception is at center meter position—this is also the maximum-signal-strength point. Stereo FM switching is automatic in the presence of a 19-kHz signal. This also serves to ignite an indicator light.

Usable information is to be had from low signals without much danger of overload from strong local stations. FM stereo separation measured only fair—16 dB at mid-frequencies, but there was little deterioration at higher (or lower) frequencies. So we suspect that a shift in alignment since the unit left the factory is responsible for the performance measurements. Regrettably, Pilot (like so many other manufacturers) did not supply alignment instructions, nor, for that matter, a schematic.

In other bench measurements the R1100 continued to show us its full-blooded qualities. Total hum and noise are 95 dB down from full output (35 watts). RIAA equalization is accurate  $\pm 2$  dB from 50 to 15,000 Hz and is identical for the two different phono inputs. The two-position loudness compensation is at its maximum at 9 o'clock. Position one offers + 8.5 dB at 100 Hz; position 2 at the same frequency is at + 10.5.

IM distortion measurements (Fig. 3) are not quite as low as we would like to see them, particularly at low-listening levels, and they exhibit the usual camel-back hump. Still, they are within acceptable limits.

#### Listening Tests

High usable bass power is the factor that often distinguishes the exceptional from the ordinary. Extensive listening tests with several different speaker systems, one

a low-efficiency 4-ohm system, revealed that this Pilot is a first class music performer. Sound is rich and full—the natural result of wide-band response, a fast-rise-time square wave, and accurate equalization. It has been demonstrated more than once that there need be no sacrifice of quality inherent in an all-in-one design. Certainly, this set is exemplary in that respect. Indeed, welcome back Pilot!

Circle 200

#### EMPIRE GRENADE 8000P SPEAKER SYSTEM

Over the past years, many types and designs of loudspeaker systems have appeared on the market, most of them having essentially the same box-like appearance. With the introduction of the Grenadier 8000 a year or so ago, a new shape was offered, one which could conceivably be described as a "natural" for certain decors. In its newest form, the 8000P, the Grenadier is still the same column, but now it

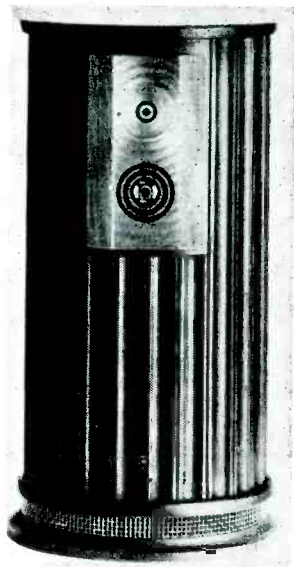

Fig. 4. The new Empire Grenadier 8000P speaker system.

is fluted, and is topped with a marble disc which is retained in place by a short dowel in the enclosure which mates with a shallow hole in the marble.

Measuring 16 inches in diameter and 29 inches high, the 8000P contains a 12-in. mass-loaded woofer weighing 18 lbs., a die-cast acoustic lens for the mid-range unit, and a domed tweeter in a bronze-finished escutcheon which has become the identifying mark of the Empire speaker systems.

The woofer faces downward, and is loaded with a plug which causes it to radiate over 360 deg. just above the floor level. The cone is freely suspended, and is back loaded centrally through the cabinet to the top, and down along the sides, terminating in a series of small "ports" at the rear. Plugs are provided so that one

or more of the ports may be stopped up at the listener's choice to vary the low-end response over a range of about  $\pm 4$  dB at 35 Hz. This is a more intelligent method of balancing the bass response to the room than the simpler mere attenuation of the mid- and high-frequency response, usual in most systems. Varying the response of the upper register does change the over-all balance, and this can be done in the 8000P, varying the response over a range of about 9 dB at 20 kHz. The control is on the bottom of the enclosure, as are the input terminals. This does not, however, change the *low-bass* response, which is particularly desirable when the speaker is to be used in different locations in the room. For instance, if the 8000P is to stand in a corner, it is best to put all the plugs in, which reduces the low-bass response about in proportion to the benefit gained by the corner placement. Conversely, if the speaker is to be used away from the corner or a wall, it is preferable to remove most of the plugs, thus compensating for the less-than-optimum position accorded it. Careful listening and adjustment of the low-end response will permit the 8000P to sound just about the same whatever its location in the room. The low-frequency resonance is at about 35 Hz, but it is not sufficiently pronounced to be recognized as a resonance—in other words, it is not a "one-note-bass" speaker.

Mid- and high-frequency ranges are more than adequately covered by the die-cast assembly, with the result that the over-all performance is crisp and clean, with a well balanced bass that is solid without being at all "juke-boxish." In all, we find the 8000P to be a most listenable speaker system, and one which is uniquely attractive in its appearance. Its shape could fit into the decor in many instances far better than the conventional rectangular enclosures. In other words, if the appearance will fit in with your ideas of room decoration, you may rest assured that the performance of the Grenadier 8000P will be completely adequate—to say the least—in the all-important area of listening quality.

Circle 201

#### UHER 9000 STEREO TAPE DECK

While ordinary, run-of-the-mill tape recorders continue to be introduced, it is also obvious that the over-all quality is being stepped up, particularly with respect to the features offered in machines intended for the serious recording buff. Just a few short years ago only the professional machines were fitted with three heads. More recently, a few of the better recorders offered the three-head advantage, but within the past months, quite a number of less expensive machines have been so equipped. Not that the Uher 9000 is "less expensive," but it is the first Uher machine we have encountered with full three-head capability. The Royal 8000 had three



**D-150** is a professional omni-directional microphone with high sensitivity and linear full-range response. It is ruggedly designed for hard use, and is attractive and inconspicuous because of its unusually small diameter. For public address, studio and on-location recording . . .

**TECHNICAL DATA**

<b>Frequency range</b>	30-20,000 cps.
<b>Frequency response</b>	± 3 db
<b>Directional characteristics</b>	Omni-directional
<b>Sensitivity</b>	- 55 db
<b>Impedance</b>	200 ohm
<b>Connections</b>	Cannon XLR
<b>Dimensions</b>	5¾" long x 5/8" diameter
<b>Weight</b>	4 ounces

The remarkably small diameter of the capsule used in both these microphones has been developed without sacrifice of the sensitivity characteristics found in our finest professional dynamic microphones. This is another significant development from the research laboratories of AKG.

**Send today for data sheets and prices.**

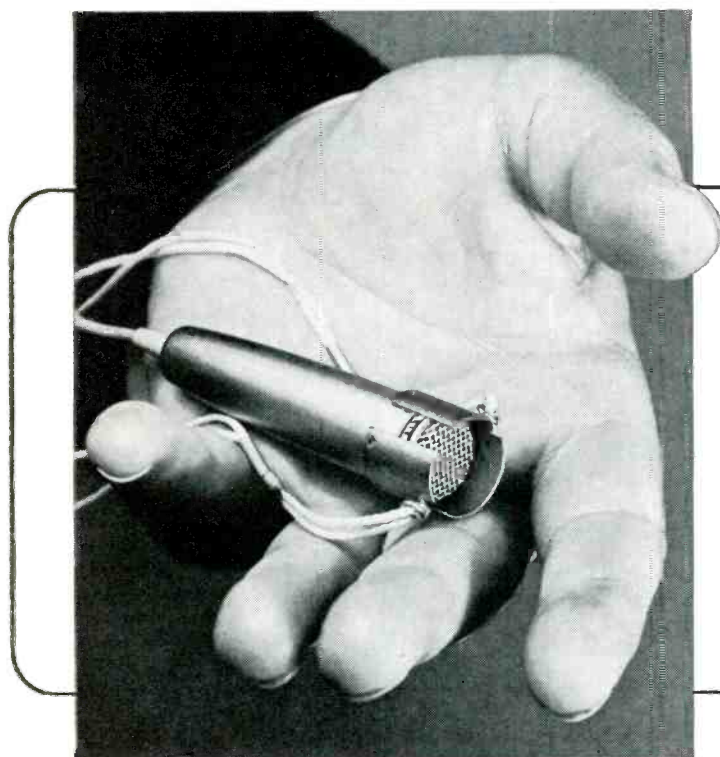

**D-109** is an attractively styled Lavalier microphone . . . a smart, practical choice for inconspicuous use. Among other features—simple raising or lowering of the Lavalier attachment cleverly attenuates the frequency response curve to specific applications.

**TECHNICAL DATA**

<b>Frequency range</b>	50-15,000 cps.
<b>Directional characteristics</b>	Omni-directional
<b>Sensitivity</b>	- 56 db
<b>Impedance</b>	200 ohm
<b>Dimensions</b>	2¾" long x 5/8" diameter
<b>Weight</b>	1½ ounces

MADE IN AUSTRIA BY AKG GMBH.



**NORTH AMERICAN PHILIPS COMPANY, INC.**  
Professional Products Division, 100 East 42nd St., New York, N. Y. 10017

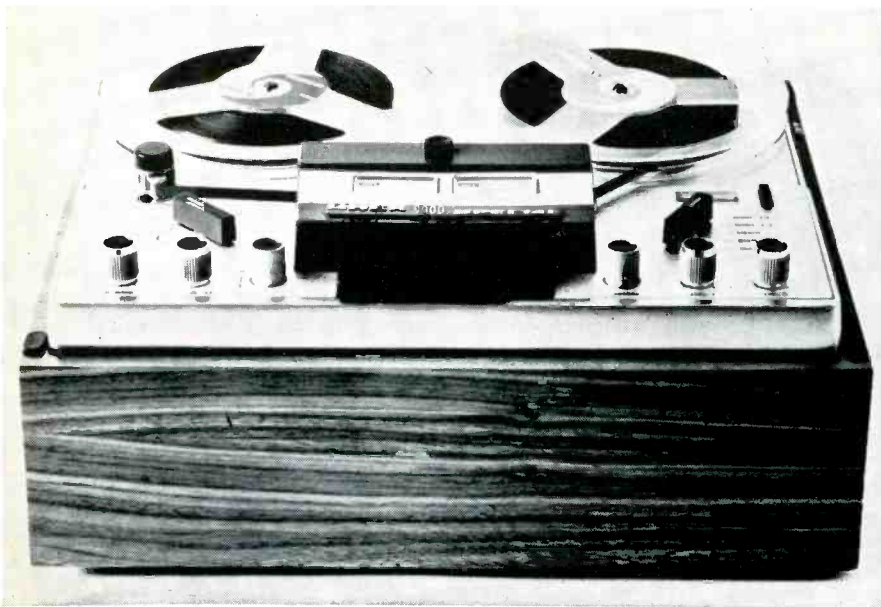

Fig. 5. Uher 9000 two-speed, three-head tape deck.

heads, but did not have enough amplifiers to permit continuous monitoring on stereo. It did on mono, using one of the stereo playback amplifiers for that purpose.

Obviously, it does cost more to provide both record and playback amplifiers for the two channels, as well as separate record and play heads, although it is recognized that the performance of a play-only head is likely to be better than the playback performance of a record-play head, since some compromises have to be made in the design of a multi-purpose head. Be that as it may, Uher has found it worth while, apparently, to employ three heads in this latest—and de luxe—recorder.

In appearance and in mechanical operation, the Uher 9000 resembles the older Stereo Record III, but is more streamlined and modern in appearance. It operates at two speeds—7½ and 3¾ ips—selected by a switch which also turns power on and off.

A second switch selects the mode of operation—MONO 1, MONO 2, STEREO, MULTIPLAY 1, or MULTIPLAY 2. The first three are reasonably obvious; the two MULTIPLAY positions require some explanation. In the first, the left channel records a mixture of left-channel inputs and right-channel playback, thus allowing sound-on-sound operation so that material previously recorded on the right channel can be rerecorded with new material from microphone, radio, or phono as desired. In the second multiply position, the right channel records the right-channel playback mixed with new material fed to the left channel input, thus making it possible to add echo to the right-channel recording in any desired amount, and adding to it from any of the signal inputs to the left channel. This type of switching provides considerable flexibility without the multiplicity of switch positions required by the circuitry of the Royal 8000.

Recording level control continues to use

the variable feedback circuit which Uher has been employing for recent models. This circuit accepts a wide variety of input levels with a minimum of distortion generation. The controls occupy the two right knobs on the front edge of the unit. The far left knob controls monitor level on both channels simultaneously; the second knob selects inputs from microphone, radio, or phono, and the third selects the monitor signal—either from source or from the tape. Tape transport is controlled by three piano-type keys—the small right one for starting the tape, utilizing a recording button as an interlock; the wide center key is for stopping tape motion, and the small left key is momentary pause. Fast forward and rewind are actuated by another bar in front of the stop key.

Two outstanding new features appear on the 9000—a knob above the head cover permits adjustment of playback-head azimuth without tools so that tapes made on another machine can be played optimally even though their azimuth may not be exactly the same as that of the record head on the 9000 (which should be adjusted to be exactly correct, of course). The playback-head azimuth can be adjusted readily by listening for maximum high-frequency output. The second new feature is the tape tension control, which also serves to remove particles of dust from the tape. This control operates additionally to shut off the unit on tape runout or breakage. Metallic strips on the tape can also be used for stopping the transport, or operation by remote control is possible.

All input and output connections are made on a panel on the back of the case to eliminate unsightly cables from the front of the machine. The panel also accommodates the line voltage selector switch, fuses, and the equalization switch which adjusts playback equalization through three positions—NAB, (50 μsec), and CCIR for both 70 and 100 μsec. Recording is in accordance with the NAB curve.

## Performance

Record-playback performance is remarkably flat from 20 to about 21,000 Hz at 7½ ips, and from 20 to 15,000 Hz at 3¾. ± 1.5 dB, and each recorder is furnished with a machine-run curve of its frequency response. In/out distortion measured less than 0.5 per cent. Signal-to-noise ratio measured 52 db, and wow and flutter approximately 0.12 per cent at 7½ ips, and 0.16 per cent at the lower speed.

Microphone input impedance is approximately 5000 ohms; radio, 47,000 ohms; and phono 1.0 meg. For full recording level, the input signal required at the three inputs was 0.14, 1.65, and 39 mV respectively.

Two outputs per channel are provided—for an amplifier input, a maximum level of 1.5 volts at an impedance of 7500 ohms, and for headphones, the same voltage at an impedance of 470 ohms, indicating the need for high-impedance (500 ohms) headphones. Twenty-five transistors, one zener diode, and one selenium rectifier make up the semi-conductor complement.

A push-button resettable 4-digit counter, is provided, as well as illuminated level-indicating meters.

Over-all dimensions are 15¼ in. wide, 13 in. deep, and 6¼ in. high, including the plastic dust cover which is readily removable. The unit weighs 24½ lbs.

Anyone familiar with the Uher line will find this an ideal model for including in a home music system. Circle 202

## AUDIO MEASUREMENTS COURSE

(from page 35)

ally occurs at specific test frequencies, being particularly dependent on the upper test frequency chosen, variation of which causes more definite distortion at some frequencies than at others. Most often it is accompanied by *some* of the conventional amplitude modulation, that the SMPE test does detect, but the phase effect can be much larger than the amplitude effect at certain frequencies, so that the reading is not a valid representation of the effect.

So testing for amplitude modulation only, as the SMPE test does, will give an unreliable indication of the effect, because phase modulation is just as discernible to the human hearing faculty as is amplitude modulation of the same "depth"—in fact, it is difficult to distinguish between the two forms aurally, just as it is not easy to distinguish musical vibrato from tremolo.



# Total Sound Spectrum



An exciting journey  
into the World of Sound . . .

Model XIIID Shown

INSTRUMENTS. COURTESY McCORD MUSIC CO.

*F*  
**FRAZIER**

FOR INFORMATION WRITE:

**INCORPORATED**

1930 VALLEY VIEW LANE • DALLAS, TEXAS • 75234

# The Tape Guide

HERMAN BURSTEIN

Send questions to:

Herman Burstein  
280 Twin Lane E.  
Wantagh, N. Y.

Include stamped, self-addressed  
envelope.

## Hum Elimination

*Q. My tape recorder has considerable hum and I would like to see what the use of d.c. instead of a.c. on the heaters would do to improve matters. Can you suggest a circuit for converting the a.c. heater supply to d.c.?*

A. The circuit of Fig. 1 will convert 6.3 volts a.c. to about 6.3 volts d.c. The full-wave bridge is a Mallory FW-50, which can supply up to about 1.5 amps provided it is operated in an ambient temperature not above 50° C (122° F). Most audio tubes operated at 6.3 volts draw about 300 MA, so that you can sup-

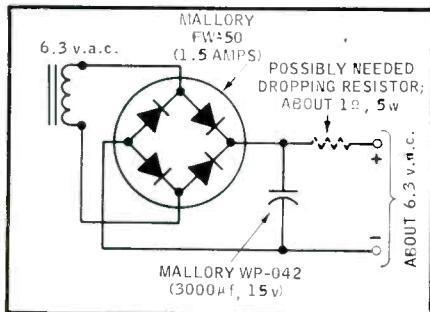

fig. 1

ply heater current to as many as five tubes. However, it would be advisable to limit them to four tubes. To minimize hum it is usually sufficient to provide d.c. just to the tubes in the first stage or two. The capacitor in the circuit is a 3000μf unit rated at 15 volts; it is a Mallory WP-042. Depending on how much current you draw from the d.c. supply, it may be necessary to insert a limiting resistor, as shown in the diagram, to prevent the voltage from exceeding 6.3. This can happen if you draw current for only one or two tubes. The required resistor will be in the neighborhood of 1 ohm, and should be rated at 5 watts or more. You may prefer to use a variable resistor instead of playing around with discrete units. Application of even slightly higher than rated voltage will considerably reduce tube life.

## "White-Box" Tape

*Q. Is unbranded (white box) tape distinctly inferior, or is it like so many other consumer items, namely of high quality but sold at a reduced price without the protection of the manufacturer's good name?*

A. White box tape is likely to be one of the following: (1) audio tape made to less exacting physical and magnetic standards than first class audio tape; (2) audio tape that was made in an attempt to meet highest standards but failed to pass inspection in one or more respects; (3) tape made for other than audio purposes which failed to pass inspection; such tape, whether or not it passes inspection for its intended purpose, often does not have the combination of characteristics best suited for audio.

## Input-Tube Choice

*Q. The playback amplifier of the Ampex 600 tape recorder uses a 6F5 as the input tube. This seems a rather off-beat tube to use, considering that the 5879 and 12AY7 were available at the time this model was designed. In fact both of the latter tubes are used in the Ampex 600. I don't believe the 6F5 has the controlled hum and microphonic characteristics of the 5879 and 12AY7, although it does have a high transconductance and a very low plate current. Why do you think the Ampex engineers chose the 6F5?*

A. I can only hazard a couple of guesses, and suggest that you write to Ampex, 934 Charter St., Redwood City, California, for the sure answer. One guess is that the large structure of the 6F5 makes it more immune to microphonics than smaller tubes such as the 5879 and 12AY7. Another is that the external grid cap of the 6F5 may have facilitated minimization of hum by permitting better and shorter routing of the cable from the playback head to the input tube.

## Updating the Ampex 400 Series

*Q. I have recently acquired a vintage Ampex 403 tape recorder and am curious about the history of this model. Was it the biggest Ampex of its day, how long was it manufactured, and—most important—how do its specs compare with modern machines? I think this machine could be converted to stereo. Where could I get a stereo head and a second preamp?*

A. So far as I know, the Ampex 400

was made in 1951-2, and was available as a portable or console. It used a capstan on the spooling or supply side of the reels. I believe that it provided substantially flat response to 15,000 Hz at 15 ips. But it may have provided flat response to a substantially lower frequency, perhaps only to about 7500 Hz at 7.5 ips. The best place to get more information, including the availability of extra electronics, a stereo head, and so on, is from the manufacturer. For the address, see the answer to the preceding question.

## Dynamu Head Specs

*Q. Quite some time ago I bought a Dynamu tape head conversion kit. Can you tell me the inductance and impedance of the record-playback head and erase head in this kit?*

A. It is more than 10 years since I have worked with Dynamu heads, and as far as I know, they have been off the market for some time. Therefore I will have to trust my memory. As I recall, the record-playback head had an inductance of about 500 millihenries, so that its impedance at, say, 1000 Hz was about 3150 ohms. I think the inductance of the erase head was about 50 or 100 millihenries, so that its impedance at an oscillator frequency of, say, 65 kHz would be between approximately 20,500 and 41,000 ohms.

## Excessive Heat

*Q. I recently bought a tape recorder and find that when it is on it heats up to the extent that one cannot touch the metal plate. Also the tape gets warm. I sent a letter to the manufacturer asking whether this is a normal condition but have as yet received no reply. Could you advise me whether this is normal and whether the tapes can be ruined because of the heat. Will the heat harm the electrical components of the tape recorder?*

A. My experience with a similar model of the same manufacturer is that it heats up considerably but without damage to the machine or tape. Your model includes power output tubes, whereas mine does not, so that yours probably heats up somewhat more. But I still doubt there is real danger of harm. At the same time, I would advise that you do not operate your tape machine inside an enclosure. Preferably it should be used in the open, for example atop a table or cabinet. If used inside an enclosure such as a hi-fi cabinet, keep the doors open and provide plenty of space for ventilation. If there isn't plenty of natural ventilation, provide forced ventilation by means of one of the special fans sold for this purpose in hi-fi stores. The fan can be installed so that it goes on when the tape recorder is turned on. One way of doing this is to put the line cord of the fan in parallel with that of the tape machine; thus you can connect both line cords into a multiple a.c. receptacle, and plug this receptacle into the a.c. outlet where your tape machine's line cord is presently inserted. You may prefer to connect the fan so that it goes on whenever the power amplifier of your hi-fi system is turned on.

(Continued on page 64)

## AUDIOCLINIC

(from page 4)

this should be. There is a cancellation action in a push-pull stage which cannot be achieved in a single-ended stage. For reference, a typical push-pull stage employing cathode bias is shown in Fig. 3. Note that we have two signal grids, one for each tube in the stage. For proper operation, the grids must be driven in opposite directions electrically. In other words, when the grid of one tube is driven in a positive direction, the stage is driven in a negative direction. Notice that the two cathodes are connected together and go to a common resistor. When no signal is flowing onto the grids, the stage operates under static conditions and each tube will draw

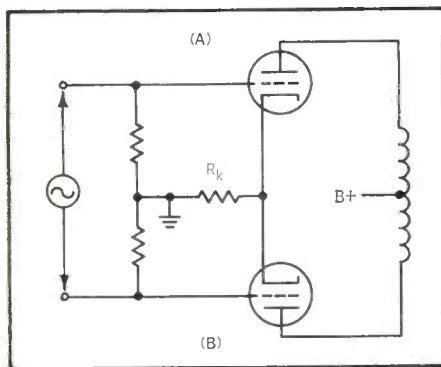

Fig. 3

plate current through the common cathode resistor. Now we shall introduce signal and see what happens to the bias. One grid moves more positive and this reduces the bias on the tube. The plate current would like to rise, as has been noted before. However, at the same time that grid A goes positive, grid B goes negative by an equal amount and this results in decreased plate current flow through tube B. The plate current in tube A has increased and that of tube B has decreased, with the total remaining approximately constant, so the actual voltage across the cathode resistor (and hence the bias voltage) has not changed appreciably.

Some of you have no doubt noticed that in fixed-bias stages there are often separate cathode resistors for each tube and there would be cancellation just as is true of a single-ended stage. These resistors are used as metering resistors and have values around the 10-ohm mark. This resistance value is so low that any voltage developed across it will be insignificant. The purpose of these resistors is to allow the user of the equipment to balance the two halves of the push-pull stage through the use of a meter connected between the cathode of each stage and ground.

### Power Supply Considerations

*Q. I wish to construct a monophonic transistor power supply. Apparently, the construction projects which interest me, like the El Cheapo 2-30 in the November, 1964 issue of AUDIO, are designed for*

*stereo. Can I use the power supply designed for two channels to operate just one channel without modifications? If not, what are the consequences?*

*Does your answer apply for tube-type amplifiers also? If not, why, and what are the differences? Peter K. Fong, San Francisco, California.*

A. In general, you can use the same power supply which is designed to operate two stereo channels for a single channel of a design similar to either of the two stereo channels. However, if the capacitors are operated too close to their rated breakdown voltages, the lighter loading by the single channel may cause the B voltage to rise to too high a value and some damage may result. Therefore, you may have to drop the voltage with an extra filtering

resistor or choke. Alternatively, you can use choke-input filtering to obtain the lower voltage. You will also gain in voltage stability of the power supply. Solid-state devices often present less of a problem in this regard than is true of tube devices. I suspect, too, that solid-state devices will benefit from operation from a power supply originally intended for two channels and loaded with only one channel. This is especially true when the filtering in the power supply is marginal. Too-heavy loading will cause loss of low frequencies because of common coupling in the power supply.

Where Zener diodes are used to maintain constant voltages, diodes having a lower capacity may have to be substituted in order to maintain the best regulation.

**S-10**  
**SYNCRON**  
**SOLID STATE**

**CONDENSER MICROPHONE**

*Self Contained Convenience*

FET circuitry eliminates external power supply • Permanently polarized  
Powered by 1000-hour battery • Frequency Response: 40 — 20,000 Hz  
Pressure gradient • Mylar diaphragm • Cardioid Pattern • 20 db discrimination  
• No overload protection needed • Low noise (less than 23 db)  
High output (-53 dbm) • Connector is on-off switch • Beautiful satin  
nickel finish • Only 9 ounces with battery • Full accessory line • Wind  
screen • Elastic suspension • Desk stand • Fully guaranteed • \$240 complete  
(with battery, case, swivel mount, 20-feet of cable) • Made in U.S.A.

**SYNCRON CORPORATION**  
WALLINGFORD, CONN., U. S. A.

# NEW PRODUCTS

● **Tape Player.** The Viking 807 is actually a transport only. It comes equipped with a hyperbolic stereo playback head. Thus it is to be connected to a system that provides a tape-head input with standard NAB/RIAA equalization facility. As such, the Viking 807 is to be considered in the same light as a disc turntable—a unit for the playing of recorded materials. The 807 mechanism is similar to the transports used in other

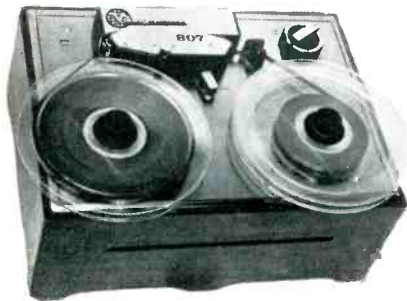

800 series systems. Two motors, one for capstan drive and rewind, the other for take up, are used. The single play head is of quarter-track configuration and is mounted on a shift plate so that the head may be centered relative to the track positions on half- and full-track recordings. Speeds of 7½ or 3¾ ips may be selected. The 807 is supplied mounted on an oiled walnut base. List price is \$124.95. Circle 210

● **Tape Head Cleaner.** Latest in a long line of tape-care devices is this head cleaning tape from Robins Industries. The tape is actually a ¼-inch wide strip of cloth impregnated with cleaning and lubricating chemicals. It is available on either a 3- or 5-inch reel. In use it is



simply threaded on the machine to be cleaned and played in the normal fashion. Its action in passing through the machine cleans every surface contacted by normal magnetic tape. Catalog number THC-3 on the 3-inch reel lists for \$1.65; THC-5 on a 5-inch reel is \$2.50. Circle 211

● **Self-Contained Condenser Microphone.** The S-10 Synchron is a pressure-gradient-type condenser microphone that requires no external power supply, nor is any overload protection required. Operation is from a built-in (but readily removable) Mallory TR-126 mercury battery with a 1000-hour life under use. This microphone is the first to employ a field-effect transistor. Permanent polarization

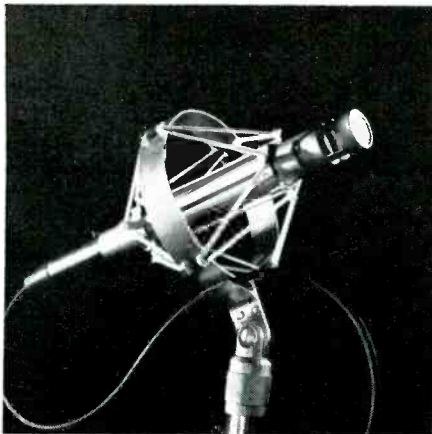

is supplied at 62 volts and the Mylar diaphragm provides a response of 40-20,000 Hz, with a deviation of less than 3 dB. The cardioid pattern gives effective front-to-back discrimination of about 20 dB. Sensitivity is rated at -53 dBm re: 10 dyne/cm<sup>2</sup> at 200-ohm load. The NLR-type 4-pin connector serves as an on/off switch, eliminating unnecessary battery drain. Finish of the barrel is satin-finish and measures 7¾ inches; weight is 9 oz. The S-10 is delivered with 20 feet of cable, swivel mount, battery, and carrying case. List is \$240. Wind screens, desk stands, and elastic suspensions (this last named is shown in the illustration) are available as accessories. Circle 212

● **Multi-Purpose Voltmeter.** A new Hewlett-Packard meter, the Model 427A, is a d.c. voltmeter, an a.c. voltmeter for the frequencies from 10 Hz to 1 MHz, with a ±2 per cent full-scale accuracy. D.c. full-scale ranges are ±100 millivolts to ±1000 volts; a.c. ranges are 10 mV to 300 V rms. Ohms ranges are provided. They are ±5 per cent accurate, are 10 ohms center-scale to 10 megohms center-scale. Heart of the unit is a new d.c. amplifier, using a FET both for high-input impedance conversion and, through a balancing circuit, for temperature compensation. Input resistance is above

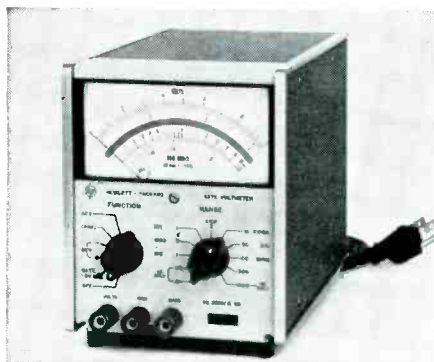

10 megohms. D.c. drift with temperature is typically under 0.5 mV per degree centigrade. A single 22.5 V internal dry cell is the normal power source. Power consumption is 400 milliwatts for more than 300 hours of battery life. Built-in facility to also operate from the a.c. line is an option. A.c. and d.c. are measured from the same terminals. Overloads are well tolerated—1200 volts d.c. or 300 volts a.c. will not harm their respective ranges. The Model 427A is \$195.00. Option 01, adding a.c. line to battery operation, is \$25.00 additional. Circle 213

● **Grenadier in a Cabinet.** Latest design from Empire is this bookshelf-type cabinet containing the same elements as in the floor-standing Grenadier systems. This is the Model 8400 with louvred front panels and a hand-rubbed satin-walnut finish. It is designed for standard shelf placement or for use on its own walnut bench. Features include: a low-frequency

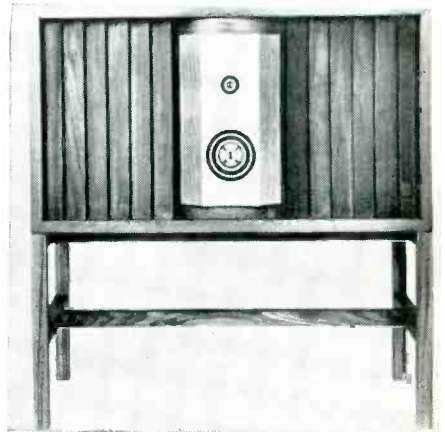

hyperbolic horn, a midrange direct radiator and ultra-sonic-domed tweeter—both coupled to die-cast acoustic lenses. Over-all frequency response is stated as 25 to 20,000 Hz. Nominal impedance is 8 ohms with a maximum handling capacity of 100 watts undistorted. List price of the Model 8400 is \$205.00. The optional matching bench is \$20.00. Circle 214

● **Ball-Type Microphone.** This new microphone from Shure Brothers, Inc. features a ball front similar in appearance to those used in professional broadcast microphones. Called the Spher-O-Dyne, this new dynamic is omnidirectional in character picking up sound from in front, in back and all around the microphone. It has been specially designed for faithful reproduction of music and voice in all general purpose, public-address installations, as well as tape recording. Features include a built-in wind, breath



and pop filter, an on-off switch, and an adjustable swivel adapter, which permits the microphone to be tilted through 90 deg. from vertical to horizontal when mounted on a stand. The adapter permits quick disconnect for hand holding of the microphone. Weight of the unit is 11 oz. There are two models: the 533SA is a high-impedance version; the 533SB is low impedance, suitable when there are long lengths of cable involved. Frequency response of either version is 40-11,000 Hz. List price of the 533SA is \$50.00; the 533SB is \$47.50. Circle 215

## NEW LITERATURE

● **Index of Record Reviews.** The 1965 Polart Index to Record Reviews has now been released. This annual publication lists, by composer or subject matter, all of the record reviews that have appeared in ten of the leading recorded music review journals including *Arbitro*. Both discs and tapes are covered. A listing will tell you where a review of a favorite work appeared, complete to the publication(s) issue date and page number. In addition, major reports will indicate their approximate length. Copies of the Polart index are \$1.50 each. Write to Polart, 20115 Goulburn St., Detroit, Michigan, 48205.

● **FETs Explained.** H.H. Scott has just released a 16-page booklet on field-effect transistors. These solid-state devices, previously only available to the military, are now finding their way into audio gear. H.H. Scott, in fact, was the first high-fidelity component manufacturer to use FETs in their tuners. Their claim is that the use of FETs results in measurable improvements in spurious response (cross modulation) rejection, freedom from drift, and tuner sensitivity. There is no charge for the booklet. Circle 220

● **Mike Techniques for Public Speakers.** The news release announcing this new booklet is subtitled "How To Be Listened To Instead Of Laughed At." Sound advice, we think. This booklet is specifically aimed at the public speaker with no previous microphone training. A few minutes spent with this booklet will likely improve the audience reaching capabilities of a neophyte P.A. speaker. Included is information on microphone speaking techniques with an understanding of the part mike patterns play in performance. A page of common microphone usage problems and their cure will be found most useful by many new speakers. The final two pages of the booklet are devoted to a partial catalog, including list prices, of Shure microphones. They are listed according to pickup pattern. There is no charge for this booklet. Circle 221

● **Tape Recording Booklet.** Elpa Marketing has just published this manual, written by tape expert Joel Tall. Entitled "Your Tape Recorder" it is designed to inform the new recorder purchaser, or one contemplating a recorder purchase, about the tremendous versatility potential that is built into tape recorders. The book is illustrated and covers subjects such as The Reproduction of Sound; How a Tape Recorder Works; How Magnetic Tape Works; Types and Selection of Tape; How to Record; Recording Speed; Recording Live; Using a Mixer; Wow and Flutter; How to Splice; Storage of Tape; plus suggestions on the many uses for tape recorders. The book is available through local audio dealers or directly from Elpa Marketing Industries, New Hyde Park, New York. Cost is \$1.00.

● **Tape Recorder Brochure.** Magnecord is offering an attractive brochure/catalog on their two new tape recorder/reproducers for commercial application. The six page, three-color folder describes the features and lists specifications of the Magnecord Model 1021 and 1022. The 1021 is a mono recorder/reproducer designed and made up to include the features most requested by broadcasters. Speeds of 3¾ and 7½ ips are provided. The Model 1022 is a stereophonic unit with 15- and 7½-ips speeds. Both recorders are fully transistorized. The brochure describing these units is available at no charge. Circle 222



## WHO NEEDS IT?

That's the first question Tandberg engineers ask themselves when they design a tape recorder. Is a part really necessary? Is there a better way to design it? □ Tandberg gives you what you really need in a tape recorder — not something that's just fashionable and technically inferior. □ Take mechanical push-button controls, for example. Tandberg uses one operating lever instead. Why? Fewer parts reduce possibility of breakdown — and mishandling by pushing the wrong buttons is eliminated. The result: a more reliable tape recorder with substantially reduced maintenance problems and costs. □ A Tandberg tape recorder gives you superior performance — because it's been designed with you in mind.

Stereo and Mono Models from \$199.50 to \$498.00 at franchised dealers only.

**Tandberg®**  
DISTINCTLY BETTER, CLEARER, MORE NATURAL SOUND

TANDBERG OF AMERICA, INC./ P.O. BOX 171/8 THIRD AVE./ PELHAM, N. Y. 10803

Circle 137 on Reader Service Card

# Sound & Sight

HAROLD D. WEILER

THE DECEMBER, 1965, issue of *AUDIO* carried a reprint of an article from the September 8, 1888, issue of *Electrical World* which we believe was the first public mention of the recording and reproduction of sound, magnetically. This article was of particular interest since Oberlin Smith's concept preceded the work of Valdemar Poulsen, the acknowledged inventor of magnetic recording, by about five years.

Shortly after this issue appeared the writer chanced upon what we believe to be the first public mention of a video camera, in the June 5, 1880, issue of *Scientific American*. Since the reader response to the *Electrical World* reprint was quite enthusiastic, we trust that the following reprint will be equally well received.

*Scientific American*, June 5, 1880  
**Seeing by Electricity**

The art of transmitting images by means of electric currents is now in about the same state of advancement that the art of transmitting speech by telephone had attained in 1876, and it remains to be seen whether it will develop as rapidly and suc-

cessfully as the art of telephony. Professor Bell's announcement that he had filed at the Franklin Institute a sealed description of a method of "seeing by telegraph" brings to mind an invention for a similar purpose, submitted to us some months since by the inventor, Mr. Geo. R. Carey, of the Surveyor's Office, City Hall, Boston, Mass. By consent of Mr. Carey we present herewith engravings and descriptions of his wonderful instruments.

Figures 1 and 2, Plate 1, are instruments for transmitting and recording at long distances, permanently or otherwise, by means of electricity, the picture of any object that may be projected by the lens of camera, Fig. 1, upon its disk, P. The operation of this device depends upon the changes in electrical conductivity produced by the action of light in the metalloid selenium. The disk, P, is drilled through perpendicularly to its face, with numerous small holes, each of which is filled partly or entirely with selenium, the selenium forming part of an electrical circuit.

The wires from disk P are insulated and are wound into a cable after leaving bind-

ing screw B. These wires pass through disk C (Fig. 2), in the receiving instrument at a distant point, and are arranged in the same relative position as in disk P.

A chemically prepared paper is placed between disks C and D, for the image of any object projected upon disk P to be printed upon.

Figure 3 is a sectional view of Fig. 2, showing wires and the chemically prepared paper.

Figure 5 is a sectional view of disk P showing selenium points and conducting wires.

Figure 6 is a sectional view of another receiving instrument with platinum or carbon points, covered with a glass cap D, and insulating plate or disk C.

These points are rendered incandescent by the passage of the electrical current thereby giving a luminous image instead of printing the same. These platinum or carbon points are arranged relatively the same as the selenium points in Plate P (Figs. 1 and 4); each platinum or carbon point is connected with one of the wires from

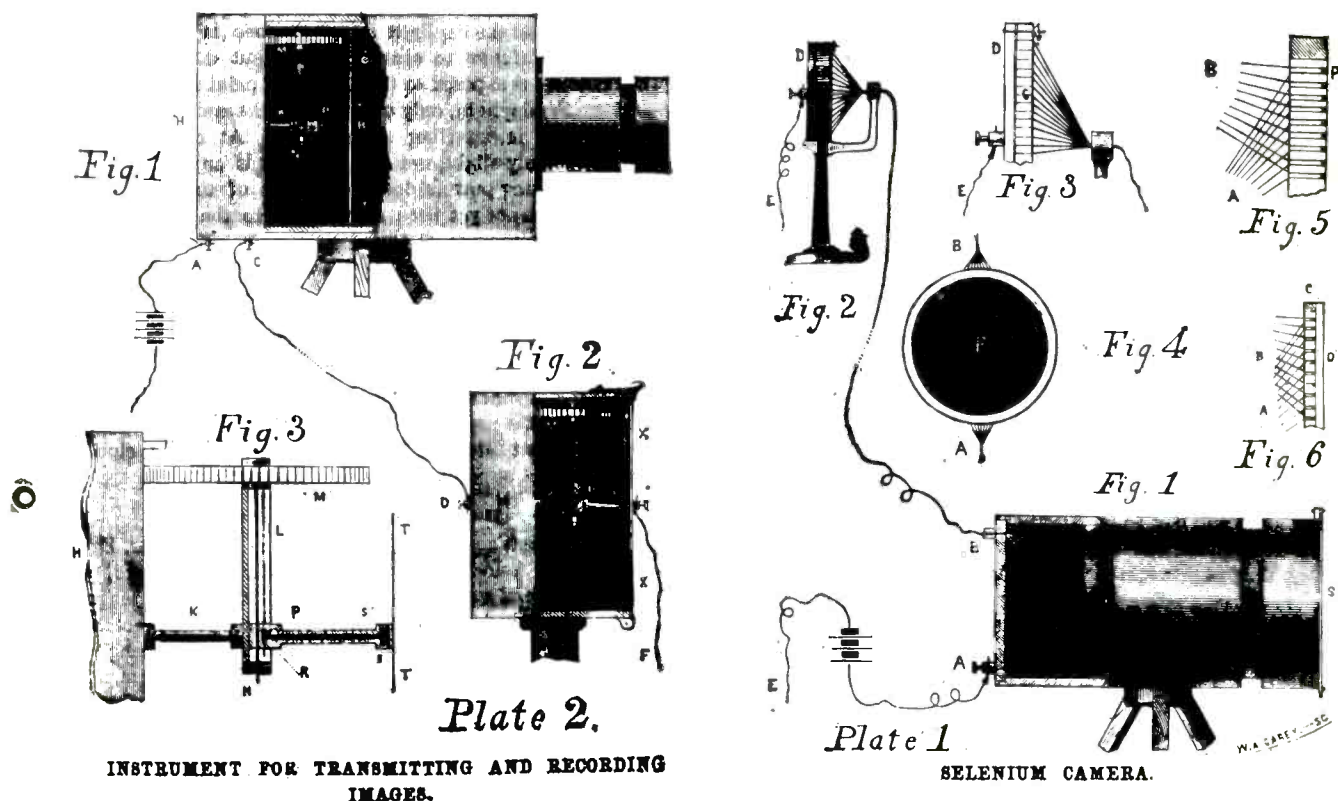

selenium point in disk P, and forms part of an electrical circuit.

The operation of the apparatus is as follows: If a white letter A upon a black ground be projected upon disk P, all parts of the disk will be *dark*, excepting where the letter A is, when it will be light; and the selenium points in the light will allow the electric current to pass, and if the wires leading from disk P are arranged in the same relative position when passing through disk C, a copy of the letter A as projected upon disk P. By this means any object so projected and so transmitted will be reproduced in a manner similar to that by which the letter A was reproduced.

Figures 1 and 2, Plate 2, are instruments for transmitting and recording by means of electricity the picture of any object that may be projected upon the glass plate at T T by the camera lens. The operation of these instruments depends upon the changes in electrical conductivity produced by the action of light on the metalloid selenium.

The clock-work revolves shaft K causing the arm L and wheel M to describe a circle of revolution. The screw N being fastened firmly to wheel M turns as wheel M revolves on its axis, thus drawing the sliding piece P and selenium point, disk, or ring, B, towards the wheel M (see Fig. 3). These two motions cause the point, disk,

The recently released Sylvania vidicon camera with a 4 to 1 Angenieux zoom lens.



or ring, B, to describe a spiral line upon the glass, T T, thus passing over every part of the picture projected upon the glass, T T.

The electric currents enter camera at A, and pass directly to the selenium point, disk, or ring, B; thence through the sliding

piece P and shaft K by an insulated wire to binding screw D (Fig. 2), through shaft K and sliding piece P to point E (Fig. 2); then through the chemically prepared paper placed against the inner surface of the  
(Continued on page 63)



### Why we avoid the word 'BEST' in our advertising:

Products that are really 'BEST' attain that stature on the strength of their performance . . . not by puffery in print. The enthusiastic acceptance of our NEUMANN Condenser Microphones, lathes and consoles, EMT Turntables, reverb units, STUDER Tape Machines and other audio products speaks volumes. And the kudos that count most come from the professionals using our lines in their daily vocations. They pass the word along. Isn't it eminently better for you to know by their experience that this equipment excels? It is the most effective way of advertising.



**GOTHAM**  
AUDIO CORPORATION

2 WEST 46TH STREET, NEW YORK, N.Y. 10036. 212-CO-5-4111

In Canada: J-Mar Electronics Ltd.

SETTING THE PACE WITH ENGINEERING KNOW HOW AND UNEXCELLED IMPORTED PROFESSIONAL AUDIO SYSTEMS

Circle 130 on Reader Service Card

# RECORD REVUE

Edward Tatnall Canby \*

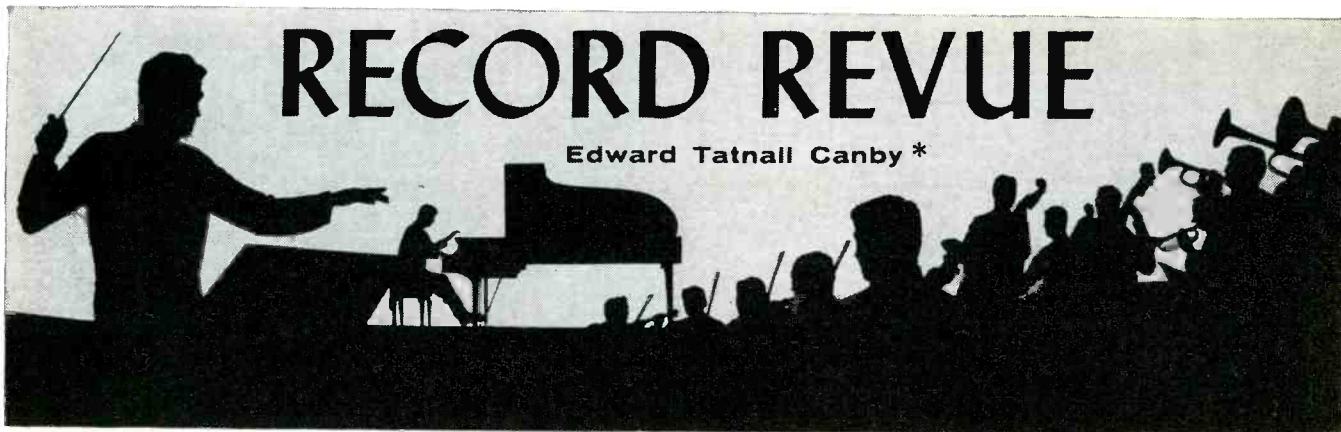

## HIP CHURCH

Jazz Suite on the Mass Texts. Paul Horn. Composed and conducted by Lalo Schiffrin.

RCA Victor LSP 3414 stereo

A Man Dies. Boys and Girls of St. James Church, Lockleaze, Bristol (Engl.).

Odeon P33X 1609 mono (Capitol imp.)

The church—numerous churches—will be struggling increasingly these days to “harness” all the excess musical energy we are throwing around in the new popular styles. Here are two more tries.

The Jazz Suite isn't exactly church music—yet. It merely aspires to be, when somebody gets up the nerve. The music was recorded in a safely secular studio. That may take awhile, because this is solid music, real jazz, not wishy-washy watered-down stuff. Maybe it isn't “great” but at least it talks. An oddly stagey effect, close-up jazz group, distant heavenly choir of child angels, off in the reverb, who chant sacred-style along with the jazz. One number is a trick: big congregation shouts out the Credo, higher and higher, until they shriek, all ad lib.

If I were an enterprising church (probably Catholic or Anglican-Episcopal) I'd risk it.

“A Man Dies” is a now-famous 'teen show about the Crucifixion, complete with Jesus in jeans and hippish music. It's earnestly youthful, very sincere and, all in all, a bit amateurish in sound, once the shock value has subsided. Great success in Britain, on the telly as well as in church.

Mahler: Symphony #10 (Performing Version by Deryck Cooke). Phila. Orch. Ormandy.

Columbia M25 735 (2) stereo

Mahler was a super-Romantic in a modern day, even to that familiar awe of the Beethoven Ninth which puts a jinx on anybody's Tenth: he didn't finish this one. Died in the middle. But it was sketched musically complete and at last, after many long years (since 1911), the entire work is now available in the splendid performing version by the English musician Deryck Cooke. (For many years, only two movements of the five were available, via Mrs. Mahler's permission. The rest were taboo.)

It is a stupendous work—no better word. Huge, endlessly long, but like all Mahler good and solidly put together, its musical girders plenty big enough to justify and support the great size. The extreme dissonance of this work, an ulti-

mate Romantic dissonance based on endlessly poignant chords of the eleventh, thirteenth, fifteenth . . . (i.e. basically “higher-overtone” dissonance) makes perhaps the saddest, most stabbingly human music written in our century. But it takes keen ears to follow its musical logic.

The Ormandy performance is, unfortunately, just what it seemed likely to be—letter-perfect, note-perfect, even mood-perfect, polished and outwardly everything it should be, and yet, oddly, missing boat after boat in terms of real subtlety. Compared to the memorable first movement on Epic (BC 1024) with Szell and the Cleveland Orchestra, this version is ham. Good ham, and no doubt about it.

Interesting period cover, “art nouveau” decoration, complete with Tiffany-lamp-like stylized flowers and 1911 lettering, as of the time the symphony was composed.

Brahms: 4 Complete Symphonies. Pittsburgh Symphony, Steinberg.

Command CC 14001 (4) stereo

The Pittsburgh-Steinberg Brahms Second of a few years ago won a vast amount of that praise which the admen call ACCLAIM, including a bit from this corner. Inevitably, the other three symphonies followed (plus the Tragic Overture, squeezed in next to the Third Symphony here), both as separate records and, now, in this handsome box.

I still think the Second is outstanding and unusual. The others are excellent, if not quite somehow as special as that. Brahms isn't easy to play, these days, and Steinberg does hit a good workable compromise between too much old-fashioned tear-jerking and the coldly furious approach of some of the middle-aged youngsters. (Not to mention the new-fashioned ultra-slow romance of the *very* young conductors!) It is taut Brahms and a bit fast, often, yet not musically hardened; there's plenty of give where it's needed.

Command's sound is clean as ever, big and reverberant but, compared with the latest in multi-miked modernism, rather pleasantly distant. Good for Brahms. No print-through—35mm magnetic film—but that doesn't prevent an occasional groove echo, just like on other peoples' records.

Schubert: Octet in F, (D.803). Philharmonisches Oktett Berlin.

Deutsche Grammophon 139-102 stereo

A superb recording of a superb piece of music, as far as recording technique goes. But the playing itself is somehow slightly disappointing.

Don't go away yet! Part of this is a legitimate and interesting difference that

crops up over and over again between Berlin and Vienna music-making. This is Viennese music, played in Berlin. The Berlin manner, today, is to perform in a classically restrained fashion, smoothly, rather fast, without excess sentiment. It applies even to Berlin choruses—as, for example, Brahms *German Requiem*, in several recordings.

The Viennese, oppositely, go in for a rich, wobbly, warmly Romantic approach, taking their time to the point of seeming sluggishness. In choral music, their voices are large and lush, as compared to the lean vocal quality of the Berliners.

Since this is Viennese music *par excellence*, if of another century, I can't help liking the famed Vienna Octet recording, still available on Westminster, better than this. But the difference is legitimate, and worth hearing for one's self, to make up one's own mind as to pleasure given and received.

Beethoven: Septet, Op. 20. Philharmonisches Oktett Berlin.

Deutsche Grammophon 138 887 stereo

Odd, how tricky this question of musical styling can be. Here is Beethoven in the Berlin styling—and it comes over distinctly better than Schubert's Octet played by the same group.

The difference is in the music. The Beethoven work, on which Schubert outwardly based the shape of this Octet, is earlier, simpler, jauntier, a much less “big” piece—for Schubert, as so often, got carried away and wrote some of his greatest music, whereas Beethoven, in his suavely popular early period, wrote to perfection for the customers. (He regretted it ever afterwards.)

And Beethoven, living in Vienna most of his life, was, after all, not Viennese. Compared to Schubert's music, his has a Northern crispness that is congenial to this Berlin group's playing. They make a North German piece out of it, and it works.

Schubert: “Trout” Quintet, Op. 114 in A. Peter Serkin, pf., A. Schneider, M. Tree, D. Soyer, J. Levine, strings.

Vanguard VSD 71140 stereo

Schubert: The Sonatas (violin and piano), Op. 137, Nos. 1-3. Alexander Schneider, vl., Peter Serkin, pf.

Vanguard VSD 71128 stereo

Vanguard's “Little Marlboro” chamber music series, featuring Rudolf Serkin's son Peter and the veteran Alexander Schneider, rolls smoothly on beside Columbia's Marlboro music and comes very close to surpassing it. Peter is still only 19, if I figure it right, and Alexander S. is getting on, but they make a remarkably responsive team, aiding and abet-



ting each other. Peter has all of the impeccable European musicianship of his father's long years of music making, and a great deal of his father's bouncing enthusiasm, too—but he is smoother, more suave, without losing a bit of spontaneity, his musical ear and stylistic sense superb for someone his age. (After all, he's lived with this kind of music for all those 19 years.) Schneider, still his sometimes rough violinistic self, adds maturity and forcefulness where it is needed.

All in all, you will scarcely hope to find a nicer pair of Schubert records what with the first-rate co-operation of the other "Trout" artists.

See also others in the continuing series—Mozart, Dvorak, Boccherini.

**Leonard Pennario/The Debussy Preludes.**  
RCA Victor LSC 7036 (2) stereo

When Pennario was at Capitol he applied his extremely versatile pianistic talents to the kind of playing he does here, technically excellent even superb, but somehow distant, emotionally and musically. At Capitol, though, it was usually workhorse stuff that got the Pennario keep-your-distance treatment. This isn't workhorse at all. No tougher musical assignment could be imagined.

Well—when you come down to it, only a handful of recorded artists have ever managed to get over Debussy with compelling success. The biggest, in recent times at least, was Giesecking. Than which there was no whither, as far as Debussy is concerned. Sheer piano magic. Compared with him (what else can we do?), Pennario simply plays a good piano. *Extremely* good. In fact, so good that I maybe ought to take it all back. But no—not quite.

I'm just expecting too much. Something superhuman. Pennario is a first-rate pianist, that's all. Not quite human enough. But *what* a pianist! No complaints at all, really . . . he's terrific.

**Hermann Scherchen conducts Bach/Art of the Fugue.** Members Vienna Radio Orch., Vienna Symphony.

Westminster WST 237 (2) stereo

Yep—A very great work, this. Yep, Bach did leave it—in a very typically Baroque fashion—without specific instrumentation, just written out as four lines of music, in the abstract. Which leaves old Bach wide open, 200-plus years later, for Hermann Scherchen's interpretation and orchestration.

All I can say is, unless you know nothing at all about Baroque music, Bach sound and Bach tempi, STAY AWAY. Or you'll find yourself screaming.

Of course old man Scherchen has as much right to his opinions as the rest of us, since a lot of our modern Bach is, after all, hypothetical. But does that give him license to do a super-Stokowski—a Walt-Disney, Salvador-Dali Stokowski, a superbly incredible mixture of everything from "authentic" to Mahler-Romantic, all in the same zany package? Yep, I suppose it does.

If you have ANY ideas at all about reasonable and proper limits for Bach—even very wide limits—again I say, STAY AWAY! Unless you want to bust a blood vessel just for kicks. OUTRAGEOUS! Er . . . what else?? Words fail me.

He leads from strength, all right. Nobody could do things like this and be less than almighty strong.

## 'The Adjustables' from Elac. The cartridges that know the angles.

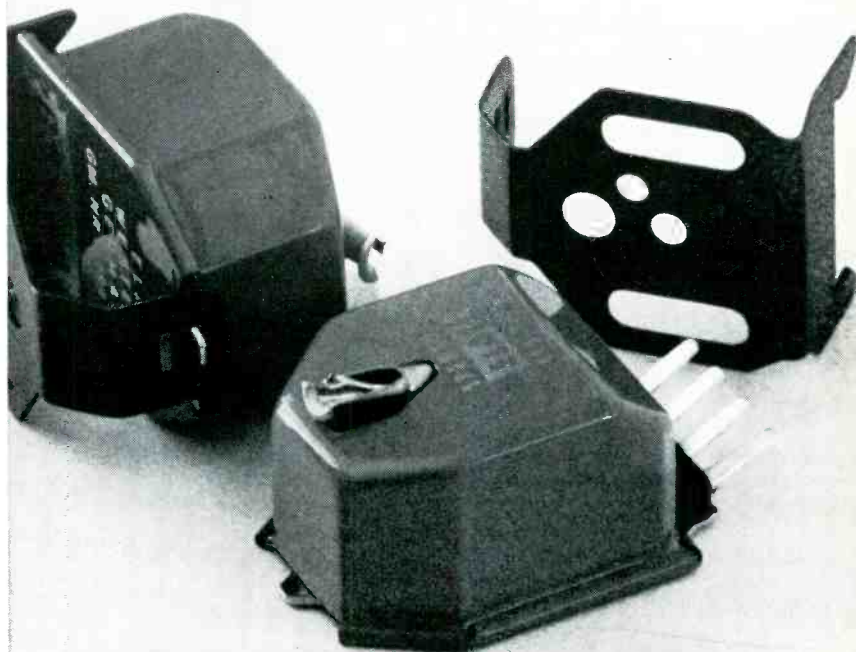

You can't mount just any cartridge into any arm, and let it go at that.

For each arm there is only one position for the cartridge stylus, in terms of distance from the arm pivot. This is critical with regard to tracking error and distortion.

Cartridge and stylus angle is another factor, especially with changers. The number of records on the turntable may introduce considerable error if a wrong angle was originally set.

Elac offers the ideal solution. Instead of mounting the cartridge directly into the arm, an ingenious retaining bracket is used. Two slots permit front-to-back position of the cartridge to be set for the correct stylus-to-arm-pivot distance recommended by the manufacturer. Two additional slots determine the cartridge angle: one for turntables and the other for changers.

The cartridge is simply snapped into the retaining bracket, the solderless connector sleeves slipped onto the terminals, and you're ready to play. You know that you are now getting the best performance from both the arm and the cartridge.

Elac, first to develop the moving-magnet stereo cartridge, offers three models:

**Elac 322** (stereo only) virtually flat from 20 to 20,000 cycles; IM distortion, less than 1%; THD, less than 2%; tracks at less than 1 gram; 0.5 mil diamond stylus, \$24.95.

**Elac 322 DE** same as 322, but with elliptical cartridge for further reduction of pinch effect distortion, \$29.95.

**Elac 240** (mono-stereo) probably the finest compatible cartridge available today. Comparable to many highly-reputed, stereo-only cartridges; 0.7 diamond stylus, \$19.95.

See your hi-fi dealer for details, or write: **BENJAMIN ELAC**  
Benjamin Electronic Sound Corp., Farmingdale, New York 11736.

Green  
boxes...  
full  
of magic



WITH  
ferro-sheen®  
PROCESS



Well, almost magic. You'll hardly believe your ears the first time you play back a reel of Irish Tape. Beautiful sound — crisp, clear, response. Friends will think you've turned "pro" but you'll know how smart it is to demand Irish Tape — in the green box. (And Irish costs no more!)

**FREE** — Send for catalog describing the complete Irish line — sizes and technical specifications.



## IRISH MAGNETIC RECORDING TAPE

458 Broadway, New York, N.Y. 10013

Circle 132 on Reader Service Card

### The 5th AUDIO Anthology

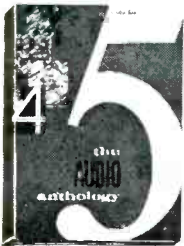

No. 125 \$3.50

Edited by C. G. McProud, publisher of AUDIO. An anthology of the most significant articles covering: stereo recording and reproduction; stereo multiplex; measurements; stereo technology, construction and theory—which appeared in AUDIO during 1958 and 1959. The 5th is truly a collectors' item and a valuable reference for the professional engineer, teacher, student, hobbyist and hi-fi fan. 144 pages.

### The 6th AUDIO Anthology

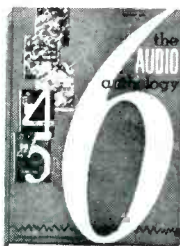

No. 130 \$3.95

Edited by C. G. McProud, publisher of AUDIO. Includes articles on the two most significant milestones in the field of high fidelity: FM STEREO and TRANSISTORS IN AUDIO EQUIPMENT. A meaningful reference for everyone in the fields of audio engineering, recording, broadcasting, manufacturing and servicing of components and equipment. A necessary book for the high fidelity enthusiast. 144 pages.

### The 7th AUDIO Anthology

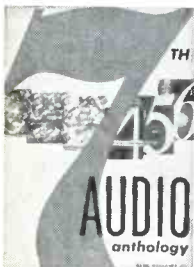

Edited by C. G. McProud. A compendium of articles relative to the art of high fidelity reprinted from AUDIO Magazine. A valuable reference tool for the audio hobbyist, the latest edition of this great series. 144 pages.

No. 135 \$3.50

## SPECIAL

Order all three  
SAVE \$3.00  
Circle 567  
YOUR COST \$7.95

AUDIO Bookshelf—AUDIO MAGAZINES, INC.  
P. O. Box 629, Mineola, New York 11501

\*All U.S.A. and Canadian orders shipped postpaid.

Please send me the books I have circled below. I am enclosing the full remittance of \$..... (No C.O.D. or billing.)

125      130      135      567

NAME \_\_\_\_\_

ADDRESS \_\_\_\_\_

CITY \_\_\_\_\_ STATE \_\_\_\_\_ ZIP \_\_\_\_\_

Bach: 6 Brandenburg Concerti; Orchestral Suites Nos. 2 and 3. Berlin Philharmonic, Von Karajan. Deutsche Gramm. 138 976/78 (3) stereo

Major symphony orchestras just should not play Bach on records. But they always do.

There are good things here, but not nearly good enough to meet the excellent (recorded) competition by smaller, more specialized orchestral groups who play this music at its natural size without constraint.

Von Karajan's Brandenburgs are variously tailored-down, to size, even to the solo groups and the harpsichord continuo—but there is always a feeling of a "reduced" big orchestra, cut down to an abnormally small ensemble, and this is bad. Yet even so, the strings seem often much too thick and bulky—there is too much heavy bass (excess contra-bass power?) and in string music like the 3rd concerto there seem to be just plain too many players. Muddy, turgid, thick.

As for the Suites (Ouvverturen), they get the full symphonic treatment, though thanks to mike trickery the harpsichord continuo plunks gaily along right in the midst of the huge orchestra. Typical wrongly dotted rhythms in the slow openings—Von K. just hasn't caught up yet on this score—and a massive, thickened sound throughout.

Inwardly, the performances are accurate and reasonably in tempo, never forced, but of a somewhat chilly sort, —again, with a sense of "scaled-down-ness" from, presumably, the more normal Strauss, Brahms, and Wagner.

### CLASSICAL AUDITIES

Carl Ruggles: Sun Treader (1933). Robert Helps: Symphony No. 1 Columbia Symphony, Zoltan Rozsnyai.

Columbia MS 6801 stereo

Well, about time! Old Carl Ruggles, born in 1876, is one of the rugged pioneers of our American music, only two years younger than Charles Ives and the two were good friends, each a total independent in his own way. Ruggles, in Vermont, wrote sparingly and far more radically even than Ives — also much later; "Sun Treader" was completed in 1933. He has a theory, it's said, that too much music is being written (how right he is!) and so he took his own time; but each of his few picturesquely named works is a monument to informed independent radicalism in music—timeless, almost ageless in style, incredibly dissonant, shriekingly dissonant, yet superbly assembled and somehow out of the ages. Strange stuff!

"Sun Treader," coming after shorter pieces, (earlier titles are "Men and Mountains," "Portals," "Men and Angels") is a full length work and a rip-snorter—a Nineteenth century tone poem cast in the most extreme dissonance. You aren't likely to love it first off—but you won't ignore it either, you can bet. It hurts—even now! It was first heard in Europe in 1932 but it has never yet been heard "live" in its own country. Quite a musical experience.

Robert Helps's (ouch—what an inconvenient possessive) Symphony, quite recent and from a man born 51 years after Ruggles, goes surprisingly well with "Sun Treader." Both men like a common sort of acid-seventh dissonance, more or less constantly; Helps's (again!) idiom is of course more modern but not in any radical fashion, being fully symphonic in a traditional way, more Romantic

than snazzy-jazzy, or classic-academic. It seems to me uneven, music its best expressive material sometimes interspersed with a too-facile outward skillfulness of a heavyish sort; next to it, "Sun Treaders" is a miracle of violent consistency.

**William Walton: Variations on a Theme by Hindemith; Symphony No. 2.** Cleveland Orchestra, Szell.

**Columbia MS 6736 stereo**

William Walton mostly falls between stools for us here (except his Shakespearean film music)—either he is too Romantic, or too modern, or both. But he's given us a winner in these Hindemith Variations, good enough listening to carry us right through even the recent Symphony No. 2 of 1960.

Seems Hindemith and Walton were close friends. Now that I know, I see the resemblance, even beyond these Variations—never thought of it before. The Variations, though, *are* Hindemith, or a remarkably alive evocation of him, without being the less Walton. The discipline of the Variation form, too, keeps the somewhat big-sounded and long-winded

Walton right on the rails—as it did for Sir Edward Elgar in his one really popular work, the "Enigma" Variations. Here, you will find many an echo of such now-classic music as Hindemith's "Mathis der Maler" Symphony, though the actual Hindemith theme comes from the Cello Concerto. What with superb, movie-slick orchestration, this work really hits home for those who like big, solid orchestral music in a squarely modern setting. The music is recent—1963.

The symphony isn't so easy. If I'd heard it first, I would have been discouraged. But after the Variations, it flows onward very nicely. Terrific performances out of the energetic Szell—taut and clean as well as expressive.

**P. D. Q. Bach. Peter Schickele; Chamber Orch., Jorge Mester.**

**Vanguard VSD 79195 stereo**

If you liked the Hoffnung Festivals on Angel, then you'll bust a gut over this one, too. P. D. Q., a belatedly rediscovered member of the Bach family, was born (so it says) in 1807 and died in 1742(?). His works include a Concerto

for Horn and Hardart, complete with little boxes that open when you put money in them. (The Automat, for you outlanders.) Also a cantata called Iphigenia in Brooklyn. The instruments, aside from the Hardart (above), are things like a left-handed sewer flute and a double-reed slide music stand. Also bagpipes, lute, balalaika and ocarina. Enough said! You can imagine the rest.

As competition to the recent "Baroque Beatles Book" (Nonesuch) this one isn't in the running—or rather, in a very different running. The Baroque Beatles was deadpan serious and musically very worthwhile, a tour de force of mock-Baroque composition. This one is sheer slapstick. Just to be sure, we have a live audience to help. It splits its guts every five seconds. Marvelous for a party once-through!

**Mendelssohn: Concerto for Two Pianos and Orch. in A Flat; Overture "The Fair Melusina."** Chamber Orch. of the Saar, Ristenpart.

**Nonesuch M-71099 stereo**

For close to a hundred years, 44 volumes of assorted early Mendelssohn lay unpublished and untouched in a perfect-

# 88

## Stereo

### COMPACT

**SOUND AS GOOD**

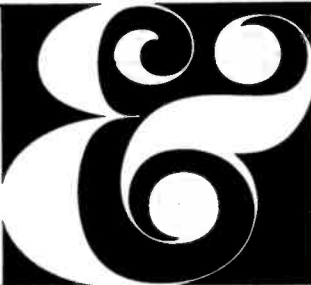

# 880

## Stereo

### PORTABLE

**AS THEY LOOK**

The choice of music connoisseurs who demand the ultimate in full stereo fidelity. Though compact in size these Viking tape recorders set a standard of excellence for dramatic, life-like realism in recording quality. Compare feature for feature, size, quality, styling—and dollar for dollar you too will prefer a Viking tape recorder.

Choose an 88 Stereo Compact in the traditional cabinet with folding cover at left, or select the modern enclosure, center, to match your music system. For portability Viking recommends the 880 Stereo at right, complete with detachable speakers.



An 88 Stereo Compact costs less than \$340.00  
Walnut cabinets extra.

880 Stereo portable recorder less than \$440.00  
At better hi-fi dealers most everywhere.

**Viking** OF MINNEAPOLIS®  
9600 Aldrich Ave S Minneapolis, Minnesota 55420



Circle 133 on Reader Service Card

ly accessible Berlin library. Nobody was interested.

Then, just at the perfect wrong moment, we all started in on our present "rediscovered music" kick. It was after WW II, and the 44 volumes, still in their library, found themselves locked out, in East Berlin! But that indefatigable Mendelssohnian descendant, Geo. Mendelssohn of Vox, decided he must have some. And he got it, finally, via some neat little across-the-Iron Curtain exchanges. Two 2-piano concerti. The old Vox recording of these appeared first in the early '50s.

Now, the music is getting around, at last. Here's one of the concerti in a new and very creditable stereo job, via Nonesuch. Along with it comes an overture that was once thought of as Mendelssohn's finest. Tastes change, but the music still goes down like, say, Bristol Cream sherry. Nice and warm.

The Concerto is dreadfully long and wordy—so were all concerti in 1824. Very stylish. If you let it take its own time, the pleasing Mendelssohn melodies soon take over. Like Bristol Cream sherry, maybe.

**Choral Songs of the Romantic Era.** (Mendelssohn, Loewe, Brahms, Silcher, Schumann). Chorus of the Univ. of Leipzig, Rabenschlag; Camarata Vocale of Bremen, Blum.

Nonesuch H 71081 stereo

I know the texts of this collection only too intimately—I floundered for weeks over the translations (on the back of the album), trying to combine semi-literal renditions with a sense of the original

poetry. Some job! (I'm proud of a few lines, cringe in retrospect when I see others staring me in the face. Ugh.)

These are the ensemble equivalent, loosely speaking, of the Schubert, Schumann, or Brahms *Lieder* (songs) for solo voice. The poems, by notable German Romantics are the same sort. The music is more often strophic (in successive verses to the same music, repeated) than the *Lieder*. They are uniformly lovely, a melting, eloquent music, gently folkish in an old-fashioned way, shedding sweet tears of a tender, Romantic variety and, more important, full of the most touching melodies and harmonies.

Two different performances here, two extremes, neither optimal. The Leipzig chorus is big outfit full of a million small children—or so it sounds. But WHO are those eight-year-old sopranos and altos? Little-boy geniuses at the University??? Little-girl prodigies? They don't sound a day older than ten, anyhow, and it is a pleasant sound, however produced! A few less singers and it would be much better still.

The Camarata Vocale, oppositely, is group of solo performers, four or five only. As such, they do a relatively good job of blending; but their music, even so, is full of wobbly overtones and hence a bit on the difficult side for the unaccustomed ear. Those who know the music will be charmed—and maybe everybody will, given a few replaysings. Some of the items are ultra-familiar (Brahms, for example). Others are seldom heard, at least in the U. S. A. In Germany everybody sings them. It's a sort of patriotic duty.

**Chants of the Church.** Choir of the Abbey of Mount Angel (Oregon).

RCA Victor LSC 2786 stereo

This is Gregorian chant from Oregon—and, though it follows the universal tradition of this famous Catholic music in excellent style, there are amusing traces of unintended Americanism to be heard for the sharp ear. They don't much impede the excellent fervor of the singing, which is almost Romantic in its intensity.

The chant is entirely unaccompanied, of course. The living tradition comes mainly now from the abbey of Solemnes in France, where the earlier corruptions (with modern accompaniment) were banished and the old way of singing restored—hence everybody tends to sound like Solemnes in this music. These Oregon monks do, too, as expected. Indeed, Gregorian is much the same, and should be, wherever it may originate.

But we are so badly brought up musically in this country! (Unless we join the great folk movement or jazz.) We sing "Happy Birthday" and "Sweet Adeline" all out of tune and the "Star Spangled Banner" even worse. So these Americans struggle manfully, painfully at times, to stay on pitch in this austere, uncompromisingly beautiful chant, with never a note from a piano or an organ or a gee-tar to help! It is agonizing at some points, but warm and amusing too. A number of the chants go flat, on the first side, and one (they must have been nervous) goes sharp. The rest toe the line neatly.

Also—the boys sing their Latin with



**New "Dynarange" Recording Tape records the same amount of music on half the tape**



*A tape so sensitive you can record at half the speed with no loss in fidelity. Your budget will applaud.*

Now enjoy music the way you hoped it would sound... full, faithful, clear. Notice it particularly in the critical soprano or high frequency range. That's because SCOTCH® Brand "Dynarange" Series Recording Tape cuts background noise. It's so sensitive—you get the same full fidelity at slow 3¾ speed that you ordinarily hear only at 7½ ips.

"Dynarange" costs a little more, but you need only buy half as much. You can save 25% or more in your tape costs. And if you use "Dynarange" at 7½ ips, you'll hear new fidelity you didn't know your recorder had.

"Superlife" Coating gives "Dynarange" 15 times the wear life of ordinary tapes. Low rub-off keeps recorder heads clean. Lifetime Silicone lubrication smooths tape travel, protects against head wear. Ask your dealer for a demonstration of "Dynarange" Tape now.

"SCOTCH" AND THE PLAID DESIGN ARE REGISTERED TRADEMARKS OF 3M COMPANY, ST. PAUL, MINNESOTA, 55119 © 1966, 3M CO.

Magnetic Products Division **3M** COMPANY

a fine, healthy American accent. That, too, is pleasant to hear.

Danceries Françaises et Italiennes. Orch. de Cuivres Jean-Louis Petit.

Société Française du Son  
SXL 20.093 stereo  
(via London)

Rameau: Suite pour trompettes et cordes; Suite "Les Paladins." Orch. de Ch. Jean-Louis Petit.

Soc. Fr. du Son SXL 20.521 stereo

Marin Marais: Suites "Semele," "Alcide"; 1er suite en re mineur. Orch. de Ch. Jean-Louis Petit.

Soc. Fr. du Son SXL 20.117 stereo

Three discs by the Jean-Louis Petit orchestra from France, and I have mixed feelings. The music itself is most worthwhile, piece by piece. But the playing, though always brilliant, is over-tense, dogmatic, often un-musicological to a degree we no longer easily tolerate. And the sound itself has gross faults here and there—notably very amateurish tape editing with inexcusable lapses in pitch (in the Marin Marais disc).

The first, an all-brass recording, features a splendid modern brass ensemble of virtuoso calibre, but their playing is strictly modern, with little insight into the old (mostly 16th c.) music they play. And the endless succession of similar dances, notably no less than 26 consecutive Bransles by Claude Gervaise, is wearing on the ear. The anonymous 17th c. suite from the Cassel library, however, is worth this whole disc—it is Lully-Purcell in sound, full of variety and better styled than the other works. In the 16th c. dances the players obstinately leave out all the cadence-figure raised tones, sharps, or naturals that were never indicated in the written music. Annoying for any ear—it just sounds wrong (and is wrong).

The big Rameau suites are lovely but rather heavy going with suprisingly little contrast and a dearth of good Handelian-style tunes. I'm suspicious of the dense orchestration; it sounds beefed up to me. Still—any Rameau of this sort is a lot better than none. He was a big man.

As for Marin Marais, the great viola da gambist, his operas are even rarer and the two orchestral suites are suprisingly lovely, though similarly blown up in orchestration. A splendid chaconne in one of them, and lots of easy melody. But the third item, the suites in "re" (D minor) is an unjustifiable orchestral transcription of a work for viola da gamba, very uncomfortable in this grossly enlarged form.

In addition to the outrageous pitch lapses in this one (they come far enough apart to allow you to listen mostly in peace!) the tonal quality of all the recordings is not as clean as it ought to be.

Lackadaisical French! It's the famed gallic so-what attitude, *tant pis*, with a shrug of the shoulders. Faults? That's life. Whaddya expect, perfection or something?

Sandy Bull. Inventions, (Guitar, oud, banjo, electric bass, electric guitar). With Billy Higgins, drums.

Vanguard VSD 79191 stereo

This very personable young Sandy Bull, about as blondly American as they come, has roused up a solemn spate of high critical praise for his enthusiastically oddball musical mixtures of West and East and what-have-you, turned out in lengthy hunks called



With just a flip of a switch, the new Uher 8000E tape recorder offers you 4 track stereo, monaural recording and playback, 4 speeds, 4 heads, synchronous sound on sound, multiplay sound with sound, echo effects, exclusive built-in automatic slide synchronizer (Dia-pilot), optional sound activator, (whew) and a host of other fantastic features. (You'll also flip over its all new solid state circuitry.)

If the above isn't enough reason to switch to Uher, you should listen to its concert hall sound.

For a demo visit your hi-fi dealer or write for literature. Martel Electronics, Los Angeles: 2356 South Cotner; New York City: 1199 Broadway; Chicago: 5445 North Lincoln Avenue. End wasted tape. Send for the new Martel "Tape Tabulator" for the timing of classical repertoires (\$2.75 value). Dept. B, California office. Enclose 25 cents for postage and handling. Sound begins and ends with a Uher Tape Recorder.

**to, martel**  
MARTEL ELECTRONICS  
SOLE IMPORTER FOR  
UHER TAPE RECORDERS.

Circle 136 on Reader Service Card



World-Wide Products  
of Distinction

**Ortofon**

SPE/T and SPE/GT  
ELLIPTICAL CARTRIDGES

Ortofon, master cartridge maker of the world, was the first to develop and mass produce the remarkable elliptical stylus, a feat so advanced that it opened a new era in sound REcreation®. The elliptical stylus eliminates "pinch effect" and other causes of sound distortion, creating music more faithful to the original than any other stylus yet developed. Model SPE/GT is mounted, for all Ortofon tone arms. Model SPE/T is unmounted, for use in other universal tone arms. Ortofon continues to lead the world in cartridge, stylus and tone arm advances.

**Specifications**

Frequency Response: 20-30,000 cps  
"Septra Spectrum" Channel Separation:  
20-25 db  
Impedance: 50,000 ohms  
Stylus Pressure: 1-2 grams recommended  
Equivalent Mass at Stylus Point:  
1 milligram

Model SPE/T or Model SPE/GT Elliptical \$75  
Model SPU/T or Model SPU/GT Universal \$50

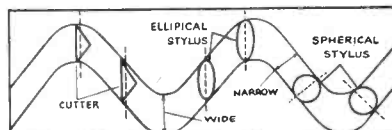

A MUST FOR RECORD LOVERS!

HOW TO CLEAN, MAINTAIN and PROTECT YOUR RECORDS by Cecil E. Watts. only 25c  
Send 25c for Watts Booklet and FREE descriptive Booklet on the Ortofon Elliptical Stylus.  
ELPA MARKETING INDUSTRIES, INC. • Dept. 111A4 • New Hyde Park, N. Y.

Available in Canada

Circle 135 on Reader Service Card

**THIS BOOK IS FOR YOU!**

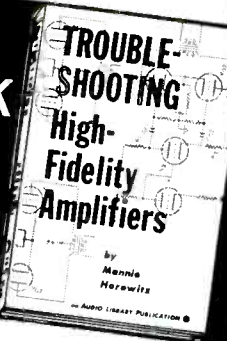

This book is for the hobbyist and technician who wants to know the plain and simple approach to **TROUBLESHOOTING HIGH FIDELITY AMPLIFIERS.**

Written by Mennie Horowitz, his fact-filled, illustrated chapters spell out the most direct approach to curing both, vacuum tube and transistorized amplifier ills. Everything from instruments and test procedures, to servicing transistorized stereo amplifiers, is covered in a writing style that makes it easy to read and absorb.

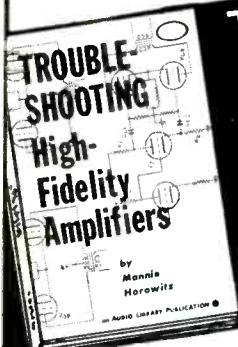

**THIS BOOK IS FOR PROFIT!**

**TROUBLESHOOTING HIGH FIDELITY AMPLIFIERS** was written specifically for the service technician and the audio hobbyist who specializes—or wants to specialize—in the growing and highly profitable field of audio and high fidelity service and repair.

A wealth of information  
—makes a perfect gift!

only \$2.95—Use convenient coupon below, just enclose your remittance—we pay the postage.

Radio Magazines, Inc., Dept. T62  
P.O. Box 629  
Mineola, New York, 11501

I am enclosing \$ \_\_\_\_\_, please send me \_\_\_\_\_ copies of **TROUBLESHOOTING HIGH FIDELITY AMPLIFIERS\***, by Mennie Horowitz.

NAME \_\_\_\_\_

ADDRESS \_\_\_\_\_

CITY \_\_\_\_\_ STATE \_\_\_\_\_ ZIP \_\_\_\_\_

"Blends." This is disc No. 2 (my first) and my reaction is mixed.

If the guy weren't so likable and direct, he'd be just plain pretentious. The assorted mixtures he plays on his assorted instruments are too often just flat-footed, overblown, halfbaked, anticlimactic. For all their multifarious elements—out of Mike Seeger, "Wabash Cannonball," tunes from Turkey, Cairo, Pakistan, U.S. blues, Indian ragas, juke box—anything that strikes the boy's ear—these lengthy solo jam sessions are mostly slack, repetitious, and long-winded—though always saved from unpleasantness by the obviously genuine and modest enthusiasm of the performer himself.

He is 24 and "came to music late"—his ear is quick to catch anything and everything, but it is still dismally uneducated and his trouble is a total lack of discrimination. The stuff is all jumbled together, undigested, unshaped, unskillful. He doesn't know the difference between pathos and bathos. He solemnly plays a Bach "Gavotte" (if it is a Gavotte I'll eat my typewriter) on electric guitar, then again on the plain guitar, as though nobody in the world had yet discovered guitar Bach. And Machaut—out of the 13th century! Him too. And Indian ragas, after a vague fashion, and Chuck Berry. You name it, he plays it.

No complaints about the idea of a mixture—that's just fine. But the Sandy Bull synthesis is just mostly nothing at this point, only a mildly amateurish sort of endless doodling of this and that, like what happens off in a corner at an all-night party.

If praise (not mine!) doesn't go to his head, this voracious musical indigestion may pass. For he has a quick interest in all sorts of musical sounds and the urge to transmogrify them into something of his own. It could end up in music of real tension and meaning. Not yet.

**Military Fanfares, Marches & Choruses from the Time of Napoleon.** Brass & Percussion, Gardien de la Paix, Paris; vocal ensemble.

Nonesuch H-71075 stereo

A curious and interesting record, this, if you have ever been intrigued by the Napoleonic era—with its old-fashioned

Imperial grandeur, its pomp, its archaic military costumes in brilliant colors, its latter-day Kings and Princes (created by Napoleon) dressed in Roman togas, its utterly primitive fire power and horse power—and, of course, its unprecedented World Wars, actually global-wide. This is merely the music of military and home-front pomp, but it brings back an era most vividly, between about 1792 and 1812.

The performance is all-French and the several short choral works, for soldiers' chorus with brass band, are particularly effective. Too bad we don't have the texts; you have to translate for yourselves. The spirit is clear enough. It's all very rousing and inspirational, which is the more interesting considering what carnage and death resulted from these splendid musical challenges to battle.

**Robert Speaight Reading Four Quartets** by T. S. Eliot.

Argo RG 11 mono

A splendidly listenable recording of the most important work by T. S. Eliot, the late and influential (between-the-wars) poet born in St. Louis and more English than the British. This Robert Speaight is excellent—he reads without the slightest actorish mannerism, casually, off-hand, and yet with a perfect diction and a marvelous way of making the complex sense and imagery of the poems clear to the listening ear.

No two ways about it, this was written for out-loud hearing. T. S. Eliot himself did a wonderfully communicative job of reading his own works (still available on reissue records), speaking in a modern "deadpan" style that belied the excellence of the audibility, so to speak. Robert Speaight manages to sound just a bit like T. S., yet without any self-conscious or stylized imitation. All in all, this is definitely for those who may have wondered what all the fuss was about, and still is. Just listen awhile and you'll soon hear! (I should note that Argo has an excellent catalogue of British-made speech recordings which, unfortunately, must go mostly unreviewed here. Too many other records pouring out. Look the others up if you like this one.)

## AUDIO, ETC.

(from page 14)

out change in timing) wouldn't have much use in speech? You were wrong again.

Yep, you can play. Great fun, if expensive. You can turn the big boss's dignified bass into a querulous tenor. What a gag for the office party! Vice-versally, it's easy to get hold of his handsome young lady secretary's dictation to her under-secretary, or maybe her telephone voice, so sweetly answering "Doctor Busybody's office!" and turn her into a formidable basso. **DOCTOR BUSYBODY'S OFFICE!** Laughs? Worth twice the price. Remember—it's at normal speech tempo, all this. Only the pitch is changed.

But there are much more serious and useful things to be done via changing the pitch of a speaking voice without changing its speaking speed. I'll give you just one as an example.

### Helium

Helium. 'Nuff said? (What—you don't

understand? What's helium to do with it?)

A lot. When you try to talk in an atmosphere of helium gas, replacing the normal nitrogen of the air (part helium the rest being the usual O<sub>2</sub> and CO<sub>2</sub>) your voice rises up alarmingly. You start down here and, astonishingly, it comes out *up here* (said in a queer, girlish tone of voice).

Now mind you, the girlish tone is more or less intelligible, per se. But it wounds the vanity and the pride. It is disconcerting as all get-out. And thus it impedes communication, not to mention working efficiency under duress. Can you imagine what would happen in your office if all the men started talking soprano, like girls, and all the girls turned into little canaries?

Of course only very special people have to talk in an atmosphere of helium. But right now they are rather important, and what they say is extremely important. One major area of such operations is the new undersea living experiment, where men set

up housekeeping far down in the deep, for days and weeks at a time, to see what might happen. When it happens, or doesn't happen, they talk about it. In helium. (Nitrogen gives the bends via gas bubbles in the blood. Helium avoids the trouble, giving more mobility to the underwater teams.)

You can actually hear a filmed helium conversation, if I remember rightly, in a marvelous Costeau color movie about the pioneer French experiment in this field. "The Silent World" is the name, and it is superb. (Being merely French, Costeau's venture doesn't get much credit from us these days. Our own boys have been down there underwater in a U. S. experiment, which has taken all the bows. They'll never beat that French movie though—not in a thousand years.)

If you haven't figured it out already, you can now understand that a judicious use of a Pitch Changer would correct that helium voice problem 100 per cent. Just lower away, reducing pitch to normal, leaving the speaking-speed unchanged. How's that!

My highly sketchy info here says that the American experiment did dicker with another brand of pitch-changer. (Remember, the alteration of *pitch* by rotating heads is not exclusive to Eltro; only the change of *tempo*, pitch remaining constant, is an Eltro protected exclusive.)

## THIS MONTH'S COVER

To meet the requirements of our cover format, long-time-reader Evo J. Bernardini, of Livermore, California, moved the two JBL Hartsfield folded-horn corner enclosures with their serpentine acoustic-lens/horn assembly adjacent to his equipment cabinet—quite a job, since the horns measure 46 by 47 by 24½ in. and weigh almost 300 pounds apiece. Made of two-inch walnut and costing about \$1100 each, they are practically worth their weight in something.

Except for the transistorized Sony 777 tape recorder, all the equipment is tube-type, and represents the ultimate in the art, according to its owner. Since the tuner is a Marantz 10B, followed by a Marantz Model 7 preamp and a McIntosh 275 stereo amplifier, we must accept his opinion. For recorded music, there is an Empire Troubadour turntable with an Or-

That other machine produced a frequency range only from around 300 to 3000 Hz, or so I hear. It could have been disappointing for vital communication work. There is no doubt about it, the Eltro can do a lot better. I've heard it. The specs say 30 to 15,000 Hz, and distortions introduced are few and not easily audible. So with a brace of Eltros on deck (up on the ocean surface or maybe even down in the submerged housing) the helium problem should be neatly solved. Normal-pitch voice communication.

### Fourth Dimension

I have only one further comment, to end with, straight out of Gotham Audio. It seems that at the frequent lecture-demonstration affairs all over the country which Gotham puts on, in a salesworthy way, there's always some serious soul who jumps mentally way ahead too far. He races straight toward the trap, all enthusiasm. Zowie, the things you could do with this! Holy smoke! And then it hits him. Up goes his hand, fingers shaking with excitement.

(Question from the floor:) "Sir, how about attaching the tempo changer to a public address system, say at a banquet? To speed things up. Or, hey . . . maybe RIGHT NOW (begging your pardon . . .)? How about that now! Speeding up a speaker. Boy what an idea! Let's try it."

WHAT?? Now wait a minute. . . Æ

tofon arm and cartridge with an elliptical stylus, and the Sony 777. The power amplifier is adequately cooled by a Rotron Whisper fan, and the antenna is a JFD LPL-FM-10 with 75-ohm coax feeding the tuner. For private listening, a pair of Koss Pro-4 headphones completes the set-up.

In most instances this type of cabinet is used to house the speakers in the two end compartments—here the owner has used the space for the power amplifier and the tape recorder. The latter is fitted with a pause-control button on its remote control unit to permit operation from across the room with pause-control convenience.

Mr. Bernardini deplors the trend of hiding components in "walls and unattractive breakfronts," and much prefers the "judicious selection of cabinetry and speakers exhibiting expansive and attractive walnut, both for appearance and for impressive listening." And so do we. Æ

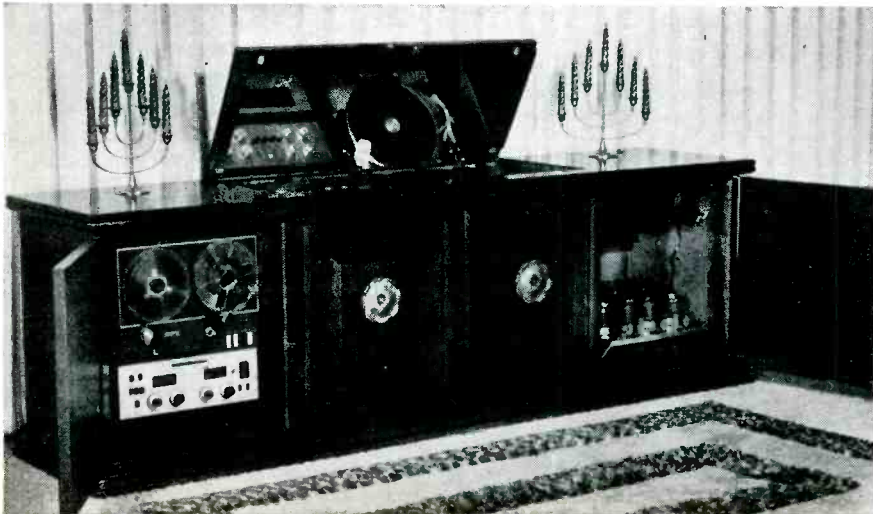

## Pinnacle of SOUND imagery!

From the traditional house of sound comes the fabulous HERITAGE SERIES of sound systems. UTAH has a tradition of producing the finest quality speakers and cabinets and this new series is part of that heritage. Both bookshelf and console models set new standards in total quality. Each high styled cabinet is individually assembled. Tweeters have a "double shell" construction with fiberglass between the chassis and outside cover to minimize reflections. High flux density and a special cone clamping technique contribute toward the high efficiency. Woofers have massive Alnico V magnetic circuits and large diameter voice coils for effortless reproduction. Utah's crossover networks are tailored to the reproducers and enclosures for best system "balance" and minimum distortion.



**Heritage I**  
Bookshelf Model  
3-speaker system  
12" woofer  
2-5" tweeters



**Heritage II**  
For the expert  
connoisseur  
4-speaker system  
Frequency response:  
25/20,000 cps  
Power handling:  
50 watts



**Heritage III**  
A new level of  
music enjoyment  
8-speaker system  
Frequency response:  
20/20,000 cps  
Power handling:  
80 watts

Write us **now** for complete information



**utah**

HUNTINGTON, INDIANA

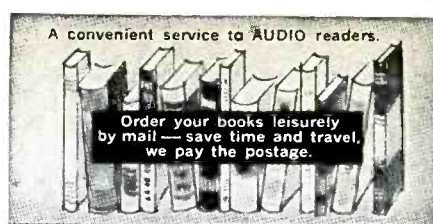

**Maintaining Hi-Fi Equipment**  
**Joseph Marshall**  
 A valuable reference for anyone whose living or hobby is servicing hi-fi equipment. Outlines the professional approach for servicing all types of hi-fi components. Covers trouble-shooting of electronic, mechanical and acoustic problems. 224 pages.  
**No. 58 Paperback \$2.90\***



**Designing and Building Hi-Fi Furniture**  
**Jeff Markel**  
 Written by a professional hi-fi furniture designer who has taught furniture design at leading colleges, this book is an authentic reference of value to the hi-fi fan and professional custom builder. Covers everything from types of woods to furniture finishing for the mechanically adept; design principles, styles and arrangements for the decor minded. 224 pages.  
**No. 79 Paperback \$2.90\***



**HI-FI TROUBLES**  
 By Herman Burstein  
**HOW YOU CAN AVOID THEM HOW YOU CAN CURE THEM**  
 Just published! At last, a book which deals directly with the problems you face in maintaining your audio system in peak condition. Tells you how to locate troubles, what to do about them and how to do it—and, just as important: what NOT to do. Helps you to achieve the best in listening pleasure from your equipment.  
**No. 120 \$3.95**

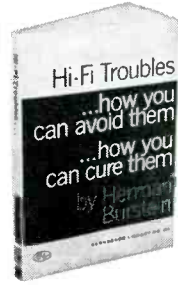

**McProud High Fidelity Omnibook**  
 Prepared and edited by C. G. McProud, publisher of AUDIO and noted authority and pioneer in the field of high fidelity. Contains a wealth of ideas, how to's, what to's, and when to's, written so plainly that both engineer and layman can appreciate its valuable content. Covers planning, problems with decoration, cabinets and building hi-fi furniture. A perfect guide.  
**No. 115 \$2.50\***



**The 5th AUDIO Anthology**  
 Edited by C. G. McProud, publisher of AUDIO. An anthology of the most significant articles covering: stereo recording and reproduction; stereo multiplex; measurements; stereo technology; construction and theory—which appeared in AUDIO during 1958 and 1959. The 5th is truly a collectors' item and a valuable reference for the professional engineer, teacher, student, hobbyist and hi-fi fan. 144 pages.  
**No. 125 \$3.50**



**"The AUDIO Cyclopedia"**  
**Howard M. Tremaine**  
 Here is one single volume with the most comprehensive coverage of every phase of audio. Concise, accurate explanations of all audio and hi-fi subjects. More than 7 years in preparation—the most authoritative encyclopedic work with a unique quick reference system for instant answers to any question. A vital complete reference book for every audio engineer, technician, and serious audiophile.  
 • 1280 pages  
 • 3400 topics  
 • 1600 illustrations  
**No. 123 \$19.95\***



**Tape Recorders and Tape Recording**  
**Harold D. Weiler**  
 A complete book on home recording by the author of *High Fidelity Simplified*. Easy to read and learn the techniques required for professional results with home recorders. Covers room acoustics, microphone techniques, sound effects, editing and splicing, etc. Invaluable to recording enthusiasts.  
**No. 112 Paper Cover \$2.95\***



**"the best of AUDIO"—**  
 edited by C. G. McProud  
 A new compendium of AUDIO knowledge. Here is a collection of the best of AUDIO — The AUDIO Clinic by Joseph Giovanelli . . . noted audio engineer and the original high fidelity answer-man — EQUIPMENT PROFILES edited by C. G. McProud . . . Editor of AUDIO. Here is a wealth of hi-fi and audio information. Answers to the most important issues in high fidelity and a valuable reference.  
**No. 124 Volume I \$2.00\***



**The 6th AUDIO Anthology**  
 Edited by C. G. McProud, publisher of AUDIO. Includes articles on the two most significant milestones in the field of high fidelity: FM STEREO and TRANSISTORS IN AUDIO EQUIPMENT. A meaningful reference for everyone in the fields of audio engineering, recording, broadcasting, manufacturing and servicing of components and equipment. A necessary book for the high fidelity enthusiast. 144 pages.  
**No. 130 \$3.95**

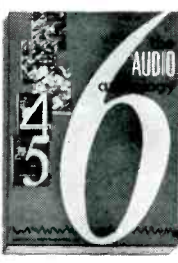

**• MONTHLY SPECIAL! SAVE \$5.00**

Save almost 50% with this collection of AUDIO books.  
 "best of AUDIO" (\$2.00)      5th AUDIO ANTHOLOGY (\$3.50)  
 McProud High Fidelity Omnibook (\$2.50) and  
 Tape Recorders & Tape Recording (\$2.95)

**TOTAL VALUE ALL FOUR BOOKS . . . \$10.95**

**Your cost only . . . \$5.95 Postpaid**

**CIRCLE OS400**

This offer expires April 30, 1966, and is good only on direct order to the Publisher

**High Fidelity Simplified**  
**Harold D. Weiler**      3rd Edition  
 The complete hi-fi story—answers all questions about tuners, changers, amplifiers, tape recorders, speakers, record players, etc. Lots of ideas for custom installations. Tells how to achieve concert hall reception in your home. 216 pages.  
**No. 142 \$3.30**



**AUDIO Bookshelf—RADIO MAGAZINES, INC.**      \*All U.S.A. and Canadian orders shipped postpaid.  
 P. O. Box 629, Mineola, New York 11501

Please send me the books I have circled below. I am enclosing the full remittance of \$..... (No C.O.D. or billing.)

- |     |     |     |     |     |       |
|-----|-----|-----|-----|-----|-------|
| 58  | 79  | 112 | 115 | 120 | 123   |
| 124 | 125 | 130 | 142 | 251 | OS400 |

NAME \_\_\_\_\_

ADDRESS \_\_\_\_\_

CITY \_\_\_\_\_ STATE \_\_\_\_\_ ZIP \_\_\_\_\_

**Getting The Most Out Of Your Tape Recorder**  
**Herman Burstein**  
 Written in "plain talk" for the man who has, or wishes to buy, a tape recorder. It answers the myriad questions raised by tape recording enthusiasts. Its chapters cover every phase of operation and maintenance—from adding a tape recorder to the hi-fi system, to a thorough dissertation on microphones. Lots of practical information on how to buy. 176 pages.  
**No. 251 \$4.25**





## SOUND & SIGHT

(from page 53)

metallic plate X X by wire F to the ground, thus completing the circuit and leaving upon the above mentioned chemically prepared paper an image or permanent impression of any object projected upon the glass plate T T by the camera lens.

Figure 2, is the receiving instrument, which has a clock movement similar to that of Fig. 1, with the exception of the metallic point E in place of the selenium point, disk, or ring (Fig. 1) at B.

Figure 3 is an enlarged view of clock-work and machinery shown in Figs. 1 and 2.

The following week the editor of *Scientific American* received the following letter regarding the article:

To the Editor of *Scientific American*:

Your article on "Secing by Electricity" contained in the issue of June 5 will prove of interest to many. Early in the fall of 1877, the principles and even the apparatus for rendering visible objects at a distance through a single telegraphic wire were described at No. 21 Cortlandt Street, in this city, to James G. Smith, Esq., formerly superintendent of the Atlantic and Pacific Telegraph Company, and now of the Continental Telegraph Company, I believe, and to Messrs. Shaw & Baldwin, telegraph constructors, also, I believe, now connected with the Continental. At that time I was engaged in perfecting an autographic telegraph by which maps and pictures were daily transmitted by telegraph over a single wire.

The recent announcements of this discovery in three different directions, each undoubtedly independent of my own experiments, show how the same idea often occurs in separate minds. There is no likelihood of any plan of this kind ever being reduced to practice, for some of the difficulties in the way of all of the plans are insuperable, as will be apparent from the following reasons:

1. The action of light upon selenium in changing its electric conductivity is slow; although new discoveries may remedy this feature.

2. To convey with any accuracy an image, one even so small as to be projected upon a square inch of surface (I am speaking now of the apparatus you describe), would necessitate that this surface should be composed of at least 10,000 insulated selenium points, connected with as many insulated wires leading to the receiving instrument; for the variation of the one-hundredth of an inch either way will "throw a line out of joint."

3. The most delicate apparatus would not indicate a change in resistance by the projection of light upon merely a selenium point.

4. Isochronism is unattainable, as required. The method I proposed involved the isochronous movement of the separate instruments. The transmitter consisted of a coil of fine selenium wire in a darkened case, having a diameter of say three inches.

Light from the image to be transmitted was to be let into the chamber and upon the selenium coil by a fine tube which, starting at the periphery of the circle, would draw concentric imaginary spiral lines until reaching the center of the circle. Thus light emitted or reflected from the image to be transmitted would affect the selenium just in proportion to the brightness of the image at the different points within the compass of the circle traversed by the imaginary lines drawn by the opening in the tube. The speed of motion of the tube was to be such that in describing all the spiral lines from the periphery to the center of the circle, the impression made upon the retina while at the periphery of the circle would not have ceased until the light ray should have reached the center of the circle.

The receiver consisted of a darkened tube, having an inside diameter of three inches (corresponding to the transmitting circle), with its sides and bottom absolutely black. In this tube, describing imaginary lines just as the tube in the transmitter, was a blackened index carrying two fine insulated platinum points very close together connected with the secondary wire of a peculiar induction coil, the primary wire of which constituted a part of the main wire leading to the transmitter.

The transmitting ray of light and the invisible index in the darkened receiving tube were to start at the periphery and describe their spiral motions in exact unison until the center should be reached, and the speed being sufficiently great it is obvious that as the first spark between the receiving platinum points would not have ceased to affect the retina until the last spark, with the index at center, would have been produced, an exact image of the object before the transmitter would be reproduced before the eye of the observer placed at the darkened chamber of the receiver.

But the trouble is to make the selenium sufficiently active, and to get the *isochronous motion*. Perhaps some of your readers may like to try their hands at rapid synchronism.

W. E. Sawyer

New York, June, 1880

It is interesting to compare Mr. Cary's cameras of eighty-six years ago with *Sylvania's* recently released video camera.

The unique vidicon assembly illustrated lends itself to a number of important applications requiring an ultra-miniature camera which will provide broadcast quality. This assembly measures only 4 x 3 x 8 and weighs only 4½ pounds. It detaches easily and rapidly from its control unit. When used together with one of the superb Angenieux zoom lenses which provide either a 10 to 1 or a 4 to 1 zoom range, (the 4 to 1 lens is illustrated) it provides a light-weight, ultra-compact camera for either hand-held or tripod shooting—a natural for sports, news, documentary, political events, and so on. Æ

# Up- grade your sound !

Whatever your receiver or amplifier is capable of doing, EMI loudspeakers have a unique way of making it sound better.

Perhaps it's the ease with which EMI loudspeakers project sound. So smooth and natural, it seems to float on the air in all its concert hall glory. Filling the room.

Or perhaps, it's the deep bass, the incomparable realistic midrange and the full, silky highs.

Or it could be the subtle detailing of their transient perfect response that catches you unawares.

So, for better sound from your receiver or amplifier, come on up to EMI loudspeakers.

There's an EMI loudspeaker to meet any requirement and budget. From \$49.95\* to \$395.00\*



\*Slightly higher in South and West

## EMI / SCOPE

Scope Electronics Corporation  
470 Park Avenue South  
New York, New York 10016  
Also available in Canada.

Circle 139 on Reader Service Card

# FREE STEREO INFORMATION

FM station directory . . . covers FM stations in U. S. and Canada. Factual equipment test reports. Test reports on tuners, preamps, poweramp/preamps. Find out what the experts think. A complete 36 page catalog tells about tuners, power amplifiers, preamplifiers, preamp/power amp combinations, and tuner preamp.



ALL FREE—  
JUST WRITE  
TO:

McIntosh Lab. Inc. 6 Chambers St.  
Binghamton, N. Y. 13903

NAME \_\_\_\_\_  
STREET \_\_\_\_\_  
CITY \_\_\_\_\_  
STATE \_\_\_\_\_ ZIP \_\_\_\_\_

Circle 140 on Reader Service Card

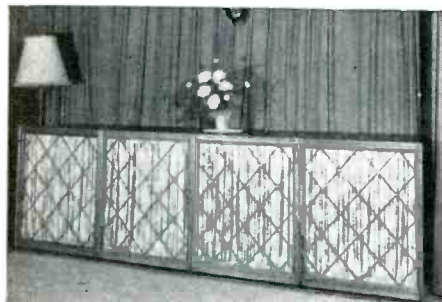

New MAESTRO, an all-horn-loaded, compression-operated uni-bass system, the world's first for home installation—, gives crisp, clean and clear bass unobtainable by any cone-type woofer.

Other models: Orchestra, Concert, Symphonia and Symphonietta.

For further details, contact:

**Provo High Fidelity**  
P.O. Box 204, Batavia,  
N.Y. 14021



**YL ACOUSTIC CO., LTD.**

No. 34-6, 2-chome, Nishi-Shimbashi  
Minatoku, Tokyo, Japan.

Circle 141 on Reader Service Card

## ROOM DESIGN

(from page 24)

Next to the room shape in importance comes the availability of loudspeaker space. Anyone who has ever studied loudspeaker cabinets and their performance in relation to high-fidelity signal reproduction must have come to the conclusion that a large baffle is as simple a device as any to avoid the various resonances and diffraction effects associated with cabinet edges, depths, and so on (see Fig. 2). Therefore, a false wall in which a set of speakers may be installed is probably as cheap an enclosure—and possibly cheaper—as a pair of highly polished walnut “high-boys.” Besides, the false wall can also be used to build in other enclosures, such as book shelves, amplifier equipment, bar, or the like. A depth of 1 foot is recommended for the false wall, in which some sound-absorbent material may be laid on the floor or nailed to the ceiling or sides of the wall before the row of studs is erected which represents the skeleton of the false wall. Obviously, the wall should not be “leaky,” so as to permit radiation from the rear of the cones to reinforce or to cancel radiations from the front of the cone, but should be substantial. A hardwood plywood wall, ½” thick, or a plaster-board covering will be entirely adequate.

There are still two other acoustic factors to be mentioned for the satisfactory planning of such a “hi-fi” room, namely, sufficient sound insulation between it and adjoining enclosures, and the acoustic treatment of the music room itself. To assure quiet in other parts of the house, it is often desirable (depending on how loud one is wont to listen to music) to employ so-called double-stud walls and solid-core doors. For the sound-absorbent treatment of the music room, care should be taken to avoid “double” acoustic treatment, as in the case where a ceiling with acoustic plaster opposed by carpeted floor, with the sidewalls remaining bare; or where two opposite sidewalls are treated with acoustic tile. The acoustic treatment should exist in a more-or-less uniform manner in the room, with the possibility of slightly more absorbent treatment on the wall facing the speakers, compared to the acoustic treatment of the other walls.

## TAPE GUIDE

(from page 48)

### Step-up Transformers

Q. In the June, 1965, issue of *AUDIO* you answer a question regarding the use

## CLASSIFIED

Rates: 10¢ per word per insertion for noncommercial advertisements; 25¢ per word for commercial advertisements. Rates are net, and no discounts will be allowed. Copy must be accompanied by remittance in first of the month preceding the date of issue.

HIGH FIDELITY SPEAKERS REPAIRED  
AMPRITE SPEAKER SERVICE  
168 W. 23rd St., New York 11, N. Y.  
CH 3-4812

HARPSICHORD: Same as owned by Philadelphia Orchestra and RCA Victor. In kit form for home workshop assembly, \$150. Clavichord kit, \$100. Free brochure. Write: Zuckermann Harpsichords, Dept. R, 115 Christopher St., New York, N. Y. 10014.

HI-FI SPEAKERS EXPERTLY REPAIRED  
USED SPEAKERS BOUGHT  
AUDIO SPEAKER TECHNICS  
22 Astor Place, New York, N. Y. 10003  
AL 4-2140

PRESSINGS FROM YOUR TAPES.  
WHOLESALE PRICES. SPECIALIZING IN  
SMALL QUANTITIES. DOUBLE DUBLYU  
RECORDINGS COMPANY, 221 Carton Avenue,  
Neptune, N. J. 07753.

ANY RECORD PUT ON TAPE: Single, LP, stereo. Quantity prices. 1 or 100. Write John G. Ellis, Box 15852, Del Valle, Los Angeles, California 90015.

STEREO REVERBERATORS for experimental application, \$7. Mono, \$5. Cal's, Box 234, Dearborn, Michigan.

PROTECT YOUR LP'S. HEAVY POLY SLEEVES FOR JACKETS, 5¢. MIN 50. LIGHT SLEEVES FOR RECORDS 3¢. MIN 100. POLY CO., HILLBURN, P. O. BOX 323, New York, N. Y. 10931.

NEW IN SOUND FOR “66.” Full fidelity bookshelf loudspeaker enclosures. Teak or walnut. Various styles. 8 and 16-ohm, kit or factory assembled. 1 year guarantee. Brochure. C-T Acoustic Laboratories, Box 543, Newark, Calif. 94560.

FREE! Send for money saving stereo catalog A4M and lowest quotations on your individual component, tape recorder, or system requirements. Electronic Values, Inc., 200 West 20th St., New York, N. Y. 10011.

WANTED: One set of portable cases for Magnecord P60AC: 5C (81D50), 8C (81D56), 10A, B or C (81E95), 81E90 or any case or cases which the P60A and P60C will fit into individually or together. Bauer, 119 North Birchwood Avenue, Louisville, Kentucky 40206.

Latest SME-3012 \$59. QUAD equipment: 2 electrostatic speakers, \$195 each, stereo preamp, \$68. FM stereo, \$110, 2 amplifiers, \$69 each. Lewis Lanese, 295 Angell, Providence, R. I.

5-YEAR INDEX TO STEREO EQUIPMENT TEST REPORTS appearing in 15 American and British periodicals. 1700 reports (1961-65) listed by type of equipment. \$2.00. J. B. Woy, P. O. Box 4216, Philadelphia, Pa. 19144.

WANTED: JansZen 1-30 electrostatic tweeter (4 element) in good condition. John McBride, 2626 Boxwood Drive, Wilmington, Delaware, 19803.

REVERBERATION UNITS (HAMMOND) all models and types. Available without electronics. Write for details, specifications, and prices. Harvey Organ Electronics, P. O. Box 268, Harvey, Illinois, 60426.

Additional Classified on page 65

**SAVE over 40% on hi-fi**

**COMPONENTS & TAPE RECORDERS**

- Easy-Pay-Plan—Up to 24 mos. to pay.
- 15 day money-back guarantee.
- Our guarantee — unconditional — 2 yrs. parts & labor, except styli and tape heads 90 days.
- Most items shipped promptly from our \$250,000.00 inventory.
- Trade-Ins—Highest allow—Send your list.
- Shipments double packed & fully insured.
- Special consideration — Export & APO inquiries.
- 21st yr. dependable service—World Wide. Write for our price first. You'll be glad you did.

"We own the sharpest pencils in the U.S.A."

**HI-FIDELITY**

CENTER  
The House of Low Prices

239 U East 149 St.,  
New York, N.Y. 10451

Circle 142 on Reader Service Card

**CANADA  
High Fidelity Equipment**

Complete Lines • Complete Service

Hi-Fi Records — Components  
and Accessories

**ELECTRO-VOICE  
SOUND SYSTEMS**

126 DUNDAS ST. WEST, TORONTO, CANADA

Circle 143 on Reader Service Card

**ADDITIONAL  
CLASSIFIED**

**PUBLIC ADDRESS SPECIALIST WANTED** to survey and estimate costs for installation of revolutionary new PA systems. New York based. Some travel. Write Box CD-1, AUDIO, P. O. Box 629, Mineola, N. Y. 11501

AMPEX tape recorder 351-2 with Sel-Sync, excellent condition, \$1695.00. 2 Ampex MX-35 mixers wired for echo like new, \$350.00 each. Fairchild equalizers and compressors, \$100.00 each. Langevin power supply and program preamplifiers. 2 Altec A7 speaker systems. 2 RCA 77D and 2 Electro-Voice 655C microphones. 2 professional TEAC electronics for tape recorder, same as Concertone 93, excellent condition, \$285.00. Mixing consoles for above equipment, \$100.00 each. Johnny Price, 11819 Lippitt, Dallas, Texas.

WANTED: Altec 250 SU mixer or model 1567A mixer and professional equalizers, limiters, microphones, etc. R. Johnson, Box 18234, Dallas, Texas.

WANTED: Factory wired Harman Kardon Citation "A" preamp with walnut case. State price, when and where purchased, present condition. Gerald Griepentrog, 2420 Orchard Place, Apt. 201, New Brighton, Minn. 55112.

**TOP-PROFIT OPPORTUNITY FOR DISTRIBUTORS JOBBERS & REPS**  
Here's your chance to get in on the booming tape market. cartridge and reel-to-reel . . . high turnover, long commissions, strong repeat business, and big profits! General Recorded Tape, Inc., America's newest duplicator of superior quality top-chart albums. Some areas available. Contact: Mr. Alan J. Bayley, President General Recorded Tape, Inc., 1262 Lawrence Station Road, Sunnyvale, California, 94086.

of transformers between mixer and tape recorder. Quoting from the Ampex manual for their 3761 mixer: "An output impedance of 250 ohms is normally provided to feed the 250-ohm input on Ampex series 400 recorder . . . Connect the output cable from mixer . . . Place input transfer switch to 'Mic' position." In this position it is 250 ohms also unless strapped otherwise. Are you saying that Ampex is incorrect?

A. I see no inconsistency between my statements in the June TAPE GUIDE and your quotation from the Ampex manual. I said that a microphone stepup transformer is used (when necessary) before the mixer, not after. Your excerpt from the Ampex manual does not indicate otherwise. If a mixer with low input and output impedances is used with a low-impedance microphone and a tape recorder having a low-impedance input, no stepup transformer would be used.

**"Professional"**

Q. Why do so many advertisements for tape recorders claim these machines to be "professional"? To me, professionals are the ones like the major recording studios producing records for public consumption and companies producing recordings for radio stations, TV commercials, and the like. You'll find them using big, rugged machines with transformer inputs and outputs, bridging connections, and so on. With these they use professional microphones. You and I know that good professional mikes cost at least as much, or more than a number of so-called "professional" tape recorders.

A. It appears that the advertising people have taken over the word professional in the same way that they have taken over the term high fidelity. To them it is a sales slogan that does not have a precise meaning.

**Synchronous Motors Throughout?**

Q. Why do some machines say that they use synchronous motors throughout? It seems to me that the very characteristics of a hysteresis motor (steady speed, essentially dependent on frequency and independent of load) would be out of place for the purpose of turning the feed and takeup reels, where speeds and loads constantly vary.

A. I too am puzzled by the occasional claim that the winding motors as well as the capstan motor are of synchronous type. I don't know of any high-quality tape machine that uses hysteresis motors for the feed and takeup reels. Perhaps some reader of this column can enlighten us.

**One Channel Stereo?**

Q. I have a \*\*\*\* tape recorder and a \*\*\*\* turntable. I bought the turntable just for recording (directly into the tape recorder). I get a fair response when playing records through the tape machine (using the latter as a monitor amplifier-speaker), but when I try to record I only get one track.

A. One section of the tape head or one channel of the tape machine's recording electronics may be defective.

**THE**  
*Turntable of the Tape-Age*  
**807**



Enjoy the superior quality of tapes with the convenience of phonograph records.

Connect a Viking 807 to your music system and play stereo or monaural tapes, half or quarter track at 3-3/4 or 7-1/2 ips. Automatic shut-off, cueing, fast forward and rewind features included for your pleasure.

807 complete with walnut base \$124.95



MADE BY SKILLED  
AMERICAN CRAFTSMEN AT  
Viking OF MINNEAPOLIS®

9600 Aldrich Ave. So. Minneapolis, Minn. 55420

Circle 144 on Reader Service Card

**40 DB LIMITING**

Less Than 1/2% Distortion



**TELETRONIX  
LEVELING AMPLIFIER**

Using Revolutionary Optical Control

- NO LAG
- FLAT RESPONSE
- REPLACES EXISTING LINE AMPLIFIERS
- LOW NOISE LEVEL

OVER 500 IN USE BY MAJOR NETWORKS  
INDEPENDENT STATIONS & RECORDING  
STUDIOS

Our 8th Year Of Service To Industry

**TELETRONIX ENGINEERING CO.**

manufacturers of  
FM Broadcast Transmitters and RF Amplifiers  
Audio Relays, Solid State Remote Station Controls  
Volume Levelers, FM Broadcast Antennae  
308 Monterey Road, South Pasadena, Calif.  
EXPORT: GOTHAM AUDIO CORPORATION  
2 West 46 Street, New York, N. Y. 10036

Circle 145 on Reader Service Card

## HOW TENDER IS A HUNK OF STEEL? EXCEEDINGLY...

*When you are dealing with high-permeability core laminations.*

In the original state, no. You can punch it, draw it, form it, shear it, or bend it and it's only thin sheet steel. But once formed into laminations and hydrogen annealed to bring out their peculiar magnetic properties, these laminations are delicate beyond belief. Drop them three inches to a hard surface, grind them ever so lightly, or merely bend them slightly and the magic is lost . . . you're back to bits of sheet steel again.

MHI performance begins with unique, sintered brass core holders so stable and precise that core laminations can be formed to the final contour *before heat treatment*. No grinding is necessary, ever. The ultra thin laminars are hand-inserted and loosely stacked. (Pinch them ever so lightly and you'd have a mediocre head.)

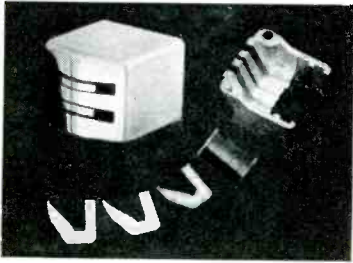

After inductance balancing, the assembled heads are cased, epoxied and bake-cured at 250° F. — your assurance that gaps and inductance will hold at any normal environmental temperatures. A final lapping and polishing of the head face is accomplished (again without grinding techniques) to provide a finished head with more inherent, built-in performance than other heads of so-called premium quality.

MHI heads provide high-end performance second to none, a superb low end, and long trouble free service life.

All of this is our way of saying: When you buy a high fidelity tape player or recorder, MHI heads as factory equipment are not exactly cause for disappointment.

Or, when buying a replacement head for your present tape equipment, you or your dealer can obtain an MHI replacement in just about five days. We make only one quality. *Standard* MHI replacement heads in the four-track stereo type retail at only \$24.50. *That's less than ordinary premium heads.*

*If you are concerned with the manufacture or engineering of teaching equipment, tape players of any type, or instrumentation systems, write or call for details on full track, half-track and quarter track heads suited to your needs.*



MacALLISTER / HOGAN, INC.  
5710 W. 36th St.  
Minneapolis, Minn. 55416

Circle 146 on Reader Service Card

## Advertising Index

Acoustic Research, Inc. ....	13
Altec Lansing Corporation ....	Cov. III
Audio Bookshelf .....	62
Benjamin Electronic Sound Corporation .....	55
Boynton Studio .....	14
Bozak .....	29
British Industries Corporation .....	3, 43
Classified .....	64
Dynaco, Inc. ....	30, 31
Electro-Voice, Inc. ....	Cov. IV, 1
Electro-Voice Sound Systems .....	65
Elpa Marketing Industries, Inc. ....	59
EMI/Scope .....	63
Empire Scientific Corporation .....	33, 34
Fairchild Recording Equipment Corporation .....	6
Frazier, Inc. ....	47
Garrard Sales Corporation .....	3
Gotham Audio Corporation .....	53
Harman-Kardon, Inc. ....	11
Heath Company .....	39
Hi Fidelity Center .....	65
Irish Tape .....	56
Kenwood Electronics, Inc. ....	4
3M Company .....	58
McIntosh Laboratory, Inc. ....	64
MacAllister Hogan, Inc. ....	66
Marantz, Inc. ....	27
Martel Electronics .....	59
North American Philips Company, Inc. ....	45
Pickering & Company, Inc. ....	17
Pioneer Electronic Corporation .....	15
Roberts Electronics .....	10
Scott, H. H., Inc. ....	Cov. II
Sherwood Electronic Laboratories, Inc. ....	18
Shure Brothers, Inc. ....	25
Stanton .....	9
Superscope, Inc. ....	5, 8
Syncon Corporation .....	49
Tandberg of America, Ltd. ....	51
Teletronix Engineering Company .....	65
United Audio .....	41
University Sound .....	7
Utah .....	61
Viking of Minneapolis .....	57, 65
YL Acoustic Co., Ltd. ....	64

# AR INC. books et al

## HIGH FIDELITY SYSTEMS—

*A User's Guide* by Roy F. Allison

AR Library Vol. 1 70 pp., illus., paper \$1.00

A layman's practical guide to high fidelity installation. We think that it will become a classic work for novices (and perhaps be consulted secretly by professionals). From the Bergen Evening Record: "completely basic . . . If this doesn't give you a roadmap into the field of hi-fi, nothing will." From The American Record Guide: "really expert guidance . . . I would strongly urge this book as prerequisite reading for anyone contemplating hi-fi purchases." From High Fidelity: "welcome addition to the small but growing body of serious literature on home music systems." From Electronics Illustrated: "To my mind, this is the best basic book now available on high fidelity."

## REPRODUCTION OF SOUND

by Edgar Villchur

AR Library Vol. 2 93 pp., illus., paper \$1.00

Vol. 2 explains how components work rather than how to use them, but it presupposes no technical or mathematical background. Martin Mayer writes in Esquire: "far and away the best introduction to the subject ever written—literate, intelligent and, of course, immensely knowledgeable." From HiFi/Stereo Review: "just the books to satisfy that intellectual itch for deeper understanding."

## RADIO MAGAZINES, INC.

P. O. Box 629, Mineola, N. Y. 11501

Please send me the following:

Roy Allison's "High Fidelity Systems—A User's Guide" at \$1

Edgar Villchur's "Reproduction of Sound" at \$1

I enclose \$\_\_\_\_\_ in bills, money order, or check only. (All prices post-paid.)

NAME \_\_\_\_\_

ADDRESS \_\_\_\_\_

ZIP \_\_\_\_\_

# COLORFUL IMPROVEMENT!



**SOLD**

When unprecedented demand exhausted our entire initial production run of the new 711A stereo receiver, we asked customers and dealers to suggest improvements for the next edition.

"Change the blue metal cover to a brown one!" they said.

Because we want to be perfect, we incorporated the "improvement" in the latest 711A's. The rest of the features are staying—they're what made the demand get ahead of the supply!

The metal cover, entirely enclosing the 711A, tells an interesting story. The reason we can use *any* cover, blue *or* brown, is that the all-silicon-transistor circuitry creates almost no heat. Altec's military-type silicones mean trouble-free dependability. These rugged transistors can withstand at least 200% more heat than the germaniums most receivers use!

## WHAT WE DIDN'T CHANGE

**THE AMPLIFIER SECTION** gives you 100 watts of clean, undistorted power—the kind you can *use*, not just talk about! Turned up to a roof-lifting 70 watts, the amplifier has a total harmonic distortion of a mere 0.25%. Even at the full 100 watts, distortion is still only 0.5%!

And if you want to improve on the 711A's frequency response of 20-20,000 cps  $\pm 1$  db at 100 watts, you can always lower the power and get a fantastic 10-100,000 cps  $\pm 1$  db! Rocker switches plus a complete control panel give you instant mastery of every audio and electronic function. You never even have to change fuses, thanks to the 711A's automatically resetting circuit-breakers. Of course, there are no transformers to cause distortion.

**THE TUNER** has a masterful combination of sensitivity and selectivity to pick up even the weakest stations—and then hang onto them like a bulldog. Drift is a problem of the past!

The 711A tuner is extremely sensitive, with a volume sensitivity of 0.9  $\mu$ v and usable sensitivity of 2.2  $\mu$ v IHF. Other specs that back up the superior performance of this years-ahead tuner include capture ratio of 2.5 db, stereo separation at 1000 cps of 40 db, and a power bandwidth of 20-20,000 cps  $\pm 1$  db.

A unique 4-gang tuning condenser makes the 711A's special sensitivity-selectivity combination possible. The fully neutralized IF uses the newest high-gain silicon transistors for optimum integration with the tuning gang.

## CONVINCE YOURSELF — SEE & HEAR THE FANTASTIC 711A NOW.

It's all silicon—it's all excitement! It's only \$378. If you don't like blue *or* brown metal, there's an optional walnut case for \$24. Your Altec dealer's waiting to show you the 711A now! Or send for complete information.

At only \$3.78 per watt, the 711A is your best power-per-dollar value among *quality* receivers!



**ALTEC LANSING**

A Division of *LSPV* Ling Altec, Inc.

ANAHEIM, CALIFORNIA

Circle 102 on Reader Service Card

This E-V driver has a hole in the back . . . . .



# It's one of the ways Electro-Voice takes the holes out of P.A. system response!

ⓔ Too often, ragged frequency response starts at the P.A. driver. And all too often, there's a big hole in response from about 2 to 7kHz. But that's right where you need solid response for top-notch intelligibility. So E-V did something about it.

With these new P.A. drivers, E-V insured smooth, commanding high frequency response. How? By reducing the moving mass without reducing the strength of the diaphragm and voice coil. Special attention was also paid to internal sound paths — attention that paid off with unusually uniform response—and significantly improved articulation.



MODEL 1828R

There are three versions of these new 30-watt drivers. The Model 1828R fits any reentrant or other conventional

horn. When coupled to an E-V Model AR150, FR150 or HC400 reentrant horn, the wide-range performance belies the modest cost.

The Model 1828C — also rated at 30 watts — is a compound driver. It has a hole in the back. While it can be used on reentrant horns, it is specially designed to operate in exclusive E-V compound horns. The idea is simple: a big horn for lows hooked to the back of the 1828C, and a small horn for highs attached to the front. It means wider range and dramatically lower distortion. You can choose the famous CDP® (FC100) wide angle horn, or the fantastic new AC100 concentrating version.



MODEL 1828C

The third model — the 1828T — also

fits either reentrant or compound horns. In addition it has an efficient 70.7-volt line transformer built in. A transparent panel lets you see what tap has been selected, and you can change taps at any time — without disturbing the primary wiring.

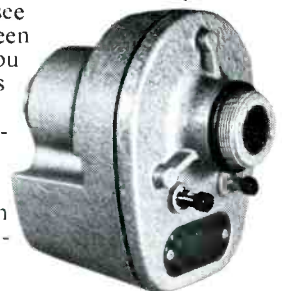

MODEL 1828T

There's much more to recommend the 1828 Series of P.A. drivers. Die-cast housings, spring-loaded terminals, improved weatherproofing and the highest production standards in the industry. Try these new E-V P.A. drivers today. They're designed to keep you out of a hole!

ELECTRO-VOICE, INC., Dept. 466A  
602 Cecil Street, Buchanan, Michigan 49107

microphones • public address loudspeakers • high fidelity components  
phonograph needles and cartridges • organs • space and defense electronics

Circle 104 on Reader Service Card

**Electro-Voice**®  
SETTING NEW STANDARDS IN SOUND