

AUDIO

OCTOBER, 1963

60¢

...the original magazine about high fidelity!



3 GREAT NEW SCOTT AMPLIFIERS

POWERHOUSE



New 299D 80-Watt Stereo Amplifier

This best-selling stereo amplifier, top-rated by all leading consumer testing organizations, is now better than ever. New luxury features include: direct connection for powered center channel and extension speakers, speaker switch for private listening, new switching for choice of five low level inputs, non-magnetic electrolytic aluminum chassis, exclusive Scott Balance Left/Balance Right level balancing system, and massive output transformers. Behind the handsome panel, with its easy-grip knobs, is a lifetime of trouble-free performance and power to spare. \$229.95

TOP PERFORMER



New 222D 50-Watt Stereo Amplifier

There's a new look to the ever-popular 222 series . . . and new performance, too. Massive transformers deliver enough power to drive even the most inefficient speaker systems . . . and the 222D gives you power in the low frequencies, where it's really needed. This value-packed performer incorporates a center channel speaker connection without the need for an additional amplifier, speaker switch for private listening, front panel switch for selection of phono or tape deck. Build a quality music system around this most versatile, feature-filled amplifier. \$179.95

MODEST COST

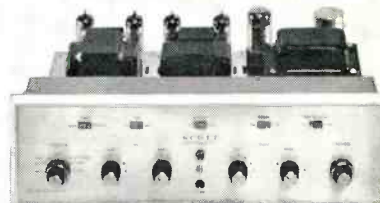

New 200B 30-Watt Stereo Amplifier

Scott performance and looks at a budget price! Oversize transformers give full power in the critical bass range . . . power enough to drive low efficiency speakers to full room level. The new 200B has features you'd never expect to find at this price: stereo headphone output on front panel, dual tone controls, tape monitor, and a handsome, massive panel and knobs. Scott gives you all the controls and power you'll ever need at a price not much higher than you would pay for ordinary equipment without Scott quality. \$139.95

How to select the right one for your system

FEATURES

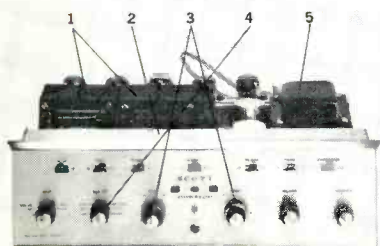

Wide Range of Features and Controls

1. Oversized output transformers for full bass response.
2. Non-magnetic electrolytic aluminum chassis for cool operation and lowest hum.
3. Dual tone controls for maximum adjustment of any program material
4. Exclusive Scott balancing method for perfect stereo regardless of speakers or program material.
5. Conservatively designed power-supply assures years of trouble-free enjoyment.

SPECIFICATIONS

	299D	222D	200B
Power per channel (IHF) watts	40/40	25/25	15/15
Power band (cps)	19-25,000	19-25,000	25-15,000
Hum Level (db)	-80	-80	-70
Tape Monitor	Yes	Yes	Yes
Dual Tone Controls	Yes	Yes	Yes
Stereo Headphone Output	Yes	Yes	Yes
Low Level Inputs	2	2	1
High Level Inputs	3	3	2

WANT MORE INFORMATION?

Mail this coupon for complete information on all the great new Scott components and kits.

H. H. Scott, Inc. Dept. 35-10
111 Powdermill Road
Maynard, Mass.

Send me complete information on the new 1964 Scott line of stereo components & kits.

Name

Address

City Zone State

Include names of interested friends, and we'll send them duplicate materials.

SCOTT®

Export: Morhan Exporting Corp., 458 Broadway, N.Y.C.
Canada: Atlas Radio Corp., 50 Wingold Ave., Toronto
All prices slightly higher west of Rockies. Accessory cases extra.

AUDIO

OCTOBER, 1963 VOL. 47, No. 10

Successor to **RADIO**, Est. 1917

C. G. McPROUD • *Publisher*

DAVID SASLAW • *Editor*

JANET M. DURGIN
Production Manager

Contributing Editors

EDWARD TATNALL CANBY

JOSEPH GIOVANELLI

HAROLD LAWRENCE

CHARLES A. ROBERTSON

CHESTER SANTON

HERMAN BURSTEIN

HENRY A. SCHOBER
Business Manager

SANFORD L. CAHN
Advertising Director

EDGAR E. NEWMAN
Circulation Director

Representatives

Bill Pattis & Associates,
4761 West Touhy Ave.,
Lincolnwood 46, Ill.

James C. Galloway,
6535 Wilshire Blvd.,
Los Angeles 48, Calif.

Warren Birkenhead, Inc.,
No. 25, 2-chome, Shiba Hama-
matsu-cho,
Minato-ku, Tokyo, Japan

AUDIO Articles

- | | | |
|--|----------|---|
| Transistorized Stereo Microphone Mixer
Organs and Organ Music—
In Two Parts, Part 1 | 19
23 | <i>Peter A. Stark</i>
<i>Wintthrop S. Pike</i> |
| Crossover Design—In Two Parts, Part 2
Audio Engineering Society
15th Annual Convention | 26
36 | <i>Norman H. Crowhurst</i> |
| Harmonic Distortion—Tests and
Measurements | 38 | <i>Mammie Horowitz</i> |
| Light Listening | 8 | |
| Record Revue | 52 | |
| Heathkit Transistor Electronic Organ | 44 | <i>Model GD-232</i> |
| Empire Record Playing System | 46 | <i>Model 498</i> |
| EICO Stereo Tuner, 35-Watt Stereo
Amplifier, Stereo Preamplifier | 48 | <i>ST'97, ST'70, ST'84</i> |
| Sennheiser Condenser Microphone | 50 | <i>MKH-104</i> |

AUDIO Reviews

Chester Santon
Edward Tatnall Canby

AUDIO Profiles

Model GD-232
Model 498
ST'97, ST'70, ST'84
MKH-104

AUDIO in General

- | | | |
|-------------------|----|-----------------------------|
| Audioclinic | 2 | <i>Joseph Giovanelli</i> |
| Letters | 6 | |
| Audio ETC | 14 | <i>Edward Tatnall Canby</i> |
| Editor's Review | 16 | |
| Tape Guide | 34 | <i>Herman Burstein</i> |
| About Music | 62 | <i>Harold Lawrence</i> |
| New Products | 64 | |
| New Literature | 66 | |
| Cover Story | 70 | |
| Industry Notes | 79 | |
| Advertising Index | 80 | |

Number 2 in a series of discussions
by Electro-Voice engineers

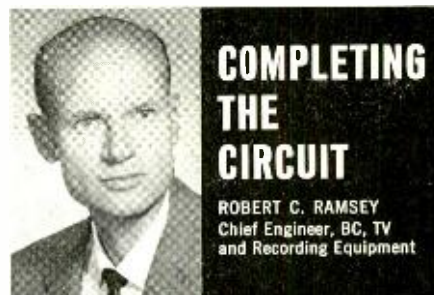

COMPLETING THE CIRCUIT

ROBERT C. RAMSEY
Chief Engineer, BC, TV
and Recording Equipment

Generally, sound pickup quality is controlled, in large measure, by correct choice of the microphone. On occasion, however, what seems to be the right choice doesn't work as planned. One factor often overlooked is the proper electrical match between the microphone and its input circuit. Let us consider the various cases encountered by the sound engineer.

Most common is the condition where the microphone output is connected to an open grid—the microphone is not loaded. Since microphone specifications are normally based on open circuit measurements, response and level should be as specified.

When microphones are terminated by loads approaching their own impedance values, their performance will differ from that specified for the unloaded condition. Examples of the loaded condition include the use of low level mixing, and transistor amplifiers with low input impedance. Performance changes under these conditions are important to both the manufacturer and the user.

The simplest condition of loading is when the microphone is terminated by a resistive load equal to its own impedance value at all frequencies. When this occurs, the result is simply a drop in level at all frequencies. No change in response is experienced.

Another important type of loading occurs when the load impedance varies with frequency and results in a change in overall frequency response. An example is the effect of cable capacitance when the microphone is used in the Hi-Z mode. The cable impedance decreases with increasing frequency, resulting in high frequency attenuation. A dynamic high impedance microphone will show serious high frequency loss when cables longer than eighteen feet are used.

Mass-controlled bidirectional and cardioid microphones generally have impedance curves that decrease sharply as frequency increases in the range from 100 to 2,000 cps. When these microphones are connected to resistive loads, both a loss in level and a change in response occurs: The most noticeable change is that of reduced bass response.

In most applications, professional microphones are connected for open circuit operation and the loading problem simply does not exist. Professional microphones are usually low impedance so that the effect of cable capacity is extremely small, even with very long cables. For example, a loss of only one db at 10 kc will occur with a 50 ohm microphone connected to a 620-foot cable. The same one db loss will be noted at 190-feet when an impedance of 250 ohms is used.

Loading professional microphones will not normally seriously degrade sound quality. For instance, using a 250 ohm microphone in a 50 ohm input results in 7 db higher output level, with a slight bass roll-off, and a slight attenuation at 10 kc. A 50 ohm microphone used in a 250 ohm input results in a 7 db loss in level, but no change in response. "Mis-matching" can sometimes actually improve results, when the effects of loading are carefully considered.

This excerpt from *E-V Microphone Facts*
(Volume 2, No. 1) presented as an industry
service. For more detailed discussion, write:
ELECTRO-VOICE, INC., Dept. 1033A
Buchanan, Michigan

Electro-Voice
SETTING NEW STANDARDS IN SOUND



AUDIO (title registered U. S. Pat. Off.) is published monthly by Radio Magazines, Inc., Henry A. Schober, President; C. G. McProud, Secretary. Executive and Editorial Offices, 204 Front St., Mineola, N. Y. Subscription rates—U. S., Possessions, Canada, and Mexico, \$5.00 for one year, \$9.00 for two years; all other countries \$6.00 per year. Single copies 60¢. Printed in U.S.A. at 10 McGovern Ave., Lancaster, Pa. All rights reserved. Entire contents copyrighted 1963 by Radio Magazines, Inc. Second Class postage paid at Lancaster, Pa.



RADIO MAGAZINES, INC., P. O. Box 629, MINEOLA, N. Y.
Postmaster: Send Form 3579 to AUDIO, P. O. Box 629, Mineola, N. Y.

Coming NEXT Month

Construction...

● Remote Control with Light. William G. Dilley describes a method of controlling equipment—volume, or any other parameter which can be controlled by a variable resistor—with light-sensitive cells.

Science and Opinion...

● 15-Deg. Vertical Angle—A Key to Better Stereo Sound. Benjamin B. Bauer of CBS Laboratories takes up the cudgels to defend the RIAA-suggested standard of 15 deg. for the vertical angle of pickups.

● The Matched Load, by George Fletcher Cooper. Here are some thoughts and opinions, concerning the matched load, which extend the traditional concept.

and

Equipment Profiles...

1. Lafayette "Criterion" transistorized stereo power amplifier, Model LA-280
2. Dual 1009 Automatic Turntable
3. Dyna "Stereo-35" Power Amplifier
4. Heathkit IM-30 Transistor Tester

In the November Issue

On the newsstands, at your favorite audio dealer's, or in your own mailbox

AUDIO CLINIC

Joseph Giovanelli



Send questions to:

Joseph Giovanelli
2819 Newkirk Ave.
Brooklyn 26, N. Y.

Include stamped, self-addressed envelope.

Power Amplification

Q. It has always been my understanding from articles I have read that the amount of amplifier power needed is mainly governed by the efficiency of the speakers, the size of the listening room, and the acoustical environment. In my particular case, the efficiency of the speakers is high. The size of the room is approximately 25-ft. long x 16-ft. wide x 8-ft. high. The acoustics are slightly on the live side, yet I find that some people in the field insist that even with efficient speakers the really high-powered amplifiers will give audibly better reproduction at the extremes of the frequency range. For lack of a more refined scientific term, the results are called "cleaner," "more transparent," "effortless." Recommendations have been up to 150 watts triode power per channel. Others disagree emphatically, claiming that 30-watts per channel is more than enough reserve power for reproduction of the very finest commercial recordings available today.

I have no way of proving or disproving these opinions, unless I had access to this higher-powered equipment and could arrange for A-B comparison in my basement. Unfortunately, manufacturers do not loan out 150-watt power amplifiers to satisfy the experimental nature of the audiophile. Therefore, at this point, professional advice is in order. Robert De Salvo, Franklin Square, New York.

A. You called your topic "Power amplification." It should have been "Power Output" because you are not concerned here with the amount of amplification possessed by a particular amplifier, but you are concerned with the amount of power the amplifier can deliver to the loudspeaker. Strictly speaking, a power amplifier takes a small amount of power and amplifies it to a larger amount of power. This is something which you very well would be concerned about if you had a preamplifier which had extremely little output and you would then have to know if the amplification, or gain, of the power amplifier were sufficient to raise the feeble signal of the preamplifier up to the level of the maximum capabilities of the amplifier. Quite a bit could be said on this subject, but it is not the purpose of this paper to delve into that aspect of sound reproduction.

There is no really definite answer to your problem. A high-powered amplifier will certainly deliver clean sound to the speakers if it produces clean sound. The fact that an amplifier can deliver large amounts of power does not necessarily mean that the sound produced will be clean.

If you compare the sound of a clean, 14-watt amplifier to the sound produced by a 100-watt unit which produces considerable distortion, the 14-watt amplifier will likely sound better than the 100-watt unit.

Getting to the heart of the matter, if the low-power amplifier is clean at its maximum output, you can use it with any speaker—even the least efficient—provided you are listening in an average-sized room. Although your listening room is larger than average, you point out that your speakers are quite efficient, and this fact should offset this.

I know this is a very controversial point. All I can say is that I am using very inefficient speakers and a 14-watt amplifier. The amplifier is clean at its maximum output. That is the secret. I have had some 20-watt units here and I could not use them with the same speakers.

FM-Stereo Detectors

Q. Would it be advantageous to replace the discriminator detector with a ratio detector for operation with a stereo multiplex adaptor? Robert W. Timmerman, South Charleston, West Virginia.

A. It is frequently desirable to convert a discriminator circuit to one employing a ratio detector when FM stereo is to be installed in the music system. This is true in those instances in which the tuner was built before the advent of FM stereo.

The discriminator transformers used with some of these old sets did not have the bandwidth required for good FM stereo. It has been determined that the best cure is to replace the unit with a ratio detector. Modern ratio-detector circuits have somewhat better bandwidth characteristics than do today's discriminators. Further, modern ratio detectors are able to produce fine sound quality, as opposed to some of the units used in older tuners. Many of you can remember how easy it was to tell if you were listening to a discriminator or a ratio detector. It is not so easy to do this nowadays.

Current Limiting with Silicon Diodes

Q. My power amplifier uses two silicon rectifiers in a voltage-doubling arrangement in the power supply. When I first turn it on, there is quite a surge, resulting in a loud hum in the speakers which lasts 10 to 20 seconds. I assume this does the components no good over a period of time.

Do you recommend wiring a surgistor or thermistor of some sort into the circuit? Perhaps one of the types that simply plug-in between the amplifier and the 117-volt a.c. line? Fred W. Schill, Palo Alto, California.

A. Because a silicon diode requires no warmup, and because its forward resistance is much lower than that of a thermionic rectifier, the filters charge very quickly. This could cause the filters to overheat if it was not for the fact that the power transformer with which they are associated has

TYPE A
Automatic Turntable
\$79.50



AT6
Automatic Turntable
\$54.50

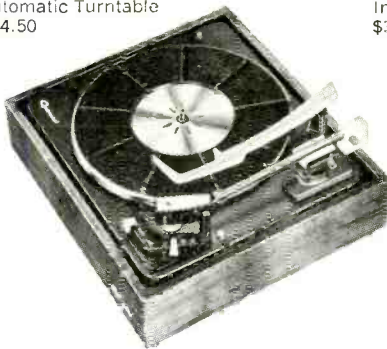

AUTOSLIM/P
Intermix Changer
\$39.50



This year again, more people will choose one of these 3 Garrard models than all other record playing components combined.

To help find the Garrard which is best for you—
let us send you the new Comparator Guide.

Clearly and concisely, it describes the important Garrard advances—all of which play a vital part in insuring top performance and longer life for your records. Every Garrard model is pictured in full color with detailed photographs, descriptions of its features and explanations of how they contribute to your enjoyment. The coupon below will bring you a copy of the Garrard Comparator Guide—without charge.



GARRARD, Division of British Industries Corp., Port Washington, N. Y.



Canadian Inquiries to Chas. W. Pointon, Ltd., 66 Racine Road, Rexdale, Ontario
Other territories to Garrard Engineering & Mfg. Co., Ltd., Swindon, Wilts., England

Dept. CR-13, Garrard
Division of British Industries Corp.
Port Washington, N. Y.
Please send a Garrard Comparator Guide
Name _____
Address _____
City _____ State _____

real FM
authorities
agree . . .



for the best seat in the house . . .
you need a **FINCO**® AWARD WINNING
FM ANTENNA

Guarantee yourself the best seat in the house for tonight's FM concert . . . install a fidelity-phased FINCO FM antenna.

THE FINNEY COMPANY
Bedford, Ohio
Dept. A

some resistance in its secondary winding. This resistance limits the current flow.

The only thing to be concerned about is the situation which might result if the circuit has no bleeder and if the warmup voltage is almost high enough to break down the electrolytic capacitors.

If these conditions exist in your equipment, you should definitely use a device to limit the voltage during warmup. Otherwise, the life of the filter capacitors will be materially shortened. Any of the devices you mentioned will function provided that the voltage is normal after the filaments have come up to operating temperature. I prefer devices which are thermostatically controlled in such a way that when the equipment has fully warmed up, the contacts close. You are thereby certain that the voltage fed to the equipment is the actual line voltage.

Units of Capacitance

Q. I have been studying the circuit diagram of a tape recorder I have just bought. I am puzzled by the capacitors with values in "nF." (There are also capacitors with values in "pF" and MF, so the nF's cannot be mistakes in this circuit diagram.) From the way they are used in the circuit, I guess that 10 nF equals 0.01 MF, and that 1 nF equals 0.001 MF. Am I right? B. D. Burks, Silver Spring, Maryland.

A. Your understanding of the values of the nF is correct. This is the new nomenclature of capacitors which has been adopted by the National Bureau of Standards. We will see more and more of this notation in time.

MF stands for microfarad. You more often see this written as μF . This unit is one millionth of a farad.

MMF or $\mu\mu\text{F}$ stands for micromicrofarad. This, in turn, stands for one millionth of a microfarad. Because micromicrofarad is a long word and has a three-letter abbreviation, the prefix pico has been substituted for the prefix micromicro. Pico represents one millionth of one million. Pico is coupled with farad to produce picofarad, pF. One pF is equal to 1 $\mu\mu\text{F}$.

It is also a good idea to have some unit equal to 0.001 μF so as to make writing of capacitance values easier. Such a unit has been devised. It comes from the Greek word for nine. That number is equal to the number of zeroes that would be present if the capacitor was expressed in fractions of a farad. In other words, the nanofarad, nF, is equal to 10^{-9} farads, or 1 nF equals 0.001 μF . Æ



\$2.50
each

SAVE YOUR
COPIES OF
AUDIO

- Each file holds a full year's copies.
- Jesse Jones Volume Files for every publication.
- Covered in durable leather like Kivar, title embossed in 16 Kt gold.

Satisfaction guaranteed

Attractive and
practical for your
home or office

3 for \$7.00
6 for \$13.00

ORDER NOW — send
check or money order
MAGAZINE FILE CO.
520 FIFTH AVENUE
NEW YORK 36, N. Y.

FREE DESCRIPTIVE FOLDER
UPON REQUEST



Now there are two Troubadors

The New Empire 498 — No Larger Than A Record Changer . . . Every Inch A Troubador. The model 498 is tailor-made for console or equipment cabinets. Record playback in console cabinets has special problems. Acoustic feedback, for one. Because of the close proximity of turntable to speaker, stereo equipment often "talks back." Not too long ago, Audio Magazine tested the Empire Troubador . . . they reported: "We tried to induce acoustic feedback by placing the turntable on top of our large speaker system and turning up the gain—WE WERE UNSUCCESSFUL." Other factors important to cabinet owners are stability and level requirements. Many turntables call for a perfectly level surface, and the jars and jolts of heavy footsteps or accidental bumps can jump some arms even in the most stable of cabinets. Stability under virtually any conceivable situation is assured by Empire's sensational "Dyna-Mount" (vibration-absorbing multiple-floating suspension system). As for levelness . . . the New 498 Troubador with more perfect balance, tracks and plays even while turning upside

down. (Dimensions: 15 $\frac{7}{8}$ " wide x 13 $\frac{1}{4}$ " deep . . . height required above mounting board 2 $\frac{3}{4}$ "; depth required below turntable base plate 3 $\frac{1}{2}$ ").

The Famous Empire 398. Outstanding! Too perfectly engineered for even a whisper of distortion . . . too handsomely finished to hide behind cabinet doors. The response of the country's hi fi magazines to the Empire Troubador says it as well as we could. High Fidelity, for example, reports: "The 'Troubador' represents a precision-engineered product of the highest quality . . . wow, flutter and rumble completely inaudible . . . first-rate audio components: hum field completely negligible . . . speed accuracy very good . . . maximum tracking error of the arm was judged to be negligibly small . . . very low needle talk, minimum hum pickup . . . clean response . . . one of the finest, handsomest record players available."

TROUBADOR

TABLE OF CONTENTS

Empire 3-speed "silent" turntable . . . Empire 980 dynamically balanced playback arm with the sensational Dyna-Lift . . . and the new Empire 880p mono-stereo cartridge featuring the virtually indestructible Dyna-Life stylus . . . Complete with handsome walnut base 498 — \$170 398 — \$190.

For a demonstration: see local Hi Fi dealer / For complete literature write Empire Scientific Corp., Dept. H., Garden City, N.Y.

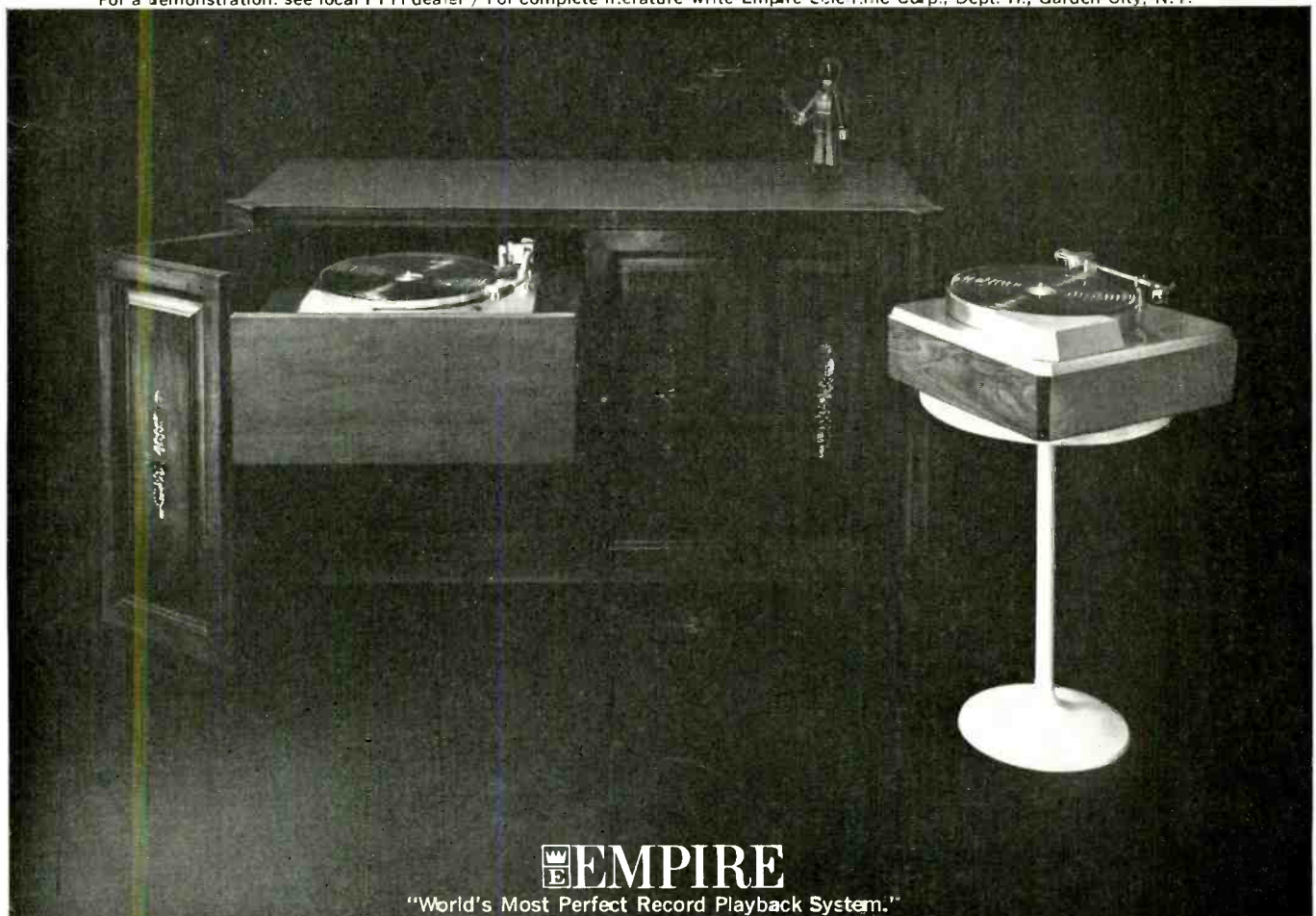

EMPIRE

"World's Most Perfect Record Playback System."

EXPORT: EMEC. PLAINVIEW, L. I., N. Y. • CANADA, EMPIRE SCIENTIFIC CORP., LTD., 1051 EGLINGTON WEST, TORONTO

**BRAND NEW
FOR '63**

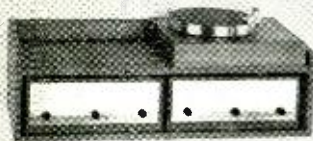
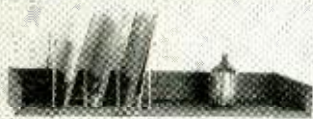

101 Puts your components on the wall where they may be enjoyed so conveniently. A refreshing new approach to express your individuality. Offers a thousand and one decorative possibilities. Complete with equipment enclosure, record shelf, custom panel and concealed wall supports. Finished in Oiled Walnut. **\$69.50**



303 Award winning design created for "Shelf Speakers." Place your shelf speakers at each end and instantly a beautiful Stereo Music Center is created. Has adjustable component shelves, sliding changer/turntable pull-out shelf and place for hundreds of records and tape deck, too. Over six feet long. **\$109.50**

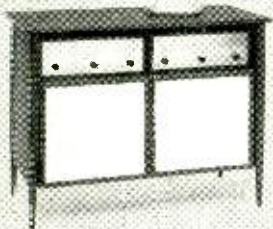

404 Stunning equipment cabinet that features two big pull-out drawers, one for changer/turntable, the other for hundreds of records or tape deck at your fingertips. Beautifully accented fronts in cane or matching veneers. **\$99.50**

All are carefully crafted from genuine hardwoods and superbly finished to match every decor. See the complete line at leading Hi Fi dealers or write for free brochure.

**Audio
Originals**

474 S. MERIDIAN ST. INDIANAPOLIS 25, INDIANA

LETTERS

He Likes Pipe Organs

SIR:

Hooray for Mr. Pickering's excellent article (Electronic Simulation of Organ Sounds) and a comprehensive survey of the things that most electronic organs simply don't do. There are, however, two facets of the sound of a real organ that Mr. Pickering either overlooked or failed to mention in his article. One of these is the actual change in harmonic development within a given rank of pipes as one runs up the scale. This, it seems to me, is one of the major faults of so many electronic instruments, in that harmonic development is the same for each note of the scale.

The second item concerns non-harmonic sounds that are to be found in pipe organs. Pipes which are voiced in the manner of the seventeenth century have a delightful "zzzzzt" (not to be confused with the "chiff") when they are sounding. This added sound tends to give clarity to voice lines and greater pitch definition to each note. Oddly enough, this sound is mostly the result of a cluster of non-harmonic sounds that vary little from note to note: i.e. they have little if any relation to pitch. Any system of tone formation that relies exclusively on development of proper musical harmonics only must perforce sound less interesting than a sound which carries these little non-harmonic sounds. Likewise, many reeds develop strange noises and other non-harmonic sounds that add greatly to the characteristic tone quality of the stop. This is particularly true of the short-resonator solo reeds of the Regal type.

Mr. Pickering mentions the need for equal loudness over the entire scale. In fact, the loudness should, if anything, increase in the treble and be somewhat attenuated in the bass. The seventeenth-century builders arrived at this conclusion empirically and frequently used two pipes per note in the trebles of the more important stops.

Mr. Pickering's comments on the use of "borrowed" mutations (specifically the twelfth and nineteenth) is something that cannot be stressed too highly. If proof be needed, try the combination 8', 2 $\frac{2}{3}$ ', and 1 $\frac{1}{2}$ ' on a derived group of stops and then on separate, properly tuned, ranks. In the first instance each of the three pitches stands out and they do not truly blend, whereas in the second instance the three combine to form a new sound that is difficult to break down into its component parts.

As an organist, I find that one of the most frustrating things about the electronic instruments I have played upon is the lack of independence of each note. When everything is derived from the same oscillator and octave couplers, playing middle C while tenor C is already playing does not actually sound like a note being added. This, of course, destroys all balance and effect in any polyphonic work.

One final thought: Doesn't the logical conclusion of Mr. Pickering's articles negate the first advantage he gives for electronic organs? It certainly sounds as if building an electronic instrument along his suggested lines to achieve a more realistic sound must inevitably lead to costs that are virtually the same as pipe organ. And pipe organs have certainly proven their durability when one considers the sixteenth and seventeenth century instruments that are still used regularly in Europe.

Oops, I almost forgot one minor item. Even the mighty Wurlitzer gives pause to

the electronics when the "sob" of the Tibia is considered. Here we have the case of a pipe that is actually being overblown at regular intervals thanks to the huge tremulant. The result is that certain of the harmonics more or less come and go to create the characteristic "sob." How can the electronic generator achieve this?

EDWARD P. WOOD,
1548 Lexington Court,
The Village Green,
Kansas City 10, Mo.

More Transistors vs. Tubes

SIR:

In reference to Mr. Crawford's LETTER which appeared in the May issue, I must say that I agree with Mr. Crawford's observation that transistor amplifiers have no inherent magic on the reproduction of square waves. I disagree with his analysis of the limitations of vacuum-tube amplifiers.

Square-wave testing of amplifiers is a powerful tool, since proper reproduction of square waves shows frequency response, phase shift, and transient ringing or instability (proper damping). It was early recognized (prior to World War II) that square-wave testing was the best method of checking video amplifiers for television, and as techniques advanced the same principles were applied to audio amplifiers. E. B. Harrison of Peerless and Altec-Lansing wrote the first paper on square-wave testing of audio output transformers. It appeared in *Tele-Tech* magazine in March, 1950. Shortly thereafter Dave Hafler and Herb Keroes of (at that time) Aero Transformers also produced output transformers which would pass good square waves with fundamental frequencies for 20 to 20,000 cps. Perhaps you recall the "Musician's Amplifier" article which Dave Sarser (a professional musician) and I wrote in 1949. This amplifier passed square waves, as did designs by Hafler and Keroes. So a properly designed vacuum-tube amplifier equipped with a good output transformer will pass square waves with fundamental frequencies from 20 to 20,000 cps. Modern amplifiers which pass square waves do sound better according to my many contacts with professional musicians, so this question of square waves is important, although transistors do not have a corner on this.

I most heartily agree with Mr. Crawford's comments on music power *versus* sine-wave power ratings. The continuous sine-wave power rating (watts at a given distortion) is the only meaningful measure. To carry the same reasoning a step further (as I always did in my amplifier articles) the continuous sine-wave power should be given for frequencies from 20 to 20,000 cps. The best method is a plot of constant distortion power *vs.* frequency.

MELVIN C. SPRINKLE,
3403 Saul Road,
Kensington, Md.

SIR:

Mr. Crawford's letter pinpoints some of the difficulties in trying to analyze an amplifier from a schematic, especially when the transistors used are not standard units. Even an experienced engineer like Mr. Crawford is bound to come up with a few erroneous conclusions. For example: 1. The required signal to produce 40 watts output per channel at 16 ohms on the Acoustech I is 2.5 volts—exactly as specified. At lower

(Continued on page 57)



YOU ARE NOW LOOKING AT 20 DIFFERENT MICROPHONES

MODULAR MICROPHONES!*
Another exclusive concept that makes UNIVERSITY microphones better.

20 microphones? Yes—for any **one** of University's MODULAR MICROPHONES can provide at least **five** different methods of operation! University has inaugurated a new era in microphone design and construction—**professional** microphones offering **total interchangeability** with every conceivable type of adapter! This permits long-term savings as well as improved versatility, for you can add suitable adapters as your microphone requirements change—**without buying additional microphones**. You need never compromise quality to meet a price.

And it works as simply as this: equipped with a minimum of basic University MODULAR MICROPHONES, any one of University's interchangeable adapters may be chosen to complete the microphone assembly you require...with or without switches, for cables with and without quick-disconnect plugs, for screw-on or slide-on floor and desk-stand operation. And you can make **instant** impedance changes without tools, rewiring or soldering!

* TRADE MARK



For the complete story on University's MODULAR MICROPHONES, send for free 16-page brochure. Write Desk R-10,

UNIVERSITY LOUDSPEAKERS
 Division of Ling-Temco-Vought,
 Oklahoma City, Oklahoma



LIGHT LISTENING

Chesler Santon

Marty Gold: Sounds Unlimited RCA Victor LSP 2714

If you like to keep track of the rise and fall of controversies in the record business, put down the month of August '63 in your diary. It was in that month that RCA Victor showed signs of resolving the Dynagroove controversy insofar as their popular music recordings are concerned. The solution is a simple one that should prove acceptable to any reader of this magazine. The jackets and labels of several Victor stereo discs issued in August carried the name Dynagroove but the records themselves had been purged of just about everything I had objected to in the Dynagroove process. The good points of the process have been preserved: record surfaces are quiet; signal level is still a shade above the industry average and the over-all sound contains several clues indicating retention of a tape speed of 30 ips for the master recording. The best news, of course, is the return to a full range of frequencies and dynamics on the record that we used to take for granted in RCA's pre-Dynagroove releases. Now everybody should be happy. The console and portable crowd, which hears pretty much what the ads tell them they're going to hear, will never know the difference and continue to buy the records because of the Dynagroove emblem on the disc. The component crowd assuming RCA continues to put out a "normal" record such as this one will know that the switch back to full sound has taken place and will not let the Dynagroove emblem deter them from buying an RCA record—so long as real sound is to be found on the disc. That the changeover to sensible sound will be a gradual one is borne out by the fact that the Morton Gould and "Cleopatra" Dynagroove recordings I've heard recently had the limited frequency range associated with computer processing.

Marty Gold's tasteful treatment of seasoned musical favorites features closeup miking of several talented soloists. The Mel Davis trumpet has extraordinary tonal sheen in *There Goes My Heart*. Phil Bodner's alto sax adds just the right touch of fluid elegance to *Moonlight in Vermont* while the tuba of Don Butterfield and Joe Wilder's flugelhorn spark four other tunes. With the return to normal frequency response on the disc, the stereo depth and spread missing in previous Dynagroove recordings is back on full display here, giving the ear a chance to appreciate the very fine channel balance Marty Gold has attained in these Sounds Unlimited.

Midnight in Tokyo

M-G-M SE 4126

This label's 21 Channel Sound has been transplanted to Japan in order to add more dash to an elaborate tour of Tokyo's leading night spots. "Midnight in Tokyo" features the work of Japanese musicians performing in that city's very modern recording studios filled to the brim with Japanese, American, and European equipment. This is not the first time an American label has offered such a combination in a formal recording session. A little over a year ago, Time Records began to issue an ultra-modern music series in classical releases played by Japanese symphonic ensembles picked up with native audio gear. Popular music of the Orient has been slower in reaching us despite the efforts of Capitol Records to publicize the street sounds and music of Tokyo in its Capitol of the World series.

In this multiple-channel recording, Tadaaki Nisago leads a big band called the Tokyo

Boys in a dozen selections composed by Sam Ural reflecting the musical fare that might be heard in a current tour of Tokyo nightlife. Side One takes in some of the magnificent night clubs that stretch from the Ginza to the celebrated Akasaka Strip. Side Two attempts to paint a picture of some of Tokyo's great new hotels. No matter where this recorded tour pauses for musical refreshment, there are many opportunities to sample the Dodonpa, the off-beat Mambo music that seems to be the current national craze in Japan. Stereo directionality in this release is patterned on the American studio recordings. Frequency response fits easily within the best of current domestic standards.

Hear That Whistle Blow

Mobile Fidelity MF 12

A strict timetable of releases for steam railroad fans is still being maintained by Mobile Fidelity Records of Burbank, California. The locomotives starred in this series are almost entirely vintage stock but the audio gear used in preserving their highly individual sounds is of the very latest design. In addition to top-rated mikes, selected on the basis of weather and temperature conditions on the day of recording, this railroad series now boasts a new feature in the production process—a transistorized control board for feeding the signal to the master disc lathe. Owners of solid-state preamps will be the first to find consolation in the fact that Mobile Fidelity has dispensed with transformers and vacuum tubes in their control board.

Shortline steam railroads in widely scattered parts of the country are brought into play for this release. Locales range in altitude from the creek level run of a Georgia Pacific Corp. train near Dundon, West Virginia, to the breathy scramble of doubleheaded locomotives of the McCloud River and Yreka Western lines working in the vicinity of Northern California's 14-thousand-foot Mount Shasta. There are many moments of drama in depth as the whistles search out the contours of the landscape. As a matter of fact, there are fascinating moments in just about every release Mobile Fidelity has on the market. In this particular recording, the intricate rhythms of the doubleheader's mountain struggle are the special stereo treat.

She Loves Me (Original Broadway Cast)

M-G-M SE 41180C-2

The way things have been going on Broadway in recent months, the start of the season for good musicals has been getting later and later. It was not until April 23rd of this year that the 1962-'63 season found itself with a reasonably outstanding show on the boards. "She Loves Me", starring Barbara Cook, Daniel Massey and Barbara Baxley is an old-fashioned, dyed-in-the-wool Continental-style musical that would have attracted ample attention in former seasons, even as part of a normal crowd of good shows. This year it's a godsend to Broadway and the first real break to come the way of original-cast record buyers in many months. In one respect, this M-G-M album breaks new ground for the home listener. It's the first album I can recall that devoted two full discs to a Broadway show within a month after its opening. Only one other musical, to the best of my knowledge, has received such comprehensive coverage on records. "The Most Happy Fella" by Frank Loesser was released in a complete,

three-record version by Columbia Records but that event took place some time after the show first came out in the usual single record original-cast version.

If this two-record set of "She Loves Me" does well in sales, perhaps other Broadway producers will be encouraged to follow the lead of Harold Prince in making available a larger portion of their forthcoming productions to the record buyer. As it happens, the story of this romantic musical set in a Hungarian perfume shop of the 1930's (it has no libretto in the usual sense of the word) would not have been easy to follow on discs if the album had consisted of only one record. By the time you get through the four sides of this album, there's very little you don't know about the characters and setting of the show. The songs by Jerry Bock and Sheldon Harnick contain far more of the basic ingredients of the plot than we find in the typical musical.

To this listener, the significance of "She Loves Me" lies in the fact that a standard Broadway team such as Bock and Harnick, whose previous music and lyrics were of a semi-documentary nature in such shows as "Fiorello" and "Tenderloin", can turn out a European-style charmer of such wit and polish.

The United States Marine Band

RCA Victor LSP 2687

By special arrangement with the U.S. Department of Defense, RCA Victor has issued the first commercial recordings ever made by the nation's service bands. In addition to the Marine Band, the bands and choruses of the United States Army, Navy, and Air Force may now be heard in a series of recordings offered for public sale. Proceeds of such sale are to go to the campaign now in progress to raise a sum of thirty million dollars for the National Cultural Center that will rise on the banks of the Potomac in Washington, D.C. The recordings by the Marine and Navy bands will be of particular interest to oldtimers in the audio field who remember the days when the radio broadcasts of the bands were a favorite source of program material for off-the-air recordists. The Marine Band has lost none of the sparkle that has always set apart this high-morale organization but RCA's Dynagroove process is a distinct disappointment in this "location" recording. (All four service bands were recorded at Cramton Auditorium, Howard University, Washington, D.C.) Of the entire quartet of recordings, only the U.S. Navy Band is given a modicum of bass response. All four stereo discs (the others are RCA LSP 2685, 2686 and 2688) fail to include anything approaching the fundamental frequency of the bass drum. At normal (RIAA) crossover, my four woofers picked up only a suggestion of the overtones of the bass drum. I then tried a crossover of 800 cps instead of 500 and discovered that the overtones in question could be beefed up into a semblance of bass drum sound—after an increase in an already healthy playback level. All this, however, gave me results still far removed from the bass drum fundamentals readily available at 500 crossover on dozens and dozens of earlier RCA stereo discs. No wonder the claim is being made that Dynagroove reduces tracking difficulties on any phonograph in public use today. At the other end of the spectrum, high-end response on all four of these band recordings is virtually nonexistent above 9000 cps under the RIAA playback curve.

Teri Thornton: Somewhere in the Night

Dauntless DS 6306

Tom Wilson, the far-ranging artist and repertoire director of Audio Fidelity's Dauntless label, has a new entry in the gal vocalist sweepstakes that have always kept record companies on their toes. New talent in the vocalist field is continually undergoing a process of development because the quirks of public taste still complicate the task of picking a winner. Teri Thornton comes to the Dauntless label from the midwest, bearing with her a recommendation from no less a jazz figure than Cannonball Adderley, who considers her "the greatest voice since Ella

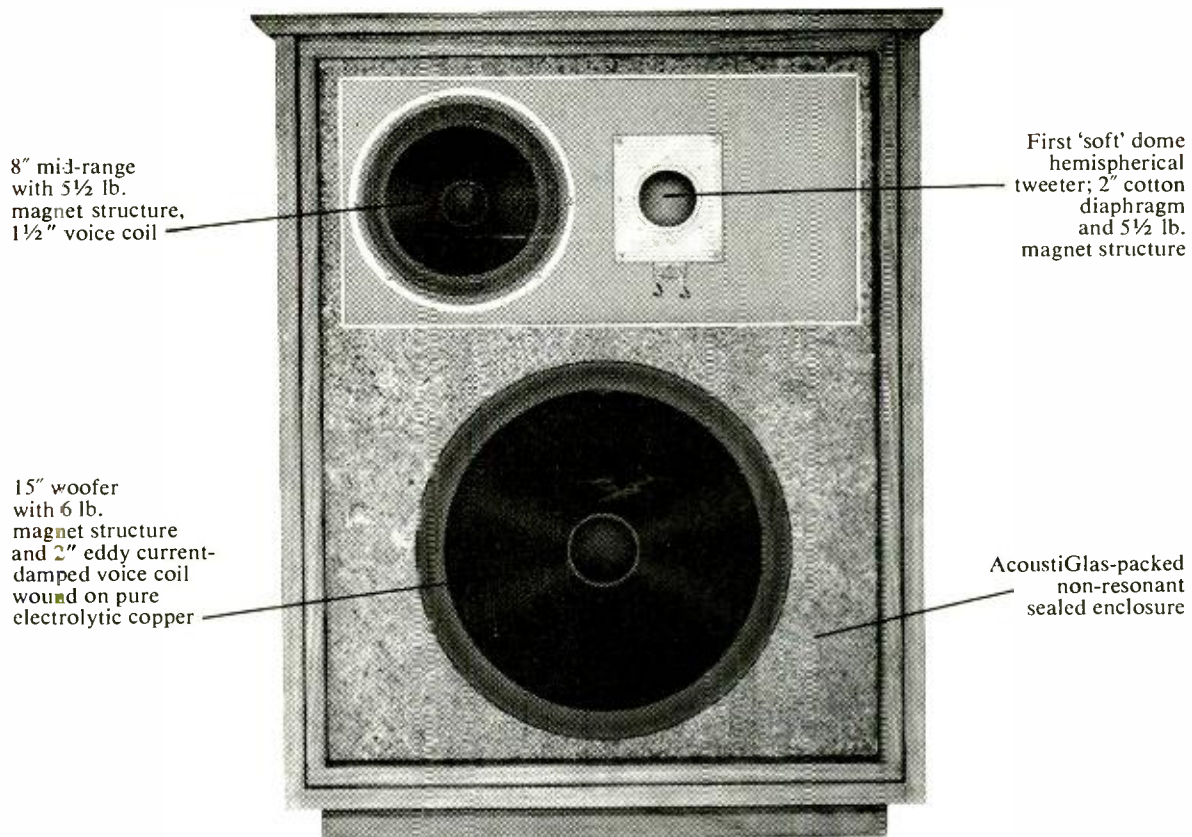

8" mid-range with 5½ lb. magnet structure, 1½" voice coil

First 'soft' dome hemispherical tweeter; 2" cotton diaphragm and 5½ lb. magnet structure

15" woofer with 6 lb. magnet structure and 2" eddy current-damped voice coil wound on pure electrolytic copper

AcoustiGlas-packed non-resonant sealed enclosure

Introducing the XP-10...an extraordinary new speaker system.

THE XP-10 CONSOLETTA is a new 3-way loudspeaker system utilizing hand-made, high-compliance transducers with massive, high flux density magnet assemblies. It is relatively compact in size but has the ability — due to the increased cone dimensions of the drivers used — to produce the "big" sound usually found only in the largest, most expensive systems available today.

The woofer, for example, is a large 15" transducer utilizing a pure electrolytic copper 2" voice coil to generate eddy currents which achieve frequency-linear damping of cone motion. The cone itself has a butyl-impregnated half-roll surround and is extremely stiff and straight-sided so as to operate as a true, rigid piston throughout its assigned range. The heavy magnet structure (6 pounds) achieves a very high flux density for precise control of the rigid, compliantly-suspended moving mass. Open-air resonance of this superb bass unit is below 19 cps.

The midrange speaker is a full 8" with a 5½ lb. magnet structure. Due to its relatively large size and special design, an unusually low cross-over point of 200 cps is facilitated, resulting in negligible phase distortion (since the same speaker reproduces the major part of musical intelligence produced by orchestra and voice). It is housed in its own AcoustiGlas-packed sub-enclosure for optimum loading and to prevent distortion-causing interaction with woofer and tweeter.

High frequencies are more 'transparent' than ever as the result of major breakthrough in speaker design—the "soft" dome tweeter. This tweeter, which handles frequencies above 2,000 cps, consists of a soft cotton hemispherical dome bonded to a light copper 2" voice coil. The use of a soft

cone instead of a rigid diaphragm virtually eliminates high frequency resonances. Transient response is unsurpassed due to the unit's remarkably high flux density (14,000 gauss) and low moving mass (1¾ grams). Cone break-up is virtually eliminated by applying the driving force to the soft cone on its periphery rather than at its center.

The system utilizes a low-loss 6 db/octave quarter-section inductance-capacitance network crossing over at 200 and 2,000 cps. All inductors are of the low-loss, air-core type. Continuously variable level controls for mid-range and treble speakers provide wide flexibility in compensating for differences in room acoustics. Overall system response extends from 28 cycles to

beyond audibility. Each system is matched within ± 1 db of a laboratory standard to insure balanced stereo response when used in pairs.

The infinite baffle enclosure is made of ¾" reinforced, non-resonant, compressed particle board with bonded genuine wood veneers. It measures 24¾" wide x 30½" high x 14¾" deep and weighs 80 lbs. It is luxuriously crafted in Scandinavian Walnut.

In the area of such objective criteria as frequency response, distortion and instrumentation measurements, the XP-10 meets the challenge of much larger, more expensive loudspeaker systems. Its true capabilities invite direct comparison with only the finest transducers available. Once seen and heard, you will find it difficult to believe it is priced at only \$249.50*.

Foreign residents write to: Fisher Radio International, Inc., Long Island City 1, N. Y. Canadian residents write to Tri-Tel Associates, Ltd., Canada.

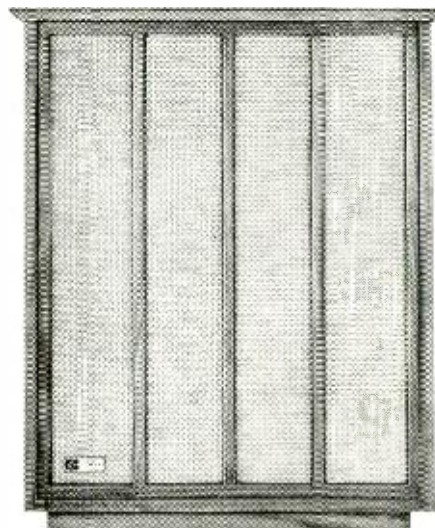

The XP-10 Consolette by Fisher

\$1.00 VALUE! ONLY 25¢!

Please send me the new 1963 edition of The Fisher Handbook, a 44-page illustrated stereo guide. I enclose 25¢, double-wrapped, to cover cost of handling and mailing.

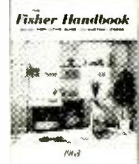

FISHER RADIO CORPORATION
21-29 44th Drive, Long Island City 1, N. Y.

Name _____
Address _____
City _____
Zone _____ State _____

031010

NEW! ENGINEERING BREAKTHROUGH

ROBERTS CROSS FIELD

"770"®

records automatically—



**15 high fidelity
stereo albums
for the price of one**

Now, 8 hours of full-range, true, high fidelity stereophonic music, or 16 monaural hours, can be yours on one 7" reel, with the revolutionary new Roberts Cross Field "770" Tape Recorder. The average tape cost per album: only 33¢. The "770" has an exclusive patented third head, the Cross Field Head, which separates recording and biasing functions. The result: the "770" records 40 to 22,000 cps, producing true fidelity at 1 7/8 ips and preserving the high frequency harmonics that breathe life into music playback. The Cross Field playback head has a gap width of only 40 micro-inches, the smallest, most responsive head ever engineered. For this head, Roberts employs NC-88, a new alloy, that is practically wear-proof. Other features: 2-speed, electrically-switched, heavy-duty hysteresis synchronous motor, miniscule wow and flutter at slow speeds; special ventilation system keeps the "770" cool even after 8 hours; two 5" x 7" self-contained elliptical, extended-range, heavy-duty Alnico V-magnet speakers; new automatic total shut-off switch.

Today, see the Roberts Cross Field "770" Tape Recorder at better music and camera centers. **\$499.95.**

Specifications: 7 1/2, 3 3/4, 1 7/8 ips. Power Amplifier Output: 12 watts • Frequency response: at 7 1/2 ips, 40 to 22,000 cps ± 2 db; at 3 3/4 ips, 40 to 18,000 cps ± 2 db; at 1 7/8 ips, 40 to 13,000 cps ± 3 db • signal to noise ratio: — 55 below 0 recorded level • Wow and flutter: at 7 1/2 ips, less than 0.12% rms; at 3 3/4 ips, less than 0.20%; at 1 7/8 ips, less than 0.30% • Blower vent system • 2 large stereo 5" x 7" elliptical, extended range, heavy duty Alnico V magnet speakers • Hysteresis synchronous instantaneous electrically controlled 2 speed motor • Automatic total shutoff • Operates Horizontally or Vertically.



New Model 330: Another achievement of Roberts' electronic engineering. Sound-on-sound multiple recording, 3 heads for separate record, playback, erase; two 7" full-range speakers. Special biasing for FM Multiplex Recording Systems. Speeds: 7 1/2, 3 3/4 ips. 27 lbs. \$349.95.



New Professional Model 455: Has three electrically switched, dual-speed motors, separate bass controls, 4 simultaneous mixing inputs, playback loudness controls, track selector, two full range 5" x 7" speakers. 7 1/2, 3 3/4 ips. \$599.95; Remote control, \$49.95.

See the entire line of Roberts professional and home tape recorders from \$269.95 at better music and photo centers.



FREE BOOKLET! "40 AND MORE WAYS TO USE A ROBERTS TAPE RECORDER"

Roberts Electronics, Inc.
5978 Bowcraft, Dept. A-10, Los Angeles 16, Calif.

Please send free booklet

Please send me complete information about Roberts Tape Recorders.

Name

Address

City State

IN CANADA: J. M. Nelson Electronics Ltd., 7725 Adera St., Vancouver 14, B. C. (Prices slightly higher in Canada)

Fitzgerald." While still a long way from Ella's exceptionally mature brand of poise in a lyric, Miss Thornton does hold forth more than average promise in a very crowded and competitive field. The arrangements and conducting of Larry Wilcox complement her torchy approach in *Clap Your Hands* as well as the moodier treatments of *Mood Indigo* and *Stormy Weather*.

Jackie Gleason: Champagne, Candlelight and Kisses

Capitol SW 1830

Mr. Gleason, never at a loss for an elaborate album title, tries his hand at a mixture of mood music in this release. Here is an item that is virtually two records in one. Gleason's familiar twin string orchestras take care of the ballads while, at intervals during the program, a Dixieland combo (scaled down in volume) entertains in the brighter paced tunes. An interesting stereo touch is the use of a trumpet soloist in each channel. One channel carries a muted trumpet, the other an open one. The interplay of contrasting tonal colors offers exceptionally good illustration of stereo's practical advantages when the ear is asked to follow equally prominent soloists. Other pairs of soloists emerging from the ensemble include trombones, clarinet with alto flute and piano teamed with guitar. Jackie Gleason has never had occasion to grouse about the quality of engineering attention that Capitol has always given him and this release certainly follows the standard pattern.

Frances Langford Sings Old Songs

Capitol ST 1865

All that's missing here are the wartime jokes of Bob Hope and the active mustache of Jerry Colonna. This album features Frances Langford in many of the songs she sang as a member of the Bob Hope overseas entertainment troupe that visited some five million G.I.'s in Korea and all six theaters of World War II. It's hard to say how many of the men who heard her then are still active record buyers. Capitol Records is certainly justified in its assumption that there are enough of them to warrant release of this album. To preserve the impromptu atmosphere of her wartime appearances, Miss Langford sings *The Moon Was Yellow, My Ideal, Yours* and other favorites of that era to the accompaniment of Tony Romano's guitar and Murray McEachern's trombone. It's quite a reunion.

Mantovani: Latin Rendezvous

London Tape LPM 70065

Mantovani: Classical Encores

London Tape LPM 70064

Normal procedure in the selection of music for a given disc or tape album consists of a conference between the artist and all interested echelons of the record firm. This routine was not followed in the case of Mantovani's latest tape release—"Latin Rendezvous." An elaborate contest was drawn up by London Records in order to give Mantovani fans a voice in the selection of Latin-style tunes for the album. Under the rules of the contest, twelve titles were to be suggested, along with a format or title. The only restriction: the songs picked had to be selections that Mantovani had never recorded in the past. Since most listeners (including this one) suspect that Mantovani has already recorded everything ever written, London Records thoughtfully added to the entry blank a list containing all the songs recorded so far by this never-resting artist. Apparently, enough contestants had a free week available to wade through all the selections on the entry blank and this reel is the final fruit borne by the contest.

The companion Mantovani tape released this month, while doing less to sustain the cause of democracy, offers decidedly more substantial musical fare. Instead of familiar titles in a Latin beat, *Classical Encores* gives the orchestra a chance to expand into the melodious staples usually found on the programs of our summer Pops concerts.

(Continued on page 56)

“Well worthy of the Fisher name, both in performance and in ease of construction... Beautifully packaged and ‘instructed’... Excellent specifications, and the performance equals or exceeds the specs.”

—AUDIO MAGAZINE

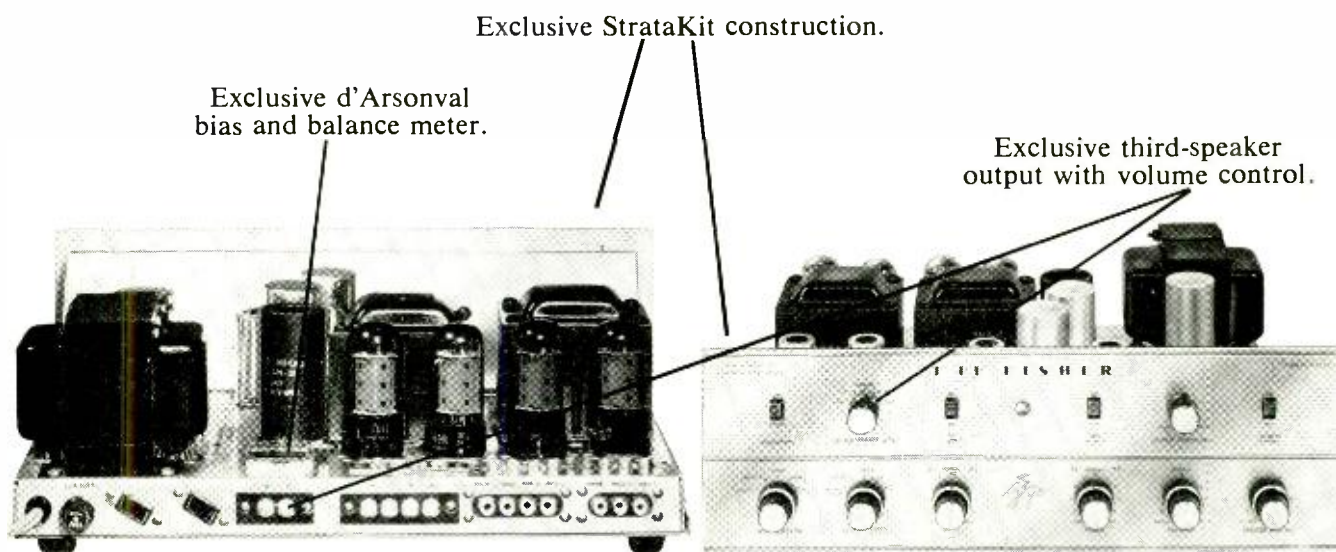

The Fisher KX-200 StrataKit, the 80-watt stereo control-amplifier kit, \$169.50*

This is the most powerful and in every way the most advanced single-chassis stereo control-amplifier kit you can buy — and by far the easiest you can build.

The 80-watt music power output (IHFM Standard, both channels) assures peak performance with even the most inefficient speakers. Engineering features never before offered in an integrated control-amplifier kit result in unequalled versatility. And the exclusive Fisher StrataKit method of kit construction makes the technical skill or previous experience of the builder completely unimportant and immaterial.

But the most exclusive thing about the KX-200 is the Fisher name -- your guarantee of a head start in kit building before you even pick up your screwdriver!

FREE! \$1.00 VALUE! The Kit Builder's Manual: a new, illustrated guide to high-fidelity kit construction.

The Kit Builder's Manual

FISHER RADIO CORPORATION
21-29 44th Drive
Long Island City 1, N. Y.

Please send me without charge The Kit Builder's Manual, complete with detailed information on all Fisher StrataKits.

Name _____

Address _____

City _____ Zone _____ State _____

* WALNUT OR MAHOGANY CABINET, \$24.95. METAL CABINET, \$15.95. PRICES SLIGHTLY HIGHER IN THE FAR WEST. EXPORT: FISHER RADIO INTERNATIONAL, INC., LONG ISLAND CITY 1, N. Y., CANADA: TRI-FEL ASSOCIATES, LTD., WILLOWDALE, ONT.

EICO 2536 FM STEREO RECEIVER

EICO 2200 FM STEREO TUNER

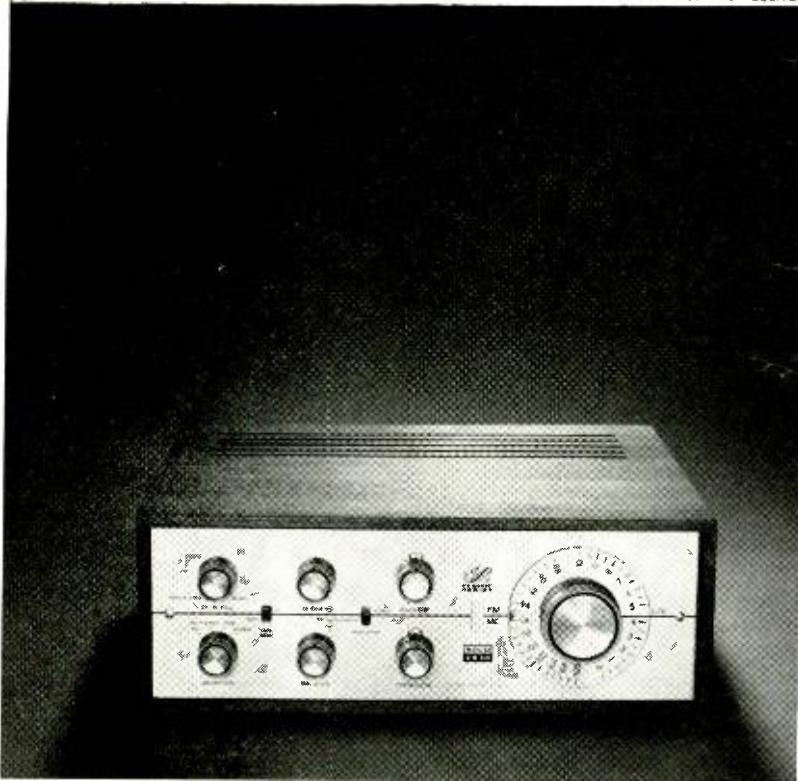

suddenly all other stereo components seem overpriced...

EICO 2036 36-WATT STEREO AMPLIFIER

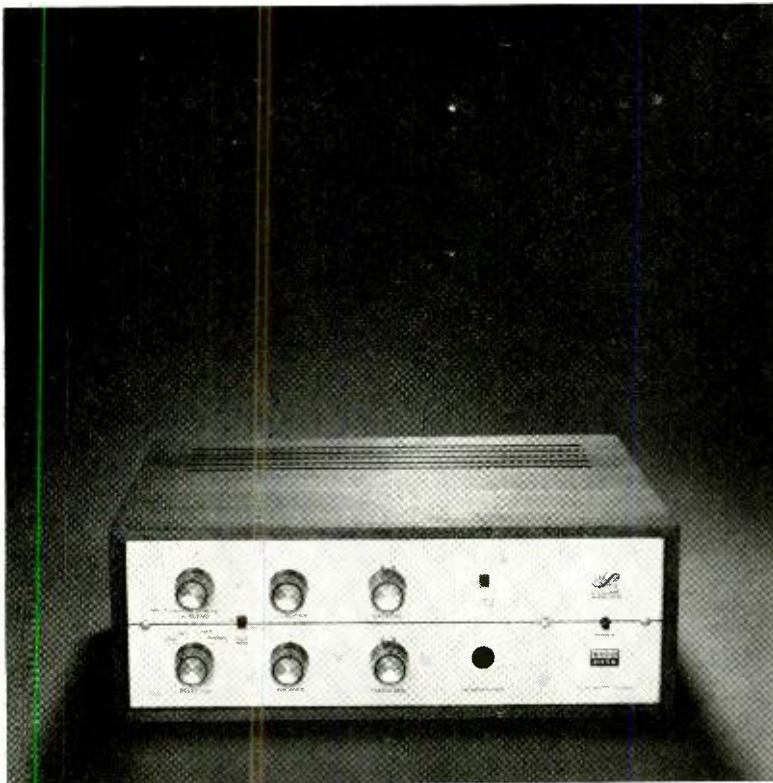

EICO 2050 50-WATT STEREO AMPLIFIER

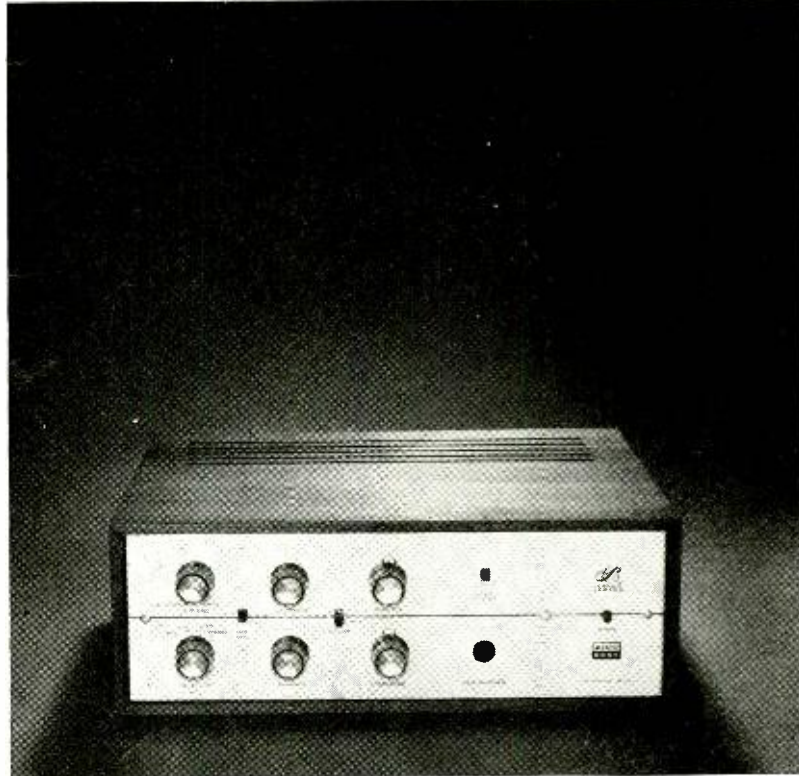

New Classic Series by Eico

In basic performance quality, in overall reliability, and in refinement of appearance and handling, Eico's new Classic Series matches or surpasses components selling for much higher prices. And this is true whether you buy Classic components factory-wired, or build them from the kit.

How did Eico achieve this? Simply by stripping their Classic components of all impractical or unnecessary features . . . by concentrating on circuit and component quality . . . by making top performance their basic engineering goal. For proof—simply examine our specifications. And then listen to any Classic component at your Eico dealer!

Now, if you're interested in building any of these superb stereo components at home, look at the new Classic Series Kit Package, and see the features Eico has built into it for your kit-building ease, convenience, and assurance of success: the logical, orderly arrangement of parts . . . the ease with which the kit sets up for work and closes down between work sessions—with no loose parts to go astray . . . the ready-to-wire chassis with sockets, jacks, terminal boards, and transformers pre-mounted.

Thumb through the 2-color Construction Manual. Ever see such graphic diagrams? Every step is clear and unmistakable—and no diagram covers more than 20 steps. And here's another thing you can see from the diagrams: how simple the wiring is—with no tricky frills, no clutter, no confusion, even around switches and controls. Plenty of space to work in.

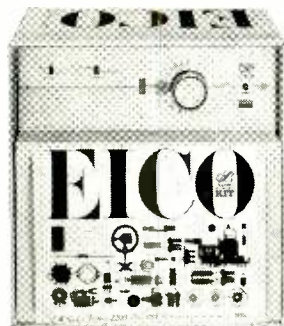

Compare these kits with any others on the market, and decide: do any other kits do more to make kit-building an enjoyable, creative experience than the Eico Classic?

EICO CLASSIC 2536 STEREO FM RECEIVER TUNER SECTION: Front end and IF strip are supplied prewired and prealigned; no adjustments or test instruments needed. The IF strip has 4 amplifier-limiter stages and a wide-band (1-mc) ratio detector. A high quality circuit board and pre-

aligned coils are provided for the stereo demodulator circuit. Sensitive, bar-type electron ray tube serves as tuning and stereo program indicator. **IHF M usable sensitivity:** $3\mu\text{v}$ (30 db quieting), $1.5\mu\text{v}$ (20 db quieting). **Stereo sync sensitivity:** $3\mu\text{v}$. **Frequency response:** 20 to 15,000 cycles ± 1 db. **Channel separation:** 30 db. **IHF M S/N ratio:** 55 db. **IHF M capture ratio:** 3 db. **IHF M harmonic distortion:** 0.6%. **AMPLIFIER SECTION:** Baxendall bass and treble controls do not interact or affect loudness, permit boost or cut at extremes of audio range without affecting mid-range. Balance control permits complete fade of either channel. Blend control is variable from switch-out, for maximum separation, to full blend. Tape monitor switch permits off-the-tape monitoring with the Eico RP100 stereo tape recorder. **Power:** 36 w IHFM, 28 w cont. (total). **Power bandwidth at rated power, 1% harmonic distortion:** 30 cps—20 kc. **IM distortion (each channel):** 2% at 14 w, 0.2% at 1 w. **Response:** ± 1 db 15 cps—40 kc. **Noise:** -65 db at 10 mv, mag phono; -80 db, others. **Sensitivity:** 2.3 mv mag phono, 250 mv, others. **Outputs:** 8, 16 ohms. Kit: \$154.95. Wired: \$209.95. Optional: Walnut Cabinet WE-73, \$19.99. Metal cover, E-12 \$7.50.

EICO CLASSIC 2200 STEREO FM TUNER Identical with the tuner section of the 2536 Receiver. Audio output 1.5 volt. Kit: \$92.50. Wired: \$119.95. Optional: Walnut Cabinet WE-72, \$19.95. Metal cover, E-11, \$7.50.

EICO CLASSIC 2036 36-WATT STEREO AMPLIFIER Identical with the amplifier section of the 2536 Receiver, plus speaker system switch, headphone jack. Kit: \$79.95. Wired: \$109.95. Optional: Walnut Cabinet WE-72, \$19.95. Metal cover, E-11, \$7.50.

EICO CLASSIC 2050 50-WATT STEREO AMPLIFIER Same control facilities as amplifier section of 2536 receiver, plus speaker system switch, headphone jack, and high filter switch. **Power:** 50 w IHFM, 44 w cont. (total). **Power bandwidth at rated power, 0.8% harmonic distortion:** 30 cps—20 kc. **IM distortion (each channel):** 2% at 22 w, 1% at 17 w, 0.1% at 2 w. **Harmonic distortion (each channel):** 0.5% at 17 w, 40 cps—20 kc. 0.3% at 5 w, 30 cps—20 kc. **Response:** ± 1 db 10 cps—40 kc. **Noise:** -65 db at 10 mv, mag phono; -80 db, others. **Sensitivity:** 1.7 mv mag phono, 190 mv others. **Outputs:** 8, 16 ohms. Kit: \$92.50. Wired: \$129.95. Optional Walnut Cabinet WE-72, \$19.95. Metal cover, E-11, \$7.50. See the Eico Classic Series at your high fidelity dealer. Write for new catalog. Eico Electronic Instrument Co., Inc., 3300 Northern Blvd., L.I.C. 1, N. Y. Export: Roburn Agencies Inc., 431 Greenwich St., N.Y. 13.

EICO
add 5% in West

AUDIO ETC.

Edward Tainall Canby



SYNCHRO-BAFFLED

People are always having ideas about how to achieve even better (and still better) sound reproduction. It's been going on for years. Mostly, our new ideas are about things, not people. They have to do with electrical and/or mechanical means towards improved hi fi. Occasionally, though, someone barges off into the uncharted waters that surround all of us who expect our products to be *listened to*, by human ears and brains and nerve centers. People reaction.

These psycho-acoustic waters of audition are only too well charted by those who are experts in the area. Any one of them can stop an audio engineer cold with pattern perceptions, thresholds, recruitment (nothing to do with the Army)—unless your engineer can fire right back with volley-type conduction, mid-line localization, and binaural shift. Tricky matters, indeed, and my only compass when barging into them myself is my own trusty ear, for better or worse. When my ears start to contradict what seems to be solid psycho-acoustic theory, I am in a fix all right.

These observations result from a frustrating series of experiments I've been carrying on for some time with an electronic device that is billed as "a totally new approach to music reproduction" by its sponsors, who have been urging me towards a trial of it for several years back. The "Synchro-Amp," a small chassis that plugs between your preamp and your power amplifiers, was designed out on the West Coast, however, and didn't seem to be available in person for us distant Easterners.

Moreover, the whole thing was shrouded in considerable secrecy. After raising my curiosity to a reasonably feverish pitch, the company blandly told me that the nature of its beast could not quite yet be disclosed. My fever went right back down. And soon other commitments barged into my consciousness.

Then one fine day last spring, both the AUDIO office and myself, 30 miles apart, were called upon in person by a representative from Inter-Aural Research, Inc., and each of us received a Synchro-Amp in the flesh—together with something more significant, a set of instructions plus a lengthy article by the Founder at last explaining the psycho-acoustic thinking behind the Synchro-Amp and the "Synchro-Wave Process" by which it operates. Basic Concepts, it was subheaded.

Well, this Synchro-Amp has involved me in some of the most perplexing thinking I've done in quite some time.

Mono and Stereo

The Synchro-Amp isn't hard to describe in a factual sort of way (now that I have the fuller explanation before me), even without the actual circuitry, which, to be

sure, is in itself nothing startling. It's the purpose of the circuitry that counts—and on that basis you're bound to be intrigued, just as I was.

The thing is basically a filter-phaser-mixer, taking preamp output, delivering signal to the power amps. The basic electronic mechanism is a band-pass action that excerpts a mid-range area out of each stereo signal, roughly from 800 to 3500 cps, boosts it as much as 12 db—that's a lot—and *reverses its phase* before feeding it back into the unreversed main signal in an additive-subtractive mixture. Interesting?

More precisely, from a mono source the boosted midrange is divided, an in-phase version going back into one channel of a two-channel system and the 180-deg. out-of-phase segment going into the other channel. Note that only the selected middle range of frequencies is affected. Only these are boosted, only these are reversed in phase. The rest of the signal remains as is. The product, then, is partly out of phase with itself, so to speak. Actually, the out-of-phase elements would cancel against their equivalents in the unaltered signal, but over-ride when there is gain added in the doctoring process.

In stereo, following a similar pattern on a more complex routing, the excerpting and de-phasing gets itself involved in one of those alphabet-algebra arrangements that used to bother us in the early stereo days when we were tearing hair about center-channels and holes-in-the-middle. L , $2L$, $R-L$, $-(R-L)$, and so on. (Don't let your red flag go up; R merely means right signal and L left.)

The stereo block diagram is quite something. Now we have *two* band-pass circuits, one for each stereo leg. And two trains of modification.

First, for the "upper" R channel (I always get mixed up but let's call it Channel 1) we mix the two mid-band excerpts together for a "mono" combined signal, as with any old blend-control: this is called, sensibly, $R+L$. Then comes the phase inverter, which includes a feed-through bypass. Two outputs, that is, one of them reversed in phase, the other unchanged. The unchanged "mono" mid-band signal goes straight back to be mixed into the main Channel 1 signal, i.e., R . The other, reversed in phase, goes into Channel 2, or L .

But meanwhile, trickier things are happening down in Channel 2. After its initial band-pass, there's a branch line that runs to a second phase inverter, this one for Channel 2 alone. (The other took the combined "mono" signal). By means of this, Channel 2 is ingeniously de-phased in its mid-range portion: the reversed segment is fed back into the main signal. This channel being L (as the Synchro-Amp has it), we now get an odd sort of mid-range, adding $-2L$ to L . (The rest of the signal, remember again, is unaffected—all this has *only* to do with the 800-3500 cps mid-range.) Your L channel is now neatly de-natured in its mid-range, though quite normal elsewhere. But we aren't finished with it yet. Finally, it is mixed into the out-of-phase combined "mono" mid-band signal from the other phase inverter, as per above. (Read back.)

As Inter-Aural puts it at this point, "the scaler mathematics here is obvious" and, for safety, I'd better give it to you here.

On this left channel, we get a mid-range final product that is described as $-(R+L) + (-L)$, which equals $-(R+2L)$. On the right channel, we get a mid-range product that goes under the designation of $R+L+R$, which equals $2R+L$. (By golly, you know, it really does, if you add and subtract it all up!) I'm not entirely clear how that L phase inverter manages to produce a $-2L$, which would seem to be up 6 db—but let that pass. It must be so; they say it is.

So there you have it. So simple. One mid-band segment, mixed into R , is $2R-L$. The other, mixed into L , is $-(R-2L)$. And the whole thing passes merrily on into your power amplifiers—but wait; we didn't quite include 12 db of gain which was applied.

That would give a pair of midbands that look (and sound) a bit differently. Very significantly, as you shall see. What we actually feed to our two speakers, in the middle range, is on the left, $-(3R+4L)$ and on the right, $4R+3L$. (This should follow OK, if you note that 12-db gain is a factor of 4.) Alas! Things seem to be neatly cancelling out. I'll let the company have the last word on this:

"The stereo signals L and R appear at the outputs unaltered, and the mixed midbands do not over-ride them because they are synchronized, out of phase, and of equal intensity; and, therefore, not perceived as added loudness, but of presence and dimension. This operation completes the Synchro-Wave Process."

Binaural Shift

—And right here we must leave the purely electronic side of this somewhat astonishing circuitry and ask the all-important question WHY? Why on earth go to such weirdly complex machinations as these? The clue is in that phrase, "*not perceived as added loudness, but of presence and dimension.*" Right here we barge into psycho-acoustic waters. And right here, for the sake of space, comes the reasonably (Continued on page 59)

Fig. 1. Block diagram of Synchro-Amp.

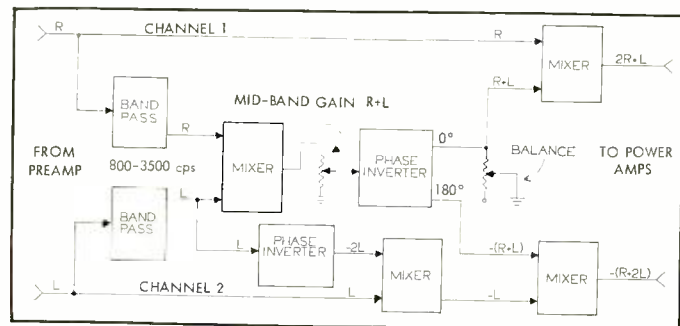

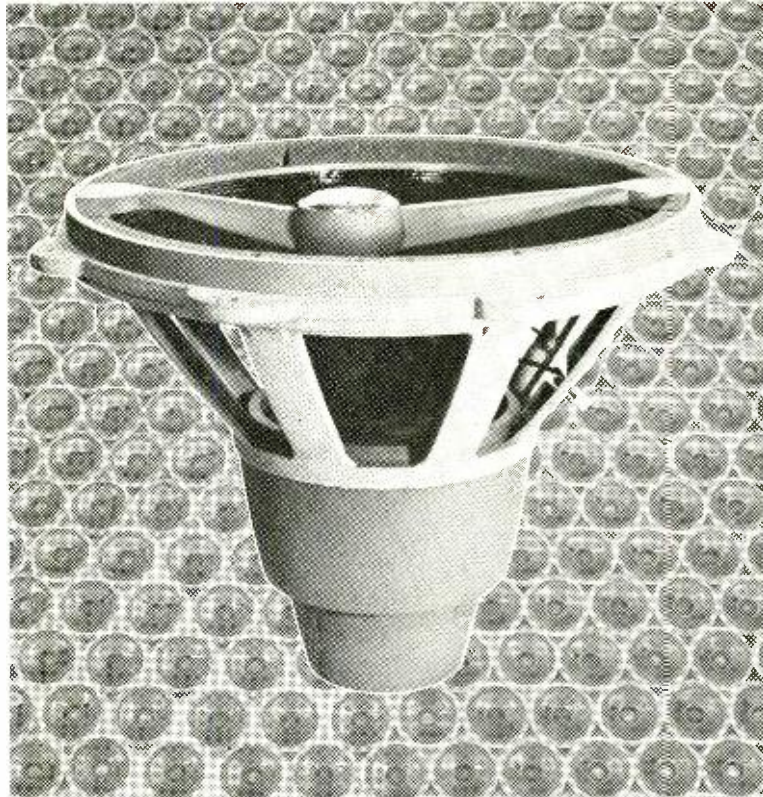

FROM THE DIMINUTIVE TO THE GIGANTIC... PIONEER MAKES IT!!

Typical of Japan's world-renowned electronic industry is the Pioneer Electronic Corporation. During the quarter of a century that has elapsed since it came into being, Pioneer has built up an enviable reputation in the production of quality loudspeakers, a reputation based upon relentless research and the latest production methods.

In particular, Pioneer has in recent years become the undisputed leader in the production of the miniature loudspeakers used in the tiny transistorized radio or television sets that are the star performers in Japan's current export trade.

Pioneer produces loudspeakers of every size, ranging from tiny 1½" models to gigantic 32" models. It has the largest production capacity in the world — 1,200,000 units per month. Uniformly outstanding in performance, and sturdy and reliable in durability, these speakers are also used by well over a 100 top manufacturers of electronic appliances around the world, including such world-famous names as Hitachi, Toshiba, or Sony.

Yet Pioneer's comprehensive line of loudspeakers is but one of its highly diversified activities in the audio world. Pioneer-made high fidelity amplifiers and other quality audio components are equally well known among both professional and enthusiast alike.

So whatever the requirement is, be it commercial, professional or home, Pioneer can help — help bring to the discerning better sound.

 **PIONEER®**

PIONEER ELECTRONIC CORPORATION

5 Otowacho 6-chome, Bunkyo-ku, Tokyo, Japan
Cable Address: PIONEER TOKYO

Distributors: Canada - Importhouse of Canada, 2939 Eglinton Ave. E., Scarborough, Ont.

EDITOR'S REVIEW

THE RECORDING ENGINEER

OF TEN WE RECEIVE LETTERS asking us to present articles which give techniques for recording a variety of performances; some are interested in symphonic groups (home town symphony orchestra, of course), some are interested in dramatic performances, some are interested in choral groups. Some letter-writers even request information about how they might go about learning to be a recording engineer.

We don't encourage the latter group much; the odds against them are so large that if they have to ask their chances are lessened appreciably.

However, that's not what we were pointing at; our main purpose was to tell why it is so hard to have an article explaining the really significant requirements—the "nubbin" as it were. We also wish to throw a bouquet or two to the recording engineer.

The fundamental reason that a mere knowledge of equipment is not enough is that the recording engineer must have enough knowledge of music (or whatever he is recording) so that he can re-constitute a performance in all its relationships—dynamics, balance, location of the instruments, and so forth. Of course he must know his equipment; he must know it so well that he doesn't have to think about it when recording, just as the skillful musician knows his instrument.

In a way we can compare the good musician to the good recording engineer; both of them achieve music with their instruments. Some people may say that the engineer doesn't create music, he just translates it into a different form. But we believe that the act of translating a three-dimensional performance to a two-dimensional medium in such a way that one retains the essence of the three-dimensional performance is a creative act. Just compare this process to painting or photography wherein three-dimensional objects are re-created in two dimensions; no one would deny the creative acts possible in these media. Perhaps the best argument we could give is the many unmusical recordings available—and the fewer outstanding ones. We do not mean to detract from the importance of the musician, but we do wish to place the recording engineer in proper perspective.

Getting back to those letters requesting articles about recording techniques—we certainly mean to present articles of that kind (and we invite qualified readers to submit them), but we recommend that all would-be recording engineers take heed; know music or whatever you would record, and know it intimately.

By the way, the reason we got started on this subject was that we were at a recording session recently at a studio run by old friend of *AUDIO*, Dave Sarsar (remember his "Musician's Amplifier"?). We were impressed with the way his knowledge of music (he is a working musician, too) carried him through some rather unexpected and unusual moments. We will try to describe the session in some future issue—the recording was the "recorded" part of the live-*vs.*-recorded performance presented at the New York High Fidelity Show this year. Those of you who attended the show can attest to the unusual nature of that performance.

COMPONENTS IN FANCY DRESS

There has been a decided trend recently towards more and more "packaging" on the part of compo-

nent manufacturers. For instance, several of the most famous lines in the component industry also make "consoles." Somehow it seems rather strange to think of component manufacturers making consoles—we were raised on the concept that the word "consoles" was one of those unmentionables. But now many of the component manufacturers are tending in that direction: One manufacturer who makes speakers is now marketing a sort of portable miniature console; another manufacturer who makes changers is getting ready to market a similar miniature console. Basically what has happened is that manufacturers are marketing their own components in a package with other components. Similarly, just as the trend was to the integrated amplifier a few years ago, now the trend is to the receiver—a tuner and integrated amplifier on one chassis.

What significance does this trend have? It seems to us that it is part and parcel of that over-all American trend toward packaged foods and the multitude of other convenience items which make it less effort to live today. (Of course some people would question whether effortless living is more enjoyable living, but we don't intend to get off on that tangent now.) Certainly it is easier for women to accept a handsomely "integrated" high fidelity system that perhaps a half-dozen "segregated" components. Certainly it is easier for the non-technical music lover to buy once instead of going through the agony several times.

But what about sound? Will this trend towards packaging maintain component-quality sound? Possibly so; after all, if you put components in fancy clothes the only difference should be that they look nicer. On the other hand, care must be exercised by the manufacturer to avoid falling into a trap.

For example, suppose the manufacturer decides to package a regular line of separate components in one housing. He will thus end up with an item whose aggregate price may well be over \$1000. That's much harder to sell than several pieces that are priced at \$150 each. So the manufacturer decides he needs a full line—models in various categories. How does he make a lower-priced line? You know it! Even with the best of intentions, and the best components at the beginning, he soon finds himself in competition with a variety of the traditional "package" manufacturers. Now he has to compete with them somewhat more on their own level—meaningless "features," arbitrary style changes to obsolete last year's models, and all the other special tricks that the larger manufacturers use to pay for an ever-increasing cost of doing business. Of course, one does what is necessary to succeed, and in a way it is quite understandable. But it doesn't tend to make for better sound, alas.

The trend is there. We hope component manufacturers adhere to their traditional policy of quality first and produce "consoles" we would be proud to show in *AUDIO*—and we will show them if the manufacturers make them.

OOPS, PARDON US

Last month, in concluding Mr. von Recklinghausen's article we inadvertently left out the last few paragraphs. It really doesn't make amends fully to include it this month (it's on page 61) but unfortunately that is the best we can do now. We apologize to you and to D. von R.

DIAMONDS BY CARTIER

a jewel for Garrard

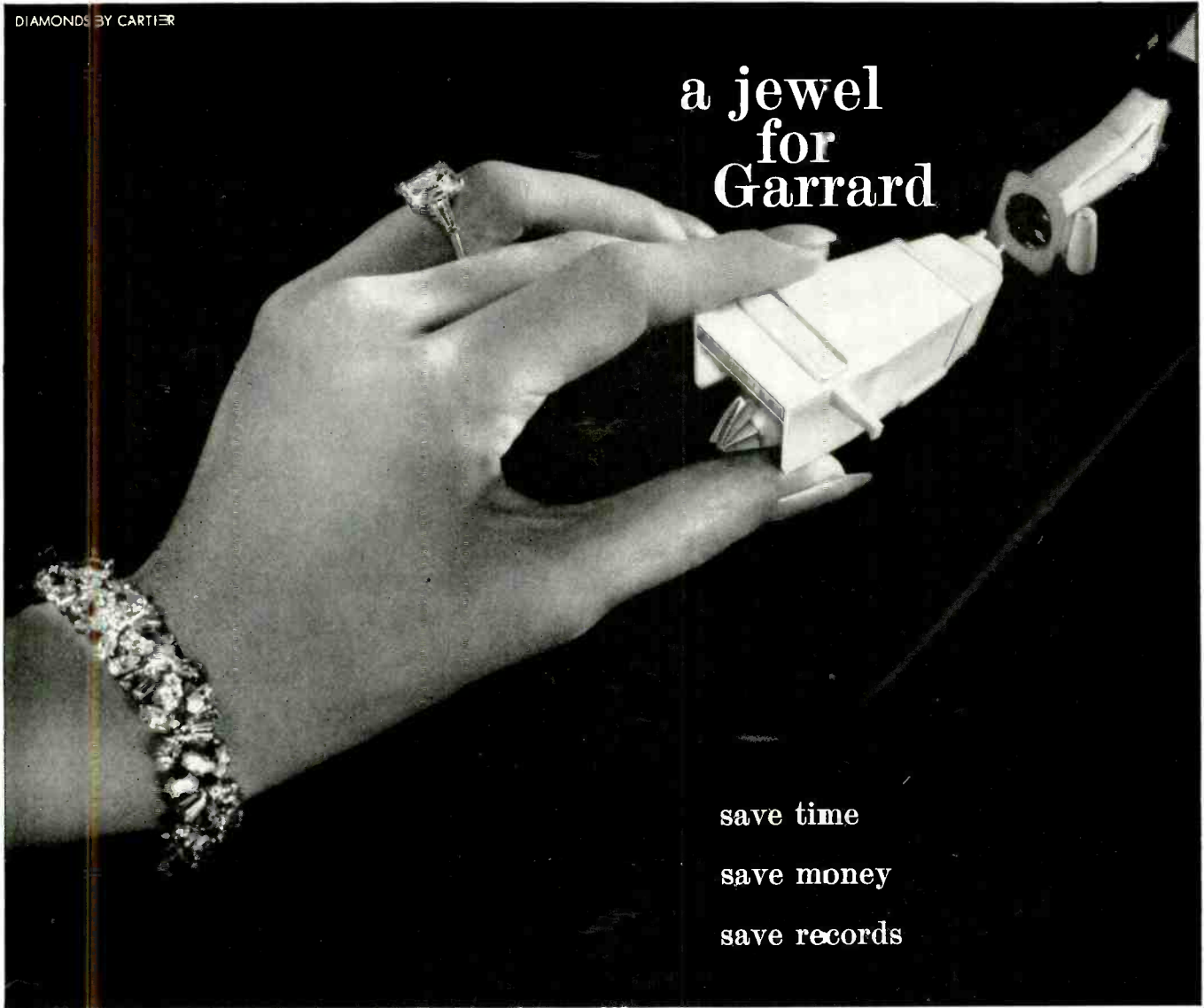

save time
save money
save records

Plug-in head assemblies with pre-mounted cartridges for Type A and Model AT6 Garrard Automatic Turntables.

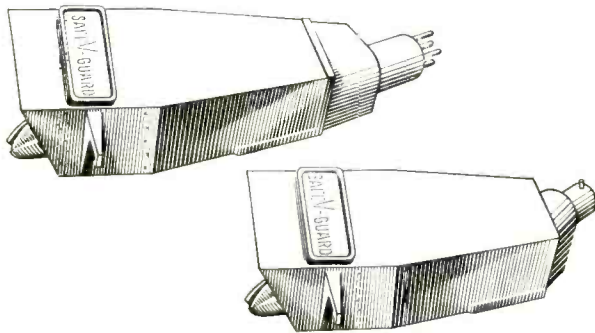

Choose the right pickup for your Garrard installations — choose a Pickering — the new U38/ATG and the famous U38/AT are both available pre-mounted in Plug-in Heads for Garrard Type A and Model AT6 Automatic Turntables.

FEATHERWEIGHT OPERATION — for maximum record protection, 1 to 3 grams tracking (recommended 2 grams) — where environmental conditions permit light tracking forces.

GA/38ATG — for Garrard Type A **G6/38ATG** — for Garrard Model AT6
Includes U/38 Stereo Fluxvalve Cartridge (premounted) with D3807ATG Golden SAFE V-GUARD "Floating Stylus"

STANDARD OPERATION — for use where environmental conditions require a nominal tracking force of 4 grams or more.

GA/38AT — for Garrard Type A **G6/38AT** — for Garrard Model AT6
Includes U/38 Stereo Fluxvalve Cartridge (premounted) with D3807AT SAFE V-GUARD® "Floating Stylus"

©1963 Pickering & Co., Inc., Plainview, N. Y., U.S.A.

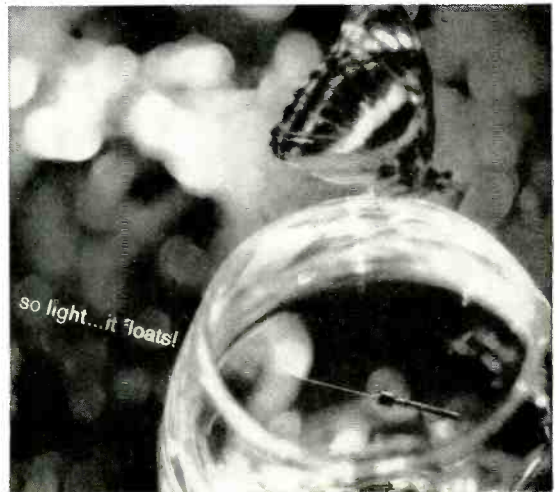

Featuring Pickering's exclusive "floating stylus" ... so little mass that it actually floats on water... so light it "floats" over the surface of your records. The Pickering "floating stylus" action protects the diamond and the life of the record while it plays.

Pickering FOR THOSE WHO CAN HEAR THE DIFFERENCE
PICKERING & CO., INC., Plainview, N. Y.

Why did Sherwood zero-in on the problem of tuning accuracy?

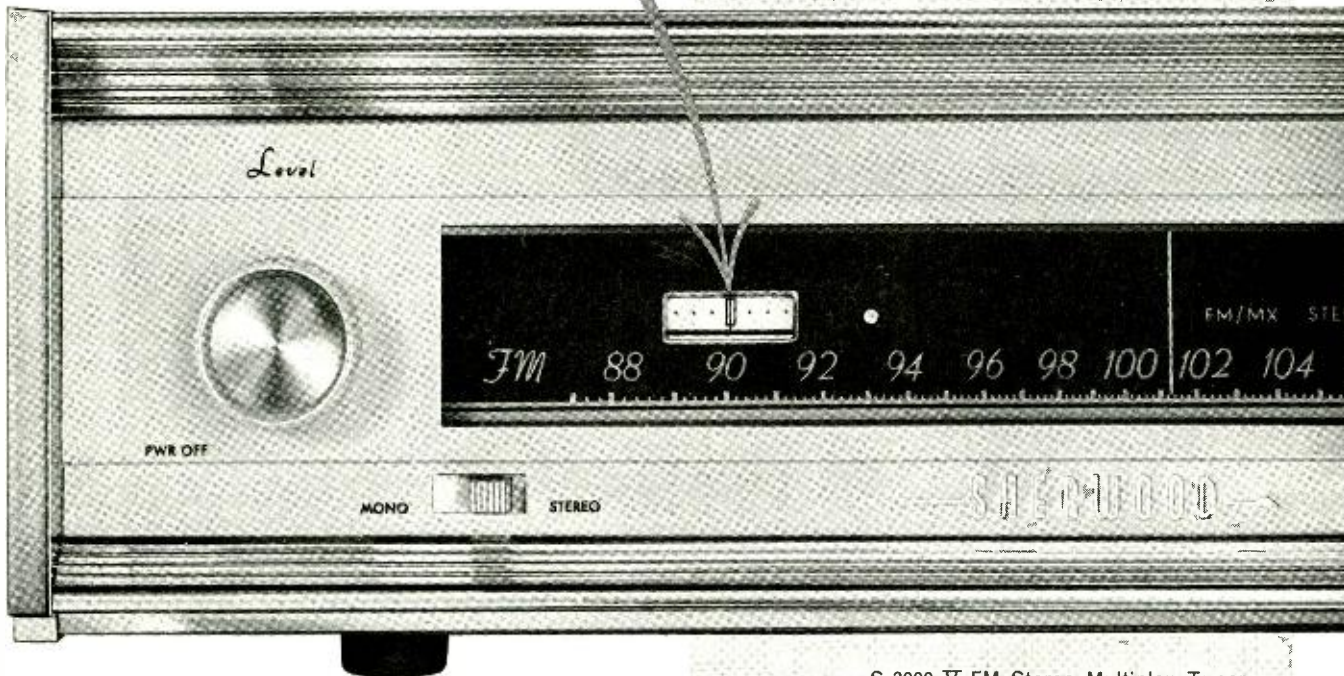

S-3000 V FM Stereo Multiplex Tuner with professional zero-centered tuning meter and Stereo Indicator Light.

It takes wider bands to broadcast the multiple information for stereo FM multiplex, and the most precise "dead-on-center" tuning to receive it . . . with maximum stereo separation and minimum distortion.

This is why in the new S-3000 V Tuner, Sherwood engineers incorporated a professional zero-centered tuning meter. Superior to tuning eyes, better than peak meters, it uses the same D'Arsonval meter needed to design, align and test FM tuner circuits. When the meter reads "zero" . . . you're right on. No guesswork. No maybe's.

Gain three tuning advantages

- Tune accurately, the first time.
- Tune low-power Class "A" stations interspaced between more powerful broadcasts.
- Tune with professional surety.

Added value features of the S-3000 V

- Stereo Indicator Light: identifies stereo broadcasts.
- Superb sensitivity: $1.8\mu\text{v}$ (IHF) for -30db . noise and distortion.
- No background noise: pace-setting 2.4db. capture effect.
- FM Interchannel Hush: suppresses between-station noises.
- Flywheel tuning: smooth as silk.
- 20% longer dial scales: professional accuracy.
- Price: \$165.00. (Leatherette case optional at \$7.50.)



New S-8000 III FM Stereo MX Receiver. Combines above tuner features with an 80-watt stereo amplifier. Price: \$319.50. (Leatherette case optional at \$9.50.)

Prices slightly higher in the Far West.

Sherwood
 HIGH FIDELITY
 Stereo Receivers • Tuners
 Amplifiers • Stereo Indicator Lights
 Speaker Systems • Contemporary Cabinetry

For complete information write Dept. A-10, Sherwood Electronic Laboratories, Inc., 4300 North California Ave., Chicago 18, Ill.

Transistorized Stereo Microphone Mixer

PETER A. STARK*

This compact unit features fully transistorized circuitry, small size, self-powered operation, and plug-in component boards, and is eminently suitable for construction by the advanced experimenter.

THE TRANSISTORIZED MICROPHONE MIXER described in this article and pictured in *Fig. 1* has performance features more than satisfactory for commercial use, and in addition has enough flexibility to make it very useful for the serious amateur who needs a versatile unit usable in many ways for many jobs.

This microphone mixer has four inputs and two outputs; an internal cue bus may be tapped for a third output. It may be used for either mono or stereo, and each input may be switched to either of the outputs. The mixer has master volume controls and VU meters, as well as monitoring facilities. It accepts a wide variety of inputs, both high and low level. Plug-in amplifier boards may be changed for different uses to change response or input impedance.

As shown in the over-all schematic *Fig. 2*, the four inputs to the mixer are identical. Input 1, for example, consists of balanced input jack J_{11} , transformer T_1 , unbalanced input jack J_1 , input level-set potentiometer R_{21} , and signal amplifier 1. The unit shown in the photographs does not have balanced inputs and transformers in channels 2 and 3,

but space is available on the chassis for later inclusion of these.

Each of the six signal amplifiers is a separate plug-in printed-circuit board, and all six are identical. Each amplifier provides approximately 55 db voltage gain, and has an input impedance of 500 ohms and an output impedance of 8000 ohms.

The output of each of the four input-signal amplifiers is applied across the corresponding input level control, potentiometers R_1-R_4 . The outputs of the controls are applied through resistors $R_{11}-R_{14}$ respectively, to input switches S_1-S_4 . In position 1 of each switch, the corresponding input signal is applied to output 1 volume control R_7 in the left channel. In position 3 of each switch, the corresponding input signal is applied to output 2 volume control R_8 in the right channel. The signals across these potentiometers are applied to the output signal amplifiers through resistors R_{17} and R_{18} , respectively, and then to left and right output jacks J_7 and J_8 . Each of the outputs is applied to the VU-meter amplifier through a meter-adjusting potentiometer, so that the meters indications can be matched to show correctly the level of the output signal from the mixer.

In position 2 of switches S_1-S_4 , the corresponding input signal is applied to the cue bus. The left and right monitor channels, which feed either a set of low-impedance headphones or small loudspeakers, are selected by switches S_5 and S_6 . In positions 1 and 3 of the switches, the monitor channels may be connected to the left and right signals after the output level controls. In normal stereo operation, the left monitor output would be connected to the left signal output by placing switch S_5 in position 1, and the right monitor output would be connected to the right signal output by placing switch S_6 in position 3. The monitor level could then be adjusted by R_5 and R_6 . If either S_5 or S_6 , or both, are placed in position 2, the corresponding monitor channel(s) are connected to the cue bus. This position is useful for checking the signal picked up by a microphone before it is actually connected to one of the outputs. The switching is noiseless, and microphones may be switched from output channel to output channel even during use if required. An optional third-channel output may be obtained from the cue bus by connecting an additional jack; there is no master volume control for this output, and no VU meter, so that these would have to be added externally, if found necessary. The mixing circuits introduce a large signal loss into the system, but this is required to assure isolation between inputs. By increasing the values of resistors R_{11} through R_{14} to 33K ohms, as many as four additional inputs may be added without increasing input interaction.

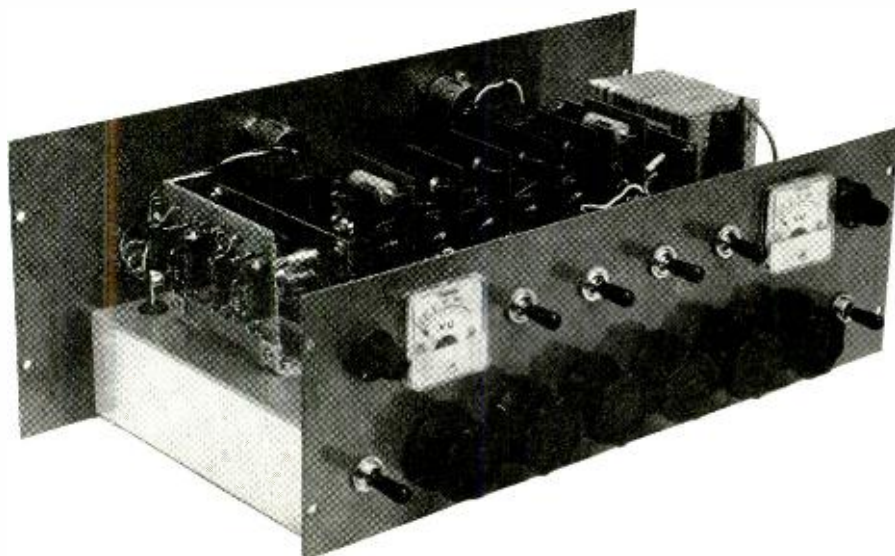

Fig. 1. Out-of-cabinet view of the transistorized microphone mixer, showing over-all parts placement.

Performance Characteristics

The frequency responses of the individual signal modules and of the overall microphone mixer are shown in *Fig. 3*. As shown in the figures, the response of the signal amplifier is within ± 0.5 db from 20 to 20,000 cps, with the internal feedback loop connected. With the feedback loop disconnected, amplifier response drops by 6.1 db at 20 cps and by 3.4 db at 20,000 cps. Over-all frequency response for the entire unit is flat from

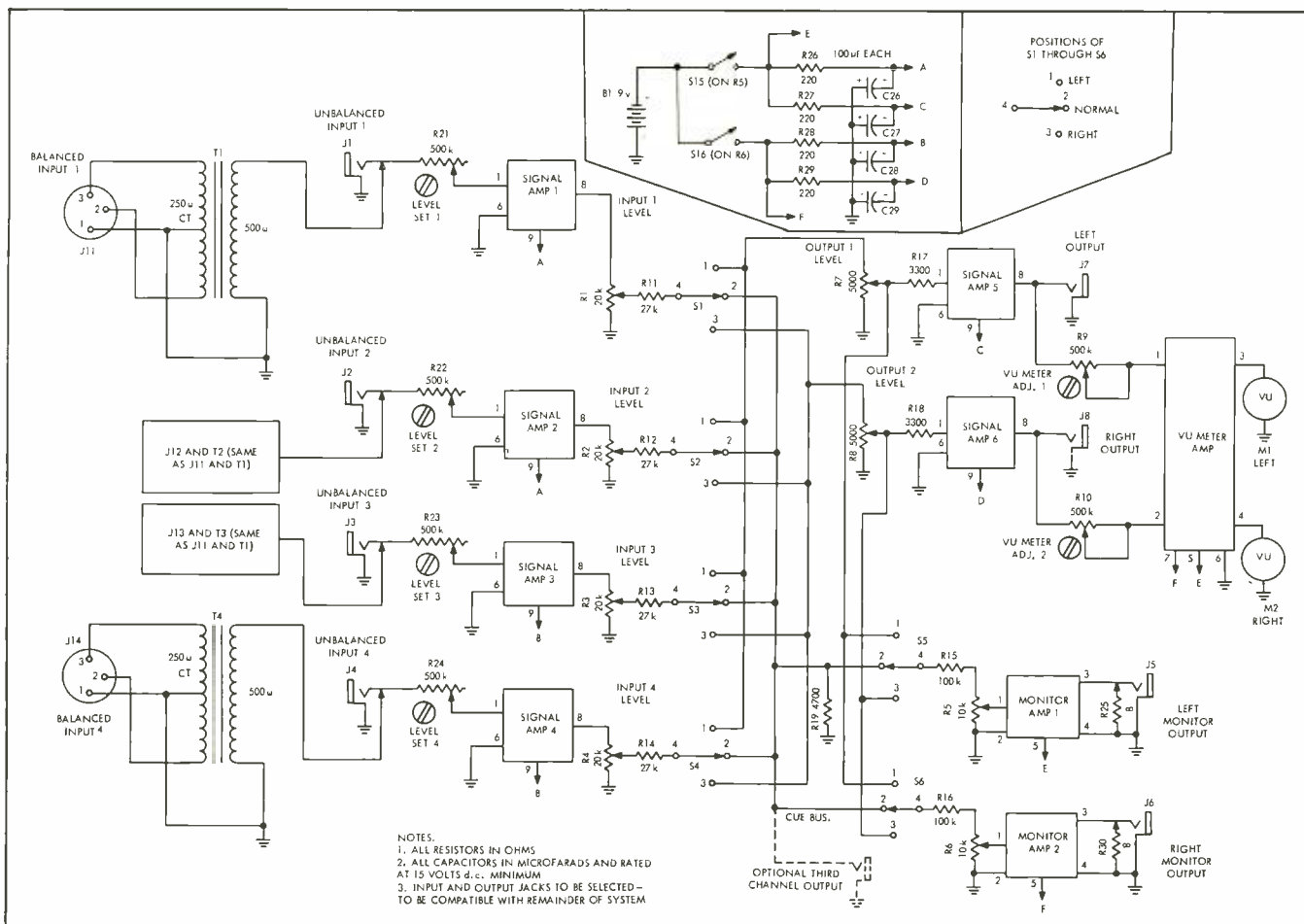
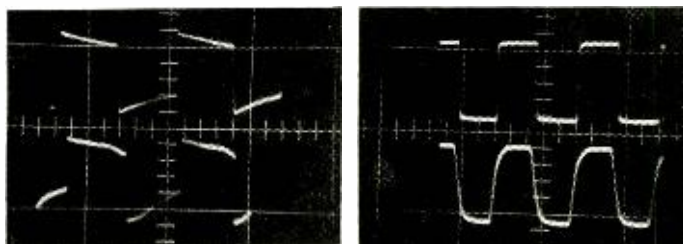

Fig. 2. Combination block diagram and schematic of the mixer to show interconnection of various individual component sections.

50 to 10,000 cps, and is down 0.8 db at 20 cps and down 1.4 db at 20,000 cps. This is equivalent to flat response ± 0.7 from 20 to 20,000 cps. Harmonic distortion of the mixer at 1 volt output is 0.1 per cent between 20 and 20,000 cps, and intermodulation distortion at the same level is 0.45 per cent (60 and 6000 cps, 4:1).

Figures 4 and 5 show the square wave response of the mixer at 50 and 15,000 cps. Except for a slight waviness of the output curve at 50 cps, due to hum in the test setup, very slight deformation of the input wave results, showing good response below 50 cps for at least several

Fig. 4 (left). Square-wave response of mixer at 50 cps, with input signal at top and output at bottom. Fig. 5 (right). Similar square-wave curves for 15,000 cps.



octaves. Rounding of the 15,000-cps wave indicates slightly decreased response at the high end, bearing out the frequency-response measurements.

The input levels are set by placing potentiometers R_{21} - R_{24} to a setting at

which the output of the mixer is slightly above 1 volt, and the meter indicates 0 VU on program peaks. With the potentiometers set for minimum resistance, the unbalanced input impedance is 500 ohms. Over-all gain of the mixer at 1000 cps is 73 db, resulting in a sensitivity of 0.23 millivolts for 1 volt output. The output impedance is 8000 ohms.

With potentiometer R_{21} - R_{24} set for maximum resistance, the input impedance becomes 500,000 ohms. Over-all mixer gain is then 23 db, with a sensitivity of 0.07 volt for 1 volt output. Intermediate settings of the potentiometers produce intermediate gains and input impedance.

As described later, slight modifications in the input signal amplifier modules permit higher input impedances at high gains, and also permit special equalizations for special purposes, such as equalizing a magnetic phono cartridge. Several different input amplifier modules may be prepared for different applica-

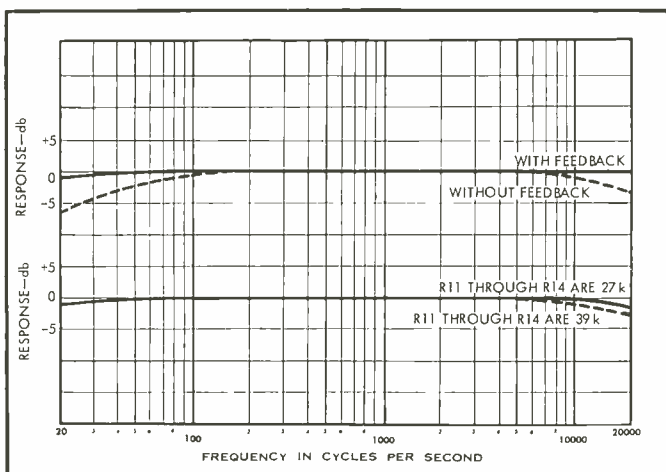
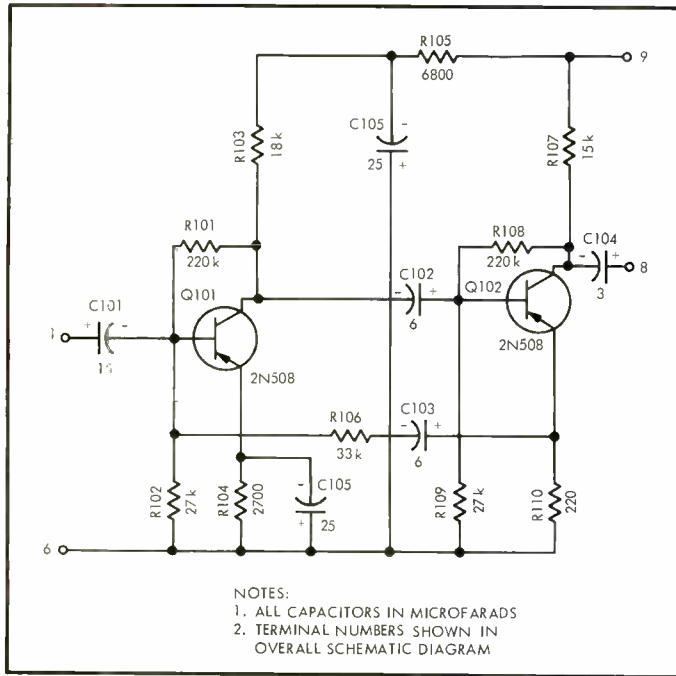

Fig. 3. Frequency response curves of signal module (above) and the complete mixer-amplifier (below). Dotted lines indicate response without feedback, solid lines with.



tions, and the right one plugged in for each function.

Signal Amplifier

The schematic of the basic signal-amplifier module is shown in *Fig. 6*. The amplifier consists of two common-emitter amplifier stages with a built-in feedback loop. Emitter resistors are used in both stages for d.c. stabilization. The emitter resistor of the first stage is bypassed to increase gain, but the second emitter is unbypassed, both to provide negative feedback (emitter degeneration) in the output stage, and to provide a take-off point for the feedback to the base of the first stage. The feedback also

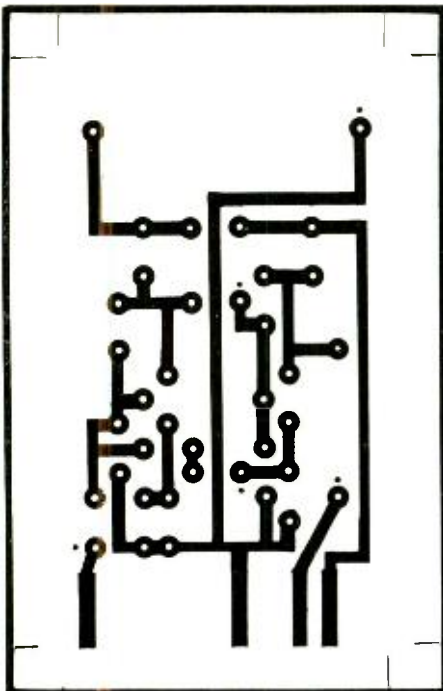

Fig. 7. Full-scale layout for amplifier module of *Fig. 6*.

decreases effects of transistors and component tolerances on circuit performance.

The pattern for the printed circuit board for the signal amplifiers is shown in *Fig. 7*. The board fits snugly into an Amphenol 143-010-01 connector mounted directly on the chassis. The dots on the figure indicate the positive terminal for electrolytic capacitor with the PNP transistors shown.

Component mounting on the board is shown in *Fig. 8*. With the exception of capacitors C_{101} and C_{105} , all other components are mounted vertically to conserve space. One of the leads of the component is bent all the way back so that it is parallel to the body of the component, before the leads are inserted into the boards. As a result, the component is not flush with the board, but only one end touches the board, while the other end of the component does

Fig. 9. Modified signal - amplifier module to increase input impedance.

Fig. 6. Schematic of signal-amplifier module.

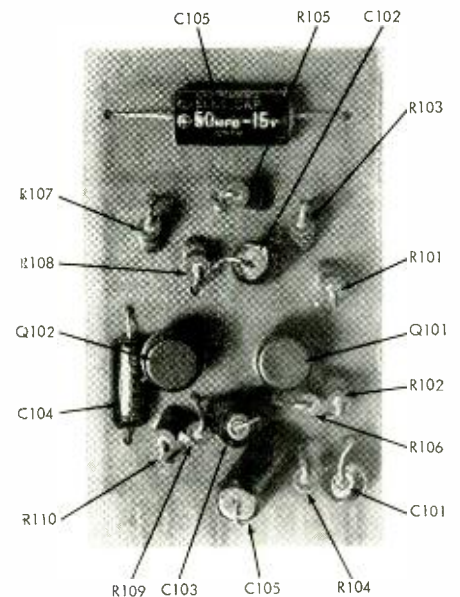

Fig. 8. Arrangement of parts on the signal-amplifier module.

not. Polarities of capacitors are important and must be observed.

Other transistors can be used, although the 2N508 is preferable because of its extremely low noise. The over-all noise of a typical signal amplifier is 71 db below 1 volt output, for an equivalent input noise of only 0.47 microvolt, approximately 126 db below 1 volt input.

Various modifications of the signal amplifier are possible. Resistor R_{106} and capacitor C_{103} may be replaced by 6800 ohms and $0.03 \mu\text{f}$, respectively, to provide the low end of the RIAA phono curve. The high end of the curve may be achieved by loading down the output of the phono cartridge by setting the input level-set potentiometer to approximately 4000 ohms (the exact value depends on the cartridge).

If the input impedance of 500 ohms is too low, the circuit modification in *Fig. 9* may be used to increase the impedance

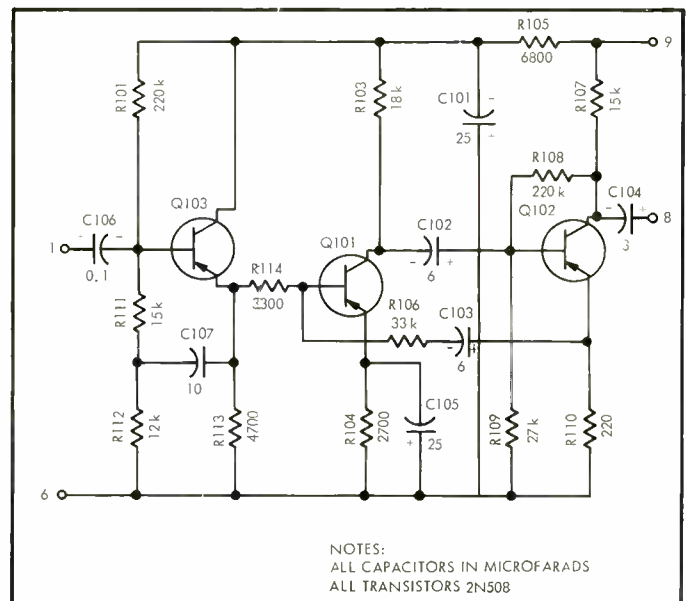

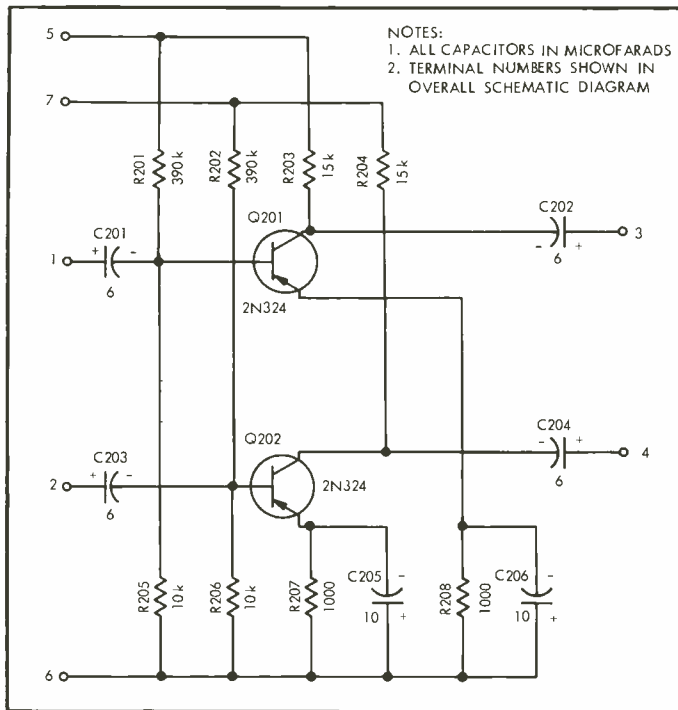

Fig. 10. Schematic of VU meter amplifier. Terminal numbers correspond to those of Fig. 2.

to about 200,000 ohms. The circuit is essentially a direct-coupled emitter-follower input stage, with bootstrap coupling capacitor C_{107} which prevents the 27,000 ohm resistance from the base of Q103 and ground, required for biasing, from loading the input. Resistor R_{114} isolates the feedback network from the emitter follower, and prevents loading of one by the other. The resistor decreases amplifier gain by about 8 db, but does not affect frequency response, distortion, or noise level.

VU Meter Amplifier

The VU meter amplifier consists of two grounded-emitter amplifier stages, one for each meter, as shown in Fig. 10.

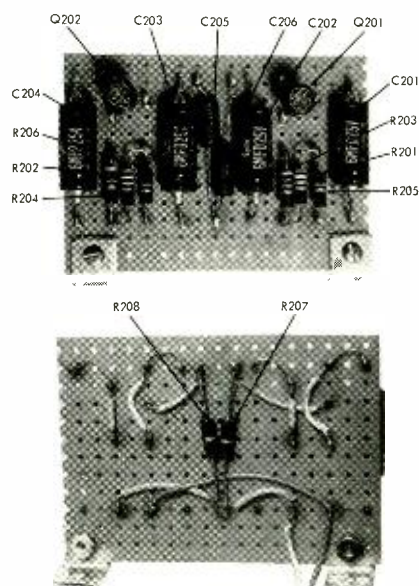

Fig. 11. Parts arrangement of VU meter amplifier board.

The circuit is straightforward and uses 2N324 transistors because of their uniformly high gain. Meter adjusting potentiometers R_9 and R_{10} adjust the signal level applied to the amplifiers, and are normally set so that the meter indicates 0 VU at an output of 1 volt rms from the mixer.

As shown in Fig. 11, the VU meter amplifier is built on a perforated board available through many jobbers, using the flea clips especially designed for these boards. This type of construction is best suited for one-of-a-kind amplifiers, since the bother of making a printed circuit board does not pay in that case. The board is mounted on small

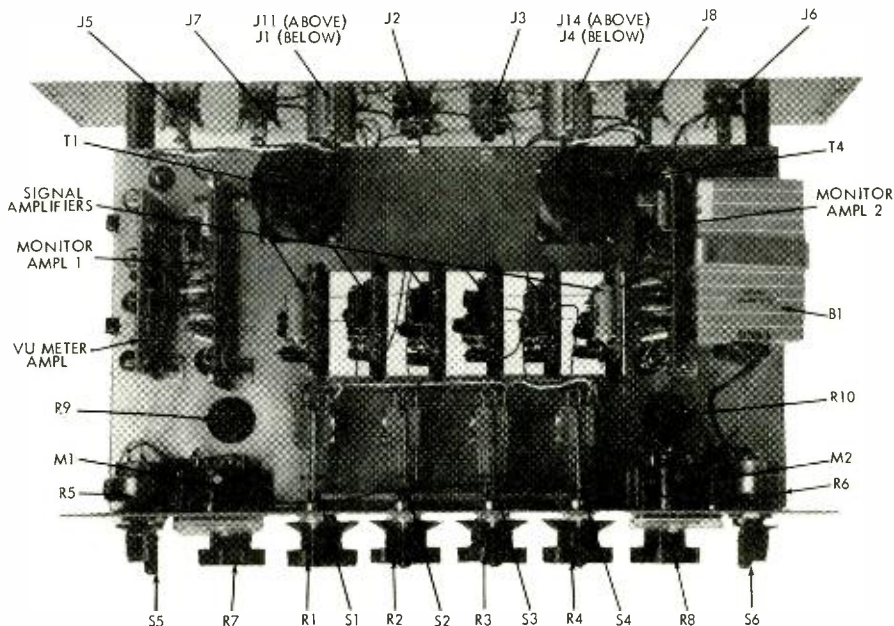

Fig. 12. Top view of mixer-amplifier showing the placement of all signal modules, meter and monitor amplifiers, switches, and controls.

brackets, and directly soldered to its connecting wires, unlike the signal amplifiers which are plug-in units.

Monitor Amplifiers

The type of monitor amplifier used depends on the application of the mixer. Where only high impedance headphones will be used for monitoring, the best monitor amplifier is simply another plug-in signal amplifier. The unit shown, however, was desired for use with either low impedance phones or with small speakers. The mixer was also desired as a small amplifier for other uses than just during recording, so that low-impedance output was desired. Rather than build a low-impedance amplifier, the author used a pair of Lafayette Radio model PK544 amplifier boards. These printed circuit boards, which are made in Japan, are slightly better than the average transistor radio audio stages, except that the push-pull output stage is rated to deliver 0.36 watt at an output impedance of 8 ohms. Other commercially available transistorized amplifier modules are available, at ratings up to 2 watts, and are small and inexpensive. The use of negative feedback was tried around these units, but proved unstable at large amounts of feedback; small amounts of feedback had little effect on performance.

The PK544 amplifier is designed for an external volume control between the first and second stages, and has leads which may be connected to the control. In this application, the entire first stage of the amplifier was disconnected, and the input to the amplifier was applied directly to the second stage. The gain of the amplifier is high enough to permit

(Continued on page 77)

Organs and Organ Music

In Two Parts—Part I

WINTHROP S. PIKE*

Selection of an electronic organ depends very greatly on the type of music one intends to play on it. An intelligent choice involves an understanding of the requirements of organ music.

OVER THE YEARS various papers¹⁻⁸ discussing electronic organs have appeared in these pages. Other magazines and books⁹⁻¹² have also covered the subject. Though these publications have provided a wealth of technical detail, far too few of them have said anything at all about the musical aspects of the organ and the manner in which the design of the organ is influenced by the music played on it. This paper attempts to do something about this. In Part I, some of the physical requirements imposed on the organ by its classical literature will be explored. I shall discuss the number of manuals required, the number of playing keys per manual, the importance of the pedal keyboard, and similar topics. Examples of different techniques of using these resources will be given. In Part II, the selection of an organ stop list will be treated and I shall attempt to answer the often asked question, "Why doesn't my brand new electronic organ sound as good as a pipe organ?" This entire paper is hopefully based on the premise that some day you might want to play some genuine organ music on that brand new electronic.

First, what does a piece of genuine organ music look like? *Figure 1* reproduces the first three measures of a short prelude in C major by J. S. Bach. (ref. 14, pg. 2). Observe that it is written on three staves rather than two. This is the case with most (but not all) organ music. The upper two staves are bracketed and marked "Manual." The notes upon them are played with one's hands upon the

* 101 Leabrook Lane, Princeton, N. J.
¹⁻¹² Bibliography will appear with Part 2.



Fig. 1. The opening bars of a typical organ piece. (Praeludium in C Major, J. S. Bach)



Fig. 2. Manual and Pedal ranges.



Fig. 3. A typical pedal passage: (upper) as written by Bach, and (lower) one way of playing it on a 13-note pedal clavier.



Fig. 4. A passage in which the melody is played by the pedal. (Choral Prelude, "Once He Came in Blessing," J. S. Bach)

manual keyboards. The bottom staff, marked "Pedal," is played with the feet upon the pedal keyboard. The novice can easily be confused by advertisements for organs with "full 39-note keyboards," even fuller 44-note keyboards, 13-note pedal boards, 17-note pedal boards, etc. How many notes are really needed? (Can I play *Fig. 1* on a Zilch "Cathedral-ette" or should I buy the larger "Virtuoso" model?)

To answer these questions I examined

about 100 different organ pieces¹³⁻¹⁸ trying to select a representative cross section of the classical organ literature. All of these works are well known and should be readily available at any music store whose stock is not limited to mandolin picks and "simplified" arrangements of timeworn old chestnuts. It may also be said, with calculated malice, that

any church organist who hasn't heard of all of these pieces and doesn't play at least some of them, has no business in the profession. *Figure 2* summarizes my findings. The lowest pedal note found was C, two octaves below middle C; the highest, F, a fourth above middle C, or thirty notes in all. The lowest manual note was also C two octaves below middle C; the highest, G, two octaves and a fifth above middle C. There are a few pieces which exceed these limits but they probably number less than one per cent of the literature. Of greater importance for our purposes, however, is the fact that about 80 per cent of these 100 pieces require a pedal board of not less than two octaves (25 notes) and manual keyboards of at least four octaves (49 notes).

The American Guild of Organists¹⁹ has formulated excellent standards for organ consoles. An A.G.O. standard con-

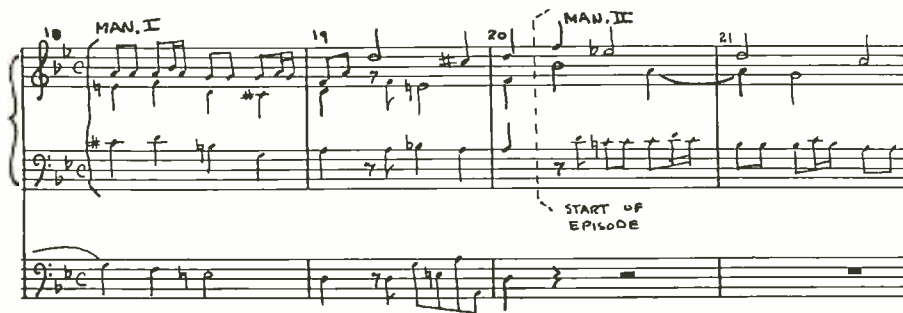

Fig. 5. A passage in which an abrupt change in registration is made by changing manuals. (Fugue in G Minor, J. S. Bach)

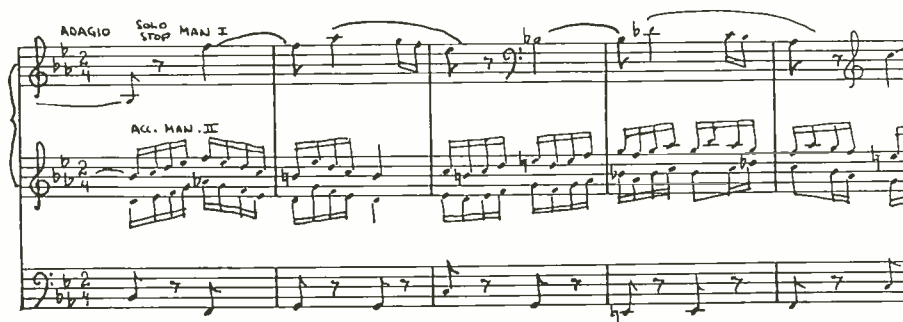

Fig. 6. Showing the use of a solo stop on one manual accompanied by different stops on another. (Adagio, Second Organ Sonata, Felix Mendelssohn)

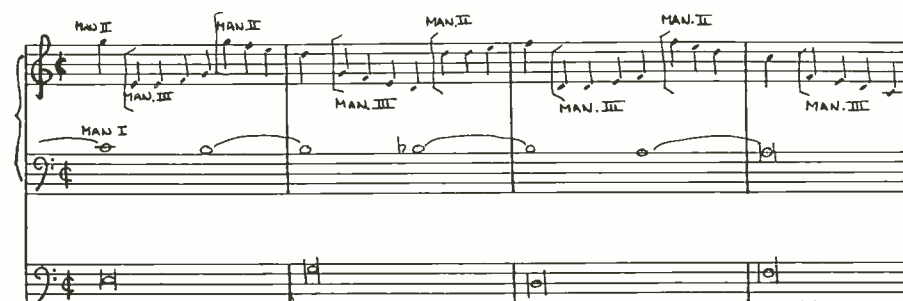

Fig. 7. Showing the use of three manuals. (Fantasia in Echo Style, Jan Pieter Sweelinck)

sole, as found on virtually all modern pipe organs, will have 61-note manuals (5 octaves) and a 32-note pedal clavier. In addition, certain critical parameters such as the height and position of the manuals above the pedals, the distance between manual keyboards and their overhang are specified. Be it noted that a console cannot truly be called "A.G.O. Standard" unless it meets all of these specifications. Certain manufacturers have not been overscrupulous in applying this description to their products. Many of the currently popular electronic "spinet" organs, for example, have such short manual and pedal keyboards that it is literally impossible to play any legitimate organ music on them despite the "rich cathedral tones" and "thrilling orchestral voices" attributed to them by bemused advertising copywriters.

No department of the organ seems to be as widely misunderstood as the pedal organ. "Doesn't it just play the bass?" you will say. "If I run out of notes on my Zileh 'Cathedralette' can't I just play an octave higher or lower?" Harmonically speaking this makes reasonable sense. Melodically speaking—as in a

fugue—it just won't do at all. (A) of Fig. 3 reproduces a pedal passage from a typical fugue (ref. 14, pg. 5). Although this short fragment has a range of far less than one octave it lies around the C on the second space of the bass clef, going both above and below it. While this C is comfortably in the middle of an A.G.O. pedal board, it would be the top C of a typical spinet 13-note pedal board. (B) of Fig. 3 shows one of the several possible ways in which this example could be played on such an instrument. Play these two passages on a piano fully to appreciate the violence done to the fugue subject by a 13-note pedal board.

Importance of the Pedal Section

One further digression should suffice to dispose for all time of the fatuous fiction that the pedal division is simply a "bass organ." Figure 4 is part of a chorale prelude from Bach's "Orgelbuchlein" (ref. 15, pg. 5). The markings *Man. Princip. 8'* and *Ped. Tromp 8'* designate the timbre and pitch of the stops to be used; one of the very few authentic examples of Bach's registrations avail-

able to us. This composition is in canon form, the tenor imitating the soprano an octave lower. The tenor is played by the pedal (bottom line). The real bass line is on the middle staff and is played by the left hand on the manuals. This is not an isolated example of this technique; there are countless others in the literature. The pedal is vital in genuine organ music, often having, as here, an important melodic function.

It follows from this that the pedal division of any organ, pipe or electronic, should be on a par with the manuals in tonal versatility and completeness. Figure 4, for example, calls for the pedal line to be played on an 8' Trumpet stop. You probably won't find one on that Zileh "Cathedralette," or, for that matter, on most of the other popular electronic organs. Paradoxically, the cost of a pedal Trumpet stop on many of them would be only the cost of another "formant" filter comprising a mere handful of inexpensive components. On the other hand, such a stop in a pipe organ is very costly indeed; few builders will supply one for less than \$1000.

Most organs have at least two keyboards; some, more. Why? How does one use them? Does one always use a separate keyboard for each hand? Well, it all depends—on the music being played. A few examples of some of the different playing techniques called for in the literature will settle these questions as well as establishing some guide lines for the number of manuals required.

How Many Manuals?

Figure 5 reproduces bars 18–21 of another organ fugue (ref. 14, pg. 22). In bar 20, observe that the pedal voice drops out. This is the beginning of what is called the "episode" of this particular fugue. Up to this point a good organist will have been playing with both hands on the same manual using a rather robust selection of foundation stops. At the start of the episode a lighter, more sprightly tone is desirable as a relief from the previous section. Often, as here, such a change must be made rapidly; there is not time to change stops, nor does one have a hand free with which to do so without interrupting the progress of the music. The customary way of accomplishing such a change is to set up the two desired contrasting registrations on two different manuals before starting to play. At the appropriate point in the music one simply shifts one's hands from one keyboard to the other. In this example Bach would probably have been playing on his "Hauptwerk" manual up to bar 20, switching to the "Ruckpositiv" for the episode. Today, on the usual two-manual electronic organ, one uses the inevitable "Great" and "Swell" claviers correspondingly.

Figure 6 shows an example of a diff-



Fig. 8. A passage requiring a solo reed stop. (Chorale No. 1, Cesar Franck)

erent technique. This is a portion of Mendelssohn's Second Organ Sonata (ref. 16, pg. 38). Here the two hands play on different manuals, the right delineating the melody on a solo stop on one, while the left hand provides a suitable accompaniment on another. In this case the pedal really does "just play the bass." A typical registration for this passage might be an Oboe, Clarinet, or Krumphorn solo stop on the manual used by the right hand, mild 8' and 4' Flute stops on the manual used by the left hand and soft 16' and 8' stops on the pedal, possibly with the accompanimental manual coupled to the pedal. The loudness balance and timbre contrast between the right and left hand parts require rather skillful adjustment for the melody to be effective in passages such as the 3rd bar where it dips below the accompaniment in pitch.

In this example all but the most case hardened "baroque" bugs would make judicious use of the Swell pedal to make the organ louder and softer as Mendelssohn's lush melodic line rises and falls. For such gradual changes of loudness without corresponding changes of timbre, the Swell pedal is the usual recourse. In a pipe organ this pedal controls the opening and closing of a set of hinged shutters between the pipes and the listener. In an electronic organ, the pedal simply operates some form of loudness-compensated attenuator. The range of most electronic organ Swell pedals is usually at least 10 to 20 db greater than that of their pipe organ counterparts. Although this tends to facilitate easy dynamic adjustment while playing, it is a mixed blessing from a musical standpoint, often leading to inartistically exaggerated dynamics in the hands of inexperienced performers.

To digress, it seems to be a common misconception that the changes of loudness made by the pipe organ Swell pedal are caused by altering the wind pressure supplied to the pipes. This is not the case. Once an organ pipe has been voiced, or adjusted by the organ builder to speak properly on a given wind pressure, it is forever committed to that particular pressure unless the voicing operation is repeated. At any other pressure it will behave most

unmusically indeed, running the gamut from simply not sounding at all or sounding "flat" in pitch if the pressure is lowered to overblowing to a higher harmonic if the pressure is raised. This is one of the few characteristics in which the transistor oscillators used in some of the better electronic organs are superior to pipes. When properly designed, these oscillators are extremely stable in frequency with respect to supply voltage changes. At least two manufacturers cleverly exploit this stability to obtain percussive effects or to make a unit rank of oscillators play with different degrees of loudness at its several pitches. These tricks are impossible in a pipe organ and the second of them would be extremely useful.

Occasions arise when more than two manuals are virtually necessary. Figure 7 is an example. This is a portion of the "Fantasia in Echo Style" of Sweelink (ref. 17, pg. 21). Here the player's feet and left hand supply accompanying harmonies on suitable stops of the pedal and one manual while the right hand alternates rapidly between two other manuals on which contrasting solo stops produce a series of naively quaint echo effects. Although this work can be played on two manuals, it is much more effective on three.

There are other possibilities implicit in the use of several manuals, but these examples will suffice to indicate the general principles involved. One may justifiably conclude that an organ having two full-length (56- or 61-note) manuals and at least a 30-note (preferably A.G.O.

Std. 32-note) pedal clavier is the minimum requirement if a reasonable percentage of the bona-fide classical organ literature is to be played. For popular music these requirements may be relaxed somewhat; the manufacturers of spinet organs have not been slow to grasp the commercial significance of this.

One might, in passing, be curious concerning the practical limit of the number of manuals. Seemingly, this is provided only by the physical dimensions of the performer. The celebrated organ in the Grand Court of Wanamaker's Philadelphia store, certainly one of the very largest organs in the world, has a six-manual console. A descriptive booklet published by Wanamaker's reassures us that "everything is within the organist's reach." But the console appointments of the colossal organ in the Atlantic City Convention Hall make Mr. Wanamaker's box of whistles seem like pretty small beer. There are two complete consoles, one of five manuals, the other of no less than seven. Could this be the musical equivalent of the automotive horsepower race, or are the Convention Hall organists perhaps a pair of Juillard trained octopi?

It is safe to say that these monster organs are extreme examples for which there is little real musical justification. Something like 90 per cent of the classical organ literature can be played adequately on a well designed two-manual instrument of 20 to 30 stops. A good three-manual organ of 40 to 60 stops will easily handle all but about 0.1 per cent. There are a very few pieces, largely of virtuoso calibre, which do actually require a four-manual organ or at least present formidable difficulties on a smaller instrument. However, a large organ is not harder, but easier to play than a smaller organ due to the added flexibility provided by the extra manuals. This is particularly true in a recital or a highly liturgical church service where the organ must play almost continuously with frequent changes of timbre and dynamic level.

TO BE CONCLUDED.



Fig. 9. Example to be recorded on a single-track recorder.



Crossover Design

NORMAN H. CROWHURST

In this second part, the author tells the practical details of selecting and winding components for the crossovers whose values were determined from data given in the first part and also describes how to check the performance of crossovers and set them up correctly.

In Two Parts—Part Two

BEFORE GOING INTO DETAILS about inductors, it is pertinent to answer a question often asked about capacitors. Values for voice-coil impedance crossovers are often in microfarads, tens or hundreds of microfarads, so the natural choice, to get the required value in a satisfactory physical size, is electrolytic. Whether this type is satisfactory for crossover networks has caused some argument, so we will try to present the facts of the case.

A reason often given for rejecting electrolytic capacitors—that they tend to rectify the signal, causing waveform distortion—is not valid. Even without their customary polarizing voltage, electrolytics do not behave as rectifiers—at least to audio frequencies (they might to frequencies measured in cycles per minute, or cycles per hour!). The major legitimate reason for questioning the suitability of electrolytics is a question of the reliability of their values. Not only are electrolytics manufactured within tolerances that seem absurdly wide for filter use, but if you carefully select samples that are within suitable tolerance of the calculated value, there may be no guarantee they will stay at that value.

In general, the so-called “reversible” types are manufactured to slightly closer tolerances, and are less subject to “drift,” due to change in dielectric thickness, which is what causes an electrolytic to change its value. But even this type is by no means a predictable entity. On the other hand, it is usually out of the question, in terms of both cost and space, to use paper capacitors with the kind of value needed so electrolytics seem a more satisfactory choice, if some way can be found to make them acceptable.

A working voltage (rated) between 10 and 50 is quite enough for crossover use, enabling quite compact sizes to be obtained. If you have a capacitance bridge, you can select values, as they are when you measure them at least. If you use reversible types—or if ordinary ones without polarizing seem good enough—you should make sure they have been on the shelf long enough to have “forgotten” their polarizing, so they will have attained their maximum value—say six months—before measuring it with intent to use in a crossover network. Even then, it is not safe to assume they will stay close enough to their measured value for any but the simplest circuits—(A)

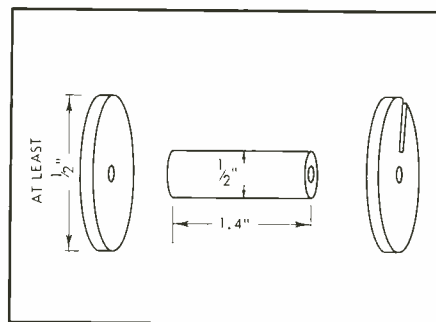

Fig. 12. Mandrel parts for winding air-cored coils.

through (D) in *Figs. 3 and 7*. In these configurations, a reasonable deviation will not seriously invalidate performance.

If you want to use more complicated circuits with electrolytics, or if you want to keep even the simpler circuits closer to correct operation, it would be advisable to take steps to control their value. The value does not change very quickly after voltage has been changed, taking several hours, possibly a day or so, before it settles to a steady value, but maintaining a specific polarizing voltage will hold the value close to constant, so it will deteriorate only slightly with age.

If you get 50-volt rating capacitors in pairs, whose nominal value is slightly less than twice the required element value, a circuit that will polarize them so adjustment of voltage will vary capacitance until the right value is obtained, is shown at *Fig. 11*, for one configuration. A polarizing feed resistor of 10k will be quite low enough to allow the capacitors to charge up to close to the adjusted voltage value, without causing material loss in the filter circuit action. Finding the correct value can be achieved by the method described later, if you do not have a capacitance bridge of the type supplied for a fairly low cost by most capacitor manufacturers.

Now to the coil construction: first, air or iron cored? This depends on crossover frequency: above 1000 cps, air cored are cheapest and best—iron cored do not represent material improvement and

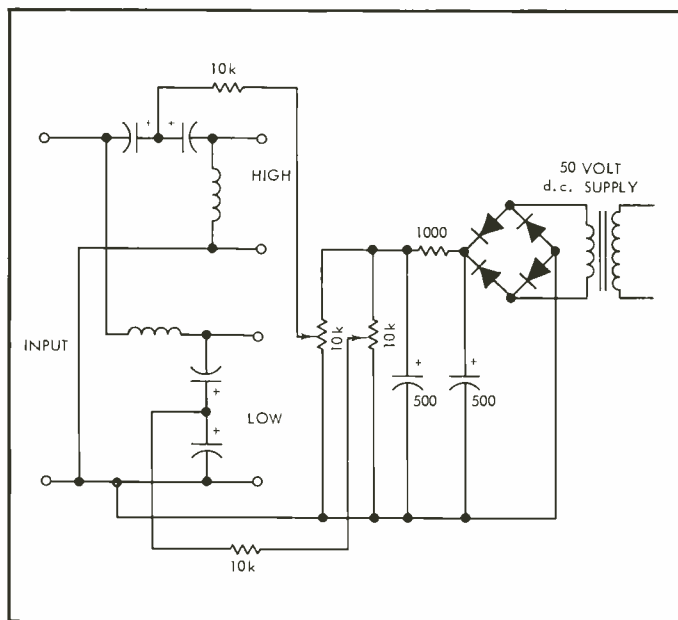

Fig. 11. A method of providing polarizing supply for electrolytic capacitors in a crossover circuit, so their value can be controlled. Higher voltage reduces effective capacitance and vice versa. Some time should be allowed for the electrolytic film to change, before a steady capacitance value is achieved for each voltage adjustment.

certainly no saving: below 1000 cps, a high-Q iron-cored inductor is the best choice. At these lower frequencies, the Q of an air-cored coil gets too low and virtually disappears, while if the coils are made big enough to achieve anything close to design performance, they will be prone to hum pickup—even without benefit of amplification!

To simplify the air-cored design procedure we have selected a "standard" size for this range, using a winding mandrel that is 1/2-in. in diameter by 1.4-in. long. It should have flanges, one of which has a slot for bringing out the inside lead (Fig. 12). For smaller numbers of turns

in heavier gage, you may be able to count the turns on. For the larger numbers of turns, you'll have trouble remembering where you are and a mechanical counter is virtually a necessity. The mandrel can be mounted on a shaft coupled to a revolution counter, which can often be picked up for a song at a junk shop.

Turns should be wound on carefully, filling each layer closely and solidly: winding capacitance is no problem at these impedances! All the coils you will need are best hand wound—you will get them neater than is possible with a motor driven winder, unless it's a professional

machine. Larger numbers of turns will need a little more patience, but the process is by no means exhausting.

The chart of Fig. 13 gives the numbers of turns for inductances in the range you need, using a wire gage that will not make build-up over 1/2-in.—the over-all diameter will stay within 1 1/2-in. Overlap in wire gage lines on the chart is due to the fact that difference in size makes the build-up different; also some suppliers only carry even sizes, while others may carry odd sizes. This arrangement enables you to pick a suitable gage from either the odd or even set and use the appropriate turns for that gage.

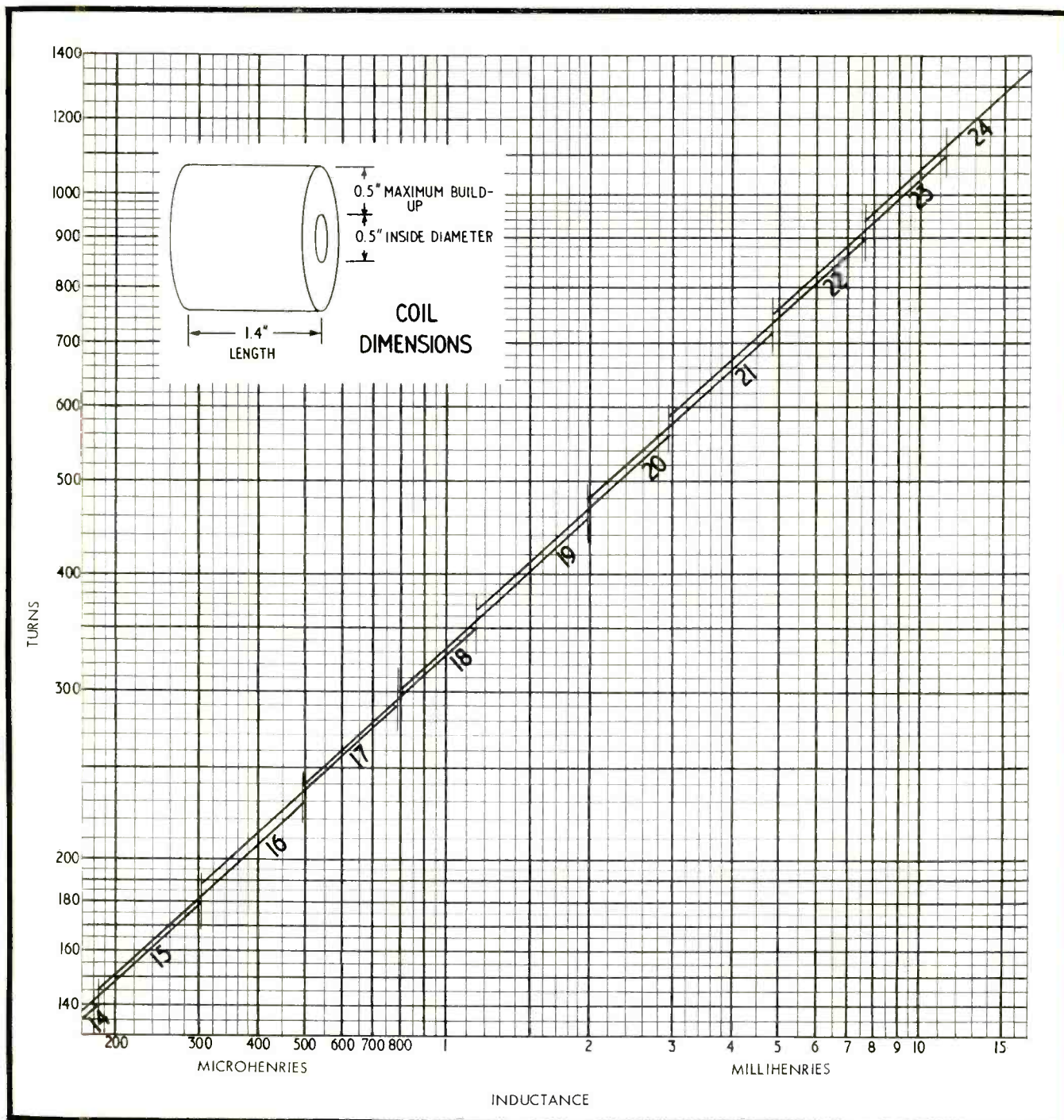

Fig. 13. Chart for selecting wire gage and turns to give required inductance in air cored coils. These should only be used for crossover frequencies of 1000 cps and up.

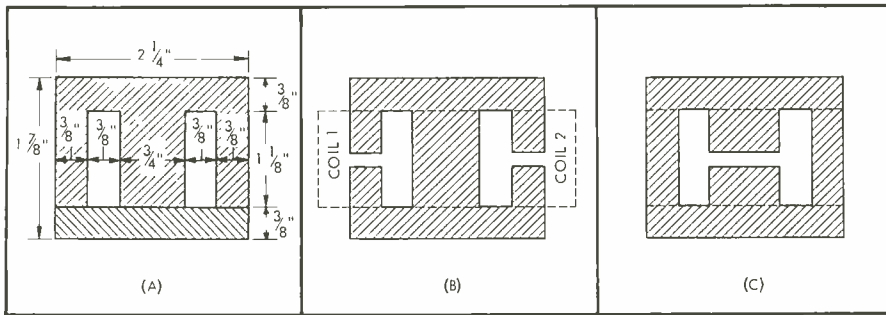

Fig. 14. The lamination size for which iron-cored coils are designed in this article: (A) the unmodified lamination pair; (B) the assembly as modified for the smaller coils, used for frequencies in the range 600 to 1000 cps; (C) the assembly as modified for the larger coils, used for frequencies below 600 cps.

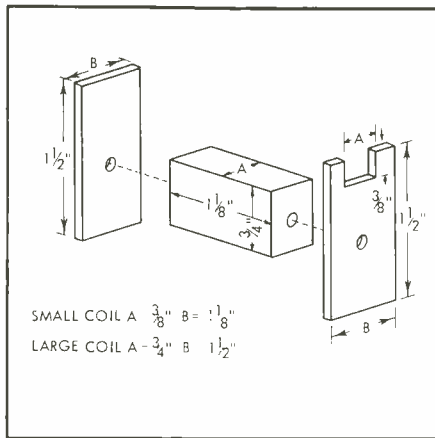

Fig. 15. Mandrel parts for winding iron-cored coils.

For example, a coil for the three-way crossover designed in part 1 needed to be 270 microhenries at 3400 cps, which can be air cored. A suitable coil would be 170 turns of AWG 15 (enamelled) or 173 turns of AWG 16. Other inductance values are just as easy to get from this chart.

For frequencies below 1000 cps, an iron-cored type is best. We have given design data for coils in two sizes, using a core built from laminations with the dimensions shown in (A) of Fig. 14. This is a fairly common size for inexpen-

sive output and speaker matching transformers, and yields satisfactory Q factor for frequencies from 600 to 1000 cps in the smaller size, which allows two coils to a core ((B) of Fig. 14), while for frequencies below 600 cps the larger version should be used ((C) of Fig. 14) requiring a core to itself.

To wind the coils for these inductors, a rectangular mandrel and end flanges will be needed (Fig. 15). To facilitate removing the coil from the mandrel when winding is complete, a few wraps of paper should be put round the center of the mandrel, as shown in (A) of Fig. 16, followed by tie-in tapes, shown in (B), and a wrap of adhesive tape, the width of the coil, 1 1/8-in., to secure them. After the coil is wound, with care not to allow the wire to protrude above the flange sides on the sides where it will pass through the core window, these tie-in tapes are pulled across the top of the coil and stuck down with another wrap of adhesive tape, to finish the coil before it is removed from the mandrel.

To select the right coil, the chart of Fig. 17 is used. The top part applies to the smaller coils, while the lower part is for the larger coils. As the window is the same for both, the turns and wire gage data fit both sizes and the same code is used to identify the appropriate

selection (although the dimensions are different, to fit the appropriate core leg). These coded windings are tabulated below:

Code	Turns	AWG
A	42	14
B	60	15
C	65	16
D	75	17
E	110	18
F	150	19
G	200	20
H	250	21
I	320	22

In this case, turns have been selected to fill the window area comfortably with wire of that gage. Steps between numbers of turns and between corresponding reference lines on the chart, are uneven, because the number of layers needed sometimes fits the space better than other gages. But for each size there is no point in using less than enough turns to fill the space, as specified here, because that will degrade the Q factor. The correct inductance is achieved, not by adjusting turns, but by adjusting the air gap, which the chart gives for the required inductance values.

For example, the 800-cps crossover of Fig. 6 in part 1 uses inductors of 1.23, 2.1, 3, and 5 mH, all of which can use the smaller size coil. Referring to the top part of the chart (Fig. 17), 1.23 mH can use coil C with a gap of 0.083-in., coil D with a gap of 0.108-in., or coil E with a gap of 0.233-in. For 2.1 mH, it could use coil E with a gap of 0.138-in. or coil F with a gap of 0.25-in. For 3 mH, it could be coil E with a gap of 0.096-in., coil F with a gap of 0.178-in., or coil G with a gap of 0.312-in. For 5 mH, it could be coil F with a gap of 0.106-in., coil G with a gap of 0.19-in., or coil H with a gap of 0.3-in. precisely.

The overlap in coil sizes serves two functions here: it enables you to use odd or even wire gages, as in the air-cored coils; it also enables you to pick matching, or nearly matching, air gaps in coils that share a core.

The 1.23-mH and 5-mH coils could share a core, using D and F coils respectively. The 1.23-mH and 2.1-mH coils could share a core, using E and F coils respectively. The 3-mH and 5-mH coils could share a core, using G and H coils respectively. Other choices could be figured out and, if the gages do not suit, different gaps might be needed.

To get the gaps right, the laminations should be cut as shown at (A) in Fig. 18 for the small coils, or (B) of Fig. 18 for the large coils. Note that all the lamination pieces formed by cutting are used for the small assembly, but only the E_s cut down to F_s are used in the larger as-

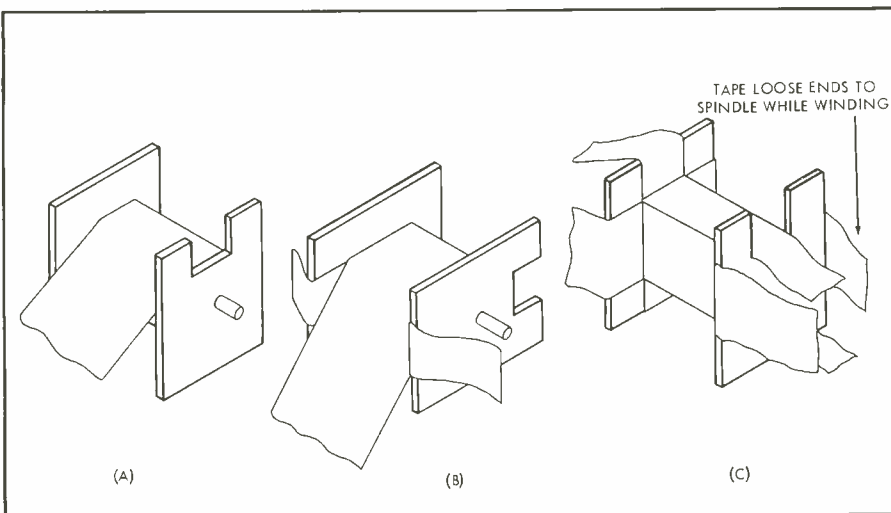
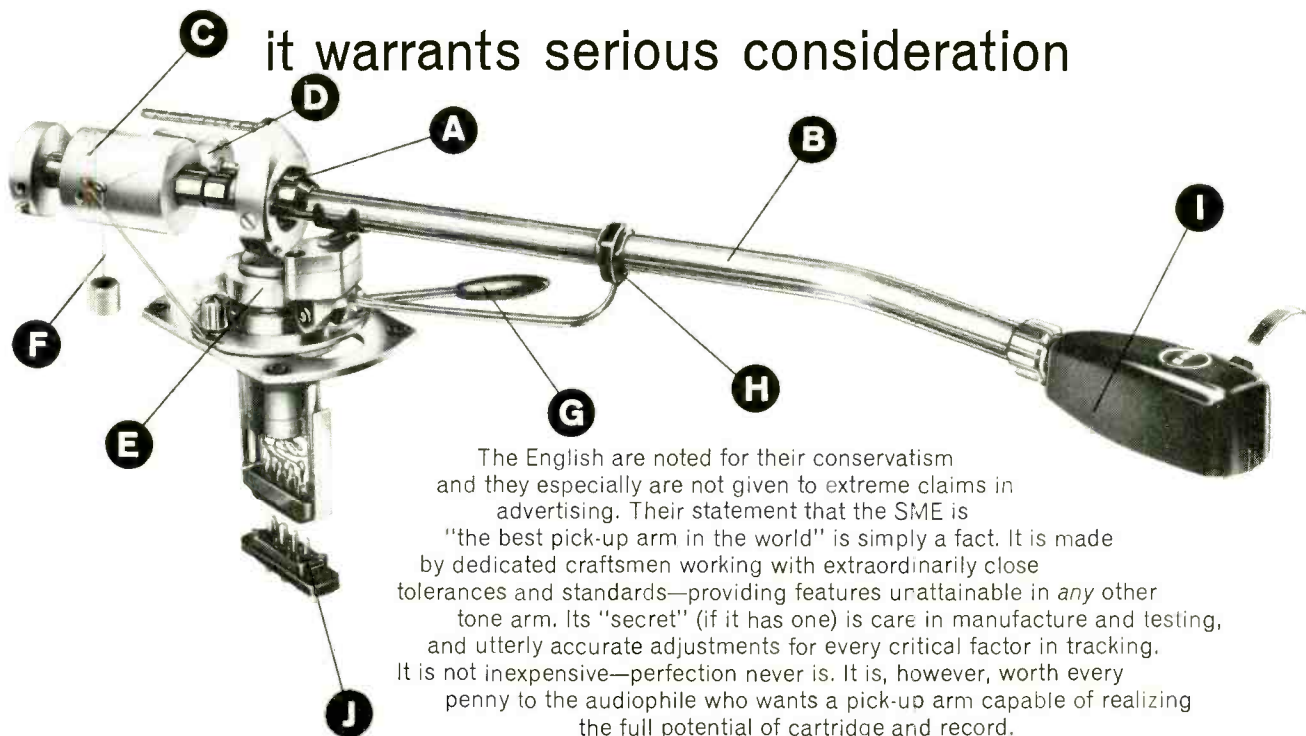

Fig. 16. Method of preparing for winding iron-cored coils on the mandrel assembly.

when the British say
“the best pick-up arm in the world”
 it warrants serious consideration



The English are noted for their conservatism and they especially are not given to extreme claims in advertising. Their statement that the SME is “the best pick-up arm in the world” is simply a fact. It is made by dedicated craftsmen working with extraordinarily close tolerances and standards—providing features unattainable in any other tone arm. Its “secret” (if it has one) is care in manufacture and testing, and utterly accurate adjustments for every critical factor in tracking. It is not inexpensive—perfection never is. It is, however, worth every penny to the audiophile who wants a pick-up arm capable of realizing the full potential of cartridge and record.

SHURE SME DESIGN FEATURES

A. Virtually frictionless knife-edge bearings. Pivot friction is less than 20 milligrams, horizontal and vertical!
B. Wood-lined stainless steel tube arm. Resonances are outside recorded range, of small amplitude, and damped.
C. Unique weight system statically balances arm longitudinally AND laterally.
D. Rider weight adjusts tracking force from ¼ to 5 grams, adjustable for ¼ or ½ gm. increments, as accurate as a fine stylus pressure gauge.
E. Sliding base offers alignment adjustment through 1 inch. Height is adjustable through ¾ inch. Fulfills optimum requirements of length, offset, overhang when adjusted with alignment protractor included.

F. “Anti-skating” bias adjuster counteracts tendency of the arm to move toward record center and “favor” inner groove.
G. Hydraulic lever-operated set-down for “slow-motion” feather-light lowering onto any part of the recording.
H. Nylon-jaw arm rest with stainless steel locking link.
I. International standard 4-pin socket. Cartridge shells fitted with detachable pillars and mounting screws at standard ½ inch spacing.
J. Output socket and plug provides a rigid junction for the “stiff wiring” and delicate pick-up lead, eliminating influence on free tone-arm movement.

PRICES:

Includes one shell, arm, template, alignment protractor, hardware
 MODEL 3009 for 12" recordings \$89.50 net
 MODEL 3012 for 16" recordings \$99.50 net
 ADDITIONAL SHELL Model A30H \$5.50 each

the
 perfect companion
 cartridge

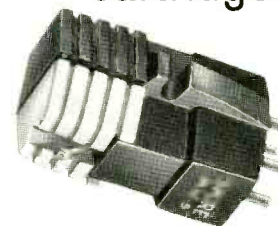

The Shure M33-5, of course. With the SME, provides absolute minimum tracking force . . . *without distortion*. Incredibly transparent sound. Peak-free high end, clean lows, astoundingly natural and clear in the middle range where most other cartridges suffer serious deficiencies. 22 x 10⁻⁶ cm per dyne compliance. \$36.50 net.

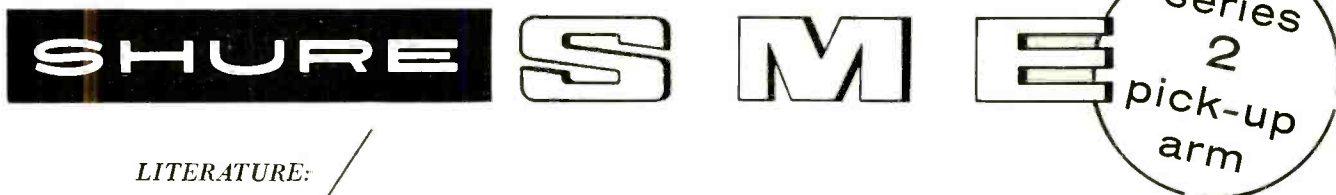

LITERATURE:

SHURE BROTHERS, INC., 222 HARTREY AVE., EVANSTON, ILLINOIS

Manufactured under U.S. patents 3,055,988; 3,077,521; 3,077,522; D193,006; D193,934; other patents pending.

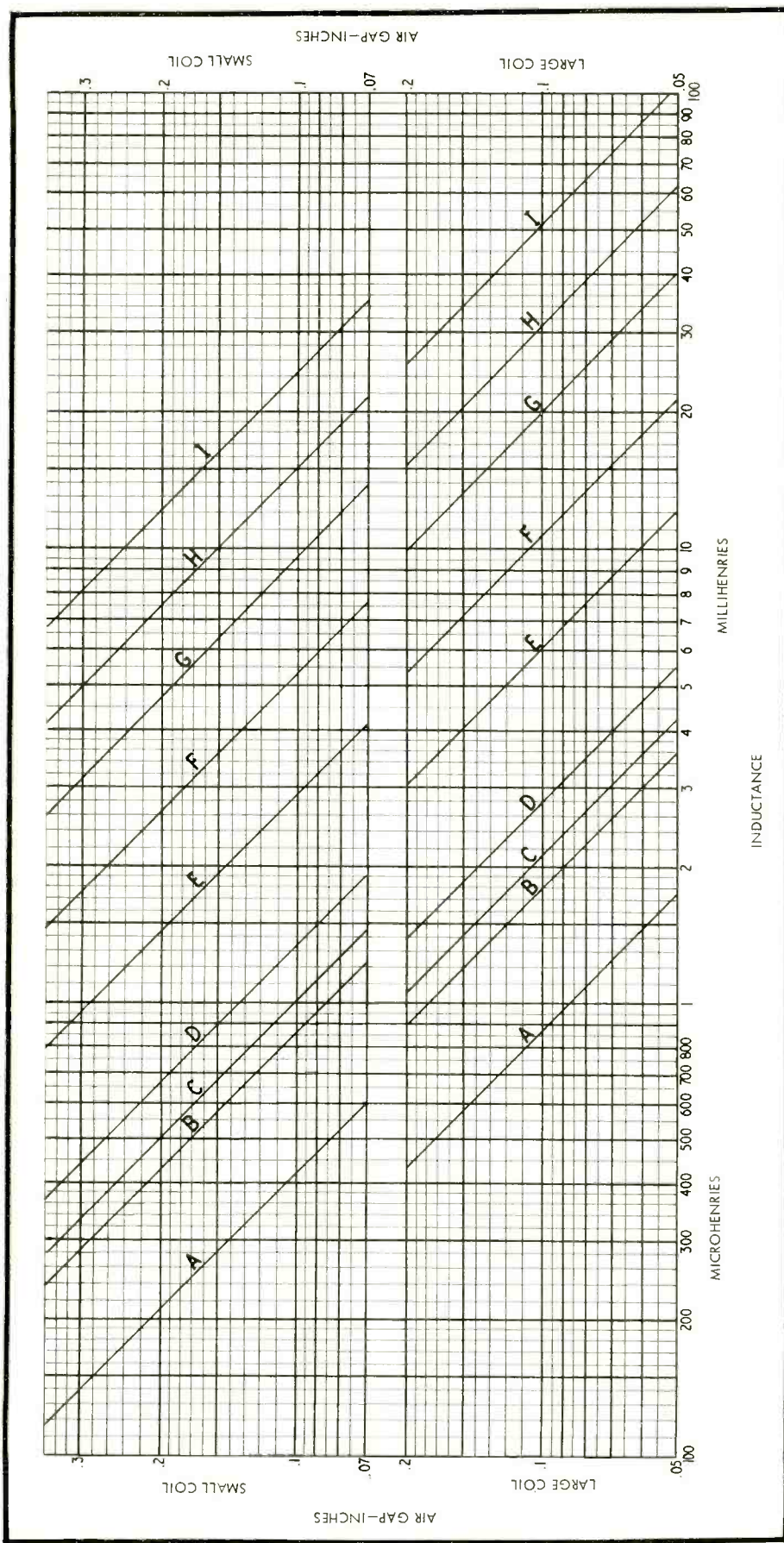

Fig. 17. Chart for selecting winding details (tabulated in article) and air gap to be used in iron-cored coils. Upper part is for smaller and lower part for larger coils. For explanation of letter code see table on preceding page which gives number of turns and wire gage.

sembly. This size is available as an F stamping, but rarely stocked. However, if you can obtain some, it will save cutting.

Spacers should be built up whose dimensions are somewhat less than $\frac{3}{8}$ -in. wide for the small coils, or $\frac{3}{4}$ -in. for the large coils, but as close as possible to exactly $\frac{3}{4}$ -in. the other way, to fill the entire stack dimension of the assembly (a $\frac{3}{4}$ -in. stack is used for both sizes). The spacer thickness should be built up to the calculated air gap thickness for that particular inductance value. Card, plastic, or any non-magnetic, non-conducting material may be used for this spacer.

After cutting, the laminations should be flattened so they assemble closely without loss of space. When the coil has been filled to capacity with laminations, and the laminations tightened down onto the gap spacer, the laminations may be mounted in a suitable clamp to hold them and to mount the assembly. But no clamp of magnetic or conducting material should in any way bridge the gap inside the coils, or the Q will be degraded and possibly the inductance value changed.

If you have the turns and air gap right, according to the chart, the inductor value will be close enough to value to be relied upon and trimming can be achieved with the capacitors, if necessary, to get the right response. This is done at crossover frequency, as compared with some frequency fairly remote (say ten times, or one tenth, for the respective sections) from the crossover. The object is to get the amplitude and phase correct at this frequency.

Treat each section (high pass, band pass, or low pass) as a separate entity for this, by disconnecting it from its neighbors. In testing a band-pass section, check each point at each crossover frequency, as compared with a frequency at precisely mid-band. For example, where the crossovers are at 600 and 4000 cps, the appropriate mid-band frequency is 1550 cps.

Figure 19 shows the complete set of patterns, with critical dimensions for amplitude and phase, to be obtained when the filter output is connected to the 'scope Y plates (vertical input) and the point marked A, B, or C to the 'scope X plates (horizontal input). As the crossover is to be used with a loudspeaker and not a dummy load, a speaker load should be used on the outputs. If the speaker's impedance is close to resistive at crossover, the voltage across it may be connected to the vertical input (with points marked G connected to 'scope common ground). But if the speaker has appreciable reactance at crossover, a small resistance should be connected in

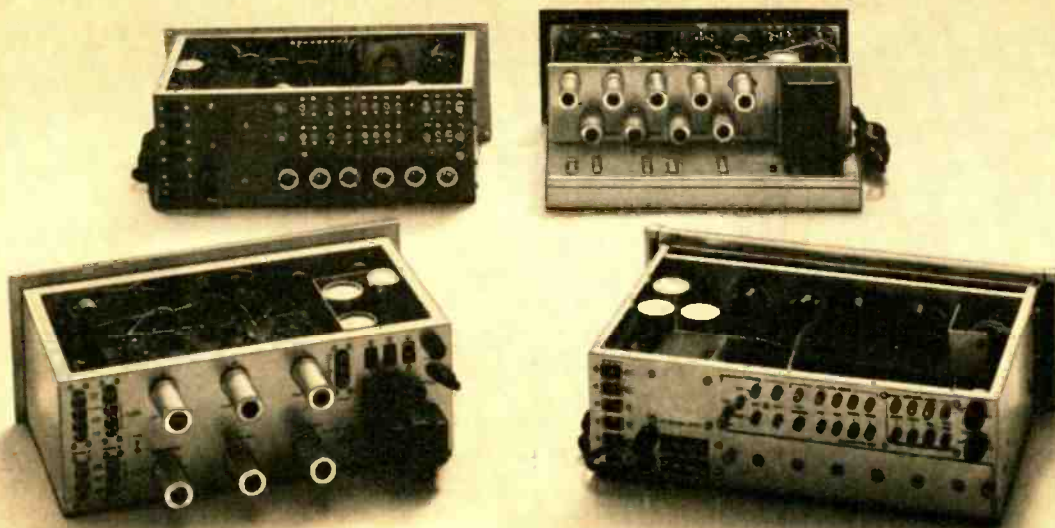

THERE ARE FOUR EXCELLENT VACUUM TUBE STEREO CONTROL CENTERS ON THE MARKET TODAY.



WHY DOES THE NEW CITATION A SURPASS THEM ALL?

Part of the answer is suggested by an authoritative report which appeared recently in *High Fidelity Magazine*. Here are some excerpts:

- "Marks a major breakthrough in the application of semiconductors to high fidelity sound."
- "Superb response characteristic is not matched by any other known preamplifier."
- "Citation A literally has flat response to beyond one million cycles and distortion that is non-measurable by the usual methods."
- "Excellent transient characteristics and virtually no phase shift throughout its extremely wide range."
- Harmonic distortion is "actually less than the residual distortion of the measuring equipment."
- "Its listening quality is superb.... The overall effect of listening to Citation A is simply, more music and less fatigue."
- "Should meet the demands of the most critical listener and audio perfectionist."
- "It suggests that... a sound path could be set up that approaches the classic goal of amplifier design—that is, a straight wire with gain."

For a complete folio of reports and test evaluations of this remarkable new instrument, write Citation Division, Dept. A10, Harman-Kardon, Inc., Plainview, New York.

harman kardon

HK 106 A subsidiary of THE JERROLD CORPORATION

Harmonic Distortion—Tests and Measurements

MANNIE HOROWITZ*

It's much easier to use a harmonic distortion meter to determine the distortion in an amplifier or other electronic equipment, but considerable information can be gleaned by the use of an oscilloscope and a suitable network and the application of some cerebral energy.

A DISCUSSION OF HARMONIC DISTORTION should begin with a thorough study of the Fourier Analysis of non-sinusoidal waves. This topic has been most adequately covered in many excellent engineering texts¹ and will not be repeated here. Much of the information included below will be drawn from the analysis, and will be stated rather than derived.

A Review of Trigonometry

In (A) of Fig. 1, R is one of the radii. As the tip of the radius (a point on the circumference) rotates from θ to a , the radius must rotate through an angle θ . θ is an angle which can be measured in degrees. As drawn in (A), θ is 45 deg. In (B), θ is 90 deg. All the values of θ are noted on the drawing, until it rotated through the complete 360 deg. in (F).

* 1035 Clarkson Ave., Brooklyn 12, N. Y.
¹ Hugh Hildreth Skilling, "Electrical Engineering Circuits." John Wiley & Sons. New York: 1957, Chap. 14.

Ronald E. Scott, "Linear Circuits." Addison-Wesley Publishing Co. Reading, Mass.: 1960, Chap. 20.

Egon Brenner and Mansour Javid, "Analysis of Electric Circuits," McGraw-Hill. New York: 1959, Chap. 19.

If it rotated twice through 360 deg., θ would be equal to 720 deg.

The angle can also be designated in radians. There is a direct relationship between degrees and radians. In (F) of Fig. 1, 360 deg. = 2π radians. It follows that $2 \times 360^\circ = 2 \times 2\pi$ radians or $720^\circ = 4\pi$ radians. Several other intermediate relationships are shown in Fig. 1.

If the radius rotates at an angular velocity of ω radians per second, and t is the time it took for the radius to rotate through the angle θ , the relationship

$$\theta = \omega t \quad (1)$$

follows from the basic equation that distance is equal to the velocity multiplied by time.

" ω " is a basic notation found in harmonic analysis. It is an angular velocity, in terms of the number of radians the radius turns each second. A radius rotating through 360 deg. has completed one cycle. A velocity of one cycle per second is the equivalent of 2π radians each second. If two cycles are completed each second, it is the equivalent of covering $2 \times 2\pi$ radians per second. Thus ω can be stated mathematically in two ways with identical meaning

$$\omega = \frac{2\pi}{T} = 2\pi f \quad (2)$$

where T is the time for one cycle (period) and f is the number of cycles each second (frequency). f is the frequency in cycles per second, abbreviated cps.

Returning to (A) of Fig. 1, it is desirable to find the sine of the angle θ for all values of θ . By definition,

$$\sin \theta = e/R \quad (3)$$

the opposite side over the hypotenuse. It should be noted that the length of the radius remains unchanged for all values of θ . For the sake of simplicity, R is made equal to 1. Then

$$\sin \theta = e \quad (4)$$

By the simple construction in Fig. 2, the $\sin \theta$ function, which is equal to $\sin \omega t$ —for $\theta = \omega t$ from Eq. (1)—can be plotted on an axis showing how e varies with ωt . This is the sine wave as usually shown in the literature. Each cycle must go through 2π radians.

The plot can be changed from being a function of ωt , to a function of time. This is shown at (A) in Fig. 3. When the wave goes through a complete cycle in 1 second, its frequency is 1 cycle per

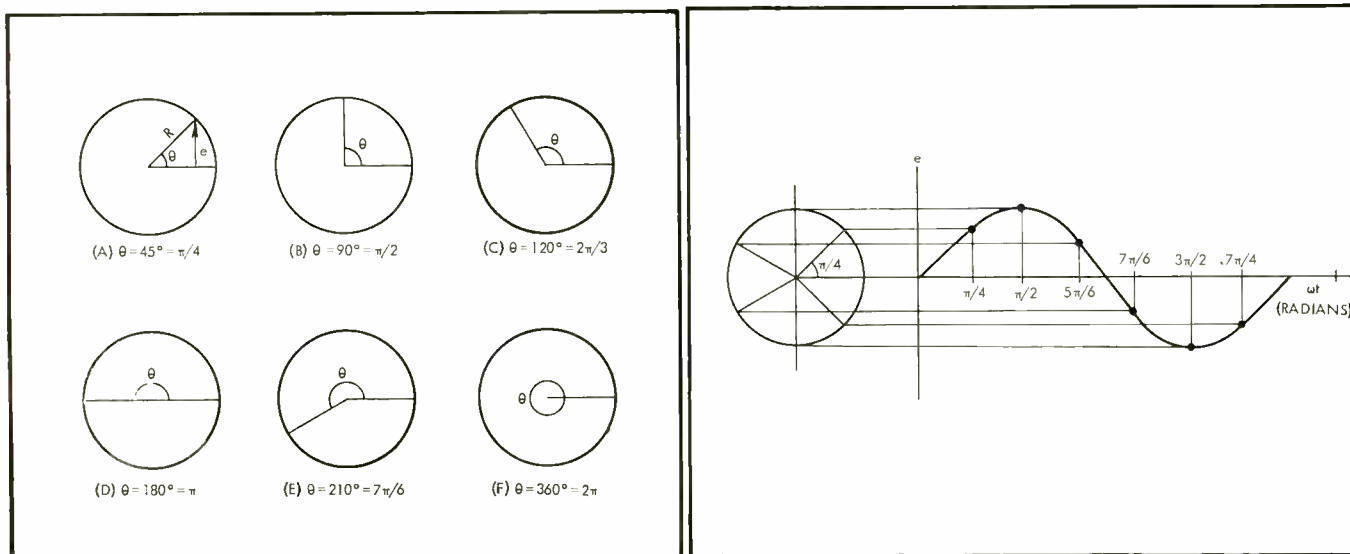

Fig. 1 (left). The various angles of θ . Fig. 2 (right). Graphical portrayal of the generation of a sine wave.



The AR turntable

good for the money?

SPEED ACCURACY

high fidelity

"... showed the lowest speed error that has been encountered in {fixed speed} turntables"

WOW AND FLUTTER

HiFi/Stereo review (Julian D. Hirsch)

"The wow and flutter were the lowest I have ever measured on a turntable."

RUMBLE

AUDIO

"The AR turntable introduces as little 'signal' of its own as any turntable we have had occasion to test."

ACOUSTIC FEEDBACK

HI-FI (John Milder)

"... the best answer so far to the interrelated problems of rumble and acoustic feedback in stereo-record playing"

SAFETY



The AR turntable is listed under Reexamination Service of Underwriters' Laboratories, Inc. We do not know of any other current non-automatic separate turntable or record player so listed.

The AR turntable is guaranteed for one year; the guarantee covers both repairs and reimbursement of any freight costs.

Literature, including a list of dealers in your area, is available on request. The AR turntable and AR speakers are on continuous demonstration at AR Music Rooms, on the west balcony of Grand Central Terminal, N.Y.C., and at 52 Brattle Street, Cambridge, Massachusetts. No sales are made or initiated at these showrooms.

\$68⁰⁰ complete with arm, oiled walnut base, and dust cover, but less cartridge, 33 $\frac{1}{3}$ and 45 rpm

(33 $\frac{1}{3}$ only, \$66)

The price of the one-speed turntable has been increased from the original \$58. This price increase, made necessary by manufacturing costs, is the first in AR's nine-year history.

5% higher in the West and Deep South

ACOUSTIC RESEARCH, INC., 24 Thorndike Street, Cambridge 41, Massachusetts

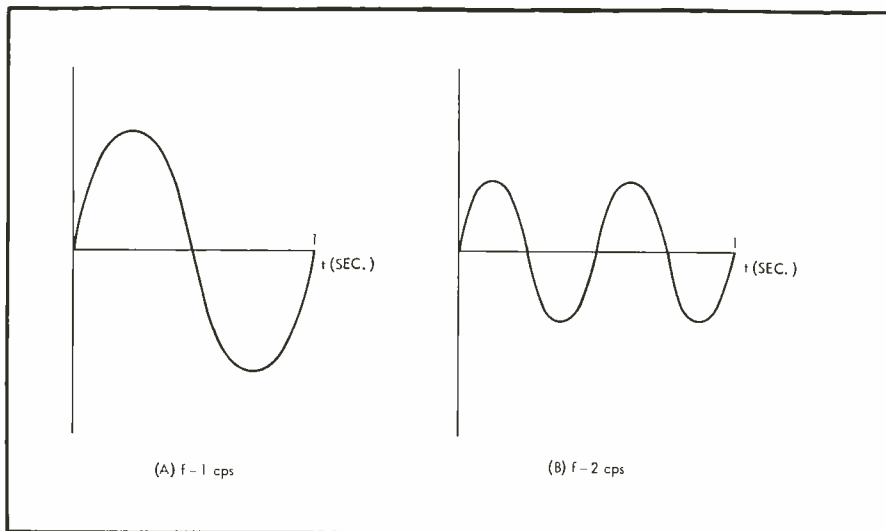

Fig. 3. (A), representation of one cycle per unit of time, and (B), representation of two cycles in the same unit of time.

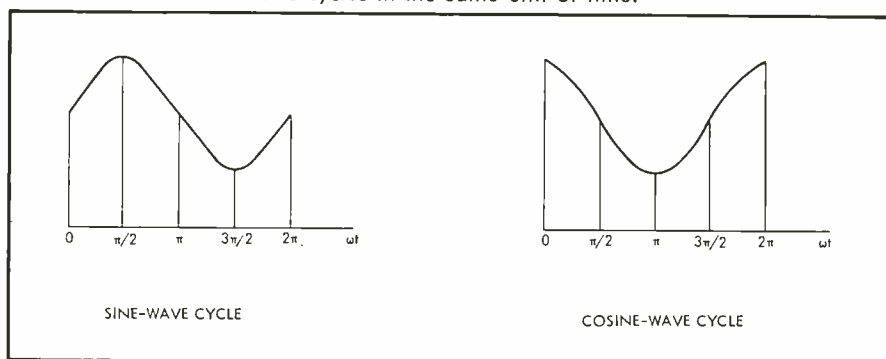

Fig. 4. Comparison between one sine-wave cycle and one cosine-wave cycle.

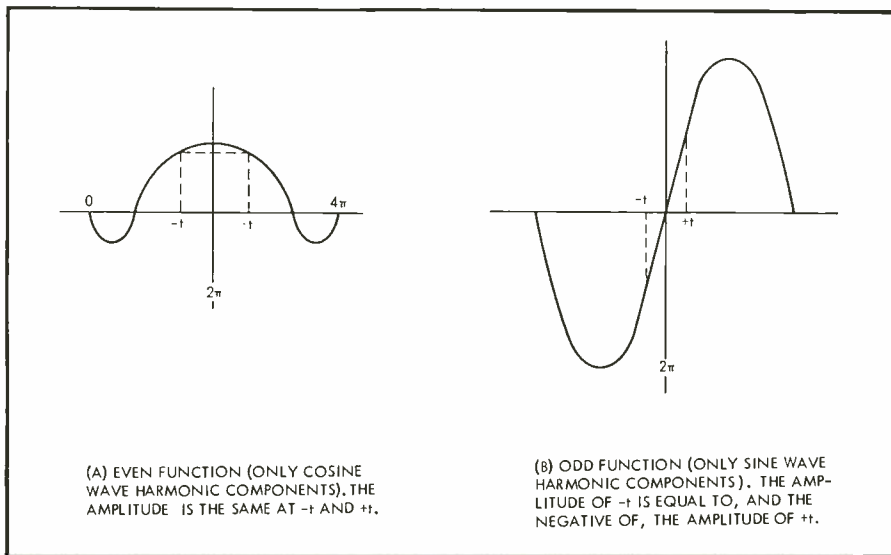

Fig. 5. Two types of functions. (A), even function (only cosine-wave harmonic components). The amplitude at $-t$ equals the amplitude at $+t$ (B), odd function (only sine-wave harmonic components). The amplitude at $-t$ is equal to and the negative of the amplitude at $+t$. (Note that odd and even do not refer to the order of the harmonics.)

second. If it does this twice in one second, its frequency is 2 cycles per second, as shown at (B). Each complete cycle represents an angle of 2π radians. The radius traversed these 2π radians twice in (B) of Fig. 3. The equation for the sine wave in (A) can be written as

$$e_1 = E_1 \sin \omega t \quad (5)$$

and that for (B) as

$$e_2 = E_2 \sin 2\omega t \quad (6)$$

where E is the peak value of the sine wave, and e is the value it assumes each instant of time. The exact frequency is immaterial, but the relationship between the two is represented by a factor of 2, indicating that one is double in shape

to that of the $\sin \theta$ curve. It just starts 90-deg. or $\pi/2$ radians later. The two are compared in Fig. 4.

Defining Harmonic Distortion

From the Fourier Analysis, it can be determined that a distorted wave is composed of the original frequency (fundamental), as well as frequencies which are two, three, four, and so on, times the original frequency (harmonics). Stated analytically, it can be written

$$e = E_1 \cos \omega t + E_2 \cos 2\omega t + E_3 \cos 3\omega t + \dots + B_1 \sin \omega t + B_2 \sin 2\omega t + B_3 \sin 3\omega t + \dots \quad (7)$$

In the equation, $\cos \omega t$ or $\sin \omega t$ is the fundamental, while $\cos 2\omega t$ and $\sin 2\omega t$ represent the second harmonic, $\cos 3\omega t$ and $\sin 3\omega t$ represent the third harmonic, and so on. The remaining terms of the equation, representing the fourth, fifth and sixth harmonics, up to the infinite harmonic, are not shown in the equation, but should be understood to exist. Harmonics greater than the third are usually too small to be of any significance, and will consequently not be considered here.

The E_1, E_2, E_3 and B_1, B_2, B_3 in the equation are the peaks of the harmonics.

Not all the harmonics in Eq. (7) are present in a distorted wave. By careful choice of the 2π axis, several of the terms in the equation can be discarded as contributing nothing to the wave. Several examples are shown in Fig. 5.

Assume the 2π axis can be chosen as at (A), so that points equidistant from and on either side of the 2π axis were identical (with respect to the 2π axis) in amplitude, and in the same (positive or negative) direction. That is, the amplitudes at t and $-t$ are identical. Then only cosine terms will be present in the equation. The sine components in Eq. (7) can be discarded.

Now assume the curve takes the form shown at (B) in Fig. 5. Here, the amplitude at t and $-t$ are identical, but one is the negative of the other. In this arrangement, only the sine terms in Eq. (7) apply.

Some functions can be either odd or even, depending upon the choice of the 2π axis. The results of the analysis are the same. The choice is determined by convenience. The only difference is the phase and thus it does not affect the harmonic content.

Either choice can exhibit both even and odd harmonics. In Fig. 6, we can see one more criterion to simplify analysis. If the amplitude at any time t , is identical, but opposite in sign, to the amplitude at the time $t + \pi$, only odd harmonics are present in the curve. The even harmonic terms can thus be eliminated from Eq. (7). Combining this with the

GENUINE PLAYBACK EQUIPMENT

A DISTINCT STEP-UP FROM HIGH FIDELITY

Genuine studio **PLAYBACK** equipment is as superior to conventional "hi fi" components as these components are superior to typical package "hi fi." The reason: **PLAYBACK** equipment is what the conductors, artists and recording engineers rely on in the studio to accurately compare the realism of a recording with the live rendition.

In professional audio, where no compromise with performance and reliability is tolerated, only genuine **PLAYBACK** equipment is deemed acceptable. Altec Lansing is synonymous with **PLAYBACK**, because major professional users—studios, concert halls, theatres—have used Altec equipment predominantly since the beginning of modern sound technology.

The Altec 605A "Duplex"® is an outstanding example of such studio equipment and has been judged the finest single-frame speaker in existence. It is the ultimate refinement of Altec's original 604 which had served as the **PLAYBACK** standard since the birth of long play records.

One hearing will quickly demonstrate why the 605A "Duplex" is supreme. These specifications will explain some of the reasons: The 605A is a 15", two-way speaker system employing a true multicell horn for perfect dispersion of high frequencies throughout the entire audio range. Its guaranteed frequency response is 20-22,000 cycles. The Altec 605A "Duplex" is so free of distortion and false coloration that other speakers sound shrill and constricted by comparison. That's why leading Capitol recording stars such as Judy Garland, Peggy Lee, Nat King Cole and Vic Damone can rely on the "Duplex" in studio **PLAYBACK** for evaluation of their work before the recording is "wrapped-up."

WIDE VARIETY OF WIDE-RANGE SPEAKERS

The 605A is priced at \$168.00 including dividing network. At 35 pounds, it is the "heavyweight" of the line. Two other "Duplex" **PLAYBACK** speakers of exceptional quality are also available. The 602C is a 15" two-way speaker which provides outstanding performance at the modest cost of \$132.00. For those who want genuine **PLAYBACK** sound in comparatively small space, Altec's two-way 601C is the ideal answer at \$108.00.

For "starter" systems on a budget, consider Altec full-range, single voice-coil "Biflex"® speakers: the 15" 415C and the 12" 412C. And, for speakers throughout the home, there's the remarkably smooth 8" 755C "pancake," a popular utility monitor in the broadcast and recording field for many years.

AUDIO'S MOST IMPORTANT FORMULA

Whatever you invest in your system, put major emphasis on the speakers. The speakers are the voice of your system and here, a compromise is most audibly apparent. If, for various reasons, you must compromise with overall quality, it is best not to do so in speaker selection but elsewhere in the audio system. Naturally, you will be assured best results by a stereo system made-up entirely of components of homogeneous quality such as offered by genuine Altec **PLAYBACK** speakers, amplifiers, and tuners.

Hear Altec speakers, speaker systems and other **PLAYBACK** components at your nearest Altec Distributor's (see your Yellow Pages). And while you're there, be sure to ask for your courtesy copy of "PLAYBACK and Speech Input Equipment for Recording and Broadcast Studios." Although prepared specifically for the recording and broadcast industry, it provides the obvious answers to better home listening as well. Or, for your free copy, write Dept. A-10.

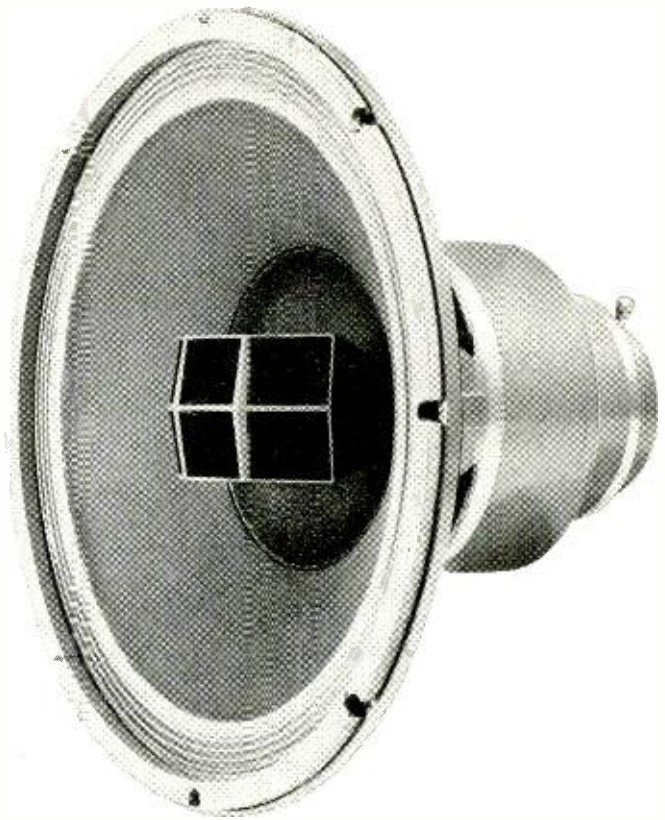

Interior of Columbia Records' Studio A in Hollywood showing CBS-built cabinets housing Altec 605A "Duplex" Loudspeakers for professional **PLAYBACK**.



Monitoring with Altec "Duplex" speakers in Capitol's Control Room. More than 70 Altec "Duplex" speakers are used for various **PLAYBACK** purposes throughout Capitol Records' recording facilities.



ALTEC LANSING CORPORATION

A Subsidiary of
Ling-Temco-Vought, Inc.
ANAHEIM, CALIFORNIA

©1963 ALTEC LANSING CORPORATION

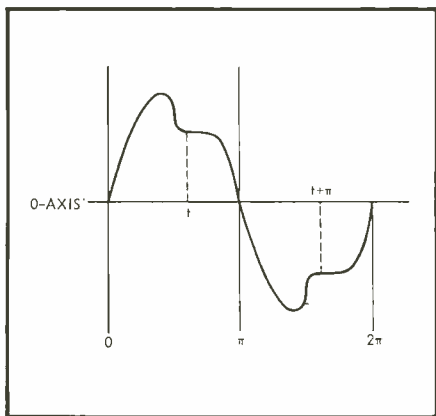

Fig. 6. Only odd harmonics are present. The amplitude at any point " t " is equal to and the negative of the amplitude at " $t + \pi$." The signal below the zero axis from " $t = \pi$ " to " $t = 2\pi$ " is the mirror image of the signal above the zero axis between " $t = 0$ " and " $t = \pi$."

considerations in Fig. 5, most of the terms in Eq. (7) can be eliminated.

(Do not confuse these with the even and odd functions discussed with reference to Fig. 5. In Fig. 6, we refer to the order of harmonics only, while in Fig. 5 we identify cosine functions as even and sine functions as odd. This has nothing to do with the odd or even harmonics discussed in Fig. 6.)

An easy way to identify the presence of odd harmonics only is to move the section of the curve between π and 2π under the section from 0 to π . If one is the mirror image of the other around the t axis, then only odd harmonics are present.

A curve which does not exhibit mirror symmetry around the t axis is composed primarily of even harmonics.

Through the remainder of this discussion, it will be assumed that only cosine terms are present in the distorted signal. E_1 is considered the magnitude of the fundamental, E_2 is the magnitude of the second harmonic, and E_3 is the magnitude of the third. All higher harmonics are supposed to be so small as to render them negligible.

The percent distortion is defined as

$$\text{Per cent HD} = 100 \frac{(\text{sum of the amplitudes of the harmonics squared})^{\frac{1}{2}}}{\text{amplitude of the fundamental}} = \frac{(E_2^2 + E_3^2)^{\frac{1}{2}}}{E_1} 100 \quad (8)$$

This exact formula can be used if all components are known from measurements on a wave analyzer.

In most cases, Eq. (9) is used.

$$\text{Per cent HD} = \left(\frac{E_2^2 + E_3^2}{E_1^2 + E_2^2 + E_3^2} \right)^{\frac{1}{2}} 100 \quad (9)$$

This is effectively identical to Eq. (8) when the harmonics are small—let us say not more than 10 per cent of the funda-

mental. The conventional harmonic distortion meter measurements comply with Eq. (9) and are thus inaccurate for large percentages of distortion.

Observing Distortion on a 'Scope

Distortion magnitude of 5 per cent (or in some cases 10 per cent) or less, can seldom be seen on the scope. Inserting the differentiating network between the signal and the scope, as shown in Fig. 7, will frequently make it possible to observe small percentages of distortion. This can be explained as follows.

R and C form a differentiating circuit because the reactance (X_c) of C is considerably greater than the resistance of R . The current through R is thus determined by the reactance of C alone, and is $i = C de/dt$, where e is the voltage across C . Because X_c is large compared to R , the voltage across R is negligible and is effectively the total voltage applied to the network.

The voltage across R is the product of the current through the network, $C de/dt$, and R , which is

$$e_o = RC de/dt \quad (10)$$

The output voltage is then the derivative of the voltage at the circuit input.

Now assume that a distorted signal is

applied to the network from an audio amplifier

$$e = E_1 \cos \omega t + E_2 \cos 2\omega t + E_3 \cos 3\omega t \quad (11)$$

and furthermore that the harmonic components are not visible on the 'scope. It is desirable to increase the size of the harmonic components when applied to the 'scope, so that they can be seen.

Put this signal with the harmonics through a differentiating network. Mathematically, it results in:

$$\begin{aligned} \frac{de}{dt} &= \frac{d(E_1 \cos \omega t)}{dt} \\ &+ \frac{d(E_2 \cos 2\omega t)}{dt} + \frac{d(E_3 \cos 3\omega t)}{dt} \\ &= -\omega E_1 \sin \omega t - 2\omega E_2 \sin 2\omega t - 3\omega E_3 \sin 3\omega t \quad (12) \end{aligned}$$

Here, the relative size of the second harmonic is double and the relative size of the third harmonic is tripled. Thus, with respect to the fundamental, the sizes of the harmonics are increased. When connected to a 'scope, the distortion now becomes more obvious.

A signal with second harmonic components was applied to the network in Fig. 7. The input to the network looked per-

(Continued on page 71)

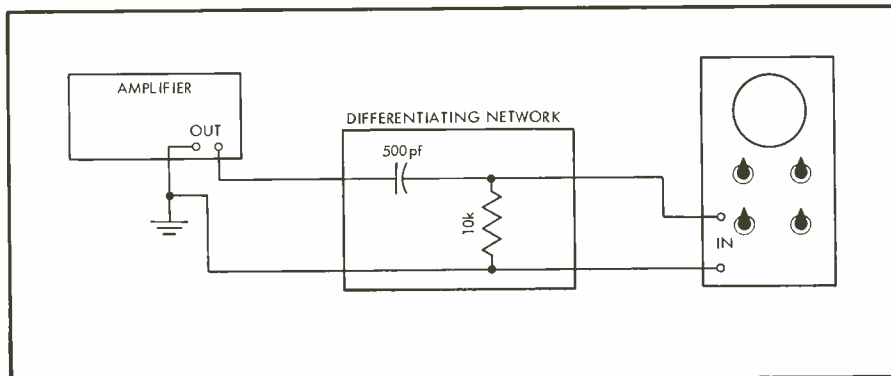

Fig. 7. Differentiating network emphasizes distortion.

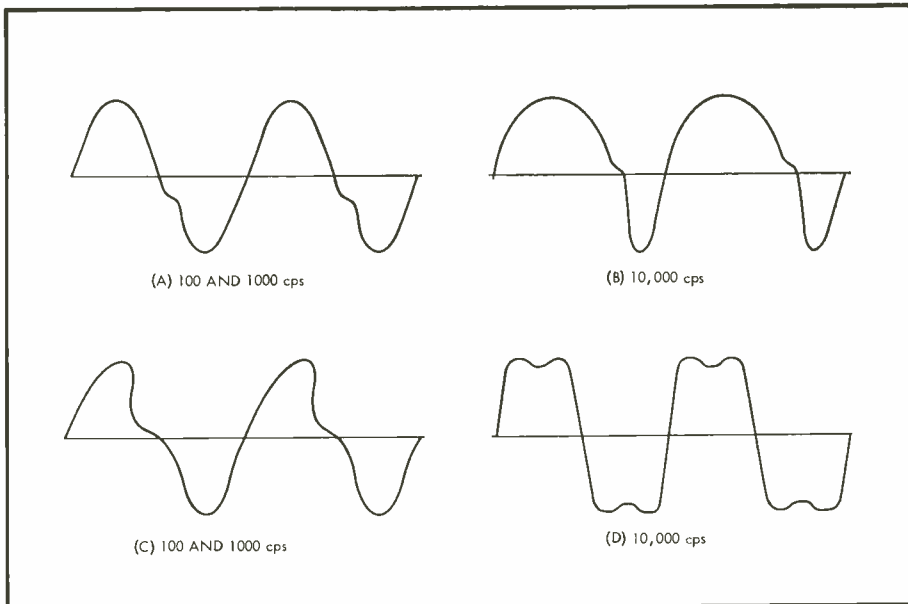
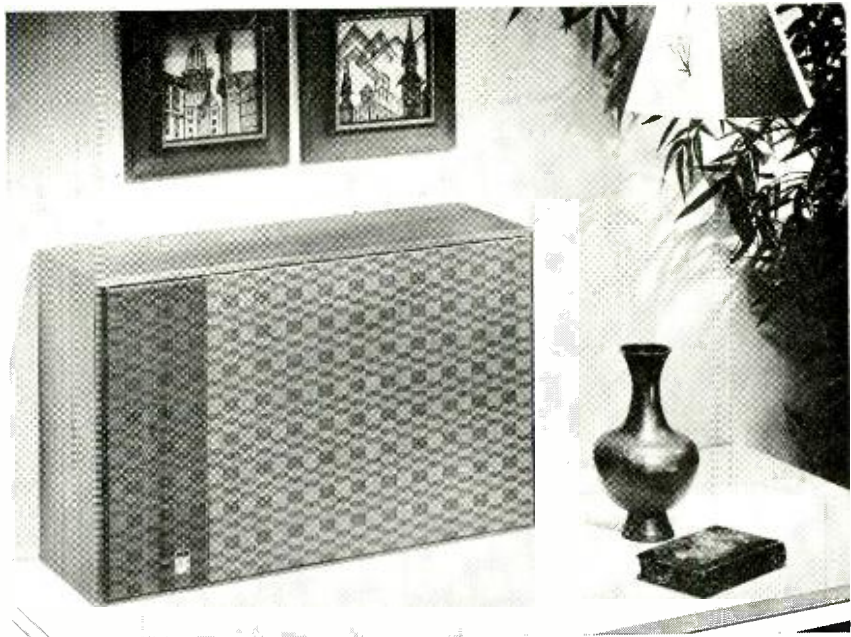

Fig. 8. In (A) and (B) the second harmonic is made more obvious; in (C) and (D) the third harmonic is made more obvious.

the magnificent **NEW**

TF-4

**5-speaker
4-way system
by
JENSEN**



Has Ear Appeal . . .

In Jensen's TF-4, smooth, finely-balanced, full-range reproduction is achieved by expert blending of five speakers: a high-compliance, long-travel FLEXAIR® woofer; a special 8" midrange; two direct radiator tweeters; and Jensen's SONO-DOME® ultra-tweeter for frequency extension beyond audibility. Look, listen and compare. We think you'll agree there's nothing like the TF-4 in sound . . . and in value.

Has Eye Appeal . . .

The new TF-4 comes to you in a new full-size but gracefully slender format that combines big speaker performance with elegant appearance. The wood is *genuine* walnut veneer in oil finish. (Available, too, in the money-saving unfinished gum hardwood for custom finishing or building-in.) Both models are available with a choice of a two-tone harmonizing grille fabric or the popular rattan. Cabinet measures 16" H, 25½" W, 8½" D. Write for Brochure MT.



Your choice of two decorator fabrics: a two-tone design custom-woven for us in an exciting new pattern, or the popular all-over rattan.

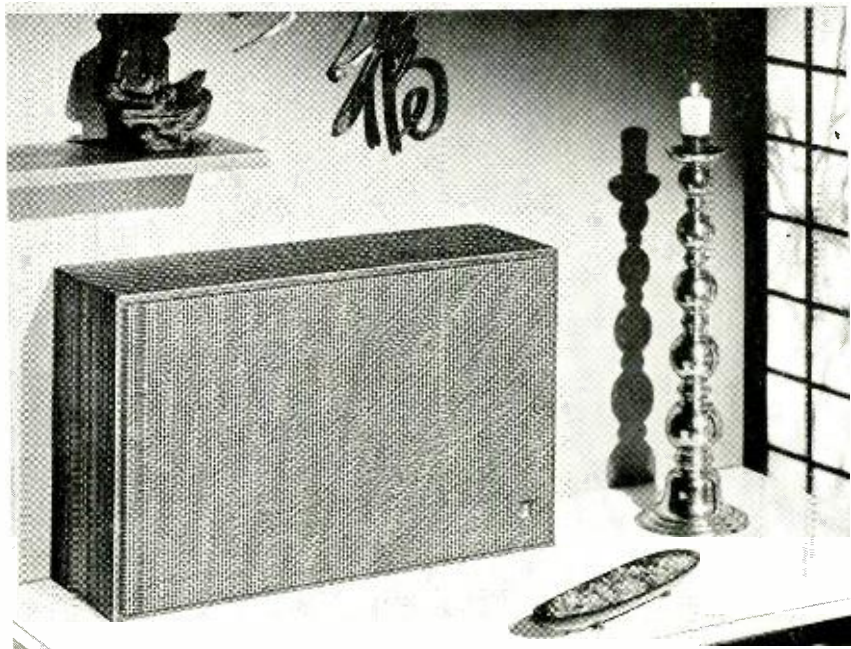

JENSEN MANUFACTURING COMPANY / DIVISION OF THE MUTER COMPANY / 6601 SOUTH LARAMIE AVENUE, CHICAGO 38, ILLINOIS
 Canada: Radio Speakers of Canada, Ltd., Toronto • Argentina: Ucoa Radio, S. A., Buenos Aires • Mexico: Fapartel, S. A., Naucalpan, Mex.

EQUIPMENT

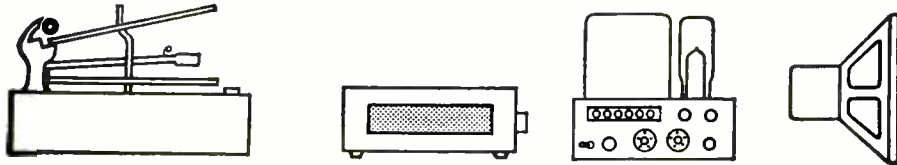

PROFILE

HEATHKIT (THOMAS) TRANSISTOR ELECTRONIC ORGAN, MODEL GD-232

This kit is a rather unusual combination of efforts by two well-known manufacturers—the Thomas Organ Company and the Heath Company. Fundamentally, what happened was that Heath took a product designed and manufactured by Thomas and "kitted" it. A rather good idea in our opinion. It makes available to the kit builder and experimenter a product at a substantial saving. In some cases it may mean the difference between getting it or not. (The kit costs in the neighborhood of \$350, the commercial equivalent is about \$200 more.)

Before continuing, we should describe the unit. The Thomas transistor organ, Model A (that's what Thomas calls it) is a two-manual, 37 notes (three octaves) per manual, 13 pedal notes (one octave), ten-voice organ which uses transistors for the tone generators and dividers. We understand that the 1964 version will include a feature called repeat percussion—sort of a built-in drummer. In organ classifications it falls in the "spinnet" category. For the uninitiated, spinnet in these circumstances means less than a full church or theater organ, usually with far fewer keys and voices. We refer you to Mr. Pike's article "Organs and Organ Music" in this issue for a fuller explanation of the shortcomings of a spinnet, at least in the opinion of a "full" organ enthusiast. Suffice to say that a spinnet will play most popular and classical music with ease, and is a relatively simple instrument to play.

Another aspect of the "spinnet" organ is

its modest size, which makes it an ideal small-home instrument. In size and appearance it resembles a slightly abbreviated spinet piano. With its lovely walnut veneers (the cabinet comes completely finished) it certainly would be a decorative asset to many homes. (See Fig. 1.)

Circuit Description

Figure 2 shows the block diagram of the organ. Notice that this organ uses 12 master oscillators to generate the tones for both manuals and the pedal keyboard. Note also that the switches follow the oscillators in the circuit, this situation usually called a free-running oscillator system. The significance of this is that special attention must

be given to avoiding switching clicks.

The electronic system consists of the tone generation system, a distribution board, keying, voicing, an audio amplifier, a vibrator oscillator, and a power supply. Also there are several volume and balance controls as shown in Fig. 2.

The tone generators are contained in 12 identical modules (identical except for the tuning capacitors C_{102} and C_{103} , and the bias capacitor C_{104}), each module consisting of a master oscillator and two divider networks. (See Fig. 3.) The master oscillator is a modified Hartley circuit which produces the waveshape shown just below the schematic. This waveform is rich in both odd and even harmonics.

The frequency dividers use a bistable Eccles-Jordan configuration. The first divider halves the frequency of the master oscillator, and the second halves it again, thus producing three frequencies an octave apart. The output waveforms of both dividers are shown in Fig. 3. Note that they are square waves containing only odd harmonics. The even harmonics are later reinserted by mixing the divided frequencies with the master oscillator frequency in the distribution board.

Of course the distribution board does more than just mix various frequencies—it also connects the vibrator and power-supply voltages to the tone generators, as well as being the junction point between the tone generators and the keyboard. The mixing is accomplished by simple "Y" networks each with a 100k resistor in the master frequency leg and a 220k resistor in the divided frequency leg. The output waveshape (staircase) is similar in harmonic content

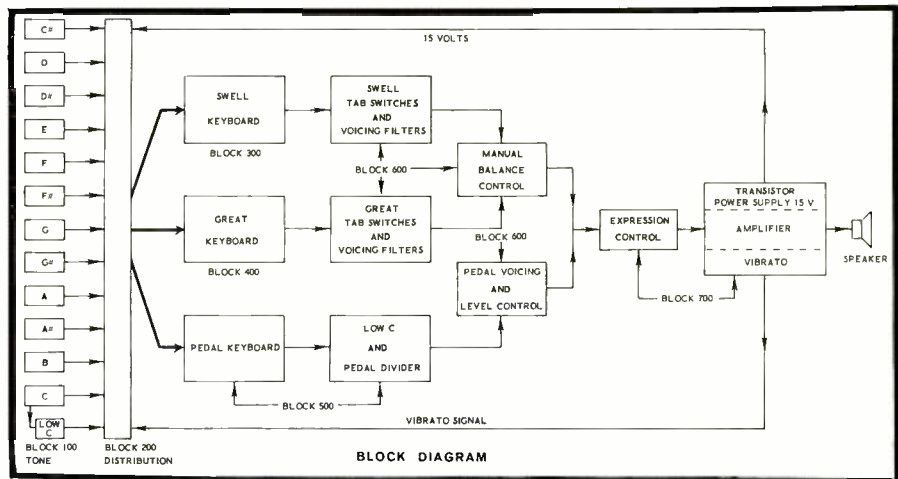

Fig. 2. Block diagram of organ.

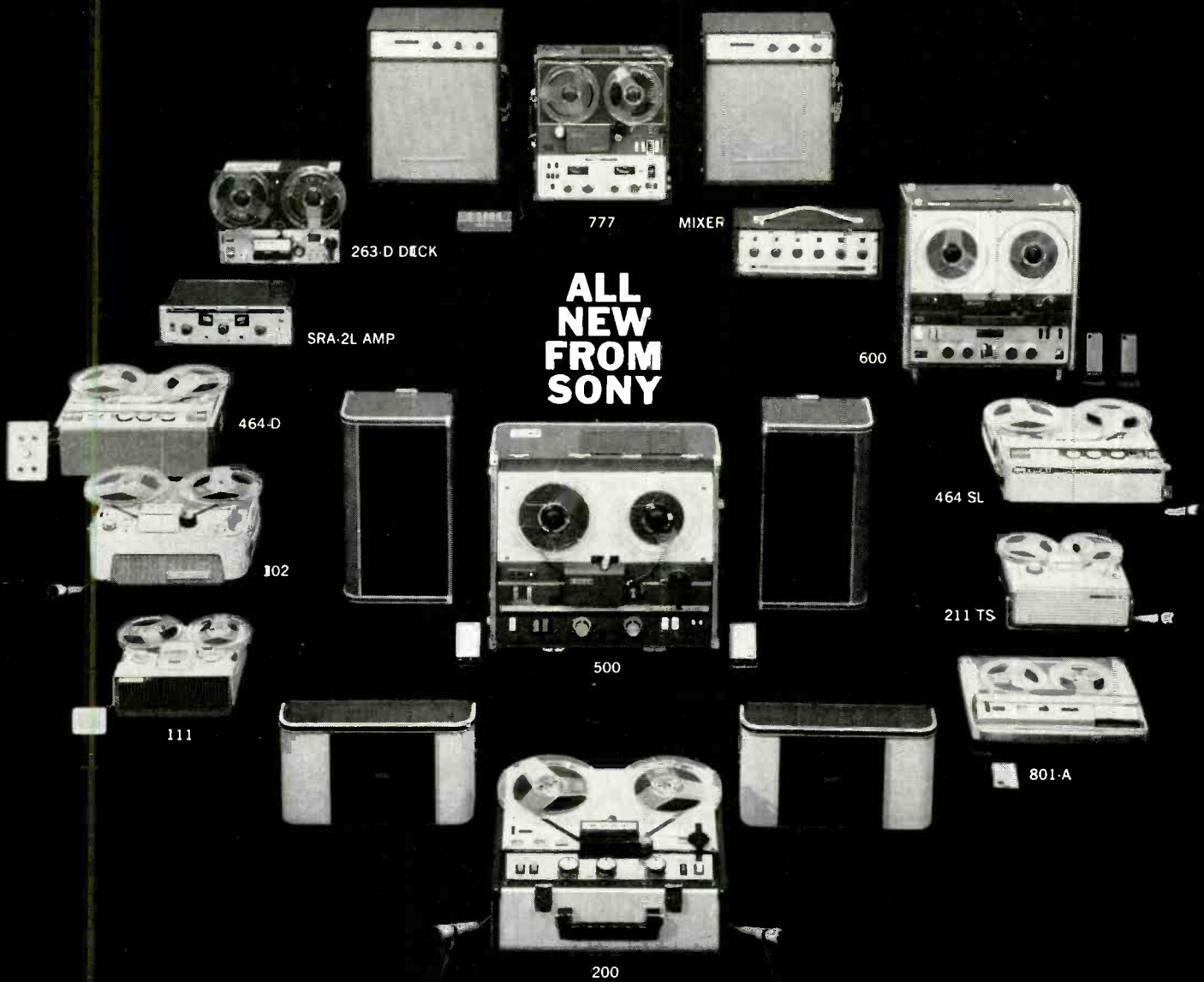

Fig. 1. Heathkit (Thomas) transistor organ, Model GD-232.

to the master oscillator signal.

The keyboards, including the pedal keyboard, are in essence rather elaborate switches for turning on the appropriate generator. The only point of significance is the use of an electrically conductive vinyl material on the signal and ground busses to absorb shock and thus minimize audible key click.

The voicing is accomplished by means of a series of filter networks which modify the harmonic content of the keyboard signals. The swell and great keyboard voices are formed by shaping the total signal except in the case of the flute voice on the swell keyboard. In this case the signals from the three swell bus bar sections are individually filtered (low-pass) and their outputs combined by means of isolating resistors to form a common flute signal for the entire keyboard. (See Fig. 4.) The remaining voices of the swell keyboard are formed by resistively mixing the three bus-bar signals.



THE MOST COMPLETE LINE OF QUALITY TAPE RECORDING EQUIPMENT IN THE WORLD

■ Sony Sterecorder 777 S—Professional, all transistorized 2 or 4 track stereo/mono tape recording system featuring remote control and the exclusive Sony Electro BiLateral head system. World's finest tape recorder. Less than \$695. ■ Sony Amplifier/Speaker System SSA 777—All transistorized, 10 watt, extended range 8" infinite baffle hi fidelity speakers created to produce perfect, full-sound reproduction with the 777 S. Less than \$175. ■ Sony Stereo Mixer MX 777—For advanced recording techniques, this all-transistorized, battery-powered 6 channel stereo/mono mixer is the perfect accessory to complete the 777 professional system. Less than \$175. ■ Sony Stereo Tape Deck 263-D—Add tape to any sound system with this 4 track stereo playback tape transport. 3 heads, 2 speeds, vertical or horizontal operation. Less than \$119.50. ■ Sony Stereo Recording Amplifier SRA-2L—All the facilities for adding stereo recording to the 263-D unit. Less than \$99.50. ■ Sony Sterecorder 464-D Deck—2 speed, 4 track, stereo/mono, record/playback compact tape deck with built-in pre-amps. Ideal for custom installation. Less than \$199.50. ■ Sony Portable Tape recorder 102—Rugged 2 speed, dual track, hi fidelity recorder with deluxe features and 7" reel capacity satisfies the most exacting recording requirements. Less than \$129.50. ■ Sony Tape recorder 111—A popularly priced, high quality bantam recorder for everyday family fun. Less than \$79.50. ■ Sony Sterecorder 200—The most compact and lightweight quality 4 track tape recording system on the market today. Carrying case lid separates into

NOW ON DISPLAY

AT YOUR FRANCHISED SONY / SUPERSCOPE AUDIO / TAPE DEALER

2 full range speaker systems. Unequaled for performance and price. Less than \$239.50. ■ Sony Sterecorder 500—A complete 4 track stereo/mono tape system with unsurpassed studio quality. The full range, infinite baffle detachable speaker systems integrate into the recorder lid, and separate 15 feet for optimum stereo effect. Less than \$399.50. ■ Sony Battery-Operated Executive Portable 801-A—A distinctively styled, transistorized, 2 speed all purpose recorder of utmost precision and quality. For the executive desk or portable use. The self-storing mike features a remote stop and go switch. Tape it with you for less than \$250. ■ Sony 'Slide-Sync' Tape recorder 211-TS—Incredibly versatile, serves the photo enthusiast with an exclusive, automatic built-in 'programmer' to activate a slide projector in 'sync' with your own recorded narration. Also the most compact tape teaching recorder available. Less than \$129.50. ■ Sony Tape Teaching Recorder 464-SL—A deluxe language and music teaching aid, 2 speed, 4 track, stereo and mono. Less than \$219.50. ■ Sony Sterecorder 600—3 heads, tape and source monitoring, sound on sound, vertical or horizontal operating, this 4 track stereo recording and playback unit is perfect for professional quality home installation. Less than \$450. ■ Also available, an extensive line of professional studio quality microphones and accessories. All Sony Sterecorders are Multiplex Ready! For detailed literature and name of nearest franchised tape dealer write Superscope, Inc., Dept. 7, Sun Valley, Calif.

IN NEW YORK, VISIT THE SONY SALON, 585 FIFTH AVENUE.

SONY

SUPERSCOPE

The Tapeway to Stereo

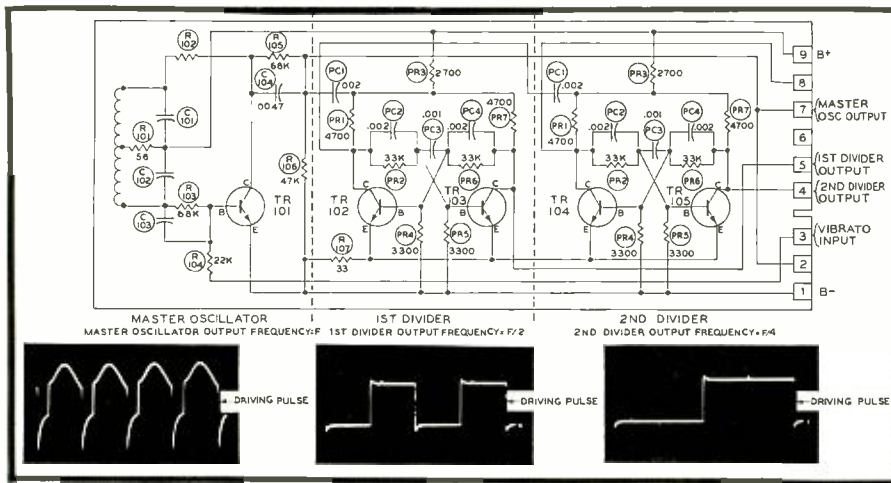

Fig. 3. Schematic of master oscillator and dividers board with wave shapes produced by each section.

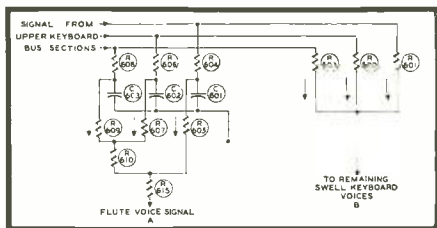

Fig. 4. Method for obtaining flute voice from swell keyboard.

Vibrato is provided by an RC oscillator circuit around one section of a 12AT7 located on the audio amplifier chassis. Oscillation frequency is approximately 6 cps. Note here that this organ is not completely transistor—the vibrato, audio amplifier, and the power supply (including the transistor power supply) use tubes.

The amplifier is a rather simple affair consisting of a pair of 6BQ5 output tubes in push pull, a 12AX7 amplifier, and the remaining 12AT7 section as a phase splitter. It delivers just a bit over 10 watts. The power supply for the tubes uses a 6CA4 in a full-wave rectifier circuit. The transistor supply uses a pair of silicon diodes in a full-wave rectifier circuit that develops 28 volts. This supply is grounded at the voltage midpoint to provide +15 volts for the transistor circuits and -13 volts for fixed bias on the amplifier output tubes.

Altogether the electronic section of this organ uses 65 silicon transistors, 5 vacuum tubes, and a pair of silicon diodes.

Instruction and Construction

When first received, the Heathkit organ comes in two large packages; one package contains the cabinet and bench and the other package contains the electronics. Total shipping weight of both containers is just short of 180 pounds. The 78-lb. electronics package contains five sub-packages, each one corresponding to a major assembly section. Each of these packages is opened just before it is to be used so that one is not faced with the problem of parts strewn all over the place, and the risk of misplacing small parts.

The instruction manual is unusually well detailed, in our opinion the most thorough of its kind we have seen. Each stage is carefully described and ample illustrations are provided to clarify hard-to-understand mechanical assembly procedures.

Strangely enough, the most difficult part about putting this organ together is the

mechanical assembly. The electrical assembly is as simple as can be, albeit tedious. Practically every major circuit is a printed board—in fact the 12 tone generators are identical except for the values of three capacitors. In addition all the major cabling has been done in advance so that one need only connect the right colored wire to the right place. Yes, assembling the keyboards, pedals, and voice switches is much more difficult than the electronic assembly. We recommend careful attention to detail in both the mechanical and electrical assembly procedures, however, because there are so many similar steps that one tends to get careless.

The tuning procedure described in the manual is both standard and satisfactory. Basically it consists of beating various related notes against known notes and either zero-beating or attaining a given number of beats in a given number of seconds. Obviously one does not need musical knowledge to tune the organ, but rather a stopwatch and patience. In order to provide a known source to start from, a factory assembled and adjusted C oscillator is provided in the kit.

It takes 40 some odd hours to put this kit together, with a few more hours thrown in for tuning. A good winter project.

The performance of an electronic organ cannot be described in the same terms one would describe the usual piece of electronic

gear. After all it is supposed to be a musical instrument rather than a carrier of musical tones originating elsewhere. In other words, we are interested only in how it sounds and whether it is capable of playing the music we wish to play on it.

We have heard this instrument played by several rather competent musicians and we must admit that it sounds surprisingly good. We admit to being surprised since we had expected a rather thin and limited musical sound because of the limited number of voices and generators available. It does have a rich sound nevertheless. (It would take a substantially greater investment to attain the multiplicity of voices and generators required for much richer organ sound.) For ourselves, we found we were enjoying the instrument immensely, and so did various nearby offspring. Although this instrument may not be able to play a full range of classical literature (a la Pike), it is certainly capable of producing a broad range of popular music, including the inevitable folk songs. This instrument is a lot of fun. L-20

EMPIRE MODEL 498 RECORD PLAYING SYSTEM

Empire certainly has done it this time—they have changed the well-known "Troubador" turntable decidedly for the better. Most of the changes are technical, but the change that struck us first was the new appearance. They have made the 498 lower and more compact than its predecessor, and to our weary eyes, by far the best-looking design they have ever issued. We were immediately aware of, and delighted with, the new look. Of course there are no doubts about its antecedents, but still the visual impression is new.

Before continuing with the changes we had better describe what the Empire 498 system contains. First there is the 408 three-speed turntable. Next there is the well-proved 980 arm. Finally there is the handsome walnut base. (The turntable and arm are available without the base and is then known as the 488 system.)

Aside from appearance, the major change is the acoustic suspension system which makes the 498 almost impervious to acoustic feedback and shocks. We found it to be one of the stables mounting systems we have encountered to date.

The several other changes we noted in the turntable were all related to the previous major changes. We will discuss them more fully later.



Fig. 5. Empire Model 498 Record Playing System.

for magnificent sound

TARZIAN TAPE

engineered for highest fidelity



Check these outstanding characteristics

- **High Output**—can accept signals with dynamic range to realize the full potential of even the finest professional equipment.
- **Wide-Range Response**—virtually flat response for all recording frequencies.
- **Low Distortion**—distortion is less than 2½% at maximum record level as measured by Navy Specification W-T-0061.
- **High Uniformity**—uniformity within a 1200-foot reel is within plus or minus ¼ db. A new oxide formula and special selectivity of oxides protect recording heads from wear and prevent abrasion.
- **Humidity and Temperature Protection**—special coating, priming, and binding techniques help keep Tarzian tape in new condition longer in ordinary good tape storage conditions.

■ Given great sound in the first place, Tarzian Tape will keep it for you, and give it back undiminished and undistorted. It is a tape of truly professional fidelity, worthy of your most valued recordings, at a price that lets you use it for all your work (or play).

The proof is in the listening...of course. But you can see the smooth, tightly bonded oxide surface that doesn't flake, that does run smoothly without abrasion and without contributing to wow or flutter. Hold a reel to the light. You can see that Tarzian Tape is wound on the reel at perfect tension. You'll find a written replacement guarantee in every box. The box is well made, with ample identification space. You'll see that the tape is factory sealed in a plastic bag, with labels and a tape-end clip included.

Try Tarzian Tape...let it speak for itself. Choose from 1½ and 1 mil acetate, and 1 and ½-mil Mylar*. Available on 3-, 3¼-, 5-, and 7-inch reels plus professional lengths on reels or hubs. If your dealer cannot supply you from stock, send us his name and we will promptly satisfy your requirements.

Write today for Tarzian's free 32-page illustrated booklet, "Lower the Cost of Fun With Tape Recording."

*DuPont trademark



SARKES TARZIAN Inc.

World's Leading Manufacturers of TV and FM Tuners • Closed Circuit TV Systems • Broadcast Equipment • Air Trimmers • FM Radios • Magnetic Recording Tape • Semiconductor Devices

MAGNETIC TAPE DIVISION • BLOOMINGTON, INDIANA

Export: Ad Auriema, Inc., N.Y. • Canada: E. J. Piggott Enterprises Ltd., Toronto, Ont.

outlets are provided, one switched.

Sensitivity on the phono channels is 4 mv for rated output; on the tape head inputs it is 1.4 mv for 3¼ ips and 2.15 mv for 7½-ips; on high levels the sensitivity is 0.48 volts for rated output. Measured frequency response showed equalization to be within ± 2 db of the required curves. Provision is made for feeding a tape recorder at an impedance of 400 ohms on the low-level inputs, and at the same impedance as the source on the high-level inputs.

Power output measured 35 watts at 1 per cent harmonic distortion and at 0.75 per cent IM with only one channel in operation. With both channels excited, output at the same distortion points measured 28 watts per channel. Our only question regarding the unit relates to the loudness control. In this circuit, which as usual consists of a resistor and capacitor in series from a tap on the volume control, it is customary to short out the capacitor in the off position of the loudness switch. This does not cause a change in level at 1000 cps, for example, when the loudness compensation is switched on and off. In the ST70 (and also in the earlier HF85 and the current ST84 as well), the series capacitor/resistor combination is simply disconnected from the tap. This causes a jump in volume—about 15 db—when the switch is moved from on to off. This results from a system philosophy which is unique to Eico—it is the only company which uses this arrangement. The individual builder can change this to the conventional arrangement quite simply, however, so that the capacitor is shorted out in the flat position and open in the compensated position. As a matter of fact, it would save a few pennies for Eico to make this change, since a dpdt switch would be required instead of a 4pdt switch. We have discussed this with Eico engineers, but they remain adamant regarding the change. We feel that it should be mentioned, however.

Aside from this one objection, the ST97 is an excellently performing amplifier, and we would not hesitate to recommend it. Over-all construction time on this amplifier is just under 20 hours. The instruction books—in two parts, although bound as one so the construction section can be removed readily—are reasonably clear and lucid, although we feel that one or two of the diagrams could be improved, and we would recommend the mounting of the selector switch onto the front panel before connecting the leads from the input phono jacks if one is to end up with a neat appearance.

The ST84 Stereo Preamp

Similar in appearance to the ST70, the ST84 employs essentially the same circuitry up to the output section. The selector switch provides for three high-level inputs instead of the four in the ST70, with one additional low-level input being provided for microphone input. Other controls are similar, with an output impedance of 8000 ohms and a rated output signal of 2 volts. IM and harmonic distortion measure in the vicinity of .05 per cent at 2 volts. This unit can serve excellently in a system where a high-power output amplifier is required—such as the HF89, which has an output of over 50 watts per channel—or perhaps where the user already has a satisfactory power amplifier but simply wishes to update his equipment to a more modern and flexible preamp. With its construction time of less than 10 hours, the ST84 is an ideal project which is sure to result in a satisfying preamplifier-control unit. L-22



Fig. 8. The Sennheiser condenser microphone.

SENNHEISER MKH-104 CONDENSER MICROPHONE

The condenser microphone has achieved considerable acclaim over the past few years because of its performance, and it is well recognized that practically all microphones used for measurement purposes are of this construction. Aside from the fact that the condenser microphone is subject to all of the acoustic limitations which affect every type of microphone, and is thus also subject to the same acoustic rules which apply to the other types, it is likely that the fact that there is nothing attached to the diaphragm to increase its mass is responsible for its high-frequency performance. Its one drawback appears to be its requirement for a polarizing voltage supply which—albeit transistorized and miniaturized to a high degree—is still an accessory which must be accommodated somehow.

Some work has been done in recent years with the possibility of high-frequency bias or polarizing voltage for the condenser unit, and one such microphone has reached the market stage. This unit is the Model MKH-104, a product of Sennheiser Electronic, a relatively new name in the U.S. although its products, under other names, may be familiar.

The MKH-104, shown in Fig. 8, measures 5 in. in length, and ¾ in. in diameter. It consists of a conventionally constructed condenser head, together with a transistorized oscillator and demodulator to give an output of around -53 db at a nominal impedance of 800 ohms, unbalanced and ungrounded. The demodulator unit is powered by a -8-volt supply, and requires about 5 ma. While we are not exactly sure about the functioning of the demodulator circuit, shown in Fig. 9, it consists of a 10-mc transistorized oscillator which feeds

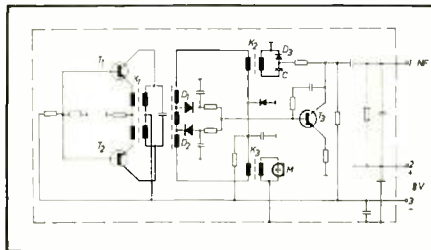

Fig. 9. Schematic of the oscillator-modulator built into the Sennheiser microphone to provide high-frequency polarization to the condenser head.

one transformer, K_1 , which has the condenser head across its other winding, and also feeds transformer K_2 which is in the feedback circuit from transistor T_2 . Diodes fed from taps on the third winding of transformer K_2 are connected to the base transistor T_2 . (We are looking forward to a full technical description from the company's engineers in a forthcoming issue.)

The output plug on the microphone has three terminals—1, audio output; 2, ground and common; and 3, -8-volt supply voltage. This voltage may be obtained in a variety of ways—in studio equipment it would undoubtedly be fed from a central supply; a separate battery box could be employed where long periods of operation were required; a screw-on battery carrier, shown

in Fig. 10, using six Mallory RM-625R (or equivalent) mercury cells can be attached to the microphone; or it may be furnished from the internal batteries of a battery-operated portable recorder.

The portable battery carrier, model MZA-6, has a receptacle for the microphone at one end and a plug at the other, and when attached to the microphone extends the over-all length to 8¼-in. Its diameter is 7/8 in., only slightly greater than the microphone itself. The batteries in this unit will power the microphone for about 50 hours of operation.

The fourth type of battery supply—directly from the batteries in a portable recorder—appealed to our imagination to the extent that we installed a receptacle in such a machine to accommodate an additional lead for the -8 volts. This machine was an inexpensive unit, little more than

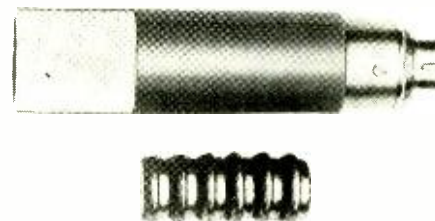

Fig. 10. Attachable battery case and six mercury batteries to power the microphone.

a toy, but we were interested in the principle of the operation. At first we heard considerable "hash" from the recorder motor, but an additional 150-ohm resistor in series from the battery and filtered with another 100-µf capacitor eliminated the hash completely. Such an arrangement makes it possible to use this top-quality microphone with a portable tape recorder. If the lead to the microphone socket is taken from the "record" side of the battery switch, there is no current drain to the microphone when not actually recording.

Performance

Each MKH-104 microphone is furnished with a machine-run response curve made on the specific microphone. The unit we tested was indicated as flat ± 1 db from 40 to 10,000 cps, rising gradually to a 5-db plateau from about 15,000 to 18,000 cps, then dropping down again to flat from 20,000 to 22,000 cps, and then dropping off. We have seen a number of such curves for the MKH-104, all extremely flat to 10,000 cps, and with slightly varying response over the next octave, but none was greater in peaks than 6 db. All showed response to about 23,000 cps. Output at 1000 cps is approximately 2 mv/microbar.

As would be expected, there is no tube noise from the microphone, and no audible hiss, since there are no tubes in it. The absolute noise level of the unit is more than 65 db below the output signal by actual measurement, but this was done in a normally quiet room in which the noise level was actually about 30 db above threshold. To all intents and purposes, therefore, there is no more noise output from this unit than from a microphone employing no electronic devices.

(Continued on page 67)

***Do you own one
of these fine amplifiers?***

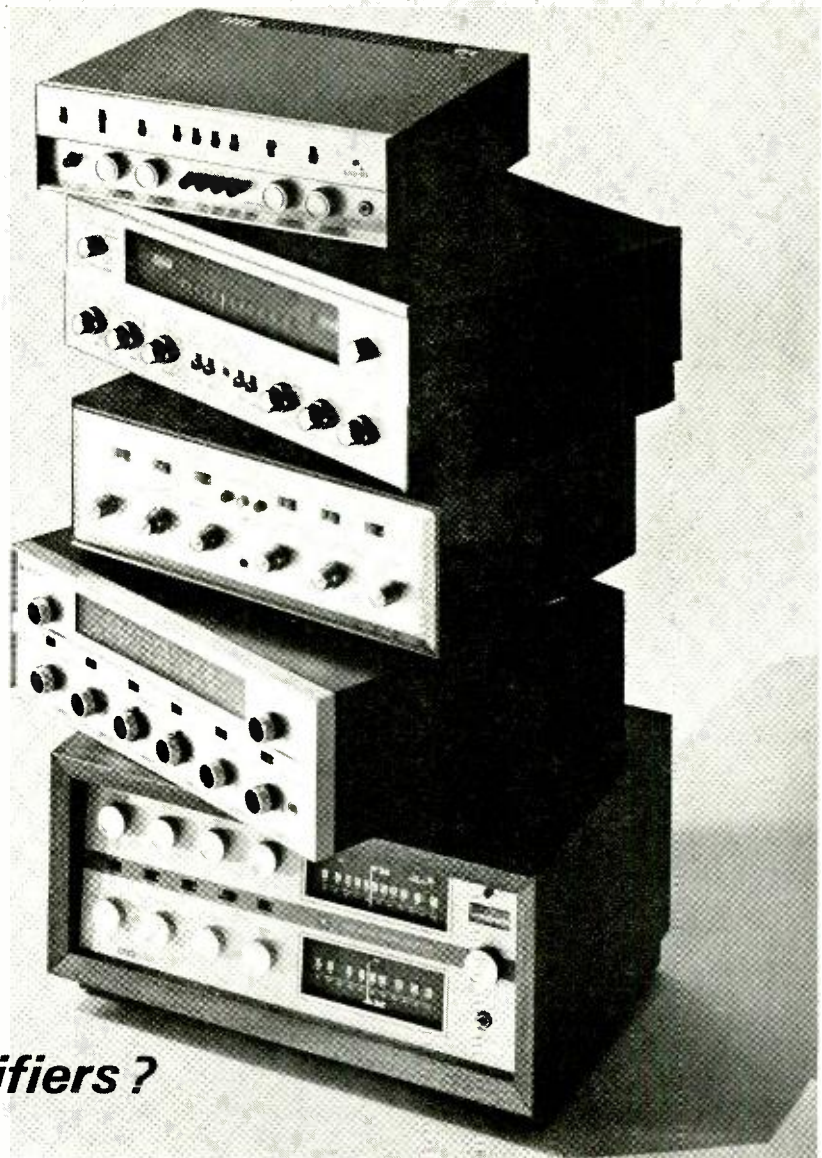

From top: Knight, Fisher, Scott, Bogen, Harman-Kardon

If you do — and you don't own a set of Koss stereo headphones — you've got a lot of fun still coming! You've got the whole great experience of Koss "solo flight" listening ahead, because your amplifier is equipped with a jack just right for Koss Stereophones.

Just plug them in, slip them on and . . . well, prepare for take-off. Your Koss phones will send you soaring into private sonic bliss. You'll hear it all with startling clarity and a new "up-closeness" you've never experienced before. What's more, you'll listen in complete seclusion, with no disturbance to or from the others in the room.



PRO-4 STEREOPHONES
Fluid-filled earpads for tight, comfortable seal. A durable phone designed for professionals. 30-20,000 c.p.s. response 16 ohms impedance. \$45.00.

SP-3X STEREOPHONES
Wide range 10-15,000 c.p.s. response obtainable only through earphone listening. Sensitive 3½" sound reproducers mounted in each earpiece. Soft sponge foam ear and head cushions. Impedance 4-16 ohms. \$24.95

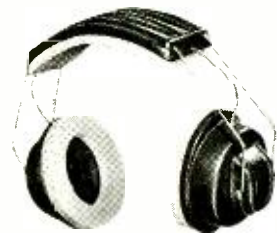

KOSS electronics inc.

2227 N. 31ST STREET • MILWAUKEE, WISCONSIN 53208

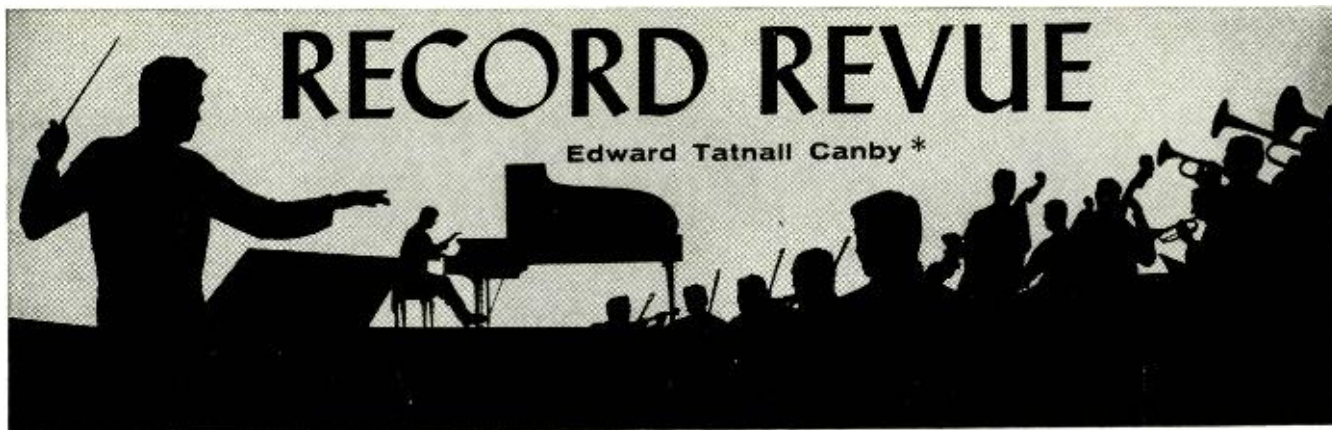

RECORD REVUE

Edward Tatnall Canby *

The Living Organ

The King of Instruments — Organ Music and Vocal Solos, the Mother Church, Boston. Frederick Jagel, tenor, Ruth Barrett Phelps, organist. **Aeolian-Skinner AS 313 stereo** (Aeolian-Skinner Organ Co., 549 E. 4th St., Boston 27, Mass.)

Expecting not very much, I played this disc through and was rewarded with one of the finest individual organ performances I ever hope to hear, on just one band of the LP. It is a *Fantasia in A*, a long, rambling work by the mystically Romantic French composer César Franck, the sort that in these days mostly loses itself in vagueness or builds into great meaningless roarings of sound. Here, it is absolutely beautiful—the music, the organ, the playing and the stereo recording. Unbelievable, indeed, and easily worth the rest of the disc.

The less said the better about Mr. Jagel. He is a church tenor. Period. Very well known. But Ruth Barrett Phelps is immediately, as one listens, not only a proficient organ technician but a really communicative musician as well. Her other offerings—Buxtehude and a piece by Nancy Plummer Faxon—are nice; so is her accompaniment to the unfortunate Mr. Jagel. But when we get to the Franck, something opens up. She reveals a depth of understanding and feeling for this moody French music that is marvelous to hear.

And thereby, in turn, she reveals, in this mammoth organ of the Mother Church (Christian Scientist) two superb Aeolian virtues in one—an absolutely beautifully organ sound and an unbelievably fine stereo recording. The company should be proud.

Under Miss Phelps' sympathetic and sensitive hands (and feet), this organ seems for all the world like a living thing, an orchestra of poetic, breathing, alive performers. What an amazing illusion! Especially in a long, flute-like solo passage toward the middle, which simply cannot come from the mere pressing-down of so many keys on a keyboard, it is too human. Yet it does. And what bass—nothing could be lower, nor more delicate. . . . Try it.

MULTIPLE SERIES

The King of Instruments—Catharine Crozier, vols. I and II. Organ of the Mormon Auditorium, Independence, Mo. **Aeolian-Skinner AS 315, 316 stereo**

These two discs come from the long-continuing series by which the famous organ company promotes the sound of its famous products, piece by piece, "on location" in various parts of the country. (You can't sample an organ's sound in a show room. There aren't any "models"—each is hand-designed, tailored acoustically to fit its own permanent audi-

torium. So this is a tricky sales idea, on a very high level all around.) The recordings are wholly professional in every respect, but they aren't always suited for the general listener even though the fit is superb.

This well known lady performer, for instance, plays a typical mixed bag of organist's show-pieces, ranging musically from the sublime to the perishingly uninteresting. She is a superior technician whose feet and fingers are stronger than her sense of style and phrasing. She may be famous but I don't dig her, nor much of her music either.

The organ she plays, too, must be tailored to Mormon (Reorganized Church of Jesus Christ of Latter Day Saints) specifications—by which I mean it sounds pretty churchy. Aeolian makes 'em in all types. The recording presents the churchy sound superbly, which is all it can hope to do.

The Sun-Times Library of Recorded Masterpieces: Haydn (LRM 502), Wagner (LRM 507) Prokofieff (LRM 510) stereo. Vienna New Symphony, assorted assisting artists, Goberman.

The above abbreviated titles introduce a really heartening new venture, a low-priced series of a dozen discs soon to be distributed through newspapers, in the time-honored manner once inaugurated by the *New York Post*. (N. Y. outlet this time: the *Journal-American*.) These discs present a composer apiece and will come to you at typically easy-going prices, like many another "Music Appreciation" series. But whatever the flamboyant ads may say about them (or about the others), I can unreservedly recommend this batch both on technical grounds and on musical.

First, the music is well played, by which I mean, with intelligence, precision, taste and style, plus forcefulness. Sometimes it is played really splendidly—seldom is it less than excellent, in spite of the historical span of different styles.

Second, the music is chosen wonderfully sensibly, crediting you, the listener, with the intelligence that you most assuredly possess. There are familiar semi-"war horses" on each record, though not every time the inevitable same old ones. But in every case there is also top-quality music from the same composer of a more unusual sort, right along with the familiar. What finer way to suggest that "great" composers are worth listening to, for pleasure, in a wide variety of their output? What better way of suggesting that good music, enjoyable music, isn't necessarily the "great" war horse array that is plugged to death in the usual "appreciation" offerings?

Schubert, for instance. Yes—the "Unfinished Symphony." But also the superb "Rosamunde" music, beloved of all who enjoy Schubert, plus a "Magnificat" that has never before been recorded. The Haydn record presents the "Oxford" Symphony, No. 92, one of the loveliest and easiest to hear of the late symphonies (thank the Lord, not the inevitable "Surprise," too often plugged), plus two utterly charming and completely unknown Haydn opera overtures and a group of four madrigal-like songs for mixed vocal quartet, highly humorous. ("Friends, water makes us silent; learn that from the fish. But with wine. . . .")

Prokofieff? "The Classical Symphony," very nicely played, the "Lt. Kijé Suite," the pleas-

antly raucous "Love for Three Oranges" *Scherzo* and *March*, plus one of my favorite tid-bits of Prokofieffiana, the New York-composed "Overture on Hebrew Themes," practically straight out of Brooklyn.

Excellent technical work, no compromise at all that I can see except a low level to accommodate a lot of music.

The Horowitz Collection. Vladimir Horowitz, piano. Color booklet.

RCA Victor LD 7021 (2) mono

The Soria Series is back again, RCA's fanciest picture-book line. This year's series embodies a familiar RCA policy—back to the treasure vaults, the Company's 60-odd years of Victor recordings.

The "Horowitz Collection" is two-fold. First, a selection of his piano recordings from the 1943-1955 period, mono, some from wax, some from tapes, or so we can assume. Second, three gorgeous color plates, Manet, Degas, Picasso (early), from Horowitz' private art collection, presumably financed at least in part by proceeds from the recordings. The Skira reproductions are graced with large-print commentary by the inevitable Samuel Chotzinoff, who is usually around when Toscanini or his son-in-law (Horowitz) require inspirational treatment.

For what it's worth, I note a considerable variation in the recordings, reflecting RCA's then struggles to pass safely from the old tested wax 78 recording into the age of slow-speed plastics and of tape. It was a tough period for all recording technicians; too bad that such a great individualist pianist as Horowitz had to do his finest playing right in its midst. But he comes through well enough for complete musical communication of the typical Horowitz drama and tautness, best in Chopin, Czerny, even Prokofieff, not so good for Mozart.

Toscanini The Philadelphia Orchestra Schubert The Great Symphony in C Major No. 9 First Release of an Historic Recording . . . 1941.

RCA Victor LD 2663 mono

Well this really is a find, in spite of RCA's slightly hysterical titling, reproduced faithfully above. For once, obsolescence has paid off; the things couldn't be put forth at all until it was old enough to be, so to speak, a technological antique.

Without a doubt, and even for rabid Toscanini-dislikers (as of his later NBC Symphony recordings), this is a superbly interesting performance. It has all the expected Toscanini Italianisms, the high-speed tempi, each movement a bit faster than you ever imagined it could be played, the scintillating brilliance and perfection of detail, along with that utter lack of German gravity which was inevitable to such a temperament. (See Bruno Walter for the opposite.) But where the later Toscaninis became over-tense, edgy, inaccurate, too much plagued by the relentless press-radio-TV spotlight, this performance relaxes from tension, these players play tautly but not under Klieg lights, following a great conductor, inspired by him to do their best, but never thrown off their collective bases by it all. Not in 1941, not in Philadelphia!

The recording was never issued due to war

NEW Record Entertainment!

AF AUDIO FIDELITY records

Humor!

**FAST, FAST, FAST,
RELIEF FROM
TV COMMERCIALS**

**AFLP 2112
AFSD 6112**



Ever had fun in front of your TV set spoofing the commercials? With a little imaginative push they can often be parodied into complete absurdity. Hear how talented professionals have done it in this rich harvest of humor album. Some of the 34 skits are: The Typist, Punjab Cigarettes, Greasy Kid Stuff, The Bicycle, Biblical Spectacular,

Witchcraft!

**AFRICAN, LATINO
VOODOO DRUMS**

**AFLP 2102
AFSD 6102**



Brilliantly applied percussive expression of primitive African rhythms, savage West Indian beats and syncopated Latin dance rhythms. An expert recital of ritual and festive drum beats out of the past enchant and bewitch with savage yet technically masterful rhythmic figurations.

Groovy!

**ESO ES
LATINO JAZZ... MAN!**

**AFLP 2117
AFSD 2117**



Arranged and conducted by Lalo Schifrin, one of today's most notable blenders of the best of both Latin and American jazz styles and rhythms. Instrumental greats play: Mambo Jazz Opus 7, Harlem Nocturne, Caravan, Poinciana, What Kind Of Fool Am I? others.

Talent!

**BOSSA NOVA at
CARNEGIE HALL**

**AFLP 2101
AFSD 6101**



All the great Brazilian talent gathered at Carnegie Hall to treat the U.S. to the first live performance of authentic bossa nova, the sensational new Brazilian jazz form. Included were: João Gilberto, Luiz Bonfá, Oscar Neves Quartet, Agostino Dos Santos, Sergio Mendes Textet, Antonio Carlos Jobim, Carlos Lyra, Roberto Menescal.

Charm!

**PATACHOU at
CARNEGIE HALL**

**AFLP 2109
AFSD 6109**



The ever popular French song stylist offers a selection of numbers from her Carnegie Hall performance including: Impossible Amour, Ma Fête A Moi, Que Reste-t-il, etc.

Festive!

**TZENA TZENA
and other Wedding Dances**

**AFLP 2114
AFSD 6114**



Spirited, sentimental, always delightful horas, waltzes, frailachs, polkas, etc. Includes: Roumanian Bulgar, Chusen Kala Mazeltov, Kozatski, Bublichki, etc.

ALSO AVAILABLE NOW AT YOUR RECORD SHOP:

- SOUND EFFECTS, Vol. 5—DFM 3016/DFS 7016
- HOME MOVIE SOUND EFFECTS—DFM 3018/DFS 7018
- ORGAN JAZZ SAMA PERCUSSION, Andre Penazzi & His Orchestra—DFM 3020/DFS 7020
- EL HOMBRE MEXICANO, Arcadio Elias & His Mariachi Nacional—AFLP 2116/AFSD 6116

MONO or STEREO—\$4.98 (sugg. list)

Please write for FREE catalog: AUDIO FIDELITY INC. 770 Eleventh Avenue, New York 19, N.Y.

restrictions on raw materials for record making. (Remember the scrap-record collections—ground up to make new records?) By 1945, it apparently was out of date in the technical sense though, actually, it shouldn't have been. 1946 Fords and Chevies were simply 1941 models held over, so why not records? Probably, my car suggests, there were technical flaws in the record masters themselves, unrepairable as with present tape editing. I did notice, too, some odd little tape-like flutters and drop-outs that suggest trouble in the later restorations. Could be. No matter—not now, anyhow. It's a great recording that everybody who is musical should try his ears on.

An Evening of Elizabethan Music. The Julian Bream Consort.

RCA Victor LDS 2656 stereo

More Soria—more color from Skira in Switzerland, a wealth of interesting black-and-white, plus a brand new stereo recording of England's lute phenomenon, Julian Bream, and his "consort" of players and singers, some of whom are already familiar to followers of this sort of music. Desmond Dupré, for instance.

The recording alternates between solo works played by Bream on his lute and works for the newly disclosed popular "broken consort" that seems to have been used as regularly as the instruments of a jazz combo or a folk song get-together today: lute, cittern, pandora, bass viol, violin (or treble viol), flute (or recorder), an "odd concoction" that, however, was never directly specified in the musical scores. No need to: it went without saying. So we have spent much musicological research to put two and two together and determine that these were the common instruments for "sweet music," often played in Shakespearian drama and the like.

Bream is a master lutenist in technique—quick-fingered, neat, minus the objectionable slapping noises that clumser players often make—and he is a fine musician, too, drawing out phrases, lines, counterpoint, from the plucky and disconnected lute tones. His Consort companions, like those of Alfred Deller in the Deller Consort, are stylistically a bit uneven in ensemble and, in any case, it will take you awhile to get used to the odd sound of three plucked instruments, two strings and a flute. But like most good music it will grow on you given a chance. What else is a record for?

The color pictures include a lovely print of Queen Elizabeth I in mid-air, hoisted up by the Earl of Leicester during a dance. She seems a good two feet into space at least, but you can't be sure. Doesn't look a bit disturbed, though. Obviously, a Queen *always* lands right side up.

Beethoven: Symphony No. 4; Leonore Overture No. 3. Cleveland Orch., Szell.
Epic BC 1264 stereo

Debussy: La Mer.

Ravel: Daphnis et Chloé, Suite No. 2; Pavane. Cleveland Orch., Szell.
Epic BC 1263 stereo

In his fiftieth conducting year George Szell is known as an "orchestra builder" and a man of precision, equipped with a useful Central-European background plus an equally useful American-style drive. Depending upon the music, these faculties shape typical Szell performances in this continuing series with the virtuoso Cleveland orchestra.

In the Beethoven we hear unmistakably the established and valid European tradition, so often hazed over with eccentricity by other conductors old and young. We hear also the Szellian drive, which in this case is not the best thing for Beethoven—it is cold rather than warm, peaking the intensity but not the compassion of the music. Nevertheless, adding up the virtues of tradition and precision, we find a pretty good sort of listening here. Especially in the always-difficult Fourth Symphony, botched-up by many a top conductor.

Debussy and Ravel, interestingly, make another and even better story. Szell is no Frenchman, but his passion for the sound of the orchestra itself is decidedly in tune with French thinking. These two large works and the "Pavane for a Dead Princess" are done

in a thoroughly alive and original fashion, clearly out of a love for the sheer sound of them—and a know-how that catches onto countless fascinating details.

I'd rate this Szell disc at the very top in the French category.

Beethoven: String Quartet Op. 127. Fine Arts Quartet.

Concert-Disc CS 233 stereo

Schubert: Octet for Strings and Winds. Fine Arts Quartet, New York Woodwind Quintet.

Everest SDBR 3082 stereo

The able Fine Arts Quartet is one of the most musical in the business. Budapest, Juillard et al. notwithstanding. And, all on their own, they have been enterprisingly in stereo since the very earliest tape days. Their periodic releases on their Concert-Disc and Concert-Disc labels are now merged with the new Everest catalogue, most of which, in the "classical" field, will probably appear on the also-absorbed Counterpoint label, Concert-Disc, Everest or Counterpoint, these offerings by the Fine Arts and their long-time colleagues the New York Woodwinds are technically excellent and musically even more so. Keep an eye out for them—on all three labels.

Beethoven: Quartet No. 12 in E Flat, Op. 127. Budapest Quartet.

Columbia MS 6383 stereo

The Budapest justly has a top-flight reputation, not for sensuous beauty of tone, not even for sheer precision, but rather for a kind of teamwork, an intensity of performance that is still unmatched in any other working quartet though these men having been playing the same music for a quarter century and more.

This shows up at its very best in Beethoven and Mozart. Somehow, this group makes more of every musical "play," heightens the details of meaning into a higher emotional impact and a more profound plumbing of the musical depths, than any other group we have with us today. After the Budapest's Beethoven or Mozart, most other versions seem somehow lax, or merely note-perfect. One misses countless priceless details of unforgettable meaning that the Budapests have found and others apparently do not hear.

These new late-Beethoven recordings are faithful to the past standards set by the group in many earlier recordings and in hundreds of performance over the years. The interpretations, indeed, do not significantly vary from the older versions; the Quartet has long since "set" its performing practice for those works. Only an occasional slight blur in the more rapid passages especially in the difficult first violin part, indicates the encroachment of old age.

BRAHMS

Barhms: Violin Concerto. Zino Francescatti; N. Y. Philharmonic, Bernstein.

Columbia MS 6471 stereo

I wish they wouldn't cast Zino Francescatti in the role of Great Virtuoso. He is never really comfortable in the part, however hard the public relations people push. It is simply not his role to play opposite other companies' big names—Heifetz of RCA, for instance—and nowhere is he less Heifetz (or Horowitz, Kreislerish, Piatigorsky-like) than in big German music. In spite of his name, Francescatti is a Frenchman. Also, he is easy-going in outward personality, friendly, lacking the jutting chin and piercing eyes, the spectacular mein, that the great role requires! And if I guess right, in his heart of hearts he really doesn't like Big German music, or Big Russian.

So you'll find all the violinistic trapping here, plus a too-tense violin sound, unadapted to the music, an excellent facsimile of the grand manner without its dramatic conviction, and not a few lapses where the great Francescatti just sounds a bit tired and out of tune. Poor man, he's a human being.

What's new from Ampex?

Collector's Library

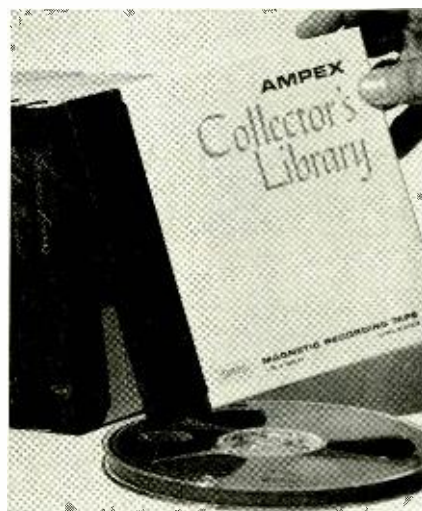

Here's good news for people who care how their sounds sound—and how their tape collection looks. It's Collector's Library—a new tape from Ampex. It's ideal for all general recording needs and for building an attractive tape library. Here's why: 1) An exclusive Ferro-Sheen* oxide surface gives maximum frequency response, clean operation and low head wear. 2) The new book-like design on the box gives your tapes a matched set appearance. Just five or six boxes look like a collector's library. In addition to this each box comes with famous "Signature Binding"—the simulated leather binding and gold foil strip for custom labeling of your tapes. 3) Collector's Library is economically priced. You'll save money on every box of tape you buy. Available on Mylar** and acetate bases in all popular sizes. Collector's Library is the latest addition to the fine line of Ampex precision tape. Ampex Corp., Redwood City, California.

*TM Ampex Corp.

**TM for Dupont Polyester Film





What new recorder is virtually custom-built?

AMPEX F-44

The F-44 is a brand new 4-track stereo recorder from Ampex. It's Ampex through and through. And there's this, too: at every stage of manufacture Ampex tunes, adjusts and aligns each F-44 to obtain its maximum performance — far beyond minimum specifications. Thus, no two F-44s are quite alike. Each is virtually a custom-built recorder. Each performs to the utmost of its capabilities. And each gives you the best possible sounds today — and for many years to come. As an F-44 owner, you'll receive from Ampex a record of the individual performance specifications of your own F-44. This record shows the frequency

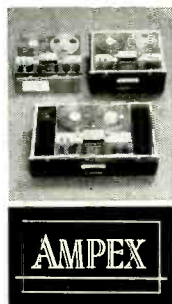

response curve, the signal-to-noise ratio, the flutter and wow, and the crosstalk rejection measurement. And it is signed by the Ampex engineers who tuned and adjusted your recorder. The new Ampex Fine Line F-44 also features a new special design hysteresis motor for smooth, quiet, accurate operation; an easy-to-read point-to-point record level meter for each channel; multiple sound-on-sound capability; new simplified controls; and the Ampex one year warranty. See and hear the new F-44 at your local Ampex dealer. Brochure? Write: Ampex Corporation, Redwood City, California. Sales and service throughout the world.

CONCERTONE 605



If you're willing to pay anything for professional quality.....but would rather not

The Concertone 605 is for the one man in several who can't stand less than perfection...but can't see why professional quality should cost so much. Never before have so many features and so much professional quality been available at this price. Read ahead carefully and see: Precision plug-in head assembly...includes four precision heads; Separate microphone and line controls (input can be mixed); Delay memory control circuit (never spill or break tape); Automatic glass tape lifters, including electric cue feature; Sound on sound and add sound; Solenoid operated brakes; Three motors, including 2-speed hysteresis synchronous drive; Automatic rewind; Exclusive Reverse-O-Matic®. Learn all about the 605 in complete detail. Ask your dealer for a demonstration or send for free literature today.



CONCERTONE 607

Broadcast version

The Concertone 607 with higher impedance is for the true professional or broadcaster. Remote control optional. This superb tape recorder is constructed to 19" x 14" dimensions, permitting it to be used as an exact replacement for old or outdated tape recorders.

CONCERTONE 400 COSMOPOLITAN

For people on the go...it's the Cosmopolitan - Combination Tape Recorder with AM Radio. A versatile companion and co-worker for business or pleasure travels. 5" reel capacity. Push-button operation. Amazing fidelity. Remote mike. Foot-pedal control. This all-transistorized recorder has big recorder features in miniature form.

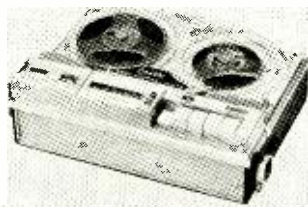

for further
information
write:



AMERICAN CONCERTONE, INC.
A DIVISION OF ASTRO-SCIENCE CORP.
9449 W. JEFFERSON BLVD. • CULVER CITY • CALIF.

Export: J. D. Marshall International, 170 W. Washington, Chicago, Illinois

Luckily, Bernstein, a genuine admirer of Great Romantic Music, is on hand to keep the Brahms work going right along. The Bernstein drama tends to be a mite clumsy as always but it hits the heroic tone unerringly, if fervently. Columbia really needs a different type fiddler for this big stuff. No two ways about it. Let Zino play in the dazzling French-Italian pastures where he is at home.

Brahms: Violin Concerto. Heifetz; Chicago Symphony, Reiner.

RCA Victor LCS 1903 stereo

—And here's the opposite story in more ways than one! It is the fiddler here who is the Great Virtuoso, supremely fit for the commanding role in this big work, dramatic in every sense, fiery enough to keep Brahms' overweight down, reduce the apparent length of the long pull from start to finish.

And it is the conductor, (recorded before his retirement from Chicago) who is temperamentally not suited to the grand style of such a work—though his razor-edge tautness and discipline does it plenty of good in the over-all. I always have felt that Reiner hated his necessary "war-horse" duties, and showed it in hard, brutal playing via his orchestra. Here there is a good deal of the teeth-gritting drive, but not too much to harm a slightly doughy score, in need of tautness to keep it alive.

Seems to be an oldish recording, this, perhaps held over, only now released. Low number, a since-retired conductor, and a trace of teeth-gritting distortion too, plus some odd little tape flutters (2nd mvt.), indicating a certain aged-in-the-vault ripeness. And where is Dynagroove? To compensate, you'll get a flossy Heifetz book, with pictures of career. (Chotzinoff)

Brahms: 19 Hungarian Dances. Hartford Symphony, Fritz Mahler.

Decca DL 710058 stereo

Two or three of these are ultra-familiar. The rest, as is the way with so much music, are very seldom heard and for poor musical reasons; the "catchy" ones have the most immediate and superficial musical appeal.

Your first impression, then, will be of an immensity, a surprisingly big collection that adds up to a full-sized work for big symphony orchestra. Where have these been lurking all my life? Well, here they are.

Second impression, almost simultaneous, will be the thick richness of this late-Nineteenth century sound, so utterly unlike any sound we apply today to a folksy idiom! The themes are actually Hungarian gypsy material (true Hungarian folk music was still undiscovered by the musical intellectuals, the property of the peasants). Their Brahms settings are strictly "art music," as was the style of the day, adapted for symphony orchestra, in all its glory. Most of us will find the stuff too turgid, too creamy and buttery. Nicely buttery, though.

Fritz Mahler's team plays unevenly—probably, I'd guess, because of rehearsal limitations. The familiar dances roll off in perfect teamwork, but some of the less known ones sound perilously close to sight-reading, of a sophisticated sort, of course. The players had never heard them either. ZE

LIGHT LISTENING

(from page 10)

Joe "Fingers" Carr: Brassy Piano
Warner Bros. Tape WSTC 1456
George Greeley: Popular Piano Concertos
Warner Bros. Tape WSTC 1415

Within the total space of one and a quarter inches these two reels take up on a tape shelf, it is possible to cater to a yardful of musical tastes. Carr and Greeley are easily the two biggest piano names in the Warner Bros. tape catalog released by UST. Both men are specialists in the full meaning of the word. "Fingers" Carr is usually the first name to

come to mind when ragtime piano is mentioned among record and tape fans. (That name hardly hurts in the matter of identification.) To set up this album on a somewhat different plane, Warner Bros. has provided Carr with a fine array of brass instruments. Led by busy trombones and trumpets, these sidemen tackle the enormous job (for a brass section) of following Carr in his elaborate Ragtime figures.

Warner's other piano album this month features the Greeley touch in keyboard versions of leading Broadway hit songs. As the prime practitioner of "sweet" piano on this Hollywood label, George Greeley has spent most of his time turning out flossy arrangements of movie tunes. Greeley fans will welcome the change of scenery as he covers the songs that belong on Broadway.

Robert Morse and Charles Nelson Reilly
Capitol ST 1862

Now that Capitol has established the point in this album, it is surprising to recall how few recent recordings have been devoted solely to the comedy songs of past and present Broadway shows. In selecting Robert Morse and Charles Reilly of the long-running cast of "How To Succeed in Business Without Really Trying," the producers of this album have performed a conspicuous service in a specialized field. Morse and Reilly, zany as ever, prove to be a natural pair of wags for the recreation of the more hilarious moments of musicals that have won fame on and off-Broadway. Many of the songs delivered here in newly devised settings are usually encountered over the air or on records only in original cast albums. It's a real convenience to have these light-hearted tunes available on one disc. Elliott Lawrence, musical director of "How To Succeed," leads the orchestra in this album as Morse and Reilly cavort in a variety of dialects. The comedy songs recalled are to be found in such fine shows as "Silk Stockings," "Damn Yankees," "Parade," "Let It Ride," and "Fiorello." A release such as this should go a long way in balancing the heavy diet of ballads that has always been available in show music recordings. AE

LETTERS

(from page 6)

impedances, less input signal is needed to produce this rated output. 2. The negative feedback of the amplifier is considerably in excess of 17 db. 3. The intermodulation distortion drops to insignificant amounts at low levels because the circuit is not strictly Class B.

Mr. Crawford is correct that germanium output transistors do exist with beta cutoffs above the *audio* range. In fact, such a device is being used as a driver for the output stage of the Acoustech I. However, the beta cutoffs of the silicon ST 7175 output transistors of the Acoustech I is above *one megacycle*. It is this high beta cutoff, combined with the ability to operate at higher temperatures without damage that makes the use of silicon transistors mandatory in any amplifier claiming to provide outstanding performance.

We cannot agree that 4-ohm published ratings are *not* misleading. Only one American loudspeaker is rated at 4 ohms. All others are rated at either 8 or 16 ohms. If Mr. Crawford purchased a "200" watt amplifier and found that it provided only 18 watts per channel into his 16-ohm speaker, we are sure he would feel misled.

MARSHALL R. MYERS, JR.,
MORLEY D. KAHN,
Acoustic Technology Laboratories, Inc.,
139 Main St.,
Cambridge 42, Mass.

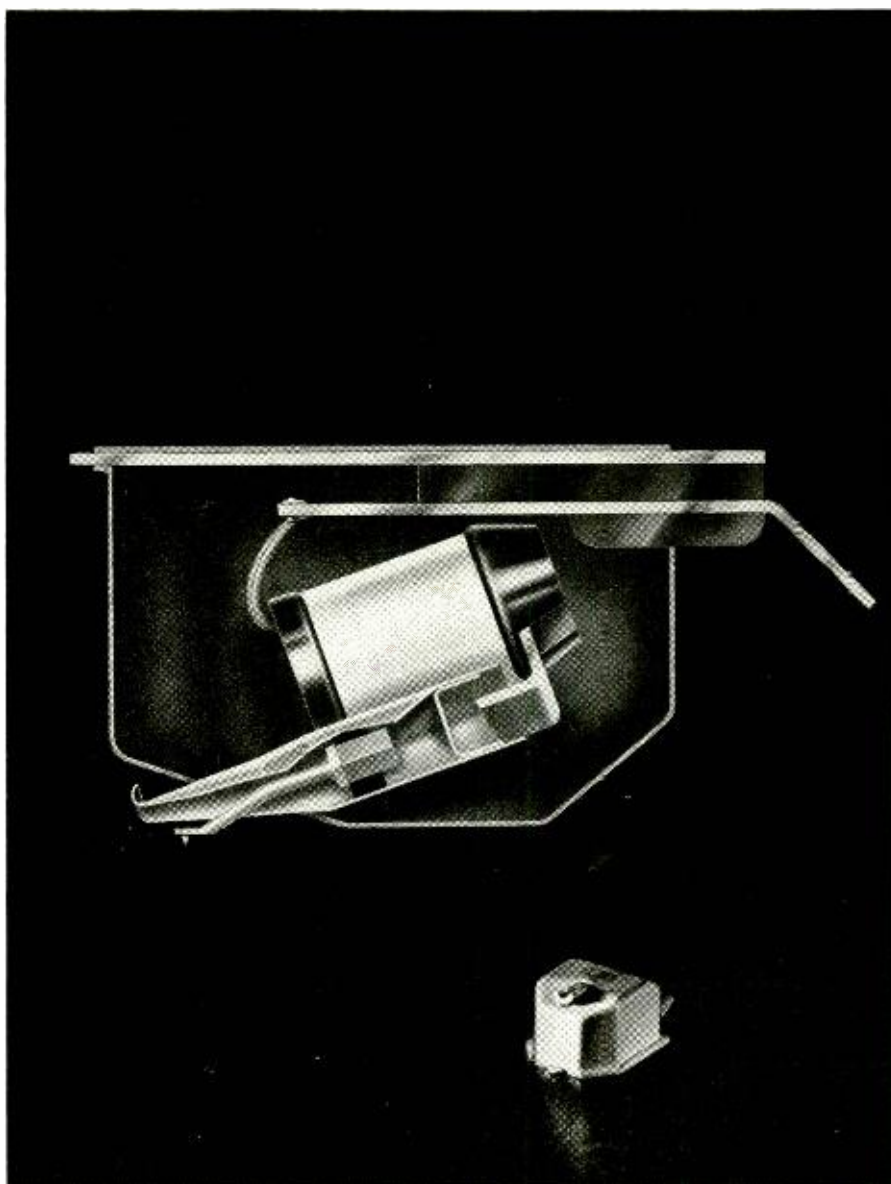

Have you any idea of the quality you hear from a stereo record with a cartridge that produces an almost perfect waveform of the sound groove?

Then hear the new Elac 322. Hear the quality possible only with a cartridge that has less than 2% intermodulation distortion, less than 1% harmonic distortion, and a smooth frequency response from 20 to 20,000 cycles, ± 2 db. Hear what effective crosstalk damping does for stereo integrity with channel separation better than 25 db at 1000 cycles, 20 db at 10,000 cycles, and an incredible 12 db at 20,000 cycles. The Elac 322 tracks at from 1.5 to 3 grams with most arms (1 gram with some). Price with .52 mil diamond stylus and universal mounting bracket is \$49.50.

Also hear the new compatible mono/stereo Elac 222, \$39.50 with .7 mil diamond. At your hi-fi dealer now. For complete details, write to: BENJAMIN ELECTRONIC SOUND CORP. 80 Swalm Street, Westbury, N.Y./U.S. distributor for Miracord and other Electroacoustic (Elac)[®] Record Playing Components.



NEW ELAC 322 STEREO CARTRIDGE

UNIMPAIRED FIDELITY TO THE FRONT...

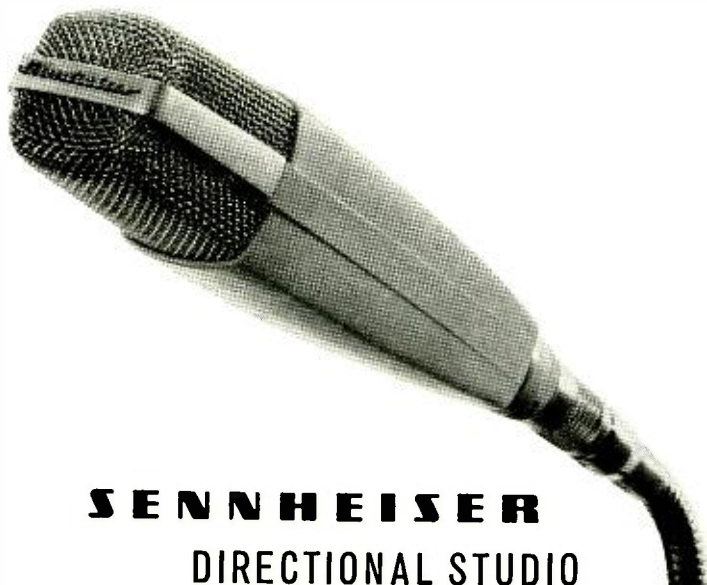

SENNHEISER
DIRECTIONAL STUDIO
MICROPHONE MD 421
A Wide-Range
Moving-Coil Design
Professional Net: \$95.00

Discrimination against interfering background sounds and the effects of a poor acoustic environment is assured by at least 16db rear rejection at any frequency above 250 cps, yet natural reproduction is maintained throughout the area of desired sound. The frequency response curve shown here depicts performance of the MD 421 truthfully because it is not merely representative of on-axis performance. The polar diagram shows why. Polar response is essentially the same for all frequencies of interest, which cannot be said of all directionals. There is no loss of detail and balance, no blurring of sounds, no effective high-frequency roll-off, from off-axis sound sources.

Proof of performance: an individually plotted frequency response curve is supplied for each Model MD 421, and it is guaranteed to be within ± 2.5 db of the average curve shown between 40 and 16,000 cps. Impedance of the standard version is 200 ohms. A cable transformer for high impedance is available. Model MD 421 HN offers high and low impedance. (Professional net: \$98.00.)

The MD 421 and 421 HN include a bass control, calibrated in distance markings as well as for speech and music. Proper setting of this control eliminates the low-frequency emphasis common to directional microphones in close-up use.

ACOUSTIC BARRIER TO THE REAR

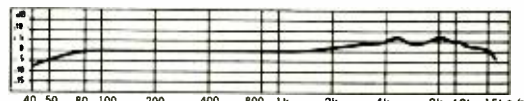

Frequency Response of the MD 421

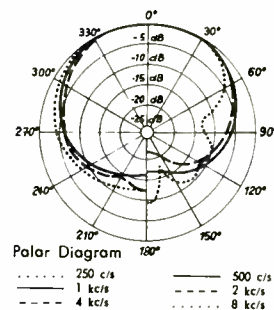

Polar Diagram

..... 250 c/s ——— 500 c/s
- - - - 1 kc/s - - - - 2 kc/s
- - - - 4 kc/s - - - - 8 kc/s

TECHNICAL DATA:

Frequency range:	30 to 17,000 cps
Maximum deviation from nominal curve:	± 2.5 db between 40 and 16,000 cps
Output level:	-53 db re 1mw/10 dynes/cm ²
Impedance:	MD 421: 200 ohms MD 421 HN: 30,000 ohms or 200 ohms
Directional pattern:	Cardioid
Discrimination at rear:	At least 16 db for frequencies above 250 cps
Magnetic field interference factor:	5 μ v/50 milligauss
Speech-music control:	Fitted in MD 421 and MD 421 HN
Dimensions:	6.96" x 1.9" x 1.81"
Weight:	13.4 oz., approx.

For complete technical specifications, call or write Sennheiser Electronic Corporation (N.Y.). For demonstration of this model and the full Sennheiser line, call or write Harvey Radio Co., Inc., franchised distributor for the New York metropolitan area.

Harvey
RADIO CO., INC.

103 West 43rd Street, New York 36, N.Y. • (212) Judson 2-1500



SENNHEISER
electronic
CORPORATION (N.Y.)

25 West 43rd Street, New York 36, N.Y. • (212) Longacre 4-0433
Plant: Bissendorf/Hannover, West Germany

AUDIO ETC

(from page 14)

condensed and probably less-than-ideal Canby explanation, as briefly as I can de-phase the idea for you.

1. Because of the peculiar shape and distance between ears on people combined with our tricky binaural direction-sensing, we experience certain specific areas of false perception. The interesting "binaural shift" is a well-known example—even I had heard of it. Move a loudspeaker around a blindfolded person's head and at a crucial point, at a particular wave-length, he suddenly hears the thing on the opposite side from where it actually is. This is thanks to the fact that we monitor the wave-fronts as they get to our ears and sometimes the tail of one wave gets tangled with the head of another, so to speak. The front of one wave hits the further ear just ahead of the front of the *next* wave at the near ear, and so the ears, confusing the two waves, think the further ear has been hit first—and so the sound appears on the far side.

In complex sound hearing, as with music, these effects tend to confuse and reverse—or cancel out—our direction-perception in certain areas, certain frequency ranges. They put our pattern-perception into a state of partial confusion and so blur up the total result. For better or worse, as the case may be.

(I can't help remarking, at this point, that maybe Nature wanted it this way; furthermore, I'm quite sure that Bach wanted it this way. Also Beethoven and maybe even Benny Goodman.)

2. If we neatly separate out this area, or some of these areas and *reverse the phase* we will tend to return those errant sounds back to the correct side of our heads, where they really were all the time. Tricky idea! Could it be put to use? Seems so.

Inter-Aural Research has done some heavy between-the-ears snooping into this business and has come up, after psychological testing galore and via much professional backing-evidence from the literature, with a mid-range area which they say does the mostest for most of us. 800 to 3500 cps. Their average curves of people's reactions are not unlike the familiar Fletcher-Munson curves on people's loudness perception (recruitment above threshold equated with frequency, says I in good professionalise). Averaged, general-purpose guides to the way normal ears-in-the-mass actually operate in conjunction with the perceiving brain. Apply such a formula to an electronic circuit and you're in business.

3. The pay-off is yet to come. Inter-Aural has found, it says, that the ears take very kindly to a big boost in these chosen mid-frequencies *provided they are treated with the reverse-phase, de-sexing process*. The ears like what they hear and so do not really object to the presence boost, in this pleasingly useful out-of-phase form. Helps their pattern-perception where it most can use some help. So says Inter-Aural.

Instant Patterns

Now pattern-perception is a very real thing. It tells us about the placement of various sources of sound in space by virtue of an elaborate and instantaneous analysis in our higher minds upon the total sound we hear. Two-eared hearing (binaural) is only a part of it. All sorts of intricate memory-experience info goes into the process, all instantaneously.

Similarly, you will note, our two eyes can infer visual perspective from mere

shapes and lines, even those as sketchy as in a pen-and-ink drawing. We can add vivid perspective—even without two-eyed vision—via relative *movements*, as on a movie screen or TV tube. It is in this same sense that we derive instant info about a space via mono sound, even minus the stereo or binaural aid.

And so Inter-Aural's idea make sense for me. Your ears so nicely appreciate an unexpected bit of extra pattern-information, with all the phase-confusion (binaural shift) taken out by the de-phasing circuitry, that they are ready to absorb a considerable "extra" mid-range boost, in order to get hold of it. They don't notice the boost, so to speak, being busy absorbing the extra info. Indeed, the company tells us, experiments prove that we can take up to 14 or more db presence boost without hearing it as such, under these conditions. But it adds, significantly, being a higher-consciousness "central" nerve function, this effect may well have to be *learned*. It can increase with familiarity.

I have often remarked, myself, that one must *learn to hear* stereo sound, just as one must learn to hear music itself (or tell Chevrolets from Fords at a hundred yards). Central perception. So this idea makes good logic.

Accordingly, Inter-Aural Research, Inc. has plunked that firm 12-db boost into its mid-band Synchro-Amp circuitry, lumping the doctored central portion of the stereo spectrum by the whopping power factor of 4. We'd *better* learn! So sure is the company of its theory, that a volume control, originally intended to vary this boost, has been removed in my Synchro-Amp. Now, its 12-db boost or nothing. You can take it or leave it. (Your tone control will merely tip the boost over, rolling off the upper highs that aren't even involved, along with the Synchro'd mid-range.)

Now here I must remark, as you will have done to yourself, that everybody knows about the effect of "presence," i.e., a boosting of selected (or non-selected!) frequencies in the mid-range area. Quite in accord with the general theory that our perception of tonal differences, of differing wave-patterns, is at a maximum here and thus a boost in the area tends to make things more "real," more alive, more sharply differentiated and more positively placed in space.

The only trouble is, of course, that the same boost that adds presence also distorts tone color. To be brief, it adds a sort of snarl, a characteristically hollow, conduit-pipe sound, through the nose, that becomes increasingly obnoxious (to the tuned ear) as the mid-range boosts or peaks become more drastic. Many a listener has played with presence—and put it aside after awhile. Many a manufacturer has done the same, wittingly or no, and still does. Presence, alas, makes the cheap turntable go 'round. Presence sharpens up the slickest recordings. We all know about added presence. In the end, we distrust it, if we are thoughtful.

Generally speaking (as Inter-Aural notes), a rough 4 or 5 db of concentrated presence-boost is about all a well-trained ear will accept in useful hi fi. Above that, the sound becomes merely distorted. I agree heartily.

BUT, says Inter-Aural, de-phase the mid-range, cancel out the stereo phase differences; then our sheer pattern-perception can get to work on the mid-range sound, unhindered by false readings due to binaural shift. And thus we don't hear the boost—we ignore it in favor of the added space-information we are supposed to be lacking up.

THE NEW WEATHERS ML66A IS DESIGNED TO PLAY YOUR RECORDS WITH MORE CARE AND PRECISION THAN ANY OTHER TURNTABLE YOU CAN BUY. HERE'S WHY.

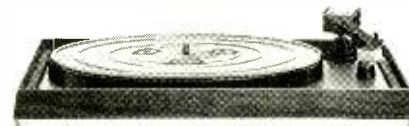

Low mass and weight make it perfect for today's high compliance tonearms and cartridges. Measures only 16 $\frac{1}{4}$ " x 14 $\frac{1}{4}$ " x 2 $\frac{3}{4}$ " high including its integrated base. Offers quietest performance (-60db rumble) and most accurate speed (only 0.4% wow and flutter). Exclusive "Seismic Platform" suspension completely eliminates feedback from room vibrations.



ML-66A Includes New Universal Tonearm

Mount any cartridge in its interchangeable plug-in shell. Perfect balance eliminates side thrust or "skating." Exclusive full-time viscous damping prevents accidental stylus and record damage, insures that correct stylus force is constantly applied. Crafted of non-resonant walnut. Mounts on any other turntable. ML-66A with Universal Tonearm—\$99.50. K-66 Turntable, Arm and Weathers LDM Cartridge—\$129.50. K-66P Turntable, Arm and Famous Professional Pick-up—\$195.50. MT-66 Universal Tonearm only—\$31.50.



New Stress-Generator LDM Cartridge

The only cartridge with complete freedom to respond to the most rapid record groove motions, reproducing peak passages with no break-up, giving you the cleanest, most musical sound you've ever heard. Provides same design principle employed by the famed Weathers Professional Cartridge. \$39.50.



Introducing the New Sound Studio Loudspeaker

A speaker system of professional studio quality measuring only 12" x 20" x 7". Exclusive Weathers variable mass damping attains a transparency and smoothness of sound previously heard only in the costlier full range systems. Unique electrical crossover eliminates crossover coloration and ringing. Model SE-200—\$99.50.

Write for free catalog: Dept. P-2,

WEATHERS

Cherry Hill Industrial Center,
Cherry Hill, N.J.
50 W. 44th St., N.Y. 36, N.Y.



Only **DYNAMIC DIMENSION** Control Equipment by **FAIRCHILD** Can Radically Improve Your Broadcast and Recording Sound!

FAIRCHILD DYNALIZER—Model 673

The newest approach for the creation of "apparent loudness"—the Dynalizer is an automatic dynamic audio spectrum equalizer which redistributes frequency response of the channel to compensate for listening response curves as developed by Fletcher-Munson. Adds fullness and body to program material. Completely automatic with flexible controls. Easily integrated into existing equipment.



FAIRCHILD CONAX Model 602

The world-acknowledged device that eliminates distortion problems caused by pre-emphasis curves. Allows higher average program levels through inaudible control of high frequencies. Invaluable in FM broadcast and disc recording. Eliminates stereo splatter problems in multiplex channels.

FAIRCHILD LIMITER—Model 670

Fast attack stereo limiter (50 micro-seconds) with low distortion and absence of thumps. Sum and difference limiting position eliminates floating stereo image, despite amount of limiting used in one of the two channels. Also includes regular channel A and B limiting. Dual controls and dual meters provided. Now used throughout the world in recording studios. (Mono model available).

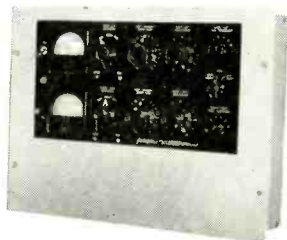

FAIRCHILD COMPRESSOR—Model 666



A flexible compressor capable of 40 db compression without distortion. Can also be used as line amplifier. Has 30 db of gain. Includes variable threshold and variable release up to 30 seconds, amplifier gain controls and compression meter. Special device—Fairchild Autoten eliminates compressor breathing during long pauses. Permits high average modulation levels.

Write to Fairchild—the pacemaker in professional audio products—for complete details.

FAIRCHILD

FAIRCHILD RECORDING EQUIPMENT CORP., 10-40 45TH AVE., LONG ISLAND CITY 1, N. Y.

But do we need added space-information? Not if the recording engineers have done their job well.)

All of which is quite plausible when you think it over. The ears do react that way to many kinds of acceptable sound-information. Good listening acoustics, for instance, make a poor system sound a lot better than it is, whereas punk room-sound can make the finest hi fi set-up sound positively nasty. The ears do, indeed, defy reality and substitute their own idea of it! So do the eyes. And the rest of us. Thank the Lord it is so. Or we would not be able to see, hear, feel as we do, nor would there be (minor tragedy) any hi fi for us at all. So Synchro-Wave theory sounds reasonable and it ought to work.

Rueful Conclusion

It really should work. But truth compels me to come to my rueful conclusion. It doesn't for me.

I've tried the Synchro-Amp at real length, in my regular daily listening. I've check and rechecked, switched it on for minutes, hours, days. I've tried to learn, I really have. But all I've ever got out of it was the too-familiar sound of an unpleasant, snarling, hollow, mid-range boost. That's all.

Oh yes—I do hear striking details in the music, in spite of a dismal absence of bass and treble along with the snarling mid-range. Clarity and separation, oh definitely. The presence range at work.

A quite muddy large-scale Bach *Cantata*, for instance, showed up an astonishing range of inner musical detail in both color and counterpoint under Synchro-Amp stimulus. The muddiness vanished, the hidden melodies came jumping forward, a faintly audible trumpet blared loudly and the mumbling chorus leapt to the front of the stage and bellowed at me. Understood every word they enunciated, through their grating teeth. I heard quite a bit of extra Bach, admittedly. Most unpleasant.

A solo grand piano, I found, threw its every individual string at me with ghastly separation. Such a jangle you never heard, not a single piano but dozens of individually competing strings all crying for attention. A string quartet in the same way lost its blended ensemble and became four maniacs, every man for himself and the composer be damned. A harpsichord turned into a dentist's nightmare, hundreds of audible miniature drills puncturing the ear drums. And yet—a heavy-handed Baroque concerto took off under Synchro-Amp power with a lighter-than-air whoosh. Not unmusical at all. It all depended. Bad recordings were stridently a little better. Good recordings were blasted into super-clarity that nobody around *my* ears found really necessary. This was "Studio 8-II" thinking.

Even so . . . even so. That theory is a good one. It really must work. It has to work, I kept saying. And so I tried again. Alas, in every case, through all this varied listening and more, I could not help but hear the same harsh, sinus-like snarl of an outrageous over-boost in the presence range. That's all. That's what my stupid ears kept yelling at me. Normal stereo, to be sure, did sound muddy after the hepped-up effects. But what lovely mud. I liked it.

I think I began to lose weight. Could I have done something dreadfully wrong, abysmally stupid? Was my system, for instance, really in phase to begin with? Inter-Aural warns ominously of the consequences of wrong phasing. In the Instructions it says, "STOP EVERYTHING! . . . It is imperative that you . . . make a supreme effort to insure proper phasing of the

speakers in your system . . . INCORRECT PHASING . . . WILL MAKE THE SYNCHRO-AMP USELESS."

I checked, and checked again. Regretfully, I found all in order. I still didn't hear anything as I really hoped I would. I wanted to hear right.

Today I'm really in the dog house. I've just performed a last, decisive experiment. I reversed my speaker phasing in mid-stream while the Synchro-Amp was at work.

That should do it, I thought. If the warnings are right, if the theory stands up, if my ears are any good whatsoever, then the flick of my little phase switch (portable on an extension cable for use in listening position), I figured, should Tell All. I positively trembled as I took it in hand. So did my assistant, whose ears are younger; he has more ear-power at stake than I do.

I couldn't hear the slightest difference between in-phase Synchro-Amp sound and Synchro-Amp out-of-phase. Nor could he. Except, of course, a noticeable change of phase at the speakers. Nothing else. Just the same old presence-snarl.

So good bye. I'm off to bury my baffled ears upon a sand-filled beach. If you don't dig me now, try again in six years or so.

Meanwhile, please write Inter-Aural Research, Inc., 4635 S.E. 28th Av., Portland 2, Oregon, for the complete paper called "The Synchro-Wave Process—Basic Concepts." You'll enjoy it. AE

von Recklinghausen CONCLUSION

The figures of Table 2 and 3 show that tuner sensitivity is determined by a number of factors, each of which when "improved" actually causes a serious degradation of other more important performance factors of a tuner. In practice, most tuner sensitivity figures are actually somewhat poorer—but this is not of serious consequence since listening is done not at the "knee" of the signal-to-noise ratio curve but at considerably higher signal levels. Whether a tuner has a sensitivity of 2.5 or 3.2 microvolts means a signal-to-noise ratio change of only 2 db at signal levels where actual listening is done.

Some sensitivity figures may actually be a little lower. Here, either a measurement error is the cause or a number of performance aspects are actually degraded. This may not show in the type of measurements made but they are degraded nevertheless. Otherwise, an error in rating has been made.

Therefore, the sensitivity of a tuner is much less important than has been thought heretofore. Other specifications of a tuner are of higher value. In Table 1 they are listed in order of importance with suggested values.

If these specifications are followed in their order of importance, then satisfactory FM listening can be had. An over-all improvement of performance will be noted if the more important characteristics are improved, even if it means a slight sacrifice in performance of the less important specifications. AE

Listening Tests Prove DYNACO BEST

Specifications are important, but present measurement standards do not fully define how equipment sounds. High fidelity equipment has achieved its ultimate goal when it delivers sound so realistic that skilled listeners cannot distinguish the difference between "live" and "recorded" music in a side by side comparison. This test has been performed dozens of times before thousands of people in programs sponsored by Dynaco, Inc. and AR, Inc. with "live" portions performed by the Fine Arts Quartet. In these comparisons, Dynakit's superlative performance was amply demonstrated, since the vast majority of the audiences readily admitted that they could not tell the difference between the electronic reproduction using Dyna Mark III amplifiers and the PAS-2 preamplifier, and the "live" music by the Fine Arts Quartet.

Such perfection in reproduction means that listeners at home can have a degree of fidelity which cannot be improved regardless of how much more money were to be spent on the components used. All Dyna components are of a quality level which permits reproduction indistinguishable from the original. The unique engineering in all Dynakits makes them fully reproducible, so that everyone can hear the full quality of which the inherent design is capable. Dynakits are the easiest of all kits to build—yet they provide the ultimate in sonic realism.



FM-3—An outstanding stereo FM tuner featuring automatic transition to stereo with the visual Stereocator. The FM-3 is a super-sensitive drift-free tuner with less than 0.5% distortion at all useable signal levels, four IF stages, wide-band balanced bridge discriminator, and time-switching multiplex system.

FM-3 kit \$109.95; assembled \$169.95

SCA-35—Combined stereo preamp and amplifier with low noise, lower distortion, and 17.5 watts continuous power per channel. Distortion less than 1% at full power from 20 to 20,000 cycles. Unique feedback circuitry throughout.

SCA-35 kit \$99.95; assembled \$139.95



PAS-3—The famous "no distortion" PAS-2 stereo preamplifier with a new look. Wide band, lowest noise, with every necessary feature for superb reproduction. Less than 0.1% distortion at any frequency.

PAS-3 kit \$69.95; assembled \$109.95

STEREO 35—A basic power amplifier similar to that used in the SCA-35. Inaudible hum, superior transient response, outstanding overload characteristic, and extremely low distortion at all power levels. Fits behind PAS-3 or FM-3.

ST 35 kit \$59.95; assembled \$79.95



STEREO 70—A superlative power amplifier — continuous 35 watts per channel with unconditional stability and near-perfect transient response. Frequency response extends below 10 cps and above 40,000 cycles without loss of stability.

ST 70 kit \$99.95; assembled \$129.95

ASK YOUR DEALER FOR A DYNA DEMONSTRATION
Write for detailed specifications and descriptive literature

DYNACO INC. • 3912 POWELTON AVE. • PHILA. 4, PA.
Cable: DYNACO Philadelphia

PRESENTING THE

Richard Allan SPEAKER

For the Connoisseur
at last...

An English Import With
All the Fine Qualities
and Crafts-manship
of Today's Most
Expensive Speakers!

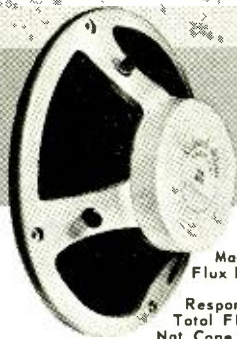

CG12T - \$53.99
Size - 12 inches
Magnet type - Ferrubo II
Flux Density - 14,000 lines
per sq. cm.
Response - 25 to 15,000 cps.
Total Flux - 82,000 Maxwells
Nat. Cone Resonance - 30 cycles

Richard Allan . . .

HIGH PERFORMANCE SPEAKERS IDEALLY SUITED FOR "SLIMLINE" CABINETS. OFFERING HEAVY CAST FRAME AND CAMBRIC SURROUND. INCORPORATING THE LATEST ADVANCES IN MAGNET DESIGN AND MORE.



THE BRONZE

8" and 10"

Robust die-cast chassis. Wide frequency range. Low priced at 8" . . . \$19.99
10" . . . \$31.99



THE 1214

12" (30.5 cm)

Magnificent construction. Exceptionally smooth frequency response. \$51.99

GOLDEN ERA "860"

8" most popular "workhorse" in the Richard Allan line. \$5.49

Richard Allan

SALES CORPORATION

P. O. BOX 95

JERICHO, L. I., N. Y.

Dealer and Manufacturers
Representatives Inquiries Invited



ABOUT MUSIC

Harold Lawrence

A Visit to the R.T.F. (Part 2)

By the time the French National Radio transmitted its first *modulation de fréquence* broadcasts less than a decade ago, our airwaves were already thronged with FM stations. Today the RTF still operates only one exclusively FM network: France 4, but the scope of its programs would make FM program directors in the United States turn green with envy.

Primarily responsible for the destinies of France 4 are two energetic administrators in the RTF—Jean Tardieu, chief of France 4; and Marius Constant, (Fig. 1) the networks music director, both of whom I met at the new *Maison de la Radio* in Paris this summer.

A poet and playwright, Tardieu began working for the RTF after the Liberation of Paris; Constant, a composer and conductor, took over his present duties when the government created its purely FM *chaîne* in 1954. "FM was virtually unknown in France at that time," Constant recalled. "There was no point in transmitting FM broadcasts if nobody was going to receive them. So we set out to encourage French manufacturers to produce FM radios and tuners. We promptly ran into a stone wall. The companies opposed the idea, but for contradictory reasons. They said the public was not ready for it; but the same breath, they predicted that a sudden swing to FM would make obsolete their large inventories of AM sets." Constant smiled at Tardieu, flicked the ash off his cigarette. "We went ahead with our program anyway. The French manufacturers soon changed their

tune when they saw Frenchmen buying foreign-made FM radios—and expensive ones at that. There are now 1,000,000 FM sets in France, and 50 per cent of the French units manufactured today are either FM or AM-FM sets."

Both France 3 and 4 are, for want of a better word, "cultural" stations. Apart from the fact that the latter is exclusively FM, how do they differ? "Music is our principal commodity," Tardieu explained. "The spoken word is *non grata* on France 4. At first, we broadcast dramatic and literary programs, too, but our audience made it very clear that they wanted to hear music and little else. The newspaper critics added their voice, and soon the word came down from the Ministry of Information: 'more music and less talk.'" As a man of letters, how did Tardieu feel about the crackdown? Tardieu shrugged good-naturedly. "We're interested in pulling in audiences, that's the most important consideration. Besides, they allow us to broadcast three minutes of poetry each day."

"What is the proportion of recorded and 'live' music on France 4?" I asked Constant. "Roughly, it's an 80-to-20 ratio in favor of recordings. For our recorded programs, we try to obtain copies of master tapes from the record companies, to avoid surface noise and the inevitable deterioration of microgroove discs under studio conditions. All but two of the disc firms cooperate with us furnishing these tapes. We supply the raw stock, they do the dubbing. But that's the only part of the story. From

Fig. 1. Jean Tardieu and Marius Constant—FM for the RTF.



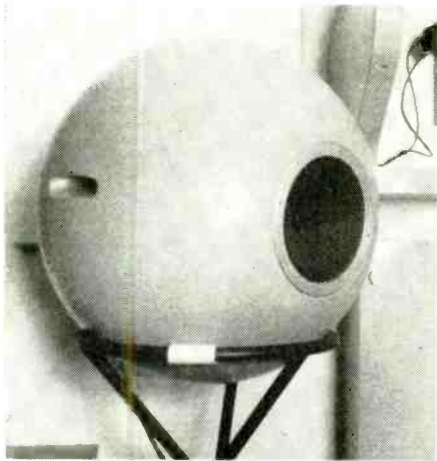

Fig. 2. Elipson monitor loudspeaker.

the standpoint of our archives, this is a marvelous arrangement. With the record companies deleting recordings left and right, it becomes increasingly difficult to replace scratched or worn-out records. We never have to replace tape."

Under the supervision of Tardieu and Constant, forty *producteurs* direct programs on France 4. None of these programs "talks down to our listeners." To illustrate this point, Constant spoke about one of the most recent shows on the network: a Wagner Quiz, lasting two weeks and asking 28 tough questions. "Did you know that there are more Wagnerians per capita in France than anywhere else in the world except Germany?" Constant said. "Surprising, isn't it? But the French were late in recognizing Wagner; they probably want to make up for the rude treatment the composer received at the hands of Parisian audiences in the 1860's." 5000 listeners participated in the Wagner Quiz. A measure of the difficulty of the quiz was the fact that no one answered all the questions correctly, and only a dozen answered 27 out of 28. The two leading contestants won complete sound systems; others received separate components and records.

Another popular program on France 4 is *La Double Audition*. Produced by a young director named Micheline Banzet, the series features important but "difficult" contemporary works, such as a string quartet by Bartók or a sonata by Hindemith. Mlle. Banzet first introduces the music to be played without commentary. After the performance, she analyzes the music in detail.

(Continued on page 78)

Fig. 3. Couperin in Arabic.

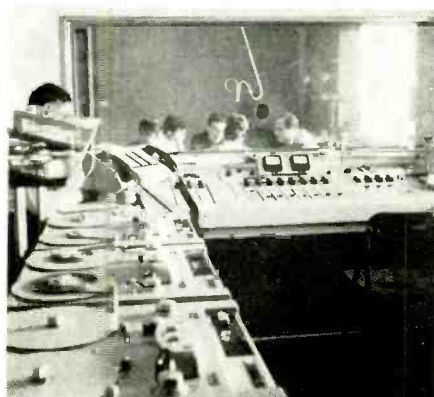

ladies
and gentlemen,
may we
present
"the beginning
of a
new era"
in listening
pleasure

TD-224

THORENS

Masterpiece

Turntable and
Record Changer

• Professional Turntable • Automatic Changer • Outstanding Tone Arm • 4-Speeds plus variable pitch tuning $\pm 3\%$ • Built-in Electric Strobe • Full Year Warranty
Now, for the first time, you can get all the quality that only a turntable can provide, along with all the convenience of an automatic record changer. Thorens found the secret of combining the best of both to bring you the finest instrument in high fidelity today. Only the TD-224 plays records individually, yet changes automatically. A masterpiece of engineering perfection.

More advanced features than any other equipment of its kind.

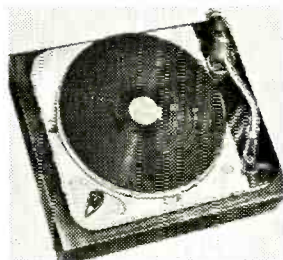

"The Concert" — Thorens TD-124 Transcription Turntable with Ortofon RMG-212 Tone Arm. A combination of brilliant craftsmanship. 4 Speeds. Built-in strobe.



"The Overture" — Thorens TD-121 Turntable with Ortofon SMG-212 tone arm. Ideal for 33 $\frac{1}{3}$ performance, and easily convertible to other speeds.



"The Prelude" — Thorens TD-111 Single Speed (33 $\frac{1}{3}$) Turntable, plus Ortofon SKG-212 tone arm. Designed for those who demand top performance plus economy.

ALL WITH FULL YEAR WARRANTY. SEE THEM DEMONSTRATED!



FREE! CATALOG

Largest and greatest of all ELPA catalogs! Featuring Thorens, Ortofon and Cecil E. Watts world renowned high-fidelity products. Write for catalog and name of nearest dealer.

THORENS DIVISION

ELPA MARKETING INDUSTRIES, Inc.

Dept. A

In Canada: Tri-Tel Associates Ltd., Willowdale, Ont.



NEW PRODUCTS

● **30-Watt FM-Stereo Receiver.** Harman-Kardon, Inc. announces that a new, moderately priced 30-watt FM-stereo receiver, the Award FA3000X, is now being marketed. The FA3000X receiver combines a stereo tuner, preamplifier, and power amplifier on a single chassis. It delivers 30 clean watts and offers a host of design and performance features, including a sensitive, stable, wide-band circuit, and a new multiplex section with frequency response of ± 1 db from 15 to 15,000 cps and 30 db



separation. An accurate FM stereo indicator light permits instant visual identification of stereo broadcasts. The new receiver offers a high degree of flexibility, made possible by a full complement of input and control facilities. An illuminated push-button on/off switch permits the receiver to be turned on and off without disturbing pre-set controls. The power amplifier section features grain-oriented cores in the output transformers to provide a frequency response of 15 to 70,000 cps at normal listening levels. Price is \$224.95. Harman-Kardon, Inc. Plainview, L. I., N. Y. **L-1**

● **New Line of Tape Recorders.** Estey, an old name in the organ industry, this year is adding tape recorders to its product line. Heading the line of four "foolproof" tape recorders which are being manufactured by Estey is Model 70 (shown) a stereophonic tape recorder with authentic sound-on-sound. It is priced at \$339.95. In addition to sound-on-sound, Model 70 also has sound-with-sound recording; four-track mono recording; illuminated recording level meters; external speaker switches for monitoring and public address; an output of 20 watts per channel; and two detachable speaker wings. Another unit in the line



is Estey's Model 50, also fully stereophonic and priced to retail at \$229.95. A feature is sound-with-sound. Other features are detachable wing speakers; a digital-tape counter; external speaker jacks; speaker on-off switch; provision for use of the recorder for public address and monitoring. Estey's Model 70 and Model 50 were specifically designed to be mounted vertically. All four Estey tape recorders have two speeds, $7\frac{1}{2}$ and $3\frac{3}{4}$ ips; all take 7-in. reels, and all have a single knob for fast forward and rewind operations. Estey Tape Recorder Division, Estey Electronics, Inc., Hicksville, N. Y. **L-2**

● **New Headphones.** The Fisher headphones, Model HP-50, are designed to complement the acoustic characteristics of high-fidelity components. They feature comfort, durability, and fine reproduction. Frequency range is 30 to 17,000 cps; distortion is unmeasurable at normal listening levels; power input required for average listening levels is 15 milliwatts and maximum permissible power input is 1 watt; nominal impedance is 12 ohms. Connections are made to the left cup via a



single $6\frac{1}{2}$ -foot cable terminated in a three-contact plug. All wires are strain-relieved. Full foam-cushioned cups, of high-impact plastic (Cyclolac), with fully-adjustable vinyl-covered spring-steel headband. Fisher Radio, 21-29 44th Drive, L. I. C., 1, N. Y. **L-3**

● **"Littel-Jax."** A new three conductor stereo "Littel-Jax," Part No. 14B has been introduced by Switchcraft. The new stereo jack is specially designed for switching out speakers when connecting stereo headphones and for switching three-wire stereo input circuits. Dual normally-closed switch



contacts open both stereo circuits independently when a three conductor plug is inserted. Part No. 14B, stereo "Littel-Jax," lists for \$0.95. (U.S.A.) It mates with standard Switchcraft three-conductor "Littel-Plugs," Part Nos. 260, 267, 269 and 297. Switchcraft, Inc., 5555 No. Elston Avenue, Chicago 30, Ill. **L-4**

● **Auto Tape Player.** Featuring an extremely compact package, the Viking Auto-Tape contains a solid-state amplifier (2-watts per channel), a cartridge deck, and can be operated from any 12-volt d.c. power source. It is designed along the lines of other Viking cartridge handlers used in the background music and broadcasting

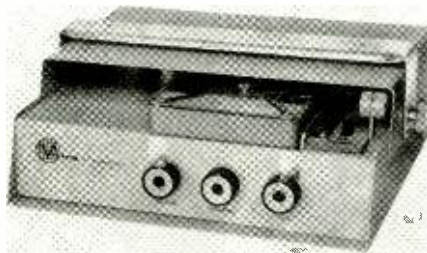

industry and will accept all Viking cartridges with pre-recorded quarter-track stereo programs for $3\frac{3}{4}$ -ips playback. Viking also announces a library of pre-

recorded background music in Viking M-4 cartridges for the 500. This new model is primarily intended for installation in car or boat; however, applications are limited only by the imagination. For example, it can be used for wild-life study, narration in any number of languages for sight-seeing tours by bus or boat, in company field personnel cars for sales lectures, booked up to external speakers on campaign wagons, mobile vendors with pre-recorded message, and of course, a choice of background music for discriminating car and boat owners. Viking of Minneapolis, 9600 Aldrich Ave. So., Minneapolis, Minn. **L-5**

● **Mike Stand.** A new three-legged microphone floor stand designed for easy disassembly and compact handling, the Atlas Model CS-52 lists at \$11.75. When disassembled, it fits compactly in a single carton, suitable for reshipment. Model CS-52 features a full-grip, velvet-action clutch



which permits simple adjustment of the chrome-plated upright from 34-in. to 62-in. in height. The base is finished in a scuff-resistant dark gun-metal shrivel, with shock-absorbing base pads on each leg. Atlas Sound, Division of American Trading and Production Corporation, 1419-51 39th Street, Brooklyn 18, N. Y. **L-6**

● **New Stylus Assembly.** The new ADC-R30 stylus assembly will fit into the ADC-1 and ADC-1 Mark II Cartridge bodies. It is a special stylus in that it is restricted in use by the following conditions: 1. To be used with modern stereo records only. May not be used with existing mono records. 2. It is not intended for use at forces over 1.5 grams. The ADC-R30 is a natural addition to any existing ADC-1 or Mark II cartridge in field use today. The stylus tip radius of the ADC-R30 is 0.00035-in. (0.35-mil). The compliance is nominally rated at 40×10^{-6} cm/dyne minimum. The usual tracking force, even at extreme sound levels, is between 0.5 and 0.75 grams. Audio Dynamics Corporation, Pickett District Road, New Milford, Conn. **L-7**

● **Two-Directional Playback Tape Recorder.** The "Retro-Matic" 220 represents Viking's entry into the top-bracket tape-recorder market. The "Retro-Matic" 220 is a two-speed quarter-track stereo tape recorder that features two-directional playback. A new concept places the capstan between two playback heads so that the tape is pulled over the head in both forward or reverse playback. Automatic reverse playback is controlled by a timed silence-sensing device which detects the end of a program, reverses the reel motion, and switches playback heads. Pushbuttons control all tape motion either at the machine

McIntosh

PROMISES

YOU

▶ In every specification McIntosh makes a solemn promise. For 15 years McIntosh has made and kept such promises to you. We have guaranteed to equal or exceed our published specifications or refund our advertised price.

▶ McIntosh specifications hide no tricky evasions. For example, you need not fear fine print on our stereo amplifiers subtly limiting our specifications to one channel at a time.

▶ Nor will you find that McIntosh amplifiers are limited to 15 seconds at full treble power as are some of today's transistor amplifiers.

▶ You will not be oversold by McIntosh exaggerating the importance of square wave response or useless extension of high-frequency response.

▶ The promise to you in McIntosh specifications is not based on a single "LAB MODEL." The maximum realizable performance of a McIntosh instrument is well above the written McIntosh specifications.

For example, our MC 240 Stereo Amplifier which is rated at 40 watts per channel, both channels at the same time, will actually deliver 50 watts 20 cycles to 20,000 cycles at less than ½ of 1% harmonic distortion. There is no other commercial audio amplifier with this margin of performance above specifications coupled with such low power dissipation in its output tubes as the McIntosh MC 240.

▶ If you want stereo amplifiers and tuners in your home that give life-like pleasing sound, you can trust McIntosh to fulfill its promise to you.

McIntosh LABORATORY INC.

2 CHAMBERS STREET, BINGHAMTON, N. Y.

Phone—Area Code 607-723-5491

Zip Code 13903



or on a remote control center that plugs into the recorder. The integrated stereo amplifiers deliver 6 watts per channel. Solid-state preamps have adjustable playback equalization to compensate for tape and head variations. Matching circuitry for 4 to 600-ohm headphones is built in. Record circuitry uses vacuum tubes. Other features include four hyperbolic heads, hysteresis capstan motor plus two reel-drive motors, independent channel controls, illuminated VU meter and record button, "A-B" comparison switch for simultaneous record/playback monitoring, stainless steel face panel, vertical or horizontal operation. Walnut enclosure or portable case and remote control available as

accessories. The "Retro-Matic" 220 lists for \$860. Viking of Minneapolis, Inc., 9600 Aldrich Avenue South, Minneapolis, Minnesota. **L-8**

• **Test Tape.** Burgess Battery Company has started marketing a new test tape which will permit the home tape recordist to test his tape recorder and check it for maximum record and playback efficiency without the necessity of additional auxiliary test gear. The test tape features a step-by-step explanation on sound that tells the recordist how to check his recorder for fidelity, balance, timing and frequency response. The test tape will also teach production techniques such as sound-on-sound, splicing, editing, and



other ways to use tape and recorder for more home pleasure. Burgess Battery Co., Freeport, Ill. **L-9**

• **Mono 18-Watt Receiver.** The EICO Model 2715 employs standard Classic Series FM front end and 4-stage i.f. strip plus a basic high fidelity power amplifier delivering 18-watts 1HF music power and 14-watts continuous power. It provides ceramic

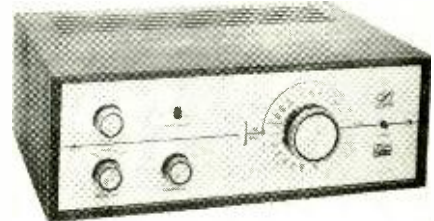

phono and tape inputs and a three-position input selector. It features a precision rotary tuning dial with illuminated readout and bar-type eye tube tuning indicator. Speaker outputs are 8 and 16 ohms, and 25-volt line (45 ohms). The 2715 is intended for use in offices, waiting rooms, stores, restaurants, and so forth. It also can serve as a high quality FM tuner-amplifier in the home. Price, wired only, \$129.95. EICO Electronic Instrument Co., 33-00 Northern Blvd., L. I. City 1, N. Y. **L-10**

NEW! The 6th AUDIO ANTHOLOGY



The SIXTH AUDIO ANTHOLOGY includes articles on two most significant milestones in the field of high fidelity: FM STEREO and TRANSISTORS IN AUDIO EQUIPMENT. The FM STEREO articles which appeared in AUDIO — the original magazine about high fidelity — were written by the men who actually worked on the system approved by the FCC. The articles pertaining to TRANSISTORS IN AUDIO APPLICATIONS cover interesting aspects of designing with the semiconductor. ■ As in previous editions of the AUDIO ANTHOLOGY, the SIXTH is a compilation of important articles which appeared in AUDIO over a period of about two years. And, all of the articles were written by knowledgeable and experienced authorities in the field. ■ The SIXTH AUDIO ANTHOLOGY is a meaningful reference for everyone in the diverse fields of audio engineering, recording, broadcasting, manufacturing and servicing of components and equipment, and for the audio fans who made this business of high fidelity what it is today.

SAVE!— Save \$1.95 by ordering the 5th AUDIO ANTHOLOGY at the same time. Both the 5th and 6th sent postpaid* at the special low price of \$5.95...regular price of both is \$7.45!

*POSTPAID anywhere in the U.S.A. Add 25¢ per book for foreign orders.

RADIO MAGAZINES, INC.
Dept. A-6
Post Office Box 629
Mineola, New York

Enclosed is my remittance for \$
Please send me the items checked below:

- _____ copies of the 6th AUDIO ANTHOLOGY @ \$3.95 POSTPAID*.
 _____ copies of the 5th and 6th AUDIO ANTHOLOGY at the special combination price of \$5.95 POSTPAID*.

Name _____
Address _____
City _____ Zone _____ State _____

NEW LITERATURE

• **Professional Equipment.** Descriptive literature is available for the new line of products from EMT Wilhelm Franz, handled by Gotham Audio. There are brochures on the EMT 140 reverberation unit, the 930 and 940 turntables, Studer C-37 tape machine, special r.f.-shielded audio cabinets, and other products. Catalogs and literature are also available for Tuchel-Koutakt connectors, Preh linear-motion deposited-carbon pots, and the complete Neumann line of microphones and professional disc recording equipment. Gotham Audio Corporation, 2 West 46th St., New York 36, N. Y. **L-11**

• **Organ Builders Manual.** This manual has 250 pages of detailed information for the amateur electronic organ builder and is designed to answer the needs of the thousands of organ lovers who are turning to the hobby of building an organ in their home. The first chapter, "Planning Your Organ-Building Projects," covers the basic principles of the organ. Subsequent chapters take up the sub-assemblies—tone generators, tone changers and vibrators, power supplies, manuals and couplers, amplifiers, stops, expression pedals and others. It has many illustrations, block diagrams and a progressive assembling outline and tells how to order components for four-manual giants down to one-manual practice models. 8½ x 11 plastic bound, price \$5.00. Artisan Organs, 2476 North Lake Ave., Altadena, Calif.

• **Recording and Broadcast Equipment.** An entirely new informative and illustrative brochure covering professional playback and speech input equipment for audio engineers in the recording and broadcast industries has been prepared by Altec Lansing Corporation. The new brochure entitled "Altec's Playback and Speech Input Equipment for Recording and Broadcast Studios" covers the complete line of the company's playback speaker components, stereo control consoles, power amplifiers, mixer amplifiers, compressor amplifiers, microphones, and network relay tuners with complete technical data and specifications. The "Playback" brochure is available free of charge to recording and broadcast management and engineers by writing to: "Playback," Altec Lansing Corporation, 1515 South Manchester Avenue, Anaheim, Calif. **L-12**

● **Electronic Wire and Cable Catalog.** The Belden 1963 Electronic Wire Catalog #863 is the most complete wire catalog in the industry. New items featured are: 1. Two miniature retractile 4-conductor microphone cables, one with two conductors individually shielded and two unshielded, and the other with four conductors unshielded. 2. A double parallel coaxial cable for stereo, hi-fi, and headphone sets and a totally shielded hi-fi interconnecting cable. 3. Four different neoprene jacketed retractile (coiled) power and control cables. 4. Seven new multiple-pair individually-shielded audio and sound cables ranging from 3 pair to 27 pair using the exclusive Beldfoil "Z" fold 100 per cent shield and polypropylene insulation for excellent high frequency properties and mechanical toughness. 5. A 60-kv d.c. coaxial high-voltage cable. 6. A categorized Instrumentation Section featuring a new miniature coaxial cable using polypropylene which may be steam autoclaved for medical research and two subminiature cables with Beldfoil total shielding. To help cable specifiers locate cables more quickly among the thousands of cataloged items the catalog has a new chart called the Cable Finder. It references the number of conductors, gauges of the conductors, and shield construction to trade numbers and to the catalog page. Belden Manufacturing Company, 415 S. Kilpatrick Avenue, Chicago 44, Illinois. **L-13**

● **Sound Catalog.** A 20-page catalog, "Sound," describing amplifiers and systems for industrial application, is now available from the Commercial Sound Division of Harman-Kardon, Inc. The new catalog, designed as a technical "how to" manual and reference work for buyers of commercial sound components, shows how to evaluate amplifiers and how to design and use a commercial sound system. It points out the pitfalls of loosely defined specifications and fully details the features a prospective buyer should insist on before he chooses a P.A. amplifier. It discusses the importance of certified power output ratings to assure optimum speaker performance; frequency response; and how to evaluate the true response rating of an amplifier. It also discusses the considerations that assure stability and the facilities that determine an amplifier's flexibility—its ability to "grow" with the user's requirements. The catalog contains a sound system design chart to help determine the audio power required for typical applications in restaurants, auditoriums, stores, offices, hospitals, churches, and so on. Complete technical data and photographs of the new Harman-Kardon Commander "CA" Series and Troubador Series of transistorized public address amplifiers are contained in the catalog, as well as information on loudspeakers and microphones. Harman-Kardon, Inc., Commercial Sound Div., 55 Ames Court, Plainview, L. I., N. Y. **L-14**

EQUIPMENT PROFILE

(from page 50)

The polar pattern of the MKH-104 is essentially circular, since it is an omnidirectional unit. Response falls off at the high frequencies only in the direction of the rear or plug end of the housing.

Available as an accessory is a plastic and nylon windscreen which is sufficiently effective that it eliminates the "pop" sound from the words beginning with "p", as well as making it possible to use the microphone in the open without any wind disturbance. Also available are a cable transformer to match the 800-ohm output to 200 ohms, and a transistor amplifier built into a cable plug to give a 0-level output.

Aside from its advantages because of the low supply voltage and current required, the MKH-104 offers the performance normally expected from any high-quality condenser microphone. **L-24**

A MUST FOR EVERY RECORDING & BROADCAST ENGINEER

ALTEC'S COMPLETE LINE OF STUDIO PLAYBACK AND SPEECH-INPUT EQUIPMENT IN ONE HANDY REFERENCE CATALOG.

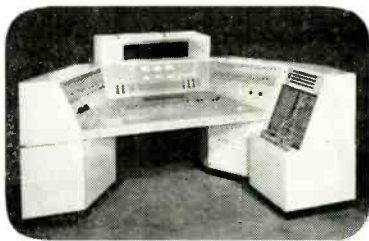

Custom-built Altec control console in ABC-TV's Studio One, New York. Note jack panel containing 720 connections that permit virtually any patching configuration.

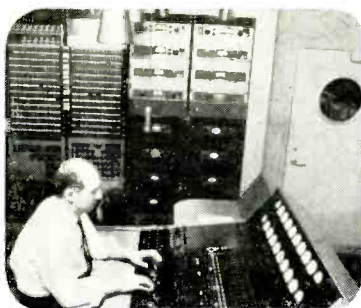

Banks of Altec 128B Amplifiers used for PLAYBACK monitoring by Universal Recording Corp., Chicago.



Control-room view of three A-7 Systems used for 3-channel PLAYBACK monitoring at United Recording Studios, Hollywood.

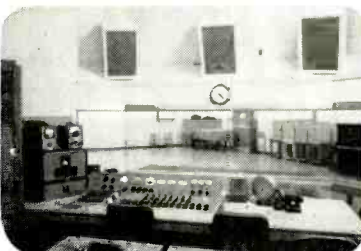

Monitoring with Altec "Duplex"® Speakers in Capitol's control room. More than 70 of these speakers are used throughout Capitol's recording studios in Hollywood.

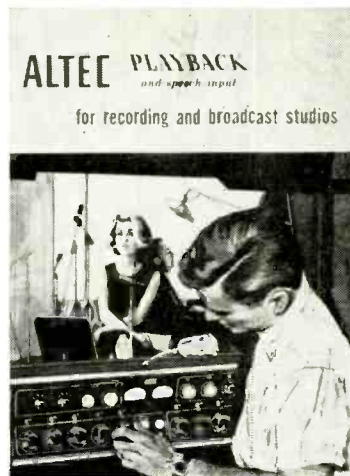

There's no longer any need to search through hundreds of Altec catalog sheets... everything is now together in one "book" especially prepared for the recording and broadcast engineer. In it, you will find complete information on...

● **SPEAKER SYSTEMS** to satisfy most stringent requirements of studio PLAYBACK. Indispensable for accurate A-B comparison of the taped recording with the live rendition for judging accuracy and realism.

● **MICROPHONES** including the only American-made condensers; 8 new models of studio dynamics featuring exclusive Altec Sintered Bronze Filters (some models come with individual, certified calibration curves); famous studio stand-bys, the W.E.-type 639 and 633; plus complete information on the revolutionary new 690A dynamic microphone / transistorized amplifier that directly replaces the carbon transmitter in ordinary handsets to provide broadcast quality in TV and radio programming.

● **AMPS AND PREAMPS** you've used or heard about, including a few that may be new to you. Covered are power, program, compressor, remote mixer amplifiers; preamplifiers; the all-purpose 250 SU Stereo Control Console.

● **TUNERS** guaranteed to meet the most critical FCC broadcast standards. The 314A FM MPX Tuner for the ultimate in multiplex network relay... and for off-the-air executive stereo monitoring, record and tape PLAYBACK, the 708A "Astro," the only AM/FM MPX Tuner-Amplifier with transistorized power output stages.

If you insist on the best in professional PLAYBACK and speech-input equipment, this new catalog is a MUST. Write to Dept. AM10, for your FREE copy now, while a sufficient supply is still available.

©1963 ALTEC LANSING CORPORATION



ALTEC LANSING CORPORATION

A Subsidiary of
LTV Ling-Temco-Vought, Inc.
ANAHEIM, CALIFORNIA

TAPE GUIDE

(from page 34)

Recording 1/4 Track Mono

*Q. I have a *** tape recorder and would like to know how I can record quarter-track mono. Would a slight modification make this possible? There is only one input, but one can play back quarter-track stereo.*

A. I understand that your machine employs separate heads for recording and for playback; and that the record head is half-track, while the playback head is quarter-

track. Therefore it is impossible to record four tracks with your present setup.

For quarter-track recording it would be necessary to replace the half-track record head with a quarter-track one, and install a switching arrangement so that the two leads going to the record head can be switched to either the upper or lower section. At the same time, the requirements of the quarter-track record head might differ from those of the half-track one with respect to audio current and bias current, so that the proper adjustments in the amount of current would have to be made, requiring technical knowledge and instruments. In the case of bias current, this would have to be adjusted to the value recommended by the head manufacturer; it would be measured by inserting a 100-ohm resistor be-

tween the ground lead of the head and ground, obtaining the voltage across this resistor, and computing current on the basis of Ohm's Law. In the case of audio current, this would have to be adjusted so that a recording level at 400 cps resulting in 3 per cent harmonic distortion corresponds to the maximum permissible level as shown by the record-level indicator.

76,000-cps Filter

Q. I am having difficulty in taping FM stereo programs. I own a quarter-track stereo tape recorder whose bias-oscillator frequency is nominally 60,000 cps. I wonder if you could provide details of a multiplex filter that I may construct myself? In the July, 1962, issue of AUDIO you provided an answer to a reader who had a problem of 76,000-cps interference. Can I use that circuit?

A. The solution described in the July issue of AUDIO applies to your case. What you want to prevent from entering your tape recorder is the 76,000-cps signal produced by the multiplex portion of the tuner, this being the second harmonic of the 38,000-cps carrier frequency produced by the multiplex oscillator. The 76,000-cps signal beats with the bias frequency of your tape recorder, and the difference between the two is what you hear. Thus if your tape oscillator frequency is actually 65,000 cps (although nominally 60,000), the difference between this and 76,000 cps would be 11,000 cps, which is audible.

If a homebuilt filter such as that described in the AUDIO article doesn't eliminate your difficulty, I suggest that you try a commercial filter, such as the Viking MX-10. If you still have a problem after all this, I think your problem should be directed to the attention of the manufacturer of your tuner. Æ

HOW IS THE SOUND



SCHOEPS



The 1963 Newport Folk Festival was recorded by Vanguard with **SCHOEPS MICROPHONES**

(Illustrated are The Rooftop Singers)

TRY IT WITH SCHOEPS MICROPHONES

SOUND IS THE CRITICAL FACTOR in your decision about which professional condenser microphone you should select. Technical Data* . . . Curves . . . NOTHING can give you the sound like hearing it yourself. That is why we offer you the Schoeps Microphone on a 30 day trial, with no obligation. Get one . . . and hear the sound!

*You will receive Technical Data with your microphone.

Shown: the M221B with MK26 — 3 pattern capsule



INTERNATIONAL ELECTROACOUSTICS INCORPORATED
333 SIXTH AVENUE NEW YORK 14, N. Y. 212 WA 9-8364

AES CONVENTION

(from page 36)

Transient Frequency Deviations of Oscillators as Measured with Audio Instruments

Charles A. Cady, General Radio Company

On When to Look and When to Listen

S. D. Speeth, Bell Telephone Laboratories, Inc.

An Introduction to Wave Analysis

Arthur R. Soffel, Bissett-Berman Corporation

Thursday, October 17, 1963

9:30 a.m. DISC RECORDING AND REPRODUCTION

Robert C. Moyer, RCA Victor Record Division, Chairman

A Record for Measuring Vertical Pickup Angles

Benjamin B. Bauer and Arnold Schwartz, CBS Laboratories

Tracing Distortion—Its Cause and Correction in Stereoidisc Recording Systems

E. C. Fox and J. G. Woodward, RCA Laboratories

The "Dynagroove" System

Harry F. Olson, RCA Laboratories

The Saga of the Recording Stylus

Arnold Schwartz, Arthur Gust, and Benjamin B. Bauer, CBS Laboratories

A Method for Raising the Load Capability of Stereo Cutters

Horst Redlich and Hans-Joachim Klemp, Telefunken-Decca

On the Damping of Phonograph Pickup Stylus

Benjamin B. Bauer, CBS Laboratories

A Review and Report of the 1963 NAB Recording and Reproducing Subcommittee on Discs

John J. Bubbers, Pickering and Co., Inc.

1:30 p.m. MAGNETIC RECORDING

W. M. Fujii, Ampex Corporation, and Audio Division, Chairman

"State-Of-The-Art" Effects on Magnetic Tape Recording of Scientific Data at the U. S. Navy Underwater Sound Laboratory
William S. Latham, U. S. Navy Underwater Sound Laboratory

Requirements in Performance and Reliability with Design Solutions for a Master Tape Recorder

Rein Narma and W. M. Fujii, Ampex Corporation, Audio Division

A New Magnetic Tape with Greater Dynamic Range

Alfred H. Moris, Minnesota Mining and Manufacturing Co.

Dynamic Range Limitations in Tape Recording

R. Z. Langevin, Ampex Corporation, Audio Division

Extending the Dynamic Range of Magnetic Recorders

Kenneth Clunis, Minnesota Mining and Manufacturing Co.

The Measurement of Instantaneous Speed Stability of Instrumentation-Type Magnetic Tape Transport Systems

Domenic Balducci, U. S. Navy Underwater Sound Laboratory

Mechanical Damping in Tape Transports: Why and How

John G. McKnight, Ampex Corporation, Audio Division

A New Method of Controlling the Hold-back Tape Tension in Tape Recorders for Professional Use

P. Zwicky and F. Hirsch, W. Studer Company

Trends in Magnetic Recording—Reappraisal III

Marvin Camras, IIT Research Institute

Friday, October 18, 1963

9:30 a.m. RECORDING TECHNIQUES

J. G. Woodward, RCA Laboratories, Inc., Chairman

Magnetic Tape Cartridges

Austin A. Knox, Sound Corporation of America

A High Fidelity 1/8-IPS Recording System

Lloyd D. Lubinski, Minnesota Mining & Manufacturing Co.

A System for High-Speed Multiple Duplication of 3-Track 15/16-IPS Magnetic Tape Cartridges

Arthur Kaiser and Henry Mahler, CBS Laboratories

A New and Improved Feedback Monitor System for the Westrex 3C Stereo Cutter

Howard S. Holzer, HAECO (Holzer Audio Engineering Co.)

Psychoacoustics, The Determining Factor in Stereo Disc Distortion

John E. Jacobs and Paul Wittman, Shure Brothers, Inc.

Simulation of Stereophonic Recordings from Monophonic Sources

Jack A. Somer, RCA Victor Record Division

Unified Analysis of Tracing and Tracking Error

Duane H. Cooper, Coordinated Science Lab., University of Illinois

1:30 p.m. FM STEREO TRANSMITTERS AND RECEIVERS

Richard W. Burden, Burden Associates, Chairman

Stereophonic Broadcasting—Past, Present and Future

Harold W. Kassens, Broadcast Bureau, Federal Communications Commission

Monitoring and Measuring the FM-Stereo Broadcast

D. Ridgely Bolgiano, Radio Station WJHA-FM

A Pilot Phase Monitor for FM-Stereophonic Broadcasting

J. Fleming Dias and Jouke Rypkema, Zenith Radio Corp.

A New Stereo-Monophonic Modulation Monitor

A. Prose Walker, Collins Radio Company

FM-Stereo Receiver Performance as a Function of Pilot Circuit Design

A. Csicsatka and R. Linz, General Electric Co.

A Study of SCA Interference in Stereo FM Receivers

Don J. Popp, Zenith Radio Corporation

Stereo Transmission Considerations

John A. Moseley, Moseley Associates, Inc.

Serrasoid and FM Stereo

B. T. Newman, General Electronic Laboratories

7:30 p.m. STEREO AND HIGH FIDELITY

Irving Joel, Capitol Records, Inc., Chairman

The Customers' Dilemma

Anton J. Schmitt, Harvey Radio Company, Inc.

Personal High Fidelity

Benjamin B. Bauer, CBS Laboratories

High Fidelity Through The Years

Irving Joel, Capitol Records, Inc.

PANEL DISCUSSION

James A. Stark
Phonograph Product Engineering, G. E. Company

C. G. McProud
Publisher, AUDIO Magazine

Werner Freitag
Communication Arts Group, New York University

Arnold L. Seligson
Consumers Union

Following the presentations above, there will be an open forum.



“... practically any use that can be imagined is possible with the Uher 8000.”

Audio Magazine couldn't describe it in less than 1,457 words.

Here are some excerpts on the most revolutionary tape recorder to hit the Hi Fi industry in years . . . **Uher 8000 by Martel.**

“There are seven position-four speeds with three OFF positions between. Selecting the speed also adjusts equalization for each. A second switch together with an interlocked RECORD button, controls all of the electronic functions in its eleven positions, which are marked: 1—mono record or play on upper track; 2—mono record or play on lower track; STEREO—record or play; MULTIPLAY I—permits recording on the upper track from microphone and mixing with material from lower track; MULTIPLAY II—permits recording on lower track and mixing material already recorded on upper track; DIA-PILOT I—used for recording from microphone and/or from phono record or another tape machine on upper track as commentary for slides; DIA-PILOT II—after making recorded commentary on upper track, this position is used to record sub-sonic tone on lower track at points where a slide is to be changed and for playback with slide projector thereafter, with the slide changing at each point when the tone button was depressed in the second run-through; ECHO 1—4—permits adding delayed sound to an original recording on upper track, the amount of delay depending on the speed of the tape; ECHO 2—3—same operation for lower track; SYN-PLAY I—used for recording on one track for later recording another signal in synchronism with the first but on a second track when the switch is turned to the SYN-PLAY II position. Thus, practically any trick type of recording can be made with no external interconnecting or switching.

Akustomat makes it possible to use sound as a controlling medium for the recording operation. The machine can be used as a dictating machine, for example, without the need for a start-stop button—one simply speaks and the machine starts recording, and when the dictator pauses, the machine stops. Thus it may be used to monitor and record sounds of an intermittent nature over a long period of time without actually running except in the presence of some sound. We know no other machine which has this feature.

At the slowest speed and in the echo mode, the machine can be used to check pronunciation in the study of languages. One simply says a word, and then hears it back a fraction of time later. The various features of the machine provide a wide range of facilities useful in the study of music or languages. In short, practically any use that can be imagined is possible with the Uher 8000.

If you're interested in the complete review of the Uher 8000, Write for nearest dealer and reprint of complete review.

MARTEL ELECTRONICS / **HOLLYWOOD** 645 N. Martel Avenue Phone (213) 938-2803 / **CHICAGO** 1141 Merchandise Mart Plaza Phone (312) 644-0430 / **NEW YORK CITY** 1199 Broadway Phone (212) 684-0943

Crown
 — first choice
 of those who
 demand the best!

NEW

Solid State
 CONTROL CENTER
 FOR SERIES 800, 1000
 AND 1400 MODELS

**DOUBLES
 former performance**

Quarter-Track Record/Play Data			
ips	db	cps	s/n
7-1/2	±2	50 — 30,000	56db
3-3/4	±2	30 — 20,000	52db
1-7/8	±3	30 — 16,000	50db
15/16	±3	30 — 10,000	48db

The most complete recording instruments ever designed for stereo use. Audio circuitry, ±1/4 db from 10-100,000 cps; extended range, 5-500,000 cps. Plug-in circuit modules are printed on epoxy and gold plated. Engineered to space craft reliability.



THE HALLMARK
 OF CROWN —
 SUPERLATIVE
 CRAFTSMANSHIP
 THROUGHOUT!

INDIVIDUAL PERFORMANCE
 RECORD SUPPLIED
 WITH EACH CROWN

WRITE DEPT. AU-10.

Crown
 INTERNATIONAL
 1718 Mishawaka Rd. • Elkhart, Ind.

CIRCLE 81

**THIS MONTH'S
 COVER**

The equipment shown on the cover this month is located in the home of Mr. and Mrs. Vincent Barsotti, 1150 N. River Road, Des Plaines, Illinois. Mr. Barsotti, formerly a professional cabinet maker, constructed the loudspeaker and equipment cabinetry and also finished the living room which houses this elaborate system.



Fig. 1. The equipment console. When not in use, the turntable base lowers so as to be flush with the sloping panel top.

The equipment (see Fig. 1) consists of the McIntosh MC-240 dual 40-watt amplifier plus an additional MC-40 for a center chan-

nel. A McIntosh C-20 preamplifier is the control center. The Scott 350 FM tuner brings in stereo FM signals. Two tape machines are used, a Grundig TK-64 and a Tandberg 65 deck. The turntable is a Rek-O-Kut N33H with the AP-320 "Auto-poise" arm and Shure M33-5 cartridge. The speakers include a pair of Jensen Model G-610B triaxial 15-in. loudspeakers,

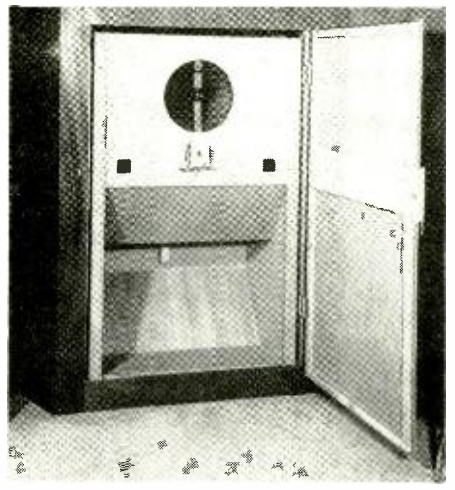

Fig. 2. The Imperial folded horn enclosure with the hinged grille panel swung aside.

each in a Jensen Imperial folded horn (see Fig. 2.), and a direct-radiator speaker in a completely sealed acoustic enclosure for the center channel. The plans for the Imperial folded horn were supplied by Jensen. Mr. Barsotti supplied the labor.

NEW DECOR AND SIZE NEW PERFORMANCE

This is the Exciting New
**"CG" Cavity Generator
 Spherical Sound System.**

"CG" Construction and Performance are uniquely different than anything you have ever known and create a new awakening in Market Standards, in Quality, and in Price!

Check with your local dealer or send for complete information.



Introducing the
CAMILLE SERIES

Size: 17" x 3' x 4 1/4" — Full Frequency Range (without boom). Power: 8 Watts (measured). Propagation: 360 Spherical Degrees. Optional Finishes: Jiled Walnut, Harvest Maple or Lined Oak. Moderately Priced at **\$39.95**

Murray-Carson Corporation

2424 E. 55th STREET, DEPT. 3A, INDIANAPOLIS 20, INDIANA

NEW LISTENING PLEASURE NEW PRINCIPLE
 CIRCLE 70

DISTORTION

(from page 42)

feet. The output at 100 cps and 10,000 cps looked like curve (A) *Fig. 8*, and at 10,000 cps it looked like curve B. When an apparently perfect signal was fed to the network, the third harmonics appeared at the output, as shown in (C) and (D).

Other qualitative methods are possible to indicate small amounts of distortion. For example, an LC network, resonant at about 50,000 cps, can be put in series with the load. An undistorted signal will pass through without alteration. When distortion is present in the signal, it will trigger the network into an oscillatory state. This condition will turn up as pockets of oscillation in an otherwise perfect-looking sine wave.

From all the possible qualitative methods, it appears that the differentiating network in the output circuit is about the most effective in causing small amounts of distortion to be perceptible on an oscilloscope screen.

Estimating Harmonics from 'Scopes

Several methods have been developed which enable one to estimate the harmonic components of signals appearing on the oscilloscope screen. Analyses of these signals have appeared in numerous books.² The complete analysis using these methods are most useful for complex waves. In the analysis required here, only second and third harmonic components are considered to be of any significance. The analysis will be further simplified by the assumption that in all practical situations, the 2π axis can be chosen as at (A) in *Fig. 5*. It is further assumed that only cosine functions and harmonic terms will be present in the signal.

One simplifying factor has been assumed up to now and will continue to be used. This requires some explanation here.

Eq. (7) assumed a zero d.c. component. This means that the area between the signal and the zero axis above the axis is equal to the area between the signal and the zero axis below the axis. In curve (A) of *Fig. 9*, the area *a* above the axis is equal to the area *b* below the axis. Because area *a* minus area *b* is equal to zero, the d.c. component must be zero.

If the zero axis were as in (B) of *Fig. 9*, a negative d.c. component would exist, for the area *d* under the zero axis is greater than that of *c* above the axis. A

² R. W. Landee, C. D. Davis, A. P. Albrecht, "Electronic Designer's Handbook," McGraw-Hill, New York: 1957, pp. 22-8, 22-9, 22-10.



**BENJAMIN
MIRACORD**

shown with new

INTEGRATED COVER/BASE Model CB-1

Attractive as it is protective, the new Integrated Cover/Base keeps your Miracord dust-free at all times—at rest and during play. Consists of clear plexiglass cover hinged to handsome, oiled walnut base. Cover need not be removed or kept open while in use, even when playing records automatically with long spindle. Yet, slip-hinge design permits removal of cover, where desired. Measures $18\frac{3}{8}$ " wide x $14\frac{3}{4}$ " deep x 9" high with cover closed. Complete Cover/Base price is \$19.95. Miracord prices, less base and cartridge: Model 10 (4-pole induction), \$89.50; Model 10H (hysteresis), \$99.50. See them at your hi-fi dealer. For literature, write to:

BENJAMIN ELECTRONIC SOUND CORP. 80 SWALM STREET WESTBURY, N. Y.
U.S. distributor for Miracord turntables, Elac cartridges and Truvox tape recorders.

CIRCLE 71

New!



INSTRUMENTS for AUDIO MEASUREMENTS

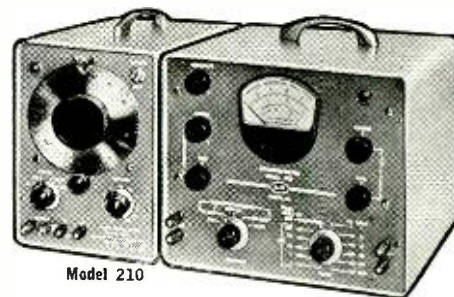

Model 210

Model 410

MODEL 410 DISTORTION METER

- Measures audio distortion, noise level and AC voltages • Also a versatile vacuum tube voltmeter.
- Distortion levels as low as .1% can be measured on fundamental frequencies from 20 to 20,000 cps, indicates harmonics up to 100,000 cps • Distortion measurements can be made on signal levels of .1 volt to 30 volts rms • The vacuum tube voltmeter provides an accuracy of $\pm 5\%$ over a frequency range from 20 cps to 200 KC. For noise and db measurements, the instrument is calibrated in 1 db steps from 0 db to -15 db, the built-in attenuator provides additional ranges from -60 db to +50 db in 10 db steps.

MODEL 210 AUDIO OSCILLATOR

- Provides a sine wave signal from 10 cps to 100 kc • Output level within ± 1 db when working into 600 ohms (reference 5 kc) • Power output, variable to above 150 mw • Hum and noise, -70 db at 5 volts output • Distortion is less than .2% at 5 volts output from 50 to 20,000 cps, slightly higher at higher output and frequency extremes.

These instruments are supplied with many B.C. station installations for FCC Proof-of Performance tests.

BARKER & WILLIAMSON, Inc.
Radio Communication Equipment Since 1932
BRISTOL, PENNSYLVANIA • STILLWELL 8-5581



CIRCLE 82

1963

TORONTO HIGH FIDELITY MUSIC SHOW

Park Plaza Hotel
Avenue Road and Bloor Street,
Toronto, Canada



OCTOBER 30th thru NOVEMBER 2nd

Admission
50¢ Per Person
Badge of Admission Good Every Day



Sponsored and Operated by
DOMINION HIGH FIDELITY ASSOCIATION

Incorporated in 1957 as a non-profit
educational organization

25 Taylor Drive, Toronto 6, Ontario

CIRCLE 72

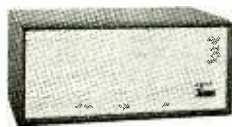

THE *Super Midget*
7-3/16" H x 15 7/8" W x 9 1/2" D
For limited space or as auxiliary unit.

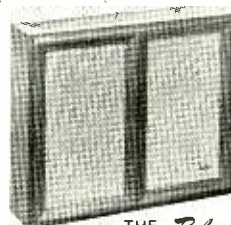

THE *Bel Aire*
19" H x 23 3/4" W x 5 3/8" D
Thin line styled for wall mounting.
Floor stand available.



THE *La Festa*
10 1/2" H x 23 3/4" W x 11 1/8" D
Unique design for bookshelf mounting.



THE *Mark V*
26 1/2" H x 14" W x 11 1/8" D
A truly remarkable speaker.

FOR THE LOVE OF
Sound

From the lowest rumblings of the organ pedal notes to the whispering overtones of the flutes . . . FRAZIER offers a complete series of full range, two-way, and three-way wide range speaker systems employing both the modified Helmholtz principle, and the exponential horn . . . Assuring the ultimate in smoothness, balance, and cleanliness from as low as 28 cycles, to 22,000 cycles in the larger systems. Oil Walnut hand crafted cabinetry. Some models available unfinished. Complete Music Wall "Playmate" Systems available in Oil Walnut and Burma Teak. Price Range \$26.95 to \$310.00. Write for complete details on all models. Over 350 Dealers in U.S. Alone.

FRAZIER
INCORPORATED

2649 BRENNER DR. DALLAS 20, TEXAS

CIRCLE 83

positive d.c. component exists in (c) of Fig. 9, for the size of e is greater than that of f . Actually, all three curves are identical. Only the placement of the zero axis line determines if d.c. components will be present in the mathematical analysis. It simplifies matters considerably if the axis is chosen so that no d.c. will be present and the analysis can be completely accomplished with Eq. (7).

It should also be pointed out that curves do not have to be sinusoidal to have a zero d.c. component. They can take any shape, as shown in Fig. 10.

Considering all these factors, the analysis below is based on the "Fischer Hinnen" method. A rigorous proof can be found in texts.³

First assume an even-function type of signal which contains only second harmonics. The only pertinent terms from Eq. (7) are

$$e = E_1 \cos \omega t + E_2 \cos 2\omega t \quad (13)$$

A drawing of this equation and its component parts is shown in Fig. 11. In (A) the fundamental is shown; in (B), the second harmonic is drawn; and in (C), the two are added to give the total of the two components, which is effectively given by Eq. (13).

In Fig. 11, the amplitude of the signal at 2π is $e_1 = E_1 \cos \omega t = E_1 \cos 2\pi = E_1$; in (B), the amplitude of the harmonic at 2π is $e_2 = E_2 \cos 2\omega t = E_2 \cos 4\pi = E_2$. The amplitude of the signal in (C) at 2π is $e_{2\pi}$. It is equal to the sum of the amplitudes of the components at 2π or

$$e_{2\pi} = E_1 + E_2 \quad (14)$$

Similarly, at 3π , $e_1 = E_1 \cos 3\pi = -E_1$ in (A) of Fig. 11. In (B), $e_2 = E_2 \cos 2(3\pi) = E_2 \cos 6\pi = E_2$. Because the signal in (C) is equal to the sum of the signals in (A) and (B), the sum of the amplitudes of the components at 3π is equal to

$$e_{3\pi} = -E_1 + E_2 \quad (15)$$

Adding Eqs. (14) and (15) will give the relative size of the second harmonic component, which is

$$E_2 = \frac{e_{2\pi} + e_{3\pi}}{2} \quad (16)$$

Subtracting Eq. (15) from Eq. (14) gives the relative size of the fundamental, which is

$$E_1 = \frac{e_{2\pi} - e_{3\pi}}{2} \quad (17)$$

The percentage of the second harmonic can be calculated from Eq. (8), namely

$$\text{Per cent 2nd Harmonic} = \left(\frac{E_2}{E_1} \right) 100 \quad (18)$$

The practical laboratory procedure can be stated simply in several steps. Use a 'scope with d.c. amplifiers and a repetitive sweep.

³ Richard H. Frazier, "Elementary Electric Circuit Theory." McGraw-Hill. New York: 1945, pp. 279-286.

TO
ENJOY
HEADPHONE
STEREO
AT
ITS
BEST



TRY
THIS

A NEW THRILL AWAITS

Slip on the Telex Stereo-Twin Headset. Wearing Glasses? The Telex fits over them. Bouffant hairdo? Never fear. It won't be disturbed. Seven-way adjustment of the stainless steel headband makes sure of that. How does it feel? Featherlight? You're right. Just 12 ounces. Lightest of all quality headsets for long hours of effortless listening enjoyment. Yet solidly constructed for years of trouble free service.

SSHHH!

Those big ultra-soft foam cushions envelop your ears with solid comfort . . . and *silence*. Distracting room noises are sealed off as you would never have believed possible. You're in a new world of your own—ready for a new kind of stereo pleasure.

NOW, UP WITH THE GAIN

Here it comes—a new thrill, a new kind of listening that puts you "in" the recording hall. Your own set, a familiar record . . . yet now so startlingly different. This is stereo as you've never known it. Down to those basses that you "feel" as much as hear—smooth and round at 16 cycles. Now to the brilliantly colored trebles with superb distortion-free peaks at 15,000 cycles. Faithful, flawless sound for the most exacting.

ALL THIS TO YOU FROM TELEX

World leader in private listening devices for industry and entertainment.

TRY TELEX AT YOUR DEALER

The Product of Sound Engineering



TELEX/Acoustic Products

COMMUNICATIONS ACCESSORIES DIVISION

3054 Excelsior Boulevard
Minneapolis 16, Minn.

CIRCLE 73

1. Determine that the curve on the oscilloscope screen has primarily even harmonics, as discussed above.

2. Set up the scope so that two cycles of measurable amplitude are on the screen.

3. Turn the amplifier under test off. Set the vertical position on the scope so that the swept line is coincident with the center of the scope screen. This sets the center of the scope screen as the 0 d.c. level. Do not touch the vertical position control after this.

4. Turn the amplifier on. Adjust the horizontal gain control and position control so that one cycle occupies a measurable portion of the screen. The cycle should be arranged so that it appears as an even function (see (A) of Fig. 5). Most signals will take this form.

5. Measure the amplitude at the beginning of this signal. Refer to this as $e_{2\pi}$.

6. Now measure the amplitude at the middle of the curve. This is $e_{3\pi}$.

7. Use Eqs. (16) and (17) to find the second harmonic and fundamental, and Eq. (18) to determine the percentage distortion.

If a wave exhibits third harmonic characteristics, as determined from Fig. 6, a similar line of analysis may be pursued. The pertinent terms from Eq. (7) are

$$e = E_1 \cos \omega t + E_3 \cos 3\omega t \quad (19)$$

It is assumed that the curve can be made to fit an even function (no sine components), and that no even harmonics are present, nor are any harmonics above the third present. Finally, it is assumed that the d.c. component is zero. All these conditions can be readily realized in practice.

The drawing of the component parts of Eq. (19) is shown in Fig. 12.

While from Fig. 11, two equally spaced ordinates in one cycle were required to find the second harmonic components, three equally spaced ordinates must be determined from Fig. 12 to find the magnitude of the 3rd harmonic component. These three ordinates are at 2π or 360 deg., $8\pi/3$ or 480 deg., and $10\pi/3$ or 600 deg.

Now consider the three significant ordinates in sequence.

At 2π , the amplitude of the fundamental is $e_1 = E_1 \cos \omega t = E_1 \cos 2\pi = E_1$; the amplitude of the harmonic is $e_3 = E_3 \cos 3\omega t = E_3 \cos 6\pi = E_3$. Then

$$e_{2\pi} = E_1 + E_3 \quad (20)$$

At $8\pi/3$, which is identical to $2\pi/3$, the amplitude of the fundamental is $e_1 = E_1 \cos \omega t = E_1 \cos 2\pi/3 = -E_1/2$; the amplitude of the harmonic is $e_3 = E_3 \cos 3\omega t = E_3 \cos 6\pi/3 = E_3$. It follows that

$$e_{8\pi/3} = -E_1/2 + E_3 \quad (21)$$

At $10\pi/3$, which is identical to $4\pi/3$, the amplitude of the fundamental is $e_1 = E_1 \cos \omega t = E_1 \cos 4\pi/3 = -E_1/2$; the

"...major
step
forward..."

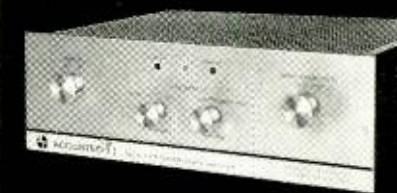
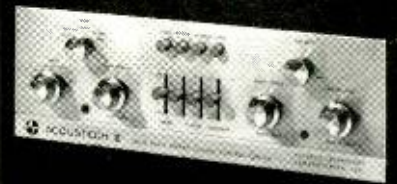

ACOUSTECH SOLID STATE AMPLIFYING SYSTEM

"... better than the best**"
"... seems to 'grab hold of' and control a speaker to a degree that has led many listeners to remark that the speaker itself 'never sounded better.'**" ... the finest square wave response I have ever observed**"

These are examples of the acclaim accorded the Acoustech I Solid State Stereo Power Amplifier since its introduction at the 1962 New York High Fidelity Show. Now the first "all-out" solid state amplifying system is made possible with the new Acoustech II Stereo Decade Control Center. These two units afford the listener a new standard in music reproduction and reliability possible only with solid state circuitry throughout.

For full information on these remarkable instruments, send coupon below.

Acoustech I \$395, Acoustech II \$348 (slightly higher west of Rockies)

*High Fidelity Magazine, August, 1962
**HiFi/Stereo Review, February, 1963



ACOUSTECH, Inc., 139 Main St.
Cambridge, Mass. 02142 Dept. A-10

Name _____

Address _____

City _____ State _____

CIRCLE 84

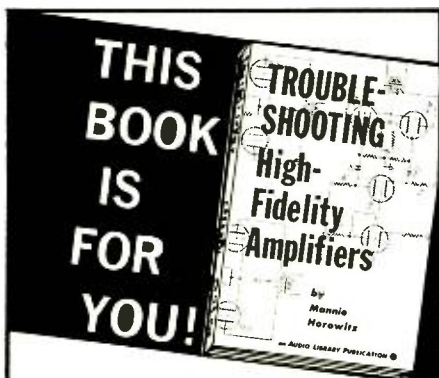

This book is for the hobbyist and technician who wants to know the plain and simple approach to **TROUBLESHOOTING HIGH FIDELITY AMPLIFIERS**.

Written by Mennie Horowitz, his fact-filled, illustrated chapters spell out the most direct approach to curing both, vacuum tube and transistorized amplifier ills. Everything from instruments and test procedures, to servicing transistorized stereo amplifiers, is covered in a writing style that makes it easy to read and absorb.

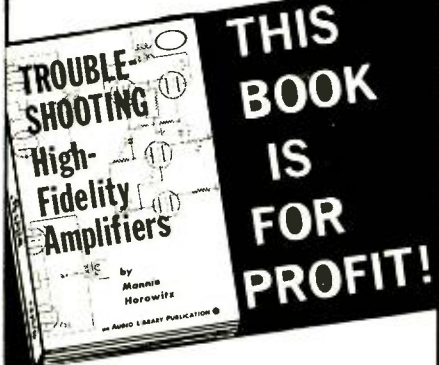

TROUBLESHOOTING HIGH FIDELITY AMPLIFIERS was written specifically for the service technician and the audio hobbyist who specializes—or wants to specialize—in the growing and highly profitable field of audio and high fidelity service and repair.

A wealth of information
—makes a perfect gift!

only \$2.95—Use convenient coupon below, just enclose your remittance—we pay the postage.

Radio Magazines, Inc., Dept. T62
P.O. Box 629
Mineola, New York, 11502

I am enclosing \$_____, please send me _____ copies of **TROUBLESHOOTING HIGH FIDELITY AMPLIFIERS***, by Mennie Horowitz.

NAME _____
ADDRESS _____
CITY _____ ZONE _____ STATE _____

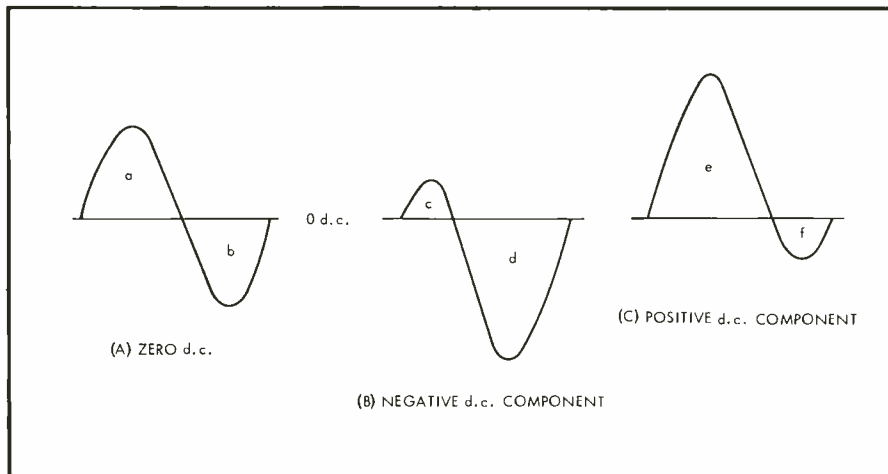

Fig. 9. Comparison of d.c. levels helps in identifying the order of harmonic distortion.

amplitude of the harmonic is $e_3 = E_3 \cos 3\omega t = E_3 \cos 3\pi = E_3$. Thus

$$e_{10\pi/3} = -E_1/2 + E_3 \quad (22)$$

The sum of Eq. (20), (21), and (22) give the relative size of the third-harmonic component. This is

$$E_3 = \frac{e_{2\pi} + e_{8\pi/3} + e_{10\pi/3}}{3} \quad (23)$$

The relative size of the fundamental can be found by subtracting Eqs. (21) and (22) from two times Eq. (20). This gives a relative fundamental amplitude of

$$E_1 = \frac{2e_{2\pi} - e_{8\pi/3} - e_{10\pi/3}}{3} \quad (24)$$

From Eq. (23), (24), and (8), the per cent of third-harmonic distortion is

$$\text{Per cent 3rd Harmonic} = (E_3/E_1) 100 \quad (25)$$

The practical step-by-step procedure is identical to that applying to the second-harmonic case, with the exception of the ordinates under consideration. Before applying the step-by-step procedure, it must be determined whether the signal contains second or third harmonics. Then proceed accordingly with the test.

Some readers may be concerned with the incomplete analysis, where sinusoidal components are omitted. Experience shows that most types of distortion found in an amplifier can be considered as an even-function phenomenon. Furthermore, the method described, though useful, is approximate. Neglecting odd functions should add little to any error.

Exact Measurement Techniques

So far, two methods to determine harmonic distortion were discussed. The first, using a differentiating network, just indicated if any distortion was present in the signal. The second was a method of estimating the quantity of distortion.

Instruments used to measure harmonic distortion were discussed in a previous article¹ of this series.

¹ Mennie Horowitz, *AUDIO*, January, 1962, pp. 21, 22.

One instrument, the wave analyzer, is used to measure the amplitude of each harmonic component and the fundamental. The data from these measurements are substituted into Eq. (8) to calculate the percentage of harmonic distortion.

Some engineers prefer to use a weighted value for percentage distortion. It is weighted as a function of the number of the harmonic. The weighted distortion factor is

$$\frac{1}{2} \left(\frac{\sqrt{(2E_2)^2 + (3E_3)^2 + (4E_4)^2 + (5E_5)^2 + \dots}}{E_1} \right) 100 \quad (26)$$

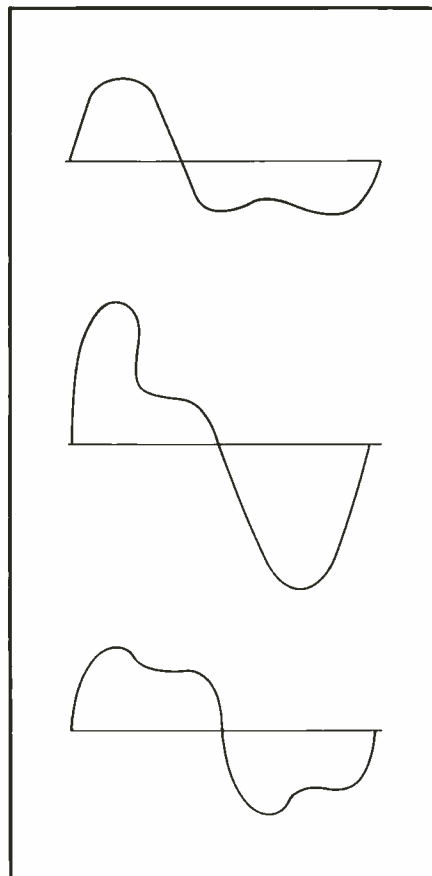

Fig. 10. Examples of curves adjusted to have a zero d.c. component.

Whichever system provides the most valid number for the percentage of distortion, it is certain that stated specifications will reject the use of Eq. (26) because the distortion figure is larger than that provided by Eq. (8).

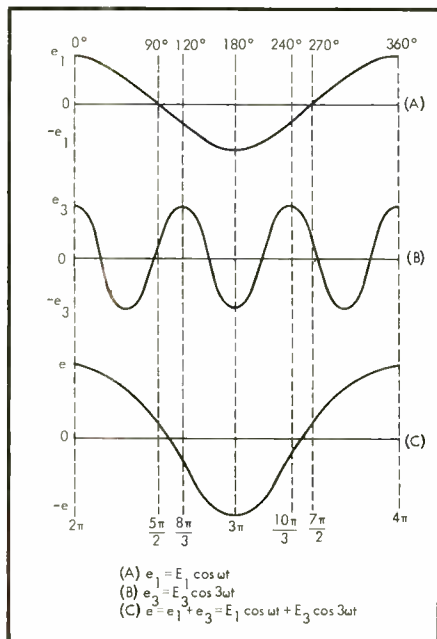

Fig. 11. A signal with second harmonics (C) is made up of the component parts, (A) and (B).

A second instrument, the harmonic distortion meter, first measures the size of the composite signal — the fundamental and the harmonics. The fundamental is then filtered out. The remaining harmonics are measured. The ratio of the two measurements multiplied by 100 provides the solution to Eq. (9) for percentage of harmonic distortion. This percentage can be read directly on the meter, for the two measurements are only relative. The reading is accurate at low percentages of distortion.

Exact readings must be made under exacting conditions. Several factors must be taken into account so that the measurements will be valid.

1. The response of the amplifier under test should be relatively flat. Deviations would tend to weigh the reading in one direction or the other. Switch out all filters and adjust tone controls to the best position for a reasonably flat response.

2. Use only high-level inputs. Phono and tape-head inputs do not have a flat response and will give weighted results.

3. Feed the amplifier from a low-distortion signal generator or use filters at the output of the generator.

4. The line voltage is a factor in the distortion reading. Adjust the line voltage to a standard value with a Variac

and monitor it with a meter throughout the test.

5. Make tests after the unit has been on for 1 hour. The power transformer heats up with time causing d.c. and filament voltages to drop. One hour can be considered as the average time during which an amplifier may be used. This can be used as a standard until any other time limit may be established by the industry.

6. Measurements should be made at all audio frequencies.

7. Measurements should be made at the 1-watt level as well as at the rated power of the amplifier.

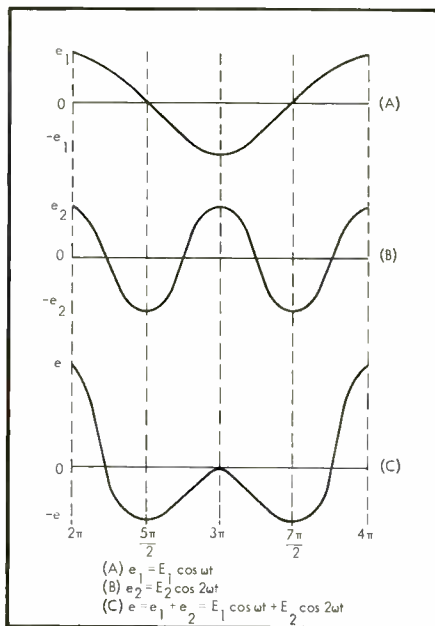

Fig. 12. A signal with third harmonics (C), and its component parts, (A) and (B).

8. Observe the output from the distortion meter on an oscilloscope. This is important in determining just what portion of the measurement is due to distortion and what portion is due to hum and noise. The percent of the measurement which represents distortion should be calculated from the thickness of the signal as it appears on the scope.

The dividing line between high fidelity and ordinary reproduction has been considered 0.5 per cent harmonic distortion. Amplifiers with lower percentages of distortion do sound better and are thus most desirable. AE

IF YOU ARE MOVING

Please notify our Circulation Department at least 5 weeks in advance. The Post Office does not forward magazines sent to wrong destinations unless you pay additional postage, and we can NOT duplicate copies sent to you once. To save yourself, us, and the Post Office a headache, won't you please cooperate? When notifying us, please give your old address and your new address.

Circulation Department
RADIO MAGAZINES, INC.
P. O. Box 629, Mineola, N. Y.

ENTICING



ADC-12 at \$139.50

ALLURING



ADC-14 at \$175.00

TEMPTING



ADC-16 at \$220.00

EXCITING

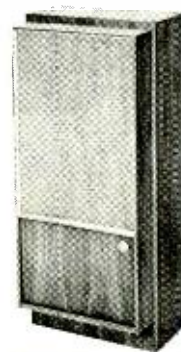

ADC-18 at \$250.00

Let only your pocketbook be your guide.

You're right with any one of these ADC speaker systems. They all have the exclusive rectangular woofer and the Mylar domed tweeter . . . from the value-packed new ADC-12 at \$139.50 to the top-rated ADC-18.



AUDIO DYNAMICS CORPORATION
PICKETT DISTRICT ROAD,
NEW MILFORD, CONNECTICUT

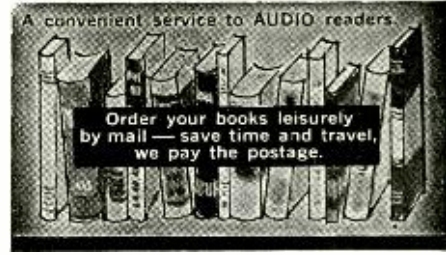

Maintaining Hi-Fi Equipment
Joseph Marshall
 A valuable reference for anyone whose living or hobby is servicing hi-fi equipment. Outlines the professional approach for servicing all types of hi-fi components. Covers trouble-shooting of electronic, mechanical and acoustic problems. 224 pages.
No. 58 Paperback \$2.90*



Designing and Building Hi-Fi Furniture
Jeff Markel
 Written by a professional hi-fi furniture designer who has taught furniture design at leading colleges, this book is an authentic reference of value to the hi-fi fan and professional custom builder. Covers everything from types of woods to furniture finishing for the mechanically adept; design principles, styles and arrangements for the decor minded. 224 pages.
No. 79 Paperback \$2.90*



"The AUDIO Cyclopedia" • 1280 pages
Howard M. Tremaine • 3400 topics
 • 1600 illustrations

Here is one single volume with the most comprehensive coverage of every phase of audio. Concise, accurate explanations of all audio and hi-fi subjects. More than 7 years in preparation—the most authoritative encyclopedic work with a unique quick reference system for instant answers to any question. A vital complete reference book for every audio engineer, technician, and serious audiophile.



No. 123 \$19.95*

McProud High Fidelity Omnibook
 Prepared and edited by C. G. McProud, publisher of Audio and noted authority and pioneer in the field of high fidelity. Contains a wealth of ideas, how to's, what to's, and when to's, written so plainly that both engineer and layman can appreciate its valuable content. Covers planning, problems with decoration, cabinets and building hi-fi furniture. A perfect guide.
No. 115 \$2.50*

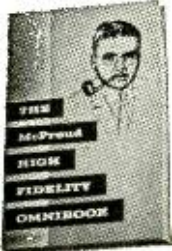

Handbook of Sound Reproduction
Edgar M. Villchur
 Right up to date, a complete course on sound reproduction. Covers everything from the basic elements to individual chapters of each of the important components of a high fidelity system.
No. 110 \$3.75*



The 5th AUDIO Anthology
 Edited by C. G. McProud, publisher of AUDIO. An anthology of the most significant articles covering: stereo recording and reproduction; stereo multiplex; measurements; stereo technology, construction and theory — which appeared in AUDIO during 1958 and 1959. The 5th is truly a collectors' item and a valuable reference for the professional engineer, teacher, student, hobbyist and hi-fi fan. 144 pages.
No. 125 \$3.50

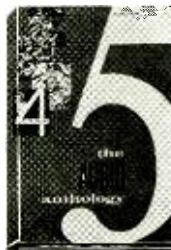

Tape Recorders and Tape Recording
Harold D. Weiler
 A complete book on home recording by the author of *High Fidelity Simplified*. Easy to read and learn the techniques required for professional results with home recorders. Covers room acoustics, microphone techniques, sound effects, editing and splicing, etc. Invaluable to recording enthusiasts.
No. 112 Paper Cover \$2.95*



"the best of AUDIO" —
 edited by C. G. McProud

A new compendium of AUDIO knowledge. Here is a collection of the best of AUDIO — The AUDIO Clinic by Joseph Giovanelli . . . noted audio engineer and the original high fidelity answer-man — EQUIPMENT PROFILES edited by C. G. McProud . . . Editor of AUDIO. Here is a wealth of hi-fi and audio information. Answers to the most important issues in high fidelity and a valuable reference.
No. 124 Volume I \$2.00*



AUDIOGUIDE
 By the editors of AUDIO, the original magazine about high fidelity. A 1962-1963 product review of stereo high fidelity components. Valuable reference for the high fidelity enthusiast and hobbyist. Part I contains a thorough discussion of the Problems of a Stereo Installation; Part II is a complete treatise on Selecting a Tape Recorder. Indispensable to the prospective buyer of stereo components and tape recorders. Includes a section on where to buy various stereo hi-fi components and accessories. 156 pages.
No. 127 \$1.00

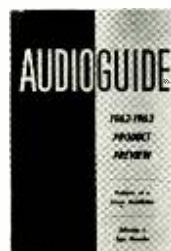

● MONTHLY SPECIAL! SAVE \$5.25

Save over 45% with this collection of AUDIO Books.
 Handbook of Sound Reproduction (\$3.75) "best of AUDIO" (\$2.00)
 McProud High Fidelity Omnibook (\$2.50)
 Tape Recorders & Tape Recording (\$2.95)

TOTAL VALUE OF ALL FOUR BOOKS \$11.20

Your cost ONLY \$5.95 POSTPAID

This offer expires November 30, 1963. Good only on direct order to Publisher
CIRCLE OS300

High Fidelity Simplified 3rd Edition
Harold D. Weiler

The complete hi-fi story — answers all questions about tuners, changers, amplifiers, tape recorders, speakers, record players, etc. Lots of ideas for custom installations. Tells how to achieve concert hall reception in your home. 216 pages.
No. 142 \$3.30



AUDIO Bookshelf — RADIO MAGAZINES, INC. *All U.S.A. and CANADIAN orders shipped postpaid.
 P. O. Box 629, Mineola, New York 11502

Please send me the books I have circled below. I am enclosing the full remittance of \$..... (No C.O.D. or billing.)

58	79	110	112	115	123
124	125	127	142	251	OS300

NAME _____
 ADDRESS _____
 CITY _____ ZONE _____ STATE _____

Getting The Most Out Of Your Tape Recorder
Herman Burstein

Written in "plain talk" for the man who has, or wishes to buy, a tape recorder. It answers the myriad questions raised by tape recording enthusiasts. Its chapters cover every phase of operation and maintenance—from adding a tape recorder to the hi-fi system, to a thorough dissertation on microphones. Lots of practical information on how to buy. 176 pages.
No. 251 \$4.25



STEREO MIKE MIXER

(from page 22)

such a connection, thus eliminating much of the amplifier noise which comes from the first stage.

Incidentally, the PK544 amplifier is designed for operation from a 9-volt battery, and may be seriously damaged by operation at higher levels. In fact, the author sought to increase the available output voltage from the mixer by increasing the battery supply voltage to 15 volts, at which time both PK544 amplifiers started to smoke. If the battery voltage is increased for any reason, therefore, provide a 9-volt tap on the battery supply to accommodate the monitor amplifiers.

Over-all Construction

The mixer is housed in a Bud SB-2143 shadow cabinet. The general location of all components can be determined from Fig. 12. As shown in this figure, construction is easy and roomy. All of the tight wiring is done on the component boards, and only a few components are located on the chassis itself. The only tight location is the front panel. Arrangement of controls and meters on the front panel is difficult to permit best operation and yet provide for functional placing of all controls.

Lever switches are used for S_1 - S_5 . Placing each switch to the left position connected the corresponding circuit to the left channel, and placing the switch in the right position connects the corresponding circuit to the right channel. The center position of each switch corresponds to the cue circuit. As a result, the VU meters are located at each end of the panel, the input controls and switches are in the center, grouped together. The output master volume controls are located directly below the corresponding VU meter. The monitor controls are located at the extreme left and right ends of the chassis. If a larger chassis and panel were used for the mixer, placement of the two VU meters next to each other would facilitate

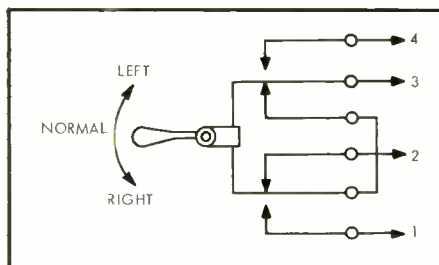

Fig. 13. Connections to Switchcraft S3036L for use as switches S_1 - S_6 . Terminal numbers correspond to Fig. 2.

matching of the two stereo channel levels.

All of the components are standard, except for the VU meters which are miniature units designed to fit limited space. Switchcraft lever switches type S3036L were used for S_1 - S_6 , because they mount in a round hole which is easily drilled, as opposed to other lever switches which required specially shaped panel openings. The connections to the switch to permit it to be used in the mixer circuitry are shown in Fig. 13.

Conclusion

The microphone mixer described here is a very versatile unit which permits use for both high- and low-level inputs, including microphones, magnetic phono cartridges, and amplifiers. Input transformers permit a balanced input for microphones. Outputs are available for both headphone monitoring as well as for speakers.

The output is at 8000 ohms, and has a maximum undistorted value of slightly above 1.5 volts rms. If greater output is desired, the output amplifier can be operated from an 18-volt supply (but see precautions under monitor amplifiers). This output is essentially useful for driving a long shielded line into an unbalanced high-impedance input of an amplifier. Assuming a good quality shielded cable of approximately 20 pf capacitance per foot, 50 feet of cable will result in a drop of only 3 db at 20,000 cps.

For use in remotes for broadcast use, an external driver amplifier must be used with the mixer to produce sufficient level to drive a telephone line. This is required because of limited battery power in the mixer, which prevents the inclusion of the required 600-ohm output for driving broadcast equipment. The 600-ohm balanced outputs of broadcast equipment are usually rated for levels of at least +20 VU, which is equivalent to 100 milliwatts power. Assuming an efficiency of 40 per cent (since a class A amplifier is virtually required for this application in transistor circuits) and the existence of two channels each of which must provide 100 milliwatts, the required battery power is around 1 watt (including the quiescent drain of the rest of the mixer circuits). The battery required to provide such power over periods of several hours in broadcast use is beyond the size limits of the mixer. An external line amplifier, located some distance away if required, is the best solution. Æ

the most noise-free recordings you have ever heard

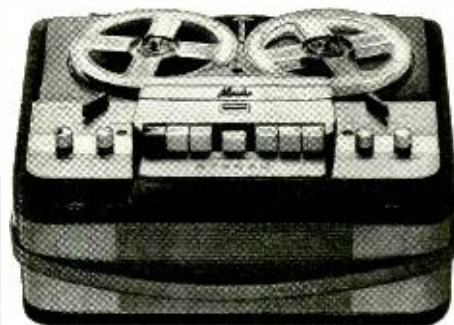

will be made on the new all-transistorized Norelco Continental '401' Stereo Tape Recorder, the only recorder using the newly developed AC107 transistors in its two preamplifiers. The AC107 is the only transistor specifically designed for magnetic tape head preamplifiers utilizing specially purified germanium to achieve the extraordinary low noise figure of 3 db, measured over the entire audio band (rather than the usual single frequency). This noise figure remains stable over large collector-emitter voltage swings and despite large variations in source resistance.

Hear the new transistorized Norelco Continental '401' • 4-track stereo/mono record and playback • 4 speeds: 7½, 3¾, 1½ and the new 4th speed of ¾ ips which provides 32 hours of recording on a single 7" reel • fully self-contained with dynamic stereo microphone, two speakers (one in the removable cover for stereo separation), dual preamps and dual recording and playback amplifiers • self-contained PA system • mixing facilities • can also play through external hi-fi system • multiplay facilities.

Specifications: Frequency response: 60-16,000 cps at 7½ ips. Head gap: 0.00012". Signal-to-noise ratio: better than -48 db. Wow and flutter: less than 0.14% at 7½ ips. Recording level indicator: one-meter type. Program indicator: built-in, 4-digit adjustable. Inputs: for stereo microphone (1 two-channel); for phono, radio or tuner (2). Foot pedal facilities (1). Outputs: for external speakers (2), for external amplifiers (1 two-channel); headphone (1). Recording standby. Transistor complement: AC 107 (4), OC75 (6), OC74 (2), OC44 (2), 2N1314 (2), OC79 (1). Line voltage: 117 volts AC at 60 cycles. Power consumption: 65 watts. Dimensions: 18½" x 15" x 10". Weight: 38 lbs. Accessories: Monitoring headset and dual microphone adapter.

For a pleasant demonstration, visit your favorite hi-fi dealer or camera shop. Write for Brochure A-7. North American Philips Company, Inc., High Fidelity Products Division, 100 East 42nd Street, New York 17, New York.

Norelco[®]

PURCHASING A HI-FI SYSTEM?

TRADE-INS OK—TIME PAYMENTS
Up to 2 years to pay!

Send Us
Your List Of
Components
For A
Package
Quotation

**AIREX
WON'T BE
UNDERSOLD**

All merchandise is
brand new, factory
fresh & guaranteed.
Visit our N.Y. Showroom
Free cabinet brochure

**AIREX
RADIO
CORPORATION**

85-AM Cortlandt St., N.Y. 7, WO 4-1820

Jim Lansing*
Altec Lansing
Electrovoice
Jensen
Hartley*
University
Acoustic Research
Janszen • Leak*
Wharfedale
USL Citizen Band
Gonet • Hallcrafters
Texas Crystals
Concertone • Viking
Bell • G.E.
Weathers
Harman—Kardon
Eico • Pilot
Sherwood*
ESL • Frazier
Superscope
Dual Changer
Bogen • Leak
Dynakit • Fisher
H. H. Scott
Finco • ECI
DeWald • KSC Sp Sys
Sony • Roberts
Challenger
Browning
Garrard • Norelco
Miracord
General Radio
Rek-O-Kut
Components
Tandberg*
Fairchild
Pickering • Gray
Audio Tape
Magnecord*
Rockford Cabinets
Artizan Cabinets
* Fair Traded

CIRCLE 78

Quick-See Album File



FRONT-VIEW, FLIP-THROUGH SELECTION

Stop stooping, squinting, straining, to find albums stacked on edge. Quick-See units glide in and out of cabinet or wall for fast, simple selection... you see the full face of your album without removing it. Ends jacket-bottom wear, too. Installs anywhere in five minutes. Sturdy welded steel and ball-bearing construction, brass finish. Nine models for LP's and tape, hold up to 125 albums... available separately or in special cabinet furniture.

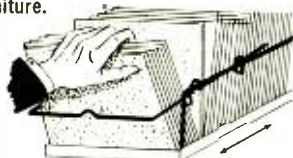

Dealer inquiries invited
KERSTING MFG. CO.
504-K S. Date, Alhambra, California

CIRCLE 85

ABOUT MUSIC

(from page 63)

illustrating her points at the piano. Then the piece is repeated in its entirety. *La Double Audition* has become so successful that it is presented in public.

The "live" programs on France 4 feature "remotes" from concert halls and opera houses throughout Europe, as well as performances especially created for the RTF and originating in the broadcasting studios. Most of these programs are shared by France 3. Of the six standing orchestras employed by the RTF, Ars Nova is the newest. Founded by Marius Constant for the express purpose of performing contemporary music, Ars Nova is an ensemble of 16 crack instrumentalists, each of whom was hand-picked by Constant. None of these young virtuosi plays for the Opéra or the Opéra-Comique; they concentrate their efforts upon building a large repertoire of works which other ensembles rarely perform. As musical director and conductor of Ars Nova, Constant plans to give six public concerts and more than a dozen recordings for the RTF annually.

Jean Tardieu had to leave for another appointment, and Constant suggested that we continue the interview over lunch in the self-service cafeteria atop the *Maison de la Radio*. Like most company restaurants, this one was inexpensive, but not *gastronomique*.

We talked about the problems of attracting top talent to the RTF. "Of course, we really can't compete financially with private managements," Constant admitted. "But somehow, prime artists accept our invitations. There are certain compensations: we record virtually every program we produce; and each time a show is repeated, the artist gets 50 per cent of his original fee—what you would call his 'residual'."

After lunch, we returned to the studios. The equipment used in the new RTF building is exclusively French, an engineer pointed out to me. This includes the following components: Lie Belin mixers, Bourdereau cutters, Pierre Clément pickups, SACM and Tolana tape machines, and Elipson loudspeakers (Fig. 2). The new RTF headquarters contain 300 tape machines and 170 turntables, to mention a pair of statistics. A technician drew my attention to an unusual feature of the new studios. Doors between the control booth and the studio have been replaced by a winding sound-proof corridor, thereby giving free access to the studio.

I walked down one of these silent corridors and came upon a program that was being taped for overseas broadcast. Seated around a table were five people speaking in Arabic (Fig. 3). There was a pause in the discussion. The panel moderator signalled to the engineer in the booth. A moment later, the incongruous sound of a harpsichord piece by François Couperin emanated from the Elipson monitor speaker.

Baroque music for the Bedouins—a typical example of France 4's sophisticated approach to music broadcasting. **AE**

CLASSIFIED

Rates: 10¢ per word per insertion for noncommercial advertisements; 25¢ per word for commercial advertisements. Rates are net, and no discounts will be allowed. Copy must be accompanied by remittance in full, and must reach the New York office by the first of the month preceding the date of issue.

HIGH FIDELITY SPEAKERS REPAIRED
AMPRITE SPEAKER SERVICE
168 W. 23rd St., New York 11, N. Y.
CH 3-4812

ENJOY PLEASANT SURPRISES? Then write us before you purchase any hi-fi. You'll be glad you did. Unusual savings. Key Electronics, 120 Liberty St., New York 6, N. Y. (Loverdale 8-4288).

SALE ITEMS—tapes—package quotes. Bayla, Box 1131-0, Wantagh, N. Y.

MILITARY DISCOUNT—name brands. Free recording tape and stereo handbook. Include rank, serial number. Electronics International, Inc., Box 3066, Charlottesville, Virginia.

WRITE for lowest quotations, components, recorders. No catalogs. HI-FIDELITY SUPPLY, 2817-3C Third, New York 55, N. Y.

HI-FI COMPONENTS, tape recorders, at guaranteed "We Will Not Be Undersold" prices. All brands in stock. 15-day money-back guarantee. 2-year warranty. Write your requirements for quotation. No catalog. Hi-Fidelity Center, 1797-V 1st Ave., New York 28, N. Y.

STEREO TAPE: 50% off. Send for free literature. P. O. Box 3603, Wichita, Kansas.

MAY WE GIVE YOU our quote on your HI-FI requirements? You'll be pleasantly surprised that what you had in mind won't cost as much as you thought. We carry all brands in stock. Components are new and fully guaranteed. Ask to be put on our mailing list for special bargains. Crown Electronics Corp., 64 Cortlandt St., New York 7, N. Y. (212) WO 4-0790.

WANTED: Pair Marantz Model 3 electronic crossovers. Joe Pasano, 2123 18th South, Seattle 44, Washington.

AMPEX 601, \$225; AR-3, \$95; Rek-O-Kut turntable B-12GI with stereo arm, cartridge, base, \$75; Empire arm and \$80-P cartridge, \$25. Many other items, test equipment, etc. Send for list. S. J. White, S2 Elm St., New Rochelle, N. Y.

FOR SALE: 4-channel microphone mixer, Lo-Z, 150/250 ohm (Amplex), \$80. 50-watt, 3101 Langevin amplifier, 600 ohms in, 15 ohms out, \$50. ADC 12-pair patch strip, rack mounted, \$25. Alto Sound Studios, Inc., 236 West 55 St., New York 19, N. Y. (212) PL 7-1664.

HEWLETT-PACKARD 130A oscilloscope. Perfect condition in original carton. Cost \$650, sell \$300. Brand new Ampex 936 tape player (with preamplifiers) \$150. R. J. Entringer, 3040 Browning, San Diego 6, California.

HI-FI RECORDS made from your tape. Any quantity, lowest prices in U. S. Write for prices. Ewing-Hutchison Sound Productions, Box 185, Union, Dept. A.

SELL: Two Acrosound Ultralinear amplifiers, 60 watts each. New tubes. One new board. Both perfect. \$100. Aronovici, 99 Hagues Mill Road, Ambler, Pennsylvania.

HARPSICHORD. Same as owned by Philadelphia Orchestra and RCA Victor. In kit form for home workshop assembly, \$150. Clavichord kit, \$100. Free brochure. Write: Zuckermann Harpsichords, Dept. R, 115 Christopher St., New York 14, N. Y.

SAVE OVER 40% ON HI-FI

USE OUR EASY-PAY-PLAN UP TO 24 MONTHS TO PAY

Don't Buy Hi-Fi-Components Tape Recorders or Electronic Equipment until you get return mail quotation from "your friend in the business."

- * Trade-Ins—Highest Allowance—Send us your list.
- * 15 day money-back guarantee.
- * Full 2 year-warranty—parts & labor.
- * We are factory franchised all lines. We ship from stock.
- * 18th year of dependable & reliable service throughout the world.
- * We guarantee "We Will Not Be Undersold."
- * Call us at (212) EN-9-3700 from any part of USA. You may deduct 3 minute toll charge if your order is in excess of \$100.00.

BEST BUY HI-FI LIST FREE

Send 10¢ for stereo tape catalog—All labels. Save up to 33-1/3%.

1797-U First Ave.
N. Y. 28, N. Y.



CIRCLE 86



BULK TAPE REELS!

1000 lot prices (assorted)

3" (1 1/4" hub)	4 1/2¢
3 1/4" (1 1/4" hub)	6 1/2¢
3 1/4" (15/16" hub) "Geloso" type	10¢
3 3/8" (DeJur-Stenorette type)	11¢
4" (1 3/4" hub)	11 1/2¢
5" (1 3/4" hub)	12¢
5" (3" hub)	17 1/2¢
5 3/4" (1 3/4" hub)	17¢
5 3/4" (2 3/8" hub)	18¢
7" (2 1/4" hub)	14¢
7" (2 1/4" hub) Heavy Duty 6 spoke	16 1/2¢
7" (4" hub) professional type	18¢
10 1/2" (metal) New	1.44
10 1/2" (metal) USED	.72
10 1/2" (fiberglass 3/4" center hole)	.84
10 1/2" (fiberglass 3/4" center hole)	.84

Write for Complete 4 Track Stereo Catalog and Wholesale Prices for Blank Tape & Recorders.

SAXITONE TAPE SALES

1776 Columbia Road, N.W. Washington (20009), D. C.

CIRCLE 87

AUDIO unlimited, inc.

Specializes in SAVING YOU MONEY

- FACTORY FRESH COMPONENTS
- LOWEST POSSIBLE QUOTATIONS
- FAST DELIVERY
- TIME PAYMENTS UP TO 36 MOS.

We are FRANCHISED by OVER 50 NATIONALLY FAMOUS MANUFACTURERS. WRITE FOR BARGAIN LIST.

Visit Our Warehouse 715A 2nd Ave., (Inr. 38th) New York 16, New York

CIRCLE 88

TAKE THE TIME

... to write to us and we will show you how to keep your HI-FI COSTS LOW!

BRITISH EQUIPMENT—Amplifiers, Tuners, Speakers, Motors, Pick-ups from the United Kingdom HI-FI Mail Order Specialists carefully packed, insured and shipped promptly at minimum cost. Send \$1.00 for catalogue.

C. C. GOODWIN (SALES) LTD. (Dept. A)

7, The Broadway, Wood Green, London N.22, England.

CIRCLE 89

CANADA
High Fidelity Equipment
Complete Lines • Complete Service
Hi-Fi Records — Components
and Accessories

ELECTRO-VOICE
SOUND SYSTEMS

126 DUNDAS ST. WEST, TORONTO, CANADA

CIRCLE 90

Industry Notes...

• **General Audio Locates in California.** Arthur C. Davis, latest enterprise, General Audio Company, is located in Santa Ana, California. Producing audio and electronic components and equipment initially for the professional and industrial trade, it expects in addition to prototype for the space-electronics trade. Mr. Davis announced that Mr. James L. Fouch, recently of Langevin, will head up the new organization as General Manager. The firm will specialize in solid-state amplifiers, power supplies, and equalizers designed by its affiliate, Electrical Research Products Incorporated, in the same city.

• **Antenna Maker Names Silverman.** Antronics, Inc., of Teaneck, New Jersey, has named Robert H. Silverman as National Sales Manager. Located at 309 Queen Anne Road in Teaneck, Antronics manufactures boosters and antenna systems in assembled and kit form, including electronic antennas for FM and FM stereo reception and types designed for home and automotive use. Mr. Silverman has an extensive background in FM. He started with WABF-FM in New York City as a copywriter and rose to the position of Sales Manager.

• **Jerrold Repped by Grossman in New England.** The M. C. Grossman Sales Co., Auburndale, Mass., has been named manufacturers representative for the Distributor Sales Division of Jerrold Electronics Corp., in Connecticut, Maine, Massachusetts, New Hampshire, Rhode Island, and Vermont. The Distributor Sales Division of Jerrold Electronics, a subsidiary of The Jerrold Corp., produces a complete line of antennas, reception aids, and TV distribution systems for the color TV market, for FM stereo, UHF, and for the black and white TV markets. Jerrold Electronics' new representative is headquartered at 339 Auburn St., Auburndale, Massachusetts.

• **Weathers, Conley, and A-V Div. Sold by TelePrompTer.** Irving B. Kahn, chairman and president of TelePrompTer Corporation, and R. L. Huffines, Jr., chairman of Defiance Industries, Inc., announced that TelePrompTer has sold three of its operating divisions to Defiance Industries. The transaction includes the Weathers, Conley Electronics, and Audio-Visual divisions of the company. The businesses included the manufacture of Conley endless loop magnetic tape cartridges, Weathers high fidelity components and the basic TelePrompTer branded products, which are sold both as individual equipments and as part of sophisticated large-screen display systems for use in broadcasting, industry, government and education.

• **Superscope Appoints Markoff.** Joseph S. Tushinsky, President of Superscope Inc. of Sun Valley, California, has announced the appointment of Paul A. Markoff as Sales Promotion Manager. Markoff will direct and co-ordinate Superscope's expanding sales promotion and publicity activities for their 1964 line of eleven new Sony/Superscope tape recorders. Markoff comes to Superscope from Concord Electronics where he served in a similar capacity. Prior to Concord, he was with Polaroid Corporation.

FAST SHIPMENTS

RECORDERS • TAPES

COMPONENTS • KITS

- BEST-BY-COMPARISON PRICES.
- FACTORY SEALED CARTONS
- SEND FOR "QUOTES" ON PACKAGE DEALS AND SAVE MORE
- WRITE FOR MONTHLY SPECIALS



CARSTON Studios

125-A. East 88 St., New York 28, N. Y.

CIRCLE 91

FREE!



LAFAYETTE RADIO ELECTRONICS

1964 Catalog No. 640

422 Giant-Size Pages

LAFAYETTE

"World's Hi-Fi Shopping Center" GIVES YOU MORE IN '64

MORE STEREO HI-FI • MORE TAPE RECORDERS • MORE C.B. • MORE TOOLS • MORE TEST EQUIPMENT • MORE HAM GEAR • MORE BOOKS • MORE RADIO & T.V. ACCESSORIES

MORE BUYING POWER—choose from Lafayette's three Easy-Pay Credit Plans. NO MONEY DOWN, up to 24 months to pay, as little as \$5 a month.

Mail the coupon below for your FREE 1964 Lafayette catalog.

LAFAYETTE PROFESSIONAL 4-TRACK RECORD/PLAYBACK STEREO TAPE DECK

99.50

No Money Down \$5 Monthly

Mikes and Case Optional



RK-140K Imported

- Plays 2-Track, 4-Track Stereo; 2-Track, 4-Track, Full-Track Mono
- Records 4-Track Stereo or Mono from FM, AM, FM MPX, Radio or Phono; Live from Mikes
- Complete with 4 Connecting Cables, 7" Take-up Reel

LAFAYETTE 4-TRACK STEREO TAPE RECORDER

129.50

No Money Down

\$7 Monthly



RK-600WX Imported

- Plays 2-Track, 4-Track Stereo; 2-Track, Full-Track Mono
- Records 4-Track Stereo and Mono
- Complete with 2 Mikes, Patch Cords, 7" Take-up Reel, Built-in Record and Playback Preamps

LAFAYETTE RADIO ELECTRONICS

Dept. AI-3 P.O. Box 10
Syosset, L. I., N. Y. 11791

- Rush my FREE 1964 Lafayette Catalog 640
- Send me Stock No. _____, shipping charges collect. \$_____ enclosed.
- I would like to order Stock No. _____ on the Easy-Pay Credit Plan.

Name.....

Address.....

City..... Zone..... State.....

CIRCLE 79

PermoFlux
Dynamic
HEADPHONES



THE ONLY HEADPHONES WITH A
LIFETIME GUARANTEE

PermoFlux presents . . . Absolutely the finest sound in stereo high fidelity today. Professional quality sound with exciting features that add up to the greatest value in stereo listening.

- TONAL STABILITY
- COMPARATIVE FREEDOM FROM HARMONIC DISTORTION
- WIDEST FREQUENCY RESPONSE
- BEST POWER HANDLING
- LONGEST LIFE

Feature for feature your best headphone buy is PermoFlux—with a lifetime warranty. Write for free details.

PERMOFLUX CORPORATION
P. O. Box 1945, Glendale, Calif.
CIRCLE 92

**SEE
YOUR
COSTS
SHRINK
WITH KEY
DISCOUNTS**

Prove it for yourself! Rush us your list of stereo hi-fi components for an immediate price-busting quotation.

Enjoy these advantages:

- LOWEST PRICES
- SPEEDY DELIVERY
- FACTORY WARRANTY
- EASY PAYMENT PLAN

For a real eye-opener, send for our valuable money-saving audio discount catalog A-17, featuring the latest in stereo equipment.



KEY ELECTRONICS CO.
120 Liberty St., N. Y. 6, N. Y.

CIRCLE 93

**ADVERTISING
INDEX**

Acoustech, Inc.	73
Acoustic Research, Inc.	39
Airex Radio Corporation	78
Allan, Richard, Speakers	62
Altec Lansing Corporation	41, 67
American Concertone, Inc.	56
Ampex Corporation	54, 55
Artisan Organs	80
Audio Bookshelf	76
Audio Dynamics Corporation	75
Audio Fidelity Records	53
Audio Originals	6
Audio Unlimited	79
Barker & Williamson, Inc.	71
Benjamin Electronic Sound Corp.	57, 71
British Industries Corporation	3
Carston Studios	79
Classified	78
Concord Electronics Corporation	35
Crown International	70
Dominion High Fidelity Show	72
Dynaco, Inc.	61
EICO Electronic Instr. Co., Inc.	12, 13
Electro-Voice, Inc.	Cov. IV, 1
Electro-Voice Sound Systems	79
Elpa Marketing Industries	63
Empire Scientific	5
Fairchild Recording Equipment Co.	60
Finney Company	4
Fisher Radio Corporation	9, 11
Frazier Incorporated	72
Garrard Sales Corp.	3
Goodwin, C. C. (Sales) Ltd.	79
Harman-Kardon	31
Hi Fidelity Center	79
International Electroacoustics, Inc.	68
Jensen Manufacturing Company	43
Kersting Manufacturing Co.	78
Key Electronics Company	80
Koss Electronics, Inc.	51
Lafayette Radio	79
Lansing, James B., Sound, Inc.	33
3M Company	37
Marfel Electronic Sales, Inc.	69
McIntosh Laboratory, Inc.	65
Murray Carson Corporation	70
North American Philips Co., Inc.	77
PermoFlux Corporation	80
Pickering & Company, Inc.	17
Pioneer	15
Roberts Electronics, Inc.	10
Sarkes Tarzian, Inc.	47
Saxitone Tape Sales	79
Scott, H. H., Inc.	Cov. II
Sennheiser Electronics Corp. (N. Y.)	58
Sherwood Electronic Laboratories, Inc.	18
Shure Brothers, Inc.	29
Sonovox Co., Ltd.	80
Superscope, Inc.	45
Tandberg of America, Inc.	49
Telex, Inc.	73
University Loudspeakers	7
Viking of Minneapolis	Cov. III
Weathers	59

**IT'S NEW...
SPHERICAL
MAGNET
STEREO CARTRIDGE**

MODEL SX-1

TYPE: MOVING MAGNET
RESPONSE: 20 TO 20,000 CPS
OUTPUT BALANCE: ±0.5DB at 1000 CPS
STYLUS: 0.7mm RADIUS DIAMOND

SONOVOX CO., LTD.
101 Tokiwamatsu-cho, Shibuya, Tokyo.

for complete data write to:
STANKEN COMPANY
Box 1191 Burlingame, Calif

CIRCLE 94

free... information on the world's happiest hobby!

ASSEMBLE IT AT HOME
THE Artisan

ELECTRONIC ORGAN KITS
for home, school, church, clubs.

The Original "Build-it-Yourself" Organ
sounds like a glorious pipe organ

SAVE 70% up to 70%

Anyone Can Do It! Here's What You Get

Manuals & Couplers, Tone Generator, Tone Changers, Pedal Keyboards, Consoles

Mail coupon below, and receive . . . absolutely FREE complete information on Artisan's new 1963 Organ-Building Kit! Illustrated instructions lead you through every step of this happy hobby, as you assemble-at-home a magnificent custom Artisan electronic organ — the best in tone and styling! No technical skill required, and you save up to 70% of comparable ready built organ costs by skipping dealer profits and factory labor! You can play as you build and pay as you build. From \$1750 to \$7500. Write today!

ARTISAN ORGANS 2476 "A" N. Lake Ave., Altadena, Calif.

NAME _____
ADDRESS _____
CITY _____ ZONE _____ STATE _____

CIRCLE 80



Command Performance

...at your fingertips

Every time you capture the magnificent world of full fidelity sound on tape.

Taped sound retains full fidelity even after hundreds of playbacks — yours to enjoy always — on VIKING tape components, naturally.

A VIKING invests you with unlimited versatility to record live programs or off the air including F.M. multiplex, duplicate, put sound on sound and edit with perfect ease.

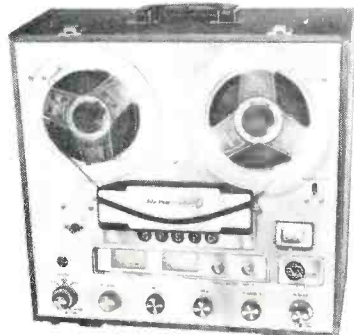

Retro-matic 220—ultimate performance with tomorrow's features for discriminating audiophiles and professionals only.

Two-directional playback, quarter track stereo at two speeds. "Feather-touch" push buttons, remote control, 12 watt amplifier, simultaneous record — playback with 20 - 25,000 cps frequency response. Independent channel controls, "luma-touch" record buttons and illuminated VU meters. Photo electric run-out sensor, four heads, hysteresis capstan motor plus two reel drive motors and digital counter. Superbly styled with stainless steel face plate this compact operates vertically or horizontally.

88 Stereo Compact — for connoisseurs of the fine things in high fidelity stereo sound.

Two speed tape recorder with choice of half or quarter track stereo. Three new type hyperbolic heads—no more old fashioned pressure pads. New design amplifier with excellent 30-18,000 cps frequency response, lets you monitor off the tape with "A-B" comparison switch. Independent channel controls and VU meters, two motors, record indicator light, counter, automatic tape shut-off. With its attractive, brushed aluminum face panel, the 88 Compact fits any installation for vertical or horizontal operation.



Put Command Performance at your finger tips with VIKING tape components — made by skilled American craftsmen.

Tape recorders, transports, cartridge players—even for your car or boat—at reputable high fidelity dealers most everywhere.



VIKING OF MINNEAPOLIS, INC.

9600 Aldrich Avenue South, Minneapolis, Minnesota, 55420

Your assurance
of Quality in
Tape Components



The Most Sweeping Change in Speaker System Design... Starts with the New E-V FOUR!

Until now, there have been just two ways to determine the absolute quality of a speaker system: the scientific method, and the artistic approach. But each, by itself, has not proved good enough.

The scientist, with the help of impersonal equipment, charts and graphs, has strived to obtain the finest possible measured results. If the figures were right, then it *had* to sound right, and anyone disagreeing was dismissed as "not objective". But often, two speakers measured substantially the same, yet sounded quite different.

On the other hand, the artistic school of loudspeaker design has depended on the judgement of a handful of experts whose "golden ears" were the final yardstick of perfection. If you didn't agree with the experts, your ear was "uneducated" and not discriminating. But too often the measured response of the expert's system fell woefully short of reasonable performance—proof that even trained listeners can delude themselves when listening to loudspeakers.

Now, with the introduction of the E-V FOUR, Electro-Voice has pioneered a blend of the best features of both measurement methods to lift compact speaker performance to a new level of quality. It wasn't easy. The use of both techniques required extensive facilities, something E-V enjoys in abundance.

For instance, E-V has one of the industry's largest, most completely-equipped laboratories for the study of acoustical performance. Actually, the E-V engineering staff alone is larger than the entire personnel complement of many other speaker firms. In the E-V lab, measurement of speaker performance can be made with uncommon precision. And the interpretation of this data is in the hands of skilled engineers whose full time is devoted to electro-acoustics.

But beyond the development of advanced scientific concepts, E-V embraces the idea that a thorough study of the

subjective response to reproduced sound is essential. E-V speakers must fully meet both engineering and artistic criteria for sound quality. Where we differ from earlier efforts is in greatly increasing the sample of expert listeners who judge the engineering efforts.

To this end, experts in music and sound from coast to coast were invited to judge and criticize the E-V FOUR exhaustively before its design was frozen. Adjustments in response were made on the spot—in the field—to determine the exact characteristics that define superb performance. It was not enough to say that a unit needed "more bass". What kind of bass? How much? At what frequencies? These are some of the more obvious questions that were completely settled by immediate adjustment and direct comparison.

The new E-V FOUR is the final result of this intensive inquiry into the character of reproduced sound. According to widespread critical comment, the E-V FOUR sound is of unusually high calibre. And careful laboratory testing reveals that there are no illusions—the measurements confirm the critics' high opinion of this new system.

Of course, it is one thing to design an outstanding prototype—and something else to produce an acoustic suspension system in quantity at a fair price. It is here that extensive production facilities, combined with creative engineering approaches, guarantee the performance of each E-V FOUR. And these same facilities ensure reasonable value. For instance, the E-V FOUR sells for but \$136.00 with oiled walnut or mahogany finish and just \$122.00 in unfinished birch. Yet, in judging its sound qualities, it was successfully compared with speaker systems costing as much as \$200.00.

We urge you to join in the analysis of E-V FOUR compact speaker performance. Visit your E-V high fidelity showroom and compare, carefully, this new system. We feel certain that you will agree with the engineers and the critics that the new E-V FOUR offers a truly full measure of high fidelity satisfaction.

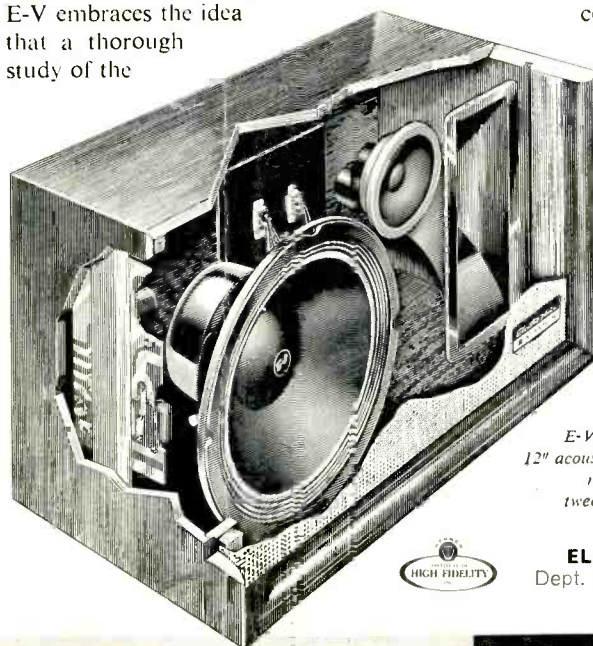

*E-V FOUR components include:
12" acoustic suspension woofer | Ring-diaphragm
mid-range driver | 5" dynamic cone
tweeter | Etched circuit crossover*



ELECTRO-VOICE, INC.
Dept. 1034A, Buchanan, Michigan



E-V TWO



E-V FOUR



REGINA



E-V SDI

