

AUDIO

APRIL, 1957

50¢

ENGINEERING MUSIC SOUND REPRODUCTION

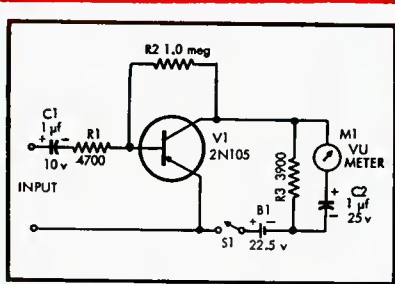

Transistorizing a standard VU meter increases its sensitivity so that it may be used with any tape recorder. See page 22.

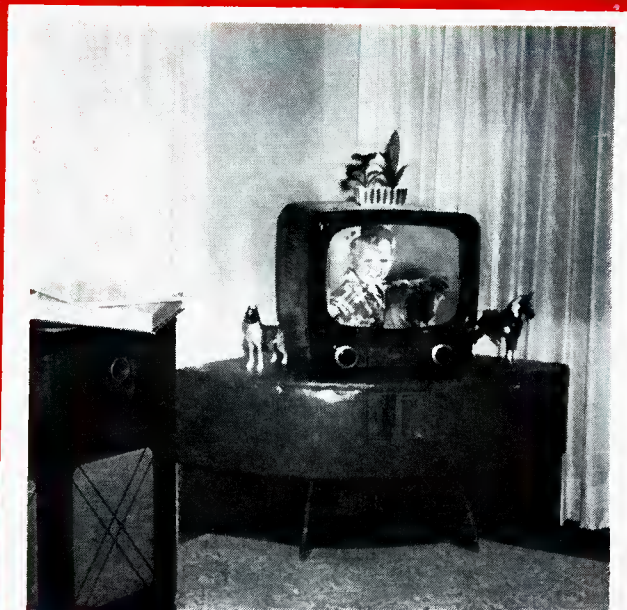

A corner cabinet design that can be constructed readily by anyone handy with tools is this model which gives good sound and also serves as a table for a television set. See page 17.

**ELECTRICAL ADJUSTMENT IN FITTING A NEW TRANSFORMER
THE PHONOGRAPH PICKUP ARM—A PROBLEM
CASCODE AMPLIFIER FOR PHONO PREAMPS
DESIGN OF A RECORDING CHARACTERISTIC SIMULATOR**

The Sounding Board

Despite their clear-cut superiority, Wharfedale speakers are very moderately priced.

THREE-WAY SYSTEM

W 15/CS	• • • • •	\$76.15
Super 8/CS/AL	• • • • •	\$21.50
Super 3	• • • • •	\$21.50

TWO-WAY SYSTEM

W 12/CS	• • • • •	\$42.75
Super 8/CS/AL	• • • • •	\$21.50

SINGLE, FULL RANGE SPEAKERS

Super 12/CS/AL	• • • • •	\$76.15
W 10/CSB	• • • • •	\$40.00
Super 8/CS/AL	• • • • •	\$21.50

IN ENCLOSURE

R-J Wharfedale combination 8" speaker in patented R-J enclosure \$57.50.

You may start with a single speaker and add as you go along, if you care to. Suitable crossover networks are available. Free construction sheets recommending cabinets for all speakers or combination of speakers are available on request.



A Quality Endorsed Product of the B.I.C. Group

- GARRARD World's Finest Record Players
- LEAK Amplifiers, Dynamic Cartridge and Tone Arm • WHARFEDALE Loudspeakers
- R-J Enclosures • RIVER EDGE Cabinets
- GENALEX Tubes • MULTICORE Solders
- S. G. BROWN Headphones

British Industries Corp. Dept. WD-17
80 Shore Road
Port Washington, New York

Please send illustrated Wharfedale literature, construction sheets, and B.I.C. High Fidelity Plan Book.

Name.....

Street.....

City..... Zone..... State.....

The Sounding Board

THE BRITISH INDUSTRIES

Sounding Board

**why are
wharfedale
loudspeakers
so hard to get?**



Because they are made by people,
not machines.

Because they are designed by G. A.
Briggs, whose unique personality
and undeviating principles guide
every step of their manufacture.

Because their exclusive "surround"
construction requires painstaking
accuracy and unflinching crafts-
manship.

Because every one is *carefully*
tested before it leaves the factory.
Each carries its own certified re-
port.

That, in essence, is why Wharfe-
dale speakers are hard to get.
Are they worth ordering and even
waiting for?

We know of no single product in
the entire catalog of high fidelity de-
components which so richly de-
serves a little patience.

Place an order with your dealer
and exercise only a moderate
degree of patience. You will be
rewarded by the cleanest, least
distorted, least colored and most
natural sound source now avail-
able.

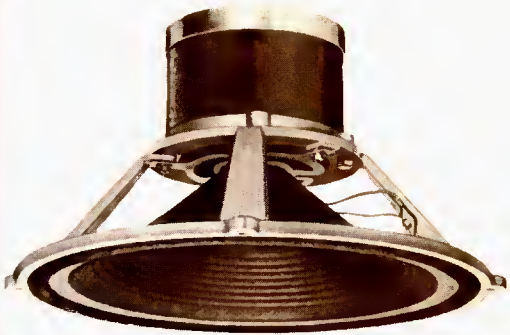

(over)

cut along dotted line and save

AUDIO

ENGINEERING MUSIC SOUND REPRODUCTION

C. G. McProud, Editor and Publisher
 Henry A. Schober, Business Manager
 Harrie K. Richardson, Associate Editor
 Joan Dioguardi, Assistant Editor
 Janet M. Durgin, Production Manager
 Edgar E. Newman, Circulation Director

Sanford L. Cahn, Advertising Director
Special Representative—
H. Thorpe Covington,
26 East Pearson Street, Chicago 11, Ill.,
DEL 7-0506
Mid West Representative—
Sanford R. Cowan, 300 W. 43rd St.,
New York 36, N. Y.
West Coast Representatives—
James C. Galloway and J. W. Harbison,
6535 Wilshire Boulevard, Los Angeles 48, Calif.



CONTENTS

Audioclinic— <i>Joseph Giovanelli</i>	2
New Literature	6
Coming Events	6
Letters	10
Editor's Report	14
Toward Ultimate Fidelity— <i>Bruce H. Vardeman</i>	17
Electrical Adjustment in Fitting a New Output Transformer— <i>Norman H. Crowhurst</i>	19
A Transistorized VU Meter— <i>Paul Penfield, Jr.</i>	22
Recording Characteristic Simulator— <i>S. K. Ghandi</i>	24
A Cascode Amplifier for Phono Preamps— <i>Joseph Marshall</i>	26
The Phonograph Pickup Arm—A Problem— <i>H. A. Schwan</i>	28
Add a Tuning Indicator to Ratio-Detector FM Receiver— <i>Carl R. Wischmeyer</i>	32
New Products	34
Equipment Report—Sonotone HFA-150 Amplifier	36
Record Revue— <i>Edward Tatnall Canby</i>	39
Audio ETC— <i>Edward Tatnall Canby</i>	44
Jazz and All That— <i>Charles A. Robertson</i>	48
About Music— <i>Harold Lawrence</i>	52
Industry People	63
Employment	62
Advertising Index	64

AUDIO (title registered U. S. Pat. Off.) is published monthly by Radio Magazines, Inc., Henry A. Schober, President; C. G. McProud, Secretary. Executive and Editorial Offices, 204 Front St., Mineola, N. Y. Subscription rates—U. S., Possessions, Canada and Mexico, \$4.00 for one year, \$7.00 for two years, all other countries, \$5.00 per year. Single copies 50¢. Printed in U. S. A. at Lancaster, Pa. All rights reserved. Entire contents copyright 1957 by Radio Magazines, Inc. Entered as Second Class Matter February 9, 1950 at the Post Office, Lancaster, Pa. under the Act of March 3, 1879

RADIO MAGAZINES, INC., P. O. Box 629, MINEOLA, N. Y.

COMPARE ...

you will agree

SHERWOOD

high fidelity
is the ultimate



The all new
S-1000 II 20 watt amplifier

	Sherwood S-1000 II • \$ 99.50	A	B	C	D	E	F	G	H	I	J	K
Feedback tone controls	✓	•	✓	•	✓	✓	•	•	•	•	•	•
EF86 low-noise preamp. tube	•	•	•	•	•	•	•	•	•	•	•	•
Presence-rise control	✓	•	•	•	•	•	•	✓	•	•	•	•
Tape-head equalization	✓	✓	✓	•	✓	•	✓	✓	✓	•	•	•
Inputs, selectable at front panel	6	5	5	4	6	4	5	5	6	5	4	5
Microphone equalization	✓	•	•	•	•	•	•	•	•	•	•	✓
Tape-monitor switch	✓	•	•	•	✓	✓	•	•	•	•	•	•
Damping-factor selection	✓	•	•	•	•	•	•	•	•	•	•	•
1M distortion at 20 watts	1.0	1.0	1.0	1.4	1.0	2.0	2.0	1.2	1.6	1.5	2.4	2.0
12db/oct. scratch filter	✓	•	✓	✓	✓	•	•	•	✓	•	•	•
12db/oct. rumble filter	✓	•	✓	✓	✓	✓	✓	✓	✓	✓	✓	✓
Cathode-follower recording output	✓	•	•	•	•	•	✓	✓	•	•	•	•
Phono sensitivity (mv) for full output	3	6	5	6	5	5	6	12	5	3	10	15
Unused inputs shorted to prevent crosstalk	✓	•	•	•	✓	✓	•	✓	✓	✓	✓	✓

*With sharp turnover provided by inverse feedback or inductor.
 Data is manufacturers' published specifications for current "flat-cabinet" amplifiers (20 or more watts).
 Technical literature available on request. Write Dept. A-4

Sherwood
 ELECTRONIC LABORATORIES, INC.
 2802 West Cullom Avenue, Chicago 18, Illinois
 In New York, hear "Accent on Sound" with Skip Weshner, WBAI-FM, week nights, 9 P.M.

The complete home music center

Only Sherwood tuners feature
0.95 μv FM sensitivity!

designed
specifically for
the 6550 tube

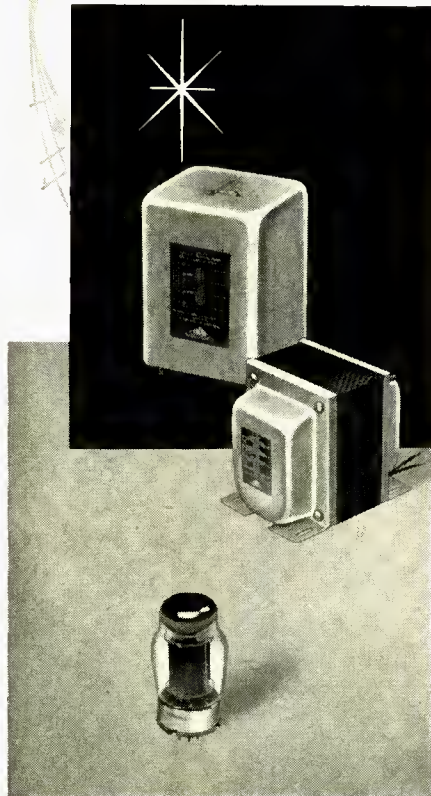

3 new TRIAD HI-FIDELITY output TRANSFORMERS

HSM-192 list price \$75.00.
P.P. 6550 tubes to V.C. Pri. Impedance
4000 ohms C.T. (split pri.) Sec.
16-8-4 ohms. Frequency response
7-50,000. 65 Watts Max. Williamson type
circuit. Proper taps on primary for
screen operation.

HSM-193 list price \$75.00.
P.P. 6550 tubes to line. Pri. Impedance
4000 C.T. (split pri.) Sec. 500-250-125.
Frequency response 7-50,000.
65 Watts Max. Proper taps on primary
for screen operation.

S-152A list price \$44.60.
P.P. 6550 tubes to V.C. Pri. Impedance
4000 ohms C.T. Sec. 4-8-16 ohms.
Output 65 Watts. Williamson
type circuit. Proper taps on primary
for screen operation.

Write for Catalog TR-57

4055 Redwood Avenue, Venice, Calif.;
812 East State St., Huntington, Ind.



A SUBSIDIARY OF LITTON INDUSTRIES

AUDIOCLINIC ? ?

JOSEPH GIOVANELLI*

UPON OPENING TODAY'S mail, I noted with not ordinary satisfaction, that among those seeking answers to queries, were names of some whom I had helped several times before. Since they ask questions on different subjects each time they write, it seems certain that either they are gluttons for punishment or I have been of genuine help to them.

While on the subject of letter writing, I must repeat for the benefit of new readers, that all letters should be sent to me, at the address shown in the footnote. Although I ultimately do receive letters addressed to AUDIO MAGAZINE, there is an added delay, during which your letter cannot receive any consideration. Before sealing that envelope, though, and directing it hither, please enclose therein another—a stamped, self-addressed one. Seriously, it does help immeasurably at this end. Since the volume of mail connected with this column is constantly increasing, much valuable time is spent addressing and stamping envelopes. I have made this request two or three times before, and have appreciated the cooperation I have received.

Naturally, as new readers join the faithful subscribers of AUDIO, there are bound to be some who have not seen my earlier entreaties. This plea, therefore, should not be construed to reflect upon those of you who have enclosed the aforesaid envelope, or those others of you who have read my earlier requests but who have not as yet sent me questions. If you do not want your name to appear in the column with your question, just send along a little note to that effect, and you will remain forever anonymous. If on the other hand, you say nothing about it, your name definitely will be used.

Before proceeding to specific questions, here are a few words about some previously printed questions which have evoked much comment. First, there was a reference to a television tuner I use in my recording studio. (This appeared in the January, 1957, issue.) The tuner uses a Standard Coil front end feeding i.f.'s tuned to 21.25 mc. Audio is obtained through the use of a limiter and discriminator combination. It feeds a 12AU7, which acts as a voltage amplifier and cathode follower output. Some of you were under the impression that the tuner was designed to work into the i.f.'s of any FM tuner. Much difficulty would be encountered by so doing. This stems partly from the fact that the Standard Coil front end is designed to work into 21.25 mc as previously mentioned. Although the oscillator probably could be moved the necessary ten megacycles or so, the front end cannot be tracked to coincide with it, which would lower the sensitivity of the front end, and increase the likelihood of spurious image response. Further, unless care is taken in wiring the front end into the FM i.f. strip, serious decrease in sensitivity of the tuner itself would occur, because of stray capacitances, misalignment, and so on. Switching would have to be pro-

vided in order to disable the TV while using FM, and vice versa.

Next, I have found that by increasing the isolating resistors R_{11} , R_{20} and R_{21} in the mixer described in the December, 1956, issue, to 1.0 megohm each, better high-frequency response will be obtained. There will be some loss in gain, but it can easily be tolerated. Increasing the size of the resistors can make possible the addition of two or three additional channels without serious degradation of the high-frequency performance.

Finally, there has been quite a number of letters asking for the parts list for the crystal tuner in the November, 1955, AUDIOCLINIC. This parts list was printed in a separate section in AUDIO MAGAZINE, December, 1955.

Superheterodyne Receiver

Q. What are the principles of operation of a superheterodyne receiver? Aaron Holstberg, Charleston, South Carolina.

A. The superheterodyne principle is used almost universally today for television, standard broadcast reception, FM, and in many other circuits, both for transmitting and receiving. The term *heterodyne* means a combining, or beating, of two signals, a basic concept for this kind of reception and transmission.

The input circuit of such a unit is much the same as that of the t.r.f. receiver described in AUDIOCLINIC, Jan. 1957. The signal may pass directly into the *mixer* stage or it may pass through one or more r.f. amplifier stages, in much the same manner as is done in the t.r.f. units. Finally, regardless of the number of pre-amplifier stages, it does enter the mixer. So that some idea may be gained of the relationships involved, let us assume we are receiving a signal on the broadcast band, on a frequency of 600 kc. This 600-ke signal now enters the mixer. Another signal also is introduced into the mixer, generated by a *local oscillator*. When receiving a station on 600 kc, the oscillator frequency is generally 1055 kc, 455 kc above that of the desired signal. The mixer, sometimes referred to a first detector or converter, is a nonlinear device and in such a device much intermodulation distortion is present, with the result that in the output circuit of the mixer there are generated frequencies in addition to those originally inserted; these are mainly the sum and difference frequencies of the original frequencies. We are interested in the difference frequency, 455 kc, and naturally there arises the problem of how to select only this frequency. It is accomplished by feeding all the signals from the mixer into an *intermediate frequency amplifier*. This amplifier is made up of fixed-tuned circuits tuned to 455 kc, and will admit only it and others plus or minus 5 kc, approximately. This leeway allows for passage of the two sidebands necessary for the reception of the amplitude modulation. Before proceeding, it should be pointed out that the modulation envelope of the original transmission is not lost during heterodyning. All that happens is that the beat

* 3420 Newkirk Ave., Brooklyn 3, N. Y.

these
are the
features

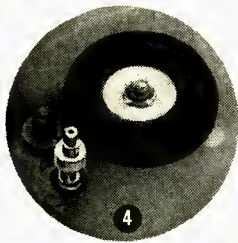
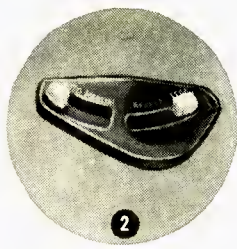
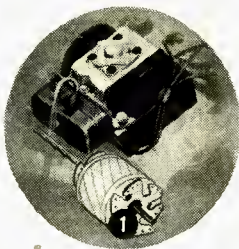

that have
made it

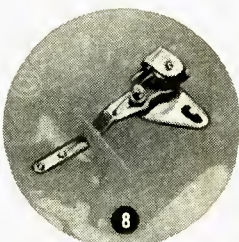
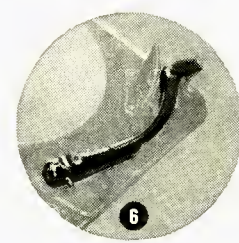
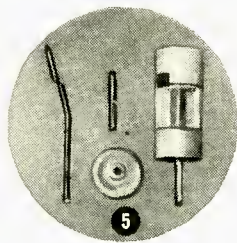

...and
kept it

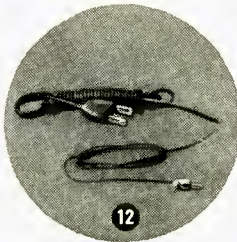
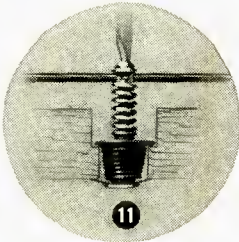
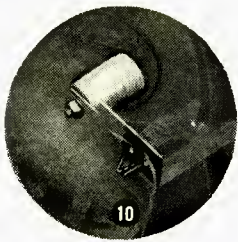
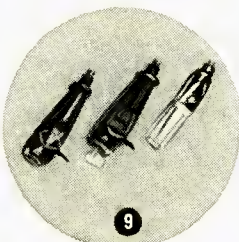

The
WORLD'S
FINEST!

1. 4-POLE SHADED "INDUCTION SURGE" MOTOR gives this changer constant speed with minimum vibration. Will not cause hum even with sensitive pickups. The rotor is dynamically balanced!

2. FULL MANUAL POSITION: Just touch the switch and tone arm is freed for manual play. Returns automatically to its rest at end of record.

3. ADVANCED GARRARD PUSHER PLATFORM: After twenty years still the only device insuring positive, gentle handling of all records, any diameter, thickness or condition of center hole.

4. PERFECTED TRUE-TURRET DRIVE operates directly off motor without belts. Combined with an oversized "soft tread" idler wheel, it gives you unflinching speed without wows or flutter.

5. INTERCHANGEABLE SPINDLES (Manual and Automatic) insert easily, remove instantly. Note that the Garrard one-piece spindle has no moving parts to nick or enlarge center holes.

6. EXCLUSIVE TRUE-TANGENT TONE ARM OF ALUMINUM plays better, provides rigidity, low mass and lightness... It has the easiest stylus pressure adjustment on any changer.

7. HEAVY STEEL PRECISION TURN-TABLE with genuine rubber traction mat. A full inch high! Eliminates magnetic hum by strengthening motor shielding. Turns on silent, free-wheeling ball-bearing mount.

8. EXCLUSIVE SENSIMATIC TRIP MECHANISM gives you sure operation even with tone arm set at lowest tracking pressures. Automatic stop after last record.

9. INTERCHANGEABLE PLUG-IN HEADS accommodate your personal choice of high fidelity pickups, fit all cartridges... magnetic, crystal or ceramic; turnover, twist or simple plug-in types.

10. REINFORCED AUTOMATIC MUTING SWITCH eliminates sound through speaker during record change cycle. Also, a special condenser-resistor network eliminates shut-off noise.

Model **RC 88** *Triumph II*

GARRARD
De Luxe Auto-Manual Record Changer



11. STEEL MONO-BUILT UNIT PLATE keeps changer permanently in line. Exclusive snap-mount springs permit you to mount changer instantly, level it from top with screwdriver.

12. CHANGER COMES READY FOR PLUG IN to any system of high fidelity components. Supplied with full 5 ft. U.L.-approved electrical line cord, and pick-up cable terminating in standard jack.

\$54.50 net
less cartridge



MAIL THIS COUPON for illustrated B.I.C. High Fidelity Plan Book.

Garrard Sales Corp., Dept. GD-17,
Port Washington, N. Y.
Send B.I.C. High Fidelity Plan Book.
Name.....
Address.....
City.....Zone.....State.....

Now there's a GARRARD for every high fidelity system!

Quality-endorsed product of the B.I.C. Group

COMING

To Your City . . .

HIGH FIDELITY



SHOWS

SEE and HEAR the latest in HIGH FIDELITY from leading high fidelity manufacturers . . .

Don't miss these public showings of Hi-Fi Equipment . . . from the most economical units for the budget-minded to spectacular home music theatres . . . compare and enjoy them all.

*Complete Hi-Fi Systems and Components.

*Amplifiers — Pre-Amplifiers — FM-AM Tuners — Turntables and Record Changers — Phono Cartridges — Microphones — Music Control Centers — Speakers.

*Speaker Enclosures and Equipment Cabinets — Finished and Assembled or Do-It-Yourself Kits.

THREE FULL DAYS OF CONTINUOUS DEMONSTRATIONS
FROM 1 P.M. TO 10 P.M. FOR EACH SHOW

Rigo Shows 1957

March 29, 30, 31	Baltimore	Lord Baltimore Hotel
April 5, 6, 7	Philadelphia	Benjamin Franklin Hotel
April 12, 13, 14	Buffalo, New York	Statler Hotel
Sept. 20, 21, 22	Cincinnati	Sheraton-Gibson Hotel
Oct. 18, 19, 20	Miami	McAllister Hotel
Nov. 1, 2, 3	Portland	Multnomah Hotel
Nov. 8, 9, 10	Seattle	New Washington Hotel
Nov. 22, 23, 24	St. Louis	Statler Hotel

ADMISSION 50¢

RIGO Enterprises Inc. 500 N. Dearborn, Chicago 10, Ill.

note is caused to vary in amplitude according to the wave shape of the modulation envelope. The 455 kc signal, or intermediate frequency, or i.f. signal, may be fed to one or more i.f. amplifier stages, depending upon the gain and selectivity needed. The output of the last i.f. stage is fed to a detector wherein the i.f. is converted into a.f. as in the t.r.f. receiver. Energy from the output is fed back as pure d.c. to the grids of previous stages in such a manner as to add more bias on them as the signal strength from station to station increases, so as to prevent receiver overload.

The r.f. stage or stages are needed for something more than improving the sensitivity of the receiver. They also serve to improve the *image rejection*. Suppose the tuned circuits feeding the mixer were very broad tuning or nonexistent. It would seem that all that would be needed would be to shift the oscillator frequency and the i.f. amplifiers would pick out the beats between the oscillator and the wanted 600-kc signal. But suppose a station were operating on a frequency of 1510 kc. This is 455 kc *above* the oscillator. It could and would enter the mixer and beat with the oscillator to form a beatnote which could pass through the i.f. amplifier. Thus, two signals would be received at once. If they do nothing else, the input tuned circuits must provide sufficient selectivity so that this image frequency, 1510 kc, will be reduced in amplitude by 30 db or better, preferably better.

If the receiver being considered is a television receiver or FM tuner, the principles are the same, although the i.f. bandwidth may be different from that of the broadcast set, or the frequency chosen as the i.f. may differ. The higher the frequency we wish to receive, the higher must be the i.f., because of the decreasing sharpness of front-end tuned circuits as frequency increases.

Desoldering

Q. I am an experimenter and, naturally, it is necessary for me to reuse many components, such as filter capacitors, tube sockets and the like, many times. I find it difficult to remove solder from the lugs of such components. What can I do? Milford Spencer, Newark, N. J.

A. If the components are not mounted on the chassis, it is possible for you to apply heat to the lug you are cleaning with it facing downward. This will allow the molten solder to run off the lug, rather than flow into the component, possibly ruining it. How many sockets and other type connectors have been ruined in just this way? If the component is made with polystyrene, polyethylene or similar substances used as the insulation, do not apply too much heat, or this material will most certainly melt, too. If, because of bits of wire still remaining in the hole, the solder clings tenaciously, use a fine knitting needle made of aluminum. Place it where the hole should be and heat the lug. Apply a little pressure to the needle and it will force the solder from the hole. Many times, if no knitting needle is available, an ordinary paper clip or corsage pin may be used with good results. When unsoldering germanium diodes or transistors, use long-nosed pliers to grasp the wire firmly between the unit and the point to be desoldered. This will prevent too much heat from entering the germanium pellet, and ruining the device.

The World's Finest P.A. and General Purpose Microphone

Electro-Voice®

**664 HIGH-FIDELITY
CARDIOID DYNAMIC**



With Revolutionary Variable D* Design

ONLY **\$82⁵⁰** LIST (less stand)

Without a doubt, the Electro-Voice 664 cardioid is the world's finest P. A. and all-purpose cardioid. Its amazing versatility is the result of the unique E-V variable D design. The unidirectional, high-fidelity "664" provides highly directional sound selectivity, reduces pickup due to ambient noise and reverberation up to 50%. Proper placement of the 664 discriminates against unwanted sounds, gives accurate, natural pickup of voice and music . . . smooth, peak-free response at all frequencies from 60 to 13,000 cps, *no boominess* from close talking. The 664 so outdistances the field that we confidently guarantee it to **OUTPERFORM** any other P. A. cardioid . . . **OR YOUR MONEY BACK!**

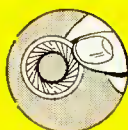

Exclusive, indestructible Acoustalloy Diaphragm—a single moving element—withstands high humidity, temperature extremes, corrosive effects of salt air, and severe mechanical shocks. With the E-V "664" you are sure of dependable, long-life operation indoors and outdoors.

Model 664. Variable D Super-Cardioid Dynamic Microphone. Uniform response at all frequencies from 60 to 13,000 cps. Output level, -55 db. 150 ohm and high impedance. Impedance changed by moving one connection in cable connector. Low impedance balanced to ground and phased. Acoustalloy diaphragm, shielded from dust and magnetic particles. Alnico V and Armco magnetic iron in non-welded circuit. Swivel permits aiming directly at sound source for most effective pick-up. Pressure cast case. $\frac{5}{8}$ "-27 thread. Satin chrome finish. 18 ft. cable with MC4M connector. On-Off switch. Size: $1\frac{1}{8}$ " diam., $7\frac{1}{16}$ " long not including stud. Net Weight: 1 lb., 10 oz. List (less stand) \$82.50

1. **Model 419.** Desk Stand. Modern, sturdy design (extra). List Price \$10.00.
2. **Model 636.** Slim, trim and terrific . . . a dynamic, omnidirectional microphone that "fills the bill" for fine quality P. A. installations, and personal tape recorder applications List (less stand) \$70.00
3. **Model 623.** Slim Dynamic—Ideal for PA, recording and general use. Use on stand or in hand. Omnidirectional. Response 60-12,000 cps; output level- 56 db. Hi- or Lo-Z by changing one wire in connector. Pressure cast; satin chrome finish. Tilttable head. On-Off switch, Built-in MC-4 connector. $\frac{5}{8}$ "-27 thread. $7\frac{1}{2}$ " x $1\frac{1}{16}$ ". 18' cable. Net Weight, 15 oz. List (less stand) \$55.00
4. **Model 927.** A crystal, omnidirectional general-purpose microphone especially desirable for radio amateur and general communications use. List (includes stand) \$22.50

* E-V Pat. Pend.

Ask a Broadcast or Recording Engineer about E-V Microphones. Write for: A.B.C.'s of Microphones, Dept. A74!

Electro-Voice®

ELECTRO-VOICE, INC. • BUCHANAN, MICHIGAN

Canada: E-V of Canada, Ltd., 73 Crockford Boulevard, Scarborough, Ontario
Export: 13 East 40th Street, New York 16, U. S. A. • Cables: ARLAB

Here's How it Works

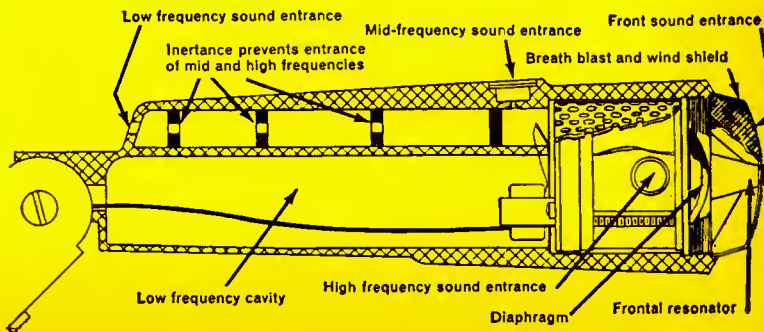

Where Fidelity speaks best for itself!



AMERICAN'S famous Dynamic Omni-directional Microphone (D-33). "Slide-lock" device permits fast removal from stand for hand use. Attractively finished in gold and black. Available in all popular impedances.

AMERICAN Microphones

The name AMERICAN on a fine microphone represents the most advanced design in audio pickup technology . . . quality and fidelity that speak for themselves! Now another great name, Elgin National Watch Company, adds its enormous experience in design and manufacturing to AMERICAN'S to meet the increasing demands in the electronic and sound instrument field.

You can choose from AMERICAN'S complete line of Full Vision—Full Sound microphones with full assurance that your money is buying the best quality on the market . . . superb "full-sound" pickup, attractive "full-vision" styling that permits both the artist and audience to enjoy perfect performance.



Dynamic and Ribbon Cardloid (DR-330)



Dynamic Omni-Directional (D-44)



Dynamic or Carbon Hand-held (SERIES 501)



ELECTRONICS DIVISION

ELGIN NATIONAL WATCH COMPANY

Elgin, Illinois

NEW LITERATURE

• **University Loudspeakers, Inc.**, 80 S. Ken-sico Ave., White Plains, N. Y., graphically illustrates the wide variety of uses for its new ultra-lightweight portable "soundcasting" systems in a new bulletin which has just been released. Two models are discussed, both well-suited for use wherever crowd control is a problem. The Model PP-1 is a completely weatherproof unit, weighs but 7½ lbs. including batteries, and includes a speaker which may be mounted on a stand together with a hand microphone with an 11-ft. cable to afford freedom of movement. Model PP-2 weighs only 4½ lbs. including batteries, and consists of a compact loudspeaker-microphone unit with a pistol-grip handle which holds the battery supply and the press-to-talk switch. The bulletin will be mailed free upon request. **D-8**

• **Duotone Company, Inc.**, Locust St., Keyport, N. J., has issued a completely interesting booklet under the title "An Objective Study of Loudspeakers." In addition to offering information on Duotone speakers and accessories, the 16-page publication contains a great deal of worthwhile data covering the theoretical and practical aspects of speaker design. **D-9**

• **Harvey Radio Company**, 1123 Sixth Ave., New York 36, N. Y., has just released a 284-page catalog which includes a 64-page high fidelity section as well as complete listings of electronic components for industrial and replacement applications. Described as the most complete catalog ever issued by Harvey, it is also one of the largest distributor catalogs ever prepared for the electronics industry. **D-10**

• **Carter Motor Company**, 2711 W. George St., Chicago 18, Ill., describes a new line of Carter custom converters and dynamotors made in adequate capacity to operate Diesel-locomotive, telephone-emergency-standby, mine, forestry and other industrial communications systems, in Bulletin No. 1256A which is available on request. Both converters and dynamotors are manufactured in several models with a wide variety of a.c. and d.c. input voltages, and output specifications up to 750 watts. The bulletin is printed in two colors and is punched for standard 8½ × 11-in. binders. **D-11**

• **Magnetic Shield Division**, Perfection Mica Company, 20 N. Wacker Drive, Chicago 6, Ill., in Technical Bulletin 122, describes advantages and methods of fabricating non-shock-sensitive non-retentive Fernetic Co-Netic magnetic shielding material in customers' plants. Seven pages of graphs are attached, including B/H curves, hysteresis curves, core loss, Curie temperatures and coatings relative to frequency graph. Available without cost. **D 12**

COMING EVENTS

Apr. 7-11—35th Annual Convention of the National Association of Radio and Television Broadcasters, Conrad Hilton Hotel, Chicago, Ill.

Apr. 9-11—Fourteenth Annual British Radio Component Show, Great Hall, Grosvenor House, Park Lane, London, W.1, England.

Apr. 12-15—The London Audio Fair, 1957. Waldorf Hotel, Aldwych, London, W.C.2.

Apr. 23-25—Symposium on the Role of Solid-State Phenomena in Electric Circuits, held by the Polytechnic Institute of Brooklyn in cooperation with the IRE Professional Groups on Circuit Theory and on Electron Devices, Auditorium of the Engineering Societies Bldg., New York City.

Apr. 28-May 3—81st Convention of the Society of Motion Picture and Television Engineers, Shoreham Hotel, Washington, D. C.

August 20-23—WESCON (Western Electronic Show and Convention) sponsored by the 7th Region of I.R.E. and the West Coast Electronic Manufacturers Association. Cow Palace, San Francisco, Calif.

"We're building a HEATHKIT[®]..."

BECAUSE IT'S SUCH GREAT FUN... AND BECAUSE WE GET SO MUCH MORE FOR OUR MONEY!"

Every day more and more people (just like you) are finding out why it's smart to "do-it-yourself" and save by building HEATHKIT high fidelity components. These people have discovered that they get high-quality electronic equipment at approximately one-half the usual cost by dealing directly with the manufacturer, and by doing their own assembly work. It's real fun—and it's real easy too! You don't need a fancy work shop, special tools or special knowledge to put a Heathkit together. You just assemble the individual parts according to complete step-by-step instructions and large picture-diagrams. Anyone can do it!

Heathkit Model SS-1 Speaker System Kit

This high fidelity speaker system is designed to operate by itself, or with the range extending unit listed below. It covers the frequency range of 50 to 12,000 CPS within ± 5 db. Two high-quality Jensen speakers are employed. Impedance is 16 ohms, and power rating is 25 watts. Can be built in just one evening. **\$39⁹⁵**
Shpg. Wt. 30 lbs.

Heathkit Model SS-1B Speaker System Kit

This high fidelity speaker system kit extends the range of the model SS-1 described above. It employs a 15" woofer and a super-tweeter to provide additional bass and treble response. Combined frequency response of both speaker systems is ± 5 db from 35 to 16,000 CPS. Impedance is 16 ohms, and power is 35 watts. Attractive styling matches SS-1. Shpg. Wt. **\$99⁹⁵**
80 lbs.

HEATHKIT

"LEGATO" SPEAKER SYSTEM KIT

Months of painstaking engineering by Heath and Altec-Lansing engineers has culminated in the design of the Legato, featuring "CP" (critical phasing) and "LB" (level balance). The result is a *new kind* of high fidelity sound, to satisfy even the most critical audio requirements. Two high-quality 15" theater-type speakers and a high-frequency driver with sectoral horn combine to cover 25 to 20,000 cycles without peaks or valleys. "CP" and "LB" assure you of the smooth, flat audio response so essential to faithful reproduction. Choice of two beautiful cabinet styles below.

"Legato" Traditional Model HH-1-T

Styled in classic lines to blend with period furniture of all types. Doors attractively paneled. African mahogany for dark finishes unless you specify imported white birch **\$345⁰⁰**
for light finishes. Shpg. Wt. 246 lbs.

"Legato" Contemporary Model HH-1-C

This fine cabinet features straightforward design to blend with your modern furnishings. Slim, tapered struts run vertically across the grille cloth to produce a strikingly attractive shadowline. Wood parts are precut and predrilled for simple assembly. Supplied in African mahogany for dark finishes unless you specify imported white birch for light finishes. **\$325⁰⁰**
Shpg. Wt. 231 lbs.

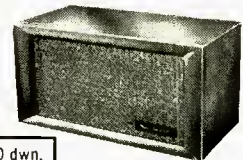

\$4.00 dwn.
\$3.36 mo.

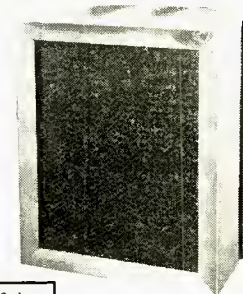

\$10.00 dwn.
\$8.40 mo.

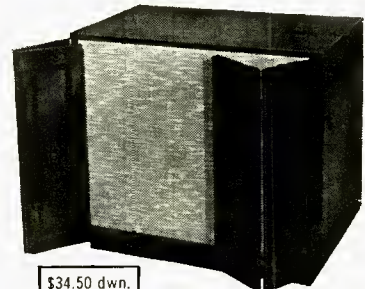

\$34.50 dwn.
\$28.98 mo.

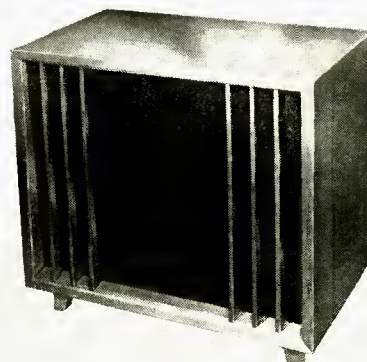

\$32.50 dwn.
\$27.50 mo.



HEATH COMPANY

A Subsidiary of Daystrom, Inc.

BENTON HARBOR 25, MICHIGAN

Make yours a **HEATHKIT**®

**It's Easy (and fun) to Plan Your Own Hi-Fi Installation
By Choosing the Heathkit Components
That Best Suit Your Particular Needs.**

As the world's largest manufacturer of electronic equipment in kit form, Heath Company can provide you with a maximum variety of units from which to choose. You can select just the amplifier you need from five different models, ranging in power from 7 watts to 25 watts, some with preamplifiers, and some requiring a separate preamplifier. You can pick your speaker system from four outstanding high fidelity units ranging in price from only \$39.95 to \$345.00. You can even select a fine Heathkit FM or AM Tuner! Should there be a question in your mind about the requirements of an audio system, or about planning your particular hi-fi installation, don't hesitate to contact us. We will be pleased to assist you.



MATCHING CABINETS . . .

The Heath AM Tuner, FM Tuner and Preamplifier are housed in matching satin-gold finished cabinets to blend with any room decorating scheme. Can be stacked one over the other to create a central control unit for the complete high fidelity system.



MODEL FM-3A



MODEL BC-1



MODEL WA-P2



PRE-ALIGNED TUNERS . . .

A unique feature of the Heathkit AM and FM Tuners is the fact that both units are pre-aligned. A signal generator is not necessary! IF and ratio transformers are pretuned at the factory, and some front-end components are preassembled and pretuned. Another "extra" to assure you of easy kit assembly.



HEATH COMPANY

A Subsidiary of Daystrom, Inc.
BENTON HARBOR 25, MICHIGAN

EASY TIME PAYMENTS . . . We invite you to take advantage of the Heath Time Payment Plan on any order amounting to \$90.00 or more. Just 10% down and the balance in twelve monthly payments. **WRITE FOR COMPLETE DETAILS.**



HIGH FIDELITY SYSTEM

1 HEATHKIT HIGH FIDELITY FM TUNER KIT Features AGC and stabilized, temperature-compensated oscillator. Sensitivity is 10 microvolts for 20 db of quieting. Modern circuit covers standard FM band from 88 to 108 mc. Employs ratio detector for efficient hi-fi performance. Power supply is built in. Illuminated slide rule dial for easy tuning. Housed in compact satin-gold enamel cabinet. Features prealigned transformers and front end tuning unit. Shpg. Wt. 7 lbs.

MODEL FM-3A Incl. Excise Tax (with cab.) **\$25⁹⁵**
\$2.60 dwn., \$2.18 mo.

2 HEATHKIT BROADBAND AM TUNER KIT This fine AM Tuner was designed especially for use in high fidelity applications, and features broad bandwidth, high sensitivity and good selectivity. Employs special detector circuit using crystal diodes for minimum signal distortion, even at high levels. Covers 550 to 1600 kc. RF and IF coils are prealigned. Power supply is built in. Housed in attractive satin-gold enamel cabinet. Shpg. Wt. 8 lbs.

MODEL BC-1 Incl. Excise Tax (with cab.) **\$25⁹⁵**
\$2.60 dwn., \$2.18 mo.

3 HEATHKIT HIGH FIDELITY PREAMPLIFIER KIT This pre-amplifier meets or exceeds specifications for even the most rigorous high fidelity applications. It provides a total of 5 inputs, each with individual level controls. Hum and noise are extremely low, with special balance control for absolute minimum hum level. Tone controls provide 18 db boost and 12 db cut at 50 cps, and 15 db boost and 20 db cut at 15,000 cps. Four-position turn-over and four-position rolloff controls for "LP", "RIAA", "AES", and "early-78" equalization. Derives power from main amplifier, requiring only 6.3 VAC at 1A and 300 VDC at 10MA. Beautiful satin-gold enamel finish. Shpg. Wt. 7 lbs.

MODEL WA-P2 (with cab.) **\$19⁷⁵**
\$1.98 dwn., \$1.66 mo.

4 HEATHKIT ADVANCED-DESIGN HI-FI AMPLIFIER KIT This fine 25-watt high fidelity amplifier employs KT66 output tubes by Genalex and a Peerless output transformer for top performance. Frequency response ± 1 db from 5 to 160,000 cps at 1 watt. Harmonic distortion less than 1% at 25 watts, an IM distortion less than 1% at 20 watts. Hum and noise are 99 db below 25 watts. Output impedance is 4, 8 or 16 ohms. Extremely stable circuit with "extra" features.

MODEL W-5: Consists of W-5M plus WA-P2 Preamplifier **\$59⁷⁵** \$5.98 dwn., \$5.02 mo.
Shpg. Wt. 38 lbs. **\$79.50** \$7.95 dwn., \$6.68 mo.
Express only

MODEL W-3M \$5.98 dwn., \$5.02 mo.
Shpg. Wt. 31 lbs. Express only

5 HEATHKIT DUAL-CHASSIS HI-FI AMPLIFIER KIT This 20-watt Williamson-type amplifier employs the famous Acrosound model TO-300 output transformer, and uses 5881 tubes. Frequency response is ± 1 db from 6 cps to 150 kc at 1 watt. Harmonic distortion less than 1% at 21 watts, and IM distortion less than 1.3% at 20 watts. Output impedance is 4, 8 or 16 ohms. Hum and noise are 88 db below 20 watts.

MODEL W-3M
MODEL W-3: Consists of W-3M plus WA-P2 Preamplifier **\$49⁷⁵** \$4.98 dwn., \$4.18 mo.
Shpg. Wt. 37 lbs. **\$69.50** \$6.95 dwn., \$5.84 mo.
Express only

6 HEATHKIT SINGLE-CHASSIS HI-FI AMPLIFIER KIT This 20-watt Williamson-type amplifier combines high performance with economy. Employs Chicago-Standard output transformer and 5881 tubes. Frequency response ± 1 db from 10 cps to 100 kc at 1 watt. Harmonic distortion less than 1.5% and IM distortion less than 2.7% at full output. Output 4, 8 or 16 ohms. Hum and noise—95 db below 20 watts.

MODEL W-4AM
MODEL W-4A: Consists of W-4AM plus WA-P2 Preamplifier **\$39⁷⁵** \$3.98 dwn., \$3.34 mo.
Shpg. Wt. 35 lbs. **\$59.50** \$5.95 dwn., \$5.00 mo.
Express only

7 HEATHKIT 20-WATT HIGH FIDELITY AMPLIFIER KIT Features full 20 watt output using push-pull 6L6 tubes. Built-in preamplifier provides four separate inputs. Separate bass and treble controls. Output transformer tapped at 4, 8, 16 and 500 ohms. Designed for home use, but also fine for public address work. Response is ± 1 db from 20 to 20,000 cps. Harmonic distortion less than 1% at 3 db below rated output. Shpg. Wt. 23 lbs.

MODEL A-9B **\$35⁵⁰**
\$3.55 dwn., \$2.98 mo.

8 HEATHKIT ELECTRONIC CROSS-OVER KIT This device separates high and low frequencies electronically, so they may be fed through two separate amplifiers driving separate speakers. Eliminates the need for conventional cross-over. Selectable cross-over frequencies are 100, 200, 400, 700, 1200, 2000 and 3500 cps. Separate level controls for high and low frequency channels. Attenuation 12 db per octave. Shpg. Wt. 6 lbs.

MODEL XO-1 **\$18⁹⁵** \$1.90 dwn., \$1.59 mo.

9 HEATHKIT 7-WATT ECONOMY AMPLIFIER KIT Qualifies for high fidelity even though more limited in power than other Heathkit models. Frequency response is $\pm 1\frac{1}{2}$ db from 20 to 20,000 cps. Push-pull output and separate bass and treble tone controls. Good high fidelity at minimum cost. Uses special tapped-screen output transformer.

MODEL A-7E: Same as A-7D except one more tube added for extra preamplification. Two inputs, RIAA compensation and extra gain. **\$17⁹⁵** \$1.80 dwn., \$1.51 mo.
Shpg. Wt. 10 lbs. **\$19.95** \$2.00 dwn., \$1.68 mo.
Incl. Excise Tax

HOW TO ORDER

Just identify kit by model number and send order to address below. Write for further details if you wish to budget your purchase on the HEATH TIME PAYMENT PLAN.

HEATH COMPANY

A Subsidiary of Daystrom, Inc.
BENTON HARBOR 25, MICHIGAN
Please send Free HEATHKIT catalog.

Name _____
Address _____
City & Zone _____ State _____

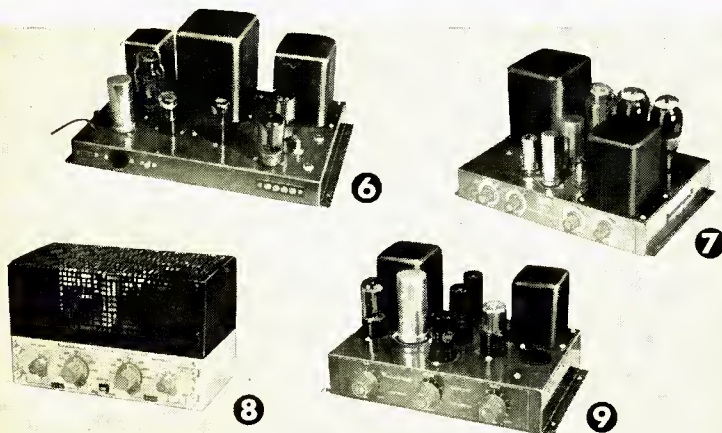



Birds of a feather
flock together,
And so will pigs
and swine;



Rats and mice
will have their choice,
And so will I
have mine.

My choice is Norelco,
Speakers, of course,
The reason I'm honored
to tell;
Few other speakers are
quite as true,
Or will please you
half as well.

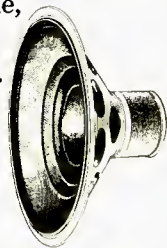

Norelco *F.R.E. Speakers are available in 5", 8" or 12" sizes in standard impedances. Priced from \$6.75 to \$59.98. Blueprints are available for the do-it-yourself enclosure builder. Norelco Enclosures are available in three sizes, priced from \$33.75 to \$119.95.

ADD TO... and improve any sound system with **Norelco**®
*FULL RESPONSE SPEAKERS

Write today to Dept. A4 for brochures and prices of these unique speakers.



NORTH AMERICAN PHILIPS CO., INC.
100 E. 42nd St., New York 17, N.Y.

LETTERS

How Much Power, Again

SIR:

This open letter to Mr. Briggs and other "ten watts is enough for anybody" persons is prompted by the two following statements made by Mr. Briggs in a recent letter to me.

He says, "I do not think there is anything further to say about amplifier power, as we are all entitled to use the size of amplifier and the type which gives us satisfaction."; and secondly, "As regards the power produced by an orchestra, I do not think it is possible to measure this at 75 watts and so that is that."

I am as happy as anyone that we can use whatever sound systems we please but I do not agree that there is nothing further to say about the problem of power requirements.

To the second statement, I must report that such measurements were made in 1931 (Ref. 13) and have recently been repeated and found correct. That there is an improvement of sound when changing from 15 to 50 watts, even in a modest sized listening room, is evident in several of the references.

Mr. Briggs' "ton of experience" is outweighed by 10 tons, more probably a mountain, of experimental and theoretical evidence on the other side.

Below is a brief list of popular references on the power requirements subject. The comments are my own. I claim my only prejudice on the subject to be that I am very hard to please on the aspect of perfection in reproduced sound.

1. David Hafler, *Radio and Television News*, Jan. 1957, p. 44. An excellent article with sound experimental ideas and data.
2. R. A. Greiner, Letter in *AUDIO*, Nov. 1956, p. 6. The author's caustic comments calculated to cause controversy.
3. E. D. Nunn, Letter in *AUDIO*, Jan. 1957, p. 8. An interesting letter about a listening experiment with important conclusions about power requirements. (The author had the good fortune to listen in on this session.)
4. G. A. Briggs, *AUDIO*, Feb. 1957, p. 26. The "last word" from the other side.
5. C. G. McProud, *AUDIO*, Nov. 1956 p. 54. The editor of *AUDIO* comments on the 1956 Briggs concert.
6. E. M. Villechur, *AUDIO*, Jan. 1953, p. 32. This is a good chapter from Mr. Villechur's book on sound.
7. G. A. Briggs, *AUDIO*, Sept. 1956, p. 8. This is Mr. Briggs first letter on power. This is the starting point for the present discussion.
8. J. P. Overley, *IRE Trans. on Audio*, 1956, p. 120. "Energy distribution in music."
9. R. W. Benson, *IRE Trans. on Audio*, 1956, p. 19. "Efficiency and rating of loudspeakers."
10. H. H. Scott, *J.A.E.S.*, 1955, p. 132. "Power amplifiers for music reproduction."

11. W. T. Selsted and R. H. Snyder, *AUDIO*, Jan. 1957, p. 22. "Acoustical and electrical considerations in symphony orchestra reproductions." A very informative article by people who used very superior reproducing equipment.
12. J. D. Hirsch, *AUDIO*, April 1956, p. 26. "True-fidelity organ reproduction."
13. L. J. Sivian, H. K. Dunn and S. P. White, Bell Telephone Laboratories Technical Publications, April 1931. "Absolute Amplitudes and Spectra of Certain Musical Instruments and Orchestras." This is a very fine early article on the subject of power generated by various instruments. This work was so carefully done that recent experiments indicate no changes in the data.

The above references will be interesting even to those who like their music out of a hearing aid at ten paces. I would never suggest that everyone use two 50-watt amplifiers just because I do. In the final analysis only the listener must be satisfied. As with one's musical preferences, one can have his martinis as powerful as he wishes. (Thank you Mr. Smith.) (*And with as little vermouth.* Ed.)

RICHARD A. GREINER,
Dept. of Elec. Engr.,
Univ. of Wisconsin,
Madison 6, Wisconsin

(*Who's next?* Ed.)

Where does the Power Go?

SIR:

Prof. Henstone was perhaps a little hasty in stating (*LETTERS*, February) that Mr. Boegli had made certain mistakes in the latter's article in November. At the very least, Prof. Penstone's criticism was on somewhat shaky ground.

To put the matter briefly, Prof. Penstone invoked the law of conservation of energy and asked, in effect, "With no increase in the total power fed to the two speakers, where would the extra power come from to provide a peak in response at the crossover frequency?"

Surprisingly enough, he does not seem to have even wondered about the corollary question, "In case the connections are reversed and there is a dip in response at the crossover frequency, where does the extra power go?" Are we to assume that he would complain bitterly if his bank statement credited him with more money than he put in, but would consider it perfectly normal for his balance to be *short* of what it should be? The fact is that you can't get more energy out of a system than you put in, but neither can you cause energy to simply vanish.

Where the controversial power comes from (or goes to) may be suggested by an analogy: Suppose that a broadcasting station is engineered to put 1000 watts of r.f. power into a single antenna. Suppose, further, that one day a second antenna is added to the system and that the transmitter is adjusted so that exactly

The Greatest Names in British Electronics use

Mullard Tubes

British equipment manufacturers are making a vital contribution to the development of electronics in all fields of application.

Their products are being exported to every corner of the world, earning a universal reputation for advanced techniques and excellent performance.

The majority of these electronic equipment manufacturers consistently use Mullard tubes. This choice is decided upon because they prefer the greater assurance of efficiency and dependability, and because the vast manufacturing resources of the Mullard organisation guarantee ready availability of Mullard tubes wherever they are needed.

Supplies of Mullard tubes for replacement in British equipments are available from the companies mentioned below:—

In the U.S.A.

International Electronics Corporation,
Department A4,
81, Spring Street, N.Y. 12.
New York, U.S.A.

In Canada

Rogers Majestic Electronics Limited,
Department HD,
11-9 Brentcliffe Road,
Toronto 17, Ontario, Canada

Mullard

Electronic Tubes — used throughout the world

MULLARD OVERSEAS LTD., MULLARD HOUSE, TORRINGTON PLACE, LONDON, ENGLAND

Mullard is the Trade Mark of

Mullard Ltd. and is registered in most of the principal countries of the world



MEV 45

You Can't
Beat This

TECH-MASTER COMBINATION

60

WATTS undistorted, at any audio frequency (20 to 20,000 cps)

2

UNITS a superlative power amplifier combined with a versatile preamp-control

1

CHASSIS with low-silhouette beige cabinet and striking black-and-gold panel

0.25%

IM DISTORTION or less, at all ordinary listening levels (less than 1% at 60 watts)

\$129.50

COMPLETE for the greatest engineering-per-dollar value in hi-fi history!



model 19 – high-fidelity amplifier-preamplifier

Now, for the first time, an integrated high-power amplifier package for the budget-minded audio perfectionist—complete with low-distortion preamplifier in a single low-slung unit of strikingly elegant appearance. Only the most advanced high-fidelity circuitry and the finest available components are used in this superb new Tech-Master instrument. Reserve power is great enough to drive without distortion the new wide-range electrostatic loudspeakers. The pre-amplifier provides compensation for all recording characteristics. Regardless of new developments in other hi-fi components, the Model 19 is your gilt-edged insurance against amplifier obsolescence for many years to come.

- Frequency response flat from 10 to 50,000 cps.
- Special 10 lb. output transformer with tapped primary for 'Ultra-Linear' connection
- Direct interstage coupling
- Output matching for 4, 8 or 16-ohm speakers
- Hum level 65 db below rated output through magnetic cartridge input; 72 db below rated output through other inputs
- Variable calibrated pickup load control
- Equalizer positions for RIAA, AES, NAB, Orig. LP, and 78's
- Input Selector switch for Piezo cartridge, Tuner, TV Sound and Tape
- Cathode-follower tape recording take off
- Low-distortion feedback type tone controls with concentric control knobs
- Dimensions: 14¼" wide x 10¾" deep x 5¼" high

Model 19 (including cabinet)
Net Price \$129.50

At all leading Radio Parts Distributors

TECH-MASTER CORPORATION
75 Front Street, Brooklyn 1, New York



Makers of
Custom-Built
TV Chassis

LETTERS (Cont'd.)

500 watts of power is fed into each of the two antennas. As a result, some listeners report an increase in signal strength with the new arrangement. Would Prof. Penstone deny that this is possible, on the grounds that total radiated power has not been increased? Probably not, for it should be evident that for each listener who reports increased signal strength there will be another who says it has decreased.

When response from a two-channel loud-speaker is measured by the usual methods the results correspond with those observed by favored listeners in the above example. It can be proven analytically that the stated peak *should* exist under certain conditions and it is a matter of experience that it does exist. Material shortly to be published by Paul Veneklasen, acoustical consultant, will discuss remedies for the situation.

WARNER CLEMENTS,
13435 Java Drive,
Beverly Hills, California

Errata

SIR:

Just in case someone would write about some omissions in the schematics in my article "Professional Equalizer Preamp Suitable for Home Use," (AUDIO, Feb. 1957) I offer them herewith:

1. The unidentified capacitor in Fig. 3 below C_1 is C_2 , .0056 μ f.
2. A line should be shown between the COL LP and LON positions of S_{2c} , the turnover switch.
3. The value of R_{21} is 30,000 ohms, $\pm 5\%$.
4. R_{27} , 6800 ohms, should be shown in the B+ line between the junction of R_{26} and R_{30} to isolate the second and third stages.
5. Resistors R_{33} , R_{35} , and R_{35} should be 1 watt.
6. For minimum noise, R_{17} and R_{26} should be low-noise types or 2-watt conventional.

KENNETH W. BETSCH,
8515 Pleasant Plains Road,
Baltimore 4, Md.

Vertical Attenuators Lauded

SIR:

Referring to Mr. Augspurger's article on high impedance mixing circuits (AUDIO, Feb. 1957), I feel he missed a most interesting feature of the KASC console by not mentioning the vertical-type faders. I have worked with this type of control at station WIJK in Cleveland where this form of construction originated. They are much easier to handle and provide smoother operation than the conventional rotary type. It is unfortunate that more commercial equipment does not incorporate this feature.

JAMES CRAIG,
2098 Alton Road,
East Cleveland 12, Ohio

why the Collaro

RC-456

is today's outstanding HIGH FIDELITY RECORD CHANGER



**Minimum
Noise and
Distortion**

Balanced, heavy 4-pole motor . . .
balanced pulley and coupler reduce
rumble to an inaudible minimum.
Automatic muting switch and R/C
network eliminate 'clicks.'

**Accurate
Speed & Pitch**

Collaro quality control limits for the
RC-456 are .25% wow and flutter
. . . unmatched by any other
record changer.

Jam-Proof

Collaro safety-clutch prevents
damage even if tone-arm is held
or moved during change cycle.

Four Speeds

Plays all 78, 45 and 33 1/3 rpm
records . . . plus new types designed
for 16 2/3 rpm speed.

**Automatic
Intermix**

Plays 7, 10 and 12-inch records
stacked in any order —
automatically.

**Manual
Operation**

For playing records individually or
for selecting and playing specific
bands and parts of a record.

**Simple
Installation**

Prewired power and audio connections
eliminate soldering. Pre-cut
mounting board available.

...Plus

- ★ Rapid change cycle independent of record speed.
- ★ Automatic 'shut-off' after last record.
- ★ Simple, one-knob speed selection.
- ★ Gentle, straight-spindle record handling.
- ★ Interchangeable, plug-in cartridge shells.
- ★ Heavy, rim-weighted turntable for flywheel action.
- ★ Automatic idler-disengage prevents idler flats.

At leading sound dealers, or write Dept. WD-1

ROCKBAR CORPORATION • 650 Halstead Avenue, Mamaroneck, N. Y.



EDITOR'S REPORT

TEST REPORTS

IN VIEW OF THE CONTENT of the February issue of a widely circulated report to consumers, AUDIO now feels that it is competent to make Equipment Reports on a far greater variety of items than has heretofore been covered. Herewith our first such report, this one on automobiles. In succeeding issues, AUDIO will report on diapers, oil-well drilling rigs, and antibiotics.

Automobiles

Buick, 1957, Century. Due to oversight on the part of the supplier, this car ran out of gas after the first mile of operation, and was therefore dropped from further consideration.

Lincoln Continental, 1957. Æ's testing engineers lost the key to this car, so it was therefore dropped from further consideration.

Harry K. 5 cylinders. Model tested was a 7-passenger sedan, priced at \$1239.27, not including state and local taxes nor optional accessories which usually amount to \$942. However, the car may usually be obtained from discount houses for as low as \$1240 including all extras.

This car was judged to be a fine value in a medium priced automobile, and would be rated acceptable after making a few minor changes which are described herein. In the first place, the speed, power, and acceleration can be made acceptable by replacing the engine with a 1957 Cadillac engine, which may be obtained from General Motors at a cost of \$1250, which includes the hydramatic transmission. The labor charge for making this change should run somewhere in the vicinity of \$250 (unless the user is particularly handy with do-it-yourself projects, which should enable him to save \$4 or \$5) but with this change the performance would be rated acceptable.

Riding quality was nearly acceptable, but could be improved by replacing the rear springs with aircraft-type rubber shock absorber cord. This would entail the addition of some welded-on fittings, for which instructions may be obtained from Æ.

With the replacement of this engine, the additional weight causes the front end to sag considerably, but this may be compensated by changing the front wheels and tires from the standard 6.00/15's to the larger 8.20/14 tires, it being necessary to change the wheels to accommodate the smaller interior diameter of the new tires. The larger tire diameter does not compensate for the sag completely, so Æ has found it desirable to decrease the air pressure in the rear tires to 6.214 pounds which will make the car ride fairly level. With the changes, the *Harry K.* would be rated acceptable.

Of course, this is the April (1) issue, but in all seriousness we feel that the lack of responsibility shown by

some of the so-called consumer service organizations should merit nothing but contempt for their findings. When one reads reports on a subject with which he is thoroughly familiar and finds them both biased and lacking in factual information, he has no choice but to disbelieve the reports on subjects with which he is not familiar. Hiding behind a cloak of "consumer service" and thus practically untouchable by legal process, it would appear to Æ that such organizations should be unassailable in their accuracy. But when practically everyone who knows anything about high fidelity disagrees with the findings of the self-styled experts of at least one of these organizations, it seems unfair to manufacturers that no recourse is open to them.

NEW FM STATION

We extend our congratulations to KTGM—keep tuned, good music—in Denver, Colorado, which went on the air on January 27th. The new station is the second "good music station" in the Mile-High city, and from the announced intention of its management, it is likely that the programming will become as popular as has WBAI-FM in New York. According to Irving Jackson, general manager at KTGM, a "broadening of the good music program format which includes many new people who have 'caught on to hi-fi' but might not all be long experienced good-music listeners" would seem to indicate that the new station plans to follow the line of other successful FM stations. Needless to say, there is a large segment of the listening audience which is not attracted by either heavy classical programming or the "popular" types of music exemplified by the rock-and-roll DJ. When a station makes an especial point of putting out a top quality signal with selected quality recordings, it will win listeners, and there are plenty of excellent recordings available today without the necessity of going to extremes in choice of program material. There are many people who will never grow to like Hindemith or Charles Ives, and there are many others who will never grow to like some of the currently popular male "singers." Between these extremes, however, there is much that will be pleasing to everyone.

Best wishes to the new KTGM.

END OF THE FIRST TEN

With this issue, AUDIO completes ten years of publication, and thus starts its second decade of service next month. In May, 1947, the first AUDIO ENGINEERING came into being. Many people liked it from the start, and as each one came out some were heard to say, "Sure, that's a great issue, but how long can they keep it up?" We have often thought that, too—usually about once a month. But even if it sounds a little like boasting, we *have* kept it up for the first ten years, which are said to be the hardest.

Now we start trying for twenty.

everyone's acclaiming the *extraordinary new*



\$59.85

incl. 1 mil diamond stylus!

Fluxvalve-Unipoise pickup-arm

WITH ITS OWN BUILT-IN CARTRIDGE CONTAINING AN EASILY REPLACEABLE STYLUS...ALL STYLUS SIZES ARE AVAILABLE INCLUDING THE EXCLUSIVE 1/2 MIL

The all-knowing, the cognoscenti, music critics and record-playing enthusiasts have accorded the Fluxvalve-Unipoise Arm an acceptance never before seen in the history of Hi-Fi equipment. Here is the ultimate arm-cartridge for perfect tracking... for minimum stylus wear... for maximum record life and for optimum performance... there's nothing like it... nothing to compare.

The Fluxvalve-Unipoise Arm, latest development in record-playing arm-cartridge combinations, embodies all the features exclusive to the Fluxvalve... and at the remarkably low price of \$59.85 for the arm-cartridge combination—including 1 mil diamond stylus!

This combination of features is exclusive with the Fluxvalve-Unipoise:

- Very high compliance
- Very low tracking force, 2-4 grams
- Resonance-free, flat frequency response to 30kc
- Distortion-free dynamic tracking
- All stylus sizes, including 1/2 mil
- Maximum stylus life
- Minimum record wear
- Feather-weight, a rframe design
- Single friction-free pivot bearing
- High output
- Easily replaceable styli

Ultra-dynamic styling to match ultra-dynamic performance!



PICKERING & CO., INC. OCEANSIDE, N. Y.

Professional Audio Components

"For those who can hear the difference"

EXPORT: AD. AURIEMA, INC., 89 BROAD ST., NEW YORK / CANADA: CHARLES W. POINTON LTD., 6 ALCINA AVE., TORONTO

Enjoy a demonstration at your hi-fi sound studio... you'll hear the difference. For the dealer nearest you or for literature write Dept. A-16

What kind of men develop microwave highways?

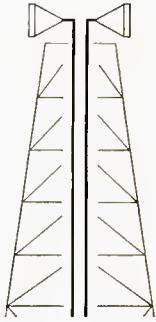

The great microwave systems that relay telephone conversations along with television programs from coast to coast will have to work harder than ever to meet growing demands for service. But at Bell Laboratories scientists have been making important advances in the art of microwave communication. These advances are being applied in the development of a new and more efficient system in which single beams of microwaves will carry simultaneously many more telephone conversations and television programs than is now possible.

The development of the new system demands the varied skills of men in many fields of science and engineering. Just a few of the specialists necessary are . . .



PHYSICISTS like J. A. Weiss, Ph.D. in Physics, Ohio State, to harness the properties of ferrites in new ways for better control of the transmission of microwaves.



MICROWAVE ENGINEERS like P. R. Wickliffe, M.S. in E.E., M.I.T., to design new circuitry. Microwaves must be conducted, controlled and amplified through waveguides which resemble pipes.



MECHANICAL ENGINEERS like W. O. Fullerton, B.S. in E.E., Iowa State, to embody new principles in designing the many structures and devices used in microwave telephony—with all parts feasible to manufacture, practical to install and easy to maintain.

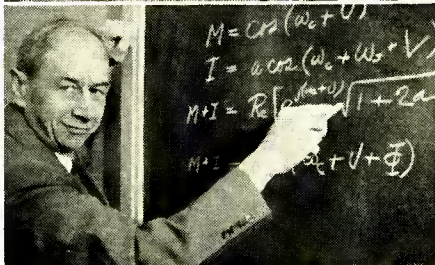

SYSTEMS ANALYSTS like J. P. Kinzer, M.E., Stevens Institute, for over-all system planning and prediction. Mr. Kinzer works with numerical quantities and characteristics to predict on paper the performance of an operating system. What will it do? How must it perform to meet the needs?

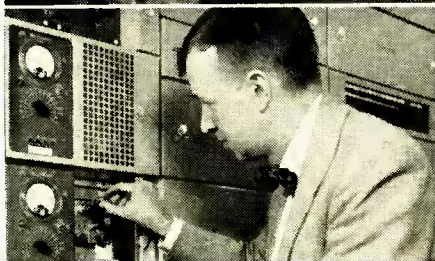

ELECTRONIC ENGINEERS like B. C. Bellows, B.S. in Engineering, Cornell, for the development of “watch-dog” equipment to protect against failure. Protective devices must operate automatically in split seconds to maintain uninterrupted service.

BELL TELEPHONE LABORATORIES

WORLD CENTER OF COMMUNICATIONS RESEARCH AND DEVELOPMENT



Toward Ultimate Fidelity— The Husskee Lo-Duo

Useful, ornamental, and effective, this new corner horn-loaded design offers convenience as well as good sound quality. Easily constructed by anyone handy with wood, concrete, and furniture covering.

BRUCE H. VARDEMAN*

PROMISING development work on a new type of loudspeaker enclosure is currently underway. The enclosure makes full use of the best commonly known principles, as well as a few new ones. Pictured is the original experimental enclosure, known as the Husskee Lo-Duo model 100. The design is covered in a recent patent application.

For the sake of economy, the enclosure is built to derive maximum performance from a single extended range speaker. If, however, minimum intermodulation distortion is required, a separate tweeter may be added, as pictured.

The problems that must be considered in seeking to obtain maximum performance from the single extended-range speaker are: First, maximum dispersion of highs must be provided for. Second, midrange efficiency requires high air loading. Third, maximum possible air load must be provided for efficient low bass reproduction. Fourth, air load must contain high resistive component to produce rapid transient decay. High-note efficiency is not considered a problem, as the amplifier can readily make up for lack of efficiency here, with little increase in total power.

Both location and design affect performance. A corner location places less stringent requirements on high-frequency dispersion. The entire listening area may be covered with smaller dispersion angle. Effective low-frequency radiation area is quadrupled by the containing surfaces of a corner. Increased radiation area provides, at bass frequencies, higher air load and better damping. These technical considerations tip the scale heavily in favor of corner placement. But doesn't the family want that corner for the television set? Let's try to make the enclosure low enough to serve as a television table.

Having decided on a corner location, let's seek the design that most adequately meets the requirements. Perhaps the easiest to meet is air load for mid-range frequencies. The properly designed exponential horn gives efficient loading over several octaves. Down to

* Husskee Development Co., Rt. 2, Cedar Rapids, Iowa.



Fig. 1. Serving as a stand for a TV set, this new design of loudspeaker enclosure will accommodate 8-, 10-, or 12-inch extended-range units, or may be used with a tweeter as shown in this example.

about two-hundred cps, its dimensions are reasonable. Shall it be a vertical horn, or horizontal? For midrange frequencies, the difference is small. But won't our highs be emitted from the midrange horn? Vertical position would cost us a loss of highs, through cancellation and absorption upon reflection from ceiling, and so on. Let's use a horizontal horn. Next, we want to disperse those highs. We would achieve little dispersion by flaring a horizontal midrange horn from a speaker mounted in an approximately vertical plane. Throat area will be too large for effective horn loading of highs. Okay, let's mount the speaker in a horizontal plane, and place a small, hard, and rigid surface at an oblique

angle in front of the speaker as shown in Fig. 2. This surface, located near the throat of the midrange horn, will reflect and disperse highs. The midrange horn should be tilted upward for vertical dispersion of highs; and to prevent their absorption by floor covering. No fancy driver construction for distribution will be required. The straighter the highs leave the center of the cone, the better.

Horn Loading Requirements

So far, so good. The greatest problem is left. Highest possible air load, and adequate damping, for bass reproduction. The mid-range horn will add some air load. At low frequencies, it will act as a mass reactance and lower the

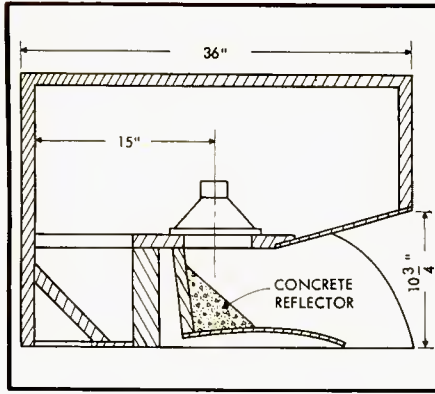

Fig. 2. Cross-sectional view through the center of the "front" horn (Section A-A)—the center element of the three openings visible in Fig. 1.

speaker resonant frequency. This horn is to expand horizontally from the corner. Its length is thus limited. Adequate mouth area for dispersion of highs requires fairly rapid flare rate. Such design is not adequate for bass reproduction. A folded back horn would extend bass range, but not as far as we'd like. A phase inversion chamber, with a horn expanding from the port, might add half an octave or so extension beyond that given by a folded horn. Let's try loading the back of our cone with a combination of phase-inversion chamber and exponential horn, as in Fig. 3.

Can we get all this in a room corner? Our back horn should be as long as possible, consistent with simplicity. Mouth area must be maximum and flare rate low. Its mouth need not open directly toward the listening area, but the midrange horn mouth should. For maximum length, let's place the back horn throat in the very corner. To open the midrange toward the listening area, we'll split the back horn and expand it along the two sides of the midrange. In order that the floor may provide an image of our horn mouths, we will place the horns against the floor, and the phase inversion chamber above them. Figure 4 shows a plan view with the top removed.

For all the mouth images corner surfaces provide, mouth area cannot be made large enough for optimum coupling at the lowest frequencies. Rapid ex-

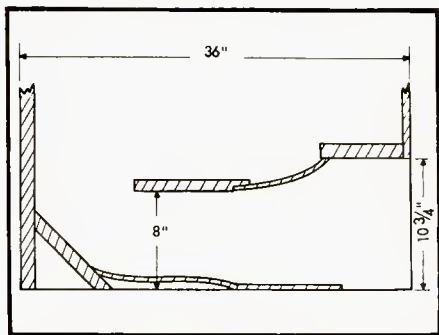

Fig. 3 Section B-B through either of the side horns which load the back of the loudspeaker.

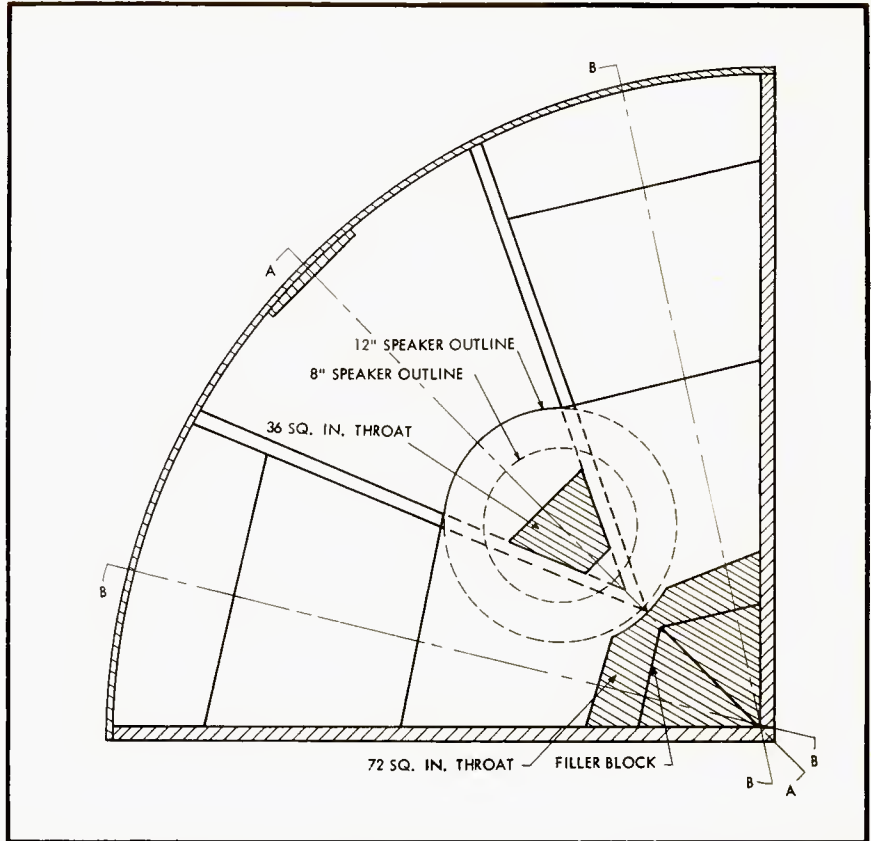

Fig. 4. Section through the phase-inversion chamber showing placement of the speaker unit, as well as throats of both front and back horns.

pansion of sound from a mouth of less than optimum area produces a reflected sound wave toward the throat. This reflection gives rise to resonances at frequencies determined by horn length. An exponential slot, converging toward the throat from horn mouth, will allow leak expansion and give an effect of indefinite horn length. Resonances will be lowered and broadened.

Sound reflection from a closed end of a pipe is in opposite phase to that from an open end. Between the fully closed and wide open end treatment there should lie some orifice opening at which, for a single frequency, no reflection would result. In other words, the reflection from some partial baffle should be equal and opposite to that from the complementary partial opening. Possibly this reasoning can be applied to a degree by restricting our horn mouths. Don't carry it too far—maximum mouth area is important. But suppose we presented some restriction by decreasing flare rate at the beginning of the exponential slot. Horn resonance might be further lowered and broadened. This method of joining the horns will further allow equalization of sound pressure between them, at low frequencies; and make full use of their combined mouth area as a low-frequency radiator.

Wow! The number of considerations that are entering into our design! Well, let's try to mix them in proper proportions to form an outstanding enclosure.

The Realization

Our phase inversion chamber should be large, to produce that low, low bass. Its shape will give almost a complete absence of parallel surfaces, and attendant standing waves. The greater efficiency of high-frequency emission from the front horn will eliminate any necessity for absorbent lining.

Our back horn should be long. Considerations of required volume and horn length point to using the maximum permissible radius from the room corner. Possibly we can use a three foot radius without domestic difficulties. (Incidentally, the original Lo-Duo was received by the wife, and acclaimed by friends, as an attractive furniture piece.) The plan area will then be $3^2 \times \pi/4 = 7.05$ square feet. Internal volume per inch of height will be about $0.95(7.05/12) = 0.56$ cubic foot. (5 percent is allowed for structure. Hence the 0.95.) If we take 22 inches as a reasonable height, our volume is just over twelve cubic feet. Half of this will make an adequate phase inversion volume. Let's accept this height.

By playing around with a plan view, we find that placement of a 12-inch speaker axis 15 inches from the inside corner of our phase inversion chamber gives room for a throat opening of 72 square inches in the corner. The air load that we are providing should draw response from the 12-inch speaker supe-

(Continued on page 61)

Electrical Adjustment in Fitting a New Output Transformer

If you have to replace an output transformer, it is a good idea to check up on its performance to make sure that you are getting as much out of your amplifier as you were before the change. Here are the steps to take.

NORMAN H. CROWHURST*

THE OUTPUT TRANSFORMER is usually one of the more reliable components in an amplifier but occasionally one will go bad, developing a short circuit or open circuit, or maybe just shorted turns; in which case it becomes necessary to effect a replacement. Often, for various reasons, an exact replacement is not available: for example, by the time an output transformer goes bad it is quite probable that the particular amplifier is no longer being currently manufactured; however most transformer manufacturers make quite a range of output transformers from which it should be possible to select one having the right nominal ratings to suit the amplifier in hand.

But the fact that two output transformers have the same nominal ratings, in impedance ratio, power handling capacity, and frequency response, is no proof that they will behave equally well in the same amplifier. When a substitute transformer is connected into a modern feedback amplifier it may oscillate its head off or it may stay stable, but even when it is stable it is probable that the response and other aspects of the performance of the amplifier differ from the original. So it is well to make some checks and, if necessary, electrical adjustment to get the amplifier performing approximately according to its original specification.

If Amplifier Oscillates

If the amplifier oscillates with the replacement transformer, the first thing to do is get it stable. Try a small capacitor from plate to plate, say 100 micro-microfarads. If this makes no difference to the oscillation except possibly changing its frequency (if this can be observed), then remove the capacitor and try changing the value of the phase-shift capacitor already connected in the amplifier. This is the capacitor connected across one or other of the feedback resistors.

First try removing it and, if this does

not stop the oscillation, try substituting values different from the original by one or two steps in the preferred value range. For example if the original capacitor was 68 micromicrofarads try a 100 or 150 and then try a 47 or 33. Usually one of these adjustments will make the amplifier stable so that measurements can be conducted.

Tests to Make

In most instances however, the new output transformer will not make the amplifier oscillate (perhaps it would be better if it did, because then the fact that something was different would be a little more obvious). Usually the difference in amplifier performance, caused by the change in output transformer, is a little more concealed. So set the amplifier up with a resistance load connected to the output, in place of the usual loudspeaker, and make the following measurements.

Distortion Characteristic

Set the audio oscillator to 1000 cps and if necessary use a 1000-cps filter between the oscillator and amplifier to remove any residual harmonics in the oscillator. Use a harmonic distortion meter to check the distortion present in the output from the oscillator after filtering. This must be less than the

lowest amount of distortion you expect to measure from the output of the amplifier. Then measure the distortion in the output. See Fig. 1.

Most harmonic distortion meters provide a scope output so that the residual harmonic can be observed on a scope. Connect a scope to this. When the harmonic distortion meter is set to the calibrate position, so the scope displays the fundamental, adjust the scope time base so that a single sine wave is displayed on the screen. Then, when you switch over to measure harmonic, the trace on the scope will indicate the dominant orders of harmonic.

This can sometimes be useful in tracking down the cause of distortion, but a more useful aspect is that it checks whether the reading obtained is actual harmonic distortion, or hum. When the scope time base is set this way, so as to show only a single sine wave of fundamental, harmonic distortion will show up as a single trace on the screen, with a somewhat distorted waveform and having two or more cycles across the screen. On the other hand hum is evident by the fact that the trace is unsteady or a number of traces appear vertically displaced from one another.

From this it is possible to estimate how much of the measured distortion is hum and how much is harmonic. Fig. 2 illustrates this for a typical case: the

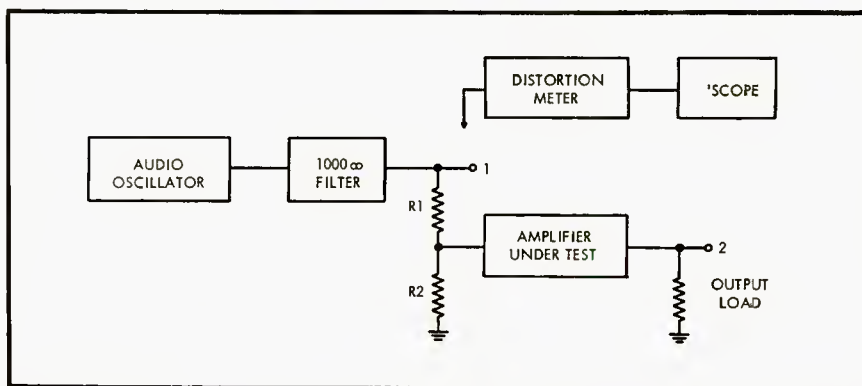

Fig. 1. The arrangement for making a distortion characteristic. First the waveform going in, at point 1, is checked, then the output waveform, at point 2. The resistors R_1 and R_2 form an input attenuator, so the level is not too low measure at point 1, but is right for the amplifier input at the junction of R_1 and R_2 .

* 150-47 14th Road, Whitestone 57, N. Y.

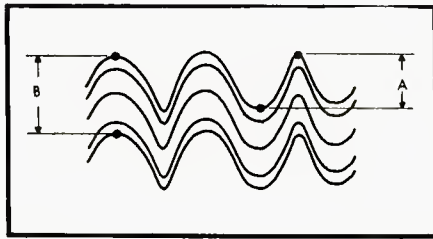

Fig. 2. How to interpret the waveform displayed on the scope, when the distortion meter is set to measure harmonic percentage: this waveform represents a residual with dominant third harmonic, plus higher order components, whose peak-to-peak amplitude is A; the multiple trace shows that a hum component is also present, of peak-to-peak amplitude B.

amplitude deviation of an individual trace, represented by A in Fig. 2, is the peak-to-peak voltage of harmonic distortion present in the residual output; the amount by which the whole trace fluctuates up and down, represented by B in Fig. 2, is the peak-to-peak hum voltage present in the residual output.

By estimating the relative components of each it is possible to deduce the actual harmonic distortion and hum voltage separately without the use of filters to actually separate them. Remember that the voltages combine, for measurement purposes, approximately on a root-mean-square basis. So, if the output reading is, say, 0.3 percent and the values of A and B measured on the scope trace are approximately equal, there will be about 0.2 percent of hum and 0.2 percent harmonics. The harmonic can be plotted in the form of a distortion characteristic as at Fig. 3.

Distortion

The next thing to check is the distortion at low frequencies, say 60 cps and, if possible, on down to 20 cps. Usually there will be difficulties in using a harmonic meter down at these frequencies, partly because it is difficult to get the oscillator output sufficiently free of distortion at these frequencies. However, fortunately the amount of distortion likely to be present under incorrect operation is considerably greater, so it is satisfactory to check distortion at the low-frequency end by looking at the waveform on a scope.

First check that the input waveform is a satisfactory approach to a true sine wave and then look at the output waveform (at full power output).

Another low-frequency defect that change of output transformer can set up is low-frequency instability or near instability. Instability will show up on the scope by a slow up and down movement of the trace. Near instability will cause the trace to "bounce" when input to the amplifier is changed or keyed.

Next make a check of distortion at high frequencies. Using a sinusoidal input,

watch the scope on the output as the frequency is swept way up to 20 or 30 ke at full output. See that the output waveform does not "fold over" anywhere over the frequency range from 20 to 20,000 cps (and higher, if possible).

Square Waves

The last but not the least check to make with a new output transformer installed is on the reproduction of square waves. A suitable square wave can be obtained from a number of sources. Some audio signal generators have a provision for changing from sine-wave to square-wave output. Another useful piece of equipment that will give square waves is the electronic switch used for providing two displays simultaneously on an oscilloscope screen: by turning the bias control over to one side and not connecting any inputs to the input terminals, the output becomes a square wave whose frequency can be adjusted by the frequency control on the electronic switch.

First check the wave shape of the square wave going into the amplifier.

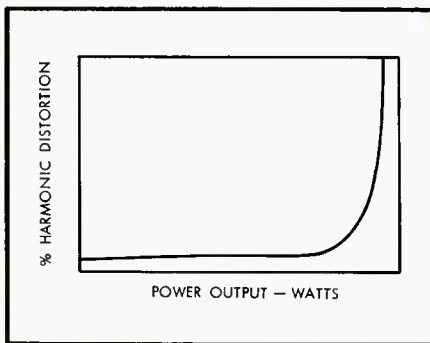

Fig. 3. Typical output/distortion characteristic, obtained with the method illustrated in Fig. 1.

A frequency of about 1000 cps is satisfactory for this purpose. Then check the waveform on the output, first with the resistance load still connected and then with a loudspeaker load. With a resistance load there should be no appreciable overshoot or ringing as shown in Fig. 4. With a loudspeaker load the waveform will definitely depart from square due to the reactances in the load, but there should not be any appreciable overshoot or ringing even under this condition.

Correcting Deficiencies

Having outlined the tests to be made we will now discuss what to do about rectifying any faults that show up under each test in turn.

First, if too much distortion shows up at mid-frequency: what usually happens in this case is that the distortion characteristic begins to rise earlier than the amplifier specification shows, as indicated at Fig. 5. If the original rating at which 1 percent distortion shows is 50 watts and the replacement transformer

drops the 1 percent point to, say, 47 watts, one has to decide whether or not this is acceptable.

If there are no other detrimental effects from the transformer, the difference between 47 and 50 watts is only 0.3 db, which no one is ever going to be able to detect audibly. On the other hand, it is just possible that a check is required for some reason to show that the amplifier still performs to specification. In this case steps are necessary to raise the output to the full 50 watts.

First check that the transformer ratio is correct for the impedance transformation it is supposed to produce. The formula for this has been published a number of times, also charts to facilitate the calculations. The voltage ratio can be readily obtained by measuring the primary and secondary voltages with an a.c. voltmeter using a steady signal of a 1000 cps going in from the audio signal generator.

If the ratio checks as being correct, the next step is to determine where the loss of power is occurring. First check that the voltage reaching the plates of the output tubes is according to specification. If the voltage actually reaching the plates is lower than the specified value, but the B+ is correct, this indicates that the primary resistance of the transformer is higher than the original.

The way to overcome this is to boost the B+ supply a little. This is not too easy to do as a rule because amplifiers usually push the B+ supply pretty well to the limit of the components used. Most modern amplifiers use a capacitor input filter and a few more volts can usually be achieved by increasing the reservoir capacitor value. This however will often exceed the rectifier dissipation so that it is necessary to double up on the rectifier.

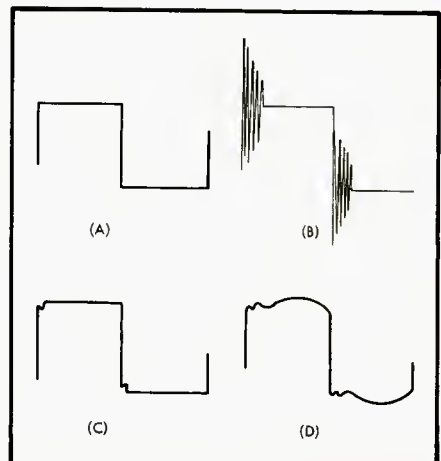

Fig. 4. Typical waveforms associated with square wave testing: (a) the input wave; (b) a typical wave when there is excessive ringing; (c) a waveform like this, with a resistance load on the output, is acceptable, and should be the target; (d) when the loudspeaker is connected, the waveform should be something like this.

If, for example, a 5U4 rectifier is used, it would be advisable to use two 5U4's in parallel with twice the reservoir capacitor. This means an additional filament supply for the second 5U4, which will have to be provided by means of a separate filament transformer—using resistance in series if a 6.3 volt transformer is used with the 5 volt filament, to adjust the actual filament voltage to exactly 5 volts. This is shown in Fig. 6. Also watch that the voltage rating of electrolytics is not exceeded in making this change. Use new components with higher rating, if necessary.

If the plate voltage is not lower than the schematic indicates and the B+ is normal, it may be that the resistance of the secondary winding is too high, causing loss of some of the power. This can be checked by transferring the resistance load from secondary to primary. Obtain a plate-to-plate resistance of the rated loading value and sufficient dissipation and connect this across the primary side and again make measurements of power. This will check whether the loss is in the transformer windings or not.

If it is not easy to make this check because suitable resistances are not at hand, it is probably hardly worth going to the trouble of getting resistances, because there is little you can do about it except obtain another transformer. Do not try boosting the B+ voltage in this case, because you will be over-running the output tubes and, as stated earlier, the loss of 3 watts in 50 is quite unimportant anyway.

Inadequate Inductance

If distortion shows up at low frequencies the most probable explanation is that the output transformer has inadequate magnetic core to sustain the low-frequency amplification without running into saturation. However, as explained in the previous article, distortion at low frequencies is not always due to saturation of the core.

It can also be due to inadequate inductance of the primary. This can be

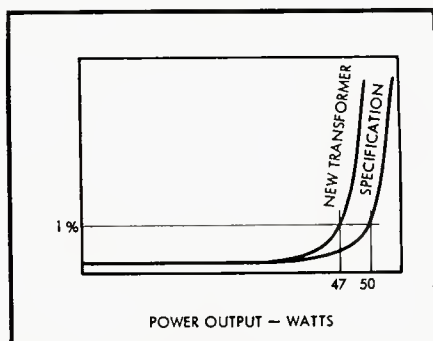

Fig. 5. Typical relationship between the published specification for distortion characteristic, and the measured figures, when the new output transformer has resulted in loss of efficiency, due to some cause that should be identified.

checked by the method described in the previous article, and if the waveform displayed proves that the trouble is due to deficient inductance rather than saturation, it is possible that a change in output loading may improve the performance at the low-frequency end. It will, of course, deteriorate the maximum output power throughout the whole frequency range.

The instability or near instability is also due to difference in primary inductance. It can sometimes be rectified by changing coupling capacitor values in the amplifier. The only way to work out positively what correction is required here would be to calculate out the stability criteria—equivalent to complete design! Trial and error approach is usually quicker.

If the output transformer comes with 4-, 8-, and 16-ohm taps try connecting an 8-ohm load first to the 4-ohm tap and then to the 16-ohm tap, to see whether the distortion changes at low frequencies, as compared with the distortion turnover or clipping point at middle frequencies. If so, it is possible that use of the amplifier with deliberately incorrect loading of this nature may produce better results.

However, before deciding to do this, check the distortion characteristic with the changed load at the middle frequency: you may find it better to live with the low-frequency distortion, or you may try for a better transformer.

High-Frequency Distortion

Next, if you get distortion at high frequencies, it is probably due to some kind of resonance in the output transformer that should not be there. The straight resonance between primary shunt capacitance and leakage inductance may modify the frequency characteristic and the performance on square waves, but it should never prove sufficient to cause distortion of the fold-over variety at the higher frequencies.

Where this occurs it is probably due to primary-to-secondary capacitance introducing a resonance. This is unlikely to occur in a transformer with a secondary impedance no higher than 16 ohms, but some output transformers provide for constant-voltage-line distribution with a higher impedance output—say 500 ohms. Effective capacitance between the primary and this winding can cause trouble in a modern feedback amplifier.

Usually some point on the secondary has to be grounded as part of the feedback arrangement. The point to be grounded will depend upon the phase of signal. Usually the capacitance between primary and secondary causes distortion because the wrong point on the secondary is grounded. If we ground a different point on the secondary, however, the feedback will be in the wrong phase, so

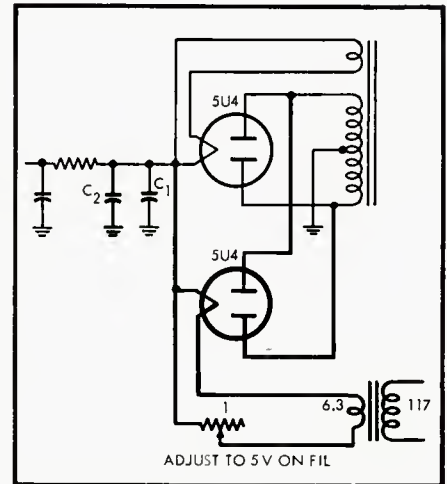

Fig. 6. Additions necessary to typical amplifier to boost B+ voltage. The extra components are shown in heavy lines. The extra capacitor should have the same value as the original C₁. Check that ratings are not exceeded.

the solution is to change the connection from the primary: connect the plate leads to the opposite output tubes; in this way the secondary connection can also be reversed in phase and this will usually obviate the effect. In an Ultra-Linear output stage, the screen leads must also be changed when the plate leads are reversed.

Ringings and Overshoot

The commonest and most important effect that the change of an output transformer can have on the performance of an amplifier shows up on the square-wave test. You may wonder why this test was reserved till last. The reason is that if any adjustments have to be made to satisfy the other conditions the square-wave performance will also be modified. If adjustments were made at the outset to correct the performance on square waves and then other adjustments prove necessary to eliminate distortion at low or high frequency it would only be necessary to conduct the square-wave test all over again with further adjustments. This was reserved till last so that when this test is made and the circuit modified as necessary the amplifier is complete.

Ringings or overshoot on the output under this test shows that the amplifier has a tendency to peak at some supersonic frequency. The remedy is the same as that described for oscillation at the beginning of the article, but more careful adjustment is necessary to eliminate overshoot or ringing than just to keep the amplifier stable.

First try the effect of different capacitors across the primary of the output transformer. If any capacitance at all across the primary increases the overshoot or ringing then don't connect any. If the connection of capacitance across the primary tends to minimize the over-

A Transistor VU Meter

A simple transistor amplifier will increase a VU meter's sensitivity so that it can be used in many applications.

PAUL PENFIELD, JR.*

WHENEVER VOLUME IS CONTROLLED for some purpose other than immediately hearing it, some sort of volume indicator is necessary. Recording machines, P. A. systems, and broadcast facilities all need fairly precise control over volume and some sort of indicator.

Of the several ways to observe volume, the best is with a special type of meter—the well-known *VU Meter*, or *Volume Unit Meter*. Less desirable ways include a “magic eye” tube, a series of flashing neon lights, or a conventional-type meter. The reason the VU meter is the best is that it is made specifically for the job.

Professional equipment almost invariably incorporates a VU meter, rather than the less desirable schemes mentioned above. However, the cost of the meter, plus the fact that it is relatively insensitive, combine to keep its use in “home” recorders and even high-fidelity equipment small. While the device described here cannot reduce the cost, it does do away with the problem of sensitivity.

The VU Meter

For those readers not familiar with VU meters, they are a type of voltmeter made especially for reading volume. Program material contains varying levels all the time. Conventional meters do not agree with one another in readings taken of the steep wavefronts contained in sound, because they have different types of suspension systems. So although they might agree well on steady tones, the mechanical differences make them respond differently on transients. On the other hand, VU meters were designed just for speech and music. The ballistics and electrical properties are now standardized so that any two VU meters will always read the same—on any type program material. The most important features of the standard are summarized in the box below.

Most important, though, is the fact that readings taken on VU meters correspond very closely with audible distortion in amplifiers, recorders, and so on. That is, the point of first audible distortion will occur at the same VU-meter indication regardless of the type of program material. Other indicating devices are not as good in this respect. On, say, a power meter, distortion might first be-

* 53 Marion St., Apt. 16, Brookline 46, Mass.

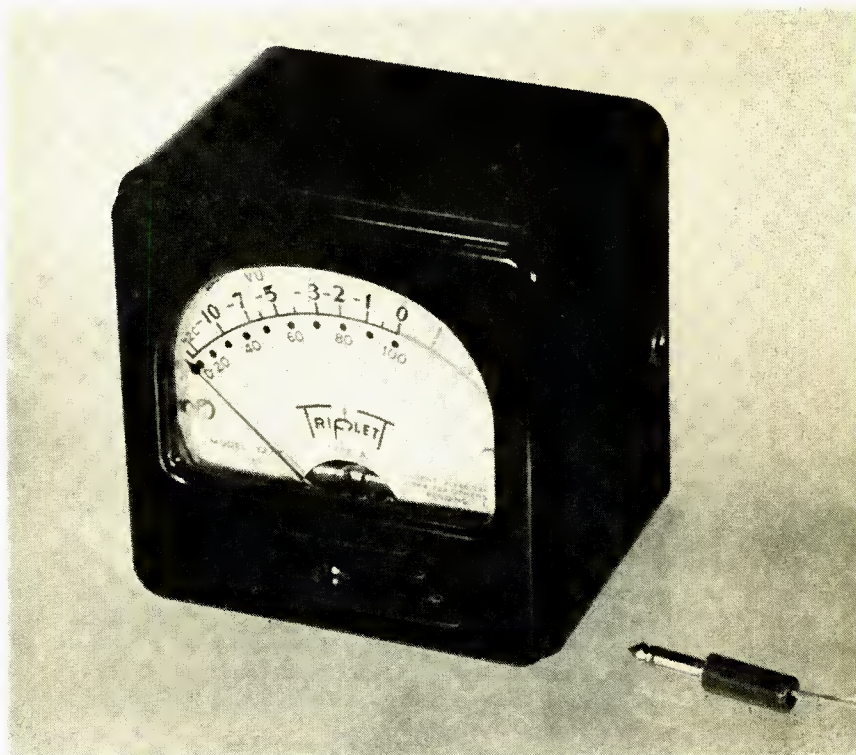

Fig. 1. A typical modern VU meter. Most meter manufacturers make one or more models of VU meters.

Specifications for VU Meters

So that all VU meters will respond the same, the design has been standardized. Here are the most important specs from the American Standards Association C16.5-1942.

FREQUENCY RESPONSE: Flat to within 0.2 db from the 1000-cps value between 35 and 10,000 cps, and within 0.5 db between 25 and 16,000 cps.

IMPEDANCE: Internal resistance of the meter is 3900 ohms. For correct ballistics it must work from an external impedance of 3900 ohms.

BALLISTICS: Sudden application of a 0-VU level sine wave voltage will make the pointer reach 99% of 0-VU between 0.27 and 0.33 seconds, and will cause the pointer to overshoot to between 1.0 and 1.5%.

OVERLOAD CAPACITY: The VU meter can withstand peaks of 10 times 0-VU voltage for 0.5 seconds, and a continuous overload of 5 times 0-VU voltage.

SCALE: Two standard scales are specified of which scale A is pictured in Fig. 1. Scale B has the 0-100 markings on the top.

STANDARD CIRCUIT: A standard circuit, including an external attenuator, is specified for using the meter to read from a 600-ohm line.

HARMONIC DISTORTION: The VU meter will not introduce more than 0.3% harmonic distortion to a 600-ohm line when connected in the standard circuit.

come noticeable at a certain indication for speech, at another indication for chamber music, and so on. With the VU meter, this difference is much less.

Steady-tone measurements can also be read on the VU meter, just as on any a.e. voltmeter. But the VU meter is the *best* meter to use for monitoring audio programs because it was designed for the job.

Of course such a good meter has disadvantages. First, it has a big magnet, and should be kept away from steel. Use aluminum or wood panels instead. And second, its sensitivity is low. With the recommended auxiliary equipment, it has a full-scale sensitivity of about 1.2 volts r.m.s with an internal resistance of 7500 ohms. This, as panel meters go, is mighty insensitive. While this is no problem in radio stations, large public-address systems, and the like, there is often in an audio system no point where the signal is sufficiently strong at the correct impedance to use the VU meter direct. There is no place on most home tape recorders, for example, where one can be attached.

An amplifier will boost its sensitivity, without losing any of the advantages of

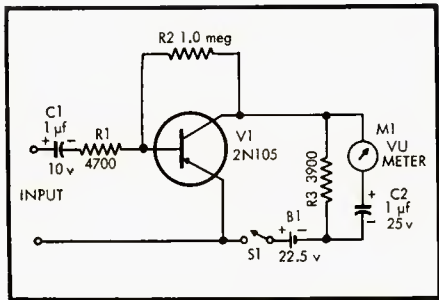

Fig. 2. The simple transistor amplifier which converts the VU meter from an insensitive instrument to one that responds full scale on five microamperes signal current.

the meter. A transistor is used in the amplifier described here.

The Amplifier

No unusual parts are required for the VU meter amplifier. Any VU meter, any size or make, will do. The Triplett 327-TC VU meter comes in an attractive plastic case (Fig. 1) into which the amplifier can fit easily. The whole unit using this meter is made self-contained. Of course this is not necessary—if the finished meter is to be mounted on a panel, there is no point to the miniaturization techniques.

However, using the 327-TC the construction is quite simple. The parts fit around the meter proper as shown in Fig. 3. The only trick is providing for the input terminals, and an on-off switch. To do this, one can use a miniature Telex closed-circuit jack, #8570, and plug, #9231. The inner contact of the jack was bent as shown in the right of Fig. 4, so that it closes the circuit

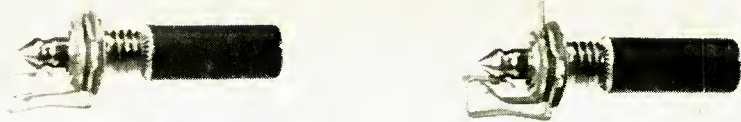

Fig. 4. Bending the inner contact of the jack changes it to a normally-open model.

when the plug is *in*, rather than when the plug is out. The jack fits perfectly in the hole in the Triplett case without any work whatever. The circuit was made to turn the device on by inserting the plug; with the plug out, no current is drawn from the battery.

Obviously other solutions to this problem are just as good—this one is offered merely as one example.

The transistor circuit is quite straightforward. For correct ballistics the meter must operate from a source of about 3900 ohms impedance. This is approximated quite closely by using a load resistor (R_L) of just that value.

Figure 2 shows the schematic. 22.5 volts is needed as a battery to provide sufficient swing for voltage peaks in the speech or music waveform.

The input resistor R_1 is set at 4700 ohms as a compromise between ultimate sensitivity and hum pickup. In practice an external resistance greater than this must be added anyway, to decrease the sensitivity, and to prevent excessive loading on the circuit tapped into, as will be explained later. There is nothing particularly significant about its value.

The base bias resistor supplies current to the base from the collector circuit in an attempt to improve the stability. It helps (as opposed to taking it directly from the battery) some 15 percent or so, although the device is still somewhat temperature-sensitive. However, the 2N105 transistor has quite a low cutoff current, as well as good uniformity from one transistor to the next, so there's less need for good d.c. stability measures.

The input capacitor C_1 merely blocks d.c. on the input circuit, and so any size capacitance which will pass the lowest frequency of interest may be used. If the meter is hooked to a circuit that has, for example, B+ on it, an additional high-voltage capacitance in series with the input will be necessary.

Connecting the Meter

The transistorized VU meter can be connected to the audio system in a variety of places—speaker lines, inside amplifiers, etc. Do *not* connect it across the recording head, however, since the supersonic bias is apt to get through as well as the program material, throwing the readings off.

Anywhere inside the amplifier will do—any high-level single-ended grid or plate, for example. If possible, use the grid of the phase splitter or the final stage. Use a plate only when necessary, however, since this means extra trouble in the form of a required capacitor in series with the input lead to block the d.c. component. The input capacitor C_1 has a low voltage rating, in the interest of making it small physically, and so is easily overloaded.

Generally a resistor will be required in series with the input. The complete device operates full-scale on five microamperes. Thus only in unusual circumstances will the device be too insensitive to use. The resistor necessary to draw only five microamperes for any given signal voltage, computed to take account of the input resistance of the amplifier, is shown in Fig. 5. Experimental points agree closely, within component tolerance errors.

To adjust the sensitivity of the VU meter, put some kind of program material on, or preferably a steady tone.
(Continued on page 59)

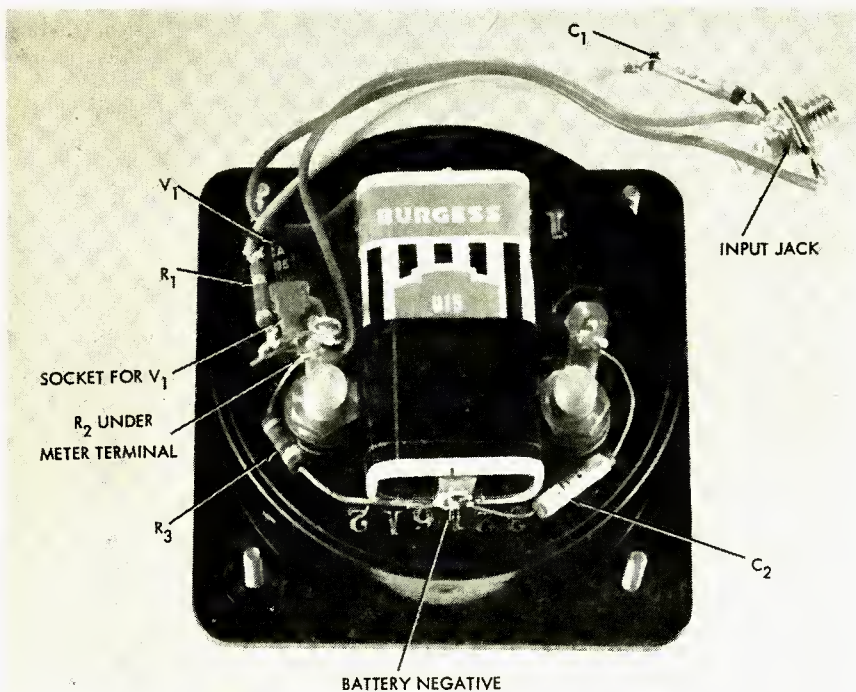

Fig. 3. The parts placement using the Triplett 327-TC meter and housing. The small battery and other parts fit inside the housing.

Recording Characteristic Simulator

This simple device will make it possible to check response curves of phonograph preamplifiers in a minimum of time and with reproducible accuracy—completely eliminating the need for adjusting signal levels as you change frequency.

S. K. GHANDI*

A SIMPLE METHOD of testing the frequency response of an audio system is to feed into it a series of audio-frequency signals, whose amplitudes vary according to a particular recording characteristic. The over-all system response is correct when the output signals are of constant amplitude. Feeding in these signals of different amplitudes is normally considered to be a nuisance, and the audio enthusiast usually ends up by purchasing a test record having the various frequency bands already recorded at the appropriate amplitudes. This entails some disadvantages:

a) A good test record costs money. (With the price comparable to that of a regular long-playing record, music is always a much better buy.)

b) The test record is usually cut for one particular characteristic, while the audiofan has provisions for at least four.

c) After a few runs of the record (and the record is often borrowed by friends having "permanent" osmium tipped needles), the surface noise becomes so great that meter indications on the output are often swamped by the record noise.

With the above points in mind, the

* Laboratories Department, Electronic Division, General Electric Co., Syracuse, N. Y.

Fig. 2. Straight-line approximation (dotted) and actual transition curve for a "corner" frequency f_0 of 1000 cps.

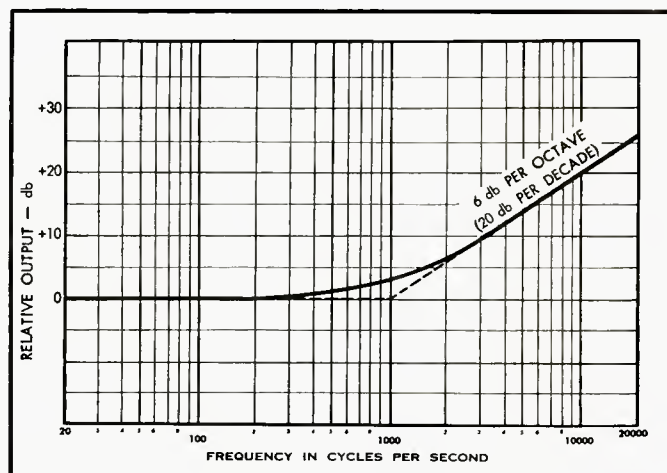

writer set out to construct a recording characteristic simulator, of the type suggested by D. T. N. Williamson.¹ Such a device is essentially a network. One end of this network is fed from a signal generator such as the Heathkit Model AG-8, which covers the audio band without too much variation in signal output (± 1 db), while the other end is fed into the preamplifier input. An a. e. vacuum-tube voltmeter is put across the output terminals of the power amplifier, with

a resistive load instead of the speaker; the system compensation is correct if the meter shows no variation as the signal generator is swept over the audio-frequency band.

Certain restrictions had to be placed immediately.

a) The device had to use no inductances, and a minimum of other components.

b) The device had to be passive, and operate with a reasonably low output impedance so as to avoid hum pick-up in the output leads.

c) The input impedance had to be

¹ D. T. N. Williamson, "High-quality amplifier modifications." *Wireless World*, May 1952, pp 173-176.

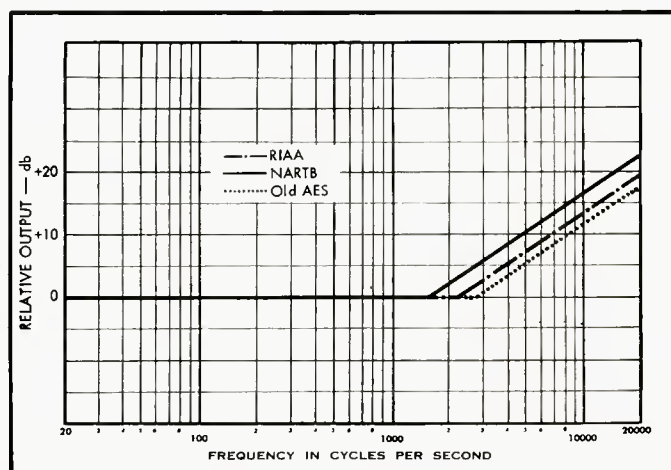
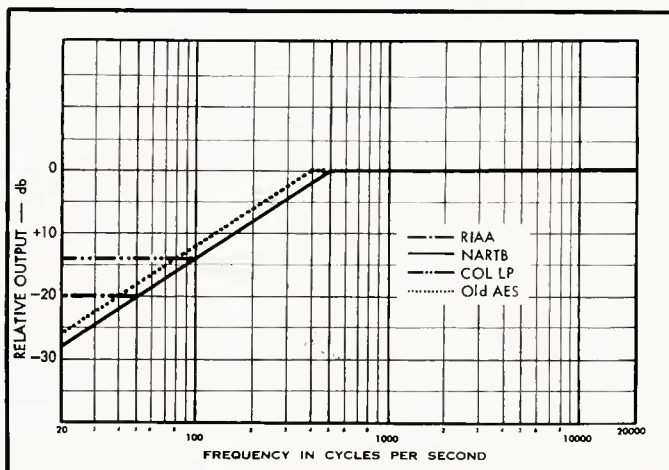

Fig. 1. Recording characteristics, before being rounded off as they are in actual practice. Left, low frequency, and right, high frequency.

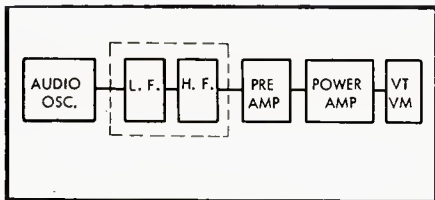

Fig. 3. Block schematic of manner in which the recording characteristic simulator is used in making measurements.

high enough so as not to load the signal generator.

d) As many recording characteristics as possible were to be handled by the device. While the unit to be described was restricted to microgroove records, (the writer has only three 78-rpm discs) certain simple changes will allow it to be used for standard records also.

After studying the various lists of manufacturers and their recording characteristics, it was seen that the low-fre-

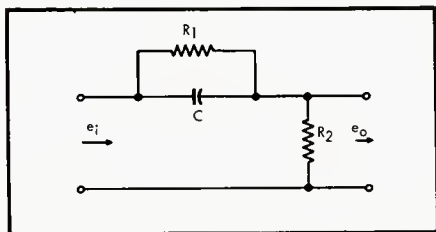

Fig. 4. Configuration of each of the two sections of the simulator.

quency end was covered by three such characteristics:

a) RIAA. (Record Industry Advisory Association), which is flat up to 50 cps, then rises at 6 db per octave to 500 cps, where it again flattens out.

b) COL. (Columbia), which is flat up to 100 cps, then rises at 6 db per octave to 500 cps, where it flattens out.

c) NAB. (National Association of Broadcasters), which has a steady rise at 6 db/octave to 500 cps, where it flattens out.

d) Old AES. (Audio Engineering Society), which has a steady rise at 6 db per octave to 400 cps, where it flattens out.

The high-frequency end was covered by three characteristics:

a) RIAA, flat up to 2120 cps and then rises at 6 db per octave.

b) NAB, flat up to 1590 cps, and then rises at 6 db per octave.

c) AES, flat up to 2500 cps and then rises at 6 db per octave.

While the characteristics are most conveniently described in the above terms, it is to be understood that Mother Nature simply won't stand for sharp kinks in the response curves. Actually, a smooth transition occurs at all the "corner" frequencies, and the above description may be considered to be a straight line approximation of what ac-

tually happens. (A) and (B) of Fig. 1 show the straight line approximations of the recording characteristics at low and high frequencies. The 0 db reference axis is chosen quite arbitrarily in all cases, since this is entirely dependent on the position of the gain control. Figure 2 shows a straight line approximation at a typical corner frequency, together with the actual transition. It should be pointed out that the behavior of all minimum-phase-shift networks using only resistances and capacitances may be described by a series of straight lines which are either flat, or rising or falling at slopes that are multiples of 6 db per octave.

Network Design

The design of the network for the recording characteristics is taken up in two sections, and the sections cascaded. Care is taken to see that the second section does not load the first, so that the over-all response is the combined response of the two networks taken separately. This is done by putting the low-frequency network before the high-frequency network as in Fig. 3. At low frequencies the second network has a very high impedance, and by the time its impedance falls (at high frequencies), the output impedance of the first network is considerably lessened. In this manner, loading is avoided at all frequencies. The basic network used is shown in

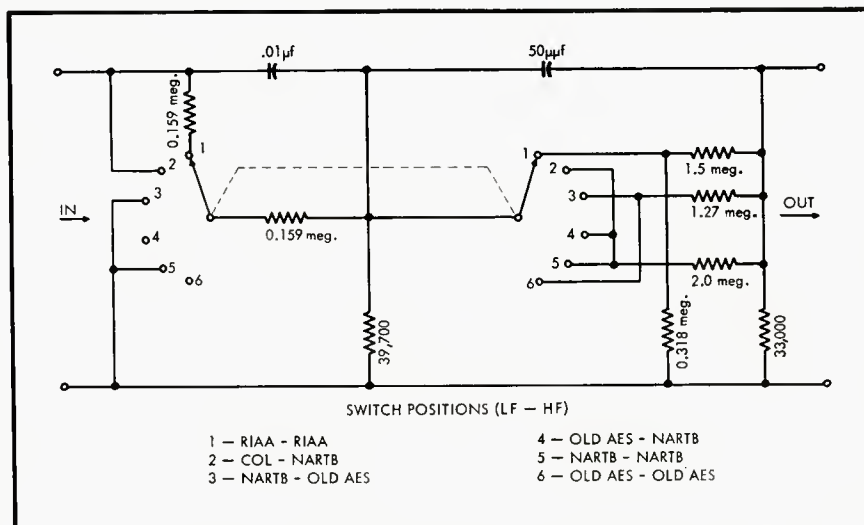

Fig. 6. Complete schematic of the recording characteristic simulator

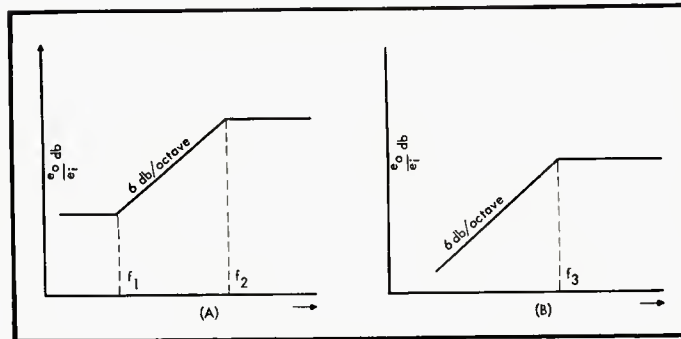

Fig. 4. (A) of Fig. 5 shows the straight line approximation of the behavior of this network. The corner frequencies are given by

$$f_1 = \frac{1}{2\pi CR} \quad (1)$$

$$f_2 = \frac{1}{2\pi C \left(\frac{R_1 R_2}{R_1 + R_2} \right)} \quad (2)$$

where C is in microfarads, and R_1 and R_2 are in megohms. (B) of Fig. 5 shows the behavior when R_1 is removed from the network. In this case,

$$f_3 = \frac{1}{2\pi CR_2} \quad (3)$$

The low-frequency networks may now be designed. The COL and RIAA networks will be as in Fig. 4, while the NAB and AES networks will have R_1 missing.

It is impossible to design the high-frequency network with only one corner (f_1) since this would require an indefinite rise at 6 db per octave with increasing frequency (again, Mother Nature won't stand for this). Sooner or later, the curve must flatten out. Consequently, while the network of Fig. 4 is still used, f_2 is selected so as to be at least a decade beyond the audio range, so that its influence is not felt in the operating range (20-20,000 cps). Figure 6 shows the actual network.

While the actual computed values are given in Fig. 6, the closest available
(Continued on page 60)

A Cascode Amplifier for Phono Preamps

A comparative analysis of the advantages and disadvantages of the cascode as a preamplifier—from the viewpoint of this author. A typical circuit and several modifications offer room for experimentation.

JOSEPH MARSHALL*

Noise has always been the principal villain in phonograph reproduction. Until recently turntable rumble, hum and flutter, record scratch, hiss and popping, and hum picked up by the pickup have been the dominant foes. The availability of turntables with noise levels 50 and 60 db down, the reduction of hum pick-up by cartridge, lead and arms, and steady improvement in the noise level of recordings themselves, has shifted attention to the noise produced by the preamp-equalizer. Particularly when some of the newest low-level cartridges are used, the noise in the form of hum or tube noise contributed by the preamplifier is quite likely to be the limiting factor in record reproduction. A year ago a preamp with a noise level 40 db down was considered very good; today, to get the most out of available recordings a noise level of 60 db or better is desirable. In an attempt to reduce residual noise to the irreducible minimum I have made some experiments with the cascode amplifier in phono equalizers. This paper is a report on those experiments and may be helpful both to the amateur and the professional engineer in assessing the value of the circuit for such usage.

Actually, to summarize my conclusions, the cascode amplifier does not offer any great *net* advantages as a phono preamplifier over the conventional arrangement using cascaded stages. It is true that tube noise can be reduced to a level slightly better than that possible with a good 12AY7 tube. Furthermore, the low noise level is achievable with cheaper tubes and tubes which seem to maintain their characteristics better than the few 12AY7's I have used which have a habit of turning noisy after a period of use. To continue on the positive side, the circuit is simple, stable and reasonably unceritcal both as to design and performance in normal home use. High gain can be achieved with moderate plate voltages. The 12AT7 will deliver a gain of about 100 with 150 v. on the plate and a load of 100K; under the same conditions the 6BK7A will deliver about 75. The cas-

* Ozone, Tennessee.

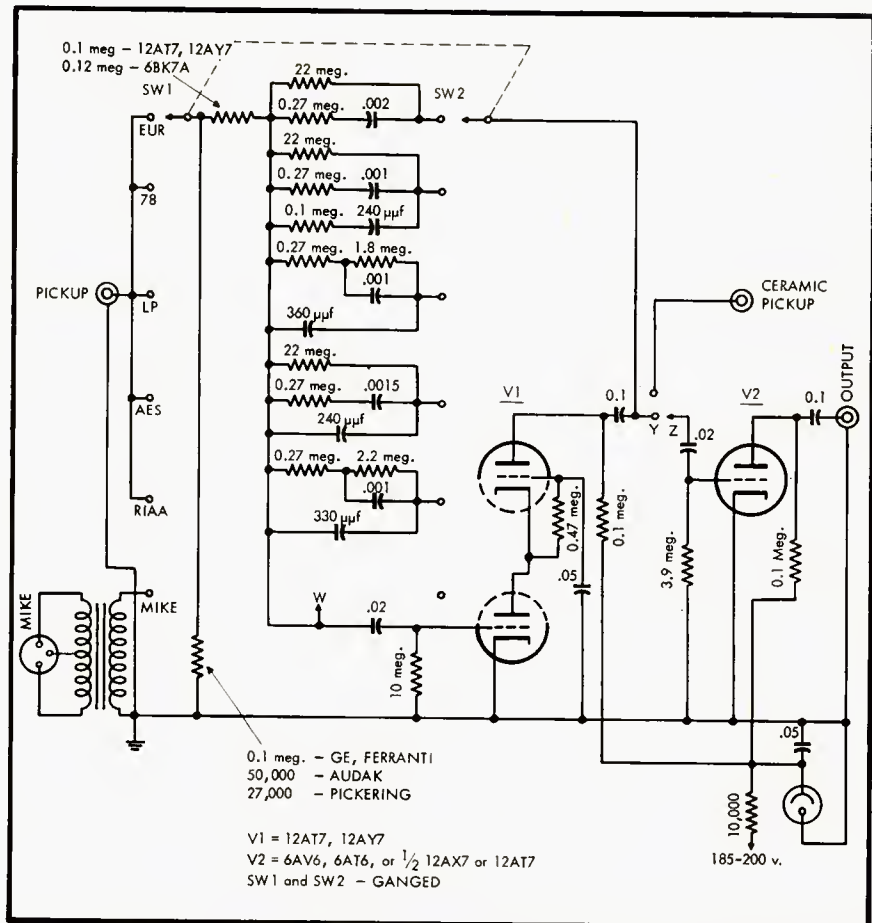

Fig. 1. Schematic of suggested amplifier, together with details of the equalizer circuits for five phono characteristics.

code configuration appears to be capable of handling higher inputs than the same tubes as simple triodes and this appears to be true whether cathode or contact-potential biasing is used.

On the other hand, the gain of a cascode stage using the available twin-triodes, (even with plate-supply voltages higher than 150 v.), is not great enough to provide, after full equalization, an output voltage sufficient to drive typical control units to their necessary output. An additional stage is, therefore, necessary even with high-level magnetic cartridges. Since it is quite possible to obtain full equalization (at least of the RIAA, NARTB and LP curves) with a single 12AX7 or even 12AT7 in conven-

tional cascaded circuits, the use of a cascode input stage requires more tubes. This may not complicate design if the preamplifier is embodied in a more complex control unit providing also tone and loudness control, since a half-section of a twin triode may be spared for the job without increasing the over-all number of tubes.

Moreover, the improvement in noise figure with the cascode stage is evident only when d.c. is used on the filaments and with an extremely well filtered power supply; and even then it is not spectacular. As long as a.c. is used on the filaments, even if the filament circuit is balanced and/or biased, the residual hum will be equal to or greater than the tube

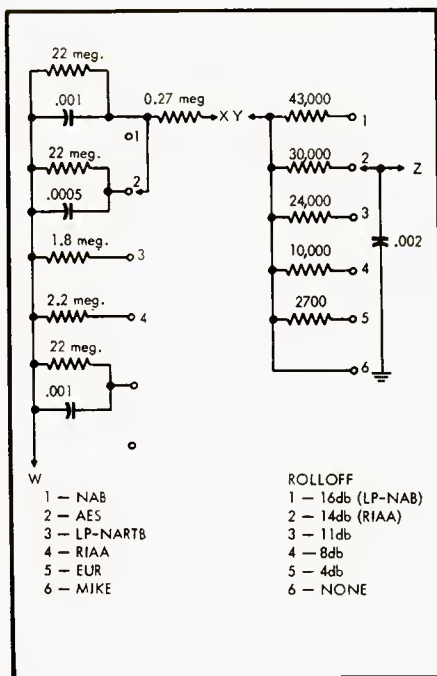

Fig. 2. Equalizer circuits which may be used when it is desired to separate low- and high-frequency compensation circuits.

hiss and the advantage of the cascode is not fully revealed.

To illustrate: I designed a preamp about a year ago using either a 12AT7 or a 12AY7 in a cascode circuit with bass equalization provided by a feedback loop over the first stage and treble equalization provided by a bypass network between the stages. A.c. was used on the filaments but biased about 50 volts positive and a VR tube was employed as a final hum and decoupling element. The unit was entirely independent (save for the power supply which was to be obtained from some other source) and totally enclosed, including the shielded tube, in a Flexi-Mount case. (See *Radio-Electronics* for June, 1954). With the best 12AY7 the total noise measured at the output could be as low as 0.5 millivolts. A selected 12AT7 could be held down to under 1.5 millivolts, and the average 12AT7 produced around 2.5 millivolts. When the filament supply was changed to d.c., the good 12AT7 got down below 1.0 mv, but a good 12AY7 improved only some 25 or 33 per cent. Using precisely the same construction method but substituting cascode configuration produces a preamp which is about as good with a 12AT7 as the other was with a good 12AY7, but the improvement with a 12AY7 was not very great, certainly not over 3 db.

The reason for this, of course, is that there is a limit to the noise figure achievable at low levels even with the best tubes in the best available circuitry—and that is why in amplifiers for biological investigations requiring sensitivities below 1 microvolt, various modulation methods are substituted for direct amplification.

For one thing, the preamp must have a net gain, after equalization, of between 50 and 100 to bring the output of most magnetic pickups up to a level sufficient to drive following control units. Even if we had no plate supply ripple whatever, no filament hum, and no resistor thermal noise at all, and if the noise at the first grid were no more than 1 microvolt, we would still have 50 or 100 microvolts at the output. Assuming a 1-volt output this would give us a noise figure of 80 db. This, however, is the noise figure for average and perhaps even peak output. The softer passages on records are at least 20 or 30 db down and the significant noise figure is obviously the one which obtains at low level or, even, no-signal conditions; for, after all even a fairly loud hum is drowned out by peaks, whereas at very low levels any audible noise at all will be masking. And even the theoretical ideal appears to limit the no-signal noise figure to, at best, something between 60 and 70 db.

But the practical limit is at least 6

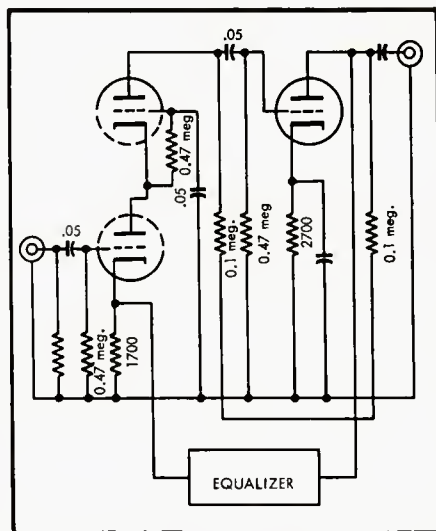

Fig. 3. Another circuit configuration with the equalizer feeding back around two stages.

to 10 db poorer. In the first place I don't think we have any tubes with no more than 1 microvolt grid noise with audio signals. In the second place, unless we use a battery supply, we cannot assume perfect filtering even with heroic measures; and a few microvolts of hum at the plate of the first tube will be amplified to 50 or 100 microvolts or more at the output. Finally, even a fully enclosed preamp will have some slight inductive pick-up of hum in a modern household in which electrical wiring and appliances set up an amazing field as is evidenced by observing an oscilloscope or voltmeter with a short length of ungrounded wire connected to the input. If this inductive field is not passed on as 60 cps hum it is very likely to be rectified by connections, joints, and so on, and to become audible as hash. So,

taking all things into consideration, it would seem that a total noise of around 300 microvolts is about the best we can achieve in a practical circuit and a practical gadget and anything between that and 1 millivolt can be considered very good indeed.

I seem to have made out a case against the cascode configuration rather than one in favor of it. And I do think it is only fair to say that for the average application it does not provide enough hope of improvement to justify the additional complication. However, those who are interested in approaching the unattainable ideal as closely as possible may well find it worth the complication; and for these I provide a couple of circuits which have delivered excellent performance.

The Circuit

The audio version of the cascode circuit is extremely simple and, in fact, requires no more components than a pentode of the same gain would require. The two tubes are connected in series, the input tube being a grounded cathode amplifier, while the output tube is a grounded grid amplifier. The theory of operation has been covered many times and I won't bother repeating it. The advantage over either a single grounded-cathode or grounded-grid stage is this: the grounded-cathode input stage with its high input impedance has a much better noise figure at the grid than a grounded-grid stage with its low input impedance would have; on the other hand, the grounded grid stage in this form achieves higher gain than it would as an input tube. And the combination produces both a better noise figure and higher gain than either section could alone.

Assuming 150 volts is used on the plate (a good practical value which permits plenty of hum filtering and decoupling from succeeding stages) the gain of 100 is enough to provide both

(Continued on page 56)

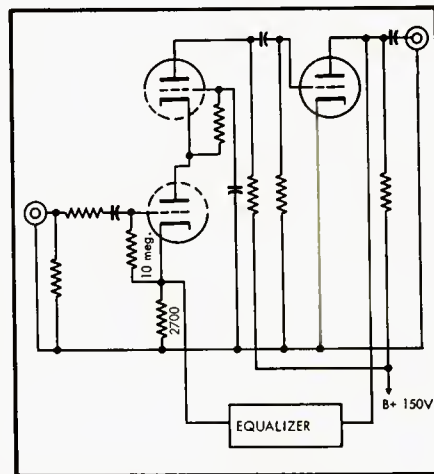

Fig. 4. Modification of Fig. 3 to permit obtaining bias for cascode from panel potential.

The Phonograph Pickup Arm— A Problem

A discussion of needle forces and
a method for their reduction

Details of an interesting device which offers a theoretical solution to a problem which has plagued phonograph designers for years. The photographs show one physical embodiment of the author's idea, but countless others could undoubtedly be devised by the experimenter who is handy with electro-mechanical problems.

H. A. SCHWAN*

Photographs by E. J. Gauss

REDUCING PHONOGRAPH RECORD WEAR has long been an aim of engineers associated with the development of phonograph equipment.

Efforts to this end have produced precious-stone styli, high-compliance pickups, and low-mass and resonance-free pickup-arm assemblies. The results are devices capable of tracking the record grooves with very small stylus forces and reproducing the fragile impressions with low values of distortion and wear.

However, there is one aspect of the problem which appears to have been neglected by development people until very recently. This is the radial component of needle force resulting from pickup arm off-tangency. An argument arises immediately, wherein the offset head and the British Burne-Jones arm are held up for scrutiny. A quick and simple analysis of the forces involved with these two arm styles will show that a rather considerable radial needle force still exists.

Force Analysis

Figure 1 shows a pickup arm with an offset head and the forces acting on the needle while the record is rotating. Assume that the stylus is engaged in groove A. As the groove moves under the stylus, friction causes the groove to try to carry the needle along with it, producing tangential force F_t on the needle in a direction tangent to the groove. The needle is prevented from moving in this direction by the restraint imposed by the pickup arm, but, because of the way the arm is mounted, the only force it is capable of exerting on the needle to balance F_t is the reaction F_a . This force

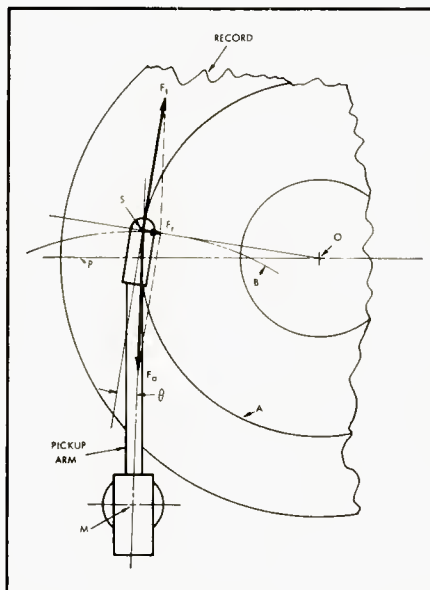

Fig. 1. Diagram showing forces acting on the stylus in a conventional pickup arm.

is necessarily directed along the line joining the point of stylus-record contact with the center of the arm pivot. It is obvious from Fig. 1 that the two forces do not cancel each other completely since they are not oppositely directed. Radial force F_r , directed toward the groove center, appears as the unbalanced component. If this force remains unbalanced the needle will move in toward the center of the record.¹ This radial force finds cancellation against the inside wall of the groove, but since the walls are not vertical, the stylus must climb a small dis-

¹This is true for the diagram shown. If the off tangency were of the opposite sense; i.e., if the point of needle contact were below the radius P , the radial force F_r would reverse its direction.

tance up the wall before complete cancellation occurs.

It can be seen that the magnitude of this radial force varies with the angle θ between F_t and F_a and also with the amount of frictional force applied to the stylus. The angle θ varies with arm length and the position of the needle on the record. (θ is usually largest at the inside groove.) The frictional force varies with record and needle materials and condition and with the dynamics and frequency of the engraved sound. This is one of the biggest reasons why records often show white wear bands in the last inch or so of grooves. It is here where the off-tangency is the worst and the dynamics of a symphonic finale are the heaviest.

Nothing constructive is accomplished by the presence of the radial needle

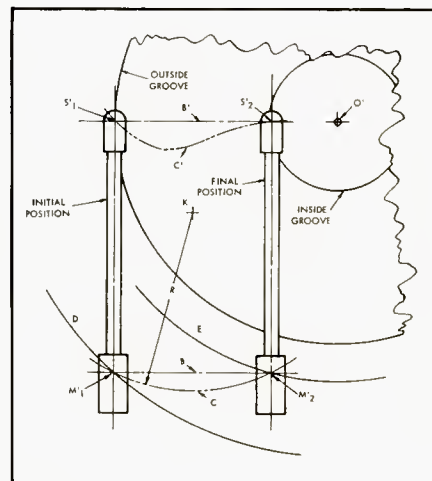

Fig. 2. Diagram showing the essences of two geometries of driven-mount pickup arms arranged to maintain tangency at all positions of the stylus.

* 1320 24th St., Boulder, Colo.

Pilot

now gives you . . .
component convenience
plus Beacon Tuning

in the New
HF-42



*FM-AM Tuner—Phono and Tape Preamp—20-Watt Amplifier
On One Chassis . . . In One Handsome Enclosure*

\$199⁵⁰ slightly higher
West of Rockies

How welcome this will be to those of you who have been seeking an easier path to genuine high fidelity. For it is true, that many of you have actually denied yourselves the thrilling performance of components—simply because of a disinclination to 'do it yourself'.

Recognizing this, Pilot developed the fabulous HF-42. With one bold stroke, Pilot eliminated the inconvenience of wiring and the chore of special installation. In the HF-42, Pilot embodied all the necessary high fidelity components—integrated on one chassis and ready for use: a superb FM-AM tuner—a versatile phono-preamp with full record and tape equalization—dual tone controls—

and a 20-watt amplifier . . . plus the added accuracy and ease of Beacon Tuning.

And then, Pilot designers styled an enclosure for the modern home and set it off in deep burgundy and brushed brass. The result is so attractive that you'll want to show it off on an open shelf or table top.

To complete this truly fine high fidelity system, you need only add a Pilot Companion or other high quality speaker system. And with the inclusion of a changer or turntable, you can enjoy record reproduction that approaches the realism of the concert hall.

See your high fidelity dealer or write: Dept. CD-1

the

Pilot

RADIO CORPORATION

37-06 36th STREET, LONG ISLAND CITY 1, N. Y.

IN CANADA: Atlas Radio Corp., 50 Wingold Avenue, Toronto 10, Ontario



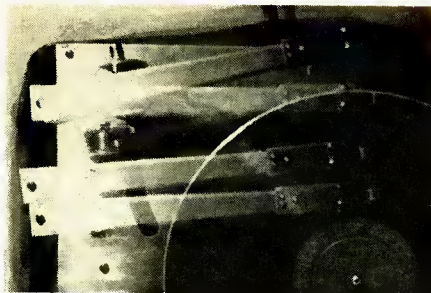

Fig. 3. Multiple exposure of device in operation showing pickup arm on the rest and in successive positions on the record. Note that the arm is tangent in all positions.

force. On the contrary, it serves only to prevent proper stylus seating and it increases the over-all resultant needle force. In fact, it can account for one-fourth of the total needle force in standard players. In some cases this force becomes great enough to cause the stylus to jump the groove wall, and skipping is the result. Its elimination is highly desirable.

The Present Arms

An offset pickup arm is designed in such a way as to maintain the axis of the cartridge as nearly tangent to the groove as possible. It greatly reduces the amount of distortion produced over that which would be experienced if an equivalent straight arm were substituted. But if the cartridge axis is tangent to the groove at the point of needle contact, the line of action of the arm must differ from tangency at the same point by the angle of offset. The offset arm offers some gain over an equivalent straight arm, but it certainly is not a complete solution to the problem.

For all practical purposes, the *Burne-Jones* arm maintains the pickup cartridge axis tangent to the groove at all positions of the stylus on the record. This is certainly desirable, and the *B-J* arm represents an improvement over the offset arm. However, an analysis of the forces and torques set up in this arm will show that the radial needle force is still present and that it is still of considerable magnitude. The *B-J* arm, then, is not a complete solution either.

In the author's experience, the only pickup support device which satisfies all the *theoretical* requirements for cartridge and line-of-action tangency is one in which the pickup moves along a radius of the record, as is the case with the *Orthosonic* arm. It is certainly a concrete step in the right direction. However, if the very simple, time honored method of operating a phonograph could be retained and if bearings rolling in line or surface contact could be eliminated, both without destroying the essence of the geometry, the author feels that a truly acceptable solution to the problem would be at hand.

A Solution

Since the reduction of stylus friction to zero is impossible, it appears that the only way to eliminate the radial force is to maintain the angle θ of *Fig. 1* at zero for all positions of the stylus on the record. This can be done with an infinitely long straight arm, or it can be done with a short, rigid arm mounted on a guide track. It can also be done with a conventional straight arm with a *movable* pivot mount.

Figure 2 shows the essences of two practical geometries for a straight arm with a movable pivot mount. If the arm is mounted by means of a conventional swivel to a carriage which can be driven along the line *B* by means of lead screws or the like, the condition of tangency at



Fig. 4. Three-quarter view of device in operation. Notice slot to accommodate the movable pickup arm mount post.

all points of stylus-record contact can be met if the carriage drive is operated at the proper speed. However, since different areas of a given record are often cut with different pitches the carriage velocity cannot be constant. In the author's models, this problem was solved by incorporating the carriage drive into

a simple servo-mechanism wherein the drive is turned on and off by means of a very light sensing switch mounted on the carriage and operated by the pickup arm. Thus, if the arm is not tangent, it will also not be perpendicular to the lead screw, and a light wiper carried by the pickup arm will have been rotated into contact with a switch element mounted on the carriage. Such contact closes a relay which energizes the drive mechanism, drawing the carriage and pickup mount along the line *B* until the arm is tangent, at which time, contact is broken and the drive turns off. The carriage is returned to point M_1' by the same drive operated at a higher speed in reverse by the same wiper and an opposing switch element on the carriage.

After several such machines were constructed it became evident that building a device which employed the straight line drive was not practicable. It was ascertained that the same end result could be obtained by driving the pivot mount in *any* appropriate manner from *any* point on the arc *D* of *Fig. 2* to *any* point of arc *E*, each arc being drawn from the record center through the corresponding extreme position of the mount center.

If the pickup arm is mounted on a lever which rotates about point *K* the mount will follow the arc *C*, and the stylus will follow a curve such as *C'*. This construction requires that the reference elements of the sensing switch be positioned by a cam or some other means external to the pickup support lever. However, in the long run, construction of a quiet, smoothly operating machine was simplified by using this geometry.

(Continued on page 60)

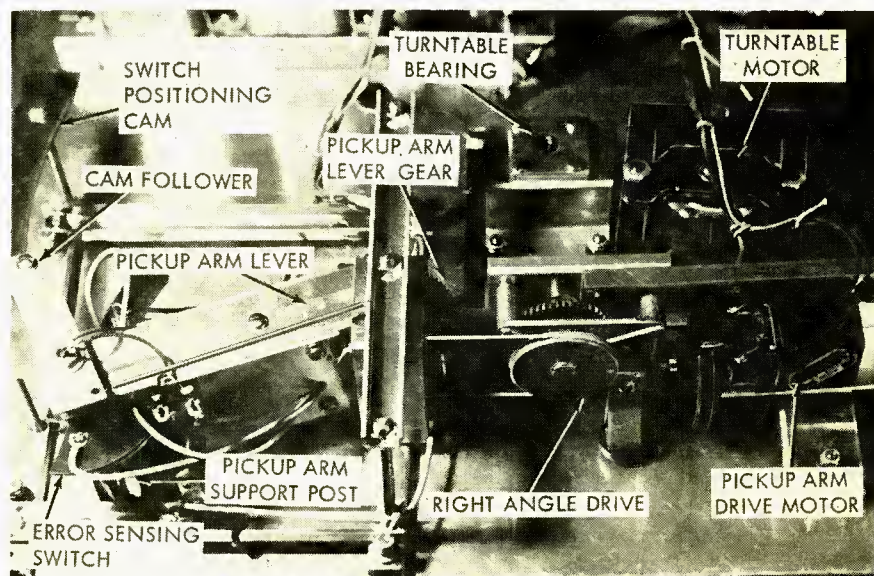

Fig. 5. Under-chassis view of mechanism showing all mechanical parts. It is to be noted that only seven moving parts are involved in the arm positioning section including the motor and belt, and that it can easily be done with three. A simple clutch was also used successfully to take power from the turntable to position the pickup-arm mount.

Let's Get Down To Earth About Electrostatics

FEW developments in the audio field have created such a whirlwind of fantastic claims, sarcastic denunciation, and fanciful daydreaming as the electrostatic loudspeaker. We doubt that any product has ever created so many self-appointed experts in so short a time. The electrostatic has been alternately praised on the one hand as tolling the doom of the dynamic loudspeaker, and on the other hand wishfully dismissed as a "romantic" concept of speaker design "which has been thoroughly disproven". Neither statement is accurate. While we firmly believe that eventually all quality systems will include an electrostatic high and mid-frequency reproducer, it appears at this juncture that the low end can best be reproduced with cone designs. Manifestly, the head-in-the-sand ostrich approach which tries to dismiss the electrostatic with a wish, is proclaimed either out of abysmal ignorance or malice.

The development of electrostatic loudspeakers has progressed to the point where they can no longer be referred to as identical, any more than all dynamic designs can be so classified. In some respects, there is an even wider divergence of design between the various electrostatics than exists in their dynamic counterparts. No informed individual would attempt to evaluate a \$300 multi-driver speaker on the same performance basis as a \$2.00 replacement cone. Neither should the inexpensive single-ended electrostatics be compared with the precision-built push-pull designs.

The electrostatic is in the ascendancy not because it is now simpler and more inexpensive to build, but rather because the basic principle, long recognized as superior to dynamic designs for reproduction of the upper octaves has been made practical for the first time by the utilization of new materials, techniques and theories previously overlooked. Adherence to rigid production tolerances and test procedures virtually assures that the JansZen will never become a mass-produced item. Its relatively high cost directly reflects the uncompromising design and construction for which it is justly famous.

Since efficiency, per se, is no real criterion of loudspeaker performance, we have made no attempt to

emphasize this factor in our electrostatic design. In fact, the last thing we would want to do would be to match the raucous output of loudspeakers designed for theater use, whose outrageous invasion of one's sensibilities creates the effect of a brass band in the bathroom. We take strong exception to the thinking of some theater sound purveyors who prefer to base their high-powered efficiency claims on a single frequency or narrow band where conversion of electrical energy into acoustical energy is highest, even though claimed response is far in excess of these limits. With a given power amplifier, the maximum acoustic power output of the JansZen is higher than that of any other loudspeaker at the higher frequencies. Over the entire frequency range it is a suitable match for the very finest low frequency systems.

While high frequencies are by nature directional, the exclusive JansZen array results in uniform high frequency distribution throughout the room, without the use of any baffles, gratings, etc. imposed between you and the music. The result is a broad sound source with none of the resonances and reflections common to mechanical systems.

We categorically state that the JansZen has the finest transient response, and will provide the smoothest, most extended frequency response available in any high frequency loudspeaker, with absolutely no trace of any inherent noise.

In the light of the above facts, we hope when you are planning your "ultimate system" that you will give serious thought to the inclusion of an electrostatic, preferably a JansZen.

JansZen Electrostatic

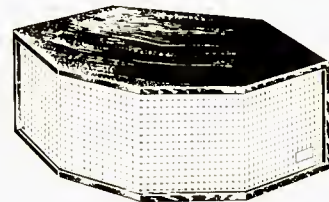

Send for complete literature on the JansZen 1-30 Electrostatic as well as the name of your nearest dealer!

PRODUCT OF

NESHAMINY ELECTRONIC CORP. NESHAMINY, PA.
Export Div.: 25 Warren St., New York 7, N. Y. Cable: Simontrice, N. Y.

Add a Tuning Indicator to Ratio-Detector FM Receiver

Presenting a satisfactory manner by which a tuning eye may be connected to give a visual indication for tuning FM receivers of a particular type.

CARL R. WISCHMEYER*

THE NECESSITY of accurately tuning an FM receiver to an incoming signal is indisputable; but without either a tuning indicator or automatic frequency control the process may present some difficulty, especially to the uninitiated.

At the outset it must be remarked that proper r.f., i.f., and discriminator alignment are essential to optimum performance of any tuner. Tuning indicators which give an "intune" indication at the frequency for which voltage gain to the discriminator is a maximum, in which class the present circuit falls, require the absence of side peaks (also flat top) of the selectivity characteristic in order to function properly. Receivers with tuning indicators which operate on the d.c. voltage at the audio take-off point, positive on one side and negative

on the other side of correct tuning, also require correct alignment of the whole receiver for optimum performance. An ingenious scheme combining the above two methods appeared recently,¹ but meaningful indication still depends upon correct alignment. Let us therefore assume correct alignment of the tuner.

The following note deals with the exceedingly simple details of adding a tuning-eye tube to FM sets using the popular ratio detector. A typical example is the modification of the venerable Pilot T-601 FM tuner, an excellent performer still enjoying widespread use. However, the following applies equally well to any ratio-detector type of receiver, which may be recognized by connections from the ends of the discriminator transformer

¹ Robert S. Ferguson, "FM tuning meter." *Wireless World*, July 1956, page 340.

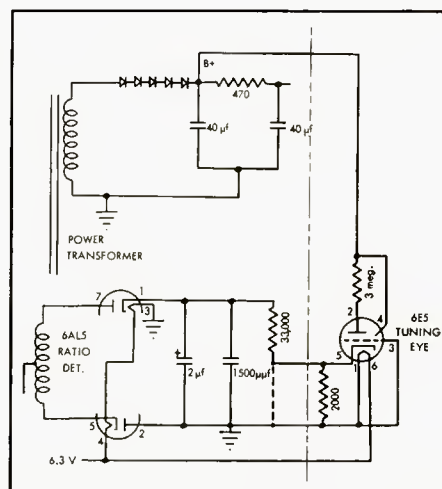

Fig. 1. Schematic of the few changes required to add the tuning eye.

secondary to one plate and to one cathode of a pair of diodes.

As shown in *Fig. 1*, there is required only the addition of two resistors plus the 6E5 tuning-eye tube and connections to the tuner circuit at a total of four points. The additions to the circuit of the tuner are shown at the right of the broken line. The grounded end of the 33,000-ohm load is disconnected and brought out to the 6E5 cathode, thereby tapping the ratio-detector load resistor so as to maintain the cathode of the 6E5 at an appropriate potential above ground. The drop across the resistance to ground from the 6E5 cathode is determined largely by the d.c. output of the ratio detector, which in turn is a function of the strength of the signal to which the set is tuned. Proper tuning of a signal, therefore, results in a maximum developed d.c. across the ratio-detector load and hence maximum grid bias (and minimum shadow angle) of the tuning-eye tube.

The circuit constants shown are not particularly critical, those in the schematic circuit having performed satisfactorily in all four of the Pilot T-601 tuners which this author has seen modified. Weak signals which do not afford satisfactory limiting action produce a perceptible deflection of the eye, while strong local signals virtually close the eye. The useful variation in shadow angle may be made to respond to stronger or weaker received signals by connecting

(Continued on page 57)

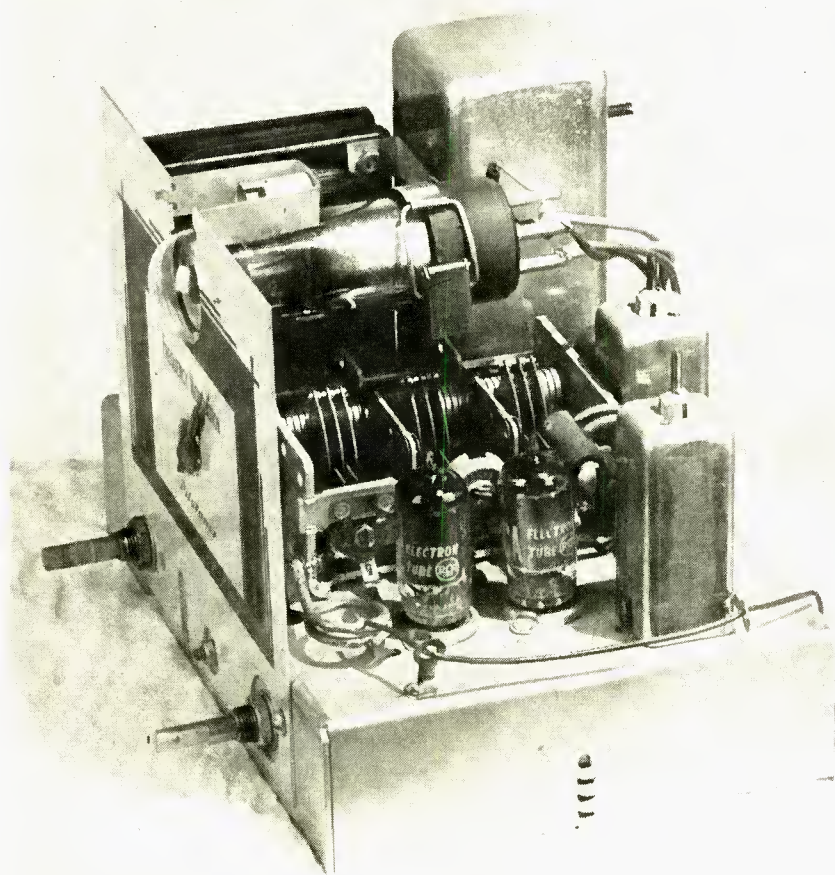

Fig. 2. One method of installing the indicator tube so it is visible from the front.



Ellington Photo by Aram Avakian

The Duke was made for High Fidelity

Ferde Grofe, who went on to write for Toscanini, used to sit all night in the old Cotton Club, moved and mystified by the music of Ellington. He finally confessed that the Duke's magic could not be set down as so many notes on a piece of paper. The phonograph records of those days in the late twenties, treasures though they are, give us little more than the shadows of what Ferde Grofe heard.

The elegance which is Ellington's now was there 30 years ago when he and his five Washingtonians sat down to make their first records before a solitary horn pick-up in a New York loft. It is still there in muffled echo for those lucky enough to have the old recordings. For the essence of jazz is the impulse of the man who plays it; and the essence of the Duke is not one instrument—but 15—because he alone among jazz composers has made the whole orchestra his instrument.

Today, for the first time, we are as rich as he, for the records we play at home over high fidelity, or the performances we listen to over FM, have all the sumptuous texture that taunted Ferde Grofe because it seemed to him then beyond recapture.

High fidelity has come of age and many excellent instruments are available today. The distinction that is Harman-Kardon's comes, perhaps, from the sensitivity and understanding its people have for the work their products do. There is more here than simple devotion to perfection in curves and percentages. That surely exists at Harman-Kardon; but a genuine feeling for the "bursting white lights" and the limitless shadings of the music is also there. Inescapably, this special sensitivity to the music—whether Ellington's or Mozart's—is expressed in the way operating controls are organized, in the emphasis placed on one function over another and in the way the product looks.

Perhaps the finest expression of this marriage of engineering skill and feeling for the art is the Harman-Kardon Festival II, Model TA-1040, shown above. Here in a graceful compact unit is a complete and powerful high fidelity electronic center. Simply connect it to an equally fine record player and speaker, and a high fidelity system of incomparable performance is yours.

The Festival combines a highly sensitive AM-FM tuner, a complete preamplifier and a 40 watt hum-free, distortion-free power amplifier. It features: magnificent Armstrong FM with Automatic Frequency Control to insure accurate tuning *automatically*; Automatic Noise Gate to eliminate noise between stations when tuning; sensitive AM with 10KC whistle filter; Dynamic Loudness Contour Control to provide precise balance for your own hearing characteristics; enormously effective treble and bass controls to adjust for the acoustics of your room; selectable record equalization; remote speaker selector switch; illuminated tuning meter and rumble filter. All this expressed in six easy to operate controls.

The cage and control panel are finished in brushed copper; the knobs and escutcheon frame in matte black. The Festival stands 4-5/16" high, 16-1/8" wide and 14" deep.

The Festival price is \$225.00

We have little regard for the typical commercial testimonial, but happily, our admiration for Edward Kennedy Ellington is reciprocated by the Duke. Long before this advertisement was contemplated, he had chosen Harman-Kardon tuners and amplifiers for his personal and professional use. The Festival, he tells us, is his favorite for listening at home.



FREE: beautiful, new, fully illustrated catalog. Describes complete Harman-Kardon line and includes guides on how and where to buy high fidelity. Send for your copy now. Write: Harman-Kardon, Inc. Department A-O4, 520 Main Street, Westbury, New York.

harman kardon

INCORPORATED

NEW PRODUCTS

● **"Staticmaster" Record Brush.** Removal of static charges and static-attracted lint and dust is greatly simplified by means of the Staticmaster, manufactured by Nuclear Products Company, 10169 E. Rush St., El Monte, Calif. Metal parts are recessed and all plastic surfaces are gently



rounded so that any possibility of damaging records is minimized. Polonium is the material used to remove the static charge. Upon expiration of the guarantee period, when the polonium has lost its strength, the Staticmaster may be returned to the factory for insertion of a new polonium strip at a fraction of the unit's original cost. **D-1**

● **Jensen Constant-Voltage Transformers.** As an addition to its Professional Series line of commercial speakers and accessories for industrial, institutional and public-address applications, the Jensen Manufacturing Company, 6601 S. Laramie Ave., Chicago, Ill., is now producing a group of Type ZC constant-voltage transformers.

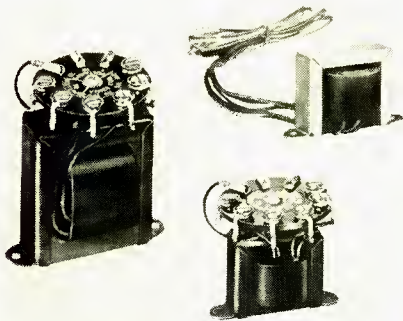

Engineered expressly for distribution systems commonly referred to as 70-volt constant-voltage systems, the transformers are designed to draw a predetermined amount of power from a 70-volt line. Heavy-duty screw terminals are provided for speaker and line connections. The transformers are completely impregnated and dip-processed for operation in outdoor and industrial atmospheres. Additional technical information is available on request. **D-2**

● **Ampex High-Speed Tape Duplicator.** New improvements in Ampex tape duplicating equipment make possible an even higher standard of audio quality than was possible with earlier models. Up to ten



copies of an hour-length program—may be made in as little as 1½ minutes. Although operation of the new S-3200C duplicator is essentially the same as that of earlier models, convenient central control is accomplished through a master control panel above which are mounted a master electronic assembly and a master bias oscillator. Previously recorded tape which is to be duplicated is placed on the master unit and reels of blank tape are placed on all slaves. After all machines are threaded, one pushbutton is used to activate the entire system. The master tape is generally threaded in the tail-out position and duplicates are recorded backwards. The copies, when removed from the slaves, will then be front end out and ready to package with no rewinding necessary. All new Ampex duplication systems will make copies of any audio recording made on standard ¼-in. tape at speeds of 3¾, 7½, 15, or 30 ips, including full-track, half-track and two-channel stereophonic (in-line or staggered head) recordings. Ampex Corporation, 934 Charter St., Redwood City, Calif. **D-3**

● **Tape Cartridge.** A long-play tape cartridge capable of playing a full hour at 7½ ips has been developed by Sound Electronics Laboratories, Toledo, Ohio. Called Fidelipac, the cartridge is only slightly

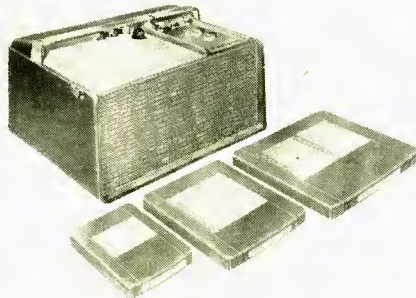

larger than standard 1200-ft. reels. Built around a very simple drive system, the unit is designed for economical mass production. Using standard quarter-inch tape and the conventional continuous loop, the principal new feature is a patented method of reducing tape friction and static by the cartridge design. Tape tension is constant at all times, resulting in stable reproduction. Pressure pads are not required to assure good tape-to-head contact, thus greatly reducing head wear. Design of Fidelipac minimizes exposure of tape to dust and dirt. Also, static charges are neutralized. Produced in a colorful plastic case of modern design, the cartridge is simply inserted in the playing device and automatically locked in proper position. The tape itself is never touched or handled. **D-4**

● **Dynamu Stereo Magnetic Head.** Engineered for in-line recording and playback, the new Model 8031 Bionic stereo head affords a response of 70 to 12,000 cps ± 4 db at 7½ ips. Gap length of the heads is 0.00015 in. with both gaps precisely

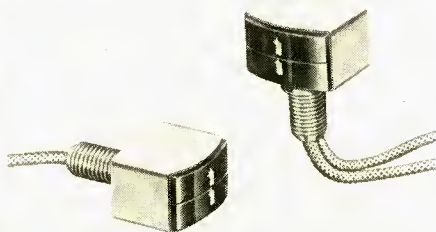

aligned for exact coincidence. Mu metal shielding is used and each unit is supplied with shielded conductors. The heads are

readily adaptable for installation in existing tape transports. Uniformity is such that the heads may be incorporated into new tape equipment using normal production procedures. Detailed specifications and prices may be secured by writing Dynamu Magnetronics Corporation, Division of Maico Company, Inc., 21 N. 3rd St., Minneapolis 1, Minn. **D-5**

● **Components Two-Speed Turntable.** Features of interest to high fidelity enthusiasts in the new Components duo-speed professional-type turntable include a unique positive-action speed control lever and a belt-driven heavyweight non-magnetic 12-in. table. The unit also includes



a precision-built 4-pole constant-speed motor which is magnetically shielded and a non-slip cork pad to protect records. Available in two models, Model 45 for 33-1/3 and 45 rpm, and Model 78 for 33-1/3 and 78 rpm. Rumble of the unit is down 65 db and flutter and wow are less than 0.1 per cent rms, according to the manufacturer. Manufactured by Components Corporation, Denville, N. J. **D-6**

● **Printed Circuit Kit.** In six different sizes ranging from the basic model which provides enough material to make several small printed circuits up to the Prototype Laboratory Kit which is intended for use in developing printed circuit plates for commercial use and bringing the preparation up to the stage of mass production with either photographic or silk screen techniques, complete kits of parts have been made available by Techniques, Inc., 178-84 Central Ave., Hackensack, N. J.



Sheets of laminate—single sided in the smaller kits and both single and double sided in the larger ones—sockets, eyelets, terminals, etchant, resist, and all necessary material is included. For either experimenter or development engineer, these kits permit one to acquire a working knowledge of printed circuits and the requirements of layout and design. Further information will be furnished on request.

In addition to the kits, the company can provide complete engineering and production service on sample, prototype, and small or medium production runs on printed circuitry, and the company specializes in fast service. **D-7**

Martin Block says;

"I use the CAPPS CONDENSER MICROPHONE exclusively for broadcasting the Make Believe Ballroom."



Martin Block, Dean of Disc Jockeys and authority on sound uses the CAPPS CONDENSER MICROPHONE on his daily broadcasts over Radio Station WABC-AM FM. Tune in and hear Mr. Block and the high quality CAPPS CONDENSER MICROPHONE in action.

Only by using the custom built CAPPS CONDENSER MICROPHONE and newly designed POWER SUPPLY can you record true voice quality and achieve presence in recorded music.

Go to your nearest dealer for a free demonstration and hear the difference.

CAPPS & CO., INC.

20 Addison Place
Valley Stream, L. I.



Equipment Report

Fifteen-watt Sonotone HFA-150 Amplifier

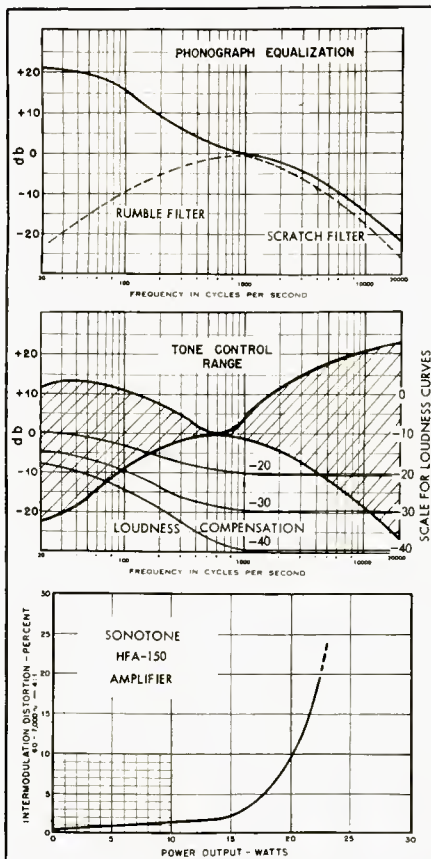

Fig. 1. Performance curves for the HFA-150.



Fig. 2. Sonotone's "15-watt amplifier at a 10-watt price," Model HFA-150.

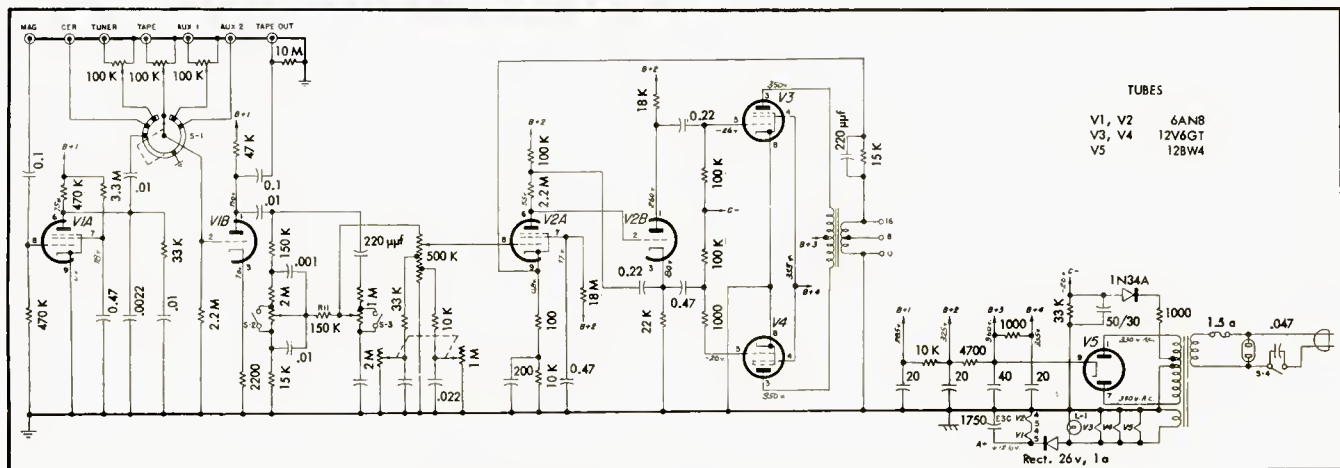

Fig. 3. Complete schematic of the Sonotone HFA-150.

ONE OF THE MOST COMPACT 15-watt amplifiers we have encountered lately is the Sonotone HFA-150, shown in Fig. 2. This unit combines an attractive design with good performance and indicates a conscientious study of the problem from both engineering and styling standpoints.

The amplifier employs only five tubes—two 6AN8's, two 12V6GT's, and a 12BW4 rectifier. The pentode section of the first 6AN8 serves as the phono preamp, and is equalized approximately in accordance with the RIAA curve. Five high-level inputs and the output from the preamp section are switched by the selector switch and fed to the triode section of the tube, which in turn drives the tone control network. The pentode section of the second 6AN8 is a voltage amplifier and the triode section is a phase splitter, driving the output tubes from the split-load circuit.

Three unique features appear in the circuit, shown in Fig. 3. *S-2*, across a portion of the bass tone control, serves as a rumble filter. The switch is actuated by pulling the knob outward slightly. *S-3*, across a portion of the treble control is actuated in the same manner and serves as a scratch filter. Curves for both of these filter circuits are shown by the dotted lines in the upper section of Fig. 1. The con-

trol consists of a dual potentiometer with each section across one of the capacitors in the tapped volume control circuit. In the flat position, both of these capacitors are shorted out; as the control is rotated, the low-frequency response is increased in the lower-volume settings of the volume control, resulting in the curves shown in the center section of Fig. 1. The tone control range is also shown in this section. Intermodulation distortion is shown in the lower section of Fig. 1. Provision is made for 8- and 16-ohm speaker loads, and the amplifier is extremely stable with respect to the reactive loads, with no instability being evidenced with a 2.0- μ f capacitor across the 16-ohm output—which is somewhat unusual with feedback amplifiers.

One of the more important features of the amplifier is the use of d.c. on the filaments of the two 6AN8's. This results in a low hum level, which measures 66 db below one watt at the operating point of the volume control on phono input, or 74 db below 1 watt on the high-level inputs. These figures correspond to approximately 78 and 86 db below maximum output (15 watts) which is the usual method of indicating hum and noise.

The tone controls seem to be somewhat more abrupt than is usual, but with the smaller amplifiers it is considered likely that the user may not be using a speaker system with extremely good response at the top and bottom of the audio spectrum, and the additional boost and cut is provided to compensate for speaker deficiencies. Actually, however, the subjective effect is excellent, and the amplifier sounds clean throughout normal operating outputs.

Sensitivity is such that a 1-watt output is obtainable from a phono input of 1.65 mv, and from a high-level input of .079 volts, and the signal at the TAPE OUTPUT jack is 0.5 volts from these inputs. Separate level adjustment potentiometers are provided for three of the high-level inputs. Physically, the perforated metal cover is arranged to mount with a slight overhang in front for a modern appearance, or flush with the front panel for a more conventional appearance. The unit is available in a wide range of colors.

Belden 8411

If it's worth Engineers' time . . .

Belden 8422

. . . It's worth Engineered Cable

Belden 8412

**Belden
microphone
cables**

Whatever the installation,
whatever the requirements,
there is an accurately
rated Belden Microphone
Cable built for the job.



4-8

1001 WIRES FOR EVERY ELECTRONIC NEED



Exciting New Releases!



AUDIO FIDELITY RECORDS

1. The phenomenal **DUKES OF DIXIELAND Vol. 2** – Spontaneity Supreme! The Dukes, and the Duchess, go all out on My Blue Heaven, Mama Don' 'Low, Sheik of Araby, etc. You have to hear it to believe it! AFLP 1840
2. **ROME WITH LOVE** – Come wander down picturesque streets, past little shops and elegant palaces . . . accompanied by the music of Rome, played by Jo Basile and his accordion. AFLP 1822
3. **TORERO! La Fiesta Brava! Vol. 3**—Another completely new album of Bullfight music played by the Banda Taurina. Luxuriously packaged, complete with 50-pg. illustrated book *El Toreo*, in English. AFLP 1818
4. **FIESTA EN ESPAÑA** – Flamenco—exciting, hand-clapping, heel-tapping music full of fire, color, passion and desire . . . danced and sung by authentic Flamenquistas. AFLP 1819
5. **HONKY TONK PIANO** – The roaring 20's in Hi-Fi! It's Eddie "Pianola" Barnes at the old upright playing favorites like: Hindustan, My Sister Kate, Little Nelly Kelly, etc. AFLP 1827
6. **RENDEZVOUS A PARIS (Accordion de Paris, Vol. 2)** – A dimly lit bistro . . . a long, soft sigh — and the singing accordion of Jo Basile create the mysterious enchantment for a Rendezvous in Paris. AFLP 1821
7. **LEON BERRY at the GIANT WURLITZER PIPE ORGAN** – A Strauss Waltz . . . a "Pop" tune . . . a Dixieland favorite. An exciting new excursion into the world of Theatre Organ Music. AFLP 1828
8. **CHA CHA CHA**—Pedro Garcia and his Del Prado Orchestra and the bubbling, infectious beat of romantic Latin rhythms. Complete with illustrated dance instructions. AFLP 1810
9. **PLAZA DE TOROS! La Fiesta Brava! Vol. 2** – Another afternoon at the Bullfights with the Banda Taurina. Luxuriously packaged with portfolio of full-color reproductions of Bullfight paintings, ready for framing, by renowned artists. AFLP 1817
10. **BAWDY SONGS and BACKROOM BALLADS Vol. 3** – Gather 'round you lovers of lusty lore . . . Oscar Brand has done it again! A complete new album of spicy musical folklore. AFLP 1824

each 12-in. LP
\$5.95

WRITE FOR
FREE CATALOG



NATIONALLY DISTRIBUTED BY
DAUNTLESS INTERNATIONAL 750 TENTH AVENUE • NEW YORK 19, N. Y.



EDWARD TATNALL CANBY*

OPERA SPECIALS

Gluck: Orpheus and Eurydice (Orig. French score.) Leopold Simoneau, Suzanne Danco, Pierrette Alaire; Roger Blancard Vocal Ens.; Orch. des Conc. Lamoureux, Rosbaud. **Epic SC 6019 (2)**

For anybody who has heard all or parts of this famous opera, this is an extraordinary recording, both beautiful in itself and intensely revealing. For it, at last, restores the shape of the original French version (which in turn was fashioned from an earlier "Orfeo" composed to Italian text in Vienna)—and "breaks" with a century-old tradition by assigning an honest-to-goodness tenor to the celebrated role of Orpheus, invariably sung by an alto in all current-day productions. What a revelation? What a pleasure to hear male music sung by a male!

An alto? Most of us have assumed that the alto Orpheus was a leftover from the old tradition that required a castrato male voice for many heroic male opera parts in the 18th century. It was a shock to me to read, in the excellent notes here provided, that the original Italian 1762 "Orfeo" did indeed specify a castrato high male voice, but that the revised French version of twelve years later, 1774, was rearranged for the tenor voice which we hear in this recorded version—many whole sections being transposed into new keys by Gluck to suit the tenor range and even some connecting passages rewritten to lead to different keys.

Howcome the alto tradition? It seems that in the 1850's old Hector Berlioz obliged with a revamping of the older score, in order to satisfy some obscure Romantic idea that the opera would sound better with an alto for the hero, instead of the normal male! A flighty and impermanent fancy, we can be sure, but somehow the new version stuck and an alto it has been ever since, through thick and thin, in sheer defiance of the originals by Gluck—both of them for a male singer. So those who have submissively sat through the usual "Orpheus" with its busty lady hero who makes love to another busty lady heroine can now breathe a sigh of relief and listen to a properly masculine voice.

(Never forget that even a castrato, though singing a soprano or alto range, was a male person. The 18th century made a very clear distinction between males, "altered" or no, and genuine females. We are rediscovering the essence of this distinction in the newly popular "counter tenor," a genuine male who, however, has trained his falsetto alto voice up to solo, singing strength, and sings in the alto register. The counter tenor is utterly unlike an alto, mainly in that his is a male voice, even though a high one.)

In this recording the entire sense of the opera is changed by the constant play between the two leading singers—now a tenor and a soprano. Leopold Simoneau is excellent, in spite of numerous tired high notes in less important spots—he saves his best singing for

the big moments, including the famous "I have Lost My Eurydice," usually sung, of course, by a contralto.

Suzanne Danco, who is, if I'm right, Jugoslav, fits beautifully into the French singing tradition with her bright, accurate, dramatic voice, and she makes a superb Eurydice. The Lamoureux orchestra plays the lovely, lyric ballet music and the pulsing, highly expressive accompaniment for the singers with uncommonly fine feeling. All in all, the opera comes through here as both remarkably modern and surprisingly easy to listen to, especially if you follow the complete French text and the English translation, given in a parallel column.

Prokofieff: The Love for Three Oranges (1919). Soloists, Choir, Orch. Slovenian Opera, Leskovitch. **Epic SC 6013 (2)**

This is a tough proposition in a way, yet a most rewardingly musical and humorous opera if you will take the pains to follow its preposterous and satirical story along with the music. I found it fresh and funny and remarkably modern, both in its fantastic fun-making magic plot and its snazzy music, out of the Nineteen Twenties yet also out of the great Russian school of opera too. But don't by any means try it as background music!

The plot is a sort of Hans Christian Andersen take-off in grotesque, complicated, slapstick. A king's son is languishing away of melancholia and, as it soon develops, plain hypochondria. He must be made to laugh—and is, eventually, via magic. Much to do about three oranges, out of which come three maiden princesses two of whom promptly die of thirst in the midst of a desert . . . magicians right and left, a henchman who tries to invoke his own private magic spirit and can't quite make it (a crack at such dead-serious operas as Weber's "Freischütz" and, later, Wagner and his magic fire and the like), a lady cook with a bass voice who wields a terrible ladle, and, best of all, a collection of comic Greek choruses who keep butting into the story to criticize from the side-lines, insisting that the plot be changed immediately, screeching gleefully when something goes to their liking, objecting noisily at unwanted developments—all of course, to music. They sit in stage galleries and go by such giddy names as the Empty Heads, the Ridiculous People, the Lyricists. . . .

Well, where am I getting? The opera is not unlike my description of it, hectic, diffuse, zany, dreadfully complicated in a giddy sort of way. What is seriously pleasing though is, first, the fine musical line of Prokofieff, strong and full of melody under its Nineteen Twenties brassiness and, second, the very intriguing combination of modern satire and the Russian massive style—for the music is sung in Russian and by singers of the "Boris Goudonov" sort, (notably the huge, ponderous bass voice) with all the expressive *shnks* and *snski* sounds of the Russian language.

The final touch of incongruity: the opera had its 1921 premiere in, of all places, Chicago. A flop, but it had a big success at New York's City Center only a couple of years ago. We finally have caught up with it.

Stravinsky: Le Rossignol (The Nightingale). Soloists, Chorus, Orch. Radiodiffusion, France, Cluytens. **Angel 35204/L**

This exotic Stravinsky opera is a natural for records though seldom heard on the opera stage. Its oddest feature is that the first act was composed very early, in 1909, before Stravinsky tackled his first big orchestral work, "Fire Bird." The rest was postponed for years, until after he had gone through such progressively advanced pieces as "Petrouchka" and "Rite of Spring." Thus the later acts are in a style quite unlike the beginning, yet the music holds together surprisingly well.

The story is pseudo-Chinese and so, in a way, is the music. This is the Hans Christian Andersen tale of the emperor who threw out a real nightingale in favor of an ingenious mechanical bird. Both sing in this music, along with a wonderful pensive fisherman—for a contrasting and very beautiful night-song—and a host of the emperor's giddy court clique, who can't tell a nightingale song from a cow's bellow or a bullfrog chorus!

Very colorful music, superbly performed by this integrated, all-French cast. Text in French, with translation.

SPOKEN WORD

Synge: The Playboy of the Western World. Cyril Cusack, Siobhan McKenna et al. **Angel 3547B (2)**

Are you partial to a real Irish brogue? If so, it won't matter two pins if you can't at first make head or tail of this story—the voices themselves are enough to gladden any Hibernian's heart.

The story is plenty low-brow, and the play was celebrated, around 1907, as a first-rate rotten egg attractor. Nothing shocking now, but a wonderful look into life in an Irish country pub with the barmaid the heroine and an upstart Irish lad who keeps tellin' 'em he's bumped off his *faither* with a blow from a shovel, as the hero. The father keeps walking in, hale and hearty and full of grouching and complaints, each time the Playboy has got away with his story.

A terrific recording for naturalness and lively, homespun realism—not a trace of self-conscious "acting" and, with the help of a fine booklet of background material and story line, you can keep track of everything very easily in spite of the outlandish Irish racket. It's the real thing and no fooling.

I should add that the same Irish company issued an even better known play last spring in an equally fine performance—"Juno and the Paycock," which many of us have seen in its film version. Better have a try at that one too. It also features Siobhan McKenna, as Juno the wife of the doughty "Captain." (Angel 3540)

Walter de la Mare, reading. **Caedmon TC 1046**

A lovely recording and one that is so simple as to amount to a work of genius in the recording art, in a gentle sort of way. Here is

* 780 Greenwich St., New York, N. Y.

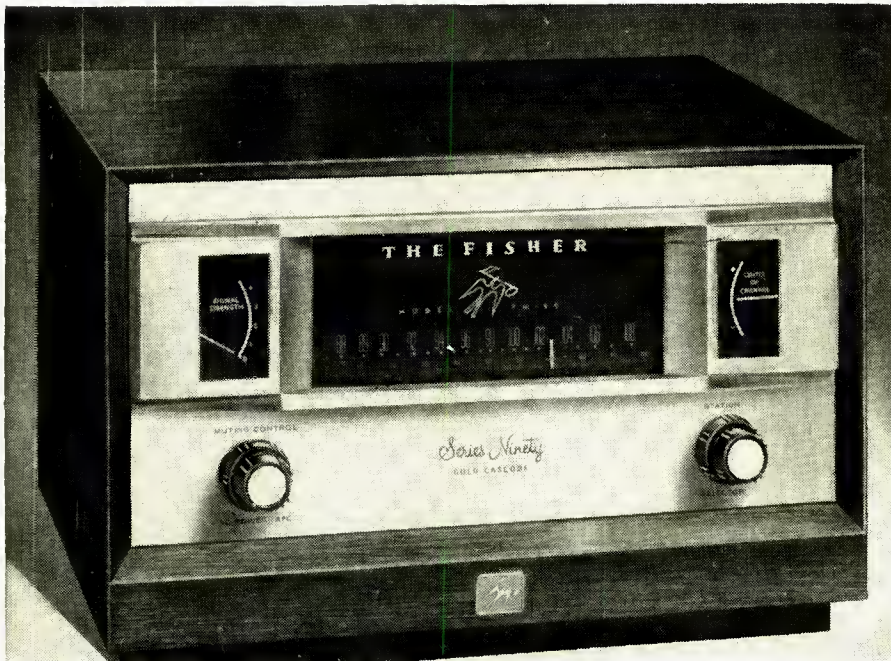

AMERICA'S LEADING FM TUNER • IN SENSITIVITY, APPEARANCE AND WORKMANSHIP

THE ABSOLUTE SENSATION

OF THE 1957

LOS ANGELES and SAN FRANCISCO
HIGH FIDELITY SHOWS!

THE FISHER

Gold Cascode FM Tuner

FM-90X

THE EXCITING RECEPTION bestowed upon the new FISHER FM-90X on the occasion of its recent introduction, was unanimously supported by the ovation accorded it at the Los Angeles and San Francisco high fidelity shows! The revolutionary GOLD CASCODE RF amplifier, and exclusive FISHER circuitry break through the sensitivity barrier to reach its theoretical limits — a feat never before possible — and surpass all other FM tuners. The GOLD CASCODE tube is the costliest of its type in the world — and carries a *two-year* warranty. *Only THE FISHER has it!*

Basic Features of the FM-90X

- TWO meters, for micro-accurate tuning.
- Revolutionary, dual dynamic limiters in operation on signals as low as 0.5 microvolts, assure noise-free reception where all others fail.
- Full wide-band detector for maximum capture ratio.
- Exclusive, variable inter-station noise eliminator.
- Full limiting on signals as low as 1 microvolt.
- Dual triode, cascode-tuned RF stage, silver-plated RF shield, triode mixer, four IF stages.
- 0.75 microvolts for 20 db. of quieting.
- Uniform response, 20 to 20,000 cycles.
- Three outputs (Main, Recorder and Multiplex).
- Dual antenna inputs (72 ohms or 300 ohms balanced).
- Four controls.
- 10 tubes plus four matched germanium crystal diodes.
- Special circuits for meter operation.
- Chassis completely shielded and shock mounted.
- Beautiful, die-cast, brushed brass escutcheon and control panel.
- Dipole antenna supplied.
- SIZE: 13 $\frac{3}{8}$ " wide x 6 $\frac{1}{8}$ " high x 8 $\frac{3}{4}$ " deep (plus 1" for knobs).
- WEIGHT: 15 lbs.

FM-90X • Gold Cascode FM Tuner • \$169.50

MAHOGANY OR BLONDE CABINET: \$17.95

Prices Slightly Higher in the Far West

FISHER RADIO CORP. • 21-29 44th DRIVE • L. I. CITY 1 • N. Y.

a famous poet, but more than that, just a person, an old man, clearly with little strength left and yet with such a quiet, sunny, gentle personality that in a few moments you'll envy him, for equanimity in a tortured world. He's dead now.

Caedmon made no great fuss about de la Mare but, rightly, led him to read in his own living room, whatever he had on his mind, a group of short poems evidently quite recent and perhaps unpublished, a long, wonderful story about himself as a sixteen-year-old romantic in a haunted house.

The voice is so low it's just audible (if you turn the volume down to a right level), the words are often slurred and trail off, there's an odd repetition in the story that seems—might have been—an unintentional wandering of the mind of an old man, so naturally is it done. And to begin, there are two "un-rehearsed" bits of quiet conversation, starting on the perfect note, a casual "isn't it a lovely day!"

Peter Bartok was the engineer and the unobtrusive other half of the conversation.

Incidentally, Caedmon has some of the most beautiful record covers I ever hope to see and I'm surely going to put this one on my wall somewhere. A fine color reproduction is combined in an ensemble with the title material for an over-all effect of design that can't be beat. See also the "Ulysses" cover.

James Joyce: Ulysses—Soliloquies of Molly Bloom, Leopold Bloom. Read by Siobhan McKenna and E. G. Marshall. **Caedmon TC 1063**

Who but the enterprising Caedmon girls would think of this—and who but they would carry it off in such a tasteful manner? The famous Molly Bloom sequence at the end of "Ulysses," printed without punctuation and all one "sentence" for dozens of pages on end, is cut down here but not particularly censored, though some passages were clearly left out as better read than heard aloud. If you want to find unprintable words here, you'll find 'em and without guile or fuss; Miss McKenna, the star of "Saint Joan" and many another play, speaks in a wonderfully natural Irish way and makes the whole night-time day-dreaming seem wholly real and simple. The main cutting-down is simply a matter of time, to fit the LP necessity. Joyce was garrulous!

Husband Leopold's day-dream of the same sort, taking place on a beach, isn't nearly as effective, as I hear it. For one thing, Mr. Marshall has no Irish accent at all and, indeed, sounds like a well-dressed, tweedy college professor. Not my idea of the seedy, coarse Leopold Bloom, and I'm sure in any case that both sides of the record should have been in "Irish"—or neither.

HITHER AND YON

Brahms: Piano Concerto #1. William Firkusny, Pittsburgh Symphony, Steinberg. **Capitol P 8356**

We've come to expect great things from William Steinberg's series with his Pittsburgh orchestra and this Brahms has plenty to recommend it, with a few qualifications. The orchestral part is up to Steinberg's best and, in his unswerving manner, it has the faults—or virtues, if you wish—of a modern approach; clean, terse, architectural, keeping the Romantic lushness of detail under firm control (where old Stokowski used to "let 'er rip," as schmaltzy as you please). Some listeners may find they prefer a more unbuttoned version, but though I miss the fullness of the richly woven texture now and then, I really can't find it in me to complain—for Steinberg's modernity does so much for Brahms, the playing of the orchestra is so beautifully disciplined, the long lines so superbly felt, that the piece is almost a new one. (It's so easy to "mess up" this turgid sort of Brahms, too.)

The second movement, the slow movement, is particularly beautiful in the orchestra. The opening measures, especially, have a serenity, an evenness of flow, a sense of long rhythmic pulse, that is absolutely beautiful. Nobody has ever done them better and I recommend this

passage (beg. side 2) as a prime example of top-flight orchestral playing.

I don't mean to run down the piano and Mr. Firkusny, but it must be said that his part contributes less to the whole. He is a hard modernist pianist who makes short shrift of the Brahms sentiment—except in the slow movement, where he is most expressive. It seems to me that whereas Steinberg is modern and yet poetic, Firkusny is just modern, in a superbly efficient way. He misses the bigness of spirit (and interpretation) that Steinberg achieves, even though his playing is dazzling in its clarity throughout.

Schubert: Octet. David Oistrakh and others. Angel 35362

To an old hand at music listening the name of a big soloist is a danger signal in this sort of music. A "name" solo player in the midst of chamber music is too often a fish out of water (or, if you like, a big fish in a little puddle). That's no problem in this recording. The great Oistrakh—the violin—isn't especially featured and he doesn't stand out in any abnormal way from the other players. All is equality, as it should be.

However, this mostly-Russian ensemble, though it plays with spirit and very musically, is hardly the disciplined, well-trained unit that is really needed for this music. I've heard performances with a great deal more subtlety than this which is, relatively speaking, a rough and ready one though brilliantly done. Schubert of all composers benefits tremendously from carefully worked out detail, in a million and one cumulative little ways that can add up to real potency. That sort of team work is missing here.

The horn is out of place for my ear; he plays in the French manner, with a vibrato like a saxophone. In other countries (including Schubert's own) the "French" horn is played minus vibrato, which is the way it ought to be in this piece.

A beautiful recording in the sound, spacious and natural.

Mendelssohn: Songs Without Words (complete). Ania Dorfmann, piano. RCA Victor LM 6128

Remember those sweet and sentimental parlor pieces that grandma used to play in her pensive moments to edify her dinner guests of an evening? Remember how each one had a sort of strumming, chordlike half-improvised introduction, so that the people could quiet down and begin to listen . . . "so charming, isn't she a picture!" Then, when the soft voices were mostly lulled and everybody looking sweetly expectant, the main tune would come along.

Well, here they are, the Songs Without Words, though Grandma surely never got to play all of them—far from it. But she probably managed to get through the "Spring Song" and "Meditation" and perhaps one of the "Venetian Boat-Songs." She avoided "Lost Illusions"—not exactly dinner-party material—and "Delirium," same reason. (Anyhow, they were too hard.) But not "The Poet's Harp"—that's a charming piece and such a romantic picture, just too lovely . . .

All of which I preface to my suggestion that Ania Dorfmann gets the idea. She plays these old-fashioned charmers for what they are and as they were intended; you can trust her to entertain you discreetly, in perfect Mendelssohnian taste.

I say that because another recording of the same items left me speechless with amazement—the pianist ploughed into those sweet, meandering little introductions with iron determination as though they were the leading motives to some Concerto for Steel Foundry and Keyboard. And she whanged out the sentimental tunes in the same mood, with muscles of steel cable and the rhythms of a Stan Kenton. Miss Dorfmann put Mendelssohn in his place, which is precisely what he needs. You'll enjoy him.

Stravinsky: L'Histoire du Soldat (1918). Ars Nova, Robt. Mandell. Westminster "Lab" W-LAB 7049

This is the first of the "Lab" recordings I've heard since the earliest issues (there are now dozens available) and it was a pure pleas-



ON ONE COMPACT CHASSIS! FISHER FM-AM TUNER, AUDIO CONTROL AND 30-WATT AMPLIFIER!

New!

EVERYTHING YOU NEED!
ON ONE SUPERB CHASSIS!

THE 
FISHER
"500"

THOUSANDS have asked us for it—and here it is! An extreme-sensitivity FM-AM tuner, a powerful 30-watt amplifier, and a Master Audio Control—all built on one compact chassis. Simply add a record changer and loudspeaker to the FISHER "500" and, as easily as that, you have a complete high fidelity system. Its quality—in the finest FISHER tradition. Its appearance—the timeless beauty of classic simplicity. Here is the most economical form in which you can own FISHER equipment.

Chassis Only, **\$249.50**

Mahogany or Blonde Cabinet, **\$19.95**

Outstanding Features of THE FISHER "500"

- Extreme sensitivity on FM and AM. Meter for micro-accurate tuning.
- Full wide-band FM detector for maximum capture ratio.
- Powerful, 30-watt amplifier; handles 60-watt peaks.
- Uniform response, 16 to 32,000 cycles.
- 4 inputs, including separate tape playback preamp-equalizer.
- 4, 8 and 16-ohm outputs match all existing speakers.
- Recorder output ahead of volume and tone controls.
- 7 Controls, including 9-position Channel Selector (AM, FM, AES, RIAA, LP, NAB, TAPE, AUX 1 and AUX 2), Loudness Contour (4-position), Volume, Bass, Treble, AC-Power, Station Selector.
- Beautiful, die-cast, brushed brass escutcheon and control panel.
- Pin-point, channel indicator lights.
- Smooth, flywheel tuning.
- Largest, easy-to-read, slide-rule dial, with logging scale.
- High efficiency FM and AM antennas supplied.
- 14 tubes plus 2 matched germanium diodes.
- SIZE: 13 7/16" w. x 12 3/4" d. (excluding knobs) x 6 1/4" high.

Prices Slightly Higher In The Far West

WRITE TODAY FOR COMPLETE SPECIFICATIONS

FISHER RADIO CORP., 21-29 44th DRIVE • L. I. CITY 1 • N. Y.

Make your room
a Carnegie Hall

pioneer

with
PAX-15B

HIGH FIDELITY SPEAKERS



15" COAXIAL SPEAKER

A quality wide frequency response loud-speaker specially designed for improved transient response and directional characteristics. The cone of woofer section is made by the patented APC process that combines high Young factors, suitable internal loss, and low mass, while maintaining adequate strength. The diaphragm of horn type tweeter consists of a special phenolic molding of low mass and high stiffness, and the voice coil is wound with aluminium wire.

Voice coil impedance: 16 ohms
Maximum power: 25 watts
Frequency range: 30 - 16,000 cps.
Sensitivity: 101.0 db/watt
Weight: 7.5 kg.

PT-3

4 3/4" x 2" HORN TWEETER

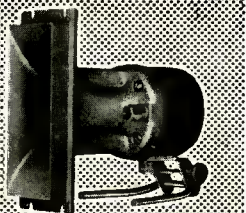

Despite its low cutoff frequency, the dispersion characteristics are greatly

improved by placing the mouth of its rectangular horn in a vertical position.

Voice coil impedance: 16 ohms
Frequency range: 1,700-16,000 cps.
Maximum power: 20 watts
Sensitivity: 102.0 db/watt
Crossover frequency: Over 2,800 cps.
Weight: 0.9 kg.

Write for catalog to: —

FUKUIN ELECTRIC WORKS, LTD.



5, Otowacho 6-chome, Bunkyo-ku,
Tokyo, Japan

ure in the listening. I like the music, approve of the performance and am all for the recording technique itself.

My hi-fi philosophy is simple enough. Hi-fi reproduction, in my book, is a means to an end. If the stuff itself bores me, or is tastelessly recorded, I don't give a fiddlestick for all the fi in the world and never will. Not so here.

First, this is a good playing of the dry, snazzy "L'Histoire" suite, on the precise side but with a very pleasing vein of rakish humor peeping through unmistakably. Secondly, the recorded sound is superb and miked in the one way that suits this music—close-to and dead. That is how the priceless early first recording of the work, done about 1930 with Stravinsky himself at the helm, was recorded, and though other recent hi-fi jobs have tried the modern big-liveness technique (making the seven players sound like 70), I still am convinced that this piece is one of the few that really does need a dead-type recorded sound. It has a razor-edge sharpness and clarity, a keen solo-instrument nearness, that is ruined by soft, fuzzy liveness. Westminster has hit the right effect, exactly.

Since I don't too often get hold of these specialty hi-fi items, I had better say here that the "Lab" project is, as I see it, a very legitimate one within its perfectly clearcut intentions and probably worth the extra cash in terms of its special purpose, the best possible physical set-up for good disc sound at the deliberate expense of longer playing time. It may seem a paradox that in these records less music should cost more—but that is just the point. Deep, wide-spaced grooves, but only part way in to the center, minimize several major causes of LP distortion and allow for a wider dynamic range.

My reservations on the "Lab" series thus have been mostly musical, so far: the idea itself is beyond criticism. With good music, well played and appropriately recorded as here, the "Lab" is a highly desirable item.

**Sessions: The Black Maskers (1923, 1928).
Hovhanness: Prelude and Quadruple Fugue
Lo Presti: The Masks. Eastman-Rochester
Symphony, Hanson. Mercury MG50106**

Roger Sessions' early "Black Maskers" has become a classic of its period, the extreme time of the brash, early dissonant Nineteen Twenties. This was enough to keep it well hidden for many years, but increasing understanding on the public's part and our new ear for hi-fi effects combine to make it a wow in the listening. You'll find it not unlike Stravinsky's "Rite of Spring" in its sound, though simpler and even more dissonant. A terrific hi-fi piece, no doubt about it, and Mercury's stark one-mike recording is excellent for it. Hardly a sweet background piece!

The extra pieces aren't very *a propos*, in spite of the similar title of "Masks." Lo Presti's prize-winning work is sincere, noisy and for my ear full of modern platitudes. You can have it. Hovhanness' *Prelude and Fugue* is an early opus, revamped recently. It already shows the curiously static but ever-in-motion quality that emerged so effectively when Hovhanness turned to Armenian idioms. A skillfully written piece, and good listening.

John Dunstable: Motets.

Joh. Okeghem: 5 Chansons. Pro Musica Antiqua (Belgium), Safford Cape.

Archive (Decca) ARC 3052

Chansons et Motets du 13^e Siecle. Leoninus, Perotinus: Organa. Pro Musica Antiqua (Belgium), Cape.

Archive (Decca) ARC 3051

Here are two out of the new big batch of Deutsche Grammophon Archive records—one in each of the twelve research periods into which music history has been divided for the series. In spite of the formidable scholarship, in spite of the clutter, complicated cover titles and the enormous cardboard index cards inside, these records are surprisingly listenable just for pure musical enjoyment, especially if you have the patience to allow new kinds of music to infiltrate your ear awhile, at leisure.

The best reason is good performance. The

Archive recordings are, with only a few exceptions, on a high musical level of performance and communication. So it is with these recordings by the well known Safford Cape group whose singers and players, no matter what they tackle, are able to produce lovely and musical sounds.

Dunstable and Okeghem are names you'll find in plenty of music history books; they're at last beginning to make sense to us for what they were—fine artists and great communicators of human feeling, highly revered in their own day. Dunstable was English but influenced the continent through the then British holdings in France. He flourished during the time of Joan of Arc in the early 1400's. Okeghem was a generation later, born in 1430 and living, immensely revered by all and evidently a very wonderful person, until 1495.

The second record here goes back a step earlier to the brasher, harsher (so we hear it) school of France in the middle 1300's, centering on the familiar cathedral of Notre Dame in Paris, now standing exactly as it did then. In Leoninus and Perotinus you'll find the first exciting ways of producing more than one melody at a time, notably the strange organum, where the notes of Gregorian chant are stretched out for minutes at a time while rhythmical, dance-like semi-improvisations are sung about them. High Gothic art, and you can almost hear the gargoyles snorting! The other side of this disc goes to music of the Troubadours, Trouvères, Minnesingers, full of courtly love and princely living.

Bach: Two Cantatas, "Ich will den Kreuzstab" and "Ich habe genug." Dietrich Fischer-Dieskau, bar., Berlin Motet Choir, Karl Ristenpart Chamb. Orch., Ristenpart. Archive (Decca) ARC 3058

I haven't nearly "had enough" of this one ("Ich habe genug"), for it is excellent. Fischer-Dieskau is the very best sort of present-day German baritone and though his technique is too heavy and wobbly for the faster notes in Bach's writing (so is almost everybody's, nowadays), he is able to get over the lovely, compassionate sense of this music superbly to any ear without fuss and feathers. You'll like him, and the instrumental backing is lovely too. These are solo cantatas, the chorus coming in only incidentally, singing the closing hymn or chorale. The melodies and the "tone painting" are Bach's absolute best.

Orlando Gibbons: Anthems, Madrigals, Fantasias. Deller Consort (voices) Viols of the Schola Cantorum Basiliensis.

Archive (Decca) ARC 3053

Here is one of the few Archive releases that strikes me as unfortunate, at least in part. Alfred Deller, the British counter tenor, is so superb on his own that we (and Deutsche Grammophon) can easily assume that his own singing group will be as good. I find it dismayingly dull and lacking in feeling for the older choral music, and I've sung a good number of these pieces myself, in chorus, as well as conducted them.

Somehow, the Deller Consort manages both to wobble unconsciously and to ignore the lovely words and the superb word-setting of this brilliant Elizabethan composer, one of the best of them all. The anthems are so expressive, so outgoing—and here they are mumbled and bumbled and given a false piety that simply obscures the music. Nope, not for me.

The string group from Basel, Switzerland, does a nicely modest job with the Gibbons' *Fantasias*, and these are just fine.

Spotlight on Brass. Roger Voisin, Harold Meek, Jos. Orosz; notes by R. D. Darrell.

Spotlight on Keyboard. Bruce Simonds, Claire Coci, Walter Kraft, M. Hohermann, Har. Tompson. Notes by R. D. Darrell.

Vox DL 300, DL 362

Here are two volumes in an ambitious series, each designed to illustrate in actual

sound the many musical instruments within a given "family," both modern and ancient. The idea is an excellent one and the examples here recorded, if not 100 percent comprehensive (Heaven forbid that . . .) are at least a useful cross section of the available sounds in each category. The instruments are not only played in scales, blasts, chords and the like but are given frequent short musical passages, to place them in the musical background where they belong.

Extensive commentary by the knowledgeable R. D. Darrell and much factual information in tablature and alphabetical reference form fills up the large accompanying booklet in each volume along with plenty of pictures, to add visual information to the audible. Indeed, I should have nothing but admiration for the whole project if it were not for a ghastly, wide-open, dreadful mistake in organization which, for me at least, makes the entire series as here presented a tantalizing annoyance. It's so simple: the material inside the booklet is not coordinated with the recorded musical material.

What do I mean? Well, Vox decided to avoid spoken recorded commentary, as **redundant and unpleasant on repetition**. Good, I agree. So the dozens of examples are recorded without identification, on many LP bands often two or three to each band, with various illustrations of each instrument. No clue to the identity of each one, as you listen (except for the many and very narrow band separations). And so you turn to the booklet to find out what's happening.

And there, aside from a brief index, the entire material is presented in categories completely unrelated to the recorded order of the examples! Result: you go nuts trying to find out which instrument you are hearing and the facts about it, and if you are persistent you'll rip the booklet into shreds in no time, frantically searching for the relevant information, as you listen. It's spread all over the place.

Talk about not seeing the forest for the trees. And talk about good scholarship gone awry. What good is it to organize your information alphabetically, historically, by categories, into tables and charts and pictures and what-not—if you can't apply it to the sound itself, at the moment you hear it?

Vox has done well with the series so far and I mean no criticism of the basic material, the recorded sound of all sorts of musical instruments from the serpent to the accordion and the monochord to the modern grand piano. But if new editions are forthcoming, as is likely, I'd suggest two simple changes. First, identify each instrument vocally on the record—merely the name of each, just before it plays. That'll eliminate vast amounts of confusion (and the near-useless cardboard example-locator now provided). Then reprint the big booklet with all the specific information about each instrument *in one place and in the order of listening*. The excellent background material can remain as it is, in essay form.

It's a fine series and nicely recorded in hi-fi; I wouldn't bother to discuss it if it weren't.

When Dalliance was in Flower and Maidens Lost Their Heads. Ed McCurdy; Erik Darling, banjo, Alan Arkin, recorder.

Elektra 110

'Tis enough to say that these brilliantly bawdy ballads, ostensibly collected from many a century past, are neatly printed, for every eye to see and be amaz'd, in the booklet that goes along with the record. I read it first, then got around to playing the stuff. Zestful, hearty and, as the notes suggest, "forthright."

A bumbling baritone voice, a good bit of banjo (and guitar?) for accompaniment, plus a recorder interjection, hither and yon, maybe because one bawdy bit talks about the young man's recorder (flute) and the lady's lute—innocuous stuff musically, strictly luke-warm, and sometimes the harmonies just don't quite keep up to the melody. Who cares. It'll go over fine at parties . . . of that sort.

(Continued on page 62)

ALTEC LANSING 436A COMPRESSOR AMPLIFIER



...first choice for paging systems

In plant paging systems where rugged dependability and economical operation are prime requirements, there is no substitute for Altec Lansing's 436A compressor amplifier.

The 436A costs \$140 less than its closest competitor, yet features such low distortion and superior performance that it has found wide acceptance in the recording industry. The small, self-powered unit occupies only 3½ inches of rack space and provides line level output and automatic gain control for all PA and industrial installations.

Front panel contains meter to indicate db of compression, a power switch, fuse and pilot light. The input employs a high impedance transformer which can bridge a 600 ohm line or the output of the 1510A and 1511A preamplifiers. The output transformer provides load taps of 150 and 600 ohms or may be operated directly into the high impedance input of the 1520A or 1530A amplifiers.

Frequency response is nominally ± 1.5 db from 30 to 15,000 cps gain 54 db, and compression threshold -2 dbm (output). Distortion with 25 db of compression is less than 2%, 35 to 15 KC. Output level at 30 db compression is +19 dbm. The attack time is approximately 50 milliseconds with 63% recovery in 1 second.

**Other Compressors Available Soon— 438A high gain, built-in preamplifier
439A 30, 250, 600 ohm input**



Dept. 4AP
1515 S. Manchester Ave., Anaheim, Calif.
161 Sixth Avenue, New York 13, N.Y.

**A SOUND REPUTATION
SECOND TO NONE**

AUDAX TONE ARM NOW IN KIT FORM

Anyone can assemble it in about 10 minutes—and save 50%! Exactly duplicates Audax "Compass-Pivoted" transcription arm long recognized as top "blue chip". "Selector-Index" permits instant adjustment for any stylus pressure. Newly-designed cartridge housing permits all-important stylus-to-groove alignment at a glance. Accommodates ANY make cartridge.

KT-12 \$14.55 NET
factory-assembled
\$24.00 NET

KT-16 \$17.55 NET
factory-assembled
\$30.00 NET

Read CONSUMER REPORTS
January 1957, page 25.

LISTENING QUALITY IS EVERYTHING!

Impartial Lab reports on the new Audax Hi-Q7 magnetic cartridge:

A leading recording studio:

"Because readings showed an amazing total lack of distortion, check-tests were repeated 3 times"

Consumer sheet:

"Good frequency and transient response. Practically no high frequency distortion. Low intermodulation distortion."

Listening quality is everything — and Audax Hi-Q7 has it to a degree not equalled by any other pickup. But — HEAR it yourself . . . there is no other way! Net \$47.70, with 1 Chromatic Diamond and a Sapphire . . . Other models as low as \$20.70 Net.

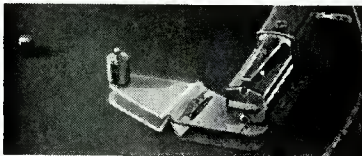

STYLUS-BALANCE

"This really works . . ." (Audio Magazine)
Stop deformation of record grooves! Only Audax Stylus-Balance can give you the all-important certainty of correct stylus pressure—ALWAYS. Precision-calibrated like a pharmacist's balance. Works with any arm and cartridge. Gold Finish. Net \$4.80

LISTENING QUALITY CUTTERS

Flat to 14,000 cps. Distortion 0.6% at 1000 cps. Fully modulates groove with input of about 16 db with 220 lines. Z's up to 500 ohms. Two models:

H - 5 Net \$111.00
H - 4 Net \$75.00

Any above item, when shipped
from New York, add 40c.

AUDAX COMPANY

500 - 5th Ave., New York 36, N. Y. Att: Mr. A.

- I enclose 25¢ for handling & postage. Please send FREE \$1.00, 22-page "ELECTRONIC PHONO FACTS" by pioneer Maximilian Well.
 Send FREE latest catalog & name of nearest dealer.

Name
Address
City Zone State

AUDIO ETC.

Edward Tatnall Canby

0. Erratum

MY LEAD SECTION in the March issue entitled "MORE ABOUT STEREO" was actually an unsatisfactory early version of the material that I had withheld for extensive rewriting—a routine procedure in the literary business as every good writer knows. Unfortunately, thanks to a communication snafu, the editor thought I had okayed it and so went merrily ahead.

I ask your indulgence in retrospect and, at the risk of invidious comparison, we herewith present portions of the expanded and revamped version. The repetition is therefore intentional.

1. Simultaneity

I'm reminded, because of our "live" recorded concert described the past two months, of the constant newspaper ads, these days, for LIVE TV appearances. Why? Is it because the TV picture is technically better when the performers are actually there, at the moment? Or is it because people react differently when they know that what they see on TV is *actually happening*, right then? The currently extensive controversy within TV over "live" versus recorded (kinescope or tape) material is intimately tied up with this basic difference. Is it *happening*, or isn't it?

Obviously, filmed and taped TV is the more convenient, flexible, useful medium. It can be controlled, handled more easily, edited, corrected, timed and all the rest. Every advantage is on the side of recording *except* that of simultaneity. It doesn't happen as you watch it. And that is enough to overbalance all the rest.

Now all of this, mind you, isn't intended to run down recording, whether TV, stereo tape or disc. I should point out quickly that most of the world's major art forms and entertainments media depend on the after-the-fact kind of portrayal. Our entire film industry depends on it, for no film acting ever happens at the moment you watch it. The entire disc recording industry depends on after-the-fact reproduction.

But simultaneity is also important, and the two are always poles apart. Note that simultaneity is the big power behind the performing arts, not only music but the theatre and—why not?—the ball games and the horse races. Actually happening. Why, once more, do we have featured "in person" appearances, both in the flesh and on TV and radio, of famous stars of screen and TV? Because—there they are, actually happening. You see 'em and hear 'em alive and kicking, and it doesn't matter whether it's in the flesh or on the TV screen.

And so my conclusion is simply that you

can't afford to ignore this basic difference between actual happenings and after-the-fact happenings, yet all too often we do ignore it.

Recording technicians run afoul of it, for example, when they sit in their monitoring rooms and try to judge a reproduced sound as the performance is happening. They must be extremely careful—for the sound isn't yet a recording! For proper judgment, they must play back the sound after the fact. Then, for the first time, it takes on the characteristics of a recording, not a live performance. Plenty of mistakes in judgment can be traced to this sort of thing. I've made 'em myself.

Take the famous instance of the music festival recordings, on the spot. There's all too often a dreadful disparity between the excitement of the actual festival itself and the audible results when the whole thing is down on tape and becomes a recording, not a living happening. What's good at a festival isn't always good in the re-hearing, and this is only as must be expected.

Similarly, many recordings are unfairly compared to living performances. Many recording techniques are wrongly condemned on the basis of live performance. Musicians often disapprove of tape editing. Music must unfold in one piece, they say, as intended. Surely! In the live performance. But a recording is *not* a live performance; in it, all sorts of other factors come into play and we must evaluate recordings and work with recording material in its own terms. Editing, as many musicians now realize, is one of the new essentials for best recorded performance, always granting that the editing job is well done. Recording is simply a different world from living performance and it's just too bad that the musician himself necessarily has to perform "live" for his recording—and yet think in terms of recording. So, after all, does the film actor. He long since learnt to accept editing and all the business of takes and retakes and patching-together of time that goes with it. We understand these things in the film art, but we aren't quite yet aware that precisely the same factors apply to recorded music!

A recorded musical performance taken down in one unbroken piece is like a filmed scene that is taken straight through without a retake or a break. I know of only one famous film that was done that way, deliberately, and I can't remember its name. It was a freak, if a good one.

* * *

I'm rambling a bit? Well, yes; but not too far. I'm still thinking about that

stereo reproduction, first as the sound was actually happening, then as an after-the-fact recording. It really hit a problem right on the head.

2. Selective Control

An extra word about our technical set-up for the stereo concert. We were able to achieve an interesting selective control over our violin and piano sound in two-channel reproduction via a simple use of tone controls on the amplifiers. The idea should prove useful in many similar situations.

The two channels, as previously explained, overlapped in their pickup by a lot. Stereo pickup always does—indeed, it must. Turn up one channel and all the the music is louder. So we fed one of our mikes, close to the violin soloist, through a McIntosh preamp with the high control boosted up about 25 degrees—two “points” on the dial—and the bass control rolled off a similar amount. This channel, then, inherently favored the violin, which was close to it, building up the violin’s highs, rolling off the bass. The piano, at some distance from this mike, had less bass to begin with because of that distance; the bass preamp rolloff reduced the main bulk of piano sound even more, and the boosted highs made little difference in the piano’s relatively weak high end.

The second channel, with its mike placed close to the grand piano’s half-opened tail end, picked up much more bass to begin with. Since bass and mid-range make up the main component of piano tone, we increased this selective pickup by boosting the bass end on this channel, via its preamp tone controls again.

The result of this selective use of tone settings was that we had a surprisingly delicate control of the separate instruments, violin, and piano, in spite of the large overlap in the sound pickup. “More violin” or “more piano” could be accomplished over a wide dynamic range, to alter the listening balance.

With the first or “violin” channel alone, on this controlled setting, the piano was very weak in bass and too faint in the ensemble (as both instruments played together). When the other channel, the “piano” channel, was tried by itself the piano boomed tremendously and the violin was almost drowned out. To achieve listening balance we began with the violin channel open, then gradually brought in the other channel, adding piano bass range, until the stereo balance was adjudged correct.

As the violinist moved back and forth in the excitement of playing we were able to readjust the two channels to keep him musically in balance. We even made changes dictated by musical differences between one piece and another. In some numbers the piano was more important, had more to do, and so was brought out in the stereo balance. In others it had to be pushed down a bit.

We played some of the stereo recording to the great man himself, Szigeti, who was very much interested in the sound of his own performance as reproduced in stereo. When at one point he muttered, “there the piano izz too loud!” I hastily turned down the right-hand (piano) channel gain a bit, and he beamed. To this day I don’t

The Altec 3000A loudspeaker the ONLY 22,000 cycle tweeter

The Altec 3000A high frequency speaker is the only tweeter or so-called “super-tweeter” made which has a guaranteed range extending to 22,000 cycles. Many people question the necessity of a high frequency speaker with a range extending half an octave beyond that of the human ear. The extra range has been provided to assure smooth reproduction throughout the entire audible range. In frequency response the 3000A is down approximately seven decibels at 22,000 cycles but is essentially flat from 3000 cycles to the upper limit of human hearing.

Another popular tweeter with an advertised range to 16,000 cycles, the upper limit of human hearing, is down five decibels at 16,000 cycles and this roll-off or loss of high frequency reproduction actually starts at 11,000 cycles. In comparison it can be seen that the extension of the Altec 3000A to 22,000 cycles results in a better response throughout the top 5,000 cycles of the audible range.

Heart of the 3000A speaker, its driving element, is the L1 Pressure Unit. This compression driver without its exponential horn has a useful frequency response to 60,000 cycles and is down only 25 decibels at 100,000 cycles.* This range above 22,000 cycles, which is of no use in high fidelity reproduction, has been reduced in the 3000A in order to achieve the smoothest possible distribution and high efficiency.

The Altec 3000A high frequency speaker is exceptional in its smooth frequency response from 3,000 to 22,000 cycles, and in its even distribution pattern, high efficiency and freedom from tonal coloration. It is ideal for extending the high frequency range of existing speaker systems or as the high frequency component of new low and medium power two-way speaker systems.

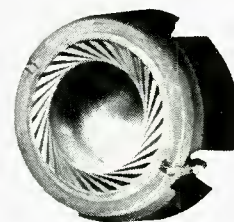

L1 Pressure Unit

* For those interested in the detailed performance above 22,000 cycles, we will be glad to provide references to the acoustical textbooks which contain charts and data on the L1 Pressure Unit.

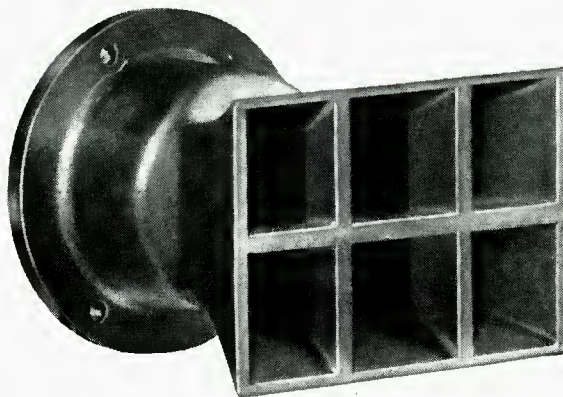

Price \$36.00
N-3000A Network \$18.00

ALTEC FIDELITY IS HIGHEST FIDELITY



ALTEC
LANSING CORPORATION

Dept. 4A
1515 So. Manchester Avenue, Anaheim, Calif.
161 Sixth Avenue, New York 13, N.Y.

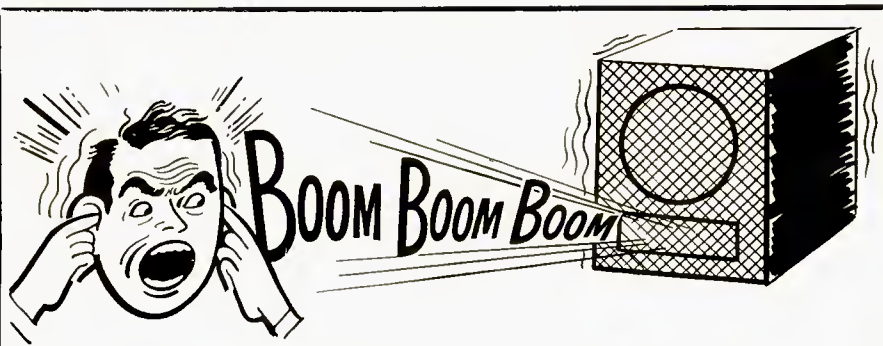

Are you Boom Conscious? . . .

Most people know by this time that many, if not most, loudspeaker enclosures . . . regardless of size or price . . . boom. Boom is that dull, heavy, toneless thud often heard at low frequencies. Boom is also called "one-note bass" or "juke box bass." It is an inherent characteristic of so-called "resonant" enclosures. Boom is nothing but distortion, and any speaker system that booms is not high fidelity.

Notwithstanding this, and believe it or not, there are still people who will spend hundreds, and even thousands, of dollars for prime amplifiers, tuners, etc., and then go out and buy a boom-box. Why?

A noted psychiatrist undertook to find the answer. He found that (1) some people mistake mere loudness (so-called "augmented" bass) for true bass; (2) others are unable to tell the difference between true bass and boom; (3) some think boom is bass; (4) others think boom is bass because it comes from large and/or expensive enclosures; (5) others have a fixation for expiring myths, such as, "the bigger the box the better the sound"; (6) some innately resist progress and never seem able to adjust themselves to better things as they come along; (7) others are impressed by

expensive advertising and high-pressure sales promotion.

And so it goes, even though, actually, no one ever heard boom from a live orchestra. And since a live orchestra is not a boom-box, why should anyone want a boom-box in his home? Fortunately, no one has to buy a boom-box.

To those who want live-music facsimile instead of boom, competent sound engineers unequivocally recommend **THE BRADFORD PERFECT BAFFLE. IT DOES NOT BOOM . . . EVER.** The result is clean, true bass. This is accomplished by a new, patented device based upon a scientific principle. It is not a bass-reflex or folded horn.

Moreover, it satisfies every other criteria of the discriminating audiophile: *Compactness*; 12" x 12" x 9" for 8s and 10s; 17" x 17" x 14" for 12s and 15s. *Finest Construction and Finish*; 3/4", genuine mahogany, korina blond, walnut and ebony veneers; and unfinished birch. *Economy*; from \$34.50 to \$69.50.

If you are boom conscious, want live-music facsimile instead of those dull, heavy, toneless thuds, hie to your dealer or write for literature.

BRADFORD & COMPANY, 27 East 38th Street, New York 16, N. Y.

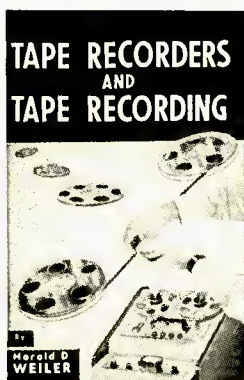

TAPE RECORDERS AND TAPE RECORDING

By

Harold D. Weiler

Author of

"High Fidelity Simplified"

The first complete book for the home recordist. Tells why, how, and what in easily understood language—not too technical, yet technically accurate. Covers sound, room acoustics, microphones, microphone techniques, editing and splicing, sound effects and how to make them, maintenance, and adding sound to slides and home movies.

RADIO MAGAZINES, INC., Book Division
P. O. Box 629, Mineola, N. Y.

Please send me copies of Weiler's TAPE RECORDERS AND TAPE RECORDING. I enclose check money order . Board cover, \$3.95, paper cover, \$2.95.

Name
Address
City Zone State

know whether the pianist himself played too loud or whether our reproduction was out of balance. Doesn't matter. We could fix it, and we did.

(Note that, having set the tone controls as indicated above, we thereafter used the "volume" controls, the regular gain settings, to bring out the piano or the violin, selectively. It was the difference in the fixed-up response curve of the two channels that made our wide degree of selective control possible. If each channel had been set for flat response, the amount of control would have been much less.)

3. Ring-free

One of the best exercises for the human mind, these days, is to find words—one's own words—for observed phenomena. As noted last month, we have words for everything and we take pleasure in twisting them around to mean as little as possible while suggesting all. But what of the guy who sees something, feels something, hears something, and is at a loss to describe it? That's what poets are made of.

Engineers and scientists are spoiled. They have words—terms—for any old thing. Sure, all yuh got is a little IM distortion. Indeed, it's so easy to throw out these fine terms (which are wholly justified in their proper and accurate usage) that too many of us just sit back and toss terminology without bothering to be accurate. Not so the fellow who has no terminology and has to make up his own as he goes along. He's got to think.

Take, for instance, a letter I received awhile back, last spring, from Mr. Anthony Jowitt of Winter Park, Florida. He's a hi-fi enthusiast with a good ear. He had been reading AUDIO and (to my pleasure) he felt that I approached hi-fi listening in a more "realistic" way than other hi-fi writers. Yah-boy! I like that kind of talk . . . but that isn't my point. Mr. Jowitt was hearing things, in hi-fi, and he couldn't find the right words for what he heard. He was thinking out loud—and I quote what he said, as a perceptive and intelligent account of a first-hand experience such as most of us have had. Species of distortion.

" . . . Incidentally, there is a situation with regard to my hearing of recorded strings which has me puzzled and which maybe you can elucidate. When I have listened to the more elaborate hi-fi sets, I have often heard a peculiar and very unpleasant and unrealistic effect from the strings which I can only describe as a sort of ringing effect. It sounds as if someone was very gently striking a cymbal in the background. Does this convey anything to you?

"Most radio stores, when this is mentioned, say 'Oh well, if you don't like the highs, just use your treble control and turn them down.' In vain I reply that I do like the highs but not these highs. All I get is blank looks and a quick change of subject. I'm not sure, but I believe I've noticed this effect more in the higher-powered sets than the less expensive. It is most noticeable when the string section attacks a fairly forte passage. In other words, all the bows strike the strings together."

Now you engineer readers will be applying your knowledge to Mr. Jowitt's de-

scription and, whatever terms you use, I'm sure you'll admit the perceptiveness of this analysis. Especially two points—first, that he notes the effect more in the "higher-powered" sets (by which he means the more expensive systems, only incidentally of higher power) and second, that it occurs most noticeably on a sharp attack. Darned good observing!

As to the first point, distortion of this sort shows up most quickly in a high-quality over-all system which has a very wide frequency response. An old and familiar problem—the better your equipment, the sooner does distortion in any one area show up.

And as to the second, the type of distortion he describes always occurs most noticeably where there are severe transient wave forms to cope with. (Listen to me using big words.)

Now I tried to speak to Mr. Jowitt, in my answer, without using fancy terms myself. I'm not a professional engineer either, and my own business is to use words—my own words—as well as I can. I told him, in part:

"I think the sounds you hear in recorded strings represent a very accurate ear analysis of a rather typical distortion.

"I'm not too sure just how it can be analyzed, but I know what you mean only too well. It is often loosely called ringing distortion (using the selfsame term) and it is usually due to resonant peaks, lack of damping, in the cartridge stylus . . . or sometimes in the amplifier, or both. (Also, I might further suggest, in the loud-speaker.) A GE cartridge with one of its little rubber damping blocks missing will give exactly this sound, and so will other pickups (with faulty damping), especially those that have been used for some while, when damping troubles are likely to crop up. Some have liquid damping which disappears. In some the damping material dries up or cracks or gets goeey.

"This sort of thing is extremely likely to occur under the sort of tough playing conditions found in radio stores. The salesmen in those places no longer have ears."

That, I'll admit, is a slightly amplified version of my letter to him. I never copy any of my own stuff without adding more of the same, it seems. (Ask the editor.)

Further than this I cannot go, except to note that I have a cartridge in use this very moment that produces exactly that sort of sound. It shall be nameless since I'm not sure just where the trouble is and whether it's my fault. Maybe I dropped the point too hard.

"Ringing" transient distortion, so I gather, can happen all over the place and as often as not is due, in any one situation, to a plurality of causes, all operating at once. Aren't most troubles that way? Change the cartridge and you may clear up part of it—but not all. Change the speaker and some more of it departs, but you still, maybe, have to cope with the vagaries of a tired amplifier circuit or an unsuspected mismatch before your strings are silky and ring-free.

P.S. It's not only in radio stores you hear these sounds. I've heard all too much of this type of distortion in such hallowed

(Continued on page 55)

the finest
CARDIOID
MICROPHONE
available
...THE NEW
ALTEC LANSING
670B



This improved version of the famous Altec 670A cardioid microphone contains refinements that make it the finest cardioid microphone available on the market today. Improved sensitivity, discrimination and frequency range have been incorporated into a small, rugged, light-weight microphone that delivers highest quality performance at moderate cost.

The 670B is ideal for sound systems and for radio and television broadcasting. It consists of a ribbon type velocity element coupled to an acoustical network and enclosed in an attractive lightweight plastic housing. Three directional patterns, omnidirectional, bidirectional and cardioid, are easily selected by means of an adjusting screw at the back of the microphone. In addition to these three distinct patterns, it is possible by shutter adjustment between the patterns to shift the null points of the microphone over a 90° angle and effectively suppress undesired sounds. The screw driver switch located under the nameplate permits selection of proper output impedance.



Type: cardioid ribbon
Frequency response: 30-16,000 cycles
Output impedance: 30/50, 150/250 ohms
Output level: —56 dbm/10 dynes/cm²
Discrimination: average front to back, 20 db
Hum (Max.): —130 dbm ref 10-3 gauss
Dimensions: Height 6½", including swivel.
Width 2½", Depth 3¾"
Weight: 1¼ lbs.
Finish: dark gray
Mounting: ⅝"-27 swivel head
Price: \$120



Dept. 4AJ
1515 S. Manchester Ave., Anaheim, Calif.
161 Sixth Avenue, New York 13, N.Y.

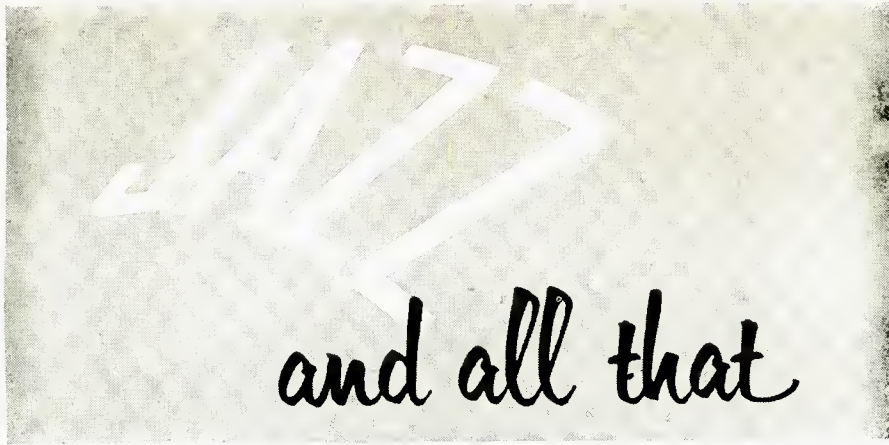

CHARLES A. ROBERTSON*

Music from the South: Vol. 8, Young Songsters. Folkways FP 657

Vol. 9, Song and Worship Folkways FP 658

The musical portion of the monumental work Frederic Ramsey, Jr. has accomplished in his "Music from the South" is brought to a close in these two volumes. The tenth volume will consist of talking backgrounds to accompany a book he is preparing on his experiences in Alabama, Louisiana, and Mississippi during 1954 as he gathered this priceless folk material under a grant from the John Simon Guggenheim Memorial Foundation.

Young Songsters catches this music in transition from the "old Dr. Watts" type of singing to the modern gospel style which is invading the southern states by way of the phonograph record and touring song groups. The Starlight Gospel Singers of Heiberger, Alabama, had never faced a microphone before, as in the case with the other performers taped by Ramsey. They began singing locally in 1952 and have been influenced by the professionals without submitting to their arranged slickness and polish. Their nine spirituals show how Nathaniel Benson, the leader in the group, has assumed the position of the pastor who "lined out" the words of a hymn for the congregation to come in behind him. The five other members act out the role taken by the congregation in the old style of singing with rhythmic hand clapping and feet tapping. Their listeners are still able to identify themselves with the performance, but Ramsey fears it will not be long before all such groups acquire the sameness of the harmonizing quartets acceptable to mass entertainment media.

Two gifted young Alabama women are to be heard on the second side. Ella Cash sings a passionately expressive *All My Troubles Soon Will Be Over*, and is joined by male voices in *Yes, He Cares*. Since removed to Oakland, California, Dorothy Melton sings two hymns handed down by oral tradition. The Combs Gospel Singers of Tunica, Louisiana, and the Mississippi Wandering Travelers of Pickneyville, Mississippi, are all under twenty-one. Each group contributes a selection typical of present day tendencies.

Song and Worship is a fitting close to this series as it presents two religious bodies at worship and conveys the deep devotions of two itinerant singers. The evening service in commemoration of the sixteenth anniversary of the Morning Star Baptist Church in New Orleans was taken down in its entirety and edited to fill the first side.

During blackberry season, Dora Bliggen has gone every morning to the swamps near Algiers to pick berries and return on the ferry to cry them through the streets of New Orleans. On learning she was also a preacher, Ramsey persuaded her to do two hymns and a prayer with a moving chanted invocation. Elder David Ross, accompanies himself on guitar in *He Gave Me a Heart to Love*.

In conclusion, five members of the small congregation of the First Independent Holy Church of God in Marion, Alabama, gather in

Elder Effie Hall's cabin for a Wednesday evening round of song before they "go down on the old sill" in prayer to end a valuable musical, sociological, and psychological documentary.

Ramsey makes a plea for further investigation in this field, warning that the time set for such work is short. Judging by the high standard he has set in recording and research, it is to be hoped that he will be one of those enabled to continue it. Some of the people in this series were presented on the Sunday, Jan. 13th Odyssey TV program, which has sent him to Jamaica to document a voodoo ceremony.

Mahalia Jackson: Bless This House.

Columbia CL 899

Here is one of the great singers of our time. And she has yet to be recorded in the sound and context that would reveal the full power and intensity of her voice. Before she came to this company, millions of her records were sold in badly made 78's, some of which were transferred to LP with an increase in distortion.

In her three LP's for Columbia, Miss Jackson has been recorded in a studio with about as much attention to the immensity of her voice as is accorded a run-of-the-mill pop vocalist. The results have been listenable as it would be hard to obscure that rich vitality and elemental drive which has conquered capacity crowds in Carnegie Hall, as well as surmounting the less felicitous acoustics of numerous auditoriums and stadiums.

It is a voice that demands the spaciousness of a concert hall or church and the full range and tone of a live organ behind it. Many churches in the metropolitan area have opened their doors for recordings and acoustical demonstration, including the Village Church of Bronxville, N.Y., and St. Mark's Episcopal Church in Mt. Kisco. It should not be too difficult to find one that is suitable.

The story of Miss Jackson's determination to remain a gospel singer, and her refusal to sing jazz or the blues is well known. She has been persuaded to record a few secular numbers. In these, as in the more moving spirituals, she is hampered by the pseudo-swing of the lumbering Fall-Jones Ensemble. Such an accompaniment is not helpful and it is not compatible to Miss Jackson's honest artistry. Still it is generally accepted that her primal beat is closer to the origins of jazz than that of most contemporary singers in the field.

She would be best served by some of the older jazz performers, who are capable of playing this music straight as it may be heard on a few old Vocalion and Bluebird discs. Some of them used it to learn their instrument and have played it in churches. But it is not necessary to go back that far. Buck Clayton could play this kind of trumpet. Possible trombonists are almost too numerous to mention: J. C. Higginbotham, Dicky Wells, or Wilbur De Paris. And clarinetists could start with Omer Simeon.

All of Mahalia's potentialities are apparent on this record which ranges from the *Lord's Prayer to Summertime*. The thirteen selections include *Let the Church Roll On, Trouble With the World, Sometimes I Feel Like a Motherless Child, and Down by the Riverside*.

Orchestra Marimba Chiapas: Marimba Mambo y Cha Cha Cha.

Audio Fidelity AFLP 1802

Pedro Garcia: Cha Cha Cha.

Audio Fidelity AFLP 1810

Memo Salamanca: Cha Cha Cha.

Audio Fidelity AFLP 1813

This label has gone to Mexico for three contributions to help fill the demand for cha cha cha and mambo rhythms. The marimba sides were made in Chiapas and hold most appeal for high fidelity listening. The peculiar low droning sound made by the instrument's bladder-covered sounding board is usually lost in recording. It is heard clearly here along with some pleasant highs in eleven selections which include the folk dance Guadalajara. Two marimbas were used along with bongos and conga drums.

The Pedro Garcia Orchestra has been at the Versailles Room of Mexico City's del Prado Hotel since its opening in 1948. It is a more musical group than is ordinarily entrusted with this music. Garcia attended the National Conservatory of Music and has played cello under Carlos Chavez in the Symphony Orchestra of Mexico City. Antonio de Marco is featured vocalist in the twelve selections.

Popular with the younger set in the capital city, the Memo Salamanca Orchestra is less restrained. Four violins are included in the instrumentation for some clean highs. Both the last two sets include instructions and diagrams of cha cha cha steps on the liner and the sound could fill a fair-sized hall without distortion.

Wilbur de Paris: At Symphony Hall

Atlantic 1253

Taped during a concert at Boston's Symphony Hall on Oct. 26, 1956, five of the nine compositions on this LP are previously unrecorded Wilbur de Paris originals, making automatic its acquisition by New Orleans style devotees. So this seemed to be a good opportunity to visit the fifty-five-year-old bandleader to have him relate how he went about selecting his audio system and ask him whether it was worth the effort. A modernistic apartment spread over the third floor of an old loft building on West 19th Street in Manhattan is the home of this pet-loving bachelor. Along with Zizi, his French poodle, it is shared by tanks of tropical fish and numerous cages of parakeets and rare birds.

In the early days of LP, de Paris purchased the usual factory packaged three-way combination and soon wanted something better as high fidelity became publicized. As he read more about the subject, he determined to get components capable of satisfying his needs for some time, but, like most audio novices, was bewildered as to how to go about it. Three years ago, when the Institute of Radio Engineers was in session at the Kingsbridge Armory, he got unexpected help. As he tells the story: "A group from the convention dropped into Jimmy Ryan's to relax and catch the band. In conversation between sets, I asked their advice and soon a sheet of paper was going around the table as each one made suggestions and changes. Finally, I had a list they all more or less agreed on."

But some time was to elapse before he could locate two engineers who would undertake the installation. By then progress in the industry warranted their suggestion of two changes which he was able to check with the same group, back for the next year's convention. Work began on the rack mounting, about seven feet high, topped by a Berlant Concertone tape recorder which can be used binaurally with two carefully oriented Bozak B-305 two-woofer speaker systems. Next comes a REL Precedent tuner, which may soon be off the market as that company concentrates on government work, and an Interelectronics preamp and amplifier. One of the last changes added a Weathers arm and cartridge on which de Paris comments, "I have heard of people having trouble with these because they are so sensitive. I just keep it clean and it works fine. For older 78's, I weight it with a subway token." The turntable is a Rek-O-Kut Rondine.

When asked to compare it with his old combination there was emphatic approval: "There is no comparison. They are as different

* 732 The Parkway, Mamaroneck, N. Y.

as night and day. I have the building to myself at night so I can really play that thing. I can go into my darkroom to work and it will sound as though the band is all there in the next room. I am looking for fresh copies of all my 78's as I can hear things on them I never heard before."

As one who has been going to recording studios for more than twenty-five years with both big bands and small groups, de Paris commented: "I have never seen such care taken with audio as in the past few years. And now that many dates are set up for stereophonic tapes, even more pains are taken. Everyone seems to be trying for better sound and my system has been a big help in keeping me up-to-date. I can make occasional tape checks of the band, especially when working out an original."

On the subject of on-the-spot recording, he was noncommittal, stating: "It is true that the success of a session often depends upon how the musicians feel, but I wouldn't want to say how much an audience contributes to that feeling. There are a couple of numbers on this one that I might have liked to remake in a studio, but then the record would be uneven. There is atmosphere and the open sound is pleasant for a change."

When this appears in print Wilbur and the band, including Lee Blair who was missing for a time, will be in West Africa on a tour of a month and possibly more, under the auspices of the International Exchange Program of the American National Theatre and Academy, beginning March 6th in Accra, Nigeria, Sierra Leone, Liberia, and French West Africa are on the itinerary. It will be his first visit and he is looking forward to it with the anticipation of one who has kept close watch on the progress made there since the war. "I didn't expect them to come along so fast," he said. "All the men in the band want to see what is being done there. My camera will go along and I am going to find out if weight restrictions will allow a small tape recorder."

The Symphony Hall album is marked by its freshness of material. The originals include an addition to the de Paris "M" series in the Spanish rhythms of *Majorca*. *Banjoker* is designed for the banjo of Lee Blair, and Sonny White has his say in *Piano Blues*. *Toll Gate Blues* and *Wrought Iron Rag* impress with well-executed ensembles and the searing cornet and trumpet passages of Sidney de Paris.

Omer Simeon arranged *Juba Dance* to feature his clarinet, and if anyone was feeling right on this day, it was this veteran with his superb choruses. Wilbert Kirk, the new drummer and graduate of the Fate Marable riverboat band, brightens up *Sister Kate* with two harmonica interludes. *Cielito Lindo* and *Farewell Blues* complete a recording that is good for a concert performance, aside from the enthusiastic and heavy-handed applause in the middle of some numbers.

Session at Riverside

Capitol T761

The burgeoning of record companies on Manhattan Island and the encroachments of television have placed a premium on studio space of any acoustic worth. In a continuing search, Capitol has ferreted out the ballroom of Riverside Plaza, a small hotel on a quiet upper West Side street, and it is admitted to be one of the best by competing audio men. Its properties are given a thorough test by twelve top swingmen in an exhilarating all-out session which points up how important good acoustics are to big band sound.

The trumpets of Billy Butterfield and Charlie Shavers make the rafters ring with some of their best work on record. Coleman Hawkins turns out a fine chorus on every number and is allowed to extend himself on *Out of Nowhere*. Everyone is given a chance to solo: Urbie Green and Lou McGarity, trombones; Peanuts Hucko, clarinet; Earl Warren, alto; Jerry Jerome, tenor. Art Ryerson, guitar, is the powerhouse of the rhythm section as with Milt Hinton, bass, he sets a tempo reminiscent of Django Reinhardt when he backed Hawkins for the French Swing label. Lou Stein, piano, and Osie Johnson, drums, are in good form.

There is a definitive *Undecided, I Want to be Happy, Broadway*, the title tune and *Escape Hatch* which takes its line from a

no other Quality Speaker offers so much for so little



World Famous for
consistent good sound
...unequalled Quality features and LOW COST!



LORENZ LP 312
12" WIDE-RANGE LOUSPEAKER

A quality, dual-purpose speaker. Can be used as wide-range reproducer or woofer unit in expanding system. **FEATURES:** EXTRA heavy magnet, long magnetic path, small air gap, long voice coil, non-resonant frame, perfect gap alignment and multi-parameter, tropicalized cone.

SPECIFICATIONS: Impedance — 16 ohms at 800 cps; Response — below 20 to above 14,000 cps; Output — 25 w average, 35 w peak; Magnet Wgt. — 61.5 ozs; Voice Coil Diam. — 1½"; Baffle Opening — 10½"; Depth—6¾"; Frame—heavy duty cast aluminum girder construction. net **39.50**



LORENZ TB-1 and TB-2
TWEETER COMBINATIONS
For all 12" speakers.

Completely assembled and ready for installation. Fits across 12" speakers with out projecting beyond front of speaker mounting baffle. Specially designed steel bracket supports tweeter(s) coaxially. Rigid metal construction discourages resonance in speaker or tweeter.

TB-1 (bracket with single tweeter)net **11.85**
TB-2 (bracket and two tweeters) net **21.69**



LORENZ LP 208
8" WIDE-RANGE LOUSPEAKER

Versatile, 3-purpose reproducer. Designed as wide-range speaker alone or in groups, as high or low end of 2-way system, or as mid-range unit in 3-way system. **FEATURES:** extra heavy AlNi magnet, perfect gap alignment, tropicalized cone, oversized voice coil, small air gap, non-resonant frame. **SPECIFICATIONS:** Impedance — 8 ohms at 800 cps; Response — 35 to 14,000 cps; Output — 15 w average, 21 w peak; Magnet Wgt. 28.5 ozs; Voice coil Diam. — 1"; Overall Diam. — 8½"; Baffle Opening — 7¼"; Depth — 4"; Frame — heavy duty cast aluminum girder construction. net **19.95**



LORENZ LP 312-1 and LP 312-2
12" COAXIAL AND DIAxIAL SPEAKERS

Extended response coaxial or diaxial speakers are obtained by adding Lorenz TB-1 or TB-2 Tweeters to Lorenz 12" wide-range reproducers.

SPECIFICATIONS	LP 312-1	LP 312-2
Impedance (at 800 cps);	16 ohms	16 ohms
Response:	20-17,000	20-17,000
Output:	27 w	27 w
Overall Diam.:	12¼"	12¼"
Baffle Opening:	10½"	10½"
Depth:	6¾"	7½"

Price: net **49.50** net **59.50**
(includes HP-1 Hi Pass Filter)



LORENZ LP 65
HORN-TYPE TWEETER

Fits any enclosure or speaker without the usual interaction. **FEATURES & ADVANTAGES:** solid back permits wide application; round cone design assures even sound dispersion; soft plastic construction prevents metallic overtones. **SPECIFICATIONS:** Impedance — 5.5 ohms at 800 cps; Response (with High Pass Filter HP-1)—2,000 to 17,000 cps; Sound Dispersion—120° (in all directions); Output—2 w; Outside Diam.—2½"; Cone Diam.—2¼"; Baffle Mounting Hole—2½" flared to 2½" or more. net **8.50**



LORENZ HP-1
HIGH PASS FILTER

For use with any tweeter. Introduces highs at rate of 3 db per octave starting at 2,000 cps, with nominal crossover at 5,000 cps. Effect increases smoothly to limit of audibility. Installed within speaker enclosure. **DIMENSIONS:** Overall height 2¾"; Mounting (square base) — 1½" between hole centers. net **4.95**

Exclusive U.S. Distributors

See and Hear Them At Your Hi-Fi Dealer Now!
Kingdom PRODUCTS, Ltd.
514 Broadway, New York 12, N. Y. • WOrth 6-0800

New GRAY High Fidelity Audio Control System
(Preamplifier - Equalizer)



Superb Transient Performance. Can be used with any power amplifier AND with ALL magnetic or ceramic cartridges.

- Multi-Input Selector • DC used on tube heaters for optimum signal-to-noise ratio • Two position loudness compensation control • Two cathode follower outputs for main output and tape output • Separate low frequency

turnover and high frequency roll-off controls for complete record equalization. • Uniform control knob positions for standard record reproduction • Separate power supply unit available for special applications • Attractively styled wood cabinet available in mahogany, walnut or blonde.

Many other features. At all Gray dealers or write today for complete technical literature.

GRAY RESEARCH and Development Co., Inc.
MANCHESTER, CONNECTICUT
Subsidiary of the Gray Manufacturing Company



Export Division: Rocke International Corp., 13 E. 40th Street, New York 16, N.Y. — Cables: ARLAB

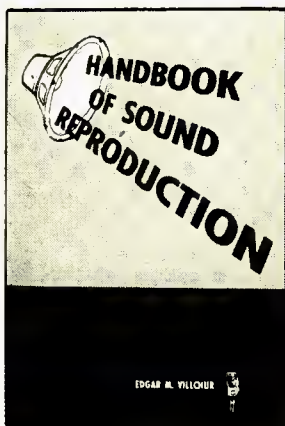

AT LAST!

The book you have waited for so long —

EDGAR M. VILLCHUR'S

HANDBOOK OF SOUND REPRODUCTION

For over two years, this material ran in consecutive issues of AUDIO and was followed avidly by every reader. Now available in

book form, with corrections and minor revisions, this material will be recognized as the basis of a thorough course in sound reproduction. Covers the subject from the elements of sound to individual chapters on each of the important components of a sound reproducing system. Ready for immediate delivery, \$6.50 postpaid (Foreign, \$7.00 postpaid).

Customary discounts to dealers and distributors

RADIO MAGAZINES, INC., Book Division
P. O. Box 629, Mineola, N. Y.

Please send me copies of Villchur's HANDBOOK OF SOUND REPRODUCTION. I enclose check money order for \$6.50 each.

Name
Address
City Zone State

song so long in the public domain as to be traditional. You will be surprised when you spot it. Dave Cavanaugh produced what I hope will be the first of a long series at Riverside.

Jazz By Sun Ra, Vol. 1

Transition TRLP 10

When a small jazz group has added tympani, it has usually been at the instigation of a drummer-leader, perhaps first by the historic Vic Berton in 1935 with his own band and that of Red Nichols. In those depression days, he found a more lucrative position in the Roxy Theatre orchestra, then Hollywood studios, emerging shortly before his death to appear as tympanist on the fine Capitol version of Bartok's *Music for String Instruments, Percussion, and Celeste*. George Wettling used kettle-drums in a now-deleted Columbia LP of a few years ago. Now a young Chicago pianist and composer known as Sun Ra has integrated them into his orchestra where they take an important role in a battery which includes bells from India, chimes, tambourines and timbali. And when he uses the Hammond organ to reinforce it, there is plenty of range to please the sound fan.

Sun Ra displays a fertile mind in eight varied compositions for an auspicious debut, and is not too avant-garde to dismay any but the most hardy jazz follower. Harry Revel's *Possession* shows his treatment of a standard. John Gilmore, tenor, is the most notable soloist, but it is the unity of the musicians that impresses. Sun Ra guides and molds them from the piano in somewhat the same manner as a Basie or Ellington.

Frankly, I am going to listen to Sun Ra a lot longer before assessing his worth. But I think in his case, before forming your own opinion, you will have your money's worth out of the album and the twelve-page booklet explaining his musical views, if only as a conversation piece. Anyone who has liked the percussive pieces of Chavez or Varese should be delighted with it.

Odetta: Ballads and Blues

Tradition TLP 1010

Tradition, a new label devoted mainly to the folk music field, seems to have come up with a winner in Odetta, a twenty-five-year-old Californian who shows her versatility in sixteen ballads, blues and spirituals to the accompaniment of her guitar. Her voice has had several years of operatic training and it is this cultured instrument that is revealed on the ballads, throwing doubt on the liner comparison to famous blues singers of the past. Not until the stirring opening line "Good mornin' captain, good mornin' sun," of *Muleskinner Blues* are such pleasantries thrust aside and the full power of an authentic blues voice unleashed. In the spirituals both styles are combined to good effect, particularly in the closing trilogy.

Much of her repertoire has not been overdone, and her wholly individual approach revitalizes the more familiar *Jack O'Diamonds* and *Alabama Bound*. Few singers now active can match her in a blues vein. It is to be hoped she will be able to devote an entire album to them, augmented by a sympathetic group of musicians, especially if the recording is of the same high standard.

Frank Sinatra: Close to You

Capitol W 789

A hasty assurance to admirers of the distinguished Hollywood String Quartet, given a featured role in the group accompanying the vocalist, that it has not been rendered asunder, smothered by a large studio orchestra, or otherwise damaged in its first venture into the pops field. Nelson Riddle has given these accomplished artists sensitive arrangements in which only a harp and one or two solo instruments are added at any one time. They should be studied by recording directors with a penchant for tacking the phrase "with strings" on album titles.

In keeping with the title, Sinatra takes care of a dozen old and new ballads in his most intimate mood. I do not actively encourage the use of strings with jazz musicians, but am forced to wonder how such

Capitol favorite sons as Woody Herman or Nat Cole would work out in this context. If it must be done, it should be done well as in this instance, though strings as capable as these could be recorded more forward.

George Shearing: Latin Escapade
Capitol T737

Les Baxter: Skins
Capitol T774

Latin flavor is evident in abundance and variety on these two well-made offerings. The George Shearing quintet expands its smooth-flowing rhythm section to provide a dozen danceable numbers, some of them exotically arranged standards.

Just about every type of drum is introduced into the studio in Les Baxter's expounding of percussive timbres. The album has been five years in the planning and presents a cumulative display of rhythms. An ancient Porto Seguro harpsichord-piano is played by Baxter, as well as a celeste, in solos which spark the activities and add to the aural interest. Plenty for the hi-fi fan: deep bass drum, mammoth congas, triangles, gongs, and Turkish cymbals. And the aspiring bongo player can use it for a workout.

Dave Pell: Love Story Atlantic 1249

Eight West Coast arrangers have their day with some well-seasoned standards prepared for the Dave Pell octet as a scenario for the conventional boy-meets-girl fable. Jimmy Guiffre probes most deeply in *Solitude* and Johnny Mandel performs the astonishing feat of finding something fresh to do with *I Found a New Baby*. Other contributions are by Marty Paich, Jim Emerson, Bill Holman, Wes Hensel, Andre Previn, and Jack Montrose.

Sophisticated, but somewhat understated, solos are offered by Pell on tenor; Don Fagerquist, trumpet; Ray Sims, trombone. A good studio recording by John Kraus, designed for relaxed listening.

The Kenny Drew Trio
Riverside RLP 12-224

A virile young contemporary pianist, Kenny Drew grew up on Fats Waller and other pianists of that era and does not neglect his left hand. He puts down a swinging beat with somewhat more economy but no less rhythmic aptitude. He acquits himself well on six standards including *Caravan* and *Taking a Chance on Love*. His two originals are the imaginative *Weird-O* and *Blues for Nica*.

It would be hard to surpass Philly Joe Jones, drums, and Paul Chambers, bass, as they join with Drew to achieve a real playing unity. Many a horn player is going to listen to this group and wish he could have such backing just once. Good engineering by Jack Higgins of Reeves Sound Studios.

Boborough: Devil May Care
Bethlehem BCP-11

A young pianist and composer from Arkansas, Boborough, phrases or alters song lyrics to fit his peculiar style of vocalizing on the improvised line that might be followed by a horn. He is most successful in two tunes of his own composition *You're the Dangerous Type* and *Devil May Care*, where the words are designed to withstand such treatment. In the ten standards, he ranges from mere cleverness to a few passages of sustained excitement. Warren Fitzgerald, trumpet, and Jack Hitchcock, vibraphone, fit well with Boborough's competent piano. Bill Takus, bass, and Jerry Segal, drums, complete a group better suited at present for a club than records.

With the disappearance from the scene of the 10-inch LP, Bethlehem has salvaged several sessions issued by Period and remastered them on the larger size with generally happy results. The Jack Teagarden sides are on BCP-32, and Charlie Shavers is heard with Maxine Sullivan on BCP-67. "The Happy Jazz of Osie Johnson" appears on BCP-66. Ahead of its time when recorded in December, 1954, the work of Charlie Mingus is preserved on BCP-65, and is the keystone of any collection of this musical innovator, or of trumpettman Thad Jones.

(Continued on page 54)

have fun... save money

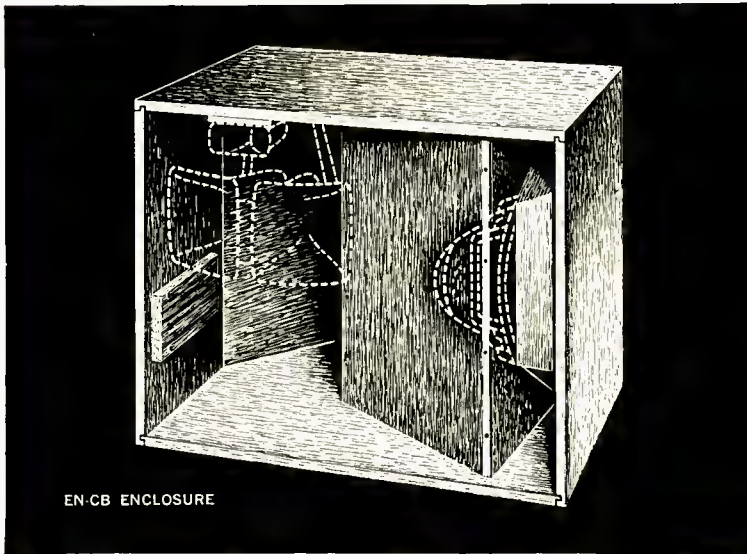

EN-CB ENCLOSURE

The famous University CLASSIC speaker system (shown at right), represents the highest achievement in audio engineering, the ultimate in sound! The CLASSIC is a true, folded, self-contained exponential horn which operates the woofer as a compression driver for maximum efficiency. Each detail has been so carefully worked out that the complete system functions as a beautifully coordinated team. A truly self-sufficient cabinet, it functions independently of walls and floor, achieving an amazing realism... almost like having a concert orchestra in your own home. The superb craftsmanship of the cabinet and high University standards to which the CLASSIC components have been built make the price really attractive. Mahogany \$450.00, Blond \$460.00.

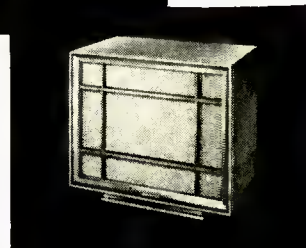

BUILD ONE OF THE FINEST SPEAKER SYSTEMS IN THE WORLD

University has taken the heart of the magnificent CLASSIC system and made it available both as the EN-CB UNFINISHED-UTILITY enclosure and the S-9 UTILITY CLASSIC SYSTEM, complete with components installed and wired. It came about as a result of an overwhelming demand on the part of "do-it-yourself" enthusiasts who wanted to build their own CLASSIC system.

The EN-CB is a superb piece of craftsmanship—constructed of Grade 1 Birch plywood using locked and mitred joints and braced with heavy glue blocks for maximum efficiency. Supplied with full instructions to mount speakers and network components. Designed acoustically to permit versatile use as "lowboy" or "highboy." Naturally, all speakers sound better in an EN-CB. However, if starting from scratch, we recommend: C15W woofer, Cobreflex-2 mid-range horn with T-30 driver, HF-206 "Reciprocating-Flare" super-tweeter and N-3 ACOUSTIC BATON crossover network. The price of the EN-CB is only \$120.00.

The S-9 is the EN-CB with the recommended CLASSIC components completely installed and wired... A real convenience for those who wish to buy the whole system—ready to use or finish. No charge for installation and wiring. Price: \$293.00.

• The EN-CB and S-9 are a boon to the home decorator who plans to custom build part of his furniture. Decorating ideas are limitless: as built-ins, room dividers, for period treatments and custom finishing.



BUILT-INS



ROOM-DIVIDERS

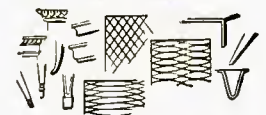

PICK A PERIOD



CUSTOM FINISHING

THE COMPONENTS THAT MAKE THE CLASSIC THE ULTIMATE IN SOUND



C15W



HF-206



COBREFLEX-2



T-30



N-3

LISTEN

University sounds better

UNIVERSITY LOUDSPEAKERS, INC., 80 SOUTH KENSICO AVENUE, WHITE PLAINS, N. Y.

**SAVE
25%**



This is our

GROUP SUBSCRIPTION PLAN

Now you, your friends and co-workers can save \$1.00 on each subscription to **AUDIO**. If you send 6 or more subscriptions for the U.S., Possessions and Canada, they will cost each subscriber \$3.00 each, 1/4 less than the regular one year subscription price. **Present subscriptions may be renewed or extended as part of a group. Remittance to accompany orders.**

AUDIO is still the only publication devoted entirely to

- Audio
- Broadcasting equipment
- Acoustics
- Home music systems
- Recording
- PA systems
- Record Revues

(Please print)

Name
Address

New Renewal

Name
Address

New Renewal

Name
Address

New Renewal

Name
Address

New Renewal

Name
Address

New Renewal

Name
Address

New Renewal

U. S., Possessions, and Canada only

RADIO MAGAZINES, INC.
P. O. Box 629, Mineola, N. Y.

ABOUT MUSIC

HAROLD LAWRENCE*

Recorded music on the air—a glimpse behind the scenes

To good music broadcasters the filing and storage of discs and tape are naturally of vital concern. The program director must have at his finger tips everything he requires as to timing, artist, composer, dates of performance, library number, and so on, of every item catalogued, and must see to it that the maximum care is exercised in handling each record and reel from the day of its arrival through its audition, cataloguing, storage, and actual transmission . . . and no station insists on more elaborate and thorough precautions than WQXR, the bulk of whose 19-hour daily schedule consists of recorded music.

For a closer look at these operations, let's investigate the case histories of a sample disc and tape. Each new recording is auditioned utilizing the same equipment found in the control booths. Acceptance or rejection is based on 1) musical performance, 2) recording engineering, and 3) processing. Of the 20,000 LP's now on the market (not to mention the hundreds that have been withdrawn by manufacturers since 1948), many obviously do not pass the test among the myriad versions of Beethoven symphonies, Tchaikovsky ballets, Strauss waltzes and other musical chestnuts that now crowd the pages of the long playing record catalogue. Included in the same category are the lamentably ungifted soloists who make mysterious, sudden appearances on the crest of a record company's publicity wave, plunging recklessly into repertoire that even a Backhaus or a Heifetz would find challenging. There are also the innumerable 'single-take' sessions hastily organized by low-budget firms interested only in quantity, as well as countless other examples of shabby record making.

Enormous strides have been made in recording techniques since the advent of the LP disc, but there is still room for improvement. That electronic will 'o the wisp, the perfect microphone set-up, continues to elude recording directors on many an ill-fated session, with such curious results as when the harpsichord emerges as a rococo rattler, the triangle a cowbell, the kettle-drum a wet pillow, and the breath of the flutist and the fingering of a bassoonist compete with the tones produced by these respective players. The balance achieved by the best microphone placement can be undone, however, by re-recording from tape to disc using questionable equalization. In the editing of master tapes, the awkwardly-joined splice can also cause damage of a more subtle nature: the mismatch of levels from one 'take' to the next; the premature cutting off of decay at the end of a movement or piece, noticeable by as little as a fraction of a second; and the disruption of

rhythmic flow by an early or late marriage of tape fragments.

But the most apparent damage to the LP disc is committed in the factory. There a faulty stamper, unstable vinyl compound, improper groove-molding, off-center pressing and just plain ticks, grit, pops, and swish can disqualify a record. On the air, of course, each of these defects is magnified and, for some unexplained reason, an off-center "wow" always seems to waver more on a radio program than on home equipment. Perhaps it's the realization that thousands of people are also hearing it "swing" to the bitter end. (A "swinger" is the graphic description used to refer to the lateral rocking of the pickup arm as it tracks an off-center disc.) But swing it will, for program schedules must be adhered to, and besides, you can't cut short the *Eroica* Symphony.

Tape would appear to be the solution to the hazards of disc production. End of side distortion, groove-wear, surface noise, 'wow' and other defects are automatically eliminated—all of which endows the magnetic ribbon with a vastly increased life span, uniform quality from the first minute to the last, and superior signal-to-noise ratio. However, recorded tape is still not an unmixed blessing. Duplicators (or "slaves") require constant vigilance to maintain fidelity to the master recording. Flutter, signal interruption, level fluctuation, abnormal hiss are some of the weeds that can spring up in the sonic garden without proper supervision. But no amount of vigilance can prevent a tape from developing print-through when it has a mind to. Climate and molecules are temperamental.

As for the mechanics of programming, tape is an unwieldy medium when it concerns anything but long works, or pre-arranged selections. Given a group of short works which do not appear in consecutive order on the same reel or are taken from different reels, two steps would have to be taken: purchase and assemble a bank of machines, each of which could then have its piece ready to be played; extract (or re-record) the different pieces and place them in their proper order on a single reel. The first alternative is expensive, the latter time-consuming. For ease of operation, it is simpler and more efficient to locate short works on an LP disc. (In cases where spirals have not been cut, a yellow crayon-pencil, sharpened to a fine point, is lined up at the center of the pickup and the turntable is set in motion; upon reaching the place to be marked, the pencil is lowered gently and steadily to the grooves for the duration of a revolution.) As a compromise, short taped works could be intermingled with discs, but the mixture must be carefully planned: too frequent

* 26 W. Ninth St., New York 11, N. Y.

shuttling between tape and disc is easily spotted by the FM listener and gives rise to an uneven aural picture.

Once a record or tape has passed its musical and technical requirements, it is catalogued. At this point, a certain amount of applied musicology is necessary since the average set of program notes and label copy hardly represents the best in musical scholarship. And here, omission of data can be as misleading as the inclusion of erroneous information. After the new entry has been assigned a catalogue number, it is cross-indexed under composer, timing, artist, and medium (vocal, orchestral, instrumental), and filed in the library.

Now begins the 'baptism of air.' Upon being scheduled, a disc is not simply taken out of its jacket, spun on the turntable and returned to its place. It is inspected first by the announcer (or producer) for correct number and title, and slipped back into its cover; the engineer performs the same examination before racking the disc; after its airing, back to the rack for the duration of the show, then finally to rest in the jacket. Thus, for a single play, the disc is moved in and out of rack and jacket for a total of eight times. Multiply this by the number of times a favorite disc is scheduled over a month's period and the figure is in the hundreds. Jackets consequently have to be mended regularly (strips of adhesive tape along bindings), and the LP's vulnerable surfaces become gritty, no matter how many times they are cleaned.

The listener, I am sure, has a firm impression that the engineer has the most leisurely job in the radio world. Yet when spot announcements, station breaks, program bulletins, and the cueing up of the first piece on the next program follow each other in rapid fire succession, he has to flip switches, twirl knobs, seize discs, and lift pickups. Apart from occasional slips, the transitions are effected so deftly that it is hard to realize that the pace is as relentless as that of a juggler keeping aloft half a dozen uncooked eggs in graceful aerial flight.

When a disc develops surface noise, becomes off-center as a result of "spindle-spread," or is otherwise damaged, a report is turned in by the engineer and the offending selection is withdrawn from active service until a replacement has been made.

Given a fair signal-to-noise ratio, adequate recorded sound, and the absence of print-through, tape offers fewer problems than the LP disc. One rule, however, is strictly observed. Reels are always stored in 'played' position (tails out) to avoid uneven winding at fast speed. When curled, the passage of the tape across the playback head can produce flutter, interruption of sound, level changes, and the slicing off of part of the frequency spectrum. Thus, tape is rewound immediately before the broadcast, never right after its play.

In the world of audio, WQXR is to records and tape what the Indianapolis Speedway is to new automobiles: a rigorous proving ground for quality and performance.

(Note: Mr. Lawrence, now music director for Mercury Record Corporation's classical division, was director of recorded music at WQXR from 1950 to 1956. Ed.)

Specifications

Description: The 121-C is a self-powered equalizer and preamplifier, complete with the dynamic noise suppressor.

Input Facilities: 2 magnetic inputs, switched on front panel; crystal or ceramic input; five high-level channels including provision for tuner, tape and TV sound. **Tape Recording and Monitoring:** Two special tape recorder output connections, plus monitor channel with monitor-playback switch. **Tape Playback:** Separate channel, with NARTB tape equalization, for playback of tape direct from tape heads. **Frequency Response:** Flat from 19 cps to 35 kc. **Total hum and noise:** On high level inputs 85 db below full output; on low level inputs, 3.2 microvolts equivalent noise input. **Dimensions in mahogany case:** 13½" x 5" x 9½" \$159.95 — Mahogany Case \$19.95.



**THE 121-C
Dynaural Equalizer Preamplifier**

The most versatile control and compensation unit ever offered. It includes continually variable record equalizers and Scott's patented Dynamic Noise Suppressor.

**H. H. Scott presents
Components for the Perfectionist**



H. H. Scott, Inc., 385 Putnam Ave
Cambridge, Mass.

• The Most Versatile Control and Compensation Unit Ever Offered — The 121-C Dynaural Preamplifier.

• The Cleanest Sounding Power Amplifier Ever Developed — The "280" 80 Watt Power Amplifier.

**The "280" 80 Watt
Laboratory Power Amplifier**

The 80-watt output of this superb amplifier provides ample power reserve for the most demanding applications. Its exclusive Dynamic Power Monitor affords full output on music, yet automatically protects expensive speakers against burnout.



Specifications

Power ratings: 80 watts on music wave-forms (short-time maximum r.m.s.); long-time continuous output 65 watts r.m.s. instantaneous peak output 160 watts. **Frequency response:** Flat from 12 cps to 80 kc. **Dynamic Power Monitor:** Reduces possibility of speaker burnout on overload by limiting maximum continuous output to any value desired between full power and 10 watts. **Speaker Damping control:** Permits continuous adjustment of output impedance to any value between 3% and 200% of load impedance. **Total Hum and Noise:** 90 db below full output. **Harmonic Distortion:** Less than 0.5%. **First-order difference tone IM distortion:** Less than 0.1%. **Outputs:** 3 to 24 ohms and 70 volt tap. \$199.95. **Also from H. H. Scott:** The "240" 40 Watt Laboratory Power Amplifier incorporating many of the features of the "280" ... only \$99.95

Complete H. H. Scott Amplifiers Start at \$99.95!

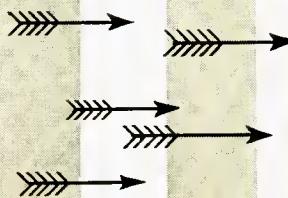

WRITE FOR YOUR FREE COPY OF H. H. SCOTT'S NEW CATALOG
H. H. Scott, Inc., 385 Putnam Avenue, Cambridge, Mass.
Rush me your new catalog A-4 showing complete high fidelity systems for my home.

Name _____
Address _____
City _____ Zone _____ State _____

Export Dept: Telesco International Corp.
36 W. 40th St., New York City

For the finest in sound...

ACROSOUND

ULTRA-LINEAR

OUTPUT TRANSFORMER U.S. PAT. NO. 2,680,618

THIS SYMBOL IDENTIFIES EQUIPMENT MEETING QUALITY STANDARDS PRESCRIBED BY KEROES ENTERPRISES

Acrosound transformers with the black and gold "K" symbol are correctly tapped for top performance in Ultra-Linear circuits. Enjoy the finest in sound . . . with the transformer that assures best Ultra-Linear results. Write for our free 16 page catalog.

Send 25¢ for new booklet "Theory and Operation of the Ultra-Linear Circuit"

ACRO PRODUCTS COMPANY
369 SHURS LANE • PHILADELPHIA 28, PENNSYLVANIA

Marantz

...the ultimate goal
of the
critical listener

Audio Console
preamplifier with cabinet \$168*

Power Amplifier
\$198*

*slightly higher west of the Mississippi

marantz company
44-15 Vernon Boulevard, Long Island City 1, N. Y.

write for literature

JAZZ

(from page 51)

Horace Silver: Six Pieces of Silver
Blue Note 1539

With the dispersal of the Jazz Messengers, Horace Silver has formed his own quintet to act as a vehicle for his distinctive compositions and imaginative piano. Its success in the clubs over the past few months indicates that it will be around for a while. Only one of the seven tunes is a standard, the others being the product of the gifted Silver pen. *Cool Eyes*, *Virgo*, and *Camouflage* are in direct swinging style. *Enchantment* and *Senior Blues* intrigue most as a mixture of the blues with a personalized Latin beat.

Louis Hayes, a talented eighteen-year-old drummer from Detroit, is introduced. With Doug Watkins, bass, he complements the piano in the tricky rhythms more effectively than might have been the case with some better-known musicians. Donald Byrd replaced Art Farmer on trumpet for this date and is heard with Hank Mobley, tenor, in articulate solos. *Shirl* is a relaxed piano solo as is the standard *For Heaven's Sake*. One of the better Van Gelder recordings.

Bud Shank: Jazz at Cal-Tech
Pacific Jazz PJ 1219

In concert at the California Institute of Technology at a Thursday morning assembly on January 19, 1956, Bob Cooper, tenor and oboe, joins the Bud Shank quartet for a diverting rundown of nine standards. Benny Carter's *When Lights Are Low*, a favorite of mine since it was first recorded in England twenty years ago, is refurbished to start things off. On *The Nearness of You* and *Lullaby of Birdland*, Shank turns from alto to flute to be joined by Cooper's oboe in some virtuoso passages. Don Prell, bass, solos on *Old Devil Moon*, and Claude Williamson, piano, on *Somebody Loves Me*. Basie's *The King* provides a rousing ending, just as the session begins to jell.

This has the best sound of any on-the-spot recording I have yet heard. When drummer Chuck Flores kicks off a bomb it reverberates about the hall a bit on the way to the microphone. The balance between the flute and oboe might have been improved, but engineer Phil Turetsky is to be congratulated, as is the audience for respectfully restraining its enthusiasm until the end of each number.

The Black Watch Folkways FW 8810
Max Dunbar: Songs and Ballads of the Scottish Wars Folkways FP 3006

Two collections to gladden the heart of any Scotsman are led off by the "Kilties" of the United States Second Army, and the pipes and drums of the Black Watch (Royal Highland Regiment) of Canada in concert at the 200th Anniversary Festival and Ball of the St. Andrew's Society at the 107th Infantry Regiment Armory in New York City on Nov. 16, 1956. Engineers Henry Mandler and Robert Strome have their work cut out for them, as the groups parade about the floor and the drums echo and re-echo in the cavernous drill shed to the scuffle of marching feet. They have an easier task when the bands play at rest. But for the most part they are successful, and the sound contrasts well with studio recordings of highland pipes.

Edinburgh-born Maxwell Dunbar is now associate professor of Zoology at McGill University in Montreal. His first professional recording is the result of years of study of the folklore of Scotland and Ireland. His pleasantly lyric voice is accompanied by his guitar in twenty-three songs close to Scots history up to 1745. Full text, explanatory notes, and glossary are to be found in the booklet included in the set.



JBL signature



great
speakers...

All that it takes to make a speaker great—excellent basic design, precision-made parts, painstaking craftsmanship, meticulous assembly—goes into JBL Signature Loudspeakers. The JBL Signature Model D130 is the only fifteen-inch extended range speaker made with a four-inch voice coil of edge-wound aluminum ribbon. It has a rigid cast frame, silvery dural dome, highly refined magnetic circuit. The D130 is distinguished by its clean, smooth coverage of the complete audio spectrum... crisp, clean bass; smooth, extended highs. It is the most efficient speaker made anywhere.

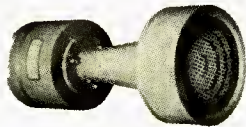

PRECISION
HIGH FREQUENCY
UNITS

The greatest single improvement you can make in your high fidelity system is to add a JBL Signature High Frequency Unit. The popular 175DLH is made with all of the precision necessary to retain the subtleties which are the essence of high frequency reproduction. In addition it has an acoustical lens—an exclusive JBL Signature feature—which disperses sound over a 90° solid angle with equal intensity regardless of frequency.

Circle 55A

AUDIO ETC.

(from page 47)

places as the Audio shows. Dare I say it?

Even so, it could well be no more than poor listening acoustics. With ideal equipment, a bad listening room can produce what seems to be distortion in the highs, though on *very* close analysis you'll find it isn't quite the same sound. Just as unpleasant but different.

I have every kind of faith that Mr. Jowitt would hear the difference clearly enough. I rather wish I had his likes around as a walking tone analyzer, to assist my tired ears.

4. 70-Volt Systems

Technically out of my area but interesting to me is a reprint which many readers may want to study for applicable ideas, called "70-Volt Sound Systems," by Jack L. Bowen of Electronic Communication Equipment Co., Chicago; it appeared in, of all mags, Railway Signaling and Communications, March 1955 issue, and has to do with railway paging systems. On first look, you'd hardly expect this to relate itself to hi-fi and home sound, but I keep having a persistent feeling that there might be something here for the home gadgeteer.

I'll let you look it up yourself (address below), but the essential point is this. In the 70-volt system, a constant output voltage is fed to all speakers connected to the amplifier regardless of load. This, as the article points out, is analogous to the home power system where, within system capabilities, the voltage remains the same under all sorts of household loading. (The trouble with European house currents is that too often they don't!) With such a speaker-amplifier set-up, you may plug in and plug out numerous speakers without altering the available voltage and, of course, without altering the volume level of other speakers in the system. In far too many multiple-speaker lay-outs, removal of one speaker from the circuit alters the set-up electrically and the remaining speakers are affected. Matching is thrown off, etc etc.

Now this principle is clearly of no interest to the man who listens to his hi-fi in one place alone. But for those gadgeteers who promote a sub-speaker into every room of the house not excluding the bath room, plus the back garden and swimming pool, an arrangement of this sort is *de rigueur*. Required.

Wanna know more about it? Write to Sands Associates, 26 O'Farrell St., San Francisco 8, Calif. That's where my reprint came from. It's an interesting treatise on simple matching problems, any way you read it.

5. Pre-Digested

A most helpful outfit called Ruder and Finn, of New York, has offered to come to my assistance in writing this department. They have a brand new Magazine Division, aimed to assist free-lancers in their work. Pre-digested research. All I have to do, they tell me, is to fill out one



If you are to hear fundamental bass tones, your speaker must be properly enclosed. JBL Signature Enclosures are engineered to make full use of the great sound potential in Signature Speakers. They are handsome to look at, wonderful to listen to. A wide range of types—bass reflex and folded horns—and sizes is available. All are superbly engineered, superbly designed, superbly built. Panels of specially selected plywood are precision cut. Joints are lock-mitred and wood-welded. An unusually wide choice of fine, hand-rubbed finishes is offered. It is even possible to order an enclosure from the factory to exactly match a sample supplied by you. If you want to build your own, you can get detailed blueprints of most Signature Enclosures from your audio dealer or the manufacturer.

superb
enclosures

Below is shown the new JBL Signature "Harkness," a back-loaded folded horn in lowboy console styling. Although its proportions are such that it will be welcome in any living room, the Harkness encloses an ingeniously folded six foot horn path for smooth, crisp, deep-down bass.

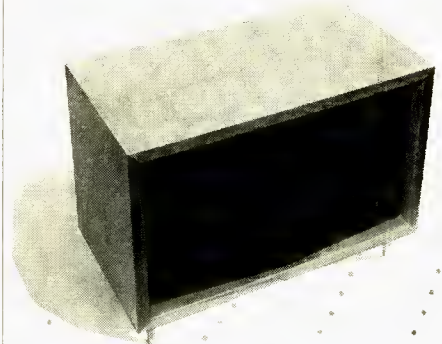

THERE IS A JBL
SIGNATURE SPEAKER
SYSTEM FOR
EVERYONE... ONE IS
JUST RIGHT FOR YOU.

Write for free catalog and technical bulletins and the name of the authorized JBL Signature Dealer in your community.



JBL means

JAMES B. LANSING SOUND, INC
2439 Fletcher Drive, Los Angeles 39, Calif.

Circle 55B

avoid a costly mistake

in your
high fidelity system



send for this new REK-O-KUT booklet

colorfully illustrates...
factually describes... the
important advantages of
playing your records on a
precision turntable!

FREE — SEND COUPON TODAY!

NAME _____

ADDRESS _____

CITY _____ ZONE _____ STATE _____

REK-O-KUT COMPANY, INC.
38-01 Queens Blvd.
Long Island City 1, N. Y. A

of the half-dozen handy postcards they enclose and they'll rush me the material, post-haste.

They sent along a list of topics upon which this pre-digested stuff is available, ready-to-use. It's quite impressive. Alphabetically, I can get the dope on Aircraft Control Instrumentation, Atomic Energy (limited), Automatic Boilers, Automation, Auto Seat Covers, Beauty, Bicycle Safety, Carpentry Equipment, China Ware, Choir Gowns, City Planning, Conservative Judaism, Cosmetics . . . well, that's plenty to

give you the general idea.

Maybe it's just as well they skipped Audio, Hi-Fi and Phonograph Records, though they didn't skip Plastic Dinnerware and Pressurized Cylinders. It's lucky they by-passed Home Music Systems—for I have to revise my book on that subject one of these days. It's *very* fortunate that I seldom get around to discussing Venetian Blinds in my free-lance writing. Or Selling by Home Parties and Club Methods. Because if I did, Ruder and Finn would be writing my columns, instead of me. ●

CASCADE AMPLIFIER

(from page 27)

bass and treble equalization for the LP, RIAA, and old NARTB curves; (though possibly not for the old AES curves), in a single loop around the input stage. The first version of the cascode preamp of *Fig. 1*, therefore, is one which provides this form of equalization. Since the result is that the entire equalization job is limited to the single stage, this configuration is very useful for embodiment in control units, for the second section which provides merely additional gain can be employed also for other purposes. With the 3.9 megohm grid leak, for instance, it would be excellent input for hi-fi ceramic cartridge. For the sake of reducing the size of capacitors and thereby forwarding compactness, grid-leak or contact-potential biasing is used in both stages. However, cathode biasing can also be employed, and might improve the noise figure, assuming d.c. is used on the filaments. The bias is sufficient to handle such cartridges as the Pickering and new Audak without significant distortion.

The same circuit can be used for a more elaborate unit in which bass equalization is produced by the feedback loop around the first stage, and treble equalization by a bypass network between stages simply by changing to the equalizers diagrammed in *Fig. 2*. Incidentally, in all these cases, the use of push-button switches is recommended for selecting equalization. They are not only somewhat freer of switching thumps and clicks; but the number of such transients is minimized because any curve can be selected immediately and without need for passing through intervening switch positions.

Equalization can also be obtained through a single feedback loop around both stages as in *Fig. 3*; and if it is desired to keep the grid-leak biasing to reduce the size of capacitors, it can still be done as indicated in *Fig. 4* which is identical to *Fig. 1* but with a resistor added from junction of cathode with bottom end of grid-leak to ground. This does not change the bias but does present a point to which feedback can be applied. If this resistor is made variable when the circuit is tested, it can be adjusted to produce optimum equalization.

Similarly, if in *Figs. 1* and *2* the resistor R_2 is made a variable initially, the bass equalization can be adjusted to allow for slight differences in gain, tolerances in components, and the like.

The circuits in *Figs. 3* or *4* have not been tried and so no details are given on the equalizers for this reason. However, they can be figured out mathematically or they may be determined experimentally if suitable measuring facilities are at hand.

It is recommended that the preamp be entirely shielded where possible, and that even the tube, though totally enclosed, be given an individual shield. Also recommended is the use of a VR tube either as an integral part of the equalizer-preamp or remotely in the control unit or power supply, to improve hum filtering and decoupling. The miniature types are compact, efficient and cost little if any more than the one- or two-section filter capacitor they replace. In most cases it is a good idea to bypass the VR tube with a small capacitance (.05 μf is usually good) for filtering any hash it may develop; in some instances, however, this might cause oscillation and if this occurs try first removing this capacitor.

It will be noted that in *Fig. 1* one position of the switch is arranged to remove equalization entirely and switch in a microphone. The cascode has found excellent application as a mike preamp and my experience confirmed the performance of the cascode amplifier for this purpose, particularly if a low-impedance mike and an input transformer are used. Incidentally, such pickups as the Ferranti, ESL and Fairchild which require input transformers may be connected to any of the diagrammed circuits across the 0.1-meg load suited also for the G-E cartridge.

Although the improvement possible with the cascode amplifier is not as dramatic as casual thought might indicate and although that obtainable is paid for in terms of slightly greater complication of circuitry, the improvement has some appeal for needs requiring the best obtainable noise figure, and the circuit deserves more attention than it has received. ●

TUNING INDICATOR

(from page 32)

the cathode of the 6E5 nearer to or farther from (respectively) the grounded end of the ratio-detector load. Adequate brightness of this tuning-eye display is obtained from a B+ supply of approximately 130 volts.

The tuning-eye tube may be mounted satisfactorily in either of two ways. Where the tuner is to remain in its original cabinet and where visibility permits, the tube may be mounted outboard, as shown in Fig. 3, using a clip fastened to the rear cover of the tuner.

A somewhat more appealing style of mounting, shown in Fig. 2, involves

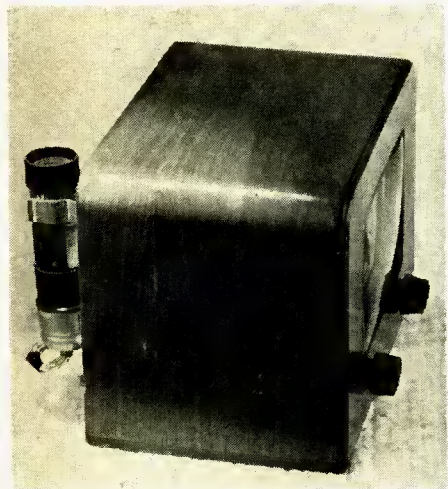

Fig. 3. "Piggy back" mounting of the indicator tube. User must look over top of cabinet, but this method requires minimum modification of the set.

cutting a one-inch hole in the panel and supporting the tube by means of an easily made clamping bracket fastened to the power transformer. The added resistors may be mounted either under the chassis or at the 6E5 tube.

If reasonable care is exercised in making the connections to the circuit, there will be no need of realignment nor will there be any discernible change in performance.

With the tuner removed from its cabinet for the addition of the tuning indicator, a fuse in the 115-volt a.c. supply circuit may easily be added also. ●

OUTPUT TRANSFORMER

(from page 21)

shoot or ringing then choose a value that produces a minimum overshoot without causing a rounding of the wave.

Usually the matter cannot be completely rectified just by capacitance on the primary of the output transformer, so the next step to try is adjustment of

NEW

and magnificent!

- ▶ ESL-BJ Super 90 all-new tangential phono arm
- ▶ Complete line of ESL moving coil microphones, microphone transformers, and transistor transformers
- ▶ ESL transistor amplifier

Write for free details

FOR LISTENING AT ITS BEST

Electro-Sonic Laboratories, Inc.

Dept. A • 35-54 Thirty-sixth Street • Long Island City 6, N.Y.



Famous for the ESL electrodynamic cartridge, the world's most advanced phono pickup • From \$14.95

Circle 57A

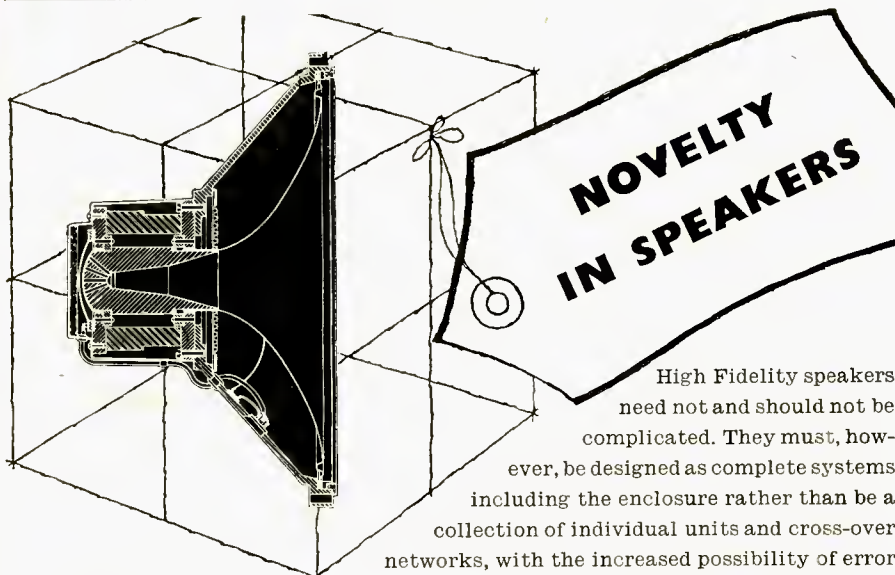

BASIC SPECIFICATION

12" and 15" models

Frequency response
30—20,000 c.p. ± 3dB.

Polar Distribution for
60° inc. angle-4dB.
at 10,000 c.p.s.

Intermodulation
Products
less than 2%

NOVELTY
IN SPEAKERS

High Fidelity speakers need not and should not be complicated. They must, however, be designed as complete systems including the enclosure rather than be a collection of individual units and cross-over networks, with the increased possibility of error and the lack of necessary equipment for tests in the home when finally assembled. Few people would obtain a motor-car by buying the engine, chassis, body etc. and assembling it at home. They would rightly regard this as a job for expert engineers—and so with loudspeakers, where naturalness not novelty is the desired result.

TANNOY

REGD.

DUAL
CONCENTRIC
SPEAKERS

TANNOY (AMERICA) LTD. 38 PEARL STREET, NEW YORK, 4, N.Y., U.S.A.
TANNOY (CANADA) LTD. 36 WELLINGTON STREET EAST, TORONTO 1, ONTARIO, CANADA

Circle 57B

ENGINEER, EE or PHYSICS MAJOR

Acoustical Engineer familiar with Loudspeaker Design and Application

for General Electric's
Radio Receiver Department
in Utica, New York

CITIZENSHIP NOT REQUIRED

Our engineering organization has a stimulating, creative opening for an EE or Physics graduate with 3 to 5 years' experience in acoustical design.

Applicants with lesser experience will be considered.

Rapid expansion makes this position particularly inviting to a man of ability, where advancement and promotion are important factors.

Ours is a consumer goods product—G.E.'s outstanding line of table and clock radios, transistor radios and portables.

Location: Utica is in the heart of the Mohawk Valley, near the famed Adirondack Forest Preserve, and is noted for its all-season recreation and sports facilities.

Send your resume in confidence to: Mr. R. P. Stitt

RADIO RECEIVER DEPARTMENT

GENERAL ELECTRIC

869 Broad Street, Utica, N. Y.

the phase-shift capacitor in the feedback loop. Where any capacitance at all across the transformer primary exaggerates the effect, the phase-shift capacitor alone will have to be relied upon to produce the best compromise. Where capacitance across the transformer primary improves the situation, various values can be tried in both positions to see which combination produces the minimum overshoot or ringing.

In some instances it will not be possible to produce a satisfactory waveform

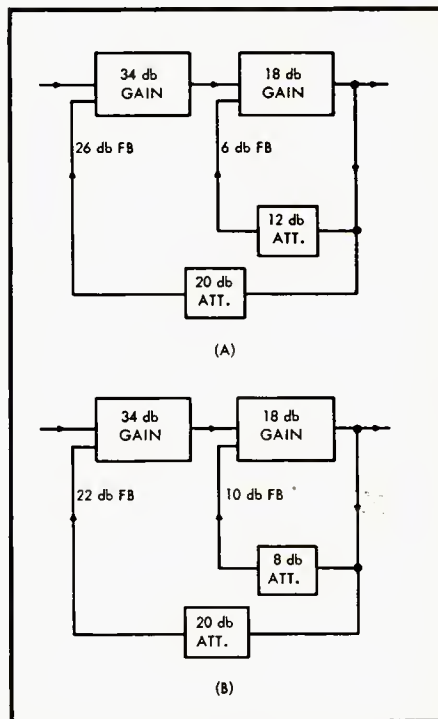
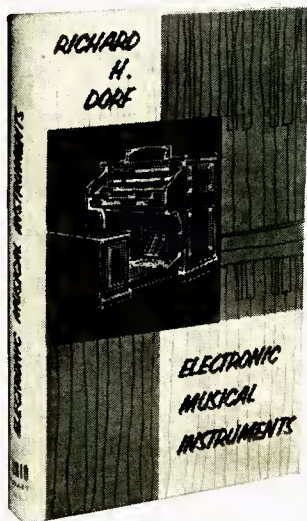

Fig. 7. Block schematics illustrating how the distribution of feedback can be modified in a two-loop feedback amplifier: in the original amplifier (A) the inner loop gives 6 db feedback, with an attenuation in the feedback of 12 db across a gain of 18 db; this gives a resultant gain of 12 db; the over-all gain is controlled chiefly by the 20 db attenuation in the over-all feedback; with $34 + 12 = 46$ db total forward gain, this loop gives 26 db feedback. By increasing the inner-loop feedback to 10 db (reducing the attenuation in the feedback path from 12 db to 8 db), the output section with feedback now drops to 8 db gain (B), and the over-all gain is now only $34 + 8 = 42$ db. As a result, the outer-loop feedback is now 22 db instead of 26 db. These figures are approximations based on the formula $A = 1/B$, which is not too accurate here; in practice there would be a change in gain of 3 db feedback on the inner loop and of about 2.7 db on the outer loop, leaving a net change of about 0.3 db (lower). A slight reduction in outer-loop feedback could offset this.

by any combination—always the overshoot or ringing seems to be somewhat excessive. Under these circumstances the only solution is to change the feedback arrangement itself. It may be necessary to reduce the over-all negative feedback.



The supply of pipe organs won't go on forever—Keep informed about the Electronic models
ELECTRONIC MUSICAL INSTRUMENTS

By
Richard H. Dorf

In one big volume, you can now learn all about the intricacies of commercial electronic organs, including the Allen, Baldwin, Connsonata, Hammond, Minshall-Estey, Lowrey Organo, and others, together with many smaller instruments. Constructional details on the author's Electronorgan and the simpler Thyratone show you how to build one of these fascinating instruments for yourself. A compilation in book form of the author's articles in **Radio Electronics**, brought up to date and with many additions. Price \$7.50 (Foreign, \$8.00).

Customary discounts to dealers and distributors

RADIO MAGAZINES, INC., Book Division, Dept. T

P. O. Box 629, Mineola, N. Y.

Please send me copies of Dorf's ELECTRONIC MUSICAL INSTRUMENTS. I enclose check money order for \$7.50 each (Foreign, \$8.00).

Name

Address

City Zone State

However this is a little undesirable because it will result in slightly greater distortion, because the over-all feedback reduces the distortion present in the output. But if the amplifier employs two feedback loops as many modern amplifiers do, it may be possible to introduce a compromise by increasing the feedback in the inner loop and reducing the feedback on the outer loop.

To achieve this the feedback resistors in the outer loop need not as a rule be changed, because increasing the feedback in the inner loop alters the effective gain in the outer loop and so automatically reduces the feedback in the outer loop by approximately the same amount as the inner loop feedback is increased. Figure 7 illustrates this. Do not try to vary this more than about 3 to 6 db from the origi-

nal operating condition. Even this much may sacrifice some of the available power output, due to the fact that the operating levels in the amplifier are disturbed and the same maximum levels cannot be achieved to produce the full output of the amplifier.

It may be well in conclusion to stress the significance of an error that has been made more than once on this job. A transformer can fail to give good results because *it is too good for the amplifier*. If the amplifier was originally built round a low cost transformer, it will seldom work as well with a higher quality job. So don't make the common mistake of concluding the transformer is not up to spec. After some careful adjustments in the manner outlined, you will have a better amplifier. ●

TRANSISTORIZED VU METER

(from page 23)

and adjust the series input resistor until the desired sensitivity is achieved. A calibrated attenuator ahead of the meter may be useful in some cases where it is

necessary to read a wide variation in volume.

There are many places where the transistorized VU meter can help out by

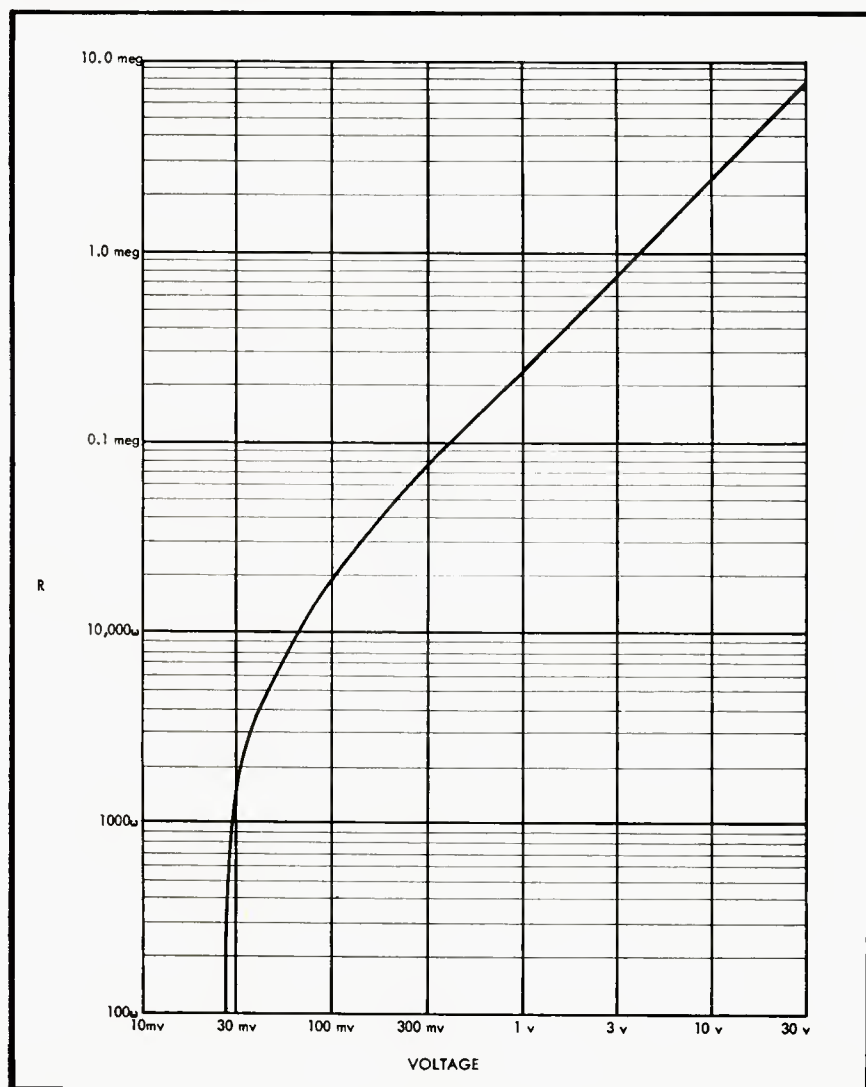
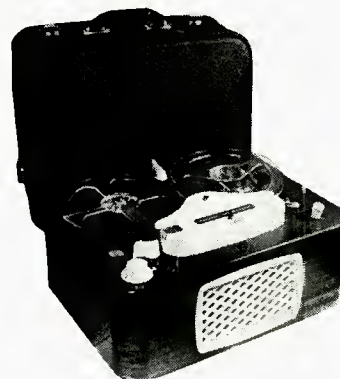

Fig. 5. Use this graph to find approximately how much series resistance is needed for any expected a.c. voltage.

at
LEONARD RADIO....

**For the most
Versatile
Home & Industrial
Tape Recording
Applications**



TANDBERG

featuring

**8 hours play on
a 7" reel**

Tandberg alone gives you the pleasure of correct speed selection for varied programs. Recording live music at 7 1/2 IPS the Tandberg registers the full sound spectrum audible to the human ear.

Foolproof operation permits changing from fast forward to fast rewind instantaneously without tearing or even stretching 1/2 mil tapes.

Available in 2 or 3 speed models with or without provision for foot control.

Model 2 2 speed \$249.50
Model 2F . 2 spd, ft. control \$299.50
Model 3 3 speed \$299.50
Model 3F . 3 spd, ft. control \$349.50

*Complete specifications on request.
On demonstration at our studio.*

TANDBERG HI-FI CORNER SPEAKER

The TANDBERG Corner Speaker is only 29.4 in. high, 20.9 in. wide and 9.6 in. deep. The Wide Frequency Range from 60 to 16,000 cycles is provided by its combination of 8" speaker and a tweeter cone, both driven from the same coil. The cone is so designed with a metal diffusion grill that the high frequencies are distributed over a wide angle. An excellent choice for industrial, school and home applications where space is at a premium and tastes in musical and sound reproduction runs high.

Model 165BK \$66.50

*Complete specifications on request.
On demonstration at our studio.*

Mail orders filled. 25% deposit, balance C.O.D.

LEONARD RADIO, INC.
69 Cortlandt St. N. York 7, N.Y. Cortlandt 7-0315

AR-1

PRESS COMMENT

The Atlantic (John M. Conly)

"The AR-1W woofer gives the cleanest bass response I ever have heard."

AUDIO (Edward Tatnall Canby)

"... the highs impressed me immediately as very lovely, smooth, unprepossessing, musical (for music) and unusually natural. No super-hi-fi screech and scratch... As to the lows... I was no end impressed, from the first time I ran my finger over a pickup stylus and got that hearty, wall-shaking thump that betokens real bottom bass to the time when I had played records and tapes on the speaker for some months on end."

*The Audio League Report**

"Speaker systems that will develop much less than 30% distortion at 30 cycles are few and far between. Our standard reference speaker system,† the best we've ever seen, has about 5% distortion at 30 cycles."

*Vol. I No. 9, Oct., '55. Authorized quotation #30. For the complete technical and subjective report on the AR-1 consult Vol. I No. 11, *The Audio League Report*, Pleasantville, N. Y.

†The AR-1W

The Saturday Review (R. S. Lanier)

"... goes down into the low, low bass with exemplary smoothness and low distortion. It is startling to hear the fundamentals of low organ notes come out, pure and undefiled, from a box that is two feet long and about a foot high."

High Fidelity (Roy Allison)

"... a woofer that works exceptionally well because of its small size, not in spite of it... I have heard clean extended bass like this only from enclosures that were at least six or seven times its size."

The Nation (B. H. Haggin)

"... achieves the seemingly impossible; a real and clearly defined bass in a cabinet only 14 by 11 $\frac{3}{8}$ by 25 inches in size."

audiocraft

"The reproduced sound* so perfectly duplicated that of the organ that no one could be sure which was playing."

*As a demonstration of live vs. recorded pipe organ, in which the reproducing system included four AR-1's.

ACOUSTIC RESEARCH, INC.
24 Thorndike St., Cambridge 41, Mass.

providing an easy-to-read indication of volume with high sensitivity. Tape recording is the most obvious, but others include P.A. systems, high-fidelity rigs, and so on.

REFERENCES

O. Berliner, "Uses and abuses of the VU meter." *AUDIO*, Nov., 1955.
H. M. Tremaine, "Power level and volume indicator meters." *RADIO & TELEVISION NEWS*, Nov., 1950.
H. A. Chinn, "The measurement of audio

volume." *AUDIO ENGINEERING*, September and October, 1951.

PARTS LIST

B_1 , 22.5 v. battery; Burgess U-15 or other.
 C_1 , 1 μ f, 10 v. miniature electrolytic.
 C_2 , 1 μ f, 25 v. miniature electrolytic.
 M_1 , VU Meter, any size, any make.
 R_1 , 4700 ohms, $\frac{1}{2}$ watt.
 R_2 , 1 megohm, $\frac{1}{2}$ watt.
 R_3 , 3900 ohms, 5%, $\frac{1}{2}$ watt.
 S_1 , On-off switch, s.p.s.t. May be incorporated as part of input jack.
 V_1 , RCA 2N105 Transistor.

RECORDING CHARACTERISTIC

(from page 25)

standard values were used in the actual unit. Five per cent components were used throughout, and tests on the various arrangements indicated the network behavior to be within ± 1 db of the theoretical recording characteristics.

Construction

Mechanical construction of the unit is

quite straightforward. The entire wiring is constructed on a two-circuit, six-position switch, and mounted in an aluminum box $2\frac{1}{4} \times 2\frac{1}{4} \times 4$ in. The input terminals are a set of banana plugs, spaced at $\frac{3}{4}$ in. so as to plug directly into a signal generator. The output is taken from a pair of banana jacks spaced at the same distance. *Figure 7* shows an inside view of the unit.

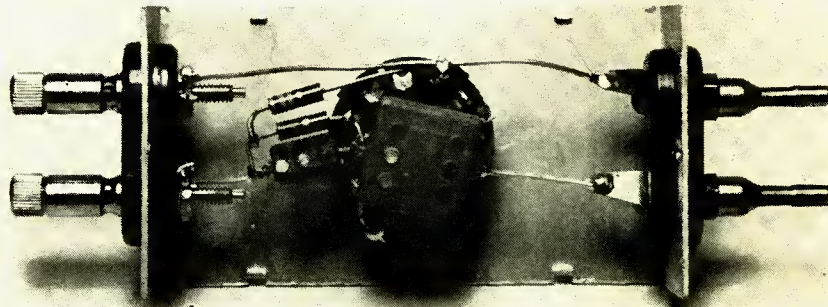

Fig. 7. Internal construction of the unit, showing how all components are mounted on switch.

PHONOGRAPH PICKUP ARM

(from page 30)

Only seven moving parts, including the drive motor, were required.

It is to be noted that in the present model, power for driving the pickup support lever is supplied by a small d.c. motor, but that power could also be supplied through a simple clutch by the turntable. In fact, a simple all-mechanical servo involving no electrical components and only four moving parts has been devised.

Evaluation

The machine appears to be more than satisfactory. The maximum tracking error is less than one-half degree. The machinery does not produce any noticeable rumble and is very smooth and quiet in its operation. Use of the device

is fully as fast, simple, and flexible as any single-play phonograph. An increase in sound reproduction quality was noticed immediately upon replacement of the eleven-inch offset arm previously used, and several well-worn recordings sounded new. This improvement was especially noticeable in the low bass and high treble ranges where the reproduction was cleaned up a great deal and the edge put back on the tympani and violins. A few records which previously skipped grooves now only click when passing those spots. This improvement is due to the fact that the stylus is now seating properly in the bottom of the groove. It is no longer riding high on the worn wall. The device fulfills all the requirements imposed upon it with a high degree of success.

TOWARD ULTIMATE FIDELITY

(from page 18)

rior to that obtained from most larger diaphragm systems. Estimating the back horn inertance to equal that of a tunnel 72 square inches in cross section and 30 inches long, we apply the standard equations, and conclude that mass reactance would balance stiffness reactance of a six cubic foot volume at about thirty-five cps. This is, of course, actually a resonance point. We hesitate to use the word resonance, however, lest "boominess" be inferred from it. The resonance contains a high resistive component; and is thus heavily damped. Since the mid-

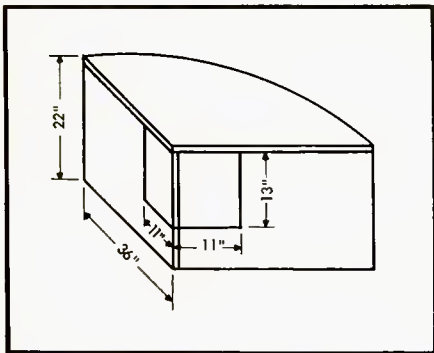

Fig. 5. Rear view of cabinet, showing speaker access doors.

range horn will lower our speaker resonant frequency, a speaker with small-baffle resonance of about fifty or fifty-five cps should match the enclosure well.

After some juggling and balancing of back and front horn requirements, we decide that vertical partitions diverging at about 50 deg., from an apex 9 inches on axis from the inside corner, (just at the edge of our 12-inch speaker) will give a good division between front and back horns. This will provide for a back horn of sixty cps cutoff, with total cross sectional area of 288 square inches about 6 inches from its mouth. The front horn will have an area of 144 square inches the same distance from its mouth, a cutoff of 120 cps, and a throat area of 36 square inches. We realize, of course, that the horns will pass frequencies considerably below their theoretical cutoff. In our design, stiffness reactance of the phase inversion chamber will act to offset mass reactance of the horns.

We'll join the horns with exponential slots beginning about six inches from their mouths, and decrease flare rates here, as shown in Fig. 2. We'll stop the upward expansion of the back horn at this point. We do not wish to stop the upward expansion of the midrange horn. The highs must travel a straight line from reflector out this mouth at its top. So we'll expand the horn bottom downward to meet the floor here.

The basic design is now settled, with the exception of materials. Some peculiar respect for theory caused the de-

signer to stick to a precise exponential expansion for both horns, requiring curved surfaces. One quarter inch untempered hardboard was bent to the contours shown in horn sections. Glue blocks were first cut to the proper contours; and the hardboard deeply saw marked where its rate of curvature was high. Notwithstanding, bending was not easy. Flat portions of the enclosure were made of $\frac{3}{4}$ " plywood. The front panel was bent of $\frac{1}{4}$ " hardboard, with somewhat less difficulty than the horn portions. Several dowels were secured between phase inversion chamber top and bottom panels, to add rigidity. Concrete was chosen as the best material for the reflector. Before pouring the sand-cement-water mix, wood screws were set in positions to secure it. The reflector surface was made convex, in the horizontal plane, to provide horizontal dispersion. A pyramidally shaped filler block was used in the fold of the back horn at the bottom corner. For easy access to speaker, the upper back corners of both side panels were made removable as seen in Fig. 5. All other joints were, of course, glued and screwed.

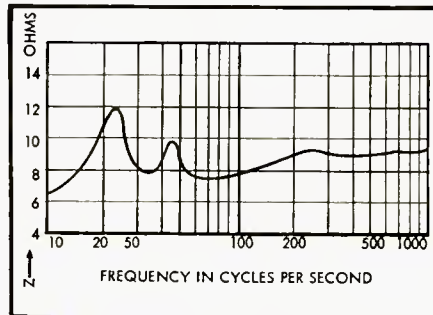

Fig. 6. Measured impedance characteristic of the Lo-Duo horn enclosure.

Exposed horn portions were spray enameled. The phase inversion chamber was then padded and covered with leatherette.

Speaker performance is most gratifying. Figure 6 shows the low end impedance curve of a twelve inch, eight ohm speaker, of fifty-five cycle resonance, mounted in the enclosure. (An 8- or 10-inch speaker may be installed with no alteration.) Note the high impedance, indicating high air load, and efficient response, to below 20 cps.

There are obviously an infinite number of variations of the original design possible. Both for commercialization, and for home construction, simplification is in order. Some improvement, as well as simplification, will doubtless be realized in time. But those of you who want the best loading yet devised for that 8- to 12-inch speaker, and want it NOW, get out the tool box. ●

AR-2

The AR-1 acoustic suspension* speaker system is now widely recognized as reproducing the cleanest, most extended, and most uniform bass at the present state of the art. It is employed as a reference testing standard, as a broadcast and recording studio monitor, as an acoustical laboratory test instrument, and in thousands of music lovers' homes.

The AR-2, our second model, is a two-way speaker system (10 in. acoustic suspension woofer and newly developed tweeter assembly), in a cabinet slightly smaller than that of the AR-1—13½"x24"x11¾". It is suitable for use with any high quality amplifier which supplies 10 or more clean watts over the entire audio range.

AR-2

The price of the AR-2 in hardwood veneer is \$96.00, compared to the AR-1's \$185.00. Nevertheless we invite you to judge it directly, at your sound dealer's, against conventional bass-reflex or horn systems. The design sacrifices in the AR-2, comparatively small, have mainly to do with giving up some of the AR-1's performance in the nether low-frequency regions, performance which is most costly to come by. The AR-2 can radiate a clean, relatively full signal at 30 cycles.

The AR-2 speaker was designed as the standard for medium-cost high fidelity systems. Our tests have shown it to be so far ahead of its price class that we think it will come to be regarded as such a standard within its first year.

AR-2

Literature, including complete performance specifications, available on request from:

ACOUSTIC RESEARCH, INC.
24 Thorndike St., Cambridge 41, Mass.

startling silence
for the perfectionist

Connoisseur TURNTABLE

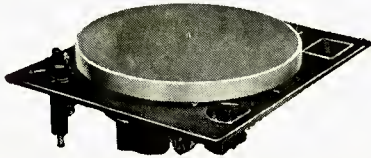

The hush of an empty church, even though the synchronous motor is running — this is the Connoisseur, crafted in traditional English quality. Precision machining assures pure sound reproduction. Non-magnetic, 12" lathe-turned table; precision ground spindle; phosphor bronze turntable bearing; $\pm 2\%$ variation provided for all 3 speeds; hysteresis motor. **\$110.00**

TURNTABLE: Rumble—better than 50 db down; Wow—less than 0.15% of rated speed; Dimensions: $13\frac{1}{2} \times 15\frac{1}{4}$ ".

PICKUP: Frequency Response — 20-20,000 cps ± 2 db at 33 $\frac{1}{3}$ rpm; Effective Mass—4 mg; Impedance—400 ohms at 1000 cps.

"Dynabanced" tone arm with Mark II super-lightweight pickup w/diamond stylus **\$49.50**
w/sapphire stylus **\$34.50**

Write today for literature.

ERCONA CORPORATION

(Electronic Division)

551 Fifth Ave., Dept. 6, New York 17, N. Y.

In Canada: Astral Electric Co. Ltd.
44 Danforth Road, Toronto 13

IF YOU ARE MOVING

Please notify our Circulation Department at least 5 weeks in advance. The Post Office does not forward magazines sent to wrong destinations unless you pay additional postage, and we can NOT duplicate copies sent to you once. To save yourself, us, and the Post Office a headache, won't you please cooperate? When notifying us, please give your old address and your new address.

Circulation Department
RADIO MAGAZINES, INC.
P. O. Box 629, Mineola, N. Y.

CUSTOM HI-FI TONE ARM

★ **NEW—LOW MASS DESIGN** Assures maximum performance of modern high-compliance cartridges.

★ **NEW — INDIVIDUALLY CALIBRATED OFFSET ANGLE AND OVERHANG** Assure correct tracking of LP records.

★ **NEW — MICROMETER TYPE COUNTERBALANCE** Assures accurate stylus pressures.

★ **NEW — LONGER LENGTHS** Assure lower tracking distortion.

- ★ 1-gram tracking
- ★ Low-friction nylon bearings
- ★ Custom hand-finished satin aluminum

CHOICE OF THREE LENGTHS

16" 18" 21" Overall

Available at better Hi-Fi dealers or write direct

Volpar

4404 W. 22 ST.
PANAMA CITY, FLA.

RECORDS

(from page 43)

Folk Songs and Ballads. Terrea Lea, with guitar.

Hifirecord R-404

OK, so Terrea Lea has her own daily TV show, sponsored, right out of Hollywood. That makes her an entertainer for millions and no doubt about it. But it doesn't make her a folk singer.

It's fairly clear to me that Miss Lea has never in her life come within earshot of a genuine folk song, though she includes a number of well known folk tunes here, with appropriate folk-research stuff in the notes about Origins and all that.

And so there's no point in denying that a lot of people will enjoy these throaty renditions, though personally I can only wince at the Lea idea of such tunes as "Aunt Rhody," "I wonder as I wander," "My Boy Willie," not to mention "Gently Johnnie My Jingo." My only real peeve is that this record should be launched as a folk disc. The folks who really know these songs from back home will agree with me.

It's super-hi-fi in the recording (AKG mikes) and you can have it on tape, too. ●

DON'T
FORGET



EASTER SEALS

National Society
for
Crippled Children and Adults
11 So. LaSalle Chicago 3

CLASSIFIED

Rates: 10¢ per word per insertion for noncommercial advertisements; 25¢ per word for commercial advertisements. Rates are net, and no discounts will be allowed. Copy must be accompanied by remittance in full, and must reach the New York office by the first of the month preceding the date of issue.

THE AUDIO EXCHANGE has the largest selection of new and fully guaranteed used equipment. Catalog of used equipment on request. Audio Exchange, Dept. AE, 159-19 Hillside Ave., Jamaica 32, N. Y. AXtel 7-7577; 367 Mamaroneck Ave., White Plains, N. Y. WH 8-3380.

AUDIO EXCHANGE EXCHANGES AUDIO

6-Element BROAD-BAND FM ANTENNAS. All seamless aluminum, \$10.95 ppd. Wholesale Supply Co., Lunenburg 10, Mass.

HIGH-FIDELITY SPEAKERS REPAIRED
Amprite Speaker Service
70 Vesey St., New York 7, N. Y. BA 7-2580

WANT A VERY LOW RESONANCE
SPEAKER?

Ask your dealer to demonstrate the Racon floating-cone, foam-suspension loudspeaker. Or write for literature and prices. Racon Electric Co., 1261 Broadway, New York 1, N. Y.

LONG PLAYING RECORDS, 20 to 50% discounts; brand new factory fresh; unplayed; all labels. Send 20¢ for catalog to Record Discount Club, 1108 Winbern, Houston 4, Texas.

FOR SALE, USED: WHARFEDALE 12CSAL speaker, \$47; University Cobraflex horn, \$18; HF206 tweeter, \$21; crossovers N2A, \$14; N2B, \$11; Electro-Voice T35 tweeter, \$26; X36, \$7. Chasick, 1206 Sheridan Ave., Bronx, New York.

25 Sets Gummed Labels (Top and End) \$1.00 postpaid. Use new set when re-recording tape. Specify 7" or 5" box. Fabro Equipment Corporation, 21 Goodale Circle, New Brunswick, New Jersey.

REAL BARGAINS in name brand hi-fi equipment. Some new, some demonstration equipment, some used. All guaranteed as represented. Send for list. AUDIO-VISION COMPANY, 1276 Old Coast Highway, Santa Barbara, California.

FOR SALE: Back file of AUDIO ENGINEERING and AUDIO magazine complete from Feb. 1948 through Dec. 1955. Also have single copies (1 each) of Jan. 1949, March and Sept. 1950, July 1951, and Jan. 1953. State offer in first letter. Box CD-1, AUDIO.

EMPLOYMENT

★ **AUDIO SALES ENGINEER.** Young, energetic, sales-minded, with strong technical background in audio and a few years in sales and administrative work. Diversified activity in factory sales and some travel. Excellent future, complete freedom of expression. Send detailed resume, state salary. Do not phone.

UNIVERSITY LOUDSPEAKERS
80 S. Kensico Ave., White Plains, N. Y.

● **AUDIO ENGINEER, B. Sc. (EE)** degree, 15 years uninterrupted experience in audio and other electronic fields seeks connection with reputable company in the audio amplifier, hi-fi, recording, or allied fields. Non-military work preferred. Minimum salary \$9500. Box CD-2, AUDIO.

PROFESSIONAL DIRECTORY

"Continuously Since 1944"

HOLLYWOOD ELECTRONICS
DISTRIBUTORS OF HI-FI COMPONENTS
EXCLUSIVELY

7460 Melrose Ave. Los Angeles 46, Calif. WEbster 3-8208

Circle 63C

FM/Q

antenna systems

High gain Broadband Yagi for max. sensitivity to both 72 and 300 ohm input. Designed for Fringe FM.

APPARATUS DEVELOPMENT CO.
Dept. C Wethersfield 9, Connecticut

Circle 63D

the finest in Hi-Fi

featuring **ElectroVoice**®
HIGH FIDELITY COMPONENTS

SOUND CORPORATION

820 W. Olympic Blvd. · L. A. 15, Calif · RI 7 0271

Circle 63E

CANADA
High Fidelity Equipment
Complete Lines • Complete Service
Hi-Fi Records — Components and Accessories

ELECTRO-VOICE SOUND SYSTEMS
141 DUNDAS ST. WEST. TORONTO, CANADA.

Circle 63F

DO YOUR TAPE SPLICING

WITH
The Carson TAPE SPLICER
(U. S. Pat. No. 2552148)

Proven in More Than
Seven Years of
Service

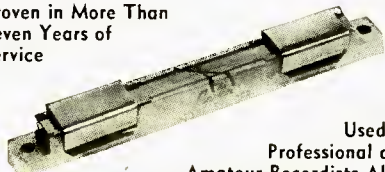

Used by
Professional and
Amateur Recordists Alike

The only low cost precision machined tape splicer that makes an even splice with straight sides.

NO BOUNCE — NO JITTER

When the splice goes through tape guides

At Your Electronic & Photographic Dealers

MAGNECESSARIES
BOX 6960 WASHINGTON 20, D. C.

Circle 63G

AUDIO • APRIL, 1957

Industry People...

I.R.E. CONVENTION SCUTTLEBUTT.

Indicative of the increasing interest in audio was the technical session held on the afternoon of March 19, under the chairmanship of Stromberg-Carlson's **Frank Slaymaker**. On the subject of "High Fidelity and Home Measurement," the meeting attracted the largest group of professional audio engineers ever to assemble for a single session. The Waldorf-Astoria's huge Empire Room was inadequate for handling the turnout, and speakers' remarks were piped to another ballroom for the benefit of an overflow crowd of some 200 persons. Appearing on the program were **A. Peterson** of General Radio Company who discussed "Intermodulation Distortion; Its Measurement and Evaluation;" **W. W. Dean** of General Electric Company whose subject was "Testing High Fidelity Amplifiers in the Home;" **W. H. Erikson** of RCA who spoke on "Disc and Magnetic Tape Phonograph Systems;" **S. Zuerker** of General Electric Company who covered "Improved Low-Frequency Loudspeaker Performance;" **W. E. Glenn** of General Electric Company who described "A Low-Pressure Phonograph Cartridge," and **B. B. Bauer** and **L. Gunter** of Shure Brothers, Inc., whose subject was "A High-Fidelity Phonograph Reproducer."

Other well-attended audio technical sessions included one on "Speech Analysis and Audio Amplifiers," with **Harry P. Olson** of RCA Labs as chairman, and another on "Magnetic Recording," under the chairmanship of **Marvin Camras** of Armour Research Foundation.

A new departure of this year's I.R.E. trade show was the establishment of a "British Room," in which British manufacturers displayed equipment available to American users. Although most of the devices shown were industrial and professional in nature, Beam-Echo, Ltd., displayed an impressive line of home audio equipment which will be sold in the U. S. under the trade name of Majestic Beam-Echo. On hand to greet visitors was **H. M. Rahmer**, managing director of the company. Another name in evidence which is familiar to audio fans was that of British Industries Corporation, whose industrial division display was attended by **Eugene Carduner**, **Arthur Gasman**, and **Jay Quinn**.

PEOPLE AND STUFF. **Woody Gannett**, whose official title is managing editor of I.R.E. Proceedings, and who holds a degree in engineering, although you'd never know it unless someone else told you (Editor's Note: Higher compliment is unavailable to man), proving once more that he is the electronic industry's foremost director of public relations... **Paul Witte** of Tech-Master Corporation elated over interest in the new Tech-Master 60-watt amplifier which received its first public showing... **Melvin Sprinkle**, formerly of Ampex Corporation and now with Production Research, Inc., greeting friends with a small wireless microphone in his hand. When pressed to talk the mike actuated a tuner-relay-recorder setup which made it entirely unwise to say anything you wouldn't want to hear repeated.

John Colvin, past president of the Audio Engineering Society, greeting old friends as a representative of The Daven Company... **Leon Adelman**, prominent New York factory representative, sharing congratulations accorded his son Arthur in behalf of the latter's recent marriage... **Saul Marantz** happily reporting failure to discover an amplifier which surpasses in performance the one his company manufactures... **Harold Renne** attending his first I.R.E. Convention in his capacity as Director of Technical Information for Bell Telephone Laboratories.

HIGH-FIDELITY HOUSE

Most complete stock of Audio components in the West

Phone: RYan 1-8171

536 S. Fair Oaks, Pasadena 1, Calif.

Circle 63H

in a

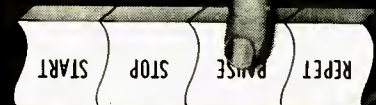

pushbutton world...

this is your
Hi-Fi Life!

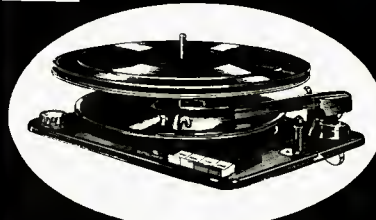

MIRACORD XA-100

"2-in-1" Fully Automatic Pushbutton Changer and Manual Player with the exclusive "Magic Wand" Spindle.

Enjoy endless hours of delightful music at the touch of a fingertip... so automatic you need never touch the tone arm. Has every advance feature you want.

Complete, Ready to Use \$67.50 less cartridge

FAR AHEAD > THE FINEST BY FAR

At All
Hi-Fi Dealers



Write for
Complete Brochure

AUDIOGERSH CORPORATION

514 Broadway, New York 12, N.Y.

Circle 63A

Better Results With
ROBINS' AUDIO ACCESSORIES!

GIBSON GIRL® TAPE SPLICERS		
1. Semi-Pro	SP-4	\$ 3.50
2. Junior	TS-4JR	6.50
3. Standard	TS-4STD	8.50
4. De luxe	TS-4DLX	11.50
5. Industrial (5 sizes to 1")		(net) 55.00

ROBINS PHONO AND TAPE ACCESSORIES		
6. Splicing tape	ST-500	\$.39
7. Jockey Cloth for Tapes	JCT-2	1.00
8. Tape Threader	TT-1	.98
9. AUD-O-FILE	AF-50 (net)	23.99
10. Changer Covers	CC-1, 2	2.00
11. Turntable Covers	CC-3	2.50
12. Disclosures	E10, 12 (pkg)	1.20
13. Jockey Cloth for Records	JC-1	1.00
14. KleeNeeDLE	NB-1	1.50
15. Phono-Cushion, 10", 12"	PC-10, 12	5.00
16. Atomic Jewel	SE-90	5.00

At Dealers Everywhere

ROBINS INDUSTRIES CORP.
BAYSIDE 61 NEW YORK

Circle 63B

the Magnificent Ferrograph

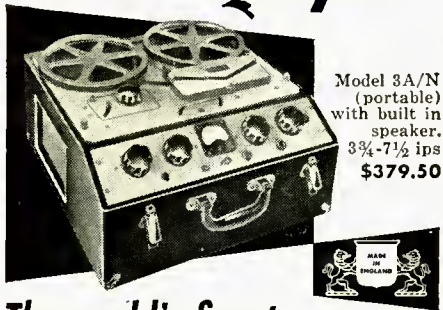

Model 3A/N (portable) with built in speaker. 3 3/4-7 1/2 ips \$379.50

The world's finest hi-fi tape recorder

The ultimate in high-fidelity tape recorders for home and professional use. Dual-speed, dual-track FERROGRAPH recorders are also available in custom models (tape decks available, from \$195.) and with 7 1/2 and 15 ips speeds. Independent field performance tests rate Frequency Response at ± 2 db between 50 and 10,000 cycles with wow and flutter less than 0.2% at 7 1/2 ips.

Quality standards have restricted our production and unforeseen demand may delay delivery, write TODAY for literature.

ERCONA CORPORATION
(Electronic Division)
551 Fifth Ave., Dept. 70, New York 17, N. Y.
In Canada: Astral Electric Co. Ltd.
44 Danforth Road, Toronto 13
Circle 64A

for everything in hi-fi GET THE MONEY-SAVING 1957 ALLIED CATALOG



featuring the world's largest stocks of systems & components

free!
SEND FOR IT

Here's your complete money-saving guide to Hi-Fi. Shows you how to select a custom Hi-Fi music system for your home at no more than the cost of an ordinary phonograph. Tells you what to look for and how to save money. Offers the world's largest selection of complete Hi-Fi systems as well as individual amplifiers, tuners, changers, speakers, enclosures and accessories. Want to build-your-own?—see the famous Hi-Fi KNIGHT-KITS. For everything in Hi-Fi—for everything in Electronics, get the FREE 1957 ALLIED Catalog.

ALLIED RADIO AMERICA'S HI-FI CENTER

ALLIED RADIO CORP. Dept. LL-47
100 N. Western Ave., Chicago 80, Ill.

Send FREE 1957 ALLIED Catalog

Name _____

Address _____

City _____ Zone _____ State _____

Circle 64B

ADVERTISING INDEX

Acoustic Research, Inc.	60, 61
Acro Products Company	54
Allied Radio Corporation	64
Altec Lansing Corporation	43, 45, 47
Apparatus Development Company	63
Audak Company	44
Audio Fidelity Recordings	38
Audiogersh Corporation	63
Belden Manufacturing Company	37
Bell Telephone Laboratories	16
Bogen, David Company, Inc.	Cov. 11
Bradford & Company	46
British Industries Corporation	facing Cov. 11, 3
Cabinart	64
Capps and Company, Inc.	35
Classified	62
Collaro Record Changers	13
Electro-Sonic Laboratories, Inc.	57
Electro-Voice, Inc.	5
Electro-Voice Sound Systems	63
Elgin National Watch Company	6
Ercona Corporation	62, 64
Fisher Radio Corporation	40, 41
General Electric Company	58
Gray Research & Development Co., Inc. .	50
Harman-Kardon, Inc.	33
Heath Co.	7, 8, 9
High Fidelity House	63
Hollywood Electronics	63
JansZen Speakers (Neshaminy Electronic Corp.)	31
Kierulff Sound Corporation	63
Kingdom Products, Ltd. (Lorenz)	49
Lansing, James B., Sound, Inc.	55
Leonard Radio, Inc.	59
Magnecessories	63
Marantz Company	54
Mullard Overseas, Ltd.	11
North American Philips Co., Inc.	10
Pickering & Company	15
Pilot Radio Corporation	29
Pioneer (Fukuin Electric Works, Ltd.)	42
Professional Directory	63
Rek-O-Kut Company	56
Robins Industries Corporation	63
Rigo Enterprises, Inc.	4
Schober Organ Corporation	64
Scott, H. H., Inc.	53
Sherwood Electronic Laboratories, Inc. .	1
Stephens Manufacturing Corporation Cov. IV	
Tannoy (America) Limited	57
Tech-Master Corporation	12
Triad Transformers Corp.	2
University Loudspeakers, Inc.	51
Volpar	62
Weathers Industries, Inc.	Cov. III

SAVE 1/2 — PAY PART-BY-PART — HAVE FUN
Assembling the Schober

ELECTRONIC ORGAN in KIT form



Now you can afford a real, full concert organ, just like those made by the foremost organ manufacturers. Because over 1/2 the cost is saved when you assemble it yourself. And it's REALLY EASY: only 24 separate units, all with printed circuits, and detailed-to-the-smallest-step instructions. In addition, you purchase each of the 24 kits when you are ready for it — and can afford it.

You'll get a real kick out of putting the *Schober Electronic Organ together — and then sitting down and pulling out the stops for Strings, Trumpets, Clarinets, Diapasons, Flutes, etc.

Compact CONSOLE

One of the many exclusive features of this exceptional offer is the handsome console, made by hand in Old World Craftsman manner. It is equally at home in a traditional or modern setting, and takes little more space than a spinet piano.

Free Literature

Complete descriptive booklet and price list are available on request. And, if you wish to hear the glorious pipe organ tone of the Schober Electronic Organ, a 10" long playing recording by Dr. C. A. J. Parmentier, renowned organist, is available for \$2. This is refundable when you order. Write today and see what a fine instrument you can get at such a great saving.

The SCHOBER ORGAN CORPORATION

2248-K Broadway, New York 24, N. Y.

*Designed by Richard H. Dorf Circle 64C



PFK-120/150



PFK-500



PFK-300

pfK
pre-finished Kits

designed by Paul Klipsch

Now you need only a screw-driver to put together a furniture-finished Klipsch speaker enclosure, indistinguishable from factory-assembled Rebel 3, 4 or 5. Also available as conventional, unfinished kits.

cabinart

Write for Complete Catalog!

36 pages . . . 16 other hi-fi kits . . . 29 equipment cabinets . . . 4 matched speaker systems . . . 20 hi-fi accessories.



57

Cabinart

99 North 11th Street
Brooklyn 11, N. Y.

largest manufacturer of cabinets and kits for hi-fi
a division of G & H Wood Products Co., Inc.

Circle 64D



...a perfect ending

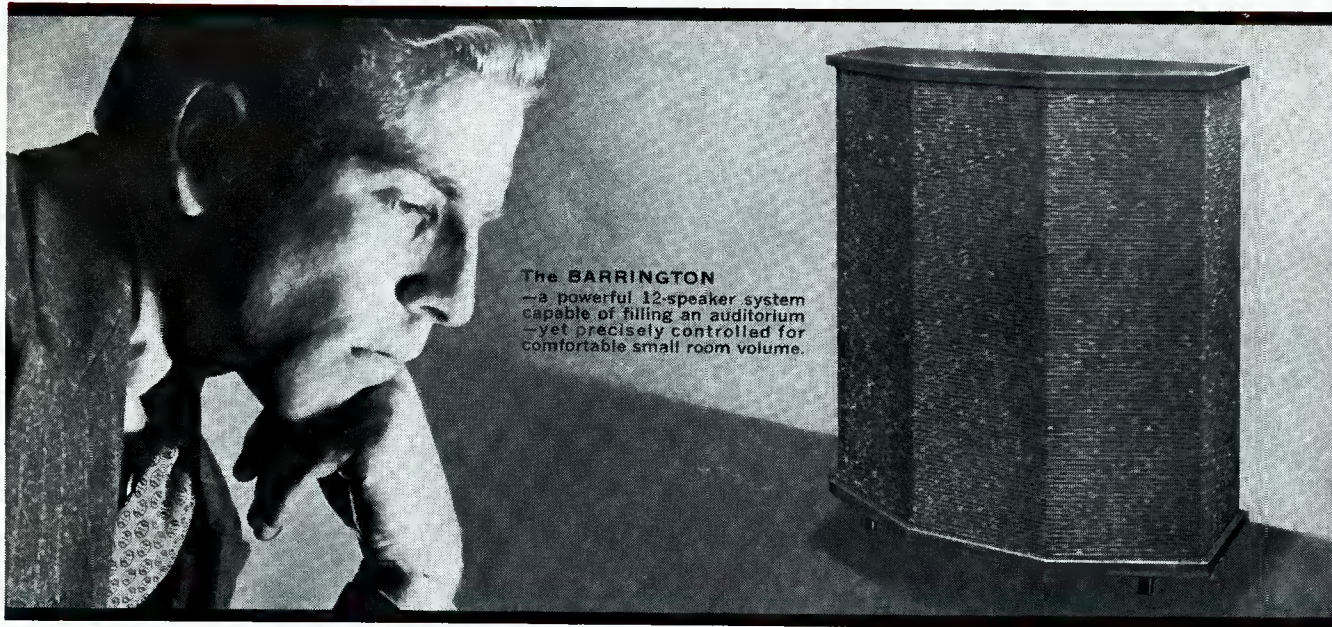

The BARRINGTON
 —a powerful 12-speaker system
 capable of filling an auditorium
 —yet precisely controlled for
 comfortable small room volume.

Weathers high fidelity achievements are not measured in words—but dramatically in sound! Weathers new, improved FM Pickup system is perfectly balanced to a one-gram stylus force, faithfully tracks the finest record engravings, causes *no* record wear. Only such dependable design results in perfect tone quality. Weathers Speaker systems are just as finely engineered. Here you have sound reproduction in the exact middle register—sound with startling realism because it is perfectly natural!

Write for full
 information on
 all Weathers
 components.

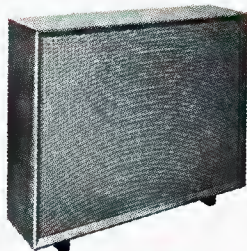

The DECORATOR

—a beautiful, compact system achieved only by Weathers exclusive hi fi developments through scientific use of sonic principles...a functional décor for any room.



The MONTE CARLO

—a new six-speaker system, presenting a graceful elegance patterned after the Barrington design...rounds out Weathers selective line of systems for audiophile or beginner.



WEATHERS STYLUS GAUGE

—a simple, accurate measure for balancing a phonograph pickup for its specifically designed tracking force...makes records last longer, sound better.

Export:
 Joseph Plesencia, Inc.
 401 Broadway, New York 13, N. Y.

Weathers

Industries, Div. of Advance Industries, Inc.
 66 E. GLOUCESTER PIKE, BARRINGTON, N. J.



1=2

With engineering magic by the originators of coaxial speakers, two voice coils in one 12" speaker cover the entire audio range without distortion. Complete, compact and requiring comparatively little enclosure space, the 122 AX Coaxial Speaker System reflects TRU-SONIC quality engineering and materials. \$63.00

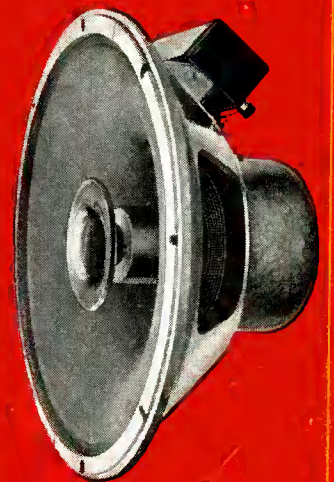

Listen... you'll always hear more from:

STEPHENS TRU-SONIC INC[®]

8538 Warner Drive, Culver City, California
Cable Address: MORHANEX • Export Address: 458 Broadway, New York 1