

Organ for One-Finger Artists - See Page 19

AUDIO ENGINEERING

SEPTEMBER
1953
35c



STYLUS-DISK

THIS STYLUS-DISK IS MADE OF SPECIAL SOFT MATERIAL, RESISTANT TO MOISTURE AND SOFT AND SILENT AT STORAGE BETWEEN YOUR OTHER RECORDS!

TO CHECK STYLUS

Place a 25¢ coin on the flat top of the stylus. Then place the other side of the coin on the top of the stylus. If the coin does not move, the stylus is good. If the coin does move, the stylus is bad. (The coin should not be placed on the stylus if the stylus is bad.)

NOTE

The grooves are rubberized and clear again, and finally damaged by a delinquent stylet.

The side with the top narrower band is microgrooved - extra carefully recorded.

The side with the 1/2" wide band is standard grooved.

THIS STYLUS-DISK IS MADE BY THE AUDA COMPANY.

AUDA COMPANY

100 FIFTH AVENUE

NEW YORK, N.Y.

© 1953 AUDA COMPANY

Approved for use in U.S.A.

REGISTERED

THE WORLD OF SOUND

for the
FINEST
 in recorded
 sound



America's leading phonograph record manufacturers use
audiotape® for the original sound
 and audiodiscs® for the master recording

NO ONE listens to recorded sound with a more critical ear than the professional recordists who make America's finest phonograph records. Here there can be no compromise with quality.

That's why it's significant that so many of them repeatedly specify Audiotape and Audiodiscs to meet their most exacting requirements. For example, it was found that 29 of the 30 best selling records of 1952 were made from Audiodisc masters. And over 43% were first recorded on Audiotape before being transferred to the master discs.

Remember - you get this same superlative sound by using Audiotape and Audiodiscs in *your* recording work.

© The exclusive trade-mark of Columbia Long Playing Records - Reg. U.S. Pat. Off.

• Trade Mark. Audiodiscs are manufactured in the U.S.A. under exclusive license from PYRAL, S.A.R.L., Paris

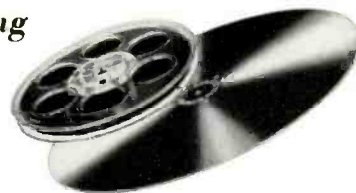

AUDIO DEVICES, Inc.

444 MADISON AVE., NEW YORK 22, N. Y.
 Export Dept.: 13 East 40th St., New York 16, N. Y.
 Cables "ARLAB"



audiodiscs
 audiotape
 audiofilm
 audiopoints

Successor to **RADIO** - Established 1917

AUDIO ENGINEERING

INCLUDING



C. G. McProud, Editor and Publisher

Henry A. Schober, Business Manager

Harrie K. Richardson, Associate Editor Edgar M. Villchur, Contributing Editor
 Robin Melton, Production Manager S. L. Cahn, Advertising Director
 Edgar E. Newman, Circulation Director H. N. Reizes, Advertising Manager

Editorial Advisory Board

Howard A. Chltn
 John D. Colvin
 J. P. Maxfield



Representatives

H. Thorpe Covington, Special Representative
 7530 North Sheridan Road, Chicago 26, Ill.
 Sanford R. Cowan, Mid-West Representative
 67 W. 44th St., New York 18, N. Y.

West Coast

James C. Calloway J. W. Harblson
 816 W. 5th St., Los Angeles 17, Calif.



CONTENTS SEPTEMBER, 1953 Vol. 37, No. 9

Audio Patents—Richard H. Dorf	2
Letters	8
Coming Events	10
Book Review	12
Audiology—W. R. Ayres	14
Editor's Report	16
Organ for One-Finger Artists—Richard H. Dorf	19
Horn Enclosure for Custom Installations—A. J. Gassan	22
The Dictating Machine—Part II—R. M. Somers	24
Flexible Tone-Control Circuit—Basil T. Barber	29
A New Volume Visualizer—Norman Prisament	30
The Case for Music—John H. Thompson	32
D.C. Pack for Heaters and Bias—Allan M. Ferres	33
Twin-Triple Resistance Decader and Bridge—L. B. Keim	34
Handbook of Sound Reproduction—Chap. 12, Part III—Edgar M. Villchur	36
Industry Views The Audio Fair—Harrie K. Richardson	40
Equipment Report—Bogen R714 Tuner, Lorenz Speaker System	42
Improvements on the Universal Tape Recorder Amplifier—C. G. McProud	44
Record Revue—Edward Tatnall Canby	46
New Products	52
New Literature	57
Employment Register	73
Radio's Master Reports	82
Industry Notes and People	83
Advertising Index	84

COVER

Since phonograph records provide such a large part of the source material for home music systems, this cover is in the nature of a tribute to a new device which offers a means for determining the condition of the all-important stylus tip—a means which does not involve expensive laboratory equipment (doubtful in effectiveness anyhow except in the hands of an expert) but which may be used at any time with a minimum of trouble and which will give reliable results to even the novice in the hi-fi art.

RADIO MAGAZINES, INC., P. O. BOX 629, MINEOLA, N. Y.

AUDIO ENGINEERING (title registered U. S. Pat. Off.) is published monthly at 10 McGovern Avenue, Lancaster, Pa. by Radio Magazines, Inc., Henry A. Schober, President; C. G. McProud, Secretary. Executive and Editorial Offices: 204 Front St., Mineola, N. Y. Subscription rates—United States, U. S. Possessions and Canada, \$3.00 for 1 year, \$5.00 for 2 years; elsewhere \$4.00 per year. Single copies 35c. Printed in U. S. A. All rights reserved. Entire contents copyright 1953 by Radio Magazines, Inc. Entered as Second Class Matter February 9, 1950, at the Post Office, Lancaster, Pa. under the Act of March 3, 1879.

by **TRIAD**

Designed by Triad to meet exacting military requirements for airborne telemetering equipment, the tiny electric wave filter shown above actually contains eleven precision components: 2 toroidal inductors, 5 JAN-C-5 capacitors, and 4 precision wire-wound resistors. The resulting attenuation slope is over 50 decibels per octave.

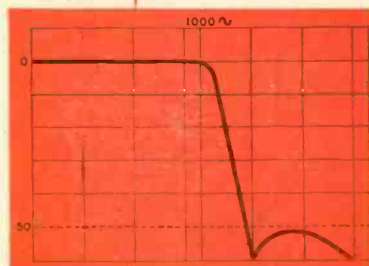

The same brilliant design and controlled manufacturing that goes into Triad's distinguished line of hermetically sealed military transformers is available to you for licking the toughest wave filter problems. Call Triad first!

For specifications and prices on Triad's general line of transformers, write for Catalog TR-53F.



4055 Redwood Ave. • Venice, Calif.

Engineering

WRITERS

ENGINEERS, E. E. or PHYSICS GRADUATES, for preparation of technical manuals...

HUGHES RESEARCH AND DEVELOPMENT LABORATORIES' expanding program for production of radar, electronic digital computers, guided missiles and other military advanced electronic systems and devices requires the following:

1 ELECTRICAL ENGINEERING AND PHYSICS GRADUATES to prepare operating, servicing and overhauling instructions for complex electronic equipment. Those with previous maintenance experience on military equipment preferred. Writers will participate in a three-month program in our technical training school to become familiar with the latest Hughes equipment prior to writing assignments.

2 ENGINEERS EXPERIENCED in the writing and preparation of maintenance manuals for electronic equipment or guided missiles. These specialists will work step-by-step with the people designing, developing and manufacturing the products involved. Experience in the writing of engineering reports is of value.

HOW TO APPLY

Write full details of your qualifications to

HUGHES

Research and Development Laboratories

SCIENTIFIC AND ENGINEERING STAFF
Culver City, Los Angeles County
California

Assurance is required that relocation of the applicant will not cause disruption of an urgent military project.

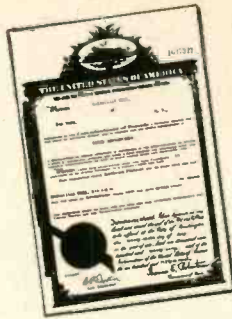

AUDIO PATENTS

RICHARD H. DORF*

ONE OF THE FEW points on which magnetic recording loses the argument to disc recording is the matter of cost. Using ordinary tape methods, the cost of tape for a recording of given length is much higher than the cost of a record blank for the same program content. This does not matter particularly when the taped material is kept only temporarily, but when one is building a library or retaining tape for record purposes, the cost is high. For that very reason the writer keeps high-quality disc recording equipment in addition to a magnetic recorder; once taped, the music is divided up appropriately and put on LP discs, after which the expensive tape is free for the next session.

Inventor Robert H. Dicke of Princeton, N. J., has come up with Patent No. 2,641,656, which covers a method of cutting down tape speed drastically and still retaining the wide frequency capabilities of conventional speeds. According to the specification, one typical embodiment of the invention will allow a tape speed of only 1 ips to record frequencies up to 9000 cps, for which conventional techniques require at least the standard 7.5 ips. While the system has certain apparent disadvantages such as a lower signal-to-noise ratio, the complications it adds do not seem great and the principle is most interesting.

The system is basically a method of converting all audio frequencies to lower frequencies by beating and then reconvert them in playback to their original values. The low beat frequencies can be recorded on the slow-moving tape. Unlike some other schemes, however, the action of this one is mechanical. It is both simpler and less susceptible to error than other similar ideas.

Figure 1 shows the assembly that does the job, consisting of a magnetic recording head of very special design including the rotating modulator. The U-shaped section of the head is more or less standard, made up of core laminations with a coil wound around the closed end. The pole pieces are

separated from the U-core by nonmagnetic spacers which create auxiliary air gaps. The pole pieces themselves are made of laminations, each separated from the rest by a nonmagnetic spacer. Thus when the tape passes over the portion of the pole pieces shown, a number of separate tracks are recorded on the tape equal to the number of pole-piece laminations, which is nine. The gap over which the tape passes is very small, as is customary.

The lower gap between the pole pieces is comparatively large. A special modulator cylinder is mounted as shown in Fig. 1.

Figure 2 shows how the modulator is built. It consists of three groups of toothed wheels, each group containing three identical wheels. The first three wheels have four teeth each, the second three have eight, and the last group 16. All are on a common shaft, and each wheel is separated from its neighbors by a lamination of nonmagnetic substance. The separations between wheels are so arranged that when the modulator is in position as shown in Fig. 1 each wheel coincides with a pair of pole-piece laminations. When a tooth of any wheel is in the correct position, it completes the magnetic circuit through the lower pole-piece gap between a pole-piece lamination on the left and one on the right.

Notice in Fig. 2 that the wheels in each group are so oriented that each wheel is displaced one-third of a tooth spacing—120 deg.—from the next one.

The two gaps in the pole pieces—one over which the tape passes and the other occupied by the modulator—are in parallel. For a given tape track (defined, you will recall, by one set of pole-piece laminations) the tape will be magnetized most strongly when the bottom gap of that set of laminations is not completed by a wheel tooth; it is magnetized least when the lower gap is filled with a wheel tooth, since the lowered reluctance of the lower gap bypasses more of the available field strength. The nonmagnetic laminations separating the pole pieces from the U-core emphasize this effect.

Now assume that the system is turned

* 255 W. 84th St., New York 24, N. Y.

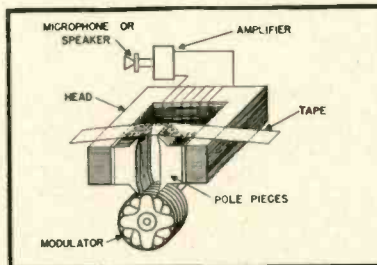

Fig. 1.

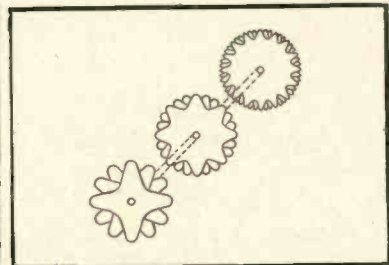

Fig. 2.

FAN FAIR!

CHICAGO

International Sight and Sound Exposition
and Audio Fair in Chicago

Room 705 Palmer House
September 1-23

For you who enjoy fine music at home, here is an opportunity not to be missed!

We cordially invite you to see and hear a special demonstration of Britain's finest music reproducing equipment. You will hear records played on the Garrard, world's finest record changer. You will see a brand new Garrard changer, a manual player and a transcription turntable. You will hear the new Leak "Point One" Vari-slope amplifier, and examine the unique cloth suspension of Wharfedale loudspeakers. You will also hear the remarkable performance of the tiny RJ enclosure, scarcely larger than the loudspeaker it houses. This combination has been enthusiastically applauded by thousands of critical listeners throughout the country.

Certainly, if you love music and want to have a genuine basis of comparison for your own purposes, you should avail yourself this once-in-a-year opportunity.

And the British Industries demonstration is only one of many high spots of the Sight and Sound Exposition! If you are anywhere near Chicago, be sure to come!

NEW YORK

Audio Fair—Audiorama 1953
Rooms 650, 652, 653 Hotel New Yorker
October 14-15-16-17

There are three British Industries Exhibits this year — and something of special interest in each one!

ROOM 653: A special demonstration of Garrard, world's finest record changers, Leak "Point One" amplifiers and Wharfedale loudspeakers. This will be personally supervised by two world-recognized British sound engineers, Harold J. Leak, designer and builder of Leak Amplifiers, and G. A. Briggs, engineer and manufacturer of Wharfedale Loudspeakers and author of many widely-acclaimed books on high fidelity. Mr. Leak and Mr. Briggs will be available to you in discussing the projects you may have in mind for your own home.

ROOM 652: A room devoted entirely to Garrard, showing in detail things you as a consumer should know about record changers. There are four new Garrard models, shown for the first time at the Fairs.

ROOM 650: The RJ Room - featuring a transparent RJ enclosure! Now you can see for yourself how the RJ is made and how it provides such remarkable performance, though small enough to fit an average living-room book shelf.



GARRARD

World's finest record changers and record players. See the new Model RC90, the greatest Garrard changer ever built, and the 301 transcription turntables, plus other new models.



LEAK

"Point One" amplifiers. See the new "Varislopa" pre-amplifier... the only pre-amp with this feature.



WHARFEDALE

Cloth-suspended loudspeakers. Single speakers with the range and brilliance of multi-speaker combinations.



RJ ENCLOSURES

Maximum bass... minimum space! Finest performance from any loudspeaker.

IF YOU CANNOT COME TO EITHER AUDIO FAIR... Send in the coupon for **FREE** literature especially prepared for these events. Our 24-page booklet, "Sound Craftsmanship" will bring the British Industries exhibits to you! Limited edition... write today.

BRITISH INDUSTRIES CORP., 164 DUANE STREET, NEW YORK 13, N. Y.

BRITISH INDUSTRIES CORP., 164 DUANE ST., NEW YORK 13, N. Y.

Please send my **FREE** copy of "Sound Craftsmanship."

Name.....

Address.....

City..... State..... AE-9

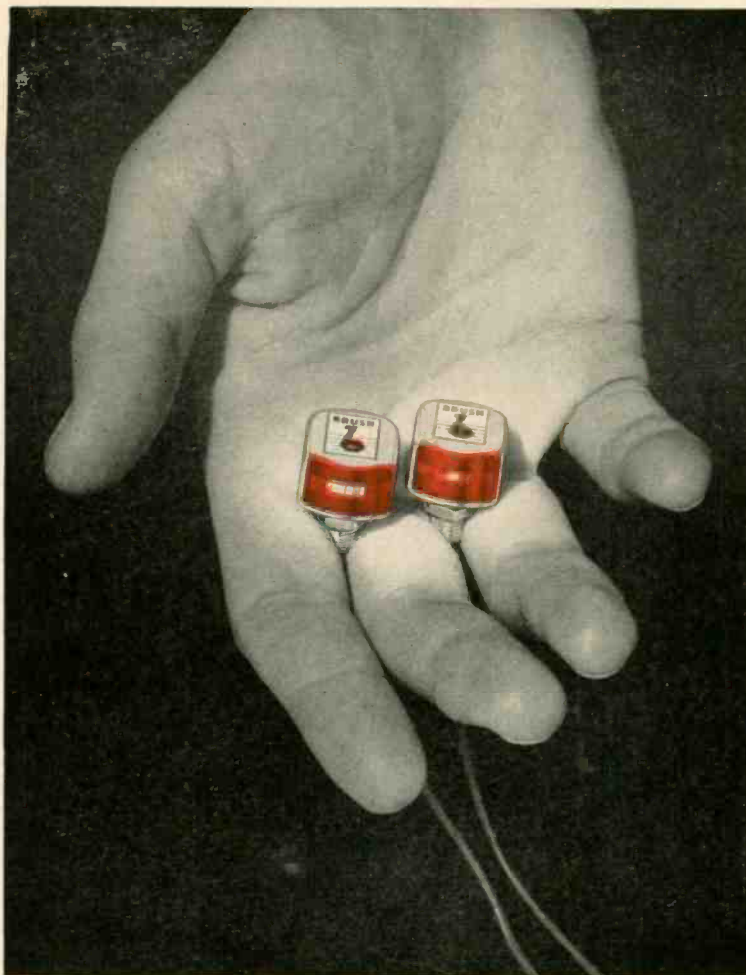

Meet the Redheads... tops for tape recording

See how the latest additions to the Brush family of magnetic recording components can improve your tape recorders!

The BK-1090 record-reproduce head has the standard track width designed for dual track recording on $\frac{1}{4}$ inch tape. It provides unusually high resolution and uniformity over an extended frequency range. Cast resin construction assures dimensional stability, minimizes moisture absorption, and affords freedom from microphonics. Its balanced magnetic construction, precision lapped gap, Mu-metal housing, and single-hole mounting provide important design advantages.

The BK-1110 erase head has the same basic construction as the companion record-reproduce unit. Its outstanding feature is its efficient erasing at low power consumption—less than $\frac{1}{2}$ voltampere.

Investigate these new "Redheads" for your magnetic recording. Your inquiries will receive the attention of capable engineers. Write Brush Electronics Company, Department ZZ-9, 3405 Perkins Avenue, Cleveland 14, Ohio.

BRUSH ELECTRONICS

INDUSTRIAL AND RESEARCH INSTRUMENTS
PIEZO-ELECTRIC MATERIALS • ACOUSTIC DEVICES
MAGNETIC RECORDING EQUIPMENT
ULTRASONIC EQUIPMENT



COMPANY

formerly
The Brush Development Co.
Brush Electronics Company
is an operating unit of
Clevite Corporation.

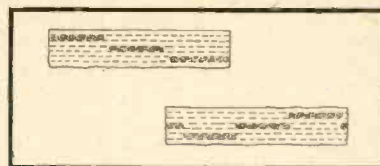

Above, Fig. 3; below, Fig. 4.

on and a constant (d.c.) current applied to the head coil. On any one tape track the magnetism left on the tape will vary from maximum to minimum every time a tooth of the corresponding rotating modulator wheel passes through the lower gap. If we assume that the modulator is so geared to the capstan motor that it rotates at a speed of 9000 r.p.m. or 150 r.p.s., magnetism of the three tracks coinciding with the four-toothed wheels will vary 600 times per second, of those opposite the 8-toothed wheels 1200 times per second, and of those against the 16-toothed wheels 2400 times each second.

The wheel teeth are so shaped that the variations are of sine form. Thus we have nine tracks, each now containing tones; the first three of 600, the second three of 1200, and the third three of 2400 cps. However, if the tape is now played back, either with an ordinary head or with this head minus the modulator, the total output will be zero at each frequency. The reason is that the outputs of all tracks combine. And because of the 120-deg. displacement of the wheels in each group, the three recorded tones for each frequency are of identical level and 120 deg. apart in phase. They cancel exactly, leaving nothing in the output.

Let us suppose, however, that instead of d.c. in the coil we have a tone of 1500 cps. This tone is modulated by the 600-cps wheels to produce 900- and 2100-cps beats, by the 1200-cps wheels to produce 300 and 2700-cps beats, and by the 2400-cps wheels to produce 900 and 3900-cps beats. It is these beats which are recorded on the various tracks. Specifically the difference rather than the sum beats are recorded, since it is assumed 1200 cps is the top frequency limit of the tape because of its slow speed.

Now suppose we play back the tape, with the modulator still running. The 900-cps recorded tone will combine with the 600-cps-wheel modulating frequency to produce either 300 or 1500 cps; the 300-cps tone with the 1200-cps wheel will produce 900 or 1500 cps; and the 900-cps tone with the 2400-cps wheel will produce 3300 or 1500 cps. In each case the original 1500-cps tone is reproduced. In addition, a second tone would be produced for each modulator frequency if there were only one wheel for each frequency. That is because, the playback being a re-beating process, sum and difference frequencies would both appear.

How the presence of three wheels per group corrects this ambiguity is not easy to understand, but the following explanation may clarify the operation. Each modulator frequency appears in three different phase relationships because of the three 120-deg.-displaced wheels. A frequency higher than the modulating frequency represents a case of advancing phase with respect to a constant-phase sine wave at the modulator frequency. A lower frequency is a case of continually lagging phase.

During the first third of the signal cycle it will produce the most magnetism on that one of the three tracks with whose modulation waveform it is most nearly in phase. Figure 3, for instance represents a piece

(Continued on page 74)



This brand new baseball glove, pre-oiled and deep-pocketed, needs no breaking in.



This new reel of SOUNDCRAFT Tape, Micro-Polished at the factory, needs no breaking in.

Now! a "Broken In" Tape

Exclusive SOUNDCRAFT Micro-Polished Tape
Gives Stable High Frequency Response right from the start*

In the past, all *new* reels of Magnetic Recording Tape had surface irregularities and protuberances (oxide nodules) on the ferrous oxide surface. These irregularities and nodules caused imperfect head contact and a subsequent loss in high frequency response, *until the tape surface was worn smooth by the recording head*. This is the reason for the widespread professional practice of "breaking in" a new reel of tape. This is why engineers run new tape through the recorder a number of times *before recording*, wasting time and effort, and causing undue wear of the recording head.

ONLY SOUNDCRAFT TAPE IS MICRO-POLISHED

There is no break-in period needed with SOUNDCRAFT Tape. *Because all SOUNDCRAFT Tape is Micro-Polished*. This exclusive process pre-conditions SOUNDCRAFT Tape *before it leaves the plant*. Micro-Polishing subjects the ferrous oxide coating

to high mechanical stresses. It produces a mirror-smooth tape surface. It achieves *immediate* stable high frequency response. And it allows new tape to be interspliced with tape that has already been used.

OTHER SOUNDCRAFT FEATURES

Not only is Soundcraft Recording Tape Micro-Polished, but it is also endowed with the following features developed by Soundcraft research engineers.

PRE-COATING to insure better adhesion, prevent curling and cupping —

DRY LUBRICATION to eliminate squeals —

SPLICE-FREE guarantee on all 1200' and 2500' reels.

Why settle for less than the best?

Next time, insist on Soundcraft Recording Tape. *It's Micro-Polished!*

REEVES
SOUNDCRAFT
CORP.

10 East 52nd St., Dept. B-9, N. Y. 22, N. Y.



*Pat. Applied For.

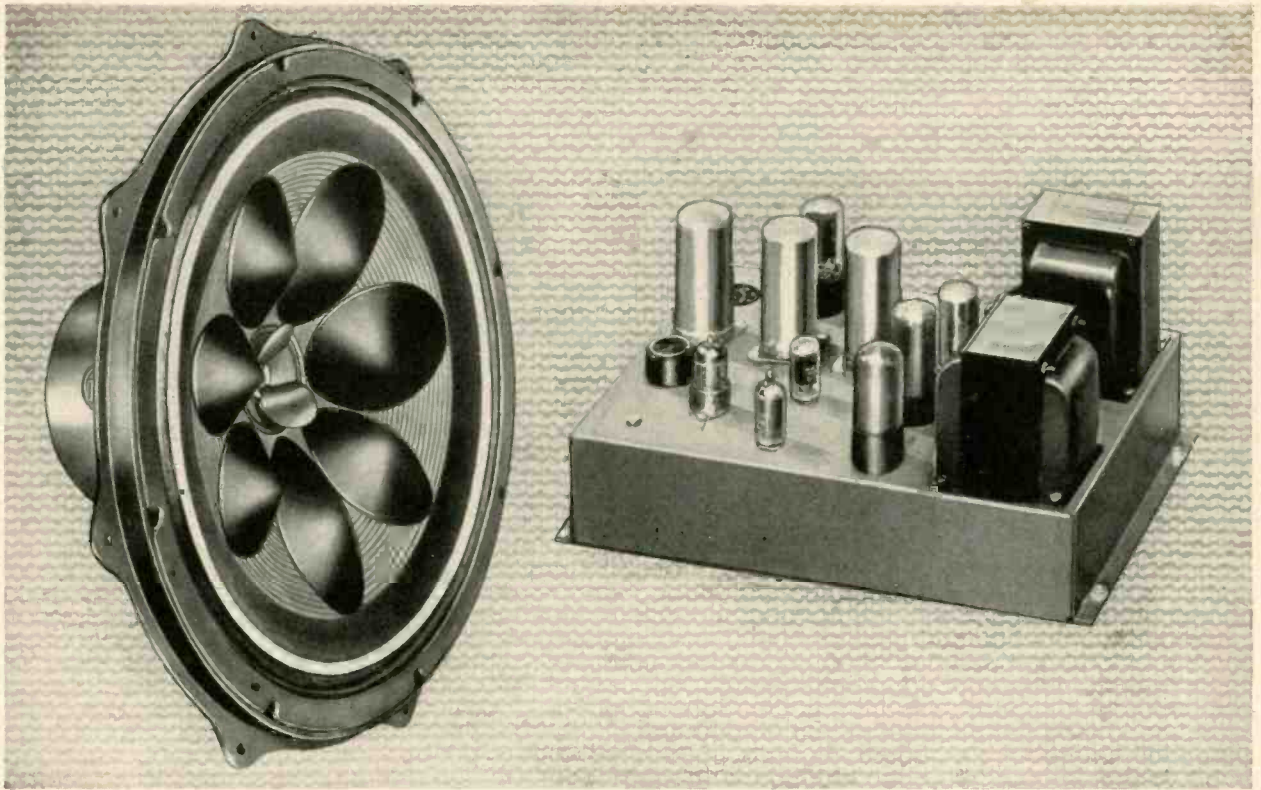

THE FAMED LC-1A SPEAKER—for years the measure of perfection among users of professional-quality equipment. Now, more brilliant than ever with RCA's

INTERMATCHED High-Fidelity—cleaner than ever with **ACOUSTIC DOMES** on low-frequency cone and **DISPERSION VANES** on high-frequency speaker.

DELUXE AMPLIFIER—designed and built to RCA's highest engineering standards—"power-proportioned" to the exact requirements of RCA

INTERMATCHED High-Fidelity equipment. An unusual combination of power and balance for the most discerning high-fidelity enthusiast.

RCA Intermatched

A new idea in Extended-Range Sound

NOW HEAR high-fidelity as you've never heard it before—the thrilling extended-range reproduction of RCA's new **INTERMATCHED High-Fidelity Systems**.

Here is truly fine reproduction at every price level. Here is a complete line of equipment designed *all the way through* to offer the finest in high-fidelity sound.

INTERMATCHED RCA High-Fidelity equipment offers you—for the first time ever—a wide selection of units designed to meet the music lover's needs. Intermatching lets you buy a fine—but reasonably priced—RCA system now, and progress to the finest—without fear of mismatching at

any stage. Or you can buy the finest now with the assurance that all components are engineered to work as a system.

RCA—with its great background in all phases of professional-quality sound—has built into its intermatched line a combination of thorough engineering and thorough understanding of good-music reproduction. Only RCA can offer you equipment so thoroughly intermatched that you can interconnect any RCA components you choose—merely by plugging one unit into another.

Now, ask your local RCA Electronics Distributor to let you hear true, high-fidelity through RCA's **INTERMATCHED High-Fidelity Systems**.

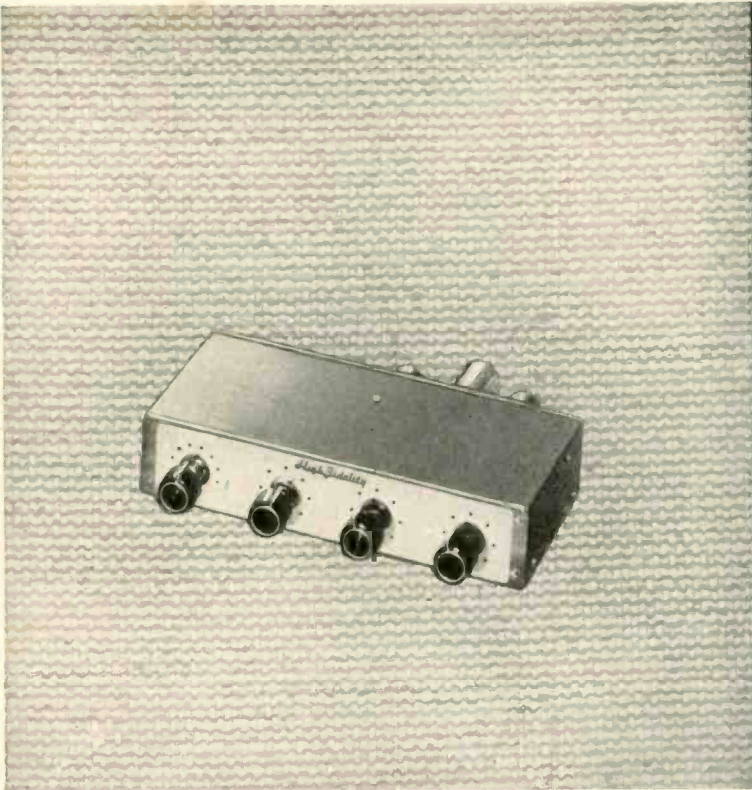

FULL-FUNCTION PRE-AMPLIFIER
—carefully engineered to match
RCA's DeLuxe 10- and 20-watt
amplifiers—wide-range pre-
amplification plus all controls

including equalization for four
types of recording characteristics
—four input selector positions—
volume control—bass and treble
controls.



RCA INTERMATCHED AM-FM TUNERS



RCA INTERMATCHED CHANGER



RCA INTERMATCHED SPEAKERS

High-Fidelity



RCA INTERMATCHED CABINETS

Fine furniture—fine, high-fidelity units—styled to the requirements
of RCA INTERMATCHED High-Fidelity Systems.

**FOR FULL DETAILS AND ADDRESS OF
YOUR LOCAL DISTRIBUTOR MAIL COUPON NOW**

RCA Engineering Products, Dept. 220U, Building 15-1, Camden, N.J.

- Please send me your new booklet on RCA Intermatched High-Fidelity Equipment.
- Please send me information on RCA Victor High-Fidelity "Victrola"® phonographs.

Name _____

Address _____

City _____ Zone _____ State _____



® Tmks.

RADIO CORPORATION OF AMERICA
ENGINEERING PRODUCTS DEPARTMENT,

CAMDEN, N. J.

new audio attenuator

TYPE 8514-B



SMOOTH
STRAIGHT-LINE
SLIDE-WIRE CONTROL

Write today for
Bulletin C-1025



CINEMA ENGINEERING CO.

DIVISION AEROVOX CORPORATION
1510 W. VERDUGO • BURBANK, CALIF.

IN NEW ENGLAND & UPPER N. Y.,
Samuel C. Hooker Co.
METROPOLITAN N. Y., Audio-Video Products
PHILADELPHIA, W. Henry Cordray
CLEVELAND, Edwards-Lohse Associates
MINNEAPOLIS, A. J. Warner Co.
SEATTLE, Jas. J. Backer Co.
DENVER, Dick Hyde Co.
N. CALIF., David Ross Co.
OTTAWA, CANADA, Samuel C. Hooker, Ltd.
EXPORT, Frazar & Hansen

LETTERS

Re: "High Fidelity"

SIR:

We liked Mr. Dickey's article "High Fidelity" (*Æ*, April, 1953) very much, and were especially interested in his remarks concerning the disappointment and frustration of some newcomers to the audio field. These same feelings have been expressed by quite a few members of the Audio Club (of Musicians and Music Lovers, Inc.). However, the interesting feature is that frequently the trouble is *not* due to too much high-pressure salesmanship.

These music lovers—who are *not* cranks with tin ears—have equipment which is the result of excellent engineering design and practice, and is functioning correctly. They choose their records carefully, use appropriate playback equalization, and are still unhappy with the tonal result.

Where, then, does the trouble lie?

Here is a partial list of possible sources: acoustical matching of speakers and enclosures, the acoustics of the room, the volume level, and the setting of the bass and treble controls.

The other areas pertaining to the ear which were listed by Mr. Dickey—variations in pitch with changes in intensity, etc.—we believe to be of minor importance. Of major importance are incorrect tonal balance, scale distortion, and single-point sound source.

We are thoroughly in accord with Mr. Dickey's conclusion: "If we are to reach the goal of having the recreated seem as the original, the listener alone can supply that final measure of understanding which must take over where techniques fail."

However, a basic requirement for this type of understanding is a musical experience which many music lovers do not have. This experience is acquired only through years of listening to the original, and for a while these music lovers will have to depend upon the professional musician. It is surprising how intelligent use of the volume and tone controls overcomes much of the disappointment and frustration mentioned above. The solution to the problem of reproducing a full symphony orchestra with a reasonable "illusion of reality" lies, we believe, in the direction of multiple speakers and channels.

DAVID MANKOVITZ and
FRED F. SALOMON,
Audio Club,
119 West 57th St.,
New York 19, N. Y.

It's Never Finished

SIR:

May I take this opportunity to disagree with Mr. Dorf's letter in the July issue. My answer, if published, would most emphatically be "You are never finished."

After reading Mr. Dorf's letter, I reviewed the articles in my file on improvement of home music systems. I was indeed surprised that this material was referred to as an "overabundance of riches." That to me is like calling all up-to-date medical literature superfluous—like saying let's use what we have had and used before, and the heck with any new-fangled ideas.

In my humble opinion, audio engineering

—like medical and other sciences—will always seek to improve, and the audio engineer, like the physician, will never consider any system finished. The owner of a home music system is a real enthusiast who always seeks and wants the finest. To tell him not to touch his system any more is paradoxical. For one who wants music in its true tone, free from the mental fatigue of intermodulation distortion and frequency discrimination, no trouble is too great in the search for any and all improvements.

I am disappointed that Mr. Dorf considers his system finished, since I have enjoyed his many tomes and treatises on what he calls "gimmicks." Certainly there is no greater satisfaction than the purchase and installation of a newly advertised gimmick which improves the performance of my music system. My own system will never be finished, and I shall look forward with continued eagerness to more stories on audio tricks and new product improvement.

It is my sincere hope that Mr. Dorf will not bury his head in the sand, but that he will continue to be a comrade to those of use who investigate every idea, gimmick, and trick which will make our home systems sound better and afford more enjoyment.

HOWARD MILLSTEIN, M.D.,
4489 Broadway,
New York 33, N. Y.

Recording Characteristics

SIR:

Whoever started this talk about "recording characteristics" and "curves" back as far as 1948 or 1949 should have kept quiet in the first place if such curves and characteristics were to be kept a secret, or if it does not make any difference in sound. If one's equipment were to be made flexible, why do some people insist that there was a difference with conforming to each company's curve?

And now there is (possibly) to be a change of the NARTB to the New Orthophonic. What a vicious circle! Why not forget curves if room conditions or microphone placement affects the kind of sound obtained? Why not go back to the simple way, just telling us all that "It didn't make a bit of sense about trying to standardize equalizers"?

If recording companies are afraid of giving away what they call secrets so we have no basis to go on, then I don't suppose their records are going to be enjoyed to their fullest.

F. T. HAYASHI,
235 Kuauiwi Ave.,
Wahiawa, Oahu, Hawaii

(*Æ's credo has always been, and still is: Provide sufficient flexibility, then adjust the controls until the reproduction is satisfactory to the listener.*)

Help Wanted

SIR:

As a regular reader of *Æ*, I send out a plea to other readers who might help me solve a serious problem. I am a collector of Operatic, Vocal, and Lieder recordings, ranging in date of manufacture from 1901

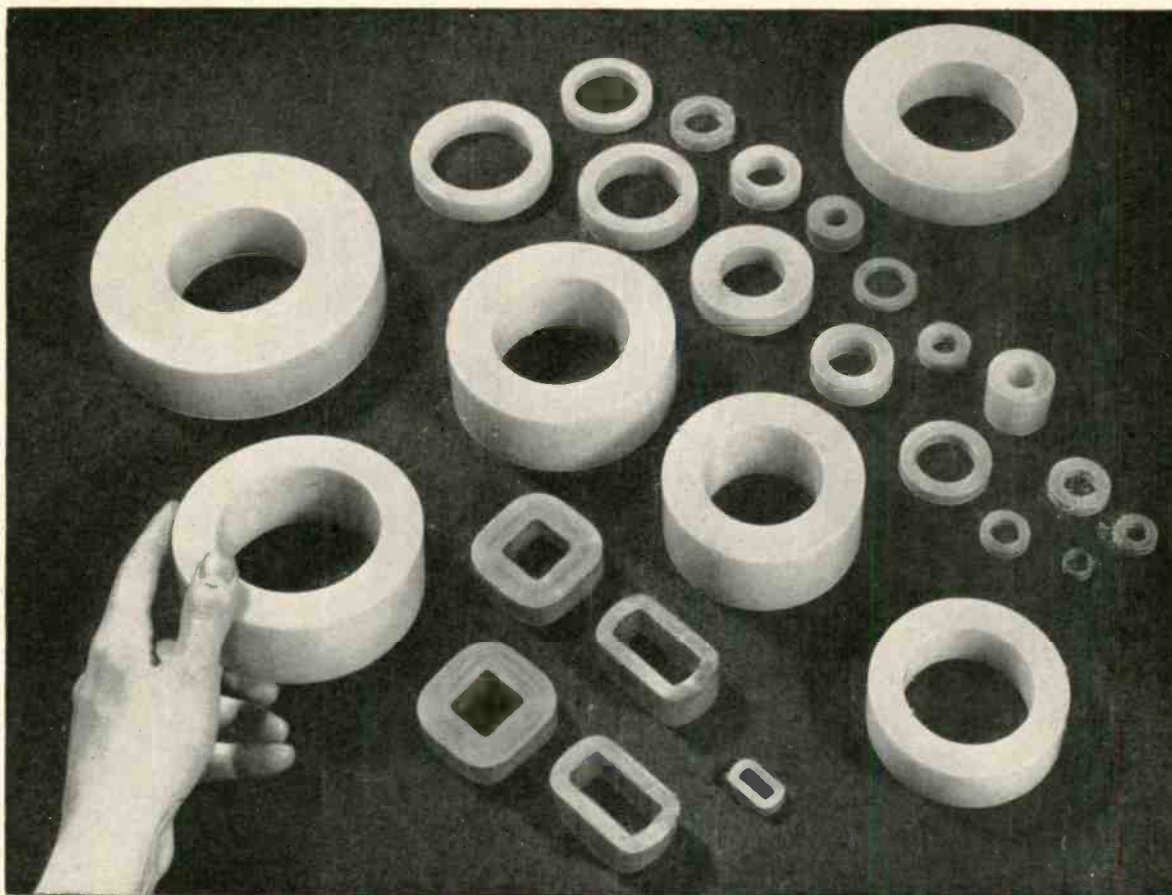

IN *TAPE-WOUND CORES* JUST NAME YOUR REQUIREMENTS!

RANGE OF MATERIALS

Depending upon the specific properties required by the application, Arnold Tape-Wound Cores are available made of DELTAMAX . . . 4-79 MO-PERMALLOY . . . SUPERMALLOY . . . MUMETAL . . . 4750 ELECTRICAL METAL . . . or SILECTRON (grain-oriented silicon steel).

RANGE OF SIZES

Practically any size Tape-Wound Core can be supplied, from a fraction of a gram to several hundred pounds in weight. Toroidal cores are made in twenty-two standard sizes with protective nylon cases. Special sizes of toroidal cores—and all cut cores, square or rectangular

cores—are manufactured to meet your individual requirements.

RANGE OF TYPES

In each of the magnetic materials named, Arnold Tape-Wound Cores are produced in the following standard tape thicknesses: .012", .008", .004", .002", .001", .0005", or .00025", as required.

Applications

Let us help with your problems of cores for Magnetic Amplifiers, Pulse Transformers, Current Transformers, Wide-Band Transformers, Non-Linear Retard Coils, Peaking Strips, Reactors, etc.

Address: ENG. DEPT. A

W&D 4613

THE ARNOLD ENGINEERING COMPANY



SUBSIDIARY OF ALLEGHENY LUDLUM STEEL CORPORATION

General Office & Plant: Marengo, Illinois

DISTRICT SALES OFFICES . . . Boston: 200 Berkeley St.

New York: 350 Fifth Ave.

Los Angeles: 3450 Wilshire Blvd.

Precision

Presents

YOUR PRODUCTION AT ITS BEST

CLOSE CHECK ON PROCESSING

Constant analyses and sampling of every processing operation is the function of this department. Sensitometric operations test the responses of raw stock emulsions; densitometry is employed to check on developing and printing results.



YOUR ASSURANCE OF BETTER 16mm PRINTS

16 Years Research and Specialization in every phase of 16mm processing, visual and aural. So organized and equipped that all Precision jobs are of the highest quality.

Individual Attention is given each film, each reel, each scene, each frame — through every phase of the complex business of processing — assuring you of the very best results.

Our Advanced Methods and our constant checking and adoption of up-to-the-minute techniques, plus new engineering principles and special machinery enable us to offer service unequalled anywhere!

Newest Facilities in the 16mm field are available to customers of Precision, including the most modern applications of electronics, chemistry, physics, optics, sensitometry and densitometry — including exclusive Maurer-designed equipment — your guarantee that only the best is yours at Precision!

Precision Film Laboratories — a division of J. A. Maurer, Inc., has 16 years of specialization in the 16mm field, consistently meets the latest demands for higher quality and speed.

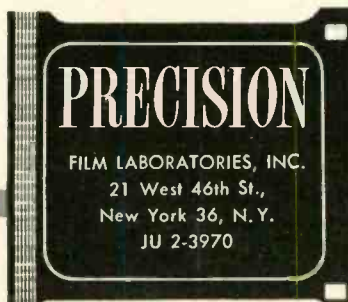

down to 1953. My collection includes such various types as the very early Zonophones, G & T's, Odeons, Gramophone Schallplatte, as well as more recent electrically recorded domestic and European 78's and all types of wide-range LP's.

I am using top-flight professional audio equipment throughout—1953 vintage—to play these discs. My one big stumbling block is the lack of a completely versatile front-end. Realizing that my problem is not unique, and that there must be in America alone several thousand collectors of old and new discs who are in the same dilemma, I hope this letter may find at least one person somewhere who has completely solved this problem.

KEMP BORDLEY,
43 Woodside Lane,
Arlington, Mass.

Balancing Tubes

SIR:

I agree with Mr. Fonseca that a Q & A department would be a valuable service to the readers of our magazine.

Situations arise which call for information that may be quite difficult for the average hobbyist to find. One instance of this is the "simple" replacement of tubes which must eventually fail. Several times I have seen reference made to the necessity for balancing output tubes, yet I have been unable to find any explanation of what this involves and I doubt very much if any local service man would know any more about it than I do.

Fortunately I have not yet had to replace tubes in my hi-fi equipment but I should like to be prepared for the situation when it arises and should appreciate any information you may care to give or any reference to where this information may be found.

ROBERT E. TINDALL,
315 N. Liberty St.,
Independence, Mo.

(A very good question, indeed, for a Q & A starter. We will answer this reader directly, and save his question for the November issue, which will have the first Q & A department. Balancing tubes in an amplifier which is not equipped with means for such balancing and which does not have provision for metering is quite a problem. Ed.)

COMING EVENTS

September 1-3—INTERNATIONAL SIGHT AND SOUND EXPOSITION, combined with the CHICAGO AUDIO FAIR. Palmer House, Chicago, Ill.

September 13-16—THE ELECTROCHEMICAL SOCIETY, INC., Sessions on corrosion, electrodeposition, and batteries. Ocean Terrace Hotel, Wrightsville Beach, N. C.

September 25-27—NORTHERN CALIFORNIA AUDIO SHOW. Palace Hotel, San Francisco.

October 14-17—Fifth Annual Convention of the AUDIO ENGINEERING SOCIETY, and THE AUDIO FAIR. Hotel New Yorker, New York City.

November 3-4—THIRD ANNUAL HIGH-FIDELITY CONFERENCE and AUDIO SHOW. Benjamin Franklin Hotel, Philadelphia.

8 db more output

with no increase in noise or harmonic distortion!

It's the new

REG. U.S. PAT. OFF.

SCOTCH

BRAND

Magnetic Tape

High  Output
TRADE MARK

AVAILABLE IN 300, 600, 1200, 2400
and 4800 foot lengths



High-Output and  TM 3M Co.

The term "SCOTCH" and the plaid design are registered trademarks for Sound Recording Tape made in U.S.A. by MINNESOTA MINING & MFG. CO., St. Paul 6, Minn.—also makers of "Scotch" Brand Pressure-Sensitive Tapes, "Underseal" Rubberized Coating, "Scotchlite" Reflective Sheeting, "Safety-Walk" Non-slip Surfacing, "3M" Abrasives, "3M" Adhesives. General Export: 122 E. 42nd St., New York 17, N.Y. In Canada: London, Ont., Can.



performance
Style
 ECONOMY

TURNER

GIVES YOU ALL THREE



THE TURNER

80

You get a dependable, versatile performer in the Turner 80. A crystal mike that takes PA, home recorder, dictating machine and amateur uses in its stride — *brilliantly*. And for smart, modern styling you can see for yourself that Turner is way ahead of the field. Look at those graceful lines, and that satin-chrome plated finish.

For PA use, you're seen as well as heard. The 80 measures just 4½ inches from stem to stern. Cradles in the palm of your hand. *All this* at a popular price! Yes, you get all three . . . performance, style, economy . . . in the Turner 80 microphone.

Sensitivity: Approx. 58 db below 1 volt/dyne/sq. cm.
 Response: 80 to 7000 cps
 Weight: 5 ounces less cable

Cable: 7 foot attached single conductor shielded cable.

Model 80 microphone
 List price—\$15.95

Model C-4 stand
 (illustrated with mike)
 List price—\$5.75

THE TURNER COMPANY
 929 17th St., N.E., Cedar Rapids, Iowa

In Canada: Canadian Marconi Co.,
 Toronto, Ont., and Branches
 Export: Ad Auriema, Inc.,
 89 Broad St., New York 4, N. Y.



BOOK REVIEWS

RADIOTRON DESIGNER'S HANDBOOK, Fourth Edition. F. Langford Smith, Editor. The Wireless Press, Australia, Publishers. Photolithographed in the U. S. A. by the Radio Corporation of America, 1953. xl+1482 pages, \$7.00.

Ten authors and twenty-three co-operating engineers have combined efforts to give us here not just another handbook, but a text treatise annotated with thousands of references to both book and periodical literature. Seemingly nothing has been omitted, and the copiousness of the references make this book essential for the engineering library of today. Some 38 chapters comprise the seven sections into which the text is divided, and the index is complete and well cross-referenced.

Naturally the opening section deals with vacuum tubes, their theory, physical make-up, performance-rating interpretation data, determination of non-published parameters, etc. A complete section on the testing of valves follows. The second section deals with network theory, components as such, transformers in theory and practice, wave motion and modulation, and inductor design and calculation. A thorough analysis of the problems and uses of inverse feedback, conditions for stability over multistage loops, and similar engineering problems make this a source manual for anyone designing amplifiers or similar electronics.

But it is the third section that will be of particular interest to *Æ* readers. In some 409 pages are crammed more audio data of a practical nature than has heretofore appeared in print in one book. While it is true that much material pertaining to audio design is found in other sections, this is the main center of interest in this volume. Every angle of voltage amplifier theory and design practice is covered with rich citations of reference material. Power amplifiers of all types are similarly discussed and analyzed, again with valuable reference data. The data is right up to the minute, with full treatment of such newer amplifier designs as Williamson, McIntosh, etc.

Fidelity and distortion and their many forms next come under examination. To this reviewer, however, the highlight of the audio section is chapter 15, "Tone Compensation and Tone Control." This should be required reading for every devotee of hi-fi equipment. Never before in one place has such a wealth of data appeared. Nor is the broadcast engineer slighted. Volume compressors, microphones, preamplifiers, attenuators, and mixers have all been dealt with in a scholarly manner. Speech clipping for channel space saving and communication system simplification as a whole is discussed.

Record reproduction and its attendant problems are covered with discussions of styli, recording characteristics, and the proper equipment for best reproduction. Particularly valuable is a comprehensive listing of all available commercial test records as to speed, content, and method of manufacture. Finally the loudspeaker and dividing network close this section.

Part 4 covers radio frequencies, from antenna types through all sections of the receiver right up to the transducer. Power supplies and filters comprise the next section, while Part 6 details design factors affecting the complete receiver.

Part 7 is a mass of tables, charts, and sundry data to which the laymen and engi-

(Continued on page 74)



An Ampex Automatic Station now in operation at KEAR in San Mateo, California. It sustains the evening programs on tapes prepared by the daytime staff.

Announcing

THE AMPEX AUTOMATIC STATION

a new concept in radio programming and operation

Now a 16 hour broadcast day can be handled by an 8 hour staff. Commercials and announcements for the full broadcast day can be pre-taped in fast succession and will be automatically cued to prepared program material.

AUTOMATIC CUEING

Your broadcast time can be sustained automatically by alternate operation of two Ampex 450 Continuous Tape Reproducers. One carries a program tape—the other has a tape with commercials and announcements. One stops—the other starts. It's "cued automatically" with sub-audible "trigger signals" recorded on the tapes themselves. And when desired both machines can be stopped and live programs, separate tapes or discs can still be broadcast in the conventional manner.

ELECTRONIC SPLICING

The announcer pre-records his announcements, pressing a button between each one to place the "trigger signal" on the tape. In effect he is putting the announcement in its proper place with a fast "electronic splice."

PRE-PLANNED PROGRAMS

Program tapes for use in your Ampex Automatic Station will contain the cueing signals. Selections and exact performance times are available to your program director for accurate integration with commercials and local announcements.

Sub-audible tones on each tape stop one machine and automatically start the other.

Write today for further information to Dept. B-1217A

AMPEX

MAGNETIC RECORDERS

AMPEX CORPORATION
934 CHARTER STREET, REDWOOD CITY, CALIFORNIA
Distributors in principal cities
In Canada: Canadian General Electric Company

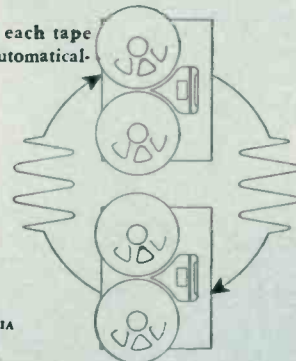

ultra-fidelity
ultra-utility with ultra-smart

"LIBRETTO"
remote control

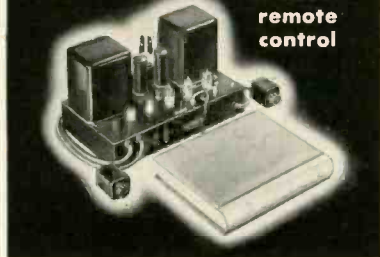

HEAR the difference, SEE the difference
in the **Rauland** model 1826
ultra-fidelity ensemble

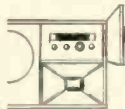

The proof of unprecedented superiority of the new RAULAND Ultra-Fidelity Ensemble is in its unmatched performance. That proof awaits you now at your Hi-Fi dealer. The Master Amplifier is of matchless quality. The unique self-powered "Libretto" Remote Control-Preamplifier, with its amazing flexibility, is an ingenious innovation. The laboratory tests are a revelation, but the ultimate proof of superiority is in the thrilling listening and operating experience.

The specifications summarized below can only hint of the quality of this new dimension in sound.



the master amplifier

A truly superb instrument with frequency response of ± 0.3 db, 20 to 40,000 cps at rated 20 watts output. Harmonic distortion less than 0.5% at rated output, less than 0.3% at 10 watts. Intermodulation distortion less than 0.4% at 1 watt (home level), 0.7% at rated output (measured at 60 and 7,000 cycles 4 to 1 ratio). Output imp., 8 and 16 ohms. 4-position input selector—for magnetic pickup, crystal pickup and 2 auxiliary. Dimensions: 14" x 9" x 8" high.



the LIBRETTO remote control

A true remote control, completely self-powered and capable of operation several hundred feet from amplifier. Uniquely fashioned in the form of a luxuriously bound book (only $8\frac{3}{4}$ x 11 x 2" thick). Backbone lifts to provide easy access to tuning controls. Operates flexibly in either horizontal or vertical positions.

CONTROL FUNCTIONS

1. 6-position crossover control (flat, 150, 300, 450, 700, 1000 cycles). 2. 6-position roll-off control (flat, -5, -8, -12, -16, -24 db at 10,000 cps). 3. Volume Control—instant choice of conventional control or loudness control. 4. Bass Tone, +24 db to -20 db at 20 cps (db calibrated). 5. Treble Tone, +18 db to -30 db at 10,000 cps (db calibrated).

Custom-Engineered, Custom-Styled
For Audio Connoisseurs

See the RAULAND 1826 Ultra-Fidelity ensemble at your Hi-Fi dealer, or write for full details.

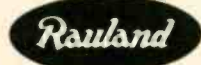

RAULAND-BORG CORPORATION
3515 W. Addison St., Dept. AD, Chicago 18, Ill.

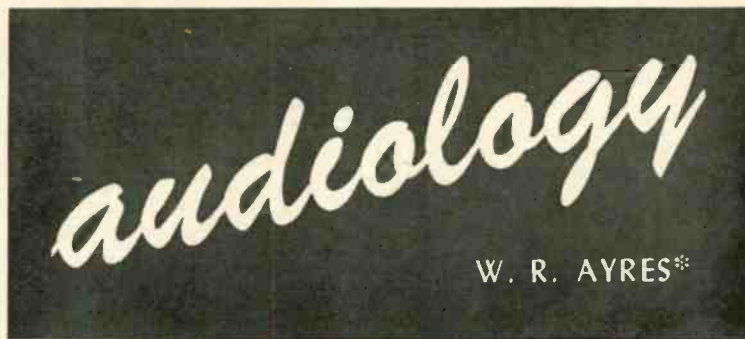

Stability Testing of Feedback Amplifiers

IT IS COMMON if unwise practice to blandly apply negative feedback and hope that no troubles will be encountered. Tests are often limited to simply noting the increased feedback permissible without causing oscillation, and sometimes this test is sufficient. However, with amplifiers employing secondary or tertiary feedback, the simple test is sometimes either invalid or applied only with difficulty. Furthermore, the situation may be greatly complicated when light or capacitive loads must be accommodated.

The requirements for stability in feedback amplifiers have been frequently quoted in the literature. Simply stated, the amplification around the feedback loop must be less than unity at the frequency or frequencies at which the phase relations are correct for oscillation. Exceptions to this rule have been analyzed in great detail, but would appear to be of little practical usefulness, and are not considered here.

To assure satisfactory stability in a production design, under the various conditions imposed by component and tube tolerances, etc., it is desirable to have a nominal amplitude margin of at least 6 db under the worst condition of output loading. This is for Class A or A_1 operation; for overbiased operation characteristic of more efficient power amplifier circuits, a yet higher nominal degree of amplitude margin is required for unconditional stability, as described below. A good phase margin of stability is 30 deg.; that is, the phase shift around the feedback loop at any frequency of unity gain or greater shall be at least 30 deg. different from that correct for oscillation. For circuits of the so-called minimum-phase-shift type, this corresponds simply to a rate of cutoff (around the loop) of no greater than 10 db per octave, at any frequency for which the loop gain is at least unity.

The proposition that a feedback amplifier is stable with any load if it is so with rated load, no load, and short-circuit load, can be a painfully erroneous assumption. Most oscillatory arrangements of either R-C or L-C form require one or more shunt reactances for their operation, and oscillations cease when one of these circuit elements is removed or changed to a value incompatible with the remainder of the loop. Oscillator forms assumed by unstable feedback amplifiers often conform to the same pattern, despite their relative complexity, oscillations simply not beginning until suitable reactive

load termination is connected. It follows that stability is not assured by the simple test of applying some arbitrary resistive load, and reducing a series feedback resistor to apply feedback in excess of normal.

The more difficult instability problems usually occur at frequencies above the audio band, and output transformer high-frequency characteristics are usually intimately associated therewith. While it could be that inductive amplifier termination would produce an oscillatory circuit, capacitive termination is more often the troublesome case. The thought that a loudspeaker voice coil is inductive at high audio frequencies is little consolation, however, since the speaker load is usually electrically self-resonant below frequencies at which amplifier instability troubles arise, and hence appears capacitive in the circumstances under consideration.

The basic method for loop tests is that of breaking the feedback loop in some convenient part of the circuit, injecting a signal of suitable magnitude, and noting the phase shift around the loop by the conventional oscilloscope method. The gain at each such frequency is simply the ratio of output and input voltages.

Primary-feedback amplifiers (any in which the feedback voltage is obtained from the primary side of the transformer) are usually stable regardless of the loading, while with secondary feedback capacitive loading usually represents the troublesome case. When the feedback voltage is derived from a tertiary winding, various loads must still be tried, because though the secondary winding is not ordinarily considered to be within the feedback loop, the primary-to-tertiary amplitude and phase characteristics are usually greatly influenced by the secondary current.

When the loop gain is relatively small (corresponding to only a small amount of feedback), conditions for oscillation (usually in the range of 20 to 500 kilocycles) may be fulfilled over only a narrow range of load capacitance; in fact, oscillation may not occur with any value of capacitive load. But when the loop gain is high (corresponding to a large amount of feedback), oscillations may persist over a wide range of load capacitance, the frequency or amplitude of oscillation simply changing with different capacitive loading. Obviously an amplifier which is stable with a small amount of feedback is sufficiently increased (high loop gain).

* RCA Victor, Camden, N. J.

(Continued on page 81)

Britain's
**GREAT
 CONTRIBUTION
 TO
 HIGH
 FIDELITY**

THE NEW
Collaro
 AUTOMATIC
3-SPEED RECORD CHANGER
 FOR 7, 10, AND 12 INCH RECORDS

Model 3/532 Intermixes
 10 and 12 inch records.
 List Price.....\$65.00
 Model 3/531 Non-intermix.
 List Price..... 54.50
 Model 3/534 Single record player.
 List Price..... 33.60

Available at radio parts jobbers,
 distributors, and hi-fi dealers.

It is more than coincidence that Britain and the United States both have gained distinction for accomplishment in the field of sound recording and reproduction. More likely, it is because of the common objectives and understanding shared by members of the great engineering fraternity on both sides of the Atlantic. Each has strived to score over the other, but with a characteristic sportsmanship in the interchange of know-how and experience.

Britain already has scored well with the Collaro record changer. In England and on the European continent, the Collaro is more widely used than any other record player in the world. Having won the acclaim of Europe's most discriminating audio devotees, Collaro record changers are now well on their way to repeating this experience in America.

The new Collaro record changers are truly a great contribution to high fidelity. Rumble, wow and flutter have been reduced to levels previously considered impossible in changer design. In all respects, the Collaro establishes a new standard of performance... and brings high fidelity reproduction a long way toward its ultimate goal of perfection.



Write for complete details to:

ROCKBAR CORPORATION
 211 EAST 37TH STREET, NEW YORK 16, N. Y.

EDITOR'S REPORT

"LET'S KEEP THE 'HIGH' IN 'HIGH FIDELITY'"

WITH THOSE WORDS as his opening statement, Leonard Carduner, President of British Industries Corporation, begins a personal campaign in keeping with the penultimate paragraph from this page in the August issue. We are heartily in accord, and the coincidence of Mr. Carduner's remark with our own sentiments is not particularly surprising in view of the offerings at the Music Industry Trade Show in July. Charles Fowler, editor of *High Fidelity*, comments similarly in the September-October issue of his magazine. And today's mail brings a copy of a flyer from The Dubblings Company of Long Island City decorated with a portrait of a Hyphithidiac—described as "a person affected with hypithiasis, a condition or state of affairs developing among audiophiles when, in spite of all efforts, his hi-fi equipment remains one step short of perfection."

Now these three items are not particularly related, but they do tend to show that the term "high fidelity" is—to put it mildly—sweeping the country. Many of us have been touting the term for years, always believing it to mean a *faithful* reproduction of music or speech with a minimum of distortion, and with adequate frequency range to transmit all the necessary intelligence required for true re-creation of the original program. We believe that if all home radio and music installations were of true high-fidelity characteristics, it would no longer be necessary for announcers to be constrained to spell such simple words as "whiz" or "vim." Perhaps, on hearing their transcribed messages on a \$19.95 radio set, these announcers feel that they do *not* enunciate properly, and that the fault is theirs.

Returning to Mr. Carduner's statement, he says further that "a small part of the public has already heard real hi-fi, with such enjoyment and enthusiasm that it has spread and is becoming a national hobby. Naturally, no one who has enjoyed high-fidelity sound could possibly be satisfied with less. Real high fidelity is what people want—not ordinary equipment named for promotional reasons to take advantage of the public demand." To which we say "Amen." Mr. Carduner concludes with: "The increased demand in the field (of hi-fi) has naturally brought on a resurgence of interest in home music listening equipment by commercial set manufacturers. This can be fine, and I am heartily in favor of it, if the sets produced are genuine. The phrase "high fidelity" itself means nothing. If it is distorted by poor product performance, people will lose interest and confidence in the entire field, to everyone's detriment."

The old timers in hi-fi will never be fooled—labeling a poor piece of equipment with two magic words will never keep it sold—although it may spur sales for a

time. Semi-hi-fi equipment may serve some purpose, over a long period, in that it may whet people's tastes for something better. But we do need definitions of what actually constitutes high-fidelity—a yardstick by which equipment can be measured accurately and conclusively.

A rose by any other name may smell as sweet, but when one applies the name *rose* to a well known striped-back animal, the latter does not thereafter affect the delightful scent of the American Beauty. We suggest, therefore, that we fall into the habit of calling only roses roses.

"THE REPRODUCTION OF SOUND"

That is the title of Edgar M. Villchur's fall course at N. Y. U. commencing on September 23 and extending to January 20, 1954. The material of the course is that covered by his currently appearing "Handbook of Sound Reproduction," augmented by his personal instruction. The classes are to be held on Wednesday evenings from 7:00 to 9:45 at the Division of General Education, New York University, at Washington Square in New York City. Registration for the course begins on September 9, and further information may be obtained from the Registrar.

ELGIN SEEKS ENTERPRISES

In an unusual approach, the Elgin National Watch Company recently announced that it is actively seeking companies in the electronics and precision instrument fields with a view of affiliation. At a recent press conference, J. G. Shennan, President, said that Elgin's prime motives are the need for higher return on capital and greater long-term stability. This does not presage a decrease in the demand for watches, but an expansion of watchmaking techniques to a field where such facilities might well be in demand.

We would be pleased to welcome Elgin into the electronics field—knowing full well that the company's integrity would soon develop it into a mainstay in the industry.

LARGEST TAPE RECORDING JOB

The largest tape recording job to come to our attention was recently completed by Audio and Video Recording Company, in New York. The job consisted of duplicating 10,769 copies of eleven different two-hour recordings—12,922,800 feet of magnetic sound tape—for Jehovah's Witnesses, whose conclave in Yankee Stadium was held during the week of July 20. To complete the massive recording operation, ten tape recorders worked continuously 24 hours per day, for eight days, turning out an average of 65 copies an hour, according to Charles E. Rynd, President of the company.

PICKERING

PROFESSIONAL AUDIO EQUIPMENT

BALANCED COMPONENTS / MAXIMIZE PLAYBACK PERFORMANCE

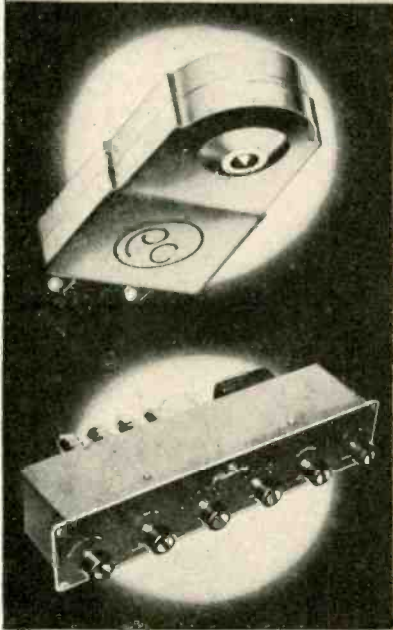

PICKERING CARTRIDGES . . .

are the choice of audio engineers throughout the world. They are universally acclaimed because of their high output, wide range performance and low distortion. They are used wherever a fine cartridge is required in radio stations, recording studios and for purposes of quality control by leading record manufacturers.

MODEL 410 AUDIO INPUT SYSTEM . . .

is designed to provide a complete audio control center. Model 410 may be used in any high quality playback system. Three input channels are provided—one for magnetic cartridges and 2 "flat" channels for other audio circuits. A 3-position equalizer network is built into the magnetic cartridge channel and provides accurate equalization for LP, AES and 78 rpm recording characteristics. Separate bass and treble controls are also provided. These are of the step-type and permit bass and treble adjustments in 2 db increments. The tone control circuits are intended to compensate for record characteristics and for listener-environment acoustical conditions. They are not intended to compensate for amplifier and/or loudspeaker deficiencies. Model 410 is intended for use with the highest quality professional type playback equipment. The output of the Model 410 is fed from a cathode-follower circuit and will work into any high quality audio or line amplifier having a high impedance input. It may also be used with a transformer for the purpose of feeding a 500 ohm line. Because of its flexibility, low noise and low distortion level, it is ideally suited for bridging and monitoring purposes and for critical listening applications.



THE MODEL 190 ARM . . .

Is designed primarily for use with microgroove records. Its design has been recognized by leading audio engineers as that which incorporates all of the desirable tracking characteristics. Analysis has shown that for maximum performance with LP records the vertical mass of the moving arm element must be held to a minimum and further, that the arm must be counterbalanced about the vertical axis. This permits minimum stylus or tracking force and provides maximum record life. The Model 190 Arm embodies these all important features necessary for proper microgroove record playback.



MODEL 230H EQUALIZER-PREAMPLIFIER . . .

is unique in its accuracy of equalization and frequency response. The intermodulation distortion is .2 per cent at normal output level. It is intended for use with high quality amplifiers having gain and tone controls. When used with the Pickering Model 132E Record Compensator the 230H is ideal for radio station and recording studio use and for applications requiring accurate low noise and distortion free playback.



MODEL 132E RECORD COMPENSATOR . . .

is designed to be used in conjunction with a magnetic cartridge preamplifier such as the Pickering 230H or any preamplifier which provides 6 db per octave bass boost. Six playback positions are incorporated:

- 1—European 78 rpm Records
- 2—Victor 45 rpm and Decca 78 rpm Records
- 3—No high frequency roll-off, 500 cycle turnover
- 4—All Capitol Records, new Victor 33 1/2, Audio Engineering Society Curve
- 5—Columbia, London and most LP Records
- 6—To remove the hiss from old noisy records

Precision elements are used in its construction to give accurate compensation. The 132E is inherently a low distortion R-C device.

PICKERING PROFESSIONAL AUDIO EQUIPMENT

"For those who can hear the difference"

... Demonstrated and sold by Leading Radio Parts Distributors everywhere.
For the one nearest you and for detailed literature, write Dept. A-2.



PICKERING and company incorporated • Oceanside, L.I., New York

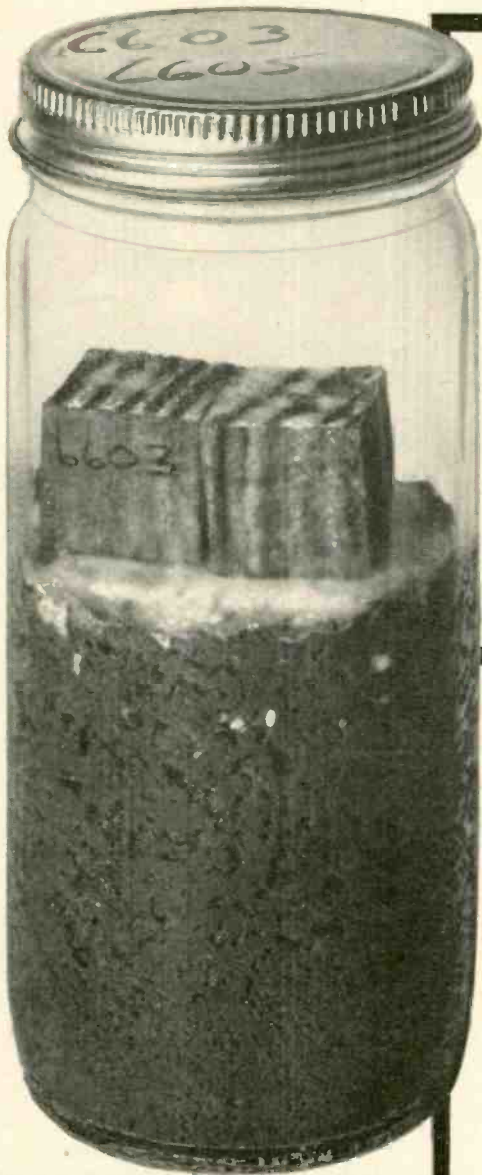

THIS BOTTLE TURNS SEVEN YEARS INTO SEVEN MONTHS

◀ Test blocks of pole wood are fed to destructive fungi in bottles like this at Bell Laboratories. Wood rests on soil which controls moisture conditions and promotes fungus growth. Test speeds search for better preservatives.

This year the Bell System is putting 800,000 new telephone poles into service. How effectively are they preserved against fungus attack and decay?

Once the only way to check a preservative was to plant treated wood specimens outdoors, then wait and see—for seven years at least. Now, with a new test devised in Bell Telephone Laboratories most of the answer can be obtained in seven months.

Cubes of wood are treated with preservatives, then enclosed in bottles with fungus of the most destructive kind, under temperature and humidity conditions that accelerate fungus activity. Success—or failure—of fungus attack on cubes soon reveals the best ways to preserve poles.

The new test has helped show how poles can be economically preserved for many years. It is another example of how Bell Telephone Laboratories works to keep down the cost of your telephone service.

A boring is taken from a pole section to see how far preservative has penetrated. For poles to last, it must penetrate deeply and be retained for a long time.



BELL TELEPHONE LABORATORIES

*Improving telephone service for America provides
careers for creative men in scientific and technical fields*

Organ for One-Finger Artists

RICHARD H. DORF*

Design ingenuity provides a wide variety of tones and combinations in a relatively simple instrument which can be played with a minimum of instruction and practice. The author describes the Chord Organ circuit by circuit.

THE HAMMOND INSTRUMENT COMPANY has an interesting history which not only includes being among the first to popularize the nonacoustic musical instrument but also emphasizes the unconventional. The Hammond organ with its drawbars and the Solovox with its original idea of a melody instrument for use with the piano are the most outstanding items; and the Novachord, with its complex combinations of effects, though no longer manufactured, is remembered with pleasure by many players and listeners.

The newest Hammond contribution is the Chord Organ shown in Fig. 1. Though it adds little to the art of music as such, it is designed as an instrument which can fulfill the dreams of many innately musical people who have not had the opportunity to learn to play normal instruments. The Chord Organ is primarily for one-finger artists and it gives them, with small practice, the ability to play full musical selections, complete with harmonies. To do this it resorts to more complexity than most electronic instruments (which are usually compound—having many similar circuits) but it is easy to understand and is so ingeniously designed that the Rube Goldberg aspect disappears after thorough examination.

What The Chord Organ Does

Examination of Fig. 1 shows that the organ has a 37-note key manual, a board

* Audio Consultant, 255 West 84th Street, New York 24, N. Y.

From the forthcoming book "Electronic Musical Instruments," published by Howard W. Sams & Co., Inc.



Fig. 2. The chord section is operated by 96 buttons, providing eight chords for each of the twelve keys in an octave.

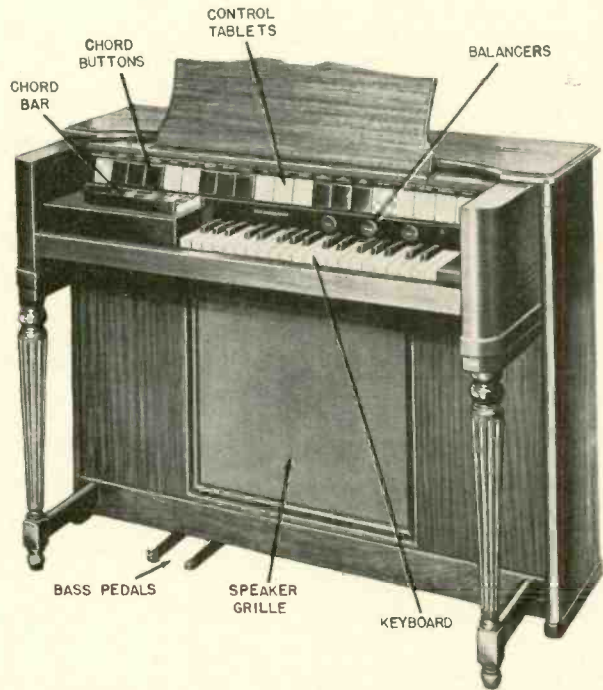

Fig. 1. The Hammond Chord Organ.

at the left with 96 buttons, a row of control tablets above the manual and buttons, and a pair of pedals.

There are four divisions. The solo division operates in the same manner as a Solovox: it is suitable for one-note-at-a-time melody playing using the keyboard Bass, tenor, and soprano tablets control the registers, somewhat as the 4-, 8-, and 16-ft. registers are selected in a normal organ. FAST ATTACK and ACCENT tablets give the solo tones a fast attack or a percussive quality. A WOODWINDS tablet gives a symmetrical waveform emphasizing odd harmonics. And DEEP TONE, FULL TONE, FIRST VOICE, SECOND VOICE, and BRILLIANT tablets give various tone colors.

The organ division, played on the same keyboard at the same time, gives polyphonic music—several notes simultaneously. STRINGS and FLUTES tablets are provided to call forth either quality or both together. Thus, when the manual alone is played with several notes simultaneously, the organ division is heard on all notes and the solo division on the top note only.

The chord division is the main distinguishing feature. Figure 2 is a close-up of the button board. When a single

button is pressed, a chord sounds. There are 96 buttons; for each of the twelve musical keys there are eight available chords—from minor 7th to major plus 6th, as shown in Fig. 3. Movable button caps are provided so that before playing a selection the chords which will be used may be marked with the caps to make recognition quicker. In Fig. 3, for instance, a typical selection in the key of C calls for F major (subdominant), G seventh (dominant seventh), D seventh (dominant seventh of dominant) and so on.

A SUSTAIN CANCEL tab is provided for the chord division. With the switch on,

	D ₇	A ₇	E ₇	B ₇	F	C	G	D	A	E	B	F ₇	
MAJOR + 6th	●	○	○	○	○	○	○	○	○	○	○	○	○
NINTH	○	○	○	○	○	○	○	○	○	○	○	○	○
MAJOR	○	○	○	○	○	○	○	○	○	○	○	○	○
MINOR	○	○	○	○	○	○	○	○	○	○	○	○	○
SEVENTH	○	○	○	○	○	○	○	○	○	○	○	○	○
DIMINISHED	○	○	○	○	○	○	○	○	○	○	○	○	○
AUGMENTED	○	○	○	○	○	○	○	○	○	○	○	○	○
MINOR 7th	○	○	○	○	○	○	○	○	○	○	○	○	○

Fig. 3. Numbered caps may be placed on the buttons to aid the beginner in selecting the proper chords for the key in which he is playing.

pushing a chord button brings in the chord at moderate volume; when the chord bar (see Fig. 1) is pressed at the same time with the palm or thumb, the chord gets louder. With the tab off the chord will not sound at all unless the chord bar is pressed. A MUTE tablet makes chords more "mellow".

The pedal division consists of the two pedals and a FAST DECAY tab. When the left pedal is pressed, a low-octave tone similar to the lowest note of the chord being played is heard; when the right pedal is played, the pedal tone is a fifth higher; the two give variety. The FAST DECAY tab makes the pedal tone disappear almost at once; without it, "the melody lingers on."

How The Organ Works

The block diagram of Fig. 4 gives an idea of what is in the organ behind the panelling, though the diagram is very much simplified. There are three separate generating systems, all using vacuum-tube oscillators. The solo and organ generators are controlled by the keyboard, after which the selected tones go to the tab controls, thence to a pair of volume controls called balancers, the amplifier, the expression control, and finally to the built-in speaker.

The chord generators are controlled by the chord buttons, the chord bar, and the pedals, as well as by the tabs. Chord-button tones have no balancer as they are fixed in relative level; pedal tones can be balanced as desired. In the following we shall describe the divisions separately, which will clear the cobwebs of complexity.

Solo Division

The solo division of the Chord Organ is really a complete Solovox. It is shown schematically in Fig. 5. V_1-V_2 is the oscillator, which is tuned over the range from F-349.2 cps to F-2794 cps. The tuning is done by the 37 tuning inductors, which are connected in series between the grid of V_1 and ground. When a key is pressed, a corresponding key contact connected between two of the series coils shorts the junction to the solo tuning bar, which is grounded. This reduces the net inductance between V_1 grid and ground, raising the oscillator frequency to that of the key. The lowest F has no tuning contact, since with all the inductors working the oscillator tunes to the low F. C_{2A} is the main tuning capacitor, while the two groups C_1 and C_2 , and C_7 and C_{12} are for coarse and fine tuning respectively. They tune the entire range, of course,

not the individual notes. The latter may be tuned by sliding the cores in and out of the inductors.

The oscillator rectifier V_{3a} creates the sharp positive pulse necessary for the driver, V_{3b} . The latter drives an aperiodic flip-flop circuit which reverses its condition once per pulse—once per oscillator cycle. Output taken from one side of the flip-flop is an almost square wave of frequency half that of the oscillator, or one octave below. The output of the first flip-flop frequency divider is taken from the plate of V_{4a} through R_{20} .

A second driver and flip-flop divider is driven by the output from the first, so that for each oscillator tone, there are three octavely related frequencies made available.

For each frequency there are two tones, a woodwind tone and a complex one. The highest-tone woodwind output is the cathode of oscillator V_{11} , a sine wave. The next two are square waves from the plates of one triode of each divider. The complex tones are taken from the plates of the rectifiers and driver stages. Waveforms are shown in Fig. 5.

The six outputs pass through modifying networks of resistors and capacitors to take some of the "edge" off the

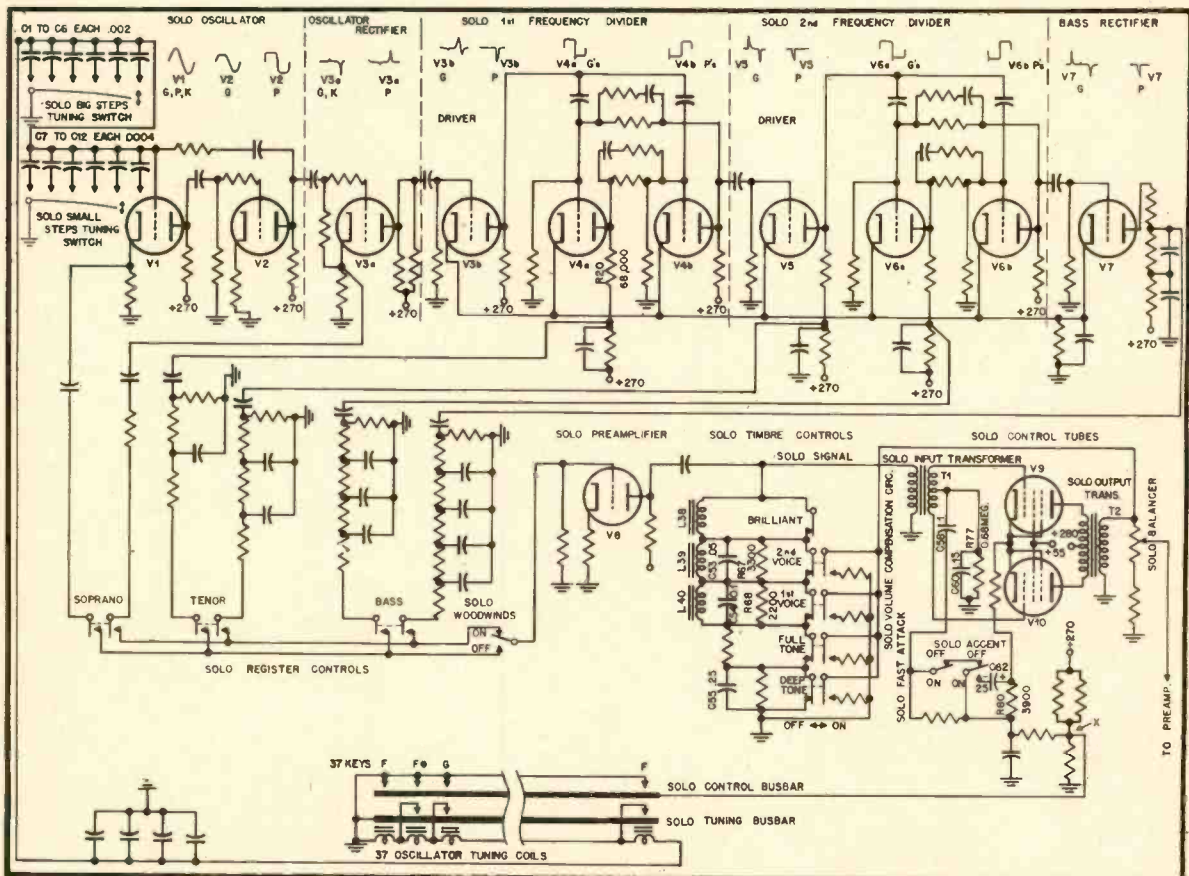

Fig. 5. Simplified schematic of the solo section showing the tone-forming circuits which follow the oscillator and the frequency-dividers.

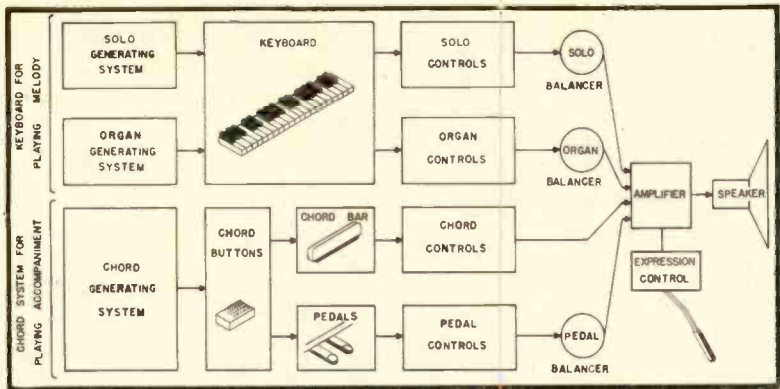

Fig. 4. Simplified block diagram showing the various sections of the instrument.

tones and make them more pleasing. The DPDT bass, tenor, and soprano controls switch the three registers as desired to the woodwind switch. With the latter on, the grid of solo preamplifier V_9 is connected to the woodwind modifying networks; when the tab switch is off, the more complex tone goes to the preamplifier grid.

The preamplifier plate circuit feeds a tone-color network containing five sections in series between the plate line and ground. Each section is normally shorted by a tab switch when the switch is in the nominal OFF position—contacts closed on one side. When, for example, the 1ST VOICE tab is placed in the ON position, the parallel combination of L_{40} , C_{55} , and R_{58} is placed across the signal line. This gives the tone a peak near 750 cps, imparting to it a horn-like quality. The 2ND VOICE section peaks at around 1,000 cps. DEEP TONE places a capacitor across the line to cut highs and make the tone more "mellow," while FULL TONE has only a resistor and gives flat response. BRILLIANT shunts the line with an inductor, reducing bass to give a rather piercing quality.

The solo control stage V_9 - V_{10} exists to allow control of the tonal attack. Normally the cathodes are at about plus 65 volts, obtained by voltage division from the 270-volt point shown in the diagram. This cuts off the stage. When any key is pressed, a solo control line connected to point X is shorted to ground by the solo control busbar under the keys and the key contact. This shorts the bias voltage to ground. With the switches in the position shown, C_{58} makes the attack fairly slow because a sudden decrease in the cathode voltage causes a negative surge through the capacitor, charges C_{60} negatively, and moves the grid in the negative direction, which remains until the charge on C_{60} leaks off through R_{77} . When the FAST ATTACK tab is operated its switch opens, disconnecting C_{58} . With the solo accent switch in the ON position, not only is C_{58} disconnected but C_{62} is connected across R_{89} . For the sudden decrease in cathode voltage caused by pressing a key, C_{62} effectively shorts the resistor and reduces the bias for an instant, causing the note to be loud at first and giving a rather percussive effect.

Output from the solo division is con-

trolled by a balancer potentiometer, the arm of which goes to the main organ preamplifier in common with outputs of the other divisions.

Chord and Pedal Divisions

Figure 6 shows the pedal and chord divisions, as well as the amplifier section, which is simple.

There are six chord oscillators, each tunable to two frequencies, making a full octave of twelve tones available. No chord has more than four notes and all use tones between F-174.6 and E-329.6 cps. The chord oscillators also supply the tones which pass through frequency dividers and give the pedal notes.

Each oscillator has four contacts, one associated with each of four busbars. When a contact is touched to the upper busbar the oscillator is moved down one-half tone by connecting a capacitor from the tap on the tuning inductor to the grounded bar. When a contact is touched to the second bar the oscillator plate output is connected to that bar. This second busbar carries the chord output signals.

The lower two busbars carry pedal output signals taken from the oscillators in the same way.

The chord actuating system is a mechanical assembly which cannot well be shown here. Each of the 96 buttons selects the right three or four notes for the chord and the correct two notes for the pedals. The notes are predetermined by the positions of small projections on 96 pivoted levers underneath the buttons. The projections press actuators to operate the required contact springs.

Let us take an example, say the button which creates the C-major chord consisting of C-E-G. When the button is pressed one lever projection actuates the contacts connecting the B-C oscillator to the chord signal busbar. (This oscillator need not be tuned since it is normally running at the frequency of

(Continued on page 68)

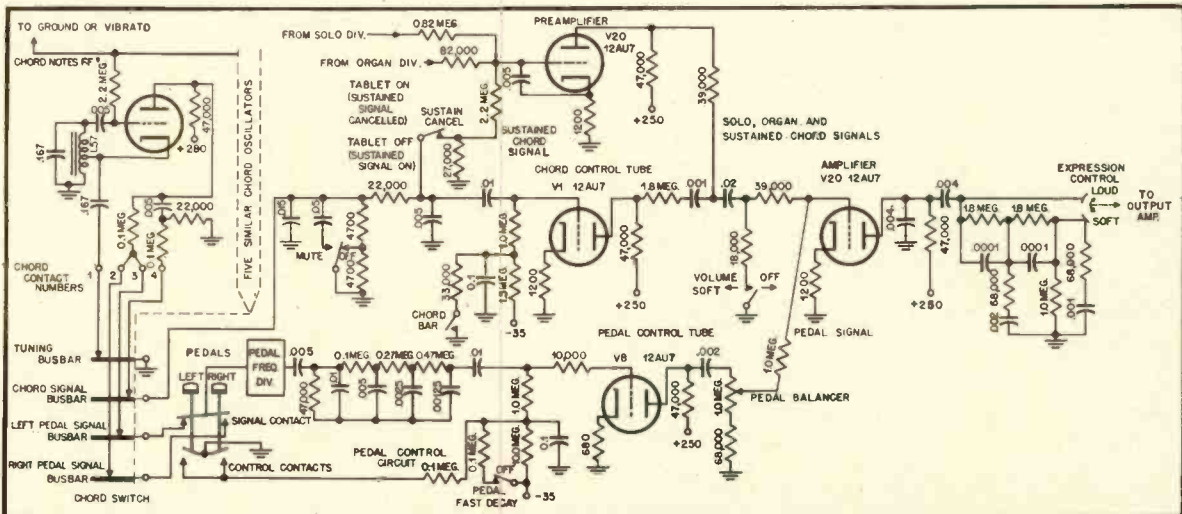

Fig. 6. Simplified schematic of the chord section and the combining circuits.

A Horn Enclosure for Custom Installations

ARNOLD J. GASSAN*

Construction details for a built-in horn-type loudspeaker which is not larger than the room in which it is to be used. The author covers the steps involved in the original concept, and describes the installation fully.

IN EXAMINING the types of horn-loaded loudspeaker enclosures presently available, certain *a-priori* assumptions were considered. The first of these is that a horn should be so constructed that it will radiate along an axis of 45 degrees from either of perpendicular walls. The second is that a horn constructed in this way will produce an optimum sound pattern for listening. In many cases the assumptions are justified. However, if the room in which the enclosure is used is considerably longer than it is wide, and the sound system is designed to provide pleasure for a small number of people, as it usually is, these

* 2176 S. Washington St., Denver 10, Colo.

assumptions are not necessarily valid. In the writer's home the assumptions certainly are *not* valid, for he has tried enclosures of the "corner" type, and they did not produce the results desired, perhaps because the listeners usually sat at one end of the room, as indicated at (A) in Fig. 1. From observation, it was decided that a horn radiating along the major axis of the room was more satisfactory, as indicated at (B). The same circumstances have been noted in certain custom installations—that the optimum radiation was along the major (or in an odd case, the minor) axis.

In certain cases there is a practical objection to the use of a conventional corner horn: it demands the availability of two walls which are clear for a dis-

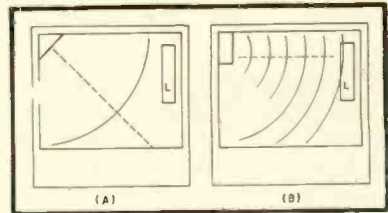

Fig. 1. Comparison between coverage of conventional corner enclosure (A) and the author's horn (B), which is designed to radiate primarily over the major axis of the listening room.

tance from the horn. In practice this is quite often impossible to obtain.

From experiments in the writer's home, and the observations made above, a decision was made to develop a horn utilizing one clear wall, and the junction of that wall with the floor. There were definite and pressing limitations on the expense of the prototype horn and its associated speakers, as well as limitations of the base area of the enclosure. The general limiting parameters were:

1. Width—not in excess of four feet.
2. Height—not more than eight feet.
3. Depth—little more than one foot.
4. Speakers—limited by what was on hand, or available at low cost.
5. Frequency—original design for two-way system, with provision for simple conversion to three-way.
6. Crossover—600 cps, for reasons discussed in text.
7. Horn frequency—60-cps theoretical cutoff.

The first two conditions were those imposed by the maximum size of standard plywood sheets. The depth of the unit was controlled by the proposed use of similar models in custom installations in new houses, where a horn could be built into one wall, as an integral part of the wall and a bookcase, where no floor space was to be used for enclosures. Because this horn began as an experiment, it seemed worthwhile to try certain other innovations, such as using an inexpensive speaker, especially treated, for the horn driver. Also, there was no attempt to provide an elaborate transition or coupling chamber between the speaker cone and the horn throat proper. In other words, there was a deliberate at-

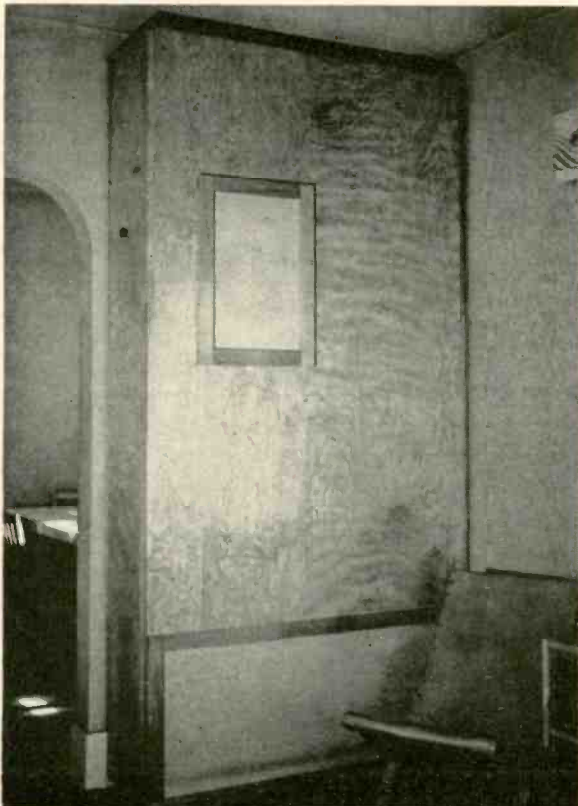

Fig. 2. Because of extending to the ceiling, the enclosure does not appear to be excessively large.

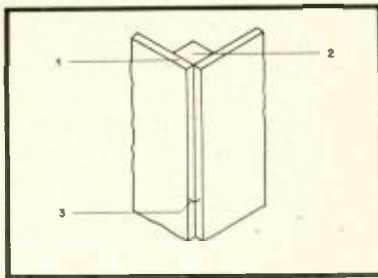

Fig. 5. Detail of corner construction.

tempt to find the limits of accuracy and design necessary in a straight horn, an attempt which could be afforded because the proposed structure made modifications comparatively simple. This would not be true in a conventional horn.

Crossover Frequency

The reason for using a 600-cps crossover is rather complex. It is the writer's opinion (and difficult to justify) that a folded horn with an axis rotation through 270 deg. should be used with a crossover of 200 cps. Operation with a crossover of 400 or 600 cps is not particularly good; there seem to be too many resonances, unpleasing to the ear, which develop in the second octave. Now whether these are due to the variations of rigidity in the cabinet, the use of one piece of wood as the wall of two sections of the horn, or the organ pipe resonances encouraged by the sharp bends necessary in a tightly folded horn, is not immediately apparent. One experimental horn the writer studied had definite organ-pipe resonance, wood resonance, and Helmholtz resonance. But, because the proposed horn would bend through only 90 deg., and be simply constructed and adequately back-loaded, it was felt that a standard 600-cps crossover network could be used.

The theoretical cut-off of the horn was set at 60 cps. The reasons are more easily justifiable than those for the crossover. The curve of a 60-cps horn is easy to plan; the horn can be of an effective length (approximately 6 feet) without having a mouth area the size of a wall. Practically, there is good radiation to 40 cps, with audible sound to 17 cps. Finally, considering the loudspeakers available, it was doubtful if any frequency lower than 40 cps could be expected.

Description of Horn

The horn structure itself is quite simple, as can be seen from Figs. 3 and 4. It consists of two parallel walls, the front and rear, 13 inches apart, and slightly over six feet long; a long straight narrow wall separating the front and rear walls; and a fourth wall which is an approximation of the curve necessary to provide an increasing area which is a function of an exponential curve. The computations for determining this curve have been discussed previously.¹

The horn is back-loaded, which does

¹ See *AUDIO ENGINEERING* for March, April, and October, 1952.

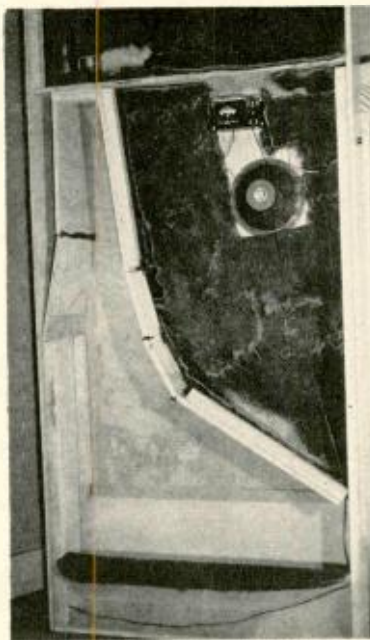

Fig. 6. Rear view of horn during construction, showing details of the horn and of the speaker and crossover network mounting.

create a loss of power. However, the adequate absorption of the back-wave removes the attendant difficulties immediately apparent when one realizes that in all horns using radiation from both the front and the rear of a single speaker, two identical frequencies issue from the same plane, and are not in phase. It would be interesting to see some work done on the shifts in radiation pattern and coincident reinforcements and cancellations of such horns.

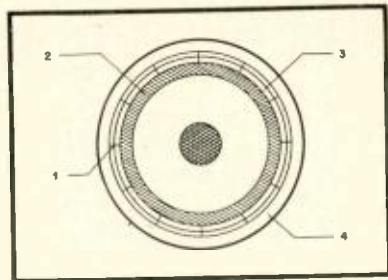

Fig. 7. Loudspeaker modifications: (1) Radial slits; (2) Cemented area; (3) Rim, treated with glycerol; (4) Supporting ring of speaker frame.

Also, the curves drawn of the frequency response of the entire unit indicate that the horn unit is quite efficient when compared to the treble unit.

Rather than try to hide the horn, considering it both as a prototype and—if it performed satisfactorily—as a permanent fixture in the writer's home, it was decided to make it an obvious piece of furniture, generally rectilinear in shape. The volume not used by either the horn or the back-loading space was used as an enclosure for the treble unit, in this case an Electro-Voice SP-12B. At the time the plans were drawn it was decided that the framework holding the grill cloth over the treble speaker would be large enough and so placed that a horn could be added later behind the same grill. In other words, the basic design is fairly flexible. Because of the position the horn would occupy in the home, birch veneer 3/4-in. plywood was used for the outer surfaces. The corners were left open, the plywood touching corners as shown in Fig. 5, and 3/4-in. square maple strips were glued into

(Continued on page 63)

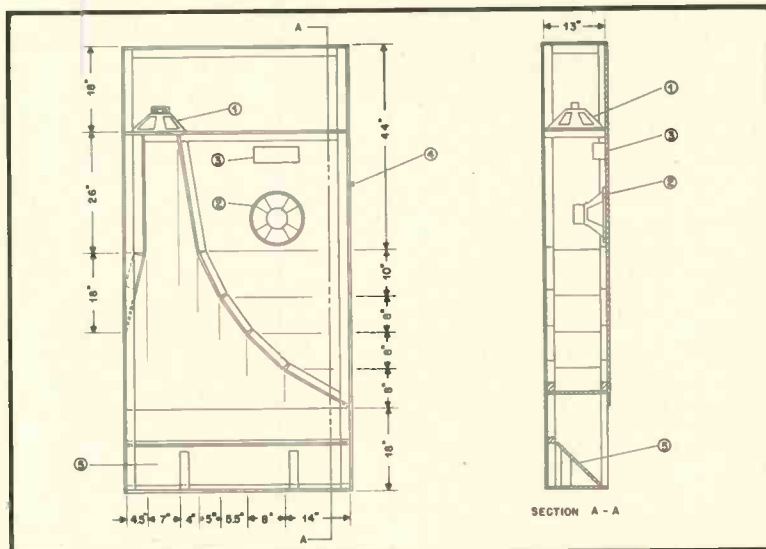

Fig. 3 (left). Construction of horn, viewed from the rear. Front and back could be interchanged to suit room shape and configuration. Fig. 4 (right). Cross-section through A-A. The numbers refer to the following parts: (1) Horn driver, an especially modified 12-in. speaker. (2) Treble unit; a tweeter can be mounted above or below it. (3) Crossover network. (4) Crossover network control pad. (5) Reflecting baffle.

The Dictating Machine— A Specialized Recording System

RICHARD M. SOMERS*

In two parts—Part II

UNTIL NOW, this report has been sufficiently objective to cover the dictation art as interpreted by the four major manufacturers.

From here on in, discussion is limited to the Edison Voicewriters, but it should be possible to obtain a good idea of the general manner in which problems peculiar to dictation recording are solved. At the present time, Edison is concentrating its sales efforts on two

different types of dictation systems, involving two recording units and one secretarial transcribing unit. Although both systems have been given considerable publicity, this is the first time the complete circuitry of each is being exposed to the critical eye of the technical reader.

For many years it has been recognized that a centralized system of dictation would be desirable. There are many reasons why such a system was so long delayed but hindsight indicates that only two were of any real importance; 1) lack of understanding of the

problem and 2) lack of equipment to carry out the program. The first was overcome by Operation Guinea Pig, wherein some 60 installations were made in one locality over a period of approximately 5 years. Each one differed from all the others and varied from standard telephones to practically complete recording machines at the dictator's desk. From these evolved the simple system in use today.

In order to understand the operation of the TeleVoice system, it is necessary to deviate for a moment and discuss some dictation habits. As mentioned

* Manager of Engineering, Ediphone Division, Thomas A. Edison, Inc.



Fig. 9. The TeleVoicewriter and related equipment: (A), recorder; (B), executive desk station; (C), alternate wall station; (E), secretarial start-stop-backspace control mounted on typewriter; (D), secretarial transcribing instrument; and (F), method of placing disc in recording position; (G), the recorder with the outer case removed.

previously, a dictator rarely listens back to his dictation except when he has been interrupted. Under these circumstances he listens only to the last sentence or so in order to obtain his trend of thought. Therefore, a remote dictating system must include a means to obtain this result. Further, as the system is used by many people, it is improper to permit one dictator to listen back to another's recorded dictation. Another problem is that while a dictator will indicate a length mark after each letter during a period of dictation, he usually fails to indicate the length of his last letter. This no doubt is due to the fact that he mentally finishes his work at the end of dictation and merely hangs up the microphone. Hence, it is advisable to make the last indication automatic.

A long study of dictating habits indicated that the average length of letter dictated was one and one-half minutes, and that the average number of letters dictated at any one time was two. Further, although the average dictation takes place at the rate of 100 words per minute, so that a dictating machine might take some 40,000 to 50,000 words a day, the actual number that can be fed into a system used by more than one individual is approximately 6,000-10,000 words, because of the possibility of collision between two dictators desiring to use the system simultaneously and to the large percentage of dictation time employed for thinking. Of course these figures do not hold for report writing and other special applications.

Early experience revealed that dictators were perfectly willing to wait one or two minutes for a machine but objected to longer waits. Although dictation equipment has been on the market for years, many people are still "mike shy" and welcome the introduction of a more familiar type of microphone—the standard telephone handset.

The above are some of the factors that determined the form of configuration of the system finally evolved. Fig. 9 shows the components of the TeleVoice System, in which (A) is the recorder, (B) the executive desk station, (C) the alternative executive wall station, (D) the secretary's transcribing instrument with (E) her start/stop and backspace controls. The disc record is shown as item (F). (G) shows the internal appearance of the recorder, while Fig. 10 shows the underside and the control base.

The recording is embossed on both sides of the 7-in. Vinyl plastic disc having a 1½-in. center hole. Although a band of only approximately 1½ in. is utilized on each side of the disc surface, one disc is sufficient for 36 minutes of recording. The disc revolves at 20 r.p.m. and is embossed at approximately 260 grooves per inch. The inside recording is at the rate of about 4 in. per sec. and the outside at 1.7 times this linear speed. The disc is mounted simply by raising the enclosure cover, slipping the disc in as far as it will go and lowering the cover. The turntable does not have the customary spindle, but in its place a centering cone is mounted on a shaft

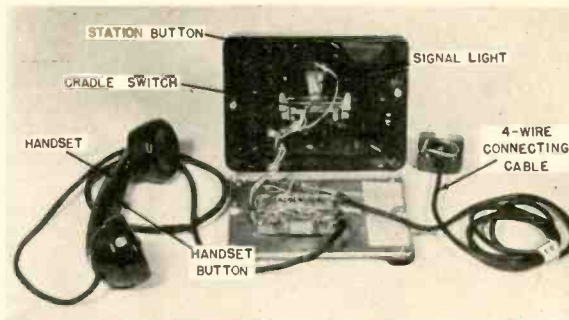

Fig. 11. Inside view of the executive desk station.

carried by the bridge over the turntable. This cone is actuated by the enclosure cover to center and clamp the disc to the turntable. Centering is accurately reproducible to within 0.001 inches—much better than that obtained on phonograph records.

The stations (Fig. 11) are modified telephone sets, employing the standard carbon button transmitter and magnetic receiver. The dictator can perform the functions of (1) seize the system; (2) start and stop; (3) signal correction; (4) signal end of dictation; and (5) play back a portion of the recording. Seizure is accomplished by removing the handset from the hanger. As basic TeleVoice is a party line system, the signal light is turned on in all stations by this act. Thus another dictator need not lift his handset to determine whether the line is busy or free.

The handset button controls start and stop, while the button on the station plays back the last 15 or 20 words. Pressing both buttons at the same time makes a correction hole in the index slip on the recorder. Hanging up the handset or momentarily depressing the hanger produces and end punch hole. The controls and the voice are transmitted over a 4-wire network to the centrally located recorder.

Usually the Transcribing and Recording instruments are placed close together so that one operator can handle both.

TeleVocewriter Electrical Circuits

Figure 12 is a complete schematic of the TeleVoice system which can be broken down into three units:

- a. The remote-control circuits, low-voltage power supply, and remote telephone-type stations;
- b. The mechanism—electro-mechanical devices to provide drive, start/stop, indexing (cueing), etc.; and
- c. The amplifier—including recorder and reproducer.

The telephone-type instruments which comprise the "business end" of this dictating system are connected in parallel by a four-wire network to the centrally located, low-voltage power supply. One pair carries the a.c. supply for the red warning "Busy" light on each remote station. Since the other pair carries the audio, the pairs must be individually twisted to maintain the hum below audibility. At the same time, the d.c. supply for the carbon button transmitter is used as the relay control current to reduce the number of wires required in the remote network.

The low-voltage d.c. supply of 45 volts is obtained through a step-down transformer T_3 and a full-wave selenium bridge rectifier CR_4 with associated filter. The relays in this circuit add appreciably to the filter system. When the handset is removed from the cradle at a remote location, the circuit is completed from this low voltage supply through 1500 d.c. relays, K_2 and K_3 , the primary of the input transformer T_1 , and a 680-ohm resistor across the transmitter and "talk" switch.

The resulting current of approximately 45 ma is sufficient to energize only relay K_3 , the contacts of which in

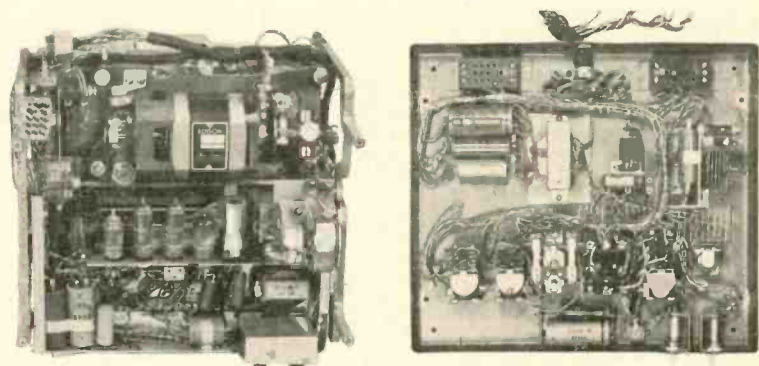

Fig. 10. Two views of the TeleVocewriter—(A), underside, showing amplifier and motor; and (B), the control base.

turn energize the "Busy" lights, start the motor and permit this dictator to seize the system.

When the dictator is ready to talk, he presses the handset button thus placing the carbon button (d.c. resistance approximately 50 ohms) in parallel with the 680-ohm resistor. This increases the current in the network to approximately 60 ma and energizes the second control relay K_2 , which operates the electro-magnet which engages the clutch and thus starts the turntable.

The playback relay K_2 , operated by the "listen" button on the station base is energized by the same low-voltage power supply, using one leg of the a.c. lamp circuit in conjunction with one leg of the audio circuit.

The playback relay operates the clutch magnet K_1 and the record-reproduce rotary solenoid K_7 . The discharge surge of a 40- μ f capacitor is used to overcome the high inertia of this unit, while a steady d.c. current keeps it energized.

The well shielded record-reproduce switch operated by the solenoid transfers both the input and the output circuits of the amplifier—the input from the transformer to the reproducer and the output from recorder to the remote audio lines.

When the equipment is set up for operation, both the recorder and reproducer are *on* the disc, although the reproducer is displaced in such a way as to trail the recorder by a preset number of grooves. Therefore, when a dictator listen back, both the recorder and reproducer continue to track—the former

embossing an unmodulated groove while the latter is picking up the last few sentences of dictation. The dictator can therefore stop listening back at any time and proceed with his dictation without the possibility of over-recording or the loss of dictation.

The cuing or indexing system is composed of two small coils mechanically coupled to the record-reproduce arm through a linkage which amplifies the motion of the record-reproduce arm by about 4 to 1, thus increasing the accuracy of the indexing system. The two indexing coils with brass pointed plungers are pulsed by the discharge of an 80 microfarad capacitor through relay contact combinations. De-energizing relay K_3 pulses the "Length" index coil L_3 (marking the end of the dictation) while energizing K_2 , K_4 and K_5 at once pulses the "Correction" or "Special Instruction" coil. The brass plungers in turn punch holes in a paper index slip.

System Set-up

For practical purposes the limiting factor on the number of stations per recorder is the total dictation workload emanating from these remote locations. The 6,000 words per day average figure which has been chosen as the result of an extended field analysis of the non-objectable waiting and collision times, limits the number of stations in the average installation to approximately ten.

The technical factor limiting the number of remote stations which may be connected to one central recorder, how-

ever, is the current available to light the "Busy" lights and in many cases this is the determining limit. This factor is a function of the transformer design, the requirements of a sufficiently bright, long-lived lamp and the voltage drop in the remote lines. The maximum secondary transformer rating—16 volts open circuit and 3 amps short-circuit—are more or less set by the electrical code requirements on low-voltage wiring. These factors result in the permissible maximum of 20 stations connected to one recorder.

In order to keep network wiring costs at a minimum, standard telephone type cables (#22 wire) may be employed in most cases. If, however, an exceptionally large number of stations or exceptionally long runs are encountered, the use of #18 wire can eliminate the voltage drop in the lines from consideration as a limiting factor in the installation.

Mechanically coupled to the drive system and the disc loading system of the TeleVocewriter itself are a series of warning devices which make incorrect setup and operation of the equipment practically impossible. A neon light in the plate circuit of one-half of a 12AU7 used as a multivibrator, flashes if the instrument is not correctly set up to receive dictation. When the multivibrator is operating due to faulty set-up, a warning relay K_6 is energized which in turn lights the remote "Busy" lights and injects a 60-cps hum, rich in harmonics, from across one leg of the bridge rectifier into the audio lines.

When a disc is on the turntable and

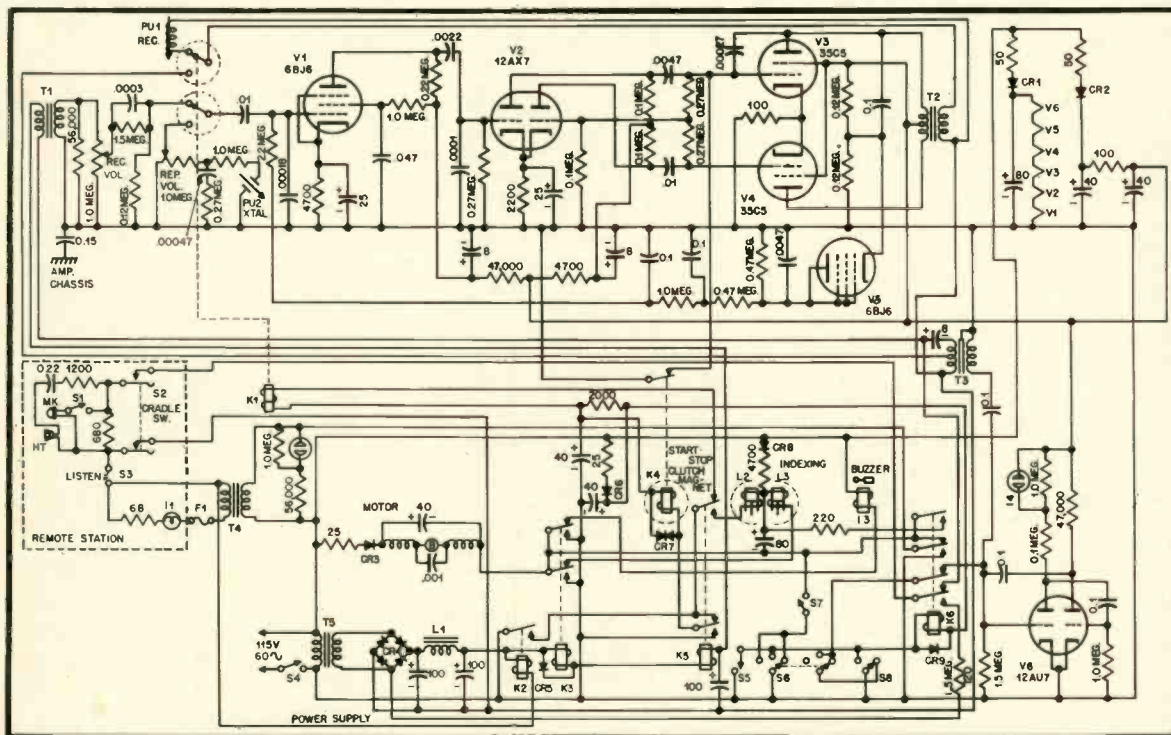

Fig. 12. Schematic of the TeleVocewriter, including amplifier, control circuits, and a remote station.

the recorder is on the disc, one grid of the multivibrator is grounded causing the light I_4 to glow constantly. At the same time, the warning relay K_6 is de-energized. These actions are all accomplished by mechanically operated switches linked to the front control lever, and the disc cover and centering cone.

As the recording arm and its associated control linkage is driven, it carries with it a series of trips which actuate various switches. The first of these switches, S_7 , has no effect upon operation until relay K_5 is de-energized by depressing the cradle switch on a remote station. It then completes a circuit through an a.c. buzzer I_3 which warns the attendant at the recorder that a disc exchange is necessary. The point at which S_7 operates can be preset, depending on the average length of dictation, to cause an automatic exchange insofar as the dictator is concerned. In effect, the disc will seldom be recorded to the end because anyone who hangs up in the period between the closing of S_7 and the end of the disc will automatically cause an exchange.

If, however, a dictator proceeds through this portion without hanging up and approaches the end of the disc, a second trip opens the grounded circuit of the multivibrator causing it to operate.

The pulses from this grid are fed into the audio system through an injection transformer and serve as a "tick" to signal the approaching end of the disc. This ticking sound does not interfere with the recording. Finally, if a dictator proceeds all the way to the end of the disc, the same trip closes the circuit to the warning relay K_6 which in turn injects the end tone (hum) into the audio system to signal that the end has been reached, sounds the warning buzzer I_3 and cuts out the first two control relays K_3 and K_6 .

The Amplifier

The audio amplifier in this instrument is a straightforward dual-purpose unit employing three resistance-capacitance coupled stages—a voltage amplifier, a phase inverter, and a push-pull output stage. Since the carbon buttons approximate constant-voltage devices (output voltage proportional to sound pressure, equal at all frequencies within their pass range), and since the magnetic recorder is a constant-velocity transducer (stylus motion proportional to frequency), the amplifier is designed with a substantial high boost. The result is a constant-amplitude recording. The playback head employs a PN crystal, which is amplitude operated. Therefore, the playback portion of the amplifier is flat in response. As the whole amplifier is used in both record and reproduce it is necessary to place the equalizing networks in the input circuit.

The output of this amplifier is coupled through a transformer either to a low-impedance magnetic recorder or to the remote audio lines by the record-reproduce switch. The high-impedance input is provided by a step-up transformer

Fig. 13. The VP Edison Voicewriter.

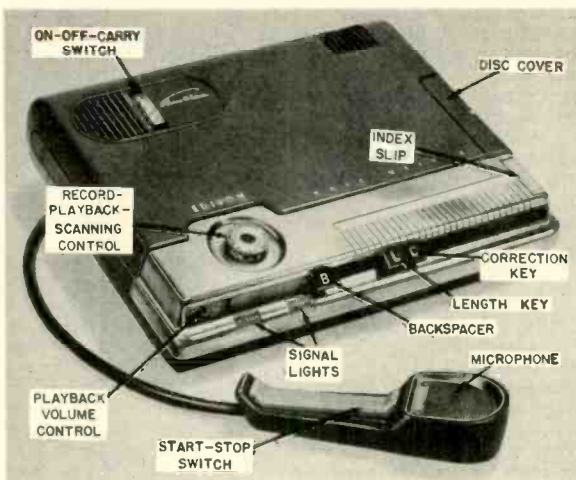

from the remote audio lines or the crystal reproducer directly.

Some a.v.c. action is necessary in this amplifier to compensate for variations in signal strength due to varying lengths of line or to different voice amplitudes. The 6BJ6 pentode connected as a diode provides this action. The bias for the a.v.c. circuit is preset by a voltage divider network across the plate supply to which the cathode of the a.v.c. tube is connected.

In order to prevent recorder chatter due to amplified noise when the equipment is in standby, a mute switch grounds the signal at the grid of the output tubes. This switch is mounted on the clutch magnet and opens when the clutch engages. This circuit is a refinement of an earlier model which provided muting by biasing the cathode circuit of the output tubes to cutoff, but the power output life of these tubes was adversely affected due to cathode poisoning. This same problem has been encountered in computer circuits.

Thus it can be seen that the Tele-Voice System provides simple, complete dictation facilities wherever instruments can be permanently set up. To complete the line of dictation equipment it was necessary to develop a more flexible instrument that could be readily moved around within the office and easily carried for dictation anywhere at anytime.

THE VP EDISON VOICEWRITER

Although a study of business work pattern revealed that 94 per cent of all instrument dictation took place within the office rather than at home or on the road, the public began to register its demand for one machine sturdy enough for daily desk use and light enough for comfortable carrying outside. In the long run, the customer gets what he wants. Early in 1950 Edison engineers—together with the eminent industrial stylist, Carl Otto—began shaping plans for the first truly portable dictating instrument in the history of the business. In this matter the original thinking seemed simple and sure. Since the one extra piece of equipment a businessman

never seems to mind carrying with him is his own brief case, the decision was made to produce a machine which could be slipped right into a standard letter-type case.

A large number of standard letter cases were purchased and it was found that a block of wood not greater than 2½ in. in height would readily go into all of them. The width and depth of the cases gave considerable latitude to the other two dimensions of the instrument. An interesting bit of history is that, by computing the average weight per cubic inch of a number of standard dictating machine components, such as motors, amplifiers, drive systems and so on, a weight expectation was arrived at which turned out to be within 2 pounds of the final machine.

With the important dimension determined, it was thought that the problem was solved until it was realized that there were a number of other items in recording equipment that determine whether or not it is really portable. Consider, for example, the recorder and reproducer styli. Tests indicated that it is not good common sense to have them bouncing around on the record while the instrument is being carried. This was solved by adding a third position to the ON-OFF switch—a CARRY position which locks up the recorder and reproducer. Another one that presented quite a problem was that the loudness with which most people talk is determined, not only by their own natural habits, but by the noise level surrounding them. Thus, a man will talk rather low in a quiet, soundproofed room, but the same individual will practically shout in a noisy room. This meant that the recording levels can not be readily preset, for one man in his travels will encounter all variations of ambient noise levels. To overcome this problem, a varistor-type peak clipper was developed which limits the recording level just below that which would tend to cause cut-over between grooves. Of course, when the limiter is working hard, some distortion is introduced, but for all normal ranges this is not noticeable and ap-

parently does not impair the results. An input range of some 60 db can be obtained for a single setting of the volume control. This covers the range from a relatively low voice to a rather loud shout.

The solution of some of the problems peculiar to portable equipment apparently improved the instrument for desk use. Electronic instruments carried about sometimes must operate from odd power sources through some type of conversion equipment, as for example when recording machines are used in automobiles. This is a common use for portable dictation equipment—many salesmen and investigators dictate their reports immediately upon returning to their cars. Thus it is desirable that the power requirements should be as low as possible. By employing a low-powered motor and increasing the efficiency of the recorder (which permitted the use of a low-power single-ended amplifier) the required power consumption was reduced from the previous minimum of 60 down to a value of 25 watts.

It is obvious that if the new instrument employs the same disc as other Edison instruments it can be much more readily integrated into existing systems. This has been accomplished, even though the disc now takes up a good portion of the total instrument area. Figure 13 gives a good view of the instrument and its microphone. In addition, a floor switch and a stethoscope-type hearing device are available to permit operation of the instrument for transcribing purposes. This feature of "combination" use is handy when traveling if, by chance, the user should find himself in an area where no Edison transcribing equipment is available or if the instrument is used by doctors, lawyers, or others whose dictation periods practically never correspond to transcription periods.

The new instrument is known as the VP Edison Voicewriter. Its low silhouette permits all controls to be approached and operated from the top

of the instrument. The ON-OFF-CARRY switch is located next to the air intake for the blower type cooling fan. This fan—more readily seen in Fig. 14—is used in spite of its power consumption, in order that the instrument will never reach temperatures on its outer case high enough to interfere with the packing of the instrument into brief case or suitcase with other articles immediately after dictation has been concluded.

Mounting of the plastic disc is essentially the same as on the Edison Tele-Voicewriter. The disc cover is raised, the disc slipped in against a curved stop, and the cover is lowered, bringing down a cone which automatically centers and clamps the disc.

A single knob called the 4-in-1 control handles all recording and playback operation. This includes positioning of the styli, movement of the styli to any point on the disc, and changeover of amplifier circuit from record to reproduce in two different ways. An innovation is the elimination of a neutral position in which both styli are raised off the disc by the user. Since a user will be either recording or playing back, the ability to move over the surface of the disc has been combined with the playback position.

With the control knob down, as shown in Fig. 13, the VP is ready to record. Both the diamond recording stylus and the sapphire playback stylus are on the disc with the reproducer head trailing the recorder head by a few grooves. The amplifier change-over switch, S_1 , in Fig. 15, is now set for recording. To obtain playback of the last sentence or so, the user turns the control knob to the right. This moves the S_1 to the reproduce position and the voice plays back through the hand microphone. Since the recorder stylus is still on the disc during this recall playback, unmodulated grooves are embossed. The control knob has a spring return bringing it back to recording position when released.

Lifting up the control knob fixes it

in reproduce position. This lifts the recorder stylus from the disc and puts the change-over switch in the reproduce position. In playback position it is possible to scan the reproducer head through any portion of the disc by rotating the control knob. This may be done while the turntable is turning in order to locate a particular part of the dictation. The relatively light reproducer stylus pressure does not damage the grooves.

Signal System

The signal system on the VP has been refined to give positive warning with minimum distraction. The on light glows continuously as long as the power is on. The TALK light is on only when the instrument is set up to record. If the control knob is not in recording position or a disc is not on the turntable or the disc compartment cover is not closed, the TALK light is out.

The dictator is warned of the approaching end of the disc by a ticking sound. This starts during the last minute of recording, and gradually increases in intensity until the end. This is accomplished by two little hammers alternately raised by a pin on the recorder carriage and dropped to hit the bottom cover.

At the end of the disc a switch is closed by the moving carriage, which stops the turntable (during recording only) and turns off the TALK light.

The indexing mechanism moves relative to the recorder-reproducer carriage through a gear and rack arrangement. The indexing mechanism and the CORRECTION and LENGTH buttons are driven by a cord which is pulled by a wheel attached to the gear rack, the other end of the cord being reeled onto a spring-loaded wheel. A 4-to-1 length amplification of the recorded band on the disc is obtained on the index slip. Pressing down on the "L" key for length of letter or the "C" key to indicate a correction perforates the index slip in the

(Continued on page 66)

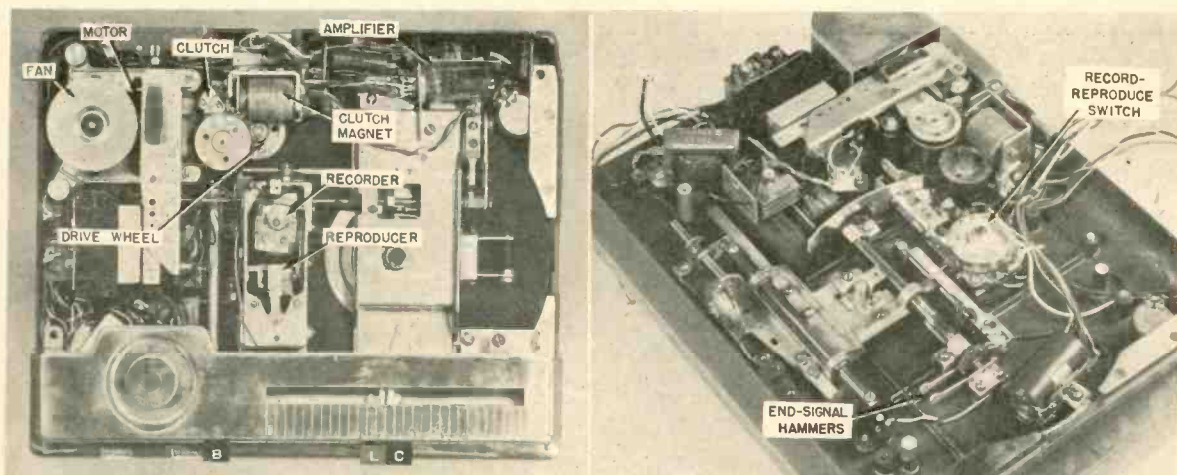

Fig. 14. The VP Voicewriter, (left) with cover removed, and (right) with turntable and front escutcheon removed to show drive and feed mechanism.

Flexible Tone Control Circuit

BASIL T. BARBER*

The advantages of variable inflection points in tone controls are well recognized, but the circuit complications and additional expense does not always justify their use. The author Americanizes a previously published circuit which is relatively simple.

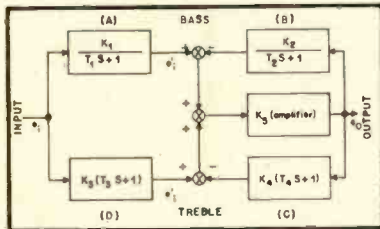

Fig. 1. Simplified block diagram of the tone control which employs negative feedback to provide variable inflection points. Idealized lead and lag networks are shown.

RECENT INVESTIGATIONS on the subject of tone controls indicate the desirability of having the transition frequencies variable, with the amount and direction of variation determined by the degree of boost or attenuation required.

The analysis and determination of the varying parameters and their range are arily covered in Mr. Villchur's article.¹ Most tone-control circuits available at present have a single transition frequency between 800 and 1000 cps, which remains essentially constant at any position of the controls and their flexibility and effectiveness is therefore limited.

A method of tone compensation is presented in this article offering a con-

* Research Engineer, Mass. Inst. of Technology, Cambridge 39, Mass.

¹ "The selection of tone-control parameters," *AUDIO ENGINEERING*, March, 1953.

tinuously variable transition frequency and a number of other advantages. The original article was written by P. J. Baxandall² and for a detailed explanation of the circuit the reader is referred to his article.

One way of looking at this circuit is to analyze it in terms of Laplace Transforms. Oversimplifying the original schematic, the circuit can be broken down into two lead and two lag networks, as shown in Fig. 1. The lead network (C), being inside a negative feedback loop, becomes a lag network and similarly the lag network (B) becomes a lead network.³ The net curve will therefore be either a boost or an attenuation, as shown in Fig. 2, depending on the relative position of the time constants T_a , T_b , T_c and T_d . When $T_a = T_b$ and $T_c = T_d$, the curves cancel each other producing a flat frequency response.

Figure 3 presents the tone-control circuit in detail. It is similar to the original circuit,⁴ but with parameters slightly modified to make the circuit adaptable to American tubes and components.

Figure 4 shows the actual frequency response of the schematic of Fig. 3. The low-frequency turnover is made variable from 800 to about 100 cps, depending on the degree of bass boost or attenuation required. The high-frequency turnover varies similarly from 1000 to 8000 cps, depending on the degree of treble boost or attenuation required. These curves

² *Wireless World*, October, 1952.

³ See Appendix.

⁴ Ref. 2, p. 404, Fig. 6.

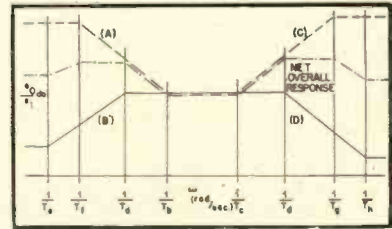

Fig. 2. Frequency response of the actual lead and lag networks of Fig. 1. B' and C' are curves B and C after feedback.

should therefore prove to be effective in compensating certain deficiencies of an audio system explained in Villchur's article. Specifically, "partial" speaker compensation can be accomplished without any boominess (especially on male voices), and without high-frequency distortion.

The circuit presented has, in addition, a number of other advantages which are equally important. In most tone-control circuits at present, the apparent boost is attained at the expense of an equal attenuation at the center frequency. An additional gain equal to the boost attainable must therefore be provided. In a "flat" position, there is unity gain plus all the distortion generated by the stage of amplification. In the proposed circuit, the loss is in the form of negative feedback with its associated advantages of reduction of distortion, impedance, and noise, and the increase of the linearity and frequency response of the circuit. For instance, if we assume that a boost

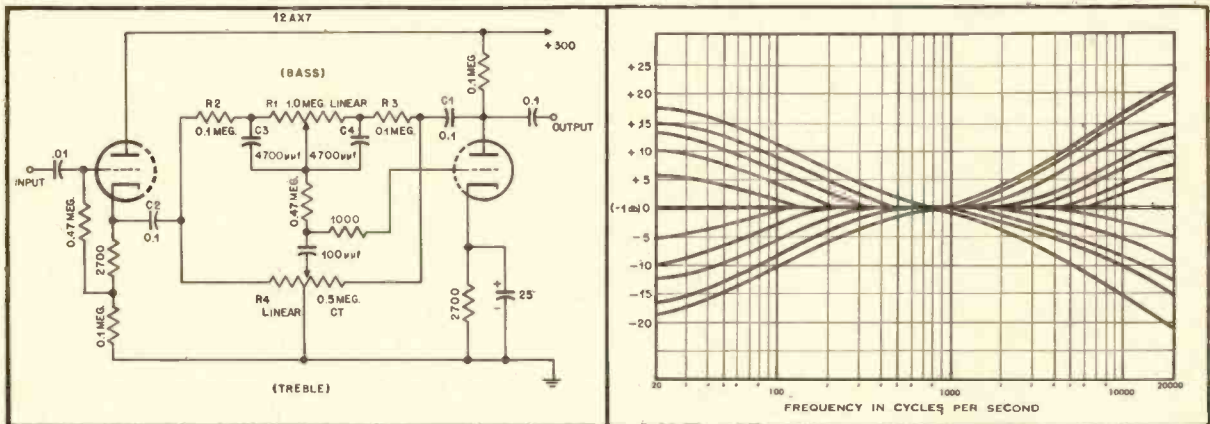

Fig. 3 (left). Over-all schematic of the circuit as modified for American tube types. Fig. 4 (right). Response curves obtainable with the feedback-type tone control.

A New Volume Visualizer

NORMAN PRISAMENT*

Utilizing a conventional oscilloscope as the indicator, a new driver unit provides instantaneous level readings which are made useful by incorporating a controllable delay circuit.



Typical studio application of the new volume visualizer, using a conventional scope as the indicator.

THE HISTORY OF THE RECORDING ART portrays a wide variety of methods for indicating the level at which the recording is being made, each one attempting to give the engineer a more reliable picture of the signal as it is fed to the recording apparatus—whether it be disc, film, tape, or wire. While standard VU meters are now in general use in broadcasting studios—and even in most recording plants—there is some reason to believe that the familiar VU meter is incapable of showing the true condition of the recording operation.

In the earliest days of broadcasting and recording, the meter used as a volume indicator had little damping and considerable overswing, but served quite well in the absence of other methods for indicating the signal intensity. One of the principal disadvantages of the early VI panel was that it occupied considerable space, but in addition it required its own power supply, and when extension

* *Reverend Company, Inc., 35-54 36th St., L.I.C., N.Y.*

meters were needed the leads to them were some 100 to 150 volts above d.c. ground potential. The tube-type volume indicator was superseded by the copper-oxide rectifier type of meter, which served quite well when used correctly. Recognizing the need for faster movements, the manufacturers developed the high-speed meter which responded to the signal with a minimum of delay and with low overshoot. The very speed of the movement, however, defeated its purpose to some extent, for the operator's eyes could hardly follow its movements.

Another type of high-speed volume indicator that was often used was an arrangement of neon lights, each being actuated so that it flashed at a given signal level. This instrument was somewhat complicated, difficult to maintain in adjustment, although it was fast and did provide an easily read indication.

In an attempt to give extremely high speed with some means to enable the operator to read the instrument easily, circuits were developed to permit a

meter to follow the initial transients of waveforms quickly but instead of returning to zero immediately, the pointer "floated" back slowly. With controllable delay this circuit was useful for recording because the meter tended to float along the peaks of the signal. Such instruments did not attain much popularity, and were generally displaced by the standard VU meter which was adopted by broadcast stations in an attempt to standardize level indications throughout large and widespread network operations. For its purpose, the VU meter is essentially satisfactory, but for many recording operations a faster indicator is more desirable.

Use of The Oscilloscope

Obviously, the inertia of a beam of electrons is considerably less than anything attainable with a mechanical meter movement. By its very speed, however, it becomes difficult to read easily, especially when simply connected to a signal circuit. Furthermore, since beam deflection is linear with respect to voltage, it does not give satisfactory scale with respect to db. This problem has been overcome in the new volume visualizer which connects between any circuit being monitored and a conventional oscilloscope. In the visualizer, the instantaneous level is shown by a deflection of the scope trace, and suitable delay circuits give the "floating" action necessary to make the indication easily readable. In the first form in which the instrument was made, the intensity of the signal is shown as a square pattern on the screen, with both vertical and horizontal deflections being equal. A zero signal is indicated by a spot in the center of the screen, and 100 per cent modulation would be shown by a square of light occupying the entire screen area—the deflection being approximately linear with respect to db. However, the circuit is so arranged that 50 per cent modulation can be indicated at any desired deflection from one half to three

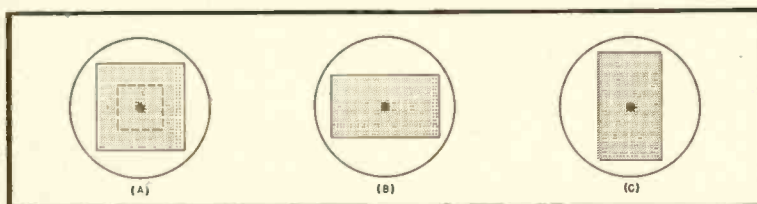

Fig. 1. (A) Typical pattern obtained with the Visualizer at 100 per cent modulation and the symmetrical presentation. The dotted line shows 50 per cent modulation, and the small dot at the center of the pattern indicates zero modulation. (B) and (C) Asymmetrical presentation for signals having differing polarities.



Fig. 2. Three rectangular c-r tubes arranged for presentation of level information on three channels simultaneously.

quarters of full screen area. *Figur. 1* shows three typical patterns.

If the instrument were to be used solely for measuring steady-state signal levels, nothing else would be required. However, in recording operations, it is desirable to have an indication which is easily readable by the engineer and the delay network makes this possible. A five-position switch selects various delay times so that the deflection can be made to follow the instantaneous value of the input voltage, or so that the pattern will expand quickly to maximum size and then recede slowly.

One other feature of the instrument is its ability to indicate polarity or phase of the signal. As is well known, most program material is composed of voltages which differ in magnitude on the positive and negative halves of the cycle. The signal is fed to two diode rectifiers which can be switched so as to control both amplifiers simultaneously, thus making both indications equal and proportional to the average of positive and negative peaks, or so as to control the two amplifiers independently. In this case, the pattern will appear as a vertical rectangle, for example, if the positive half cycle is the greater and as a horizontal rectangle if the negative half cycle is the greater. For certain types of recording, this feature is of considerable value, and it also offers some advantages to broadcast program monitoring.

In a more recent and simpler form, the Visualizer provides an indication in only one direction, being presented as a half-inch band of light varying in length in accordance with signal intensity. As a simple instrument for volume indication of only one channel, this permits the use of a rectangular-screen cathode ray tube, mounted horizontally so as to give a conventional indication from left to right. For stereo recording, using two or more channels, a number of these rectangular-screen tubes may be mounted side by side, as in *Fig. 2*, to permit easy observation of the level in each channel. Although the simpler system does not provide any indication of polarity, operation of a switch can select either positive or negative polarity, or the two may be averaged for the indication.

Basic Circuitry

The circuit of the instrument is relatively simple. Referring to the block schematic, *Fig. 3*, it will be seen that the signal is fed through an amplifier to two diode rectifiers, with a control voltage being developed across cathode-to-ground resistors and charging up two capacitors. The time constant of this circuit is controlled by the value of the resistors, which are adjustable.

The voltages developed across the capacitors are fed to the grids of two amplifier tubes through isolating resistors, and the outputs of two sine-wave oscillators are fed to the grids through capacitors. The oscillators operate in the vicinity of 50 kc, and differ in frequency by a slight amount to prevent interaction. The outputs of the two

Fig. 3. Block schematic of the Volume Visualizer in its original form.

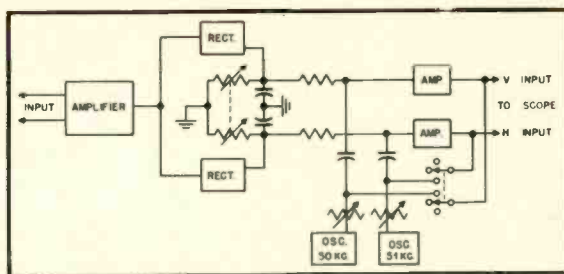

amplifier stages are fed to vertical and horizontal inputs of a conventional 'scope. Controls are provided for adjustment of operating conditions, such as audio buss level, pattern desired, delay recession time, etc.

Figure 4 shows the complete schematic of the original instrument. The input amplifier consists of two cascaded stages, using a 6SL7 and employing 20 db of feedback. The output of the second stage is transformer coupled to the two diodes, and the switch S_2 selects the cathode resistors to control delay. Switch S_1 connects the two cathodes together for symmetrical indication of phase or signal polarity, being left open for asymmetrical patterns. V_4 and V_5 are the two oscillators, arranged so as to permit adjustment of frequency so they do not interlock and cause pattern abnormalities. The outputs of the two oscillators are adjustable by R_9 and R_{22} . Switch S_3 permits either oscillator to be fed directly to the 'scope to provide a single-dimensioned pattern such

as those of (B) and (C) in *Fig. 1*. Both oscillators are normally coupled to the grids of V_3 , and the amplification of the two sections of V_3 are independently controlled by the diode voltage. Thus the signal fed to the 'scope is proportional to the input voltage, giving the pattern described. The instrument is powered by a conventional supply followed by a voltage regulator tube, V_7 .

When used as a single-dimension driver, the instrument is simplified by the elimination of one of the control circuits and by operating one of the oscillators at a lower output level to provide the half-inch band of the pattern. When used with a stereo system, only one pair of oscillators is required since all the controlled amplifiers can be supplied by one and all the band-deflecting circuits can be supplied by the other. Thus the size and cost of a multichannel indicator is not in direct proportion to the number of channels. *Figures 5* and *6* show the instrument from front

(Continued on page 77)

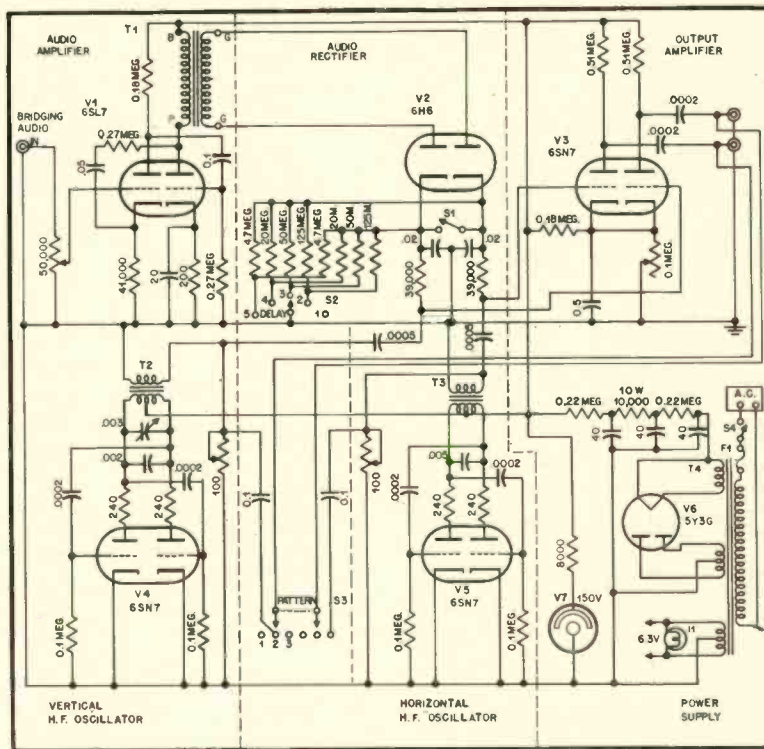

Fig. 4. Complete schematic of the cathode-ray Volume Visualizer.

The Case For Music

J. H. THOMSON*

The author suggests that the installation of high-quality audio equipment is not, of itself, the last step for full music enjoyment. Perhaps his opinions have considerable merit.

HAVE YOU HEARD some of the phonographs owned by music teachers? In schools and colleges, teachers of music literature, theory, instruments and voice usually have phonographs, of some kind, for demonstration or study purposes. In general, the quality of the music reproduction is terrible. There are good ones, and the number of good ones is increasing, but in the decade between 1940 and 1950 most of them were very poor. They used heavy crystal pickups and replaceable needs which wore the records badly, and after several years, the sound that came out of the speakers was, in every sense, terrible.

These people live from day to day with music. They work with it, and with people making it, and for the most part, they love it. The thought of losing interest in it never seriously occurs to them. The winters are spent teaching music, going to concerts, singing in church choirs, or playing in ensembles or orchestras. The summers are spent often at music camps, festivals or at summer sessions of music schools. These people know a great deal about music. They know about the lives and times of the composers, they know about the theory and notation of music, and they know about instruments, players, singers, and conductors involved in various compositions and performances. Most of them have studied music for ten years, and some for twenty or thirty or more. Their enthusiasm for music would no more die than the average person's enthusiasm for food.

Have you ever known of a situation similar to the following one? An acquaintance, not trained in music, was visiting a friend where he heard a brilliant recording played on a good quality reproducer. The acquaintance enquired about the cost and availability of the phonograph. His friend showed him his collection of catalogues of audio gear, and within two months a corner of the living room was cluttered in typical fashion with a corner baffle, cables, glowing tubes, and a pasteboard box holding the record-changer. The system worked very well. For a short time, his interest in the phonograph was intense.

It is only fair to say that his knowledge of music was very limited. He did not play any instrument, nor did he sing in a church choir. His knowledge of the literature was limited. He knew practically nothing about the lives of the

composers of his music, and he knew very little about the instruments in the orchestra. Furthermore, he was not interested in those fields and made no effort to learn about them. When his phonograph was playing, it was a background for other activities, usually conversation, and practically never, after the first week of ownership did he really listen to the music that came out of the speaker. Consequently, his interest did die. His music reproducing gear was considerably better than that of most professional musicians, but his musical knowledge was so limited that it could not long support enthusiasm.

This problem is a serious one and a common one. The center of our friend's musical activities was his phonograph. After he had acquired it, there was almost no place to go. The center of a musician's musical activity is the music itself, and his phonograph is simply a tool to help him enjoy his music. Consequently, after he gets his gear, there is everywhere to go.

Listener's Imagination Necessary

Let us go one step deeper into the problem of listening to records. It is, at present, impossible to reproduce music exactly as it sounded originally because of a number of technical difficulties and different listening conditions. Since this is the case, it is always necessary to bring to a record-listening situation a certain kind of musical imagination, usually subconscious, which can add to or subtract from what is heard to make the "real sound." This type of imagination is similar to the imagination needed to turn words, sentences, and paragraphs in a book into real people and happenings, and the kind of imagination needed to change characters and scenes in a play into believable people and vital situations. Of course, the worse the reproduction, the more the need for imagination.

Most musicians have this kind of musical imagination developed to a high degree so they are able to listen to a ragged, distorted version of some composition, and immediately all of their old thoughts and feelings associated with this composition crowd around them. Their knowledge of the composer and the forces that influenced his composition and his life—and probably technical knowledge of the difficulties of performance also—contribute to their appreciation of the composition. So they

get out of the situation, with comparatively little help from the phonograph, a great deal of pleasure because of what they knew about the music. If our musical novice heard the same performance, all he would have heard was the poor-quality sound, and the unfamiliar music by an unknown composer. His attention would probably have wandered and he would have missed the recurrence of a theme which might have been a key to some enjoyment of the composition. So he would have become bored and probably would have decided it was very dull stuff and not worth listening to again. He would have derived from the situation nothing but boredom, largely because of his lack of musical knowledge.

The quality of the sound reproduction is important to both of those people in a variety of ways. The better phonograph, for the musician, cleans up the inner parts, makes the instruments sound more like themselves, and makes it much less of a strain on his "musical imagination" to make "real" music out of the sound. To the musical novice, the better sound is generally more agreeable to listen to. At worst, he has not had an unpleasant experience listening to the music, and at best he has really listened to the music and enjoyed it.

Since the increase in the quality of the sound is nowhere near proportional to the cost of the gear, especially past the \$250 to \$300 region, and since the use of "musical imagination" is necessary anyway and not detrimental to anyone, it appears to this writer that reasonably good quality sound should be acceptable to the most critical listener. The only thing that a phonograph can be expected to do is to reproduce the music on recordings reasonably well. Therefore the only way that the phonograph can give lasting pleasure is for the listener to learn as much as he can about the music the phonograph plays for him. If he doesn't, he is not doing his share by meeting the phonograph and his records half way, and the penalty is that he simply will not be satisfied with his phonograph or records.

How Does the Listener Learn

This process of learning about music, as with everything worth doing, is fraught with additional trouble, expense and disappointment, but the results are so satisfying that once the process is thoroughly begun there is usually no question of stopping.

(Continued on page 51)

* 1138 California Ave., Cincinnati, Ohio.

D.C. Pack for Heaters and Bias

ALLAN M. FERRES*

A simple and practical device which will provide hum-free heater power for low-level amplifier stages, thus making one further step toward perfection in reproducing systems.

IN ORDER TO TAKE full advantage of the excellent fidelity now available in home radio-phonograph installations, the hum level of the system must be reduced to a value much lower than that required a few years ago. Moving toward improved realism, designers have incorporated into the systems speakers and amplifiers with better low-frequency response and, at the same time, signal sources and circuit which require greater voltage gain at these low frequencies. The magnetic cartridge, which is the accepted standard for high-fidelity record reproduction, and the increased use of magnetic tape in the home, combined with "loudness" and separate bass-boost controls, all contribute to the problem. A gain of 30 to 40 db at hum frequencies over the mid-frequency gain is often encountered in most equipment.

The hum reduction problem centers around the low-level stages where the signal level may be as low as 100 microvolts. In order to keep the hum from exceeding the acceptable maximum, usually considered to be 55 to 60 db below normal listening level, careful design is essential.

After all possible precautions are taken to reduce the hum picked up by the input source, the residual hum is produced by the tube operating at the lowest signal level. In good design, this is the first tube in the circuit, that fed by the input source. The hum produced in this stage may be considered to come from one or more of four sources: magnetic fields, electrostatic fields, plate-supply ripple, and heater-supply ripple. As the a.c. magnetic field is usually caused by the power transformer, proper spacing between it and the input tube will eliminate this source of trouble. The effect of electrostatic fields may be minimized by completely enclosing the tube and its associated parts in an aluminum or copper shield can. As a resistance-coupled stage, customarily used in pre-amplifiers, requires plate current of the order of one milliamperes or less, the plate voltage ripple can be reduced easily by means of an R-C filter, and so may be discounted as a "problem" in hum reduction. Therefore, the remaining factor—heater-supply ripple—is the common cause of the residual hum.

When a.c. is used to heat the cathode of a tube, hum enters the signal circuits by heater-cathode leakage, the a.c. magnetic field surrounding the heater, and by capacitive coupling between the

Fig. 1. External view of the author's d.c. heater pack.

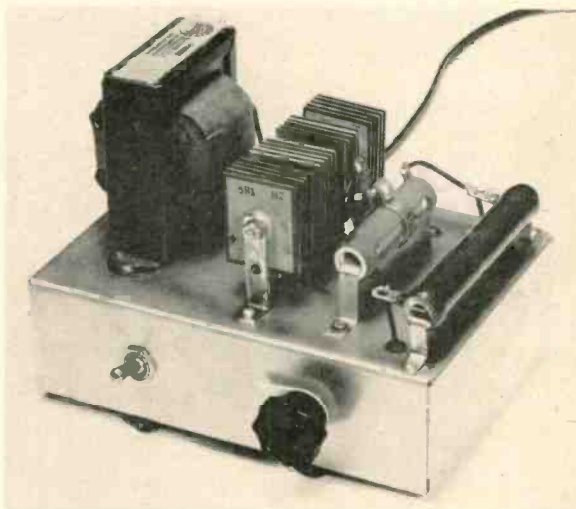

heater and the other tube elements and circuit components. Although careful selection of tubes and arrangement of parts can bring this hum down to a minimum, a point is finally reached where the only method of further reduction is the use of d.c. as the heater supply. (Although high-frequency heater current can be used, it is not considered in this discussion due to its complications.)

Advantages of d.c. Supply

The use of a d.c. heater supply has many advantages. As power-supply a.c. does not have to enter the shield compartment of the low-level stages, shielding requirements of grid and plate leads are not as stringent and better high-frequency response is easier to obtain. Cathode followers and certain types of phase inverters and feedback circuits which require the cathode to be un-bypassed can be used at lower signal levels. This, at times, simplifies design problems. The type of high-frequency oscillator often used in FM receivers in which the cathode is above ground potential is a stubborn source of modulation hum until d.c. is used. More leeway is permitted in the choice of the type of tubes which can be used and the circuit will be less critical as to individual tube selection.

In any given amplifier, the improvement to be expected by changing the heater current from a.c. to d.c. is difficult to predict, as too many factors are

involved. If the amplifier under discussion is still in the design stage, then d.c. should be used if the lowest hum level is required, depending only upon the cost involved. If the amplifier has already been built, then the improvement can be readily measured by disconnecting the heater leads from the transformer and substituting a battery of the proper voltage. (This, incidentally, is a good way of isolating the cause of hum in equipment when trouble-shooting.) It is possible that when the battery is used, the hum will increase. This is due to hum voltages from the heater having been out of phase with hum caused by some other source. It is usually due entirely to coincidence and should not be depended upon as a method of hum reduction, as the other source often produces a voltage which varies in amplitude and phase. The other hum source can now be tracked down and corrected.

If the d.c. heater supply used has a ripple of 1 per cent or less, it may be assumed to produce no more hum than the battery, and the supply should be designed with this in mind, unless experience has proven that in a particular circuit a greater ripple can be tolerated.

Methods of Obtaining d.c.

In general, there are three sources of d.c. which can be used. The first is to connect the heaters in series in the negative side of the plate power supply, and

* 267 W. 11th St., New York 14, N. Y.

Twin-Triple Resistance Decader and Bridge*

LLEWELLYN BATES KEIM**

Development of tube circuits is simplified when accurate means are available for measuring resistor values or for providing calibrated values of resistance.

OF THE MANY DIFFERENT components comprising a vacuum tube circuit, none is more important than the resistor. It establishes operating parameters, determines signal level, and it is across this same component that the signal is developed. Because of its importance, a device which can serve as a source of many resistance values which can be quickly introduced into the circuit under study is a valuable tool in the hands of the design engineer.

Some idea of the importance of the correct value of resistance in a particular circuit location is well known to those who have made extensive studies of intermodulation distortion in audio amplifiers and of methods of reducing it. A slight change in the value of a cathode resistor or an increase of perhaps 20 per cent in a plate-load resistor may cut IM distortion to one quarter its previous value. Hence, it is of paramount importance to have available some means of making resistance measurements and substitutions if any really worthwhile audio design work is to be attempted. The widely publicized tables of R-C values for resistance-coupled amplifier design are drawn up for commercial standards, but their empirical use is likely to lead to disappointment. These tables can be taken as a starting point from which design commences, but improvement may be obtained by careful selection of the "right" value of

* Author's copyright. Design, patent applied for.

** 11 Riverside Drive, New York 23, N. Y.

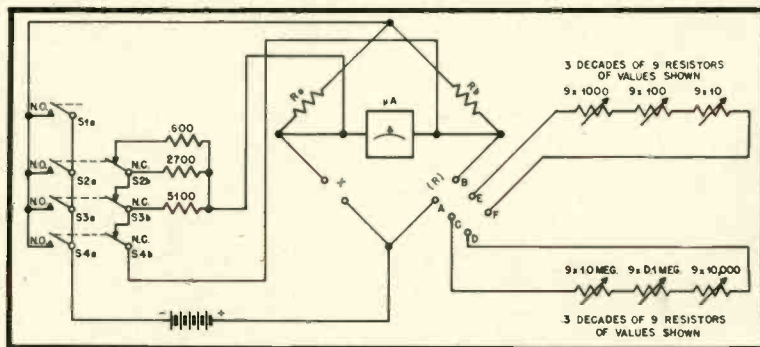

Fig. 2. Schematic of the Twin-Triple Resistance Decader and Bridge.

resistance in the circuit for slightly less gain per stage, possibly, but with a materially lower distortion figure. Cathode followers are increasingly interesting as the terminal stage of a preamplifier, because their low output impedance will permit a long line to the power stages without frequency discrimination, and also the possibility of feeding more than one power stage without loss of response. A variable resistance box will allow quick determination of the optimum load, at the same time keeping the distortion at a minimum. Still another source of trouble is the selection of the proper decoupling resistor to prevent motor-boating, without causing an undesirable loss of supply voltage. Other uses will suggest themselves to the researcher as his familiarity with the convenience of this device becomes appar-

ent.

Some years back it was possible to buy a semi-calibrated 1.0-meg potentiometer which was capable of being clipped into the circuit for ascertaining the value of a defective resistor, and for general circuit use in experimental work. This unit was logarithmic in scale, and permitted reasonable accuracy in determining the value. However, these components seem to have disappeared from the market, the only similar unit available now being a 0.1-meg linear potentiometer. Because of this, the author determined to construct a completely flexible decade resistance box. Study of the needs of audio circuitry reveals the fact that resistors from 10 ohms to 10 megohms are used, and this range of variables must be pro-

(Continued on page 60)

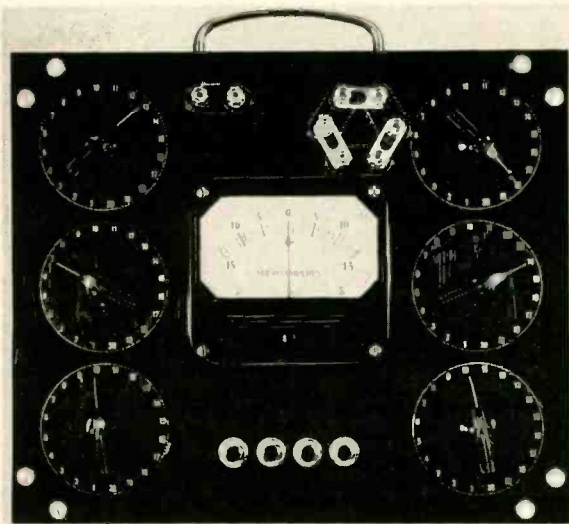
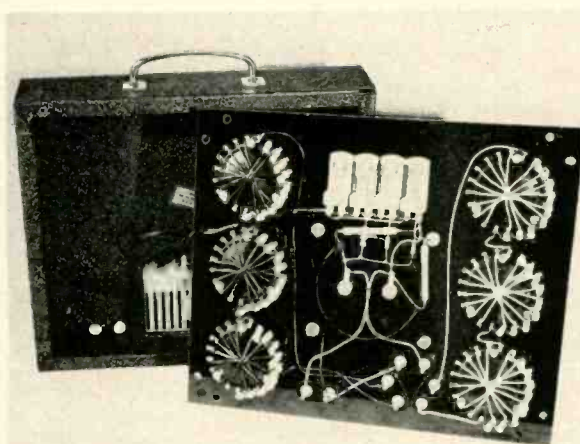

Fig. 1 (left). Completed bridge and substitution resistor box. Fig. 3 (below). Internal appearance of the bridge showing simplicity of construction.



FACTS

you want to know ABOUT HIGH FIDELITY REPRODUCTION

Here for the asking is valuable information for everyone—for the hi-fi enthusiast, music lover or professional expert. Includes important facts about the foremost selection of high fidelity reproducers to suit every taste and budget. Send now for the Bulletins you want.



BULLETIN 189. Tells how to add octave of bass (and better highs) with E-V ARISTOCRAT Klipsch licensed folded horn corner enclosure and 12" complementary speaker systems. Includes complete data on PEERAGE sound equipment console.



BULLETIN 185. Tells about E-V REGENCY folded horn enclosure with built-in corner for 15" coaxial speakers or separate 2- and 3-way speaker systems. Has full data on E-V BARONET corner enclosure for 8" speakers.

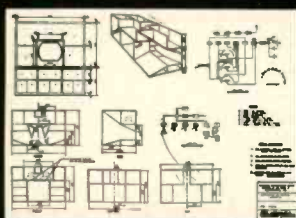

BULLETIN 172. Chart for building complete high fidelity Residence Entertainment Center, with ideal reproducer system. Includes space for all audio components, radio-phonograph, television receiver, etc.

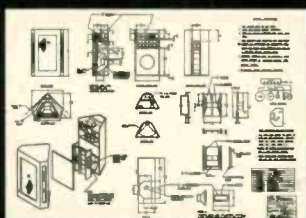

BULLETIN 173. Construction drawing details and mounting information on how to build the famous E-V PATRICIAN folded horn corner enclosure for today's outstanding 4-way reproducer system.

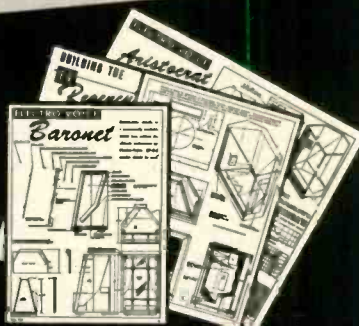

BULLETIN 174. How to build BARONET corner enclosure for 8" speaker.

BULLETIN 175. Construction drawing on E-V ARISTOCRAT corner enclosure for 12" speaker systems.

BULLETIN 176. Building E-V REGENCY enclosure for 2-way and 3-way systems.



BULLETIN 196. Explains about E-V PATRICIAN 4-way audio reproducer in custom-crafted corner enclosure—HI-FI experts say: "finest of all." **BULLETIN 199.** Tells about the magnificent new GEORGIAN 4-way reproducer in folded horn enclosure.



BULLETIN 197. Gives full information about the revolutionary CDP compound diffraction projector for outdoor full-range high fidelity reproduction. Used also as pressure type mid-range driver for hi-fi multi-way systems.

BULLETIN 198. New ultra-linear, wide range, constant amplitude ceramic phonograph cartridge described in full detail.

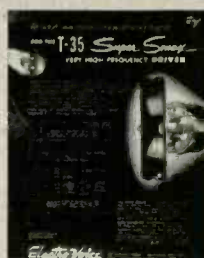

BULLETIN 194. Tells how you can enjoy at least one more octave of silky highs by adding T-35 Super Sonax very high frequency driver to your extended range single speaker for a 2-way system, to your coaxial for 3-way, or to separate multiple 2-way for super 3-way.

BULLETIN 193. Illustrated 8-page folder shows the most complete selection of authentically styled richly finished, folded horn corner enclosures with complementary loud-speaker systems.

CONDENSED CATALOG 116. Full 8-page digest of information on the many products created by E-V; high fidelity enclosures, speakers, speaker systems, microphones, phonograph pickup cartridges, television accessories.

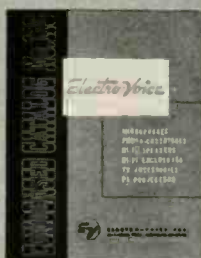

Individual Bulletins will be sent to you

FREE

If you want all the Bulletins, send 25¢ in coin or stamps to cover handling cost. Check coupon.

ELECTRO-VOICE, INC., BUCHANAN, MICHIGAN

Send the Bulletins checked below. (Individual bulletins free)

- | | |
|---|--|
| <input type="checkbox"/> Bulletin No. 189 on Aristocrat and Peerage | <input type="checkbox"/> Bulletin No. 175 on Aristocrat Construction |
| <input type="checkbox"/> Bulletin No. 185 on Regency and Baronet | <input type="checkbox"/> Bulletin No. 176 on Regency Construction |
| <input type="checkbox"/> Bulletin No. 196 on the Patricia | <input type="checkbox"/> Bulletin No. 197 on CDP Sound Projector |
| <input type="checkbox"/> Bulletin No. 199 on the Georgian | <input type="checkbox"/> Bulletin No. 194 on T-35 Super Sonax |
| <input type="checkbox"/> Bulletin No. 172 on Entertainment Center | <input type="checkbox"/> Bulletin No. 193 on Folded Horn Enclosures |
| <input type="checkbox"/> Bulletin No. 173 on Patricia Construction | <input type="checkbox"/> Catalog No. 116 on all E-V Products |
| <input type="checkbox"/> Bulletin No. 174 on Baronet Construction | <input type="checkbox"/> Bulletin No. 198 on Ultra-Linear Cartridge |
| <input type="checkbox"/> Complete set of all Bulletins 25¢ (coin or stamps) enclosed. | |

NAME _____

ADDRESS _____

CITY _____ ZONE _____ STATE _____

Electro-Voice

BUCHANAN, MICHIGAN

Export: 13 East 40th St., New York 16, U.S.A. Cables: Arlab

Handbook of Sound Reproduction

EDGAR M. VILLCHUR*

The Power Amplifier. Chapter 12, Part III.

The Output Stage and the Loudspeaker— Variation in Value of Load Impedance

The selection of a value of load impedance to present to the output stage involves, as we have seen, a compromise between maximum power output and minimum distortion. A special problem is created when the load impedance value varies with frequency, as is the case with a loudspeaker. Low internal amplifier impedance can keep the voltage across the speaker constant, but does not keep the actual speaker impedance constant.

Standard design procedure is to match the amplifier to the *rated* impedance of the speaker, which is close in value to its minimum impedance over the frequency spectrum. In this way all mismatching that occurs is in an upward direction; changes from the optimum value of load are always increases. With triodes power is lost—no particular disadvantage in the bass—but the increase of load decreases distortion, where a decrease of load would have had the opposite effect. Pentode distortion may be increased by the load increase, but to a lesser degree than would occur with a downward mismatch, and more rather than less power is absorbed. Sufficient negative feedback can bring pentodes to constant voltage operation, and counteract the distortion.

Classes of Operation

The $I_p - E_g$ curve of Fig. 12-21 is known as a *transfer characteristic*, since it indicates the plate current that will flow (other circuit conditions having been defined) when the voltage between grid and cathode is at a specified value. The input signal to the grid alternates between positive and negative polarities; for audio applications it is therefore necessary to create circuit conditions such that, with no signal input, the plate current flow is somewhere between zero and maximum. This is achieved by providing a negative "bias" voltage on the grid. The signal can then influence the plate current in either direction, and the accuracy of control can be read from the linearity of that portion of the transfer curve over which current variations take place.

It should be noted that the input signal is a voltage variation, while the output signal is plotted in terms of instantaneous

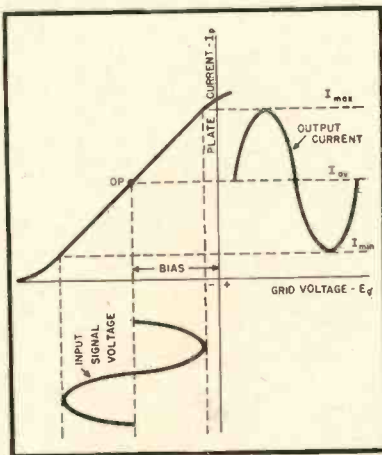

Fig. 12-21. Transfer characteristic illustrating Class A_1 operation. Plate current flows during the entire cycle, and the input signal is neither allowed to engage the curved lower portion of the $I_p - E_g$ curve, nor to drive the grid positive.

ous current. The relative physical size of the input and output wave forms as they appear on the diagram thus does not represent either the voltage or power gain of the stage. The output voltage is the product of the current and the load impedance, and is not shown here.

Figure 12-21 illustrates what is known as class A_1 operation. The point of no-signal current, or operating point, is chosen (by determination of grid bias in relation to other circuit conditions) so that the input signal never causes the plate current to cut off completely, and plate current flows during the entire signal cycle. In addition, the input signal is not allowed to engage the bottom curved section of the transfer characteristic on its negative cycle peak, or to cancel the grid bias on its positive peak, an event that would create the undesirable flow of grid current. It may be seen that the average value of plate current over the cycle is not affected by the amplitude of the signal.

Class A_1 operation provides the highest potential fidelity but lower power output and efficiency from the same tube or set of tubes. It is used in practically all audio voltage amplifiers, and in output stages in which the power requirements, relative to the capabilities of the tubes, are limited.

The subscript 1 used above refers, as in other classes of operation, to the fact

that grid current is not allowed to flow. Class A_1 operation also keeps plate current flowing at all times, but raises the operating point and allows grid current to flow on positive peaks. Class A_2 allows greater power output but is seldom used.

A class B amplifier has a lower operating point, and allows plate current to flow approximately half of the cycle, when the input signal is positive. It is able to provide higher output and increased efficiency for power amplifier stages, but the distortion in single-ended use would be so great as to make the circuit useless. Class B operation therefore must be used with push-pull circuitry, where the asymmetrical waveform distortion tends to cancel out. This class of operation is useful for high-power, high-efficiency industrial amplifiers. Class B amplifiers are usually of the type with subscript 2.

Class AB operation is midway between Class A and Class B. Plate current flows during appreciably more than half of the cycle. Since current does not flow during the entire cycle, Class AB amplification must, like Class B, use push-pull circuitry. The combined effect of the transfer characteristics of Class AB₁ tubes in push-pull is illustrated in Fig. 12-22. The stage is able to operate in class A for weak signals, and increased signal amplitudes create a transition to Class AB. The average value of the plate current is increased for large signals with both Class AB and Class B operation.

Class AB₁ operation is common in high-quality power amplifiers where the power available in pure Class A is not considered sufficient, and where any distortion generated is severely reduced by negative feedback.

In Class C operation the grid bias is greater than the cut-off point of the tube, and plate current flows during appreciably less than half of the signal cycle. This is the most efficient class of operation, but is entirely unsuitable for audio service.

Grid Bias

Negative grid bias voltage may be provided in several ways. *Fixed* bias, so called because it remains the same under all signal conditions, is secured from an independent voltage source. The old "C" battery or bias cell was such a source; nowadays a separate power transformer winding, rectifier, and filter are used. (See A in Fig. 12-23.)

* Contributing Editor, AUDIO ENGINEERING.

Tuner-Amplifier Wedding arouses Hi-Fi interest



SR-401 FM-AM Radio Tuner and AR-410 10-watt Amplifier now combined in this SR-405 chassis.

An event of country-wide interest occurs with Stromberg-Carlson's announcement of the "wedding" of two popular components in its "Custom 400" line.

The already-accepted features of the High Fidelity "SR-401" Radio Tuner and the "AR-410" 10-watt Amplifier are now available in *one* chassis—at a price considerably below the cost of the separate components.

An interesting advantage of the new "SR-405" receiver-amplifier combination is its easy application to the modernization of existing Radio-Phonographs. Fine old players—with cherished cabinetry but lacking true high fidelity—can be brought to top performance by substituting, for the old tuner and amplifier, this compact 13¼ x 8 x 12-inch unit.

Further information and the name of your nearest dealer gladly furnished on request.

SPECIFICATIONS

Audio Power Output
10 watts at less than 1% total harmonic content.

Frequency Response
FM—20 to 20,000 cps. ±1.5 db.
AM—20 to 7,500 cps. ±3 db. Interstation whistle filter; Microphone, Television, Crystal Phono and Magnetic Recorder inputs 20-20,000 cps. ±1 db.

Radiation
Meets RTMA specification REC-129-C for minimum radiation.

Base Control
Control provides 12 db. boost
20 db. droop at 40 cps.
Loudness control at 10% rotation. . 10 db. boost
Maximum Base Boost 22 db.

Treble Control
Control provides 12 db. boost
20 db. droop at 10,000 cps.
Loudness control provides 6 db. boost
Maximum Treble Boost 18 db.

Radio Sensitivity
FM-3 microvolt signal produces 20 db. quieting.
AM-5 microvolt signal produces 1 watt output using low-impedance antenna terminals; 15 microvolt signal using high-impedance antenna terminals.

Input Sensitivity for Rated Output
Magnetic phono input—low level .008 volt, high level .08 volt; Microphone .008 volt; Magnetic Recorder, Television and crystal phono input .1

volt. Crystal phono Input and Magnetic Recorder Input sensitivity easily changed to 2.0 volts.

Output Impedances
4, 8, 16, 120 and 600 ohms. All 600 ohms at +8 VU level.

Output Voltage Regulation
2 db.

Antenna
FM—72 to 300-ohm for use with dipole antenna. AM—High impedance for short antennas, low impedance for low impedance loop or long antenna with coaxial cable lead-in.

Power Supply
117 volts, 50 to 60 cps., 138 watts.
Tube complement—16

There is nothing finer than a **Stromberg-Carlson®** Sound  Division

1219 Clifford Ave., Rochester 3, N. Y.

Makers of famous XY dial equipment—telephones—television—radio—carillons and sound systems.

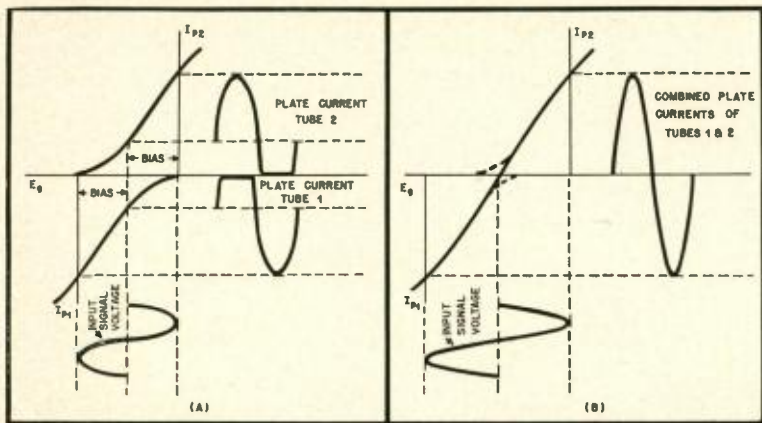

Fig. 12-22. (A) Transfer characteristics of two tubes in Class AB₁ push-pull. The two curves effectively combine into the single curve of (B).

With a given pair of tubes, fixed bias permits greater power output, at the same distortion, than does bias which is dependent on the average value of plate current. This is because with fixed bias the operating point of the tube is held constant during increased signal amplitudes, rather than shifted downward on the $I_p - E_p$ curve. The disadvantages of fixed bias lie in greater cost and circuit complexity, and in the fact that the input impedance to the power amplifier stage must be of low value, almost always involving transformer coupling between driver and output stages.

The low value of impedance is required in order to protect the tube from damage by surges of plate current. At the moment that the signal grid is driven positive—a possibility with high signal input—current will flow from the C supply towards the grid. If the grid-circuit impedance is high this flow of current will create a large voltage drop, and the protection given by the grid bias supply against dangerously high plate current flow is largely removed.

Cathode or self bias is secured from the voltage drop across a resistor inserted in series between cathode and ground, as at (B) of Fig. 12-23. The current flow through this resistor, which can only be in a direction from ground to cathode, creates an IR drop which makes the cathode positive with respect to ground. Since there is no d.c. flow through the grid resistor there is no voltage drop across it ($I=0$, hence $I \times R=0$), and the grid is at the same d.c. potential as ground. The grid is thus made negative with respect to the cathode, in an amount determined by the size of the cathode resistor and by the amount of current flowing through it.

Cathode bias is much simpler and less expensive than fixed bias. It has the further advantage of protectively increasing the bias voltage, in a Class AB circuit, when the signal amplitude becomes great enough to raise the average value of plate current. The input impedance to such a stage can be a conventional grid resistor of several hundred thousand ohms.

The protective raising of the negative grid voltage produced by cathode bias also shifts the operating point, which limits the power output at low distortion. However, in straight Class A operation, cathode bias provides the same operating characteristics as fixed bias because the plate current flow remains constant, resulting in a constant value of IR drop across the bias resistor. In Class AB, cathode bias remains constant when the signal amplitude is low.

Even with Class AB operation, therefore, cathode bias provides approximately the same operating performance as fixed bias at lower power levels. For example, tube manuals list the Class AB₁ power output of 6B4's as 10 watts at 5 per cent distortion with cathode bias, and 15 watts at 2.5 per cent distortion with fixed bias. It would be a mistaken interpretation of this data, however, to assume that the two circuits maintain the same relative quality rating at low power output. Actually their operating characteristics in the latter circumstance are substantially identical.

The cathode resistors of power amplifiers are normally bypassed by electrolytic capacitors of high value, to

keep the signal variations from the bias voltage. These variations, as we have seen, would introduce negative current feedback, raising the source impedance of the output stage. The reactance of the bypass capacitor at low frequencies must be small ($50 \mu\text{f}$ is a common value of capacitance) relative to the value of the parallel bias resistor, to avoid frequency selective feedback.

Often the two output tubes use a common bias resistor, halving its required resistance and doubling its required wattage rating. In such a case the signal currents from each half of the push-pull stage will combine out of phase and oppose each other, removing the current feedback to the extent of the symmetry between the two signals. Unless the stage is operated in Class A and the signals are carefully balanced, however, the cancellation will not be complete. In an unbalanced amplifier, furthermore, there is the danger that the distortion of one half of the stage will be introduced in phase into the grid circuit of the other half. The residual signal from one tube that appears across the cathode resistor is applied as *negative* feedback to that tube, and as *positive* feedback to the other. While this improves balance and would be a desirable feature in a voltage amplifier circuit with low distortion, it is not desirable for the output stage, from which the greatest distortion is to be expected.

Back bias taps the negative voltage from a series resistance or choke in the B minus line, as illustrated at (C) in Fig. 12-23. This provides a compromise between fixed and cathode bias. The voltage drop across the bias resistor is independent of signal amplitude to the extent that the total B-supply current contains current not used by the output stage.

An automatic bias control circuit has been described,¹¹ and used commercially, (see Fig. 12-24) in which the amplifier is biased for Class A operation up to

(Continued on page 77)

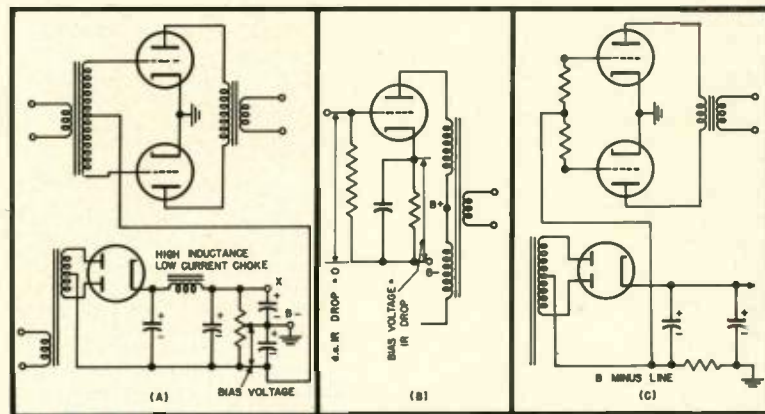
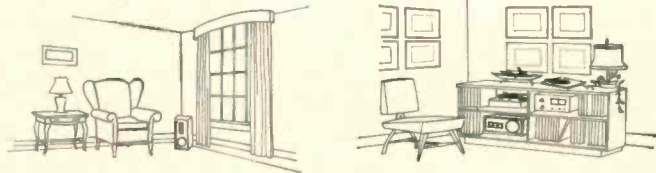

Fig. 12-23. Methods of providing grid bias voltage. (A) Fixed bias from separate power supply. The point marked X is sometimes used to supply plate voltage for low-current voltage amplifiers. (B) Cathode or self-bias. (C) Back bias.

NEVER SUCH EXTRAVAGANT MUSIC
SO MISERLY IN SPACE AND COST
WITH THE NEW JENSEN *Duette*

Here's a specially designed unit, coordinating speakers and small enclosure . . . "presence" you never dreamed you'd get in such a compact, inexpensive unit . . . two speakers in a true 2-way system for real high fidelity performance. Ideal for small space hi-fi, as a second or extension speaker, or in a pair for binaural sound.



Use on table bookshelves or on floor standing on side or end
The "Duette" gives clean, smooth reproduction with the unmistakable "presence" of the 2-way hi-fi reproducer. Uses special heavy duty 8" "woofer" and multicell horn "tweeter" like expensive speaker systems. Impedances: 4 and 8 ohms. 20 watt power rating.

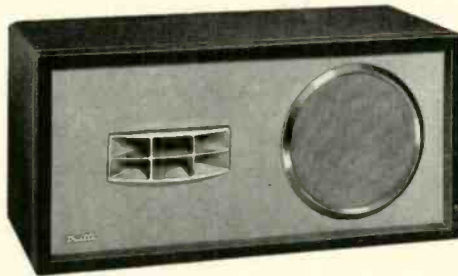

Only 11" high, 23½" wide, 10" deep. Mahogany toned pigskin plastic finish with contrasting front.
Net price . . . \$69.50

Jensen

Jensen Manufacturing Company • Division of the Muter Company
6601 S. Laramie Ave., Chicago 38, Illinois
In Canada: Copper Wire Products, Ltd., Licensee



Listen to the new H-530 Coaxial Loudspeaker (15") . . . it is an advanced design coaxial with new compression-driver horn-loaded "tweeter" with the smoothest reproduction you've ever heard from a 2-way system! Sets a totally new standard of coaxial performance. Furnished with H-F Balance Control. \$129.50 net

See us at the Audio Fair • Rooms 518-519
Hotel New Yorker • Oct. 14, 15, 16, 17.



Hear the H-520 Coaxial Loudspeaker (15") . . . big brother to the famous H-222 (12") with all of the good listening qualities of a finely balanced compression-driver tweeter coaxial. Furnished with H-F Balance Control. \$79.50 net

Burton Brown Advertising

Industry Views The Audio Fair

What the Audio Fairs mean to the audio industry as a whole is highlighted by these representative comments from a few of its members.

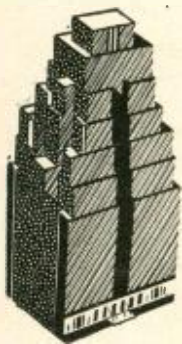

MORE THAN 20,000 MUSIC LOVERS, audio hobbyists, broadcast technicians, and recording and sound engineers will pour through the entrance of Manhattan's Hotel New Yorker October 14, 15, 16, and 17 to make the 1953 Audio Fair the greatest public exhibit in audio history. Using the attendance at previous Fairs as a

basis of comparison, the twenty thousand figure is distinctly on the conservative side, according to a recent announcement of Harry N. Reizes, Fair manager.

Paralleling a new high in attendance will be a record-breaking number of exhibitors, many of whom are major manufacturers entering the high-fidelity field for the first time this year, and who have chosen the Audio Fair as the most effective means of introducing publicly their audio products.

Indicative of industry growth and the acceptance of the New York Audio Fair as the official meeting place of manufacturers, engineers, and hobbyists alike, is the fact that the Fair this year will occupy three floors of the New Yorker in comparison with the two floors which have sufficed in previous years.

Joining with the Fair management in announcing completion of plans for the country's foremost audio event were officials of the Audio Engineering Society, whose annual convention is scheduled to coincide with the Audio Fair. Jerry B. Minter, convention chairman, stated that this year the AES will entertain a greater array of technical papers on audio subjects than has ever before been presented at a single meeting.

Shortly before press time, the editors of *Æ* approached a number of industry leaders in an effort to measure the enthusiasm which would welcome the Fair of '53. Considering that six weeks are yet to lapse before the opening day, we believe you'll agree that the opinions which follow point to a Fair which will really be something to write home about.

LEONARD CARDUNER, president, British Industries Corporation: "My company has exhibited at every Audio Fair held to date.

"We have found the Fairs invaluable for a reason which is not, perhaps, self-evident. That is, that we not only have the opportunity to display and demonstrate our new equipment but, what is even more valuable, we have the opportunity to talk

to our past customers and our potential future customers.

"The insight thus gained as to what the high-fidelity enthusiasts are hoping for, and looking for, in new equipment, has proved to be an invaluable guide to us. I believe that our industry has a brilliant future so long as the manufacturers within the industry maintain the highest possible integrity in keeping faith with the public by producing truly first-rate equipment, and standing firm on the question of quality of product.

"The Audio Fair has in the past proved to be a most valuable meeting place for us and a wonderful opportunity to greet our customers on common ground. We are sure that it will continue to be just that."

LAWRENCE EPSTEIN, sales manager, University Loudspeakers, Inc: "The concept of an Audio Fair must be marked as one of the prime contributing factors toward public acceptance of high-fidelity equipment. It has been an invaluable aid in exposing the lay public to the virtues of high-quality music systems considered heretofore exclusively in the realm of the theater and laboratory; and has done much to stimulate greater interest in audio on the part of hobbyists and experimenters. Execution of the Audio Fair has, in my opinion, been highly satisfactory and I add my vote of thanks to the originator."

F. SUMNER HALL, president, The Audio Engineering Society. "As one whose interest in audio is basically professional, I regard the Audio Fair, together with the AES Convention with which the Fair coincides each year, as a literal necessity to the audio equipment industry. Convening under one roof and at the same time, they offer the professional engineer an unequalled opportunity for keeping well informed on the technical and commercial aspects of audio. Everyone with a sincere interest in the betterment of reproduced sound should attend both the Convention and the Fair."

BRYCE HAYNES, vice-president and sales manager, Audio Devices, Inc: "We at Audio Devices are again looking forward to participation in the Audio Fair, for at this annual convocation of audio experts one can, at first hand, feel the pulse of the entire industry. And by reviewing the past and evaluating the present, future trends become readily discernible.

"We feel that the Audio Fair has done much to further the development and growth of the recording industry. By bringing together the finest, modern modern equipment and materials, as well as the best engineering talent, it has helped to stimulate the interest and enthusiasm of all

concerned. The results speak for themselves."

HERMAN HOLSTEIN, advertising manager, Hudson Radio and Television Corporation: "We look forward to the Audio Fair each year because it is a stimulant for our business and for the entire high-fidelity industry. It enables us to present our wares and our services directly to the public under the most competitive conditions. Thus, our people are alerted to keep abreast or ahead of competition. The Audio Fair also permits us to meet large numbers of interested people, and to observe their tastes, preferences and reactions. By so doing we can guide our buying and merchandising in the right direction."

CHARLES RAY, Arrow Electronics' Audio Center: "We at Arrow Audio Center are certain that the high-fidelity industry has now passed through its critical infancy and is making vigorous strides as it becomes of age. Public acceptance has been marked by ever increasing attendance at the annual Audio Fair with which Audio Center has been proudly associated from the beginning. Audio fans wait in anticipation of the new wonders to be unveiled at each show, and always come away with a personal feeling of pride in the accomplishments of 'their' industry."

GEORGE SILBER, president, The Rek-O-Kut Company, Inc: "It must be recognized that the Audio Fair is a powerful medium for bringing the experience of high-quality sound to the general public. As a manufacturer of high-fidelity equipment, we are vitally interested in this market. Therefore, it is important that we be able to reach this market with our story of product quality.

"Naturally we employ advertising to do this for us. But nowhere can we hope to achieve the advantage of direct personal contact as it is offered at the Audio Fair.

"Whatever may have been the expectation when the idea was born, the Audio Fair in practice is a dynamic marketing aid. It supplements and reinforces our efforts to make high quality sound a part of the American way of life."

Reflecting the penetration of reproduced sound and music into all phases of home and industry, the 1953 Fair will be built around a theme of "Audiorama," a word coined to dramatize the extent to which audio has gained acceptance as a prime amenity in the panorama of American life.

In keeping with the policy established with the first Audio Fair five years ago, the 1953 conclave will be open to all interested parties, professional and amateur, free of charge.

Remember, the Audio Fair is **YOUR** affair! Plan **NOW** to be there!—*H.K.R.*

**EVERYBODY
HAS BEEN
WAITING FOR IT!**

**NOW . . .
IT'S HERE!**

**THE BIGGEST
AUDIO and HI - FI
EVENT OF THE YEAR!**

SPONSORED BY



IN CONJUNCTION
WITH ITS
FIFTH ANNUAL
CONVENTION

AUDIORAMA
is presented by
THE AUDIO FAIR

HARRY N. REIZES
Managing Director
67 W. 44 St., N. Y. C.

An Audio Fair - Video Fair, Inc., Project

AUDIORAMA 1953

5th Anniversary of THE AUDIO FAIR

You and over 20,000 other Broadcast Engineers, Government and Military Agencies, Recordists, Sound-On-Film Men, Hobbyists, High Fidelity Enthusiasts, and Distributors and Dealers of quality audio and high fidelity equipment as well as just plain lovers of good music reproduction will be treated to the most exciting experience in sight and sound.

YOU WILL SEE AND HEAR

for the first time, units representing the latest up-to-the-minute developments in sound reproduction.

YOU WILL SEE AND HEAR

more equipment devoted to quality sound reproduction than has ever before been assembled under one roof.

YOU WILL SEE AND HEAR

the remarkable components which are giving new meaning to music enjoyment in the American home which has set a new standard in American culture.

A new popular interest has arisen . . . and it is spreading like wildfire across the face of the land! Hi-Fi is rapidly becoming the most talked-about pleasure in human experience.

This Is Your Show . . . it is run for your benefit . . . for you to see and to hear . . . for you to experience, appraise and pass judgement . . . therefore, you pay

NO ADMISSION CHARGE

NOTE THE TIME AND PLACE
WHEN: October 14, 15, 16, 17, 1953

WHERE: Hotel New Yorker, New York City
Registration on 7th, 6th and 5th Floors

EXHIBIT HOURS

Wednesday, Oct. 14	11:00 A.M. to 9:00 P.M.
Thursday, Oct. 15	10:00 A.M. to 6:00 P.M.
Friday, Oct. 16	(AES Banquet at 7:30 P.M.)
Saturday, Oct. 17	10:00 A.M. to 10:00 P.M.
	10:00 A.M. to 5:00 P.M.

Equipment Report

BOGEN R701 AM-FM TUNER

WHILE MANY music lovers obtain most of their entertainment from records, it must be remembered that still many others use radio as the principal source of program material. There are two recognized trends in equipment arrangement—one involves the use of a stripped tuner, without tone or volume controls, and without any means of providing for phonograph pickups and therefore requiring a pre-amp/control unit; the other involves the use of a tuner with all of the necessary control facilities. In many instances, the tone controls and other circuit refinements incorporated in tuners have not been as well designed as they might be, causing

the user to employ a more flexible "front end" to provide the necessary compensation for magnetic pickups, and thus increasing over-all cost.

This does not appear to be the case in the new Bogen R701 tuner shown in Fig. 1, for—with two accessory items which are available for use with the tuner—a great degree of flexibility is available. Considering first, however, the specific characteristics of the radio section of the tuner, the new model is extremely satisfactory. It has a sensitivity of 3 microvolts for 30 db of quieting in the FM section, and a sensitivity of 5 microvolts for the AM section. FM drift is stated to be ± 3 kc with the a.f.c.

circuit in operation, and only ± 20 kc with the a.f.c. defeated. However, it is not practicable to operate the tuner with the a.f.c. defeated since the control is a push button—the circuit being designed so the user depresses the push button to defeat the a.f.c. circuit while tuning a station in, then releasing the button for normal operation. Critical tests on the performance of the tuner indicate that when the set is turned off after several hours of operation and allowed to cool overnight, the same station is tuned in quite accurately when the set is turned on again. Thus for practical purposes, there is no drift. Frequency response on FM is within ± 0.5 db from 20 to 20,000 cps.

Two positions are provided for AM reception—the hi-fi position is flat from 20 to 7500 cps, while the normal position is flat from 20 to approximately 4000 cps. Hum and noise are more than 60 db below 100 per cent modulation, and distortion at 3 volts output is less than 0.5 per cent.

Tone controls provide boost and cut for both bass and treble, as shown in the curves of Fig. 3. It will be noted that the response shows resonance at around 60 cps for both cut and boost, the effect being apparent at the extremes. It is undoubtedly the result of the tone-control circuit employed, the choke and capacitor serving as a resonant circuit at maximum settings. Subjectively,

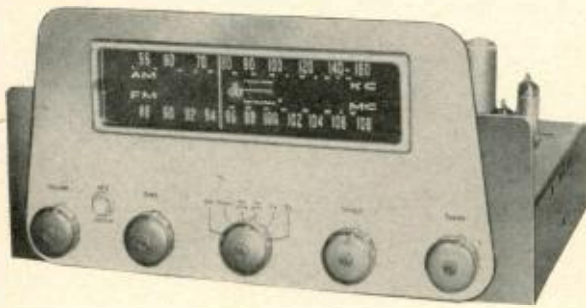

Fig. 1. The Bogen R701 AM-FM tuner, with built-in pre-amplifier.

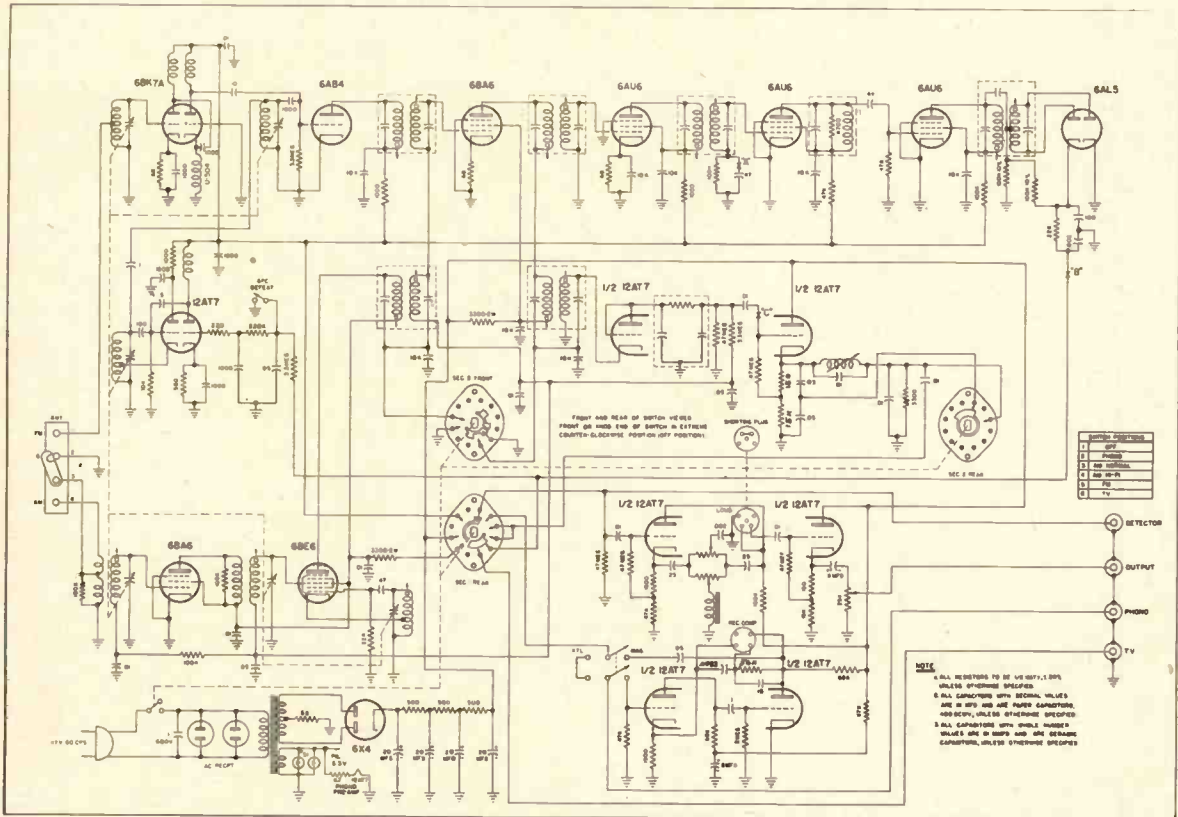

Fig. 2. Complete schematic of the Bogen R701 tuner. Circuit details for the Loudness Control Selector and for the Record Compensator are not shown.

the controls are smooth, and are adequate for all practical requirements.

Although the volume control is uncompensated, a Loudness Control Selector is available as an accessory. This unit plugs into the rear apron, and functions as a loudness control with 10-db steps. Thus it is set by the user for the approximate loudness level desired (in db below normal maximum room level), and the volume control is then used for minor variations in output. The curves for the selector follow the Fletcher-Munson curves approximately.

When a crystal pickup is used, the pre-amplifier is disconnected from the circuit by a switch on the rear apron, and any required compensation may be introduced by the tone controls. For magnetic pickups, however, an accessory Record Compensator is plugged into the rear apron. This unit is marked with six positions, and adjusts turnover and roll-off in accordance with the required characteristics. Both accessory units are equipped with similar

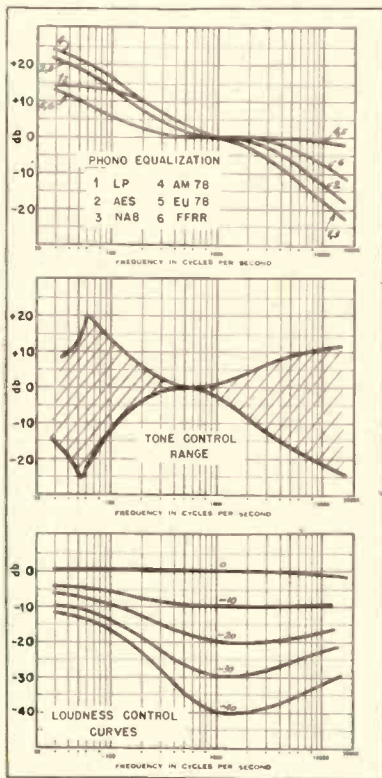

Fig. 3. Performance data for Bogen R701 tuner.

brushed brass dial plates which match the appearance of the main face plate of the tuner. They may be attached to the sides of the chassis, in holes already provided, or they may be placed at any convenient location adjacent to the tuner.

The complete unit employs 14 tubes, including rectifier, and is 15 by 8½ by 9 inches in size. Output impedance is 6000 ohms, which permits operation at a reasonable distance from the main amplifier. An additional input is available for TV, tape recorder, or any similar source. The Bogen R701, with a good power amplifier, would provide a satisfactory tuner and preamplifier-control unit for any high-quality home system.

(Continued on page 64)



More Disc
Recordings
Are Made Today

...THAN
EVER
BEFORE!

the
REK-O-KUT

Challenger

Portable PROFESSIONAL DISC RECORDER
and PLAYBACK PHONOGRAPH

The outstanding advantage of a permanent disc recording is that it can be played on any phonograph. Most tapes, in fact, ultimately end up on discs.

Naturally, the quality of the results greatly depends upon the quality of the equipment used. The Rek-O-Kut Challenger is the only portable disc recorder designed expressly for professional recordists, musicians, educators, and recording enthusiasts, who desire the kind of quality normally associated with costly professional installations. The Rek-O-Kut Challenger is, in fact, the only portable, 12-inch recorder capable of handling professional 13¼" masters.

Every feature has been embodied to assure the highest quality of recorded sound. It is the only portable, 12-inch recorder driven by a constant speed, hysteresis synchronous motor. This means recordings with virtually no noise, wow, or flutter. Moreover, it is the only portable recorder with a professional overhead recording lathe and with interchangeable leadscrews for standard as well as microgroove recordings, whether at 78 or 33 1/3 rpm (an accessory idler is available for 45 rpm).

The Challenger amplifier was designed for the utmost fidelity. It has a frequency response ±1db from 30 to 20,000 cycles, with independent equalizer controls for bass and treble response. Recordings can be made from microphones, from radio tuners, tape recorders, and other signal sources. Recording level is visually indicated by means of a meter.

For playback, the Challenger is a complete high fidelity phonograph with dual-stylus magnetic pickup, and a wide range 10-inch PM loudspeaker.

Rek-O-Kut Challenger for 78 and 33 1/3 rpm, with Standard Groove Leadscrew \$459.95

For complete details, write to dept. DJ-1

THE REK-O-KUT COMPANY

38-01 Queens Boulevard, Long Island City 1, New York

Export Division: 458 Broadway, New York 13, U.S.A. Cables: Morhanex
In Canada: Atlas Radio Corp., Ltd., 560 King Street, W., Toronto 2B

Improvements on the Universal Tape Recorder Amplifier

C. G. McPROUD

Description of the second model of the unit first presented in these pages last year. Minor refinements provide slightly improved performance.



Fig. 2. View of the chassis removed from the case to show new transformers and new mounting of the selector switch.

ONE OF THE DIFFICULTIES in building only one of a piece of equipment is that there is no opportunity to improve on layout, circuit, or mechanical design in the same fashion that a manufacturer would before introducing the instrument or equipment to the market. The Universal Amplifier described in the earlier article¹ was no exception to

¹ *Æ*, May-July, 1952. This article adapted from the original material describing the second model which appeared in the *2nd audio anthology*, but which has not appeared in *Æ* heretofore.

this difficulty, as was mentioned. Certain changes and improvements were indicated as desirable if a second unit were to be built. Not that the unit was unsatisfactory as it was—but although it performed well and turned out good recorded tapes, there were a few slight deficiencies.

In the first place, the transformers used for inputs were relatively old, and while their frequency response was adequate for most applications, there was a 4-db peak at 10,500 cps which caused a higher hiss level than was considered

desirable on playback. Also, there was some loss in the circuit for direct monitoring of the incoming signal, as compared to the *nor* position of *SW*, necessitating an increase in the gain setting of the amplifier which followed. Furthermore, it was felt that the difficulty of changing the volume controls—in case they became noisy—was too great.

Modifications

Accordingly, the entire amplifier was rebuilt. The same outside case was used, as well as the same panel, VU meter, and switching arrangements. The input transformers were changed to Triad HS-5 and the output transformer was changed to Triad HS-52. The Triad HS-5 transformers were designed to work from a 30/50-ohm microphone into a grid; frequency response is extended, and the amplifier is now free of the hiss level which accompanied the first model. This was not considered too troublesome at the time of the first articles on this amplifier, because it was felt that very few who might wish to duplicate the unit would go to the expense or trouble of obtaining the Western Electric transformers specified for the input circuits.

All three of the Triad transformers are mounted in the same size of case, and the total chassis space required was somewhat less than with the three previ-

(Continued on page 71)

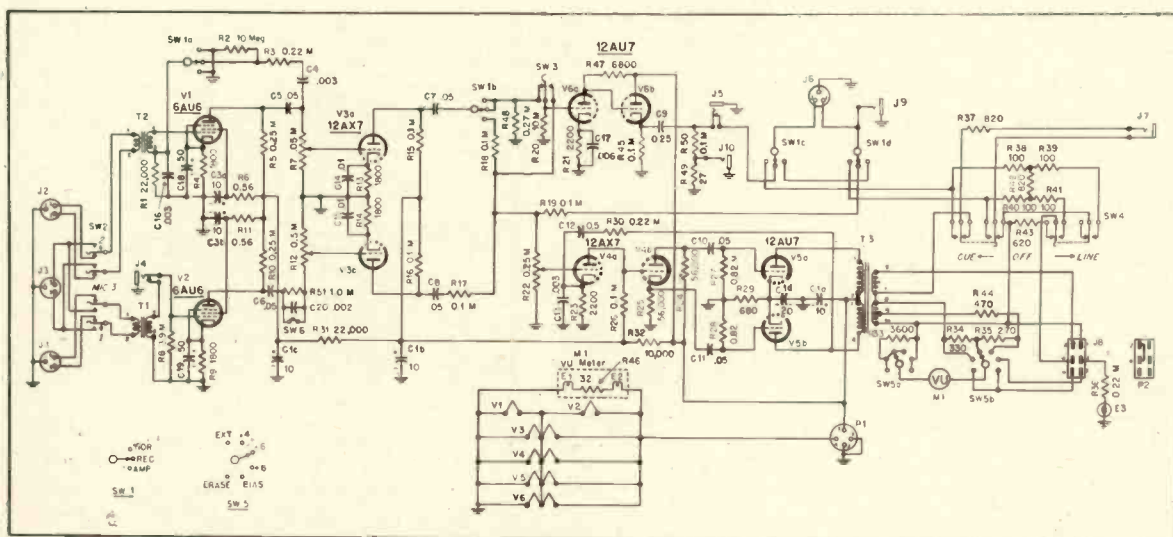

Fig. 1. Revised schematic for the second model of the Universal Amplifier. Principal changes are in equalizing circuits and in monitor output circuit for playback channel.



falling... or rising?

A few false prophets have said that tape recording will replace discs entirely. But don't be deceived by such assumptions.

Sales figures prove that the use of PRESTO discs has shown a steady increase during the past year. They prove something else, too . . . that more broadcasters, recording companies, and schools prefer PRESTO to any other disc.

The reason is plain . . . PRESTO discs are manufactured from superior aluminum and finer lacquer . . . produced in the world's most modern disc plant . . . and inspected and selected for *quality*.

Yes, the use of PRESTO discs is going up not down . . . and PRESTO "Green Label" brand are flying highest of all.



PRESTO

RECORDING CORPORATION

PARAMUS, NEW JERSEY

EXPORT DIVISION: 25 Warren Street, New York 7, N. Y.

CANADIAN DIVISION: Walter P. Downs, Ltd., Dominion Square Bldg., Montreal

WORLD'S LARGEST MANUFACTURER OF PRECISION RECORDING EQUIPMENT AND DISCS

LISTENING QUALITY IS EVERYTHING

Again and again the question—"What makes the AUDAX CHROMATIC the outstanding instrument that it is?" That is as difficult to answer as the question, "Why that glorious tone from a Stradivarius?" KNOW-HOW, that comes only with years of specialization, is undoubtedly the most important factor. We list below a few of the salient features that are responsible for the world-wide acceptance of the AUDAX CHROMATIC as the finest, smoothest performing instrument (*cartridge*) yet devised.

BUT . . . only YOU can decide what sounds best to you. See and hear the AUDAX CHROMATIC and YOU be the judge . . . Yet AUDAX costs no more than ordinary pickups!

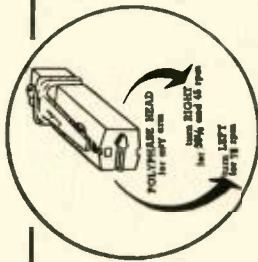

AUDAX CHROMATIC

1. One single magnetic unit plays any and all home records—and with the same point pressure for all.
- *2. Be it diamond or sapphire every stylus has only a limited life; diamond lasts the longer. Obviously then, replaceability of the stylus—AT HOME—is of the greatest importance. Only in AUDAX is each stylus replaceable independently of the other.
3. Near-infinite compliance.
4. Needle-talk practically nil.
5. Response 10 c to over 15 kc.
6. No "Hidden Pull". Available with the new AUDAX Compass - Pivoted arms and to fit the high quality record changers.
- *When to change stylus



Unquestionably the Simplest and Most Efficient Arms Yet Devised

- Only THREE parts.
- No restraint to stylus travel.
- Frontal oscillation nil.
- No springs . . . No fatigue.
- Maintains point-pressure — regardless of climatic changes.
- Greatest possible distance between stylus and vertical pivots.

Obtain Free copy of "1953 Electronic Phono Facts" at your dealer or write us enclosing 15¢ for postage and handling
Also be sure to obtain free descriptive literature on *STYLUS-DISK*

Send for free copy of 1953 ELECTRONIC PHONO FACTS

AUDAX COMPANY

500 Fifth Avenue 42nd Floor New York 36, N. Y.

Creators of Fine Audio-Electronic apparatus for over 25 years

"The Standard by Which Others Are Judged and Valued"



STYLUS-DISK

Trade Mark

1. Gives Visual indication (before your valuable records are ruined) of whether or not the stylus is in playable condition.
2. Will test ANY type of stylus, in any type of pickup—in a jiffy.
3. Neither the stylus nor the cartridge need be removed for the test. Nothing need be disturbed.
4. The grooves may be used over and over again, until finally worn or defective stylus scrapes the delicate groove-walls.
5. Should last for years with ordinary care in using and storing.
6. Costs only \$3.90 net.



EDWARD TATNALL CANBY*

Paris, France

THIS DEPARTMENT, now comfortably lodged overnight in the most hair-raising city of Europe from the traffic standpoint (I have my own car, Heaven help me), has but recently emerged from the densest fog in memory—a fog of the moist sort that covered astonishing areas of the greater North Atlantic, the Irish Sea and the English Channel, during the halting voyage of a vessel of doubtful ancestry named the *T.S.S. Neptunia*, built in Holland (so we heard), registered in Panama, operated by the Greeks and staffed with a crew of Germans, a mixture that is not hereby recommended for any sort of fog penetration. A thousand or so crammed souls and myself took 8½ days to figure out what that mysterious T.S.S. meant, during the rare moments when we were able to speculate at all on anything less immediate than the angle from the horizontal then existing underfoot. (The entire cocktail bar and human contents slid to one side of the ship in a welter of glass and spilled chairs during one of our more terrifying lurches.) The explanation which we got finally from a steward, was simple and he was utterly astonished at our raucous laughter when we heard it. T.S.S. means merely *Twin Screw Steamship*. Most of us, you see, have return tickets on the same floating palace. Two propellers, he insisted. . . .

I didn't sail for these parts without a good mental cargo of audio stuff that has been accumulating for just such a happy occasion and so, if the editor can believe my good typing (a new featherweight Hermes in my lap) I'll get on to some more observations concerning the still hot binaural situation, rounding out the comments in *Æ* for last April.

True-Binaural and Panoramic

Most of the trouble and confusion over "binaural" and associated systems and phenomena is due to the dismal hodge-podge of terminology, official and unofficial, now being muddled a bit more by the advent of assorted kinds of "3-D," both sight and sound. It's had enough to have solid and respectable terms like binaural and stereophonic used in contradictory ways, but that's only the half of it. For the presently official terminology in the sound field is linguistically badly out of line with that of the seeing area. How can we help lining up "stereophonic" in one area with "stereoscopic" in the other, given the two ears and eyes that are in plain sight on every one of our faces! Anybody with common sense will assume that the two represent

parallel effects, one with two ears and the other with two eyes. Unfortunately, the specialists in these two fields were not in communication when they got to inventing words. The two are not parallel at all.

Whereas a "stereoscopic" picture is composed of two pictures, one exclusively for each eye with complete separation, the corresponding sound reproduction is properly called "binaural," not stereophonic. The latter term is officially applied to the type of multichannel reproduction via loudspeakers where the sound channels are *not* separated, all of them reaching both ears. Tough on the uninitiate.

Personally, I am afraid that until we somehow manage to by-pass this linguistic road block we'll never get ourselves into the clear. You just can't have that sort of out-of-line wordage in general use without trouble, quite aside from the further confusion represented by the current usage of "binaural" for two-loudspeaker sound that is not actually binaural at all since it does not provide the separation, one channel for each ear, that is necessary for true-binaural reproduction. Gerald Schoenwald, in the *Bolex Reporter* (Bolex sells 16-mm home stereo movie cameras) makes a valiant stab at the confusion by switching "stereophonic" arbitrarily to a different meaning, to bring it into line with "stereoscopic"; for him, stereophonic now means two-channel separated sound—in my language, true-binaural. But whoa! It's too late to do that; let's leave stereophonic where it is and avoid piling confusion upon confusion.

Schoenwald makes a further suggestion, however, that's a lot more practical. He calls the multichannel loudspeaker type of reproduction "panoramic," a word that nicely describes the effect of the spaced-out sound samplings projected to the listener in that kind of system. Whether it's two channels, as in home "binaural" sound, or up to six, as in Cinerama and other theatre film systems, "panoramic sound" is appropriate, simple, and has the advantage of a good correspondence with the panoramic type of wide-screen film projection. In both hearing and seeing by the panoramic methods there is no separation—no earphones, no glasses, both eyes seeing the whole projection, both ears hearing the whole sound. And so I vote for PANORAMIC, as a popular term to supplement the quasi-official STEREOPHONIC.

I am very much against the current use of "binaural" indiscriminately to cover two-channel reproduction both via phones and via speakers, not because it really matters what word you choose for a given phenomenon, dictionary or no, but rather because whatever terminology we choose,

we must not fly against the facts and lump into one area two phenomena that are basically different, in the most fundamental respects extending into every phase of recording, reproduction and listening.

To the best of my understanding, as noted here earlier, two-speaker "binaural" does not involve any significant true binaural effects in the listening (separation of the two tracks, one for each ear) and therefore is *not* binaural. The very definite improvement that, under the right conditions, can certainly be had with the loudspeaker two-channel system occurs for quite different reasons—as plainly different as the obvious difference between wide-screen movies without glasses and true stereo films that require the polaroid separating spectacles. Terminology in the films is as vague as in audio, but the general public has got the idea of the basic difference there pretty clearly now, thanks to actual experience. Either you wear glasses or you don't. Our audio friends are still in a state of utter confusion, by comparison, over the parallel difference we have. Either we wear earphones or we don't; we have the same three systems (counting the old "standard" or "ordinary" reproduction) as the films and sooner or later we've got to understand how each works and what the differences are.

Earphones—There Isn't Any Other Way

Enough. I'm sure you share my own sense of frustration at this point, though I've been doing my best, these many months, to find a way to make these practical distinctions both clear and interesting in the explanation. Let us at least, at this point, take the difference between earphone and loudspeaker two-channel as a fact, which it is; here are two different systems, whatever we call them. Everybody's been trying loudspeakers for two-channel sound. Radio sends it out via FM and AM. LP records have it, tape machine and speaker companies promote it, a vast amount of demonstration has been done with it. Loudspeaker two-channel sound is in good hands and I could not possibly find anything wrong with it except its limitations—it is not always as glorious an improvement over single-channel sound as it has been cracked up to be, nor is it sure-fire in results, and it requires very tricky operation. (It's expensive and impractical for average home use at the moment, but that can easily change.)

Look, then, at what I can only call True-Binaural, two-channel reproduction via earphones. What has it to offer?

From current implications, you might think nothing more than a couple of sore

* 780 Greenwich St., New York 14, N. Y.

ears and a headache! The feeling seems to be that loudspeakers are more practical.

Practical, yes—but for what? Not for true binaural! I hold no brief for earphones as such and I'm quite ready to groan at a moment's notice about their sheer nuisance value as a promoter of extreme annoyance. I wear the things too much of the time. But nuisances are tolerated according to necessity. Will people ever want to bother with earphones for binaural listening? They'll rush for 'em, if the result is worth it. I'm here to say that it is, decidedly. The genuine binaural reproduction is a sound that can be extraordinarily interesting and important and unique—and there's only one way (at present) to hear it in sound reproduction. Earphones.

I spent most of the early part of this year experimenting on my own exclusively with binaural via earphones. Last December, I decided that as far as I was concerned,

I had done about all I could usefully with loudspeakers and so, as a kind of challenge, I dispensed entirely with my speaker system and set out to find what could be done with the true binaural effect, via phones. Since then I've been 100 per cent busy following up true binaural leads—and here I am en route to Switzerland for a consulting job with a Swiss firm on an exclusively earphone binaural project, as merely one result.

Believe me, once you have opened your eyes (ears) to the reality of earphone binaural as a phenomenon in itself utterly unlike anything else in the entire world of sound reproduction, you begin to discover an astonishing array of potentialities. The first thing I discovered was that true-binaural is not merely to be considered as an uncomfortable and inconvenient alternative to loudspeaker listening; instead, here is a sound reproduction system that is virtually unrelated to any that we now have and its possibilities—granted the inconvenience of phones—are in the most unexpected new areas.

Music on True-Binaural

Music is the first thought for most of us. Via earphones (and from mikes closely spaced, not more than 15 or 20 inches apart at maximum) musical sound is heard in the reproduction as it sounds on the spot.

There, I'd guess, is the understatement of the year! No other system of sound reproduction can remotely approach this special effect, and there are no words left to describe it further. No matter that our senses, confused a bit by the contradictions of our eyes being in one place and our ears just as definitely in another, tend to distort the directionality of binaural music, sometimes placing the musical source wrongly—behind the head or slightly above when it should be in front. This is of very slight importance in binaural musical listening; the exact direction is inconsequential, the feeling of being on the spot, in the music is the exciting part. What makes the earphones bearable is a kind of realism that makes people of a musical turn of mind gasp, on first hearing. Don't think you've heard binaural sound until you hear a good earphone two-track recording.

Moreover, for reasons previously discussed in this column, the liveness of a true-binaural transmission, via phones, is that of two ears on the spot. Therefore a true-binaural transmission, not to be reproduced on speakers but by phones only, can be miked anywhere at all that normal ears find pleasing. That means music from concert-seat distance, if you wish—or close-up, to taste. The entire technique of monaural pickup goes out the window. Binaural mike technique—phones only, remember (I can't repeat that too often)—is that of the ordinary human hearing and it has all of the flexibility, the adaptability, the tolerance of normal binaural hearing. This is decidedly not true of loudspeaker "binaural", which, not being binaural, requires a modified monaural technique. For loudspeakers, two-channel music must be miked close-to, more or less as is the usual recording set-up.

I have, for example, a true-binaural recording of a harpsichord recital in a large stone chapel. My recorder was set up so that the two mikes were in the center aisle about sixty feet—deliberately—from the stage. The recording (via phones) sounds exactly as it did in the church to those who had choice seats in that area. The performer's remarks, reinforced by a low-level p.a. system, are inaudible in the far distance when heard via a speaker, but via phones every word can be understood. (The

same performer, Fernando Valenti, has been recorded monaurally by Westminster at a distance of about three feet.)

I also have a splendid organ tape, from the same chapel at Washington University, which makes a good monaural recording and is plenty effective even via monaural phones. But switch to binaural, after a few moment's listening and watch for what I'm beginning to call the "binaural face"—that expression of astonishment and pleasure that comes over people's faces when binaural hits them for the first time. I also have an orchestral tape that was made, necessarily, at close range, about 20 feet from the conductor. It is an ideal monaural sound—but, thanks to the flexibility of binaural, it is quite spectacular on binaural phones, too.

You can record music anywhere, then, close or far, if you are willing to use only phones for listening, and the results are almost sure-fire. It's very nearly impossible to go wrong with binaural for phones—except in one paradoxical way: monaural technique will not work—record a string quartet or a clarinet and piano at a mike distance of a few feet, as in monaural, and you'll get a most unpleasant closeness, not at all proper for the music. That, of course, is exactly what would happen if you were to listen at the usual monaural location. I've heard a number of binaural recordings that were poor for this very reason—too much monaural thinking. Back away, then, and set mikes where the music sounds good to you. That's true binaural.

Birds, Organs, Folk Tales

Space runs out—but look for a brief moment at a few of the other true-binaural possibilities that I ran into. Remember that true-binaural mike pickup, unlike all other kinds including speaker "binaural", is not limited by the usual monaural acoustical necessities. This is of far-reaching significance.

Birds, for example. I took my binaural recorder out on the front porch of a Missouri farm house and let it run, early in March. The three-dimensional space in which flocks of spring birds were singing was "even more realistic than the sound itself", as the farm's owner, Leonard Hall put it. He swore he heard birds in the recording, off in the distance, that he could not have heard on the spot. This is commendable exaggeration, but it does express the feeling that true-binaural gives to most listeners. Binaural bird-song recording, with earphones only, of course, will soon open up a whole new field of useful research and pleasure for bird lovers and especially for bird experts. My tapes have been heard by a number of the latter, including Prof. Paul Kellogg, of the Cornell bird song records, who hopes to be in the field with a portable binaural Magnemite before the summer is over as a result. Again, the usefulness of this method depends directly upon the true binaural effect, which in this case places the birds in space, gives them size and perspective and, above all, allows the ears to sort out individual sounds out of a confusion of noises, as no monaural recording can ever do even with the rather artificial aid of the parabolic reflector, used by most bird song recordists under present monaural techniques.

By sheer accident I discovered that binaural sound pickup, with phones, can be of immense usefulness in the building and installation of pipe organs. It is extremely difficult to judge organ sound and balance from the playing console; binaural mikes set up a hundred feet away and fed to binaural phones on the organist's ears allow

The complete, up-to-date
bible of Hi-Fi

Edward Tatnall Canby's HOME MUSIC SYSTEMS

How to Build
and Enjoy Them

● Writing with the ease and clarity that distinguish his column in *Audio-Engineering*, Edward Tatnall Canby presents a comprehensive account of every aspect of the hi-fi system, from the initial ordering of parts, through the building of the set, to locating the sources of breakdown once the system is in use. Beginning with a discussion of the various definitions of high fidelity, he then examines each part of the system: speaker, amplifier, speaker housing, etc., in terms of function, the various types manufactured, and specific assets of each brand. Complete with lists of hi-fi dealers, supply houses, custom builders and a special appendix on load resistances for magnetic cartridges, *Home Music Systems* gives you all the information you need for immediate reference, in convenient, up-to-date form, as well as new ideas and recent developments in the field.

At all bookstores \$3.95

HARPER & BROTHERS
49 East 33rd Street,
New York 16

him to hear his organ as others hear it, from any part of a church or auditorium. The general manager of one of the Big Three organ makers tried out my Magnecorder with me and went away muttering that his firm could have saved thousands of dollars with such a gadget. They had tried monaural recording and earphones, with dangerously false results. Organists themselves should benefit, too, from the self-listening potentialities of binaural pickup. Phones, only, of course. Incidentally, this gentleman was at first apparently not too well impressed with the sound he heard in the phones as he played—until, realizing what was the matter, I walked out to the mikes and talked into one of them at close range. A hundred feet away, he turned to one side to answer me; he thought I was at his side. That did it.

I haven't had a chance to explore folk music collecting via binaural phones yet, except to the extent of one set of humorous local Missouri Ozark stories, told to a group of us around the binaural mikes by Leonard Hall, who owned the farm mentioned above. But the extraordinary sense of presence (at ten feet mike distance, not one or two) that is heard in those recordings—especially the comments and laughter of the other people, around and about you (as you listen) on all sides, makes me sure that here, too, is a field that should be of immense importance for folk lore experts. The likelihood that there will soon be a binaural portable Magnemite makes this possibility even more attractive. (The Magnemite is definitely steady enough for virtually any musical purpose; I have one along with me, for experiments yet to begin.)

Binaural Home Movies

What am I doing in Switzerland with binaural recordings? Thanks to Magnecord, I have shipped my loan Magnecorder ahead and will find it waiting for me at Yverdon, in French Switzerland, where the Paillard Company makes the Bolex 16-mm movie camera—with the new stereo attachments. We are about to try true-stereo, true-binaural sound photography, with earphones and glasses. I have very positive indications that it will work, too; we've tried it. I'll have more to say on this after our experiments, but meanwhile, after perusing this installment, you may be able to figure out for yourself why true-binaural recording, with phones, is the *only* possible means of making genuine sound home movies—anywhere, indoors or out, with the microphones *always* mounted at the camera. No patent on the idea—you can try it yourself if you want.

Just before I left for Europe, Editor McProud and I took a good look into the nooks and crannies (and files) of the new (to me) Æ office in Mineola, Long Island; we turned up, to our surprise, a golden cache of unpublished Canby record reviews that had been quietly pruned away over a period of months, to fit space requirements in the various issues. Never one to miss such a fine opportunity, I stuffed them into my suitcase and present some of them herewith. They aren't brand new, but they aren't very old, either, and aside from the fact that newer records of the same works or types of music may have appeared since, they are as good as new. All, of course, are still available.

RECORDS

* Wagner: Excerpts from the Ring des Nibelungen, vols. 1, 2. Munich State Opera Orch., Kowitschny. Urania 7063, 65 (Also album 603)

THE FINE-ARTS QUARTETTE

of the American Broadcasting Company

PLAYS FLAWLESSLY...



George Sopkin

Irving Illmer

Leonard Sorkin

Joseph Stepansky

They record their music faithfully with the 'SONODYNE' DYNAMIC MICROPHONE



The Quartette Recording During Rehearsal ...



The Fine-Arts Quartette is famed throughout the country among professionals as a group of "musicians' musicians." Staff artists of the American Broadcasting Company in Chicago, the Fine-Arts Quartette is known for its unsurpassed tone quality and technical perfection. Consistent recording of all rehearsals has helped this renowned quartette achieve the high standards of perfection for which it is known.

High-fidelity enthusiasts, as well as professional recording artists, are using the "Sonodyne" in ever-increasing numbers. Home users of tape-recorders are finding that the "Sonodyne" reproduces voice and music with a remarkable degree of "naturalness." It makes the "Sonodyne" the ideal high-quality, moderately-priced replacement for the conventional microphones supplied with tape recorders.

Model "51" Sonodyne. List price, \$47.50.
Available at Shure Distributors everywhere.

Patented by Shure Brothers, Inc.

SHURE

SHURE BROTHERS, Inc. ★ Microphones and Acoustic Devices
225 West Huron Street, Chicago 10, Illinois • Cable Address: SHUREMICRO

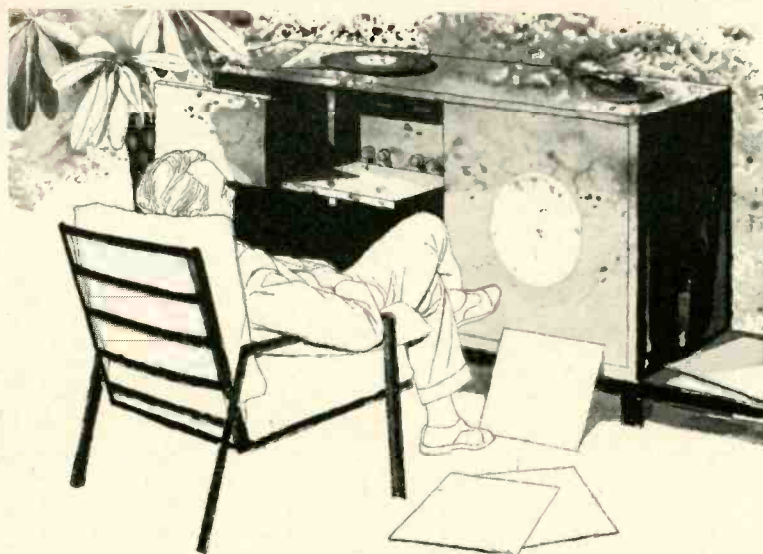

GENERAL ELECTRIC ANNOUNCES



Custom Music Ensemble



Preamplifier-control unit A1-200



Power Amplifier A1-300



Deluxe Tone Arms:
A1-500 (12")
A1-501 (16")



Dual Coaxial
Speaker
A1-400

Speaker
Enclosure (Bland
or Mahogany
Veneer) A1-406



Ideally matched high-fidelity units that offer every home new sound quality... new pleasure in favorite recordings! Individual General Electric components will improve your present system or, get a complete ensemble for the finest home-decorator installation. Call a local G-E distributor today! Sec. 4493, General Electric Company, Electronics Park, Syracuse, New York.

* * *

See and hear the General Electric Custom Music Ensemble at the International Sight and Sound Exposition, Palmer House, Chicago, Sept. 1-2-3.

You can put your confidence in—
GENERAL ELECTRIC

Wagner: Overtures (Flying Dutchman, Rienzi, Die Feen, Das Liebesverbot). Munich State Opera Orch., Kowitschny.
Urania 7069

Three of the best orchestral Wagner discs I've ever heard, musically in the playing and technically in fabulously big, clean, well-miked recording. Real hi-fi stuff of the first water, especially the four overtures—with a tremendous drum, rattles, cymbals etc., etc. The two earliest overtures, Liebesverbot and Die Feen, are most interesting to hear, one full of Weber and Schumann, the other as Italian as spaghetti, reeking of Rossini!

Urania is finally getting out of its German radio reissues, with their so-so quality. These must be brand new. Or a miracle.

Bernstein: Fancy Free. Copland: Rodeo. Ballet Theatre Orch., Levine.

Capitol P-8196

An intriguing musico-technical problem here. Presumably the two sides were pretty much identical in recording—why, then, does the Copland ballet seem so much more "high fidelity," so much richer in sound, fuller, better balanced? I'm inclined to think it's in the music.

These are near-relatives in style. Both are in that racy, high-strung, jazzy-brassy manner of recent American ballet, full of blats, squawks, violent synecopation, mixing jazz and cowboy man and pupil, sounds strangely ineffective, small, even a bit childish here, whereas the older Copland (who, after all, more or less originated the style) is immediately mature, vigorous, potent in sound. Yet in its proper surroundings "Fancy Free" is delightful—why this reaction now? First, I think, is the direct comparison with Copland, much to Copland's advantage. Second, Bernstein is a younger and more "modern" composer is most at home in a relatively dry, close-up acoustical situation; his music scintillates in a night-clubby recording. Copland can easily fill the big, concert-like liveness of Capitol's present recording, but Bernstein is somehow out of place in it.

If you want to hear some of Fancy Free in a different and better acoustic, try Decca's recent 10-inch excerpting.

De Falla, The Three Corned Hat (Complete). Opera-Comique Orch. of Paris, Martinon; Amparito Pérés de Prulière, sopr.
Urania UURLP 7034

This is a find! Several dances from this ballet are conventionally played and recorded again and again in the standard suite—but the rest of the music, including the tantalizing short solos for soprano here, the shouted interjections of a chorus, are unknown to most of us. A beautifully played performance and nicely recorded.

Some Recommended Bach-Period Music

Bach, Clavier Concertos #1 in D mi., #5 in F mi. Lukas Foss (piano); Zimmler String Sinfonietta.
Decca DL 9601

Bach Organ Works: 5 Chorale Preludes, 6 Chorales. Helmut Walcha, organ.
Decca DL 9569

Bach Organ Works: Six Trio Sonatas.
Decca DX 114 (2)

A blind German organist does a fine job on two different old German organs with the intriguing highly colored "Baroque" tone color of Bach's own period. The most colorful and easiest to follow are the Trio Sonatas; the chorales (hymns) are more serious.

Handel, Water Music Suite, arr. Chrysander. (Complete). Berlin Philharmonic, Fritz Lehmann.
Decca DL 9594

The complete Water Music is about four times as long as the familiar suite, and mostly worth it, too. This is not unlike the familiar Harty arrangement; horns, trumpets, strings, here plus harpsichord, a big-symphony sound, not really authentic and with rather stumpy tempi, mostly fast, but very easy listening for most folks not specialists in the Baroque.

THE CASE FOR MUSIC

(from page 32)

Probably the most important single thing to do to broaden one's musical knowledge is to make a point of hearing all the fine live music available nearby. A season ticket to the local symphony is a good beginning. Local music schools have recitals at least weekly, and usually stage choral and orchestral concerts once or twice a year. It is important to keep in mind that the music is the vital element in all of these performances, and that the performer is of secondary importance. Thus a flawless performance is not necessary to enjoy the evening. (Listening to live music helps to solve "tone control" and "recording characteristic" problems. If one has just heard the local orchestra play a concert, a good reference for proper dial settings is still ringing in one's ears.)

Another step, which is probably the most painful but also the most rewarding to one's general musical education, is to learn to play an instrument. By far the most rewarding of all musical activities is ensemble playing. Since some instruments fit into many ensembles, and others are useful mainly as solo or orchestral instruments, careful consideration should be given to selecting the particular instrument to be studied. During the first period of study, the pain usually outweighs the pleasure, but after the initial stages are past, the musical rewards are very great.

Books about composers and their music, about theory and the technical aspects of music, and about music history and literature are all valuable contributions to general musical knowledge. Careful reading will increase the pleasure of music listening all out of proportion to the effort involved.

One is likely to derive satisfaction approximately in proportion to the effort and understanding one expends.

In music—as in other artistic fields—effort is amply repaid, but a genuine, sincere, and sustained effort must be made. All auxiliary devices—recording machines, records, phonographs, speakers, vacuum tubes, and output transformers—are at best but aids to the enjoyments music can provide, and at worst, are makers of noise without artistic conscience.

See and Hear at the

AUDIORAMA
1953

Presented by

THE AUDIO FAIR

HOTEL NEW YORKER

34th ST. & 8th AVE. NEW YORK CITY

OCTOBER 14, 15, 16, 17, 1953

CANNON PLUGS

get good reception

O SERIES



X SERIES



P SERIES



XK SERIES

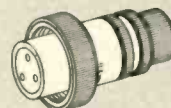

GB SERIES

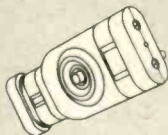

UA SERIES

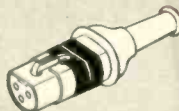

XL SERIES

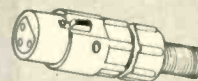

D SERIES



XKW-B1 SERIES



K SERIES



U SERIES



TELEPHONE RECORDER

K SERIES



TELEVISION

WRITE FOR
PRICE FOLDER
C-109

The high quality audio connectors shown above are available from all Cannon Franchised Distributors. In their great variety of sizes, shapes and contact arrangements there is no problem or technical requirement in the radio, sound, TV or related fields that cannot be met. Cannon plugs are standard on leading makes of audio equipment and microphones.

M1 SERIES



CANNON ELECTRIC

Since 1915



Factories in Los Angeles, Toronto, New Haven, Benton Harbor. Representatives in principal cities. Address inquiries to Cannon Electric Company, Dept. 1-109, P.O. Box 75, Lincoln Heights Station, Los Angeles 31, California.

NEW PRODUCTS

● **Non-Corner Horn-Type Speaker Enclosure.** Known as the Purest, a new baffle recently introduced employs a horn load on the back side of the speaker it encloses for optimum low-frequency response, at the same time permits direct radiation of



high frequencies. It is designed for use along any flat surface and does not rely on the walls of the room in which it is used to act as an extension of the horn. Adequate horn mouth area is gained by exhausting on three sides of the enclosure. Total fold of the horn is 180 deg. Dimensions of the Purest are 33 in. high x 28 in. wide x 18 in. deep. Technical literature and prices will be mailed on request by Gately Development Laboratory, Barrington, N. J.

● **Hi-Fi Table-Model Phonograph.** Compactly styled to meet the requirements of small homes and apartments, the new table model phonograph recently announced by Sound Workshop, 75 N. 11th St., Brooklyn 11, N. Y., is designed to utilize the complete housing as a speaker baffle, and thus provides a standard of performance comparable to conventional

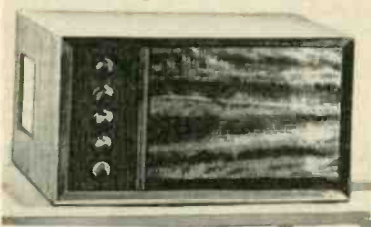

consoles considerably larger in size. Known as the Superb, the new phonograph is equipped with an amplifier based on the Williamson design, and contains separate bass and treble controls as well as a control for new- and old-record equalization. Webcor record changer is equipped with GE magnetic cartridge. For operating convenience the changer is mounted on drawer slides and is withdrawn for record replacement. Obtainable in hand-rubbed mahogany, walnut and korina, with wrought-iron matching base for chair-side use available as an accessory.

● **Improved Soundcraft Recording Tape.** Micro-Polishing is the descriptive term applied to a new patented process now being used in the manufacture of all magnetic recording tape produced by Reeves Soundcraft Corporation, 10 E. 52nd St., New York 22, N. Y. Use of the process results in a mirror smooth recording surface and the virtual elimination of microscopic protuberances which often cause inconsistencies or interruptions in the recorded signal, particularly in telemetering and calculating applications. Use of the Micro-Polishing process assures surface uniformity and stability of tape output right from the first playing, thus eliminating the "wear in" period which heretofore was necessary before new tapes could be interspliced with older ones. There will be no change in existing price schedules.

● **School-Sound-System Console.** Modular-type construction is featured in a new line of centralized control consoles for school sound systems, recently introduced by the David Bogen Company, 29 Ninth Ave., New York 14, N. Y. In addition to flexibility of installation and operation, the units afford convenience of expansion as the future demands. In their basic form the new consoles provide three primary services—(1) a means for transmitting emergency announcements to the entire school or to any desired group of classrooms, (2) a means for transmitting live, recorded, or broadcast program material to any classroom or group of classrooms, or from any classroom to any other classroom or rooms, and (3) an intercom system be-



tween the console and all classrooms. The new consoles are being offered in two basic lines, the SCH single-channel series, and the DU dual-channel series. The basic single-channel system includes a radio tuner, a three-speed transcription player, and three high-impedance microphone inputs. It affords one channel for program distribution, and another for intercommunication. The latter may be used without program interruption. The system is supplied to serve any multiple of 15 classrooms. Where less than 75 classrooms are involved, one 30-watt amplifier is provided for the program channel. Larger single-channel systems have two 30-watt amplifiers. The basic dual-channel system includes an additional channel for program distribution and an additional microphone input. It is designed for any multiple of 12 classrooms. Further details are available from the manufacturer.

● **RCA Home-Model Tape Recorder.** Push-button control of all mechanical operating functions is featured in the new RCA portable tape recorder. Packaged in a luggage-type carrying case, the recorder weighs but 25 lbs, and measures only



14 x 12 x 9 ins. Capable of using all sizes of tape spools up to 7-ins., the dual-speed machine can record or play back up to two hours, and can be rewound in approximately two-and-three-quarters minutes. Operating speeds are 3 3/4 and 7 1/2 ips. The recorder is equipped with both input and output jacks to permit easy attachment to phonographs, radio tuners, and public address systems. Engineering Products Department, Radio Corporation of America, Camden, N. J.

● **Miniature Audio Transformer.** Although tiny in size, the new Triad JAF series audio transformers are magnetically shielded and hermetically sealed. Designed for use with transistors and sub-miniature tube amplifying equipment, they achieve

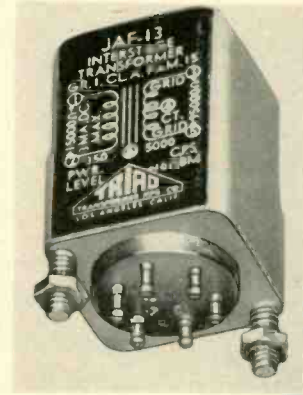

the extreme in miniaturization without compromise on insulation or moisture protection. Circuit and winding data for each transformer are carried on a permanently attached decal. All units in the new series are described in Catalog TR-53, copies of which may be obtained by writing Triad Transformer Corporation, 4055 Redwood Ave., Venice, Calif.

● **Distortion Filter.** Designed for the elimination of distortion from signal sources, the new Type DE filters will reduce harmonics from the second to the eighth by a minimum of 60 db. They are so constructed that a drift of \pm three per

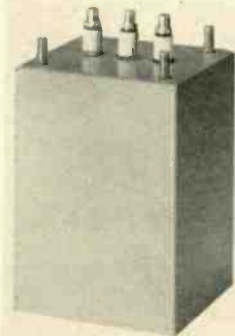

cent in signal source frequency will not affect filtering action. The filters are available in a variety of impedances and can be made for any frequency from 20 to 20,000 cps. Through their use in production tests, low values of distortion measurements can be made using any available signal generator. Full technical specifications will be supplied upon request to Ortho Filter Corporation, 196 Albion Ave., Paterson, N. J.

● **Presto Tape-Transport Mechanism.** Replete with improvements over earlier models is the new Presto Model RC-11 tape transport mechanism, a unit of almost absolute accuracy, with separate heads for record, playback, and erase. Compactly built on a "unitized" construction principle, the RC-11 employs a capstan drive unit which contains a precision motor, endless Nylon belt, brass flywheel, capstan shaft, pressure pulley, and solenoid. This entire segment of the mechanism is self-contained and instantly removable for servicing or replacement. Other features include a heavy cast-aluminum panel for rigid support of all components, enclosure for recording heads, and complete push button operation. Reels up to 10 1/2-in. di-

HARVEY the House of Audio



REK-O-KUT *Challenger*

Portable, Professional Disc Recorder
and Playback Phonograph

For making permanent, high quality disc recordings from edited tapes, off-the-air, and live program material. It is the only portable 12" recorder that handles 13 1/4" masters; driven by a hysteresis synchronous motor; and is equipped with a professional overhead recording lathe with interchangeable leadscrews for standard and microgroove recordings.

The Challenger operates at 78 and 33 1/2 rpm (an accessory idler is available for 45 rpm). The amplifier has a response from 30 to 20,000 cps; ± 1 db with equalizer controls for bass and treble. It is provided with dual stylus magnetic pickup, and a wide range 10" PM loudspeaker. Complete with standard Leadscrew.

\$459.95

REK-O-KUT

12-inch, 3-Speed TURNTABLES

Model L-743



A broadcast quality turntable designed for discriminating users . . . professionals and audiophiles. Driven by 4-pole motor. Turntable itself is made of cast aluminum, and exerts no pull on magnetic cartridges. It is precision machined with a heavy rim for dynamically balanced flywheel action.

A single knob permits instantaneous selection of any record speed: 33 1/2, 45, or 78 rpm. Record slippage is eliminated through use of new mat material. There is virtually no rumble, wow or flutter. Complete with 45 rpm record adapter.

\$59.50

Model T-12H A DeLuxe version of the above for the ultimate in turntable design for 33 1/2 and 78 rpm only. Driven by constant speed hysteresis synchronous motor.

\$119.50

HARVEY carries
a complete line of

AMPEX

PRECISION MAGNETIC
RECORDING EQUIPMENT



All models are on Demonstration at the Harvey AUDIO-torium, and are Available for Immediate Deliveries directly from Stock. Write for Complete Details.



JIM LANSING

D-130 LOUDSPEAKER

A high quality, 15-inch, general purpose speaker capable of continuous 25 watt operation. The D-130 employs a large Alnico V permanent magnet field. It has an edge-wound ribbon voice coil, 4" in diameter. A coaxial aluminum diaphragm covers the high frequency range. This is rear-vented to eliminate nonlinear compression effects. The nominal impedance is 16 ohms.

\$70.40

Visit the HARVEY AUDIOtorium

If you want to See and Hear the finest . . . the widest selection of high fidelity equipment . . . be sure to visit the HARVEY AUDIOtorium. It will thrill you.

NOTE: Prices Net, F.O.B., N.Y.C. Subject to change without notice.



HARVEY RADIO COMPANY, INC.

103 W. 43rd Street, New York 36, N. Y. JUdson 2-1500

PILOTUNER

Model AF-824
FM-AM TUNER



A sensitive, selective, and stable tuner designed for high fidelity applications. FM section is provided with temperature compensation against drift, as well as AFC which can be cut out by means of front panel disabling switch. Effects 20db quieting with only 10 microvolt signal. AM section employs separate tuning condenser. Output is .2 volts with 10 microvolt signal.

Model AF-824 has built-in preamp-equalizer for LP, NAB, AES, and Foreign recordings. Frequency response is $\pm 1/2$ db from 20 to 20,000 cycles. Separate bass and treble control circuits permit up to 19db boost or attenuation at 20 and 20,000 cps. Cathode follower provides low impedance, permitting long line to main amplifier without high frequency loss, and without hum pickup. Power supply is self-contained.

Complete with Tubes and Front Escutcheon **\$119.50**

FISHER HIGH FIDELITY UNITS

Master Audio Control
Preamplifier-Equalizer
Model 50-CB



A high quality, high gain, all-triode circuit with virtually no distortion. Has shielded, self-contained power supply with DC for tube heaters thus eliminating audible hum. Cathode follower input and two cathode follower output stages assure isolation of all control circuits, also providing low output impedance, permitting long leads without frequency discrimination.

Five inputs provide accommodation for microphone, magnetic cartridge, tuner, tape recorder, and other signal sources. There are eight controls: 1. Volume which operates either conventionally or as a loudness control. 2. Loudness Control Switch which selects the function of the volume control. 3. Selector Switch for the five input positions. 4 & 5. Low and High Frequency Switches provide 16 combinations of low frequency turnover and high frequency roll-off. 6 & 7. Bass and Treble Tone Controls produce up to 16db of boost or attenuation at 50 and 10,000 cycles respectively. 8. Power Switch turns units on and off and furnishes AC power to three spare receptacles. There are also five independent level controls, one for each input.

Complete with Tubes. **\$97.50**

LABORATORY STANDARD AUDIO AMPLIFIER Model 50-A

Through the employment of a special type of cathode follower driver, a well regulated bias and high voltage power supply, the 50-A has achieved an undistorted power output far in excess of 40 watts. Triode-connected type 1614 tubes are used in the output. The overall result is extremely low hum and noise (-92 db), good transient handling, good linearity, and wide frequency response: 20 to 20,000 cycles ± 1 db, and 5 to 100,000 ± 1 db.



Power supply is built-in. A jack is provided for measuring plate current of the output tubes. Damping factor is 31, and efficiency in excess of 55%. Harmonic Distortion: .05% at 5 watts, .08% at 10 watts, and .3% at 40 watts. Intermodulation Distortion: .4% at 10 watts, .8% at 40 watts, and 2% at 45 watts.

Complete with Tubes. **\$159.50**

POWRTRON[™] by WHITE SOUND

New Revolutionary Amplifier Circuit

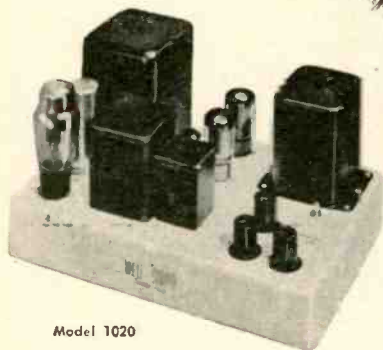

Model 1020

Ultra High Fidelity

Which gives you for the first time an output power wave form which is the same as the input voltage waveform, regardless of changing load impedance.

No More

- Pentode Operation
- Triode Operation
- Voltage Feed back

Now

- Power Control with Powrtron

WHITE SOUND AMPLIFIERS

White Sound's new circuit has established a New High in the realistic reproduction of music. The finest electronic components, precision engineering and White's new design combine to give you Ultra High Fidelity.

Exclusive! Non-resonant Cross-Over Circuit:
• Cross-Over (24db./ Octave) at the Input of Dual Channel Amplifier.

Model 1010, 10 watts Model 1020, 20 watts. Model 2010, Dual Channel Amplifier with the Model C-101, Cross-Over Network.

WHITE CABINET SPEAKERS

- A True Exponential Horn (within 1%) . . . Coupled to Speaker through a New Unique Phasing Device and Sound Tray • Nine foot Horn compactly Curled into Non-Resonant Cabinet • Response: 15-18,000 cps • White Cabinet Speakers offered in 5 Sizes . . . 3 Finishes . . . 5 Prices.



Model 3422
15-18,000 cps.

©Copyrighted

For Complete Information, see your Distributor or Write to Department H-9

105 W. MADISON ST. **WHITE SOUND, INC.** CHICAGO 2, ILLINOIS

priced models of the new Crestwood tape recorder, recently announced by the Daystrom Electric Corporation, Poughkeepsie, N. Y. The Crestwood Model 303 is a single-packaged unit for home and general recording, with a frequency range stated by the manufacturer to be 50 to 10,000 cps. It is equipped with power amplifier and speaker. Model 401 consists of tape-transport mechanism and preamplifier in a single housing, and is designed for use with its companion Model 402 power amplifier and speaker, or with any other hi-fi amplifier-and-speaker combination. Frequency response of the 401 is stated to be 30 to 13,000 cps. Both models are of the dual-track type and record at 7 1/2 and 3 3/4 ips. Rewind and fast forward are 20 times faster than recording speed. Provision is made for head alignment. In the Model 401, d. c. is applied to low-level tube heaters to minimize noise level. Technical sheet is available from the manufacturer.

• **Multi-Speaker Hi-Fi Table Phonograph.** Three speakers, a loudness control, and a variable-reluctance pickup are among the features which contribute to the quality performance of the new Webcor "Musical." Despite its small size the unit has



an audio response of 50 to 12,500 cps. Changer is the Webcor Type 121 which plays records of all sizes and speeds automatically, and which is equipped with automatic shut-off. A five-tube amplifier affords five watts output with low distortion. Webster-Chicago Corporation, Chicago, Ill.

• **Miniature Audio Mixer.** A new advance in input mixing equipment is the "Mini-Mix," a tiny two-position mixer which plugs directly into the regular high-impedance input of any recorder, amplifier or musical instrument. Measuring only

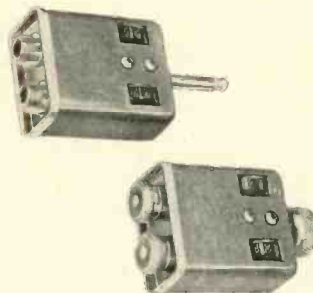

2 1/16 x 1 13/16 x 1 1/16 ins. and weighing but three ounces, the Mini-Mix offers the advantages of a full-size mixer. Short lead lengths inside a shielded housing minimize stray pickup. Separate gain controls for each channel are afforded by recessed knobs. The Mini-Mix is available with either standard jack or microphone-connector fittings. Full information may be obtained by writing the manufacturer, Switchcraft, Inc., 1328 N. Halsted St., Chicago 22, Ill.

NEW LITERATURE

◆ **General Radio Company**, 274 Massachusetts Ave., Cambridge 39, Mass., has performed a notable service to the audio industry with the publication of "The Handbook of Noise Measurement," a 100-page treatise which covers thoroughly the measurement of airborne sounds, and includes definitions, standards, measuring equipment, procedures, and interpretation of results. The book is authored by Dr. A. P. G. Peterson of the GR engineering staff, and Dr. Leo L. Beranek of M. I. T., both of whom are well known in the field of acoustic measurement. Copies of the Handbook are available at a price of \$1.00 postpaid.

◆ **United Transformer Company**, 150 Varick St., New York 13, N. Y. illustrates and describes the complete line of UTC transformers, reactors and filters in newly-published Catalog 530. In addition to conventional buying information, the book is replete with technical data to aid in the selection of units for highly unique applications. A truly worthwhile assemblage of helpful information for which UTC is to be highly commended.

◆ **Amperex Electronic Corporation**, 230 Duffy Ave., Hicksville, N. Y., has issued a new condensed catalog in which are listed all of the tube types manufactured by the company, together with mechanical and electrical specifications. Tubes listed include types for the great majority of industrial and amateur applications.

◆ **General Electric Company**, Schenectady 5, N. Y. has produced a new bulletin on uses of miniature selenium rectifier stacks in electronic circuitry. Designated publication GEA-5935, the 4-page pamphlet contains information on the applications, constructional features, and electrical characteristics of small selenium rectifiers. Included also are tables of ratings and dimensions, plus graphs on the effect of temperature and the life expectancy of various types of stacks.

◆ **Precision Film Laboratories**, 21 W. 46th St., New York 36, N. Y. covers all aspects of 16- and 35-mm film processing in a new and informative booklet which will be mailed free in response to requests on company letterheads. Printed in color and effectively illustrated, the booklet simulates a personally conducted tour through the Precision plant. The reader is escorted figuratively through each department, and is shown exactly what happens to film from the moment it is received until it is shipped.

◆ **Buchanan Electrical Products Corporation**, Hillside, N. J. describes a complete line of solderless wire connectors and specialized electrical fittings in its new 16-page catalog No. 53. Included are complete specifications, dimensional data, application instructions, and ordering information. An exceptionally well-conceived booklet, Catalog 53 should be in the hands of everyone with professional interest in equipment of this type.

◆ **Hess, Goldsmith & Co., Inc.**, 1400 Broadway, New York 18, N. Y., introduces the use of glass fabric in modern industry with a handsomely-produced 32-page book, let titled "Glass Textiles for Industry." Discussed are three basic fibre textile forms, together with end uses for each product listed. Copy of the booklet may be obtained by writing Industrial Products Division at the address shown above.

◆ **Federal Telephone and Radio Company**, 100 Kingsland Road, Clifton, N. J. is distributing a new catalog which lists the wide range of cables which are now available from the company's Selenium-Intelin Division. Devoted essentially to sealed-dielectric cables, the 24-page book covers many types of cabling for transmission of radio frequencies, including vhf and uhf communications.

◆ **Stevens-Arnold, Inc.**, 22 Elkins St., South Boston, Mass., describes the entire line of Millisee plug-in relays in recently published Catalog 337. Explained is the use of gold contacts in place of platinum-rhodium for low-current applications where ultra-high-speed operation is a necessity. Included in this pamphlet is a great deal of technical information of value to users of high-speed relays.



look to

CHICAGO

for the "missing links" in

EXACT REPLACEMENT TRANSFORMERS FOR

LINK RADIO EQUIPMENT

For many years, CHICAGO has made most of the transformers and filter reactors for Link Radio equipment which is widely used in police communication and other mobile applications. CHICAGO Exact Replacement Transformers for this equipment are now available through your electronic parts distributor. The CHICAGO catalog numbers are identical to the Link parts numbers. See your distributor for these components.



IN STOCK FOR IMMEDIATE DELIVERY

CHICAGO CAT. NO.	TYPE OF UNIT	REPLACES LINK RADIO PART NUMBERS:	MTG. TYPE	LIST PRICE
TR-1034	Vibrator Transformer (6 v.)	TR-1034 and 12534	V	\$ 9.50
TR-1035	Vibrator Transformer (12 v.)	TR-1035, 14269	V	9.50
TR-1040	Plate Transformer	TR-1040 and 11862	FS	97.50
TR-1050	Vibrator Transformer (6 v.)	TR-1050	V	9.90
TR-1054	Plate Transformer	TR-1054, 11944, 4891	V	18.50
TR-1056	Filter Choke	TR-1056, 0122U	V	10.85
TR-1063	Filament Transformer	TR-1063, 11992, 7211	V	10.50
TR-1065	Power Transformer	7650N, TR-1065	S	13.50
TR-1072	Power Transformer	TR-1072, 6248	V	9.50
TR-1073	Vibrator Transformer (6 v.)	TR-1073, 6250, TR-1080	V	9.25
TR-1077	Filter Choke	TR-1077, 7282N	BX	24.25
TR-1081	Output Transformer (Plate to Grid or Line)	TR-1081	S*	15.00
TR-1082	Filament Transformer	TR-1082	TX-1	31.25
TR-1083	Filament Transformer	TR-1083, 8218N	TX	20.50
TR-7074	Vibrator Transformer (12 v.)	TR-7074	V	11.50

*Pin-type terminals in place of solder lugs.



Free "New Equipment" Catalog

You'll want to have the full details on CHICAGO'S New Equipment Line, covering the complete range of "Sealed-in-Steel" transformers for every modern circuit application. Write for your Free copy of Catalog No. CT-153 today, or get it from your electronic parts distributor.

CHICAGO TRANSFORMER

DIVISION OF ESSEX WIRE CORPORATION
3501 ADDISON STREET, CHICAGO 18, ILL.



Export Sales Div.:
Scheel International, Inc.
4237 N. Lincoln Ave.
Chicago, Ill., U.S.A.
CABLE ADDRESS:
HARSHEEL

FLEXIBLE TONE CONTROL CIRCUIT

(from page 29)

of 10 db is required at both extremes of the audio spectrum, then 7 db of negative feedback will still remain at both extremes, and 17 db at the mid-frequencies. At "flat" position, the circuit has a loss of 1 db⁵ which is negligible. The circuit can therefore be inserted anywhere with no complications.

The only disadvantage is that the input to the tone control must come from a low-impedance source, but not neces-

sarily from a cathode follower as shown in Fig. 3. A source impedance of 10,000 to 15,000 ohms will have no adverse effect, and this impedance can be readily attained from a low-mu tube such as a 6SN7 or 12AU7.

Because of the large amount of negative feedback employed, the output source impedance is low, giving the circuit all the advantages of a cathode-follower output stage.

Use and Abuse of the Tone Controls

While the writer is not naive to the point of believing in "ideal curves," flat speakers, and acoustical heavens in general, it is believed that in a reasonably high-quality preamplifier-equalizer the tone controls should not be called upon to perform functions which they were not originally designed to perform.

Following are the areas where abuse is most likely to occur:

Preamplifier

There are scores of well designed circuits which offer adequate flexibility and adaptability to meet any record characteristics and their deviations without resorting to tone-control compensation. Since the low-frequency turnovers and the high-frequency pre-emphasis fall well below and above the "center" frequency of the tone controls, no adequate compensation can be attained.

As for reducing any record noise, hiss, or rumble, the tone controls are not especially effective since, at best, most of them have an attenuation rate of 6 db/octave, hardly adequate for any effective suppression without sacrificing the musical content of the program.

Loudness Control

Compensation for the Fletcher-Munson curves with the tone controls would seem to make them perform a function actually belonging to a loudness control. In addition, once the tone controls are set on the reciprocal of the Fletcher-Munson curves, their usefulness for any other function will be restricted, if not nullified.

Speaker

The most serious misunderstanding seems to be on the question of speaker compensation. It is well known by now that phase as well as amplitude response of a speaker plays an important role on the quality of music reproduction. A speaker, being essentially a non-linear electromechanical transducer, has a phase response which includes several reversals, rendering any effects for effective compensation rather futile, especially with simple networks. Circuits have been designed which effectively compensate for some speaker deficiencies, using variable slope as well as variable turnover frequency, but their cost is usually several times the price of the average speaker, making any impending "Fire Sale" on high-quality loudspeakers highly improbable.

Why use tone controls at all then? They fill a definite need and most of their functions are covered in Mr. Villchur's article and can be summarized as providing:

⁵ Since the total gain in a negative-feedback circuit is equal to the forward gain divided by one plus the loop gain. In our case, this ratio is less than one. In addition, there is a slight reduction in gain due to the cathode-follower input, but the circuit parameters have been selected to keep the total loss less than 1 db.

BEST VALUE IN TAPE RECORDING HISTORY!

HEAR US AT THE SHOWS

Hear and see the new Crestwoods at the Sight and Sound Exposition, Chicago, September 1-3, Room 778 in the Palmer House; and the Audio Fair, N.Y.C., October 14-17, Room 703 in the Hotel New Yorker.



HiFi Crestwood 400's

Crestwood engineering makes tape recorder history! Matches the finest professional equipment in hi-fi performance—frequency response of 30 to 13,000 cycles at 7½" per second tape-speed. Yet costs only \$199.50 to \$299.50 (taxes not included). All Crestwoods exceed NARTB standards.

NEW Crestwood 303

Nothing like it at the price—little like it at many times the price! Unusual high-fidelity performance—50 to 10,000 cycles frequency response at 7½" per second tape-speed—for only \$199.50 (taxes not included). Smart styling, too.

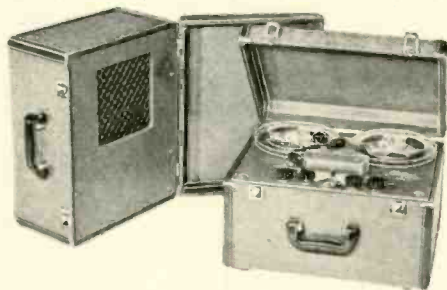

Crestwood
BY DAYSTROM

TAPE RECORDERS

Open a Brand New
World of Recorded Sound

SEND IN COUPON TODAY

Crestwood Division of Daystrom Electric Corp., Dept. AE-9, Poughkeepsie, N. Y.
Please send me complete information about the new Crestwood models.

My name _____

Address _____

City _____ Zone _____ State _____

1. Over-all tonal balance of the complete system.
2. Compensation for any acoustical such as resonance, for example.
3. Compensation for any deficiencies of studio equipment, means of transmission, or for faulty records.
4. Bass reduction to eliminate boominess of male voices, especially on low settings of the loudness control.

APPENDIX

Negative feedback can be employed to transform a net work into its reciprocal, as shown below. Although the following derivations are for ideal lead and lag networks, they apply equally on actual networks having two break frequencies, both being important in determining the over-all frequency response of the circuit.

1. Transformation of a Lag into a Lead Network (Bass).

Referring to the upper section of Fig. 1 we have,

$$\left[e_i - \frac{K_1 e_o}{T_1 S + 1} \right] K_1 = e_o$$

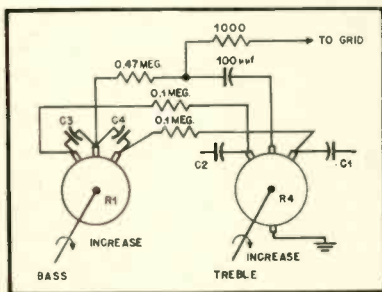

Fig. 5. Suggested wiring arrangement for the tone control. The two potentiometers R_1 and R_2 could easily be combined as a concentric control.

from which

$$\frac{e_o}{e_i} = \frac{K_1(T_1 S + 1)}{T_1 S + 1 + K_1 K_2} = \frac{K_1}{1 + K_1 K_2} \frac{(T_1 + 1)}{\left(\frac{1}{1 + K_1 K_2} \right) T_1 S + 1}$$

The original lag (B), has been therefore transformed into a lead network (B') having two break frequencies, $1 + K_1 K_2$ apart.

2. Transformation of a Lead into a Lag Network (Treble)

Referring to the lower section of Fig. 1 we have,

$$\left[e_i - [K_1(T_1 S + 1)] e_o \right] K_1 = e_o$$

from which

$$\frac{e_o}{e_i} = \frac{K_1}{K_1 K_2 T_1 S + 1 + K_1 K_2} = \frac{K_1}{1 + K_1 K_2} \frac{K_1 K_2}{\left(\frac{K_1 K_2}{1 + K_1 K_2} \right) T_1 S + 1}$$

The original lead network (C) has been transformed into a lag network (C').

The method of combining the two original networks (A) and (D) and the two modified networks (B') and (C') to obtain an overall response (boost in this case) is shown in Fig. 2.

When $T_b > T_a$ and $T_d > T_c$, then an attenuation of both extremes is attained, while at $T_a = T_b$ and $T_c = T_d$, we have a completely flat frequency response.



A new concept
of recorded music

THE HEATHKIT Dual RECORD PLAYER KIT

- Plays all record sizes, all speeds
- Newly developed ceramic cartridge
- Dual Matched speakers
- Acoustically correct cabinet enclosure
- Automatic shut off for changer and amplifier

MODEL RP-1

\$59.50

SHIPPING
WT. 30 LBS.
Shipped
Express
Only

Here is a new introduction to quality record reproduction. A simple to operate compact table top model with none of the specialized custom installation problems usually associated with high fidelity systems. Two matched speakers mounted in an acoustically correct enclosure reproduce all of the music on the record, reproduction with the unique sensation of being in a halo of glorious sound. This spectacular characteristic is possible only because of the diffused non-directional properties of the matched speakers. The performance level of the Heathkit Dual is easily superior to that of the ordinary

phonograph or console selling for many, many times the price of the Dual. Automatic record changer plays all three sizes at all three speeds with automatic shut off for both changer and amplifier after the last record is played. A wide range ceramic cartridge features an ingenious "turn-under" twin sapphire stylus for LP or 78 records without turning the cartridge. Simplified easy to assemble four tube amplifier featuring compensated volume control and separate tone control. Proxilyn impregnated fabric covered cabinet supplied completely assembled. You build only the amplifier from simple detailed step-by-step instructions. No specialized tools or knowledge required.

If a kit project has ever tempted you here is the perfect introduction to an interesting and exciting pastime. The Heathkit Dual Kit includes cabinet, record changer, two 6" speakers, tubes and all circuit components required for amplifier construction. Build the Heathkit Dual and enjoy unusually realistic room filling reproduction of fine recorded music.

OTHER Famous HEATHKIT AMPLIFIERS

THE HEATHKIT 6 WATT AMPLIFIER KIT

Model A-7B
\$15.50

Ship. Wt. 10 lbs.

The Heathkit Model A-7B Amplifier features separate bass and treble tone controls — two compensated inputs — three output impedances 4, 8, and 16 ohms — frequency response $\pm 1\frac{1}{2}$ db from 20 to 20,000 cycles — push pull beam power output at full 6 watts. Heathkit Model A-7C with preamplifier stage **\$17.50**

HEATHKIT High FIDELITY AMPLIFIER KIT

\$35.50

Model A-9A
Ship. Wt. 17 lbs.

A 20 watt high fidelity amplifier especially designed for custom installations. Low hum and noise level 9 pin miniature dual triodes in pre-amplifier and tone control circuits. Four switch selected inputs. Frequency response ± 1 db 20 to 20,000 cycles. Output impedances of 4, 8, and 16 ohms.

Write For Free CATALOG

New 32 page 1953 Catalog lists all kits, specifications, schematics and latest price information.

HEATH COMPANY
BENTON HARBOR 25
MICHIGAN

YOU SAVE BY ORDERING DIRECT FROM FACTORY

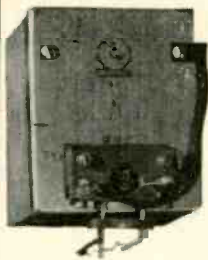

NOW AVAILABLE

The GRAMPAN Feedback Disk Recording Cutterhead Unit

Engineers and musicians now realize a perfect transient response of any recording system is of paramount importance—the Gramplan cutterhead with its precision-made true balanced armature and flux correcting feedback loop obtains this ideal.

The Gramplan is used by international radio networks to guarantee HI-Fidelity sound reproduction. You can achieve the same high quality results in your disc recording with the Gramplan.

After testing and experimenting with all types of equipment many famous record manufacturers, such as CAPITOL, are converting to the Gramplan Feedback Cutter for the best results.

For more information, write to

Wide frequency range
30 c/s to 20 kc
Low Distortion
Superior transient response



REEVEES EQUIPMENT CORP.
10 EAST 52nd STREET • NEW YORK 22, N. Y., U. S. A.
CABLE: REEVESQUIP, N. Y.

UNSURPASSED

- AUDIO FIDELITY!
- FURNITURE BEAUTY!



NEW

V-M triomatic 555 HIGH FIDELITY PHONOGRAPH



These V-M 555 features are PROOF of QUALITY:

- THREE 5" matched ultra-wide range speakers with heavy duty Alnico 5 magnets.
- 20 to 15,000 c.p.s. response from special, ceramic all-weather "flip-under" cartridge with 2 new type SAPPHIRE NEEDLES.
- Exclusive, resonance-free aluminum DIE CAST TONE ARM.
- 5 TUBE PERFORMANCE from 4 tube (plus rectifier) amplifier with push-pull output and dual purpose tube.
- NEGATIVE CATHODE feed back circuit eliminates intermodulation distortion.
- FULL RANGE CONTROL with conveniently located tone and volume controls.
- Free 12" LP Demonstration Record.
- WORLD FAMOUS V-M CHANGER eliminates record holders that grip the grooves, records LOWERED (not dropped) to spindle shelf. Siesta Switch automatically shuts off everything (amplifier too) after last record plays.
- TWO FURNITURE FINISHES, mahogany or limed oak. Handsome modern design, finest quality construction.
- Made by V-M Corporation, World's largest manufacturer of phonographs and record changers exclusively.

MAIL THIS
COUPON
FOR
COMPLETE DETAILS

V-M Corporation, Benton Harbor 6, Michigan
Please send me illustrated data on the V-M 555 high fidelity phonograph.
Name _____
Address _____
City _____, State _____

DECADER

(from page 34)

vided. Six "decades" are used, each of which has nine resistors of the same value connected therein, the several values being 10, 100, 1000, and 10,000 ohms, and 0.1 and 1.0 megohms. But it is immediately apparent that the permanent interconnection of all these six decades into one resistance unit is not desirable. For example, when work with triodes is underway, it would be possible to vary simultaneously both the plate load resistor and the cathode bias resistor if the resistor decades were split into two sections. This permits the user to determine quickly the proper combination for any particular tube type under study. This feature has been incorporated as detailed below.

Another consideration was the use of decimal values *vs.* the "preferred values" of resistor. The former were chosen, because it is impossible to secure simple ratios of resistance with any combination of the preferred values, thus impossible to secure known division of voltages with their use.

The Bridge

Having analyzed these possibilities, this project was further studied to see just how serviceable such an instrument could be made from a laboratory point of view. The availability of 1 per cent deposited carbon resistors for use in the decades makes possible a Wheatstone bridge of the same percentage accuracy by combining the decades with a galvanometer and a set of ratio arms. This has been done, using a fixed 1:1 ratio, because of the wide range of values on the "known" resistor arm. *Figure 1* shows the completed instrument in its case, while the interior construction and mounting of the battery is illustrated in *Fig. 3*. Incidentally, attention is drawn to the mothballs clearly shown in this latter picture, which have purposely been left in the case. This is a simple but valuable trick which will preserve low inherent contact resistance over long periods of time by retarding tarnish formation on the silver switch contacts. The schematic of the instrument is shown in *Fig. 2*.

To achieve the desired flexibility of circuitry, General Radio No. 938 binding posts and No. 938-L inter-connecting links are used. The grouping of six binding posts on the hexagonal pattern permits the following combinations to be achieved: the three low-value decades as a unit and the three high-value decades as a unit, independently but both at the same time; all six decades as a wide-range substitution resistor, the six decades as the known R of the bridge; as a bridge with the use of an external resistance box for the known R of the bridge; and finally as a bridge with a given resistor as the known R for purposes of matching pairs, without determination of the exact values of resistance. It is believed that no bridge commercially on the market today will

make all these various facilities available through its terminals. Figure 4 shows the proper interconnections of the three links and the external connections. As a bridge, the unknown resistance is connected to the left pair of terminals, those marked "X" on Fig. 2.

Construction Details

Ease of servicing as well as protection of the components require a workmanlike type of construction, and to keep the costs down a simple 10 x 12 in. bakelite panel is combined with a 10 x 12 x 3 chassis as the case into which to build the unit. The selection of switches is not so simple, for there are many types available, and some thought here led to the choice of a continuously rotating type. Anyone who has used a bridge or decade resistance box will immediately appreciate the convenience of continuous rotation. When this is coupled with a 20-position unit, so that starting with zero as a center it is possible to add either one or nine units of the decade with only one step of the switch, the ultimate in convenience has been achieved. The switches shown, by cross-wiring of the double set of contacts will afford this facility. Just why it is so desirable is easy to explain—when determining the value of an unknown

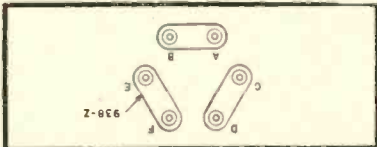

Fig. 4. Detail of terminal arrangement. Interconnections provide the following combinations:

Terms	Function
A-B	Known R arm of bridge to use external known resistor. Used to match a given resistor by connecting desired resistor to A-B and the unknown to X-X.
C-D	Terminals of the three high decades; provides values from 10,000 ohms to 10 megohms in 10,000-ohm steps.
E-F	Terminals of three low decades; provides values from 10 ohms to 10,000 ohms in 10-ohm steps.
C-E	All six decades in series, values from 10 ohms to 10 megohms in 10-ohm steps.
Strap D-F	To use the decades in the bridge.
Strap A-C, B-E, D-F	To use the decades in the bridge.

Note: In assembly, the links are permanently affixed to terminals C, D, and E.

R, and the introduction into the known circuit of another step of 10^2 ohms is too much, then the addition of $9 \times 10^{2-1}$ ohms will balance the bridge. If the inclusion of the larger resistor is just over the balance point, then commencing with nine times the smaller value will expedite the balancing operation.

The four push buttons beneath the meter serve to operate the bridge and at the same time shunt the meter at the outset to protect it from wild swings before the bridge is brought into balance. These are all DPST switches, the second, third, and fourth of which have been rebuilt so as to provide two pairs of contacts, one normally closed and one normally open, while the first push button has both pairs of contacts normally open. This rebuilding operation merely



"Of the very best!"

—HIGH FIDELITY MAGAZINE

FISHER

SERIES "50"

■ It is only natural that more than one manufacturer will claim his product is the best. For that reason it remains for you to be the judge. We say—*demand the specs.* Then check workmanship, performance and beauty of appearance. If you do all these things, the answer will inevitably be . . . THE FISHER SERIES "50." There is no finer made.

THE FISHER Master Audio Control MODEL 50-C

■ "One of the finest units yet offered to the enthusiast or audio engineer." —*Radio and TV News.* Can be used with any amplifier. 1M distortion virtually unmeasurable. Complete, professional equalization settings and tone controls; genuine F-M loudness control: five inputs, five independent input level controls, two cathode follower outputs. Self-powered.
Chassis, \$89.50 • With blonde or dark cabinet, \$97.50

THE FISHER FM-AM Tuner MODEL 50-R

■ Features *extreme sensitivity* (1.5 mv for 20 db of quieting); *low distortion* (less than 0.04% for 1 volt output); *low hum* (more than 100 db below 2 volts output.) Armstrong system, *adjustable AFC* with switch, *adjustable AM* selectivity, separate FM and AM front ends (shock-mounted), cathode follower output, fully shielded, aluminum chassis, self-powered. \$164.50

THE FISHER 50-Watt Amplifier MODEL 50-A

■ Truly the world's finest all-triode amplifier, yet moderately priced. A man's size unit! Less than 1% distortion at 50 watts (.08% at 10 watts.) 1M distortion below 2% at 50 watts. Uniform response within .1 db from 20 to 20,000 cycles; 1 db, 5 to 100,000 cycles. Hum and noise more than 96 db below full output. Quality components throughout. \$159.50

Prices slightly higher west of the Rockies

WRITE TODAY FOR COMPLETE SPECIFICATIONS

FISHER RADIO CORPORATION • 37 EAST 47th STREET • N. Y.

-to Gratify Your Wish for Excellence

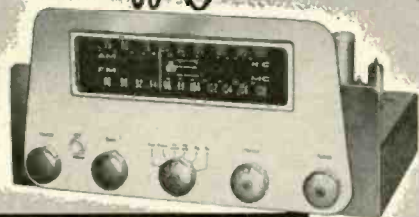

- SUPERB REPRODUCTION
- TECHNICAL SUPERIORITY
- HANDSOME STYLING
- OUTSTANDING PERFORMANCE
- EVERY OPERATING CONVENIENCE

BOGEN R-701 FM-AM TUNER

The Model R-701 is a truly superb FM-AM radio receiver designed expressly for the discriminating listener. It provides a quality of performance so brilliantly real and so vastly superior to standard mass produced receivers that it must be heard to be believed. Handsomely styled for custom installation, it is easily adaptable to any wall or cabinet closure. Six position function selector switch, volume control, and separate bass and treble correctors centralize all operation on one panel . . . permit remote location of the audio amplifier.



MODEL HO10 — A superb all triode amplifier providing minimum distortion (less than 0.3% at 10 watts), maximum response (flat 10-50,000 cycles), tremendous dynamic range and overall balance. Ideal for use with the R701 Tuner.

MODEL DO10 — New Popular priced Hi-Fi custom Amplifier, designed for use with the new R701 Tuner. Can be mounted directly behind the tuner in most installations. Ten watts output at less than 1% distortion. Response flat 20-20,000 cps.

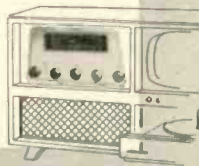

WRITE FOR LITERATURE
DAVID BOGEN CO., INC.
 29 NINTH AVE., NEW YORK 14, N. Y.

A Quarter Century of Electronic Equipment Specialization

the most widely used Electronic Supply Guide

free
 send for it

**ALLIED'S
 COMPLETE 268-PAGE
 1954 CATALOG**



the World's Largest Stocks of

ELECTRONIC SUPPLIES FOR INDUSTRY

Simplify the purchasing of all your electronic supplies and equipment. Send your orders to us at ALLIED—the reliable one-supply-source for all your electronic needs. Depend on us for quick shipment from the world's largest stocks of special-purpose electron tubes, test instruments, audio equipment, electronic parts (transformers, capacitors, controls, etc.) and accessories—everything for industrial and communications application. We make immediate shipment from complete quality lines that are always in stock. Send today for your FREE copy of the 1954 ALLIED Catalog—the complete up-to-date guide to the world's largest stocks of Electronic Supplies for Industrial and Broadcast use.

We specialize in Electronic Equipment for Research, Development, Maintenance and Production Operations

COMPLETE EXPERT Industrial Service

One complete dependable source for everything in electronics

ALLIED RADIO CORP.

100 N. Western Ave., Dept. 17-J-3
 Chicago 80, Illinois

SEND FOR FREE CATALOG



requires loosening of the spring pile-up screws and reversing of two of the contact springs, slightly bending them to secure a good firm closing of the contact when the button is in the non-operated position.

The galvanometer is quite a sensitive instrument, and was used because it was on hand. The over-all cost of the unit can be reduced by using a less sensitive unit, say 50-0-50 microamperes, with a slightly less sensitive indication on higher values of unknown resistance. Consequently it is necessary to determine experimentally the values of the meter protective shunts for any specific meter. The values shown here are recommended for the meter used.

The accuracy of the instrument as a bridge is determined by the accuracy of match of the ratio arms. Here some outside assistance will be needed, either by ordering a pair of resistors matched to better than one per cent accuracy or by actually selecting a matched pair with the aid of an accurate bridge. While exact value of resistance is unimportant, so long as they match perfectly, something in the vicinity of 10,000 ohms for these ratio arms seems desirable, being a good median for the range over which the bridge will operate successfully. With the internal battery of 7.5 volts the sensitivity is excellent to a megohm, and to 10⁷ ohms with a lower degree of precision. For best accuracy, a higher voltage is needed, say 45 volts, with a resistor of the order of 1000 ohms in series with the battery to protect the meter.

It is true that the accuracy of this instrument is only 1 per cent at best, which is less than a good commercially built bridge, but it is more accurate than any ohmmeter device, whether that be the one included with the usual multimeter or a vacuum tube voltmeter. Consequently the author felt that the inclusion of the bridge feature was well worth the added cost and the slight increase in physical size of the unit. It has already well repaid the expenditure of time and money in simplifying the design of several front-ends, as well as other devices for the design of which it has been utilized.

PARTS LIST

- 1 Bakelite panel, 10×12×3/16 in.
- 1 Steel chassis, 10×12×3 in.
- 1 Weston Model 801 microammeter, 10-0-15 μa (see text)
- 4 Switchcraft #1004 switches (see text for rebuilding data)
- 6 JBT MS-20-1-S switches, with EP-20 dial plates
- 8 General Radio 938-A binding posts
- 8 General Radio 938-Z insulators
- 3 General Radio 938-L links
- 9 each Welwyn type A-2 deposited carbon resistors, or equivalent, 1% accuracy. Values: 10, 100, 1000, and 10,000 ohms, and 1.0 megohms—total, 54 resistors
- 2 matched resistors, Welwyn A-4 or equivalent, approximately 10,000 ohms. (For ratio arms, see text.)
- 3 resistors, for meter shunts. Values used here are 600, 2700, and 5100 ohms. See text if used with other type of meter.
- 1 Battery, 7.5 volts

HORN ENCLOSURE

(from page 23)

place after all testing was completed. Plain 3/4-in. fir plywood was used for all internal members, and 2x2 in. square bracing material was used throughout for reinforcement.

Assembly of the horn is quite simple, as it had to be since no power tools were available. The total construction, including photographs and measurements, took slightly over two days. The fir plywood for the horn sections was ripped by the lumber-yard personnel into 13-in. strips, and one width of the birch plywood was ripped the long way into similar strips. The 2x2 braces were, for the most part, nailed and glued to the birch sheets, and to the horn sections. This work was done from the inside so that when completed there would be no nail holes to fill, and an unsullied surface would appear. Gaps were left deliberately between the segments of the horn curve, with the reasoning that there would be less tendency for strong vibrations to develop if each section of the curve were isolated from its neighbor. After the fast drying wood glue had set, felt strips were tamped into place between the loose joints on the curve; these can be seen in the photograph of the rear of the horn Fig. 6. The reflecting baffle at the base of the horn was made of a 13-in. strip of plywood oriented at approximately 45 deg., and braced between the upright 2x2 braces. Screws were then run in from the ends, through the side plates of the enclosure, and then covered. The two-inch space left between the top edge of the baffle-plate and the rear of the horn was filled with a piece of 2x2, and insulated from the baffle by a strip of under-rug matting, to prevent squeaks and rattles from developing due to intermittent contacts. The back was screwed on, with approximately half a gross of 2-in. wood screws run through the back and into the 2x2 braces along the horn, down the sides, and across the back-loading cavity.

A previous article² prompted the use of an inexpensive speaker for the horn

² Cameron Barritt, "Speaker treatment for improved bass." *AUDIO ENGINEERING*, Dec. 1952.

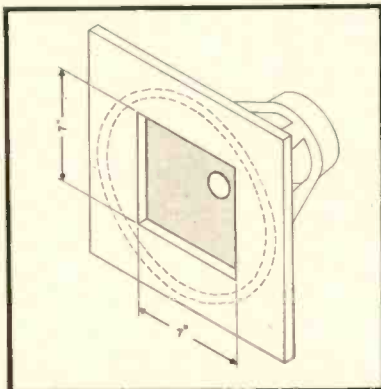

Fig. 8. Throat for low-frequency driver.

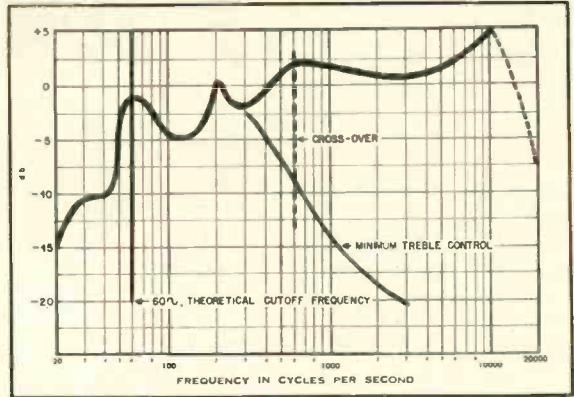

Fig. 9. Measured frequency response of the complete horn, including the mid-range unit.

From
Station Break
to Feature . . .
the NEW
"BALANCED"
TV Tripod
is doing a
whale of a job
every day!

"BALANCED"
TV TRIPOD
mounted on
3-wheel
portable
collapsible
dolly
illustrated.



We THREW THE book away and engineered a brand new "BALANCED" Tripod for every photographic and video need. The result—a revelation in effortless operation, super-smooth tilt and 360° pan action.

PERFECT BALANCE prevents mishap if the lock lever is not applied. Quick release pan handle locks into desired position. Mechanism is enclosed, rustproof, needs no lubrication. Tension adjustment for Camera Man's preference. Built-in spirit level. Telescoping extension pan handle. We defy you to get anything but the smoothest, most efficient operation out of this tripod beauty.

WE CALIBRATE LENSES . . . Precision "T" STOP CALIBRATION of all type lenses, any focal length. Our method is approved by Motion Picture Industry and Standard Committee of SMPTE. Lenses coated for photography. Special TV coating.

WE RENT AND SERVICE
CAMERAS * MOVIOLAS *

DOLLIES . . . Complete line of 35mm and 16mm equipment available for rental.

MITCHELL: Standard, Hi-Speed, BNC, NC, 16mm. Bell & HOWELL: Standard, Shiftover, Eyemos. MAURER: 16mm Cameras. ARRIFLEX. MOVIOLA: Editing machines, Synchronizers.

WE DESIGN and manufacture Lens Mounts and camera equipment for 16mm—35mm and TV cameras.

FRANK C. ZUCKER

CAMERA EQUIPMENT CO.

1600 BROADWAY
NEW YORK CITY

IF YOU WORK WITH FILM . . . It will pay you to get to know us. The country's foremost professionals depend upon our portable, versatile, adaptable equipment.



**THE NEW BN/mn DUAL PURPOSE
"PREAMPLIFIER" DESIGNED BY COOK**

AT AN AMAZINGLY LOW PRICE

Built to the highest specifications, and engineered by the originators of the Binaural record.

- The best performance at any price for single-channel listening
- Flexibility of operation — new features
- Built in equalization for both BN and mn compensation 6db/octave 20-20,000
- Single unit ganged controls for volume, Treble, bass (boost & droop)
- BN focus controls for balancing speaker volume levels
- BN channel reversing switch "puts strings on left"
- Selector switch provides for 2-speaker Monaural Playback
- Cathode follower outputs for distortionless response

WRITE FOR LITERATURE & SPECIFICATIONS

\$69⁵⁰
NET

AT YOUR DEALER

**COOK
LABORATORIES**
114 MANHATTAN ST.
STAMFORD, CONN.

HYCOR

TYPE 4200

Sound Effects Filter



This unit has been developed to meet present day requirements for compactness. The filter requires only 3½ inches of rack space.

Features . . .

- **LOW HUM PICKUP** through the use of toroid coils. The unit may be used in circuits having signal levels as low as -40 dbm without the necessity of taking special precautions against hum pickup.
- **LOW DISTORTION:** The filter may be used at levels up to plus 20 dbm with negligible intermodulation distortion.
- **RELIABILITY:** All capacitors and inductors are hermetically sealed for lifetime service. Aging effects are negligible.

General Specifications . . .

DIMENSIONS: Standard rack panel, slotted, 3½" high. Maximum depth 7½".
CONTROLS: Low frequency cutoff selector knob, high frequency cutoff selector knob, on-off key.
RANGES: Both low and high frequency cutoff controls cover 100, 250, 500, 1000, 2000, 3000, 4000 and 5000 cycles.
ATTENUATION: Approximately 16 db, per octave on both high and low frequency cutoff points.
IMPEDANCE: 500/600 ohms, in-out.
FINISH: Engraved panel finished in medium gray baked enamel. (Special colors available upon request.)
 The filter has standard input and output jacks located on the front panel in addition to the terminal block at the rear.

11423 VANOWEN ST., NORTH HOLLYWOOD, CALIFORNIA

HYCOR
Company, Inc.

SUNset 3-3860

Manufacturers of Precision Resistors, Toroid Inductors and Electric Wave Filters

REPRESENTATIVES:

Jack Beebe, 5707 W. Lake Street, Chicago, Illinois
 George E. Harris & Co., Box 3005, Municipal Airport, Wichita, Kansas
 Marvin E. Nulsen, 5376 E. Washington St., Indianapolis 19, Indiana
 Burlingame Associates, 103 Lafayette Street, New York City

For further information contact your nearest Hycor representative or write for Bulletin 5

driver. The speaker used was a 12-in. model, which was treated with glycerol, GC cement, and by slitting the rim. Figure 7 shows the details of the modifications, and Fig. 8 shows the loading applied to the speaker at the throat of the horn. The resonant frequency of this speaker was reduced from 70 cps to 53 cps. However, if a good woofer had been available, the special treatment might not have been necessary.

Performance

The enclosure is large, and there is no gainsaying it. However, in the months since it first sounded (and magnificently), it seems to the writer's family that it actually absorbs less living space than a corner horn. Probably this is due to the narrow upright structure, rather than one which juts out into the room, as a folded horn does.

A note should be added about the frequency response curve shown in Fig. 9. This curve, like all such curves, is an approximation, made with all the furniture in the house in normal position. During the measurement of the system, definite changes were noticed as the writer moved about the room. After graphing several curves, experimental curves were made, each time moving, or removing, a standard item of furniture, such as a chair. Each change caused the response curve to change markedly.

EQUIPMENT REPORT

(from page 43)

NEW LORENZ SPEAKERS

Immediately after avowing (in last month's LETTERS column) not to report on speakers, this department was shown a two-way system employing a pair of speakers imported from Western Germany by Kingdom Products, Ltd. On first hearing, these units appeared to have considerable promise, so they were checked by comparison with a large corner speaker considered by this reporter to be a standard, using the technique of making measurements over the frequency spectrum at ten different points throughout the room and then averaging. The results are shown in

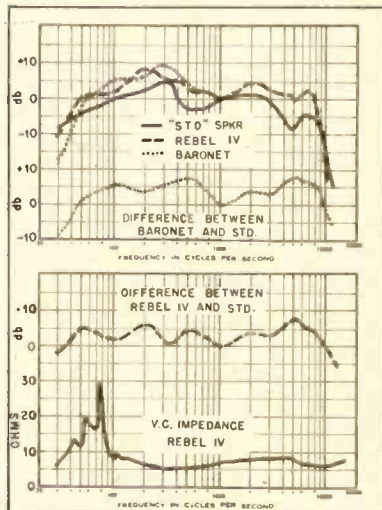

Fig. 4. Performance curves for the Lorenz units in two enclosures, as compared to a standard three-way corner speaker.

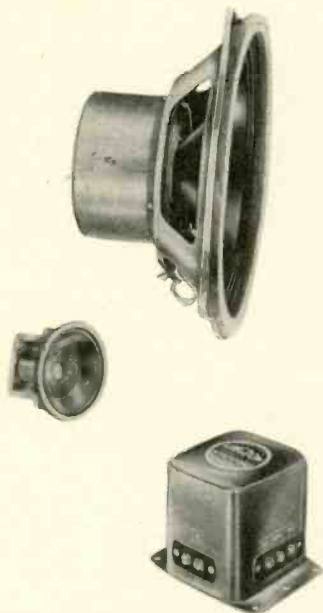

Fig. 5. The three components of the Lorenz system—8½" Woofer, 2½" tweeter, and dividing network.

Fig. 4 as a comparison, and also with the difference plotted for one of the cabinets.

The "Woofer"—although only 8½ in. diameter—has a free-air cone resonance of 83 cps. It mounts over a 7½-in. hole, and has a measured nominal impedance of 6.5 ohms. The tweeter—a design using a transparent plastic cone and a solid-backed cage so it can be mounted inside an enclosure with the woofer—has a higher impedance, and works with a dividing network which is also available. These components are shown in Fig. 5.

Measured in the Cabinart "Rebel IV" enclosure, Fig. 6, there was nearly as much output at 30 cps as in the comparison speaker, but there is a slight peak in the 100-150 cps range, as would be expected from the size of the Rebel IV. Measured in the Electro-Voice "Baronet," Fig. 7, the low-frequency radiation was only slightly less, and the character of the peak in the middle lows was different. In either cabinet, however, subjective reaction was excellent. The units were not tested with a balancing pot in the tweeter circuit, which accounts for the relatively high output in the range from 3000 to 9000 cps. A pot would correct this. It is believed that the Lorenz units with either of these cabinets would provide good quality at reasonable cost.

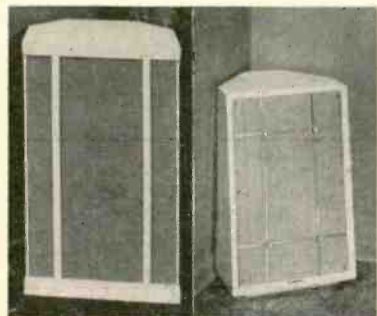

Fig. 6 (left), The Cabinart "Rebel IV," and Fig. 7 (right), Electro-Voice "Baronet."

TUNING FORK ACCURACY

Official, CITECH A.F. OF M 1917
ADOPTED BY U. S. GOVT 1920

Just like being there"
MODEL 1502

with the *Concertone* 1502

Driving the tape directly from the shaft of a two-speed hysteresis synchronous motor, this new Concertone recorder combines precise timing accuracy with unsurpassed sound reproduction. Concertone Model 1502... \$445.00

WRITE FOR BULLETIN 200

Manufactured by
Berlant Associates
4917 W. Jefferson Blvd. • Los Angeles 16, Calif.

NEW WILLIAMSON TYPE

Heathkit AMPLIFIER KIT

FEATURES

- Practically disturbanceless. Harmonic and intermodulation distortion both less than one half of 1% at 5 watts.
- Frequency response ± 1 db from 10 cycles to 100 kilocycles.
- After Loading PEERLESS or ACRO-SOUND transformers available.
- First Williamson type Amplifier supplied with matching preamplifier.

When selecting an amplifier for the heart of a fine high-fidelity audio system, investigate the outstanding advantages offered by the Heathkit Williamson type Amplifier. Here is an amplifier that meets every high-fidelity audio requirement and makes listening to recorded music a thrilling new experience through naturally clear, lifelike reproduction of sound at all tone levels. Wide acceptance of the Heathkit Williamson type Amplifier by the most critical purchasers clearly demonstrates that high-fidelity can be coupled with low cost. For factual information regarding the Heathkit Williamson type Amplifier, consult "CONSUMERS RESEARCH ANNUAL CUMULATIVE BULLETIN 1952-53."

This outstanding amplifier is offered with the optional choice of the ACRO-SOUND output transformer, or the PEERLESS output transformer. ACRO-SOUND features ULTRA-LINEAR circuitry, which is the exclusive development of the Acro Products Company and provides a greater margin of reserve power efficiency and increases power output. PEERLESS features optional primary taps to permit the optional choice of either the extended power circuitry, now enjoying current popularity, or all of the advantages of the original Williamson type circuit.

The construction manual has been simplified to the point where even the complete novice can successfully construct the amplifier without difficulty. Write for a free catalog containing complete specifications and schematic of the Heathkit Williamson type Amplifier.



PRICES OF VARIOUS COMBINATIONS

- W-2 Amplifier Kit (incl. Main Amplifier with Peerless Output Transformer, Power Supply and WA-P1 Preamplifier Kit) Shipping Weight 39 lbs. Shipped express only. \$69.50
- W-2M Amplifier Kit (incl. Main Amplifier with Peerless Output Transformer and Power Supply) Shipping Weight 28 lbs. Shipped express only. \$49.75
- W-3 Amplifier Kit (incl. Main Amplifier with Acrosound Output Transformer, Power Supply and WA-P1 Preamplifier Kit) Shipping Weight 31 lbs. Shipped express only. \$69.50
- W-3M Amplifier Kit (incl. Main Amplifier with Acrosound Output Transformer and Power Supply) Shipping Weight 28 lbs. Shipped express only. \$49.75
- WA-P1 Preamplifier kit only. Shipping Weight 7 lbs. Shipped express or parcel post. \$19.75

HEATH COMPANY
BENTON HARBOR 25, MICH.

A NEW PRINCIPLE IN TURNTABLES!

OUTSIDE IDLER DRIVE

***NON-METALLIC TABLE**
—Solid, 3/4" thick, dimensionally stable die stock—cork latex covering —non-bell-like—never needs lifting from well.

***CONSTANT SPEEDS**

33.33, 45, 78.26 — "Floating Idler" decouples motor vibration from chassis — sturdy, micro-balanced 4-pole induction motor on isolation mountings, carefully positioned for minimum hum.

Complex mechanisms are eliminated in the NEW D & R DR-12, the most significant advance in turntable design in 17 years!

A new magnitude in low noise level and IM distortion due to minimum flutter and vibration . . . all parts easily

See the NEW DR-12 at leading HI-FI dealers, or write for descriptive literature to . . . Audio Equipment Division, D & R, Ltd., 402 E. Gutierrez St., Santa Barbara, California

THE D & R DR-12, a completely new design, allowing improvements in basic engineering never before possible!

Turntable only, with standard panel mounting . . .

\$68.50

mahogany box mounting, extra

accessible, machined to professional tolerance . . . especially designed for the more exact requirements of LP record reproduction.

Acclaimed by HI-FI experts and broadcasters as the ideal combination of laboratory quality and moderate cost.

d & r LTD.

"SOMETHING FABULOUSLY BEAUTIFUL . . .

... Amazed by new purity of sound . . . clarity . . . clean definition!"

—Stereophile Record Reviewer



FAIRCHILD SERIES 215 HIGH COMPLIANCE Diamond Cartridge

First to achieve near-perfect lateral compliance — freedom of stylus to yield to rapid deflections of sensitive microgroove recordings — the amazing new Fairchild Series 215 provides all these exciting improvements:

★ New shades of tone color from fine recordings! ★ New clear timbre in high volume piano chords! ★ Rich low-frequency tones never previously heard! ★ Needle talk, record hiss, base concentration caused by arm resonance—reduced to a new low low! ★ Stylus wear vastly reduced, record quality preserved! ★ And above all — TRACKING DISTORTION ELIMINATED!

ORDER FROM YOUR
AUDIO DEALER
OR
Mail Coupon for
FREE "HI-FI Facts"
folder

Fairchild Recording Equipment Corp.
9th Ave. & 154th St., Whitestone, L.I., N.Y.
Please mail folder "Hi-Fi Facts" to:

Name _____
Address _____
City _____ State _____

VISIT US AT THE AUDIO FAIR, HOTEL NEW YORKER, OCT. 14-17

DICTATING MACHINE

(from page 28)

slot on the top of the machine. This is accomplished by two knives which ride under the slip and move up to perforate it when the keys are pressed.

A neoprene-covered friction wheel drives the turntable. This wheel is clutch operated, due to the fast start and stop requirements. The clutch electromagnet is energized through the hand microphone switch bar. This bar is depressed while dictating and may be locked for prolonged recording or playback. The magnet armature moves a linkage that forces the drive wheel against the turntable rim. The angle of contact between the turntable and drive wheel is such that the drive wheel is self-binding, ensuring against slippage. To compensate for drive wheel wear, the linkage incorporates a bow-shaped spring which has a pull curve matched to the pull curve of the armature. Two views of the mechanism are shown in Fig. 14.

Primary drive comes from a 3400-r.p.m. vertically mounted induction motor. Drive is transmitted by a neoprene belt to an intermediate pulley and from the shaft of the intermediate pulley by friction to the drive wheel. In general, sleeve bearings are employed in dictating equipment because of their quieter, smoother operation. However, the intermediate drive in this instrument uses small ball bearings because of the pull of the belt and thrust of the drive wheel.

A worm gear on the turntable shaft turns the feed screw, giving lateral motion to the recorder-reproducer carriage by means of a feed wheel driven by the feed screw threads. The feed wheel is frictioned against rotation during driving, but is slipped readily by the control knob during scanning. Movement of the recorder-reproducer carriage is transmitted to the indexing mechanism through the gear-rack arrangement previously described.

The Amplifier

The compact two-tube, three-stage amplifier was made possible through the development of an entirely new magnetic recorder head. This head, equipped with a permanent diamond embossing stylus, employs a reed-type armature damped only by the record groove. By elimination of the usual heavy external damping, efficiency was raised about 12 db, with only a 5-db rise at resonance. The amplifier has three R-C coupled stages using a 12AX7 tube for two stages of voltage amplification and a 6AK6 tube for beam-power single-ended output. The secondary winding of the output transformer provides a 4-ohm impedance to match the recorder in the high-frequency region. Figure 15 shows the complete schematic of the instrument.

Change-over from the recording to the reproduce circuit is obtained through

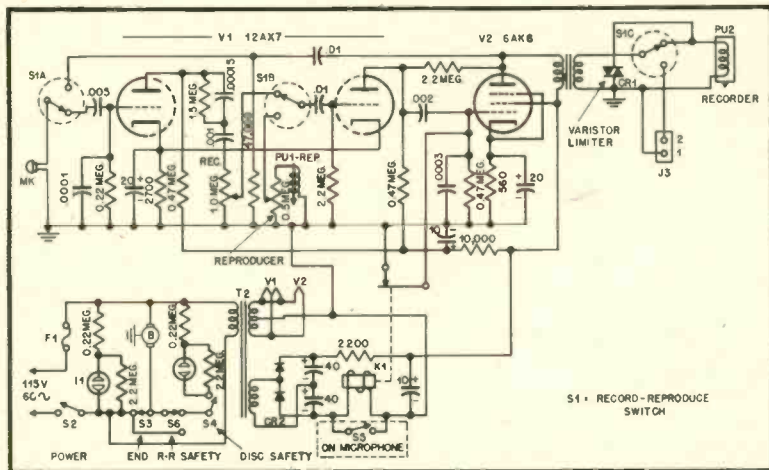

Fig. 15. Schematic of the VP Edison Voicewriter.

a specially designed 3-pole double-throw switch which incorporates flush-set silver contacts in a fully shielded design. This switch permits noiseless, undistorted change-over of high-gain, high-impedance circuits.

The playback circuit uses only the last two stages of the amplifier. In the reproduce position, playback is normally heard through the controlled-reluctance microphone. Connection is made to the microphone from the plate of the output tube through a coupling capacitor. At the same time, the secondary of the output transformer is connected to a receptacle in the back of the instrument. When the VP is used as a transcription instrument, the secretary plugs a listening device into this receptacle and starts and stops the turntable with a foot control plugged into the hand microphone socket.

The design of the power transformer called for the smallest practicable size due to space limitations. A full-wave selenium rectifier-doubler circuit is employed to cut down magnetization current and to enable the use of a high voltage.

The power transformer delivers 25 ma at 210 volts and isolates the instrument from the power line. Two stage, capacitor-input L-C filtering for the B supply is obtained by using the coil of the clutch electro-magnet as a choke in conjunction with two 40- μ f and one 10- μ f capacitors.

The amplifier tubes and most of the associated components are assembled on a compact mounting as a separate, easily replaceable unit. Most of the resistors and capacitors are soldered with short leads directly to the tube socket. Shielding problems are materially reduced in this way.

Conclusion

Many interesting problems must be

solved in the design of the electronic circuitry in dictating machines which are not shown up by the schematic diagrams of the finished product. As these instruments are connected at random into existing power outlets—often from improperly filtered inverter power supplies—they must operate satisfactorily with the plugs connected in either direction, grounded or ungrounded, and over a wide voltage range of 105 to 125 volts. As the experienced dictator rarely listens back to his recording, it can be seen that these requirements must be met without interest or knowledge on his part. This is quite different from devices in which the user's interest is primarily in listening, such as radios, phonographs and so on. To accomplish these results, it is important that currents in the chassis structure are either well controlled or well isolated from the wiring; that unknown, uncontrolled inverse feedback between wires and components does not take place; that shielding is complete and automatic so that service personnel cannot readily defeat it; that switching and other manually operated circuit devices manipulated during normal use of the equipment must have lives many times that found in apparently allied equipment. Furthermore, the whole electronic design must be such that proper results can be obtained by ordinary factory personnel.

The dictating machine is in fact a highly specialized recording system constructed to meet its requirements which differ so materially from those of other recording and/or playback devices.

PATENTS

Holland—1,229,749, June 12, 1917
 Holland—1,420,317, June 20, 1922
 Huenlich—2,042,228, May 26, 1936
 De Bernard—2,066,672, January 5, 1937
 Huenlich—2,092,917, September 14, 1937
 La Forest—2,218,542, October 22, 1940

THE AUDIO FAIR IS YOUR AFFAIR

PILOT
RADIO CORPORATION *Hi-fi*

Famous Williamson type MODEL AA-903 AMPLIFIER with built-in pre-amplifier



\$69.50

Williamson type 10 watt Amplifier. 7 tubes including Rectifier with push-pull output tubes. Controls are mounted behind decorative front panel which may be easily removed for cabinet installation, and include On-Off Volume, separate Bass and Treble Controls and Equalizer selector switch for LP, NAB, AES and Foreign Recordings. Frequency Response \pm 1DB 15 to 40,000 cycles. Distortion less than 1%. Hum level 70DB below 1 volt. Three inputs are provided for Radio and Auxiliary equipment and one input is provided with adjustable impedance for matching the various magnetic cartridges.

FM-607 FM PILOTUNER



\$59.50

8 tubes incl. Rectifier with two stage audio Amplifier and Cathode Follower Output for use with up to 100 feet of connecting cable. Audio Distortion .2% at 1 volt output, Frequency Response \pm .5DB, 20 to 20,000 cycles. Sensitivity 5 microvolts for 20DB quieting with hum level 70DB below 1 volt. Slide Rule dial with illuminated scale and self-contained front panel assembly with beautiful gold finish enables unit to be left open on shelf or easily mounted in cabinet. Three simple controls: On-Off Volume; Selector Switch for FM, FM with AFC, or Phono; and Tuning. Built-in line cord antenna.

Write for free brochure AE 5

PILOT
RADIO CORPORATION THE STANDARD OF EXCELLENCE
LONG ISLAND CITY, N. Y.



Broadcast Monitoring AMPLIFIER

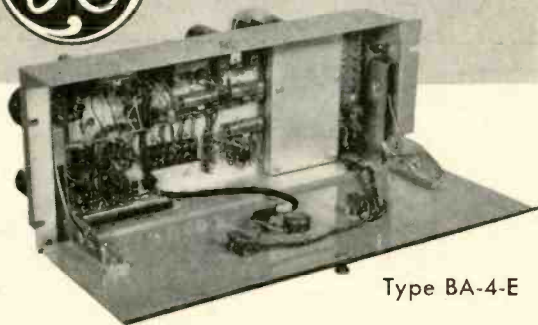

Type BA-4-E

- OUTPUT** 10 watts, ± 1 db from 50 to 15,000 cps, with 1½% or less distortion
- HIGH GAIN** 105 db., use for talkback, transcription cue, and playback applications
- COMPACT** Requires only 4 rack units of space—7"
- ACCESSIBLE** Hinged panel permits easy access to all components...speeds maintenance

Choose from a complete General Electric Amplifier line to fit every broadcast audio requirement.

For information write: General Electric Company, Section 4493, Electronics Park, Syracuse, New York

GENERAL  ELECTRIC

Check these features



- UNIFORM DEPENDABLE RESPONSE
- EXCEPTIONAL CALIBRATION STABILITY
- LABORATORY AND INDUSTRY—PROVED PERFORMANCE

for precision sound measurements and high quality recording

For more than sixteen years Kellogg Midget Condenser Microphones have been serving Industry and Research in sound measurements. Ruggedly constructed and humidity-proof, this microphone fully satisfies the exacting requirements of Laboratories for reliability and accuracy.

Users include government laboratories, universities, audio development laboratories, sound studios, and industrial plants manufacturing sound equipment.

KELLOGG

A Division of International Telephone and Telegraph Corporation Write to Dept. 27-1 today for full information

KELLOGG SWITCHBOARD AND SUPPLY COMPANY • Sales Offices: 79 W. Monroe St., Chicago 3, Ill.

ORGAN FOR ONE-FINGER ARTISTS

(from page 21)

C.) A second projection connects the D-E oscillator output to the chord signal busbar. A third tunes the G-G oscillator to G by closing the tuning contact for that oscillator. A fourth closes the contacts carrying G-G oscillator output to the chord signal bar. This completes the formation of the chord.

In addition a fifth lever projection connects a B-C oscillator output contact to the left pedal-signal busbar and a sixth connects the G-G oscillator output to the right pedal-signal bar.

The chord output signals from the chord signal busbar go to the chord control tube, shunted on the way by the MUTE switch which places a capacitor across the line to produce more "mellow" quality when desired. The tube, V_{11} , normally has 35 volts of negative bias on the grid from a fixed source, cutting off plate current. When the chord bar is pressed the bias disappears, allowing the chords to come through.

Chord signals also go through the SUSTAIN CANCEL switch to the input of the preamplifier, the grid of V_{20} , to the same point reached by the outputs of the solo and organ divisions. The pre-amplifier output goes to the second half of V_{20} , bypassing the chord control tube. Thus when the SUSTAIN CANCEL switch is closed a reduced-level chord signal comes through even though the chord bar may not be pressed.

The outputs of the two pedal-signal busbars go to the two pedals, which are mechanically interlocked. Considering only the signal contacts of the pedals, for the moment, output from whichever pedal is pressed goes to the input of a two-stage frequency divider exactly similar to those used in the solo division. In this way pedal tones two octaves below the chord tones are produced. The output of the frequency dividers goes through an R-C tone modifying network to the grid of the pedal control tube, V_8 . The grid is normally at 35 volts negative. When a pedal is pushed, a control contact on it removes the tube bias, allowing the tone to come through. The mechanical interlocking of the pedal-signal contacts is such that when the pedal is released the last signal contact made is maintained. This keeps the tone going while the bias on the pedal control tube slowly returns through the time-constant network and the tone dies away. The pedal FAST ATTACK switch modifies the time constant to make for faster attack and decay.

The output of the pedal control tube joins all the other signals at the grid of amplifier V_{20} , after passing through a pedal balancer potentiometer. The VOLUME SOFT switch in the grid circuit simply shunts the line to ground through R_{272} , reducing the volume of the entire instrument.

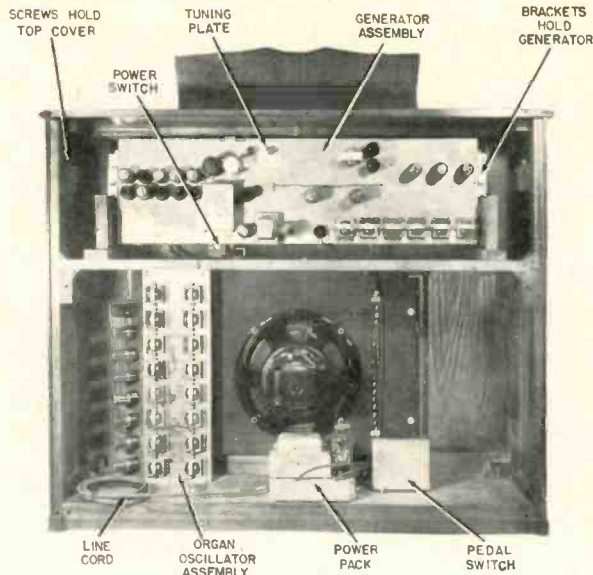

Fig. 8. Rear view of the instrument to show mounting of the various chassis.

The output of the amplifier triode goes to the expression control. This control is a special variable air capacitor with two stator plates. One stator is connected directly to the amplifier plate through a blocking capacitor C_{229} . The other stator plate is connected to the amplifier plate through a tone-compensated attenuation network. The rotor is connected to the No. 2 grid of a phase splitter of the common-cathode type. The position of the rotor, controlled through a knee lever extending from the underside of the organ keyboard, controls the level of the signal reaching the phase splitter.

The phase splitter is the driver for a conventional push-pull 6V6 output stage. Radio-phonograph inputs are provided at the phase-splitter grid. The amplifier has a negative-feedback connection from output transformer to the phase splitter grid, the frequency characteristic of

which can be adjusted somewhat by a variable capacitor. The vibrato of the Chord Organ is similar to that in the Solovox, a phase-shift oscillator and switch tube connected to the grids of the oscillators through a switch which grounds the grid circuits when vibrato is not desired.

Organ Division

The circuit of the organ division is shown in Fig. 7. The generator system for the 37 tones consists of sixteen L-C oscillators, each of which can be tuned to either of two frequencies, except for the lower four and upper one, which can be tuned to three frequencies.

The tuning is done automatically when a key is pressed. Normally the lowest oscillator, for instance, the first triode of V_{121} is tuned to the frequency of low G by C_{87} across the tuning in-

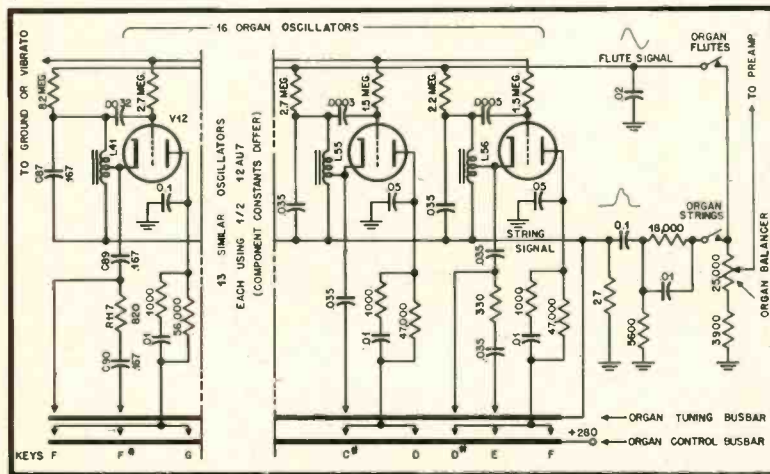

Fig. 7. Simplified schematic of the "organ" section. Sixteen separate oscillators provide 37 notes, each oscillator being tuned to one of either two or three adjacent tones.

PILOT Hi-fi

RADIO CORPORATION

For maximum performance at the lowest possible price

The AF-723 HI-FI FM-AM PILOTUNER



\$79.95

8 tubes, two stage Audio Amplifier with cathode follower. 10 MV sensitivity on FM and AM. Hum level 70 DB below 1 V. Audio output 5 V, audio distortion .2% at 1 V, audio frequency response $\pm .5$ DB, 20 to 20,000 cps. Built-in FM and AM antennas, AFC Switch disables AFC on weak stations.

THE AA-902 AMPLIFIER



\$46.95

Williamson Type Amplifier with interleaved wound Output Transformer and push-pull output. Contains 5 tubes. Frequency Response ± 1 DB, 15 to 40,000 cps at 10 watts. Distortion less than 1% at 10 watts.

THE PA912 PRE-AMPLIFIER



\$49.95

4 tube self-powered. Voltage output 5 V. Frequency Response 1 DB, 20 to 100,000 cps. Distortion .2% at 1 V. Bass and treble controls. Selector switch to choose signal from any one of 4 playback equalizers. Attractive bronze cabinet.

Underwriters Approved
Write for free brochure AE 5

PILOT THE STANDARD OF EXCELLENCE

RADIO CORPORATION
LONG ISLAND CITY, N. Y.

if you are
concerned with
**POWER
SUPPLIES**

you should have
the new and
comprehensive

LAMBDA

catalog

of electronically
regulated
laboratory

power supplies.

Manufactured by
one of America's
pioneer specialists,
this field-proven
precision equipment
is priced
surprisingly low.



SEND FOR NEW CATALOG

Lambda Electronics Corp.
103-02 Northern Blvd., Corona 68, N. Y.
Please send me the new Lambda Power
Supplies Catalog as soon as it comes off
the press.

Name _____
(Please print)
Title _____
Company _____
Street _____
City _____ Zone _____ State _____ AE-953

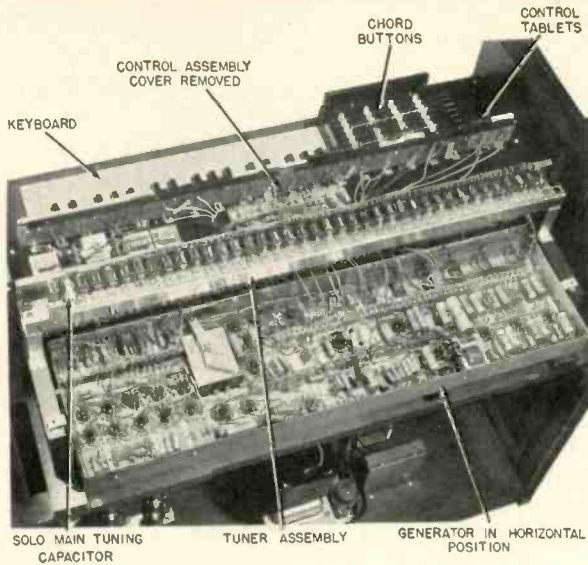

Fig. 9. Top view of the organ with the upper chassis swung down for test or repair.

ductor. When the F# key is pressed a contact connected to the lower end of C_{90} strikes the upper busbar, connecting $C_{89}-R_{147}-C_{90}$ across half the coil and lowering the frequency. When the F key is pressed a contact connects only C_{89} across the lower half of the coil, further lowering the frequency to F.

The organ oscillators are normally not operating because they have no plate voltage. Whenever a key is pressed, a contact in the lower row strikes the lower busbar. This carries the B-supply of 280 volts to the plate of the, corresponding oscillator through a simple R-C network which softens the attack somewhat.

Each organ oscillator has two outputs, one from the upper end of the tuned circuit giving a sine-wave or flute tone, and the other from the lower end, giving a waveform like that shown, known as the string tone. All similar outputs of all oscillators are paralleled and brought through tab switches and tone modifying networks to the organ division balancer, the arm of which goes to the common preamplifier grid.

It should be noted that four busbars run under all the keys. Two are shown

in Fig. 7 and two in Fig. 5. The idea of using one oscillator for two or three notes is that not too much music calls for simultaneous playing of two adjacent notes, especially the fairly simple music which a typical Chord Organ player would probably use. The frequencies covered by the organ oscillators are 174.6 to 1397, the F below middle C to that three octaves higher.

Construction

Despite the apparent complexity of the Chord Organ it is extraordinarily compact. Figure 1 shows the main controls. Figure 8 is a rear view showing how the electronisms are mounted in the case. Figure 9 is taken from above the rear of the organ with the top removed and the upper chassis swung down for test or repair. The organ works with the chassis in this position, except that the expression control lever will not actuate the control. The linkage for it can be seen in the chassis. Figure 10 is the front of the organ with top removed, and the board holding the tab switches taken off and lying upside down.

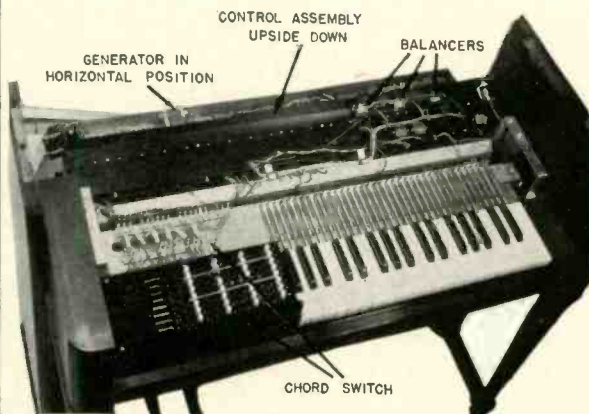

Fig. 10. Front view with the key section exposed.



HALF FULL? OR HALF EMPTY?

*Don't rely on adjectives!
Performance is no longer
a matter of opinion!*

THE REVOLUTIONARY NEW COOK SERIES 50 N-A BEAM 12" TEST RECORD

- rigorously tests tracking of cartridges distortion of amplifiers, speakers
- just play it and listen for the "A" or the "N"*
- without meters or instruments
- impartially selects the best equipment
- repays the user 100 fold

If not in stock at your dealers
write direct.

\$4.80 plus 50¢ packing and
postage.

*code "A" (dot-dash) means all right —
(less than 2% cross modulation distortion
at high frequencies)

**code "N" (dash-dot) means not all right
— sweeps entire upper audio range
from 20 kc down.

COOK LABORATORIES
114 MANHATTAN STREET
STAMFORD, CONN.

UNIVERSAL AMPLIFIER

(from page 44)

ously employed. This permitted the use of a 4-section electrolytic capacitor for plate-supply decoupling and for bypass across the cathode resistor of the output stage, since space enough for this capacitor (a Cornell-Dubilier UP-22245C) was available along the rear of the chassis. The feedback capacitor C_n is mounted between the output transformer and the filter capacitor.

With all of the transformers and these two capacitors mounted along the rear of the chassis, space was available for the mounting of the tubes in a row, thus making it possible to locate all six of them on a single rubber-mounted aluminum channel, basically similar to that used for the first four tubes in the original construction. The resistors and capacitors related to the tubes are mounted on a resistor board which is spaced about $\frac{1}{4}$ in. below the socket terminals. This

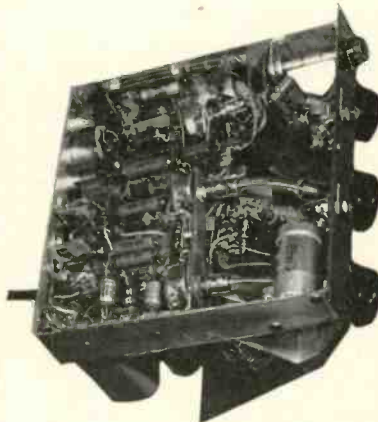

Fig. 3. Bottom view of second model of the amplifier to show placement of volume controls and short flexible shafts from knobs on panel to the controls. This permits considerably shorter leads from the tube-mounting channel and the associated circuits to the controls, with appreciably less need for equalization to maintain high-frequency response.

resistor board was made up from a punched phenolic strip and a number of terminals supplied by NAALD. With these terminals and the punched strips, and using the small staking tool designed for applying them, it is possible to make up any kind of terminal strip desired. For this particular application, a total of 31 resistors and capacitors are mounted on a single strip just below the tube sockets, thus making for short leads from the socket terminals to the associated components.

The volume controls are mounted on two brackets—one holding R_n , and the other holding R_r and the inclusive control, R_n . Short flexible shafts are used between the knobs and the controls— with panel bearings and shaft extensions

PILOT
RADIO CORPORATION **Hi-fi**

For the ultimate in HIGH FIDELITY TUNERS the AF-824 FM-AM PILOTUNER

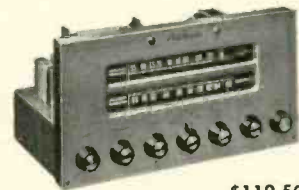

\$119.50

10 tubes, with two stage pre-amplifier equalized according to LP NAB, AES and foreign recording standards selected by Switch. Three magnetic phono and crystal and AUX. inputs. Two stage audio amplifier with cathode follower output. Sensitivity of FM-AM 10 MV. Audio frequency response $\pm 1/2$ DB, 20 to 20,000 cps. Hum level 80DB below one volt with hum balancing adjustment provided. Controls: Volume, Equalizer, Treble, AM-FM-PHONO-AUX, Bass, Tuning and AFC on-off. Built-in antennas for FM and AM.

THE AA-901 AMPLIFIER



\$99.50

New improved Williamson type Amplifier using famous KT-66 tubes. **Power Output: 10 watts — less than 0.1% distortion, 25 watts — less than 0.3% distortion, maximum output — 30 watts.** Frequency Response ± 1 DB 15 to 50,000 cycles. Hum Level 90 DB below 10 watts. Speaker output impedance 8 and 16 ohms. Tube complement 6SN7GT, 6SN7GT (2), KT-66 (2) Push-Pull Power Amplifier, 5U4G Rectifier.

Underwriters Approved
Write for free brochure AE 5

PILOT
RADIO CORPORATION THE
LONG ISLAND CITY, N. Y. STANDARD OF
EXCELLENCE

The
Best
Seats
in the
House...

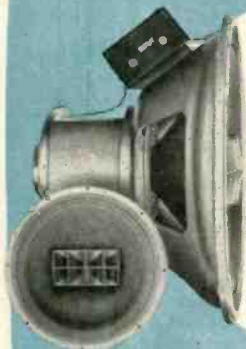

You
hear it
all —
as though
you were
there ...
when
you use
a

Stephens TRU-SONIC SPEAKER

Regarded as the international standard in high fidelity sound equipment, STEPHENS speaker systems are used throughout the world by the most discriminating listeners.

It's a SOUND PRINCIPLE
when you say

STEPHENS
TRU-SONIC

MANUFACTURING
CORPORATION

8538 Warner Drive • Culver City, Calif.

used at the panel to provide a good bearing for the knob shafts. The flexible shafts can be seen in Fig. 3.

The principal change in circuitry is in the cathode-follower section, V_6 in the original circuit, and V_{6a} and V_{6b} in the revised arrangement. This provides some additional gain so that when the unit is used with a home radio system, the output at terminal 3 of J_8 is at the same level as the signal fed into terminal 2—the loop circuit between the FM tuner and the remainder of the system. One section of the 12AU7 is employed as an amplifier, with about 10 db of gain; the other section is a cathode follower, and feeds the signal out at a low impedance. J_{10} has been added, with the voltage divider R_{10} and R_{10} , so that an ordinary patch cord may be inserted between J_{10} and J_1 to permit the use of the amplifier as an artificial reverberation generator. Performance is somewhat improved, and the level available at J_{10} is just sufficient for convenient operation of the gain control, R_{11} . Note that the voltage divider consists of a 0.1-meg resistor and a 27-ohm resistor, which provides only a very small portion of the total output signal at the cathode of V_{6b} for feeding back into the circuit on the grid of V_2 .

One other refinement in the circuit is the addition of a dialogue equalizer between the plate of V_2 and the gain control of the microphone channel. This equalizer consists of R_{12} and C_{12} , and serves to reduce the gain approximately 10 db at 100 cps, with a gradual slope up to normal gain at 500 cps. A SPST switch, Centralab 1460, is mounted on a bracket attached to the side apron of the chassis, with the shaft extending through a hole in the front apron, as shown in Fig. 3.

The use of a 12AU7 instead of the 5879 in the monitor circuit changes the requirements of the heater circuit somewhat, and the new wiring is shown in Fig. 1. The VU meter lights were changed to No. 47's, and the resistor between them in the meter case was increased to 32 ohms to reduce the illumination to a suitable intensity.

Construction

The basic construction plan is the same as in the original model—minor changes being made to accommodate the components used in the improved version. The 4-section filter capacitor is mounted directly on the chassis in holes punched, drilled, and filed by hand—rather than on a standard phenolic mounting wafer—in order to save space. The 2-section capacitor C_{2a} and C_{2b} is mounted on the right side apron of the chassis just behind the front panel as shown in Fig. 3. The two cathode bypass capacitors C_{1a} and C_{1b} are mounted on the resistor board, and are C-D BBR 50-6 capacitors, 50 μ f at 6 volts, and quite small.

The components of the dialogue equalizer, R_{12} and C_{12} , are mounted directly on S_{w2} , and the components of the tape playback equalizer are mounted on a small resistor board just above the dialogue equalizer switch. By using two

to the

E. E. or

PHYSICS GRADUATE

with an interest
or experience in

RADAR or

ELECTRONICS

Hughes Research and Development Laboratories, one of the nation's large electronic organizations, are now creating a number of new openings in an important phase of operations.

Here is what one of these positions offers you

OUR COMPANY

located in Southern California, is presently engaged in the development of advanced radar devices, electronic computers and guided missiles.

THESE NEW POSITIONS

are for men who will serve as technical advisors to the companies and government agencies purchasing Hughes equipment.

YOU WILL BE TRAINED

(at full pay) in our Laboratories for several months until you are thoroughly familiar with the equipment that you will later help the Services to understand and properly employ.

AFTER TRAINING

you may (1) remain with the Laboratories in Southern California in an instruction or administrative capacity, (2) become the Hughes representative at a company where our equipment is being installed, or (3) be the Hughes representative at a military base in this country—or overseas (single men only). Adequate traveling allowances are given, and married men keep their families with them at all times.

YOUR FUTURE

in the expanding electronics field will be enhanced by the all-around experience gained. As the employment of commercial electronic systems increases, you will find this training in the most advanced techniques extremely valuable.

*How
to
apply*

*If you are under 35 years of age
and have an E.E. or Physics
degree and an interest or
experience in radar or electronics,*

write

to **HUGHES**

RESEARCH AND DEVELOPMENT
LABORATORIES

Scientific and Engineering Staff
Culver City,
Los Angeles County, California

Assurance is required that the relocation of the applicant will not cause the disruption of an urgent military project.



the world's finest Microphones



Extremely smooth frequency response, wide dynamic range, complete absence of distortion and noise. Readily changeable field pattern. Small outside switch provides either highly directional or non-directional characteristic.



MODEL U-47M
Condenser Microphone,
power supply, cables
and plugs.

Complete **\$390⁰⁰**

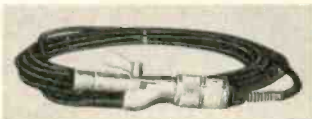

Specifications — U 47 M

Frequency response ± 3 db 30—16,000 cps.
Output impedance 30/50, 200/250 ohms, bal.
Field pattern non-directional or cardioid
Output level at 1000 cps.
Matched with 200 ohms—
cardioid 2.8 mV per dyne/cm² (—49 db)
non-dir. 1.7 mV per dyne/cm² (—53 db)
Residual noise level equivalent 24 db loudness
Non-linear distortion less than 1%

PARTIAL LIST OF USERS

RCA Victor
Reeves Sound Studios
Decco Recording

Cinerama, Inc.
20th Century Fox
Ampex Corp.

Write us for information
on the Mighty Midget Mike #201M

AMERICAN ELITE, INC.
1775 Broadway • New York City • Plaza 7-7276
Sole Importer, and U.S. Agent

Mallory extension bushings, S_{w1} has been lowered to a position where the terminals are about flush with the chassis deck. A small resistor board, located between R_7 and R_8 , and mounted on the bracket which holds the two pots, provides for R_{17} , R_{18} , and R_{19} , the mixer network, as well as for R_{20} . R_{20} connects directly from one of the terminals of the capacitor C_5 to the ungrounded end of R_{18} . R_{20} is connected directly from terminal 4 of the output transformer to a terminal of C_{12} .

A small shield made of tin was required to eliminate all traces of oscillation due to the proximity of J_1 and J_2 .

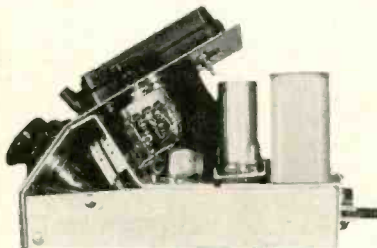

Fig. 4. View of right end of the chassis to show placement of tube channel on which all six tubes are mounted.

Before this shield was installed, the amplifier would go into oscillation when R_{12} was turned up past 50-per cent rotation. The shield eliminated the trouble completely.

The new model has all of the operating conveniences of the original, together with improved frequency response and the added advantage of the dialogue equalizer on the microphone channel. If necessary, a similar equalizer could be wired into the second channel, but the writer's requirements have not made it necessary yet. Perhaps that will come in the third version—although to date there have been no indications that this second model will be rebuilt.



Employment Register

POSITIONS OPEN and AVAILABLE PERSONNEL may be listed here at no charge to industry or to members of the Society. For insertion in this column, brief announcements should be in the hands of the Secretary, Audio Engineering Society, P. O. Box 12, Old Chelsea Station, New York 11, N. Y. before the first of the month preceding the date of issue.

* Positions Open • Positions Wanted

* **ENGINEER.** A progressive organization engaged in designing, developing, and manufacturing of electro-mechanical equipment for the geophysical industry and for the Armed Forces is in need of a graduate Physicist or Electrical Engineer with at least three years development experience to develop low-frequency audio circuits. Established in 1930, our company and subsidiaries total about 2000 people. We operate in Asia, South America, Canada, and the United States. Manufacturing involves more than 900 people, including 220 in the Research and Engineering Division. Reply by letter, giving resume of training, experience, salary requirements, and a recent photograph to P. O. Box 7045, Love Field, Dallas, Texas.

PILOT
RADIO CORPORATION *Hi-fi*

TV-520 REMOTE CONTROLLED VHF-UHF 24"-27" TELEVISION RECEIVER SYSTEM

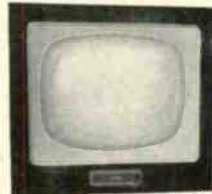

Note
cleancut
design
in rear
view



Remote Control Unit—Separate unit in mahogany, or limed oak, veneered cabinet includes VHF and UHF Tuners. Self-powered, can operate more than one picture unit. Incorporates an improved high fidelity intercarrier sound system, and is designed to receive color. Contains 12 tubes plus rectifier.

Picture Unit—Major picture controls available from front panel, improved synchronizing circuits assure positive picture lock, automatic vertical retrace blanking and positive, steady interlace. Contains 17 tubes, with 10 watt push-pull high fidelity Amplifier and 40' interconnecting cable.

TV-520 — \$346.00
less picture tube and speaker

Mounting Kits—Designed for single point suspension of 24" or 27" tubes. Ready for quick assembly complete with plywood base, front panel, mask, hardware and safety glass. Oversized panel can be cut down to fit custom installations. Supplied in mahogany or limed oak finish.

TM-527, TM-524 — \$53.50

Write for free brochure AE 5

PILOT
RADIO CORPORATION *THE STANDARD OF EXCELLENCE*
LONG ISLAND CITY, N. Y.

For the perfection you dream of in a Hi-Fi Amplifier...



BELL Model 2199



SPECIFICATIONS

Power: 12 watts at less than 1%. Peak 16 watts.
Frequency Response: 20 to 20,000 cycles plus or minus 1/2 db, with controls set for flat response.
Inputs: Radio, crystal, mag. (2), TV and tape.
Controls: Selector with record equalization; Bass; Treble with AC sw.; compensated volume; Motor rumble sw.; Loudness comp. in or out sw.
Output Imp.: 4, 8, 16 ohms. High imp. jack for tape recorder.
Pwr. Cons.: 80 watts;
117 volts; 50-60 cycles.



Completely new! Bell engineering makes this an audiophile's dream! 12 watts or more of 99% distortion-free power. Printed circuit, compensated volume control. Bass and treble boost and cut, a switch to cut loudness compensation in or out, and a motor rumble suppressor switch give assured control for best performance!

BELL Sound Systems, Inc.

559 MARION RD., COLUMBUS 7, OHIO
EXPORT OFFICE: 401 BROADWAY, N. Y. 13

WRITE FOR CATALOG NO. 101

Authoritative and Enlightening ...



*Acknowledged the Leading Publication
in the Field of Sound Reproduction*

If you are novice, hobbyist, experimenter, or engineer ... if you are a lover of music ... and in pursuit of sound, undistorted ... Audio Engineering will be your faithful, reliable companion all the way. You will find no more pleasureable and stimulating reading than there is in AE; absorbingly interesting material, valuable and authentic data, workable detailed instructions ... all comprehensively and yet practically presented.

"What to Do" and "How to Do" will guide your every move through this thrilling experience we call Audio.

Each new issue brings New Ideas, New Slants, and Latest Developments ... month in and month out ... twelve times a year.

BE SURE to get your copies REGULARLY.

**MAIL this
Coupon
NOW**

AUDIO ENGINEERING

P. O. Box 629, Mineola, N. Y.

Enclosed is Check Money Order for \$ _____
Please send a copy of each new issue of Audio Engineering for the next
 12 months; 24 months to:

Please Print

Name _____

Address _____

City _____ Zone _____ State _____

Subscription Price: U.S.A., Canada and Pan American Union: 1 year... \$3.00 2 years... \$5.00. Other countries: 1 year... \$4.00 2 years... \$7.00.

PATENTS

(from page 4)

of the tape holding the three tracks affected by the 1200-cps wheels. The magnetism shown on the tracks was produced by the beating of an 1800-cps signal frequency with the 1200-cps modulator wheels. During the first third of the 1800-cps signal it was most nearly in phase with the upper wheel teeth. As the signal cycle came into its second third, its phase advancing with respect to the modulator frequency, it was most nearly in phase with the second wheel teeth. And so on for the remaining third. At the beginning of the next cycle the whole process is repeated. We thus have for any signal frequency, a beat on the tape, a third of each cycle in one of the three tracks, with the track of greatest magnetism shifting from top to bottom whenever the signal frequency is higher than that of the modulator. Whenever it is lower, the shift will be from bottom to top, as in Fig. 4.

When the tape is played back on the same mechanism, exactly the same action takes place in reverse. In each case the reproduced frequency is either the sum or difference between the tone actually on the tape and the frequency of the associated modulator wheels, the choice depending automatically on the direction of phase rotation. When a given signal frequency can produce beats with any other of the wheel frequencies the same action takes place simultaneously and in playback the signal is again reproduced and combines with the same signal reproduced from any other beats.

The 9-wheel modulator system described is just a sample. Its maximum signal-frequency handling capabilities would be only about 4800 cps, assuming the speed to be slow enough so that the tape could handle beat frequencies up to 2400. To produce a system capable of 9000-cps performance at 1 ips, 21 modulator wheels would be needed, 3 each with 8, 16, 24, 32, 40, 48, and 56 teeth, giving modulator frequencies of 1200, 2400, 3600, 4800, 6000, 7200, and 8400 cps. Then the tape speed can be cut down to where 1200 cps represents the top recordable frequency (actually only 600 is needed, and a 100 per cent margin is added) while the system as a whole can record and reproduce everything up to 9000.

The tape savings of such a machine would be enormous. How noisy it would be, how faithfully it would recreate complex waveforms from the recorded beat frequencies, and how precision of construction and rotation of the high-speed modulator would affect practicality, I have no idea. If you'd like to have more detail and a fuller explanation, you can obtain a copy of the patent for the standard 25 cents from The Commissioner of Patents, Washington 25, D. C.

BOOK REVIEW

(from page 12)

near alike will make frequent reference. This reviewer feels that the chapter on mathematics in Section 2 might better have been here, for easier reference in the book.

This is a long review—it covers a "whale" of a book. At its price, no one who is seriously interested in problems of audio can afford to forego it for his reading shelf. It is a goldmine of information not only for what it contains within its own pages but also for the entire technical literature to date.

—L. B. Keim

New Portable Battery-Operated Spring-Motor Tape Recorder



The Magnemite*

For all field recording without AC power! Smaller and lighter than a portable typewriter, the Magnemite* actually makes field recordings that can be played on any studio console equipment. Completely self-powered, the Magnemite* does away with bulky and cumbersome generators, storage batteries and rechargers.

Just check these unusual features:

- Noiseless and vibrationless governor-controlled spring-motor assures constant tape speed.
- 100 operating hours per set of inexpensive flashlight-type dry cell batteries.
- Earphone monitoring while recording, and earphone playback for immediate quality check.
- Operates in any position, and is unaffected by movement or vibration during operation.
- Warning indicator tells when to rewind, and shows when amplifier is on.
- Broadcast models weigh 15 pounds. Slow-speed models weigh only 10 pounds.
- Requires no more desk space than a letterhead, measuring only 11 x 8 1/2 x 5 1/2 inches.

There's a choice of 5 different models for any recording need. High fidelity units, meeting primary and secondary NARTB standards, which record and play back frequencies up to 15,000 cycles, are available for broadcast stations, critical music lovers, and scientific research. For investigation, missionaries, reporters, and general dictation while traveling, there are units which play up to 2 hours per reel of tape.

Write Dept. AE today for complete descriptive literature and direct factory prices.



AMPLIFIER CORP.
of AMERICA

398 Broadway, N. Y. 13, N. Y.

*Trade Mark Reg.

D. C. PACK

(from page 33)

using a shunt or bleeder resistor, as required, so that the proper current will flow through the heaters. If a suitable power supply is available, this is the simplest and cheapest method. The voltage drop across the heaters is sometimes used as bias for the power output stage, eliminating the need of a relatively high-wattage cathode resistor.

The second method, often used in commercial equipment, is to connect the heaters in parallel and operate them from a low-voltage, high-current power supply. Parallel operation of the heaters is convenient, but suitable rectifiers and transformers are not readily available from the usual parts distributor, and the cost of such parts tends to be high.

The third method, used in the supply described in detail here, employs an isolation transformer with a 117-volt secondary, a selenium-cell bridge rectifier, adjustable series resistor for voltage adjustment and filtering, and two 150-volt electrolytic capacitors. All parts are standard items, readily available. The part values are chosen so as to furnish 150 ma at any voltage from 12 to 72, as may be required, with a ripple of 1 per cent or less. Although there is no objection to operating any of the tubes in an amplifier on d.c., it is usually not necessary for hum reduction in stages where the signal voltage averages one volt or so. In practice, the phono, tape and microphone pre-amplifier and the tubes in the equalizing pre-amplifier are d.c.-operated to advantage. It may also be desirable to supply d.c. to the heater of the high-frequency oscillator of the FM tuner, if modulation hum is encountered. As almost all 6.3-volt tubes currently used in oscillators and low-level audio stages have 12.6-volt equivalents, no difficulty will be experienced with tube selection. The tube heaters should be connected in series with the first, or lowest-level tube, connected to the negative terminal of the power supply.

Another feature of this supply is its ability to furnish up to 90 volts or so of fixed bias for the more efficient operation of Class A or A₁ output tubes. The bias is adequately filtered and adjustable from zero to the maximum value. For experimental or test work, the isolation transformer can be used separately, being switched to a two-pole utility receptacle for that purpose.

Construction

The mounting of the parts is not critical, provided a normal amount of ventilation is furnished. The unit built by the author was mounted on a 5x7x2-in. chassis, the parts being arranged as shown in Fig. 1. The cardboard covered filter capacitors R₁ and the fuse are mounted underneath the chassis. On the front can be seen the bias-adjusting pot and the a.c. on-off switch. On the back

The famous

EMITRON

KT66



SPECIFY

"EMITRON KT66"

- WORLD'S FINEST POWER TRODE
- PERFECT COMPLEMENT TO WILLIAMSON CIRCUIT
- INTERCHANGEABLE WITH 6L6
- SOLD EVERYWHERE

KINGDOM PRODUCTS LTD.

45 W. 45th ST., NEW YORK 36

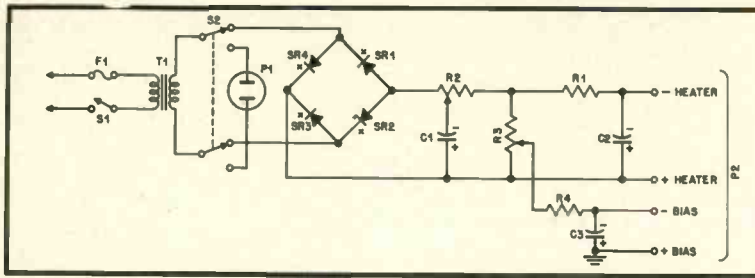

Fig. 2. Schematic of the d.c. power supply.

of the chassis are the line cord, the 4-terminal output socket, the two-pole receptacle, and the secondary switch for the transformer. The four rectifiers are

mounted by passing a threaded rod 4 in. long through the center holes and supporting it at the ends with two $1\frac{1}{2} \times \frac{1}{2}$ -in. angle brackets. Small rubber

SOUND INSTALLATIONS SOUND GOOD

—THROUGHOUT THE ROOM



Lowell

SPEAKER BAFFLES

"WITH FLOATING CONICAL ACTION"

Handsome Lowell ceiling speaker baffles are accurately engineered to provide 360° of distinct, low level sound coverage without distorting echos. Perfect speaker cone loading reduces feedback to absolute minimum to help you solve the most difficult acoustic problems. Conical diffuser mounting through soft rubber grommets eliminates metallic resonance. Lowell baffles are heavy gauge aluminum spinings finished in brushed satin, coated with colorless lacquer. Lacquer is excellent primer if on-the-job painting is desired.

PLEASE WRITE FOR COMPLETE SPECIFICATIONS AND LOW PRICES.

LOWELL MANUFACTURING COMPANY

3030 Laclede Station Rd., St. Louis 17, Mo.

In Canada: Atlas Radio Corp., 560 King St., West, Toronto, Ontario



AL Series Speaker Baffles for low ceilings. Sizes for 6" to 15" speakers.



BL Series Speaker Baffles for normal height ceilings. Sizes for 6" to 12" speakers.



CP and XCP Series Back Cover Speaker Enclosure for new or existing construction. Protects speaker from mortar, rodents, etc. All steel construction. (Model CP shown.)

grommets protect the leads passing through the chassis. The values of R_1 , R_2 and C_2 are selected from Table 1. Figure 2 is the complete schematic for the unit.

For increased tube life—and in some cases for lower tube hiss—it is recommended that 12 volts be applied to 12.6-volt tubes and 6 volts to 6.3-volt tubes. A fine adjustment of the heater voltage is made by varying the position of the tap of R_1 . It should be noted that there is no direct connection between the heater supply and the chassis, which is grounded. This is done so as to permit a wider choice in the selection of a heater grounding point in the amplifier. The proper point to ground the heater string is determined by turning on the amplifier and then running a lead from the point where the audio input jacks connect to the amplifier chassis to the tube heater pin which produces the least hum. Usually this is either the more negative terminal of the first tube or between the first and second tubes.

TABLE 1
Values for R_1 , R_2 , and C_2

Output (volts)	R_1 50-W fixed	R_2 50-W adj.	C_2 150-v. Electrolytic
12	500	200	80 μ f
18	500	200	80
24	500	100	40
30	500	100	80
36	500	100	80
42	250	250	40
48	250	250	40
54	250	150	40
60	250	150	40
66	200	100	80
72	200	100	40

After the ground connection to the heaters has been made, then the fixed bias is adjusted to the desired value by means of the 50,000-ohm pot.

The advantages of using d.c. on the heaters of low-level stages can be fully appreciated when it becomes possible to turn the gain up to maximum—with no signal input—without any output from the speaker, except a possible increase in tube hiss. When such a condition is reached, the system may be said to compare with professional installations, assuming that its other characteristics are equally ideal.

PARTS LIST

C_1, C_2	40 μ f, 150-volt, elect.
C_3	See text and Table 1
F_1	1-amp. fuse
P_1	2-pole female receptacle
P_2	4-hole socket
R_1, R_2	50-watt wirewound; see text and Table 1
R_3	50,000-ohm potentiometer
R_4	47,000 ohms, 1-watt
S_1	SPST toggle switch
S_2	DPDT toggle switch
SR_1, SR_2, SR_3, SR_4	150-ma., 130-volt selenium rectifiers
T_1	Isolaton transformer, 117/117 volts (Merit P-3096 or equivalent)
	Fuse clip
	5 × 7 × 2 chassis
	Knob for R_3
	Line cord and plug

AT LAST! THE CD-53 "SYMPHONY"

Highest Quality
and Performance
Yet Achieved in a
Record Changer



DISPLAYED IN ROOM 718
Palmer House, Chicago

SEPTEMBER 1-2-3

or write to

THORENS COMPANY
NEW HYDE PARK, N. Y.

made in Switzerland
by

THORENS

• PLAYS BOTH SIDES of all micro-groove and standard records at 33-1/3, 45 and 78 rpm.

• Plays nine 10" and 12" records mixed in any order, or twelve 7" records at 33-1/3, 45 or 78 rpm.

• Two motors E 53 with precision governor.

ME VISUALIZER

(from page 31)

there should be no possibility of over-modulation, regardless of the system of recording being employed. With controllable delay time, it is easily possible to record a piano with full knowledge of the maximum peak value of the signal at any time with an indication that is easy to read and which is not tiring to the eyes. Various types of signals will be found to require the use of different types of presentation and different delay times, but the engineer will quickly learn which is most suitable for his own method of operation.

While some types of recording are not degraded greatly by minute amounts of overmodulation, it is well agreed that when recording on film overmodulation is objectionable. This instrument provides a reliable indication of the recorded signal at all times, and permits some flexibility of indication to suit the needs of the engineer.

chassis. The unit is
ting, and occupies
nel space.

and the former with
a conventional oscilloscope connected to
the Visualizer by the two output cables.

Applications

Those experienced in recording will immediately recognize the value of an instrument of this type. With instantaneous peak indication of signal level,

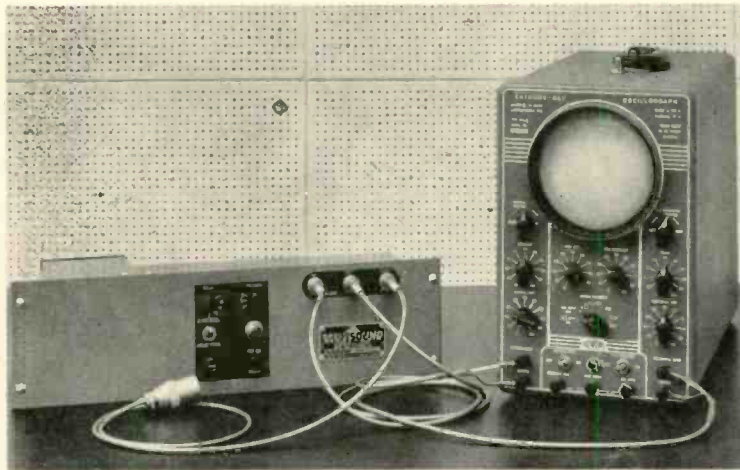

Fig. 5. Panel view of the instrument with a conventional oscilloscope.

SOUND HANDBOOK

(from page 38)

about five watts, after which the bias shifts progressively through the range of Class AB₁ into Class AB₂. This is done in order to maintain the optimum bias for a given signal amplitude, and the amplifier power output capabilities at low distortion are increased.

The Output Transformer

A generator facing a load through an ideal transformer will be blind to the transformer and will only see the load connected across the secondary, stepped up or down in value by the impedance ratio of the windings (the square of the

Fig. 12-25. Equivalent circuit to output transformer. (The transformer itself is assumed ideal.) R_w = d.c. winding resistance; L_1 = Leakage inductance; R_s = Shunt resistance equivalent to core loss; C_w = Capacitance across windings; L_s = Shunt inductance of winding; C_{w-s} = Capacitance between windings (eliminated by electrostatic shield.)

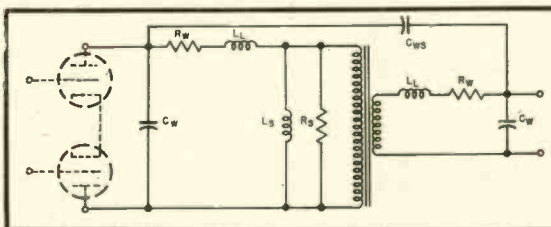

15 or 12 in.
Bass Reflex Cabinet

High Fidelity

at moderate cost*

Every essential for superb tone— $\frac{1}{2}$ " wood sides, $\frac{1}{2}$ " acoustic lining, 4.3 cu. ft. capacity, heavy construction (wt. 31 lbs).

But moderate cost with leatherette covered sides. Hand rubbed solid mahogany or blonde hardwood around front adds genuine richness. Compare it with any other and see for yourself. Only \$45.00 net (slightly higher west of Rockies).

Send for FREE Folder

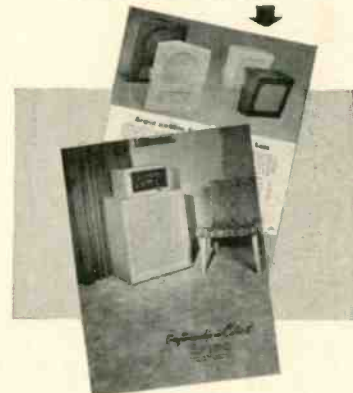

*By makers of famous TV Tube Caddy®





**OWN THIS GREAT LIBRARY
for complete authoritative
analyses of all important
AUDIO AMPLIFIERS**

Only data of its kind available on hundreds of important audio amplifiers. Complete, uniform, detailed analysis of each unit, based on actual laboratory study of the equipment. Includes circuit diagrams, chassis photo views, parts data, full technical coverage. Available in four profusely illustrated volumes—absolutely indispensable to audiophiles, engineers and students.

VOL. 4. Covers 75 audio amplifiers and important tuners produced during 1951 and 1952. Never before available in a single compilation. 352 pages, 8½ x 11".
ORDER AA-4. Only **\$3.95**

VOL. 3. Covers 50 audio amplifiers and 22 FM and AM tuners made during 1950. Detailed data on design and servicing. 352 pages, 8½ x 11".
ORDER AA-3. Only **\$3.95**

VOL. 2. Covers 104 amplifiers and 12 tuners produced in 1949. 368 pages, 8½ x 11".
ORDER AA-2. Only **\$3.95**

VOL. 1. Covers 102 post-war amplifiers and tuners produced through 1948. 352p, 8½ x 11".
ORDER AA-1. Only **\$3.95**

BEST-SELLER ON AUDIO!



"The Recording and Reproduction of Sound"

Only *complete* reference on **AUDIO!** New second edition—over 800 pages. Chapters on sound wave behavior; recording methods; the decibel; phono reproducers; cutting styli; microphones; loudspeakers;

dividing networks; attenuators; mixers; amplifiers; tuners; home music systems—hundreds of other subjects. The great Audio book by Oliver Read—largest-selling in its field.

ORDER RR-2. Only **\$7.95**

HOWARD W. SAMS & CO., INC.

Order from your Parts Jobber today, or write direct to Howard W. Sams & Co., Inc. 2201 East 46th St., Indianapolis 5, Ind.

\$.....enclosed. Send following books:
 AA-1 (\$3.95) AA-3 (\$3.95) RR-2 (\$7.95)
 AA-2 (\$3.95) AA-4 (\$3.95)

Name.....

Address.....

City..... Zone..... State.....

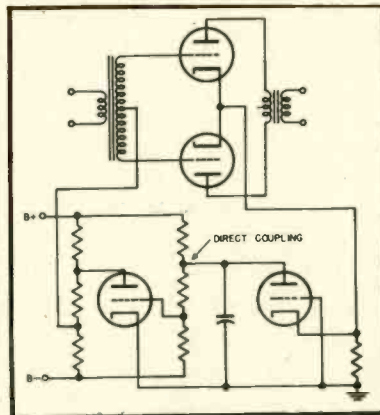

Fig. 12—24. Automatic bias control providing progressive transition from Class A₁ through Class AB₂ operation.

turns ratio).

This ideal case is never realized. Distortion is introduced by non-linear magnetization characteristics of the core, frequency transmission falls off at extremes of the reproduced spectrum, and phase shift is introduced to sabotage feedback circuits. In Fig. 12—25 the transformer itself is assumed ideal, but circuit elements equivalent to the physical characteristics of actual transformers are inserted, in series or in parallel as they appear to the generator, as "lumped" impedances. The labels on these impedances are self-explanatory except in the case of leakage inductance. This is the effect of the less than perfect magnetic coupling between primary and secondary—all of the magnetic flux produced by the current does not lie within the core and does not perfectly link all the turns of both windings. The appearance of a primary winding shunt inductance of finite value is an indication of the fact that, even with the secondary unloaded, some signal current flows through the primary.

Energy dissipation will take place due to the added resistive elements, there will be treble losses due to the shunt capacitance and series inductance, and bass losses due to the shunt inductance. The effect of core non-linearity does not appear in the equivalent circuit.

The output transformer is normally the most critical unit of the audio amplifier, and, if it is included in the feedback loop, the number of db of compensatory feedback that can be applied over the output stage is limited by this same component.

Other Characteristics of the Output Stage

1. Power Sensitivity. This defines the relationship between output signal power and input signal voltage. Expressed in mhos (a unit reciprocal to ohms):

$$\text{Power Sensitivity} = \frac{P}{(E_v)^2}$$

where P = output power in watts
 E_v = input signal voltage

Power sensitivity is a more useful index of power amplifier operation than voltage gain, since we are not directly interested in the output voltage as such.

*where precision
matters...*

THERMADOR



*Transformers for Television
... Radar ... Aircraft ...
Geophysics ... Radio*

You will find Thermador ready, willing and fully qualified to handle your transformer requirements. Engineering experience and manufacturing know-how, developed over a period of 35 years, form the hard core that makes Thermador today's largest West Coast manufacturer of electrical appliances and transformers. We would like to work with you on your next project involving the design and production of transformers for specific requirements...including joint Army-Navy specifications.

transformers:

- | | |
|-----------------|---------------------|
| Audio Auto | Geophysical |
| Driver Filament | High-Fidelity Audio |
| Input-Output | Midget Plug-In |
| Plate Power | Television |
| | Tube to Line |

... also Chokes and Reactors



**THERMADOR ELECTRICAL
MANUFACTURING CO.**

5110 District Boulevard • Los Angeles 22, Calif.

Music Lovers and *Professionals*
RECOGNIZE THE INIMITABLE

MODEL 12A4
10 WATT

MODEL 10C4
30 WATT

Naturalness
 IN SOUND REPRODUCTION

MODEL 7
SELF-POWERED PRE-AMP

AFFORDED ONLY

BY **BROOK**

HIGH QUALITY AUDIO AMPLIFIERS

Write today for complete technical data; also name of nearest dealer. Dept. AJ-3

BROOK ELECTRONICS, INC.
First in the High Quality Audio Field Since 1936
 34 DeMART PLACE, ELIZABETH, N. J.

Pentodes and beam-power tetrodes have a higher power sensitivity than triodes, and negative feedback reduces the power sensitivity (not the power capability) of both. The use of additional pairs of tubes in parallel-push-pull does not increase the driving signal voltage requirements where no power is consumed by the input circuit, but does increase the power output, thereby increasing power sensitivity.

2. *Frequency Response.* The power output vs. frequency curve of the output stage is controlled by the effect of the speaker load reactance, as discussed, and by the reactive characteristics of the output transformer. Frequency discrimination may also be introduced by the input network coupling the voltage drivers to the output stage grids, a topic which will be discussed in the section on voltage amplifiers.

3. *Harmonic Distortion.* The harmonic distortion rating of a power amplifier, in its most useful form, lists the percentages of distortion separately for each of the harmonic orders instead of presenting them as a single vector sum. A rating of this type will show, for example, that pentodes and beam-power tetrodes produce more odd and higher order spurious harmonics than triodes, increasing the need for feedback in their cases. It is also useful to know the distortion percentages as a function of frequency.

4. *Operation of Pentodes as Triodes.* Pentodes may be used as triodes by tying screen and plate together, either directly or through a stopping resistor of 100 ohms or so. The tube then takes on triode characteristics. A type of in-between operation is also possible, in which the connection between the screen grid and the output transformer primary is made neither at the center tap (pentode operation) nor at the plate end (triode operation)—but at a point intermediate between the two.¹² The load is thus distributed between the plate and screen, and the voltage on the screen grid varies inversely with the signal, constituting negative feedback to the screen. The circuit, which is called "Ultra-Linear," (See Fig. 12-26) may make possible a reduction in the cost of high-quality amplifiers, since more power at low distortion levels can be drawn from the same tubes. It has been criticized,¹³ however, as requiring especially rigid production control over the output transformer.

5. *Plate Dissipation.* Kinetic energy of the electrons in the cathode-plate stream is converted into heat when the electrons strike and enter the plate. The allowable amount of energy that can be so dissipated is limited by the fact that high

¹² David Hafler and Herbert I. Keroes, "An ultra-linear amplifier," *AUDIO ENGINEERING*, Nov. 1951, p. 15.

¹³ D. T. N. Williamson and P. J. Walker, "Amplifiers and superlatives," *Wireless World*, Sept., 1952, p. 357.

What's NEW
 in **AUDIO**
 ?

If it's NEW... **TERMINAL** has it!
SEE! HEAR! and COMPARE!
 the Finest Audio Equipment at **TERMINAL** Completely Equipped Sound Studios

Featuring The World's Leading Makes of High Fidelity Equipment.

Audio Devices
 Acro • Ampex
 Astatic • Alltec
 Atlas Sound
 Amplifier Corp
 of America
 Audak • Amphenol
 Brociner
 Browning
 Broxon • Bell
 Bogen • Brush
 Cabint • Centralab
 Clarkstan • Crescent
 Concertone
 Cook • Conrac
 Duotone • Espey
 Electro-Voice
 Fisher • Fairchild
 General Electric
 General Industries
 Garrard • Gray
 Grammas
 Hallcraft
 Hallcraft
 I.R.C. • Jensen
 Karison • Leak
 Lowell • Livingston
 Market
 McIntosh
 Minnesota Mining
 Masco • Melmsner
 Magnecord
 Newcomb
 Orradio • Pickering
 Presto • Penlon
 Permoflux • Pilot
 Reeves Soundcraft
 R-J • Rex-O-Kut
 Rauland • Revere
 River Edge • R.C.A.
 Radio Craftsmen
 Recotron • Racoon
 Stephens
 Stromberg Carlson
 H. H. Scott
 Sonotone • Shure
 Standard Wood
 Products
 Tech Master • Thorens
 Tapemaster
 University
 Ultrasonic
 U.T.C. • V.M.
 Webster Chicago
 Webster Electric
 Wharfedale
 Weathers

FISHER
 FM-AM Tuner
 Model 50-R

BOGEN
 High Fidelity Amplifier
 Model DB 20

GARRARD 3 Speed
 Automatic Record Changer
 Model RC-90

CONCERTONE
 Recorder 1502 D

The TERMINAL WAY is THE SOUND WAY
 to Your Audio Satisfaction!

FREE! NEW 1954 AUDIO GUIDE

Over 130 pages packed with everything you want to know about all the latest High Fidelity Audio, P. A., and Sound Equipment... The most Complete Buying Guide of its kind for Music Lovers, Audio Engineers, Professional and Industrial users of Sound Equipment. Reserve Your FREE Copy NOW For Early Mailing... Write Today! (Dept. AE-9)

Visit Our Sound Studios

Phone: WOrth 4-3311

Terminal
 RADIO CORP.

85 Cortlandt St. • New York 7, N. Y.

SAVE
33 $\frac{1}{3}$ %



This is our

GROUP SUBSCRIPTION PLAN

You and your friends and co-workers can now save up to \$1.00 on each subscription to **AUDIO ENGINEERING**. The more men in a Group, the more each saves. If you send 6 or more subscriptions for the U.S.A., and Canada, they will cost each subscriber \$2.00, 1/3 less than the price of a regular 1-year subscription. **Present subscriptions may be renewed or extended as part of a Group.**

AUDIO ENGINEERING is still the only publication devoted entirely to

- Audio
- Broadcasting equipment
- Acoustics
- Home reproduction systems
- Recording
- PA systems
- Psychoacoustics

(Please print)

Name

Address

Position Company

Name

Address

Position Company

Name

Address

Position Company

Name

Address

Position Company

Name

Address

Position Company

Name

Address

Position Company

U. S., Possessions, and Canada only.

RADIO MAGAZINES, INC.
P. O. Box 629, Mineola, N. Y.

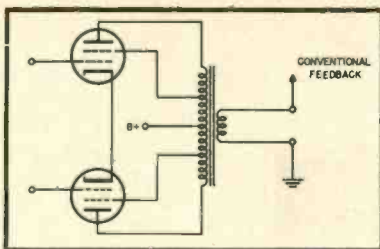

Fig. 12-26. Ultra-linear output circuit, in which the screen grid is connected to tap of output transformer, taking up part of the load and receiving a negative feedback voltage.

plate temperatures will cause secondary emission of electrons or will release gas from the plate. Operating conditions for output tubes—the magnitude of the plate and screen voltages and the amount of current allowed to flow—rarely approach the point of maximum plate or screen dissipation, but the extent to which they do will be an index of the life expectancy of the tubes. Class A operation has the highest no-signal plate dissipation.

6. *Plate Efficiency.* Plate efficiency refers to the relationship between signal power output and B supply power consumed; the miles per gallon rating, so to speak, of the output stage. This rating describes the distribution of power between plate-screen dissipation and the output signal. It may be of importance in large commercial installations or in communities where the price of electrical power is high. Triodes have a much lower plate efficiency than pentodes or beam-power tetrodes. Class A operation provides the lowest plate efficiency; the plate efficiency of a power amplifier increases as the no-signal plate current is reduced and the class of operation is changed towards Class C.

The plate efficiency of a stage may be expressed as follows:

$$\text{Plate Efficiency (\%)} = \frac{P}{E_{av} I_{av}} \times 100$$

where

E_{av} = Average d.c. plate voltage
 I_{av} = Average d.c. plate current
 P = Power output in watts

REFERENCES

Lawrence B. Arguimbau, "Vacuum-Tube Circuits," John Wiley and Sons, Inc., New York, 1948; Chapters 6 and 8.

Albert Preisman, "Loudspeaker damping," **AUDIO ENGINEERING**, March, 1951, p. 22, and April, 1951, p. 24.

Herbert J. Reich, "Theory and Applications of Electron Tubes," McGraw Hill Book Co., Inc., New York, 1944; Chapters 5, 6, and 7.

F. Langford Smith (Editor) "The Radio-tion Designer's Handbook," 3rd ed. Wireless Press. Sydney, Australia (Reproduced by Radio Corp. of America) Chapters 2, 3, 4, 6, and 26.

R. C. A. *Receiving Tube Manual*, R. C. A. Tube Department, Harrison, N. J., 1950, pp. 3-30.

J. G. Frayne and Halley Wolfe, "Elements of Sound Recording," John Wiley and Sons, Inc., New York, 1949; Chapter 5.

Measurements Corporation
MODEL 31

INTERMODULATION METER

- Completely Self-Contained
- Direct Reading For Rapid, Accurate Measurements

To insure peak performance from all audio systems; for correct adjustment and maintenance of AM and FM receivers and transmitters; checking linearity of film and disc recordings and reproductions; checking phonograph pickups and recording styli; adjusting bias in tape recordings, etc.

The generator section produces the mixed low and high frequency signal required for intermodulation testing. A direct-reading meter measures the input to the analyzer section and indicates the percentage of intermodulation.

MEASUREMENTS CORPORATION

BOONTON NEW JERSEY

Altec — V-M — Brook — Bell — Jensen

Hi-Fi

TEXAS-TV

"Southwest Sound Hq."

A corner of one of the Texas-TV air-conditioned Hi-Fi demonstration rooms in which all major lines of sound and recording equipment can be demonstrated "at the flick of a switch".

WEATHERS FM PICKUP . . . One-gram stylus. Pressure eliminates record wear. 20-20,000 response with negligible distortion. Supplied with oscillator delivering .5 volt into high impedance. **\$37.50**

"HOME MUSIC SYSTEMS" . . . New book by Edward Tatnall Canby explains Hi-Fi, recommends brands & models, tells how to test and repair equipment, build baffles, install units. Gives list of nearest dealers. **\$3.95**

HORN LOADED SPEAKER KIT . . . by Cablnart. Gain a full octave of smooth bass. All panels pre-cut and sanded ready for finishing. Kit includes everything needed. For 15-inch speakers **\$23.95** . . . **\$19.95**

SAVE—We Prepay Between Alleghenies & Rockies

TEXAS-TV

506 W. Hildebrand Avenue
San Antonio 12, Texas

Clarkstan — University — Ampex — Cablnart

Electro-Voice — Presto — Scott — Stephens — Mettelson — Pilot — Weathers — Tannoy — Melstner

AUDIOLOGY

(from page 14)

Class AB₁ Operation

When the output stage employs a more efficient class of operation, such as push-pull Class AB₁, high conduction by one tube is accompanied by essential non-conduction by the other tube. The result is that the output transformer half-primary on the inactive side is temporarily unterminated, and with likely detrimental effect upon the gain-phase characteristics of the feedback loop. Another difficulty is that tube transconductance during signal peaks may be twice (or more) its no-signal value. Such an amplifier may be stable at no-signal, but oscillatory during part of a large-amplitude signal cycle. Under such circumstances, quenched oscillations occur, and a monitoring oscilloscope (of adequate band-width, of course) will show a "bubble" of high-frequency oscillation riding on a portion of the audio signal cycle.

Thus in evaluating amplitude margin of stability noted in conventional loop gain and phase measurements, due allowance must be made for the probable increase in transconductance during signal peaks. A suitable factor may be roughly estimated from graphical examination of the path of operation along the load-line corresponding to rated resistive load. If tube transconductance during low negative grid potential is (say) twice the no-signal value, then 6 db must be added to the amplitude stability margin otherwise required, if quenched oscillations are to be avoided. When beam-power tubes are used in the output stage, the added factor may be 10 db or more; this is a strong argument favoring the use of more linear tubes, or for tube-characteristic linearization by auxiliary feedback (over extra-wide bandwidth) within the main feedback loop, such as cathode-follower output with main-loop feedback to an earlier stage.¹

There appears to be no simple, readily applied test by which one can directly and quantitatively examine susceptibility of a feedback amplifier to such quenched oscillations, since the circumstances permitting them are not continuous. But there are relatively simple qualitative tests, readily applicable to most audio feedback amplifiers, representing in effect the various worst-conditions imposed by later equipment usage; these include capacitive loading, as well as any effects of half-primary untermination by a temporarily inactive tube of a push-pull pair.

The method is to begin by monitoring for oscillation with an oscilloscope (useful to at least several hundred kilocycles) while capacitive load only is varied through the range 0.001 to 1.0 μ f in roughly 20-per-cent steps. Experience shows this range to be adequate for voice-coil output taps; for higher impedance taps, use inversely proportionate capacitances. If no oscillations are observed, proceed by applying a low-frequency signal (preferably the lowest frequency for rated power output) of amplitude to produce no-load output voltage within a db or so of overload ("flat top"), and monitor for quenched oscillation as capacitive load only is varied throughout the appropriate range. Next repeat the capacitance variation with rated resistive load parallel thereto, to produce high-transcon-

¹ W. R. Ayres, "Choice of electron tubes for audio circuits," *J.A.E.S.*, p. 49, Jan., 1953.

makes the
**FORMULAE
FAMOUS**

'C' core technique at its best

THE Type CFB AUDIO TRANSFORMER

Once again this famous 'C' core Audio Transformer is available **OFF THE SHELF**. Manufactured by highly skilled workers from the finest materials available, the CFB maintains a consistent performance hitherto only associated with specialist laboratory equipment, and is the result of untiring research into grain-oriented strip-wound 'C' core transformers.

These figures speak for themselves:
Series leakage induct 10 mH; Coupling between primaries—leakage induct. for one half (other shorted) 30 mH; D.C. resist. per half primary 88 ohms; Power up to 60 w. from 22 c/s to 30 Kc/s; dis-

ortion less than 1% with no negative feed back!

PRICE \$40 DUTY PAID

Should you experience any difficulty in obtaining CFB transformers, please write to us, mentioning the name and address of your local jobber. Remember, there is no substitute for the Partridge CFB.

PARTRIDGE
TRANSFORMERS LTD
TOLWORTH, SURREY, ENGLAND.

Now! Hear Sensational New 3-D SOUND . . . At Leonard!



Livingston Stereophonic Amplifier

Here at last is a complete stereophonic twin-channel amplifier for any 3-D sound source. Unit consists of two 10 watt hi-fi channels from cartridge to loud speaker; 3 twin inputs for disc, tape and binaural broadcasts; separate tone-controls for highs and lows; edge lighted lucite rear-engraved panel. Supplied on two chassis with individual cabinets and three foot interconnecting cable.

149.50
net



Livingston Binaural Arm

Complete with the finest cartridges available . . . the new Fairchild Diamond Stylus Model 215 . . . the Livingston Binaural Arm is your guarantee of minimum record wear and maximum fidelity to the amplifier input. Cartridges, \$37.50 each. Binaural Arm, \$35.00.

89.50
net

Complete unit

Mail & Phone Orders. 25% Deposit, Balance COD

LEONARD RADIO, INC.

69 Cortlandt Street, New York

CORtlandt 7-0315 AEB

SOUND FOR LISTENING ENJOYMENT

... with the **HARTLEY 215** LOUDSPEAKER

Bad sound is an imposition. Aside from contributing nothing to listening enjoyment, it is actually a disturbing element. The only thing it creates is the wish for relief . . . the desire to shut it off. If sound is intended for listening enjoyment, then obviously it must be free from distortion. The choice of loudspeaker then becomes one of vital importance. When Hartley owners confirm that the Hartley 215 sounds clean and can be listened to for hours, they mean that it is free from boomy bass, strident highs, resonant peaks, and other forms of distortion. They mean that the Hartley 215 was designed and built for listening enjoyment. The most remarkable fact, they say, is that the Hartley 215 sells for only \$57.50.

Hartley Products are now available in America through franchised Hartley dealers.



For complete information regarding the Hartley 215, and the new Baffle Speaker Enclosure, Preamp, and Main Amplifier, write to Department AE-8
Prices slightly higher West of the Rockies

H. A. HARTLEY CO., INC.
521 East 162nd Street, Bronx 51, N. Y.
LUdlow 5-4239

Nearly everybody reads the audio anthology

and

the 2nd audio anthology

The original **audio anthology** is still being ordered by people who have worn out their first copy or who have just learned about the book. Contains reprints of 37 articles which appeared in **AUDIO ENGINEERING** from May 1947 through December 1949. An invaluable reference work on audio in the home.

The **2nd audio anthology** continues from where the first left off and contains reprints of articles from January 1950 through July 1952. In both books the articles were brought up to date, corrected where necessary, and assembled by subject. **the 2nd a a** may still be had with board cover.

----- CUT OUT ----- MAIL TODAY -----

Book Division, Dept. 3S,
Radio Magazines, Inc.,
P. O. Box 629, Mineola, N. Y.

Sirs: Enclosed is check money order for \$..... Please send me
..... copies of **audio anthology** (paper cover) @ \$2.00 each
..... copies of **the 2nd audio anthology** (paper cover) @ \$2.00 each
..... copies of **the 2nd audio anthology** (board cover) @ \$3.00 each

Name (please print)
Address
City Zone State

ADVERTISING INDEX

Allied Radio Corp.	62
American Elite, Inc.	73
Amperite Co.	55
Ampex Corp.	13
Amplifier Corp. of America	75
Argos Products Co.	77
Arnold Engineering Co.	9
Atlas Sound Corp.	82
Audak Co.	47
Audio Devices, Inc.	Cover 2
Audio Fair	41
Bell Telephone Laboratories	18
Bell Sound Systems, Inc.	74
Bogen, David, Co., Inc.	62
British Industries Corp.	3
Brook Electronics, Inc.	79
Brush Electronics Co.	4
Camera Equipment Co.	63
Cannon Electric Co.	51
Chicago Transformer Co.	57
Cinema Engineering Co.	8
Classified Ads	82
Commissioned Electronics Co.	82
Concertone Recorders	65
Cook Laboratories	64, 71
Crestwood Div., Daystrom Elec. Corp.	58
D & R, Ltd.	66
Electro-Voice, Inc.	35
Fairchild Recording Equipment Co.	66
Fisher Radio Corp.	61
General Electric Co.	50, 68
Harper & Bros.	48
Hartley, H. A., Co., Inc.	84
Harvey Radio Co., Inc.	53
Heath Co.	59, 65
Hollywood Electronics	83
Hughes Aircraft Co.	2, 72
Hycor Co., Inc.	64
Jensen Mfg. Co.	39
Kellogg Switchboard and Supply Co.	68
Kierulff Sound Corp.	83
Kingdom Products, Ltd.	75
Lambda Electronics Corp.	70
Leonard Radio, Inc.	81
Lowell Mfg. Co.	76
Measurements Corp.	80
Minnesota Mining & Mfg. Co.	11
Orradio Industries, Inc.	Cover 3
Partridge Transformers, Ltd.	81
Pickering and Co., Inc.	17
Pilot Radio Corp.	67, 69, 71, 73
Presto Recording Corp.	45
Precision Film Laboratories, Inc.	10
Professional Directory	83
Radio Corporation of America	6, 7
Rauland-Borg Corp.	14
Reeves Equipment Corp.	60
Reeves Soundcraft Corp.	5
Rek-O-Kut Co.	43
Rockbar Corp.	15
Sams, Howard W., & Co., Inc.	78
Savage Transformers Limited	83
Simpson, Mark, Mfg. Co., Inc.	83
Shure Brothers, Inc.	49
Stephens Mfg. Corp.	72
Stromberg-Carlson	37
TapeMaster, Inc.	54
Terminal Radio Corp.	79
Texas-TV	80
Thermador Electrical Mfg. Co.	78
Thorens Co.	76
Triad Transformer Corp.	1
Turner Co.	12
United Transforming Co.	Cover 4
U. S. Recording Co.	83
V-M Corp.	60
White Sound, Inc.	56

irish

ORRADIO *makes a grade of*
SOUND RECORDING TAPE
for your 'SPECIFIC Requirements



If your tape recorder is intended for home or office use . . . we recommend:

IRISH Brown Band, No. 195 RPA

High quality, plastic-base tape, specially developed to reproduce with extreme fidelity, the frequency range between 100 and 8000 cps.

1200 Feet on plastic reel.....\$3.50



If your tape recorder is designed for professional application, you should use . . .

IRISH Green Band, No. 211 RPA

Super-sensitive, long-life, professional tape, offering greater output volume, greater amplitude constancy and greater signal to noise ratio. Manufactured to exact standards set by NARTB and RTMA.

1200 Feet on plastic reel.....\$ 5.50

2400 Feet on metal reel..... 13.85



If your tape recorder is intended for broadcast programming, professional dubbing, or any application where physical strength is an important consideration, ORRADIO offers you . . .

IRISH "Sound Plate," No. 220 RPA

New, revolutionary BREAK-PROOF tape. Will not tear or break at speeds up to 500 feet per second. Has the same high quality magnetic and audio features that have made IRISH 211 RPA the byword among professional tape users.

1200 Feet on plastic reel.....\$15.50

2400 Feet on metal reel..... 33.85



There are differences in magnetic oxides! Irish molecular lubricated oxides are more stable to coating conditions and turn out more uniform dispersions . . . that is one of the reasons for the growing acceptance of Irish Tape . . . for domestic, professional and broadcast applications.

SOUND RECORDING



REG. U.S. PAT. OFF.

Available at All Leading
Radio Parts Distributors and Photo Dealers
Manufactured in U.S.A. by

ORRADIO INDUSTRIES, INC.

OPELIKA, ALABAMA

World's Largest Exclusive Magnetic Tape Manufacturer

Export Division:
MORHAN EXPORTING CORPORATION
258 Broadway, New York 13, New York



ULTRA COMPACT UNITS...OUNCER UNITS

HIGH FIDELITY... SMALL SIZE... FROM STOCK

UTC Ultra compact audio units are small and light in weight, ideally suited to remote amplifier and similar compact equipment. High fidelity is obtainable in all individual units, the frequency response being ± 2 DB from 30 to 20,000 cycles.

Hum balancing coil structure combined with a high conductivity die cast outer case, effects good inductive shielding.

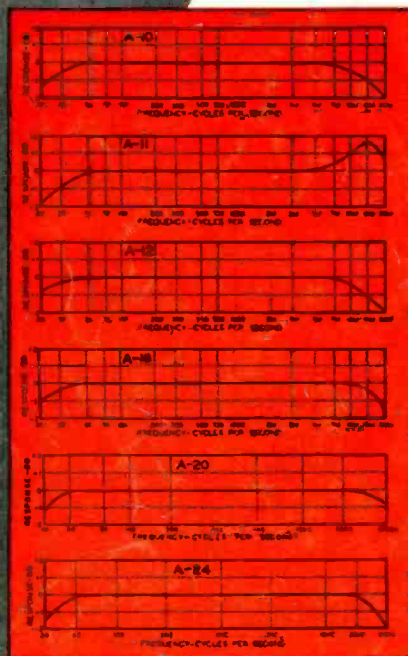

Type No.	Application	Primary Impedance	Secondary Impedance	List Price
A-10	Low impedance mike, pickup, or multiple line to grid	50, 125/150, 200/250, 333, 500/600 ohms	50 ohms	\$16.00
A-11	Low impedance mike pickup, or line to 1 or 2 grids (multiple alloy shields for low hum pickup)	50, 200, 500	50,000 ohms	18.00
A-12	Low impedance mike pickup, or multiple line to grids	50, 125/150, 200/250, 333, 500/600 ohms	80,000 ohms overall, in two sections	16.00
A-14	Dynamic microphone to one or two grids	30 ohms	50,000 ohms overall, in two sections	17.00
A-20	Mixing, mike, pickup, or multiple line to line	50, 125/150, 200/250, 333, 500/600 ohms	50, 125/150, 200/250, 333, 500/600 ohms	16.00
A-21	Mixing, low impedance mike, pickup, or line to line (multiple alloy shields for low hum pickup)	50, 200/250, 500/600	200/250, 500/600	18.00
A-16	Single plate to single grid	15,000 ohms	60,000 ohms, 2:1 ratio	15.00
A-17	Single plate to single grid 8 MA unbalanced D.C.	As above	As above	17.00
A-18	Single plate to two grids. Split primary.	15,000 ohms	80,000 ohms overall, 2.3:1 turn ratio	16.00
A-19	Single plate to two grids. 8 MA unbalanced D.C.	15,000 ohms	80,000 ohms overall, 2.3:1 turn ratio	19.00
A-24	Single plate to multiple line	15,000 ohms	50, 125/150, 200/250, 333, 500/600 ohms	16.00
A-25	Single plate to multiple line 8 MA unbalanced D.C.	15,000 ohms	50, 125/150, 200/250, 333, 500/600 ohms	17.00
A-26	Push pull low level plates to multiple line	30,000 ohms plate to plate	50, 125/150, 200/250, 333, 500/600 ohms	16.00
A-27	Crystal microphone to multiple line	100,000 ohms	50, 125/150, 200/250, 333, 500/600 ohms	16.00
A-30	Audio choke, 250 henrys @ 5 MA 6000 ohms D.C., 65 henrys @ 10 MA 1500 ohms D.C.			12.00
A-32	Filter choke 60 henrys @ 15 MA 2000 ohms D.C., 15 henrys @ 30 MA 500 ohms D.C.			10.00



TYPE A CASE
1 1/2" x 1 1/2" x 2" high

UTC OUNCER components represent the acme in compact quality transformers. These units, which weigh one ounce are fully impregnated and sealed in a drawn aluminum housing 7/8" diameter... mounting opposite terminal board. High fidelity characteristics are provided, uniform from 40 to 15,000 cycles, except for C-14, O-15, and units carrying DC which are intended for voice frequencies from 150 to 4,000 cycles. Maximum level 0 DB.



OUNCER CASE
7/8" Dia. x 1 1/8" high

Type No.	Application	Pri. Imp.	Sec. Imp.	List Price
O-1	Mike, pickup or line to 1 grid	50, 200/250 500/600	50,000	\$14.00
O-2	Mike, pickup or line to 2 grids	50, 200/250 500/600	50,000	14.00
O-3	Dynamic mike to 1 grid	7.5/30	50,000	13.00
O-4	Single plate to 1 grid	15,000	60,000	11.00
O-5	Plate to grid, D.C. in Pri.	15,000	60,000	11.00
O-6	Single plate to 2 grids	15,000	95,000	13.00
O-7	Plate to 2 grids, D.C. in Pri.	15,000	95,000	13.00
O-8	Single plate to line	15,000	50, 200/250, 500/600	14.00
O-9	Plate to line, D.C. in Pri.	15,000	50, 200/250, 500/600	14.00
O-10	Push pull plates to line	30,000 ohms plate to plate	50, 200/250, 500/600	14.00
O-11	Crystal mike to line	50,000	50, 200/250, 500/600	14.00
O-12	Mixing and matching	50, 200/250	50, 200/250, 500/600	13.00
O-13	Reactor, 300 Hys.—no D.C.; 50 Hys.—3 MA. D.C.		6000 ohms	10.00
O-14	50:1 mike or line to grid	200	1/2 megohm	14.00
O-15	10:1 single plate to grid	15,000	1 megohm	14.00

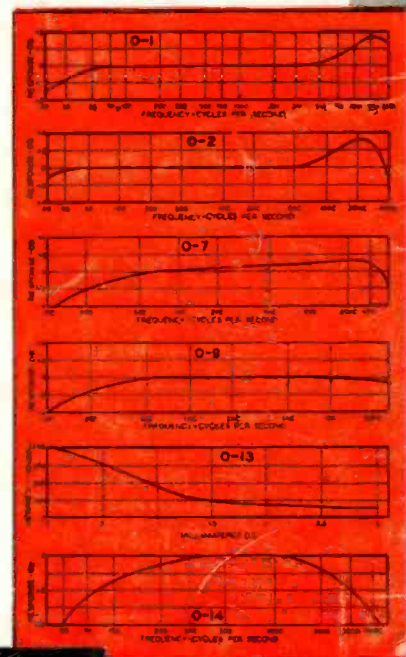

United Transformer Co.

150 VARICK STREET NEW YORK 13, N. Y.
EXPORT DIVISION: 13 EAST 40th STREET, NEW YORK 16, N. Y. CABLES: "ARLAB"