

AUDIO ENGINEERING

OCTOBER 1953 35c

and *Audio in the Home*



THE WORLD OF SOUND

only



offers you all this
valuable new information

... and it doesn't cost you a cent!



20 PRIZE-WINNING ARTICLES from Audio's International Sound Recording Contest

Here's a wealth of new ideas on how to use tape and disc recordings to achieve greater economy and efficiency in radio, TV and sound studio operation.

With reference to these articles, one of the contest judges commented as follows: "I have never received so much information which was new and exciting in such a

short time in all of my years in the business." And another judge stated that "the information and descriptions of recording operations conducted in small radio stations and recording studios throughout the country has been quite an education."

Contest winners include entries from 11 different States, as well as from Canada

and Switzerland. The 20 best articles, which were awarded cash prizes totaling \$1400, will be published in the pages of Audio Record. The information thus made available to the industry will be of real value to sound recordists everywhere.

QUICK FACTS ON MAGNETIC TAPE RECORDERS

Each year, Audio Record brings you a complete, up-to-date listing of all makes and models of tape recording machines—with conveniently arranged price and performance data. This directory issue,

published in September, is the most complete and authoritative compilation of tape recorder information available to the industry. Over 75,000 copies of the last issue were distributed.

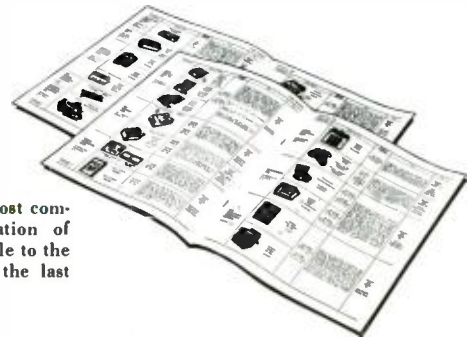

... plus many other articles of timely interest to the sound recordist

Audio Record keeps you well informed on all the latest trends and technical developments in all phases of tape and disc recording. It is not an advertising publication and its sole purpose is to render a needed and useful service to the industry.

Audio Record, published 8 times a year, is currently distributed free of charge to a request mailing list of about 35,000 sound recordists in broadcasting stations, recording studios, schools and colleges throughout the country.

IT'S YOURS FOR THE ASKING

A letter or post card will add your name to the Audio Record mailing list. And if you would like to have others in your organization read it also, send their names along, too. Just write to Audio Devices, Inc., using the Dept. No. listed below. All requests addressed to this Dept. will be started with the July-Aug., 1953 issue, so you will be sure to get *all* the prize-winning articles, as well as the 1953 Tape Recorder Directory Issue.

AUDIO DEVICES, Inc.

Dept. AR-1, 444 Madison Ave., New York, N. Y.

Export Dept.: 13 East 40th St., New York 16, N. Y., Cables "ARLAB"



audiorecords
audiotape
audiofilm
audiopoints

Successor to **RADIO** Established 1917

AUDIO ENGINEERING

INCLUDING



C. G. McProud, Editor and Publisher

Henry A. Schober, Business Manager

Harrie K. Richardson, Associate Editor Edgar M. Villichur, Contributing Editor
 Robin Melton, Production Manager S. L. Cahn, Advertising Director
 Edgar E. Newman, Circulation Director H. N. Reizes, Advertising Manager

Representatives



H. Thorp Covington, Special Representative
 7530 North Sheridan Road, Chicago 26, Ill.
 Sanford R. Cowan, Mid-West Representative
 67 W. 44th St., New York 18, N. Y.

West Coast

James C. Galloway J. W. Harbison
 816 W. 5th St., Los Angeles 17, Calif.

CONTENTS OCTOBER, 1953 Vol. 37, No. 10

Audio Patents— <i>Richard H. Dorf</i>	2
New Literature	6
Letters	8
Audiology— <i>W. R. Ayres</i>	12
Book Reviews	16
Editor's Report	18
Basic Design of Constant Resistance Crossovers— <i>N. H. Crowhurst</i>	21
Complete Remote Control for Ampex 300— <i>Richard P. Blinzler</i>	23
Three-Element Bass Control— <i>Glen Southworth</i>	24
The Piano—Part I— <i>Albert Preisman</i>	26
New Home for Allied Radio Corp.	31
Equipment Report— <i>tapeMaster HF500 and Rauland-Borg 826</i>	34
The Columbia XD Speaker— <i>Peter C. Goldmark</i>	36
Everyman's Amplifier— <i>G. Leonard Werner and Henry Berlin</i>	40
Handbook of Sound Reproduction—Chap. 13— <i>Edgar M. Villichur</i>	42
The Great Mystery of Dannemora Dungeon— <i>Emory Cook</i>	50
AUDIO IN THE HOME	
Tools for Building Temples of Tone	54
Fifth Annual AES Convention—Papers Program	69
Record Revue— <i>Edward Tatnall Canby</i>	72
The Audio Fair 1953—Directory of Exhibitors	84
New Products	100
Radio's Master Reports	118
Industry People	119
Advertising Index	120

COVER

Names Make News! And the important names during October are those associated with Audio, because the year's outstanding audio event takes place then at Hotel New Yorker. With exhibits overflowing three floors, the Fifth Audio Fair is certain to be the most-attended audio exhibit ever.

RADIO MAGAZINES, INC., P. O. BOX 629, MINEOLA, N. Y.

AUDIO ENGINEERING (title registered U. S. Pat. Off.) is published monthly at 10 McGovern Avenue, Lancaster, Pa. by Radio Magazines, Inc., Henry A. Schober, President; C. G. McProud, Secretary, Executive and Editorial Offices: 204 Front St., Mineola, N. Y. Subscription rates—United States, U. S. Possessions and Canada, \$3.00 for 1 year; \$5.00 for 2 years; elsewhere \$4.00 per year, single copies 35c. Printed in U. S. A. All rights reserved. Entire contents copyright 1953 by Radio Magazines, Inc. Entered as Second Class Matter February 9, 1950, at the Post Office, Lancaster, Pa. under the Act of March 3, 1879.

Engineering

WRITERS

ENGINEERS, E. E. or PHYSICS GRADUATES, for preparation of technical manuals...

HUGHES RESEARCH AND DEVELOPMENT LABORATORIES' expanding program for production of radar, electronic digital computers, guided missiles and other military advanced electronic systems and devices requires the following:

- 1** ELECTRICAL ENGINEERING AND PHYSICS GRADUATES to prepare operating, servicing and overhauling instructions for complex electronic equipment. Those with previous maintenance experience on military equipment preferred. Writers will participate in a three-month program in our technical training school to become familiar with the latest Hughes equipment prior to writing assignments.
- 2** ENGINEERS EXPERIENCED in the writing and preparation of maintenance manuals for electronic equipment or guided missiles. These specialists will work step-by-step with the people designing, developing and manufacturing the products involved. Experience in the writing of engineering reports is of value.

HOW TO APPLY

Write full details of your qualifications to

HUGHES

Research and Development Laboratories

SCIENTIFIC AND ENGINEERING STAFF
 Culver City, Los Angeles County
 California

Assurance is required that relocation of the applicant will not cause disruption of an urgent military project.

Check this new audio attenuator



TYPE 8514-B
MIXING
CONTROL

- ✓ Finger-Tip Control
- ✓ Straight-Line Action
- ✓ 5¼" Control Travel
- ✓ Full 45 db control
- ✓ Maximum attenuation 100 db
- ✓ Smoothest Operation
- ✓ Slide-wire construction
- ✓ Ladder Circuit
- ✓ 600 ohm Impedance
- ✓ 1½" x 7" x 6" Dimensions
- ✓ Plug-In Construction



Write today for
Bulletin C-1025

CINEMA ENGINEERING CO.
1510 W. VERDUGO • BURBANK, CALIF.

IN NEW ENGLAND & UPPER N. Y.,
Samuel C. Hooker Co.
METROPOLITAN N. Y., Audio-Video Products
PHILADELPHIA, W. Henry Cordray
CLEVELAND, Edwards-Lohse Associates
MINNEAPOLIS, A. J. Warner Co.
SEATTLE, Jas. J. Backer Co.
DENVER, Dick Hyde Co.
N. CALIF., David Ross Co.
OTTAWA, CANADA, Samuel C. Hooker, Ltd.
EXPORT, Frazar & Hansen



AUDIO PATENTS

RICHARD H. DORF*

THERE ARE many reasons why disc records are still by all odds the most important form of commercial recording, even though a few companies have undertaken to build tape libraries and probably more will do so and on a wider scale in the future. Discs are cheaper and easier to use, and they lend themselves to mass production methods.

Tapes, on the other hand, have the potential or less wear after a given number of playings and longer uninterrupted playing time. However, at least so far, they must be reproduced for mass sale by the relatively crude process of rerecording. Each copy must be made, that is, by running it through a recording machine which is fed signals from a master tape.

A few concerns have outfitted themselves with multiple recording setups for this purpose and, as might be expected, the resulting quality is as good as anyone would want, though the output in number of tapes per day is small. One problem remains, however, in a setup of this kind—inspection of the finished product. With discs an inspector can simply take a look at a record to see that the grooves are there and that there is modulation; and a random sampling can be played from time to time. This is not, of course, a completely adequate procedure, but discs are cheap enough to replace and only a small percentage of them go to a quality-conscious market. Visual inspection of tapes is, of course, impractical. Aural monitoring of each tape as it goes through the copying procedure is equally impractical, since many are running simultaneously. Yet, tapes go to quality-minded audiences and should, if possible, be inspected more stringently than discs.

Gilbert F. Dutton of Iver Heath, England, has patented and assigned to EMI a system of automatic monitoring of tapes as they are produced. His patent is numbered 2,622,155.

Figure 1 shows the standard setup for multiple tape copying. A master and a number of copy tapes (only two of the latter are shown) run simultaneously, the tapes driven in the illustration by a single motor. Playback head A picks up the signal from the master tape. This signal is amplified and fed to recording heads C, of which there is one for each copy tape, all in parallel.

Heads B and D and the additional amplifiers and rectifiers are the substance of the

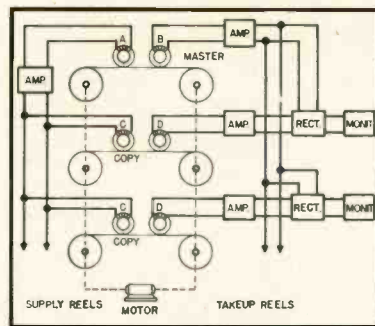

Fig. 1.

invention. Head B is a second playback head which picks up signal from the master tape; it is mounted a carefully measured distance away from head A and is so placed that a given signal reaches it *after* it has reached the main playback head A. Each copy setup has a playback head D which is carefully positioned the same distance from head C as B is from A. As a result, heads B and D should all pick up the same signals at the same instants. If they are not, there is trouble in the system—a binding drive mechanism, which would cause phase shift, a bad recording amplifier, or bad heads or connections somewhere, which could cause absence of signal, lowered amplitude, or waveform changes.

The output of head B on the master tape is amplified and fed to a number of rectifiers, one for each copy tape. To each rectifier, in parallel with this signal (though with some isolation) is fed the amplified signal from a head D. The two signals fed to each rectifier should be identical in waveform, and in amplitude (the amplifiers are so adjusted), and exactly opposite in phase (achieved by deliberately reversing polarity somewhere). If so, the net input to the rectifier will be zero signal and no output will appear. If, however, some defect causes the signal recorded on a copy tape to differ in any respect from the master signal, the perfect cancellation will no longer take place. The rectifier will produce a d.c. proportional to the difference between the two monitoring signals and this may be used to operate an alarm of some sort.

The system as described will work to very close tolerances, sometimes too close. For instance, if the two heads A and B and heads C and D are not maintained and aligned at a very precisely equal distance

* 255 W. 84th St., New York 24, N. Y.

We invite you to write for a complimentary copy



16 pages illustrating and describing Britain's finest music reproducing equipment... the products of the British Industries group. Here, in concise, useful form, are facts you'll want for planning improvements and additions to your own high-fidelity set.

mail coupon below



GARRARD "Triumph" Model RC80

World's finest 3-speed record changer. Fully automatic, with automatic stop. Your "best buy" in changers — yet priced to compete with ordinary instruments.

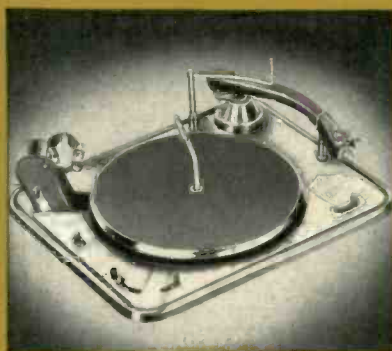

New! GARRARD "Crown" Model RC90

Most advanced 3-speed record changer in Garrard history! The super changer... extra powerful; silent; all speeds variable and adjustable! A host of innovations, plus all features of the RC80.



GARRARD "Crest" Model T

3-speed manual record player, compact, efficient... with automatic start and stop. Incorporates all record-playing features of the famed RC80 changer.



GARRARD Stylus Pressure Gauge

Use with any record player! Quickly and accurately shows weight exerted by pickup. Prevents excessive record wear.



LEAK "POINT ONE" Amplifier

With exclusive "Vari-slope" Pre-Amplifier. Amazingly low harmonic distortion of only 0.1%. Audibly better musical reproduction... unsurpassed of any price!



WHARFEDALE Loudspeakers

Built under personal supervision of G. A. Briggs. Unique cloth-suspension and felt "buffer" rim. Improved damping, more level response. Mellow, rich tone!



R-J Loudspeaker Enclosures

Maximum bass... minimum space! Thrilling performance from any loudspeaker in cabinet only slightly larger than speaker itself! Floor and bookshelf models.



KT66 "Genelex" Tubes

Finest audio tube ever made! Interchangeable in any circuit with American tube 6L6. Identical pins and connections.

British Industries Corp
 164 Duane Street
 New York 13, N. Y. Dept. AE-10
 Gentlemen:
 Please send a complimentary copy of your booklet "Sound Craftsmanship," to:
 Name _____
 Street _____
 City _____ Zone _____ State _____

(Cut on dotted line and mail for prompt service.)

talk about a beating!

multiplex radio telephony systems

must take it...

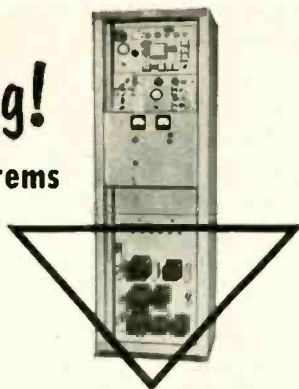

that's why REL specifies

CHICAGO

World's Toughest Transformers

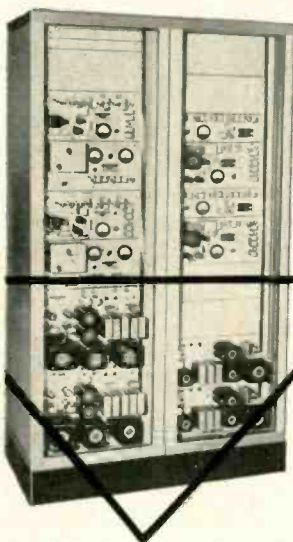

Absolute dependability under the most rugged operating conditions is a prime requirement in all REL Multiplex Radio Telephony Systems. That's why you'll find CHICAGO "Sealed-in-Steel" transformers used throughout REL equipments. These world's toughest transformers are available in 3 mountings, each featuring one-piece seamless design enclosing an electronically perfect construction. Available for every application: Power, Bias, Filament, Filter Reactor, Audio, MIL-T-27, Stepdown. Ask for them at your electronic parts distributor.



C-TYPE

With 10" color-coded leads brought out through fibre board base cover. Lead ends are stripped and tinned for easy soldering. Flange-mounted unit.



CHICAGO TRANSFORMER

DIVISION OF ESSEX WIRE CORPORATION

3501 ADDISON STREET, CHICAGO 18, ILL.

Export Sales Div.:
Scheel International, Inc.
4237 N. Lincoln Ave.
Chicago, Ill., U.S.A.
CABLE ADDRESS:
HARSHEEL

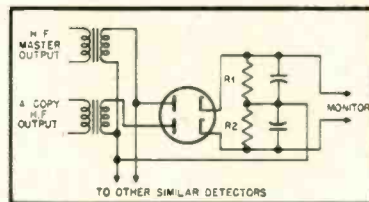

Fig. 2.

apart, there will be a phase difference in the signals. This will be noticeable first in high-frequency signals because the wavelengths are shorter. Adjustment to achieve actual perfection of distances would be very unnecessarily difficult. The inventor, therefore, modifies the original idea slightly.

He first passes the signals from each playback head B and D through both low- and high-pass filters, obtaining for each tape two signals, one including frequencies below 1,000 cps and one including those above. The low-frequency signals are treated just as in Fig. 1, with automatic monitors sensitive to any discrepancies whatever. This will show up variations in tape speed and any wow or flutter of sufficient importance to cause appreciable phase shift below 1,000 cps.

The high-frequency signals are amplified and compared by the circuit shown in Fig. 2, a differential rectifier which is sensitive only to net amplitude variations, which would be caused by actual amplitude variations or by waveform differences. It is insensitive to phase shift. One rectifier element is used to produce somewhat filtered d.c. from the master tape output; the other does the same for the copy tape output. The phases of the signals are opposite at the transformers, so that the rectified signal appearing across R_1 is opposite in polarity to that across R_2 . The monitoring alarm is connected across the cathodes, so that if both signals are identical in average amplitude the alarm will not be triggered. If these are not the same, a differential voltage is produced and actuates the alarm.

Any Insomniacs Present?

This next item is not presented as an example of advanced design techniques but just in case you can't sleep. It is called by its inventor, Charles Beazley of Chicago, the Slumberbug, and the patent is 2,644-153.

Its simple circuitry is diagrammed in Fig. 3. The 60-cps line voltage is applied to a small loudspeaker through the heater of a thermal relay or slow flasher. When the flasher heats, its normally open contacts close, and the heater is shorted. When the heater cools, the contacts open again and the cycle starts over. The choke and

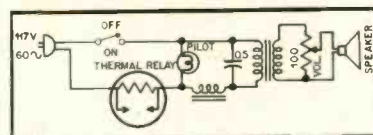

Fig. 3.

Illustrated above at right: REL 900 MC Transmitter, Series 707-757. Illustrated immediately above: REL Model 759 70 MC Dual Transmitters and Receivers. These systems make wide use of CHICAGO C-Type "Sealed-in-Steel" transformer units.

Free "New Equipment" Catalog

You'll want the full details on CHICAGO'S New Equipment Line—covering the complete range of "Sealed-In-Steel" transformers designed for every modern circuit application. Write for your free copy of this important catalog today, or get it from your electronic parts distributor.



HI-FI "TICONAL" MAGNET SPEAKERS with a MIGHTY VOICE!

Never before has there been a range of Hi-Fi speakers to match the new DUOTONE units manufactured by Philips. These loudspeakers, which replace the Alnico V, feature the introduction of TICONAL¹, the most powerful of the modern magnet steels. TICONAL gives a high flux density making possible an air gap of twice the normal depth which results in the most natural tone reproduction yet achieved. Here is a complete line of speakers that give the same tone quality whether operating at a whisper or under full power.

- ★ Improved cone design gives extended flat frequency response... absence of peaks and dips resulting in better reproduction
- ★ Various cones for small speaker types
- ★ Rectilinear response curves guide selection of larger types
- ★ External centering prevents cone stresses
- ★ Sealed air gap prevents "booming"
- ★ Optimum bass reproduction
- ★ Favorably priced competitively



Write DUOTONE today
for folder on the complete line of speakers and microphones.

¹A patented
invention of
Philips Laboratories



DUOTONE

KEYPORT, NEW JERSEY

Canadian Representative: CHARLES W. POINTON, TORONTO, CANADA
Export Division: AD. AURIEMA, INC., NEW YORK CITY, N. Y.

PROOF of PERFORMANCE

Shure slender Gradient¹ Microphones solve difficult acoustic problem

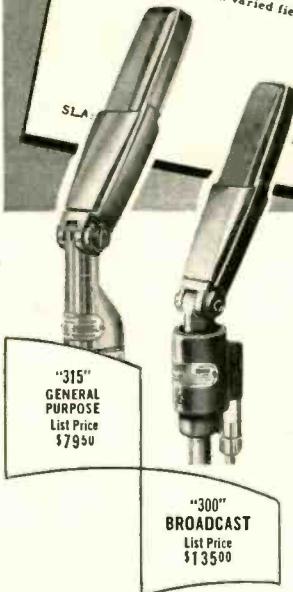
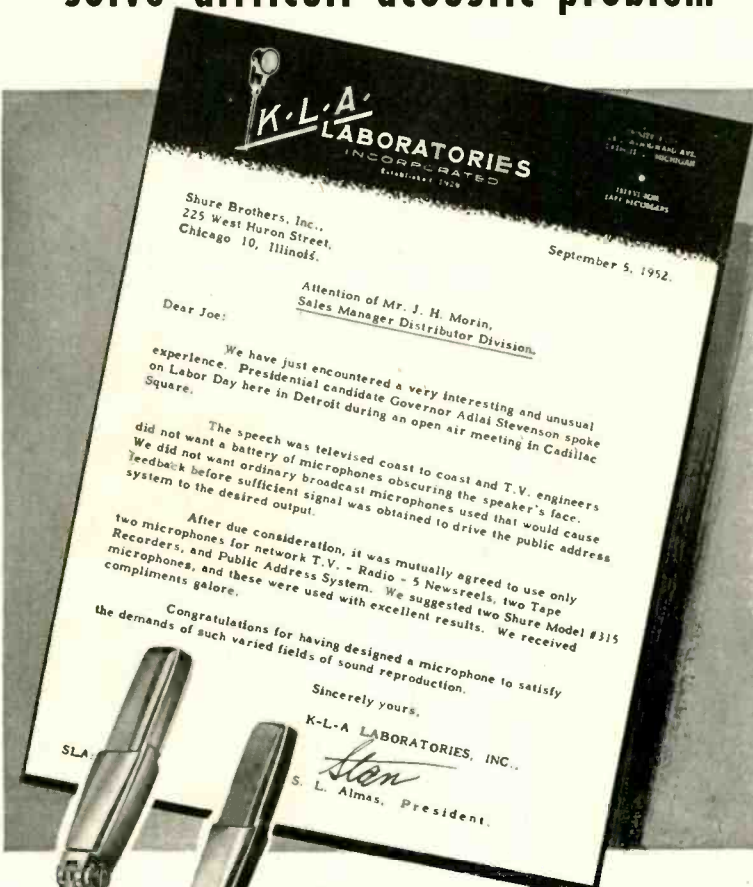

"315"
GENERAL PURPOSE
List Price \$79.50

"300"
BROADCAST
List Price \$135.00



Former Governor Stevenson of Illinois, pictured as he addressed Detroit audience on Labor Day, during the 1952 presidential campaign.



Shure Patents Pending

SHURE BROTHERS, Inc. ★ Microphones and Acoustic Devices
225 West Huron Street, Chicago 10, Illinois Cable Address: SHUREMICRO

capacitor filter both the relay clicks and the harmonics of the line voltage.

The idea behind all this is that the speaker produces a steady hum. When the relay contacts close (after about four seconds) the hum gets louder since the relay heater, in series with the line, is shorted. Then, four seconds later the volume goes down again. The inventor claims that the steady humming sound, with this slow, rhythmic, change in volume, has a sort of hypnotic effect and will put you to sleep. I wouldn't be at all surprised if it did just that, too.

The price of patent copies remains at 25¢; to look over any one, send your quarter, with the patent number, to The Commissioner of Patents, Washington 25, D. C.

NEW LITERATURE

● **Photocircuits Corporation**, Glen Cove, N. Y., does a fine job of familiarizing manufacturers with the various aspects of printed circuits in a new 8-page 2-color booklet. Exceptionally well-produced, the publication touches on such diverse points as assembly of printed-circuit components into finished electronic devices, suggested applications, and cost estimates. The printed-circuit technique is graphically portrayed. From a competitive standpoint alone, manufacturers of electronic gear should regard this booklet as a necessity.

● **F. R. Mallory & Co., Inc.**, 3029 E. Washington St., Indianapolis 6, Ind., is now distributing to dealers and servicemen the new 1953 Mallory Distributor Catalog No. 553. Listing and describing more than 2200 items, most of which are replacement components handled through the Mallory distributor system, the catalog lists prices. Available on request to the company.

● **General Electric Company**, Electronics Park, Syracuse, N. Y., has earned the appreciation of record collectors with a new 20-page booklet titled "Variable Reluctance Application Data—a Guide for the Audio Hobbyist." Although its text and illustrations are confined largely to GE products, the booklet contains a wealth of practical information which is exceptionally well presented. Superb pictures and drawings, together with competent writing, give this book a value which is far greater than casual.

● **Newcomb Audio Products Co.**, 6824 Lexington Ave., Hollywood, Calif., is now distributing a new 20-page catalog of public address equipment. Contained is illustrated information on all three lines of Newcomb amplifiers, portable systems and accessories, as well as rack and panel assemblies. Copy will be mailed on request.

● **Vector Electronic Company**, 3352 San Fernando Road, Los Angeles 65, Calif., illustrates and describes a complete line of plug-in circuit units, socket-turrets, and socket-strips in Catalog 53, a 10-page two-color publication which is now available on request. This book will be a boon to all developmental and design engineers.

● **Stackpole Carbon Company**, St. Marys, Pa., in Catalog 40A, describes standard and special carbon and graphite components and materials for chemical, electrical, and mechanical applications. Recently revised and enlarged, the 44-page book contains data on carbon and graphite as applied to products ranging from welding carbons to tube anodes. Copy of Catalog 40A will be mailed on letterhead request.

● **Dow Corning Corporation**, Midland, Mich., has developed a new silicone magnet-wire enamel which has the same life expectancy at 200 deg. C. as conventional enamels have at 105 deg. C. Known as Dow Corning 1360, the new material is not yet available commercially but its various properties are shown on mimeographed data sheets which will be mailed on request. In view of the promise Dow Corning 1360 holds for manufacturers of small motors and miniature electronic equipment, this color literature suggests that your request be not withheld.

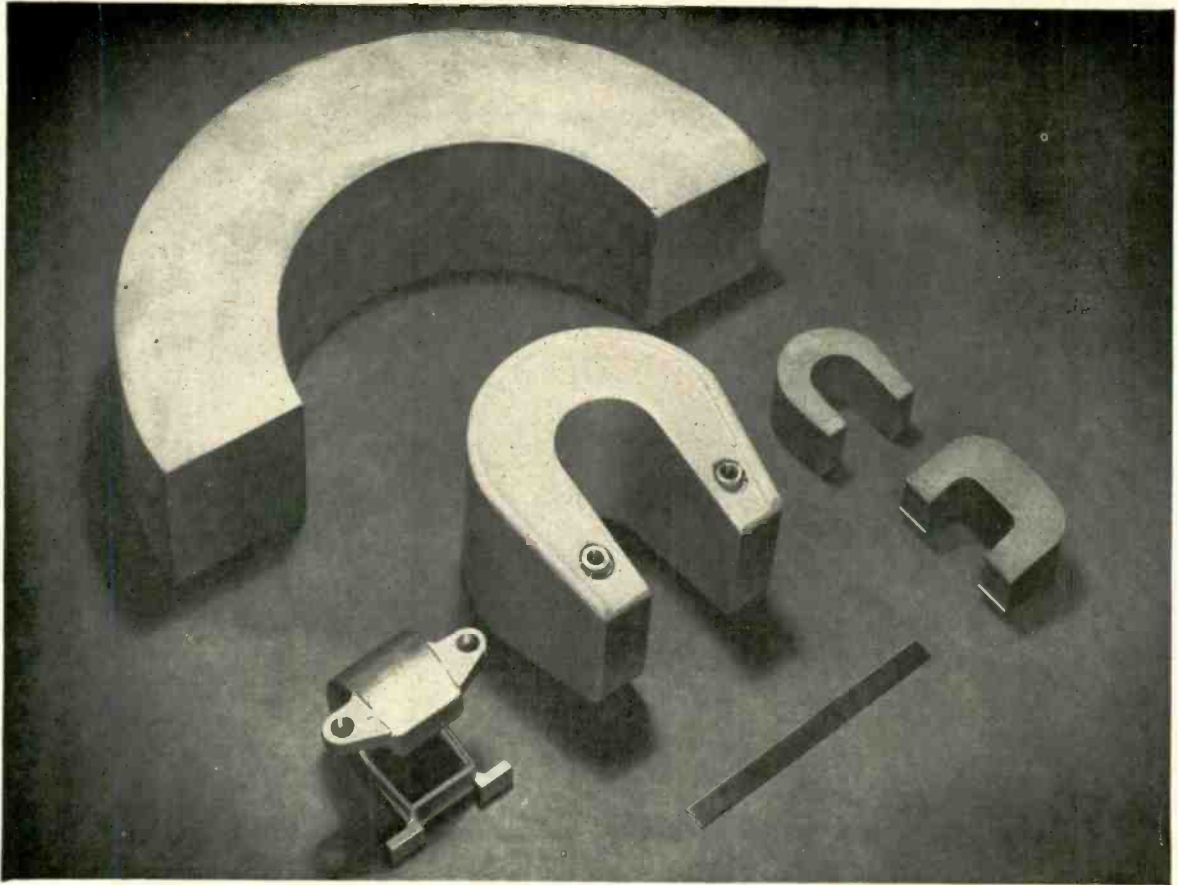

PERMANENT MAGNETS and ASSEMBLIES for Magnetrons and Traveling Wave Tubes

The group of magnets illustrated above, weighing from a fraction of a pound up to 75 pounds, are indicative of the wide range of Arnold production in this field. We can supply these permanent magnets in any size or shape you may need, with die-cast or sand-cast aluminum jackets, Celastic covers, etc. Complete assemblies may be supplied with Permendur, steel or aluminum bases, inserts and keepers as specified . . . magnetized and stabilized as desired. • *Let Arnold handle your magnetron and traveling wave tube permanent magnet requirements.*

*Made to your
Specifications*

**. . . ANY SIZE, SHAPE
OR COATING REQUIRED**

*★ We'll welcome
your inquiries*

THE ARNOLD ENGINEERING COMPANY



SUBSIDIARY OF ALLEGHENY LUDLUM STEEL CORPORATION

General Office & Plant: Marengo, Illinois

DISTRICT SALES OFFICES . . . New York: 350 Fifth Ave.

Los Angeles: 3450 Wilshire Blvd.

Boston: 200 Berkeley St.

W4D 4698

for Hi-Fi



Want a really Super performance tube for your "Williamson" or "Ultra-Linear" amplifier?

Check these ratings of the Tung-Sol 5881

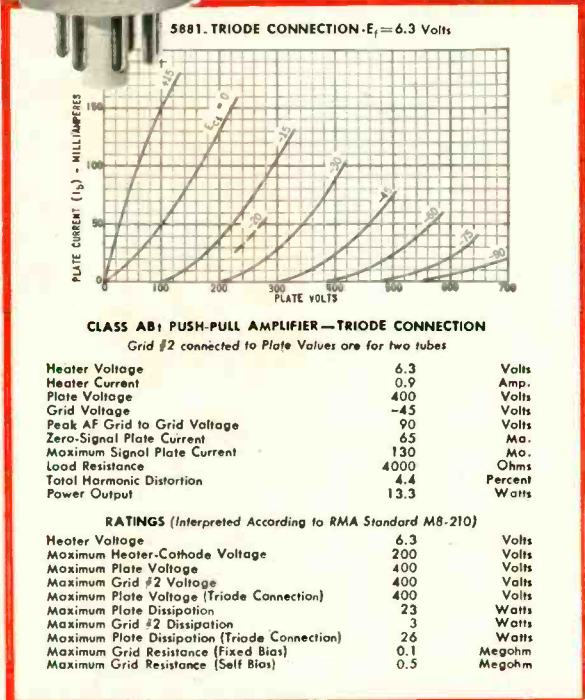

In creating the 5881, Tung-Sol engineers have made fullest use of design and production techniques which have proved themselves over the past 15 years. Pure barium getter to effectively absorb gas for the life of the tube—gold-plated wire to minimize grid emission—are among the major design improvements in the 5881. This tube is directly interchangeable with the 6L6.

Tung-Sol produces the 5881 under laboratory conditions to insure peak efficiency and maximum uniformity. Order it from your regular supplier.

TUNG-SOL ELECTRIC INC., Newark 4, N. J.

Sales Offices: Atlanta, Chicago, Culver City (Los Angeles), Dallas, Denver, Detroit, Newark, Seattle

TUNG-SOL makes: All-Glass Sealed Beam Lamps, Miniature Lamps, Signal-Flashers, Picture Tubes, Radio, TV and Special Purpose Electron Tubes and Semiconductor Products.

LETTERS

Mu-Beta versus A-Beta

SIR:

I would like to thank Mr. Mitchell for correctly pointing out an error in Chapter 12, Part I of my "Handbook." Negative voltage feedback does reduce the source impedance of an amplifier (considered as the impedance seen by the load) by the factor $1/(1-\mu\beta)$, nor $1/(1-A\beta)$ as written, and the difference between these two expressions, while not significant with triode output stages, is very large with beam-power tetrodes.

Engineers reading Mr. Mitchell's letter will have understood that, with β taken in the normal sense, μ does not refer to the amplification factor of the output tubes, but is the " μ " of the entire feedback loop; that is, the no-load voltage gain between the point of re-entry of the feedback signal and the point from which the feedback voltage is tapped. To some, however, there may seem to be a confusion of symbols. It is for this reason that I have used, in a later installment wherein is described the effect of feedback on source impedance, the symbol A' (loop gain with the load open) instead of μ .

While I am on the subject of errors, and before someone takes me to task, may I take the occasion to make another correction; the term "magnetomotive force" has been applied incorrectly in the section on loudspeakers, although I think the sense will be clear.

EDGAR M. VILLCHUR,
Woodstock, New York.

SIR:

After reading Mr. Mitchell's comments on output impedance reduction in LETTERS for August, I would like to submit the following comments:

Regarding the factor by which the effective output impedance of an amplifier is reduced by the use of negative voltage feedback, it should be pointed out for the sake of accuracy that neither Mr. Villchur's factor of $1/(1-A\beta)$ nor Mr. Mitchell's figure of $1/(1-\mu\beta)$ is completely accurate. The correct factor for the reduction of output impedance is $1/(1-\mu A_i\beta)$, where A_i is the amplification from the point at which the feedback is introduced up to the grid of the output stage.

Thus Mr. Mitchell's factor is correct only when A_i is unity, or when negative feedback is taken over the output stage alone. Feedback over only the output stage is not employed very often now for reasons which were correctly cited by Mr. Villchur. A re-check of this section (*Æ*, July 1953) discloses that in the illustrative Fig. 12-9 shown, the value of A_i would be the product of the amplifications of the first stage (cathode to plate), and the phase splitter. In any case, μ is the amplification factor of the output stage.

Thus it should be recognized that the correct factor—regardless of the point at which feedback is introduced—is $1/(1-\mu A_i\beta)$, and that Mr. Mitchell's factor is correct only when the feedback encompasses the output stage alone.

WILLIAM J. KESSLER,
College of Engineering,
University of Florida,
Gainesville, Florida.

Balancing Tubes

SIR:

In reference to the letter on tube balancing, and also regarding the many circuits published in *Æ* and in other publications, may I point out an extremely simple means of accomplishing this.

Disconnect the lead from the plate terminal of one of the output tubes, and connect the plate terminal to the plate terminal of the other output tube. Thus you have a single-ended output stage with the grids fed in push-pull. Then feed a signal through the amplifier while an indicating device (a headset is excellent) is connected to the output. The balance control is then adjusted for no sound in the phones or for a minimum in the output indicator. Restore the connections to their original condition and the operation is completed.

JOHN CARLSON,
160 Beacon St.,
Milton, Mass.

(Note: This method would most certainly work to provide a dynamic balance of the output stage—that is, to an audio or a.c. signal—but would not give a balance between the d.c. flowing in the two tubes. Two problems are encountered—in most instances the dynamic or a.c. balance would be preferable, and usually provides the lower intermodulation distortion. However, an excessive d.c. unbalance might reduce low-frequency response by reason of the magnetization of the output transformer core which would result in lowered inductance. Unless the tubes

Music that Lives!

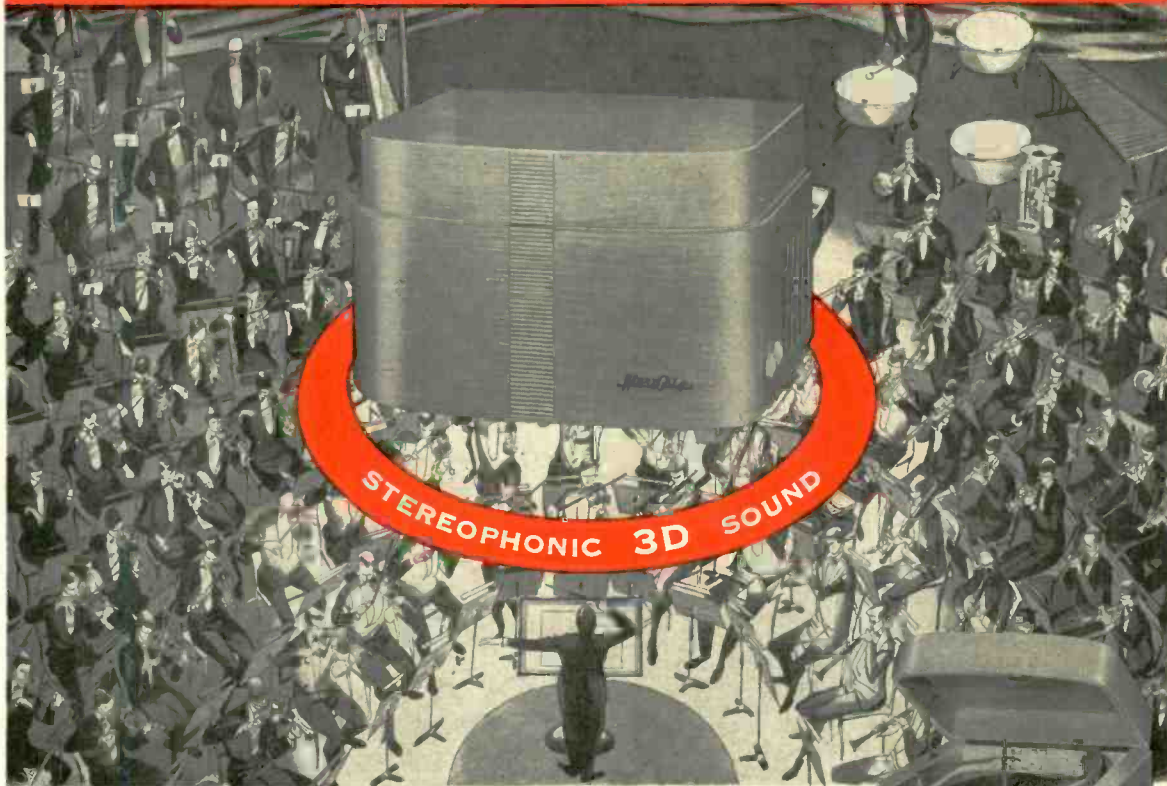

WILCOX-GAY 400

HIGH FIDELITY PHONOGRAPH

Wilcox-Gay opens the door to a new world of high fidelity music with the "400". Here is your introduction to the joys of really fine music. A magnificent hi-fi instrument offering audio reproduction in its most advanced stage. Truly a new experience in listening pleasure.

129⁵⁰ In Mahogany

slightly higher in Lined Oak, Walnut and Ebony finish.

- Plays all records in all speeds . . . automatically.
- Stereophonic side mounted Twin-Speaker system.
- Acoustically designed cabinet forms a tone-perfect chamber of unequalled qualities.
- Bentwood cabinet construction provides necessary bass-reflex.
- Dimensions: 18" wide, 11" high, 14" deep.

NOW . . . a tape Recordio for every purpose. Only Wilcox-Gay Recordio has a complete line. Only Recordio has the Prestomatic push-button keyboard.



WORLD'S LARGEST MANUFACTURER OF MAGNETIC TAPE RECORDERS

Send for free full color brochure

THE WILCOX-GAY CORPORATION 70 WASHINGTON STREET, BROOKLYN 1, N. Y.

Precision Prints

**YOUR PRODUCTIONS
BEST REPRESENTATIVE**

CLOSE CHECK ON PROCESSING

Picture and sound results are held to the closest limits by automatic temperature regulation, spray development, electronically filtered and humidity controlled air in the drying cabinets, circulating filtered baths, Thymatrol motor drive, film waxing and others. The exacting requirements of sound track development are met in PRECISION'S special developing machinery.

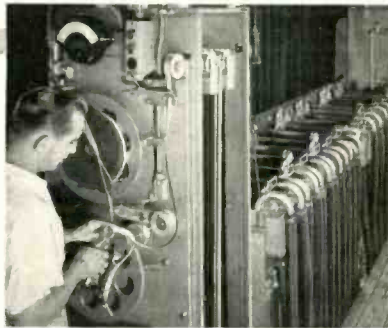

YOUR ASSURANCE OF BETTER 16mm PRINTS

16 Years Research and Specialization in every phase of 16mm processing, visual and aural. So organized and equipped that all Precision jobs are of the highest quality.

Individual Attention is given each film, each reel, each scene, each frame — through every phase of the complex business of processing — assuring you of the very best results.

Our Advanced Methods and our constant checking and adoption of up-to-the-minute techniques, plus new engineering principles and special machinery enable us to offer service unequalled anywhere!

Newest Facilities in the 16mm field are available to customers of Precision, including the most modern applications of electronics, chemistry, physics, optics, sensitometry and densitometry — including exclusive Maurer-designed equipment — your guarantee that only the best is yours at Precision!

Precision Film Laboratories—a division of J. A. Maurer, Inc., has 16 years of specialization in the 16mm field, consistently meets the latest demands for higher quality and speed.



differed greatly in plate current, the method suggested by Mr. Carlson seems to be preferred. In amplifiers in which the output cathodes are connected together, and thence through a resistance network (or even a single resistor) to ground, we suggest the permanent installation of a 15-ohm, 1-watt resistor from each cathode to the junction of the two leads. These resistors should be matched to around 1 per cent. Then a d.c. balance could be indicated by connecting a sensitive meter between the two cathodes and adjusting for a zero deflection of the meter. We also prefer an a.c. balance at some stage ahead of the output stage—possibly in the plate circuit of the driver stage, as originally suggested by Williamson in his first article on the now-famous amplifier. En.)

Figure of Merit Again

SIR:

I consider that Becker's approach to the Power Tube Figure of Merit is from the wrong angle. The real criterion is the end effect, in which the power tubes are one item only, although admittedly an important one.

The end effect is conditioned by two main parameters: fidelity, which includes distortion and noise, and cost, which sets a ceiling on capital outlay and running cost, and thus automatically puts a premium on those power tubes which achieve the desired end effect for the lowest total dissipation.

The most important factor is "true E_g ", which is "published E_g " multiplied by the feedback factor β , since low distortion can be achieved only by the use of inverse feedback. For example, a pair of tubes requiring only 20 volts to drive them to 10 watts, but producing 10 per cent distortion at that level, will require a feedback factor of 10 to reduce distortion to a design figure of 1 per cent, so that "true E_g " becomes 200 volts grid drive. Another pair requiring 40 volts drive at 4 per cent distortion will achieve 1 per cent with a feedback of 4, requiring a grid drive on only 160 volts.

In the following formula d is the published distortion figure, d' is the design distortion level, E_g the published grid drive at maximum output, and D the sum of plate, screen, and heater dissipations. I see no advantage in penalising R_L , save that abnormally high figures make transformer design somewhat more critical. P is designed power output, and is probably the same as published maximum output. The constant 10^3 is solely for convenience, and renders an answer a little greater than unity.

$$F \text{ of } M = \frac{P \times 10^3}{\frac{d}{d'} \times E_g \times \sqrt{D}}$$

By this formula, the older pairs such as KT66 and 6L6 are roughly equivalent, the former scoring on lower "true E_g " and the latter on lower dissipation. 6V6's show up well on low dissipation. Top scorers so far checked are RCA 6146, with its European equivalent the Philips/Mullard EL31, and British Mazda 11/E1, with efficiencies nearly twice as great. These conclusions agree with known data and experience.

The numerical value of the answers will, of course, depend on d' , but the ratios between answers, and consequently the information value to an engineer, will remain constant.

R. B. DYER,
33 Lower Boston Road,
London, W. 7.,
England.

Britain's
GREAT
CONTRIBUTION
TO
HIGH
FIDELITY

THE NEW
Collaro
 AUTOMATIC
3-SPEED RECORD CHANGER
 FOR 7, 10, AND 12 INCH RECORDS

It is more than coincidence that Britain and the United States both have gained distinction for accomplishment in the field of sound recording and reproduction. More likely, it is because of the common objectives and understanding shared by members of the great engineering fraternity on both sides of the Atlantic. Each has strived to score over the other, but with a characteristic sportsmanship in the interchange of know-how and experience.

Britain already has scored well with the Collaro record changer. In England and on the European continent, the Collaro is more widely used than any other record player in the world. Having won the acclaim of Europe's most discriminating audio devotees, Collaro record changers are now well on their way to repeating this experience in America.

The new Collaro record changers are truly a great contribution to high fidelity. Rumble, wow and flutter have been reduced to levels previously considered impossible in changer design. In all respects, the Collaro establishes a new standard of performance... and brings high fidelity reproduction a long way toward its ultimate goal of perfection.



- Model 3/532** Intermixes
10 and 12 inch records.
List Price **\$65.00**
- Model 3/531** Non-intermix.
List Price **54.50**
- Model 3/534** Single record player.
List Price **33.60**

Available at radio parts jobbers,
 distributors, and hi-fi dealers.

Write for complete details to:

ROCKBAR CORPORATION
 211 EAST 37th STREET, NEW YORK 16, N. Y.



by **TRIAD**

Designed by Triad to meet exacting military requirements for airborne telemetering equipment, the tiny electric wave filter shown above actually contains eleven precision components: 2 toroidal inductors, 5 JAN-C-5 capacitors, and 4 precision wire-wound resistors. The resulting attenuation slope is over 50 decibels per octave.

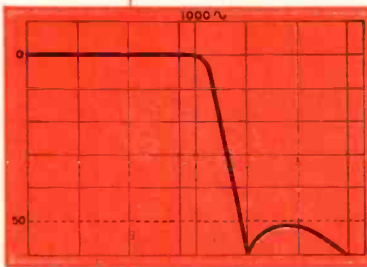

The same brilliant design and controlled manufacturing that goes into Triad's distinguished line of hermetically sealed military transformers is available to you for licking the toughest wave filter problems. Call Triad first!

For specifications and prices on Triad's general line of transformers, write for Catalog TR-53F.

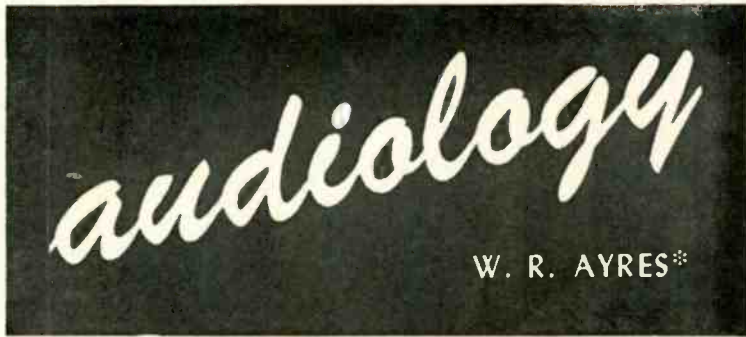

R-C Coupled Amplifier Charts

IN AMPLIFIERS up to about 75 watts power output, it is customary to eliminate all iron-core components with the exception of the rather unavoidable output transformer. The amplification from input to power amplifier grid is obtained with resistance coupling, for which one may be guided by data published in tube handbooks.

R-C coupled amplifier charts present values of cathode and screen resistance for use with various values of plate voltage, plate-load resistance, and grid-circuit resistance in the following stage. Values of cathode and screen resistance are based upon maximum useful output voltage. The data includes this output voltage, and the amplification under stated conditions.

Circuit constants and operating capabilities presented in these charts are averages based upon experiment. Accuracy implied by some of the numbers is greater than that warranted by consistency of the tubes; however, rounding off the values would tend to obscure trends in the data, and would make interpolation more difficult should the circuit designer use conditions not specifically listed in the charts.

With triodes, the cathode-bias resistance is chosen so that the stage will accommodate the largest output signal for 5 per cent harmonic distortion and no more than 0.1 microampere grid current. Cathode bypass and coupling capacitances listed in the data each cause 10 per cent lower amplification at 100 cps than at mid-frequencies. Thus the relative gain at 100 cps will be down roughly 2 db per stage. The suggested capacitances, of course, may be modified in proportion to the ratio of 100 cps to some other frequency at which this attenuation is permissible.

With pentodes, the cathode bias and screen-dropping resistances are chosen so that the stage will accommodate the largest output signal for 0.1 microampere grid current, and balanced overdrive into grid-current and cut-off regions. Cathode-bypass, screen-bypass, and coupling capacitances individually cause 10 per cent lower stage amplification at 100 cps than

at mid-frequencies. Thus the relative gain at 100 cps will be down approximately 3 db per stage.

In some instances (particularly with low plate-supply voltages), the cathode-bias voltage resulting from such adjustment is so low that even with small input signals the distortion in amplification may be excessive due to nonlinear loading of a high-impedance source. Effects due to grid current and to contact potential within the tube are not completely described by chart data, because those measurements were made with low-impedance sources. In a cathode-biased amplifier with (say) 1.0 megohm grid resistor, a minimum instantaneous cathode-to-grid potential of 1.25 volts has been recommended to prevent grid current and resulting nonlinear distortion; that is, to avoid input loading by grid current, the grid current, the grid should not come closer to the cathode than about 1.25 volts if very high input impedance is to be maintained throughout the entire signal cycle. When cathode bias with chart component values is less than this figure, then for use with high source impedance, the circuit values would preferably be revised to fulfill this added requirement, even though voltage gain and maximum signal-handling capability are reduced thereby. Obviously, bias by contact potential alone (as with grounded cathode and very high grid resistor) is suitable only with source impedance low enough to be unaffected by appreciable nonlinear loading, or when lowest possible cost is of greater importance than lowest possible distortion.

When the cathode biasing resistor is left unbypassed, additional input signal is required to produce the same output voltage. The magnitude of degenerative voltage at the cathode is related to the input signal essentially by the factor $(A_v R_k)/(Z_L)$, where A_v is the amplification with cathode resistance R_k bypassed, and Z_L is the parallel resistance of the plate-load resistance and the grid resistance of the following stage. It follows that the stage amplification is reduced by the factor $Z_L/(Z_L + A_v R_k)$.

Readily calculable from chart values,

* RCA Victor, Camden, N. J.

The NEW magnecord "M-80"



*World's Most
Versatile*
**professional
tape recorder**

- ★ Slot-loading, easiest tape handling-editing.
- ★ Push button operation and full remote control.
- ★ 15,000 cps at 7½ inches

**Check these outstanding
new features!**

- ★ 30-15,000 cps, ±2 db at 1½" per sec.
- ★ 50-10,000 cps, ±2 db at 7½" per sec.
- ★ 50-15,000 cps, ±4 db at 7½" per sec.
- ★ Timing accuracy ±3 sec. in 30 min.
- ★ Signal-to-noise exceeds 58 db
- ★ Flutter less than 0.1% RMS at 15 ips.
- ★ Standard NARTB playback curve
- ★ Instant dual speed selection
- ★ Microphone and bridging inputs
- ★ Full or half track operation
- ★ Case, rack, or console mounting

See and operate the brilliant new
Magnecord M-80 at your dealer's,
Look in the classified directory
under "recorders".

Magnecord INC.

Dept. AE-10, 225 West Ohio Street,
Chicago 10, Illinois

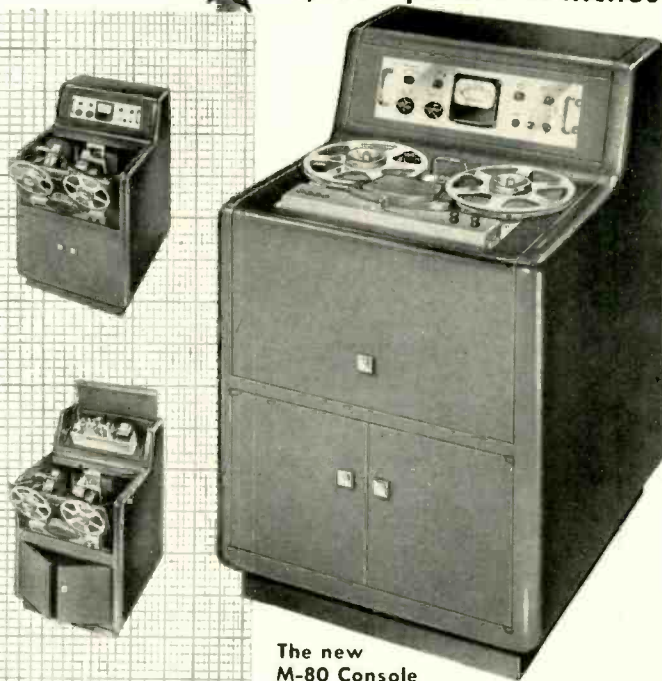

The new
M-80 Console
Amplifier and mechanical
unit inverts for servicing. No mounting screws
to remove.

**YOU MIGHT BE AMAZED
AT WHAT YOU CAN DO
WITH
SIGMA SENSITIVE RELAYS**

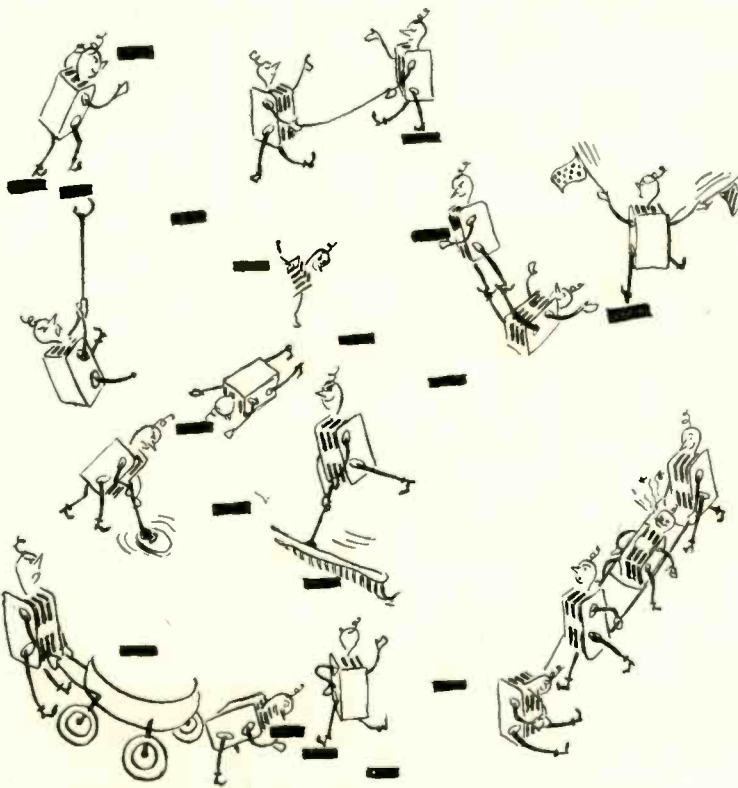
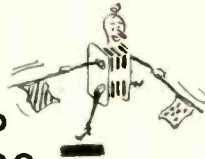

_____s new Automatic _____ is an electromechanical device which does everything that the old-fashioned human _____ did except demand a tip. Sigma is crowing about the five Sigma Type 6 magnetic latching memory relays which, together with a trifling few hundred pounds of machinery, make this all possible. The combination does everything for you except improve your _____ and the _____ rakes in the dough as never before, since the machine is not subject to strikes, hangover or bad temper. Even the displaced _____ are better off because they are now forced into decision — either go on relief or get a job.

CENSORED Unfortunately the proud manufacturer of the device we should be describing above is either a timid soul or lacks a sense of humor because he wouldn't bear of this type of reference to his pride and joy. By the time this was clear to us, it was too late to do anything except print it as above.
P.S.—Tear this out and try it on your player piano

SIGMA
SIGMA INSTRUMENTS, INC.
95 PEARL ST., SO. BRAINTREE, BOSTON 85, MASS.



6F2A1B
Here's a latching relay with only one moving part—the armature. No mechanical contacts to wear and tear, no contacts subject to shock and vibration. Contacts up to 4PDT—rated 5 amperes.
(This space paid for by Sales Manager)

the loss with cathode unbypassed is usually in the range from 3 to 6 db.

Often highest amplification is not needed, or component economy may be more important. Or perhaps the amplification of the stage must be uniform down to such a low frequency that a prohibitively large capacitance would be required. Some multistage amplifiers of quite high gain have no cathode-bypass capacitors whatever.

In pentode R-C coupled amplifiers, reduced amplification through omission of the screen-bypass capacitance is usually more like 20 db, which is such a large loss that screen bypassing is quite worthwhile.

At high frequencies, the response inevitably falls off because of shunt capacitances. With 0.5 megohm circuit impedance and 30 micromicrofarad total capacitance to ground, the high-frequency loss in amplification will amount to about 3 db at 10,000 cps (per such stage). For given shunt capacitance, wider bandwidth with constant amplification results from lower circuit impedance, so a pentode plate-circuit impedance (r_p , R_L and the following R_a , all in parallel) of 0.1 megohm or less is not uncommon in high-fidelity audio amplifiers.

In using triodes instead of pentodes as voltage amplifiers, the apparent advantage of lower plate-circuit impedance may be more than offset by the combined effects of lower amplification and higher input capacitance. The latter is due largely to the so-called Miller effect, due to feedback via the plate-to-grid capacitance. The magnitude of additional input capacitance due to this cause is approximately the grid-to-plate capacitance (tube, socket, and wiring combined) multiplied by the mid-frequency voltage amplification of the stage. Total resulting input capacitance is usually great enough to limit usefulness of high- μ triodes to situations in which the grid-to-ground capacitance is already very large, as with a long shielded input cable; or with a low-impedance source, such as a distribution line.

With either triodes or pentodes, non-linear distortion is reduced through selection of the highest permissible resistance in the following grid circuit. For output signals up to 10 volts rms or so, harmonic distortion with a pentode amplifier can be much lower than with a triode operating with the same load resistances and supply voltages. This, coupled with the possibility of much smaller input capacitance, makes a quiet pentode such as 5879 or 1620 a particularly good choice for a low-level input stage. But when a grid-to-cathode signal having a magnitude of a volt (r.m.s.) or more must be accommodated, a triode voltage-amplifier stage is usually preferable. Tube type 12AU7 is very popular in such usage. When lowest possible hum or noise is sought, a better choice might be type 12AY7, or a triode-connected 5879 or 1620.

**THE AUDIO FAIR
is YOUR affair
DON'T MISS IT!**

8 db more output

with no increase in noise or harmonic distortion!

It's the new

REG. U.S. PAT. OFF.

SCOTCH

BRAND

Magnetic Tape

High  Output
TRADE MARK

AVAILABLE IN 300, 600, 1200, 2400
and 4800 foot lengths



High-Output and  TM 3M Co.

The term "SCOTCH" and the plaid design are registered trademarks for Sound Recording Tape made in U.S.A. by MINNESOTA MINING & MFG. CO., St. Paul 6, Minn.—also makers of "Scotch" Brand Pressure-Sensitive Tapes, "Underseal" Rubberized Coating, "Scotchlite" Reflective Sheeting, "Safety-Walk" Non-slip Surfacing, "3M" Abrasives, "3M" Adhesives. General Export: 122 E. 42nd St., New York 17, N.Y. In Canada: London, Ont., Can.





Introducing

THE New

PERMOFLUX
Super ROYAL

HIGH Fidelity SPEAKER

The finest speaker ever made by Permoflux . . . retaining all the exceptional features of the famous Royal Line . . . plus new developments in design giving you a performance which is *Virtually Distortionless*. It has *Full Range Response* (to the limits of audibility), and *Superior Damping* with *Maximum Sensitivity*.

This unsurpassed performance is due to exclusive Permoflux features, such as ★T.S.C. (treated slotted cone) for extended distortionless low frequency response. ★Latest design in magnetic structure utilizing heavy Alnico 5 ring magnet for maximum flux density.

★Specially designed single cone radiator for full high and low frequency response, without the phase distortion due to separate speakers for high and low frequencies.

For descriptive literature write to . . .

Available in 3 sizes -
8, 12 and 15 inch

See and hear the
Super Royal at your
High Fidelity Dealer

Permoflux CORPORATION

4916 West Grand Avenue, Chicago 39, Illinois
236 S. Verdugo Rd., Glendale 5, California

BOOK REVIEWS

PHOTOELECTRIC TUBES, by A. Sommer. London: Methuen & Co. viii+118 pages. A "Methuen Monograph on Physical Subjects."

This second edition has been retitled to indicate clearly that it covers photoelectric tubes, not photovoltaic nor photoconductive cells. Opening with an excellent statement of the theory of operation of photoelectric emission, (in a chapter written by S. Rodda) the book then proceeds to a description of photoelectric cathodes, the matching of light sources to particular cathodes, vacuum and gaseous types of tubes, the multiplier photocell, and finally a chapter on the application of photocells in general circuitry.

The treatment is one of a descriptive nature, rather than depending upon mathematical thesis, and is easily followed by the lay reader seeking a fundamental knowledge of this phase of electronic work. As the entire present day sound picture audio reproduction is dependent upon the photocell as a source of sound from the film, this text is clearly indicated to the neophyte in this field, whether he be entering upon it from a professional or amateur status. The twenty-seven diagrams, the bibliography, and the index are most complete in opening the door to further study of this subject for those whose particular interests are concerned.

—L. B. Keim.

BASIC ELECTRONIC TEST INSTRUMENTS, by Rufus P. Turner. New York: Rinehart Books, Inc. xiv + 254 pages illustrated, 1953. \$4.00.

This revision of the same author's previous work in this field brings up-to-date the current status of test instruments in the radio and television field. Written for the practical service man, whose fundamental knowledge of electrical theory is assumed, the book not only describes the make-up of specific instruments but also their use in practical servicing. Where commercially built or kit-form testers are not available, specially designed instruments are described, based upon articles published by Mr. Turner.

Beginning with basic meters and multimeters, power, impedance, capacitance, and inductance measurements are next covered. Special bridges, oscilloscopes, signal generators, both r.f. and a.f. follow in that order. The several chapters on specific testing methods, including the use of signal tracing equipment, and finally a chapter on tube testing and tube checkers.

This author has had many years of practical servicing work, and he draws upon personal knowledge throughout his lucid writing style. The man primarily interested in audio work will find this good reading material as a fundamental step in the proper techniques of testing work. However, it must be noted that it is not fundamentally an audio treatise, but a guide for the general service technician.

One drawback from which this book suffers along with too many technical publications is the fact it is out of date before it reaches the reader, for while the techniques remain, most of the kit-form instruments described have been succeeded with newer and improved models. But for the man building a technical bookshelf on the easily understood basis, this book is ideally suited to his requirements for a text that is both clear in its statements and authoritative.

—L. B. Keim.

**you
don't
buy
one of
these
every
day!**

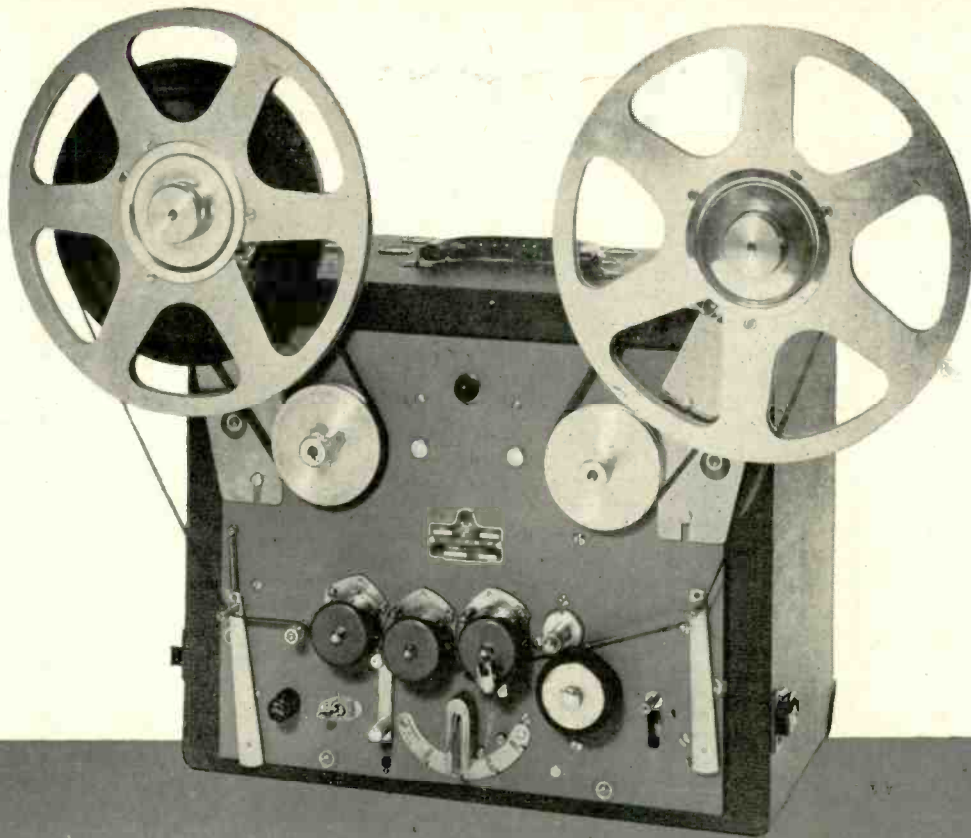

PRESTO RC-7 with RA-1 reel adapter

Compare these RC-7 features:

- Instantaneous speed accuracy
- Dynamic range better than 50db. at 3% distortion
- Three-motor drive
- No friction clutch or friction brakes
- Heavy duty construction throughout
- Separate-erase-recording-playback heads
- Twin speed: 7 1/2" /sec. or 15" /sec.
- Frequency response to 15,000 cps.
- Reel size: to 10 1/2" (with RA-1 adapter)

Purchase of a tape recorder is a major investment. And, with so many unproven brands on the market, it simply does not pay to select anything but a recognized, precision built and proven recorder.

The PRESTO RC-7 is just such a unit. Designed and manufactured by the world's foremost producer of precision recording equipment, the RC-7 with RA-1 reel adapter is today's No. 1 buy in fine tape recorders. Here is a unit that is fully portable for field recording, yet with the rugged construction and precision operation characteristic of the finest studio equipment.

If you're planning to replace an existing unit or add an additional tape recorder, your selection of a PRESTO RC-7 will pay long term dividends in faultless service, ease of operation and the genuine satisfaction of owning the best.

Do you own a Presto RC-7? The RA-1 adapter will allow you to use reels up to 10 1/2" diameter. Write for full details and price.



PRESTO RECORDING CORPORATION
PARAMUS, NEW JERSEY

Export Division:
Canadian Division:

25 Warren Street, New York 7, N. Y.
Walter P. Downs, Ltd., Dominion Square Bldg., Montreal

WORLD'S LARGEST MANUFACTURER OF PRECISION

RECORDING EQUIPMENT AND DISCS

EDITOR'S REPORT

AUDIO IN THE HOME

MANY OF *Æ*'S REGULAR READERS comment on the desire for more "butter on the popcorn"—an expression originated by Morgan Kennedy, Jr., 'way back in December, 1951. We try assiduously to comply with the desires of our readers, but all the while with the thought that Audio covers a very large field—not only for equipment used in the home, but also in the more professional aspects of the art or science, or both. Recognizing that not every reader is an engineer—nor even, perhaps, a hobbyist—we offer considerable material that can be understood readily by those who are not technically minded. We have often been criticized for including too much material of a highly technical nature, and we have been criticized just as often for including articles that were too "simple" to appear in a magazine with the word engineering in its title.

We know that audio covers a wide field—there are many readers who would be perfectly content to purchase a complete hi-fi system and then just enjoy it. We know too that there are many who buy a complete set of components and listen for a month or so and then start improving their home music reproduction by changing to a better amplifier, a speaker of wider range, or an enclosure with smoother output characteristics. There are many who build many of the components—there are those who engaged in custom installations—those who design and manufacture the components—those who work with professional equipment to provide us with the phonograph records and the radio broadcasts which are, after all, the source material for the home listener. In short, there are many kinds of people with many different kinds of interest in audio. We believe we must serve them all.

For the beginner in hi-fi, the descriptions of amplifiers and speaker enclosures and so on may seem complicated but, as everyone knows, there are many people who derive considerable pleasure from some form of handiwork. We think that a lot of the fun of audio is in making things, but the ultimate result—having high-quality sound reproduction in the home—is the aim of every music lover, and he can attain that goal just as well by buying completed units and putting them together himself, or even by buying a packaged hi-fi system—and probably a lot more quickly and economically. One of the advantages of "growing" a hi-fi system is that one can start with one exceptionally good unit—such as an amplifier, for example—and use it with the tuner portion of an existing radio set and, perhaps, a moderately priced speaker until he is ready to take another step. One does not need to get everything at once if the budget groans, but the normal procedure is likely to be that the radio set will be replaced with a good tuner, a good record changer and pickup will be added, and then possibly the speaker will be upgraded to a two- or three-way system.

But let us not be deceived by misleading suggestions from those who seek to capitalize on the current great interest in hi-fi. It is fairly well recognized that the finest speaker systems consist of two or three (or even four) units—each handling only a portion of the musical spectrum—but the presence of two or even three speakers does not automatically make a set hi-fi. Each component of a music system must be of high *quality*, and a system built of high-quality parts is almost certain to provide high-fidelity reproduction.

Howard Souther, of Electro-Voice, Inc., has prepared an interesting brochure on the components of a hi-fi system and the features to look for when making a choice of components for your own system. We felt that this material was well thought out and attractively presented, and accordingly we prevailed upon E-V to let us run it in this issue in its entirety for *Æ*'s readers. Many of the illustrations indicate a predisposition on the part of the author for his company's products—as might be expected—but they are not mentioned by name. Some of Mr. Souther's ideas may be controversial, but in general the information is reliable. This section—fourteen pages—begins on page 54.

Letters containing your questions are coming in heavily for the Question and Answer page which will start with the December issue and continue regularly from then on. Remember, though—please include a stamped, self-addressed envelope.

KEEP UP THE STANDARDS

At a meeting of the High Fidelity Committee of the RETMA held during the International Sight and Sound Exposition in Chicago, a task force was implemented to come up with definitions for *high-fidelity*. We most heartily agree that such definitions are needed—as did nearly everyone at the meeting—and it is expected that the task force will deliver at the Audio Fair. 'Til then, we await with interest.

THE AUDIO FAIRS

Two Audio Fairs in two months make quite a chore for anyone in the audio business—even attending both during every minute the doors are open is wearing. The International Sight and Sound Exposition combined with the Audio Fair in Chicago introduced the Fair idea to the people of the Windy City—a city which was sweltering in temperatures ranging from 95 to 100 throughout the day and not much better at night. But still, according to the ISSE management, attendance was over 20,000 although it was estimated at somewhat less than that by experienced Fair attenders.

At least, New York Audio Fair has something to shoot at—at Los Angeles, the attendance was around 17,000 whereas NY's last figure was around 13,000. When it comes to attendance records, the first guy never has a chance.

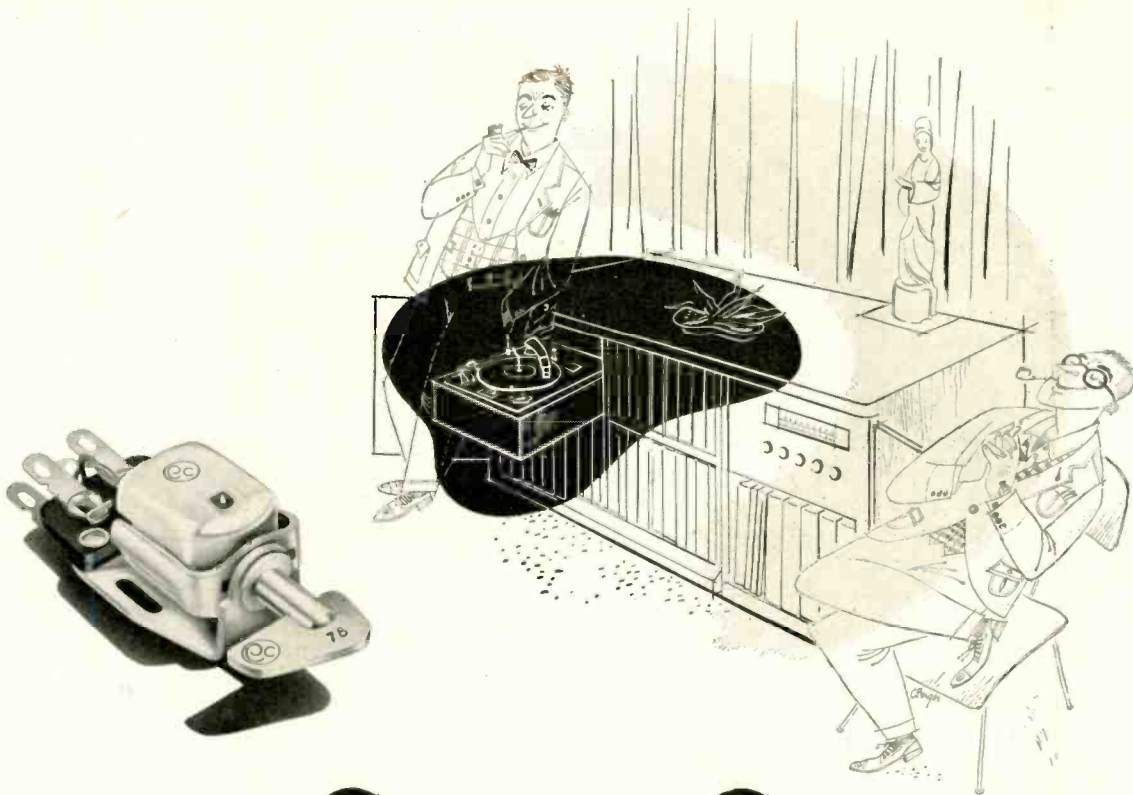

“I’m glad I waited...”

Here’s how I solved a problem that bothered me . . . and may be bothering you.

Many of my favorite recordings happen to be 78’s. They mean as much to me as any of my newer LP’s or 45’s. Changing pickups was often a real nuisance—and yet I wasn’t willing to give up the superior quality of my two Pickering cartridges.

Last fall my dealer offered a suggestion. “Wait a little longer,” he said. “You’ll be glad you did.”

He was right. I now have Pickering’s new turn-over cartridge. A simple flip of the handy lever and I’m ready to play any favorite that fits my mood—whether it’s standard or microgroove. *More than that, I’d swear my recordings sound better than ever.*

I’m glad I waited . . . but you won’t have to.

Ask your dealer to show you this convenient new turn-over cartridge. Have him demonstrate it. See if you, too, don’t hear the difference!

PICKERING and company incorporated • Oceanside, L. I., New York

PICKERING PROFESSIONAL AUDIO COMPONENTS

“For those who can hear the difference”

... Demonstrated and sold by Leading Radio Parts Distributors everywhere.
For the one nearest you and for detailed literature, write Dept. A-3



A

NEW

TWIST

IN

TELEPHONY

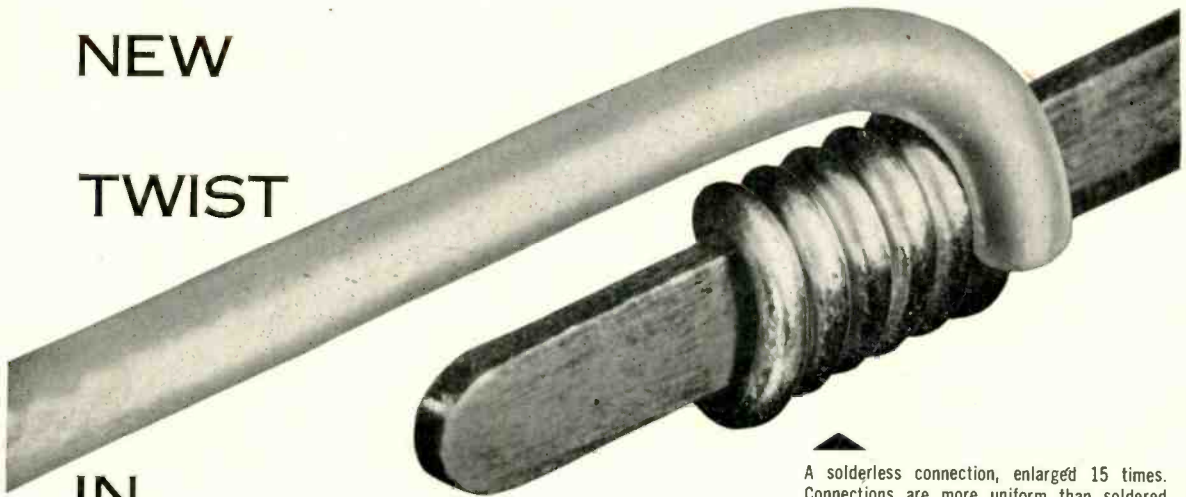

A solderless connection, enlarged 15 times. Connections are more uniform than soldered ones and only half as bulky.

For years the accepted way to connect wires to telephone apparatus was with solder. Now, Bell Laboratories engineers have discovered how to make connections faster and better—without solder.

Solder, they reasoned, wouldn't be needed if wire and terminal could be kept tightly pressed together. But, for economy, this had to be done with the wire alone—without complicating screws and springs.

They found the answer in using a properly dimensioned terminal with sharp edges . . . whipping the wire around it under high tension. The terminal bites into the wire, locking it securely into position. Thereafter the squeezed edges maintain a contact pressure of at least 15,000 pounds per square inch—even under vibration that cracks soldered joints.

The new connections can be made in half the time—a big money-saver in the billion connections that Western Electric makes each year for the Bell System. It's another example of the way Bell Telephone Laboratories works continually to keep costs low.

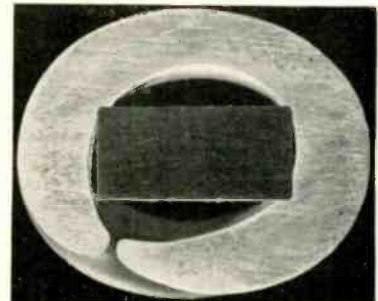

Cross section of solderless connection. Note terminal biting into wire. In a six-turn connection there are at least 20 clean contact areas impervious to moisture and corrosive gases, offering current a low resistance path.



Power tool whips wire on terminal in fraction of a second. There is no heat which could damage miniature components . . . no dropped solder or wire clippings to cause trouble later.

BELL TELEPHONE LABORATORIES

IMPROVING TELEPHONE SERVICE FOR AMERICA PROVIDES
CAREERS FOR CREATIVE MEN IN MECHANICAL ENGINEERING



The Basic Design of Constant Resistance Crossovers

N. H. CROWHURST*

An analysis of the response and phase characteristics of constant-resistance crossover networks worked out for filters employing from one to four elements.

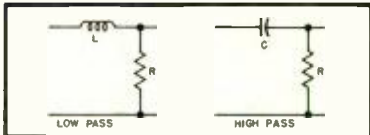

Fig. 1. Basic single-element filters for parallel combination at input into composite filter.

ALTHOUGH CROSSOVER FILTERS are now in everyday use, confusion about their design and performance still persists. Most presentations published to date concentrate attention on the filter-derived types, and if the constant-resistance variety is mentioned at all, it is just thrown in for good weight. In point of fact, the constant-resistance type of response offers several advantages over the filter-derived types.

When the parameters are correct for constant resistance, other useful properties appear that are not available with other derivations. The principal properties of these networks may be summarized as follows:

Attenuation Response

(i) The responses of the two filters, considered separately, are complementary, so that the sum of the energies delivered to the two output circuits, for constant-voltage or constant-current input (according to configuration), is constant at all frequencies.

(ii) Also the attenuation response of each filter gives the maximum flatness within its pass range, with the most rapid transition possible, with the number of elements used, short of introducing peaking in the vicinity of crossover.

Phase Response

(iii) The phase response of each filter

* 150-46 18th Ave., Flushing 57, N. Y.

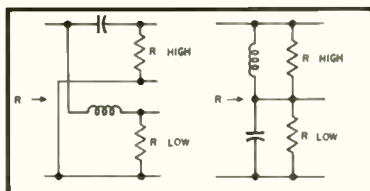

Fig. 2. The two forms of composite filter, giving constant-resistance characteristics with single-element sections. Each reactance is equal to R at crossover.

is symmetrical about cut-off frequency (which is crossover for the combination).

(iv) The difference in phase between the signal delivered to the two outputs is constant.

Input Impedance

(v) This, for the combined filters, is constant and resistive throughout the spectrum, provided, of course, that each filter is correctly terminated at its output. It is from this property of the filters that they derive their name.

This article will derive the formulas for constant-resistance filters using up to four elements in each filter, showing how the foregoing qualities apply for each case, and will consider the properties of simpler or more complex filters from the viewpoint of their effect on the fidelity of reproduction. At this stage, filters using physical inductances

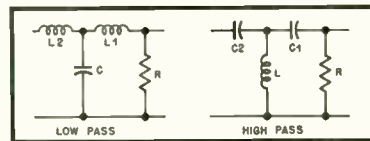

Fig. 5. Basic three-element filters.

and capacitances will be assumed, but the theory developed will be useful for application to circuits simulating the responses by other means, to be considered later.

For developing the formulas the filters will always be of such a configuration that their inputs are connected in parallel. The results are quite simply applied to filters of the type used for series combination by the principle of duality.

Single-Element Filters

Consider first the single reactance filters of Fig. 1, taking first the low-pass section. The relation between input and output voltage is

$$A_L = 1 + j \frac{\omega L}{R}$$

which can also be written

$$A_L = 1 + jx \quad (1)$$

on the assumption that $\frac{\omega L}{R} = x$.

The energy supplied to the low-frequency unit is V^2/R , and V is E/A_L .

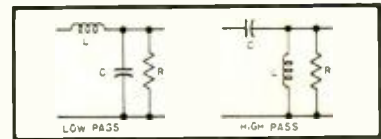

Fig. 3. Basic two-element filters for parallel combination at input to form composite filter.

So the energy supplied can be written

$$P_L = \frac{E^2}{R} \cdot \frac{1}{1+x^2} \quad (2)$$

The attenuation response is given by

$$db_L = 10 \log_{10} (1+x^2) \quad (3)$$

The phase relation between input and output is given by the angle whose tangent is the ratio between the real and imaginary parts of (1). Using the convention that positive angles represent delay, the phase-transfer characteristic is given by

$$\phi_L = \tan^{-1} x \quad (4)$$

The input impedance of the low-pass unit is

$$Z_L = R(1+jx) \quad (5)$$

or, since it is to be connected in parallel with the other unit, the admittance is required,

$$Y_L = \frac{1}{R} \cdot \frac{1}{1+jx} = \frac{1}{R} \cdot \frac{1-jx}{1+x^2} \quad (6)$$

Turning now to the high-pass section. The relation between input and output voltage is

$$A_H = 1 + \frac{1}{j\omega CR}$$

which can be written

$$A_H = 1 - j \frac{1}{x} \quad (7)$$

on the assumption that $\frac{1}{\omega CR} = \frac{1}{x}$.

The energy supplied to the high-fre-

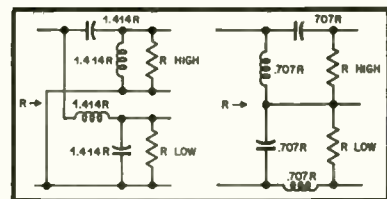

Fig. 4. The two forms of composite filter giving constant-resistance characteristics with two-element sections. Reactances at crossover are indicated.

quency unit can be written

$$P_u = \frac{E^2}{R} \cdot \frac{x^2}{1+x^2} \quad (8)$$

and the attenuation response is given by

$$db_u = 10 \log_{10} \left[\frac{1+x^2}{x^2} \right] \quad (9)$$

Adding together the energy supplied to the two units when the filters are paralleled, as given by (2) and (8),

$$P = P_L + P_u = \frac{E^2}{R} \cdot \frac{1+x^2}{1+x^2} = \frac{E^2}{R} \quad (10)$$

This proves that condition (i) applies, i.e. the sum of the energies is constant. It might also be assumed to demonstrate condition (v), because the denominator is R , but it is hypothetically possible to transfer this amount of energy without the input impedance being R , if there should be any reactive component to the input impedance, so this will be investigated.

The phase of the high-frequency output compared to the input is

$$\phi_u = \tan^{-1} \frac{1}{x}$$

which can be transposed to

$$\phi_u = (\tan^{-1} x) - \frac{\pi}{2} \quad (11)$$

It is seen that the difference between (4) and (11) is a constant angle of $\pi/2$ or 90 deg.

The impedance of the input to the high-pass unit is

$$Z_u = R \left(1 - j \frac{1}{x} \right) \quad (12)$$

whence the admittance is

$$Y_u = \frac{1}{R} \cdot \frac{x}{x-j1} = \frac{1}{R} \cdot \frac{x(x+j1)}{1+x^2} = \frac{1}{R} \cdot \frac{x^2 + jx}{1+x^2} \quad (13)$$

Adding together the admittances (6) and (13), the combined input admittance is

$$Y = Y_L + Y_u = \frac{1}{R} \cdot \frac{1-jx+jx+x^2}{1+x^2} = \frac{1}{R} \quad (14)$$

whence the input impedance is

$$Z = R \quad (15)$$

which is constant, resistive, and equal to both output loads.

When $x=1$, both P_L and P_u have half energy values, so this represents crossover frequency. Possible configurations using single-element filters are shown at Fig. 2. All reactances are equal to R at crossover frequency.

Two-Element Filters

The filter configurations for parallel connection at the input are shown at Fig. 3. For the low-pass section,

$$A_L = 1 + j\omega L \left(\frac{1}{R} + j\omega C \right) = 1 - \omega^2 LC + j \frac{\omega L}{R} \quad (16)$$

Using the same method as before, the

energy supplied to the low-frequency unit will be

$$P_L = \frac{E^2}{R}$$

$$\frac{1}{1 - 2\omega^2 LC + \omega^4 L^2 C^2 + \omega^2 L^2 / R^2} \quad (17)$$

and the attenuation response is given by

$$db_L = 10 \log_{10} \left[1 - 2\omega^2 LC + \omega^4 L^2 C^2 + \frac{\omega^2 L^2}{R^2} \right] \quad (18)$$

To conform with conditions (i) and (ii), (17) and (18) must reduce to the forms

$$P_L = \frac{E^2}{R} \cdot \frac{1}{1+x^2} \quad (19)$$

and

$$db_L = 10 \log_{10} [1+x^2] \quad (20)$$

respectively, which require $L^2/R^2 = 2LC$ and $\omega^2 LC = x^2$. These equations are satisfied by making

$$\frac{\omega L}{R} = \sqrt{2}x \text{ and } \frac{1}{\omega CR} = \frac{\sqrt{2}}{x} \quad (21)$$

Substituting these values into (16) gives

$$A_L = 1 - x^2 + j\sqrt{2}x \quad (22)$$

Applying this to the phase response,

$$\phi_L = \tan^{-1} \frac{\sqrt{2}x}{1-x^2} \quad (23)$$

and the input impedance of the low-pass unit is

$$Z_L = R \left(j\sqrt{2}x + \frac{\sqrt{2}}{\sqrt{2}+jx} \right) = R \left(\frac{\sqrt{2}(1-x^2) + j2x}{\sqrt{2}+jx} \right) \quad (24)$$

From which the admittance is

$$Y_L = \frac{1}{R} \left(\frac{\sqrt{2}+jx}{\sqrt{2}(1-x^2) + j2x} \right) = \frac{1}{R} \left[\frac{2-j\sqrt{2}(x+x^2)}{2(1+x^2)} \right] \quad (25)$$

Turning to the high-pass section,

$$A_u = 1 - \frac{1}{\omega^2 LC} + \frac{1}{j\omega CR} \quad (26)$$

The energy supplied to the high-frequency unit will be

$$P_u = \frac{E^2}{R} \cdot \frac{1}{\left(1 - \frac{1}{\omega^2 LC} \right)^2 + \left(\frac{1}{\omega CR} \right)^2} = \frac{E^2}{R} \cdot \frac{\omega^4 L^2 C^2}{\omega^4 L^2 C^2 - 2\omega^2 LC + 1 + \omega^2 L^2 / R^2} \quad (27)$$

and its attenuation response

$$db_u = 10 \log_{10} \left[1 - \frac{2}{\omega^2 LC} + \frac{1}{\omega^4 L^2 C^2} + \frac{1}{\omega^2 C^2 R^2} \right] \quad (28)$$

which should take the form

$$P_u = \frac{E^2}{R} \cdot \frac{x^2}{1+x^2} \quad (29)$$

and

$$db_u = 10 \log_{10} \left[\frac{1+x^2}{x^2} \right] \quad (30)$$

requiring the same values as given in (21).

Condition (i) is seen to apply by adding (19) and (29):

$$P = P_L + P_u = \frac{E^2}{R} \cdot \frac{1+x^2}{1+x^2} = \frac{E^2}{R} \quad (31)$$

Substituting the values of (21) into (26) gives

$$A_u = 1 - \frac{1}{x^2} - j \frac{\sqrt{2}}{x} \quad (32)$$

This gives the phase response as

$$\phi_u = \tan^{-1} \frac{-\sqrt{2}x}{x^2-1}$$

which can be transposed to

$$\phi_u = \left(\tan^{-1} \frac{\sqrt{2}x}{1-x^2} \right) - \pi \quad (33)$$

from which it is seen that the phase difference between (23) and (33) is constant at π or 180 deg.

The input impedance of the high-pass unit is

$$Z_u = R \left(\frac{j\sqrt{2}x}{1+j\sqrt{2}x} - j \frac{\sqrt{2}}{x} \right) = R \left(\frac{2x + j\sqrt{2}(x^2-1)}{x(1+j\sqrt{2}x)} \right) \quad (34)$$

and the admittance is

$$Y_u = \frac{1}{R} \left(\frac{x(1+j\sqrt{2}x)}{2x + j\sqrt{2}(x^2-1)} \right) = \frac{1}{R} \left(\frac{2x^4 + j\sqrt{2}(x+x^3)}{2(1+x^2)} \right) \quad (35)$$

Thus, by adding (25) and (35), it is seen that the combined input admittance is $1/R$, as before, and the input impedance is equal to the load connected to each output and is always resistive.

Possible configurations using two element filters are shown at Fig. 4, with the reactance values at crossover frequency.

Three-Element Filters

Figure 5 shows the basic three-element filters for parallel combination at the input.

By similar development, it may be shown that the energy delivered to the low-frequency unit is

$$P_L = \frac{E^2}{R} \cdot \frac{1}{1+x^6} \quad (36)$$

and the attenuation response is

$$db_L = 10 \cdot \log_{10} (1+x^6) \quad (37)$$

respectively to fulfill conditions (i) and (ii).

The phase response is given by

$$\phi_L = \tan^{-1} \frac{2x-x^3}{1-2x^2} \quad (38)$$

The corresponding expressions for the high-pass unit are

(Continued on page 108)

Complete Remote Control of an Ampex 300

RICHARD F. BLINZLER*

Remote operation of a standard tape recorder facilitates use by a number of studios without need for a separate recorder operator, and provides greater flexibility for small studio.



Fig. 1. Cam lever switch mounted on the front panel of an Ampex 300 tape recorder in place of the rotary switch. Switch-handle motion is forward and backward, but name plate had not been changed.

THE REGULAR REMOTE CONTROL circuit used on the Ampex 300 tape recorder allows remote operation of the START, STOP, and RECORD switches. If it were possible to extend remote operation to the circuits controlling fast forward, play, and rewind, almost complete remote control of this machine would result. These functions are normally set by a rotary switch on the front panel of the recorder.

Merely extending these switch wires, eight in all, would not provide proper remote operation because the switch remains in whatever position it is set and so some of the switches might be set in the wrong position for other remote operation.

Study of the FAST FORWARD-PLAY-REWIND switch showed that its operation could be duplicated using a cam lever switch to control two relays. On the recorder the rotary tap switch controlling these modes of tape travel was removed and a DPDT cam lever switch was mounted in the same hole.

* Audio Supervisor, WGR Broadcasting Corporation, Buffalo 3, N. Y.

Figure 1 shows the cam lever switch mounted in place of the rotary tap switch on the front panel of the recorder; Fig. 2 shows the new relay assembly and the rear of this lever switch as mounted inside the recorder on the shelf supporting connecting plugs and fuses; and Fig. 3 is a simplified schematic of the modification.

The Ampex instruction book (Control Circuits, Models 300-301-302, dated Jan. 15, 1952) shows resistors R_{801} - R_{802} - R_{803} and the rotary tap switch which control

switch) the make contacts of E_1 connects 1 to 1B, through contacts on relay E_2 , and 3 to 3 B-C. On FAST FORWARD E_1 operates as described except that 1 connects to 2C through contacts of E_2 . The operation of these relays can easily be remotely operated by the addition of three wires to the regular remote control circuits and a cam lever switch at each remote position.

Any number of remote positions can be added because all of the remote controls, both regular and this modification, are parallel circuits with the one exception which is the series connected STOP control.

Advantages of this remote operation is that the lever switch in its normal "hands-off" operation remains in the PLAY position and it is impossible for the recording engineer, as in the past, to leave the recorder with the transport switch in the wrong position and so possibly rewind off the reel instead of the desired operation.

The START button may be held down while the switch is thrown rapidly for shuttle operation of the tape but if it is

(Continued on page 116)

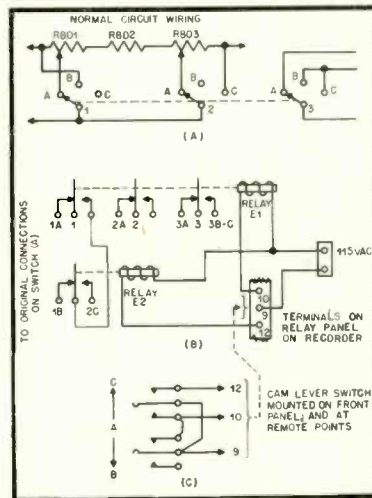

Fig. 3. Wiring schematic inside Ampex 300 recorder to permit remote operation. (A) shows normal wiring of PLAY-REWIND-FAST FORWARD switch; (B) shows connections to two relays E_1 and E_2 ; and (C) shows connections to the cam lever switch mounted in hole formerly occupied by rotary switch. All remote switches are also connected to the three terminals—9, 10, and 12.

the tape transport mode switch—i.e., fast forward-play-rewind functions. Figure 3 shows these parts and below them the two new relays and the cam lever switch.

On REWIND, relay E_1 coil is energized. On FAST FORWARD operation both E_1 and E_2 are energized. On PLAY, both relays are de-energized. In the PLAY position ("A" on the rotary switch), the 3PDT relay, E_1 , on its normally closed back contacts connects 1 to 1A, 2 to 2A, and 3 to 3A. On REWIND ("B" on the rotary

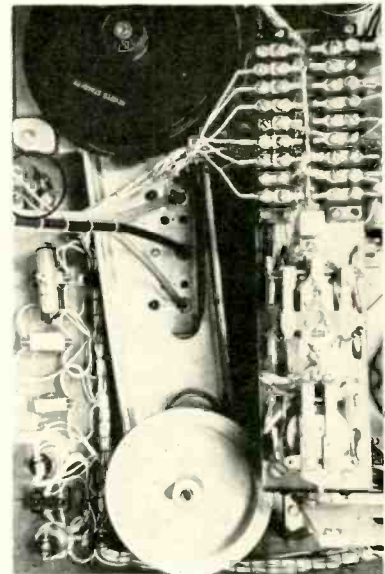
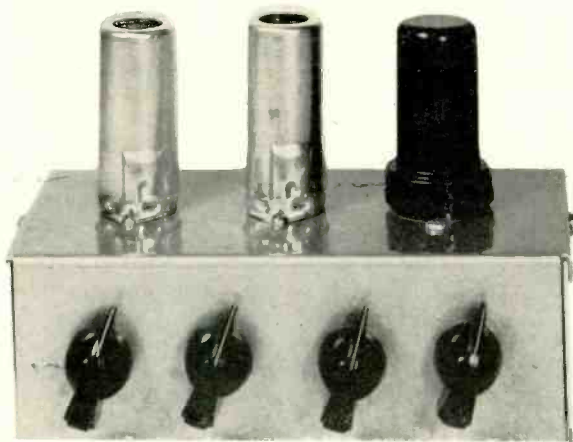

Fig. 2. New relay assembly in place inside the recorder. Rear view of the cam lever switch can be seen in the circle at upper left.

A Three-Element Bass Control

GLEN SOUTHWORTH*

One solution to the problem of providing realism in music reproduction is to introduce a controlled amount of "hangover" by means of the circuit described which permits boosting bass at three separate frequencies independently.



The three-element bass tone-control unit designed to obtain power supply from main amplifier.

IN THE DESIGN of conventional tone controls a cut and dried procedure is very often followed. A sine-wave test signal is used and the circuitry adjusted to provide the desired number of decibels boost or cut in reference to 1000 cps, typical steady state response curves being shown in Fig. 1. While very useful in many cases, this type of tone control is not very likely to provide ade-

quate compensation for some program sources as well as the listener's speaker system, room acoustics, and individual musical tastes.

The bass-boost circuitry described in this article is an attempt to provide a musical form of bass emphasis similar to the kind generated naturally by good acoustics. To do this, particular attention has been paid to the transient character of most bass sounds as well as some of the significant factors of human

* Box 284, Moscow, Idaho.

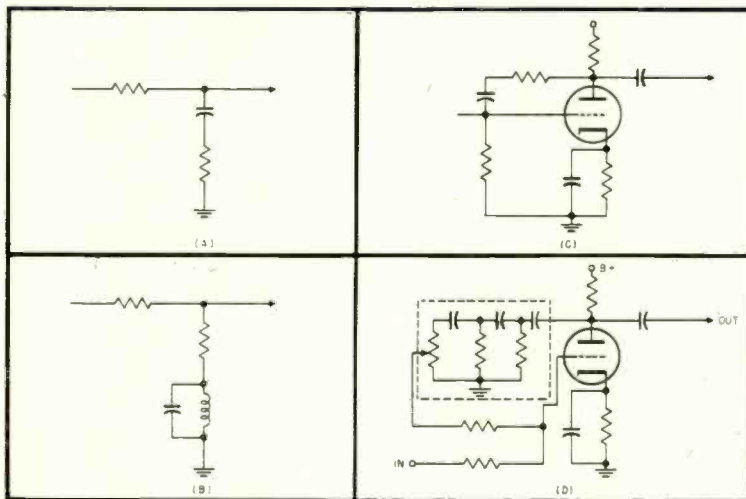

Fig. 2. Bass-boost circuits—(A) is the resistance-capacitance circuit; (B) is the resonant circuit, usually low impedance; (C) is the feedback type of bass equalization; and (D) is the simulated resonant circuit, with frequency determining elements shown in dotted box.

hearing. The results obtainable should be highly valued by the listener who desires good, full, audible and "feelable" bass together with a minimum of interaction or apparent distortion of high frequencies.

Figure 2 shows three of the most commonly used methods of bass boost. These are the R-C network, the R-C-L or resonant circuit, and the inverse-feedback method of obtaining bass emphasis. A fourth type of frequency emphasis is obtained by altering the feedback path of a triode or pentode in such a manner that the circuit simulates a resonant inductance-capacitance combination. Though more complicated than the LC circuit of (B) in Fig. 2, This circuit has a number of distinct advantages. It requires no expensive high-Q inductances, and is therefore not

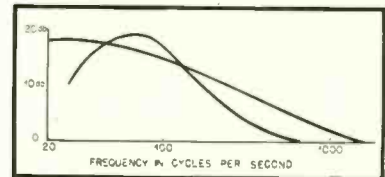

Fig. 1. Comparative steady-rate response curves of conventional bass-boost circuit (A) and resonant bass boost (B).

susceptible to hum pickup from stray magnetic fields. Likewise, it is a high-impedance device with essentially zero insertion loss and as such is easily adapted to, or combined with, other audio circuitry. In addition, control of the circuit is very flexible and apparent Q's from zero to near infinity may be obtained by varying the setting of a single potentiometer.¹

The steady-state response curves of a simulated resonant circuit are shown in Fig. 1 in comparison with those of a conventional tone control. Two factors are worth noting: First, that the curve obtained is such that added accentuation is obtained in the low-bass region where it is frequently needed to compensate for poor speaker and baffle efficiency, inferior acoustics, and possible defects in original program material. Secondly, the response can be made to drop off quite sharply below a chosen frequency in order to reduce the possibility of amplifier or speaker overload by very-low-frequency components, or in some cases to attenuate serious hum

¹"Artificial hangover." *Radio and Television News*, January, 1952.

in the program material.

Steady-state measurements tell only part of the story, and in many cases the transient response characteristics will be more important in determining what the reproduced bass sounds like. *Figure 3* shows a series of scope photos illustrating the effects of various types of bass circuits on transient pulses. In the case of the synthetic resonant circuit, nearly pure bass fundamentals are generated from the transient pulses not only at the main resonance frequency, but for an appreciable range on either side.

The synthetic construction of fundamental tones from transient pulses may be considered to give the following benefits. It tends to duplicate effects produced naturally by good acoustics, it tends to provide a signal more easily reproduced by present day speakers, and—rather paradoxically—it can result in better apparent highs. This last characteristic is a psycho-acoustic effect resulting from the fact that the masking characteristics of the low-frequency reproduction are radically changed. As a result, more bass boost can be used without drowning out the highs with strongly masking pulses or noise components. At the same time it may be found that certain transients become semi-audible that were not reproduced at all previously and these give a soft-

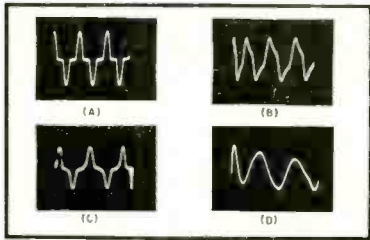

Fig. 3. Oscilloscope photos showing pulse series with repetition rate of 100 cps. (A) shows initial pulse shape; (B) shows output of R-C bass-boost network such as that of (A) in Fig. 2; (C) illustrates output from feedback type of boost circuit; and (D) is scope trace of output of the three-element bass-boost circuit.

ening and more musical effect to what might otherwise be strident highs.

In addition to its pulse-forming characteristics, the resonant circuit has another aspect that has suffered considerable misunderstanding. This is the fact that a high-Q circuit will generate "hangover" when shock excited. Unfortunately, hangover has come to be associated with a host of undesirable distortions in bass reproduction, and as a result, resonant circuits have been little used in recent years. Actually, a thumpy or boomy reproducing system is apt to be suffering from too little hangover rather than too much. The reason for this is that rapidly damped wave trains produce strong "side-bands," or adjacent frequencies, and the ear tends to hear and be irritated by the spurious high-frequency components of a too-rapidly damped bass note. Similarly, adjacent resonances in the speaker, baffle, or acoustics tend to be strongly

Fig. 4. Three-element bass-boost circuit with self-contained power supply.



stimulated and consequently may produce disagreeable beats.

The introduction of artificial hangover before the loudspeaker means several things. Short duration wave trains are lengthened and non-symmetrical components are largely eliminated, with the result that an objectionably pitched speaker or cabinet resonance is much less apt to be stimulated. Similarly, fewer spurious sidebands are produced, with the result that the listener hears deeper and clearer bass. This last may be considered of definite importance when listening at low levels due to non-linearity of the ear which gives the effect of heavily damped wave trains. However, certain precautions should be taken to secure optimum results with resonant bass boost circuits. In the average phonograph, there are apt to be three major sources of mechanical resonance in the bass region. These are the loudspeaker, the speaker cabinet, and the phonograph pickup arm, and sometimes the proper combination of these elements can result in a system with warm, vibrant, bass without electrical boost. However, if the electronic resonance is peaked at or near the frequency

of one of the mechanical resonances very disproportionate response may occur.

Practical Circuit

Figure 5 shows the schematic of a bass-boost circuit which employs three different resonant elements. By using two or more resonant elements in the bass region the over-all response may be more closely compensated for and tendencies toward "one-note" reproduction are greatly reduced. In the circuit shown, each control serves a dual purpose, acting as a means of controlling the "Q" of the resonant element as well as an attenuator of that particular channel. Thus, when the three bass controls are turned all of the way down, no bass boost occurs. When the controls are turned part way up, a low "Q" resonance is simulated and pulse forming occurs. When the controls are turned all the way up, a high "Q" resonance is simulated and artificial hangover occurs. The fourth control shown is the input level to what is called a "side amplifier," a channel which introduces no frequency discrimination, and which

(Continued on page 97)

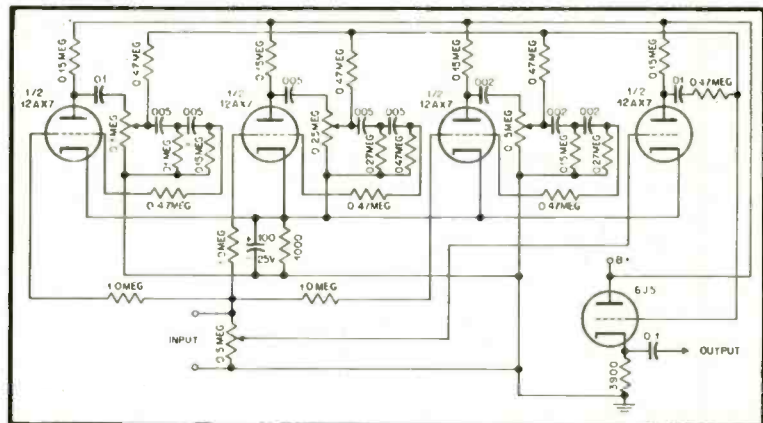

Fig. 5. Schematic of tone control system using three different simulated resonant elements, a side amplifier, and a cathode-follower output. Note that no over-all volume control is included. Resonant frequencies are 45, 80, and 120 cps.



Photo Courtesy Steinway & Sons

ALBERT PREISMAN*

In Two Parts—Part I

The author discusses the history, construction, and tonal characteristics of the piano—the most universal of the musical instruments.

AT THE CONCLUSION of a Horowitz recital, one enthusiastic member of the audience was overheard saying to his friend, "I'll come any time to hear that guy. He's a one-man orchestra!" I certainly do not wish to detract from Horowitz's ability as an artist, but some of the credit should go to the instrument he plays: the piano.

The piano is the orchestra for the home; it is a complete musical instrument in itself. Although unaccompanied pieces and suites have been written for the violin, and it is capable of playing double-stops and chords (after a fashion), it is the piano that can stand by itself or cooperate with other instruments, either as an accompanying instrument—such as for the voice or violin—or as a solo instrument, as in a piano concerto.

*Capitol Radio Engineering Institute, Washington, D. C.

The organ is an even more complete instrument in this respect, but it is a much bulkier and more elaborate device, and hardly suited for the average home. True, we must not overlook the new electronic versions, which are much more compact and eminently suited for home use, but the piano will probably continue to be one of the most popular musical instruments that are to be played rather than to be listened to.

History of the Piano

THE CLAVICHORD.—The piano is a stringed instrument, and took on its present form in about 1709. But prior to this, perhaps as early as 1323, there was the clavichord, which consisted of a number of strings, and an even greater number of keys or *claves*, which had tangents that not only struck the string, but also determined its vibrating length and hence its pitch. Thus, more than

one key was assigned to a string; each key produced a tone of different pitch. The disadvantage of this arrangement is that certain chords could not be played because the keys comprising this chord happened all to act on one string.

THE HARPSICHORD.—The Middle Ages had given rise to a form of string instrument known as the psaltery, in which the strings were plucked. From this was derived a series of instruments known as virginals, spinets, and harpsichords. In these instruments, a jack at the base of the key had a small quill or leather tongue projecting horizontally from it. When the key was depressed, its rear end and jack jumped up, and the quill or tongue side-swiped the string and plucked it. The resulting tone was a characteristic twang, of fixed intensity.

The square form of instrument, in which the strings ran from left to right, was known as the spinet (abbreviated

from *strumento da spinetta*, or instrument with quills or thorns). Another form had the strings running vertically, like in the modern upright pianos, and a third form had the strings running from front to back, like in a modern grand piano. This form was shaped like a harp, and hence was called a harpsichord.

The square and grand form were also originally known in England as virginals, probably derived from the Latin word *virga*, which referred to a rod or jack. The term was generally used in the plural—thus, “a pair of virginals.” There has been some revival in interest in the harpsichord, but the instrument has undoubtedly been superseded for good by the piano.

THE PIANO.—The piano is in a sense a return to the clavichord, in that the string is struck rather than plucked, but the important difference is that the string is struck by a hammer that immediately rebounds, leaving fixed stops to determine the pitch. It was invented by an Italian, Cristofori by name, in about 1709, when he furnished a diagram of the action.

He called his instrument “*gravicembalo col pian e forte*,” which means large harpsichord able to produce soft and loud tones depending upon the touch. The word piano is of course an abbreviation of this longer name. No longer was the loudness fixed, as in the harpsichord (except for complicated attachments); the piano allowed much greater degrees of expression and interpretation.

The Germans began to manufacture pianos, with variations on Cristofori's original hammer action. However, the results were not particularly good, especially since the Germans preferred to stick to the clavichord form; and it is to England that we must look for a more mature development of this instrument. It was here that the famous house of John Broadwood originated, and it was in England that the various stops and controls of the German pianos were reduced to the two modern pedals: the forte, in which all dampers are removed from the strings; and the piano, in which the hammers are shifted laterally so as to strike *una corda* (one string) of the two tuned to a given pitch.

France is distinguished by an Alsatian

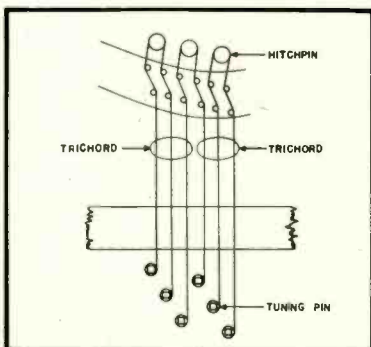
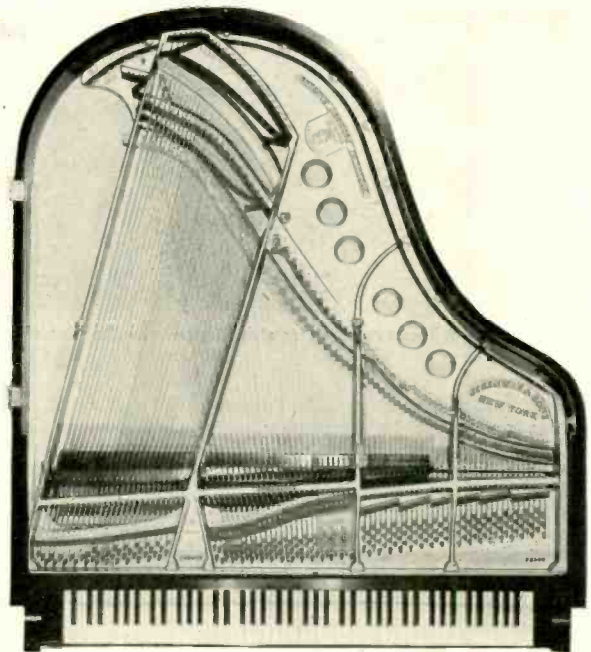

Fig. 3. Showing how one length of wire serves for two strings.

Fig. 1. Top view of the soundboard braced with the cast-iron plate, showing method of overstringing. (Courtesy Steinway & Sons)



piano maker, Sebastien Érard, who devised a key action which permits a note to be repeated more rapidly and with more force than even Cristofori's action did. Thus, after the hammer strikes the strings and bounces back, it is caught in mid-air and held closer to the string than when normally at rest, so that it can strike the strings more quickly when

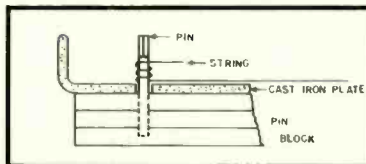

Fig. 2. Pin-block or wrest-plank, tuning pin, and string.

the key is pressed again. Érard also invented the *agraffe*, a metal stud pierced with holes, one for each string of a key, and which held the strings in place under the impact of the hammer.

The more modern history of the piano starts with Heinrich Engelhard Steinweg, born in Wolfshagen in the Harz mountains in 1797 to a humble forester already blessed with fifteen children. Of all of these, only Heinrich survived the vicissitudes which followed, and he even came through the battle of Waterloo unscathed; indeed, even won a medal for bugling without faltering while the battle raged!

He returned to go into the cabinet-making trade in an organ factory, and when he married Juliane Thieme, constructed as a wedding present to his bride, a new kind of piano with two strings to each note. The birth of their first child, C. F. Theodor, called for a new piano with three strings per note, and which took fourteen years to build. Theodor won first prize in a recital at the State Fair, and that led Heinrich to decide to become a piano manufacturer.

The revolution of 1848 led another son, Charles, to flee to America; the rest of the family of ten followed to New York. Here Heinrich Steinweg became Henry Steinway, and Steinway and Sons became the firm known throughout the world.

One of the first improvements was the combination of the cast-iron frame with overstringing in 1859. The cast-iron frame, on which the strings are stretched, was invented in America in 1833 by Conrad Meyer; the combination of overstringing of the bass strings with such a frame revolutionized piano designs. Other innovations or improvements were the diaphragmatic soundboard and the accelerated action, but perhaps the most important characteristic of a Steinway or other fine piano is painstaking care, both in the choice of materials and in the construction of the instrument.

In the city of Cincinnati, Ohio, the Superintendent of Music in the Public Schools, Dwight Hamilton Baldwin by name, decided one day in 1862 to open a small piano store on the corner of Fifth and Elm Streets. He was a well known music teacher in the Ohio Valley, and his enterprise flourished to the point where he began to manufacture his own piano, the Baldwin. Today, the Baldwin piano is well known and highly esteemed throughout the world; from the humble beginning just mentioned in a small second-story office, the Baldwin Company has expanded to a modern factory of half a million square feet of floor space, and the company maintains retail stores in major cities from coast to coast, as well as outlets through leading music dealers everywhere.

The family of Lucian Wulsin, who in 1865 became D. H. Baldwin's book-keeper and later his first business partner, has been in active control of the company for several generations in a manner similar to that of the Steinway



Fig. 4. Details of the soundboard for a small grand piano. (Courtesy The Baldwin Piano Co.)

family. It is of interest to note that two of the leading piano manufacturers are in the hands of private families rather than impersonal corporations.

There are, of course, other famous names in piano history, such as Bechstein, Bluthner, Broadwood, Chickering, Mason and Hamlin, and Knabe, but we shall conclude this brief history of the piano and proceed to other features of this instrument.

General Features of the Piano

BASIC COMPONENTS.—There are at least five basic components of the piano:

- (1) The strings, which are strung across
- (2) A cast iron frame or plate, in turn supported and reinforced by
- (3) The frame of the wooden case;
- (4) The soundboard, against which which the strings press via a structure called the bridge, and which radiates the vibrational energy into the air more effectively than the strings do, because of the low radiation resistance of the latter; and
- (5) The action, which includes the keys and the felt hammers as well as the intervening linkages and mechanism, and which enables the player's hands to set the strings into vibration by the percussive effect of the hammers.

It will be of interest to study how these components are constructed and their basic behavior before we discuss some of the finer points of their action.

THE STRINGS.—The strings are the primary source of the tone. They are made of special high-carbon steel; piano-wire is noted for the quality of its material. The string diameter varies from .030 in. to about 0.067 in. As we shall see later, one reason for the superior, more brilliant tone of the modern piano is the fact that the strings are under greater tension, which has been further increased by the rise in the pitch of standard A to 440 cps in the last century.

Mention was made previously that as many as three strings are employed in unison for a single tone. This is true in the treble, where the tone is inherently feeble, and three strings can absorb the hammer blow more efficiently and hence yield a greater acoustic output.

In the upper part of the bass register,

two strings tuned in unison are sufficient, and in the extreme lower bass section, a single string per key is employed. In order to obtain a vibrating system having a higher Q —that is, one having a greater ratio of stored to dissipated energy—it would be necessary to employ an inordinately long string in the bass register in order to be able to operate it under sufficient tension and yet have it tuned to the desired low pitch.

Hence, the well-known expedient of loading is employed: the steel-wire core is wound with a tight helix of copper or iron wire, as the case may be. Usually the machine for doing this is specially built by the piano company. The core wire is looped around a rotating shaft in a lathe-like machine, and the other end fastened to a spindle at that end. The wire is then swaged at each end by hammering it on an iron block directly under it. This makes the wire have a square cross section at those points, so that the ends of the helical wire coating will obtain a purchase on the core wire.

One end of a spool of, say, copper wire is then wrapped around the swaged part at the left end, and any surplus skillfully broken off. The core wire is then set into rotation, and the copper wire carefully wound on it by the use of a carriage, or by hand in the case of the heavier wire. When the helix reaches the right-end swaged portion of the core wire, the machine is stopped, and the copper wire broken off from that remaining on the reel. The hand is preferred for the heavier wrapping wire because the wire is too heavy for the carriage: it is important that the helix be absolutely uniform if the string is to vibrate true, particularly as regards the overtones.

The action of the copper wire loading may be explained as follows: As we shall see later, the string can be regarded as a transmission line, approximately open-circuited at its two ends. The loading, being in the form of a helix, cannot withstand any longitudinal stress or tension, hence it does not assist the core material in resisting the tension pull of the end pins when they are rotated to tune the string.

In other words, the loading merely adds to the mass of the string, without affecting its ability to withstand stretching, as would be the case if a solid wire of the same diameter were used. Thus,

we may regard loading as equivalent to increasing the unit inductance, only, of a transmission line. This would tend to lower the resonant frequency of the line. To compensate, its unit capacitance must be reduced. This is accomplished mechanically by increasing the tension of the string, thus bringing it back up to the desired pitch, and with a Q higher than the unloaded string.

The advantage of loading in the form of a helix over using a solid wire of the same diameter is that the latter has too much stiffness to bending other than that due to tension. Later on it will be shown that such stiffness tends to produce inharmonicity in the string, with resultant unsatisfactory tone qualities.

Loading, then, enables a shorter bass string to be put under greater tension for a desired pitch. It therefore is particularly useful in the case of the smaller baby-grand and spinet pianos. However, so much loading is required, particularly in the case of the latter, and the wire is so short that its inherent stiffness becomes appreciable, and the result is inharmonic overtones, as well as very little output of the fundamental bass tone.

One of the most important design features of a piano is the scaling of string lengths. This is a very specialized art;¹ and much of the piano tone depends upon skillful use of its principles, particularly in the case of the smaller pianos, such as the spinet.

If the tension and mass per unit length of a string are maintained constant, the fundamental frequency of vibration varies inversely as the length. Thus, to obtain a tone one octave lower, the string should be doubled in length. Actually, the string length does not quite double for an octave decrease, but instead increases by a factor of about $1\frac{1}{8}$ or so.

For the same tension, the frequency would therefore be somewhat too high, but this is compensated for by using a heavier gauge of wire. This in turn permits the longer string to resist better the deforming effect of the hammer blow, and also enables a uniform rule of length increase to be employed to a much lower note before the string becomes too long for the size of the piano. From this point on, of course, the strings are loaded and their lengths are considerably shorter than $1\frac{1}{8}$ times those of strings one octave higher.

Actually, the increase in wire gauge results in the lower strings being under greater tension than the treble strings. This is desirable in that but one or two strings are used in unison in the lower range, as against three in the upper range; the change in tension helps to compensate so as to make the stress more nearly uniform for all parts of the plate. In passing, we note that the highest treble strings have an effective length of about two inches.

THE PLATE.—Figure 1 shows a cast-iron plate, as used in a grand piano. Ob-

¹ W. B. White, "Problems of a stringing scale for small vertical pianofortes." *J. Acous. Soc. Am.*, Vol. 12, p. 409, 1941.

serve first how the bass strings on the left cross over those of the middle register, so as to obtain greater length in a given size frame. This is known as overstringing. At the keyboard end, of course, all the strings run from left to right as one goes up the scale; this is in order that the keys and action will form a similar left-to-right sequence. But the others ends of the strings do not have to follow in such sequence, and overstringing is therefore possible, with the advantages that accrue to longer bass strings.

Note in Fig. 2 that the ends of the strings are looped through and around steel tuning pins. Those at the keyboard end are not fastened into the cast iron plate, but are driven into a laminated maple board beneath it. This board is known as the "pin-block" or the "wrest-plank."

The tuning pin is a steel rod normally .280 in. in diameter (although it also comes in larger sizes), with a square top portion to engage the tuning hammer, and a hole beneath this square portion through which the spring passes and then winds around. The lower end of the pin has a very fine and light thread in it, so that it can be screwed out of the hole drilled in the pin-block into which it was initially driven.

This thread increases the frictional contact with the pin-block and prevents the taut string from revolving the pin and thus detuning itself. Hence, for a piano to hold its tune, the pin must fit firmly in its hole, but not so tightly that it cannot be smoothly turned by the tuning wrench. This, in turn, means that the holes must not be drilled too rapidly in the pin-block lest they become somewhat oversize. Moreover, if the wood chars slightly owing to the drilling being too rapid, the pins will move in a series of jerks, which renders tuning very difficult if not impossible. Here we have a good example of the time-consuming operations required in constructing a really fine piano.

But to return to the cast-iron plate. Each string is under a tension of about 160 pounds, average, and since there are approximately 230 strings, the total pull on the plate is between eighteen and twenty tons. Brittle cast iron is sufficiently rigid to withstand such great forces without creeping, and therefore normally used as the plate on which the strings are strung. As we shall see, the string vibration is transmitted to a spruce soundboard, which acts as the principal acoustic radiator, and the plate acts presumably as the frame that withstands the tension.

Nevertheless, as pointed out by White,² the plate presumably aids in the radiation of the higher frequencies, particularly those from the high treble strings. Plates have been made of aluminum for lightness, but it may be that such a plate has to be reinforced with steel in order to obtain proper radiation of the higher frequencies. Cast-iron, although heavy, seems to be about the best

material available for plates, and only skilled foundry men are able to handle such grey-iron castings.

There is a further interesting point about the manner in which the plate is strung. At the front end, each string is looped around a tuning pin that is imbedded in the pin-block. But at the far end, the string loops around a hitch pin and returns as the next string of the trichord, or even the first string of the next key.

This is illustrated in Fig. 3. It would appear that tuning one segment of the string would alter the tuning of the other segment; i.e., that the wire would slide around the hitch pin. Such is not the case, however.

THE WOODEN CASE.—Although cast iron is very strong in compression, it cannot withstand much tensile stress, and such stress is set up in the plate if it is allowed to bend. Since the wires are strung on one side of the plate, their pull tends to bend it so as to fold it in two. It is here that the strength of the case comes into play.

The plate is securely bolted to the sur-

rounding case, which is also braced beneath the soundboard with heavy wooden beams. In the grand piano, the curved case is made up of many plies of laminated wood, all carefully seasoned and glued together. Actually there is an inner case or rim of maple and outer rim of poplar or maple, each made separately and then glued together or glued together at once. The sound board then rests on the inner rim, to which it is glued. On a nine-foot concert grand, the outer-rim veneers are twenty feet long.

Although hide glue is still used, the new plastic resin glues are preferred, particularly for tropical regions. The only objection to the plastic glues is that they require the right temperature and humidity to set properly. In the Baldwin factory, for example, you will see special fans near the ceiling that blow in the right amount of humidified air, and electronic heating equipment has been employed to speed up the hardening process. Steinway also employs similar methods.

THE SOUNDBOARD.—This is the radiating surface. One might consider it as

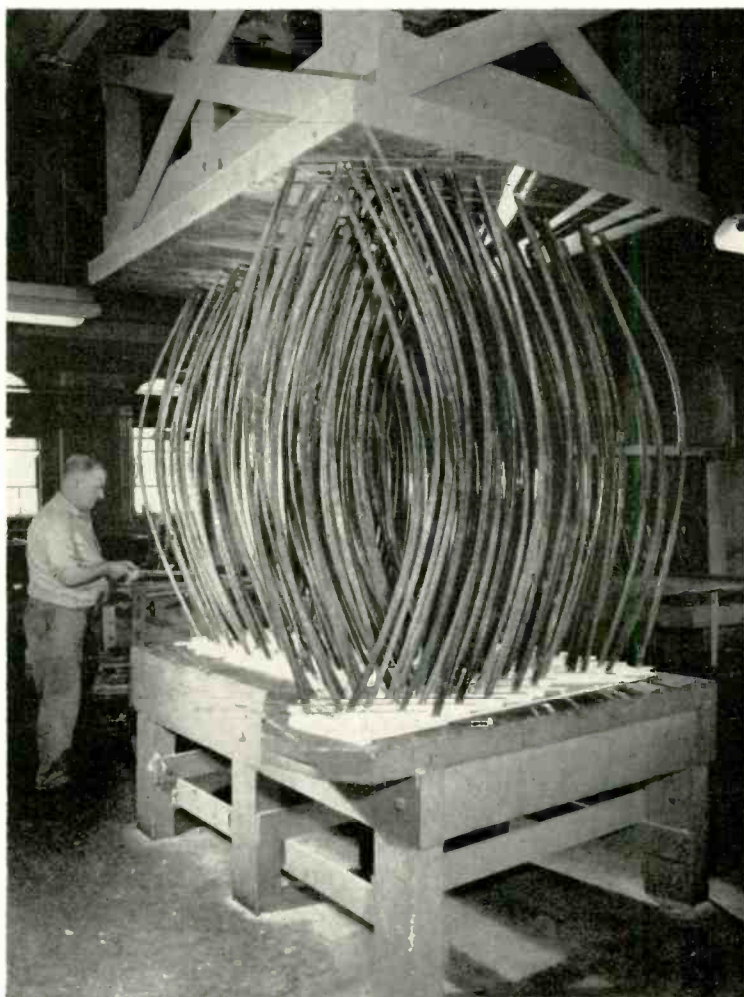

Fig. 5. Method of glueing ribs to soundboard. (Courtesy The Baldwin Piano Co.)

² William B. White, "Piano Tuning and Allied Arts."

NEW HOME for



RADIO CORP.

The "inside story" about the ultra-modern \$2 million building for the world's largest electronic supply house.

On August 10, the doors opened at 100 North Western Avenue, in Chicago, to the fabulous new home of Allied Radio Corporation—a building designed to better serve thousands of customers from all over the world who 'phone, wire, write, or just come in person, knowing that every one of the more than 20,000 items listed in the Allied catalog will be in stock for immediate delivery.

According to A. D. Davis, Allied's President, the phenomenal growth of the electronics parts industry made new and more efficient facilities necessary. In 1945, the Allied catalog listed some 8000 separate stock items—the 1954 catalog which is now being distributed lists more than 20,000. The new plant occupies 147,000 square feet of space, and provides for expansion of 80,000 square feet more when the need arises. The first floor houses the salesrooms, warehousing, shipping, and receiving sections—offices, reception rooms, and the Company's cafeteria are on the second floor. The entire building is air conditioned. Among provisions for rapid handling of orders is a five-tier conveyor system—consisting of one set of local and express belts supplying the shipping department, another set of local and express belts to the salesroom, and a return belt for empty order pans. There is also a complete system of pneumatic tubes for routing orders to the "assembly line." The building is designed to accommodate four trailer trucks at the receiving section—in a totally enclosed area so that unloading may proceed even in bad weather—and another area will accommodate four trucks at the shipping sec-

tion. Over fifteen thousand linear feet of stock shelves are used for "forward" stock—that which is considered a thirty-day supply—and slightly more than that are used for "reserve" stock, a total of over six miles of shelves. The merchandise is departmentalized, with fast-moving items located near the front, and more slowly moving items progressively further back. Orders are routed through the pneumatic tubes to the farthest station from which items are to be accumulated, and as these parts are placed in a fibreboard pan, they are carried to the next station by the conveyor system.

Each order is scheduled as to the time it should arrive at the shipping section, and when larger packages in original cartons are to be included, these are also timed to arrive at the shipping department at the same moment. Each order is checked before packing, and in most instances is on its way to the customer within two or three hours from the time it is received.

Ultra-Modern Salesrooms

Unlike the average parts distributor's showroom, Allied has installed attractive display panels to call attention to new items, to show variety of a certain class of merchandise, or to speed handling of such material as books, magazines, and other small parts. Opening off the main salesroom floor are two hi-fi studios—each equipped with Auditioners which offer immediate choice of thousands of combinations of components such as phonograph pickups, tuners, amplifiers, and speakers. Between the two studios is the hi-fi office where the customer can sit down with staff members for consultation on the selection of equipment. Another separate studio provides for "hams," and offers complete displays of receivers, transmitters, and auxiliary equipment. A "ham" station is in operation here—100 watts on phone, 150 on CW.

When the customer steps up to the counter to order a single 5Y3 or an order consisting of twenty different items, he is served promptly. For the rapidly moving tube types, a supply is available at the counter—along with numerous other popular items. When a large order is placed, the pneumatic tubes carry it out



Mr. A. D. Davis, President of Allied Radio Corporation.

to the warehouse where it is handled just like a phoned-in or mailed-in order. As soon as the order is assembled, the customer is paged on the public address system, and so does not need to stand at the counter while his order is being filled.

The Second Floor

As one walks into the main entrance—having parked his car in the customer parking area adjacent to the door—he encounters a stairway which leads up to the reception room and the main offices—a door opens off the entrance foyer to the salesroom if he is simply interested in buying something. The reception rooms are spacious and comfortably furnished, and access to the offices is immediately behind the receptionist. Private offices line the major portion of the east side and part of the north side, with the telephone order department occupying a well lighted space to itself. Conference rooms and the cafeteria are also on this floor. To the back is the supply stockroom and the service department—the latter being separated into cubicles which are soundproofed so that two or more technicians can work at their respective tasks without interference from each other. This section of the building also provides for storage of files, and houses the air conditioning equipment, the telephone equipment room, and the telephone switchboard.

With over five hundred employees, Allied built its own cafeteria to provide clean, nourishing meals at reasonable prices—the reasonableness being attested by the availability of a complete lunch with a meat course, vegetables, coffee, and dessert at about 65 cents. Obviously, the cafeteria operates at a loss, but it is a very considerable factor in promoting good employee relations.

Allied's Famous Guarantee

Allied Radio Corporation has long



Close-up of the "Auditioner"—which is a playing desk with several turntables combined with switching facilities for various amplifiers, tuners, and speakers. Above the control panel is an indicator which shows the equipment in use.

been famous for its generous guarantee policy. Quoting from the catalog, the guarantee states that "Every item you buy from us must satisfy in every way—or we want you to return it at once for exchange or refund." This policy has unquestionably had much to do with Allied's success, for it is agreed that a satisfied customer is a firm's best advertisement. And it pays off, too. For example, one customer bought a medium-power transmitting tube, used it about five months (two months over the normal guarantee period for tubes) but received a replacement when he returned the tube which had obviously been worked beyond its ratings. Some years later, this same customer ordered \$50,000 worth of equipment for a radio training school installation. Another customer came in with a blown fuse, received a replacement, and four months later or-

dered a \$1200 hi-fi installation. While it is not suggested that the guarantee policy was adopted on the off chance that such windfalls might occur, it must be admitted that it appears to be an exceptionally good policy.

Consultation by Mail

One of Allied's departments that comes in for a lot of work and occasionally an amusing inquiry is that devoted to answering customers' requests. Among interesting letters received lately has been one requesting a means for detecting poisonous paint used on roads and highways because the writer suggested this means was being used in a gigantic Communist plot to poison the citizens of this country. In another, a lady insisted she heard voices in her home although the police couldn't hear a sound. She wanted a recorder sensitive enough to record those mysterious voices so she could prove to the police that they were actually there.

Even the order department comes in for its share of surprises. During the war years, large numbers of orders were coming in from an unknown town in Tennessee. All of these orders had the highest priority ratings, occasioning some wonder as to their propriety. The government expeditor following up these orders insisted that as soon as his project was completed, it would end the war. This aroused a considerable amount of skepticism, but the orders were filled and the shipments duly made to—as you've guessed—Oak Ridge.

The entire industry salutes Allied Radio Corporation for its foresight in providing for still greater growth in the electronics parts industry—for it is such organizations as Allied that serve as the contact between the manufacturer and the customer. The record of that service may not be engraved on marble panels, but it shows in this newest monument devoted to satisfying the electronic parts buyer.

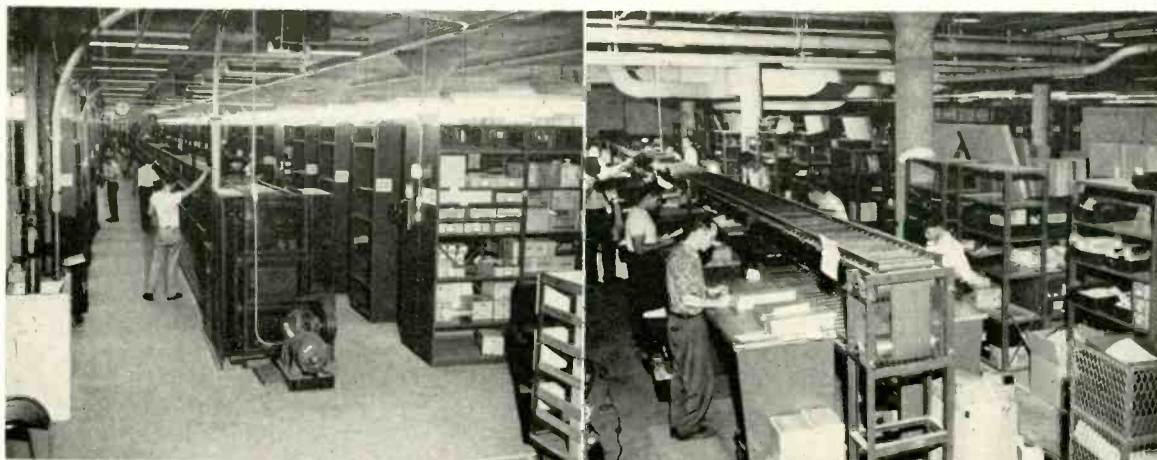

Two views in the immense warehouse—at left, the start of the conveyor belt system; and at right, the checking and packing section at the other end of the conveyor.

On the facing page: (A) Western Avenue facade of the new building, showing some of the customer parking space. (B) On opening day, the salesroom was filled with flowers from many of Allied's suppliers. (C) Display area in sales room is open and light. (D) The City Sales counter. (E) One of the two hi-fi studios, with the second seen through the door in the background. (F) Orders assembled for the City Sales counter arrive on the conveyor. (G) Open, well lighted office space on second floor. (H) The employees' cafeteria.



Equipment Report

TAPEMASTER HF500 TAPE RECORDER

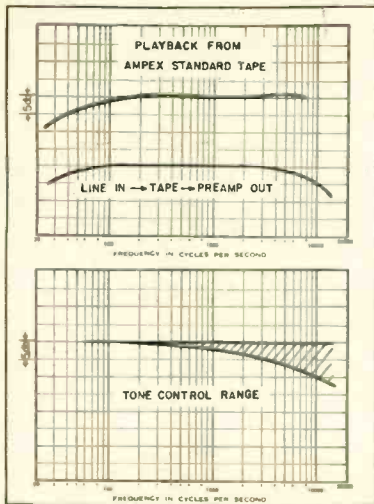

MANY USERS of tape recorders want the equalization normally employed on only the professional types of machines, yet do not feel that their requirements warrant the usually higher cost. Among these users are those who want to exchange tapes with friends who use professional machines, and in most instances the results from the usual "home" machine are not satisfactory under these conditions.

In addition to its obvious uses in strictly professional applications, the newly announced tapeMaster HF500 is well suited to the advanced hobbyist who will be satisfied only with the professional type of equalization. Recent tests on the new machine indicate that it would be adequate

for light professional requirements as well as for the advanced experimenter.

Technically, the machine offers two inputs, one for a high-impedance MICROPHONE and one for LINE—the latter being designed as a bridging input. Full modulation on the track is provided from .0008 volts at the microphone jack, or from 0.4 volts at the LINE jack. At 0 on the meter, the preamp output measures 1.6 volts, available from a cathode follower to be patched into any amplifier system. A self-contained amplifier and speaker provides for monitoring or on-the-job playback, if desired. At 100 per cent modulation, a 1000-cps tone plays back to provide an output of 0.6 volts at the preamp output. A tone control provides some high-frequency attenuation to the monitoring amplifier, but does not affect the PRE-AMP OUT jack. All connections to the recorder are made through telephone jacks. Preamp heaters are d.c. operated.

Mechanically, the machine is an improved single-speed model of the original tapeMaster. Brush Redheads give good response, and pressure pads reduce amplitude modulation to ± 0.6 db at 7500 cps. Fast forward and rewind positions permit spooling in either direction in 2 minutes for a 1200-foot reel, with no tendency to spill or break tape being noted.

Performance characteristics are shown in Fig. 1. Using a standard Ampex tape, the measured playback characteristic is as shown, and the second curve shows the characteristic from LINE IN onto the tape, and off the tape to the PREAMP OUT jack. Measured signal to noise ratio is 45 db. The curves also show the effect of the tone control. Figure 3 is the complete schematic.

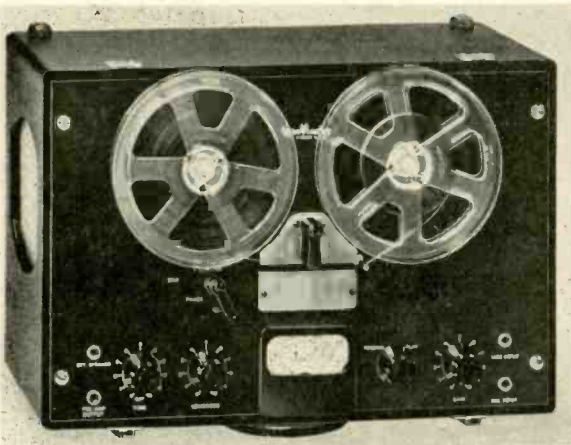
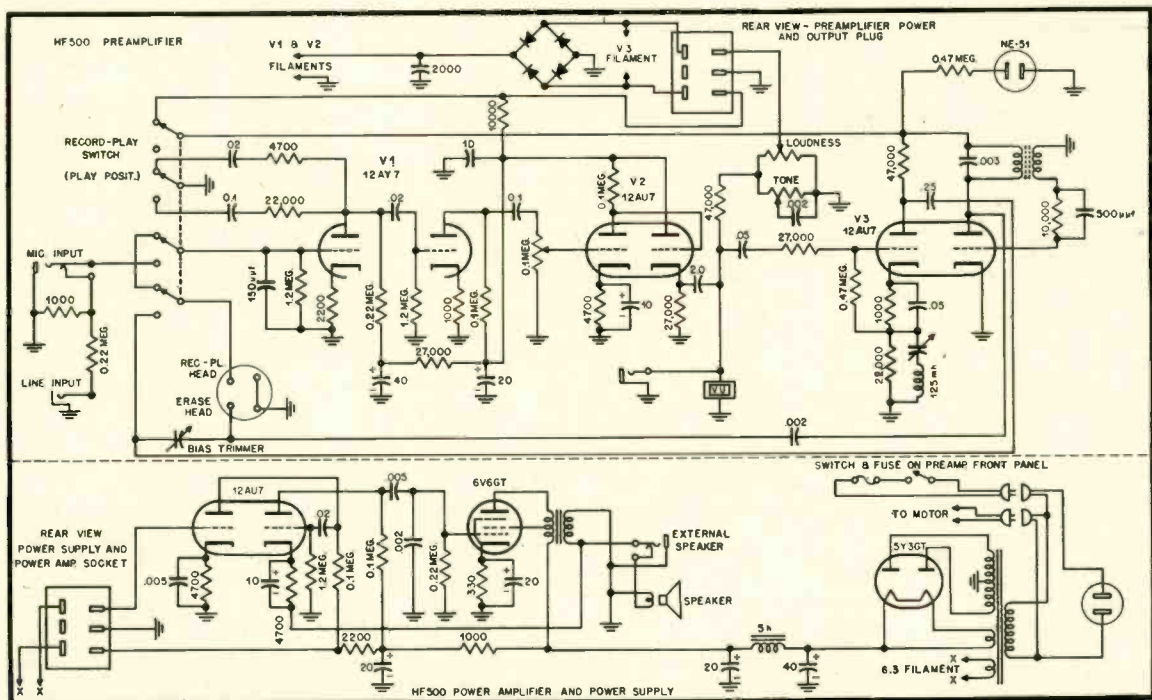
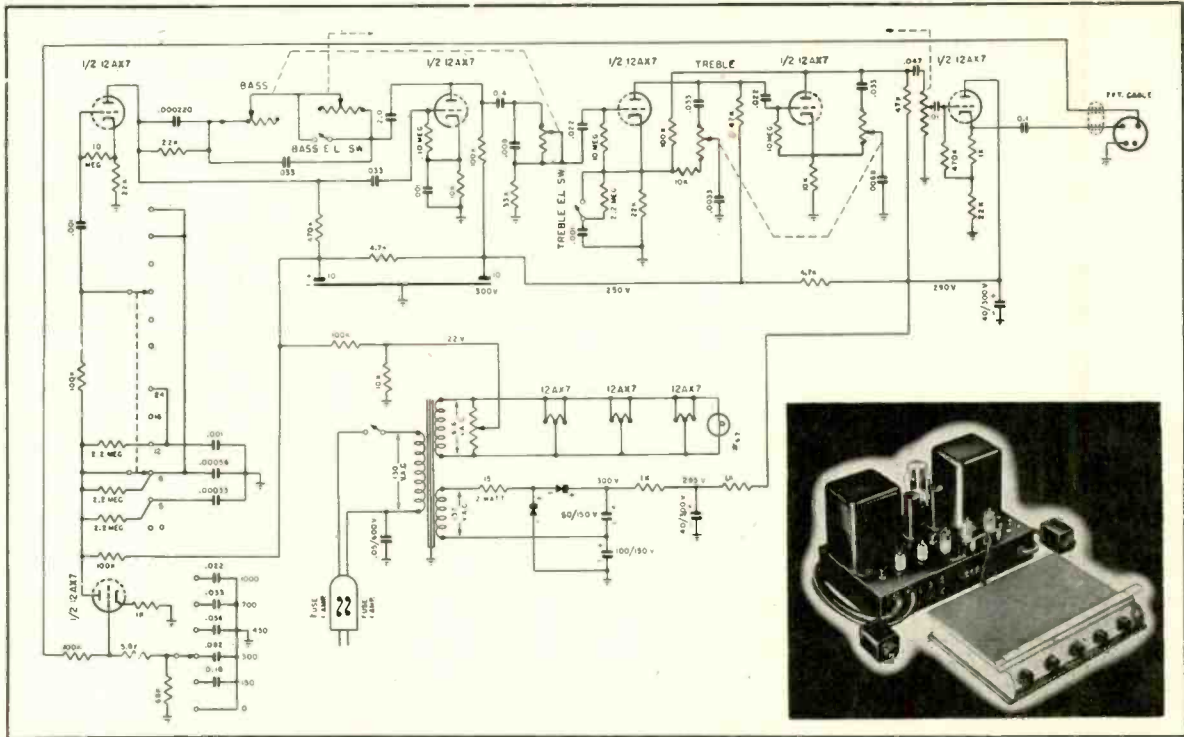

Fig. 1 (upper left). Performance curves for the HF500. Fig. 2 (left). External appearance with the cover removed. Fig. 3 (below). Over-all schematic of the new tapeMaster model.





Rauland 1826 with the Libretto

COMBINED in a system designated the 1826, the Rauland 1805 power amplifier and the Libretto remote control unit offer an unusual type of installation which would fit into the requirements of many music lovers.

The complete equipment consists of a power amplifier into which several inputs may be plugged, a separate power switch, a separate selector switch, and the Libretto—so called because of its appearance—remote unit, which is connected by a single cable to the power amplifier, of any desired length. The power amplifier consists of the usual four stages with feedback, together with a preamp stage and a cathode follower feeding the line to the control unit. Magnetic pickups and other inputs are plugged into this unit—the former being amplified before passing to the switch which selects the input to be fed to the Libretto. Once this selection is made, the remainder of the control is furnished by the Libretto, which is a leatherette-covered "book" with a gold-finished backbone which lifts on piano hinges to expose the controls, which are: crossover, roll-off, volume, bass, and treble. The Libretto is self-powered, and the power switch is combined with the volume control. A pair of slide switches on the bottom of the unit permit selection of loudness compensation on bass and treble ends of the spectrum independently.

While it might appear that the absence of a selector switch on the control unit would be a disadvantage, it is actually not. When changing from one source to another, it is necessary to go to the radio tuner, the phonograph turntable, or whatever sound source is being used, and while at that point the listener will adjust the selector switch. After so doing, he has all other controls at his fingertips in the remote unit.

The Libretto circuit, shown in Fig. 4, is unusual in that it provides for phonograph-type equalization for all program sources,

thus giving the listener considerable flexibility of control—undoubtedly more than he would ever require for radio, TV, or tape sources. However, there is no harm in having the added flexibility, and many users would welcome it. Figure 5 shows the complete system. The Libretto is provided with two escutcheon panels so it may be used in a flat position on a table, or placed upright, as in a bookshelf. This remote unit is also available separately and, with an adapter unit, may be used with any power amplifier to provide the remote control facility. The adapter consists of the preamp and cathode-follower stages—similar to those in the power amplifier—together with a small power supply, and two switches for power and input selector. As with the 1805, these switches are attached by 5-foot cords to the main chassis.

Performance curves for the system are shown in Fig. 6. Intermodulation distortion was measured with two frequencies—60 and 7000 cps with a level difference of 12 db—and it will be noted that it was necessary to double back with the curve. The relatively high power output is undoubtedly due largely to the high plate voltage (515) and the use of fixed bias on the output stage. Screens operate at 460 volts. Equalization is shown for the five crossover positions and for the five roll-off positions, in addition to the flat positions on both controls. Tone control range is also shown, and Table I gives the input voltages for

TABLE I

Signal input voltages for 1-watt output (Volume control maximum, controls flat)	
XTAL and AUX inputs	.048 volts
MAG PICKUP input	.0025 volts

crystal and the two auxiliary inputs as well as for the magnetic pickup input.

Fig. 4. Schematic of the Libretto remote control unit. Fig. 5 (inset). The complete Rauland 1826 system. Fig. 6 (below). Performance curves for the power amplifier with the control unit.

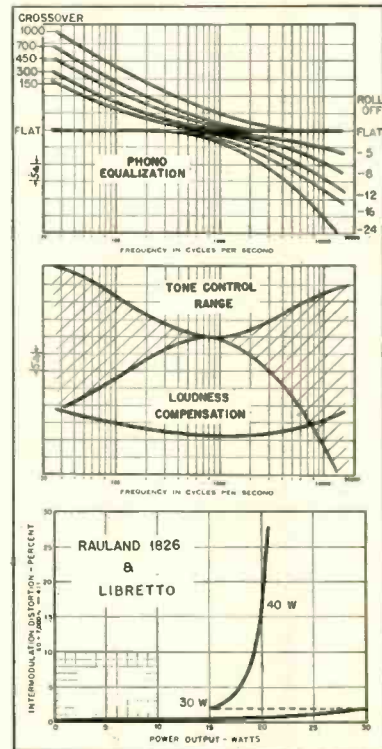

The Columbia XD (Extra Dimensional) Sound System

PETER C. GOLDMARK*

A simple means for providing a pseudo-stereophonic effect by using a small loudspeaker for the highs radiating at a point removed from the main loudspeakers in which the frequency range is restricted to the lows.

AFTER THE LP RECORDS were launched and well underway, the Laboratories' attention was turned toward investigations in the field of spatial sound. I am using the expression "spatial" in order to differentiate between the effect created by sound radiated from a hole in the wall (or a cabinet) and sound reaching the listener from different directions approaching life-like reproduction. The former has been the standard way of listening and emphasizes the synthetic nature of present-day music rendition through the conventional phonograph or radio.

Keeping in mind that reality is the most important ingredient of any reproducing medium catering to one's senses, we felt that to add to sound a new dimension, rather than just another octave or two, was our most urgent step. In the case of the phonograph and the radio, the desired effect had to be created at a low cost, at the same time using existing records and broadcasts.

There are two expressions which one hears frequently in connection with spatial sound: One is binaural and the other is stereophonic. The first one in-

*Vice-President in Charge of CBS Laboratories Division, New York, N. Y.

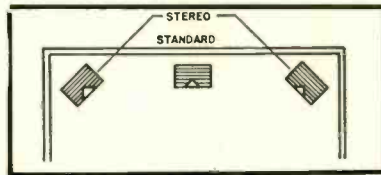

Fig. 1. Arrangement of speakers to determine listener preference for various systems.

volves the listening to a program through earphones; the binaural effect depends upon the selective perception by one's ears of different signals picked up by two suitably located microphones and recorded or broadcast on two channels. There is no question about the life-like reproduction of the original sound properly distributed in space.

But people today are used to listening to sound through loudspeakers, which brings up the other form of spatial sound rendition; namely, the stereophonic technique. Again, the original signal is picked up by two or more microphones transmitted or recorded on a corresponding number of channels, but the sound is reproduced through two or more loudspeakers suitably located in a

room. This is where the trouble begins.

To obtain the same natural sound effect as in binaural sound, it would be necessary that the loudspeaker on the right (if two are used) be heard only by the right ear and the one on the left by the left ear. The use of polaroid glasses in three-dimensional movies is the visual analogy; unfortunately, such exclusiveness has not yet been achieved and the sound from the right speaker could readily penetrate the left ear and vice versa. As a result, much of the binaurality is lost, and the listener hears reproduction through two loudspeakers.

When demonstrating stereophonic sound using two loudspeakers placed in adjacent corners of a room, only a diluted effect results which is confined to a very limited area of the room, chiefly along an axis half way between the two speakers. Even then, a non-stationary sound source, such as a singer or actor moving about, or a speeding locomotive, is needed to give a convincing demonstration. This does not, however, represent practical conditions, since most people listen to music which is static; that is, the performers stay in one place.

In the course of our three-dimensional sound research, several of the recording sessions of Columbia Records were picked up by two properly located microphones and the respective sounds were simultaneously recorded on two tracks. This provided suitable material for binaural and stereophonic sound experiments and also permitted the study of systems which would simulate stereophonic reproduction, combining both tracks into a single one.

Experimental Background

During this research program, a number of basic experiments were performed and the most decisive ones will be discussed. Several selections from the stereophonic recording sessions were spliced together to form a suitable demonstration tape. Played back binaurally—that is, with headphones—the tape proved to give a very clear three-dimensional effect.

Next, a listening room was equipped with two high-quality loudspeakers placed in adjacent corners facing the listeners. A third speaker was placed in the center of one wall, half way between

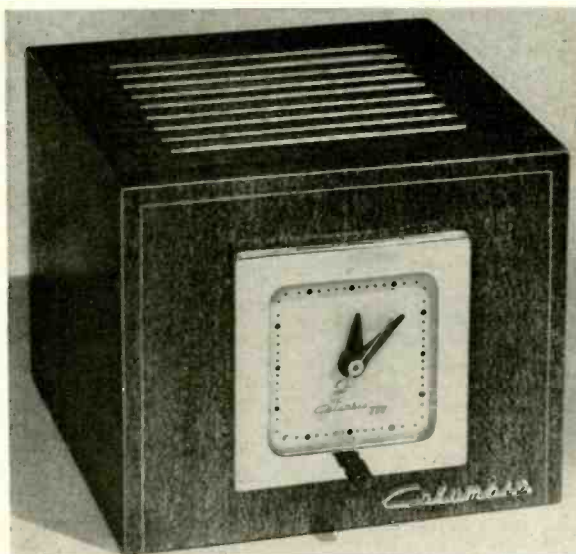

Fig. 2. The Columbia "XD" remote speaker, combined with an electric clock.

RCA INTERMATCHED HIGH FIDELITY

... to assure you of HIGH FIDELITY EXACTLY AS YOU WANT IT



Now—from RCA—comes the ideal way to achieve *exactly what you want in high fidelity*. You can be confident of top quality—every component in your system bears *the name you know best in electronics*.

For extra assurance—RCA offers a broad selection of components—all designed for top performance in their class—all *intermatched* to work together, regardless of the combination you choose.

Listen to the full line of RCA *Intermatched* high-fidelity components, look at the distinctive cabinet styles, and make your choice. You'll have a completely matched

system that's right for your home and your taste in high fidelity. You'll have a complete system that you can assemble in minutes, with just a screwdriver. And you'll be prepared at any time to add more power or extra coverage—if you feel you need them—without mismatches at any stage.

Hear RCA *Intermatched High-Fidelity* at your local RCA Electronics Distributor's. You'll agree it's high fidelity at its finest. You'll agree it's the sensible approach to high fidelity. For information, for the address of your local distributor, mail coupon below.

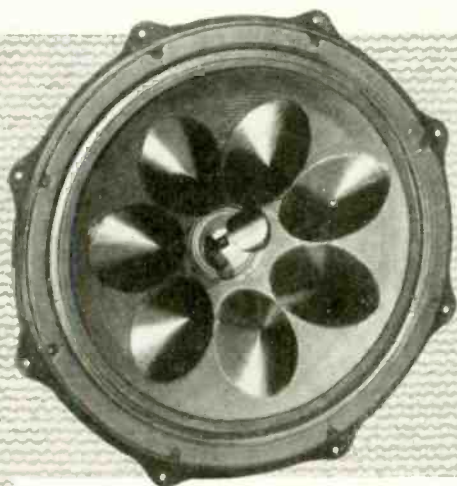

The superb LC-1A Speaker—the measure of high fidelity among professional users of sound—now more brilliant than ever with ACOUSTIC DOMES for wide-range reproduction and DEFLECTION VANES for wide-angle sound distribution. Intermatched for top performance with all other RCA components.



RCA INTERMATCHED CHANGER



RCA INTERMATCHED TUNERS

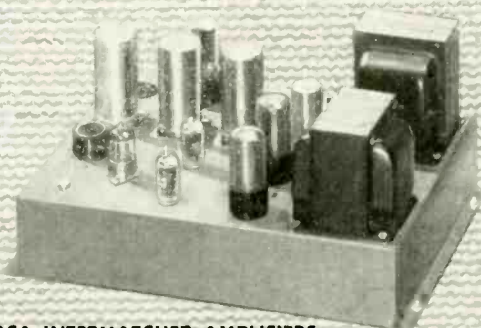

RCA INTERMATCHED AMPLIFIERS

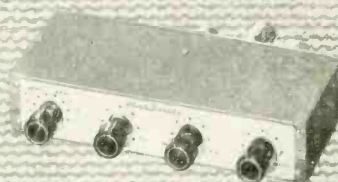

RCA INTERMATCHED PREAMPLIFIER



RADIO CORPORATION of AMERICA
ENGINEERING PRODUCTS DEPARTMENT, CAMDEN, N. J.

RCA Engineering Products
Dept. 16V, Building 15-1, Camden, N. J.
 Please send me your new, free booklet on RCA Intermatched high-fidelity equipment.
 Please send me information on the new RCA high-fidelity "Victrola"® phonographs.

Name _____

Address _____

City _____ Zone _____ State _____

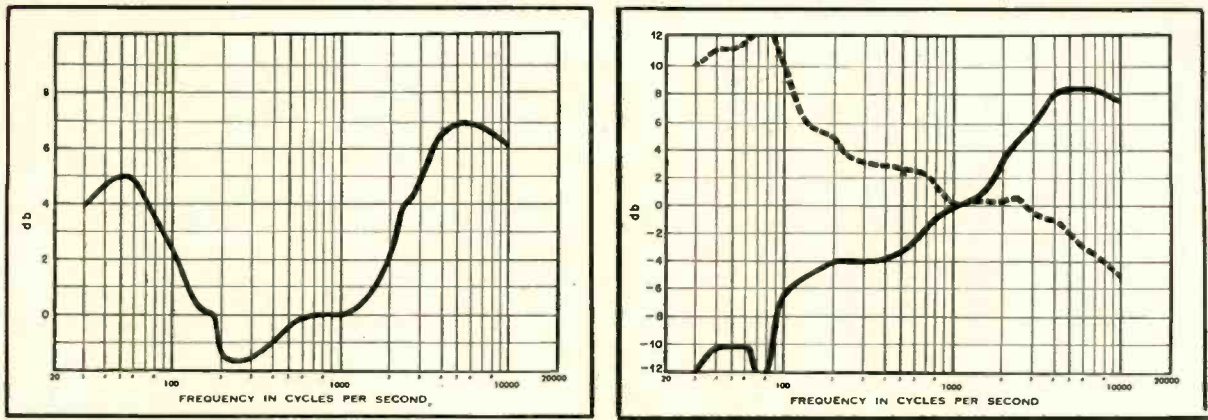

Fig. 4 (left). Amplitude characteristic of the "360" in normal use without the XD speaker plugged in. Fig. 5 (right). Responses of the "360" and the XD when the latter is plugged in.

the two corner speakers, as in Fig. 1. In addition, a switching arrangement was provided whereby the dual program tracks could be reproduced under three different conditions as follows:

Condition 1. The two tracks corresponding to the left and right microphones were electrically combined and fed directly to the center speaker. This was equivalent to conventional single speaker sound reproduction.

Condition 2. The left sound track was fed to the speaker in the left corner and the right track to the speaker in the right corner. This system corresponded to true stereophonic reproduction.

Condition 3. The two tracks were again electrically combined as under Condition 1, but before the resultant signal reached the left speaker, it passed through an equalizing circuit which at-

tenuated the lows and emphasized the high frequencies. The right speaker also received the combined signal, but through an equalizer which attenuated the highs and emphasized the lows. (The specific curves will be discussed later.)

Listeners were invited to these tests without being told what the conditions were. They were asked to express their preferences of sound reproduction by choosing from any one of the three conditions outlined above. The result of the study was startling but in some respects not unexpected. While not a single listener (about a total of fifty were exposed) preferred Condition 1—that is, the single conventional speaker—their preferences were almost equally divided between Conditions 2 and 3. Evidently, the simulated stereophonic sound seemed to give as much satisfac-

tion as the true one. As a matter of fact, when people began to wander around the room, more listeners preferred the simulated stereophonic rendition (Condition 3) because it seemed to give satisfactory results over a less restricted area than the true stereophonic sound.

A variation of these tests was performed on a number of listeners who were technically or musically well informed on the state of the stereophonic art. These listeners were told what the three conditions corresponded to and were asked to determine which Condition, 2 or 3, represented the true stereophonic rendition. Half of them guessed right and half of them guessed wrong, again proving that true stereophonic rendition can be successfully simulated with a single source of program.

It should be pointed out that a series
(Continued on page 115)

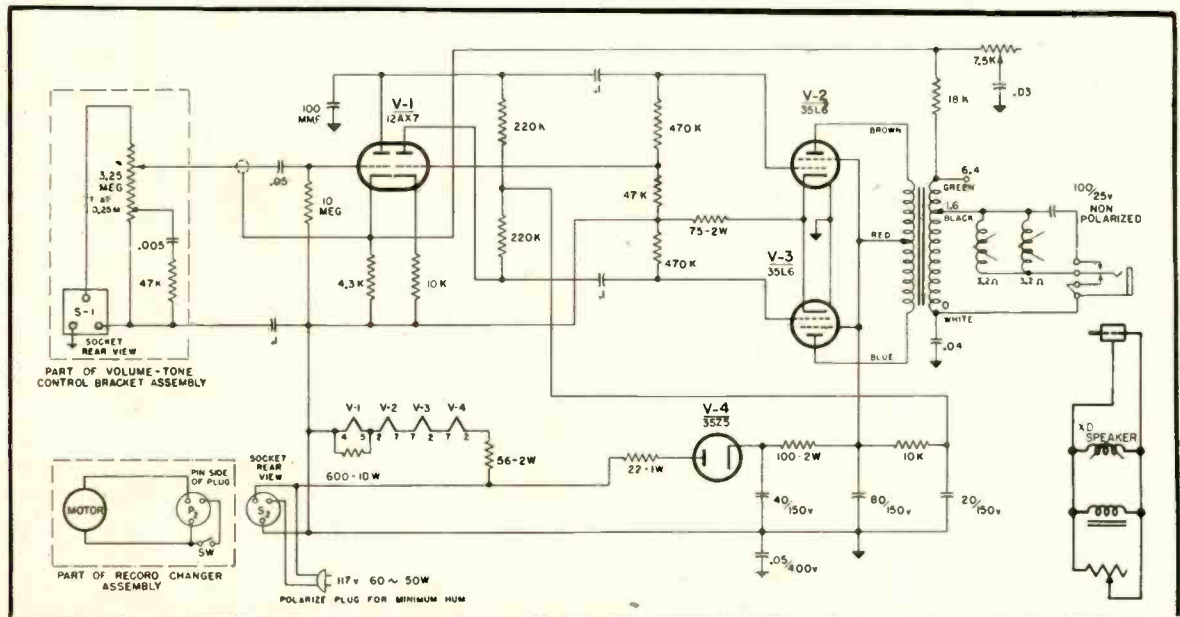
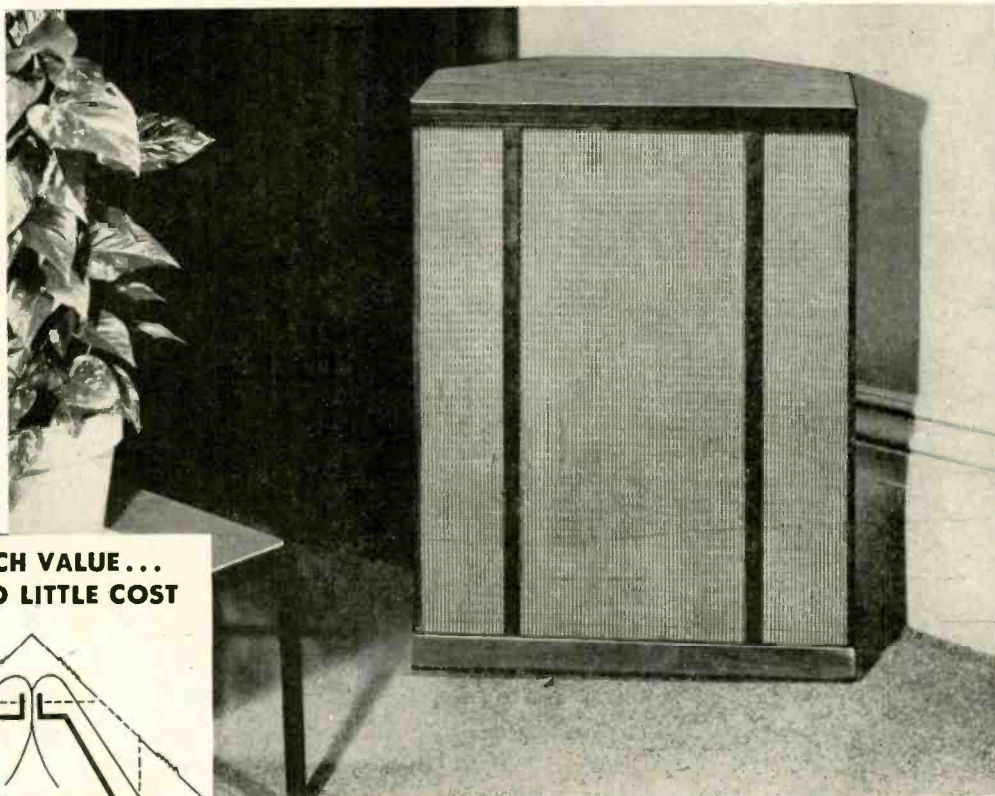
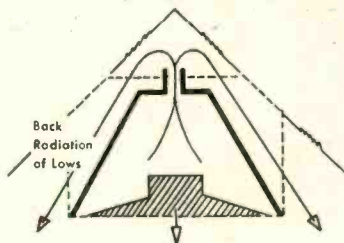

Fig. 3. Over-all schematic of the Columbia "360" and the "XD" to show circuit arrangement and switching.

paul klipsch-designed



**SO MUCH VALUE ...
...AT SO LITTLE COST**



- Large enclosure performance within minimum area achieved through principle of "backloading", which increases path length and provides better reproduction of lows.
- Direct radiation of high frequencies cuts out "Masking".

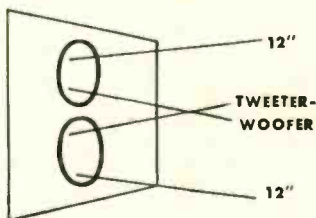

- Two-way system performance. So flexible in design so as to provide you wide latitude in determining your listening requirements. Removable panel allows for a variety of speaker combinations. For example, in the 12" Klipsch you can install a single 12", two 12" speakers or a tweeter-woofer combination.

THE REBEL IV by CABINART

Attractively styled to blend with any interior decor, the Klipsch Rebel IV by Cabinart comes in Lined Oak, Honey Walnut, French Mahogany and Black Lacquer.

\$69.00 Net for 12" model
\$87.00 Net for 15" model

"popularly priced!"

AVAILABLE AS KITS IN

BIRCH, UNFINISHED

Build your own Klipsch and save money—identical in acoustic design to assembled units and easily put together with a minimum of tools.

\$36.00 Net for 12" model

\$42.00 Net for 15" model

See it and hear it at your local parts distributor.
Write AE10 for complete technical data.



MANUFACTURED BY
G & H WOOD PRODUCTS CO.
75 NORTH 11th STREET, BROOKLYN 11, N.Y.

Pioneers in radio furniture for high fidelity equipment

Everyman's Amplifier

New Low-Cost Ten-Watt Unit Described as the "Ford" of the Hi-Fi Industry.

G. LEONARD WERNER* AND HENRY BERLIN*

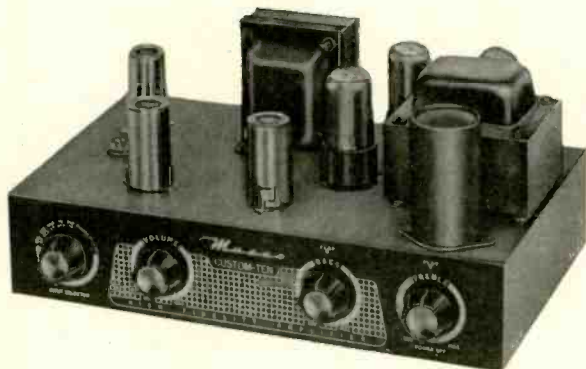

Fig. 1. The Masco "Custom Ten" amplifier, finished in black and gold.

THE NEEDS AND DESIRES of the consumer have a way of making themselves known, and as a result of information gathered through painstaking and intensive market research we have developed what is intended to be the "Ford" of hi-fi amplifiers—the answer to this need for a really good ten-watt hi-fi amplifier at reasonable cost.

The Masco Custom Ten amplifier, Fig. 1, provides features usually found only in the more expensive and higher-powered units. It was designed, however, to sell in the

* Mark Simpson Mfg. Co., Inc., 32-28 49th Street, Long Island City 3, N. Y.

popular price range. Advanced design, unusual features, a high degree of flexibility, above-average performance, and highly decorative styling were combined to provide the unit so urgently needed by the hi-fi enthusiast with a limited (or for that matter, unlimited) budget.

Features

The following features and facilities were all felt to be highly desirable:

1. *Eight-Position Selector Switch*, providing choice of any one of three high-impedance, high-level program sources (such as radio tuner, TV tuner, crystal or ceramic

phone pickup, or the outputs of tape, disc, or wire recorders).

The other five positions of the selector switch work with the magnetic phono pickup input to provide correct equalization for every type of record or tape recording—including the *New Orthophonic* recording curve used by RCA and recently described in the literature^{1,2} and which is likely to become the industry's standard recording characteristic.

The five equalizations,^{1,2,3} provided are labelled "Columbia LP," "Ortho-RCA," "NAB-LP," "78 rpm," "European 78's."

2. *Compensating Slide Switch* to permit accommodation of either high output magnetic cartridges such as Pickering or Clarkstan, or low output pickups such as GE or Audak.

3. *A Special Recorder Output*, which makes available approximately two volts of audio to permit making a tape, disc, or wire recording at the same time that the program is being heard through the amplifier system. The recorder may remain permanently connected to this jack.

4. *Bass- and Treble-Compensated Volume* (Continued on page 98)

¹ EDITOR'S REPORT, AUDIO ENGINEERING, July 1953.
² R. C. Moyer, "Evolution of a recording curve," AUDIO ENGINEERING, July 1953.
³ G. Leonard Werner and Henry Berlin, "New medium-cost amplifier of unusual performance," AUDIO ENGINEERING, Nov. 1952.

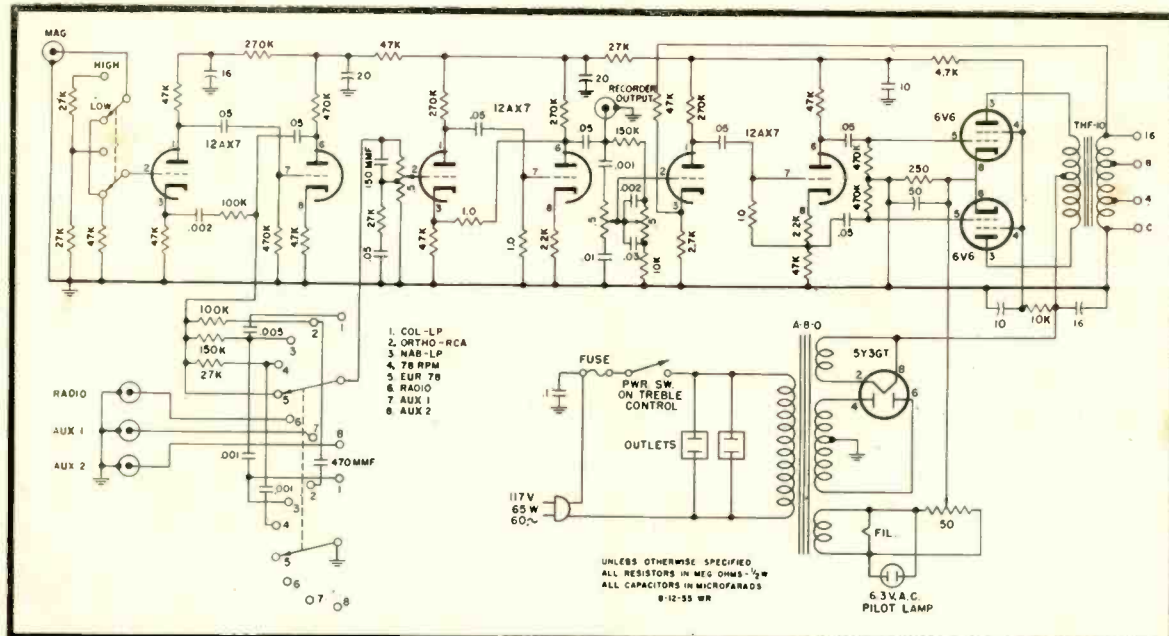
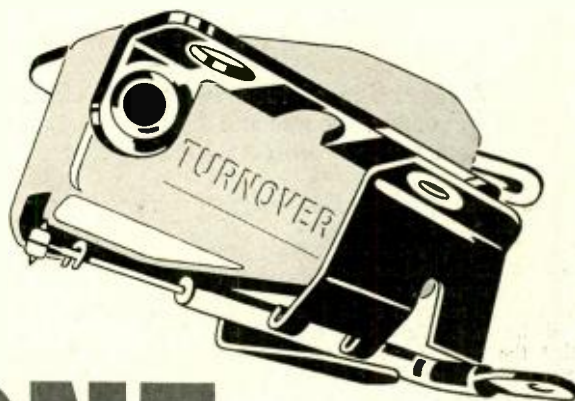

Fig. 3. Schematic of the "Custom Ten" amplifier.

You've heard about it — read about it — wondered about it —

HERE IT IS!

**The revolutionary
High-Fidelity**



TITONE CERAMIC PICKUP

Here, developed and perfected by SONOTONE, is the world's original High-Fidelity CERAMIC PICKUP. Based on an entirely new principle, neither crystal nor magnetic, the TITONE PICKUP uses revolutionary BARIUM TITANATE as the piezo-electric element.

The TITONE CERAMIC PICKUP needs neither preamplifier nor equalizer—thus offering a considerable saving. It is unaffected by moisture or temperature, and offers exceptional adaptability and sim-

licity in a true high-fidelity pickup. Only the needle rotates—not the cartridge—providing low needle point mass, yet easy replacement.

The response—without equalization—follows *almost exactly* the curve specified by a leading LP record manufacturer as “ideal.” Free from hum pickup, the TITONE CERAMIC PICKUP gives an unbelievably “clean” quality to music—separating and accentuating the orchestral instruments as you may never have heard them before.

NO OTHER CARTRIDGE OFFERS ALL THESE FEATURES!

- No preamplifier or equalizer needed
 - Unaffected by moisture or temperature
 - Wide frequency range
 - Outstanding response
 - High sensitivity • Low distortion
 - High compliance • No hum pickup
 - Superior tracking ability
 - Wide adaptability • Proper groove fit
 - Only needle rotates—simple to replace
- Complete Literature Available

SEE IT—EXAMINE IT—HEAR IT!

NEW YORK AUDIO FAIR, HOTEL NEW YORKER, OCTOBER 14, 15, 16 & 17.

SONOTONE CORPORATION

Elmsford, New York

Handbook of Sound Reproduction

EDGAR M. VILLCHUR*

Chapter 13. Voltage Amplifiers and Phase Splitters

A discussion of tube and circuit characteristics and their effect on frequency response and distortion in the low-level stages of audio amplifiers. Circuit configurations for phase splitters are shown and described.

THE VOLTAGE GAIN of an amplifier stage is defined as the output signal voltage divided by the input signal voltage. If vacuum tubes had no internal resistance this gain would be equal to the amplification factor (referred to by the symbol μ) of the tube. We have seen, however, that the open circuit output voltage of any practical generator is not applied directly to the load, but to a voltage divider made up of the internal resistance of the generator and the load resistance in series. The voltage gain of a stage of amplification must therefore always be less than the μ of the tube, in an amount determined by the ratio of the load resistance to the internal plate resistance. The greater the relative value of the load, the more closely the value of the gain can approach μ .

Equivalent Circuits

Amplifier analysis is facilitated by the use of a.c. equivalent circuits, from which characteristics such as gain, effective internal impedance, and frequency response can be readily derived. Figure 13-1 illustrates a typical stage of voltage amplification, and equivalent plate circuits. An a.c. generator, with an open-circuit output voltage equal to μE_g (the input signal multiplied by the amplification factor) is substituted for the tube

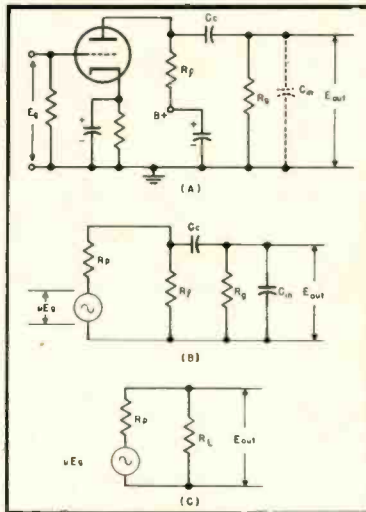

Fig. 13-1. (A) Voltage amplifier stage. C_{i1} is the effective input capacitance to the following stage. (B) Equivalent a.c. circuit. (C) Simplified equivalent a.c. circuit, assuming C_c shorted and C_{i1} negligible at signal frequencies. R_L is the parallel combination of R_1 and R_2 .

and the associated circuit elements that are required to make the tube work. All elements that are not in the signal circuit are eliminated; thus the B supply and the cathode resistor, which when properly bypassed present negligible resistance to the signal, do not appear in the diagram. The plate resistance of the tube, R_p , and the external load presented to the tube make up the total load seen by the generator. In C of Fig. 13-1 the effects of the coupling capacitor and of the input capacitance to the following stage are assumed negligible at signal frequencies; the single load R_L represents the plate resistor and the following grid resistor in parallel, that is, $R_1 R_2 / (R_1 + R_2)$.

It can be seen by inspection of C in Fig. 13-1 that the output voltage appearing across R_L will be equal to:

$$E_{out} = \mu E_g \times \frac{R_L}{R_L + R_p}$$

The voltage gain is thus equal to:

$$\frac{E_{out}}{E_g} = \frac{\mu R_L}{R_L + R_p}$$

The same expression for gain may also

be derived by applying Ohm's law, calculating the signal current from the applied voltage and total load, then calculating the IR drop across R_L . The current thus derived represents only the a.c. component of the plate current, and has nothing to do with the actual number of d.c. milliamperes flowing in the tube.

The Ohm's law derivation of the gain equation for a stage with an unbypassed cathode resistor R_c , (see Fig. 13-2), is shown below for the purpose of familiarizing the reader with the construction and use of equivalent circuits. In this case the original input voltage E_g is reduced by IR_c , the signal voltage drop across the cathode resistor. It must be remembered that the d.c. component of the tube current is neglected.

$$\text{Voltage gain} = \frac{E_{out}}{E_{in}} = \frac{IR_L}{E_g}$$

$$I = \frac{E_{generator}}{R_{total}} = \frac{\mu(E_g - IR_c)}{R_L + R_p + R_c}$$

$$\mu(E_g - IR_c) = (R_L + R_p + R_c) I$$

$$\frac{\mu E_g}{I} = R_L + R_p + R_c + \mu R_c$$

$$I = \frac{\mu E_g}{R_L + R_p + R_c (\mu + 1)}$$

$$\text{Voltage Gain} = \frac{\mu R_L}{R_L + R_p + R_c (\mu + 1)}$$

(with negative feedback)

To calculate the source impedance seen by the load, a generator of arbitrary voltage E is substituted for the load impedance, and the generator representing the tube is short-circuited, indicating zero input signal. Any feedback voltages are represented by series generators with a polarity appropriately related to that of the load generator; thus a generator representing a negative current feedback voltage will have a polarity opposite to that of the load generator, (see Fig. 13-3) while negative voltage feedback will be represented by a generator with the same polarity as the load generator. The

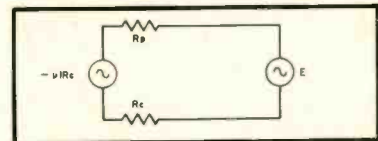

Fig. 13-3. Equivalent a.c. circuit to stage with unbypassed cathode resistor, constructed for purpose of calculating effective internal impedance. This is the impedance seen by a generator, of arbitrary voltage E , which has been substituted for the load.

* Contributing Editor, AUDIO ENGINEERING.

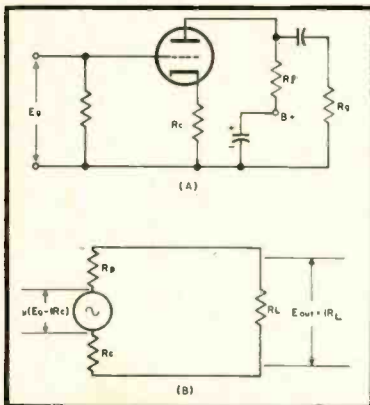

Fig. 13-2. (A) Voltage amplifier with negative current feedback secured from unbypassed cathode resistor. (B) Equivalent a.c. circuit.

TANNOY



Now **IN NORTH AMERICA**

Europe's leading acoustic pioneers are NOW distributing their famous comprehensive range of audio products in the United States and Canada.

**TANNOY SOUND
IN FAMOUS PLACES**

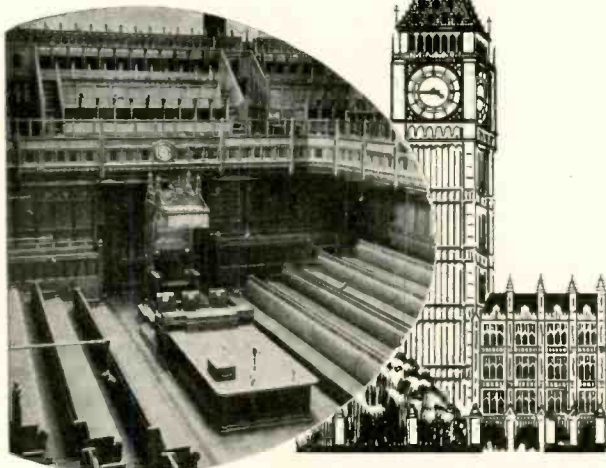

L O N D O N

A complete Tannoy speech reinforcement system in the House of Commons, London, which is installed and operated by Tannoy, as in many other legislative assemblies throughout the World, United Nations Building, New York, New Delhi, etc.

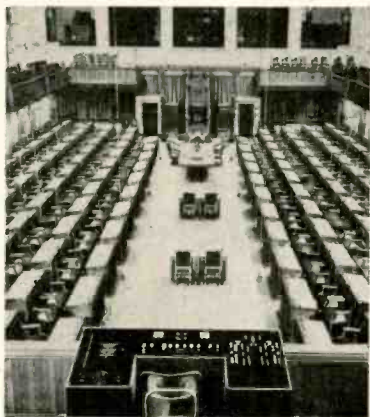

House of Commons
O T T A W A

TANNOY (CANADA) LIMITED
Presents among other unique products the improved
DUAL CONCENTRIC

*Amazing
Presence
Smooth and
Very Wide
Frequency
Response*



ALREADY the Dual Concentric "Twelve" and "Fifteen" loudspeakers have been acclaimed in the U.S.A. by both Radio Critics and High Fidelity Enthusiasts alike for their realistic translation and aural charm.

At this year's "Audio Fair", Tannoy Canada Limited offer for your even better entertainment the newest Improved models, in addition to many other examples of Tannoy craftsmanship, backed by over a quarter of a century's experience in sound engineering, which includes a superlative range of microphones and the revolutionary 100 Watt Tannoy Power loudspeaker.

★ *Send to-day for fully descriptive literature now available direct from Tannoy in North America.*

At the AUDIO FAIR 1953 (Room 607)

TANNOY (CANADA) LIMITED
475 FIFTH AVENUE, NEW YORK 17, N.Y.
Telephone: LEXington 2-4991

Head Office and Showrooms
TANNOY LTD., WEST NORWOOD, LONDON, S.E.27, ENG.

derivation given here, referred to in Fig. 13-3, is for negative current feedback; the reader may wish to check the equations for source impedance with negative voltage feedback, positive current feedback, etc.

$$\text{Source Impedance } (R_{int}) = \frac{E}{I}$$

$$I = \frac{E_{total}}{R_{total}} = \frac{E - \mu I R_c}{R_p + R_c}$$

$$I (R_p + R_c) = E - \mu I R_c$$

$$R_p + R_c = \frac{E}{I} - \mu R_c = R_{int} - \mu R_c$$

$$R_{int} = R_p + R_c + \mu R_c = R_p + R_c (\mu + 1)$$

For a multistage feedback loop μ becomes the gain with the final load open, R_c the resistor in series with the load.

Frequency Response

At low frequencies the coupling capacitor C_c of (B) in Fig. 13-1, and the grid resistor R_g , form a voltage divider that reduces the input signal to the following stage. When the frequency becomes low enough so that the reactance of C_c is numerically equal to the resistance of R_g the signal voltage across R_g will be reduced, by approximately 3 db, from the total signal across the voltage divider. (The value of the total load presented to the previous stage will also be increased somewhat.)

Although it might be expected that when the reactance of C_c is equal to R_g the signal voltage will be halved, and the reduction amount to 6 db, it must be remembered that the reactance of C_c is a vector quantity.

The low-frequency amplification of a stage may be expressed as a fraction of the mid-frequency gain:

$$A_L = \frac{A_M}{\sqrt{1 + (\omega R_g C_c)^2}}$$

where A_L = Low-frequency gain (does not include phase shift)

A_M = Mid-frequency gain

$\omega = 2\pi \times$ frequency concerned

$$R_i = R_g + \frac{R_1 R_p}{R_1 + R_p}$$

R_p = tube plate resistance; R_1 = plate resistor; R_g = grid resistor

C_c = Capacitance of coupling capacitor, in farads

Figure 13-4 plots the low-frequency transmission of amplifier networks with given coupling capacitors and grid resistors. It should be evident that the lower the value of the grid resistor the greater must be the value of the coupling capacitor for the same low-frequency transmission.

The low-frequency response of an amplifier may also be reduced by insufficiently large cathode and screen bypass capacitors. If the reactance of the cathode bypass at low frequencies becomes appreciable, relative to the bias resistor, discriminative negative current feedback and bass attenuation are introduced. If the capacitor bypassing the screen to ground is too small to be effective at low frequencies, signal voltage variations appear on the screen grid, of such polarity as to reduce the cathode-plate signal current and cause the signal frequencies concerned to be attenuated.

Simplified expressions¹ for calculating approximate required minimum capacitances in audio applications (not considering phase shift) appear below:

$$C_c = \frac{1.6 \times 10^6}{f_L R_g} \mu\text{f}$$

$$C_k = \frac{1.6 \times 10^6}{f_L R_c} \mu\text{f}$$

$$C_s = \frac{1.6 \times 10^6}{f_L R_s} \mu\text{f}$$

where C_c = Coupling capacitor

C_k = Cathode bypass capacitor

C_s = Screen bypass capacitor

f_L = Low-frequency limit in cps

R_g = Grid resistor, ohms

R_c = Cathode resistor, ohms

R_s = Screen dropping resistor, ohms

The treble response of an amplifier stage is limited by the shunt effect of the tube capacitances, illustrated in Fig. 13-5. The effective input capacitance of a stage is not merely the sum of the inter-electrode tube capacitances, but is affected by the amplification of the tube:

¹ Charles P. Boegli, "A note on volume controls," AUDIO ENGINEERING, p. 40, April, 1953.

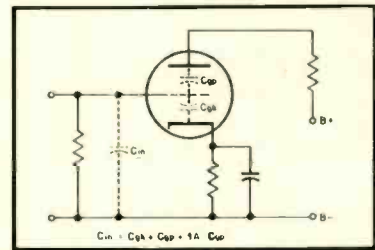

Fig. 13-5. Inter-electrode tube capacitances, whose combined effect is represented by C_{in} , the input capacitance of the stage.

$$C_{in} = C_{gk} + C_{gp} + |A| C_{gp}$$

where C_{in} = Effective input capacitance of tube

C_{gk} = Grid-cathode inter-electrode capacitance

C_{gp} = Grid-plate inter-electrode capacitance

$|A|$ = Absolute value of voltage gain

The effective tube capacitance forms a shunt across the lower arm of the plate resistance-load voltage divider. (The lower arm is the parallel combination of R_i and R_g . When the resistance of the combination of R_i and R_g is very large the shunt capacitance has an appreciable effect on the value of the total load impedance at high frequencies, but when the resistance of the combination is low the further shunt reactance changes the total load value very little. The effect of the change in load value is reduced by a low plate resistance that causes the stage to approach constant-voltage operation. Thus, high-frequency response is aided by low values of plate and grid resistors, by low tube amplification and plate resistance, and by low inter-electrode capacitance, especially that between control grid and plate. With normal R-C coupled circuits the upper frequency limit is well above the audio range.

The high-frequency amplification of a stage is equal to:

$$A_H = \frac{A}{\sqrt{1 + (\omega R_i C_{in})^2}}$$

where A_H = High-frequency gain (does not include phase shift)

A = Mid-frequency gain

$\omega = 2\pi$ times the frequency concerned

R_i = The parallel combination of R_p , R_1 and R_g

$$= \frac{R_p R_1 R_g}{R_p R_1 + R_p R_g + R_1 R_g}$$

R_p = tube plate resistance; R_1 = plate resistor; R_g = grid resistor

C_{in} = Effective input capacitance, in farads.

The insertion of a series element between stages, such as the upper arm of a potentiometer used as a volume or tone control, adds to the effective value of the source impedance seen by the input terminals of the following stage, and therefore reduces the high-frequency range for the same circuit values (counting the effect of the reduced resistance of the

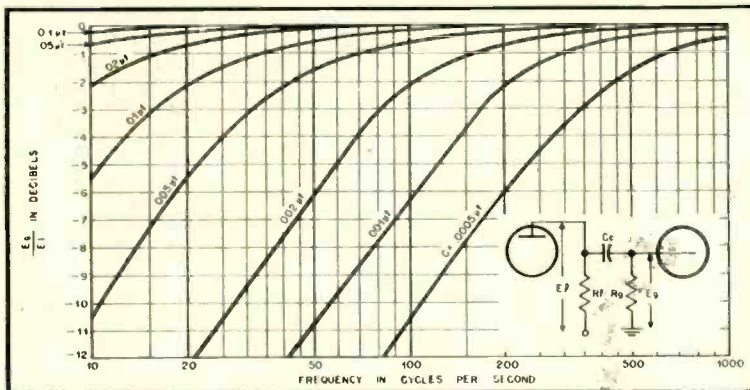

Fig. 13-4. Approximate low-frequency transmission of R-C coupling networks into grid resistor of 1.0 megohm (assuming R_p and R_1 of first stage small). For other values of grid resistor multiply C by 1.0 meg/ R_g . To include effect of R_p and R_1 , use $R_i + R_1 R_p / (R_1 + R_p)$ for R_g . (After F. Langford Smith)

Now... the ultimate in Record Reproduction



THE *Ferranti*
RIBBON PICKUP

EXCLUSIVE FERRANTI DESIGN FEATURES

- Low mass high compliance ribbon movement.
- *Unequaled tracing accuracy.
- Arm resonance removed from audible range.
- Elliptical Diamond Stylus.
- Self Protecting Stylus Suspension.
- Double Ball Race Arm Bearing.
- Built In Arm Rest.

*The Ferranti Ribbon Pickup will reproduce, with negligible distortion, a frequency of 20,000 cps recorded at maximum level on a 5 inch diameter shellac disc at 78 rpm.

Ferranti is proud to introduce this high performance pickup designed by D. T. N. Williamson. Clearly destined to earn the same enthusiastic approval as the world famous Williamson Amplifier, its brilliant realism of reproduction is matched by the quiet elegance of its style.

Precision manufacture by specialists in delicate aircraft instruments insures continued *full fidelity* from your favorite records. Completely integrated design, from stylus to arm mounting, giving flat response from 20-20,000 cps, with extremely low distortion and negligible record wear.



Plug-in heads with diamond styli for 78 rpm and micro-groove records.



WRITE FOR FULL TECHNICAL DESCRIPTION • Hear it at the AUDIO FAIR, New York, OCTOBER 14-17

FERRANTI ELECTRIC - INC. • 30 Rockefeller Plaza
New York 20, N. Y.

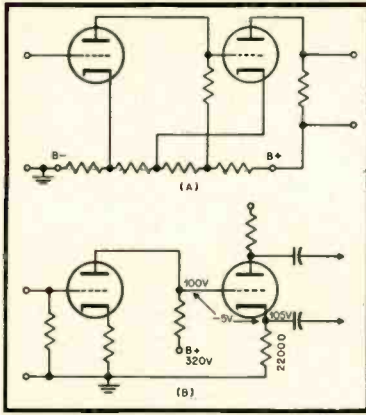

Fig. 13-7. (A) Direct-coupled amplifier using tapped B supply. (B) Direct-coupled circuit used in Williamson amplifier. The 100 volts (relative to ground) on the grid is offset by the 105 volts between cathode and ground.

lower arm of the volume control).² The restriction, however, is generally from one ultrasonic value to a lower one, and therefore not significant; controls can never be included within a feedback loop where ultrasonic response may be needed. One circuit position where the effect of the control on high frequencies may be important, however, is the input to a long cable.

² Technical Manual—Sylvania Radio Tubes, Sylvania Electric Products, Inc., Emporium, Penna., 1946, p. 32.

From the above it may be seen that the frequency range of a resistance-capacitance coupled stage can within limits be chosen at will, and is not ordinarily dependent upon any subtle virtues or defects of the circuit components.

Distortion in Voltage Amplifiers

Voltage amplifiers are, under normal circumstances, operated in class *A*₁. As in the case of power amplifiers the percentage of distortion is a function of the signal amplitude; the voltage amplifier stages that are most subject to distorting influences are therefore the "high-level" stages just prior to the power amplifier. The same methods that are used to decrease distortion in the power amplifier may be used here—the application of inverse feedback (both voltage and current feedback are equally beneficial) and the use of push-pull circuitry.

Negative current feedback can be inserted simply by omitting the bypass capacitor from the cathode bias resistor. Harmonic distortion and other undesirable effects are reduced, as with voltage feedback, by the gain reduction factor, while the increase of source impedance is of no consequence. If the loss of gain can be afforded, the only disadvantage of an unbypassed cathode resistor lies in the increased danger of hum picked up from heater-cathode leakage.

Voltage amplifiers in push-pull exercise the same discrimination against even harmonic distortion as power amplifiers. The actual cancellation does not take

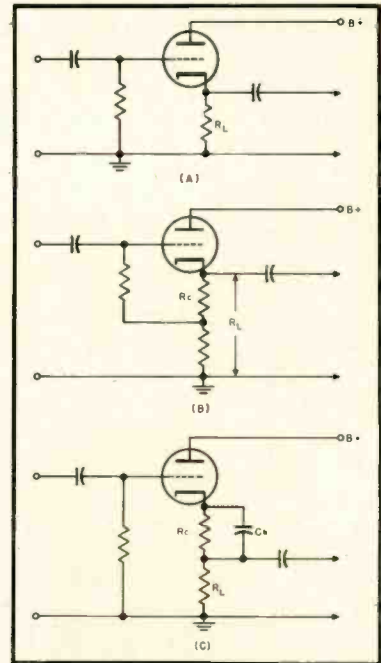

Fig. 13-8. (A) Cathode follower voltage amplifier. All of the voltage across R_L is fed back to the input, constituting 100 per cent negative voltage feedback. (B) Method of providing correct bias for cathode follower stage when R_L is too large. The bias voltage is formed across R_C . (C) Method of providing correct bias for cathode follower stage when R_L is too small. The bias voltage is formed across the series combination of R_L and R_C . If C_K is eliminated, R_C will provide negative current feedback.

place, however, until the signal passes through a common load such as the output transformer.

Bias Voltage

Bias in a voltage amplifier is obtained from a cathode resistor in the overwhelming majority of cases. Occasionally the grid resistor method is used in low-level stages such as phonograph pre-amplifiers. In the latter case a grid resistor of high value, of the order of 10 megohms, is used between grid and ground, while the cathode is grounded.

The Use of Tube-Manual Data in Designing R-C Coupled Voltage Amplifiers

Although circuit equations may be used to design voltage-amplifier stages, the values of circuit elements for most of the common applications can be determined by referring to prepared charts. Figure 13-6 illustrates a section of such a chart, and includes a diagram of the circuit elements to which the symbols refer. The gain and distortion characteristics accompanying various combinations of circuit values, supply voltages, signal amplitude, and in some cases type of bias may be read directly. The importance of not over-driving stages located prior to the volume control (where the increased signal amplitude will not be

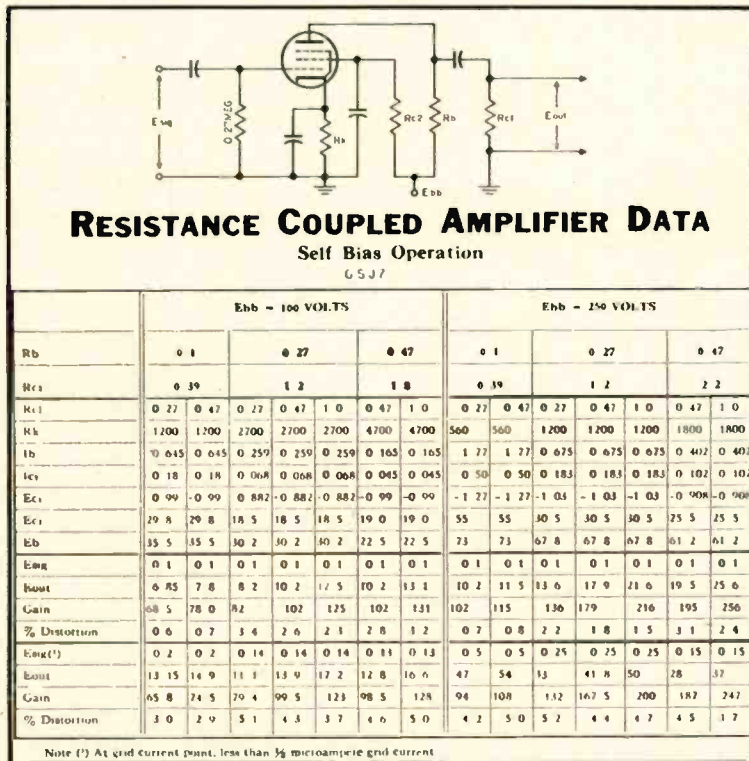
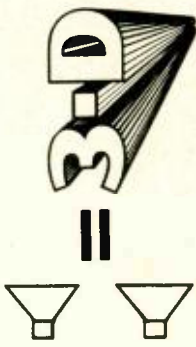

Fig. 13-6. Sample of R-C coupled amplifier data used for selecting circuit values. (Part of a chart from the Sylvania Tube Manual)

IT ALL ADDS UP . . . 3-D IS HERE TO STAY!



"Binaural" records are now available at jobbers everywhere. New recording sessions are under way at Livingston, Cook, and in at least two other record companies. Others plan to augment this steadily growing library. Both classical and popular selections are being recorded after careful screening of talent and material so that when the newness of "3-D" has passed, they will still be outstanding collector's items by both musical and the most exacting audiophile's recording standards. Yet "Binaural" records cost no more than regular "L.P.'s."

"3-D" fans will be delighted to learn that the Livingston Binaural arm is now available, optionally, with what we consider to be the finest cartridges commercially available—the new Fairchild diamond stylus Model 215's. These cartridges are carefully matched, installed, and tested in each arm by our laboratory before shipment. This means that only the final adjustments, after installation, are necessary. The remarkable part of this new arrangement is the savings passed on to the user. Over twenty dollars! Thus Livingston has made available the finest luxury type equipment at less than the cost of a compromise. The Fairchild cartridge has impressed us with its remarkably high compliance, its freedom from needle talk and hum, and of course above all, the refreshing purity and realism available from this cartridge. There was no sense in our supplying high fidelity recordings if the material recorded couldn't be taken "off the record!" The combination of the Livingston Binaural Arm and the Fairchild Cartridge is the guarantee of minimum record wear and maximum fidelity to the amplifier input. This combination is available for only \$89.50. The cost of the arm alone is \$35.00.

After waiting patiently for someone else to do it, Livingston now releases a complete stereophonic twin-channel amplifier designed specifically to take full advantage of the many 3-D sound sources currently available. Consisting of two complete 10 watt hi-fi channels from cartridge to loudspeaker, 3 twin inputs have been provided for disc, tape, and binaural broadcasts. Separate tone-controls for highs and lows on both channels mean that exciting effects can be obtained, even with a conventional monaural program source. We make no earth-shaking claims for this unit. It's just a darned fine 2-channel amplifier, good enough to bear the name Livingston. Costs only \$149.50.

As to speakers—even two dollar units sound better with 3-D but the ultimate choice of your speaker system is primarily a matter of your own tastes and requirements. The additional speaker required for the second channel might be considered an auxiliary unit. It need not be a cost factor until the rich advantages of this medium have sold themselves to you.

We're stumped! Call it what you will: "3-D," "Stereo," "Binaural"—it's just a word until it's heard. It's impossible to convey any kind of picture that will prepare you for the pleasant shock of your first good 3-D playback. For example, its hard to accept the fact that a few binaural watts seem fuller than a tremendous blast of monaural power. We give up! You'll just have to hear it.

Prove it to yourself in your jobber's sound room that a complete, fine 3-D system can cost less than a compromise.

** Products Manufactured by*

LIVINGSTON ELECTRONIC CORPORATION

Livingston, New Jersey

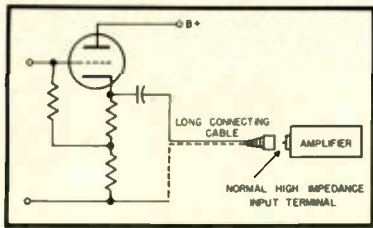

Fig. 13-9. Use of a cathode follower for overcoming effects of long connecting cable on high-frequency response and hum level. Common value for cathode load is 10,000 ohms.

evident in the final output) and of choosing tubes and circuits adequate to handle the signal voltages that will be fed to them, is apparent from the distortion data. Since negative feedback reduces only gain and not the output capabilities of the stage, the allowable input signal is increased by at least the feedback gain reduction factor.

Direct-Coupled Stages

The function of the coupling capacitor is to keep d.c. from the following grid, while allowing the signal to pass. This capacitor may be eliminated, and the plate connected directly to the following grid, if the positive d.c. plate voltage applied to the grid is over-balanced, in such measure that the resultant bias voltage between grid and cathode is negative and of the proper value. (A) of Fig. 13-7 illustrates the principle of a direct-coupled amplifier. Although such amplifiers present stability problems much greater than occur in conventional R-C designs and need special power supplies, they are required in certain applications. The measurement of minute body potentials in medical work, for example, calls for an amplifier that responds to input voltage stimuli which may change very slowly or not at all.

Direct-coupled stages may also be incorporated in audio amplifiers for the purpose of reducing phase shift within the feedback loop. (B) of Fig. 13-7 illustrates the direct-coupled input stages of the Williamson circuit. The positive voltage on the second grid is more than offset by the IR drop across the large cathode load resistor, so that the final bias voltage is -5 volts, as shown.

The Cathode-Follower Voltage Amplifier

The cathode-follower circuit mentioned in Chapter 12, various forms of which are illustrated in Fig. 13-8, is most commonly used in voltage applications. The voltage gain is always less than one, indicating that the stage can serve no purpose simply as a voltage amplifier, however low the distortion. Other characteristics, however, make the cathode follower an extremely useful circuit. These characteristics include:

1. Very low input capacitance—little more than the grid-plate inter-electrode capacitance of the tube—making possible use of the cathode follower as a buffer stage between a high-impedance source and a high-capacitance load.

2. Near-constant-voltage operation associated with the 100 per cent negative voltage feedback. The range of load impedance values that can be used is much greater than in conventional circuits, making it possible to match the characteristic impedance of low-impedance lines.

3. The output has one side grounded and is in phase with the input.

4. Very low distortion, wide frequency range, and low phase shift.

5. High signal-handling capability. When a signal is applied to the grid of the cathode follower, the instantaneous voltage across the cathode load resistor adjusts itself to a value somewhat less than the signal voltage. The voltage "gain" varies from about .5 for very low values of load impedance, such as provided by low-impedance transmission lines, to about .9 for resistances of 10,000 ohms or more.

The voltage gain of a cathode follower, ignoring reactances, is equal to:

$$\frac{\mu R_L}{R_p + R_L} \times \frac{1}{1 - A\beta}$$

[where $\beta = 1$]

$$A = \frac{-\mu R_L}{R_p + R_L}$$

$$= \frac{\mu R_L}{R_p + R_L(\mu + 1)}$$

where R_L = Cathode load resistor
 R_p = Tube plate resistance

The cathode follower is useful in vacuum-tube voltmeters, where it is very important that the input impedance be very high so as not to disturb the circuit

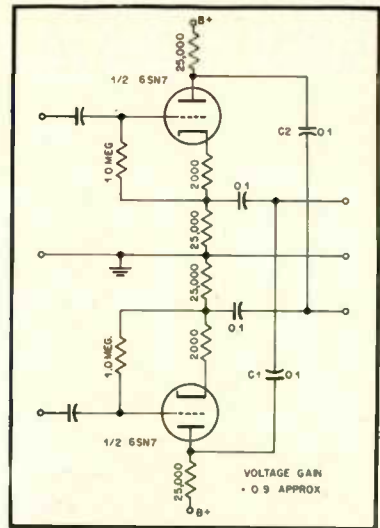

Fig. 13-11. "Phase compressor" for correcting an imperfectly balanced push-pull signal.

being measured, and in video applications. The cathode follower is also useful in audio systems as a high-quality, non-critical matching or buffer stage. A high impedance source—for example, the output of a preamplifier tube—may feed an amplifier that is located at an appreciable physical distance. The capacitance between the shield and central conductor of the cable provides an effective shunt across high-impedance circuits and attenuates the treble frequencies. In ad-

(Continued on page 104)

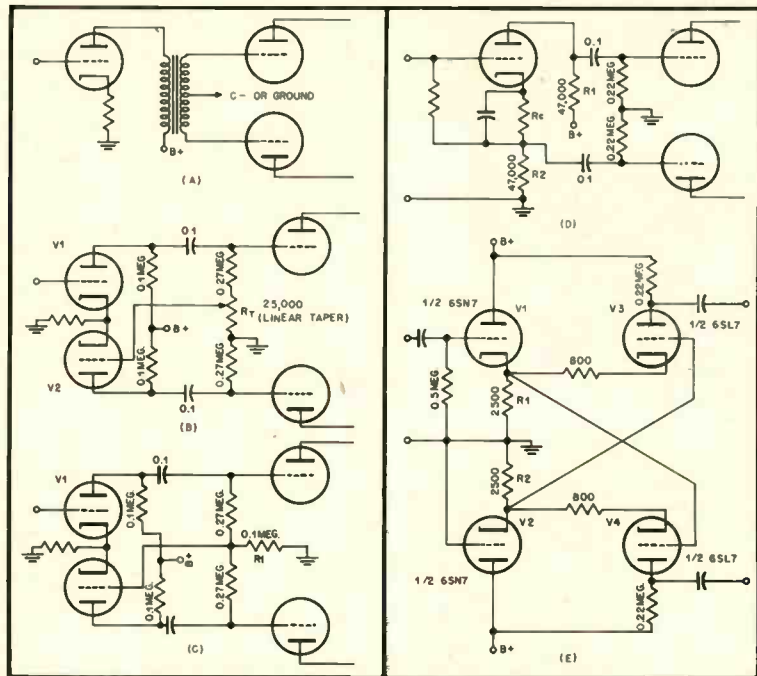

Fig. 13-10. (A) Transformer phase splitter. (B) Tapped-voltage phase splitter, with common circuit values. (C) Floating-paraphase phase splitter. (D) Split-load or cathodyne phase splitter. R_c is selected on the basis of the total load, $R_1 + R_2$. (E) Cross-coupled phase splitter.

SPECIALIZATION MAKES THE DIFFERENCE

Specialization may be defined as the concentration of all effort to a special or specific course of action

Even a mechanical device concerned with the function of record reproduction should possess all the advantages of such specialization.

Most units undertake to do much more. They change records, mix records, flip records, reject records, and assume a multitude of other functions. This is 'generalization' as distinguished from 'specialization'.

The REK-O-KUT turntable, on the other hand, is devoted entirely to playing records. And every design feature, every fragment of engineering know-how has been devoted and restricted to the all-important job of playing records . . . to provide the constant, steady, unwavering record motion necessary for the faithful reproduction of records free of mechanical distortion.

Specialization makes that difference. And all of the efforts and facilities of the manufacturer shall continue to be intensively devoted to that one objective . . . that one aim: *To make the finest turntables in the world.*

There is a REK-O-KUT Turntable for your specific discriminating requirement. Seven models are available at prices ranging from \$59.50. At Leading Radio Parts Distributors and at Sound and Music Dealers.

Write for Descriptive Literature



VISIT ROOM 636
at the AUDIO FAIR
in NEW YORK

REK-O-KUT TURNTABLES

REK-O-KUT COMPANY, 38-03M Queens Boulevard, Long Island City 1, New York
Export Division: 458 Broadway, New York 13, U. S. A. Cables—Morhanex
In Canada: Atlas Radio Corp., Ltd., 560 King Street, W., Toronto 2B

The Great Mystery of Dannemora Dungeon

Binaural by Parable, by Golly

Most readers will have heard the term "Binaural" even though they have not yet been subjected to its advantages. The author—in the forefront of binaural development—comments interestingly in an unusual form.

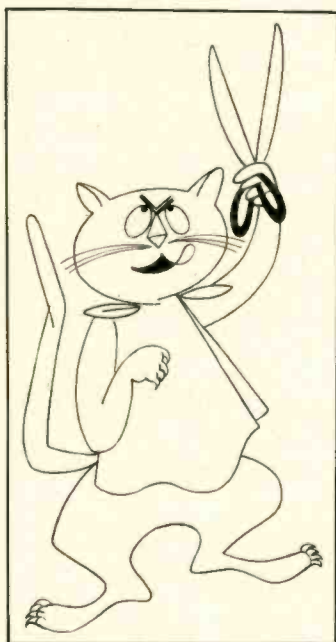

ONCE UPON A TIME there was a great dungeon deep under Dannemora castle. It often had been used for the medieval purpose of corrective politics, but now it was populated only with mice—many, many mice. The dungeon was pitch black, with not a single gleam of light, and in order to survive, the mice had to perceive binaurally the direction of approach of the castle cats. Wherever the cats would go in the inky pit, the prey would have just departed, leaving the *smell* of mice, but no *edible* mice.

Above, in the castle rooms there was a remarkable cat, the pet of a noble duke and his duchess. Tommy was not like other cats, for he was the re-incarnation of Prof. Kamstak Lodov, the great Russian scientist, well-known to have discovered the principles of depth perception and stereo several centuries ago.

One day the mice in the dungeon became a problem to the noble duke, because he wished gently to incarcerate a noble enemy—gently since he well knew that possibly some day the noble enemy might instead be incarcerating *him*. So the Duke of Dannemora called to his footman, and directed that Tommy be

placed in the dungeon in an unfed frame of mind. But Tommy refused at first to be led down the wet stony steps to the creaky iron dungeon door, and called first for the sharpest pair of scissors in the kingdom. When these were found and brought to him, he sat down and cut off the tips from all his claws,—an odd procedure indeed for a cat about to enter into predatory activities. But remember, Tommy was the re-incarnation of François Popov, world famous Russian binaural scientist.

Tommy then allowed himself to be led down the wet stony steps to the creaky iron door, and while in transit, please note, he made no clicking sound with his claws, no transient noise—only a dull

potential prey to perceive direction of approach depended upon keeping the sounds of his approach below 1,000 cps, he again clipped his claws to prevent the clicking, and set out across the moat on a black moonless night to find his fortune. Suddenly a strange and exciting scent was in the air, and as he followed it along well-filtered in his 250-cps way, Tommy was abruptly trampled to death by an old lady in a wheelchair with an ear-trumpet, who was binaurally astute down as low as 80 cps with a 9-inch ear spacing.

Tommy had made a miscalculation.

Tommy even today is again being re-incarnated.

The Explanation (?)

Of course the answer lies in examining for the particular animal in question the range of maximum sensitivity in the audio spectrum. Bats, for instance, have maximum sensitivity in the range of 12,000 cps, because those are the frequencies for which the ear spacing is a half-wave length. The human head is inaccurately described as 6 inches and functions best at 1,000 cps. Incidentally, the voice of the specie tends to pitch it-

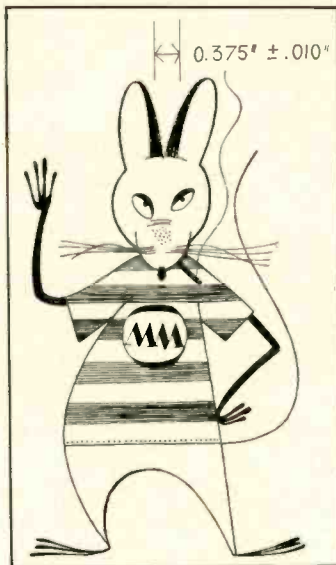

padding centering around 250 cps, as he had no doubt planned.

For all of three weeks and three days the great iron door was left closed and locked, but finally there came the predestined hour, and as the hinges groaned open, Tommy staggered out, replete and bursting with masticated mice, the product of 4 and 20 days of using low-pass filters. As Tommy recuperated on his pillow he began to reflect. The cloying taste of mice lingered overlong, and he yearned insatiably for other fare, even if only as a chaser. Well knowing by experience with mice that the *ability* of

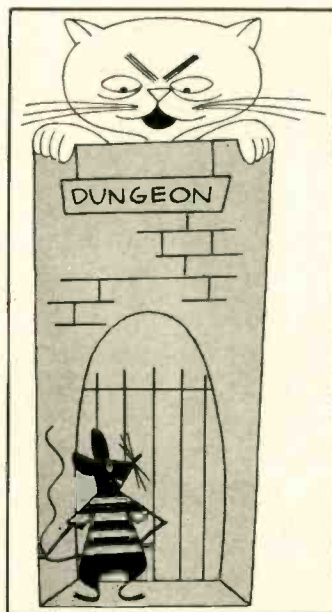

NEW! **LORENZ**

SOUND FACTS about GOOD SOUND at KINGDOM LOW COST!

Here is "realism" in sound reproduction every music lover and sound engineer will instantly appreciate. Unusual quality LORENZ speakers plus acoustically correct KINGDOM enclosures give you real "presence" of sound at surprisingly low cost.

Now you can come closer than ever before to this



Using LORENZ LP-215 "WOOFER", LP-65 "TWEETER", and KINGDOM HP-1 HIGH PASS FILTER and KINGDOM B-1 ENCLOSURE. Available individually or in a complete package. Illustrated and described here.

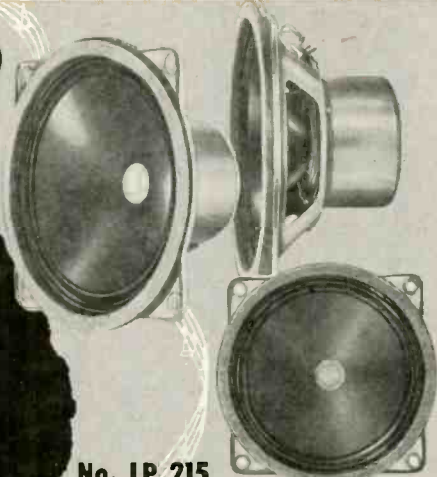

No. LP 215 "WOOFER" LOUSPEAKER

Here is a new speaker that speaks for itself. Made by Lorenz, leading European audio manufacturer and made expressly for Kingdom Products. Lorenz experience and fine craftsmanship make these speakers exceptional in quality and value! The frame is heavy and rigid, free of burrs. . . The mounting holes are outside the cone rim circle to eliminate twisting of the cone. . . The thick felt flange (no cardboard) is provided to seal and damp out undesirable resonances which may come from the enclosure.

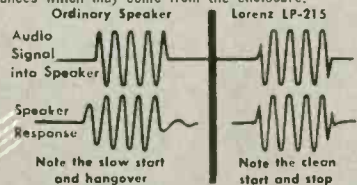

"Hangover" is completely eliminated. A drum roll is a drum roll — not a buzz or hum. Each staccato sound in is staccato out. The result is clear tonal quality which can be heard with pleasure and without fatigue at any loudness level. Specifications:

- Mounting holes — 9/16"
- Frame diameter — 8 1/2"
- Cone diameter — 7 1/2"
- Mounting hole (enclosure) — 7 1/2"
- Free air cone resonance — 75 cycles
- Frequency response — 2.5 db to 13,500 cycles
- Magnet — High FLUX — Alnico 400
- Flux density in air gap — 9,500 gauss
- Energy in air gap — 170 milliwatts
- Power rating — 8 watts
- Optimum amplifier output impedance — 4 ohms

We are proud to bring you the Lorenz loudspeakers, and we know that you will be an equally proud owner because it will match the finest equipment used with it.



NEW KINGDOM HIGH PASS FILTER

No. HP-1 — The HP-1 filter has a nominal "crossover" at 5000 cycles and is intended to increase the contribution of "highs" at a rate of 3 db per octave starting at 2000 cycles. Its effect increases smoothly with frequency so that at 12,000 cycles and up where most speakers fall off, the tweeter is in full use extending the sound output of the system to the limit of audibility.

NET \$4.95

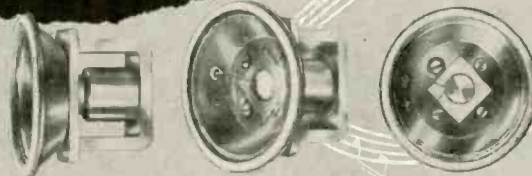

NEW LORENZ TWEETER

No. LP-65 — Here is the tweeter to complement any Woofer. This high frequency speaker will carry the "highs" as you want it — Clean, Clear and Sweet.

Specifications:

- Outside diameter — 2 1/2" (65 mm.)
- Cone diameter — 2 3/4" (67 mm.)
- Mounting hole — 2 3/4" flared to 2 1/2" or more
- Free air cone resonance — 1,600 cycles/sec.
- Upper frequency response — ± 2 db to 14,500 cycles and down 5 db at 16,000 cycles
- Magnet — High Flux Alnico 400
- Flux density in air gap — 10,000 gauss
- Energy in air gap — 37 milliwatts
- Power rating — 2 watts max.
- Voice Coil Impedance — 5.5 ohms

NET \$8.50

KINGDOM CABINETS

Designed for 8" speakers or 2-way systems. Made of hardwood half-inch thick. Acoustically correct for excellent reproduction with LORENZ speakers and other standard speakers. Size 13" x 16" x 19". Available in colors to harmonize with the following finishes:

- No. MB-1 Mahogany, Net...\$26.95
- No. LB-1 Blonde, Net\$26.95
- No. UB-1 Unfinished, Net\$24.45

Note: You know that speaker sound depends on the enclosure and the room in which it is placed. Kingdom cabinets designed for Lorenz speakers give excellent "realism" and "presence," and fit any living room. We have also found by actual test that the Rebel IV CABINART and the Baronet by Electro-Voice are also good. Other well-designed cabinets should work equally well.

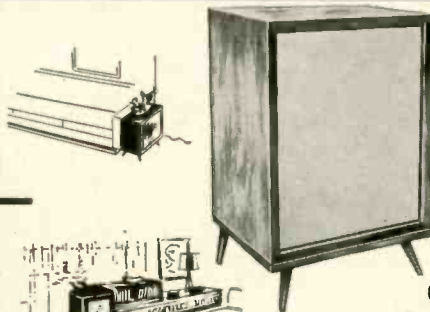

KINGDOM SOUND COMBINATION CABINET WITH SPEAKERS

Features the Kingdom cabinet size 13" x 16" x 19", acoustically correct and completely assembled with LP 215 Lorenz speaker, Lorenz SP-65 Tweeter and Kingdom HP-1 High Pass Filter matched to give you maximum listening pleasure at all levels. Available in colors to harmonize with the following finishes:

- No. MB-1x Mahogany, Net \$69.50
- No. LB-1x Blonde, Net \$69.50
- No. UB-1x Unfinished, Net \$67.00

CHAIRSIDE STAND

Sturdy attractive stand converts cabinet to a versatile occasional piece.

NET \$6.95



No. BT

Write for Literature

KINGDOM PRODUCTS, Ltd.

23 Park Place, New York 7, N. Y. • WOrth 4-8585

Hearing is Believing!
See and Hear them at the Audio Fair,
Hotel New Yorker, Room 737

self in this same range for distress calls and involuntary cries, such as screaming.¹

The corollary immediately develops that for the practical case, such as the cat and the mouse (practical at least for the mouse), or for binaural music, *there is no binaural perception worth mentioning* at frequencies lower than one-tenth the frequency of maximum sensitivity. Thus, the binaural audio system does not suffer for 6-in. humans if it subsides into monaural for fundamentals under 100 cps.

The living room filled with two-channel music from two loudspeakers or from a single binaural speaker² affords an essence of enjoyment unapproached by the point source of sound. Like the single-source "hole-in-the-wall" single-channel record player, two-channel sound is listened to with both ears; we

on the part of both. Speaker spacing and position must not be *outré*; neither may bare living room walls and floors be allowed to dominate the acoustics.

Confusion of Terms

"Binaural" has been and is currently defined by Webster and other leading lexicographers, and its associative meaning to the non-hi-fi mind does not imply a specific or precise set of conditions. Instead it is a general term. If the audio field is ever to embrace new blood, tutored in Webster, but fresh, innocent, and untutored in the devious workings of the engineering mind, perhaps it would be as well if we did not attempt to re-define Webster. Therefore it is suggested that according to present general usage, the omnibus term "binaural" be allowed to continue on its way, and that the 6-inch microphone systems,

premium cost at all. The arm price is the same as that for ordinary arms of comparable precise construction, and all the items are directly compatible for ordinary record playing. We do lose out on the cartridge—inexorably twice the cost, or double in diamonds, so to speak. But all together, two-channel sound is hardly any more expensive than ordinary sound. Even the records cost no more.³

Surprising Benefits

We all must know by now what the binaural medium is capable of accomplishing, but there are unsung and curious dividends that need to be expounded. Among them are:

Dynamic Range. The dynamic range is shocking to the confirmed single-channel listener. In a good job of pickup the reproduced acoustical dispersions give strong clues to the relative original loudness. When the orchestra strikes a triple forte the reverberative patterns tell us inevitably how loud it must have been, even if the volume is turned low, and thus it seems to be loud anyway. And in quiet moments, the dispersions again define the proportional loudness unmistakably. In recording, to change the volume control setting (compress or expand) is a signally fatal error. It fools nobody in binaural listening, raising in the midst of a moment of relaxed enjoyment the ugly connotation of having been ejected from the tenth row into the balcony at the start of the fourth movement.

Loudness. In an engineering sense, the addition of a second channel of equal power in a random r.m.s. way might be the equiv-

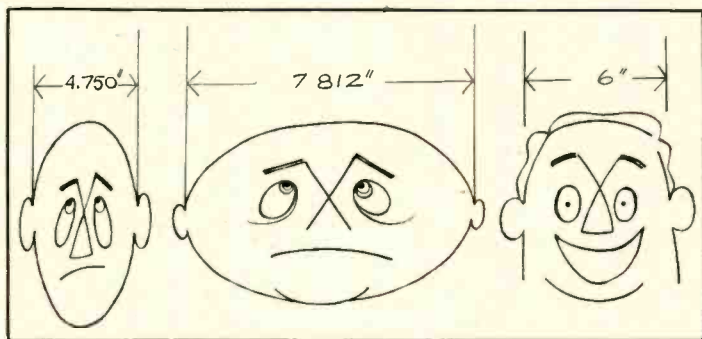

do not plug one ear when listening to an ordinary radio or record player just because it is known to be monaural. No matter how the sound medium may have been described—monaural, binaural, stereophonic, 3-D, or in sixteen syllables—it is still perceived by people with two ears in the normal case.

What Are we Trying to Accomplish?

There may be a surprising acceptance of earphones by apartment dwellers for late night listening, but basically our two-channel systems will involve loud-speaker reproduction. So if we are to listen with both ears in a room filled with music, the problem is this and this only:

We must create in the free air around the two ears of the listener an apparent acoustical environment akin to the acoustical dispersions encountered in the original concert hall at the time of the performance.

In order to accomplish this, the listener or user is in equal partnership with the recorder, for either one can spoil the broth, yet neither can correct for the others' mistakes. The healthy and cooperative spirit thus engendered between the two calls for creative effort

¹ (We specifically disclaim the implication that a high pitched hysterical scream might be assumed to have emanated from a female with an abnormally narrow cranium, lacking any corroborative information. Ed.)

² Bozak

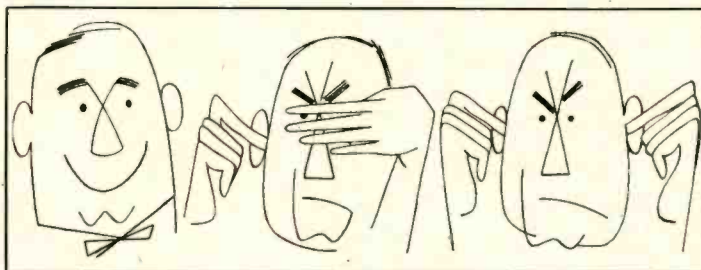

fifteen-foot speaker systems, and all the other present and future philosophies be assigned individual qualifying adjectives. Like the wise, far-sighted Duke of Dannemora, we never know when our noblest words may incarcerate us. Obviously the detractors of binaural sound have nothing to lose and a lot to gain. Practical binaural is probably the only development in the speckled history of audio which leaves everybody concerned in a better frame of mind. Even the final user is happy, and stays that way!

Cost

There is no basis for the inexplicable rumor that binaural is a "millionaire's medium." A basic audio system consists of a turntable, arm, preamplifier, amplifier and speaker. A binaural speaker in a single cabinet is now on the way at no additional cost, a binaural amplifier is coming at only 20 per cent additional, the preamplifier is already here at no

alent of a level increase of 3 db—captious and unnecessary. But two and two do not make four; the apparent loudness grows mightily, for we have a frame of reference well-linked with reality. Again, the basic engineering answer—like color TV, five to ten times the amount of information per unit time is communicated to the user, and imagination, instead of having to work overtime to supply the missing, is instead resting up for the next session with monaural. However, unlike color TV, the binaural machine is forwardly and backwardly compatible with ordinary records, groove-shapes and characteristics.

Back to the overworked imagination. We all know after a brief experience with hi-fi that there is an irritating tendency on the part of those who play

(Continued on page 76)

³ Making binaural records is like making smoked glasses for atomic bomb explosions. The market is temporarily restricted, but has a promising future.

TOOLS FOR BUILDING

Temples of tone



Electro-Voice

Buchanan, Michigan

Export: 13 E. 40th St., New York 16, U.S.A. Cables: Arlab

Fine Music

AND HOW TO REPRODUCE IT IN YOUR HOME . . .

*A man once said about art—
"Away with your oils and brushes, your chisels
and chips, for these are hypocritical rubbish! Show me only
the finished picture, the completed form!"*

*No one remembers this man's name, because so few people
agreed with him. In the art of recreating the living,
breathing reality of beautiful sound in your own living room, the tools
which enable this accomplishment are all important.*

*It is the purpose of these pages to tell you something about the
properties, capabilities and methods of using these new tools.*

*In this way you will be able to make a selection
compatible with your requirements.*

*These requirements should take into account the space you have
available, the number of music sources you wish to employ,
and the amount of money you care to spend.*

A vast, new world of listening pleasure awaits you.

Text by Howard Souther ELECTRO-VOICE, INC.

THREE TYPES OF EQUIPMENT ARE NEEDED

FOR HIGH FIDELITY REPRODUCTION



CHANGER



RECORD PLAYER

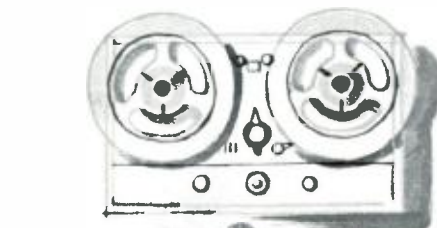

TAPE
RECORDER

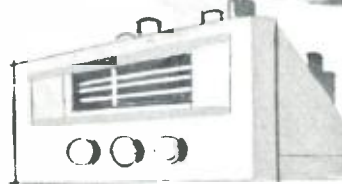

TUNER

1 *The Source*

There are three kinds of sources for home high-fidelity listening: The record reproducing mechanism, a radio tuner, and a tape machine. You may use an automatic changer or manual record player, or both. If you are within 75 or 100 miles of a metropolitan listening area, the radio can provide a wonderful source of good music. The tape machine is your finest source, and can also be used for recording and storing choice radio programs, and for transcribing your better phonograph records to permanent form in order to eliminate deterioration through repeated turntable use.

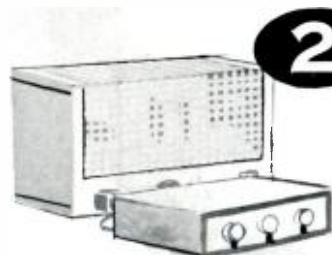

2 *The Amplifier*

The minute energy usually available from the source must be amplified to a level approaching the power found in the original music. The control section of the amplifier is highly important for it compensates for changes in musical balance in the various sources employed. It also regulates the level of sound in your living room. Any one of the above three sources may be selected at will through the one amplifier.

3 *The Speaker System*

The loudspeaker system consists of two principal components. The first of these is the driver or drivers which translate the electrical energy from the amplifier into acoustical power. The second component is the baffle, or horn, which couples the acoustical energy to the outside air of the living room. The baffle, or horn, and especially the outside housing, can make the entire assembly a decorative and functional furniture piece.

The speaker system is the most important equipment to be considered, for the widest variations are to be found in the performance of various types. This means, too, that it is potentially the weakest link in the sound reproducing chain, and that considerable importance attaches to its choice, for the qualities of the other components manifest themselves through the speaker.

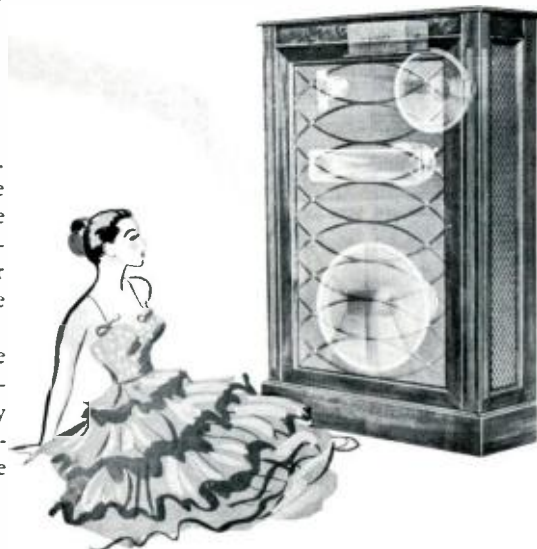

Yours to Enjoy, the Magic of High-Fidelity Reproduction

BUT FIRST—

WHAT IS MUSIC...

In order properly to choose the tools for creating a grand new world of beautiful sounds in the home, we must first discuss the final object of our efforts.

This objective is the reproduction, in the minutest detail, of the actual experience of tonal reality. Paradoxically, the requirements for perfection need not be too strongly stressed. In high-fidelity home reproduction there is an easy accommodation to the greatly reduced volume level of the symphony orchestra performing in a large concert hall. There is also a comfortable agreement to the restricted spatial effects occasioned by our own smaller listening area. These compromises are assisted vastly by the modern wizardry of the design engineers, who subtly adjust the response and balance of their equipment to enhance, in many cases, the thrilling life-like qualities of the original performance.

How the Human Ear Hears Musical Sounds...

RANGE OF SOUNDS All music consists of complex sounds, or vibrations, in the air. These vibrations range from 16 beats per second to 16,000 pulses, or beats, per second. The lowest of the great tones generated by a 16 foot organ pipe consist of 32 beats per second; the highest musical sounds are the delicate 15,000 cycle overtones observed as higher harmonics of the brilliant clash of the cymbals, the stirring snares of the drums, and the triumphant blare of the brasses.

RHYTHM The very framework of musical composition is rhythm. It is in the stirring beat of the tympani, the snares, the bass viol, and often the piano, that we find our pulses quickening in tune. Rhythm is derived predominantly from the bass sections. This fact serves to point up the importance of low response range considerations in choosing the three important elements of our music system.

VARIETY The brain, through the ear, delights in the stimulus promoted by sounds which are musically related. This musical relationship implies also a mathematical relationship, for the pleasing higher harmonics are multiples of the vibration rate of the lower tones. It follows that increasing the number of tones in a related order results in greater auditory pleasure. For this reason we achieve greatest enjoyment from the larger orchestras, and when they are reproduced in the home by those components that encompass the widest range of frequencies.

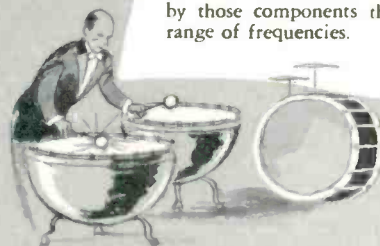

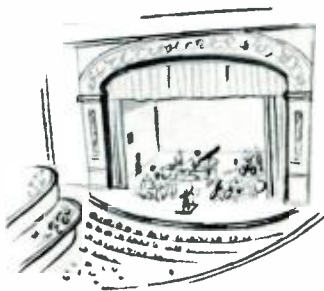

DYNAMICS The transition from a soft passage in musical composition to a louder one is carefully calculated by some composers to achieve a physiological effect. Usually this buildup in volume level is achieved through a succession of pre-climaxes, until the full fortissimo is reached in a compelling crescendo, followed by instant cessation to breath-taking quiet.

The volume range enabling this sort of performance is termed the *dynamic range* of the particular sound system, and depends partly on the quality of the source, the FM radio and the tape recorder being the best in this regard. The power handling ability of the speaker system and amplifier determines the upper limit of sound level, but the *overall* quality of the components decreases the hiss, static noises, and scratch. This extraneous noise determines the very important lower limit for the pianissimo phrases in the composition.

THE LIMITS OF AN ORDINARY COMMERCIAL RADIO OR RADIO-PHONOGRAPH

Contrasted with Extended Range High-Fidelity Reproduction



The ear is a very accommodating mechanism. Lacking a basis for comparison, the ordinary radio and radio-phonograph has appeared to be tolerable to the listening public. But the advent of high-fidelity listening has provided a comparison, and the discriminating listener now finds it possible to articulate his dissatisfaction. The high-fidelity reproducing art purveys as much as 9 octaves out of a possible 10. It can be demonstrated that the commercial radio or radio-phonograph can reproduce only the middle of the audible spectrum, and that even this range is available only in the exceptional cases. Here are the reasons:

ORDINARY RADIO RESPONSE RANGE

The type of response with which we are most familiar from the usual home set covers a range of only 5 octaves, or from 125 to approximately 5,000 cycles per second, in spite of the fact that frequently another full high octave is broadcast.

The restriction in the upper range is due to two causes. First, the Federal Communications Commission limits for AM transmission permit a minimum response of 5,000 cycles per second. Secondly, the usual telephone lines feeding network programs cut off at this same response.

This cut-off does not hold true on FM programs of local origin. Here the full band of frequencies is available to the listener. The usual set manufacturer exploits only the noise-free features of FM since his product—because of poor speaker, amplifier and tuner—cannot reproduce the wide frequency range FM provides.

USUAL PHONOGRAPH RESPONSE RANGE

The ordinary phonograph usually utilizes the old style 78 RPM shellac pressings. The rough, granular structure of the record material causes scratch, the predominant

scratch frequency being 5,000 cps. This explains why the usual phonograph cuts off at about 4,000 cycles, or lower than the predominant scratch frequency. The new Vinylite records have not only eliminated most of the objectionable scratch, but have also greatly increased the frequency response range. In spite of this, the mass set producer can only stress the long-playing feature of Vinylite records in view of the inadequacies of his components.

BASS RESPONSE IN THE USUAL RADIO-PHONOGRAPH

The tenets of musical balance demand that the upper limit of response multiplied by the lower limit of response shall equal the figure 600,000. With the upper limit as 5,000 cps imposed in the preceding paragraphs, the ordinary set must forego the first three octaves and begin bass reproduction at about 125 cps, which is the lower part of the fourth octave.

Even if additional bass were incorporated in the ordinary radio-phonograph, it would be utterly impossible to use it for many reasons. For one, the powerful impact of the drum-beat would communicate itself from the speaker through the cabinet, and into the sensitive phonograph needle. This would cause what the engineers call "acoustic feedback," and result in a low, sustained growl, similar to the high pitched whine we experience when we place an ordinary telephone receiver near the mouthpiece. In contrast to the usual radio-phonograph console, we find always that *high-fidelity music systems separate the loudspeaker from the record player and tuner location by as much as several yards whenever feasible.*

Heavier and more costly components are necessary in the amplifier and speaker to produce these bass tones. Somehow, the economics of commercial radio-phonograph design have never taken this into account.

the important subjective effects of various portions of the audible spectrum

FIRST OCTAVE 16-32 CPS



*The Threshold of Feeling and
the Region of Low Frequency
Wind and Room Effects*

The region of the first octave contributes much to the illusion of reality. The low swell tones of large organs generate sub-harmonics in this range. While two fundamental tones in the second octave only may be involved, the *difference* in vibration between these two higher tones results in a powerful beat in this first octave. These very low beats are part of some musical composition and account for the thrilling feeling of power derived from the organ, the largest of all musical instruments.

Only the most extensive high-fidelity installations permit these lowest tones to be generated. One such installation is shown on the last of these pages. Fortunately, almost all serious music confines itself to the octaves above 32 cps, so we can still appreciate keenly the most comprehensive musical passage without absolutely requiring this difficult part of the spectrum. Then, too, most source material lacks these lowest frequencies at the present time, and we must await the future years in order to achieve their full employment.

SECOND, THIRD, FOURTH AND FIFTH OCTAVES 32-512 CPS



*The Lower and Upper Bass
Regions which Lend Body and
Rhythm to the Performance*

The minimum response range necessary for the communication of intelligence lies in a band only 500 cps wide in the seventh octave, at about 1,500 cps. Reproduction confined to this band somewhat resembles the pinched quality we find in the telephone. Missing are some of the fundamental tones of speech in the lower part of the fourth octave. The low, grave tones of the drum and piano are generated in the second and third octaves. The result is fullness and richness in the performance. The rhythm of the music is most forcefully communicated through these octaves.

Exaggerated bass response in the third and fourth octaves results in boominess. This is the objectionable "juke-box" quality the music lover finds so disquieting. It is prevalent to a high degree in the commercial radio-phonograph, due in large measure to the open-back loudspeaker compartment.

SIXTH AND SEVENTH OCTAVES 512 TO 2048 CPS



*The Important Region for
Bare Communication of In-
telligence - Telephone-Like
Quality*

The ear is reasonably sensitive in this range, and almost all reproducers manage this mid-range with facility.

If the sixth octave is made louder with respect to other octaves, the music has a horn-like character. If the seventh octave (1,000 to 2,000 cps approximately) is emphasized, we achieve a "tinny" effect. Recordists, and others engaged in listening to reproduced music over long periods, find that "listening fatigue" can be very much reduced by attenuating the sixth and seventh octave range to about three-fourths of the usual level.

EIGHTH AND NINTH OCTAVES 2048 TO 8192 CPS



*The Vital Presence Range So
Necessary to Lower Level Lis-
tening*

Granting reasonable response in the lower octaves, augmented power in the eighth and ninth octaves does more to promote the magical illusion of "presence" than any other part of the spectrum. At the usual listening levels in the living room, the ear is most sensitive in this part of the range. These frequencies also form labial sounds and the fricative consonants in speech. The musical instruments approaching the human voice in timbre and vibrance are assisted here immeasurably.

It is in this range also that improperly designed speaker systems begin to beam the sound and concentrate it in certain portions of the room, generally on the axis of the reproducer. The additional energy serves to fill in the missed portions of the room by reflection and moderate a "distant" and "dull" effect due to absorption by draperies, rugs and furniture.

The lack of response in the vital "presence" region in ordinary radio-phonographs characterizes them immediately as "low-fidelity."

TENTH OCTAVE 8,192 TO 16,000 CPS



*The Final Touch in Completing
the Illusion of Reality*

Most individuals have the ability to hear sounds extending to 16,000 cps. This auditory acuity at the extreme high range degenerates to about 12,000 cps at 60 or 70 years of age.

The delightful sparkling quality which we appreciate as brilliance in the music is found in the upper part of the ninth and the tenth octave. Effervescent, tingling—the upper harmonics of many instruments find at least some expression here. They are not missed too much by our ears if they are left out of the reproduction—but like froth, they complete the picture of the wave, and serve to perfect our illusion of musical reality.

THE WORLD OF SOUND

Octaves and Frequencies

Character and Effects

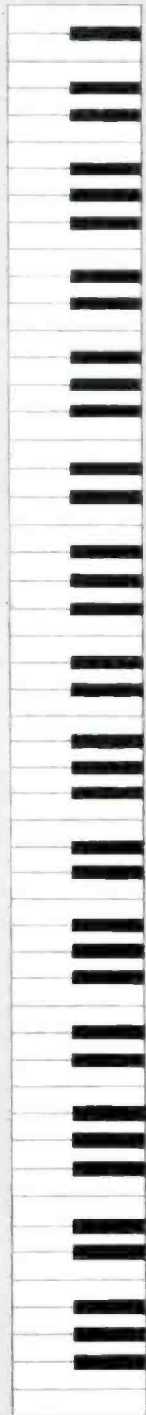

10	8,192 to 16,000 cps
9	4,096 to 8,192 cps
8	2,048 to 4,096 cps
7	1,024 to 2,048 cps
6	512 to 1,024 cps
5	256 to 512 cps
4	128 to 256 cps
3	64 to 128 cps
2	32 to 64 cps
1	16 to 32 cps

T R E B L E
B A S S

Brilliance
Sparkle
Life



Highest Overtones

Many Overtones
Realism
Labial Sounds
Fricative Consonants



Illusion of Presence



Telephone-like Quality

The Range Needed for the Bare Communication of Intelligence



Fundamental Tones of Speech and Singing

Upper Bass
Rhythm Fullness
Roundness of Tone

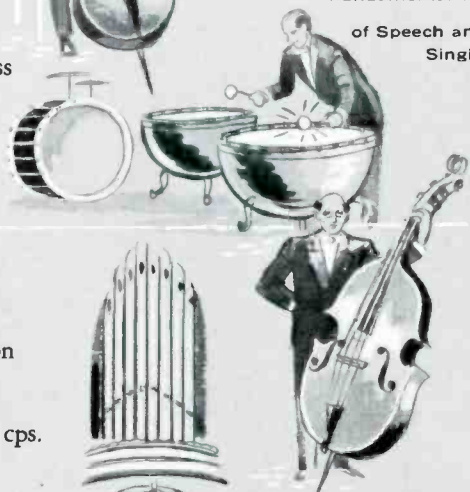

Power and Rhythm—the low deep foundation of musical structure

Lowest organ tone is 32 cps.



Low Frequency
Wind and
Room Effects



Thunder

THE FORMS OF DISTORTION IN MUSIC REPRODUCTION

Distortion in high fidelity reproduction means simply that something has been either added or subtracted which did not exist in the original performance.



AMPLITUDE OR LEVEL DISTORTION

When we play music in our home at a lower or higher level than that at which it was originally recorded, we have introduced amplitude distortion. This form of distortion *need not necessarily* be bad; sometimes perforce we must moderate the level out of deference to less appreciative neighbors. Engineers have provided us with compensation controls in the equipment which offset the deleterious effects of this changed level. Observe the figure which shows the manner in which the ear responds to the lower level of sound. The bass frequencies are much lower than they should be, and proper amplifier equipment provides a boost for these tones to which the ear has now become less sensitive. This same control affords also an accentuation of the extreme high register to adjust for this further lack of lower level responsiveness in the ear. Not found in other than the strictly professional equipment, however, is the ability of the amplifier to add a desirable mid-high boost in the vital "presence" range at 5,000 cps. There is at least one loudspeaker system on the market that today provides means for augmenting this requirement for ultimate low-level listening.

HARMONIC DISTORTION

It is the nature of all physical things to emit a tone at some fundamental mode when set in vibration. There are also an infinite number of other modes of vibration usually at a much lower intensity than this

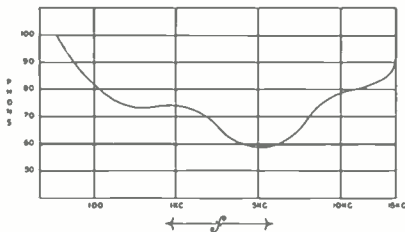

EAR SENSITIVITY . . . Heavy line represents room listening level; curved line indicates level which should be added to high and low parts of the spectrum to make music and speech appear balanced.

fundamental. This vibration can not only be mechanical, as in the pickup cartridge of the record player and speaker system, but can also assume electrical form in the amplifier. These are spurious tones not present in the original music, and if they assume certain intensities are very trying to the ear. For example, the average ear detects 3 per cent distortion, tolerates 5 per cent and rebels at 10 per cent.

Specifically, the sources available to the music reproduction enthusiast are usually under 3 per cent in distortion content. The amplifier possesses less than 1 per cent, and very good speaker systems keep the total just under the 5 per cent mark.

INTERMODULATION DISTORTION

While harmonic distortion consists of multiples of the fundamental tone, intermodulation distortion is caused by beats which are the *difference* between two tones. The most objectionable beats are those due to higher tones close together causing a low frequency beat between each other. The major disturbance is due to the contrast offered between erroneous low and high tones.

These distortions are easily measured in amplifiers, and explain why the amplifier is the most perfected of our tools for reproducing music. In the acoustical and mechanical parts of our system the amounts of distortion are determined more or less empirically. The art has still room to progress.

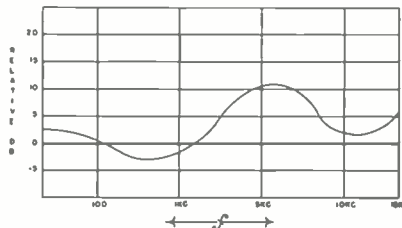

LOW-LEVEL SYSTEM RESPONSE . . . Present ideal speaker or system response to relieve "distant" effect of room playing levels. 3,000 to 6,000 cps rise adds "presence."

HOW TO CHOOSE THE COMPONENTS FOR YOUR HOME HIGH-FIDELITY MUSIC SYSTEM

In the next several pages it may seem that we become intricately and trivially concerned with processes. But the miracle of recreating the original experience of beautiful music demands that we carefully evaluate and judiciously

select the tools for the process—for even miracles must have processes of some kind, however instantaneous they may be.

the cartridge and record player

The long-playing phonograph record is currently one of our most popular sources of high-fidelity music. The granular structure of the record base is exceedingly fine, and thus, the effects of scratch are minimized. Because the objectionable noise level is so low we are able to realize the dynamic range so important to the proper translation of musical composition.

The recorded groove in the phonograph disc is a storehouse in the form of a curved matrix of the original sound. The phonograph cartridge is designed to follow the contours of sound groove, and to retranslate the mechanical energy thus generated back into electrical form.

Because of the physical limits of the record, such as size and speed of rotation, certain compensations are needed in the process of storing the music on the record. This calls for complementary compensations in picking up the energy from the record at the instant of playback, and the quality and design of the cartridge and associated amplifier controls determine critically the fidelity of the reproduction.

THE CARTRIDGE

There are two general types of cartridges, the new ceramic or barium titanate constant amplitude cartridge, and the magnetic, or reluctance constant velocity type. Both types of cartridges are excellent, in spite of the additional pre-amplifier needed for the magnetic type. All high-fidelity amplifiers currently provide this "preamp" however.

There are three ways of cutting the record groove with the electro-mechanical equivalent of the music:

With a cartridge which responds linearly to constant amplitude, such as the new ceramic type, no playback equalization is required for the bass, and the cartridge design itself compensates for the high end pre-emphasis. With the magnetic or constant velocity cartridges, a pre-amplifier is necessary to boost the bass energy, and to effect flat response in the highs.

1 CONSTANT VELOCITY

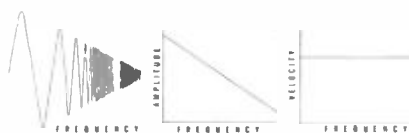

The frequency excursions are progressively limited with increasing frequency to keep the stylus tip velocity constant.

2 CONSTANT AMPLITUDE

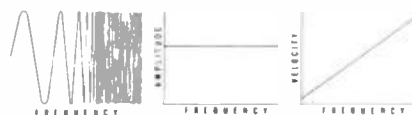

The frequency excursions are held constant for all frequencies recorded.

3 CONSTANT VELOCITY AND AMPLITUDE COMBINED

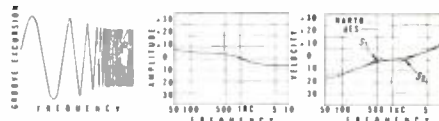

This is the modern Audio Engineering Society recording characteristic, presenting an agreeable compromise using velocity-sensitive cutters. It utilizes constant amplitude in the bass region, constant velocity in the mid-range, and attenuated constant amplitude for the critical higher frequencies. Thus, the resultant recording allows more use of the recording space and gives essentially constant amplitude response.



The transcription type turntable is the best today, because it is professional equipment with a powerful, smooth motor and heavy, flutter-free turntable.



THE RECORD CHANGERS of the high fidelity type are uniformly excellent with only a slightly noticeable amount of rumble and wow, even at the very lowest frequencies. Improvements are being made, and several manufacturers today produce changers which compare favorably with the transcription manual players. Excellent results are possible, and the record changer is invaluable for continuous unattended playing when the music system is employed for low-level background at dinners, gatherings, and for mood inducing while resting or reading.

THE RECORDING COMPANIES are constantly refining their product; certain selected recordings leave little to be desired in technical and artistic perfection. On the other hand, the serious listener must learn to discount defects in some pressings occasioned by deformed stampers used in processing the record, scratches, and ticks and pops incident to impurities in the record base.

THE TAPE MACHINE

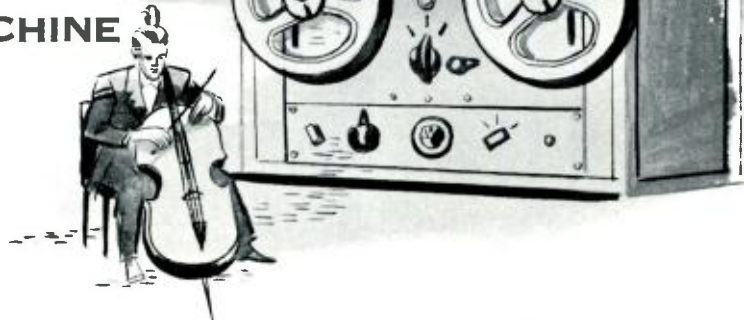

The tape machine is paramount as a source for good music because of its freedom of background noise, its wide dynamic and frequency range, ease of operation, and permanence of the recording. It is a secondary source to the record player because of the paucity of the pre-recorded tape libraries available to the user.

The music lover will choose certain programs from FM radio and record them to form part of his permanent library. Frequently, these are of such high quality that it is difficult to discern differences between such recordings and a live program. The cleanest of the long-playing records can be transcribed to tape before wear and scratch have built up, and thus can be preserved indefinitely in their finest state. The true high-fidelity hobbyist will take

his tape equipment to local music functions and interpret the performance through the medium of his machine and his own artistic ability.

Currently the 15 inch per second tape speed at "full track" delivers top quality and full range. Satisfactory response to 12,000 cps is available on lower price tape mechanisms at $7\frac{1}{2}$ inches per second, sometimes on half track. Using only one-half of the track at a time at $7\frac{1}{2}$ inches per second quadruples the amount of material which can be stored on the tape reel over that possible at the full track 15 inch per second speed. The slower speed has less dynamic and frequency response range, more flutter and consequent distortion. The $3\frac{3}{4}$ inch per second tape speed is strictly "low-fidelity" at present.

THE TUNER

AM radio programs played through the usual super-heterodyne tuners cannot be considered within the concept of high-fidelity as expressed in these pages. The restriction in high-frequency response range to less than 5,000 cps puts such reception strictly into the "low-fidelity" category. But in high fidelity AM-FM tuners, reception is not so restricted in range possibilities, nor is it subject to the high noise levels on FM. This high noise level compresses the all important dynamic range.

Many excellent combination AM-FM tuners are available on the commercial market. The combination tuner allows AM to be used for "mood-music" and pleasant background, and affords FM for the serious listening to the finest radio programs.

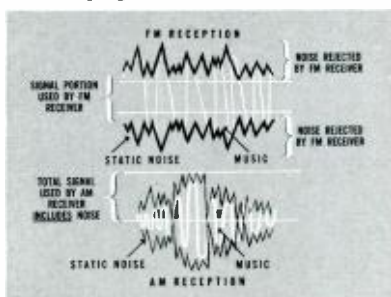

The diagrams show how AM is affected by static noise, and the method by which FM subdues these extraneous and disturbing effects.

The considerations in choosing a tuner are few, but extremely important. The selectivity, or ability to separate various stations, depends on the number of "tuned circuits," generally indicated by the multiplicity of tubes in the forward portion of the assembly. Inherent noise in the tuner is kept at a minimum. The general criteria of excellence in tuners are the larger number of tubes employed, and the higher overall cost.



THE AMPLIFIER AND ASSOCIATED CONTROLS

The high-fidelity amplifier is composed of two sections, the preamplifier and the main, or power amplifier.

THE PREAMPLIFIER:—

The preamplifier receives the infinitesimally small electrical energy from the source equipment, and amplifies it anywhere from 10,000 to 1,000,000 times, concurrently equalizing the musical balance for various levels of listening, compensating for different recording characteristics on various makes of records, and at the same time permitting the listener to adjust bass and treble to local acoustic conditions. When we amplify the signal to such tremendous amounts, we must guard against the intro-

duction of noise and hum, which would decrease the dynamic range possibilities of our system. It is in the preamplifier that we find the great differences between one make of amplifier and the next. For instance, the selection of record reproducing characteristics is possible only on the more expensive ones. Others have a range of bass compensation calculated to complement the folded corner horns to be treated on in later paragraphs. Too, the quality of the component parts and the ingenuity of design determine residual noise and hum, the important factors in maintaining wide dynamic range. No preamplifiers at this writing provide for emphasizing the "presence" range between 3,000 to 6,000 cps. This necessary compensation for low-level playing in the living room must be found in the loudspeaker, and will be dealt with in the next section.

THE MAIN OR POWER AMPLIFIER:—

The main or power amplifiers are uniformly excellent in the assemblies selling for \$50.00 or more. Distortion is kept at fantastically low figures, on the order of one and two tenths percent at good playing levels. Ten watts output is required for the bass peaks of usual room playing levels, which average out at about 1/2 watt. A 20-watt amplifier preserves a margin for safety.

the loudspeaker system...

Leonardo de Vinci used the genius of his science to promote the glory of his art; he employed technology to project his true perspectives and to mix his colors; he used his subjective sense to imprison light-like Ariel in his web. In today's experience of listening to the masterpieces of high-fidelity sound, all of the science *and* art of a vast multitude of engineers, designers, artisans, and artists find its meeting place finally at the loudspeaker system in your living room. The choice of the loudspeaker system requires importantly a technical as well as a subjective knowledge of its function and performance.

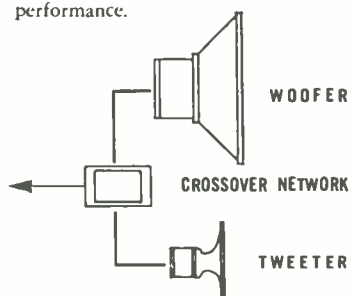

HOW THE LOUDSPEAKER WORKS

The loudspeaker in its most simple form is a motor and piston assembly. The motor moves the piston in conformance to the variations in the electrical counterpart of the music from the main amplifier.

The piston compresses and rarefies the air in our listening area in the form of waves. These waves are perceived as sound by the brain through the ear. The problem in designing a loudspeaker lies in the inability of the piston to set the air in motion uniformly at all frequencies of vibration.

two ways exist to extend the range and to lower the distortion

Two methods are used currently by the acoustical engineer to promote uniform propagation of all the tones. The first of these methods is to divide the audible spectrum between two or more drivers, or pistons. Smaller drivers are used for the higher, more rapidly pulsating tones, so that the lighter mass of the piston can trace the delicate overtones of higher instruments. The larger pistons, in the form of cones, follow with facility the powerful slower oscillations of the bass tones.



COAXIAL
SPEAKERS

Sometimes the high-frequency speaker is mounted inside the cone of the bass driver. The virtue of this arrangement is almost wholly one of accession to the public's desire for integrated assemblies. Good dual, or coaxial units of this type usually have high crossover points, and unequally divide the load between the high and low drivers. The ideal crossover point for two units is about the fifth octave, whereas coaxial loudspeakers, because of space restrictions and interference effects, must cross over between the seventh and ninth octaves. The fact still remains that the determining factor in the generation of optimum bass response is space in the housing.



MULTIPLE-WAY
SYSTEMS

Further divisions of the audible spectrum can be made with added, specialized, separately mounted driver units. In addition to insuring the maximum extended range, the higher harmonic distortions generated by the lower speakers are cancelled out by the electrical network which feeds them their respective portions of the spectrum.

THE MAGNET

A speaker system which was 100% efficient would be a perfect transducer of electrical energy into acoustic energy. Present day quality systems fall far short of this, being somewhere near 50% efficient only. This means that certain bands of frequencies must be damped down to the level of other bands in order to smooth the response. This is done properly with expensive magnets, and controlled narrow tolerances in the construction. These factors increase the complexity and cost of the structures. The magnet weight may be used generally as a guide to evaluating excellence, particularly in low-frequency drivers.

Horns, Baffles and Enclosures for the Speaker System

The second method of smoothing response and lowering distortion is to couple the area of high pressures near the pistons of the drivers to the outside air in a gradual manner. This is accomplished ideally by horns. Sometimes these horns are folded, and use the corner of the room as an extension of the horn mouth. In this manner, a pleasing furniture appearance can be effected with a minimum of space. Unfortunately, the best speakers are usually the largest, because of the inherent requirement for operative space for the lowest bass frequencies.

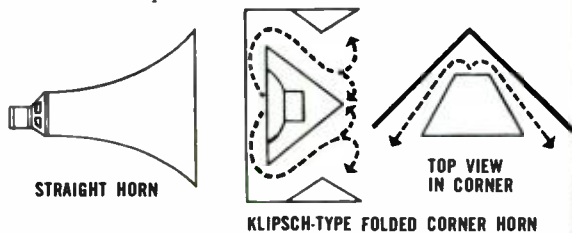

The smaller horns have crossover points situated at 800 cps or higher. In this case the frequencies from 200 cps up must be supplemented by front radiation from the bass driver. This is for the reason that these higher bass frequencies cannot follow the circuitous path of the folds.

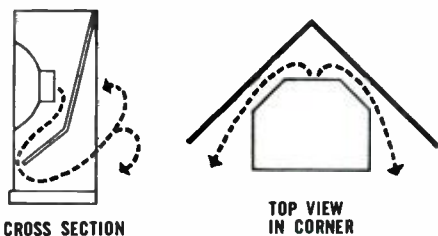

"Bass-reflex" is the term used to cover a more simplified type of baffle. These are usually 5 to 8 cubic feet in size and possess a port which reinforces the bass in the third octave. Unfortunately, immediately after the reinforcement peak, rather violent attenuation of the lower frequency energy takes place. The musical balance is nonetheless better than with no port at all.

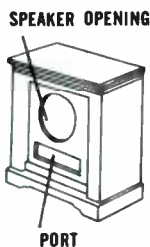

The "infinite baffle" implies mounting the speaker in a wall or closet. Next to the larger folded horns, this form of mounting is the best. With 18 to 25 cubic feet behind the bass driver, it outperforms the bass-reflex design and exceeds it by far in purity of tone.

The use of 35 or more cubic feet delivers a smooth, augmented base range exceeded only by the "Klipsch" indirect radiator types illustrated.

Whichever you choose of the above enclosures for the speaker or speaker system, much more range and purity will be achieved than that afforded by the conventional "open-back" radio-phonograph console acoustic system.

THE ROLE OF THE DEMONSTRATION

in choosing components

The loudspeaker system should be selected first, for the performance of all the other components must be judged through it. Evaluation by printed specifications is difficult because few standards exist at this writing for properly qualifying the response range and distortion products, particularly of the speaker system. Some manufacturers may claim high-frequency response to 20 or 25 thousand cps, and be very factual in the unqualified claim; they fail to state that the energy at this frequency is so low as to be almost immeasurable. Others may state "flat response ± 2 db to our performance standard," without stating of what the *performance standard* consists. Unless you are an engineer and can properly interpret the qualifications, or the lack of them, it is best that you let your own ears be the judge.

Insist first, that a clean tape recording be used through one of the best amplifiers. Play the music at a good, full level, so that you can

overcome the masking effect of ambient street and store noise. Remember that your ears are insensitive to the extremes of the spectrum at low levels under these conditions. In your quiet home listening you can play at low volume without masking by noise, and properly boost the extremes with amplifier controls for optimum musical balance.

Now, listen for the solid "step-ladder" bass; the bass viol should articulate each tone separately, and not produce a single "juke-box" thump. Listen for a full, rich quality in the high bass region, and a projected "life-like" feeling in the "presence" range of the eighth and ninth octaves. The tenth octave will probably only be apparent if a separate "super-tweeter" is present. You will perceive here the brilliant overtones and highest harmonics.

Next change amplifiers and try regulating the controls. Make certain that the bass can be controlled to produce extreme augmentation; in a quiet living room this will permit the restoring of musical balance at soft volume levels.

Now select your various sources. For the record player test, bring your own favorite record, so that you anticipate the response of certain passages. Your own record also establishes a standard of comparison with any previous music system you may own.

After you have engaged in this rather interesting and enjoyable process of purchasing and installing your sound system, you may, like Walt Whitman, say—"Now, I will do nothing but listen—Ah, this is indeed music, this suits me!"

WHERE SPACE IS AT
A PREMIUM



UTILIZING BOOK SHELVES AND
A LARGER SPEAKER SYSTEM

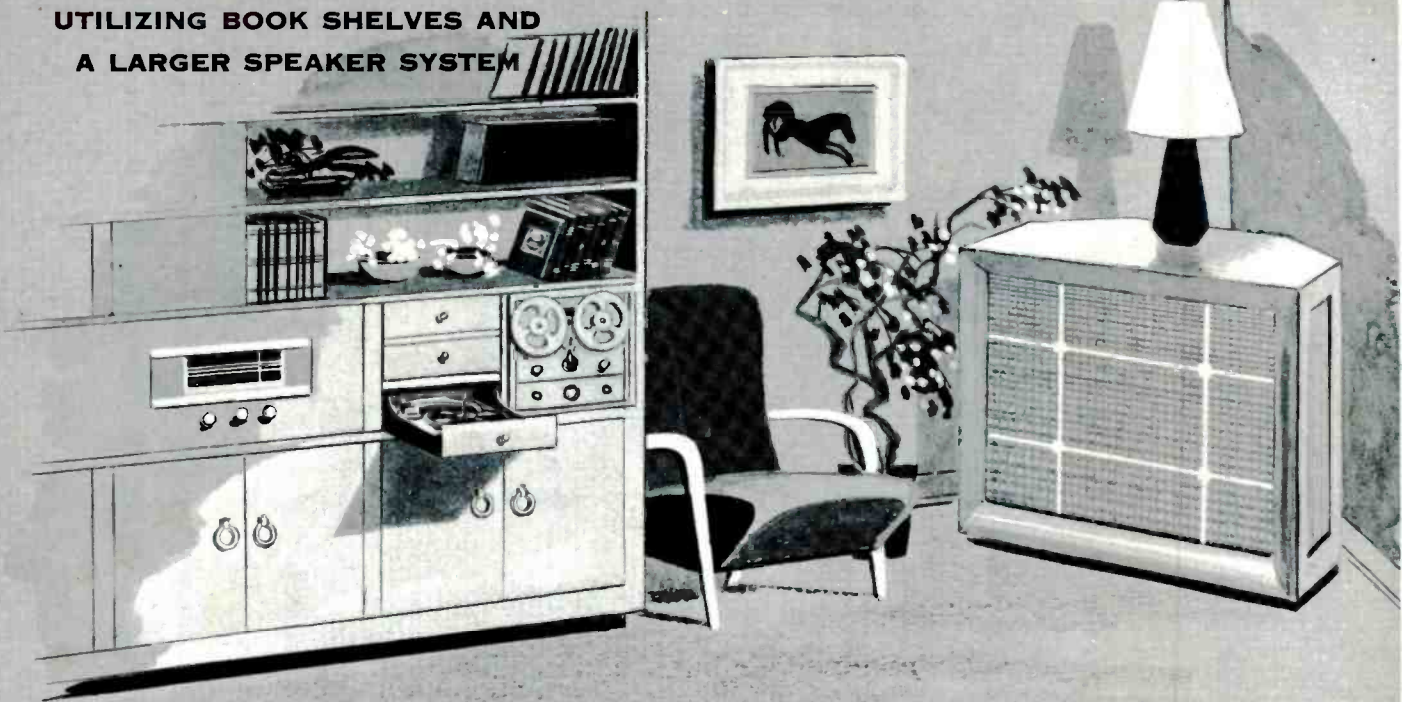

TYPICAL HOME INSTALLATIONS

for the finest listening..

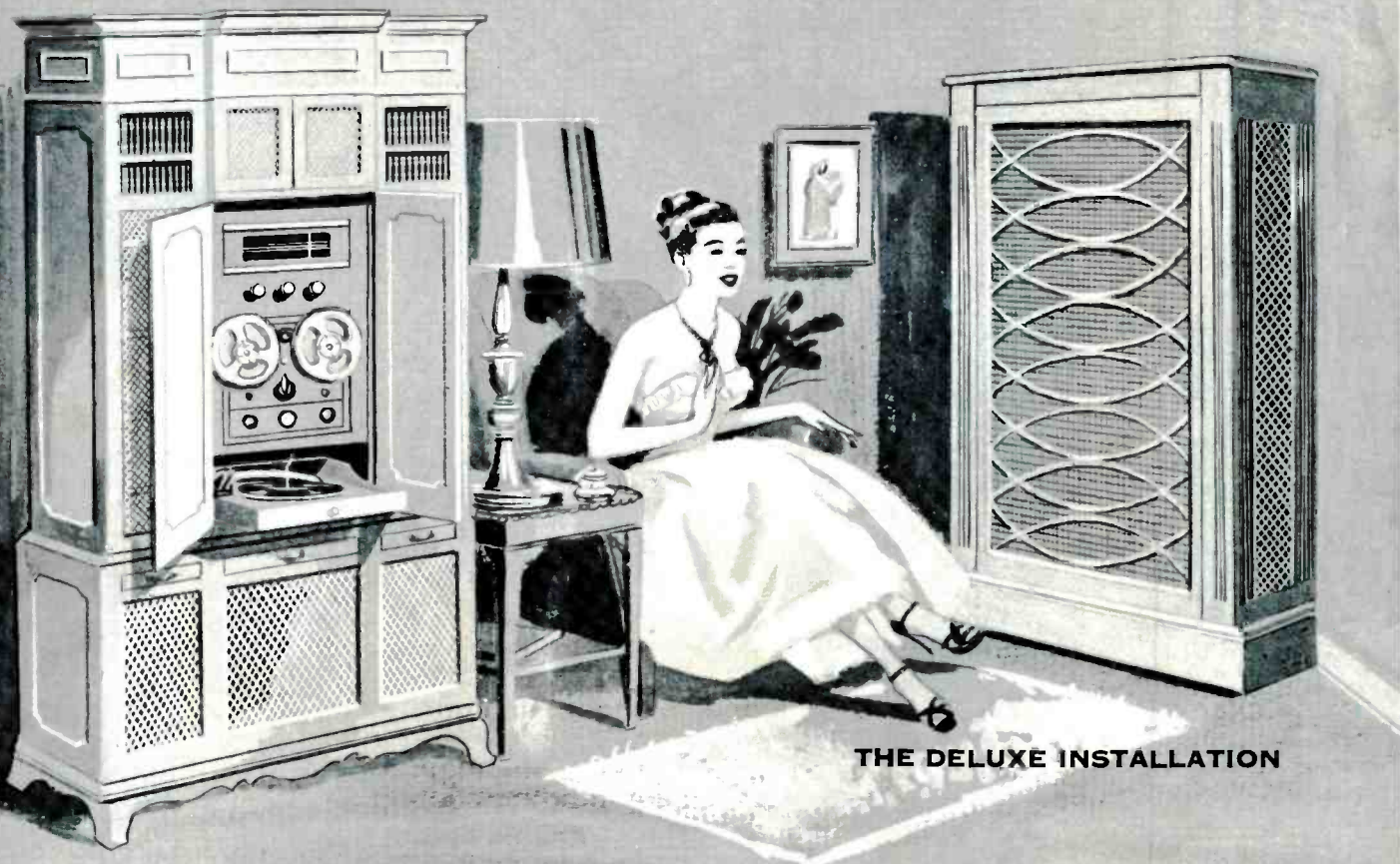

THE DELUXE INSTALLATION

THE MAGNIFICENT

Georgian



ELECTRO-VOICE
KLIPSCH FOLDED HORN

4-WAY LOUDSPEAKER SYSTEM

*Utilizing the Authentic Klipsch "K" Horn Type
Indirect Radiator for the Extreme Bass*

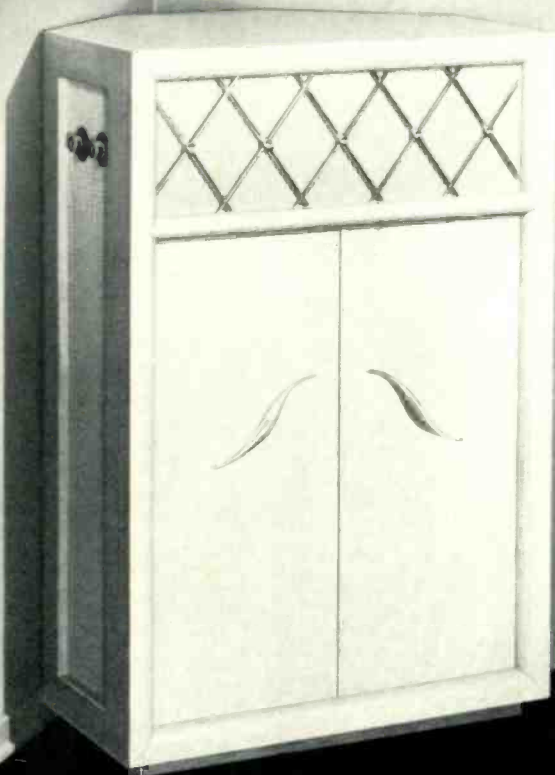

Selected Mahogany or Blonde Korina veneers in lustrous hard-rubbed finish.

53" high, 34" wide, 26" deep.

Includes Electro-Voice 15WK Low-Frequency Driver, 848-HF Coaxial Compression Type Mid-Bass and Treble Driver Assembly, T-35 Super Sonax Very High Frequency Driver, X336 Complementary Crossover Network utilizing full m derived 1/2 section crossovers, and two AT-37 Presence and Brilliance Controls.

GEORGIAN 4-Way System, Complete.

In Mahogany Audiophile Net, \$495

In Korina Audiophile Net, \$515

The luxurious cabinetry of this corner enclosure is skillfully combined with the most advanced high-fidelity engineering to give you a superlative, integrated 4-way reproducer. The magnificent GEORGIAN utilizes the famous Klipsch "K" horn with special EV 15" driver in the bass section. Electrical network makes the first crossover at 300 cps to a compression type, horn-loaded mid-low frequency driver with 58" path length. From 1000 to 3500 cps, a special E-V diffraction horn through an acoustical crossover gives smooth, augmented treble tones. Above 3500 cps, the E-V Super Sonax very-high-frequency driver takes over to provide the silkiest extended high frequencies out to and beyond the range of audibility. This multiplicity of crossover points and the specially designed crossover network permit a smooth transition from one section of the spectrum to another. Besides, the GEORGIAN is the first loudspeaker system ever to incorporate the vital "presence" control as well as a brilliance control. With its cleanliness of reproduction and extended range, you can now enjoy all the reality of living music in your home.

Write for Bulletin No. 199

Electro-Voice

Licensed under Klipsch Patents
No. 2310243 and No. 2373692

ELECTRO-VOICE, INC., BUCHANAN, MICHIGAN Export: 13 East 40th St., New York 16, U.S.A. Cables: Arlab

AUDIO engineering society

Fifth Annual Convention - 1953

Largest program in history of the Society presents 29 papers.

Wednesday, October 14th

10:00 a.m. Annual Meeting of the Audio Engineering Society

Technical Session: Loudspeakers

Chairman. R. T. Bozak, *The R. T. Bozak Co., Stamford, Conn.

10:30 a.m. DESIGN FACTORS IN HORN TYPE SPEAKERS

Daniel J. Plach, Senior Physicist, Jensen Manufacturing Company, Chicago, Illinois

A horn cannot be arbitrarily chosen for a given driver when best possible performance is required. The horn throat area, cutoff frequency, and flare parameter T must be properly related to the driver moving system constants. The advantage of the hyperbolic cosine horns over the exponential type is also discussed.

11:00 a.m. THE COMPOUND DIFFRACTION PROJECTOR

Louis S. Hoodwin, Engineer, Electro-Voice, Inc., Buchanan, Michigan

An inexpensive lightweight compound horn loudspeaker has been developed for high quality public address reproduction by coupling a re-entrant "woofer" horn and a small "tweeter" horn to opposite sides of a single diaphragm. The resulting unit has improved frequency response and polar distribution with lower distortion.

11:30 a.m. DESIGN OF A HIGH-FREQUENCY ELECTROSTATIC LOUSPEAKER

C. E. Smiley, Livingston Electronic Corp., Livingston, New Jersey

Theodore Lindenberg, Pickering and Company, Inc., Oceanside, New York
Jerry B. Minter, Measurements Corp., Boonton, N. J.

This paper will describe the design features of an effective high-frequency speaker "tweeter." A simple circuit will be described for driving this loudspeaker to produce uniform sound pressure over an extended high-frequency range.

Technical Session: Audio System Design

Chairman: W. O. Summerlin, President, Pulse Techniques, Inc., West Englewood, N. J.

2:00 p.m. PHYSIO-PSYCHOLOGICAL FACTORS IN HIGH-FIDELITY REPRODUCTION

Louis A. de Rosa, Laboratory Head, Federal Telecommunication Laboratories, Nutley, New Jersey

The design of equipment for high-fidelity reproduction and for proper stereophonic effects may tolerate reasonable amounts of distortion. On the other hand, certain types of distortion are particularly annoying to the ear. The objectionable distortions are those which indicate the presence of new sources of stimuli. Information theory, physiology, and anthropology combine in directing the design of high-fidelity systems for maximum effectiveness.

2:40 p.m. CBS TELEVISION CITY AUDIO FACILITIES

Howard A. Chinn, Chief Engineer;
Robert B. Monroe, Senior Project Engineer; and Charles A. Palmquist, Project Engineer; CBS Television, New York
CBS Television recently inaugurated program service from its new Television City headquarters in Hollywood. This paper discusses the philosophy underlying the design of the Television City audio and communication facilities and describes the installation in this modern television broadcasting plant. Emphasis is placed on description of features that are new or novel.

3:20 p.m. NEW ADVANCES IN LANGUAGE TEACHING: THE GEORGETOWN UNIVERSITY PROJECT

Morris Lewis Groder, Chief Production Engineer, Electrical and Physical Instrument Corp., Long Island City, New York
In recent years, electronic devices have played an ever widening role in the field of education. Georgetown University pioneered in the use of the tape recorder, oscilloscope, and other audio and visual devices for language teaching and multilingual interpretation. This paper describes the project at the University's Institute of Languages and Linguistics, the technical equipment used, teaching methods, and unique techniques devised to solve educational problems.

4:00 p.m. SYSTEM DESIGN FOR MULTIPLE COPYING OF TAPE AND DISC PROGRAM MATERIAL

Robert Winston, Audio & Video Products, New York City

A description of new high speed tape copying, disc mastering, and associated recording studios will be presented in this paper.

Thursday, October 15th

Technical Session: Disc Reproduction

Chairman: Alfred Jorysz, Dev. Engineer Presto Recording Corp., Paramus, New Jersey

10:00 a.m. A NEW WIDE-RANGE PICKUP

John F. Wood, Senior Engineer, Electro-Voice, Inc., Buchanan, Michigan

A wide-range, amplitude-responsive phonograph pickup has been developed utilizing a barium titanate generating element. Response has been made flat to the AES characteristic within professional tolerances. Discussion of this project is preceded by a brief consideration of magnetic pickups and recording practice. Particular emphasis is given to the amplitude-velocity relationship, and to the advantages accrued by the use of the ceramic element.

10:30 a.m. SIGNIFICANCE OF INTERMODULATION OF HIGH FREQUENCIES IN AUDIO EQUIPMENT

Emory Cook, Cook Laboratories, Inc., Stamford, Conn.

Application to audio of the constant-difference frequency method (CCIF) of intermodulation measurement is discussed. Correlation between results obtained and listener acceptance; specific means of implementing the system to produce results of maximum significance; the "N-A Beam" technique.

11:00 a.m. EFFECT OF HIGH-FREQUENCY PRE-EMPHASIS ON GROOVE SHAPE

Jerry B. Minter, Chief Engineer, and Aldo R. Miccioli, Engineer, Measurements Corp., Boonton, New Jersey

A theoretical derivation of the recorded groove shape for lateral cut records will be presented together with the effects of pre-emphasis. Experimental confirmation of these results will be included in the paper.

11:30 a.m. AN ANALYTICAL APPROACH TO PHONOGRAPH PICKUP DESIGN

Walter O. Stanton, President, Pickering and Company, Inc., Oceanside, New York
A qualitative examination of the fundamental relationships which exist between the mechanical elements in a phonograph pickup. The purpose of the paper is to derive basic equations, by a study of the dynamic tracking problem, which may be used in the design of pickups.

Technical Session: New Developments

Chairman: Sol Heller, Managing Editor, Technician, Caldwell-Clements, Inc., New York City

2:00 p.m. NEW DEVELOPMENTS AND APPLICATIONS OF PRINTED CIRCUITS

Arthur W. Kelly, Jr., Applications Engineer, Photocircuits Corp., Glen Cove, New York

The pros and cons of the latest manufacturing methods will be discussed briefly. This will be followed by a summary of the latest achievements in etched circuit techniques including examples, samples, and explanations of applications.

2:30 p.m. NEW BUSINESS OFFICE DICTATING MACHINE WITH MAGNETIC TAPE AS A RECORDING MEDIUM

Samuel J. Hyman, Chief Engineer, Permoflux Corporation, Chicago, Illinois
The development of magazine-loaded tape with standard reels has permitted flexible dictating machine design, featuring rapid start and stop as well as exceptional fidelity of reproduction. Several novel mechanical features and some unusual applications will be described in this paper.

3:00 p.m. A NEW APPROACH TO PROFESSIONAL MAGNETIC RECORDING EQUIPMENT

John W. Hines, Sales Manager, Magnacord, Inc., Chicago, Illinois

This paper will describe a new development in the field of professional magnetic recorders. This new recorder features several new and novel operating features.

3:30 p.m. ON-STAGE SELECTIVE SOUND RE-INFORCEMENT SYSTEM

Richard Edmondson, Engineering Dept., National Broadcasting Company, New York

The required mobility of performers over increasingly large stage areas in television introduces problems not only of sound pick-up but also of sound re-inforcement to the stage and the creation of favorable acoustical environments for the actors.

The need for a special system to feed audience reaction, music, sound effects, and selected cast microphones to various parts of the stage, and as well as to create "natural" acoustics for the actors will be discussed. A system designed for this purpose and used in the NBC Center Theatre will be described.

4:00 p.m. SOME NOTES ON PROBLEMS ENCOUNTERED IN THE USE OF THE STANDARD REFERENCE TAPE

Frank Radocy, Director of Production Control, Audio Devices, Inc.

1. A description of the reference tape method as used in the Interim Federal Specification WP-61A (Navy Ships).

2. Observation on the changes in performance characteristics of the Standard Reference Tape resulting from physical changes due to repeated playing.

3. Variations in the Standard Reference Tape performance resulting from the replacement of magnetic record-reproduce heads.

4:30 p.m. A NEW TRANSFORMERLESS AUDIO AMPLIFIER CIRCUIT

Kerim Onder, Engineer in Charge, Circuit Research Laboratory, 617 W. 113th St., New York 25, N. Y.

This paper will describe a new transformerless amplifier with low-impedance output and no d. c. through the loudspeaker voice coil. The amplifier will be demonstrated.

7:30 p.m. Annual Banquet, Main Ballroom.



HEAR the difference, SEE the difference
in the *Rauland* model 1826
ultra-fidelity ensemble

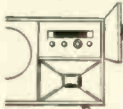

The proof of unprecedented superiority of the new RAULAND Ultra-Fidelity Ensemble is in its unmatched performance. That proof awaits you now at your Hi-Fi dealer. The Master Amplifier is of matchless quality. The unique self-powered

"Libretto" Remote Control-Preamp, with its amazing flexibility, is an ingenious innovation. The laboratory tests are a revelation, but the ultimate proof of superiority is in the thrilling listening and operating experience. The specifications summarized below can only hint of the quality of this new dimension in sound.

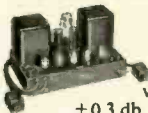

the master amplifier

A truly superb instrument with frequency response of ± 0.3 db, 20 to 40,000 cps at rated 20 watts output. Harmonic distortion less than 0.5% at rated output, less than 0.3% at 10 watts. Intermodulation distortion less than 0.4% at 1 watt (home level), 0.7% at rated output (measured at 60 and 7,000 cycles 4 to 1 ratio). Output imp., 8 and 16 ohms. 4-position input selector—for magnetic pickup, crystal pickup and 2 auxiliary. Dimensions: 14" x 9" x 8" high.



the LIBRETTO remote control

A true remote control, completely self-powered and capable of operation several hundred feet from amplifier. Uniquely fashioned in the form of a luxuriously bound book (only 8 3/4 x 11 x 2" thick). Backbone lifts to provide easy access to tuning controls. Operates flexibly in either horizontal or vertical positions.

CONTROL FUNCTIONS

1. 6-position crossover control (flat, 150, 300, 450, 700, 1000 cycles). 2. 6-position roll-off control (flat, -5, -8, -12, -16, -24 db at 10,000 cps). 3. Volume Control—instant choice of conventional control or loudness control. 4. Bass Tone, +24 db to -20 db at 20 cps (db calibrated). 5. Treble Tone, +18 db to -30 db at 10,000 cps (db calibrated).

Custom-Engineered, Custom-Styled
For Audio Connoisseurs

See the RAULAND 1826 Ultra-Fidelity ensemble at your Hi-Fi dealer, or write for full details.

Rauland

RAULAND-BORG CORPORATION
3515 W. Addison St., Dept. AD, Chicago 18, Ill.

Friday, October 16th

Technical Session: Amplifier Circuit Design

Chairman: Lincoln Walsh, Chief Engineer, Walsh Engineering Co., Elizabeth, N. J.

10:00 a.m. A NEW 30-WATT POWER AMPLIFIER

Frank McIntosh, President, and Sidney Corderman, Chief Engineer, McIntosh Laboratories, Binghamton, New York

The McIntosh unity coupled output circuit is used in a new 30-watt amplifier. Resistance capacitance coupling is employed up to the output stage eliminating the driver transformer heretofore required. The amplifier offers extremely low harmonic and intermodulation distortion, flat frequency response, good transient response, and low noise level.

10:30 a.m. CONSIDERATIONS OF HIGH-QUALITY PREAMPLIFIER DESIGN

Martin V. Kiebert, Jr., Hasbrouck Heights, New Jersey, Consultant to Fairchild Recording Equipment Corp.

A new preamplifier design will be described which is scheduled for production in the near future. This preamplifier contains several novel features and provides flexible arrangement of controls.

11:00 a.m. AUDIO AUTOMATIC VOLUME CONTROL SYSTEMS

Frank W. Roberts, Director of Engineering & Research, and Robert C. Curtis, Chief Electronic Development Engineer, Dictaphone Corp., Bridgeport, Conn.

Audio automatic volume control systems used in a variety of applications fall into two general categories: compressors and limiters. Operate times should be short without introducing "thump" in the signal. Methods of control and "thump" cancellation are discussed. Both forward and backward acting circuits are shown and compared from performance and cost standpoints. Measurement techniques are described.

11:30 a.m. THE PHILOSOPHY OF AMPLIFIER EQUALIZATION

H. H. Scott, Hermon Hosmer Scott, Inc., Cambridge, Mass.

Modern high-fidelity amplifiers include equalizing circuits to cope with the wide variety of recording curves which have been used. In the design of such circuits, some reasonable compromise must be reached between flexibility—which often implies complexity—and convenience of operation. In this respect, the designer has had to meet conflicting demands from customers, to provide a variety of curve shapes matching closely a number of the desired playback characteristics, while at the same time keeping the control as simple as possible for the non-technical music lover. Current practice includes at least four solutions to the problem, each with its attendant advantages and disadvantages. The writer has been concerned with the design and manufacture of all four types, and will discuss the various design and operating factors involved for each type.

Technical Session: Home Music Systems

Chairman: Charles J. Fowler, Editor, *High Fidelity*, Great Barrington, Mass.

2:00 p.m. DECORATING THE HOME WITH MUSIC

Russell J. Tinkham, Manager Audio Sales Ampex Electric Corp., Redwood City, California

Music in the Home should be considered as much a part of interior decor as decorative fabrics, colors, and furnishings. The development of new recording and reproducing techniques make possible home music that reflects the character of the home owner. Just as music relieves tension in busy factories, offices, and stores, it can be used to soothe the fevered brow of a homemaker.

2:30 p.m. A COMPOSITE RECORDING SYSTEM FOR STUDIO OR HI-FI APPLICATIONS

Oliver Read, Editor, *Radio & Television News*

The audio engineer or the professionally-minded audio enthusiast can increase the versatility of hi-fi components by using broadcast techniques. A composite system is described wherein facilities are provided for both monaural and binaural recording, playback, and dubbing of tapes and discs with full monitoring and other features.

3:00 p.m. ENHANCING THE LISTENING QUALITIES OF HIGHLY DAMPED SMALL ROOMS AND STUDIOS

Paul Weathers, Weathers Industries, Barrington, N. J.

If the apparent size of the listening room can be artificially enlarged and the reverberation controlled to simulate the characteristics of a perfect auditorium for the type of music reproduced, the over-all results would be:

1. Spatial effect of a large room.
2. More apparent loudness without being more audible outside the room.
3. Reduction of objectionable distortion and noise.

This paper describes systems for producing controlled delays and repetition of delays.

3:30 p.m. AUDIO AND INTERIOR DECOR

Jeff Markell, New York City

This paper will consider some of the factors necessary to properly integrate audio equipment into the decor of a room.

4:00 p.m. A PRELIMINARY REPORT OF GROUP LISTENER REACTIONS TO BINAURAL SOUND REPRODUCTION

Harold T. Sherman, Sherman Studio, Carnegie Hall, New York

Multiple channel sound reproduction provides better realism than does our single monaural channel. A simple two-channel binaural system will allow the listener to assimilate more information through better definition and more natural loudness differences. Microphone placement will be discussed and related to group listener auditory reactions.

Saturday, October 17th

Technical Session:

Multichannel Sound Reproduction

Chairman: William H. Offenhauser, Jr., New Canaan, Connecticut

10:00 a.m. STEREPHONIC REALISM

Colonel Richard H. Ranger, Rangertone, Inc., Newark, New Jersey

Appropriate coordination between intensity and timing is essential for stereophonic realism. Different handling is required for music, speech, and localized sounds. Clean cut original recordings, mixed appropriately to a minimum of magnetic channels accomplishes the realism.

10:30 a.m. A STEREO DYNAMIC MULTICHANNEL AMPLIFIER OF NEW CIRCUIT DESIGN FOR SINGLE OR BINAURAL INPUT

John Nigro, Madison Radio Sound, Madison, New Jersey

A multichannel stereodynamic amplifier for single or binaural input. A further development of a unique system of amplification, using dynamic control stages and an integrating third channel to effect greatly increased illusion of spatial distribution in reproduction of both single and binaural source.

11:00 a.m. MULTICHANNEL SOUND REPRODUCTION

Walter T. Selsted, Chief Engineer, Ampex Corp., Redwood City, California

The system described is typical of many such systems which are to be installed in the nation's theatres in the very near future. The considerations of power amplifier requirements, speaker characteristics, and power capabilities are among the many aspects of this problem which are covered in the paper. In this paper the input signal is supplied by magnetic reproducing equipment to be described in detail.



YOUR ELECTRONIC
EQUIPMENT
Demands Highly Specialized
WIRE



**THE MANUFACTURERS
AND SERVICE MEN
WHO SERVE BEST**

Specify **Belden**
WIREMAKER FOR INDUSTRY



EDWARD TATNALL CANBY*

Rome, Italy

THIS DEPARTMENT has done some fair verbal wandering in its six-and-some years, but this is the first summer it has travelled—and travelling has done something to it. Maybe it's the heat, which is placidly anchored hereabouts in the high 90's (translating from the local centigrade) day after day, nor has there been a vestige of cloud in this crazy blue sky for almost three weeks. More likely, it's the European climate of human beings, which for these few months has given me the strangest and most interesting feelings about Audio and Records and America—so absorbing that I can't help but write for you what happens to be uppermost in my slightly feverish mind. It'll all have a good deal to do with our home business of selling records (lots of them made in Europe) and improving Audio, in the long run.

Leisure

There is such a strange mixture on this continent of fatalistic leisure and hysterical excitement, in any occupation you can think of. Things are done in the most ingenious ways, with utmost and direct simplicity in some areas and the utmost in complications in others. The Romans, as I write this, are tearing up the asphalt outside my hotel with an air drill. They've been at it ever since we got here and it looks as though by the end of the month they might get up to the corner, 20 feet away. Meanwhile, the most ingenious detours are made for the trolley busses to get around the mess. Everybody stops to watch and the workmen stop to watch too, or get lyrically eloquent in their operatic-tenor voices about minor matters like picking up a shovel and putting it down again. And they take three full hours off for lunch. Nevertheless, every one of Rome's thousands of streets is paved, and well paved. Things do get done, eventually, and when they are within the traditional common-sense base-area of daily living, they are done well and comfortably.

It's only when the Europeans try to ape American "luxury" that things go haywire. Like the shower I took last night: it poured and was hot and the room was neatly tiled in modern U.S. style—but there wasn't any

drain. The water was supposed to plop into a basin about two feet square in the middle, which it did, if you didn't stand under it. Otherwise, it simply sprayed all over the floor. No curtain. Moreover, the shower is charged for, extra, and the maid practically escorts you under it. Or take the GE fluorescent shaving lamp which undoubtedly adds 20 per cent to my hotel bill; it goes on and off and flickers unbearably in the slow-cycle current. Or automatic elevator, which has three doors and stops six inches above the ground floor. Fix it? They just shrug their shoulders. To an Italian, that's the sort of thing that fancy machinery is bound to do and they aren't too worried about it. Why bother; it's only one step up. . . .

But, lest you think that this familiar story is my only one, let me quickly mention the other side. It is true that American-style gadget living (and this includes both phonograph records and the audio equipment to play them) is painfully expensive here and for most Europeans is plain out of the question. Even ordinary clothes are expensive enough. I priced a pair of Polaroid sun glasses today—\$12, with brown plastic frames. In terms of the local incomes that might be \$40 to you and me. Cameras, records, automobiles, every sort of "aid to modern living" costs that much. It's astonishing that so much is sold, even so. Yes, they can't afford gadgetry here. Only a few Europeans can indulge in record collecting and, outside of England, a microscopic number can be counted in the practicing hi-fi cult.

Newness

But the more important point is not the cost—but the fact that Europeans really don't take all these things very seriously. They manage to lead very pleasant lives, on the whole, without them. They use practical makeshifts, or they use traditional methods and old fashioned products—toilets, trains, washbasins, even records—that have long since proved their usefulness. Newness means very little, and in no time at all any reasonably sensitive American, as I hope I am, begins to feel that this is right and reasonable and proper. And sometimes even highly desirable. Indeed, the whole audio world (not to mention the current atomic explosions over 3-D, bin-a-ural, and what-not), my very profession itself, strikes me, here in Europe, as just

a bit improbable. As improbable—here—as, say, at home the manufacture of gold plated Cadillacs and automatic toilet paper. (The latter was once described to me. I'll omit the details.)

Yes, I set off to Europe with the idea of doing some fine audio investigating en route, to find out what was going on over here in this country and that, as to records and as to machines. But it has turned out otherwise. I didn't know, somehow, that when I got here the reality of Europe itself would be so overwhelming, that audio, phonographs and all the rest would somehow fade into the background. The fact that they did, and to such an extent is, I think, very significant, for myself and for all of us, since, after all, I'm one of the more ardent protagonists for the art of recording and playing-back, and undoubtedly will be again—on my return to the U. S., shortly.

I'd better say hastily that this is no attempt to discredit either phonograph records or audio in any form. Somehow, though, I've got to get over to you what strikes me so strongly here, while I'm in Europe, as a different and reasonable way of life. We should see ourselves as others see us, once in awhile.

Here, in Rome, and in Paris and Switzerland and Florence and other spots I've stopped at, are the people who might, or might not, buy our exports, our LP records, our audio amplifiers—our life itself. And here are the people who are sending us, now and then, some of their best new products, in audio as well as elsewhere. We're becoming aware of Europe in a strictly business manner, far more than we used to be. And we'll find in them what I am finding—a remarkable sense for the basic things of life and a strong tendency to avoid unnecessary gadgetry, novelty, spectacularness, in favor of tried-and-true and workable things; an equally strong tendency to take things slowly, with endless good natured complications in procedure. Forms, forms, forms! Why? Because nobody sees any reason to save time by *not* filling out forms.

Buildings and Trains . . .

Thus building construction, street repairs, electric wiring—all such things—are done with an implacable complexity and slowness. Watching the rebuilding of a

* 780 Greenwich St., New York 14, N. Y.

LISTENING QUALITY IS EVERYTHING

Again and again the question—"What makes the AUDAX CHROMATIC the outstanding instrument that it is? Like asking, "Why that glorious tone from a Stradivarius?" KNOW-HOW, that comes only with years of specialization, is undoubtedly a very important factor. Below are a few of the salient features that contribute to the superb performance of the AUDAX CHROMATIC cartridge . . . This according to the thousands of AUDAX users themselves.

BUT . . . only YOU can decide what sounds best to you. See and hear the AUDAX CHROMATIC and YOU be the judge . . . Yet AUDAX costs no more than ordinary pickups!

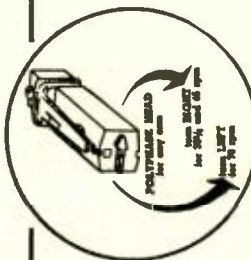

AUDAX CHROMATIC

1. One single magnetic unit plays any and all home records.
2. Be it diamond or sapphire every stylus has only a limited life; diamond lasts the longer. Obviously then, replaceability of the stylus —AT HOME—is of the greatest importance. Only in AUDAX is each stylus replaceable independently of the other.
3. Near-infinite compliance.
4. Needle-talk practically nil.
5. Response 10 c to over 15 kc.
6. No "Hidden Pull".
7. Available with the new AUDAX Compass - Pivoted arms and to fit the high quality record changers.

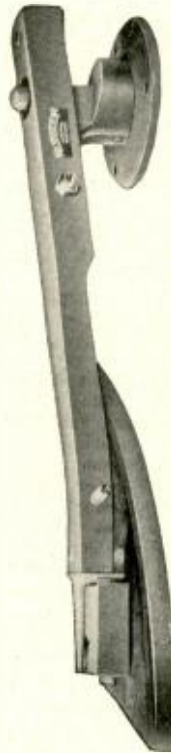

Unquestionably the Simplest and Most Efficient Arms Yet Devised

- Only THREE parts.
- No restraint to stylus travel.
- Frontal oscillation nil.
- No springs . . . No fatigue.
- Maintains point-pressure — regardless of climatic changes.
- Greatest possible distance between stylus and vertical pivots.

Obtain copy of "1953 Electronic Phono Facts" at your dealer or at your favorite store.

Also be sure to obtain free descriptive literature on **STYLUS-DISK**

AUDAK COMPANY

500 Fifth Avenue 42nd Floor New York 36, N. Y.

Creators of Fine Audio-Electronic apparatus for over 25 years

"The Standard by Which Others Are Judged and Valued"



*STYLUS-DISK

Pat. Pend.

1. Just as a fuse protects an electrical circuit, the **STYLUS-DISK** protects your records against ruination by a worn stylus. You can be sure with **STYLUS-DISK**! It acts only when a stylus *begins* to wear.
2. Gives *visual* indication whether or not the stylus is in playable condition.
3. Will test any type of stylus, in any type of pickup—in a jiffy—\$3-1/3—45—78.
4. Neither the stylus nor the cartridge need be removed for the test.
5. The grooves may be used over and over again, until finally a worn or defective stylus scrapes the groove-walls.
6. Should last for years \$3.90 net.

NEXT TIME BE SURE!

Next time insist on
PEERLESS transformers

Peerless quality is
ECONOMICAL

Peerless quality is
UNIFORM

Peerless quality is
DEPENDABLE

For years Peerless engineers have designed transformers to meet the most unusual and stringent specifications submitted by civilian manufacturers and government contractors, and have manufactured these transformers with tight quality control. The small difference in price means a BIG difference in performance.

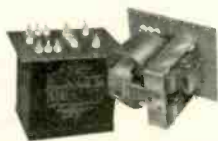

Next time let us quote on your transformer requirements.

 **PEERLESS**
Electrical Products

A DIVISION OF



9356 Santa Monica Blvd., Beverly Hills, Calif.
161 Sixth Avenue, New York 13, New York

war-bombed bridge across the Arno in Florence (they've spent two weeks already boring a single hole in the old concrete foundations) I couldn't help feeling that time would move snail-like for generations before any tangible progress was made—yet in the end I knew for a certainty that the work would be done, and well done too. It was men of this sort who built the great Gothic cathedrals, working on for centuries in the same slow, good-humored, complicated way.

There's a sureness and an infinite patience in this slowness that at first drives one to exasperation, then to admiration. I saw a dozen men moving a small mountain of gravel a few hundred yards to make a huge fill, toiling in the tropical sun with picks and shovels and hand-pushed carts on rails. Roman slaves! The work already done looked like that of a dozen steam-shovels and trucks; it must have taken years, and would take many more—to make room, finally, for some minor restaurant or filling station on the new ground. How futile, in the face of such serene patience, to say that we in the U. S. would do the job in a couple of days!

My fast express from Naples to Rome the other night had a hot box, right under my seat. Smoke poured up, we stopped and everybody immediately hopped out on the right of way to look at the interesting sight, with philosophical pleasure. The conductors gabbled to the engineers and pointed, but did nothing, the passengers took the opportunity to smoke a leisurely cigarette and enjoy the cool night breeze—right in the middle of the express track. Nobody seemed a bit disturbed, everybody talked, and not a thing was done for fifteen or twenty minutes, during which time the entire rail communication between Rome and Naples was completely blocked. After awhile, when the cigarettes were done and the pleasant intermission over, we all got back in, moved to another car, and the offending one was hauled along, smoke and all, at half speed into Rome. No excitement—for, again, this is the way with machinery, one feels. Why get excited?

As a matter of fact, this and a couple of other train trips here have been the most thoroughly enjoyable I've ever had. What blissful unawareness of air conditioning, and what an advantage! The trains are electric—that was a fundamental advance that really mattered—and the ancient and very comfortable cars have big, low, panorama windows that slide down to knee level. In this warm, dry climate every window in the train was wide open. Standing in the corridor at one side (compartments on the other) we were practically outdoors and indeed whenever the train went slower than 80 kilometers half the heads in the train were stuck outside in the fresh air. I took pictures out of one window of a friend at another. It was all extremely simple and utterly lovely, with the most delightful grapes - mountains - and - olives scenery sliding past, brief stops at dozens of stations (this was a *direttissimo*, a very, very direct train, and merely stopped at half the stations instead of all of them) where bottles of wine, orange soda, ice

cream sticks could be bought by leaning out of the low windows. So liveable, so comfortable, so *practical*. No matter that in the tunnels the noise was deafening, no matter that we didn't dare go to the dining car and leave our baggage unguarded. (Our fault for having silly gadgets like expensive cameras and light meters and nylon shirts.)

We've got ourselves so modernized at home that we can't lean out of train windows any more and take in the countryside. More's the pity.

Autos and Scooters . . .

So with other matters. I was amazed to find, with my keen eye for automobiles, that after a week or so on the continent I no longer noticed the 25-year-old and the 15-year-old cars as out of date. The plain fact is that they really aren't—they still run well, since they were built well in the first place and are well cared for as permanent valuables, now as always. No jalopies hereabouts. Even the new cars don't necessarily look new in shape. The medium Fiat imitates an early Kaiser and other models copy the U. S. in miniature, after a fashion; but the outstanding front-wheel-drive French Citroën, existing in hundreds of thousands in France and more revolutionary than anything we have, has lines not unlike the 1933-34 Ford, flattened and widened. Ancient American cars take on a reasonable and permanent dignity here—a 1940 Chevy or 1935 Ford looks as important and as desirable as the newest model. Cars are small because it's convenient and economical to have them small, which is a first-class reason. Here again, flashy "newness" is singularly unimportant, even in the relatively dynamic and modern auto industry of Europe.

Another Citroën, the cheapest model, is the simple and practical realization of what Crosley simply could not do in the U. S. It is a plain, flat-sided box of a car, crudely streamlined with a folding canvas roof and bucket seats, plus a species of motorcycle engine, and it comes in one color, dull brown-gray; but it is the poor man's auto par excellence and will take you anywhere. Moreover, it's full-sized, as cars go here—it gives the maximum room, convenience, and economy that engineering can devise, and don't think that European engineers aren't as good as ours. It isn't the engineering competence, it's the economy, but even more, the attitude! No Frenchman is going to be deterred by a hideous car, if it will serve him well.

But who wants a car? Over here, one realizes, to put it simply, their disadvantages. Cars are luxuries to begin with, but again, one feels that they are often ostentatiously cumbersome. I am aware here, every day, that I can afford things that Europeans can't, and this in itself can be unpleasant in daily life; there is envy and some dislike, only reasonable, which one must face out as well as one can. No use explaining that you really aren't wealthy.

I merely bought a car in England, to drive freely on the continent; but, inside it, I'm automatically the most dismal sort of plutocrat and moreover, I suffer incon-

veniences no end. My Austin is a big, bloated, over-fat expensive foreign car here in Italy and the funny thing is that I feel it so, and see it so, and can't help it. It is out of place, it is in doubtful taste, and in the most practical sense it is unnecessary and unsuited to the European way of life; it won't take sharp corners easily and most of this country's roads I've hit are hairpin-ridden; it fills two thirds of the street and I have to back twice to get it around two corners into my garage in Florence. Neither pedestrians nor bicycles nor motorcycles will get out of my way and I'm often reduced to moving at a humble crawl while two carefree and unencumbered souls carry on a conversation walking in front of my fender. It takes a desperate amount of energy, physical and nervous, to drive. And it's deadly hot in the sun.

How much easier, then, to own what everybody owns here, a Vespa or equivalent. The Vespa is a marvellous three-speeded scooter-bike which infests continental roads by the millions. Vespas (also a couple of million flea-powered gas-engine bicycles) can be parked on a dime (60 Lira) or in dozens of "parking lots" which are simply ground-floor rooms in houses. You just wheel your machine indoors and sometimes they actually hang it up on the wall. But Vespas will do 45 or 50 and they'll climb anything from a side of a house to an Alp. You step onto them and you can get off by walking off. A pretty and common sight is the family Vespa—Papa in front, baby in the middle and Mama serenely whizzing along sitting side-saddle in back, her elegant legs swinging luxuriously in the air. Women ride them as casually as ours drive their Chryslers.

Perhaps you can understand why I left my great road-hog of an Austin in Florence, eating its head off in a garage, and came to Rome by train!

I could go on and on about this common-sense European approach to simple conveniences and the complementary lack of understanding for our American ways. The whole thing is so fundamental, so hugely, immovably *existing*, that one gains a rather terrifying appreciation of the difficulties we all face in the so-called "West" in understanding each other. Yes, you can buy Lux and chlorophyll toothpaste and you can see 3-D and listen to Gershwin almost anywhere in Europe, and the roads are lined with Shell and Esso and Mobilgas stations and other European equivalents; life on the surface is much more like ours than most readers who haven't been here can imagine. If you're a real tourist and get yourself taken around by one of those planned-tour organizations, or go "sponsored," you'll not see much else. But just try it on your own awhile.

The English Channel is, at its narrowest parts, only 20-odd miles wide at a guess. But it took just 28 hours to get me and my car across it—and everybody was as nice and cooperative as you can imagine. Car ferry? No such simple gadget as that. We had to be on hand at 7:30 a.m. in the morning to fill up forms, show passports, receipts and a barrel of other paper—I'd got

reservations two days earlier, on advice. The cars were stowed by crane, one by one, in the very bottom hold of a special cargo boat; a second boat left, after four hours' wait, at 11:30 with the passengers. Most ingenious, too, the fancy adjustable clamps by which the cranes could whisk any size car 50 feet up in the air by its four wheels and down 100 feet into the ship's innards (where a good dozen men rushed about pushing the cars into distant and inaccessible corners). Rather terrifying to watch, especially when your own car sailed through the air overhead. On the other side, it took a half hour in a cloudburst to line up the passengers and get their landing slips stamped, then more time to have passports checked. (There wasn't any customs. The Europeans know when to stop and we haven't so much as had a bag looked at yet this summer.) Another two hours' waiting for the cars to be unloaded, one by one, from the cargo hold of the other ship—and we were off. A simple car ferry would have done the job in three hours or less. But, as I say, everyone was most cooperative and pleasant; you couldn't really get up heat enough to complain, the whole operation was so neatly, beautifully managed! The food on the passenger ship was excellent, too, and we met some very fine people—together a rather pleasant if strenuous twenty miles' worth of travelling.

But note well that, if you want to pay for it, you can have your car *flown* across in a double-deck box-car plane on regular schedule; you fly in the upper part and the car downstairs. Haven't heard of that yet, back home.

I haven't seen a toilet newer than 75 years young yet (except in the American Express in Paris) but, if I may put it delicately, I haven't suffered any. Instead of those elaborate electric table grill affairs that we give people at home for wedding presents—infra-red, bake, broil and the rest—they have a much simpler and more practical device here that struck me as truly European—a second-helping heater. There's one on each table, in Switzerland; it's a simple plastic or ceramic box-tray with perforated top and two candles burning inside. Put your serving plate on it and the food stays exactly the right temperature for the second helping—no thermostats needed, and it costs even less than "one cent a day."

Tear it down?

A last example—trolley cars. Public transportation is extensive in every city since autos aren't much used. Trolley cars—"trams"—are everywhere, along with the newer trolley buses, *flibus* in Italian. No fancy streamlining; most trams are four-wheelers that can get through the old, narrow streets with ease. To cope with larger populations they've simply added trailers, or as in Rome and Genoa, built on extra pieces of body to the old cars; one type has a front car, a middle one suspended in space without wheels and a rear trailer. Very odd looking and probably overloads the original traction motors, but I haven't seen any breakdowns and the

You are
the Maestro
with the NEW

Bogen

DB20

HI-FI AMPLIFIER



featuring

The Most Complete and Versatile Control of Sound Reproduction ever offered!

NEW LOUDNESS CONTOUR SELECTOR!
An exclusive Bogen control providing compensated frequency response to match any listening level.

ALL-INCLUSIVE RECORD COMPENSATION!
Seven positions for LP, AES, NAB, AM78, EU78, PFRR and Popular records, cover all normal requirements.

NEW WIDE RANGE TONE CORRECTION!
Individual treble and bass controls of remarkable flexibility. Bass control +17 db to -18 db at 40 cps. Treble control +15 to -21 db at 15 kc.

FOUR-POSITION INPUT SELECTOR!
Provides complete selection of matched inputs for Magnetic Phono, Radio, TV and Tape Recorded program sources.

—plus the finest overall performance ever offered at a popular price!

The DB20 embodies all the advanced design features that have made BOGEN a by-word for quality. Power output is 20 watts with 5 feedback loops and partial cathode loaded output reducing distortion to a low, low 0.3%. Frequency response is 20 to 20,000 cps ± 0.7 db. D.C. on preamp filaments reduces hum to -75 db.

WRITE TODAY FOR BULLETIN F-10



THE STANDARD OF PERFORMANCE
Bogen Sound Systems

DAVID BOGEN CO., INC.

29 NINTH AVE., NEW YORK 14, N. Y.

A Quarter Century of Electronic Specialization

We Predict
the New

BROOK

MODEL 22A

Is Destined
To Create
A Sensation!



10-watt
single-chassis
power and pre-
amplifier combination

- ... so dramatically different, it's a new concept in amplifier design.
- ... so functionally compact, it simplifies any installation.
- ... so exceptionally attractive, it captivates at first glance.
- ... But, FOREMOST, so genuine in HIGH QUALITY AUDIO PERFORMANCE, despite its unprecedented low cost.

SEE and HEAR the Model 22A BROOK "Junior" at the AUDIO FAIR—Room 511, Hotel New Yorker, October 14-17. Write for descriptive and technical data, also name of nearest local dealer.

Dept. AK-3

BROOK ELECTRONICS, INC.

First in the High-Quality Audio Field Since 1936
34 DeHART PLACE, ELIZABETH, N. J.

fare in Rome is about two cents. They can't afford many new cars here, but again, one feels they really don't consider it important to have them. I agree. Not for a higher fare, anyway.

Indeed, unless you tear down the entire European collection of cities, with their six-foot streets, their hunched, piled-together masses of overlapping buildings, rebuilt and rebuilt for hundreds of years without ever a demolition complete and sweeping, short of war or Napoleon (he did it, in part)—unless you destroy this complex ancient European civilization itself, from whence we came, this way of life, so easily and unaffected carried on in its own environment, which builds the new on top of and inside and around and under the old, which keeps to the ancient and trustworthy ways of doing things as long as they continue to be convenient and practical for the moment, which is given to violent excitement in every argument, yet exists in the utmost and unfathomable leisure with time for everything—unless you tear down all this, destroy the towns, re-educate the people, break apart what has taken thousands of years to build up—you'll never find American gadgetry making much headway, in the large or the small, on this ancient bit of soil, until it has really proved itself in a slow, measured and sober manner.

Audio

There is, after all, an application here even for the phonograph industry. I've kept a travelling eye open for signs of audio and phono life and I've seen some interesting bits of engineering, too—I'll get to some in a later edition. Yes, there are buyers in Europe for phonograph records and even a microscopic few for audio products. But the stuff costs a painful fortune in terms of salaries and wages, and more important, it must exist—and sell—in the European way. Once more, I can't help but suggest that the phonograph, as an expensive device, and the record too, must sell strictly on its purely artistic, (i.e. *practical*) merits. Nobody is going to buy gadgetry here because it is new, the "latest," exciting.

I've seen LP records in windows, but they are almost without exception those which we have in our own windows at home. Recorded in Europe, lots of them, processed in the U. S. or in England, then sold to the Europeans (who recorded them, perhaps) as "imports." I wasn't surprised to find familiar labels—Urania, Westminster, Columbia, Decca (London), RCA and the rest, nor was it remarkable that most of the discs were yellowed and faded from long inaction, in a static show win-

dow. Show windows here are for tourists, and tourists don't buy records—not LP's, anyhow.

I've heard lots of radio—same old disc jockey programs, in each language, only minus the commercial—and I've listened to a Swiss console with a jukebox tone de luxe, a boom as big as an elephant and highs to 1000 cps.; but I've also heard the best small table radio I've ever listened to, truly high fidelity, with the finest voice quality I ever expect to experience. I've seen clumsy pickups and lots of ingenious new tiny ones, three speed. Don't think that the talent for designing isn't around—it certainly is.

But the economics and the atmosphere are agin it. The civilization is agin it. You'll have to tear down not only the cities but their power systems and their communications before audio has half a chance here. I've kept tabs on current as I've gone along: 120, 180, 250 volts, all are common, with plenty of flexibility. Cycles are nominally 50—plus or minus enough to send any phono motor on a wow spree. (There aren't any electric clocks.) Electricity is everywhere, even in the tiniest and most backward village. But it's not designed for musical purposes.

A European radio dial is a nightmare of what seem to be dozens of bands and whole paragraphs of microscopic print. They're courageous here—radio, after all, is a lot more than mere entertainment to people who have lived through the last war without other source of outside information—and the shop windows are full of portables down to the miniature size, every one equipped with the complete nightmare dial and costing the usual incredible fortune. When these people really want something they'll go to any end to get it.

And so I feel that, given a minimum of high-pressure salesmanship and a maximum of quiet, common-sense persuasion—also, given plenty, plenty of time—both the LP record and our improved audio equipment will grow to be greatly appreciated in every country that is available to us. We do, after all, have values to offer, thanks to our own technical advances, and in these last few years of our post-war prosperity we've shot ahead (with England, Denmark, Germany, not too far away from us) at a speed which is wholly typical of our wild and exciting way of living.

Let's not underestimate European intelligence, common sense and native ability—and let's take Europe in its own terms, whether for audio or for world politics.

DANNEMORA DUNGEON

(from page 52)

ordinary records through wide-range systems to turn up the volume to the pain-point or the distortion point, whichever comes first. Imagination signals that it cannot quite make the grade, pull out the throttle a little more, and maybe we'll get more clues. Many a harried housewife will be glad to know that after

the first binaural blush is off, her daily stint of deafness will be only an evening memory. Daddy will play binaural at comfortable volume, and he will play the ordinary seldom if at all.

—Emory Cook,
Cook Laboratories,
Stamford, Conn.

you'll find *Everything in High-Fidelity*
ALWAYS IN STOCK AT

ALLIED



ALLIED'S NEW DUAL SOUND STUDIOS
America's Most Complete High-Fidelity Exposition

The illustration below can only suggest the ultra-modern, unparalleled facilities provided by ALLIED'S two new Sound Studios for the display, demonstration and testing of High-Fidelity equipment. Here is a virtual permanent Exposition of Hi-Fi—featuring every new development and offering an ideal opportunity to compare and select equipment. Here you will find displayed and in operation, every Hi-Fi product made that has been found worthy by painstaking tests performed by our radio experts.

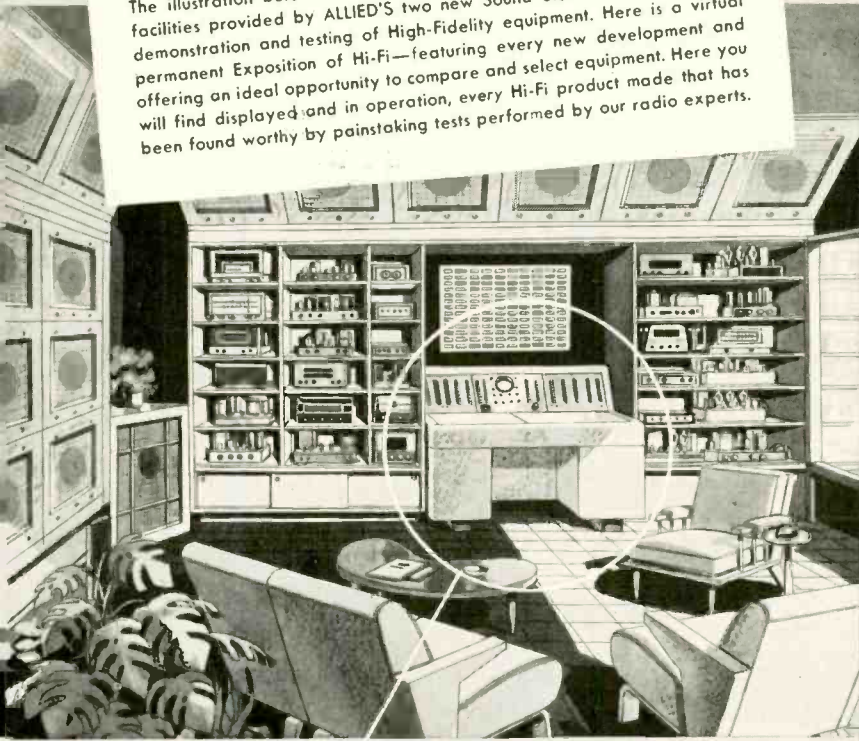

THE "TWIN AUDITIONERS": Exclusively at ALLIED—two ingenious electronic push-button control consoles, each capable of demonstrating every possible combination of audio components. The "Auditioners" are used not only for listening demonstrations, but for the determination by engineering test of the merit and quality of each piece of equipment we offer.

**EXPERT HELP
 ON EVERY PHASE
 OF HI-FI
 REPRODUCTION**

Whether you make your Hi-Fi selections in person or by mail, you can count on our expert audio specialists for straightforward, practical, money-saving advice. Don't hesitate to take advantage of our audio consulting service—we're here to provide you with authoritative, useful help on every phase of High-Fidelity reproduction and sound recording.

**2 EASY WAYS TO SELECT THE
 BEST IN HI-FI FOR LESS**

MAKE YOUR SELECTION IN PERSON: Treat yourself to an "Audiophile's Dream" in our two new Sound Studios. Here you will see the world's largest selection of High-Fidelity components. Here you can listen to your heart's desire—to any combination you may name. You will see our two "Auditioners" in action, capable of demonstrating every possible combination of audio components. You can ask the questions you want answered—our audio specialists are always on hand to provide you with practical help on every aspect of high-fidelity—the kind of help that results in intelligent, money-saving Hi-Fi selections.

MAKE YOUR SELECTION BY MAIL: You can make your selections from our Catalog with the same confidence you'd have if you came to listen in person. Our listings are *complete*—so that you have the widest choice of equipment. Our descriptions are accurate—so that you can decide with confidence on your selection. Our Audio Specialists are always available for expert, prompt consultation by mail.



**FREE 268-PAGE
 BUYING GUIDE**

Get our 1954 Catalog, featuring the most complete line of Hi-Fi components available anywhere. Come in or write for it (our Hi-Fi service-by-mail is unbeatable).

ALLIED RADIO

100 N. Western Ave., Chicago 80, Illinois

NEW HOME OF ALLIED RADIO



ultra-modern facilities
TO SERVE YOU BEST

you'll find
Everything in
High-Fidelity

ALWAYS IN STOCK AT

ALLIED



We carry the world's largest stocks of all quality high-fidelity lines and all components: amplifiers, reproducers, enclosures, FM and AM tuners, 3-speed phono changers and phono accessories, custom cabinets, etc. Our sound specialists will help you select the proper audio components to satisfy your most critical listening tastes—at substantial savings.



the
complete
Hi-Fi
Buying
Guide

Write today for our Free complete 268-page Catalog listing the world's largest selection of High-Fidelity systems and components.

ALLIED RADIO

100 N. Western Ave., Chicago 80

STANDARD OF THE INDUSTRY

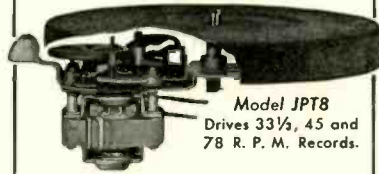

Model JPT8
Drives 33 $\frac{1}{2}$, 45 and
78 R. P. M. Records.

3 SPEED ALLIANCE PHONOMOTOR

The new Alliance Phonomotor Model JPT8 with less moving parts—dynamic balanced rotor—and many other plus features, assures unimpaired performance at all speeds!

Through the years, manufacturers both large and small, continue to rely on Alliance. The reason—simply that Alliance Phonomotors are known for their long life—quality—performance—dependability!

New Alliance single speed model also available.

ALLIANCE MANUFACTURING COMPANY

Alliance, Ohio

Always in stock at ALLIED

Tonal Range

Timbre

"Presence"



Altec Fidelity

IS HIGHEST FIDELITY!

Altec tuners, amplifiers and speakers are the choice of discriminating music lovers for perfect sound reproduction of records, radio and TV.

You are invited to come in and hear the difference on an Altec Home Music System.

"A SOUND REPUTATION SECONDO TO NONE!"



Always in stock at ALLIED

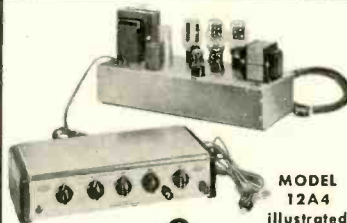

MODEL
12A4
illustrated



HIGH QUALITY AUDIO AMPLIFIERS

for the greatest degree of NATURALNESS
in Sound Reproduction

- MODEL 10C4 30-watt Power Remote Control 4B Pre-Amplifier combination.
 - MODEL 12A4 10-watt Power Remote Control 4B Pre-Amplifier combination.
 - MODEL 7 Self-Powered Pre-Amplifier.
- Designed by LINCOLN WALSH

Only BROOK offers:

- all low- μ triodes for most pleasing of listening qualities.
- exclusive BROOK transformers and circuits, designed to give finest possible reproduction of music and voice, without regard to cost.
- unique tone controls, for complete flexibility.
- inputs to accommodate even the most elaborate associated components.
- complete automatic compensation for bass-loudness characteristics of the human ear.

Always in stock at ALLIED

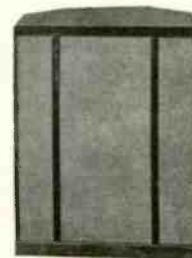

Paul
Klipsch
designed



the Rebel IV by Cabinart

Attractively styled to blend with any interior decor, the Klipsch Rebel IV by Cabinart comes in Lined Oak, Honey Walnut, French Mahogany and Black Lacquer.

\$69⁰⁰ Net for 12" model

\$87⁰⁰ Net for 15" model



... America's Leading Maker of High Fidelity Cabinets also has available a full line of Equipment Cabinets, Speaker Enclosures and Combination Units.

Always in stock at ALLIED

AMPEX

MAGNETIC RECORDERS



AMPEX TAPE RECORDERS

unsurpassed quality

- Magnetic Recorders
- Reproducers
- Duplicators

FAMOUS FOR RECORDING
PRECISION & FIDELITY

—Always in stock at ALLIED—

Audax for "Listening Quality"

manufacturers of
**Highest Quality
Magnetic Pick-Ups
Compass-Pivoted Tone
Arms, Cutting Heads and
the New STYLUS-DISK*** T.M.

(*A must for every music system.
Tells instantly, visibly,
at home, when your stylus is worn)



—Always in stock at ALLIED—



MODEL
2199

BELL

QUALITY ENGINEERED

High Fidelity Amplifier

Completely new! Bell Sound Systems engineering makes this an audiophile's dream! Six inputs, a frequency response of 20 to 20,000 cycles plus or minus 1/2 db, and 12 watts or more of 99%-distortion-free power give your home music system the versatility and fidelity you want, at a price you can afford. Bass and treble boost and cut, switch to cut loudness compensation in or out, and motor rumble suppressor switch give assured control for best performance!

BELL

Quality High Fidelity

—Always in stock at ALLIED—

Quality you can hear . . .



CLARKSTAN

RV 201 Magnetic Pickup

The RV 201 Pickup offers an entirely new approach to finest quality reproduction. The RV 201, a variable reluctance magnetic type pickup, features rugged simplicity. The needle weighing 31 mg. is the only moving part. You're assured wide-range, low-distortion reproduction, with flat response to over 15,000 cps. Output is 60 mv. with .001" lateral displacement. Stylus may be changed easily without special tools and needle talk is minimized by elimination of needless mass. The RV 201 meets FM specifications, and is stable under all normal temperatures and humidities. Standard winding has high impedance. Next time try the Clarkstan RV 201 and hear the difference!

—Always in stock at ALLIED—

"just like being there"

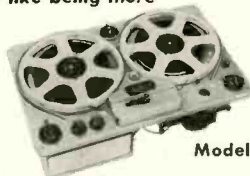

Model 150

Concertone The Only Tape Recorder Under \$1000 With All These Features

Designed for Custom, Console, or Portable installation • 50-15,000 CPS frequency response with negligible distortion • 3 Heads—Monitor from the tape while recording. • 3 Motors for superb tape motion and fast forward and rewind operation • Instantaneous selection of 7 1/2 or 15 ips with automatic equalization • "Straight line" tape threading • Plays up to 10 1/2 inch reels without extension arms • Interchangeable heads for single or dual track.

Professional Users
Net \$345.00

—Always in stock at ALLIED—

THE REVOLUTIONARY NEW COOK SERIES 50 N-A BEAM 12" TEST RECORD



follows the constant difference cross-modulation system internationally adopted as standard (CCIF).

Now with our exclusive 2% "N-A" code technique measure intermodulation and tracking of entire audio-channels without instruments.

Two oscillators sweep from 20/19 Kc, 4/3 Kc, announced frequencies, 2% synthetic coded 1,000 cps "A" (dot dash).

Now available at Allied Radio or your nearest parts house. \$4.80

Write for complete catalog or test and demonstration records.

COOK LABORATORIES

—Always in stock at ALLIED—

you'll find
Everything in
High-Fidelity

ALWAYS IN STOCK AT

ALLIED

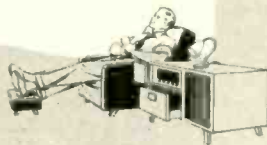

We carry the world's largest stocks of *all* quality high-fidelity lines and *all* components: amplifiers, reproducers, enclosures, FM and AM tuners, 3-speed phono changers and phono accessories, custom cabinets, etc. Our sound specialists will help you select the proper audio components to satisfy your most critical listening tastes—at substantial savings.

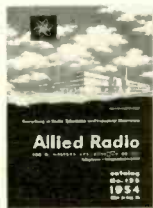

the
complete
Hi-Fi
Buying
Guide

Write today for our Free complete 268-page Catalog listing the world's largest selection of High-Fidelity systems and components.

ALLIED RADIO
100 N. Western Ave., Chicago 80

No Finer Choice Than
Electro-Voice

.....
MICROPHONES
HI-FI REPRODUCERS
PHONO-CARTRIDGES
P. A. PROJECTORS
TV ACCESSORIES



.....
ELECTRO-VOICE, INC., BUCHANAN, MICH.

Always in stock at ALLIED



MODEL 74P

HIGH-FIDELITY
at its best with the
MARKEL PLAYMASTER

- Play your records on BOTH SIDES automatically and in sequence.
- 9 HOURS continuous music.
- Plays all sizes . . . all speeds.

For real HIGH FIDELITY quality, order #74P AND #A-7161 self-powered preamp . . . response 40-12000 cycles . . . meets all proposed RETMA specs on wow and rumble.

Always in stock at ALLIED



"Of the very best!"

—HIGH FIDELITY MAGAZINE

The Fisher

SERIES "50"

Custom Audio Units

FM-AM Tuner, MODEL 50-R
Outstanding sensitivity and quality
\$164.50

FM-AM Tuner, MODEL 50-RT
Same, plus tone controls and phono eq.
\$184.50

Master Audio Control, 50-C
Most versatile made. Self-powered.
\$89.50

50-Watt All-Triode Amplifier, 50-A
No finer amplifier available. \$159.50

Hi-Lo Filter System, 50-F
New! Rumble and scratch suppressor.
\$29.95

Preamp-Equalizer, 50-PR
Professional controls. Lowest cost.
\$19.95

Always in stock at ALLIED



Model 9T-3M
\$59.75

Model PRE-7
\$39.75

Model PMC
\$114.50

PENTRON
HI-FI TAPE RECORDER

Professional quality! Low cost! For custom installation or portable use. Connects directly to tuner and amplifier. Two speeds. Dual track, or full width single track record-playback heads (removable pole pieces). Fastest re-wind, forward. All outputs and inputs.



Model 9T-3C Multi-Speed Tape Recorder
Complete self-contained portable unit. Two speeds. Interchangeable dual track or full width (single track) heads. List \$179.50.

Always in stock at ALLIED



GARRARD World's Finest
Record Changers and Record Players

5 Great Garrard Models:

- RC80 Record Changer
- RC90 Record Changer
- Model 301 Pro Transcription Turntable
- Model 301 Complete Transcription Turntable
- Model T Manual Record Player

And the other products of the British Industries Group . . . Britain's finest audio equipment:

- Wharfedale Loudspeakers
- Leak "Point One" Amplifiers
- KT66 Tubes

Always in stock at ALLIED



GROMMES
50.PG AMPLIFIER

A high fidelity single unit amplifier with unusual performance. Power output, 10 watts, 20 watts peak. Distortion at 10 watts, 1% harmonic and 2% intermodulation. Frequency response ± 5 DB., 20 to 20,000 CPS.

PRECISION ELECTRONICS, INC.
9101 KING ST. • FRANKLIN PARK, ILL.

We carry the complete line of Grommes Amplifiers

Always in stock at ALLIED



ST-83 AM-FM Tuner

Prized by Audio Experts

hallicrafters

Hallicrafters High-Fidelity audio components embody the same precision construction and skillful engineering that has made Hallicrafters products world-famous for quality.

ST-83 Tuner • Designed for flawless reproduction, high sensitivity, excellent stability and full dependability. Complete AM-FM coverage. Minimum drift; fully temperature-compensated. U. L. Approved.

A-84 Amplifier • Response ± 1.0 db, 7-100,000 cps. at 10 watts output; harmonic distortion less than 0.25%. True high-fidelity performance. All-triode amplification. High damping factor of 32:1 for maximum fidelity of square wave response. U. L. Approved.

World Famous for Quality

Always in stock at ALLIED

THE *New*
SUPER-ROYAL



BY
Permoflux

The New High Fidelity Speaker with . . .

- PERFECT BALANCE
- WIDE RANGE
- LOW DISTORTION

Available in 8, 12 and 15 inch sizes

Permoflux CORPORATION

4906 West Grand Avenue • Chicago 39, Illinois

Always in stock at ALLIED

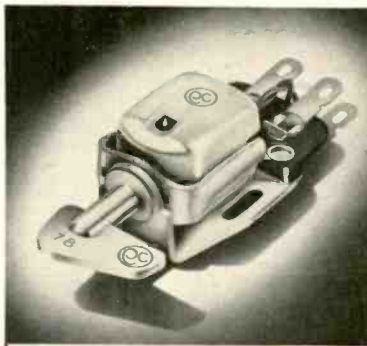

PICKERING

**PROFESSIONAL
AUDIO EQUIPMENT**

- Pickups
- Preamplifiers
- Record Compensators
- Phono-Arms
- Input Systems for Remote Control of Record Playing



Always in stock at ALLIED



\$79.95

A
Sound Investment

PILOTUNER

MODEL AF 723 HI-FIDELITY FM-AM TUNER

FOR ALL LOVERS OF FINE MUSIC

The fabulous **PILOTUNER** adds a new dimension to your listening pleasure. It brings in FM-AM broadcast music with fantastic reality—a full depth, roundness and richness that can only be compared to in-person concert performance. Let the **PILOTUNER** expand your Joy of Listening . . . and Joy of Living. Companion Amplifier and Pre-Amplifier Units available.

ALL PILOT HI-FI PRODUCTS

Always in stock at ALLIED

you'll find
*Everything in
 High-Fidelity*
ALWAYS IN STOCK AT

ALLIED



We carry the world's largest stocks of *all* quality high-fidelity lines and *all* components: amplifiers, reproducers, enclosures, FM and AM tuners, 3-speed phono changers and phono accessories, custom cabinets, etc. Our sound specialists will help you select the proper audio components to satisfy your most critical listening tastes—at substantial savings.



the
 complete
 Hi-Fi
 Buying
 Guide

Write today for our Free complete 268-page Catalog listing the world's largest selection of High-Fidelity systems and components.

ALLIED RADIO
 100 N. Western Ave., Chicago 80

the *Dorset*

only high fidelity portable unit using
 the **GARRARD**
 world's finest 3 speed
 record changer with
 the GE VARIABLE
 RELUCTANCE
 magnetic cartridge



When the cover is raised it combines with the speaker enclosure to provide a wide dispersal of sound usually associated with large, complex loudspeaker systems. Sturdy base (available at slight extra cost) converts the Dorset from a traveller to a chair-side home music system.

- TONE CONTROL
- RECORD COMPENSATOR
- 6-TUBE HIGH FIDELITY AMPLIFIER
- 8" HIGH FIDELITY LOUDSPEAKER

DORSET HIGH FIDELITY UNITS

—Always in stock at ALLIED—



Stromberg-Carlson
 "CUSTOM FOUR HUNDRED"
 25-WATT HIGH FIDELITY
 AMPLIFIER "AR-425"

This deluxe amplifier enables you to realize the full capabilities of the finest speakers. Frequency response—20-20,000 cps \pm 1/2 db.

—We handle all component parts of the Stromberg-Carlson "Custom Four Hundred" High Fidelity Series. "There's Nothing Finer Than a Stromberg-Carlson."

Ask for Bulletin SED 40-71 for complete engineering data.

—Always in stock at ALLIED—

**RCA Intermatched
 HIGH-FIDELITY**

... a Complete Line of
 Quality
 Components



Featuring the Olson
 LC-1A Speaker — the
 measure of perfection

★
 With its wide background in all phases of professional quality sound, RCA has designed a complete selection of high-fidelity equipment that will satisfy the most critical music lover. All component units have been carefully intermatched for maximum performance, and the many possible combinations can be made to meet any individual listening needs.

Hear the thrilling extended-range reproduction of RCA'S new Intermatched systems in our studios today.

—Always in stock at ALLIED—

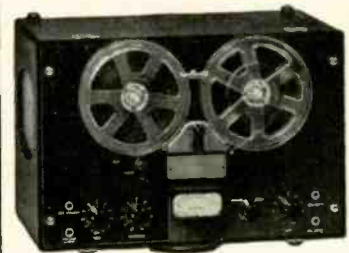

tapeMaster

**PROFESSIONAL QUALITY
 HIGH FIDELITY PORTABLE
 TAPE RECORDERS**

Model HF-500. Professional Single Speed.....Net \$279.50

Model HF-200. Similar but Dual Speed.....Net \$227.50

Model PT-150. Self-Contained Dual Speed.....Net \$124.50

Model PT-150A. Improved Model PT-125.....Net \$109.50

Model 10VU Meter. Net \$17.00
 Model 10LVU Meter. Net \$19.00

TapeMaster, Inc., Chicago 10, Ill.

—Always in stock at ALLIED—



REK-O-KUT

for Precision Turntables

TURNTABLES

3-speed LP-743 12" 33 $\frac{1}{3}$, 45, and 78 rpm., Induction Motor.

3-speed B-16H 16" 33 $\frac{1}{3}$, 45, and 78 rpm., Hysteresis Motor.

2-speed T-12H 33 $\frac{1}{3}$ and 78 rpm., Hysteresis Motor.

2-speed T43H 33 $\frac{1}{3}$ and 45 rpm., Hysteresis Motor.

PORTABLE HIGH FIDELITY PHONOGRAPHS

Recitalist: equipped with 3-speed turntable available with single or twin speakers.

Rhythmster: equipped with continuously variable speed turntable for tempo control. Available with single or twin speakers.

PORTABLE PROFESSIONAL DISC RECORDER Challenger: 12" recoder driven by hysteresis motor; with playback facilities.

RECORD PLAYERS

Turntable, motor and pickup mounted in attractive, sturdy, carrying case. Choice of 3-speed turntable or continuously variable speed turntable. Play through any radio, TV set or sound system.

Always in stock at ALLIED

GENUINE RIVER EDGE CUSTOM BUILT CABINETS



Complete cabinet line — Kits to consoles — 15 different finishes — Priced \$9.90 to \$400.00—Can be ordered with instrument panels pre-cut — Only a screwdriver needed for quick, easy installation of equipment —

Ask for complete descriptive literature covering these quality cabinets.

Always in stock at ALLIED

★
LEROY W. BEIER
COMPANY

MIDWEST REPRESENTATIVES

MAGNECORD

PICKERING

RADIO CRAFTSMEN

STEPHENS

6518 WEST NORTH AVE.

Chicago 35, Illinois

★
Always in stock at ALLIED

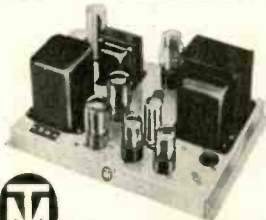

TECH-MASTER

High Fidelity Audio
Amplifier Kits and TV

Top Quality Kits:

- Tech-Master Williamson type Amplifier Kit.
- Tech-Master 4-channel pre-amplifier Kit.
- Tech-Master Gold Medal Series Custom Built DeLuxe TV Chassis, improved 630 type circuit, for picture tubes up to 30".
- Tech-Master Blue Ribbon Series Custom Built Economy TV Chassis for picture tubes up to 24".
- Tech-Master quality Television Kits Model 630D improved 630 type circuit for picture tubes up to 24".
- Tech-Master AC-DC Television Kit.

Famous for precision, quality
and performance

Always in stock at ALLIED

Everything IN LOUDSPEAKERS! University



CONE
SPEAKERS



TWEEETERS



PROJECTORS



ENCLOSURES

DEMAND THE BEST!

Look to University for the optimum in acoustic reproducer quality. There is a superior University cone speaker, tweeter, and enclosure for every high fidelity requirement . . . trumpets and drivers for all P.A. needs . . . for best reproduction results select University.

Always in stock at ALLIED

RADIO MAGAZINES, INC.

Publishers of

AUDIO ENGINEERING

and

THE AUDIO ANTHOLOGIES

sincerely congratulates

ALLIED RADIO

on the expansion of its
services and facilities
to the Hi-Fi Market

★

AUDIO ENGINEERING

and

THE AUDIO ANTHOLOGIES

Always in stock at ALLIED

THE AUDIO FAIR-1953

Directory of Exhibitors

WITH MORE THAN 100 exhibitors readying their rooms for the fifth Audio Fair, every audio engineer, hobbyist, experimenter, and music lover in the New York area is straining at the ropes waiting for the opening day—October 14—and many more thousands will be coming from afar to visit the largest and most interesting event of the audio year.

The year 1953 has been the greatest—so far—in the history of high-quality sound reproduction, and the *high-fidelity*

“craze” has hit with a considerable impact. And while there are many products labeled *high-fidelity* which do not honestly deserve such a label, there are still plenty of truly-high-quality amplifiers, speakers, tuners, and other components. The purpose of the Audio Fair is to give everyone an opportunity to see and hear what is new. The exhibitors listed below and on the following pages are those who had furnished the information by press time—undoubtedly several others will have made plans to

exhibit before the opening day. Note the time and place—

When: October 14, 15, 16, and 17, 1953
Where: Hotel New Yorker, New York City

Registration on 5th, 6th, and 7th floors.

Exhibit Hours

Wednesday ... 11:00 a.m. to 9:00 p.m.
Thursday 10:00 a.m. to 6:00 p.m.
Friday 10:00 a.m. to 10:00 p.m.
Saturday 10:00 a.m. to 5:00 p.m.

ACRO PRODUCTS COMPANY 515

369 Shurs Lane, Philadelphia 28, Pa.
Products: Acrosound Ultra-Linear transformers, Acrosound Ultra-Linear amplifier circuits.

IN ATTENDANCE

David Hafler Herbert I. Keroes
Gertrude Hafler Harold P. Blumenstein

ALPHA WIRE CORPORATION 639

430 Broadway, New York 13, N. Y.
Products: Wire and cable.

IN ATTENDANCE

Peter Bercoe Donald Rappaport
A. E. Bernardik D. Litt
Howard B. Saltzman Andrew Coy
Samuel Schaeffer Nat Frost
Sidney Manners Max Harts

ALTEC LANSING CORPORATION 619

161 Sixth Ave., New York 13, N. Y.
Products: High-fidelity home music equipment, consisting of AM-FM tuners, power amplifiers, remote preamplifiers, Duplex loudspeakers, and 820A corner speaker system. Also will be shown other important sound products used in public address, such as microphones, amplifiers, loudspeakers and Peerless transformers for custom construction of high-quality amplifiers.

IN ATTENDANCE

A. A. Ward C. S. Perkins
J. K. Hilliard R. W. Kautzky
H. S. Morris J. J. Connolly
W. H. Hazlett Tom Gallatin
L. D. Netter, Jr. R. W. Griffiths
M. N. Wolf A. E. Byers
R. E. Pierce

AMPEX ELECTRIC CORPORATION 542

934 Charter Street, Redwood City, Calif.
Products: Magnetic tape recorders and reproducers.

IN ATTENDANCE

Harrison Johnston Jules Joslow
Russell J. Tinkham Robert Sackman
Phillip N. Gundy James A. Ford
Charles Wirth

AMPLIFIER CORP. OF AMERICA 622

398 Broadway, New York 13, N. Y.
Products: Magnetic tape recorders; amplifiers.

IN ATTENDANCE

N. M. Haynes Clarence Westlake
E. Epstein William Lutter
Max Ellis Walter Bernadski
Frank Kosinski Eileen Drasin
Tony Gillette Harriet Marcus
Ernest Heller Jerry Rosenthal

AMPRO CORPORATION 716

2835 N. Western Ave., Chicago 18, Ill.
Products: Tape recorders, magnetic-optical 16-mm projectors.

IN ATTENDANCE

Howard Marx William Mullen
Howard Handweg Robert Saichek
C. Richard Smith

ANGLE GENNESEE CORPORATION 506

107 Norris Drive, Rochester, N. Y.
Products: Custom-built cabinets for hi-fi equipment—oak and mahogany.

IN ATTENDANCE

Charles E. Angle Harold L. Charles
H. Wilder Clapp James H. Brooks
L. P. Lucleer

ARROW ELECTRONICS, INC. 541

82 Cortlandt St., New York 7, N. Y.
Products: High-fidelity audio equipment

IN ATTENDANCE

Charles Ray Fred Steiner
Oscar Kraut Walter Berk
Jack Kufeld

ASCO SOUND CORPORATION 643

115 W. 45th St., New York 36, N. Y.
Products: Distributors of high-fidelity sound equipment; custom-built music systems for home, industry, schools, institutions, and professional studios; industrial speech reinforcement systems designed and installed. Custom-built furniture cabinets for sound equipment, wall units, special design units and restoration of existing units.

IN ATTENDANCE

Irving Greene Ruth Gershon
Ozzie Reiter Joseph Gshar
Gerry Macdonald

AUDAK COMPANY 629

500 Fifth Ave., New York 36, N. Y.
Products: Audio-electronic apparatus.

IN ATTENDANCE

Maximilian Well Al. Weberg
G. V. Sullivan Peter Boch

AUDIO DEVICES, INC. 651

444 Madison Ave., New York 22, N. Y.
Products: Recording discs, AUDIODISCS* magnetic recording tape, AUDIOTAPE* magnetic recording film, AUDIOFILM* recording and playback styli, AUDIO-POINTS.
* Trade Mark.

IN ATTENDANCE

William C. Speed Roderick L. Hickey
Bryce Haynes David S. Gibson
Herman Kornbrodt

AUDIO ENGINEERING SOCIETY 617

P.O. Box 12, Old Chelsea Station, New York 11, N. Y.

IN ATTENDANCE

Officers and Governors of the Society.

AUDIO EXCHANGE, INC. 735

159-19 Hillside Ave., Jamaica 32, N. Y.
Products: Audio and high-fidelity equipment.

IN ATTENDANCE

William Colbert Miriam Colbert
John Colbert

AUDIO & VIDEO PRODUCTS CORPORATION 611-612-614-615

730 Fifth Ave., New York 19, N. Y.
Products: Magnetic tape equipment; tape recording accessories; custom installations; tape libraries; electronic components.

IN ATTENDANCE

Charles E. Rynd Robert D. Winston
Kenneth B. Boothe Philip Erhorn
Thomas J. Merson Jerry Levy
Joseph F. Hards Howard Lawrence

THE AUDIO FAIR 627

67 West 44th St., New York 36, N. Y.

IN ATTENDANCE

Harry N. Reizes Jack N. Schneider
David Saltman Claire Grosfeld
Harold Weisner

AVCO MANUFACTURING CORPORATION 706

Appliance and Electronics Division

1329 Arlington St., Cincinnati 25, Ohio.
Products: High-fidelity and remote control television displays.

IN ATTENDANCE

L. F. Cramer J. M. Farrell
H. E. McCullough R. K. White
C. F. McGraw

BEAM INSTRUMENTS CORPORATION 520-521

350 Fifth Ave., New York 1, N. Y.
Products: Tannoy Dual-concentric speakers and enclosures; acoustical Q.U.A.D. amplifiers and control units; Goodmans industrial and replacement speakers; sterling audio wires and cables; cossor portable oscilloscope.

IN ATTENDANCE

T. Robinson-Cox J. S. Clark
T. R. Sheron P. Walker
J. Alan Biggs M. H. Fountain
R. W. Havliand P. Livingstone
E. Judels F. Keenan

BELL SOUND SYSTEMS, INC. 524

555 Marion Road, Columbus 7, Ohio
Products: High-fidelity amplifiers; tape recorder; disc recorders; speakers.

IN ATTENDANCE

F. W. Bell S. C. Martin
H. H. Seay, Jr. W. E. Williams
E. D. Sisson



This brand new baseball glove, pre-oiled and deep-pocketed, needs no breaking in.



This new reel of SOUNDCRAFT Tape, Micro-Polished at the factory, needs no breaking in.

Now! a "Broken In" Tape

Exclusive SOUNDCRAFT Micro-Polished Tape
Gives Stable High Frequency Response right from the start*

In the past, all *new* reels of Magnetic Recording Tape had surface irregularities and protuberances (oxide nodules) on the ferrous oxide surface. These irregularities and nodules caused imperfect head contact and a subsequent loss in high frequency response, *until the tape surface was worn smooth by the recording head*. This is the reason for the widespread professional practice of "breaking in" a new reel of tape. This is why engineers run new tape through the recorder a number of times *before recording*, wasting time and effort, and causing undue wear of the recording head.

ONLY SOUNDCRAFT TAPE IS MICRO-POLISHED

There is no break-in period needed with SOUNDCRAFT Tape. *Because all SOUNDCRAFT Tape is Micro-Polished*. This exclusive process pre-conditions SOUNDCRAFT Tape *before it leaves the plant*. Micro-Polishing subjects the ferrous oxide coating

to high mechanical stresses. It produces a mirror-smooth tape surface. It achieves *immediate* stable high frequency response. And it allows new tape to be interspersed with tape that has already been used.

OTHER SOUNDCRAFT FEATURES

Not only is Soundcraft Recording Tape Micro-Polished, but it is also endowed with the following features developed by Soundcraft research engineers.

PRE-COATING to insure better adhesion, prevent curling and cupping —

DRY LUBRICATION to eliminate squeals —

SPLICE-FREE guarantee on all 1200' and 2500' reels.

Why settle for less than the best?

Next time, insist on Soundcraft Recording Tape.

It's Micro-Polished!

REEVES
SOUNDCRAFT
CORP.

10 East 52nd St., Dept. B-10, N. Y. 22, N. Y.



*Pat. Applied For.

The NEW

Custom DC-AC CONVERTER by Carter



Delivers MORE Power for PROFESSIONAL Use

These latest-of-all Carter DC to AC Converters are specially engineered for professional and commercial applications requiring a high capacity source of 60 cycles AC from a DC power supply. Operates from storage batteries or from DC line voltage. Three "Custom" models, delivering 300, 400, or 500 watts 115 or 220 V. AC. Wide range of input voltage, 12, 24, 32, 64, 110 or 230 V. DC. Unequaled capacity for operating professional recording, sound movie equipment and large screen TV receivers. Available with or without manual frequency control feature.



HOW LEADING NETWORKS USE CARTER CONVERTERS

Photo shows Tommy Bartlett, star of NBC "Welcome Travellers" program, aboard N.Y.C. R.R. "Twilight Limited." His Carter "Custom" Converter makes recording possible on board the train, from regular train current converted to 110 V. A.C. Radio networks, stations, program producers use Carter Converters for all sorts of on-the-spot recording.

MAIL COUPON FOR CATALOG

Carter Motor Co.
2648 N. Maplewood Ave.
Chicago 47



Carter Motor Co.
2648 N. Maplewood Ave., Chicago 47
Please send new catalogs containing complete information on Carter "Custom" Converters and other Rotary Power Supplies.
Name _____
Address _____
City _____ State _____

BERLANT ASSOCIATES 532
4917 W. Jefferson Blvd., Los Angeles 16, Calif.
Products: Concertone magnetic tape recorders and accessories.

IN ATTENDANCE

Emmanuel Berlant Paul Lettl
Harlan Thompson Richard Hoskin
Gertrude Sands

DAVID BOGEN CO. INC. 632

29 Ninth Ave., New York 14, N. Y.
Products: High-fidelity amplifiers; AM-FM tuners; AM tuners; FM tuners; AM-FM receivers; equalizers; loudness contour control; transcription players; radio console cabinets; intercoms.

IN ATTENDANCE

Lester H. Bogen A. M. Zuckerman
Mortimer S. Sumberg Vinton K. Ulrich
David E. Pear

THE R. T. BOZAK COMPANY 648

114 Manhattan St., Stamford, Conn.
Products: High-quality loudspeakers.

IN ATTENDANCE

R. T. Bozak C. F. Bogart
L. F. Bozak

BRITISH INDUSTRIES CORP. 650-652-653

164 Duane St., New York 13, N. Y.
Products: Garrard record changers and phono equipment; Leak "point-one" amplifiers; Wharfedale speakers; RJ audio products; KT66 tubes; and other high-quality audio components.

IN ATTENDANCE

Leonard Carduner Harold J. Leak
Franklin S. Hoffman G. A. Briggs
William Carduner Morton Lee
Eugene Carduner

**BROCINER ELECTRONICS
LABORATORY** 523

1546 Second Ave., New York 28, N. Y.
Products: Model 4 corner horn; Transcendent 3-way corner reproducer; model A100 preamplifier-equalizer; model CA2 control amplifier; model UL-1 power amplifier; and new products now under development.

IN ATTENDANCE

Victor Brociner A. Stewart Hegeman

BROOK ELECTRONICS, INC. 511

34 DeHart Place, Elizabeth 2, N. J.
Products: Brook high-quality audio amplifiers.

IN ATTENDANCE

Lincoln Walsh Ann F. Hall
Max Baume

BROWNING LABORATORIES, INC. 645

750 Main St., Winchester, Mass.
Products: FM & AM-FM tuners.

IN ATTENDANCE

G. H. Browning S. S. Egert
R. L. Purrington Jack Fields
R. E. Lonnerberg J. Mandel

CONRAC, INC. 721

19217 E. Foothill Blvd., Glendora, Calif.
Products: Fleetwood television chassis.

IN ATTENDANCE

W. I. Moreland R. M. Alston

COOK LABORATORIES, INC. 649

Route 2, Stamford, Conn.
Products: Cook Laboratories "Sounds of Our Times" recordings; test recordings; binaural pre-amplifier.

IN ATTENDANCE

Emory Cook Michael Adrian
Bob Bollard

COWAN PUBLISHING CORP. 627

67 West 44th St., New York 36, N. Y.
Products: Radio-Television Service Dealer; CQ—The Radio Amateurs' Journal; Video Speed Servicing Systems; Radio Amateurs' Mobile Handbook.

IN ATTENDANCE

Sanford R. Cowan Oliver P. Ferrell
Sanford L. Cahn Samuel L. Marshall
Harry N. Reizes Harold Weisner
Jack N. Schneider

DAYSTROM ELECTRIC CORPORATION 703
Crestwood Recorder Division

837 Main St., Poughkeepsie, New York
Products: Magnetic tape recorders.

IN ATTENDANCE

J. F. Brehm F. L. Randell
C. R. Frost H. H. Hanlon

DuKANE CORPORATION 507

St. Charles, Illinois
Products: DuKane "True-Fidelity" tape recorders.

IN ATTENDANCE

R. L. Shoemaker H. M. Jaffe
R. W. Wilson J. N. Cooper

DUOTONE COMPANY, INC. 705

Locust Street, Keyport, New Jersey
Products: Hi-fidelity speakers, microphones, diamond phonoGraph needles, electro-wipe cloth, recording tape, adapters, recording blanks, recording heads.

IN ATTENDANCE

Stephen Nester Lee Rocke
Mrs. Stephen Nester Tom Marciano
Benjamin Rosenberg

ELECTRO-VOICE, INC. 626

Cecil & Carroll Streets, Buchanan, Michigan
Products: Standard Ultra-Linear high-fidelity ceramic cartridges; crystal and ceramic phono-pickups and cartridges; broadcast, public address, recording, communications amateur, and special purpose microphones; high-fidelity, full-range loudspeakers; low-, mid-, high-, and super-high-frequency drivers; cellular and diffraction horns; crossover networks; speaker enclosures; broadband television boosters and distribution systems; public address loudspeakers; equipment consoles; compound diffraction projectors and accessories; UHF converters.

IN ATTENDANCE

Albert Kahn Howard Souther
Lawrence LeKashman Eugene Carduner
A. M. Wiggins S. Fleischman
Howard Durbin S. Holt

ESPEY MANUFACTURING CO., INC. 634-635

409 Grand Ave., Englewood, N. J.
Products: High-fidelity AM-FM receivers, tuners, and amplifiers.

IN ATTENDANCE

Nathan Pinsley Dave Levine
Sol Pinsley Sylvan A. Wollin
Edward Robinson Bert Kohl
Paul Ash

**FAIRCHILD RECORDING EQUIPMENT
CORP.** 526

154th St. & 7th Ave., Whitestone, N. Y.
Products: Pickup cartridges, transcription arms, transcription tables, preamplifier equalizers, power amplifiers, input transformers.

IN ATTENDANCE

Jay H. Quinn C. V. Kettering
Ray F. Crews Robert Marshall
O. L. Seda

FERRANTI ELECTRIC, INC. 718

30 Rockefeller Plaza, New York 20, N. Y.
Products: Pickups, Transformers.

IN ATTENDANCE

R. H. Davies W. W. Weiss
M. J. Pope M. Dellerson

**EVERYBODY
HAS BEEN
WAITING FOR IT!**



**NOW . . .
IT'S HERE!**



**THE BIGGEST
AUDIO and HI - FI
EVENT OF THE YEAR!**



SPONSORED BY



IN CONJUNCTION
WITH ITS
FIFTH ANNUAL
CONVENTION



AUDIORAMA
is presented by
THE AUDIO FAIR

HARRY N. REIZES
Managing Director
67 W. 44 St., N. Y. C.

An Audio Fair - Video Fair, Inc., Project

AUDIORAMA 1953

5th Anniversary of THE AUDIO FAIR

You and over 20,000 other Broadcast Engineers, Government and Military Agencies, Recordists, Sound-On-Film Men, Hobbyists, High Fidelity Enthusiasts, and Distributors and Dealers of quality audio and high fidelity equipment as well as just plain lovers of good music reproduction will be treated to the most exciting experience in sight and sound.

YOU WILL SEE AND HEAR

for the first time, units representing the latest up-to-the-minute developments in sound reproduction.

YOU WILL SEE AND HEAR

more equipment devoted to quality sound reproduction than has ever before been assembled under one roof.

YOU WILL SEE AND HEAR

the remarkable components which are giving new meaning to music enjoyment in the American home which has set a new standard in American culture.

A new popular interest has arisen . . . and it is spreading like wildfire across the face of the land! Hi-Fi is rapidly becoming the most talked-about pleasure in human experience.

This Is Your Show . . . it is run for your benefit . . . for you to see and to hear . . . for you to experience, appraise and pass judgement . . . therefore, you pay

NO ADMISSION CHARGE

NOTE THE TIME AND PLACE
WHEN: October 14, 15, 16, 17, 1953
WHERE: Hotel New Yorker, New York City

Registration on 7th, 6th and 5th Floors

EXHIBIT HOURS

Wednesday, Oct. 14	11:00 A.M. to 9:00 P.M.
Thursday, Oct. 15	10:00 A.M. to 6:00 P.M.
Friday, Oct. 16	(AES Banquet at 7:30 P.M.)
Saturday, Oct. 17	10:00 A.M. to 10:00 P.M.
	10:00 A.M. to 5:00 P.M.

NEW, CUSTOM ENGINEERED G-E EQUIPMENT OFFERS

HI-FI SOUND REPRODUCTION

—WITHIN EVERY BUDGET!



Dual Coaxial Speaker A1-400
New design. Exceptional balance between speakers. Features revolutionary Pressure Equalizer.



Preamplifier-Control Unit A1-200
Self-powered. Equalized pre-amp functions plus adjustable record compensation, program input, etc.



Power Amplifier A1-300
Medium Power, compact. Essential ensemble element.



Deluxe Tone Arms:
A1-500 (12")
A1-501 (16")
Home or broadcast use. Calibrated stylus Pressure adjustment... 4 to 14 grams.



Speaker Enclosure A1-406
Attractive corner or wall cabinet in hand-rubbed blond or mahogany veneers. Also unfinished.



Custom Music Ensemble

An entirely new approach to sound realism. Full, rich response of the complete tonal range results from blending ideally matched components! And... at low G-E prices... those with either a professional or a lay interest can now experience the thrill and excitement of music as it was originally recorded!

Improve the quality of your present installation with these fine instruments or design a home system with the complete ensemble as its heart. G-E units include: Coaxial Speaker, Amplifier, Pre-amp Control, Deluxe Tone Arms and Speaker Enclosure. Write today for available literature and the name of your nearest General Electric distributor.

General Electric Co., Section 44103
Electronics Park, Syracuse, N. Y.

Please send me complete information on the new G-E Custom Music Ensemble.

NAME _____
ADDRESS _____
CITY _____ STATE _____

GENERAL ELECTRIC

FISHER RADIO CORP. 529

45-41 Van Dam St., Long Island City 1, N. Y.
Products: The Fisher model 50-A amplifier, model 50-C master audio control, and model 50-R FM-AM tuner.

IN ATTENDANCE

Avery R. Fisher	Henry Mandler
Bennett Arons	George Meyers
George Maerke	Leonard Feldman
James J. Parks	Sam Dugin
Walter O'Donnell	Kay Wyman
Paul Braun	Joan Waller

GATELY DEVELOPMENT LABORATORY 742

Barrington, N. J.
Products: The "Super Horn" corner type folded horn loudspeaker enclosure; and the "Purest," a folded horn not requiring corner location.

IN ATTENDANCE

Edward J. Gately, Jr.	Nancy S. Gately
Thomas A. Benham	Jerry Landis

GATES RADIO COMPANY 618

123 Hampshire St., Quincy, Ill.
Products: Audio equipment, including new model CC-1 ten-position audio control console, especially designed for TV use. Gates remote equipment, including the model CB-60 Dynamote. Plug-in audio amplifiers.

IN ATTENDANCE

John Haerle	E. J. Wilder
-------------	--------------

GENERAL ELECTRIC COMPANY 531

Electronics Park, Syracuse, N. Y.
Products: Phono accessories and high-fidelity products.

IN ATTENDANCE

T. J. Nicholson	F. Beguin
Mark Woodworth	P. E. Humphreys
Roy Dally	

SAM GOODY 508

235 W. 49 St., New York 19, N. Y.
Products: Speakers, enclosures, turntables, amplifiers, tuners, records.

IN ATTENDANCE

Morris Lichtman	Norman G. Long
Newton A. Chanin	

GRAY RESEARCH & DEVELOPMENT COMPANY 503

658 Hilliard St., Manchester, Conn.
Products: Transcription arms and equalizers; audio systems; A-20 graph dictating machines.

IN ATTENDANCE

C. B. Hayes	N. F. Smith
C. Snow	

THE HALLICRAFTERS COMPANY 504

4401 W. Fifth Ave., Chicago 24, Ill.
Products: Hi-fidelity tuners and amplifiers; AM-FM radios.

IN ATTENDANCE

Wm. J. Halligan, Jr.	Fritz A. Franke
John R. Halligan	Wm. Brown

H. A. HARTLEY CO., INC. 533

521 E. 162nd St., New York 51, N. Y.
Products: Amplifiers, speakers, phono equipment, tuners, cabinets.

IN ATTENDANCE

H. A. Hartley	Robert Schmetterer
---------------	--------------------

HARVEY RADIO COMPANY, INC. 631

103 W. 43rd St., New York 36, N. Y.
Products: Distributors for complete high-fidelity home music systems and components; tape recorders; radio parts and broadcast supplies.

IN ATTENDANCE

Harvey E. Sampson	Abe Koblun
Ray Neusch	James Carroll

AUDIO engineering society

APPLICATION
FOR
MEMBERSHIP

P. O. Box 12, Old Chelsea Station, New York 11, N. Y.

I desire { admission into } the Audio Engineering Society. Grade desired

.....
Print or Type Name in Full

Born at
City State Country Date Age

Residence
Street City State

Mail Address
Street City State

Occupation
Position Name and Address of Concern

Present Duties
State in Detail (Students give school and course)

Past Experience
Give Companies, Years, and Positions

Member of Other Societies
Give Names or Abbreviations, and Grade of Membership

EDUCATION

SCHOOL ATTENDED	FROM	TO	COURSE	DEGREE

ADMISSION REQUIREMENTS

A Member, according to the constitution, may be any person active in audio engineering who has an academic degree or its equivalent in scientific or professional experience in audio engineering or in a closely related field or art. Such a person shall, upon election, be entitled to all the rights and privileges of the Society.

An Associate Member may be any person interested in the objectives of the Audio Engineering Society and, upon election, shall become entitled to all the rights and privileges of the society except the right to vote or to hold office or chairmanship of standing committees.

A Student Member may be any student interested in audio engineering and enrolled in a recognized school, college or university. A student member is not eligible to vote or to serve on committees except in his own local chapter.

Three references are required with application for the member grade, two for associate membership and one for student membership. References should be familiar with your work; they need not be members. Yearly dues are \$7.50 for member, \$6.00 for associate and \$3.00 for student, each of which is halved if the date of application is between April 1st and September 30th.

Payment must accompany application, and application must be signed to expedite handling.

REFERENCES

Name	Company and Address	Title or Position
1.		
2.		
3.		

.....
Signature of Applicant

PLEASE DO NOT WRITE IN THIS SPACE							
Application Received	Amount Received	Application to Admissions Committee	Dues Payment to Treasurer	Application Approved by	Date Approved	Membership Card	Past Papers

**HAVE YOUR OWN
COMPLETE HiFi
SYSTEM
AT MODERATE COST**

**AVAILABLE
NOW!**



START NOW WITH THE

Crestwood 400's

At right—Model 401
(Recorder-Preamplifier) \$199.50*

Not shown—Model 402
(Power Amplifier-Speaker) \$100.00*

*Taxes not included. Prices slightly higher in Mountain and West Coast States.

HERE'S HOW! The Crestwood 401 is an extremely stable tape recorder (wow and flutter less than 0.3%) with a full fidelity preamplifier (frequency response 30-13,000-cycles \pm 2db). It has separate inputs for microphone, radio-TV and phonograph, which are connected to a selector switch.

The Crestwood 402 is a high impedance input, 10 watt power amplifier (frequency response 20-20,000 cycles \pm 2db) with an 8" extended range dynamic speaker, specially housed to produce exceptional frequency response for a compact unit.

IT'S EASY! With Crestwood models 401 and 402, here's all you do to complete your HiFi system:

1. AM-FM tuner (of your choosing)** is plugged into radio-TV input.
2. Record changer (of your choosing)** is plugged into phono input.

Both may be permanent installations because of the selector switch, which allows choice of inputs or tape playback.

**Certain AM-FM tuners and magnetic pickups may require special handling. Information supplied on request.

YOUR HI-FI SYSTEM IS READY TO USE! By use of the selector switch you can listen to either radio or records. And, by merely pressing the Record button, whatever you're listening to will be instantly recorded on tape—accurately, faithfully, just as you're hearing it! The same selector switch controls microphone input, allowing your own program arrangement.

CAN BE USED WITH PRESENT SYSTEM, TOO! The Crestwood 401 is an excellent unit to fit into your present HiFi system. Full fidelity and complete dependability.

FEATURES INCLUDE

- FULL FIDELITY
- SEPARATE MONITOR AND RECORD VOLUME CONTROLS
- EXCEPTIONALLY SHARP MAGIC EYE
- RECORD VOLUME INDICATOR
- SIMPLICITY OF OPERATION

**SEE YOUR DEALER
FOR FULL INFORMATION
OR
SEND COUPON**

Crestwood
BY DAYSTROM
TAPE RECORDERS
Open a Brand New
World of Recorded Sound

Crestwood Division of Daystrom Electric Corp.
Dept. AE-10, Poughkeepsie, N. Y.

Please send complete information on the new Crestwoods.

Am interested in setting-up my own HiFi system.

Am interested in HiFi tape recorder only.

Name

Address

City.....Zone.....State.....

Hear and see this HiFi system, and the complete Crestwood line, at the Audio Fair, N. Y. C., October 14-17, Room 703 in the Hotel New Yorker.

HIGH FIDELITY MAGAZINE 552-553

The Publishing House, Great Barrington, Mass.
Products: High Fidelity magazine; Hi-Fi Sales and Service; Communication Engineering; TV & Radio Engineering.

IN ATTENDANCE

Milton B. Sleeper John Conly
Charles Fowler Warren Syer
Roy Allison

HUDSON RADIO & TELEVISION CORP. 736

48 W. 48th St., New York 36, N. Y.
Products: Standard high-fidelity equipment.

IN ATTENDANCE

Roy Bellinson Jack Lee
Harold Weinberg Sidney Krinitz
Herman Holstein Irving Berger
Norman Berke Arnold Schwager
Lester Klein Mike Berman

JENSEN MANUFACTURING COMPANY 518-519

6601 S. Laramie Ave., Chicago 38, Ill.
Products: Single-unit, coaxial, and triaxial loudspeakers; complete reproducers; three-way system components; low- and high-frequency units ("woofers" and "tweeters"); crossover and filter networks; level controls; transformers; back-loading folded-horn and bass-reflex cabinets; commercial sound equipment.

IN ATTENDANCE

Chas. A. Hansen Horace L. White
Karl Kramer Louls W. Selsor

THE KELTON COMPANY, INC. 534-535

958 Massachusetts Ave., Cambridge 39, Mass.
Products: Complete hi-fidelity home music systems; loudspeaker enclosures; phonographs; amplifiers; record changers and cartridges—FM Component.

IN ATTENDANCE

Albert E. Bachmann Bernard Edelman
Henry C. Lang George Hartstone
Thomas F. Murphy James Lynch
John R. Thornton

KINGDOM PRODUCTS, LTD. 737

45 W. 45th St., New York 36, N. Y.
Products: KT66 tubes; Lorenz speakers; Portable Gramophone; hi-fi equipment and components.

IN ATTENDANCE

Adolph L. Gross

KLIPSCH EASTERN, INC. 734

420 Madison Ave., New York 17, N. Y.
Products: The Klipschorn and the Rebel, loudspeaker systems, cabinets, and auxiliary equipment.

IN ATTENDANCE

Paul W. Klipsch Eugene Altman
L. McCandless N. Norman
C. A. Paquin C. Farbach
E. P. McQueen

KLOSS INDUSTRIES 714

10 Arrow St., Cambridge 38, Mass.
Products: Baruch-Lang corner loudspeaker systems.

IN ATTENDANCE

Henry E. Kloss J. A. Hofmann

LANGVIN MANUFACTURING CORPORATION 502

37 W. 65th St., New York 23, N. Y.
Products: Langevin audio amplifiers; Langevin broadcast audio equipment; Langevin transformers.

IN ATTENDANCE

Leo G. Sands Paul C. Marrone
F. K. Hankinson Donald S. Morgan
F. J. Neidig George H. Grenier
Leroy Bremmer Nathan Paulson
W. W. Dean

JAMES B. LANSING SOUND, INC. 731

2439 Fletcher Dr., Los Angeles 39, Calif.
Products: Loudspeakers.

IN ATTENDANCE

William H. Thomas George F. Halkides

LEONARD RADIO, INC. 536-537

69 Cortlandt St., New York 7, N. Y.
Products: Radio Craftsmen, Bell, Brook, Jensen, Electro-Voice, H. H. Scott, Weathers, Bogen, Browning, Garrard, V-M, Pentron, Concertone, Presto, Duotone, Stephens, Altec, Newcomb, Wharfedale, Audak, Pickering, Fairchild, G. E., Clarkstan, Brook, Pilot, Hallerafters, Tannoy, Federsens, Bozak, and all related high-fidelity audio equipment.

IN ATTENDANCE

Leonard Levy Bernard Bernstein
 Lawrence J. Silverman Bill Barman
 Sidney Schugar Leonard Weiner
 Ellis Rosen Sam Lewis
 Norman Sanders

LIVINGSTON ELECTRONIC CORPORATION 647

Livingston, N. J.
Products: Monaural and binaural reproducer arms; recordings and associated equipment.

IN ATTENDANCE

C. E. Smiley John Hall
 R. W. Smiley

MADISON RADIO SOUND 646

Main St., Madison, N. J.
Products: Amplifiers.

IN ATTENDANCE

John Nigro Burton Smith

MAGNECORD, INC. 604-605

225 W. Ohio St., Chicago 10, Ill.
Products: Professional magnetic tape recording equipment for home, broadcast, industrial research and educational markets. Pre-recorded tape library of classical music, etc.
 Trade Names: MAGNECORDER; MAGNECORDETTE; VOYAGER.

IN ATTENDANCE

R. S. McQueen Harry Miller
 Wm. Blocki J. S. Boyers

JEFF MARKELL ASSOCIATES 608

108 W. 14th St., New York 11, N. Y.
Products: Cabinets for residential audio systems.

IN ATTENDANCE

Jeff Markell Mary Hooker

H. S. MARTIN & COMPANY 505

1916 Greenleaf St., Evanston, Ill.
Products: High-fidelity amplifier; preamplifier; FM-AM tuners.

IN ATTENDANCE

C. J. Saberson Harry Olson
 John Clark

McINTOSH LABORATORY, INC. 516

320 Water St., Binghamton, N. Y.
Products: High-fidelity audio amplifiers.

IN ATTENDANCE

Frank McIntosh Gordon Gow
 Harry Miller

MEASUREMENTS CORPORATION 527

Boonton, New Jersey
Products: Electronic test equipment including intermodulation meters, pulse generators, square wave generators, standard signal generators, television signal generators, UHF radio noise and field strength meter, peak voltmeters, R.F. attenuators, megacycle meters, vacuum-tube voltmeters, special test instruments.

IN ATTENDANCE

Harry W. Houck Nelson C. Doland, Jr.
 Jerry B. Minter Ronald C. Pittenger
 John M. van Beuren

MINNESOTA MINING & MFG. CO. 550

900 Fauquier Ave., St. Paul 6, Minn.
Products: "Scotch" brand magnetic tape and accessories.

IN ATTENDANCE

Paul W. Jansen W. F. Enright
 J. J. McDonald P. B. Van Deventer
 Dan Denham



THE FISHER HI-LO FILTER SYSTEM • MODEL 50-F

FISHER

Hi-Lo Filter System

■ Here it is at last—America's first electronic *sharp cut-off* Filter System. Suppresses turn-table rumble, record scratch and distortion, etc., with the *absolute minimum* loss of frequency response. *Separate* low and high frequency cut-offs. Can be used with *any* tuner, preamplifier, amplifier, etc. No insertion loss. Uniform response 20-20,000 cycles, ± 0.5 db. Self-powered. All-triode. Beautiful plastic cabinet. *Only \$29.95*

FISHER

Preamplifier-Equalizer

■ Now, professional record equalization facilities are within the reach of *every* record collector. THE FISHER Model 50-PR, like its big brother (Model 50-C) is beautifully designed and built. *Only \$19.95*

THE FISHER PREAMPLIFIER-EQUALIZER • MODEL 50-PR



New!

PROFESSIONAL
 AUDIO
 EQUIPMENT AT
 LOW
 COST!

OUTSTANDING FEATURES

- Independent switches for low-frequency turnover and high frequency roll-off.
- 16 combinations.
- Handles *any* low level magnetic pickup.
- Hum level 60 db below 10 mv input.
- Uniform response 20-20,000 cycles, ± 1 db.
- Two triode stages.
- Full low frequency equalization.
- Output lead any length up to 50 feet.
- Beautiful plastic cabinet, etched brass control panel.
- Completely shielded chassis.
- Built-in AC switch.
- Jewel indicator light.

Write for full details

FISHER RADIO CORP.
 37 EAST 47th STREET • N. Y.

Klipschorn*



THE STANDARD
FOR WHICH OTHERS STRIVE

The incomparable KLIPSCHORN—as majestic in sound as it is in appearance. From the “ting” of the triangle to the “feel” of the 64-foot organ pipe KLIPSCHORN reproduces the original sound with startling fidelity. There is no compromise in performance, styling, or value in the authentic KLIPSCHORN.

The Rebel*



PERFORMANCE PLUS ECONOMY

KLIPSCH quality at the lowest possible cost—incorporating, of course, the original corner horn concept. Naturally, the KLIPSCHORN and REBEL represent the maximum advances of the art. In other words, traditional KLIPSCH quality.

FOR DETAILS WRITE, WIRE OR PHONE:

KLIPSCH & ASSOCIATES
H O P E • A R K A N S A S

Phones: PProspect 7-3395—7-4538—7-5575—7-5514

*TRADE MARKS

NEWCOMB AUDIO PRODUCTS CO. 623

6824 Lexington Ave., Hollywood 38, Calif.

Products: Home music amplifiers; phonographs; transcription players, public-address equipment.

IN ATTENDANCE

Robert Newcomb Donald Warner

PEERLESS RADIO DISTRIBUTORS, INC. 547

92-32 Merrick Road, Jamaica 33, L. I., N. Y.

Products: David Bogen, Newcomb Audio, Rauland, GE, Electro-Voice, Concertone, Altec Lansing, Brook Electronics, VM, Browning Labs, Radio Craftsmen, Stephens, Pederson.

IN ATTENDANCE

Charles Shankman Frank deCarlo
David Bernstein H. Rousseau
Irving Glickman L. Risman
Leo Gross J. Thomsen
Walter Richman Eliot Finkels
Gus Klavas

PENTRON CORPORATION 711

664 N. Michigan Ave., Chicago 11, Ill.

Products: Tape recorders, tape playback unit, electronic mike mixer, basic tape mechanism, preamplifiers, AM tuner, foot pedal, speaker and baffle, large-reel adaptor, telephone pickup, and other accessories.

IN ATTENDANCE

Irving Rossman Robert Stang
M. M. Bermann Walter Fleischer

PERMOFLUX CORPORATION 640

4900 W. Grand Ave., Chicago 39, Ill.

Products: High-fidelity loudspeakers; speaker enclosures; high-fidelity headphones.

IN ATTENDANCE

L. M. Heineman A. H. Binash
R. S. Penton S. J. Hyman
F. J. Van Alstyne Rudy Napolitan

PICKERING AND COMPANY, INC. 624-625

309 Woods Ave., Oceanside, N. Y.

Products: Magnetic pickups; transcription arms; equalizers; preamplifiers; equalizer-preamplifiers.

IN ATTENDANCE

Walter O. Stanton George P. Petetin

PILOT RADIO CORPORATION 729-730

37-06 Thirty-Sixth St., Long Island City 1, N. Y.

Products: Tuners, amplifiers, converters, and TV chassis.

IN ATTENDANCE

Adolph L. Gross James I. Benjamin
Louis Abels Frank Hajek
S. Sass Sol Ablhook
Richard Shottenfield I. W. Wyckoff
Joseph M. Benjamin

PORTABLE GRAMOPHONE CO., INC. 737

45 W. 45th St., New York 36, N. Y.

Products: KT66 tubes; Lorenz speakers; Portable Gramophone; hi-fi equipment and components.

IN ATTENDANCE

Adolph L. Gross

PRECISION ELECTRONICS, INC. 549

9101 King St., Franklin Park, Ill.

Products: 210PA, 206PA, 215BA, 50PG2, LJ2, and RC-1 amplifiers, and other new products.

IN ATTENDANCE

Wm. S. Grommes L. B. Green
A. A. Hart

PRESTO RECORDING CORPORATION 621

Box 500, Paramus, N. J.

Products: Disc and tape recording and reproducing equipment, lacquer coated aluminum blank recording discs.

IN ATTENDANCE

Thomas B. Aldrich Alfred Jorysz
Austin B. Sholes Thomas Aye
George J. Sallba Henry Geist
M. M. Gruber Michel J. Cudahy

RADIO CORP. OF AMERICA,
RCA VICTOR DIV. 727-728 732-733
829-830

Front & Cooper Sts., Camden 2, N. J.
Products: Hi-fidelity sound equipment;
magnetic recorder-projector.

IN ATTENDANCE

John Hemberger S. A. Caldwell
Daniel Berne Harry Taylor

THE RADIO CRAFTSMEN, INC. 726

4401 N. Ravenswood Ave., Chicago 40,
Ill.
Products: FM-AM tuners; hi-fi amplifiers;
record changer; speaker systems; TV re-
ceivers.

IN ATTENDANCE

John H. Cashman Mitchell Cotter
Lee Hicks Jules Bressler

**RADIO ENGINEERING
LABORATORIES, INC. 720**

38-01 Queens Blvd., Long Island City 1,
Products: REL model 646-C FM tuner.

IN ATTENDANCE

C. R. Runyon, Jr. Ben Tullius
Frank A. Gunther V. E. Brennan
James R. Day George Papanarcos
Joseph Behr Shepard Parker
C. R. Runyon III Paul Gruber
Joseph Tennis Beni Hara

RADIO MAGAZINES, INC. 616

204 Front St., Mineola, N. Y.
Products: AUDIO ENGINEERING; Audio An-
thology; the 2nd Audio Anthology.

IN ATTENDANCE

Henry A. Schober Sanford L. Cahn
C. G. McProud Sanford J. Cowan
Harrie K. Richardson Harry N. Reizes
Edgar E. Newman

RADIO STATION WQXR 539

229 W. 43rd St., New York 36, N. Y.
Products: WQXR programs and promo-
tional material.

IN ATTENDANCE

Mary Rice Anderson Javen Masoomian
Robert Kneiger Robt. Cobaukh
Louis Kleinklaus

RADIO-WIRE-TELEVISION, INC. 543

Lafayette Radio
100 Sixth Ave., New York 13, N. Y.
Products: High-fidelity and recording
equipment.

IN ATTENDANCE

Arthur Wohl M. H. Kranzberg
Murray Pfeffer A. Pletman
Seymour Moed Gerald Russell
Lionel Zimmerman Paul Savell
Robert Murray William Nagata
Joseph Schocken Betty Blank
Harold M. Sperber

REEVES SOUNDCRAFT CORP. 603

10 E. 52nd St., New York 22, N. Y.
Products: Magnetic recording tape; re-
cording blank discs; Magna-Stripe; styli;
magnetic film.

IN ATTENDANCE

Frank B. Rogers, Jr. Thomas J. Dempsey
William H. Deacy William A. Morrison
Donald E. Ward George Bassett

REGENCY DIVISION, 724
Industrial Development Engineering
Associates, Inc.

7900 Pendleton Pike, Indianapolis 26,
Ind.
Products: Regency high-fidelity audio am-
plifier.

IN ATTENDANCE

Edward C. Tudor Ray A. Morris
Richard W. Mitchell R. Gordon Dougherty

REVERE CAMERA CO. 722-723

320 E. 21st St., Chicago 16, Ill.
Products: Complete line magnetic tape
recorders and sound equipment.

IN ATTENDANCE

Les Berger L. Wald

You asked for all the features in this **NEW**
tapeMaster HIGH FIDELITY
PROFESSIONAL TAPE RECORDER



See us at
Room 551
New York
Audio Fair

**Top Professional Quality
Single Speed Model HF-500**
—now at moderate cost, for the
first time!—for Easy Portable or
Fixed Operation with Self-Contained
Speaker or with your Separate Speaker.

COMPARES WITH THE FINEST

Advanced developments by *TapeMaster* make it *easier* and *more economical* now for recordists to enjoy the advantages of professional high fidelity record and playback.

The new *TapeMaster* HF-500 is single speed (7.5" per second). It provides full range response 30 cps to 15,000 cps. Illuminated professional VU meter gives level indication in both record and playback positions. Has internal amplifier and 6" extended range speaker. Can be switched to external amplifier and speaker. Inputs for microphone and radio phono. Uses Brush professional head.

Ideal for broadcast remotes, recording studios, schools and hi-fi enthusiasts. Easily portable in fine grain morocco leatherette case, 19 3/4" x 8 3/4" x 13" high. Operates on 105-125 volt, 60 cycle, AC.

Model HF-500 Tape Recorder, NET..... **\$279.50**

Model HF-200 Tape Recorder. Similar to above, but is dual speed and has magic eye in place of VU meter. Uses Shure wide range head. **Net, \$227.50**

(Prices slightly higher West and South)

Write for
Bulletin 112



Export: Scheel International, Inc.
4237 N. Lincoln Ave., Chicago 18, U.S.A.
Cable: Harscheel

OVER 50% OFF! NEW 12-TUBE HIGH-FIDELITY FM-AM TUNER BUILT TO SELL FOR \$85.00

Approved Electronics 1954 Model "V-12"



Reg. Net
Price

\$85

TRUE DISCRIMINATOR DOUBLE-
LIMITER HIGH-FIDELITY FM!

\$41.95

ORDER
36-206 AE

AN EXCLUSIVE RADIO SHACK 'SCOOP'!

When Approved's chief engineer showed us the prototype of this fine company's 1954 Model V-12, we contracted to buy the ENTIRE year's supply — the biggest special purchase of tuners EVER made by a single company. First, because V-12 is vastly superior to the previous Model A-710. Secondly, to eliminate middleman profits and save our many friends some REAL money. If you ordered an Approved A-710 from us and found, to your sorrow, we are sold out: NOW is the time to act. If you are considering buying a hi-fi tuner: NOW is the time to buy a reputable product from the East's best-known mail order company at savings NOBODY IN THE WORLD can duplicate!

SPECIFICATIONS: 12 miniature tubes plus 1N34 germanium diode 2nd det. AM. Two limiters, FM detector. Tuned RF stage on both AM and FM. Separate RF and IF stages on AM and FM. Rugged 6-gang variable, FM section copper plates. Improved sensitivity and AVC on AM. Guaranteed 15 uv. for 20 db quieting on FM. Dual AM-FM band-indicating lamps. Controls: power, tuning, bandwidth; no volume control to upset output impedance or frequency response. Cathode follower output, 30-15,000 cps. All top quality components. Standard RMA guarantee. Ultra compact: 8 1/4" W x 5 3/4" H x 8" D., ship. wt. 7 lbs. Notice: requires 6.3V AC @ 4 amps, 190V DC @ 55 ma power supply.

TUNER POWER SUPPLY ONLY \$12.05

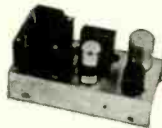

110-115V 50-60 cycles; delivers 6.3V AC @ 4 amps, 190V DC @ 55 ma. Size 3 1/2" W x 4 3/4" H x 8" D. Ship. wt. 7 lbs. Built by Approved to match V-12 tuner! Order No. 36-207 AE.



VERY SPECIAL SALE!

Limited quantity of \$82.50-list RCA 15" duo-cone coaxial speakers 'way off price. 2 voice coils, 40-12,000 cps, 25 watts, 2 lb. magnet. Design by Dr. Olson! Ship. wt. 16 lbs. \$29.50 LIST \$82.50 ORD. NO. AE-5108

ORDER BY MAIL! INCLUDE POSTAGE! SEND 25% WITH COD'S!

JUST PUBLISHED! FREE! OUR 1954 CATALOG



All new, 224-pages, including 32-page hi-fi section in rotogravure! Write TODAY for your copy of radio's favorite book!

RADIO SHACK

CORPORATION

167 Washington St., Boston 8, Mass.

REK-O-KUT COMPANY

636

38-01 Queens Blvd., Long Island City 1, N. Y.
Products: 12" and 16" precision transcription and playback turntables; disc recorder overhead-type mechanisms (12" & 16"); portable high-fidelity P.A. systems incorporating either 3-speed or continuously-variable-speed turntables; portable phono players; portable disc recorder.
Brand Names: RHYTHMASTER, RECITALIST, CHALLENGER DELUXE.

IN ATTENDANCE

George Silber Fred Moulin
Avery Yudin Philip Dubson
Sydney Simonson

RIVER EDGE INDUSTRIES

707

5 River Edge Road, River Edge, N. J.
Products: Hi-fidelity radio-TV cabinets and speaker enclosures, hi-fidelity radio-phonograph cabinets and speaker combinations.

IN ATTENDANCE

Walter Godfrey Virginia Rogers
Henry R. Sherwin George Pettit
Leon Adelman G. J. Rodgers
Martin Berlin Chas. Lienau
Sylvia Mack E. Wilks

ROCKBAR CORPORATION

641

211 E. 37th St., New York 16, N. Y.
Products: Record changers; record players; transcription turntables; cartridges; mounting bases.

IN ATTENDANCE

Syd Wimpie Wm. MacAteer
Jack Willson C. Colliaro
Ed Straw

HERMON HOSMER SCOTT, INC.

628

385 Putnam Ave., Cambridge 39, Mass.
Products: High-fidelity amplifiers; Dynanatural noise suppressors and amplifiers; sound measuring and laboratory apparatus; electronic laboratory equipment.

IN ATTENDANCE

Hermon H. Scott Dan R. von Recklinghausen
Victor H. Pomper Edmond G. Dyett, Jr.

SHIELDS LABORATORIES, INC.

712

810 N. Lincoln Ave., Pittsburgh 12, Pa.
Products: Audio amplifiers, loudspeaker enclosures, preamplifiers, various types of measuring instruments.

IN ATTENDANCE

John P. Shields Lloyd G. Orazi
Reese R. Neal Peggie A. Kroen

MARK SIMPSON MFG. CO., INC.

715

32-28 49th St., Long Island City 3, N. Y.
Products: 10- and 20-watt high-fidelity amplifiers; tape recorders; electronic microphone mixer; public-address systems; intercommunication systems; disc recorders.

IN ATTENDANCE

Miriam Simpson George Watson
G. Leonard Werner Henry Berlin
Ralph Hasen

SONOCRAFT CORPORATION

642

115 W. 45th St., New York 36, N. Y.
Products: Recording equipment for broadcast and recording studios; audio-visual equipment for institutions, schools, industrial concerns and advertising agencies; distributors of leading brands of recording equipment, playback equipment, accessories, tape and disc.

IN ATTENDANCE

Herbert H. Borchardt Howard Silver
Harold H. Oppenheimer G. F. Miller
Gary M. Behrendt Joseph Gschaar
Fred M. Lissa Leslie Lee
George Billick

SONOTONE CORPORATION

741

Elmsford, New York
Products: Phonograph pickups; phonograph needles.

IN ATTENDANCE

R. L. Lewis N. H. Dieter
R. M. Mitchell

STEPHENS MANUFACTURING CORP. 701-702

8538 Warner Drive, Culver City, Calif.
Products: High-fidelity loudspeakers; loudspeaker enclosures; amplifiers; condenser microphones; wireless microphones; multicellular horns; high-frequency drivers; theatre loudspeakers.

IN ATTENDANCE

Robert L. Stephens Neal Pierce
 Steve Van Roekel Robert C. Tetherow
 Jesse Adams

STROMBERG-CARLSON COMPANY 540

1225 Clifford Ave., Rochester 21, N. Y.
Products: Stromberg-Carlson Custom Four Hundred high-fidelity components and completed units in cabinets.

IN ATTENDANCE

A. G. Schifino F. W. Haupt
 J. W. Farrow R. P. Weis
 M. W. Zegee F. H. Slaymaker
 F. A. Spinelli

SUN RADIO & ELECTRONICS CO., INC. 601

650 Sixth Ave., New York 11, N. Y.
Products: Altec, Lansing, Astatic, Audak, Audio Devices, Bell Sound, Bogen, Brown-Ing, Clarkstan, Concertone, Cook Labs, Electro-Voice, Fairchild, G.E., Fisher Radio, Gray, Jensen Mfg., James B. Lansing, Newcomb, Pentron, Pickering, Grommes, RCA, Craftsmen, Rek-O-Kut, H. H. Scott, Stephens, Stromberg-Carlson, Tech-Master, Meissner, University, Waveforms, Webcor, Garrard, Livingston, Pilot, Cabinart, River-Edge, Herman Miller, Jeff Markell, Middlesex, Lumite, Scotch tape.

IN ATTENDANCE

Samuel Schwartz Arthur Waxman
 Samuel Gerard Morris Brown
 Irving Hodas George Panayotte
 Joseph Greenfield Elton Nachman
 Bernard Cohen Latney Hooker
 Irving Bien

TANNOY CANADA LIMITED 607

In association with **Tannoy Ltd.**, West Norwood, London S.E. 27, England
Products: Tannoy 12" Dual Concentric loudspeaker; Tannoy 15" Dual Concentric loudspeaker; Tannoy 12" direct radiator; Tannoy 100-watt high-efficiency loudspeaker. Wide range dynamic microphone. High-fidelity velocity microphone. Dynamic cardioid microphone. Dynamic tube microphone.

IN ATTENDANCE

Michael H. Fountain
 Frederick A. Towler
 Mrs. M. Towler
 Terence B. Livingstone

TAPEMASTER INC. 551

13 W. Hubbard St., Chicago 10, Ill.
Products: Tape recorders; tape transport mechanisms; preamplifiers.

IN ATTENDANCE

John S. Margolin W. L. Brooks
 R. M. Karet Ralph Epstein

TELECTRO INDUSTRIES CORP. 530

35-16 37th St., Long Island City 1, N. Y.
Products: Telectro tape recorder.

IN ATTENDANCE

Harry Sussman Fred Kantor
 Stanley Rosenberg

THE TETRAD COMPANY 719

62 St. Mary St., Yonkers 2, N. Y.
Products: Diamond phonograph styl; microscope and shadowgraph exhibits of test styl; color slide projection of methods of manufacture of phonograph styl; diamond exhibit; charts and graphs; test and demonstration of effect of worn styl on records.

IN ATTENDANCE

Morton V. Marcus Irmina M. Lota
 Howard M. Weinberger Jeanne A. Axelrod
 Emmanuel J. Marcus Leonard Miller
 Edward P. Delaney

FOR THE
 MUSIC LOVER
 WHO DEMANDS
 THE BEST...



DUPLEX LOUDSPEAKER



A-333A AMPLIFIER

A-333A CONTROL UNIT

A breath-taking new experience awaits you when you hear the music you love reproduced flawlessly by Altec... a name synonymous with highest quality craftsmanship and dedicated to the highest criteria of fidelity reproduction.

From the gentlest murmur of the viola to the imperitive thunder of the tympani, each orchestral voice is endowed by Altec reproduction with living clarity and brilliant new identity.

May we suggest that you visit your Altec dealer soon and enjoy the new high standard of reproduction that invites you to hear the world's great music as the composer intended it to be heard.



9356 SANTA MONICA BLVD., BEVERLY HILLS, CAL.
 161 SIXTH AVENUE, NEW YORK 13, N.Y.

THORENS COMPANY 602

2020 Jericho Turnpike, New Hyde Park, N. Y.
Products: Swiss-made record changers, record players, electric mounting units, electric motors, spring motors, phonographs, radio tuners.

IN ATTENDANCE

R. K. Kind E. L. Childs
 P. W. Kind J. P. Donohue

TUNG-SOL ELECTRIC, INC. 512

95 Eighth Ave., Newark 4, N. J.
Products: Receiving tubes; semi-conductor products.

IN ATTENDANCE

John D. Van der Veer Roger S. Whitlock
 John J. Corcoran Richard Jandl
 Fred A. Warren Alex V. Mitchell
 C. Everett Coon LeRoy Emmel

ULTRASONIC CORPORATION 704

61 Rogers St., Cambridge 42, Mass.
Products: Demonstration of the Ultrasonic Model U-25 loudspeaker and new package unit incorporating record player, amplifier, and speaker.

IN ATTENDANCE

Dale L. Button Edwin C. Reynolds
 William J. Gagnon John J. Welch

UNITED TRANSFORMER CORP. 522

150 Varick St., New York 13, N. Y.
Products: Transformers, amplifiers, kits, and filters.

IN ATTENDANCE

S. L. Baraf S. Mannville
 Joe Barecca Ted Craig
 Hank Russell

UNIVERSITY LOUDSPEAKERS, INC. 501

80 S. Kensico Ave., White Plains, N. Y.
Products: Woofers, tweeters, mid-range speakers; crossover networks; cabinets.

IN ATTENDANCE

Irving Golin Saul White
 Sidney Levy Abe Cohen
 Arthur Blumenfeld Edward Reiss
 Lawrence J. Epstein Seymour Blumenfeld
 Robert S. Reiss

UTAH RADIO PRODUCTS CO., INC. 606

1123 E. Franklin St., Huntington, Ind.
Products: Wall baffles; commercial speakers; high-fidelity speakers; high-fidelity enclosures; high-fidelity ensembles.

IN ATTENDANCE

A. H. Schenkel L. A. Wells
 F. L. Pyle Jean Musselman
 W. A. Dill, Jr. P. E. Monsey

VIDEO CORPORATION OF AMERICA 708

229 W. 28th St., New York 1, N. Y.
Products: High-fidelity radio-phonographs and phonograph combinations.

IN ATTENDANCE

Morton Kronengold A. Ellis
 Michael Platzman F. Ischia
 Wm. London

V-M CORPORATION 740

4th & Park Sts., Benton Harbor, Mich.
Products: V-M hi-fidelity record changers and phonographs.

IN ATTENDANCE

Roy Parr Alan Woolf
 Irving Woolf

WEATHERS INDUSTRIES 743

66 E. Gloucester Pike, Barrington, N. J.
Products: Complete line of high-fidelity capacitance-type phonograph pickups and a new pressure gauge for measuring tone arm pressure.

IN ATTENDANCE

Paul W. Weathers David W. Coffin
 Edward J. Gately, Jr. Harry Leuthold

WEBSTER-CHICAGO CORPORATION 633

5610 W. Bloomingdale Ave., Chicago, 39, Ill.
Products: Magnetic recorders, Fonographs, and Diskchangers.

IN ATTENDANCE

N. C. Owen N. Mackay
 H. R. Letzter J. Austin
 E. W. Olson C. Ollstein
 G. F. Harder C. L. Dwyer
 S. T. Seaman H. L. Ballard
 C. S. Castle

WESTMINSTER RECORDING CO., INC. 620

275 7th Ave., New York 1, N. Y.
Products: Phonograph Records

IN ATTENDANCE

Michael Naida William Lerner
 Henry L. Gage Martin Shapiro
 Harry Rubin Edward Talmus
 Kurt List

ZENITH RADIO CORPORATION 548, 832-833

6001 Dickens Ave., Chicago 39, Ill.
Products: Phonevision, high-fidelity sets, radio and television sets, hearing aids.

IN ATTENDANCE

Farrell Davission G. J. Roach
 Erik Isgrig R. C. Wallace
 Jane Temple

ZIFF-DAVIS PUBLISHING COMPANY 514
 (Radio & Television News)

366 Madison Ave., New York 17, N. Y.
Products: Radio & Television News, and other magazines.

IN ATTENDANCE

Oliver Read Leonard L. Osten
 William Stocklin Murray Goldman
 Harold Renne Jerome Jacobs
 Charles Tepfer John McArdie
 N. Rosa

The NEW MARTIN AMPLIFIERS and AM-FM TUNERS

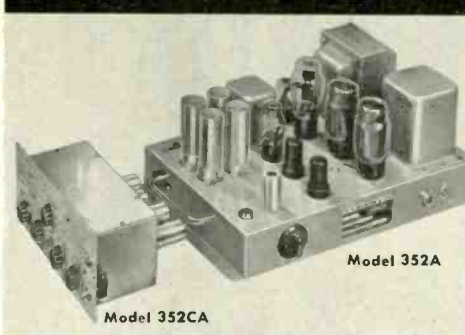

Tops in High Fidelity



Never Before HAVE ALL 3 OF THESE ESSENTIAL QUALITIES BEEN BUILT INTO 1 AMPLIFIER

1. WIDE FREQUENCY RANGE—nearly all amplifiers of merit claim wide frequency range. However, the MARTIN amplifier provides response a full octave above and below the commonly accepted limits of audibility. This is your assurance against obsolescence.

2. UNUSUALLY LOW DISTORTION—advance engineering details provide a freedom from distortion never before realized. Beauty and distinctiveness of the original music is always yours without "Hybrid Instruments" of intermodulation distortion. Noises, record scratch are much less prominent.

3. ENDURING QUALITY—no detail has been spared to assure the same unmatched performance for years to come. All components are conservatively rated. Careful inspection of the MARTIN amplifier will convince you that here is an instrument of enduring quality.

NEW! MARTIN AM-FM TUNER MODEL 153-T

- FINDS STATIONS FASTER
- LOCKS-IN STATIONS POSITIVELY
- WIDER RECEPTION RANGE

MARTIN'S top quality pre-amplifier "built-in". No drift, more effective AFC; greater sensitivity, better than 1 micro-volt AM & FM.



IN THE HOME TECHNICAL USES

Fills your home with the treasure of your favorite music... compactly designed to readily fit available space.

The Martin amplifier is well suited to specialized uses in audition work, recording and used as a laboratory instrument.



WRITE TODAY for FREE brochure on New MARTIN Amplifiers and Tuners See us at the Audio Fair, Room 505, Hotel New Yorker, October 14, 15, 16 & 17.

H. S. MARTIN & COMPANY, 1916-20 GREENLEAF ST., EVANSTON, ILL.

BASS CONTROL

(from page 25)

is used to set the level of the high-frequency response in comparison to the bass. In some respects, this part of the circuit is worthy of special attention in itself, inasmuch as the slope of the high-frequency response curve is not changed, but merely the relative amplitude of all of the highs. This means that it is possible to achieve emphasis of clarity giving middle highs without adding excessive high-frequency noise to the reproduction.

While the unit shown in Fig. 5 obtains power from the main amplifier, the system shown in Fig. 4 is completely self contained, and is designed for easy insertion between a crystal pickup or a preamplifier and the main power amplifier. The self-contained power supply, shown in Fig. 6, furnishes a B+ voltage of about 150, which is adequate for most purposes. This supply can be incorporated into a single chassis, as in Fig. 4, and will mount readily in a $3\frac{1}{2} \times 6 \times 2$ in. chassis. In a

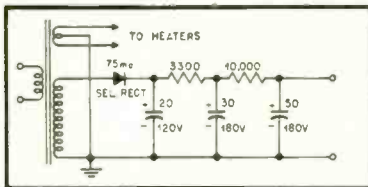

Fig. 6. Power supply incorporated in unit shown

compact, self contained, unit, care should be taken that the two dual triodes are located in the minimum field from the power transformer. This position can usually be located by means of a small pickup coil—such as a magnetic phono cartridge—and a high-gain amplifier, the best procedure being to determine the point of minimum field intensity from the power transformer before any of the components are mounted. This may be done by connecting the primary leads of the transformer and moving the exploring coil about it until the region of minimum field is established.

Performance

The frequency of each resonant circuit determined by the values of the three resistors and capacitors in the feedback loop. Increasing the value of any of these components will lower the resonant frequency, while decreasing the values will raise the point of resonance. Suggested values for specific frequencies are shown on the diagram, but superior performance with a given audio installation may likely be obtained with a different group of frequencies selected to match the resonances of the system.

Bass tone is likewise strongly influenced by the amount of low-frequency distortion present in the signal source

ARROW ELECTRONICS



offers the magnificent new REBEL IV

KLIPSCH CORNER HORN ENCLOSURE

at a price you can afford!

12" model . . . \$36 net
15" model . . . \$42 net

Easy-to-assemble kits
in unfinished birch

Also available assembled and attractively styled to blend with any decor in Lined Oak, Honey Walnut, French Mahogany, and Black Lacquer. The 12" Model . . . \$69 net, The 15" model . . . \$87 net.

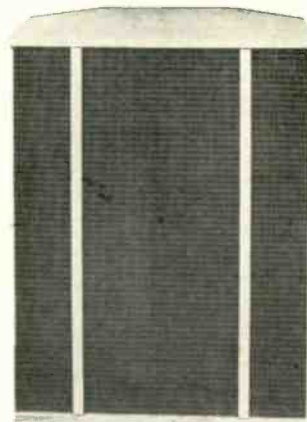

by Cabinart

SO MUCH VALUE . . .
... AT SO LITTLE COST

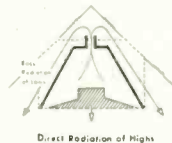

- Large enclosure performance within minimum area achieved through principle of "backloading," which increases path length and provides better reproduction of lows.
- Direct radiation of high frequencies cuts out "Masking."
- Unique cabinet design provides easy accessibility to speaker and simplifies external installation.

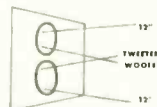

- Two-way system performance so flexible in design as to provide you wide latitude in determining your listening requirements. Removable panel allows for a variety of speaker combinations. For example, in the 12" Klipsch you can install a single 12" or two 12" speakers or a tweeter-woofer combination.

Everybody wants to own Klipsch designed corner horn and enclosures. They are the ultimate in acoustic design and now . . . you can enjoy the finest and pay no more. Order your Rebel IV at Arrow, today.

Send 25% deposit on C.O.D.'s—Deduct 2% on Pre-paid Orders. F.O.B. New York

Visit our exhibit at the
NEW YORK AUDIO FAIR
October 14th thru 17th
ROOM 541
HOTEL NEW YORKER

ARROW ELECTRONICS



BEAUTY IN SOUND
65 CORTLANDT ST., NEW YORK 7, N. Y., DIGBY 9-4714

Congratulations! Hudson

RADIO & TELEVISION CORP.

**Authorized Distributors of
The World's Finest
HIGH FIDELITY SOUND EQUIPMENT & COMPONENTS**

On the Opening of Their New Salesrooms

in the Heart of Downtown

NEWARK, N. J.

At 35 WILLIAM STREET

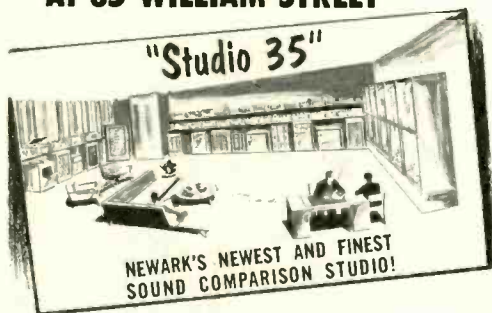

Music Lovers, High-Fidelity Enthusiasts, Dealers and Radio Servicemen—all welcome. The great new Hudson Salesrooms just opened in the heart of the mighty New Jersey Market—to provide the same Huge Stocks, Low Prices, and Superlative Service that have made our two New York Stores the leading Electronic and Audio Supply Centers of the East!

*YOU NEVER HEARD
IT SO GOOD!*

Visit our Sound Comparison Studios! Each of our three Great Salesrooms features a modern, spacious fully equipped Studio, where you can SEE, HEAR, and COMPARE the World's Finest and most Complete Assortment of Standard Brand Equipment, priced for every Budget.

These Nationally Famous Manufacturers of Standard Brand Top Quality Electronic Products and High Fidelity Components, whose Complete Lines are found in ALL THREE Great HUDSON Salesrooms, join in congratulating us on the Opening of the Newark Store:

- | | | | |
|------------------------------|-------------------------------|-----------------------------|-------------------------------|
| Acro Products | Dial Light Co. of Amer. | Jensen Industries, Inc. | Radio Craftsmen, Inc. |
| Advance Elec. & Relay Co. | Dow-Key, Inc. | Jensen Mfg. Co. | Radio Mfg. Engineers, Inc. |
| Aerovox Corp. | R. L. Drake & Co. | JFD Mfg. Co., Inc. | Radio Receptor Co., Inc. |
| Alliance Mfg. Co. | Drake Electric Works | E. F. Johnson Co. | Raytheon Mfg. Co. |
| Alpha Wire Corp. | Allen B. Dumont Labs, Inc. | Kester Solder Co. | Reeves Soundcraft Corp. |
| Altec-Lansing Corp. | Duotone Co., Inc. | Mathias Klein & Sons | Rek-O-Kut Co., Inc. |
| American Elec. Heater Co. | Dynavox Corp. | Kraeuter & Co. | River Edge Industries |
| American Phenolic Corp. | Hugh H Eby Inc. | La Pointe Electronics, Inc. | Howard W. Sams & Co. |
| Amer. Telev. & Rad. Co. | Eller-McCullough Inc. | Littefuse, Inc. | Sangamo Electric Co. |
| Amperex Electronic Corp. | Electric Solder Iron Inc. | Livingston Electronic Corp. | Sarkis-Tarzan Inc. |
| Amperite Co., Inc. | Electronic Indicator Corp. | Lysco Mfg. Co., Inc. | Walter L. Schott Co. |
| Arco Electronics | Electronic Instrument Corp. | P. R. Mallory & Co., Inc. | Shallcross Mfg. Co. |
| Arrow-Hart Megeman Elec. Co. | El Menco | Mark Simpson Mfg. Co. | Shure Bros., Inc. |
| Astaltic Corp. | Electro-Voice, Inc. | Meissner Mfg. | Simpson Electric Co. |
| Audak Co. | Eric Resistor Corp. | Merit Transformer Corp. | Herman H. Smith, Inc. |
| Audio Devices, Inc. | Equipto Co. | J. W. Miller Co. | Snap-On Drawer Co. |
| Barker & Williamson, Inc. | Espey Mfg. Co. | Marrow Radio Mfg. Co. | Sonar Radio Corp. |
| Belden Mfg. Co. | Eveready Batteries | Mosley Electronics | Sprague Products Co. |
| Bell Sound Systems, Inc. | Fahnestock Electric Co. | Mueller Electric Co. | Stanwyk Winding Co. |
| Berlant Associates | Fairchild Recording | Multi Products, Inc. | Stephens Mfg. Corp. |
| Birnback Radio Co., Inc. | Federal Industries & Rad. | National Co. | Stromberg-Carlson Co. |
| Bitley Electric Co. | Fisher Radio Corp. | National Union Radio Corp. | Switchcraft, Inc. |
| David Bogen Co., Inc. | Freud Transformer Co., Inc. | Dhmitie Mfg. Co. | Sylvania Electric Products |
| Brach Mfg. Corp. | G. & H. Wood Products | Oxford Electric Corp. | Taylor Tubes Inc. |
| British Industries Corp. | Gem Elec. Mfg. Co., Inc. | Par Metal Products Corp. | Tech-Master Products Co. |
| Brook Electronics, Inc. | General Cement Mfg. Co., Inc. | Park Metallware Co., Inc. | Triad Transformer Mfg. Co. |
| Browning Labs, Inc. | General Electric Co. | Peerless Products Indust. | Triplet Elec. Instruments |
| Brush Development Co. | Gen. Hardware Mfg. Co., Inc. | Pentron Corp. | Turner Co. |
| Burgess Battery Co. | General Industries Co. | Perma-Power Co. | Ungar Electric Tools, Inc. |
| Cambridge Co. | Gonset Co. | Permotlux Corp. | Union Carbide & Carbon |
| Camburn, Inc. | Gordon Specialties Co. | Philmore Mfg. Co., Inc. | United Transformer Corp. |
| Cannon Electric Co. | Gray Research & Develop. | Pickering & Co., Inc. | University Loudspeakers, Inc. |
| Carter Motor Co. | Greenlee Tool Co. | Pilot Radio Corp. | Vector Electronic Co. |
| Centralab | Guardian Electric Mfg. Co. | Potter-Brumfield Co., Inc. | Vibroplex |
| Cetron | Hallcrafters Co. | Precision Apparatus Co. | Walter L. Schott Co. |
| Chicago Ind'l Inst. Co. | Hammarlund Mfg. Co. | Precision Electronics, Inc. | Webster-Chicago Corp. |
| Chicago Stand. Transformer | Harvey-Wells Electronics | Premax Products | Westinghouse Elec. Corp. |
| Cinch-Jones Sales | Hickok Electrical Inst. Co. | Premier Metal Products | Weston Elec. Instrument Co. |
| Clarkston Corp. | Harvey Hubbell Co. | Presto Recording Corp. | |
| ClaroStat Mfg. Co., Inc. | Hyltron Radio & Electronics | Pyramid Electric Co. | |
| Consolidated Wire | I.D.E.A. Inc. (Regency Div.) | Quam-Nichols Co. | |
| Continental Carbon, Inc. | Insuline Corp of America | Racon Electric Co., Inc. | |
| Cornell-Dubilier | International Resistance Co. | Radiart Co. | |
| Cornish Wire Co., Inc. | Jackson Industries, Inc. | Radio Apparatus Corp. | |
| Crest Transformer Corp. | Jersey Tech Labs | Radio City Products Co. | |
| Croname Inc. | Jennings Radio Mfg. Co. | Radio Corp. of America | |

or reproducing equipment. In the construction of the three-way bass circuit, the use of different components tend to alter the character of the resonant decay curve due to changed linearity characteristics. For example, the substitution of pentodes for the triodes shown in the schematic may produce significant, though not necessarily undesirable, changes in tone color. Likewise, when using larger values of capacitance in the feedback loops, such as .01 μ f or greater, the effect of dielectric hysteresis may alter the resultant sound, but in some cases this may be beneficial.

Aside from the benefits of deeper and more musical bass, the use of the three-element bass control seems almost to add a new dimension to radio broadcasts and the various elements of a station's technical personality seem to stand out more clearly due to the superior reproduction of low-frequency transients. For example a control room microphone that is poorly shock mounted may exhibit an interesting series of thumps and bumps while the operator is reading news or changing records in the middle of an announcement. Similarly, matters like hum in different audio channels, microphonics, turntable or record rumble, air conditioner noises, and so on, tend to show up more clearly. Of course, if these sounds become too distracting they can easily be eliminated by proper setting of the bass controls, a procedure somewhat easier than getting out the hammer and saw to modify the acoustic resonances of the room or cabinet.

In conclusion, the use of multiple resonance bass circuits should appeal to many listeners who desire fullness in the lower registers. To date, the only detrimental effects that have been noted when using circuits of this nature are found when the electronic resonance is set too closely to one of the mechanical resonances of the system, or when excessive distortion elsewhere has tended to counteract the benefits derived. Particular attention might be paid to the elimination of cabinet or room rattles which may be generated by the fundamental bass tones. Similarly, amplifiers such as the "Ultra-Linear" are recommended.

EVERYMAN'S AMPLIFIER

(from page 40)

Control. We realize, of course, that the loudness control is a much disputed subject at the present time and that there are those who prefer such a control and those who prefer the standard bass and treble controls. Consequently, we provided what we felt was the best compromise—a bass and treble compensated volume control whose compensation is effective mainly at low volume, plus separate bass and treble controls capable of either completely nullifying the effect of the volume control compensation or adding to it for a higher degree of bass and treble boost or cut.

By actual measurement, the volume control adds 2.4 db bass boost at 50 cps, 0.3

AUTHORIZED FACTORY DISTRIBUTORS
Hudson
RADIO & TELEVISION CORP.
ELECTRONIC & SOUND EQUIPMENT

FREE! New Hudson 1954
HIGH FIDELITY CATALOG
Send today for your FREE COPY!
It has EVERYTHING you're looking for, in Hi-Fi Equipment!
Dept. D-10



48 West 48 St.
New York 36
Circle 6-4060

212 Fulton St.
New York 7
Circle 6-4060

35 William St.
Newark, N. J.
Market 4-5151

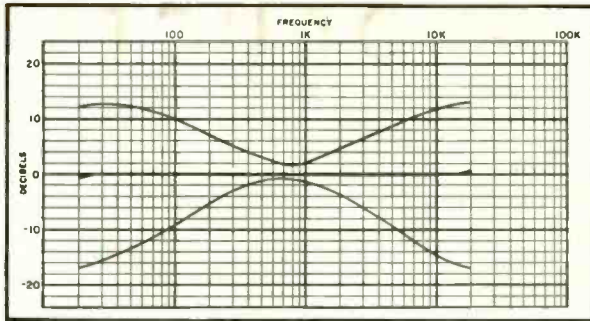
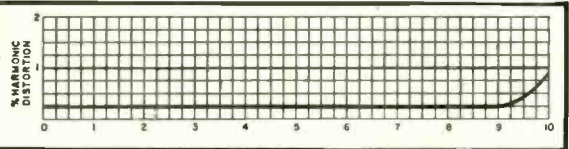

Fig. 2 (left). Limits of tone-control range, providing maximum boosts of around 12 db for both bass and treble, and maximum cut of 17 db at both ends. Fig. 4 (above). Harmonic distortion in per cent plotted against output level in watts.



db treble boost at 10,000 cps, and 0.4 db treble boost at 20,000 cps, when set for 4 watts output at the 800 cps tone control crossover frequency; at 1 watt output the volume control adds 3.1 db bass boost at 50 cps, 1.6 db treble boost at 10,000 cps, and 3.7 db treble boost at 20,000 cps.

As can be seen from Fig. 2, the tone controls provide 12 db of bass boost and 14 db of bass cut at 50 cps, and 13 db of treble boost and 17 db of treble cut at 20,000 cps. These operating data thus indicate that it would be possible to equalize almost any type of recording characteristics by the combined action of the compensated volume control and the bass and treble controls alone.

However, the provision of fixed equalization networks makes the use of tone-control equalization unnecessary, allowing these controls to provide for varying the tonal response of the amplifier to make up for taste differences and to provide a closer approach to the Fletcher-Munson hearing characteristic than is possible by loudness controls alone.

Circuit configurations of the volume control and bass and treble controls can be seen in the schematic, Fig. 3.

5. *Beauty of Appearance* was considered to be a necessary adjunct to, and suggestive of, beauty of function. The "Custom Ten" chassis is finished in black and tube shields and hardware are finished in gold to provide an attractive appearance. Screening of the front panel is in gold set against the black background, and the panel is removable for console cabinet mounting.

6. *Additional Features* which will prove popular are the provision of a set of extension shafts for the controls to make up for varying panel thicknesses in custom cabinets, and a pilot light socket and plug for remote pilot light installation.

Functional Characteristics

As to performance, the "Custom Ten" is designed to be an excellent work-a-day amplifier with response characteristics and hum and distortion figures commensurate with its use with the best modern hi-fi accessories.

Power output of the "Custom Ten" is ten watts at less than 1 per cent distortion (see Fig. 4.) Response is 20 to 20,000 cps \pm 0.5 db. Hum and noise are 80 db below full output. A hum-balancing control provides positive d.c. bias for the heaters to effect considerable hum reduction.

Amplifier stability is evidenced by the use of more than 15 db of feedback around the output transformer and three amplifier stages to minimizing distortion and to provide the high damping factor needed to reduce speaker distortion.

Summing up, the "Custom Ten" has been described as a ten watt hi-fi amplifier of good frequency response and low distortion having such desirable features as: complete provision for recording equalization, all the

needed flexibility of tonal variation, three inputs for high-level program sources, one input for either of the two basic types of magnetic pickup, separate output for tape

recorder, and beauty of appearance. Provision of these features at low cost should make the "Custom Ten" the "Ford" of hi-fi amplifiers.

V-M High Fidelity RECORD CHANGER

more exclusive high fidelity features than any other changer

EXCLUSIVE RESONANCE-FREE DIE CAST TONE ARM.

TWO DIE CAST PLUG-IN TONE ARM HEADS FIT MOST CARTRIDGES.

EXCLUSIVE SILENT 4-COIL MOTOR.

LAMINATED TURNTABLE ON 3-BALL THRUST BEARING.

* V-M TRI-O-MATIC® 936HF CHANGER ATTACHMENT: V-M 45 spindle Included. Also available, less metal pan, as Model 935HF.

V-M leads the industry in providing well-designed, properly built hi fi record changer features! V-M's superior record protecting, record handling features also contribute directly to the faithful reproduction and lasting enjoyment of fine records of all three speeds and sizes.

SEND FOR COMPLETE DATA on these and many more features offered by V-M Corporation, world's largest manufacturer of phonographs and record changers exclusively.

Visit V-M Display • New York Audio Fair • Room 740 • Hotel New Yorker, Oct. 14-17

MAIL THIS COUPON TODAY

V-M Corporation,
Benton Harbor 6, Michigan

Please send complete data on V-M Models 935HF and 936HF.

Name _____

Address _____

City _____ State _____

NEW PRODUCTS

● **Garrard Model RC90 Record Changer.** Introduced as the finest changer in the company's history, the new Garrard Model RC90 features a new type of silent 4-pole motor with adjustability of all three playing speeds, as well as a number of other improvements over earlier models. Manual playing position cuts out changing mechanism and automatic trip for playing single records. An improved new stepped-pulley drive with flywheel-type idler wheel assures flutter-free operation.



Changing cycle is rapid irrespective of turntable speed. The unit is supplied with two spindles—one for records with standard quarter-inch center hole, and the other for 45's. A muting switch operates during changing cycle, and a suppressor network across the a. c. switch eliminates the conventional "pop" when the machine shuts off. Automatic stop operates at the conclusion of the last record, returning the tone arm to rest, and retracting the idler wheel to avoid "flats." Garrard Sales Corp., 164 Duane St., New York 13, N. Y.

● **Time-Indicating Reel Marker.** Designed for ready application to standard 10½-in. NARTE reels, this new accessory available from Ampex distributors will greatly expedite the editing of magnetic tape, especially when certain portions of a long program must be found quickly. Simply an adhesive sticker with time calibrations for 7½- and 15-in. recording

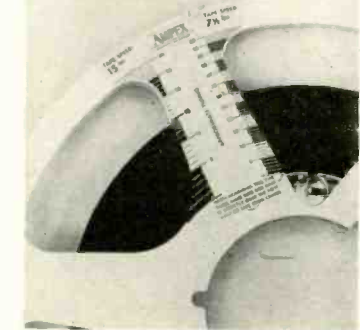

speeds, the device gives an operator a good approximation of the time used and that remaining on recording reels. The manufacturer, Ampex Electric Corporation, Redwood City, Calif., emphasizes that the markers are available only through Ampex distributors; not from the factory.

● **Power Amplifier.** Remarkable performance characteristics are embodied in the new Shields Model SPA-25 amplifier, according to introductory technical information issued by the manufacturer. Frequency response is stated to be 7 to 100,000 cps within ±1 db and rated power output is 25 watts. Intermodulation distortion is virtually non-existent. Internal output impedance of the SPA-25 is less than one ohm, allowing it to act as almost a complete short circuit to any transient distortion produced by the loudspeaker. Adaptable to virtually all types of installations, both domestic and commercial, the amplifier is designed to permit its being switched on or off from a remote point. A socket on the rear of the chassis delivers a. c. and d. c. for the operation of various accessories, including d. c. heater



supply for a preamplifier. The SPA-25 is fully described in a new bulletin which may be obtained from Shields Laboratories, Inc., 303 Shields Building, 810 N. Lincoln Ave., Pittsburgh 12, Pa.

● **High-Fidelity Receiver Chassis.** Newest addition to the extensive line of high-fidelity equipment manufactured by the David Bogen Company, 29 Ninth Ave., New York 14, N. Y. is the Model RR500 10-tube AM-FM receiver chassis which has 10-watt audio output at 3 per cent distortion. The FM circuit features a triode r-f amplifier and a triode mixer,

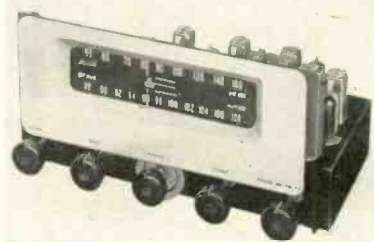

with a balanced ratio detector. Sensitivity is 7 microvolts input for 30 db quieting and frequency response is 30 to 18,000 cps within ±2 db. AM frequency response is 40 to 4000 within ±3 db. For AM operation, the RR500 is equipped with a low-impedance loop antenna. Design of the push-pull audio amplifier is based on the popular Bogen Model DB10. Included on the rear of the chassis are inputs for phonograph and television. Separate controls are provided for bass and treble. Complete technical details are available from the manufacturer.

● **Weather-Proof Faging Speakers.** Introduced as the sound industry's first weather-proof speakers with built-in transformers, the new Racon Models RE-20 and RE-11 are rated at 25 and 12 watts, respectively. The former incorpo-



rates a vacuum-impregnated transformer whose taps permit levels of 16, 8, 4, 2, 1.3, 1.0, 0.5, 0.34, and 0.17 when fed from a 70-volt line. Frequency response is 350 to 8500 cps. The lower-powered speaker is equipped with a transformer with a primary tapped at 500, 1000, 1500, and 2000 ohms, and a secondary tapped at 8 and 15 ohms. Frequency response is 450 to 10,000 cps. Racon Electric Co., Inc., 52 E. 19th St., New York 3, N. Y.

● **Precision Decade Inductors.** These units offer a simple method of component substitution in the design of wave filters, tuned circuits, oscillators, and similar devices where precision high "Q" inductors are required. Four basic decade steps—



1-10 mh, 10-100 mh, 100-1000 mh, and 1-10 hy—are available as single units. Powdered molybdenum Permalloy cores are used throughout. Step switching is accomplished by the use of instrument-type rotary switches with low-resistance contacts and laminated self-wiping blades. Manufactured by Torocoll Company, 1374 Mobile Court, St. Louis 10, Mo.

● **High-Fidelity Amplifier Ensemble.** Unique in physical and electronic design, the new Regency amplifier ensemble has been developed and built for the ultimate in audio performance without regard to cost. Consisting of three separate units—a preamp-equalizer, a power amplifier, and a power supply—the equipment is guaranteed forever against defects in materials and workmanship, excepting tubes which carry the standard RETMA 90-day guarantee. All trans-

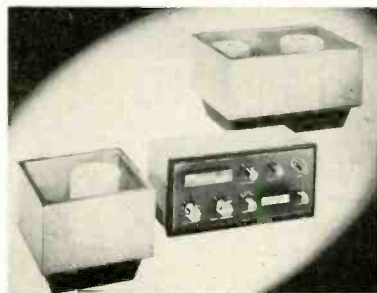

formers and chokes are hermetically sealed. Non-deteriorating oil-filled capacitors are used in all high-voltage circuits. All units are non-hygroscopic, providing complete protection against the effects of high humidity. Each unit is individually calibrated and is supplied to the user with a response curve. One low- and two high-impedance inputs are provided, each with level control. In addition to the frequency response extending beyond the limits of audibility, the Regency equipment allows precise adjustment for room acoustics and individual psycho-acoustics. Manufactured by Regency Division of Industrial Development Engineers Associates, Indianapolis, Ind.

● **Solenoid-Operated Tape Recorders.** Elimination of mechanical linkage in operating controls is featured in the new Ampro tape recorders. Identical except for tape speed and frequency response, the "Celebrity", a 3¼-ips model, and the "Hi-Fi", a 7½-ips recorder, make use of push-button-operated solenoids to control all operating functions. Separate controls are provided for RECORD, FAST FORWARD, REWIND, PLAY, and STOP. Circuitry is so arranged that the STOP key must be depressed between operations. Wow and flutter are stated to be less than one-half of one per cent. Frequency range of the "Celebrity" is 30 to 8500 cps; for the "Hi-Fi" it is 30 to

HARVEY The House of Audio NOW THE LEADER IN HI-FI BINAURAL SOUND EQUIPMENT



PERMOFLUX DYNAMIC BINAURAL HEADSET



High fidelity headphones, as used by leading artists for orchestration and choir rehearsals. Moving coil type motor assemblies. Frequency response covers the full orchestral scale within the range of human hearing. With adjustable natural cowhide headband, ear cushions, cord and plug.

High Fidelity Model B-DHS-28B \$45.00
(12 ohms impedance per phone).
High Fidelity Model B-DHS-17B \$50.00
(300 ohms impedance per phone).

Also in stock for Monaural use.

LIVINGSTON BINAURAL ARM



Designed for the new binaural recordings. A practical transcription arm which plays either binaural or standard discs, and uses standard cartridges. Beautifully balanced, superbly built, with low-friction horizontal and vertical bearing surfaces, vernier adjustment on stylus pressure, adjustable height for mounting, independent action for each cartridge and other quality characteristics.

Less cartridges \$35.00

LIVINGSTON BINAURAL AMPLIFIER



A complete twin-channel amplifier, designed to take fullest advantage of any binaural sound source. Provides two 10-watt HI-FI channels, with three twin inputs for disc, tape and binaural broadcasts. Separate tone controls for highs and lows on both channels give utmost binaural control and afford exciting effects with a monaural source. Speaker-reversing switch. Edge-lighted, rear-engraved lucite panel.

With separate power supply in matching cabinets and 3-foot connecting cable. \$149.50

NOTE: Prices Net, F.O.B., N. Y. C.
Subject to change without notice.

COOK BINAURAL PREAMPLIFIER



A complete dual channel control unit for all types of records, as well as tuners and tape units. Selector switch permits playing conventional (monaural) records through two loudspeaker channels if desired. Built to exacting professional standards: full frequency range, low distortion, low noise. Single unit ganged controls for volume, treble, bass (boost and attenuation), focus control, balances ("the orchestra" in two channels to suit listening preference).

Less power supply (usually connected directly to power amplifier) .. \$69.50

COOK 33 1/3 RPM BINAURAL RECORDS

These magnificent recordings cover the full audible frequency range. There is no equalization; you get the full dynamic range exactly as played by concert artists and symphony orchestras. May be played as monaural long-playing records with ordinary equipment . . . afford marvelous depth and presence when played with binaural arm through a binaural system.



A Partial List of Releases.....each \$5.95

- (BIZET: Introduction, Jo Act I (Carmen)
- #2064-BN { ROSSINI: Overture (La Gazza Ladra)
- { MENDELSSOHN: Scherzo (Midsummer Night's Dream)
- { von WEBER: Overture (Euryanthe)
- #2065-BN MOZART: Symphony #40 in G Minor
- #2066-BN { RIMSKY-KORSAKOV: Dance of the Buffoons
- { STRAUSS: Emperor Waltz
- { SAINT-SAENS: Danse Macabre
- { BRAHMS: Hungarian Dance No. 6

Write for complete list.

Series 30 Binaural Test Record for synchronization and stylus spacing \$2.00

MAGNECORD BINAURAL TAPE RECORDER



You'll marvel at the spatial depth and presence of Binaural recordings. The PT6-BN amplifier and PT6-BAH mechanical unit provide two complete recording and playback channels. Binaural recordings are made with two low impedance microphones, fed into the dual amplifier and taped simultaneously with the duplicate half-track Binaural heads on standard 1/4-inch magnetic tape. Speeds: 7 1/2" and 15"/sec. Amplifier provides two VU meters and three gain controls.

PT6-BN Amplifier \$515.00
PT6-BAH Mechanism \$390.00
Complete \$905.00



R-J SPEAKER ENCLOSURES for BINAURAL or MONAURAL REPRODUCTION

Designed for use with 12 or 15-inch speakers, the R-J High Fidelity enclosure reproduces tones to the lowest limits of audibility, cleanly and without "hangover". Its convenient size — just large enough to accommodate the speaker — makes it especially suitable for binaural installations . . . one speaker unit on either side of a room. Beautifully designed, the R-J has no equal in solving the problem of space.

Model FM (Mahogany).....\$49.50
Model FB (Bianche)..... 54.50
Model F15U (Unfinished 15" only)..... 43.35

Specify for 12 or 15-inch speaker

Visit the HARVEY AUDIOtorium

If you want to See and Hear the finest . . . the widest selection of high fidelity equipment . . . be sure to visit the HARVEY AUDIOtorium. It will thrill you.

TO ORDER BY MAIL—
TO GET MORE DETAILS
USE THIS
COUPON

Send me the NEW EDITION of HARVEY'S HI-FI AUDIO CATALOG.

Send full details on

HARVEY RADIO COMPANY, INC., DEPT. AE-103
103 West 43rd Street, New York 36, N. Y.

Send me the following:

Price \$.....

Price \$.....

Price \$.....

I enclose check money order in full payment plus estimated shipping charge. You will refund any surplus.

YOUR NAME.....

ADDRESS.....

CITY.....ZONE.....STATE.....

(please print)

HARVEY RADIO COMPANY, INC. 103 WEST 43rd STREET
NEW YORK 36, N. Y. • JUdson 2-1500

A NEW PRINCIPLE IN TURNTABLES! OUTSIDE IDLER DRIVE

***NON-METALLIC TABLE**
—Solid, 3/4" thick, dimensionally stable die stock—cork latex covering
—non-bell-like—never needs lifting from well.

***CONSTANT SPEEDS**
33.33, 45, 78.26 — "Floating Idler" decouples motor vibration from chassis — sturdy, micro-balanced 4-pole induction motor on isolation mountings, carefully positioned for minimum hum.

Complex mechanisms are eliminated in the NEW D & R DR-12, the most significant advance in turntable design in 17 years!
A new magnitude in low noise level and IM distortion due to minimum flutter and vibration . . . all parts easily

See the NEW DR-12 at leading HI-FI dealers, or write for descriptive literature to . . . Audio Equipment Division, D & R, Ltd., 402 E. Gutierrez St., Santa Barbara, California

THE D & R DR-12, a completely new design, allowing improvements in basic engineering never before possible!

Turntable only, with standard panel mounting . . .

\$68.50

mahogany box mounting, extra

accessible, machined to professional tolerance . . . especially designed for the more exact requirements of LP record reproduction.

Acclaimed by HI-FI experts and broadcasters as the ideal combination of laboratory quality and moderate cost.

d & r LTD.



13,000 cps. Rewind speed is 120 ips and fast forward is 72 ips for both models. Power output is 3.2 watts. In addition to a self-contained 6"x9-in. elliptical speaker, outputs are provided for external speaker and for headphone monitoring. Cabinet dimensions are 16 1/2 x 15 1/2 x 10 1/2 ins. Manufactured by the Ampro Corporation, Chicago, Ill.

• **All-Purpose Amplifier.** Exceptional versatility is inherent in the new Newcomb Model E-254 25-watt amplifier. Equipped normally with a four-channel mixer handling three high-impedance inputs for microphone and one for phono, the unit may easily be converted to low-impedance microphone operation through use of a special socket knockout and input con-



tacts. Individual bass and treble controls permit compensation of input signal to meet acoustical requirements. Frequency response is 40 to 15,000 cps within ±2 db, and distortion is less than 5 per cent at maximum rated output. Model E-504 is similar in all respects except that it affords 50-watt output. Complete specifications may be obtained from Newcomb Audio Products Co., 6824 Lexington Ave., Hollywood 38, Calif.

• **Thorens Record Changer.** There is hardly any automatic function which might be desired in a record changer which is not present in the new Thorens Model CD-53 "Symphony." Both sides of all standard types of records may be played successively if desired, or the second sides may be played in sequence after playing the first sides of all records



loaded on the changer. Ten- and twelve-inch records of the same speed may be intermixed in any order. Records may be repeated or rejected automatically. The pause between records is of adjustable duration. A single knob controls all operating functions. The changer uses two precision motors and is built on a heavy cast-aluminum frame. Normally supplied without cartridges, the CD-53 is designed to accommodate the standard GE variable-reluctance models without alteration. For details write Thorens Company, New Hyde Park, N. Y.

This Newest Book on Hi-Fi is Yours

FREE!

- Written for Music Lovers by Irving Greene, famous Audio-Engineer
- 148 Pages of vital up-to-date information on "Hi-Fi"
- Tells you what to look for in latest Hi-Fi reproduction
- Come in and get your Free copy at Asco Sound . . . or at the Audio Fair, Room 643
- Visit Asco Studios for demonstration of advanced equipment on the amazing Audiomat (see cover)



50¢

SEND COUPON

ASCO SOUND CORPORATION
115 WEST 45th STREET, 3rd FLOOR
NEW YORK 36, N. Y.

Asco Sound Corporation
115 West 45th Street, New York 36

Please send me a copy of **SOUND ADVICE**. Enclosed is 10¢ (or stamps) for handling costs.

NAME _____

ADDRESS _____

• **High-Fidelity Equipment and Speaker Enclosures.** Illustrated is Model RC-123, one of the more popular enclosures included in the new line of cabinetry introduced recently by Jeff Markell Associates, 108 W. 14th St., New York 11, N. Y. The unit shown is unique in that it virtually eliminates mechanical vibration transmitted from speaker to amplifier and



phono pickup through use of shock mounting and separating the two enclosures. The speaker cabinet has an internal volume of slightly more than 7 cu. ft. Control panel and changer board are removable for ease of servicing. Over-all dimensions are 43 x 43 x 20 ins. Catalog material will be mailed on request to the manufacturer.

• **Fifteen-Inch Speaker.** Frequency range of 50 to 10,000 cps and power rating of 25 watts are claimed as basic characteristics of the Model HF15LN hi-fi speaker recently introduced by The Oxford Electric Corporation, 3911 S. Michigan Ave.,

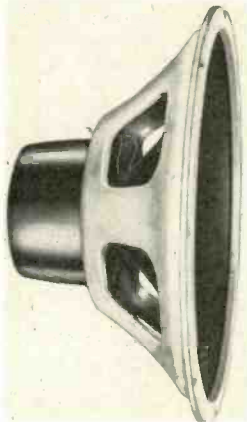

Chicago 15, Ill. Weight of the speaker's Alnico V magnet is 14 oz. and voice coil diameter is 1½ in. Impedance is 8 ohms. The unit is attractively finished in silver hammerloid enamel with a blue pot cover to match other Oxford speakers.

• **New Design Turntable.** Driven by an "outside" idler, a 3-speed turntable recently introduced also includes a number of other unique features which are said to give greatly improved performance in the moderate price range. Designated the

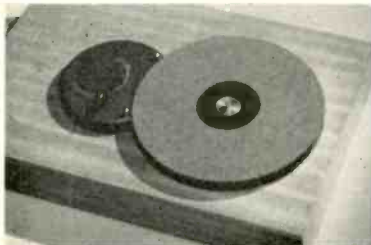

DR-12, the unit uses a non-metallic table of die stock, and what is called a "floating idler" which decouples motor vibration from chassis. Extreme simplicity of design holds the number of parts to a minimum. Descriptive literature available by writing to D & R, Ltd., 402 E. Gutierrez St., Santa Barbara, Calif.

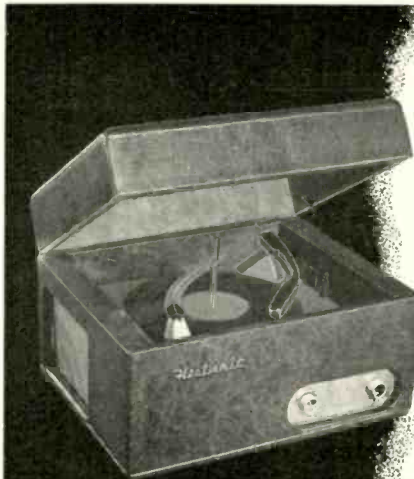

A new concept
of recorded music

THE HEATHKIT Dual RECORD PLAYER KIT

- Plays all record sizes, all speeds
- Newly developed ceramic cartridge
- Dual Matched speakers
- Acoustically correct cabinet enclosure
- Automatic shut off for changer and amplifier

MODEL RP-1

\$59⁵⁰

SHIPPING
WT. 30 LBS.
Shipped
Express
Only

Here is a new introduction to quality record reproduction. A simple to operate compact table top model with none of the specialized custom installation problems usually associated with high fidelity systems. Two matched speakers mounted in an acoustically correct enclosure reproduce all of the music on the record, reproduction with the unique sensation of being in a halo of glorious sound. This spectacular characteristic is possible only because of the diffused non-directional properties of the matched speakers. The performance level of the Heathkit Dual is easily superior to that of the ordinary

phonograph or console selling for many, many times the price of the Dual. Automatic record changer plays all three sizes at all three speeds with automatic shut off for both changer and amplifier after the last record is played. A wide range ceramic cartridge features an ingenious "turn-under" twin sapphire stylus for LP or 78 records without turning the cartridge. Simplified easy to assemble four tube amplifier featuring compensated volume control and separate tone control. Proxilyn impregnated fabric covered cabinet supplied completely assembled. You build only the amplifier from simple detailed step-by-step instructions. No specialized tools or knowledge required.

If a kit project has ever tempted you here is the perfect introduction to an interesting and exciting pastime. The Heathkit Dual Kit includes cabinet, record changer, two 6" speakers, tubes and all circuit components required for amplifier construction. Build the Heathkit Dual and enjoy unusually realistic room filling reproduction of fine recorded music.

OTHER *Famous*
HEATHKIT AMPLIFIERS

THE HEATHKIT 6 WATT AMPLIFIER KIT



Model A-7B

\$15⁵⁰

Ship. Wt. 10 lbs.

The Heathkit Model A-7B Amplifier features separate bass and treble tone controls — two compensated inputs — three output impedances 4, 8, and 16 ohms — frequency response ± 1½ db from 20 to 20,000 cycles — push pull beam power output at full 6 watts.

Heathkit Model A-7C with preamplifier stage..... **\$17.50**

HEATHKIT *High* FIDELITY AMPLIFIER KIT

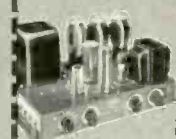

\$35⁵⁰

Model A-9A

Ship. Wt. 17 lbs.

A 20 watt high fidelity amplifier especially designed for custom installations. Low hum and noise level 9 pin miniature dual triodes in pre-amplifier and tone control circuits. Four switch selected inputs. Frequency response ± 1 db 20 to 20,000 cycles. Output impedances of 4, 8, and 16 ohms.

Write For Free
CATALOG

New 32 page 1953 Catalog lists all kits, specifications, schematics and latest price information.

HEATH COMPANY
BENTON HARBOR 25
MICHIGAN

YOU SAVE BY ORDERING DIRECT FROM FACTORY

**For Precision Sound Measurement . . .
or High Quality Recording . . .**

KELLOGG MIDGET CONDENSER MICROPHONE

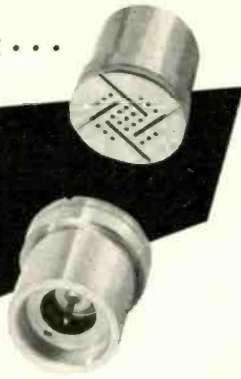

- Gives You—Uniformly Dependable Response • Exceptional Calibration Stability • Laboratory-Industry Proved Performance

Wherever quality recording or accurate measurement of sound is important, Kellogg Midget Condenser Microphone meets the most exacting standards set by research and industry. For more than sixteen years its superiority has been proved through consistently reliable and stable ser-

vice. Users include sound studios, industrial plants manufacturing sound equipment, audio development laboratories, government laboratories and universities.

• Send for Full Information
—Write Dept. 27-J Today!

RESPONSE CHARACTERISTICS		
	Model A	Model B
Response Referred to 1 volt / dyne/cm ²	— 59 db	— 55 db
Flat to Within	±3 db from 20 to 11,000 cps, for closed cavity without grille.	±4 db from 20 to 15,000 cps with or without grille for perpendicular incidence in free field.



KELLOGG SWITCHBOARD AND SUPPLY COMPANY
A Division of International Telephone and Telegraph Corporation
Sales Offices: 79 W. Monroe St., Chicago 3, Illinois

"SOMETHING FABULOUSLY BEAUTIFUL . . .

... Amazed by new purity of sound . . .
clarity . . . clean definition!"

says noted Record Reviewer



FAIRCHILD

SERIES 215
HIGH COMPLIANCE
Diamond Cartridge

NOW ONLY

\$37.50

WITH FINEST DIAMOND STYLUS

FOR 33, 45

OR 78 RPM RECORDS

First to achieve near-perfect lateral compliance—freedom of stylus to yield to rapid deflections of sensitive microgroove recordings—the amazing new Fairchild Series 215 provides all these exciting improvements:

- ★ New shades of tone color from fine recordings! ★ New clear timbre in high volume piano chords! ★ Rich low-frequency tones never previously heard! ★ Needle talk, record hiss, base concentration caused by arm resonance—reduced to a new low! ★ Stylus wear vastly reduced, record quality preserved! ★ And above all—TRACKING DISTORTION ELIMINATED!

ORDER FROM YOUR
AUDIO DEALER
or
Mail Coupon for
FREE "HI-FI Facts"
folder

Fairchild Recording Equipment Corp.
9th Ave. & 154th St., Whitestone, L.I., N.Y.
Please mail folder "Hi-Fi Facts" to:

Name _____
Address _____
City _____ State _____

VISIT US AT THE AUDIO FAIR, HOTEL NEW YORKER, OCT. 14-17

SOUND HANDBOOK

[From page 48]

dition, the line which is a physical extension of the circuit beyond the boundaries of the chassis—is susceptible to hum pick-up. Now suppose that a cathode-follower stage is inserted between the preamplifier and the line, as in Fig. 13—9. The capacitance presented to the preamplifier plate is negligible, while the resistance across the line is low enough so that the shunt cable capacitance loses any significance at audio frequencies. The impedance of the parallel combination of cable capacitance and output resistance varies very little over the signal frequency range; even if a higher load value were used the feedback secures low source impedance and near-constant-voltage operation. The danger of hum pickup from the cable is likewise reduced or eliminated.

The ill effects of a long cable connecting high-impedance circuits are thereby overcome, at the price of a virtually distortionless extra stage and a slight loss of voltage. Use of the cathode follower for this application is undoubtedly cheaper and more effective (in low-current circuits) than a pair of step-down and step-up transformers connected at the preamplifier output and amplifier input respectively.

A tube used as a cathode follower requires the normal operating grid bias. If the value of the cathode load resistor is chosen to equal the correct bias resistance the problem is solved automatically. In Fig. 13—8, (B) and (C) illustrate methods of providing bias for cathode followers when the load resistance is either lower or higher than the correct bias resistor value.

Phase Splitters

An amplifier stage located between the plate of a single-ended stage and the grids of a push-pull amplifier is the phase splitter. The signal channel up to the phase splitter is "unbalanced," which is to say, the signal potentials are on one line relative to ground. The phase splitter converts the signal channel to a balanced one, and ground becomes the midpoint between two lines whose instantaneous potentials are always opposite in polarity.

Figure 13—10 illustrates various ways of dividing the signal into two components identical in every way except that they are opposite in phase. In (A) advantage is taken of the fact that the two ends of the transformer secondary are 180 deg. out of phase with each other. Transformer coupling has the disadvantage of requiring an input transformer of critical characteristics and relatively high price, but the method is simple, stable, and suited to fixed-bias circuits.

(B) illustrates an often-used design sometimes referred to as the "tapped voltage" circuit. A fraction of the out-

SOLVE YOUR AUDIO PUZZLE...

FISHER
FM-AM Tuner
Model 50-R

BOGEN
High Fidelity Amplifier
Model DB 20

RCA Duocone
15" "OLSEN" Speaker
Type LC-1A

PILOT
FM Tuner Model FM-607

STROMBERG CARLSON
High Fidelity FM-AM
Radio Receiver
Model SR 405

CARRARD
3 Speed Automatic
Record Changer
Model RC-90

CONCERTONE
Recorder 1502 D

GENERAL ELECTRIC
Preamplifier
Model A1-200

BELL High Fidelity
Amplifier Model 2199B

...with a
Personal Comparison
of ALL the Newest
High Fidelity Equipment
at **TERMINAL**
Sound Studios

PICKERING Diamond Stylus
Turn-Over Pickup Model 280



CRAFTSMEN
FM Tuner Model C90



AMPLEX 350
Console Tape Recorder



The Terminal Sound Way is the Sure Way to Your Hi-Fi Satisfaction!

YOUR visit to the Audio Fair is incomplete until you **SEE! HEAR! COMPARE!** the latest advances in Audio Equipment at Terminal Sound Studios ... inspect the newest tuners, amplifiers, speakers, record players, recorders, etc. — leisurely and carefully ... personally combine components of **all** manufacturers to please your own taste and budget.

FREE! Terminal's Complete 1954 Audio Guide

Contains over 130 pages packed with complete information on everything in High Fidelity, P. A. and Sound Equipment, including the newest equipment featured at the Audio Fair ... The most Complete Buying Guide of its kind for Music Lovers, Audio Engineers, Professional and Industrial users of Sound Equipment.

Come in and get your FREE copy NOW!

To Reserve Your Copy for early mailing — Simply fill in and mail the coupon today!



Terminal Always Features the Newest and Finest Hi-Fi Equipment from America's Leading Manufacturers —

Audio Devices	Centralab	Markel	Radio Craftmen
Acro	Cook	McIntosh	Recoton
Ampex	Conrac	Minnesota Mining	Racon
Astatic	Duotone	Masco	Stephens
Altec	Espey	Melssner	Stromberg Carlson
Atlas Sound	Electro-Voice	Magnecord	H. H. Scott
Amplifier Corp. of America	Fisher	Newcomb	Sonotone
Audak	Fairchild	Orradio	Standard Wood Products
Amphenol	General Electric	Pickering	Shure
Brociner	Gray	Presto	Tech Master
Browning	General Industries	Pentron	Thorens
Brook	Garrard	Permoflux	Tapemaster
Bell	Grommes	Pilot	University
Bogen	Hallcrafter	Reeves Soundcraft	Ultrasonic
Brush	I.R.C.	R-J	U.T.C.
Cabnart	Jensen	Rek-O-Kut	V-M
Concertone	Karlson	Rauland	Webster Chicago
Crescent	Leak	Revere	Webster Electric
Clarkstan	Lowell	River Edge	Wharfedale
	Livingston	R.C.A.	Weathers

Terminal Radio Corporation
85 Cortlandt Street, New York 7, N. Y.

Dept. AE-10

Please send **FREE** copy of Terminal's Complete 1954 Audio Guide.

Name

Address

City Zone State



85 Cortlandt St., New York 7, N. Y. • Phone: WOrth 4-3311



Broadcast Program AMPLIFIER

TYPE BA-2-A

- EXCELLENT FREQUENCY RESPONSE** — with low distortion and noise level
- HIGH OUTPUT LEVEL** — +30 dbm with 1/2% or less distortion. +33 dbm with 1 1/2% or less distortion
- COMPACT** — requires only 7" of rack space
- HINGED FRONT PANEL** — all components readily accessible...fits any standard 19" rack

● The complete G-E Audio line includes rack mounted, plug-in, portable type amplifiers and consoles for every broadcast need.

For information write: General Electric Company
Section 44103, Electronics Park, Syracuse, New York

GENERAL  ELECTRIC

Nearly everybody reads the audio anthology and the 2nd audio anthology

The original **audio anthology** is still being ordered by people who have worn out their first copy or who have just learned about the book. Contains reprints of 37 articles which appeared in **AUDIO ENGINEERING** from May 1947 through December 1949. An invaluable reference work on audio in the home.

The **2nd audio anthology** continues from where the first left off and contains reprints of articles from January 1950 through July 1952. In both books the articles were brought up to date, corrected where necessary, and assembled by subject. **the 2nd a a** may still be had with board cover.

----- CUT OUT ----- MAIL TODAY -----

Book Division, Dept. 3P,
Radio Magazines, Inc.,
P. O. Box 629, Mineola, N. Y.

Sirs: Enclosed is check money order for \$..... Please send me
..... copies of **audio anthology** (paper cover) @ \$2.00 each
..... copies of **the 2nd audio anthology** (paper cover) @ \$2.00 each
..... copies of **the 2nd audio anthology** (board cover) @ \$3.00 each

Name (please print)

Address

City Zone State

put of V_1 is tapped off by a voltage divider and applied to the grid of V_2 . The output signal of a vacuum-tube is always reversed in phase from the input, so that the output of V_2 is 180 deg. out of phase with the output of V_1 . (Since V_2 is in the circuit solely for phase reversal purposes it is properly called a *phase inverter*. This term is often used, although incorrectly, to apply to any complete phase-splitter circuit.) If the fraction of the signal voltage tapped off is equal to the reciprocal of the gain of V_2 , the output of V_2 will be equal in amplitude although opposite in phase from the output of V_1 , and the two signals may be applied to the inputs of a push-pull stage. R_1 may be a fixed resistor of approximately correct value, or it may be a potentiometer that allows a balance adjustment.

The operation of the circuit of (C) is somewhat similar, except that the voltage tapped off by R_1 , the lower arm of the voltage divider, is an appreciable part of the total voltage, commonly on the order of 30 per cent. This would create an output from V_2 far in excess of the output of V_1 , but the signal from V_2 is applied to a voltage divider with the same resistor R_1 as lower arm. The two signals across R_1 are opposite in phase and tend to cancel until push-pull balance is achieved. The circuit is called a "floating paraphase," because the top of R_1 has a potential which is not anchored, relative to a single signal source, in the conventional manner. The two plate resistors of V_1 and V_2 are often made equal, but correct balance usually requires that the plate resistor of V_2 have a value slightly greater than the resistor of V_1 . If a variable resistance is used for the plate resistor of V_2 , the circuit may be balanced manually, and the limited self-balancing characteristics relied upon to maintain balance over a period of time. The paraphase circuit has potentially greater stability than the circuit of (B) for the same number and quality of parts. In both circuits the use of a common, unbypassed cathode resistor for V_1 and V_2 (with a value half of that required for the single tube) is advantageous for balance. When the signals are perfectly balanced there is no feedback, but when there is any unbalance negative current feedback is applied to the stage with the larger signal, and effectively positive current feedback to the stage with the smaller one. This is a permissible condition when the inherent distortion is low and when the stage is within a negative feedback loop.

The use of a partial cathode follower for phase splitting is illustrated in (D) of Fig. 13—10. All of the voltage across R_2 is fed back to the input, and therefore the output voltage at R_2 is less than the input voltage. If R_1 is equal to R_2 the signal across R_1 , which is IR_1 , must equal the signal across R_2 , which is IR_2 ; these two signals are balanced relative to ground, and together have an amplitude equal to about 1.8 times the input signal. The circuit is extremely stable, because with the same signal current necessarily flowing through R_1 and R_2 ,

(and their parallel grid resistors), balance is entirely dependent upon the equality of resistor values, and independent of tube characteristics or of operating voltages. Plate resistors and the following grid resistors should be matched by actual measurement rather than by reliance on color codes.

The cathode-loaded phase splitter has very low distortion and the ability to handle large input signals. It will be seen that the output across R_1 is subject to negative current feedback, and that the output across R_2 is subject to negative voltage feedback. The main drawback of the "split-load" or "cathodyne" circuit is a matter of economy, in space and cost; other circuits furnish appreciable gain. The fact that the cathode is well above ground potential also makes the stage susceptible to hum.

The cross-coupled phase splitter,³ illustrated in (E) of Fig. 13-10, is a self-balancing circuit in which the two voltage amplifiers V_3 and V_4 are driven by cathode followers V_1 and V_2 . Note that R_1 and R_2 are connected as cathode resistors for V_3 and V_4 respectively, and as grid resistors for V_4 and V_3 respectively, so that the voltage across either is coupled to both V_3 and V_4 , but in opposite phase. (Cathode-to-ground and grid-to-ground signal voltages are always opposite in sense).

A separate circuit for correcting an imperfectly balanced push-pull signal⁴ appears in Fig. 13-11. Restoration of balance is achieved through the cross-coupling capacitors, C_1 and C_2 connected to the cathode follower outputs.

REFERENCES

- L. B. Arguimbau, *Vacuum-tube Circuits*, John Wiley and Sons, Inc., New York, N. Y., 1948, Chapter 3.
- E. Milton Boone, *Circuit Theory of Electron Devices*, John Wiley and Sons, Inc., New York, N. Y., 1953, Chapter 3.
- Herbert J. Reich, *Theory and Application of Electron Tubes*, McGraw-Hill Book Co., Inc., New York, N. Y. 1944, Chapters 4 and 6.
- F. Langford Smith (editor), *The Radiotron Designer's Handbook*, 3rd ed., Wireless Press, Sydney, Australia, (Reproduced by Radio Corporation of America) Chapters 1 and 8.

³ J. N. Van Scoyoc, "A cross-coupled input and phase inverter circuit," *Radio and Television News*, Nov., 1948.

⁴ D. H. Parnum, "The phase compressor—a resistance-capacity output circuit complementary to the phase splitter," *Wireless World*, Jan., 1945; Correction Feb., 1945.

ADDITIONAL CLASSIFIED ADS

FOR SALE: Webster 150, GE cartridge and preamp, \$13; Radio Craftsmen RC-10, \$75; RC-2 amplifier, \$25; Hallcrafters S-38, \$28. Norman W. Tetenman, 2350 E. 27th St., Brooklyn, N. Y.

Elderly Owner-Manager Distributing Business with Franchise nationally known sound, intercom, and associated products and parts in prosperous Southern City, desiring to retire, will sell fixed assets and inventory, amounting to about \$40,000. Good lease, 4000 sq. ft. in new building. Box CP-2, Audio Engineering.

POWRTRON*

by

WHITE SOUND

New Revolutionary Amplifier Circuit

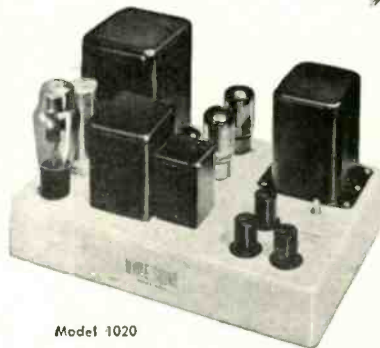

Model 1020

Ultra High Fidelity

Which gives you for the first time an output power wave form which is the same as the input voltage waveform, regardless of changing load impedance.

No More

- Pentode Operation
- Triode Operation
- Voltage Feed back

Now

- Power Control with Powrtron

WHITE SOUND AMPLIFIERS

White Sound's new circuit has established a New High in the realistic reproduction of music. The finest electronic components, precision engineering and White's new design combine to give you Ultra High Fidelity.



Model 3422
15-18,000 cps.

Exclusive! Non-resonant Cross-Over Circuit
• Cross-Over (24db./ Octave) at the Input of Dual Channel Amplifier.

Model 1010, 10 watts Model 1020, 20 watts. Model 2010, Dual Channel Amplifier with the Model C-101, Cross-Over Network.

WHITE CABINET SPEAKERS

- A True Exponential Horn (within 1%) ... Coupled to Speaker through a New Unique Phasing Device and Sound Trap • Nine foot Horn compactly Curled into Non-Resonant Cabinet • Response: 15-18,000 cps • White Cabinet Speakers offered in 5 Sizes ... 3 Finishes... 5 Prices.

*Copyrighted

For Complete Information, see your Distributor
or Write to Department H-9

105 W. MADISON ST. **WHITE SOUND, INC.** CHICAGO 2, ILLINOIS



**OWN THIS GREAT LIBRARY
for complete authoritative
analyses of all important
AUDIO AMPLIFIERS**

Only data of its kind available on hundreds of important audio amplifiers. Complete, uniform, detailed analysis of each unit, based on actual laboratory study of the equipment. Includes circuit diagrams, chassis photo views, parts data, full technical coverage. Available in four profusely illustrated volumes—absolutely indispensable to audiophiles, engineers and students.

- VOL. 4.** Covers 75 audio amplifiers and important tuners produced during 1951 and 1952. Never before available in a single compilation. 352 pages, 8½ x 11".
ORDER AA-4. Only \$3.95
- VOL. 3.** Covers 50 audio amplifiers and 22 FM and AM tuners made during 1950. Detailed data on design and servicing. 352 pages, 8½ x 11".
ORDER AA-3. Only \$3.95
- VOL. 2.** Covers 104 amplifiers and 12 tuners produced in 1949. 368 pages, 8½ x 11".
ORDER AA-2. Only \$3.95
- VOL. 1.** Covers 102 post-war amplifiers and tuners produced through 1948. 352p, 8½ x 11".
ORDER AA-1. Only \$3.95

BEST-SELLER ON AUDIO!



"The Recording and Reproduction of Sound"

Only complete reference on AUDIO! New second edition—over 800 pages. Chapters on sound wave behavior; recording methods; the decibel; phono reproducers; cutting styli; microphones; loudspeakers;

dividing networks; attenuators; mixers; amplifiers; tuners; home music systems—hundreds of other subjects. The great Audio book by Oliver Read—largest-selling in its field.

ORDER RR-2. Only \$7.95

HOWARD W. SAMS & CO., INC.

Order from your Parts Jobber today, or write direct to Howard W. Sams & Co., Inc. 2201 East 46th St., Indianapolis 5, Ind.

\$.....enclosed. Send following books:
 AA-1 (\$3.95) AA-3 (\$3.95) RR-2 (\$7.95)
 AA-2 (\$3.95) AA-4 (\$3.95)

Name.....

Address.....

City.....Zone...State.....

CONSTANT-RESISTANCE CROSSOVERS

(from page 22)

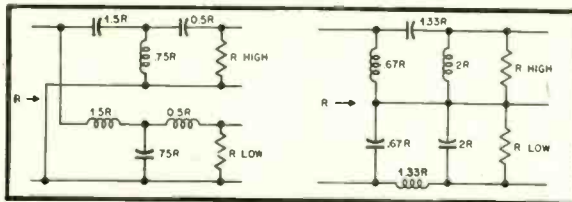

Fig. 6. Complete design data for the two constant-resistance arrangements using three-element sections.

$$P_H = \frac{E^2}{R} \cdot \frac{x^6}{1+x^6} \quad (39)$$

$$db_H = 10 \log_{10} \left[\frac{x^6 + 1}{x^6} \right] \quad (40)$$

$$\phi_H = \tan^{-1} \frac{2x^3 - 1}{x^3 - 2x} = \left(\tan^{-1} \frac{2x - x^3}{1 - 2x^2} \right) - \frac{3\pi}{2} \quad (41)$$

showing a constant phase difference of 3π/2 or 270 deg.

Possible configurations using this relationship are shown at Fig. 6.

Practical Aspects

Figure 7 shows the response curves in the vicinity of crossover for each of these arrangements, with the addition of four-element filters, the derivations for which are not given. Stress is often placed on the slope of a crossover filter, the implication being that the steeper it is the better. Presumably this is a result of a desire to ensure that each unit handles only those frequencies for which it is intended, and that frequencies beyond its range are attenuated as much as possible. In the case of high-pass filters this can have good reason, because frequencies below the acoustic cut-off of a loudspeaker suffer distortion if permitted to pass, and can also injure the voice coil assembly.

But there are other aspects that deserve attention. How about the loudspeaker impedance characteristic? The filters are designed on the basis of feeding into a constant-resistance load at each output. The properties of these networks depends upon correct termina-

tion. Practical dynamic loudspeakers depart from this ideal in two ways:

- (a) the motional impedance, near resonance particularly, contributes a rise in electrical impedance, similar to that of a parallel resonant circuit;
- (b) the voice-coil inductance causes an inductive rise in impedance at the higher frequencies in the unit's range.

With some filter configurations, the latter effect can be compensated for, and the former effect probably takes place at frequencies well removed from crossover, and so will not affect the filter characteristic appreciably.

Voice-coil inductance can be compensated for by using a filter that has series inductance at the output end of the low-pass unit. The actual voice-coil inductance is subtracted from the nominal value of this inductance, given by the design data, and the filter inductance adjusted to pad the total inductance out to the design value.

Assuming that such discrepancies are taken care of, what about production deviation from theoretical values? The larger the number of components required, the greater the possible number of combinations of error. Assume for simplicity that the errors on one filter are all the same way. Then Fig. 8 shows the deviation from level over-all response for each configuration, when the values are 10 per cent off nominal either way. It will be noted that the error not only produces greater deviation from zero level with the more complicated circuits, but also produces a more rapid change in level with frequency, which is known to give more coloration to reproduction than a gradual slope.

Confusion has sometimes arisen in defining the slope of a cut-off. The author prefers to designate a characteristic by its ultimate slope. Others seem to use the slope at the crossover point, which, for constant-resistance types, is just half the ultimate. These slopes are shown by construction lines in Fig. 7, and the following table lists the values in db/octave.

Number of elements per filter	Slope at crossover. (db/octave)	Ultimate slope. (db/octave)
1	3	6
2	6	12
3	9	18
4	12	24

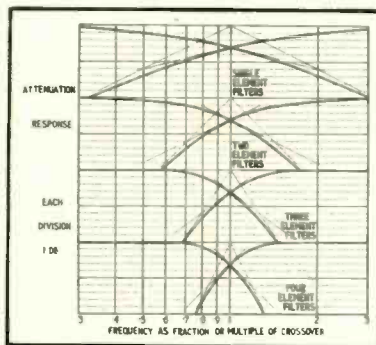
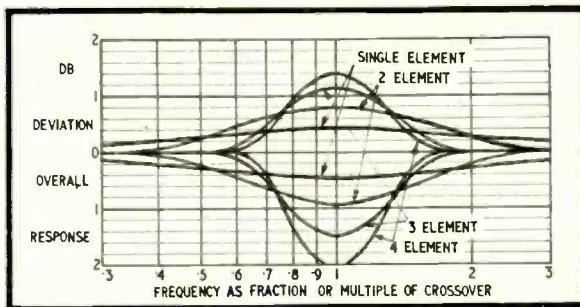

Fig. 7. Attenuation responses of composite filters in the vicinity of crossover. Construction lines show the slope at crossover, and the ultimate slope.

Fig. 8. Showing the deviation in combined response from level, due to an error of 10 per cent, either way, in component values for each filter section.



The reason for greater and more sudden deviation with error in the more complicated filters is evident from the greater slope they possess at crossover. The steepness of the phase characteristics, shown in Fig. 9, also means that error can produce greater phase deviation between the two units with the more complicated filters.

Another feature about reproduction is its handling of transients. It is well known that there is an inherent limit to the sharpness of cut-off before transient distortion begins. But doesn't the use of complementary responses, so the overall result is flat, avoid this? Transient response is tied up with how a circuit handles wavefronts, as distinct from continuous waves. Although relative phase, within a cycle or two, does not matter in the reproduction of steady composite tones, it has considerable effect upon wavefronts. For faithful treatment of transients, all component frequencies should be passed on without any delay, or else with uniform delay.

The phase responses of the low-pass filters are shown in Fig. 9. The curve for the high-pass filter is exactly similar in each case, but advanced by the total ultimate phase change, which is the same as the constant phase difference noted in the foregoing analysis, in each case. Use of constant-resistance types ensures that there is no change in relative phase between the two outputs, because the difference is constant, but the absolute change of phase for both outputs together becomes more rapid at crossover as the number of elements is increased.

In the single-element filters the phase change is so gradual that decade of frequency is required to accommodate a change of 80 deg. The ultimate change is only 90 deg.

In two-element filters a phase change of 90 deg., from 45 deg. to 135 deg., occurs over a frequency ratio of 3.732, nearly two octaves.

The three-element type produces a phase change of 90 deg., from 90 deg. to 180 deg., in just an octave, while complete phase reversal, from 45 deg. to 225 deg., takes a frequency ratio of 6.85, between two and three octaves.

The four-element filter produces 90 deg. phase change in a frequency ratio

of only 1.38, less than half an octave; 180 deg. phase change, from 90 deg. to 270 deg., takes a frequency ratio of 3.08, between one and two octaves, while it passes through three right angles of its ultimate four in little over a decade.

Visualize what happens to a composite signal using four-element filters. At crossover, both units must be acoustically near enough in phase, to avoid undesirable dissociation or cancellation effects in this vicinity. The ultimate low- and high-frequency energy from their respective units will be in phase, but both in anti-phase with energy from both units at crossover. Taking in the whole spectrum view, then, the whole band is in phase except for a range of frequencies near crossover in which phase reversal takes place. So a wavefront composed of a wide range of frequencies will probably have just one of those frequencies completely reversed in phase. If the initial transient is free from coloration, reversal of this one frequency will produce a pronounced ripple on the wavefront at its own frequency, making the transient noticeably colored. This will happen, although steady-tone response of the composite arrangement may be as straight as a line drawn with a ruler.

Choice of filter arrangement will depend on application. If both loudspeaker units have a good response, and overlap somewhat, there is no need whatever to have a filter using more than one element in each section. If each unit is listened to separately, it may seem that

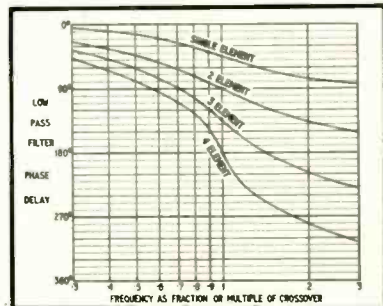

Fig. 9. Comparison of the phase response for filters using from one to four elements. Response for the low-pass section is shown. That for the high-pass section is similar.

to the

E. E. or PHYSICS GRADUATE with an interest or experience in RADAR or ELECTRONICS

Hughes Research and Development Laboratories, one of the nation's large electronic organizations, are now creating a number of new openings in an important phase of operations.

Here is
what one of
these
positions offers
you

OUR COMPANY

located in Southern California, is presently engaged in the development of advanced radar devices, electronic computers and guided missiles.

THESE NEW POSITIONS

are for men who will serve as technical advisors to the companies and government agencies purchasing Hughes equipment.

YOU WILL BE TRAINED

(at full pay) in our Laboratories for several months until you are thoroughly familiar with the equipment that you will later help the Services to understand and properly employ.

AFTER TRAINING

you may (1) remain with the Laboratories in Southern California in an instruction or administrative capacity, (2) become the Hughes representative at a company where our equipment is being installed, or (3) be the Hughes representative at a military base in this country—or overseas (single men only). Adequate traveling allowances are given, and married men keep their families with them at all times.

YOUR FUTURE

in the expanding electronics field will be enhanced by the all-around experience gained. As the employment of commercial electronic systems increases, you will find this training in the most advanced techniques extremely valuable.

How
to
apply

If you are under 35 years of age
and have an E. E. or Physics
degree and an interest or
experience in radar or electronics,

write
to **HUGHES**

RESEARCH AND DEVELOPMENT
LABORATORIES

Scientific and Engineering Staff
Culver City,
Los Angeles County, California

Assurance is required that the relocation of the applicant will not cause the disruption of an urgent military project.

HYCOR

TYPE 4200

Sound Effects Filter



This unit has been developed to meet present day requirements for compactness. The filter requires only 3 1/2 inches of rack space.

Features . . .

- **LOW HUM PICKUP** through the use of toroid coils. The unit may be used in circuits having signal levels as low as -40 dbm without the necessity for taking special precautions against hum pickup.
- **LOW DISTORTION:** The filter may be used at levels up to plus 20 dbm with negligible intermodulation distortion.
- **RELIABILITY:** All capacitors and inductors are hermetically-sealed for lifetime service. Aging effects are negligible.

General Specifications . . .

DIMENSIONS: Standard rack panel, slotted, 3 1/2" high. Maximum depth 7 1/2".
CONTROLS: Low frequency cutoff selector knob, high frequency cutoff selector knob, on-off key.
RANGES: Both low and high frequency cutoff controls cover 100, 250, 500, 1000, 2000, 3000, 4000 and 5000 cycles.
ATTENUATION: Approximately 16 db, per octave on both high and low frequency cutoff points.
IMPEDANCE: 500/600 ohms, in-out.
FINISH: Engraved panel finished in medium gray baked enamel. (Special colors available upon request.)
 The filter has standard input and output jacks located on the front panel in addition to the terminal block at the rear.

11423 VANOWEN ST., NORTH HOLLYWOOD, CALIFORNIA

HYCOR

Company, Inc.

SUnset 3-3860

Manufacturers of Precision Resistors, Toroid Inductors and Electric Wave Filters

REPRESENTATIVES:

Jack Beebe, 5707 W. Lake Street, Chicago, Illinois
 Burlingame Associates, 103 Lafayette Street, New York City

For further information
 contact your nearest
 Hycor representative or
 write for Bulletin 5

Authoritative and Enlightening . . .



Acknowledged the Leading Publication in the Field of Sound Reproduction

If you are novice, hobbyist, experimenter, or engineer . . . if you are a lover of music . . . and in pursuit of sound, undistorted . . . Audio Engineering will be your faithful, reliable companion all the way.

"What to Do" and "How to Do" will guide your every move through this thrilling experience we call Audio.

Each new issue brings New Ideas, New Slants, and Latest Developments . . . month in and month out . . . twelve times a year.

BE SURE to get your copies REGULARLY

MAIL this Coupon NOW

AUDIO ENGINEERING

P. O. Box 629, Mineola, N. Y.

Enclosed is Check Money Order for \$ _____
 Please send a copy of each new issue of Audio Engineering for the next
 12 months; 24 months to:

Please Print

Name _____

Address _____

City _____

Zone _____

State _____

Subscription Price: U.S.A., Canada and Pan American Union: 1 year . . . \$2.00 2 years . . . \$5.00. Other countries: 1 year . . . \$4.00 2 years . . . \$7.00.

the "die" beyond crossover is rather too gradual. But listen to the two units together. If their sensitivities are about equal, even with single-element filtering, the frequency does not have to be far removed from crossover for a very definite impression to be formed as to which unit is delivering apparently all the sound. The unit receiving the greater proportion of energy at a particular frequency will always mask the other one, provided the other is not producing any distortion.

For cases where the acoustic cut-off necessitates more rapid reduction in energy fed to the high-frequency unit, the two-element filter will usually be adequate. It is true that acoustic cut-off can exceed the ultimate slope of 12 db/octave, but this aspect may be safeguarded by moving crossover a little farther from the acoustic cut-off, so as to allow a margin. This will also ensure that signal amplitudes sufficient to damage the h.f. unit (below cut-off) do not reach it.

Intermodulation

As well as providing more uniform coverage over a wide range, one of the advantages of using separate units for different parts of the frequency spectrum is the avoidance of intermodulation distortion. In its commonest form, this is the modulation of h.f. tones by large amplitude l.f. tones, producing a "dithery" effect in the reproduction. By feeding the l.f. tones to a large unit designed to handle them comfortably, and the h.f. ones to another equipped specifically for responding to their more rapid vibrations, intermodulation distortion due to loudspeakers is largely avoided.

While loudspeakers can introduce much more intermodulation distortion than a respectable amplifier, no amplifier is completely free from this form of distortion. For this reason, some experimenters prefer to separate the frequency bands before final power amplification, using an individual power amplifier to drive each loudspeaker unit. Channel filters of this type should have attenuation and phase responses similar to the crossovers used in loudspeaker circuits, but the impedance at which they operate will be quite different. They can more readily be correctly terminated, and efficiency is not so important, as they will not be absorbing precious output power.

Filters for this application use more convenient capacitor values, but the inductance values come out rather large for high-impedance circuits. Inductances for use at low levels are also prone to pick up supply ripple or hum. Both these objections may be overcome by using negative feedback in conjunction with suitable capacitor values. Design for circuits of this type to give attenuation and phase responses with the same properties as those developed in this article, will be presented in a future article.

THE PIANO

(from page 30)

Hence, the bass bridge is usually made in the form shown in cross section in Fig. 8. The extension strip is also made of wood and extends in the direction toward the center of the soundboard. Slight as this distance may appear to be, it does seem to improve the tone of the piano to some extent, at least in the bass register.

A further refinement is to have the length of string from the bridge to the hitch pin be a simple fraction of the longer vibrating portion, such as perhaps one-tenth. It is felt that this small segment helps to accentuate some of the higher harmonics of the string; this may be particularly true of the highest treble strings.

After the bridges have been glued, the soundboard, complete with bridges and ribs, is solidly glued into the frame or rim. It therefore acts as a diaphragm rather rigidly clamped around its edge. When struck with the fist, it emits a dull boom somewhat like a bass drum.

At this point it may be well to point out that in time a soundboard may crack along the grain, but this has practically no effect on the tone. If the crack is such that the two edges of the wood rub against one another and produce a buzz, the crack can be widened out with a gouge. A tapered strip of spruce wood can then be coated with glue and inserted in the crack; after the glue has hardened, the excess wood can be removed. This, however, is mainly done to improve the appearance of a grand piano, where the soundboard is visible; it is hardly necessary in the case of an upright piano. However, if the crack enlarges sufficiently, that section of the soundboard will pull away from the ribs and bridges, causing rattles.

Much more serious is the separation of bridge or one or more ribs from the soundboard. This is repaired with difficulty, if at all, and an entire new soundboard may be necessary.

After the soundboard has been glued into the frame, the cast-iron plate is set in place and screwed to the frame and supporting members by means of lag screws. Then the plate is strung, as many as four per man per day, yes—by hand. The strings are then rough-tuned by being "chipped" (plucked), and are then set aside to age. Although the strings are not strained beyond their

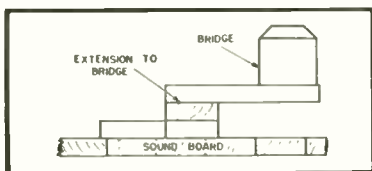

Fig. 8. Showing how the bridge is extended closer to the center of the soundboard.

NEW WILLIAMSON TYPE

Heathkit AMPLIFIER KIT

FEATURES

- Practically distortionless. Harmonic and intermodulation distortion both less than one half of 1% at 5 watts.
- Frequency response ± 1 db from 10 cycles to 100 kilocycles.
- Alike Lansing PEERLESS or ACROSOOUND transformers available.
- First Williamson type Amplifier supplied with matching preamplifier.

When selecting an amplifier for the heart of a fine high-fidelity audio system, investigate the outstanding advantages offered by the Heathkit Williamson type Amplifier. Here is an amplifier that meets every high-fidelity audio requirement and makes listening to recorded music a thrilling new experience through naturally clear, lifelike reproduction of sound at all tonal levels. Wide acceptance of the Heathkit Williamson type Amplifier by the most critical purchasers clearly demonstrates that high-fidelity can be coupled with low cost. For factual information regarding the Heathkit Williamson type Amplifier, consult "CONSUMERS RESEARCH ANNUAL CUMULATIVE BULLETIN 1957-58".

This outstanding amplifier is offered with the optional choice of either the ACROSOOUND output transformer or the PEERLESS output transformer. ACROSOOUND features ULTRA-LINEAR circuitry, which is the exclusive development of the Acro Products Company and provides a greater margin of reserve power efficiency and increases power output. PEERLESS features additional primary taps to permit the optional choice of either the extended power circuitry, now enjoying current popularity, or all of the advantages of the original Williamson type circuit.

The construction manual has been simplified to the point where even the complete novice can successfully construct the amplifier without difficulty. Write for a free catalogue containing complete specifications and schematics of the Heathkit Williamson type Amplifier.

PRICES OF VARIOUS COMBINATIONS

W-2 Amplifier Kit (Incl. Main Amplifier with Peerless Output Transformer, Power Supply and WA-P1 Preamplifier Kit) Shipping Weight 39 lbs. Shipped express only. **\$69.50**

W-2M Amplifier Kit (Incl. Main Amplifier with Peerless Output Transformer and Power Supply) Shipping Weight 29 lbs. Shipped express only. **\$49.75**

W-3 Amplifier Kit (Incl. Main Amplifier with AcroSound Output Transformer, Power Supply and WA-P1 Preamplifier Kit) Shipping Weight 39 lbs. Shipped express only. **\$69.50**

W-3M Amplifier Kit (Incl. Main Amplifier with AcroSound Output Transformer and Power Supply) Shipping Weight 29 lbs. Shipped express only. **\$49.75**

WA-P1 Preamplifier Kit only. Shipping Weight 7 lbs. Shipped express or parcel post. **\$19.75**

HEATH COMPANY
BENTON HARBOR 25, MICH.

YOU CAN DEPEND ON

SONOCRAFT

Everything for RECORDING and PLAYBACK

- ✓ Service on all equipment by experienced engineers—fast and at moderate rates.
- ✓ Expert consultation service.
- ✓ Immediate delivery—just try us.

SEE OUR EXCITING DISPLAY
at the
AUDIORAMA Hotel New Yorker
Room 642
Oct. 14, 15, 16, 17

SONOCRAFT CORPORATION
115 W. 45th St. • New York, N. Y. • JU 2-1750
3rd Floor • Next to Times Square

YOU are
invited to attend
PHILADELPHIA'S



3rd
Annual
High Fidelity
Conference
and
Audio Show

Nov. 3rd and 4th - 1953
Benjamin Franklin Hotel
Philadelphia, Penna.

- Exhibits by the world's leading manufacturers of sound and high fidelity equipment
- Live demonstrations of audio components and systems
- Lectures and panel discussions by the country's leading authorities

FREE TICKETS

Available at These Sponsoring
Audio and Sound Equipment
Distributors of Greater Phila.

- AC RADIO SUPPLY CO.
1539 W. Passyunk Ave., Phila.
- AIR-TONE SOUND & RECORDING CO.
1527 Chestnut St., Phila.
- ALMO RADIO COMPANY
509 Arch St., Phila.
- AUDIO-ELECTRO COMPANY
4923 N. Broad Street, Phila.
- DANBY RADIO CORPORATION
2042 Chestnut St., Phila.
- HI-FIDELITY
ELECTRONIC SOUND CORPORATION
368 Montgomery Ave., Merion, Pa.
- HERBACH & RADEMAN, INC.
1204 Arch Street, Phila.
- LECTRONICS
116 City Line Center Bldg., Phila.
- MAGNETIC RECORDER &
REPRODUCER CORP.
241 N. 17th Street, Phila.
- RADIO ELECTRIC SERVICE CO.
OF N. J., INC.
513-15 Cooper St., Camden, N. J.
- RADIO ELECTRIC SERVICE CO.
HIGH FIDELITY SOUND STUDIO
709 Arch Street, Phila.
- RAYMOND ROSEN & CO.
32nd and Walnut Sts., Phila.
- ALBERT STEINBERG & CO.
2520 N. Broad Street, Phila.
- CUSTOM SOUND ASSOCIATES
7900 Temple Rd., Phila.

elastic limit, they nevertheless stretch or yield somewhat at first, and have to age awhile before further tuning.

In the meantime the keys and action are installed and carefully regulated, then more accurate tuning is performed, and the hammers "voiced," as will be explained. The case is carefully stained and varnished or lacquered, but in the case of some manufacturers, the final coat is not put on until just before the piano is ready to be shipped to the store or home. The reason for this is that it has been found that if hardened lacquer or varnish is shipped through cold climates, in an unheated freight car, the finish tends to "cold check" or crack. A fresh coat of lacquer or varnish, however, is still soft and flexible even when dry, and prevents such checking. Moreover, it tends to freshen up the finish and appearance of the piano, for it takes over a year to manufacture and season a fine grand piano.

THE ACTION.—One of the main features of a piano is its action, or the mechanism that links the keys with the felt hammers that strike the strings. Most actions today are very similar, although the action for a grand piano differs noticeably from that of an upright or of a spinet. In a grand, the hammers return to their initial positions owing to the force of gravity and rebound; in an upright or spinet, a spring is required for this purpose. The result is a somewhat more sluggish response, and the action of a grand is considered much superior by a good artist. Owing to space limitations, however, we shall study only the action of a grand; to a musician, this is the only piano, anyway.

Figure 9 shows the action used in a

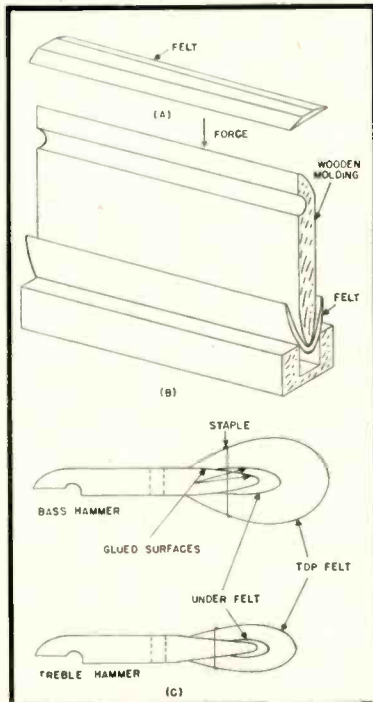

Fig. 10. Felt hammers and their construction.

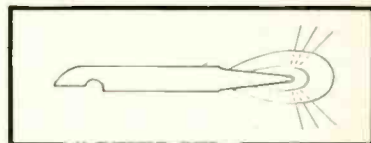

Fig. 11. Method of voicing by "pricking" a hammer.

Steinway Grand piano. The key 42 pivots on the half-cylinder or balance-rail bearing 63. When pressed down at the front end, its rear end rises, and in particular the capstan screw 32 presses against support or "wippen" 24, causing it to pivot on support flange center 30 and rotate counterclockwise.

As it does so, it raises the balancier or repetition lever 10 through support top flange 11, but particularly it raises fly 19, which works in a slot in balancier 10. The fly pushes against hammer knuckle 5 and forces it and the hammer 1 up, along with the hammer 1. As is evident from the figure, these pivot on hammerknuckle center 8.

The key can descend a minimum of about $\frac{3}{8}$ in. whereupon it hits front pin punching 70. By this time fly 19 has lifted the hammer until it is within $\frac{1}{16}$ in. of the string from an initial position $\frac{1}{4}$ in. from the string. This is as far as the fly can push the hammer, for tender 71A strikes regulating button 43, and causes the fly to rotate slightly clockwise and thus get out from under the knuckle 5.

The hammer flies up to hit the string because of its inertia, and bounds back, where it is caught by backcheck 33, covered with felt 34 and leather 35. The knuckle 5 rests on repetition lever 10, which is pressed upward about its center 12 by repetition spring 13. If, now the key is raised but slightly so as to break contact between 71A and 43, fly 19 will be pulled back under knuckle 5 by spring 22 so that it can flip up the hammer once more if the key is depressed again. In short, if the same note has to be repeated rapidly, the key need be raised but slightly from its depressed position, so as to give the fly chance to get under the knuckle once more, and the slight depression of the key from this point will cause the hammer to strike the string once again.

At the rear, the key strikes under-lever 48, which raises damper wire 56, damper head 57, and damper felts 58 from the string just before the hammer hits the string (or strings). When the key is released, the damper falls down on the strings and stops the tone. On the other hand, if the key is kept depressed, the tone continues until all the energy in the string has been dissipated in internal friction in the soundboard and in acoustic radiation. (The action of the pedals will be discussed later.)

One thing should be evident from this simplified discussion of the action; the fly cannot be permitted to press the hammer against the string, otherwise the hammer would damp the string after actuating it. Instead, the hammer must proceed on the last part of its journey by itself, so that it can almost instantly

rebound and thus allow the string to vibrate freely by itself.

The action is made of wood (such as pine for the keys and maple for the Action Parts), German silver pins for pivots, steel screws, cast iron, bronze, aluminum, or die casting action hanger 74, and bushing cloth tubes around the pivot pins to act as bearings. At first glance the construction might seem medieval, but the long trouble-free operation of this unit speaks eloquently for the fundamental soundness of its design.

It requires no lubrication; the cloth tubes glued into the holes in the wood act as excellent bearings. They are quiet yet free-acting, and, as stated previously, long lasting.

Another point of interest is Steinway's so-called accelerated action. In most other actions, the key rocks on a flat disc of felt. In the accelerated action, it rolls on the half-cylinder or balance rail bearing 63 in Fig. 9. This is Patent No. 1,826,848 issued to F. A. Vietor, a great-grandson of Henry. Mr. Theodore Steinway said that tests indicated it to be about 15 per cent faster than the older action, although the latter was so fast that only a finished artist can notice the difference.

Take such an item as the ivory overlay on the white keys. Although plastic overlays are available and used on the cheaper pianos, such as spinets, neither Steinway nor Baldwin, for example, would consider using them on their grand pianos, particularly their 9-foot concert grands. (Steinway uses ivory on all pianos, grands and verticals). The reason is that artists consider ivory cooler to the touch, and also as having less friction, even under strong pressure from the fingers, than plastic.

Engineers may question this contention as another manifestation of the emotional illogic of musicians. Certainly ivory is getting scarcer every day, and eventually plastic will have to be used; perhaps some new ivory may be obtained from synthetic elephants. Yet artists appear to be able to tell the difference between ivory and plastics, and sincerely prefer the former. On the other hand, Steinway no longer uses ebony for the black keys, but instead, a transfer-molded phenolic. This, Steinway feels is as good as ivory or ebony, if not better, but unfortunately does not come in a white color. But Baldwin still sticks to ivory and ebony.

The Hammers

We now come to the hammers. These are made as an entire group, as illustrated in Fig. 10. In (A) is shown a long strip of felt, cut in a jig with a sharp knife to the tapered shape shown. The felt is of special quality wool, and the manufacturers are rather proud of their product. The narrow end will be for the treble hammers; the wide end, of course, for the bass hammers.

Actually there are two layers of felt, as indicated in the finished hammers shown in (C). One is the under felt, over which is glued a top-felt. Some

piano makers use only top-felt, but most feel that the under felt acts to add more resilience to the hammer.

The felts are coated with glue along their edges, and a long wooden molding placed on them, as shown in (B). The assembly is forced into a form in a press, and the heavy felt is literally folded around the wood and pressed tightly against it. When the glue is hard, the assembly is removed from the form, and sawed apart into the 88 hammers forming a set for the piano. Owing to the taper in the felt and in the wooden molding, the heaviest keys are at the bass end, and the lightest at the treble end, as is clearly indicated in (C). The felts are then wired through the wooden shank, as shown, and the wire is twisted together on the far side.

Note that the felt is not glued along its most rapidly curving inner portion, but only along the sides. This somehow is supposed to improve the tone by eliminating brittle glue, although primarily the tone is determined by the nature of the outer surface.

If the outer surface were hard, like a metallic surface, for example, the tone would be sharp and clanging, because of the sharp deformation produced in the string upon striking it—the deformation itself denotes stronger higher harmonics. On the other hand, if the surface is too soft the string develops mainly a fundamental tone with some of the lower harmonics, and the tone sounds muffled.

Hence, by proper preparation of the felt surface, the tone may be rendered sharp or mellow; that is, the piano may be "voiced." The men that do this are experts, and their hearing is better trained for that particular type of tone than that of most artists. In voicing a new piano, they may pick a key which they feel represents the quality they desire. Then if some other key has too "mushy" a tone, they will file (sandpaper) off a layer of the felt to expose a harder layer underneath, and thus render the tone more brilliant.

On the other hand, if another key has a tone which is too metallic or "twangy," the voicer will "needle" the felt. This is done by piercing the felt radially with needles as illustrated in Fig. 11; note, however, that the striking surface is not pierced. This treatment serves to produce a soft bed under the harder layer of felt that strikes the string. Usually the needling is done by a wooden tool having three needles protruding about 1/2 in. from it, so as to produce several holes at once. A single long needle may also be used to even out the tone when the key is pressed down hard: this is known as taking "deep stitches."

Hammers in use for many years tend to have the striking faces of the felts flattened, as well as grooved by the strings. Such a hammer does not rebound cleanly from the string and hence tends to damp the string it just set into vibration. The upper harmonics in particular, suffer. Hence, the felts have first to be filed into an elliptical shape once more, and then voiced as required. Voicing is a long, tedious, exacting, and expensive process.

PILOT Hi-fi

at **TERMINAL**

Famous Williamson type
MODEL AA-903
AMPLIFIER
with built-in pre-amplifier

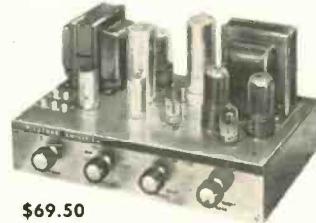

\$69.50

Williamson type 10 watt Amplifier. 7 tubes including Rectifier with push-pull output tubes. Controls are mounted behind decorative front panel which may be easily removed for cabinet installation, and include On-Off Volume, separate Bass and Treble Controls and Equalizer selector switch for LP, NAB, AES and Foreign Recordings. Frequency Response \pm 1DB 15 to 40,000 cycles. Distortion less than 1%. Hum level 70DB below 1 volt. Three inputs are provided for Radio and Auxiliary equipment and one input is provided with adjustable impedance for matching the various magnetic cartridges.

FM-607 FM PILOTUNER



\$59.50

8 tubes incl. Rectifier with two stage audio Amplifier and Cathode Follower Output for use with up to 100 feet of connecting cable. Audio Distortion .2% at 1 volt output, Frequency Response \pm .5DB, 20 to 20,000 cycles. Sensitivity 5 microvolts for 20DB quieting with hum level 70DB below 1 volt. Slide Rule dial with illuminated scale and self-contained front panel assembly with beautiful gold finish enables unit to be left open on shelf or easily mounted in cabinet. Three simple controls: On-Off Volume; Selector Switch for FM, FM with AFC, or Phono; and Tuning. Built-in line cord antenna.

Write for free brochure

Radio • Audio • Video • Electronic Equipment

Phone: WOrth 4-3311

Terminal
RADIO CORP.

85 Cortlandt St. • New York 7, N. Y.

**HOW TO
BUY A
hi-fidelity
DISK CHANGER**

Webcor engineers have developed the HF series of automatic record changers to satisfy the particular demands of the high-fidelity enthusiast. When buying a changer, investigate these three features—you'll find Webcor performance superior to all others.



 **1 Accurate Turntable Speeds.** Webcor's own powerful motor maintains constant speed and low "hum." "Step-Drive" mechanism translates power into three different speeds so accurately that "wow" is eliminated. Fly-Wheel action turntable is made of extra-heavy steel and is ball-bearing mounted. The result: constant, accurate turntable speed with a minimum of "wow," "hum" or "rumble."

 **2 Balanced Tracking.** A result of the elimination of mechanical drives and gears. The Webcor balanced tone arm "floats" in the record groove without any undue pressure. No excess wear on delicate sidewalls or records. Grooves themselves guide carefully weighted arm.

 **3 Swift, but Gentle Changing.** A Webcor exclusive, the famed "Push-Off" system that has proved itself in close to a million installations. Records slide gently from spindle step to thick, resilient carpet on turntable formed by exclusive Webcor electrostatic flocking.

Webcor "HF" Diskchangers are available with or without handsome base pan. Choose crystal or G. E. Triple Play cartridge. Will also take standard magnetic cartridges.

Available wherever fine high-fidelity components are sold.

Webcor[®]
by WEBSTER-CHICAGO
Chicago 39, Illinois

© w/c 1953

4135

MISCELLANEOUS CONSIDERATIONS.—*Figure 9* indicated that the action is quite a complicated mechanism and that there are numerous screws and parts for the purpose of adjustment. The key, it was mentioned, is permitted to descend a minimum of $\frac{3}{8}$ in. The capstan screw rises about half this distance, indicating a 1:2 lever arm. However, the hammer moves a distance of from $1\frac{3}{4}$ in. to $1\frac{7}{8}$ in. when the key is fully depressed; this is five times the distance that the front end of the key moves. Hence the overall lever arm is 5:1.

Adjustments are made to the various screws, and by the use of paper shims under the keys, etc. The keys, when not depressed, must all be of the same height, although actually the surface is slightly arched in that the middle keys are about $\frac{1}{32}$ in. higher than the end bass and treble keys. This is to compensate for the greater matting of the felt washers in the action in the middle range, where most of the playing occurs. The hammers should all lie on a straight line, and they should "let off" from the fly or jack when they are about $\frac{1}{16}$ in. from the string.

In a grand the keys spring up because of the weight of the action and hammers on their back ends. Hence, the force the finger must exert on the front end of the key depends upon this weight. The force can be decreased by balancing the rear weight with lead weights inserted into the front sides of the key, as indicated by the dotted circles in *Fig. 9*.

If the counterbalancing is appreciable, the piano is "easy" to play, but has some disadvantages. In the first place, the mass of the moving parts has been increased, and the restoring force has been decreased, so that the action becomes sluggish. In the second place, human muscles can control motions better if there is some opposition to the motion rather than if there is none. Finally, for practice purposes a "stiffer" action is preferable. The above discussion does not consider frictional opposition; if the action is properly constructed, the frictional forces should be negligible.

Part 2 of this article, covering theoretical considerations of the instrument, will appear next month.

NEW SOUND SENSATION

**BELL Model 3-D
BINAURAL
High Fidelity Amplifier**

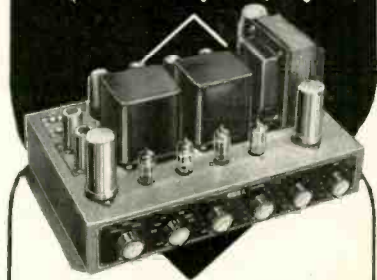

Another Bell "first"—a single high fidelity amplifier for full, masterful rendition of the new *binaural sound!* Pre-amps and special controls are all included in Model 3-D, along with three *dual* inputs for radio, tape, and hi-or-lo mag pickups (equalized for present binaural records).

Function switch lets you select operation you want—monaural (it's a *conventional* amplifier, too), binaural, or reverse binaural, each with or without loudness compensation. Balance control affords correction for variations from the original in pickups, speakers, or acoustics. A host of other quality features too numerous to list!

Power: 20 watts (10 watts each channel) at less than $\frac{1}{2}$ of 1% total distortion; peak 35 watts. Freq. Response: 20 to 20,000 cycles plus or minus $\frac{1}{2}$ db (controls set flat). Hum Level: 70 db below rated output. Dual Output Imp.: 4, 8, 16 ohms dual high Hi-Z jacks for tape recorder. Controls: 3-position selector; 6-position function switch; balance; gain; bass; treble with AC switch. Tone controls have boost and cut.

THERE'S A LOT MORE!
WRITE FOR FREE DETAILS.



**BELL SOUND
Systems, Inc.**

559 Marion Rd., Columbus 7, Ohio
Export Office: 401 Broadway, N. Y. 13.



Wide frequency range
30 c/s to 20 kc
Low Distortion
Superior transient response

NOW AVAILABLE
The **GRAMPLAN** Feedback
Disk Recording Cutterhead Unit

Engineers and musicians now realize a perfect transient response of any recording system is of paramount importance—the Gramplan cutterhead with its precision-made true balanced armature and flux correcting feedback loop obtains this ideal.

The Gramplan is used by International radio networks to guarantee Hi-Fidelity sound reproduction. You can achieve the same high quality results in your disc recording with the Gramplan.

After testing and experimenting with all types of equipment many famous record manufacturers, such as *CAPITOL*, are converting to the Gramplan Feedback Cutter for the best results.

For more information, write to



REEVES EQUIPMENT CORP.
10 EAST 52nd STREET • NEW YORK 22, N. Y., U. S. A.
CABLE: REEVESQUIP, N. Y.

RIDER'S "BEST SELLERS" for SOUND from A to Z



GUIDE TO AUDIO REPRODUCTION

by David Fidelman

Here's an A to Z explanation of the reproduction of sound—from the fundamentals to all phases of audio reproduction systems. Design, construction and assembly of these systems and their components. Comprehensive methods for testing individual units. Explanation of circuitry of pre-amplifiers and amplifiers. Complete discussion of pick-up devices (phono cartridges, tuners and microphones), loudspeakers and enclosures. Charts, tables and graphs keep mathematics to minimum. Engineers will value the book for design charts and testing methods. Practical circuits for home or custom construction enable building of systems tailor-made to individual needs.

ONLY \$3.50



HIGH FIDELITY SIMPLIFIED

by H. D. Weiler

LIFE magazine's June 15, 1953 Issue reported enthusiastically how "High Fidelity Simplified"—the only book quoted—explains the complete Hi-Fi story. RADIO-Television News stated: "Those planning high fidelity music systems for their homes will save themselves time, money and trouble by reading this first, then making purchases."

Typical Chapters: Sound; Acoustics, Electronics and Music; The Simple Loudspeaker; The High-Fidelity Loudspeaker; Loudspeaker Enclosures; The Basic Amplifier; The Amplifier—Part 2; The Record Player; The Tuner; Use of the Music System; Tape Recorders.

ONLY \$2.50



OBTAINING AND INTERPRETING TEST SCOPE TRACES

by John F. Rider

People interested in audio will welcome this book which shows over 500 actual photographs of test scope traces. Complete explanation of how to use scopes and what test scope traces mean. Valuable for audio systems and test equipment and also for TV receivers, and FM and AM receivers. Specific test equipment set-ups are shown with each application. There is no other book like it!

Typical Chapters: What's in a Scope; Getting Familiar with the Scope; Auxiliary Test Equipment for the Scope; Using the Scope for Checking Test Equipment; Checking Audio Systems With the Scope; The Scope's use in Checking Components, and four other chapters.

ONLY \$2.40

Buy these books now from your Jobber, local bookstore or, if unavailable from these sources, write to:

JOHN F. RIDER

PUBLISHER, INC.

480 Canal Street, New York 13, N. Y.

XD SPEAKER

(from page 38)

of tests, carried out prior to the ones above, indicated that true stereophonic rendition could be less easily simulated by reproduction of a single-source program—fed in identical fashion to two speakers—than by listening to the same two speakers, each with a different frequency balance. This was to be expected because, next to independent phase detection by the left and right ear, one of the important characteristics of stereophonic sound is the potential difference in spectral composition between the sound radiated from the reproducing speakers. It should be noted that from here on, instead of the double track recordings, the normal single track records were used.

The Finished Product

Encouraged by these experiments, a simple and inexpensive system was tried which resulted in the new Columbia XD system. The Columbia "360" player was launched at a time when the final design of the XD system was not yet frozen. Thus the "360" cabinet was provided with a jack in the back which later was to accommodate the XD speaker. This was not just another speaker but part of the over-all simulated stereophonic system identified as the XD (Extra Dimensional) sound.

The frequency characteristics of the "360" itself and of the separate speaker have been so fashioned that, when plugged in, the jack of the external speaker causes a roll-off of the highs and emphasis of the lows in the "360" player. At the same time, the external speaker assumes the required opposite characteristic; namely, emphasized highs and attenuated lows, exactly as determined in the previously described tests.

In order to conceal the identity of the box and at the same time to give it added utility, the extra speaker is housed in a small cabinet—a 7-in. cube—so designed that it contains an electric clock. Sound is radiated from a 6-in. speaker, which is the same type as used in the "360", through louvers inclined at 45 deg. located on the top of the box. The sound is thus deflected against the wall behind the speaker, thereby providing a diffused distribution of the higher frequencies in that area of the room. The separate speaker of the XD system should preferably be placed in a corner diagonally opposite the "360" player to give most effective results in the average room. Naturally, there are other arrangements possible, depending on the particular layout of the room.

Figure 2 shows the external appearance of the XD speaker and Fig. 3 is a schematic of the "360" and the external speaker. Figure 4 shows the amplitude characteristic of the "360" with flat signal generator input measured across the speaker terminals without the

Easier Reading VU METER



MAKES IT SIMPLE FOR ANYONE TO VISUALLY MONITOR ANY RECORDER

Permits quick, more positive reading of average power. Makes it easy for anyone, even the unskilled recorder, to visually control recording level, prevent distortion, emphasize or de-emphasize any passage—the professional way—on any recorder. Standard VU scale and sensitivity. Color-differentiated scale. Dual impedance. 3½" rectangular semi-flush mounting. Complete with instructions.

MODEL 10 VU METER. NET \$17.00

MODEL 101. Same with internal illumination. NET \$19.00

Write for Bulletin No. 110

tapeMaster inc.

15 W. HUBBARD ST.
CHICAGO 10, ILL.

Acrosound★

"300" series ULTRA-LINEAR* TRANSFORMERS FOR ULTRA-LINEAR CIRCUITS

- ✓ optimum placed screen taps for U-L use
- ✓ response ± 1 db 10 cps to 100 kc
- ✓ flat power curve 20 cps to 20 kc
- ✓ the cleanest, most natural sound available

TO-300 for KT 66's, 5881's, 807's etc. \$24.75 net.

TO-310 for 6V6's, 6AQ5's 18.75 net

TO-330 for pp par KT-66's, etc. 39.75 net

Available at leading distributors

Complete data and characteristics of Ultra-Linear Circuits and Acrosound Output Transformers on request.

*Patents Pending

ACRO PRODUCTS CO.
369 Shurs Lane, Phila. 28, Pa.

SOLVE your hi-fidelity problems with
University CONE SPEAKERS
-HIGHEST QUALITY! -LOWEST COST!



MODEL 6201 - COAXIAL SPEAKER SYSTEM. Now generally acknowledged to be Industry's finest value in a high quality 12" speaker. TRUE coaxial dual range system comprising clean sounding woofer with heavy exclusive Alnico 5W magnet, DRIVER TYPE tweeter with "Reciprocating flares" wide angle horn, and BUILT-IN crossover network complete with "Balance" control.

DIFFUSICONE-12 - WIDE RANGE WIDE ANGLE 12" SPEAKER. Exclusive "diffusicone" design utilizes the benefits of dual-horn loading, radial projection and diffraction principles to achieve unsurpassed quality and sound distribution from a single unit speaker. Enjoy full fidelity ANYWHERE in the room . . . at a surpris- ingly reasonable cost.



DIFFUSICONE-8 - WIDE ANGLE 8" SPEAKER. Same as the Diffusicone-12 except in 8" size. Remarkable fidelity and exceptional sensitivity and power handling capacity make this a truly outstanding eight. Ideal for use where space is limited, and is also a perfect selection for a mid-range speaker in 3-way systems.

MODEL 6200 - EXTENDED RANGE 12" SPEAKER. Designed for general applications, capable of highly efficient FULL-BODIED response throughout the operating spectrum. May be used with equal facility to improve commercial radio, TV, phono sets, high quality sound re-inforcement in night clubs, churches, schools, etc., or as a woofer. The 6200 must be heard to be appreciated.



MODEL C-15W - DUAL IMPEDANCE RANGE 15" WOOFER. Brand new low frequency reproducer embodying many exclusive advance features. Its superior response and acoustic output is due, in part, to a newly University-developed cone and voice coil suspension system permitting the greatest axial movement ever achieved. The incredibly low distortion results from a new magnet assembly.

There is a UNIVERSITY Tweeter for every application and pocketbook. Write for descriptive illustrated literature. Address Desk H-12

University LOUDSPEAKERS INC
 80 SO. KENSICO AVE., WHITE PLAINS, N. Y.

extension speaker plugged in. Figure 5 shows the altered response of the "360" itself with the XD speaker plugged in (dotted curve) and the frequency characteristic of the XD unit itself measured across the speaker (solid curve). There is an intensity control in the back of the XD speaker which permits balancing of its output with respect to the main instrument.

When the XD speaker is plugged into the "360", the effect on the listener is quite startling. Broadening of the sound source is immediately apparent, even to the point that the positions of the two speakers are detectable only after careful scrutiny. There is a distinct impression of spatial dispersion which is lacking in conventional single- or dual-speaker sound systems.

AMPEX REMOTE CONTROL

(from page 23)

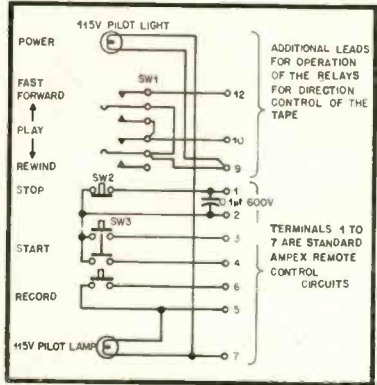

Fig. 4. Wiring of complete remote control box. Upper portion shows new lever switch, while lower portion shows normal Ampeg remote control circuit.

held down while the lever switch is slowly thrown into the PLAY position from either other position the tape will be broken. In the regular rotary switch operation the tape would break when the START button was held down when switching from REWIND to PLAY. A slight inconvenience in using the new lever switch is that during rewind and fast-forward operation the lever must be held in the proper position.

Remote Recording

To record from the remote positions,

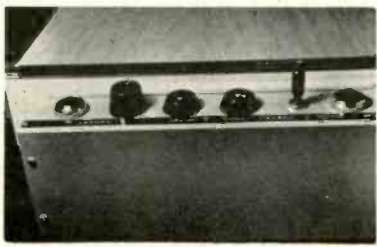

Fig. 5. Remote control box assembly.



PRE-RECORDED TAPES
 worthy of your
 Hi Fi equipment

Relax . . . and listen to
HACK SWAIN'S
 Super-Medley of
"MUSICAL COMEDY HITS THRU THE YEARS"
 (positively no vocal)

Technically perfect! Rare renditions and arrangements on unique organ-piano combo that has made "Hack" a popular radio program personality. 30 minutes of sheer joy on 7 1/2" or 3 3/4" Scotch. *AMPEX RECORDED!

Sent postpaid (with complete list of other unusual medley's) for ONLY **985** post paid Satisfaction guaranteed or your money back. Send check or money-order, specifying whether 3 3/4" or 7 1/2" is desired. TO

Hack Swain
 P. O. BOX 2384-A
 SARASOTA, FLORIDA

Today it's TRANSISTORS
 Here's the FIRST FULL-LENGTH BOOK in the field . . . the work of nine General Electric experts.

Principles of Transistor Circuits
 Edited by Richard F. Shea

- brings you both transistor theory and details on applicable techniques.
- collects the most useful information scattered through the literature.
- gives new material published for the first time.
- supplies practical data on every phase of the subject — Remember, there is no other detailed reference and guide to the new transistor horizons in electronics.

Covering:
 Semiconductor principles. Transistor forms, types, characteristics. Transistors as low-frequency circuit elements. Principles of amplifier stage. Junction transistor multistage amplifiers. Bias stabilization. Power amplifiers. Transistors as high-frequency circuit elements. Principles of high-frequency operation. High-frequency circuit design. Video amplifiers. Oscillators. Circuit design by duality. Matrix methods of circuit analysis. Feedback amplifiers. Transient analysis. Large-signal operation. Computer circuits. Noise in transistors. Associated semiconductor devices. Small-signal parameter measurement.
 1953. 535 pages. \$11.00

Send now for a copy ON APPROVAL. Write for free booklet on other Wiley books in Radio and Electronics.

JOHN WILEY & SONS, Inc.
 440 4th Ave., New York 16, N. Y.

The Magnemite*



Battery-Operated Spring-Motor Portable Recorder

Field recordings can now be made with equivalent quality and with as little effort as studio console recordings. Smaller than a portable typewriter (11½ x 10 x 8 inches) and weighing 15 lbs. including the dry-cell batteries that last 100 operating hours, the Magnemite® is easily carried and operated anywhere.

Here are truly professional specifications:

- Model 610-SD (7½ ips, 50 to 7500 cycles meets NARTB standards.
- Model 610-E (15 ips, 50 to 15,000 cycles) meets primary NARTB standards.
- Dynamic range 50 db.
- Flutter ± 0.1%.
- Constant speed governor-controlled.
- Monitoring and playback facilities.

Write for complete technical literature and direct factory prices to Dept. AE:

AMPLIFIER CORP. of AMERICA

398 Broadway, N. Y. 13, N. Y.

*Trade Mark Reg. Pat. Pend.



RECORDING TAPE (PLASTIC BASE)

at NET PRICES in Cartons of 12

WASHINGTON, D. C.: WHERE ELSE WOULD THERE BE MORE RED ^ TAPE?

- 1200 ft. plastic tape with plastic reel included.
- Each reel individually boxed.
- Choice of nationally famous top quality brands such as: Webeor (2906) 3.20; Reeves (SPN-12) 3.20; Audio (1251) 3.23; Scotch (111-A) 3.25; Panacoustic (711-A) 3.25; Irish, Professional grade (211 RPA) 3.30.
- Recording studios, schools, radio stations and other large quantity users—write for bulk price.

USED RECORDING TAPE (PLASTIC BASE)



1.99 for 7" —1200 foot
.99 for 5" — 600 foot
.59 for 4" — 300 foot
.29 for 3" — 150 foot
Plastic reels included with all above sizes.

Money cheerfully refunded if you do not find this tape cleanly erased and as good as new. (If you are skeptical and from Missouri send us 12¢ in stamps and we'll roll you a sample.)

New empty plastic reels in boxes for easy labelling. 3" 10¢; 4" 22¢; 5" 24¢; 7" 30¢; 7" Professional reel (2¼" hub) 75¢ ea. EMPTY BOXES: 3" 3¢; 4" 5¢; 5" 5¢; 7" 10¢ ea.

We carry new recorders, recording blanks, tape, tape recorders, etc. at large savings. PLEASE INCLUDE SUFFICIENT POSTAGE.

COMMISSIONED ELECTRONICS CO.
2503 Champlain St. N.W., Washington 9, D. C.

the recorder monitor output ahead of the monitor switch output is brought out to an existing supervisory speaker at each remote point. Being able to listen to the output of the tape brought up the question of how to determine when the tape was at the recorder head and also when to stop rewinding. This was solved by previously recording about ten seconds of a 400-cps tone at the very beginning of the tape.

Figure 4 is a schematic of a typical remote control assembly. Figure 5 shows the external appearance of the remote



Fig. 6. Remote control box in place in one of the control rooms.

control box, which is also shown in a typical position in Fig. 6 alongside one of the audio consoles. The new remote switch is shown in detail in Fig. 7.

Several months of operating this tape recorder "blind" from two remote points have proved that the change was well worth the effort and expense involved. The author is indebted to Mr. Kohl-brenner, of the WGR Shop, for the construction work done on this modification.

PARTS LIST

- Sw. Cam lever switch—General Control Company type MCM frame, contact forms 2-F
- Sw. H & H push-button switch, normally closed. (stock Ampex part)
- Sw. H & H push-button switch, DPST normally open. (stock Ampex part)
- Sw. H & H push-button switch, SPST normally open
- E. Advance relay type 979B 3PDT, break 3 and make 3 contacts; coil—115-v. a.c., 60-cps.
- E. Advance relay type 953B SPST; coil—115-v. a.c., 60-cps.

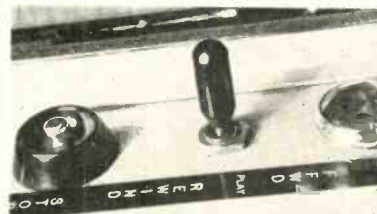
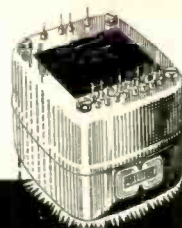

Fig. 7. Close-up of lever switch in one of the remote control boxes.

'C' core technique at its best



The Type CFB AUDIO TRANSFORMER

Once again this famous Audio Transformer is available OFF THE SHELF. Little wonder that the Partridge CFB leads the way in 'C' core transformers—these figures speak for themselves:—

Series leakage induct 10 mH; Coupling between primaries—leakage induct. for one half (other shorted) 30 mH; D.C. resist. per half primary 88 ohms; Power up to 60 w. from 22 c/s to 30 Ke/s; distortion less than 1 per cent. with no negative feed back.

PRICE \$40 DUTY PAID

If you experience difficulty in obtaining CFB transformers, please write, mentioning the name and address of your local jobber. Remember, there is NO SUBSTITUTE for the CFB.



PARTRIDGE TRANSFORMERS LTD
TOLWORTH, SURREY, ENGLAND.

AMPERITE Studio Microphones at P.A. Prices

Ideal for BROADCASTING RECORDING PUBLIC ADDRESS

"The ultimate in microphone quality," says Evan Rushing, sound engineer of the Hotel New Yorker.

- Shout right into the new Amperite Microphone—or stand 2 feet away—reproduction is always perfect.
- Not affected by any climatic conditions.
- Guaranteed to withstand severe "knocking around."



Models
RBLG—200 ohms
RBHG—Hi-imp.
List \$42.00



"Kontak" Mikes
Model SKH, list \$12.00
Model KKH, list \$18.00

Special Offer: Write for Special Introductory Offer, and 4-page illustrated folder.

AMPERITE Company Inc.

561 BROADWAY • NEW YORK 12, N. Y.

Canada: Atlas Radio Corp., Ltd., 560 King St. W., Toronto

Compeo EASY-HANDLING MAGNETIC TAPE REELS

Precision manufactured in accordance with the exacting standards set by the N.A.B.

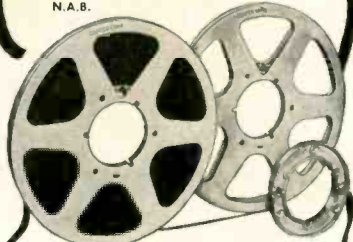

Easy to handle because:

1. Burrs and sharp edges are smoothed away.
2. Components assemble quickly, easily.
3. Aluminum flanges stay flat. Eliminate tape rubbing.
4. Hubs are die-cast to close tolerance.
5. Grey, "write-on" finish available for editing notes.

TAPE REELS, STORAGE CANS, AND SHIPPING CASES FOR EVERY PROFESSIONAL REQUIREMENT ALWAYS IN STOCK

Write for descriptive literature and price list

COMPCO CORPORATION

Manufacturers of fine products for the Audio Visual Industry.
2251 W. St. Paul Ave., Chicago 47, Illinois



A MONTHLY SUMMARY of product developments and price changes of radio electronic-television parts and equipment, supplied by United Catalog Publishers, Inc., 110 Lafayette Street, New York City, publishers of Radio's Master. These Reports will keep you up-to-date in this ever-changing industry. They will also help you to buy and specify to best advantage. A complete description of most products will be found in the Official Buying Guide. Radio's Master—available through local radio parts wholesalers.

CORRECTION: Fairchild Recording Corp.

In the August column, Model 201-B Three-Way Turret Head was reported as discontinued. It was actually replaced by Model 202 Three-Way Turret Head at \$65.00 net.

Recording Equipment, Speakers, Amplifiers, Needles, Tape

BRUSH ELECTRONICS—Discontinued Model BA-116 Microphone.
EICOR—Added Tape Recorders Model 230 at \$110.47 net; Model 400 at \$83.65 net.
FISHER RADIO—Increased price on Model 50-R FM-AM Tuner to \$164.50 net.
OXFORD ELECTRIC—Added loudspeaker Model HF15LN at \$25.50 net.
PRESTO RECORDING—Added several new Lacquer Coated Aluminum Discs.
REK-O-KUT—Added Model C-12H Carrying Case for Model T-12H 12" Turntable at \$26.95 net.
RIVER EDGE INDUSTRIES—Added Model 720 at \$25.50 net and Model 730 at \$9.90 net to their HI-FI and TV Cabinet series.

DO YOU HAVE YOURS?



If you live in the United States, you can subscribe for life at the new rate of \$25.00. If you are already a subscriber, we will refund a pro-rated amount based on your remaining term, or you can transfer it to a friend. This offer is good only in the U. S. and applies only to subscriptions entered by sending your request and check to the address below.

RADIO MAGAZINES, INC.,

P. O. Box 629, Mineola, N. Y.

Enclosed is check money order for \$25.00 for which please enter my subscription to AUDIO ENGINEERING for the rest of my natural life, and send Life Subscriber card to

Name (please print)

Address

City Zone State

CLASSIFIED

Rates: 10¢ per word per insertion for noncommercial advertisements; 25¢ per word for commercial advertisements. Rates are net, and no discounts will be allowed. Copy must be accompanied by remittance in full, and must reach the New York office by the first of the month preceding the date of issue.

THE AUDIO EXCHANGE, INC. buys and sells quality high-fidelity sound systems and components. Guaranteed used and new equipment. Catalogue. Dept. A, 159-19 Hillside Ave., Jamaica 32, N. Y. Telephone OL 8-0445.

HIGH "Q" Toroidal Inductors for use in wave filters and communication networks. Wound to your specific requirements on powdered Molybdenum Permalloy cores. Quick delivery. Low Price. Write today for descriptive literature. Torocoil Company, 1374 Mobile Ct., St. Louis, Mo.

FOR SALE: Complete system—Concertone tape recorder, UTC 20-watt Williamson, Collins FM tuner, four-way speaker system, 25-20,000 cps in the air. K. Jernberg, 7 Rochelle St., Worcester, Mass. Phone 6-8379.

FAIRCHILD 541A1 Cutterhead, equalizer, microgroove, thermosylus attachments. Box 101, St. Albans, N. Y.

FOR SALE: Electro-Voice 15WK Klipsch-type bass driver. Used by one owner in folded horn. Good as new. Packed in original carton. Must sell. First \$50 offer gets it. Mark Lauder, Box 393, Wabash, Indiana.

NORTHERN NEW JERSEY—You will be thrilled with this 3-D sound without gimmicks. Legitimate high fidelity with direction, dimension, for two ears. You are there with **BINAURAL! The fine LIVINGSTON BN Arm** with Fairchild diamond cartridges aligned and tested at great saving. **LIVINGSTON'S** extraordinary LP renews a BN and high-fidelity must. Highest quality audio and service. Come see, hear. Write Dept. AN or call for literature. **CUSTOM MUSIC SYSTEMS**, 225 N. 18th St., East Orange, N. J. OR 3-3779.

GARRARD RC-80 changer, GE cartridges, \$40; Garrard 2-speed, GE, \$20. Tone recorders (7 1/2 ips speed, 7 in. reels): Twin-Trax, automatic reverse, radio, phonograph, \$150; Brush BK-401, \$100; Eicor 1000, \$85. York Saxophone, \$75; Rider Channylast 162C, \$75; Intertalk Telephones, \$15; Audak transcription magnetic pickup, \$5; Astatic FLC-33 microgroove pickup, filter, \$8.50; portable dual bass-reflex 12-in. enclosure, \$15; vertical 1/2-in. drill press stand, \$7.50; antique Atwater Kent, AC-Dayton radios, best offer. Everything guaranteed excellent. Priced FOB. V. K. Hein, 418 Gregory, Rockford, Illinois.

WILLIAMSON amplifiers—built like a battleship. Write for data. Nicely Associates, Kenton, Ohio.

FOR SALE: Brush PL-20, equalizer, \$10; Brooks AM-FM tuner ST-14A, \$78. Audio Development transformers, 31-C output, \$16; 214H Interstage, F. McCullough, 429 Southwood Dr., Kenmore 23, N. Y.

ULTRA-Linear Williamson's custom built to highest standards. Precisely matched coupling capacitors and resistors; oil-filled filter capacitors, two chokes. Acrosound output, test jacks, and balancing controls. Provisions for preamp power with choice of a.c. or d.c. for heaters. Listening quality equal to the best regardless of price. My price is \$100. \$25 with order, balance COD. Frank Simonds, 33-73 104th St., Flushing, N. Y.

WILLIAMSON Amplifiers—buy direct from factory and save 50%. Prices start at 58 dollars. Send postcard for list. Long Island Sound Co., 19 Bennett Place, Amityville, N. Y.

FOR SALE: TANNOY 15-in. speaker complete with corner enclosure, \$175 cash. Box CP-1. AUDIO ENGINEERING.

DISC RECORDING SERVICE

Highest quality discs cut from your tape or record, all sizes, all speeds. Price, 10-in. LP records, \$2.25. Also monitoring off-the-air and recording on location. Fairchild cutter, thermosylus. UNIFA, Inc., 80-48 135th St., Kew Gardens, N. Y. Liggett 4-1208.

ATTENTION Custom Installers, Servicemen. Buy Diamond stylus direct from manufacturer. Other interesting items. Write on business letterhead, Box A, 217 Riverdale Ave., Yonkers, N. Y.

Additional Classified Ads on Page 107

DE-MAGNETIZE YOUR TAPE



SCIENTIFICALLY

with
JIFFY-ERASE

LIGHTWEIGHT • ECONOMICAL
PORTABLE • 100% ERASE
REDUCE SIGNAL-TO-NOISE
ASK YOUR DEALER FOR DEMONSTRATION



RASON

LITERATURE
ON REQUEST
DEPT. E.

MANUFACTURING CO.
8130 74th New York N.Y. S.A.

IF YOU ARE MOVING

Please notify our Circulation Department at least 5 weeks in advance. The Post Office does not forward magazines sent to wrong destinations unless you pay additional postage, and we can NOT duplicate copies sent to you once. To save yourself, us, and the Post Office a headache, won't you please cooperate? When notifying us, please give your old address and your new address.

Circulation Department
RADIO MAGAZINES, INC.
P. O. Box 629 Mincola, N. Y.

PROFESSIONAL DIRECTORY

Custom-Built Equipment

U. S. Recording Co.

1121 Vermont Ave., Washington 5, D. C.
Lincoln 3-2705

EVERYTHING IN HIGH FIDELITY*

From Primary Components
to Completed Custom Audio Equipment

KIERULFF

Sound Corp.

820 West Olympic Blvd. • Los Angeles 15, Calif.
Richmond 7-0271 Zenith 0271

"WE HAVE IT"

HI-FI COMPONENTS EXCLUSIVELY

HOLLYWOOD ELECTRONICS

7460 MELROSE AVE.
HOLLYWOOD 46
CALIFORNIA
WEBSTER 3-8208

Industry People...

Irving Greene, vice-president, Asco Sound Corporation, has achieved the height of something or other in being asked to provide a foster home for Deems Taylor's prize Persian while Taylor takes a one-month vacation—kitty's name, incidentally, is Moe Jacobs . . . Henry Vitarelli, formerly associated with the late and deeply lamented Col. Bruce Burlingame, is now operating his own factory rep firm known as Electronic Sales Company—among his first accounts are Brush Tape Recorders . . . Harry Halton is new Chicago rep for Gately Development Laboratory, Barrington, N. J. . . John A. Rankin and John S. Sturgeon have been promoted to vice-presidencies of The Magnavox Company . . . Frank B. Koessler, radio pioneer, has opened new factory rep firm in Los Angeles to cover California, Arizona and Nevada—plans to establish an office in San Francisco in the near future.

Charles W. Barbours, Jr. was recently appointed assistant chief engineer of Teletronics Laboratory, Inc., Westbury, N. Y. . . Appointment of Edward P. Atcherley as merchandising manager for renewal tubes sales of Sylvania Electric Products, Inc., announced by E. P. Gilpin, general sales manager . . . James L. Byrom is new director of engineering for General Dry Batteries, Inc., Cleveland . . . J. K. Poff, formerly with Erie Resistor Corp., has been appointed jobber sales manager of Pyramid Electric Company . . . Berne Fisher, associated with General Instrument Corporation for the past 18 years, has joined Standard Coil Products Co. Inc., as director of engineering . . . Another new director of engineering is John S. Brown, who has recently been promoted to that position with The Andrew Corporation, Chicago—also announced is appointment of Lawrence R. Krahe as head of the company's advanced development group . . . Election of Robert L. Westby to a vice-presidency has been announced by Minnesota Mining and Manufacturing Co. . . Dr. Donald W. Collier, director of research, Thomas A. Edison, Inc., has been elected a director of Atomic Instrument Co., Inc., Boston . . . W. Noel Eldred, sales manager, Hewlett-Packard Company, announces appointment of Milton Lichtenstein and Robert Asen as new H-P reps in New York area.

FOLKS AND THINGS THE AUDIO FAIR WOULDN'T BE COMPLETE WITHOUT: A. A. Ward, John Hilliard, Marty Wolfe and H. S. Morris leaving no doubt in the minds of visitors regarding the virtues of the new Altec Lansing "C" series of speakers . . . Maximilian Well dramatizing the performance of Audak pickups . . . Larry LeKashman with a new Electro-Voice Lavalier microphone draped around his neck . . . Harry Reizes with the concerned expression of a host on his face . . . Karl Kramer explaining the finer points of the design of Jensen's newest speakers . . . Maurice Weinbaum, Chet Wharfield, Lou Dezettel, and Bill Grommes, all from out Chicago way, proving that e'en the twain can meet in the world of high fidelity, as they huddle with eastern contemporaries . . . Jim Ford expressing due pride in the new Ampex Model 350 . . . Tony Schiavo and Frank Slaymaker beaming over the acceptance accorded the latest Stromberg-Carlson hi-fi developments . . . Daniel R. von Recklinghausen, along with demonstrating H. H. Scott audio equipment, passing out cards to assure correctness in both spelling and pronunciation of his moniker . . . Walter Stanton beaming over the new dual-stylus turn-over-type Pickering cart-ridge . . . John Boyers and Dick McQueen, ably abetted by Harry Miller, introducing Magnecord's improved models . . . Phil Kelsey making mental notes on the dimensions of new amplifiers, tuners, etc. for installation in the lavish cabinetry he builds . . . Likewise Bill Shrader, Kelsey's Washington, D. C. contemporary . . . Leonard Carduner striking the happy medium between British reserve and American enthusiasm while introducing the new Garrard changers, Wharfedale speakers, and Leak amplifiers . . . Tom Nicholson explaining to the press the reasons for General Electric's entry into the high-fidelity field . . . The Sandy's—Kahn and Cowan—greeting friends of many years' standing . . . visitors taking one look at Jim Pickett and wondering which bank he is president of . . . YOU having the time of your life.

VERSATILITY

Sine & Square Wave AUDIO GENERATOR KIT



EICO Model 377X

- Extremely stable Wien bridge oscillator
- Sine waves from 20 to 200,000 cps in 4 bands
- Square waves from 60 to 50,000 cps
- Response flat ± 1.5 db from 60 to 150,000 cps
- Calibration accuracy $\pm 3\%$ or 1 cps, whichever is greater
- Improved cathode follower output circuit for high output over wide load range
- 10V out at 1K Ω load (rated), 14V at 10K Ω , 8V at 500 Ω
- Continuously variable output attenuator
- Distortion only 1% of rated output
- Hum less than 0.4% of rated output
- 1% bridge resistors, 4 gang tuning condenser
- Rugged steel case, deep-etched panel

KIT \$31.95
WIRED \$49.95

LOWEST COST

See it at your Jobber!
Write for FREE Cat. RA-10



Electronic Instrument Co., Inc.
84 Withers St., Brooklyn, N. Y.



MASCO 10-watt Custom
High Fidelity Amplifier

MASCO Custom Ten

WITH 8 POSITION EQUALIZATION SELECTOR

Gives you HIGH FIDELITY

that makes every instrument in a recording
live and breathe!

Selects and correctly compensates for the characteristics of TV tuner, radio tuner, crystal phonograph pickup, plus magnetic phonograph pickup equalized for FIVE different recording characteristics including the NEW ORTHOPHONIC RECORDING CURVE.

Wide range frequency response — 20 to 20,000 cycles $\pm 1/2$ db. Ten watts of power output at less than 1% harmonic distortion. Recorder output jack permits recording while listening.

Unsurpassed in high tonal definition, in faithfulness of reproduction, in hearing satisfaction. Hear it today at your dealer's.



MARK SIMPSON MFG. CO., Inc.
32-28 49th St., Long Island City 3, N. Y.

**SEE
AND
HEAR...**

*the Loudspeaker Designed
For Listening Enjoyment*

HARTLEY
215 LOUDSPEAKER

at the **1953 AUDIO FAIR**

October 14th, 15th, 16th and 17th.
ROOM 533, New Yorker Hotel
34th Street & 8th Ave., New York City

YOU WILL ALSO • HARTLEY Baffle Speaker Enclosures
SEE AND HEAR • HARTLEY Preamplifier Control
THE NEW: • HARTLEY 20 Watt Hi-Fi Amplifier



*All available through franchised dealers
throughout the United States*

H. A. HARTLEY CO., INC.
521 East 162nd Street, Bronx 51, N. Y.
L.U.dlow 5-4239

TECH-MASTER *High Fidelity* Amplifier and Preamplifier **KITS**

- Tech Master audio amplifier kits are made with the same "custom-quality" attention that has made Tech-Master the first name in TV chassis. They are built to a standard, not to the price. There have been no compromises... every component is the finest obtainable
- workmanship is meticulous.

UL* WILLIAMSON TYPE AMPLIFIER KIT:
(with power supply.) Famous Williamson circuit with modifications for increased, undistorted power output. Uses specially wound quality output transformer.
Model TM-15A, Kit of Parts..... Net Price ... \$49.95

Model TMD-15A, DELUXE KIT: Factory assembled, all major components mounted, ready to wire. Net Price ... \$59.95

*Ultra linear operation through use of screen-tapped primary output transformer

4 CHANNEL PREAMPLIFIER-EQUALIZER KIT:
Provides complete equalization for virtually all recording characteristics now employed. Extra flexibility provided by independent bass and treble boost and attenuation controls.
Model TM-15P, Kit of Parts..... Net Price ... \$19.95

Model TMD-15P, DELUXE KIT: Factory assembled, all major components mounted, ready to wire. Net Price ... \$29.65

AT ALL LEADING RADIO PARTS DISTRIBUTORS



TECH-MASTER PRODUCTS CO.
443-445 BROADWAY, NEW YORK 13, N. Y.

TECH-MASTER, MAKERS OF CUSTOM-BUILT TV CHASSIS,
QUALITY TV KITS & HIGH FIDELITY AUDIO EQUIPMENT.

*Literature
Upon Request*

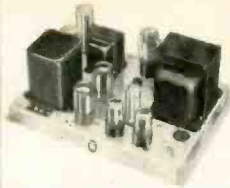

ADVERTISING INDEX

Acro Products Co.	115
Alliance Manufacturing Co.	78
Allied Radio Corp.	77, 78, 80, 82
Altec Lansing Corp.	78, 95
Amperite Co., Inc.	117
Ampex Corp.	79
Amplifier Corp. of America	117
Arnold Engineering Co.	7
Arrow Electronics, Inc.	97
Asco Sound Corp.	102
Audak Co.	73, 79
Audio Devices, Inc.	Cover 2
Audio Fair, The	87
Beler Co., Leroy W.	83
Belden Mfg. Co.	71
Bell Sound Systems, Inc.	79, 114
Bell Telephone Laboratories	20
Bogen, David, Co., Inc.	75
British Industries Corp.	3, 81
Brook Electronics, Inc.	76, 78
Carter Motor Co.	86
Chicago Transformer Division	4
Cinema Engineering Co.	2
Classified Ads	118
Commissioned Electronics Co.	117
Compro Corp.	118
Concertone Recorders	79
Cook Laboratories	79
Crestwood Div., Daystrom Elec. Corp.	90
D & R Ltd.	102
Daven Co.	Cover 3
Duotone	5
Electro-Voice	53, 68, 80
Electronic Instrument Co., Inc.	119
Fairchild Recording Equipment Corp.	104
Ferranti Electric, Inc.	45
Fisher Radio Corp.	80, 91
G & H Wood Products Co.	39, 78
General Electric Co.	88, 106
Hallcrafters Co.	81
Hartley, H. A., Co., Inc.	120
Harvey Radio Co., Inc.	101
Heath Co.	103, 111
Hollywood Electronics	119
Hudson Radio & Television Corp.	98
Hughes Aircraft Co.	1, 109
Hycor Co., Inc.	110
Kellogg Switchboard and Supply Co.	104
Kierulff Sound Corp.	119
Kingdom Products, Ltd.	51
Klipsch & Associates	92
Livingston Electronic Corp.	47
Magnecord, Inc.	13
Markel Electric Products, Inc.	80
Martin, H. S., & Co.	96
Minnesota Mining & Mfg. Co.	15
Pacific Transducer Corp.	79
Partridge Transformers, Ltd.	117
Peerless Electrical Products	74
Pentron Corp.	80
Permotlux Corp.	16, 81
Philadelphia Hi-Fi Conference	112
Pickering and Co., Inc.	19, 81
Pilot Radio Corp.	81
Portable Gramophone Co., Inc.	82
Precision Electronics, Inc.	81
Precision Film Laboratories, Inc.	10
Presto Recording Corp.	17
Professional Directory	119
Radio Corporation of America	37, 82
Radio Shack Corp.	94
Rason Mfg. Co.	119
Rauland-Borg Corp.	70
Reeves Equipment Corp.	114
Reeves Soundcraft Corp.	85
Rek-O-Kut Co.	49, 83
Rider, J. F., Publisher, Inc.	115
River Edge Industries	83
Rockbar Corp.	11
Sams, Howard W., & Co., Inc.	108
Shure Brothers, Inc.	6
Sigma Instruments, Inc.	14
Simpson, Mark, Mfg. Co., Inc.	119
Sonocraft Corp.	111
Sonotone Corp.	41
Stromberg-Carlson	82
Swain, Hack	116
Tannoy, Ltd.	43
tapeMaster, Inc.	82, 93, 115
Tech-Master Products Co.	83, 120
Terminal Radio Corp.	105, 113
Triad Transformer Corp.	12
Tung-Sol Electric, Inc.	8
United Transformer Co.	Cover 4
University Loudspeakers, Inc.	83, 116
U. S. Recording Co.	119
V-M Corp.	99
Webster-Chicago	114
White Sound, Inc.	107
Wilcox-Gay Corp.	9
Wiley, John & Sons, Inc.	116

You Can Depend on

DAVEN

for

Accuracy
in Attenuators

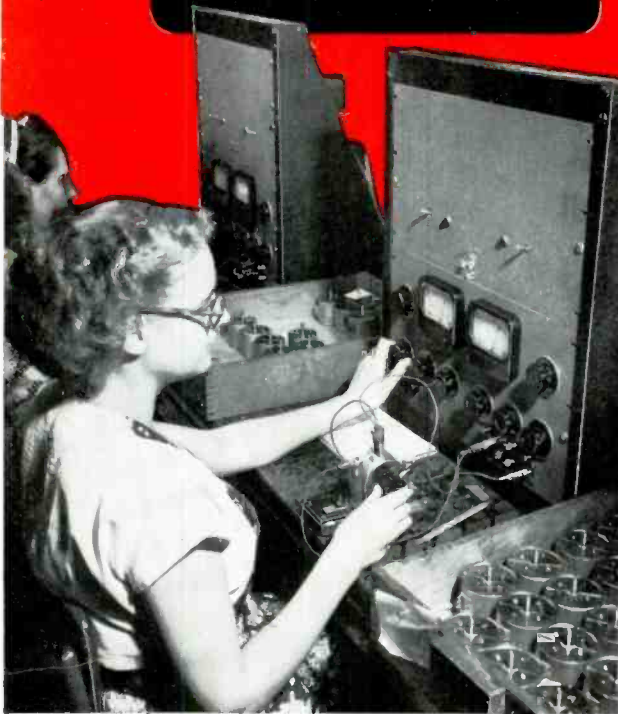

7 or many years Daven has been known for the quality of its attenuators. And, although Daven production has grown to include a wide variety of instruments for the electronics industry, the development of its attenuators has grown apace. Much of the testing equipment used by Daven to guide them in the manufacturing of attenuators has been developed by Daven's own engineering specialists. As a result, Daven attenuators have become the standard of the industry, by which all other similar equipment is measured. Shown and described here are two of the newest units that are typical of the vast Daven line of attenuators. Your inquiry for specific information to apply to your own particular problems is invited. Let Daven furnish you with completely detailed catalog data.

THE **DAVEN** CO.

195 CENTRAL AVENUE
NEWARK 4, N. J.

RF Attenuation Network



This equipment is an exclusive Daven development. It is a moderately priced attenuator incorporated in an RF Attenuation Box to insert accurate losses from D.C. to 225 MC. The unit has many applications where attenuation of UHF is desired, since it can be utilized as an all-purpose laboratory and test instrument.

SPECIFICATIONS:

ZERO INSERTION LOSS OVER ENTIRE FREQUENCY RANGE.
FREQUENCY RANGE: Zero to 225 MC.
IMPEDANCE ACCURACY: Within $\pm 5\%$ over frequency range.
ATTENUATION ACCURACY: $\pm 5\%$ over frequency range.
CONNECTORS: Receptacles are supplied. Cable plugs, if required, will be supplied at a slight additional cost. When ordering, specify which type connector is desired—either Series "BNC" (UG-185/U) or Series "N" (UG-58/U).
CIRCUIT: Constant input and output impedance (unbalanced). Zero initial loss.
RESISTOR ACCURACY: $\pm 2\%$ at D.C.

Carrier Frequency Decade Attenuator



This equipment is particularly applicable to extremely accurate measurements from D.C. to 200 kc. and can be used up to the lower radio frequencies. The Decade type switches make the box convenient to use. In addition, there are switch stops which prevent return from full to zero attenuation when making adjustments. A total of 110 Db. is available in 1.0 Db. steps, or 111 Db. is available in 0.1 Db. steps. Both of these types may be obtained in either a balanced H or an unbalanced T network.

SPECIFICATIONS:

ACCURACY: Each individual resistor is adjusted within $\pm 0.25\%$ of its correct value. The error in attenuation is less than $\pm 1\%$ of the indicated value, provided the output is matched by a pure resistance.
FREQUENCY ERROR: At frequencies below 200 kc., the total error in attenuation will not be greater than $\pm 1\%$ of the indicated value.



MINIATURE COMPONENTS FROM STOCK...

SUBOUNCER UNITS

FOR HEARING AIDS...VEST POCKET RADIOS...MIDGET DEVICES

UTC Sub-Ouncer units fulfill an essential requirement for miniaturized components having relatively high efficiency and wide frequency response. Through the use of special nickel iron core materials and winding methods, these miniature units have performance and dependability characteristics far superior to any other comparable items. They are ideal for hearing aids, miniature radios, and other types of miniature electronic equipment. The coils employ automatic layer windings of double Formex wire...In a molded Nylon bobbin. All insulation is of cellulose acetate. Four inch color coded flexible leads are employed, securely anchored mechanically. No mounting facilities are provided, since this would preclude maximum flexibility in location. Units are vacuum impregnated and double (water proof) sealed. The curves below indicate the excellent frequency response available. Alternate curves are shown to indicate operating characteristics in various typical applications.

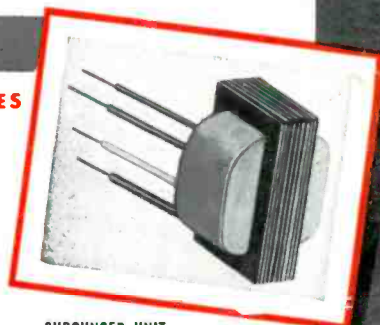

SUBOUNCER UNIT
Dimensions...9/16" x 5/8" x 7/8"
Weight......03 lb.

Type	Application	Level	Pri. Imp.	D.C. In Pri.	Sec. Imp.	Pri. Res.	Sec. Res.	List Price
*SO-1	Input	+ 4 V.U.	200 50	0	250,000 62,500	16	2650	\$6.50
SO-2	Interstage/3:1	+ 4 V.U.	10,000	0	90,000	225	1850	6.50
*SO-3	Plate to Line	+ 20 V.U.	10,000 25,000	3 mil. 1.5 mil.	200 500	1300	30	6.50
SO-4	Output	+ 20 V.U.	30,000	1.0 mil.	50	1800	4.3	6.50
SO-5	Reactor 50 HY at 1 mil. D.C.	3000 ohms D.C. Res.						5.50
SO-6	Output	+ 20 V.U.	100,000	.5 mil.	60	3250	3.8	6.50

*Impedance ratio is fixed, 1250:1 for SO-1, 1:50 for SO-3. Any impedance between the values shown may be employed.

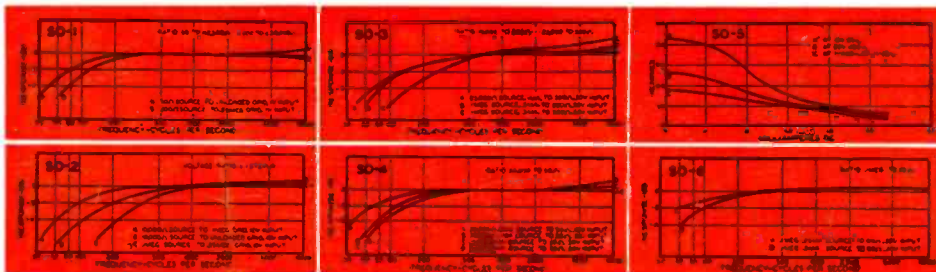

SUB-SUBOUNCER UNITS

FOR HEARING AIDS AND ULTRA-MINIATURE EQUIPMENT

UTC Sub-SubOuncer units have exceptionally high efficiency and frequency range in their ultra-miniature size. This has been effected through the use of specially selected Hiperm-Alloy core material and special winding methods. The constructional details are identical to those of the Sub-Ouncer units described above. The curves below show actual characteristics under typical conditions of application.



SUB-SUBOUNCER UNIT

Dimensions...7/16" x 3/4" x 5/8"
Weight......02 lb.

Type	Application	Level	Pri. Imp.	D.C. In Pri.	Sec. Imp.	Pri. Res.	Sec. Res.	List Price
*SSO-1	Input	+ 4 V.U.	200 50	0	250,000 62,500	13.5	3700	\$6.50
SSO-2	Interstage/3:1	+ 4 V.U.	10,000	0	90,000	750	3250	6.50
*SSO-3	Plate to Line	+ 20 V.U.	10,000 25,000	3 mil. 1.5 mil.	200 500	2600	35	6.50
SSO-4	Output	+ 20 V.U.	30,000	1.0 mil.	50	2875	4.6	6.50
SSO-5	Reactor 50 HY at 1 mil. D.C.	4400 ohms D.C. Res.						5.50
SSO-6	Output	+ 20 V.U.	100,000	.5 mil.	60	4700	3.3	6.50

*Impedance ratio is fixed, 1250:1 for SSO-1, 1:50 for SSO-3. Any impedance between the values shown may be employed.

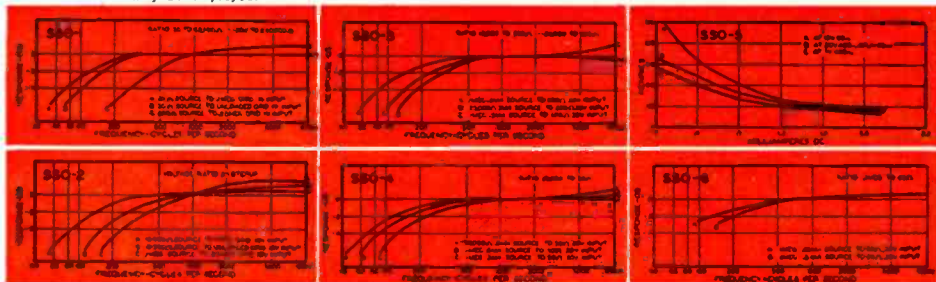

United Transformer Co.

150 VARICK STREET NEW YORK 13, N. Y.
EXPORT DIVISION: 13 EAST 40th STREET, NEW YORK 16, N. Y., CABLES: "ARLAB"