

Simplified Push-Pull Theory - See Page 19

MAY  
1953  
35c

# AUDIO ENGINEERING

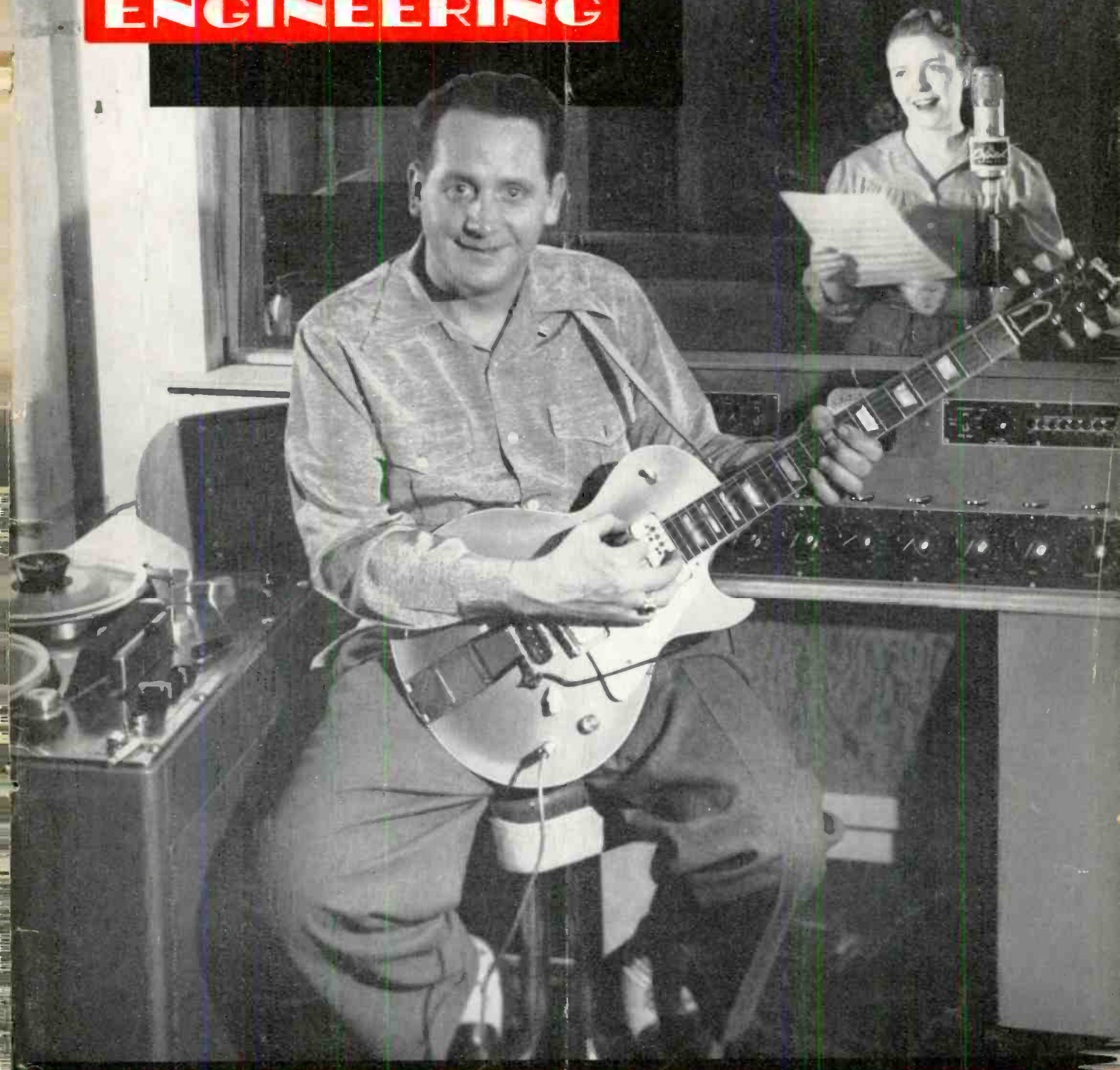

THE WORLD OF SOUND

here are the  
**30 BEST SELLING RECORDS  
 OF 1952\***

29 of them used  
**audiodiscs<sup>®</sup>**  
 for the master recording

... and over 43% used  
**audiotape<sup>†</sup>** for the original sound!

Like Audiodiscs and Audiotape, this record speaks for itself.

Of the thirty top hit records of the year, all but one were made from Audiodisc masters! And that one — a London Record — was made abroad.

It is significant, too, that the original recordings for over 43 per cent of these records were first made on Audiotape, then transferred to the master discs. This marks a growing trend toward the use of Audiotape for the original sound in the manufacture of fine phonograph records.

Yes — Audiodiscs and Audiotape are truly a record-making combination — in a field where there can be no compromise with Quality!

<sup>†</sup>Trade Mark



**AUDIO DEVICES, INC.**

444 MADISON AVE., NEW YORK 22, N. Y.  
 Export Dept.: 13 East 40th St., New York 16, N. Y., Cables "ARLAB"

Record, Artist & Label	Made from Audiodisc Master
BLUE TANGO (Leroy Anderson—Decca).....	✓
WHEEL OF FORTUNE (Kay Starr—Capitol).....	✓
CRY (Johnnie Ray—Okeh).....	✓
YOU BELONG TO ME (Jo Stafford—Columbia).....	✓
AUF WIEDERSEHN, SWEETHEART (Vera Lynn—London).....	✓
I WENT TO YOUR WEDDING (Patti Page—Mercury).....	✓
HALF AS MUCH (Rosemary Clooney—Columbia).....	✓
WISH YOU WERE HERE (Eddie Fisher—Hugo Winterhalter—Victor).....	✓
HERE IN MY HEART (Al Martino—BBS).....	✓
DELICADO (Percy Faith—Columbia).....	✓
KISS OF FIRE (Georgia Gibbs—Mercury).....	✓
ANY TIME (Eddie Fisher—Hugo Winterhalter—Victor).....	✓
TELL ME WHY (Four Aces—Decca).....	✓
BLACKSMITH BLUES (Ella Mae Morse—Capitol).....	✓
JAMBALAYA (Jo Stafford—Columbia).....	✓
BOTCH-A-ME (Rosemary Clooney—Columbia).....	✓
GUY IS A GUY (Doris Day—Columbia).....	✓
LITTLE WHITE CLOUD THAT CRIES (Johnnie Ray—Okeh).....	✓
HIGH NOON (Frankie Laine—Columbia).....	✓
I'M YOURS (Eddie Fisher—Hugo Winterhalter—Victor).....	✓
GLOW WORM (Mills Brothers—Decca).....	✓
IT'S IN THE BOOK (Johnny Standley—Capitol).....	✓
SLOW POKE (Pee Wee King—Victor).....	✓
WALKIN' MY BABY BACK HOME (Johnnie Ray—Columbia).....	✓
MEET MR. CALLAGHAN (Les Paul—Capitol).....	✓
I'M YOURS (Don Cornell—Coral).....	✓
I'LL WALK ALONE (Don Cornell—Coral).....	✓
TELL ME WHY (Eddie Fisher—Hugo Winterhalter—Victor).....	✓
TRYING (Hilltoppers—Dot).....	✓
PLEASE, MR. SUN (Johnnie Ray—Columbia).....	✓

\* According to Retail Sales, as listed in THE BILLBOARD.

**audiodiscs • audiotape • audiofilm • audiopoints**

Audiodiscs are manufactured in the U.S.A. under exclusive license from PYRAL, S.A.R.L., Paris



Successor to **RADIO** Established 1917

# AUDIO ENGINEERING

INCLUDING



**C. G. McProud, Editor and Publisher**

Harrie K. Richardson, Associate Editor  
Eve Drolet, Production Manager  
Edgar E. Newman, Circulation Promotion  
Elizabeth Beebee, Circulation Manager

Edgar M. Villchur, Contributing Editor  
Henry A. Schober, Business Manager  
S. L. Cahn, Advertising Director  
H. N. Reizes, Advertising Manager

**Editorial Advisory Board**

Howard A. Chinn  
John D. Colvin  
C. J. LeBel  
J. P. Maxfield  
George M. Nixon



**Representatives**

H. Thorpe Covington, Special Representative  
677 N. Michigan Ave., Chicago 11, Ill.  
Sanford R. Cowan, Mid-West Representative  
67 W. 44th St., New York 18, N. Y.

**West Coast**

James C. Galloway J. W. Harbison  
816 W. 5th St., Los Angeles 17, Calif.

**CONTENTS MAY, 1953 Vol. 37, No. 5**

Audio Patents—Richard H. Dorf .....	2
Letters .....	8
Audiology—W. R. Ayres .....	14
Editor's Report .....	16
Simplified Push-Pull Theory—Julius Postal .....	19
Coupled Loudspeakers—Charles W. Harrison, Jr. ....	21
Audio Engineering Awards .....	24
A New Approach To Negative Feedback Design—N. H. Crowhurst .....	26
Loudness Contour Selector in New Amplifier— L. H. Bogen and Alfred M. Zuckerman .....	31
Handbook of Sound Reproduction—Chapter 11, Part 1—Edgar M. Villchur	34
Equipment Report .....	42
Record Revue—Edward Tatnall Canby .....	44
New Literature .....	58
New Products .....	60
Industry People .....	70
Employment Register .....	71
Price and Product Changes—Radio's Master Reports .....	71
Advertising Index .....	72

**COVER**

The young man shown here with his wife is an accomplished audio engineer who has just completed design and construction of one of the country's more lavish recording studios. Built as an integral unit of his Northern New Jersey home, the studio is equipped with six Ampex tape recorders, a new RCA Type BC-2B Console, not to mention a host of microphones, speakers, and other paraphernalia meeting the same notable standards of quality. In addition to his avocation as an engineer, we are told he and his wife dabble in music front time to time, and that they are not entirely unknown in the recording field—in fact, they have just won the Æ Award for Musical and Technical Excellence in Popular Recording (Novelty Division). Their names—Les Paul and Mary Ford.

**RADIO MAGAZINES, INC., P. O. BOX 629, MINEOLA, N. Y.**

AUDIO ENGINEERING (title registered U. S. Pat. Off.) is published monthly at 10 McGovern Avenue, Lancaster, Pa. by Radio Magazines, Inc., Henry A. Schober, President; C. G. McProud, Secretary, Executive and Editorial Offices: 204 Front St., Mineola, N. Y. Subscription rates—United States, U. S. Possessions and Canada, \$3.00 for 1 year, \$5.00 for 2 years; elsewhere \$4.00 per year. Single copies 35c. Printed in U. S. A. All rights reserved. Entire contents copyright 1953 by Radio Magazines, Inc. Entered as Second Class Matter February 9, 1950, at the Post Office, Lancaster, Pa. under the Act of March 3, 1879.

to the

**E. E. or  
PHYSICS GRADUATE**

with an interest  
or experience in

**RADAR or  
ELECTRONICS**

Hughes Research and Development Laboratories, one of the nation's large electronic organizations, is now creating a number of new openings in an important phase of its operation.

Here is  
what one of  
these  
positions offers  
you

**OUR COMPANY**

located in Southern California, is presently engaged in the development of advanced radar devices, electronic computers and guided missiles.

**THESE NEW POSITIONS**

are for men who will serve as technical advisors to the companies and government agencies purchasing Hughes equipment.

**YOU WILL BE TRAINED**

(at full pay) in our Laboratories for several months until you are thoroughly familiar with the equipment that you will later help the Services to understand and properly employ.

**AFTER TRAINING**

you may (1) remain with the Laboratories in Southern California in an instruction or administrative capacity, (2) become the Hughes representative at a company where our equipment is being installed, or (3) be the Hughes representative at a military base in this country—or overseas (single men only). Adequate traveling allowances are given, and married men keep their families with them at all times.

**YOUR FUTURE**

in the expanding electronics field will be enhanced by the all-around experience gained. As the employment of commercial electronic systems increases, you will find this training in the most advanced techniques extremely valuable.

How  
to  
apply

If you are under 35 years of age  
and have an E.E. or Physics  
degree and an interest or  
experience in radar or electronics,

write  
to **HUGHES**

**RESEARCH AND DEVELOPMENT  
LABORATORIES**

Scientific and Engineering Staff  
Culver City,  
Los Angeles County, California

Assurance is required that the relocation of the applicant will not cause the disruption of an urgent military project.

# 20-20 PLUS!

S-256-Q  
Output  
Transformer

$\pm 1$  db 10—100,000 cps  
40 watts 30—40,000 cps

10 watts at 10 cps  
20 watts at 15 cps

Insertion loss  
0.4 db

Pri: 5,000 $\Omega$ CT  
Sec: 16, 12, 8, 4, 2 $\Omega$

May be operated between  
halved or doubled  
impedances



Now in Stock

Write  
today  
for the  
new  
1953  
Peerless  
Catalog

**PEERLESS**  
Electrical Products

A DIVISION OF



9356 Santa Monica Blvd., Beverly Hills, Calif.  
161 Sixth Avenue, New York 13, New York

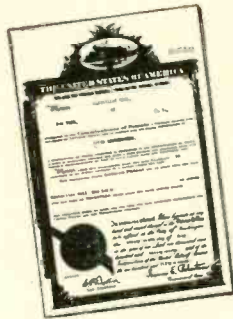

# AUDIO PATENTS

RICHARD H. DORF\*

IT SEEMS a little peculiar that volume expanders are not used more often than they are in home music systems. A few years ago the signal-to-noise characteristics and the distortion of typical home reproducers were not good enough to warrant them, but today in a really large number of homes the system noise is practically nil, and the large range allowed by expansion (provided it is not overdone) could easily be accommodated. Having spent 10 years in the broadcasting industry, the writer is of the opinion that expansion is very desirable in the receiving position to offset the sometimes rather large compression practiced at the trans-

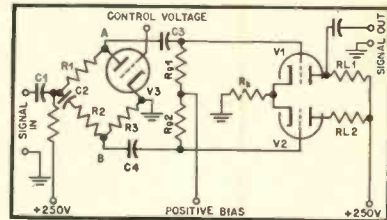

Fig. 1.

mitting point.

Of course, no automatic expander can be expected to compensate exactly for broadcast compression. In fact, no device or individual can hope to repair the havoc

\* 255 W. 84th St., New York 24, N. Y.

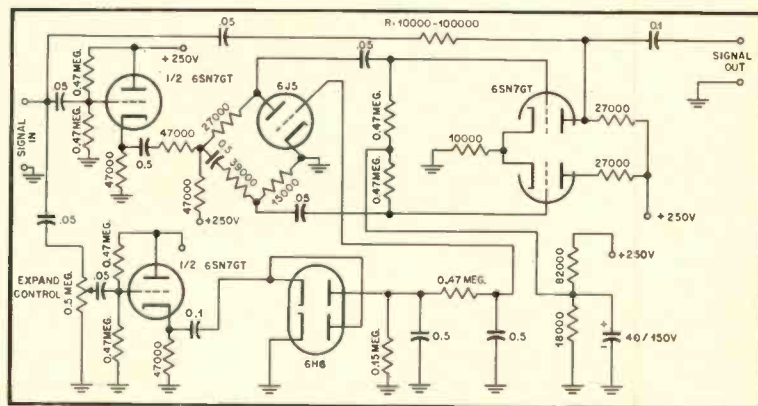

Fig. 2.

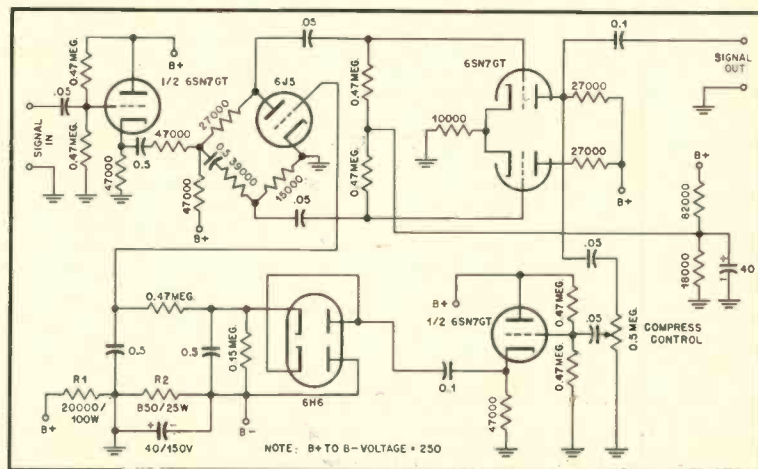

Fig. 3.



The Greatest Name  
in Turntables

designed for Quality in Record Reproduction

# REK-O-KUT

Record Reproduction begins with the rotating motion of the record! This motion expresses passage of time. And each rotation is an interval or segment of that time. This important function is entrusted to the turntable.

The faithfulness with which the turntable, a purely mechanical device, can perform this task, is related entirely to its design and construction. It is pretty generally known that any mechanical vibration will impose itself as undesirable elements of distortion in the reproduced sound, and that speed deviation will result in a variation in time or tempo, and in undulating pitch.

There is no compromise with turntable quality if the best in sound reproduction will be had. Engineers know this, and the name of REK-O-KUT is a byword in professional circles as the standard of turntable quality. But whether professional sound engineer or simply a lover of good sound, only a fine turntable can justify the fine equipment of a modern high fidelity system.

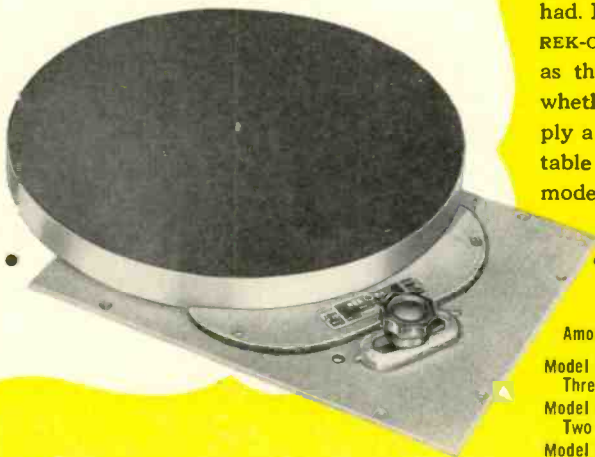

At Leading Radio Parts Distributors  
and at Sound and Music Dealers

Among the seven REK-O-KUT Turntables available are:

Model LP743—Induction Motor Three Speeds, 33 $\frac{1}{3}$ , 45 and 78.....	\$ 54.95
Model T-12H—Hysteresis Motor Two Speeds, 33 $\frac{1}{3}$ and 78.....	119.95
Model T-43H—Hysteresis Motor Two Speeds, 33 $\frac{1}{3}$ and 45.....	119.95

REK-O-KUT CO. 38-03B QUEENS BOULEVARD • LONG ISLAND CITY 1, NEW YORK

Export Division: 458 Broadway, New York 13, U. S. A. Cables: Morhanex  
In Canada: Atlas Radio Corp., Ltd., 550 King Street W., Toronto 28



## Meet the Redheads... tops for tape recording

See how the latest additions to the Brush family of magnetic recording components can improve your tape recorders!

The BK-1090 record-reproduce head has the standard track width designed for dual track recording on  $\frac{1}{4}$  inch tape. It provides unusually high resolution and uniformity over an extended frequency range. Cast resin construction assures dimensional stability, minimizes moisture absorption, and affords freedom from microphonics. Its balanced magnetic construction, precision lapped gap, Mu-metal housing, and single-hole mounting provide important design advantages.

The BK-1110 erase head has the same basic construction as the companion record-reproduce unit. Its outstanding feature is its efficient erasing at low power consumption—less than  $\frac{1}{2}$  voltampere.

Investigate these new "Redheads" for your magnetic recording. Your inquiries will receive the attention of capable engineers. Write Brush Electronics Company, Department ZZ-5, 3405 Perkins Avenue, Cleveland 14, Ohio.

**BRUSH ELECTRONICS**

INDUSTRIAL AND RESEARCH INSTRUMENTS  
PIEZOELECTRIC MATERIALS • ACOUSTIC DEVICES  
MAGNETIC RECORDING EQUIPMENT  
ULTRASONIC EQUIPMENT



**COMPANY**

formerly  
The Brush Development Co.  
Brush Electronics Company  
is an operating unit of  
Clevite Corporation.

wrought in some broadcast music by a few of the most destructive operators in broadcasting, whose object in keeping their hands constantly on the studio gain controls is to keep all sound between 80 and 100 per cent on the VU meter. Most of these are veterans of the strictly AM (and mediocre-quality) era of a few years ago, when noise could be counted on to obscure anything below the stentorian level; and of course they don't care much about music. Some of this writer's most amusing experiences in the early days of FM included various forms of "coercion" of such operators to prevent their hoisting the gain during low passages with the VU needle barely kicking.

Things are getting better, but even today almost all FM broadcasts are also sent out via AM, and they must be compressed. A certain amount of expansion would be a good thing, and a recent patent of Peter J. Culicetto of Staten Island, N. Y., presents an interesting concept for the purpose. The patent is No. 2,615,999. It should be remarked that the inventor brought his patent to the attention of the writer in a letter, a procedure to be encouraged since sometimes good bets in the Patent Gazette are overlooked.

The Culicetto circuit has several points to recommend it, at least in theory and according to the inventor's comments. Perhaps because no variable- $\mu$  tubes are used, the distortion is quite low—0.35 per cent second harmonic and 0.15 third harmonic with 17 db of expansion—in the circuit we shall discuss. Design and adjustment are uncritical and the circuit handles a wide range of signal levels and frequencies. The same concept is useful for compression, in which it can be adjusted to maintain output level within 3 db for input level changes up to 22 db, with the same low distortions. In addition, the idea can be executed cheaply and in small space.

The basic idea is diagrammed in Fig. 1. The heart of the circuit is the Wheatstone bridge consisting of  $R_1$ ,  $V_1$  and  $R_2$ ,  $R_3$ , to which signal is applied through blocking capacitor  $C_1$ .  $R_4$  is a dropping resistor through which plate voltage is furnished to  $V_2$ , and  $C_2$  is a large-value blocking capacitor to prevent a d.c. path to ground for the B voltage; neither affects the bridge to any degree.

If we assume that  $R_2$  and  $R_3$  are equal and that  $R_1$  and the plate resistance of  $V_2$  are equal, audio voltages appearing at points A and B are equal with respect to ground and they are in phase. These equal, in-phase voltages are applied through blocking capacitors  $C_3$  and  $C_4$  to the grids of  $V_1$  and  $V_2$ .

$V_1$  and  $V_2$  (normally the two triodes of a tube like the 6SN7-GT) look very much like a certain type of phase inverter.  $R_4$ , the common cathode resistor, has a large value, perhaps 10,000 ohms or so. Each triode may act as a cathode follower, the large cathode resistor giving nearly unity gain. When either triode is considered as a cathode follower, the other may be looked at as a grounded-grid amplifier.

For example, suppose a 5-volt (peak) signal is fed to the grid of  $V_1$ , with nothing fed directly to the grid of  $V_2$ . At a particular instant, the grid of  $V_1$  is at plus 5 volts. Assuming unity gain as a cathode follower, the cathode of  $V_1$  is then at plus 5 volts. Since this is also the  $V_2$  cathode, the  $V_2$  cathode is 5 volts positive to ground. And because the grid of  $V_2$  is at ground potential (no current passing through its



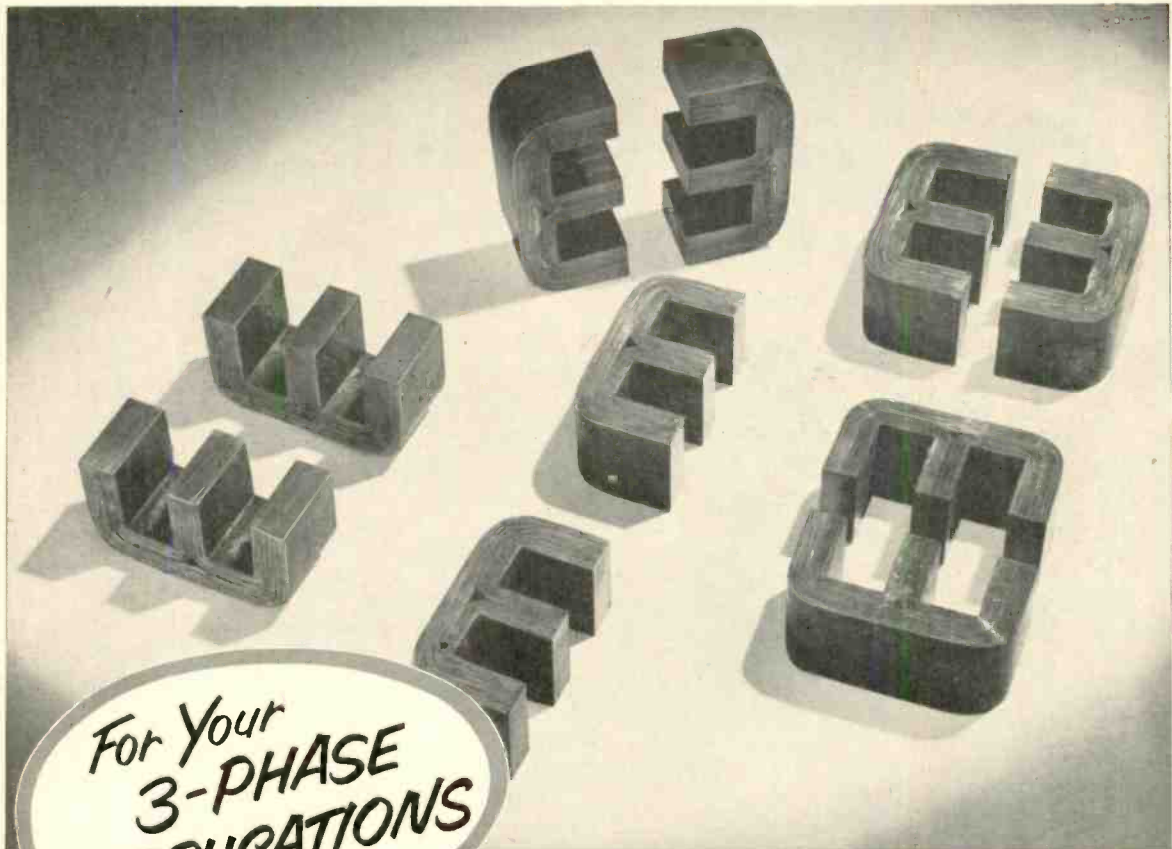

For Your  
3-PHASE  
APPLICATIONS

# Arnold E-CORES

made from SILECTRON strip  
(grain-oriented silicon steel)

The use of "E" cores, wound from grain-oriented silicon steel, results in weight and size reduction as well as higher efficiency and possible cost savings. "E" cores can be supplied in a variety of window sizes and core areas from 1, 2, 4 or 12-mil Silectron strip, for high or low frequency 3-phase applications. • All Arnold cores are made by precision methods, and carefully tested under closely controlled conditions to assure highest quality and reliability. *We'll welcome your inquiries.*

WRITE FOR BULLETIN TC-105

W&D 4650

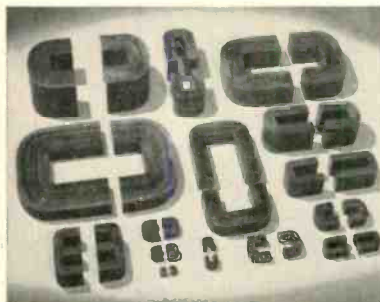

**C-Cores to meet any requirement**

For your single-phase applications, Arnold "C"-Cores are available in any shape and quantity, and in any size from fractions of an ounce to hundreds of pounds . . . wound from Silectron strip in a wide range of ultra-thin and heavier gauges. (Sizes up to 10 lbs. in 12-mil strip; to any weight in thinner gauges.)

## THE ARNOLD ENGINEERING COMPANY

SUBSIDIARY OF ALLEGHENY LUDLUM STEEL CORPORATION

General Office & Plant: Marengo, Illinois

DISTRICT SALES OFFICES

New York: Empire State Bldg. Los Angeles: 3450 Wilshire Blvd.



# CANNON PLUG ACCESSORIES

## for the "AN" Series



Here is the answer to a frequent question we receive from people everywhere. Yes, Cannon *does* make a complete line of accessories to be used in conjunction with the AN Series of connectors. Complete engineering data on each of these is given in the Cannon AN Bulletin, available on request.

## CANNON ELECTRIC

Since 1915 

Factories in Los Angeles, Toronto, New Haven, Benton Harbor. Representatives in principal cities. Address inquiries to Cannon Electric Company, Dept. E-109, P. O. Box 75, Lincoln Heights Station, Los Angeles 31, California.

grid resistor and therefore no drop appearing across it) the  $V_1$  grid is at 5 volts negative with respect to its cathode. In other words, the application of a voltage to one grid causes the same effective voltage to appear at the other grid in opposite phase.

Now suppose that at the same time, an external plus 5 volts is applied to the  $V_1$  grid. With minus 5 volts appearing as the result of the transfer from  $V_2$  and plus 5 directly applied, the net  $V_1$  grid voltage is zero. If output is taken from the plate of  $V_1$ , output is zero. Thus, whenever equal, in-phase voltages are applied to both grids, output is zero.

To descend to reality, the gain of a cathode follower can never be as much as 1, so this kind of cancellation is never complete and the output never zero. However, it is obvious that the output of the circuit can be controlled by controlling the relative magnitudes of the audio voltages applied to the grids. The cathode-follower gain is made very close to 1 by the high value of  $R_k$ ; this places too high a bias on the triodes, which must be offset by the positive bias applied to the junction of the grid resistors  $R_{g1}$  and  $R_{g2}$ . It is this positive bias which  $C_1$  and  $C_2$  block.

To function as a volume expander, the grid of  $V_2$  is fixed at or near zero bias. This places the plate resistance of  $V_2$  at its minimum, and the opposing bridge arms are so proportioned that the desired ratio of audio voltages at points A and B (and the grids of the duo-triode) is obtained for whatever minimum gain is wanted. As the signal level rises, an external rectifier operating from the signal input voltage furnishes a negative d.c. proportional to the signal level, and applies it to the grid of  $V_2$ . As the signal becomes louder,  $V_2$  is biased more negative; its plate resistance rises, more audio appears at point A than at B, and the gain of the duo-triode rises. The output level, therefore, increases faster than the input level, giving expansion.

The same circuit can be used as an effective compressor. In that case, there is a permanent negative bias on  $V_2$ , which pegs its plate resistance at the highest point, giving maximum output at point A and maximum circuit gain. As the signal level rises, an external signal rectifier produces a proportional positive voltage, which it adds to the fixed negative bias. Thus, as the signal rises, the plate resistance of  $V_2$  decreases, lowering the gain of the circuit.

Notice that there are no nonlinear elements in the circuit proper. Also note that the  $V_1$ - $V_2$  circuit has sometimes been used as a phase splitter and has been (properly) criticized as such, because it will not give equal plate outputs for any given single-grid input. In this use, however, the balance is not required, its only importance being that a closer approach to balance would give greater expansion or compression range. The circuit is not inherently frequency-selective. Thus, with proper component selection and voltage apportionment, there is nothing here to give any greater distortion than would be found in an ordinary Class A amplifier, which is not true of more conventional expander-compressors.

Figure 2 shows a practical design for an expander, complete with all component values kindly furnished by the inventor for this article. The signal circuit is the

(Continued on page 57)



NO FINER CHOICE THAN

**Electro-Voice**

HI-FI FOLDED CORNER HORN

**ENCLOSURES**  
AND SPEAKER SYSTEMS



THE BARONET



THE ARISTOCRAT



THE REGENCY

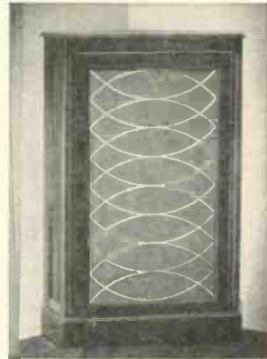

THE PATRICIAN

**KLIPSCH-LICENSED FOLDED-HORN CORNER ENCLOSURES**

New Concepts in Compact Corner Cabinets Provide Extended Bass Range with Remarkable Purity and Efficiency!

Utilizing the Klipsch principle, E-V design extends the lows, enhances the highs. Employs the walls of the room as an extension of the exponential horn air load—assures at least one full octave of added bass range with unprecedented efficiency—no boominess. Provides direct front radiation of higher frequencies. Gives smoother, cleaner over-all musical balance. Increases power handling capacity of any speaker. Authentically styled in fine veneers with lustrous hand-rubbed finish. Fits beautifully in any room.

**The BARONET.** Designed for EV or other 8" speaker. Response down to 35 cps. Conservative modern design with graceful sloping front. Hand rubbed hardwood veneers. Easily portable—can be used anywhere. Dimensions: 22 $\frac{3}{4}$ " high, 14 $\frac{1}{2}$ " wide and 13 $\frac{1}{2}$ " deep. Shipping weight 24 lbs.

Mahogany cabinet only—List Price.....\$65.00  
Blonde cabinet only—List Price.....\$69.00

**The ARISTOCRAT.** Designed for EV or any full range 12" speaker or EV separate 2 or 3 way systems, without modifications. Unusually smooth reproduction down to 35 cps. Selected mahogany veneers. Grill in brushed brass finish. Size: 29 $\frac{1}{2}$ " high, 19" wide and 16 $\frac{1}{2}$ " deep. Shipping weight 45 lbs.

Mahogany cabinet only—List Price.....\$110.00  
Blonde cabinet only—List Price.....\$120.00

**The REGENCY.** For EV or other 15" coaxial speaker, or EV 2 or 3 way systems, without modifications. Has integrally "built-in corner". Can be used in corner or against flat wall. Laboratory response flat  $\pm$  5 db. down to 30 cps. Selected mahogany veneers. Grill in brushed brass finish. Size: 28 $\frac{1}{2}$ " high, 33 $\frac{1}{2}$ " wide and 19" deep. Shipping weight 77 lbs.

Mahogany cabinet only—List Price.....\$200.00  
Blonde cabinet only—List Price.....\$215.00

**THE PATRICIAN 4-WAY SYSTEM**

Complete 4-way speaker system in custom-crafted corner cabinet for very finest in reproduction. Divides audio spectrum between four drivers, each specifically designed for distortion-free fidelity. Includes EV 18WK 18" L.F. driver, EV 12W-1 12" L.F. driver, EV T-25 H.F. driver with 611D horn, EV T-35 Super Tweeter, AT-37 H.F. Level Control and EV X-26 15-14-way crossover. Crossover frequencies 200, 600 and 3500 cps. Entire system wired and installed in elegant cabinet of selected woods and beautiful inlays. Heirloom finish in exquisite hand-rubbed mahogany. Cabinet is 60" high, 41" wide, 30" deep. Shpg. wt. 400 lbs.

Mahogany or Blonde—List Price.....\$1212.50

**THE PEERAGE**

**EQUIPMENT CONSOLE.** A beautiful and practical console designed to house any combination of the popularly known tuners, amplifiers and record changers. Simple, graceful styling harmonizes with EV speaker enclosures and lends itself to any contemporary setting. Supplied with accurate list of all tuner, amplifier and changer combinations which can be installed. Cabinet size: 29 $\frac{1}{2}$ " high, 20 $\frac{1}{2}$ " wide and 18 $\frac{1}{2}$ " deep. Shipping weight 50 lbs.

Mahogany cabinet only—List Price.....\$160.00  
Blonde cabinet only—List Price.....\$170.00



THE PEERAGE

**COMPLETE AUDIO REPRODUCER SYSTEMS**

Including Enclosure and Separate Multi-Way Speaker Systems

**WITH 12" L.F. DRIVER**

**ARISTOCRAT I.** Includes EV Model 108 2-way Speaker System. Completely wired and installed in ARISTOCRAT folded-horn corner cabinet enclosure. Cabinet size: 29 $\frac{1}{2}$ " high, 19" wide, 16 $\frac{1}{2}$ " deep. Shipping wt. 59 lbs.

Complete in Mahogany. List Price.....\$299.00  
Complete in Blonde. List Price.....\$309.00

**ARISTOCRAT II.** Includes EV Model 111 Deluxe 800 cps. Separate 2-way speaker system. Completely wired and installed in ARISTOCRAT folded-horn corner cabinet enclosure. Size: 29 $\frac{1}{2}$ " high, 19" wide, 16 $\frac{1}{2}$ " deep. Shipping wt. 79 lbs.

Complete in Mahogany. List Price.....\$392.00  
Complete in Blonde. List Price.....\$402.00

**ARISTOCRAT III.** Identical to ARISTOCRAT II except with addition of T-35, AT-37 and X-36. Shipping wt. 81 lbs.

Complete in Mahogany. List Price.....\$467.00  
Complete in Blonde. List Price.....\$477.00

**Model 108.** 800 cps. Crossover. Separate 2-way system. Consists of 12BW-1 L.F. driver, T-10 H.F. driver with 8-HD horn, X-825-1 crossover, AK-1 mounting kit and baffle board. Can be used in custom installations. Size 27" high, 18" wide, 12 $\frac{1}{2}$ " deep overall. Shipping wt. 39 lbs.

Model 108 less cabinet. List Price.....\$184.00

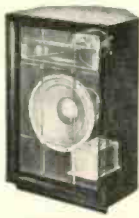

ARISTOCRAT II



108 SYSTEM

**Model 111.** 800 cps. crossover. Deluxe separate 2-way system. Consists of 12W-1 L.F. driver, T-25 H.F. driver with 8-11D horn, X-8-1 crossover, AK-1 mounting kit and baffle board. Can be used in custom installations. Overall size 27" high, 18" wide, 13 $\frac{1}{2}$ " deep. Shipping wt. 64 lbs.

Model 111 less cabinet. List Price.....\$277.00

**Model 111-A.** Identical to 111 except with addition of T-35, AT-37 and X-36. Shipping wt. 68 lbs.

Model 111-A less cabinet. List Price.....\$352.00

**WITH 15" L. F. DRIVER**

**REGENCY II.** Includes Model 114-A separate 2-way system. Completely wired and installed in REGENCY enclosure. Shipping wt. 126 lbs.

Complete in Mahogany. List Price.....\$517.00  
Complete in Blonde. List Price.....\$532.00

**REGENCY III.** Includes EV 114-B 3-way system completely wired and installed in REGENCY enclosure. Shipping wt. 130 lbs.

Complete in Mahogany. List Price.....\$592.00  
Complete in Blonde. List Price.....\$607.00

**Model 114-A.** 800 cps. crossover. Separate 2-way system. Consists of 15W-1 L.F. driver, T-25 H.F. driver with 8HD horn and X-8-1 crossover, AK-1 mounting kit and baffle board. Size: 26" high, 32 $\frac{1}{2}$ " wide, 13 $\frac{1}{2}$ " deep. Shipping wt. 86 lbs.

Model 114-A less cabinet. List Price.....\$312.00

**Model 114-B.** Identical to 114-A except with addition of T-35, AT-37 and X-36. Shipping wt. 90 lbs.

Model 114-B less cabinet. List Price.....\$387.00



REGENCY III



114-A SYSTEM

PRICES SHOWN ABOVE ARE LIST PRICES ONLY. ALL E-V PRODUCTS ARE AVAILABLE THROUGH AUTHORIZED DISTRIBUTORS AT REGULAR AUDIOPHILE NET PRICES.

Send for Hi-Fi Bulletins  
**ELECTRO-VOICE, INC.**  
400 CARROLL ST. BUCHANAN, MICH.

here's

**absolute reliability**

for heavy duty  
audio  
amplification

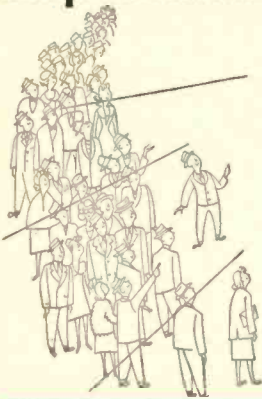

**TUNG-SOL**



**BEAM  
POWER  
AMPLIFIER**

If you've been looking for an audio output tube that's stable under the most severe conditions—completely dependable—then this is it! The Tung-Sol 5881 is rugged both mechanically and electrically—and directly interchangeable with the 6L6.

In creating the 5881, Tung-Sol engineers have made lavish use of the design and production techniques which have proved themselves over the past fifteen years—zirconium coating over the carbonized metal plate and pure barium getter to effectively absorb gas for the life of the tube—gold plated wire to minimize grid emission. These are but a few of the major design improvements in the 5881.

Tung-Sol produces the 5881 under laboratory conditions, to assure peak efficiency and maximum uniformity. You'll find this tube has the stuff to take the whole range of audio service requirements from protracted standby periods to repeated heavy overloads. So, if absolute reliability is essential in your audio circuits, the Tung-Sol 5881 is a "must." Order it from your regular supplier.

*Write for characteristics and performance data*

**TUNG-SOL ELECTRIC INC., NEWARK 4, N. J.**

Sales Offices: Atlanta • Chicago • Culver City (Los Angeles)  
Dallas • Denver • Detroit • Newark • Seattle

Tung-Sol makes All-Glass Sealed Beam Lamps, Miniature Lamps, Signal Flashers, Picture Tubes, Radio, TV and Special Purpose Electron Tubes and Semiconductor Products.

## LETTERS

### Loudspeaker Enclosures

SIR:

The graphic report contained in the March issue was read with very great interest and not a little amusement.

In case any of your readers take your hint and embark on the acoustically rewarding task of installing a brick or concrete enclosure in the home, I would like to give some guidance on the easiest method of mounting the loudspeaker.

A wooden frame should be made to fit in the brick or concrete panel, with a recessed portion in which the loudspeaker can be inserted from the front, after being mounted on a plywood sub-baffle made to fit the frame. It will be found that the weight of the speaker will usually hold the baffle in position and the arrangement has the advantage that the baffle is mounted flush with the front panel, thus avoiding an undesirable cavity in front of the cone. It is then quite easy to remove or change the loudspeaker unit, especially if some sort of handle or knob is fitted to the front of the baffle.

G. A. BRIGGS,  
Wharfedale Wireless Works,  
Yorkshire, England.

SIR:

Having read several of Briggs' books, I was also tempted to construct a brick speaker enclosure. However, not owning my own home, brick or concrete was impossible. After some thought, I arrived at what I consider the next best thing.

An 8.5-cu. ft. enclosure was constructed using two layers of 3/4-in. plywood. Between the two layers a two-inch space was made. This space was then filled with clean dry sand.

The speaker used is a rather low quality 15-in. woofer. The system has several resonances—one at about 70 cps and one at about 45 cps, neither of which is especially strong. As might be supposed, resonances in the walls and top are very well damped by the sand.

The enclosure has been moved three times with no difficulty. The top is removed and the cabinet is then tipped over and the sand poured out. Without the sand, the structure is quite light and easily moved to its new location, where the sand is replaced and the top refastened.

Although not as rigid as brick or concrete, and somewhat more difficult to make, the structure is more easily moved and the results almost as good.

WERNER G. ZINN, JR.  
4630 Westminster,  
St. Louis, Mo.

*(Has anyone ever tried a welded sheet-metal unit of similar construction to the above, but which could be filled with mercury? A faucet near the bottom would facilitate draining when moving day comes around. Seriously, perhaps Mr. Zinn would care to furnish constructional details for publication in *Æ*. Ed.)*

### Early Stereo Demonstrations

SIR:

All of us in the sound recording field have been much interested in the tremendous progress of binaural and stereophonic recording. In the last few years there have been many statements made by various groups of people as to the "firsts" that have been accomplished. Many noteworthy demonstrations prior to 1940 are often overlooked.

While I did not have the pleasure of hearing it, I understand that Bell Laboratories gave a stereophonic three-channel magnetic steel tape demonstration in 1938 at the World's Fair.

On the West Coast, I had the privilege of presenting a paper with Norman Neely, with whom I was then associated, before the 1939 Spring meeting of the Society of Motion Picture Engineers. Assisted by Stanley Cutler, also of the Neely organization, we made a binaural demonstration of a small dance band and a full orchestra along with other effective material. Mr. Cutler had recorded the two channels on an acetate disc machine by placing two cutting heads on the same lead screw about four inches apart. We used two separate pickups on reproduction, and the entire arrangement worked quite satisfactorily.

Two years ago, before the Los Angeles Section of the Instrument Society, I made a demonstration of a binaural recording with our tape equipment demonstrating what is probably the most unique method of portraying the stereophonic effect. I put two channels of our equipment on a merry-go-round and placed two microphones about 10 ft. apart to record the automatic piano and colliope while revolving around it. The effect was sensational.

WILLIAM V. STANCL, Pres.,  
The Stancil-Hoffman Corporation  
Hollywood 38, California.





**Of course he's using Soundcraft Recording Tape  
...it's **micro-polished**\***

**Perfect reproduction** — that's the reason why more and more engineers today demand Soundcraft Professional Recording Tape.

**Soundcraft is the only professional tape that is Micro-Polished.** The only tape that is polished, buffed and re-polished by a special process to produce a surface that is mirror-smooth, completely free of even the most minute irregularity. The results of Micro-Polishing are apparent to any sound engineer:

- Lower distortion**
- Uniformity of output**
- Improved high frequency response**
- Better head contact**
- Less friction, longer head life**

Soundcraft Professional Recording Tape incorporates all the features developed by Soundcraft research engineers during the last two years: **pre-coating** to insure better adhesion, prevent curling and cupping — **dry lubrication** to eliminate squeals. The 7" reel has the 2 3/4" hub, eliminating torque problems and resulting in better timing. All this, plus a splice-free guarantee on all 1200' and 2500' reels.

Why settle for less than the best? Next time, insist on Soundcraft Professional Recording Tape. It's Micro-Polished!



**REEVES**

**SOUND-CRAFT** CORP.

\* PATENT APPLIED FOR

WRITE FOR FREE INFORMATION DEPT. B-5.

10 East 52nd Street, N. Y. 22, N. Y.

ONLY  
**Precision  
 Prints**

**CAN DO FULL JUSTICE  
 TO YOUR PRODUCTION!**

**ELECTRONIC PRINTING**

This latest Maurer development in the printing of optical sound from magnetic original, as recorded on 16 mm film coated with magnetic material, is used exclusively at Precision for kinescope and other magnetic recording direct to film optical track.



**YOUR ASSURANCE OF  
 BETTER 16mm PRINTS**

15 Years Research and Specialization in every phase of 16mm processing, visual and aural. So organized and equipped that all Precision jobs are of the highest quality.

Individual Attention is given each film, each reel, each scene, each frame — through every phase of the complex business of processing — assuring you of the very best results.

Our Advanced Methods and our constant checking and adoption of up-to-the-minute techniques, plus new engineering principles and special machinery

*Precision Film Laboratories — a division of J. A. Maurer, Inc., has 14 years of specialization in the 16mm field, consistently meets the latest demands for higher quality and speed.*

enable us to offer service unequalled anywhere!

Newest Facilities in the 16mm field are available to customers of Precision, including the most modern applications of electronics, chemistry, physics, optics, sensitometry and densitometry—including exclusive Maurer-designed equipment—your guarantee that only the best is yours at Precision!

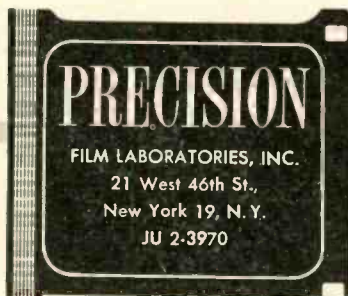

**Musical Dynamics**

SIR:

I would like the opinions of some of your readers who know and like good music. Is it possible for the dynamics in music to be fully effective when the music is reproduced at a level considerably below that of the original performance?

A great number of people disregard the dynamics of a musical number, thus losing much of the beauty of the performance. Some musicians make little of the dynamic possibilities of their instruments, while others use artificial dynamics which have been acquired by various means. Such artificiality is likely to be ineffective unless the musician possesses great feeling.

PAUL W. CONNER,  
 1208 Pullman Road, Rt. 3,  
 Moscow, Idaho

**Figure of (De) Merit**

SIR:

While I read Mr. Bender's article "A Power Tube Figure of Merit" in the March issue with much interest, I think his figure of merit could be improved upon to better suit the needs of the high-quality-amplifier builder.

My objection to his equation

$$F = \frac{P(100 - D)}{R_L E_G}$$

is that the magnitude of distortion,  $D$ , has far too little effect on the figure of merit while that of the load resistance  $R_L$  has too great an effect.

For instance, all other things remaining constant, if the distortion of an amplifier tube were reduced by a factor of five—from 10 per cent to 2 per cent distortion, for example, which is a very significant change—the figure of merit would increase by only 8 per cent. On the other hand, if the load resistance were to be cut in half, an improvement of lesser significance, the figure of merit would double.

Therefore, I propose the following figure of merit:

$$F = \frac{100 P}{D \sqrt{R_L E_G}}$$

where  $F$  = Figure of Merit

$P$  = output power in watts

$D$  = distortion, in per cent

$R_L$  = load resistance, in thousand ohms

$E_G$  = peak grid-to-grid voltage.

This figure is primarily dependent on the power output and distortion, and to a lesser extent on the load resistance and grid drive required.

The following table is computed by formula from values obtained from the RCA Tube Manual:

TUBE	CLASS	BIAS	E <sub>bb</sub>	P <sub>o</sub>	F
2A3	AB <sub>1</sub>	Self	300	10	7.2
2A3	AB <sub>1</sub>	Fixed	306	15	31.2
6V6	AB <sub>1</sub>	Self	285	14	22.9
6V6	AB <sub>1</sub>	Self	250	10	11.6
6L6	A	Self	270	18.5	65.4
6L6	A	Fixed	270	17.5	66.1
6L6	AB <sub>1</sub>	Self	360	24.5	27.0
6L6	AB <sub>1</sub>	Fixed	360	26.5	66.9

Another factor which might be included with  $R_L$  and  $E_G$  under the square root sign is the plate current required.

I would be interested in hearing the comments of others about this.

ANTHONY J. G. PRASIL  
 245 Oaklawn Drive,  
 Rochester 17, N. Y.



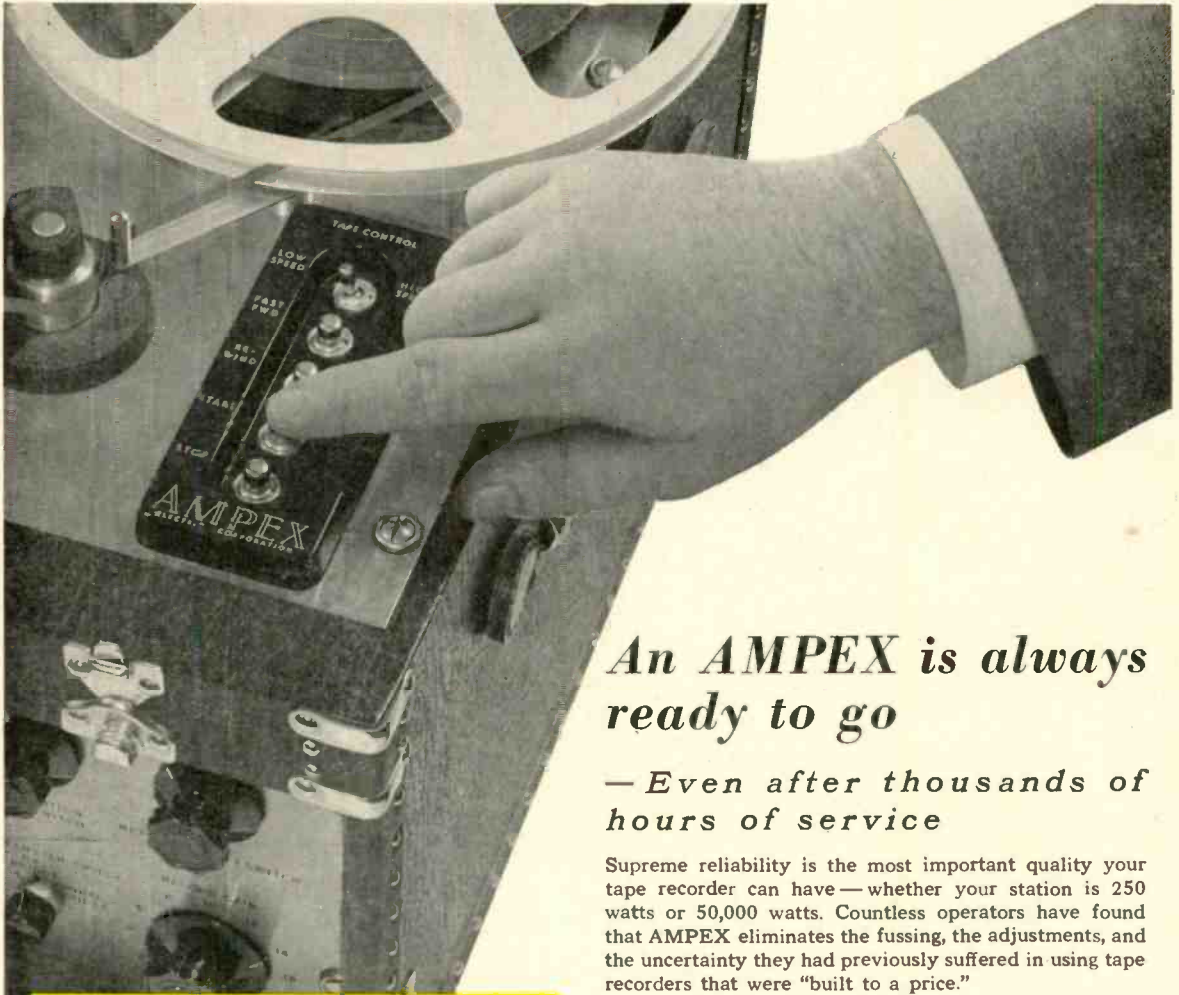

## *An AMPEX is always ready to go*

*— Even after thousands of hours of service*

Supreme reliability is the most important quality your tape recorder can have — whether your station is 250 watts or 50,000 watts. Countless operators have found that AMPEX eliminates the fussing, the adjustments, and the uncertainty they had previously suffered in using tape recorders that were "built to a price."

The AMPEX 400 Series Recorder is the one outstanding bargain in tape recorder service. It costs least per hour of use; it minimizes maintenance and adjustment; it protects your programs from the hazard of sudden failure; and its reliability frees your engineer's attention for other tasks.

Even after thousands of hours of service, your AMPEX Recorder will be reliable in these important ways:

- *When you press the button, it operates*
- *Program timing stays accurate*
- *Starting, stopping, and rewind will operate smoothly*
- *Fidelity will still be high*
- *Maintenance costs will still be low*

*For new broadcast application bulletin, write Dept. B-1041A*



Model 403C

Model 403P

***If you plan for tomorrow, buy an AMPEX today.***

# AMPEX

## MAGNETIC RECORDERS

AMPEX ELECTRIC CORPORATION  
934 CHARTER STREET • REDWOOD CITY, CALIF.

# PROOF of PERFORMANCE

Shure slender Gradient' Microphones solve difficult acoustic problem

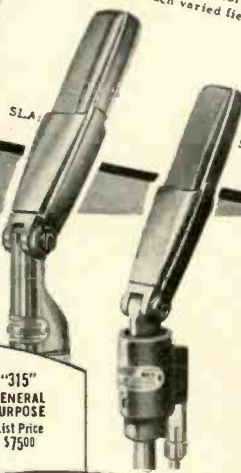
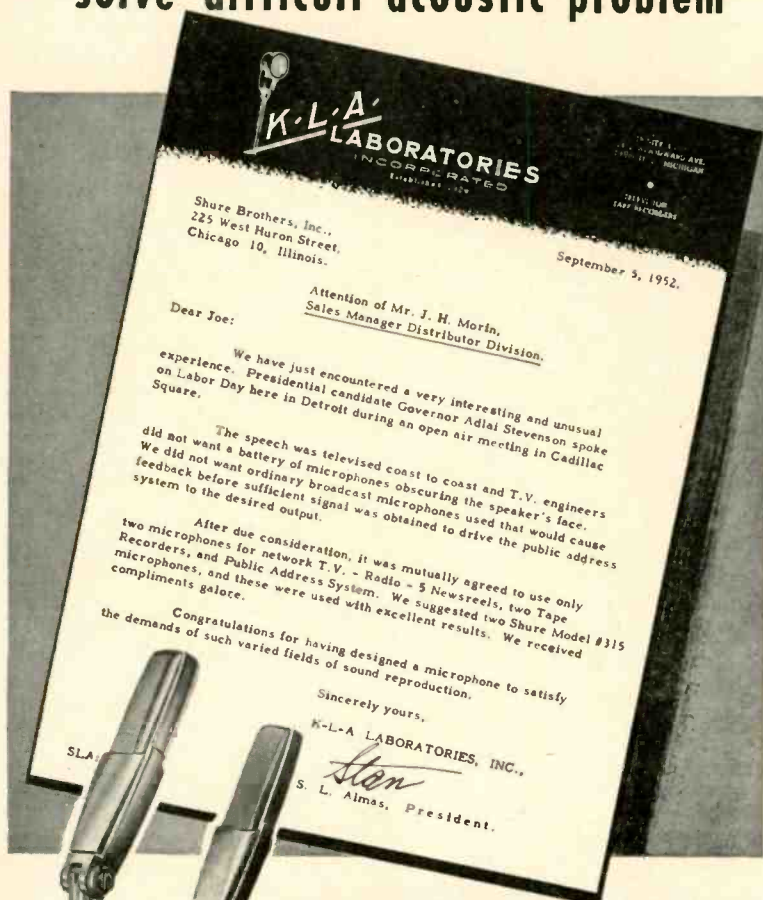

"315" GENERAL PURPOSE  
List Price \$7500

"300" BROADCAST  
List Price \$12500



Former Governor Stevenson of Illinois, pictured as he addressed Detroit audience on Labor Day, during the 1952 presidential campaign.



**SHURE BROTHERS, Inc.** ★ Microphones and Acoustic Devices  
225 West Huron Street, Chicago 10, Illinois • Cable Address: SHUREMICRO

SIR:

In my opinion, Mr. Bender has chosen a rather poor manner in which to classify power tubes, inasmuch as he grossly under-rates the importance of distortion. Since I employ WE-300B's in my own amplifier and am acquainted with their performance, I should like to submit the following illustrative examples:

(a) As noted in Mr. Bender's table, at 450 volts on the plates, two 300B's in class A develop 35.6 watts output, demanding -97 volts fixed bias and a 4000-ohm load impedance. The only non-negligible distortion is third harmonic, which totals 3.2 per cent. Entering these values in Mr. Bender's formula, one obtains a figure of merit of 4.44. (Strange that he calculated 4.90 for the case of self bias.)

(b) With the same conditions as above, except a load of 8000 ohms, one finds the power output to be 25.3 watts, at the surprisingly low distortion figure of 0.6 per cent. Using these new figures, one gets a figure of merit of only 1.62, however.

Any audio man will agree that, assuming no feedback, case (b) is far preferable to case (a) in listenability, and having experimented with both operating conditions, I can state that tests involving program material bear this out.

Therefore, I believe that it would be well to reconsider the method of obtaining power tube figures of merit, and perhaps aim at developing a formula more dependent upon distortion than upon power. I suggest something like

$$F = \frac{100 P}{DK_L E_0}$$

which gives, for the above cases a figure of merit of 1.43 for (a) and one of 7.65 for (b).

BERNARD A. ENGHOLM,  
Oak Ridge National Laboratory,  
Oak Ridge, Tenn.

SIR:

... Apparently Mr. Bender forgets completely the matter of the power required to operate the tubes in the equation he evolves. For example, if one chooses tubes such as the 203A, 211, 304TL, or 833A, the figure of merit will far exceed any which he shows in his tables. Furthermore, his placement of distortion is unreasonable. Two tubes with all other things being equal except that one has twice the distortion of the other will not give twice the figure of merit for the tube with lower distortion.

For a substitute equation, I offer this:

$$F = \frac{P \left( \frac{100}{D} \right)}{R_L E_0 E_P I_K}$$

where  $F$  = figure of merit  
 $P$  = power output in watts  
 $D$  = distortion at rated output  
 $R_L$  = load impedance in kilohms  
 $E_0$  = peak grid driving volts  
 $E_P$  = plate voltage required  
 $I_K$  = total cathode current at rated output.

Heater power in watts might also be placed in the denominator if a complete equation is desired . . . .

ROBERT GARNER,  
7414 Alabama Ave.,  
Canoga Park, California



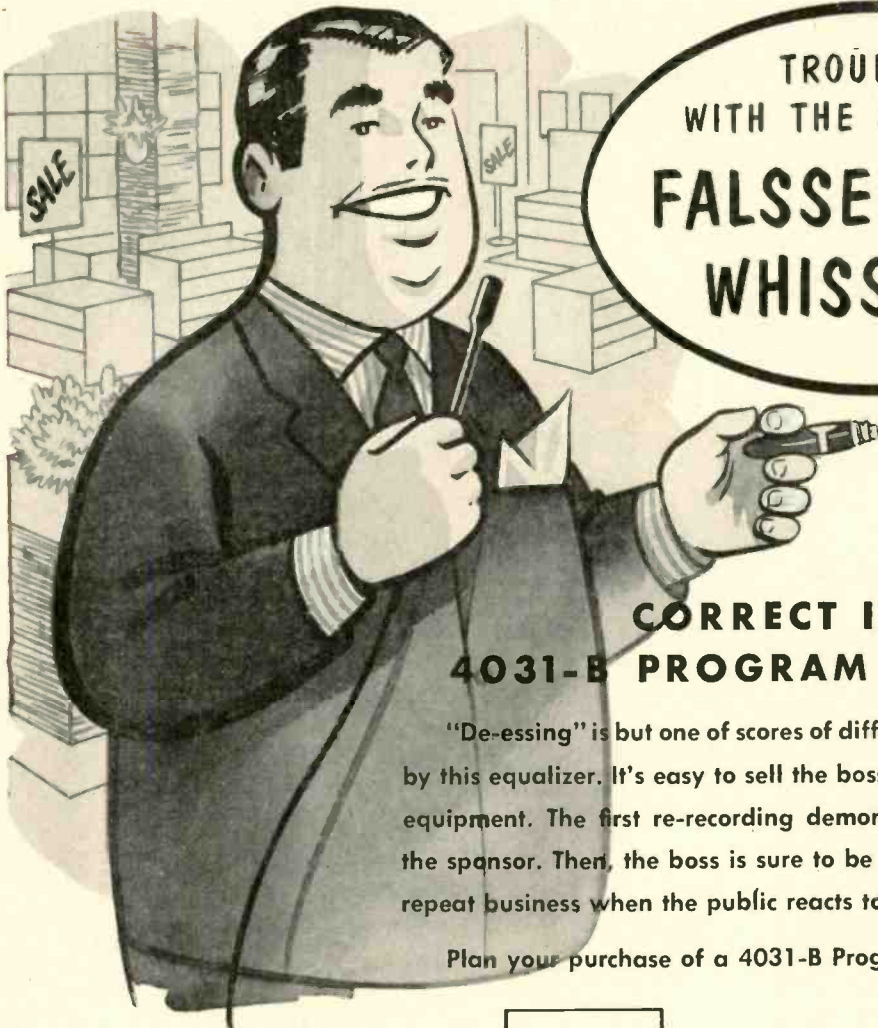

TROUBLED  
WITH THE SPONSOR'S  
**FALSSE TEETH  
WHISSTLE?**

**CORRECT IT WITH A  
4031-B PROGRAM EQUALIZER!**

"De-essing" is but one of scores of different functions performed by this equalizer. It's easy to sell the boss on this addition to your equipment. The first re-recording demonstrates the difference to the sponsor. Then, the boss is sure to be sold. Enjoy that pleasant repeat business when the public reacts to your latest sound work.

Plan your purchase of a 4031-B Program Equalizer today!

**THE CINEMA 4031-B  
PROGRAM EQUALIZER**



Used in all types of speech input equipment. The 4031-B corrective equalization saves on recording retakes; improves tonal quality; provides emphasis when needed during the program. Widely used in Motion Pictures, T-V, Recording and Military Communications.

**YOUR  
AUDIO  
IS  
ENTITLED  
TO THE  
BEST**

**THE CINEMA 6517-D  
VARIABLE LOW AND HIGH FREQUENCY FILTER**



Cut off characteristics ideal for shortening frequency range; providing sound effects, such as telephone, whispering, spooks, etc. Clickless control allows insertion upon cue. Used in Motion Pictures, T-V, and Scientific Laboratories.

*Write for descriptive literature.*

IN NEW YORK: Audio & Video Products Corp. • 730 Fifth Ave. • Plaza 7-3091



**CINEMA ENGINEERING COMPANY**  
1510 WEST VERDUGO AVENUE, BURBANK, CALIFORNIA

EXPORT AGENTS: Frazar & Hansen, Ltd. • 301 Clay Street • San Francisco, California, U.S.A.

## For Listeners in "Fringe" Areas

The two components below bring to music lovers in fringe areas (distances up to 80 miles) consistently clear, brilliant reception . . .



### SONOCRAFT FM TUNER

Acclaimed for tonal quality and faithful reproduction. New blackout tuning indicator; 3 gang inductive tuning; dual limiter; all coils slug-tuned; 5 microvolt sensitivity for 20db quieting; 200KC bandwidth at 6db down; adjacent channel down 60db; 11 miniature tubes; AFC with disable switch; compact, 10" w., 4" h., 8" d.; easy installation . . . \$89.95



### REGENCY DB98-FM SIGNAL BOOSTER

Easy to operate; simple to install. Attractive steel hammertone finished case; polished aluminum dial; Internal impedance matching for 300 or 72 ohms. Push-pull triode design. Frequency range 88-108 MC. 20db gain on all FM channels. Automatically compensates for impedance mismatch. Uses one 6J6 tube as RF amplifier. Size 3-5/16" x 4 1/8" x 5 1/4" . . . \$16.17



**GIFT . . .**  
from America's most advanced Hi-Fi studios . . . Come in for your copy of "Sound Advice" by Irving Greene, 124 pages of vital Hi-Fi data . . . It's FREE!

**ASCO SOUND CORPORATION**

115 WEST 45TH STREET, 3rd FLOOR  
NEW YORK 36, N. Y.

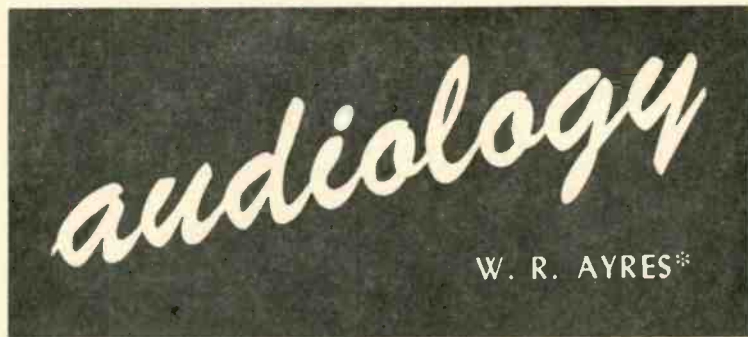

## Feedback from Output Transformer Primary

**W**ITH PARTICULAR REFERENCE to audio-frequency amplifiers transformer-coupled to the load, feedback systems may be classified broadly as primary, secondary, or tertiary, according to the transformer winding at which the output signal is sampled. Of greatest general utility is the primary feedback plan; while technically not including the output transformer within the feedback loop, it presents other advantages which are usually of greater importance in an equipment design.

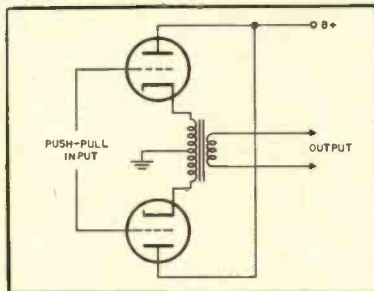

Fig. 1.

### Representative Connections

The cathode follower shown in push-pull in Fig. 1 is the simplest form of primary feedback. It is not basically different in either performance or capability than other primary-feedback amplifiers, such as the unbalanced primary-feedback arrangement of Fig. 2, having the same effective gain reduction. Optimum load conditions and maximum power output are no different than with plate loading, and the same general rules apply regarding selection of the operating point.

Though a cathode-follower output-impedance of 500 ohms or less is easily obtained, only small output voltage at low distortion could be produced across such a low load impedance. But with normal loading, distortion contributed by a cathode-follower stage is usually negligibly small. The connection is adaptable to either single-ended or push-pull operation.

Aside from general simplicity, a point favoring the cathode follower connection over primary feedback with plate-circuit load, is that relatively high plate-supply ripple is tolerable for a given output hum. Since the cathode impedance is approxi-

mately  $1/G_m$ , the portion of the ripple at the cathode is roughly only  $(1/G_m)r_p = 1/\mu$  of the plate-supply ripple. The factor is yet smaller when the cathode impedance is further reduced by additional feedback to an earlier amplifier stage. With plate-circuit loading, a large feedback factor results in practically the entire plate-supply ripple being applied across the output transformer primary.

Ordinarily, however, additional plate-supply filtering, or hum-balancing means, can be provided more easily than other problems of high-powered cathode-follower output stages can be solved. One of these is the high heater-cathode voltages resulting unless separate heater windings are provided for each half of the output stage. To use high-efficiency output tubes, special provision must be made for application of screen voltage. The crowning inconvenience is that such an enormous input signal is required that the preceding stage may easily introduce more distortion than does the power amplifier.

A useful compromise is that of placing only a portion of the load in the cathode circuit. Of several variations on this plan, one arrangement is shown in Fig. 3.<sup>1</sup> With equal turns on the various primary sections, screen-to-cathode potential of each tube remains fixed, and pentode operation results without further screen-voltage provision.

In application of primary feedback to push-pull output stages, either balanced or unbalanced feedback signals may be applied to suitable points in preceding stages. Preferred arrangements are planned as the subject of a future installment.

(Continued on page 68)

<sup>1</sup> McIntosh and Gow, "Description and analysis of a new 50-watt amplifier circuit," *AUDIO ENGINEERING*, December, 1949.

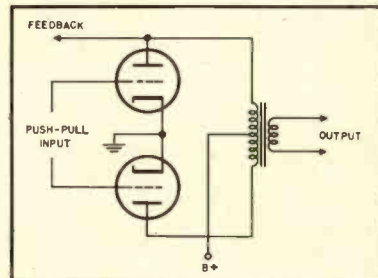

Fig. 2.

\* 311 W. Oakland Ave., Oaklyn 6, N. Y.



from  
STIFLING  
CUBAN HEAT



to  
FRIGID  
VERMONT COLD....  
*all in one week*

"Hot or cold, it's all the same to my Maurer," says Howard Cagle, well-known cinematographer. "From the stifling heat of a Cuban cane field 'burn-off' to a frigid Vermont mountain top one week later — up in the clouds with snow twelve feet deep! Despite the extreme temperatures, my Maurer functioned perfectly!"

Top performance under all conditions of light, temperature and humidity — that's what you get with the Maurer "16," choice of the world's top professionals.



THE MAURER 16MM. designed specifically for professional use, equipped with precision high-power focusing and view-finder. Standard equipment includes: 235° dissolving shutter, automatic fade control, view finder, sunshade and filter holder, one 400-foot gear-driven film magazine, a 60-cycle 115-volt synchronous motor, one 8-frame handcrank, power cable and a lightweight carrying case.



Howard Cagle shooting skiing sequence with his Maurer "16," at Bromley, Vt.

**J. A. MAURER, inc.**

37-01 31st Street, Long Island City 1, New York  
1107 South Robertson Blvd., Los Angeles 35, California

Cable Address: JAMAURER

**16mm  
maurer**

**maurer** means finer motion pictures!

# EDITOR'S REPORT

## THE AUDIO ENGINEERING AWARDS

IT IS WITH CONSIDERABLE pleasure and no little pride that we announce in this issue the results of the first annual Audio Engineering Awards, for which please turn to page 30. Because we recognize that audio enters into other than its more commonly accepted aspects—such as broadcasting, public address, TV audio, and home music installations, this competition was established with the idea of calling attention to the work of those engineers who work in fields other than those with which we are most familiar, but who are still *audio* engineers.

Phonograph records may seem to many of us to occupy a large portion of the recording industry, but actually one other branch of recording is in use hundreds of times as many hours per day as the making of musical recordings. It may seem to be somewhat prosaic, but the office dictating machine presents as many problems—albeit of a different type—as does the record business. One of the awards, therefore, goes to an outstanding achievement in the dictation machine field, with the specific citation reading “for technical excellence in the design and manufacture of dictating instruments.”

Most of us are quite familiar with the conventional public address systems seen in stadia, auction rooms, theatres, night clubs, and bingo parlors. But does it ever occur to us that another type of amplifying system is in use by several hundred thousand people every minute of the day? And does it ever occur to most of us that these miniature amplifier systems must work efficiently and reliably at a cost measured in pennies per day? And that they have their own microphone, amplifier with tone and volume controls—even with automatic gain controls and limiters in some instances—and a self-contained power supply in a space appreciably less than that occupied by a package of cigarettes, not even king-size?

Accordingly, our second award goes to a hearing-aid manufacturer who has, in the opinion of the judges, done an outstanding job of designing and building a unit which is efficient, which does a number of required jobs well, and which is still small enough that it may be carried almost as easily as a pocket lighter. The citation reads simply “for technical excellence in the design and manufacture of hearing aids.”

Coming to a more familiar field, *Æ*'s other awards,—eleven of them—go to the phonograph record manufacturers who have, in the opinion of the judges, made records which are superior both musically and technically. In each of eleven different categories, one record has been selected for an award, but every record submitted may be considered important since each one was first selected by its manufacturer as the best single product in its category.

These awards are *Æ*'s tribute to industry and its application of good engineering principles and practices. It is hoped that *Æ*'s readers will join us in congratulating the winners, and that they will endorse our recognition of audio's far reaching environs.

## THE I. R. E. SHOW

There is little risk of hyperbole in stating that the 1953 version of the I.R.E. National Convention and Radio Engineering Show was the biggest event of its kind ever staged, and may conceivably establish an attendance record which will remain untouched in the foreseeable future.

Occupying New York's Grand Central Palace for the last time, the Show—running from March 23 through March 26—presented displays of hundreds of manufacturers to more than 40,000 visitors. The Convention presented an astounding array of technical papers—so many that at times there was simultaneous occupancy of every available meeting room in the Palace, not to mention additional space in two large hotels.

All of which adds up to bigness, no question.

But, from this observer's viewpoint, bigness in itself should be only a secondary objective for affairs of this kind, the primary objective being to conduct a forum—an information clearing house, so to speak—which will repay in professional skill the cost incurred in coming hundreds and even thousands of miles in its quest.

## REWARDS

One of the rewards of conducting this page is that we are often tendered information which is of itself interesting, and that we are continually being apprised of happenings and activities of which we might not otherwise become aware.

Not the least of these is the occasional information about small but much-beloved (by their listeners) radio stations which exist to serve these listeners with the program fare the listeners most want—and which they are willing to shell out for, directly to the radio station. A few weeks ago it was KISW-FM in Seattle, and most recently we are reminded of the activities of KPFA in Berkeley, California, which has been operating as a listener-supported station for several years.

As a result of its sale of subscriptions, KPFA presents the kind of programming not attainable in most of American radio, for KPFA is not just a “good music” station. Its bi-weekly program booklet *Folio* lists folk songs for children, a story cycle, music of other lands, and “Fabulous Beasts”—a reading from the book by Peter Lum—during the children's hour on a typical weekday. The First and Second Concerts, at six and nine p.m. respectively, are devoted to “good music,” with news, comments, and cultural subjects in between. Several nights a week a program of jazz is scheduled, and even the Savoyards have their inning with a complete G & S album. Believe it or not, one of the public service talks—March 28 at 8:55 p.m.—was entitled “Garbage: A symposium on what to do with it,” with a college professor, an industrial consultant, a disposal engineer, and a health official participating on the panel. Something for everyone, says KPFA.

Seriously, though, isn't there a lesson here for the many FM stations which are in the doldrums of stereotyped programming? KPFA's *Folio* (\$10 a year) might save the cost of a high-priced program consultant.



# PICKERING

## PROFESSIONAL AUDIO EQUIPMENT

BALANCED COMPONENTS / MAXIMIZE PLAYBACK PERFORMANCE

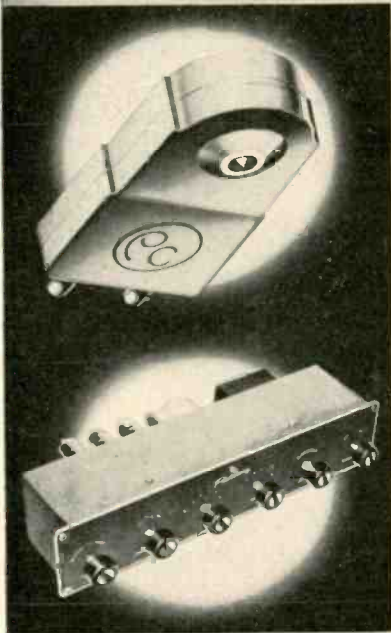

### PICKERING CARTRIDGES . . .

are the choice of audio engineers throughout the world. They are universally acclaimed because of their high output, wide range performance and low distortion. They are used wherever a fine cartridge is required in radio stations, recording studios and for purposes of quality control by leading record manufacturers.

### MODEL 410 AUDIO INPUT SYSTEM . . .

is designed to provide a complete audio control center. Model 410 may be used in any high quality playback system. Three input channels are provided—one for magnetic cartridges and 2 "flat" channels for other audio circuits. A 3-position equalizer network is built into the magnetic cartridge channel and provides accurate equalization for LP, AES and 78 rpm recording characteristics. Separate bass and treble controls are also provided. These are of the step-type and permit bass and treble adjustments in 2 db increments. The tone control circuits are intended to compensate for record characteristics and for listener-environment acoustical conditions. *They are not intended to compensate for amplifier and/or loudspeaker deficiencies.* Model 410 is intended for use with the highest quality professional type playback equipment. The output of the Model 410 is fed from a cathode-follower circuit and will work into any high quality audio or line amplifier having a high impedance input. It may also be used with a transformer for the purpose of feeding a 500 ohm line. Because of its flexibility, low noise and low distortion level, it is ideally suited for bridging and monitoring purposes and for critical listening applications.



### THE MODEL 190 ARM . . .

is designed primarily for use with microgroove records. Its design has been recognized by leading audio engineers as that which incorporates all of the desirable tracking characteristics. Analysis has shown that for maximum performance with LP records the vertical mass of the moving arm element must be held to a minimum and further, that the arm must be counterbalanced about the vertical axis. This permits minimum stylus or tracking force and provides maximum record life. The Model 190 Arm embodies these all important features necessary for proper microgroove record playback.



### MODEL 230H EQUALIZER-PREAMPLIFIER . . .

is unique in its accuracy of equalization and frequency response. The intermodulation distortion is .2 per cent at normal output level. It is intended for use with high quality amplifiers having gain and tone controls. When used with the Pickering Model 132E Record Compensator the 230H is ideal for radio station and recording studio use and for applications requiring accurate low noise and distortion free playback.



### MODEL 132E RECORD COMPENSATOR . . .

is designed to be used in conjunction with a magnetic cartridge preamplifier such as the Pickering 230H or any preamplifier which provides 6 db per octave bass boost. Six playback positions are incorporated:

- 1—European 78 rpm Records
- 2—Victor 45 rpm and Decca 78 rpm Records
- 3—No high frequency roll-off, 500 cycle turnover
- 4—All Capitol Records, new Victor 33 $\frac{1}{2}$ , Audio Engineering Society Curve
- 5—Columbia, London and most LP Records
- 6—To remove the hiss from old noisy records

Precision elements are used in its construction to give accurate compensation. The 132E is inherently a low distortion R-C device.

## PICKERING PROFESSIONAL AUDIO EQUIPMENT

*"For those who can hear the difference"*

... Demonstrated and sold by Leading Radio Parts Distributors everywhere.  
For the one nearest you and for detailed literature, write Dept. A-2.



**PICKERING** and company incorporated • Oceanside, L. I., New York

Pipes  
that  
grew  
without  
getting  
bigger

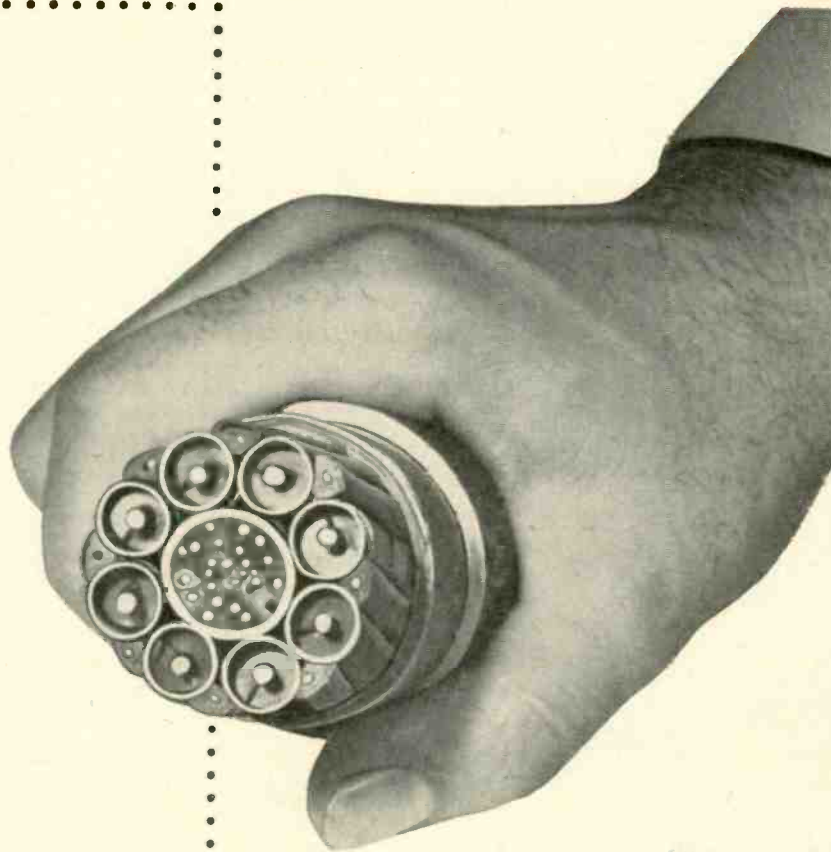

Cross-section of coaxial cable. To triple capacity, Bell Laboratories and Western Electric engineers had to make 1000 amplifiers work perfectly in tandem . . . feed repeater power along the same cable that carries messages . . . put signals on and off the line at numerous cities along the route without distortion.

Pencil-size pipes carry telephone messages and television across country through the Bell System's coaxial cable. Once, each pipe could carry 600 voices, or one television program. Now it can carry 1800 voices, or 600 voices *plus* a broadcast quality television program.

Yet the pipes aren't any larger. They are being made into triple-duty voiceways by new repeaters, new terminal equipment and other transmission advances developed by Bell Laboratories engineers.

The conversion expense is less than the cost of laying extra coaxial cables. But it calls for highly refined manufacturing procedures, made possible only by close co-operation of Bell Laboratories and Western Electric, manufacturing unit of the Bell System.

In improving the coaxial cable system they created more than 20 years ago, engineers at Bell Telephone Laboratories devised a new way to give America still better telephone service, while the cost stays low.

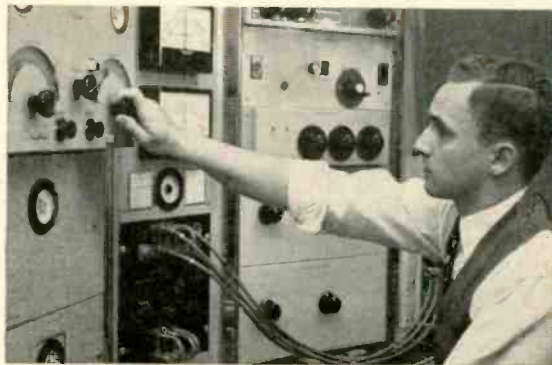

Laboratories engineer tests new triple-duty coaxial system. It marks the first time that telephone conversations and television can travel through the same pipes at the same time. With a wider frequency band being transmitted, big problem was to eliminate interference between the two types of signals.



**BELL TELEPHONE  
LABORATORIES**

IMPROVING TELEPHONE SERVICE FOR AMERICA PROVIDES CAREERS  
FOR CREATIVE MEN IN SCIENTIFIC AND TECHNICAL FIELDS



# Simplified Push-Pull Theory

JULIUS POSTAL\*

Part 1. A graphical, non-mathematical explanation of how second-harmonic and other even-order distortion is cancelled or reduced in push-pull stages, and a discussion of why push-pull operation has no effect on third-harmonic or other odd-order distortion.

**A**LTHOUGH THE CANCELLATION OF reduction of second-harmonic distortion in push-pull stages can be accounted for quite readily by mathematics—specifically by Fourier analysis—the author feels that a graphical explanation that employs no more mathematics than simple horse-sense arithmetic would be more readily appreciated, so long as it avoided the glib sleight-of-hand which often marks many of the so-called non-mathematical explanations. As a result, the presentation offered herein eventuated ultimately.

As a starter, let us review some time-honored facts about amplifiers.

1. Every vacuum tube stage has built-in phase inversion between its control grid and plate. This means that a *positive-going* signal applied to the control grid will cause the voltage at the plate to *fall*. Conversely, a *negative-going* signal at the control grid will cause the voltage at the plate to *rise*.

2. If the over-all gain of the stage happens to be 14 times, to cite a random example, a 1-volt *rise* in grid voltage will cause the plate voltage to change by 14 volts, but in the *downward* direction.

Conversely, a 1-volt *decrease* in control grid voltage will cause the potential at the plate to change by 14 volts in the *upward* direction.

3. If any two points in a circuit are at the same voltage with respect to ground, there is no voltage or potential difference *across* them and there can be no flow of current *between* them. This is a simple, self-evident electrical truth. But in the discussion which follows, it is important to bear it in mind.

4. When any two voltages are placed across any circuit element, if the voltages are *in* phase, they will add. If they happen to be *out* of phase, they will

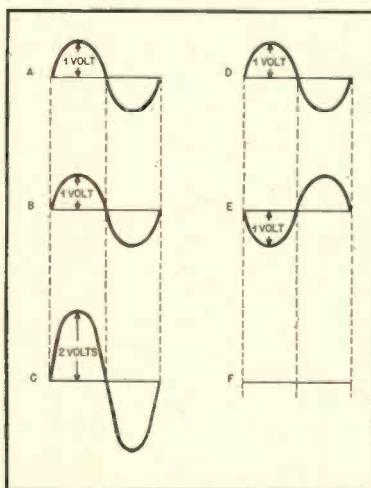

Fig. 1. (A) and (B) represent a pair of in-phase signals. (C) represents their vector sum. (D) and (E) are a pair of identical signals equal in amplitude but opposite in phase. They buck each other out completely, and yield the resultant shown in (F)—zero.

buck each other. If, in addition to being out of phase, they are also exactly equal in *amplitude*, they will cancel each other out completely. In mathematical language, we say that their vector sum is zero. This is demonstrated in Fig. 1.

Before digging into our demonstration proper, let us examine the notion that push-pull operation is impossible unless a transformer having a center-tapped primary is used. The advantages of push-pull operation (especially the reduction of second-harmonic distortion generated within the stage itself) seem to be attributed by some people to allegedly mysterious magnetic phenomena which are supposed to take place in the output transformer.

Let us understand, first, that there is nothing mysterious about the process; second, that a transformer is not essential to push-pull operation (unless we are coupling energy to a modern speaker possessing a typical low-impedance voice-coil). *Even resistance-capacitance coupled stages, inductance-capacitance coupled stages, or direct-coupled stages can be made to operate push-pull.*

Consider the simple push-pull circuit of Fig. 2. Each half of the stage possesses a conventional plate-load resistor. In addition, an ordinary high-impedance headset is connected between the two push-pull plates. Note, too, the zero-

\* 435 Warwick St., Brooklyn 7, N. Y.

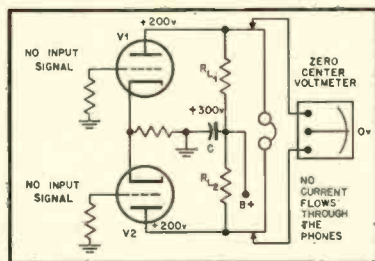

Fig. 2. The push-pull stage is here shown during the quiescent or zero-signal state.  $C_o$  is the output filter capacitor.

center voltmeter bridged across them.<sup>1</sup>

## The Quiescent Point

The circuit of Fig. 2 is shown here in its *quiescent* or zero-signal state. This is precisely the condition of the stage at the start of any a.c. cycle. The stage will also be in this same condition at the exact *midpoint* and *end* of any cycle. With no signal applied, each push-pull plate is 200 volts positive with respect to ground: *In short, the potential difference between the two plates themselves is zero.*

Let us now consider the normal operation of a push-pull stage (See Fig. 3): Two signals—equal in strength but opposite in polarity—are fed respectively to the grid of the upper push-pull tube and the grid of the lower push-pull tube.<sup>2</sup> Let each of these input signals be a sine wave having a peak amplitude of 1 volt.

Because any electrical wave has an infinite number of points, there is no profit in trying to see what happens at every point along the input cycle: There are simply not enough life-times available to find out. Referring to Fig. 3, it will be sufficient for our purposes if we examine what happens at the *be-*

<sup>1</sup> The addition of coupling capacitors between the phones and the tube plates would not affect the operation of this circuit in any fashion that would matter to our presentation. In a practical set-up, designed for listening with phones—assuming it to be push-pull, which is unlikely—blocking capacitors might be used to keep high d.c. potentials from the phones.

<sup>2</sup> The terms "upper" and "lower" as used here have no electrical significance whatever. These terms are used simply to make the presentation easier to follow on the diagrams.

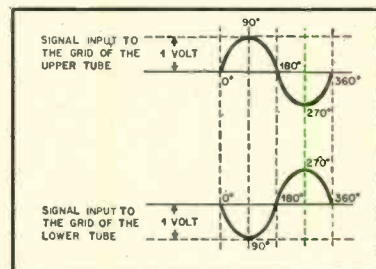

Fig. 3. These two out-of-phase sine waves represent the signal input voltages to the upper and lower halves, respectively, of the push-pull stage. Any sine wave has an infinite number of points, but only five instants during each cycle have been chosen for demonstration.

gining of each cycle (0 deg.), at the positive peak (90 deg.), at the mid-point (180 deg.), at the negative peak (270 deg.), and at the termination of each cycle (360 deg.).

At 0 deg., the amplitude of each sine wave is zero. At this instant in time, no signal voltage whatever exists across the respective grid-leak resistors of the push-pull tubes. The voltage picture is exactly as given in Fig. 4. (Note the resemblance to the voltage distribution of the zero-signal state of Fig. 2.) Each one of the plates is 200 volts above ground. Nevertheless, the pointer on voltmeter *E*, which is connected from plate to plate, stands at dead center: It reads zero volts, because at this instant no difference of potential exists between the upper and the lower push-pull plates. For the same reason, no current flows through the phones.

When each one of the push-pull input signals is at 90 deg. of its own cycle, the distribution of voltages in the circuit is as given in Fig. 5. The heavy arrows indicate the phase relationships in the grid and plate circuits.

Because the gain of each half of the push-pull stage is 14 times, any voltage change occurring at the control grid of either tube will cause a voltage change at its own plate 14 times as great.

Thus, if the grid of the upper triode rises 1 volt, the potential at the plate of this same tube falls 14 volts. By ordinary subtraction, 200 volts minus 14 volts equals 186 volts. This, then, is the instantaneous voltage across the upper triode plate and ground at 90 deg. of the input cycle.

Simultaneously, the 1-volt negative-going signal applied to the grid of the lower triode has caused the voltage at its plate to increase by 14 volts. 200 volts plus 14 volts equals 214 volts.

The voltmeter *E* will now show a potential difference of 28 volts between the two plates. At this instant, there will also be a potential difference of 28 volts across the earphones, resulting in a flow of current through the phones.<sup>3</sup> The path of this current flow will be as shown by the lightly-drawn arrows, i.e., from the plate of *V*<sub>1</sub> through the phones to the plate of *V*<sub>2</sub>, through *R*<sub>L2</sub>, the plate-load resistor of the latter, on

<sup>3</sup> It is well to point out at this juncture that only a purely resistive load directly coupled across the push-pull plates (i.e., without blocking capacitors) would yield zero phase shift between the voltage changes across the plates and the current changes through the earphones. The latter, being conventional magnetic phones, constitute a load which is basically inductive. Changes in the amount of current flowing through the phones must therefore lag—in phase and therefore in time—behind changes in the voltage across the push-pull plates. If the phones had no ohmic resistance of their own and there were no other resistive impedances in the total series path through which this current flows, the phase lag would be exactly 90 deg.

These considerations are set down here for the sake of technical accuracy. They do not in any way affect the validity of our general presentation.

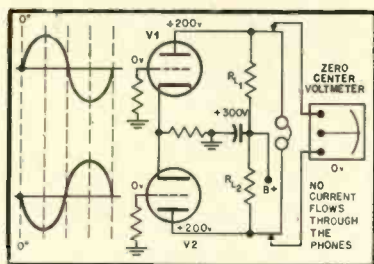

Fig. 4. The stage at 0 deg. of the input signal to each tube.

to the B point and then through the series impedance of the B supply.

#### Mid-Point of the Cycle

At 180 deg., the voltage picture will be as indicated in Fig. 6 which is exactly the same as at 0 deg. Again, both triode plates will be at exactly the same potential with respect to ground and there will be zero potential difference between them. The voltmeter hanging from plate to plate will indicate zero. Its needle will stand at dead center. And since there will likewise be no difference of potential across the earphones, no current will flow through them, either.

At 270 deg. of the input signal to each tube, the voltage picture will be as set forth in Fig. 7. During this instant in time, it will be the grid of *V*<sub>1</sub> which has travelled downward by 1 volt and the grid of *V*<sub>2</sub> which has travelled upward by 1 volt. (The heavy arrows in Fig. 7 indicate the phase re-

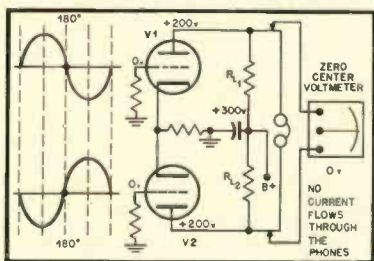

Fig. 6. The voltage picture at the 180-deg. of the input cycle to both tubes.

lationships.) It will now be the turn of the plate of *V*<sub>1</sub> to rise to 214 volts while the plate of *V*<sub>2</sub> falls to 186 volts.

Once again, the zero-center voltmeter connected between the two plates will show a potential difference of 28 volts. Only this time, the needle will be on the opposite side of the scale, highlighting the fact that there has been a change of relative polarity. It will now be the turn of the plate of the upper triode, *V*<sub>1</sub>, to be at the higher positive potential.

Since the same potential difference of 28 volts must, of necessity, be present across the earphones, current will pass through the phones. The lightly-drawn arrows in Fig. 7 show the direction of flow at this instant, namely from the plate of the lower triode, *V*<sub>2</sub>, to the plate of the upper triode *V*<sub>1</sub> through the plate-

load resistor of *V*<sub>1</sub> and thence on to the B+ point and through the series impedance of the power supply. (This is completely opposite to the direction of current flow at 90 deg.)

At 360 deg., the two input signals will have completed their respective cycles: The voltage distribution pattern for the two tubes will be that of Fig. 8. Once again, we will have returned to the situation of the quiescent or zero-signal state.

To recapitulate: At 0 deg., when there is no signal voltage on either grid, both push-pull plates are at the same potential with respect to each other. Therefore no current flows through the earphones and their diaphragms remain

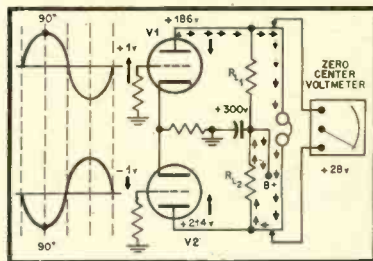

Fig. 5. The voltage picture at the 90-deg. point of the input cycle. The heavy arrows indicate the phase relationships in the circuit. The light arrows show the direction of current flow through the phones.

stationary.

At 90 deg., the voltages at the two plates have moved in opposite directions with respect to ground. The voltage at the plate of the upper triode has moved downward by 14 volts while that at the plate of the lower triode has moved upward by 14 volts. This makes the plate of *V*<sub>1</sub> 28 volts negative with respect to the plate of *V*<sub>2</sub>. The voltmeter needle kicks to one side. At this instant, (neglecting phase lag), the direction of current flow through the earphones is from the plate of *V*<sub>1</sub> to the plate of *V*<sub>2</sub>.

At 180 deg., the voltage conditions of the zero-signal apply. Once again, there is no potential difference between the two push-pull plates and no flow of current between them.

At 270 deg., the plate of *V*<sub>1</sub> the upper triode goes up by 14 volts and that of *V*<sub>2</sub>, the lower triode, goes down, by 14 volts. At 270 deg., therefore, the plate

(Continued on page 59)

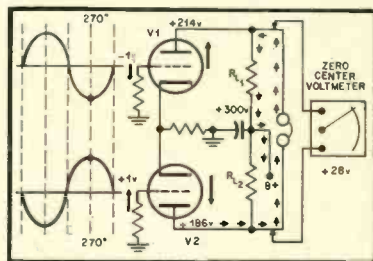

Fig. 7. The voltage picture at the 270-deg. point. The heavy arrows indicate phase relationships, while the light arrows show the direction of current flow through the phones.



# Coupled Loudspeakers

CHARLES W. HARRISON, JR.\*

A discussion of the principles of multicone speaker operation and a description of a composite corner-mounting assembly composed of four acoustic baffles of trapezoidal cross section.

**T**HE EFFECTIVENESS of a sound source depends in an important way on the phase relationship between the normal velocity of the radiating surface and the force reaction (or sound pressure) of the medium on the surface. The principal value of a horn is that it will permit sound to be generated by the vibration of a small diaphragm, but radiated from an aperture large enough to keep pressure in phase with particle velocity down to relatively low frequencies. Horns of exponential or catenoidal shape are conformable to practical application.

It is customary, in calculating the throat impedance of a horn of finite length (assuming it to be baffled so that radiation is confined to  $2\pi$  steradians), to replace the mouth of the horn by a massless diaphragm of suitable shape working in an infinite baffle. This diaphragm has no effect on the operation of the horn, but permits one (for mathematical purposes) to terminate the horn in an impedance equal to the radiation impedance of a piston operated in an infinite baffle. From the basic horn equation, in terms of the velocity potential, one obtains an expression for the pressure and particle velocity at any point within the horn. These expressions, together with the piston functions, permit determination of the throat impedance. The important thing is that the external sound field set up by the horn can be duplicated by a vibrating piston of comparable radiating area. For practical purposes the large piston radiator (a direct-radiator loudspeaker mechanism of suitable design) may be replaced by a system of properly phased tightly-coupled smaller drivers. However, it is to be remembered that in the useful frequency range of a horn, the input resistance at the throat is high and this affords additional damping over that available in the diaphragm suspension system of the horn driver. This is important at low frequencies if non-linear effects are to be minimized that are generated when large diaphragm excursions take place. For comparable performance the multiple loudspeaker must employ more highly damped drivers than are used with a horn. Such drivers are inherently inefficient, but

efficiency is of no real practical importance in the design of a high-quality loudspeaker for home use.

The question might now be asked as to why one would want to construct a loudspeaker array giving a performance similar to that afforded by an exponential or catenoidal horn. The answer is merely that the physical size of the comparable horn must be many times that of the coupled loudspeaker system. Unfortunately mouth reflections in horns give rise to air column resonances, and unless the mouth is comparable in dimension to the longest wave-length to be reproduced, tremendous variations in sound transmission must be tolerated. A second design criterion for finite horns is that the cut-off frequency of the corresponding "infinite" horn should be at least an octave below the lowest frequency in the desired transmission range if reasonably smooth response is to be obtained. When these requirements are translated into a horn capable of "properly" reproducing notes in the vicinity

of 35 cps a speaker of gigantic dimensions is obtained. Even the theater woofers which utilize exponential horns approximately four feet long on axis are nothing more than directional baffles below 60 cps. This fact can be verified readily by reviewing the theory of the exponential horn found in any text book on acoustics. The only solution, if one insists on using a low-frequency horn, appears to be that of building one in the yard out of brick or concrete. Such a speaker should never be built out of plywood, for serious spurious responses are sure to be obtained from the "ringing" of the horn walls. Yet in spite of the large size of a *properly baffled* horn, its use in the theater is justified because efficiency and power handling ability for frequencies above about 50 cps are important factors. The multiple loudspeaker using well-damped drivers unquestionably affords the best method of getting good bass response in the home where space is restricted.

Fig. 1. Photograph of acoustic baffles employed in coupled loudspeaker tests.

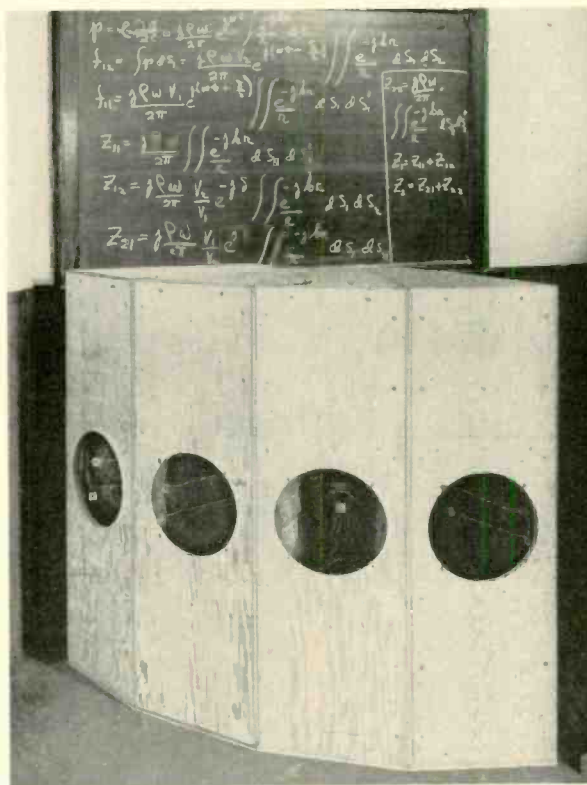

\* Commander, U. S. Navy, 33 Lawrence St., Cambridge 39, Mass.

The writer constructed a multiple loudspeaker consisting of identical wedge shaped acoustic baffles of such angular dimensions that four of them fit snugly into a 90-deg. corner. As shown in Fig. 1, each front panel is just wide enough to accommodate one direct-radiator loudspeaker mechanism mounted at its center. This insures tight acoustic coupling between adjacent drivers when the speaker enclosures are assembled in the corner of a room for operation. Notice that the radiating elements of the speaker resemble the mouth of a sectoral horn. In the following sections the reasons behind this design are set forth.

#### Radiation Resistance of Coupled Loudspeakers

It is well known that the radiation resistance (in mechanical ohms) of an isolated sound source whose dimensions are small compared to the wavelength of the radiated sound is proportional to the square of the effective radiating area. Furthermore, the value of this resistance is independent of the physical shape of the sound source. Applying this principle to the multiple loudspeaker under discussion, one concludes that when the multiple loudspeaker is isolated from all surroundings (no longer operated in a corner) that the radiation resistance of the four-speaker array at low frequencies is about 16 times the radiation resistance of one of the drivers comprising the array in the absence of acoustic coupling. It is clear, therefore, that the radiation resistance of each driver when operated in multiple is increased by a factor of 4 over that obtainable from the same driver operated as an isolated speaker. It is to be emphasized that the physical orientation of the drivers in a baffle which is small compared to the wavelength of the radiated sound is not important insofar as the radiation resistance of the array is concerned. This fact permits location of the drivers in a suitable spatial relationship to insure a desirable sound pressure pattern. If the multiple loudspeaker is now located in the corner of three large mutually perpendicular rigid planes, the radiation is confined to a solid angle of  $\pi/2$  steradians, and this "horn" loading further enhances the radiation resistance of the array. But such a situation is physically unrealizable in an enclosed space (excluding an anechoic chamber) and the idea of sound transmission in a solid angle of  $\pi/2$  steradians must give way to a rigorous analysis of sound transmission phenomena in rooms.

Possibly a more elegant way of demonstrating qualitatively that the radiation resistance of a multiple loudspeaker is proportional to the square of the effective diaphragm area at low frequencies is to comment briefly on the theory of the circular piston radiator mounted in an infinite baffle. This problem is discussed in a straightforward manner in a recently published excellent

book in the field of acoustics.<sup>1</sup> One finds the reaction force on one elemental area of the piston due to the motion of another elemental area. By a process of summation (integration) one finds the force on a given elemental area due to the motion of all other elements. Inclusion of all of these elemental areas on which the force has been computed by a second integration (taking due account of the number of times a given element is included in the calculation) gives the total force acting on the diaphragm. This force is equal and opposite to the force exerted on the fluid medium by the piston. The latter force, divided by the cone velocity, gives the mechanical radiation impedance of the speaker. As might be expected, the radiation resistance (in mechanical ohms) turns out to be proportional to the square of the effective diaphragm area at low frequencies.

The analysis has been outlined because it brings out two essential facts pertinent to this discussion:

- (a) The diaphragm of any loudspeaker may be considered to be made up of a number of suitably shaped smaller diaphragms.
- (b) The interaction or coupling between these smaller diaphragms has been properly taken into account in the analysis.

Statements (a) and (b), together with the theory of the piston radiator outlined here, permit one to draw correctly the conclusion that the radiation resistance of a tightly coupled multiple speaker system installed in an infinite baffle is proportional to the square of the effective diaphragm area at low frequencies. Naively expressed, a person might say that the radiation resistance of a multiple loudspeaker is greater than that of one of its drivers mounted in an enclosure because the drivers aid each other in compressing the air in the vicinity of the cones, causing each driver to "think" that it is working into a more dense fluid medium. A more elaborate and quantitative analysis of coupled loudspeakers, based on the principle of symmetrical phase components, has been published.<sup>2</sup>

It now seems pertinent to discuss briefly another aspect of statement (a) that the diaphragm of any loudspeaker may be considered to be made up of a number of suitably shaped smaller diaphragms. In a recent article<sup>3</sup> it is strongly implied that two low-frequency speakers are highly satisfactory, but four such speakers are taboo because "they present a problem of phasing." The writer is inclined to divide (hypo-

thetically) the two diaphragms that it is "permissible" to use into quadrants. Eight sector-shaped diaphragms are obtained. Is it to be supposed that an intolerable phasing problem has now been encountered? The writer thinks not. To throw more light on this kind of fallacious reasoning consider the following numerical illustration: Suppose that a phase-conscious observer (if one can be found) is located some distance from a piston radiator mounted in an infinite baffle, and that the line from his ear to the center of the diaphragm never makes an angle less than 30 deg. with respect to the baffle plane. Further assume that the observer does not wish complete destructive interference to obtain at any frequency in the range from 60 to 10,000 cps. Surely the "phase problem" is at its worst at null points in the angular dispersion pattern. Reflections from all objects are ignored, and it is assumed that the velocity of sound is 344 meters per second. Using these data one finds that if the "phasing problem" is to be avoided—even when using a single piston radiator, the diameter of the loudspeaker must not exceed 1.9 inches. It is obvious that one may ignore the radiation potentialities of this loudspeaker at 60 cps. If the general problem of phase is really of significance (except as discussed later in this paper) one might very well conclude that

- (a) Multiple microphone pickup of any program is to be avoided if the outputs of these microphones are to be electronically mixed and transmitted over a single channel.
- (b) Efforts to obtain a diffuse sound field, i.e., a sound field of random phase, in a studio or auditorium by the use of splays and asymmetrically placed patches of absorbent material, should be abandoned.

The writer has attempted to point out in this section that a multicone loudspeaker is capable of excellent bass response (by virtue of the fact that at low frequencies the mechanical radiation resistance is proportional to the square of the effective diaphragm area), and that an array of speakers presents precisely the same problem with regard to phase as any direct-radiator loudspeaker of small diameter, or any other vibrating body. No horn is immune from the "phase problem" for the mouth of the horn may be closed by a massless diaphragm with no deleterious effect on the performance of the horn. Before concluding this topic the writer would like to suggest a problem of considerable theoretical interest concerning the coupled loudspeaker system under discussion. Suppose one were interested in calculating the radiation impedance on the mechanical side of one of the drivers forming the four-element array, assuming the array to be operated in the corner of three perfectly rigid mutually perpendicular semi-infinite planes under free field conditions. One equivalent mathematical model consists of two suitably oriented symmetrically disposed speakers driving an infinite wedge. The sides of the wedge are linearly tapered,

<sup>1</sup> L. E. Kinsler and A. R. Frey, "Fundamentals of Acoustics", John Wiley & Sons, Inc., New York, 1950, pp. 187-195. No audio engineer should be without this book.

<sup>2</sup> S. J. Klapman: "Interaction impedance of a system of circular pistons," *J. Acous. Soc. Am.*, Vol. 11, Jan. 1940, pp. 289-295.

<sup>3</sup> W. C. Shrader, "Audio in the home," *AUDIO ENGINEERING*, July 1952, page 30.



and if extended would meet at an angle of 22.5 degrees. The height is twice the height of an enclosure. The top and bottom (which are missing) have the cross-section of an isosceles trapezoid. The basic problem is to find an expression for the acoustic pressure in the vicinity of a driver satisfying the wave equation and all boundary conditions. This is an advanced problem in mathematical physics.

#### Operation of a Loudspeaker in the Corner of a Rectangular Room

Probably the simplest boundary-value problem in applied science is the determination of the acoustic pressure distribution in a rectangular enclosure having six perfectly rigid sides under free oscillatory conditions. The wave equation in terms of the velocity potential is separated in cartesian coordinates. The acoustic pressure is equal to the density of air multiplied by the partial derivative of the velocity potential with respect to time. The air particle velocity is equal to the negative gradient of the velocity potential. The boundary conditions are that the normal component of particle velocity at all bounding surfaces of the room must vanish. One immediately obtains an expression which shows that the acoustic pressure is always a maximum in the corners of the room regardless of the room dimensions and the order of the mode of free oscillation. However, it is to be noticed that this analysis says nothing about how the normal modes of oscillation are established, and in such a room there would be no decay of sound, the vibrations continuing forever. It turns out that when the walls of an enclosure are sound absorptive, a perturbation of the simple theory just advanced enables one to compute the pressure distribution in the room for an individual mode during the transient decay of the sound field (no sound energy supplied). The pressure distribution for each mode is still a maximum in the corners of the enclosure.

Now when a "cavity resonator" bounded by sound-absorptive walls is driven by a simple source of sound, one proceeds as follows to determine the sound pressure distribution in the room:<sup>4</sup>

- (a) The form of the wave equation used must permit the injection of sound into the fluid medium by the simple source.
- (b) The flux of air from the source can be represented by a source function, and this function can in turn be expanded in characteristic functions at the source location (a point anywhere in the room).
- (c) The steady state sound pressure at any point in the room can be similarly expanded in series.

By using certain information obtained from the problem of the transient decay of sound in an absorptive room, and (a)

<sup>4</sup> A good reference is P. M. Morse and R. H. Bolt "Sound waves in rooms", *Review of Modern Physics*, Vol. 16, No. 2, April 1944, pp. 69-150.

through (c), one can evaluate unknown coefficients. A little mathematical manipulation then enables one to arrive at an expression for the sound pressure at any point in the room. The next step is to move the sound source analytically into a corner. It will be found that the pressure at any point in the room has been maximized. However, and this is the point of this entire discussion, a *max. max. value of sound pressure is obtained when the sound source is located in a corner, and the sound pressure is computed at the same point.*

The force of the fluid medium on the diaphragm of the point source is the vector sum of the pressures at this point due to all possible modes multiplied by the surface area of the vibrator. As mentioned before, the negative of this force, divided by the cone velocity, gives the radiation impedance in mechanical ohms. The real part of this impedance is the radiation resistance. The larger the acoustic pressure react-

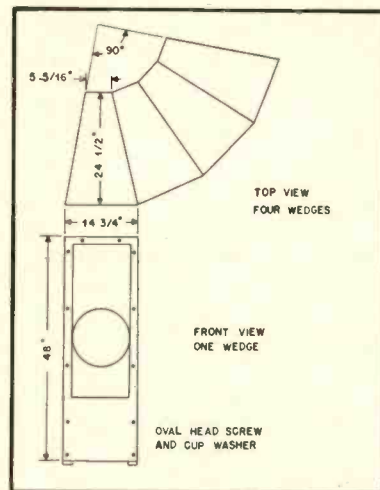

Fig. 2. Scaled drawing of multiple loudspeaker.

ing on the cone the larger is this resistance. It is apparent, therefore, that *for maximum cone loading under steady state conditions the speaker should be designed for corner operation.* For practical purposes cone loading is increased only for sustained low frequency notes. For transient signals it would appear that the use of a corner for speaker location would be no more beneficial than locating the speaker anywhere else in the room.

There is one important advantage of locating a speaker in the corner of a room in addition to the increase in cone loading obtained on sustained low frequency tones. Since all of the normal modes of a room have pressure maxima in the corners, a speaker so located will excite all possible modes. These modes are few and far between (with respect to frequency) at very low frequencies, and it is considered important to excite all of them in the interest of "uniformity" of transmission.

Under steady-state conditions, a point source of sound gives rise to a standing-wave pattern having nodes and antinodes at fixed locations within a room. Two or more such sources separated a small distance and operated simultaneously tend to fill in nulls in the sound pressure pattern. The four-driver loudspeaker array may be considered a point or simple source of sound only at low frequencies. When the frequency is increased somewhat the point source must be replaced by the appropriate distributed sound source. The large aperture of this speaker makes it rather unlikely that objectionable pressure minima will exist anywhere within the room.

#### Sound Pressure Pattern

Although the intensity of sound in a room depends greatly on the properties of the enclosed space, most of the experts agree that while the ear tolerates a certain degree of non-uniformity, a loudspeaker having a smooth response under free field conditions will generally be more acceptable under all listening conditions.<sup>5</sup> Consider the loudspeaker array shown in Fig. 1, to be oriented in the corner formed by the intersection of three mutually perpendicular perfectly rigid semi-infinite planes. Assume also that the adjacent walls of the wedge shaped enclosures are perfectly rigid (and thus non-absorptive). The equivalent mathematical model of this system is a perfectly symmetrical circular array composed of 16 wedges not displaced in length. Each wedge is twice as high as a wedge comprising the physical loudspeaker system. Two drivers are mounted in each wedge, one-fourth the way down from each end in the front panels. The mathematical model dispenses entirely with the three semi-infinite planes. It is easy to see intuitively that at low frequencies the acoustic pressure pattern in the azimuth plane<sup>6</sup> is essentially uniform since there is an angle of only 22.5 deg. between adjacent speaker axes. To maintain this uniform pattern throughout the frequency range of interest requires the use of drivers having a beam width of more than 45 deg. at the highest frequency in the range to be reproduced. The pattern of the array in the azimuth plane can be computed easily by graphical methods. One simply adds up vectorially, i.e., in proper phase relationship, the sound pressures contributed by each

(Continued on page 62)

<sup>5</sup> H. F. Hopkins and C. R. Keith, "New loudspeaker system" *J. Soc. Mot. Pict. Eng.*, 51, pp. 385-398, Oct. 1948.

<sup>6</sup> The azimuth plane is defined as a plane midway between and parallel to the two planes that individually contain the centers of 16 speakers. This plane is at right angles to the axis of the circular array. The vertical plane includes the array axis and the centers of four drivers—two in one wedge, and two in the diametrically opposite wedge.

First Annual

# AUDIO ENGINEERING AWARDS

The First Annual  $\mathcal{A}$ E Awards for Technical Excellence in two categories of audio equipment which are relatively unfamiliar to engineers not directly concerned with their development—and for Musical and Technical Excellence in Recording.

**E**ARLY LAST NOVEMBER, an unusual announcement was received by a number of companies involved in various aspects of audio. This announcement told of the establishment of an annual award to be given for musical and technical excellence in classical recording, with separate awards to be given in each of five categories—symphony, chamber, solo instrumental, vocal, and operatic—and for musical and technical excellence in popular recording, with separate awards in each of six categories—dance, jazz, musical comedy, vocal, novelty, and folk music. Two other awards were announced at the same time, one for technical excellence in the design and manufacture of hearing aids, and the other for technical excellence in the design and manufacture of dictating instruments.

In the case of the phonograph records, each manufacturer was asked to submit his best recording in as many of the categories as he wished, basing his selection on both musical and technical quality. Each hearing aid and dictating instrument manufacturer was asked to submit a model of his product which embodied the characteristics which would be considered excellent by modern design and manufacturing standards.

Eighteen record manufacturers agreed to submit their choices in the eleven categories. In itself, therefore, the list of records submitted is important, for it reflects the opinions of the musical and

technical experts of each of the companies.

A representative number of hearing aid manufacturers submitted models for study and examination by the judges; and while there are many dictating instruments on the market, over ninety per cent of the business is done by only four manufacturers, all of which were studied. Tape and wire machines—while offering certain specialized advantages for some applications—do not have general acceptance in the business world, and they were not included in the invitations.

#### The Judging Committee

Without the assistance of reputable judges, the whole effect of the Awards is meaningless. Consequently, a number of musical and engineering authorities were asked to serve on the committee of judges—each working in the field in which he is most capable.  $\mathcal{A}$ E is grateful to these judges who gave generously of their time and energy for many hours of serious study.

The committee of judges consisted of Deems Taylor—composer, conductor, musician, critic, and author; Edward Tatnall Canby— $\mathcal{A}$ E's record reviewer, record critic for *Harper's*, and regularly heard discussing records on New York City's municipal station, WNYC; Archie Bleyer—composer and arranger, best known for his work with Arthur Godfrey; Harold Lawrence—record author-

ity and Director of Recorded Music for WQXR. Norman Pickering—musician, conductor, physicist, and designer of the phonograph pickup bearing his name; W. O. Summerlin—recording engineer, electronic equipment designer and manufacturer; W. R. Ayres—circuit development engineer and regular  $\mathcal{A}$ E contributor; F. Sumner Hall—recording engineer, electronic equipment manufacturer, and AES president; John D. Colvin—chief engineer, Commercial Radio-Sound Corp., member of  $\mathcal{A}$ E's editorial advisory board; William J. Temple—Professor of Speech at Brooklyn College; and  $\mathcal{A}$ E's editor.

Shown below are the two products which receive the awards for hearing aids and for dictating instruments. The Sonotone model 1010 hearing aid—a model using one transistor to conserve battery power, yet using two tiny vacuum tubes in the first stages of the instrument to maintain a high signal-to-noise ratio—receives the award in its field. The new Edison V.P. Voicewriter receives its award for styling, efficiency, convenience in operation, and its adaptability to a variety of uses. On the opposite page is a listing of the phonograph records which receive awards, along with a complete list of all of the classical records submitted to the judges.

The announcement of these awards is being made publicly on May 14, and full details of the judges' reports will be published in the June issue.



Left, Sonotone Model 1010 transistor-tube hearing aid, recipient of the first annual  $\mathcal{A}$ E Award for technical excellence in hearing aids; and below, the Edison V. P. Voicewriter, recipient of the first Annual  $\mathcal{A}$ E Award for technical excellence in dictating instruments. Both will be described in future issues of  $\mathcal{A}$ E.





# THE BEST U. S. RECORDS OF 1952

- Symphonic**—MAHLER—5th Symphony in C Sharp Minor and 10th Symphony in F Sharp Major. Vienna State Opera, Hermann Scherchen, Conductor. **Westminster**
- Chamber**—BEETHOVEN—Complete String Quartets. Budapest String Quartet. **Columbia**
- Solo Instrument**—BEETHOVEN—Sonatas No. 17 in D Minor and No. 3 in C Major. Wilhelm Backhaus, Piano. **London**
- Vocal**—FOLK SONGS OF HUNGARY—Arranged by Bela Bartok and Zoltan Kodaly. Leslie Chabay, Tenor—Tibor Kosma, Piano. **Bartok Records**
- Operatic**—IL TROVATORE. **RCA Victor**
- Dance**—BIG BAND BASH and Selections—Billy May and His Orchestra. **Capitol**
- Jazz**—PERDIDO and TAKE THE "A" TRAIN—Duke Ellington and His Orchestra. **Columbia**
- Vocal**—DON'T LET THE STARS GET IN YOUR EYES—Perry Como. **RCA Victor**
- Musical Comedy**—THE MERRY WIDOW—Dorothy Kirsten, Robert Rounseville. **Columbia**
- Novelty**—BYE-BYE BLUES and Blues Selections—Les Paul and Mary Ford. **Capitol**
- Folk**—JOYS AND SORROWS OF ANDALUSIA—Voice and Guitar from the Ballets of Pilar Lopez. Lopez Tehera. **Westminster**

## COMPLETE LIST OF RECORD MANUFACTURERS' CHOICES

### SYMPHONIC

- VIOLA CONCERTO**—Bela Bartok; William Primrose and New Symphony Orchestra of London. Tibor Serly, Conductor. **Bartok Records**
- SCHUBERT'S UNFINISHED**, No. 8 in E Minor and No. 2 in B Flat Major, Pittsburgh Symphony Orchestra, William Steinberg, Conductor. **Capitol**
- TCHAIKOVSKY** Symphony No. 6 in B Minor, Op. 74, PATHETIQUE, The Philadelphia Orchestra, Eugene Ormandy, Conductor. **Columbia**
- MASSENET—LE CID**, Ballet Suite, RIMSKY-KORSAKOFF "Tsar Saltan" Netherlands Philharmonic Orchestra, Henk Spruit, Conductor. **Concert Hall Society**
- VAUGHN WILLIAMS—CONCERTO**, Joseph Fuchs, Violin, Zimmler String Sinfonietta. **Decca**
- TANSMAN—TRIPTYCH FOR STRING ORCHESTRA**—Zimmler String Sinfonietta. **Decca**
- THE SPIDER'S FEAST and THE SANDMAN**—Albert Roussel, Paris Philharmonic Orchestra, Rene Lebowitz, Conductor. **Esoteric**
- MOZART**—Symphonies No. 25 in G Minor and No. 29 in A Major, Chamber Orchestra of Danish State Radio, Mogens Woldike, Conductor. **Haydn Society**
- DAS LIED von der ERDE**—Ferrier and Patzak, The Vienna Philharmonic Orchestra, Bruno Walter, Conductor. **London**
- RIMSKY-KORSAKOV—SCHEHERAZADE**, Symphonie Suite, Op. 35 Minneapolis Symphony Orchestra. Antal Dorati, Conductor. **Mercury Classics**
- TCHAIKOVSKY SYMPHONY** No. 6 in B Minor, Op. 74, PATHETIQUE, Chicago Symphony Orchestra, Rafael Kubelik, Conductor. **Mercury Classics**
- BRAMMS 4TH SYMPHONY**—NBC Symphony Orchestra, Arturo Toscanini, Conductor. **RCA—Victor**
- DYORAK—SLAVONIC DANCES**, Op. 46 and Op. 72, Czech Philharmonic Orchestra, Vaclav Talich, Conductor. **Urania**
- SHOSTAKOVICH**—Symphony No. 5, Vienna Symphony Orchestra, Jascha Horenstein, Conductor. **Vox**

### CHAMBER

- SCARLATTI**—String Quartet in D Minor.
- TARTINI**—String Quartet in D Major.
- BOCCHERINI**—String Quartet, Op. 33, No. 6, The New Music Quartet. **Bartok Records**
- SHOSTAKOVICH QUINTET**—Hollywood String Quartet; Victor Aller, Piano. **Capitol**
- BEETHOVEN QUINTET IN C MAJOR**—Op. 29, The Pascal String Quartet, w. Walter Gerhard, Viola. **Concert Hall Society**
- AARON COPLAND—THE RED PONY—VIRGIL THOMSON**—"Louisiana Story," The Little Orchestra Society, Thomas Scherman, Conductor. **Decca**
- DARIUS MILHAUD—SONATA**, La Cheminee Du Roi Rene & Pastorale, Flute, Samuel Baron, Oboe, Ralph Goldberg, Clarinet, Wallace Shapiro, Piano, Milton Kaye, French Horn, Raymond Alouge, Bassoon, Bernard Garfield. **EMS Recordings**
- JOSEPH HAYDN**—Complete String Quartets, Opus 51, "The Seven Last Words of the Savior on the Cross," The Schneider Quartet. **Haydn Society**
- DEBUSSY DANSES SACREE ET PROFANE**—Phia Berghout—Barp, w. The Chamber Music Society of Amsterdam, Eduard van Beinum, Conductor.
- RAVEL INTRODUCTION AND ALLEGRO** for Harp, Flute, Clarinet & String Quartet. Phia Berghout—Harp, w. The Chamber Music Society of Amsterdam. **London**
- BEETHOVEN QUARTET**—Op. 132; Paganini Quartet. **RCA—Victor**
- BOCCHERINI**—Quartet in D Major, Op. 6, No. 1.
- de GIARDINI**—Sonata A Tre in E Flat Major.
- PUCCINI**—Quartetto Della Scala. **Urania**
- THE TWELVE CONCERTI GROSSI CORELLI**—The Corelli Tri-Centenary String Orchestra. Dean Eckertsen, Conductor. **Vox**
- BRANDENBURG CONCERTOS**—No. 5 in D Major, No. 3 in G Major, London Baroque Ensemble, Karl Haas, Conductor. **Westminster**

### SOLO INSTRUMENT

- LISZT**—Variations on the Prelude J. S. BACH—WEINEN, KLAGEN WEHNACHTS—BAUM—Excerptis, Iiona Kabos—Pianist. **Bartok Records**
- RAVEL—MIROIRS—GASPARD DE LA NUIT**—Leonard Pennario, Piano. **Capitol**
- ENCORES**—Zino Francescatti, Violin. **Columbia**

- STRAVINSKY—CONCERTO** for Piano & Wind Orchestra, Newton-Wood, Piano, Members of the Residentie Orchestra, Walter Goehr, Conductor.
- PROKOFIEFF**—Violin Concerto No. 1 in D, Ricardo Odnoposoff, Violin, Radlo Zurich Orchestra, Heinrich Hollreiser, Conductor. **Concert Hall Society**
- AN ANDRES SEGOVIA PROGRAM**—Selections. **Decca**
- BOHUSLAV MARTINU**—Sonata for Piano and Flute, Rene LeRoy, Flute, George Reeves, Piano & Charles Rosen, Piano. **EMS Recordings**
- HARP MUSIC**—XVI Cent. Spanish and Modern French & Spanish, Nleonor Zabaleta—Harpist. **Esoteric**
- J. S. BACH—CLAVIER UBUNG**—Complete Ralph Kirkpatrick, Harpsichord. Paul Callaway, Organ. **Haydn Society**
- CHOPIN SONATA**—No. 3 in B Minor, William Kapell, Piano. **RCA—Victor**
- BEETHOVEN**—Piano Music, Sonata No. 13, Rondo a Capriccio, Op. 129, Rondos, Op. 51 Nos. 1 & 2, Sonata No. 20, Variations on The Turkish March, Hugo Steurer, Piano. **Urania**
- CHOPIN ETUDES**—Opus 25, Trois Nouvelles Etudes, Gulomar Noraes, Piano. **Vox**
- FANTASIA—TOCCATA—CHACONNE—JOHANN SEBASTIAN BACH**—Reine Glanoff, Piano. **Westminster**

### VOCAL

- BRAMMS—LIEBESLIEDER WALTZES**—Roger Wagner, Conductor & the Roger Wagner Choral. **Capitol**
- ANCIENT MUSIC OF THE CHURCH**—William Warfield, Baritone, w. Andrew Tietjen, Organ. **Columbia**
- MENDELSSOHN—WALPURGISNACHT**—Op. 80, Netherlands Philharmonic Choir & Orchestra, Soloists, Otto Ackermann, Conductor. Five Songs—Uta Graf, Soprano. **Concert Hall Society**
- FARNABY**—Canzonets and Virginals Music, Oriana Singers, Charles M. Hobbs, Conductor. Blanche Winogron, performer on the Virginals. **EMS Recordings**
- JOSEPH HAYDN—ARIANNA A NAXOS and ENGLISH SONGS**—Jeanne Turel, Ralph Kirkpatrick. **Haydn Society**
- VERDI & PUCCINI ARIAS**—Sung by Mario del Monaco, w. Orchestra of The Accademia di Santa Cecilia, Rome, Alberto Erede, Conductor. **London**
- CHRISTMAS HYMNS & CAROLS, VOL. II**—Robert Shaw Choral. **RCA—Victor**
- ERNA BERGER**—Recital, Michael Rauehelsen, Piano, Handel, Brahms, Schubert, Mozart, R. Strauss, Debussy. **Urania**
- BUXTEHUDE**—5 Solo Cantatas for Soprano, Margot Guillaume, Marie-Luise Bechert, Conductor & Organist. **Vox**
- ITALIAN SONGS**—Magda Laszlo, Soprano, Franz Holletschek, Piano. **Westminster**

### OPERATIC

- DON CARLO** by GIUSEPPE VERDI—Caniglia, Stignani, Rossi-Lemeni, Picchi, Silveri Orchestra & Chorus Radio Italiana. Fernando Previtali, Conductor. **Cetra-Sorla**
- LA BOHEME—PUCCINI**—Carteri, Tagliavini, Orchestra & Chorus Radio Italiana, Gabriele Santina, Conductor. **Cetra-Sorla**
- L'ELISIR D'AMORE** by DONIZETTI—Noni, Valletti, Poli Bruscentini, Rizzoli Orchestra & Chorus Radio Italiana. Gavazzoni, Conductor. **Cetra-Sorla**
- MOZART—COSI FAN TUTTE**—Metropolitan Opera, Steber, Tucker, Guarerra, Theobom, Peters, Alvary, Fritz Stiedry, Conductor. **Columbia**
- der **ROSENKAVALLER—RICHARD STRAUSS**—Lemnitz, von Milinkovic, Troschel, Wurttemberg State Orchestra, Ferdinand Leitner, Conductor. **Decca**
- JUDAS MACCABAEUS—HANDEL**—University of Utah Chorus, Utah Symphony Orchestra & Soloists, Maurice Abravanel, Conductor. **Handel Society**
- PELLEAS ET MELISANDE—DEBUSSY**—Soloists & L'Orchestre De La Suisse Romande, Ernest Ansermet, Conductor. **London**
- DON PASQUALE—DONIZETTI**—la Gatta, Lazzari, Poli, Corena Orchestra & Chorus La Scala, la Rosa Parodi, Conductor. **Urania**
- L'HEURE ESPAGNOLE**—Opera in 1 Act, L'Orchestre Radio-Symphonique de Paris de la Radiodiffusion Francaise, Rene Lebowitz, Conductor. **Vox**
- DON PASQUALE—DONIZETTI**—Orchestra Vienna State Opera, Vienna Kammerchor-Dir. Reinhold Schmidt, Argeo Quadri, Conductor. **Westminster**

# A New Approach to Negative Feedback Design

N. H. CROWHURST\*

A thorough discussion of the characteristics of individual amplifier stages and their relation to the over-all performance of a feedback amplifier.

SINCE THE APPEARANCE of the author's handbook "Feedback," in which appeared for the first time some charts specially prepared to aid in working out design details, several friends and correspondents have suggested that the basis for these charts should be published. Most people find difficulty in digesting the mathematics of design, for which reason such details were deliberately left out of the handbook. How-

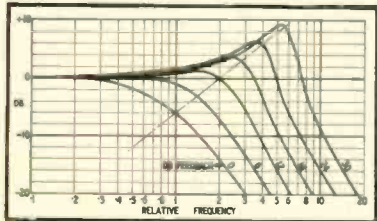

Fig. 1. Showing the effect of feedback on a feedback loop containing two identical stages. All curves plotted to the same zero reference level.

ever, further work since preparing the material in the book promises to lead to interesting new developments in the design of feedback amplifiers, and for this reason it would seem to be time to publish a little more about the method.

When a number of stages are connected into a closed loop, possibility of instability, or the consideration of frequency response of the combination, is concentrated in two principal components, contiguous with the low- and high-frequency cutoffs of the arrangement respectively. Series capacitor elements, in the interstage couplings, and any shunt inductors contribute towards the low-frequency cutoff of the complete arrangement, while the interstage shunt capacitance (to ground), and any series inductance (such as transformer leakage inductance), contribute to the high-frequency cutoff.

The simplest way to designate the characteristic of a single element producing a 6 db/octave cut-off in either direction is by its time constant, as this avoids the necessity for calculating the reactance of capacitances and inductances at different frequencies and also yields a more direct approach at a later stage. For the purposes of this treatment, each stage is assumed to possess a

single reactance causing low-frequency cutoff and a single reactance causing high-frequency cutoff. It is also assumed that no interaction occurs between the impedances of successive stages other than around the complete loop, and that there is no appreciable interaction between the components of the stage causing cutoff at the opposite ends of the frequency spectrum. Where such interaction does in fact occur, the treatment is usually only modified quantitatively, although in some cases, particularly where transformers are included in the loop, some of the time constants theoretically become complex quantities. This does not complicate matters as much as may be expected, because the necessity for actually evaluating complex time constants is avoided in this method, as will be shown later. In application, the number of equivalent stages around the loop for l.f. and h.f. cutoff representation may not always be identical.

## General Form

To pave the way for detailed treatment, the h.f. response of a single network can be represented by the expression  $1 + jx$ , where  $x = f/f_0$ , and  $f_0$  is the frequency where the shunt reactance is equal to the circuit resistance it shunts. A number of such responses combined, but not necessarily using the same  $f_0$ , can be represented, with respect to a

suitable reference frequency, by an equation,

$$D = 1 - ax^2 + bx^4 \dots + jcx - jdx^3 + jex^5 \dots \quad (1)$$

This expression represents the loss due to these couplings in both magnitude and phase. A similar expression can represent the l.f. response by using  $x = f_0/f$ .

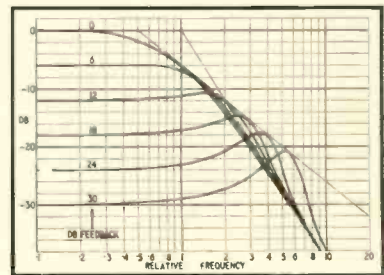

Fig. 2. The curves of Fig. 1 replotted to take loss of gain due to feedback into account. The significance of the chain dotted lines in these figures is explained in the text.

Assume now that an amplifier has a gain, where no reactances are having any effect, of  $A_m$ ; then the gain at other points will be given by

$$A = \frac{A_m}{D} \quad (2)$$

Now we introduce the well-known feedback equation, using  $A_{fm}$  to represent the gain with feedback at a frequency where no reactances are having effect,

$$A_{fm} = \frac{A_m}{1 + A_m\beta} \quad (3)$$

or at other frequencies,

$$A_f = \frac{A}{1 + A\beta} \quad (4)$$

Substituting Eq. (2) into this gives

$$A_f = \frac{A_m}{D + A_m\beta} \quad (5)$$

This can be rearranged to give the effective attenuation from mid-band gain (without feedback),

$$D_f = \frac{A_m}{A_f} = D + A_m\beta \quad (6)$$

In expression (3),  $A_m\beta$  is the loop gain (or loss, but usually greater than unity, representing a gain) and  $1 + A_m\beta$  is the feedback factor, by which gain is modi-

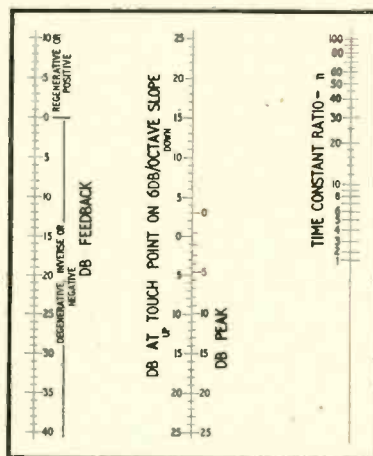

Fig. 3. An abac to aid in calculating the response of any feedback loop with two stages, using positive or negative feedback.

\* 82, Canterbury Grove, London, S.E. 27, England.



fied, as well as impedance, distortion and anything else for which feedback may be used. Writing, for the feedback factor,  $F = 1 + Am\beta$ , and substituting (1) into (6), the latter may be re-written.

$$Df = F - ax^2 + bx^4 \dots$$

$$jcx - jdx^3 + jex^5 \dots \quad (7)$$

the right side of which is identical to that of (1), except that  $F$  has been substituted for 1. This fact proves convenient in developing the expressions for various conditions.

#### Single Stage Loop

Applying this to the simple single-stage case, where the feedback loop only includes one reactance affecting cutoff at the h.f. end (or similarly for the l.f. end),

$$D = 1 + jx \quad (8)$$

and

$$Df = F + jx \quad (9)$$

In this case the 3-db loss point, which is also the frequency at which phase shift is 45 deg., occurs where the imaginary term is equal to the real term. Without feedback this is when  $x=1$ . With feedback, as shown by (9), it is when  $x=F$ . This means that for this case the frequency range is extended in direct proportion to  $F$ , the feedback factor.

#### Two-Stage Loop

Consider first the case using two couplings with identical h.f. cutoff characteristic, for which

$$D = (1 + jx)^2 = 1 - x^2 + j2x \quad (10)$$

and

$$Df = F - x^2 + j2x \quad (11)$$

Squaring both sides, and taking 10 times the logarithm to the base 10, the expression for db response becomes,

$$db = 10 \log_{10} Df^2$$

$$= 10 \log_{10} [(F - x^2)^2 + 4x^2]$$

$$= 10 \log_{10} [F^2 + (4 - 2F)x^2 + x^4] \quad (12)$$

Differentiating the term in brackets with respect to  $x$  and equating to zero will find the location of any peak in the response. This gives

$$x_p^2 = F - 2 \quad (13)$$

From this it is evident that there is no peak provided  $F < 2$ , or 6 db feedback. For values of  $F$  greater than 2, the square root of expression (13) gives the frequency of peak in terms of the original cutoff frequency of each network as reference. Peak height is given by substituting (3) and (13) into (12),

$$db_p = 10 \log_{10} \frac{F^2}{Df^2}$$

$$= 10 \log_{10} \frac{F^2}{4(F-1)} \quad (14)$$

For large values of feedback, this approaches  $10 \log_{10} (F/4)$ , which means that 2:1 increase in feedback (6 db) then raises the peak height by an additional 3 db.

Another reference of particular interest in this case is the point where the response slope is 6 db/octave. This is found by equating  $\frac{d \log Df}{d \log x} = 1$ , which

Fig. 4. Variations in response shaping possible with two-stage loops. The frequency scale is relative to the touch point on a 6 db/octave slope.

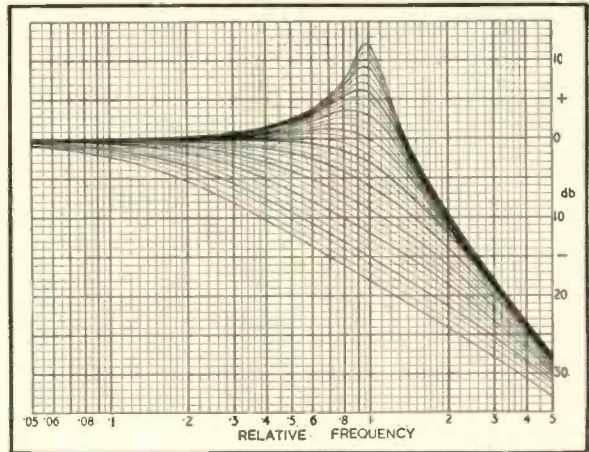

gives

$$\frac{d \log Df}{d \log x} = \frac{d 2 \log Df}{d Df^2} \times \frac{d Df^2}{dx^2} \times \frac{dx^2}{d 2 \log x}$$

$$= \frac{2x^4 - 2(F-2)x^2}{x^4 - 2(F-2)x^2 + F^2} = 1$$

which simplifies to give an expression for the 6 db/octave slope frequency,

$$x_6^2 = F \quad (15)$$

Attenuation at  $x_6$ , the 6 db/octave slope point, is given by substituting (3) and (15) into (12), giving,

$$db_6 = 10 \log_{10} \frac{F^2}{Df^2} = 10 \log_{10} \frac{4}{F} \quad (16)$$

Table I gives a comparison of responses at intervals of 6 db feedback. Positive db figures represent attenuation; negative, lift.

TABLE I

Feedback		6 db/octave pt		Peak	
db	F	$x_6^2$	$db_6$	$x_p^2$	$db_p$
0	1	1	+6	—	—
6	2	2	+3	—	—
12	4	4	0	2	-1.25
18	8	8	-3	6	-3.6
24	16	16	-6	14	-6.3
30	32	32	-9	30	-9.17

Figure 1 shows this family of curves plotted with a common zero reference level. At Fig. 2 the same curves are drawn to take into account the loss of gain due to feedback. From this it appears that the 6 db/octave slope point is always tangential to a 6 db/octave line passing through zero level at half the cutoff frequency of both circuits. On the common zero reference level presentation of Fig. 1, these points fall on a rising line of 6 db/octave slope. In Fig. 2, the ultimate cutoff is the same 12 db/octave response (also shown by a chain dotted line). These two constructions with this presentation help in visualizing how the response changes as feedback is progressively increased.

In this two-stage case, the response never becomes unstable, a condition that is indicated by infinite peak height.

The foregoing has applied to identical cutoff networks combined. In practice many other combinations can occur. It

will be assumed that one network has  $n$  times the time constant of the other. So

$$D = (1 + jx)(1 + jnx)$$

$$= 1 - nx^2 + j(n+1)x \quad (17)$$

$$\text{and } Df = F - nx^2 + j(n+1)x \quad (18)$$

and the response is

$$db = 10 \log_{10} Df^2$$

$$= 10 \log_{10} [F^2 + \{(n+1)x\}^2]$$

$$= 10 \log_{10} [F^2 - nx^2 + (n+1)^2 x^2 - 2Fn x^2 + n^2 x^4] \quad (19)$$

Differentiating with respect to  $x$  and equating to zero gives

$$x_p^2 = \frac{F}{n} - \frac{(n+1)^2}{2n^2} \quad (20)$$

Substituting this, with (3), into (19) gives peak height as

$$db_p = 10 \log_{10} \frac{F^2}{Df^2} = 10 \log_{10} \times$$

$$\frac{F^2}{\left(\frac{(n+1)^2}{n} F - \frac{(n+1)^4}{4n^2}\right)} \quad (21)$$

To find the 6 db/octave slope reference point:

$$\frac{d \log Df}{d \log x} = \frac{2n^2 x^4 - [2Fn - (n+1)^2] x^2}{n^2 x^4 - [2Fn - (n+1)^2] x^2 + F^2} = 1$$

or

$$x_6^2 = \frac{F}{n} \quad (22)$$

Whence attenuation at the 6 db/octave slope point is

$$db_6 = 10 \log_{10} \frac{(n+1)^2}{nF} \quad (23)$$

From (20) it is evident that there is no peak provided

$$F < \frac{(n+1)^2}{2n}$$

Substituting this limiting value of  $F$  into (23) gives the attenuation at the 6 db/octave slope point as  $10 \log_{10} 2$ , or 3 db. The factor  $(n+1)^2/4n$  is important, because it represents the effect of staggering the time constants by the ratio  $n$  on the response shaping. For this reason terms including this factor appear in expressions (20), (21), and (23).

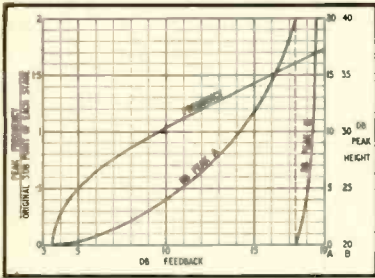

Fig. 5. Effect of negative feedback on frequency and height of peak, using a feedback loop with three identical stages.

This inter-relation between quantities using two cutoffs, as well as the inherent stability of these networks, will prove useful in designing feedback amplifiers with desired correction characteristics and rock-steady stability. Another useful fact about two-stage cutoffs is that the half-phase-shift of 90 deg. occurs at the 6 db/octave point.

Since the basic variables are so few, a simple three line abac can tell all there is to know about these networks, shown at Fig. 3. This gives, for db feedback on the left and time-constant ratio  $n$  on the right, the shape of response applicable in Fig. 4, which is plotted with the 6 db/octave slope point as reference.

This information is also applicable to the response of a.f. transformers, as appears from the fact that Fig. 4 is actually the same as Fig. 2 of the article "Making the Best of an Audio Transformer" in the January, 1953, issue. Conditions with the 6 db/octave slope point above a level of 6 db below zero level, without feedback, will be represented on the abac of Fig. 3 by points on the Time Constant Ratio scale below  $n=1$ , which is left a blank line. This region represents complementary complex time constants, but their exact value is unimportant, because the appropriate point on Fig. 3 can be used to see the effect of any degree of feedback.

To use the information in the abac for such cases, the response curve of the transformer in its associated circuit is taken, and either the height of the peak or the 6 db/octave touch point noted. For the latter, which must be used when there is no peak, the response is plotted on db/log-frequency paper, and a 6 db/octave slope is drawn touching the response curve. The attenuation below or above zero reference level at this touch point is noted and used on the chart of Fig. 3. Provision is also made on this abac for positive feedback prediction, up to 10 db. This can prove useful for eliminating the peak in the response of transformer coupled circuits, using the kind of feedback for the required impedance effect as well.

Output source impedance is reduced by negative voltage feedback, or positive current feedback. Conversely it is increased by positive voltage feedback or negative current feedback. An advantage of the positive variety of feedback in this connection is that zero or infinite impedance can be achieved quite simply with absolute stability.

### Three-Stage Loops

Taking first the case using three couplings with identical time constants:

$$D = (1 + jx)^3 = 1 - 3x^2 + j3x - jx^3 \quad (24)$$

$$Df = F - 3x^2 + j3x - jx^3 \quad (25)$$

$$db = 10 \log_{10} Df^2 = 10 \log_{10} \times [F^2 + (9 - 6F)x^2 + 3x^4 + x^6] \quad (26)$$

$$x_{p^2} = \sqrt{2(F-1)} - 1 \quad (27)$$

(only real root)

$$db_p = 10 \log_{10} \left[ \frac{F^2}{(F-1)[F+7-4\sqrt{2(F-1)}]} \right] \quad (28)$$

With three-stage networks there is a stability limit to  $F$ , so there are two boundary conditions of interest: (a) the point at which peaking commences, and (b) the point where instability commences. The former occurs in h.f. cutoffs where the peak frequency passes through zero, before becoming imaginary. For l.f. cutoffs the peak frequency passes through infinity (i.e.  $x_p = 0$  in either case). From (27) this is at  $F = 1.5$ , or 3.522 db feedback. The latter boundary occurs at a point where  $Df$

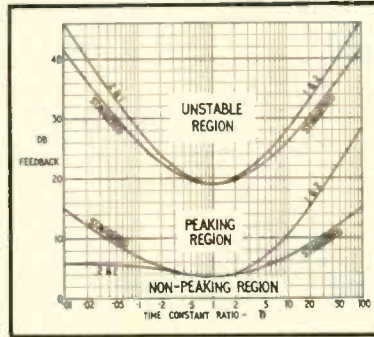

Fig. 6. Limit chart to aid in assessing performance of three-stage loops with non-identical time constants.

becomes zero, for which both its real and imaginary parts must be zero. Equating the imaginary part to zero finds the value of  $x^2$  at which it occurs, and then substituting this value in the real part finds the value of  $F$ . For three identical h.f. cutoffs instability occurs at  $x^2 = 3$ , or  $x = \sqrt{3}$ , and  $F = 9$ , or 19.1 db.

The half-slope point could be found by equating  $\frac{d \log Df}{d \log x} = \frac{3}{2}$ , but this does not have the same usefulness as in the two-stage case.

Turning to non-identical cases, which

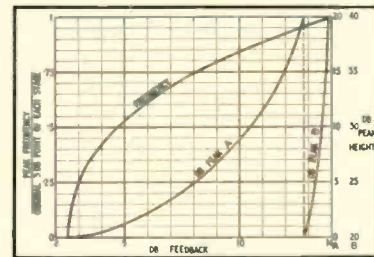

Fig. 7. Effect of negative feedback on peak frequency and height, using a feedback loop with four identical stages.

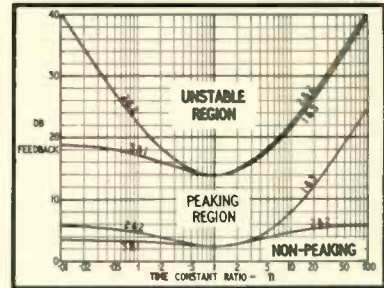

Fig. 8. Limit chart to aid in assessing performance of four-stage loops with non-identical time constants.

are necessary for practical application, the time constants can vary in more ways than where there are only two networks. Extreme possibilities can be represented by using  $n$  for the ratio between the time constants having the widest difference, and then considering (a) the case of two at one extreme and one at the other, and (b) the case of three networks geometrically staggered within this range. Every other possibility must fall between these extremes.

### One and Two

Assuming one time constant is  $n$  times each of the other two (for h.f. cases; for l.f. cases, the same formulas will apply by using  $1/n$  times the other two):

$$D = (1 + jx)^2(1 + jnx) = 1 - (2n+1)x^2 + j(2+n)x - jnx^3 \quad (29)$$

$$db = 10 \log_{10} [F^2 + \{(2+n)^2 - 2F(2n+1)\}x^2 + (2n^2+1)x^4 + n^2x^6] \quad (30)$$

Here it is evident that the peaking boundary can be found by equating the  $x^2$  coefficient to zero, or

$$F_p = \frac{(2+n)^2}{2(2n+1)} \quad (31)$$

As before the boundary for stability is found by equating both parts of  $Df$  to zero, giving

$$x_{s^2} = \frac{2+n}{n} \quad \text{and} \quad F_s = \frac{(2+n)(2n+1)}{n} = \frac{2n^2+5n+2}{n} \quad (32)$$

### Staggered

Here the extreme time constants can be assumed each to have a ratio of  $n^{1/2}$  to the central one, in opposite directions.

$$D = (1 + jn^{-1/2}x)(1 + jx)(1 + jn^{1/2}x) = 1 - (n^{-1/2} + 1 + n^{1/2})x^2 + j(n^{-1/2} + 1 + n^{1/2})x - jx^3 \quad (33)$$

$$Df = F - (n^{-1/2} + 1 + n^{1/2})x^2 + j(n^{-1/2} + 1 + n^{1/2})x - jx^3 \quad (34)$$

$$db = 10 \log_{10} [F^2 + \{(n^{-1/2} + 1 + n^{1/2})^2 - 2F(n^{-1/2} + 1 + n^{1/2})\}x^2 + (n^{-1/2} + 1 + n^{1/2})x^4 + x^6] \quad (35)$$

The peaking boundary occurs where the  $x^2$  coefficient is zero, or

$$F_p = \frac{n^{-1/2} + 1 + n^{1/2}}{2} \quad (36)$$



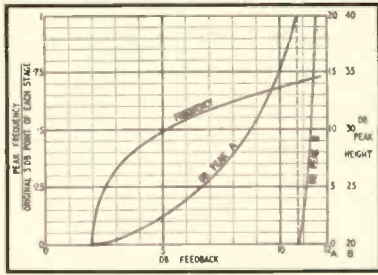

Fig. 9. Effect of negative feedback on peak frequency and height, using a feedback loop with five identical stages.

and stability boundary where both parts of  $D_I=0$ , or

$$x_s^2 = n^{-1/2} + 1 + n^{1/2} \quad \text{and} \quad F_s = (n^{-1/2} + 1 + n^{1/2})^2 \quad (37)$$

For three-stage networks, Fig. 5 shows a plot of expressions (27) and (28) for identical networks, and Fig. 6 a plot of expressions (31), (32), (36), and (37) for non-identical loops. Figure 5 gives an idea of the rate at which transition from one boundary to the other occurs, while Fig. 6 shows the boundaries for limiting cases, using a maximum time constant ratio of  $n$ . Fractional values of  $n$  mean that the two similar time-constant cutoffs come into action before the remaining one, and vice versa with values greater than unity. With the staggered arrangement the curves are obviously symmetrical for both boundaries. For the stability boundary they are both symmetrical, but the one and two arrangement gives the highest peaking boundary for values of  $n$  greater than unity, that is, when one network introduces cutoff acting nearer the pass range than the other two.

#### Four Stage Loops

Taking first the case using four couplings with identical time constants:

$$D = (1 + jx)^4 = 1 - 6x^2 + x^4 + j4x - j4x^3 \quad (38)$$

$$D_I = F - 6x^2 + x^4 + j4x - j4x^3 \quad (39)$$

$$db = 10 \log_{10} [F^2 + (16 - 12F)x^2 + (4 + 2F)x^4 + 4x^6 + x^8] \quad (40)$$

To find the peak conditions, the expression in square brackets is differentiated with respect to  $x^2$  and equated to zero, leading to the expression,

$$x^6 + 3x^4 + 2x^2 + 4 = F(3 - x^2).$$

This is a cubic equation in  $x^2$ . To plot the frequency of peak, it is simpler to take the frequency as independent variable and then find corresponding values of  $F$  from,

$$F = \frac{x^6 + 3x^4 + 2x^2 + 4}{3 - x^2} \quad (41)$$

To know the limits between which to plot, the value of  $x^2$  producing instability is  $x_s^2=1$ , and as before, peaking commences at  $x^2=0$ .

To find the height of the peak, still using  $x$  as independent variable, values of  $F$  from (41) are substituted into (40). The results are plotted in Fig. 7, using  $F$  as the common variable for convenience.

The peaking boundary is  $F_p=4/3$ , or 2.5 db feedback, and the stability boundary is given by equating both parts of (39) to zero, whence,

$$x_s = 1 \quad \text{and} \quad F_s = 5, \quad \text{or 14 db feedback} \quad (42)$$

For arrangements other than identical, still greater range is possible than for the three-stage case, but it is obvious that any staggered arrangement will not give such good possibilities as an arrangement using networks each of which is at one or other limit of the time-constant range, so such limits only need be considered. This reduces the number of possibilities to be presented to two.

#### One and Three

Assuming one time constant is  $n$  times each of the other three,

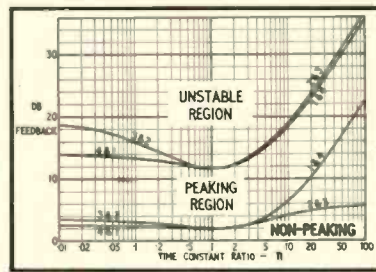

Fig. 10. Limit chart to aid in assessing performance of five-stage loops with non-identical time constants.

$$D = (1 + jx)^3(1 + jnx) = 1 - 3(1 + n)x^2 + nx^4 + j(3 + n)x - j(3n + 1)x^3 \quad (43)$$

$$D_I = F - 3(1 + n)x^2 + nx^4 + j(3 + n)x - j(3n + 1)x^3 \quad (44)$$

$$db = 10 \log_{10} [F^2 + \{(n+3)\}x^2 - 6F(n+1)\}x^4 + \{3n^2 - 2n + 3 + 2nF\}x^4 + (3n^2 + 1)x^4 + n^2x^8] \quad (45)$$

Although it contains a negative term, the whole  $x^4$  coefficient can never be negative, so the only possibility of a peak is when the  $x^2$  coefficient is negative, whence the peaking boundary, as before, occurs when the  $x^2$  coefficient is zero, or

$$F_p = \frac{(n+3)^2}{6(n+1)} \quad (46)$$

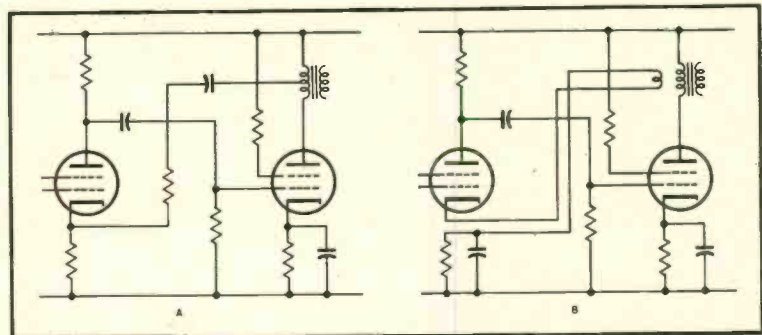

Fig. 12. Practical types of circuit for two-stage loops with ample feedback. These can be applied equally well to push-pull circuits, but are shown single-ended for simplicity.

and the stability boundary is given by equating both parts of (43) to zero, whence,

$$x_s^2 = \frac{n+3}{3n+1}$$

$$\text{and } F_s = \frac{(n+3)(8n^2+9n+3)}{(3n+1)^2} \quad (47)$$

#### Two and Two

Assuming two pairs of identical time constants, of ratio  $n$  between pairs,

$$D = (1 + jx)^2(1 + jnx)^2 = 1 - (n^2 + 4n + 1)x^2 + n^2x^4 + j2x(n+1)(1 - nx^2) \quad (48)$$

$$D_I = F - (n^2 + 4n + 1)x^2 + n^2x^4 + j2x(n+1)(1 - nx^2) \quad (49)$$

$$db = 10 \log_{10} [F^2 + \{4(n+1)\}x^2 - 2(n^2 + 4n + 1)F\}x^4 + \{2n^2F + (n^2 + 1)\}x^4 + 2n^2(n^2 + 1)x^6 + n^4x^8] \quad (50)$$

The only possibility of a peak is when the  $x^2$  coefficient is negative, so the peaking boundary is found by equating this coefficient to zero, or

$$F_p = \frac{2(n+1)^2}{n^2 + 4n + 1} \quad (51)$$

and the stability boundary by

$$x_s^2 = \frac{1}{n} \quad \text{and} \quad F_s = n + 3 + \frac{1}{n} \quad (52)$$

Curves of expressions (46), (47), (51), and (52) are plotted in Fig. 8. Naturally the two-pairs arrangements has symmetrical curves. The 3-and-1 combination (three acting before one) has lower boundaries than any other

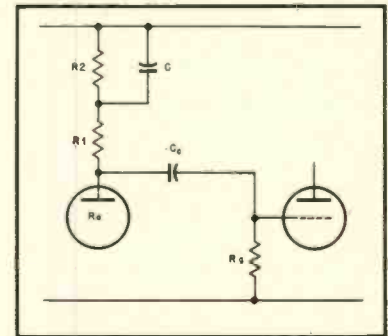

Fig. 11. This form of step circuit is often used in long over-all loops with large feedback, to aid in obtaining stability.

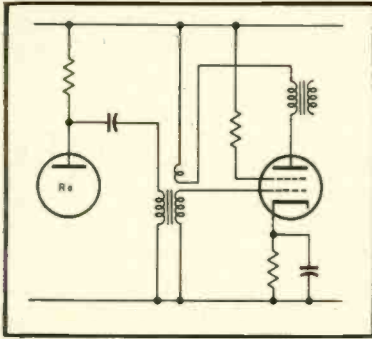

Fig. 13. This is a useful circuit for obtaining positive current feedback. With the cooperation of transformer manufacturers, it should feature in future amplifier circuits.

combination (three acting before one) has lower boundaries than any other combination of four cutoffs, and so is not of practical value unless instability is sought. Notice here that, though the two-and-two arrangement only approaches 6 db feedback before peaking occurs, however large  $n$  is made, so the one-and-three arrangement is better for minimizing peaking, the two-and-two arrangement is slightly better for its stability margin. The lesson here would seem to be that at least two of the networks should be removed beyond the range by a factor  $n$ , and the other two may have one at the nearer limit, and one somewhere between the first and second time-constant limits, dependent upon whether exact shape of response or margin of stability is regarded as the more important factor in design.

#### Five-Stage Loops

Taking first the case using networks with identical time constants:

$$D = (1 + jx)^5 = 1 - 10x^2 + 5x^4 + j5x - j10x^3 + jx^5 \quad (53)$$

$$D_I = F - 10x^2 + 5x^4 + jx - j10x^3 + jx^5 \quad (54)$$

$$db = 10 \log_{10} [F^2 + (25 - 20F)x^2 + 10Fx^4 + 10x^6 + 5x^8 + x^{10}] \quad (55)$$

The peaking boundary is given by equating the  $x^2$  coefficient to zero, or  $F = 5/4$ , that is 1.938 db.

Using the same method as for four-stage loops for relating feedback to peak frequency, and height,

$$F = \frac{x^8 + 4x^6 + 6x^4 + 5}{4(1 - x^2)} \quad (56)$$

The stability boundary is given by taking the lowest root obtained by equating the imaginary part of (54) to zero, this giving the first phase reversal in the transfer characteristic,

$$x^2 = 5 - 2\sqrt{5} = 0.528 \text{ approx.}$$

or

$$x^2 = 0.7266 \text{ approx.}$$

and

$$F_0 = 80\sqrt{5} - 175 = 3.885 \text{ approx. or } 11.8 \text{ db} \quad (57)$$

whence it is evident that  $x_p$  must be plotted between zero and 0.7266 in (56) to find values of  $F$ . Substituting these values into (55) gives the height of peak

to correspond. Figure 9 shows these results.

Again taking two possibilities for the non-identical networks:

#### One and Four

Assume one network has a time constant  $n$  times the other four:

$$D = (1 + jx)^4(1 + jnx) = 1 - 2(3 + 2n)x^2 + (1 + 4n)x^4 + j(4 + n)x - j2(2 + 3n)x^3 + jnx^5 \quad (58)$$

$$D_I = F - 2(3 + 2n)x^2 + (1 + 4n)x^4 + j(4 + n)x - j2(2 + 3n)x^3 + jnx^5 \quad (59)$$

$$db = 10 \log_{10} [F^2 + \{(4 + n)^2 - 4(3 + 2n)F\}x^2 + \{4(n - 1)^2 + 2F(1 + 4n)\}x^4 + 6n^2x^6 + (1 + 4n^2)x^8 + n^2x^{10}] \quad (60)$$

From which the peaking boundary is given by

$$F_p = \frac{(4 + n)^2}{4(3 + 2n)} \quad (61)$$

and the stability boundary by

$$x^2 = 3 + \frac{2}{n} - 2\sqrt{2 + \frac{2}{n} + \frac{1}{n^2}}$$

and

$$F_0 = 8 \left( 5n + 4 + \frac{1}{n} \right) \sqrt{2 + \frac{2}{n} + \frac{1}{n^2}} - \left( 56n + 71 + \frac{40}{n} + \frac{8}{n^2} \right) \quad (62)$$

#### Two and Three

Assume two networks each have a time constant  $n$  times that of the other three:

$$D = (1 + jx)^2(1 + jnx)^3 = 1 - (3 + 6n + n^2)x^2 + (2n + 3n^2)x^4 + j(3 + 2n)x - j(1 + 6n + 3n^2)x^3 + jn^2x^5 \quad (63)$$

$$D_I = F - (3 + 6n + n^2)x^2 + (2n + 3n^2)x^4 + j(3 + 2n)x - j(1 + 6n + 3n^2)x^3 + jn^2x^5 \quad (64)$$

$$db = 10 \log_{10} [F^2 + \{(3 + 2n)^2 - 2(3 + 6n + n^2)F\}x^2 + \{3(3 - 4n + n^2) + 2(2n + 3n^2)F\}x^4 + (1 + 6n^2 + 3n^4)x^6 + (2n^2 + 3n^4)x^8 + n^2x^{10}] \quad (65)$$

From which the peaking boundary is given by

$$F_p = \frac{(3 + 2n)^2}{2(3 + 6n + n^2)} \quad (66)$$

and the stability boundary by

$$x^2 = \frac{3}{2} + \frac{3}{n} + \frac{1}{2n^2}$$

$$- \sqrt{\frac{9n^2}{4} + 7n + \frac{15}{2} + \frac{3}{n} + \frac{1}{4n^2}}$$

and

$$F_0 = \left( 8n + 18 + \frac{12}{n} + \frac{2}{n^2} \right) \times$$

$$\sqrt{\frac{9n^2}{4} + 7n + \frac{15}{2} + \frac{3}{n} + \frac{1}{4n^2}}$$

$$- \left( 12n^2 + 45n + 63 + \frac{42}{n} + \frac{12}{n^2} + \frac{1}{n^3} \right) \quad (67)$$

Curves of expressions (61), (62), (66), and (67) are plotted in Fig. 10, for values from .01 to 100, as in the other cases. Conclusions to be drawn from this are that three of the networks should

have time constants to remove their cutoffs well beyond the frequency range, by a ratio  $n$ , while the remaining two may be adjusted according to the frequency response and margin of stability required.

#### Step Networks

Figure 11 shows a popular type of circuit often included in an over-all feedback loop to improve stability with large amounts of feedback. The same circuit may be applied for instability at either end of the response, using values suitable for the application. To apply this network in relation to the data here given, the simplest way is to regard the circuit as a synthesis of two time constants. The effect of one of these is inverted and would, if exactly equal to another somewhere else in the loop, cancel its effect, leaving the remaining time constant of the step circuit, operative at a higher frequency, in its place. The advantage of this method for improving h.f. stability is that less gain has to be sacrificed over the pass band in order to get the required time constant relationships, the effective plate coupling being  $R_1 + R_2$  instead of just  $R_1$ . Applied for l.f. stability, one cutoff is brought into the pass band, but its effect is offset by the feedback; this saves the necessity for unduly large capacitors to obtain the time constants needed by the straight circuits.

#### Margin of Stability

It is often not appreciated that input and output impedances interact with the feedback in over-all feedback loop amplifiers. For example, where negative voltage feedback is used, the amount of feedback increases as the load impedance is raised. Similarly at the input end, where an input transformer is used particularly, the amount of feedback occurring at high frequencies will influence the response of the transformer, by modifying the impedance it "looks into" (This is assuming that the transformer itself does not form part of the feedback loop, i.e. feedback is injected in the grid circuit). This accounts for the fact that amplifiers with wonderful characteristics often exhibit unpleasant peaky effects when connected to certain

(Continued on page 53)

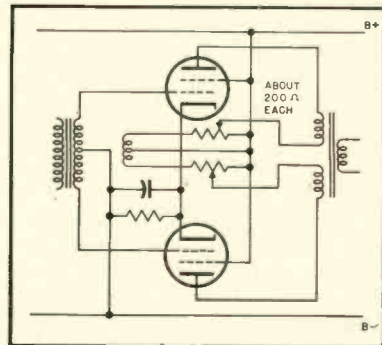

Fig. 14. Method of obtaining adjustment of positive current feedback, using the basic circuit of Fig. 13 in push-pull arrangement.



# Loudness Contour Selector in New Amplifier

L. H. BOGEN\* and ALFRED M. ZUCKERMAN\*

A description of a new commercially built amplifier which introduces a new approach to the loudness-control problem.

**A** FEW YEARS AGO, one of the pundits of audio engineering remarked that, developments having reached their then present stage, what was needed least was to hear about a new amplifier. The remark was intended not as a slur against amplifiers but rather to point out that their design had already surpassed that of other components of the system and that the attention of the trade should be directed toward new loudspeakers and phonograph pickups.

While new developments and improvements have subsequently appeared in these other audio system components, amplifier design has not been static. The evolution in amplifiers has taken two directions—one, a constant striving toward an improvement in quality at the same or lower cost, and the other, the incorporation of new features and controls which make the amplifier a more flexible unit.

Both of these trends have been examined in the design of the new Bogen 20-watt high-fidelity amplifier, model DB20, which is intended to fulfill the need for a moderately priced high-performance model. It gives excellent results and incorporates a relatively simple yet effective set of tone and loudness controls, including a new approach to the latter problem, which we have called the Loudness Contour Selector.

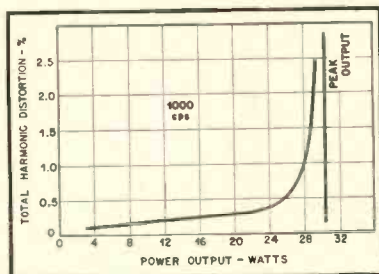

Fig. 1. Power output vs. harmonic distortion of DB20 amplifier.

In approaching the question of economy in the design of the DB20, we have further explored the territory pioneered by Williamson. One interesting source of information on the subject is a recent

\* David Bogen Company, Inc., 29 Ninth Ave., New York 14, N. Y.

External appearance of new single-chassis amplifier which incorporates a number of novel features.



article<sup>1</sup> in which the merits of the Williamson circuit compared with several others are discussed. (For those with a taste for the ironic, Mr. W.'s dismayed reactions to the claims advanced by others for the Williamson and the so-called "improvements" thereto should prove amusing.) One of his major points was that the Williamson circuit was designed with efficiency in mind because of the relatively high cost of power in Great Britain. Comparisons given in the article indicate, for example, that on the basis of considerations other than efficiency, the circuit configuration featuring low- $\mu$  triodes, also popular in this country, compares favorably with the Williamson circuit.

However, from the point of view of the audio enthusiast, there is good reason to consider efficiency also in amplifiers designed for use in this country. Even though electric power here is cheap, a more efficient circuit means that more economical design of the power supply is possible and hence, a less expensive amplifier can be designed with excellent characteristics.

#### Partial-Cathode-Loaded Output

For these reasons we were interested in Mr. Williamson's remarks about another circuit—that used in the

<sup>1</sup> D. T. N. Williamson and J. P. Walker, "Amplifiers and superlatives," *Wireless World*, September, 1952.

British Q. U. A. D. amplifier. The DB20 employs a circuit similar in some respects to this, which we shall call by the descriptive name, Partial-Cathode-Loaded Output. The schematic diagram of the DB20 in Fig. 3 shows the method of approach. The idea of cathode loading is not a particularly recent one, basic patents dating back to 1937.<sup>2</sup>

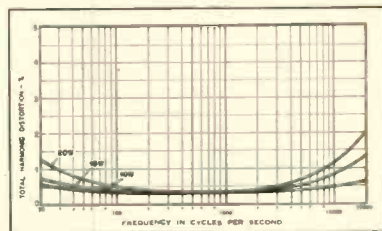

Fig. 2. Distortion vs. frequency for various power outputs.

It will be noted from the schematic that tetrodes are used with the screen connected at a point between that used in normal operation as a tetrode and the direct connection used in triode operation of the tubes. In addition, feedback is applied between the cathode and grid by means of a special winding in the output transformer. A number of experimental transformers were wound by our transformer department during the design period of the amplifier, and the one finally adopted repre-

<sup>2</sup> H. S. Black, U. S. Patent No. 2,102,671.

sents what we feel to be the best combination of quality, electrical characteristics and economy of design. It uses a two-inch stack of 1 1/4-inch "Audio A" laminations, almost the same size as would be required for amplifiers of lesser performance which might be rated at twice the power output of the DB20 and with similar distortion and damping characteristics. Figures 1 and 2 give an indication of the amplifier's performance.

**Tone and Loudness Controls**

Of late, much more attention has been paid to tone and loudness correction circuits than in previous years, when interest centered on stretching the frequency response of reproduction systems without much consideration either of program sources on the one hand, or listening conditions on the other. In the DB20, four separate sets of controls provide compensation for both external factors. They include a seven-position record equalizer, separate and continuously variable bass and treble controls, a conventional gain control, and the Loudness Contour Selector innovation.

There is still a good deal of confusion in the record-producing industry with regard to the choice of recording curves. Announced LP curves may, however, be divided into three general classes with reasonable safety. These are the

Fig. 4. Curves showing characteristics obtainable with various positions of the record selector switch.

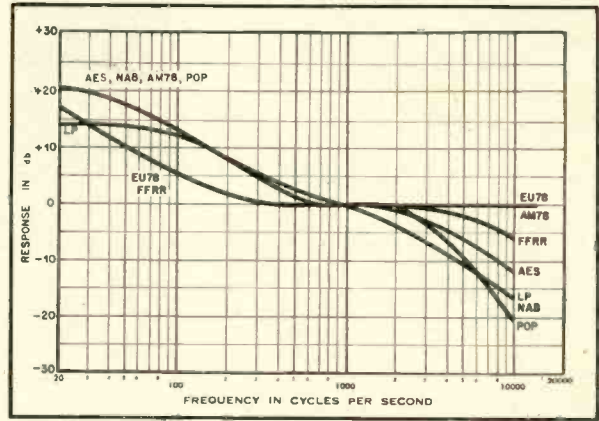

Columbia LP curve, the AES curve, and the NAB curve. The record equalization control provides positions for these three as well as four others—American 78 rpm records, European 78's, a flat response curve, and a sharp cutoff position for extremely worn or low quality popular recordings. (See Fig. 4.) These seven positions are designed to give the listener maximum flexibility in record playing by covering all of the possibilities now likely to be encountered. However, separate variable tone controls are also necessary as part of any high-quality audio amplifier for three reasons—to compensate

for the particular acoustic conditions present either in the studio or the listener's room, to compensate for deficiencies in the listener's over-all audio system and, above all, to cope with the subjective factor of the listener's taste, for no matter how good the measurements or how careful the design, it must sound good to him. (See Fig. 5.)

From the strictly scientific point of view, the quest for absolute fidelity in the equalization curve may be interesting, but the listener should reserve the right to adjust the sound output of his

(Continued on page 54)

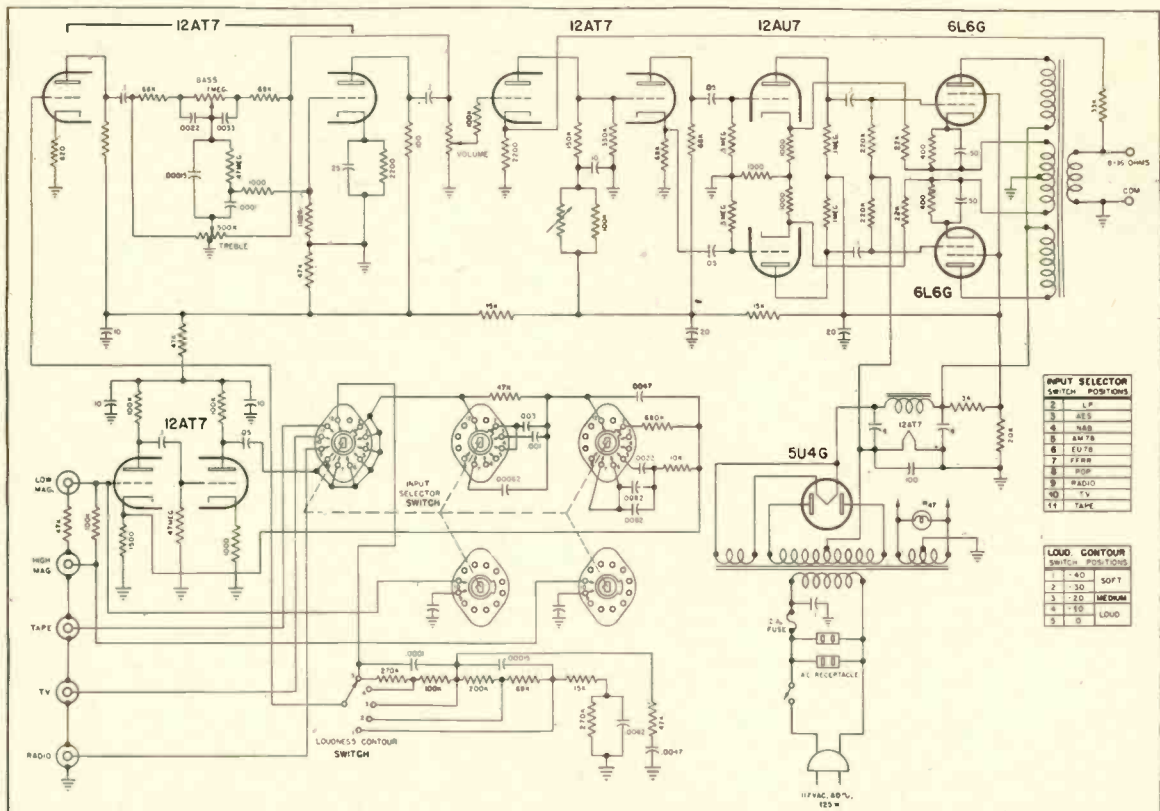

Fig. 3. Over-all schematic of Bogen DB20 amplifier.





## portrait of an engineer...

Engineers are a happy lot, until faced with a moment like this:

A recording is completed. The disc is put on the playback table . . .  
but it's full of "pops," "ticks" and "hisses".

This can easily happen in the life of any engineer, if he has not been  
discriminating in his selection of recording discs.

If this picture fits you . . . you are ready for a change in brand. And the  
wisest change is to PRESTO Green Label discs . . . because this label is your  
assurance of the smoothest lacquer surface available and  
top performance every time.



**PRESTO**  
RECORDING CORPORATION  
PARAMUS, NEW JERSEY

EXPORT DIVISION: 25 Warren Street, New York 7, N. Y.

CANADIAN DIVISION: Walter P. Downs, Ltd., Dominion Square Bldg., Montreal

WORLD'S LARGEST MANUFACTURER  
OF PRECISION  
RECORDING EQUIPMENT AND DISCS

Manufacture of a lacquer-coated disc is one of the most *exacting* of all industrial processes. It has taken PRESTO many years of chemical research and constant improvement in every phase of manufacture to produce the famous *Green Label* disc. Even after manufacture, many hundreds of discs are rejected before those are chosen to bear the respected insignia . . . PRESTO Green Label.

# Handbook of Sound Reproduction

EDGAR M. VILLCHUR\*

## Chapter 11. Loudspeaker Mounting. Part 1.

The performance of a loudspeaker is shown to be greatly dependent upon the baffle or enclosure in which it is mounted. A new method of adjusting a bass-reflex cabinet is also presented.

IF A mechanical source of power is harnessed through a coupler which makes positive and rigid contact with the load, an effective transfer of energy can be made. Almost all of the energy of a rotating shaft, for example, may be transmitted to another mechanism through a system of meshed gears. If, on the other hand, an attempt were made to couple energy from the shaft to the molecules of air surrounding it, there would be far less of a transfer because of slippage. Unless a special device were used to improve the coupling very little air would be set into motion, as a propellerless airplane engine would demonstrate. Propeller blades are needed to allow the engine to get a sufficient "bite" of the air load.

The voice coil of a loudspeaker is given its bite of the air by a cone or diaphragm and by the speaker mounting device. The purpose of the mounting device, whatever its type, is to improve the speaker-to-air coupling by enabling the cone to engage and move a larger volume of air. The cone itself is an adequate coupler at high frequencies, but is very inefficient at low frequencies.

If the mounting device is efficient in the frequency range of speaker resonance the benefits are not confined to preventing bass losses. The resonant frequency of the speaker mechanical

system is lowered because of the increase of mass created by the extra air load, and voice-coil velocity at the resonant peak is decreased by virtue of the damping effect of the air-load resistance. Air resistance reduces voice-coil excursion without loss of acoustical output, an obvious advantage from the point of view of distortion.

### The Acoustical Coupler as an Impedance Matching Device

A coupler which links a mechanical energy source with an air load may be compared to an impedance matching transformer between an electrical source and its load. When the electrical source is properly loaded down—that is, when the internal source impedance and the impedance of the load are equal—maximum power can be drained from the source. When the source and load impedances are very unequal, power transfer will be small unless coupling is achieved through an impedance matching device.

Air is a low-impedance load; it is easy to push around. In more technical language, not much pressure (voltage in the equivalent electrical circuit) is needed to create a flow of moving molecules (measured as volume velocity, and equivalent to a.c. current flow with air molecules substituted for electrons).

A loudspeaker mechanical system is a high-impedance source. This sort of description is more familiar to most readers as applying to an electrical source, one with relatively high terminal voltage and low current capacity. But

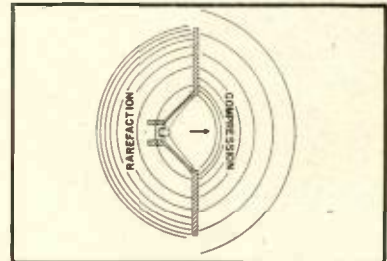

Fig. 11—2. The loudspeaker baffle, preventing interflow of air currents between compressed and rarefied areas at front and back.

the description may be used equally well for a mechanical device like a loudspeaker, which supplies a large amount of driving force but limited excursion, which is to say limited velocity. The relationship between force and velocity is directly analogous to the relationship between voltage and current in the electrical source.

In order that a large amount of electrical energy be accepted by a low-impedance load, large current flow is necessary, and if the electrical source has a high internal impedance a matching step-down transformer will be required. In order that a large amount of acoustical energy be radiated into air the volume velocity of the molecules must be high.

\* Contributing Editor, AUDIO ENGINEERING.

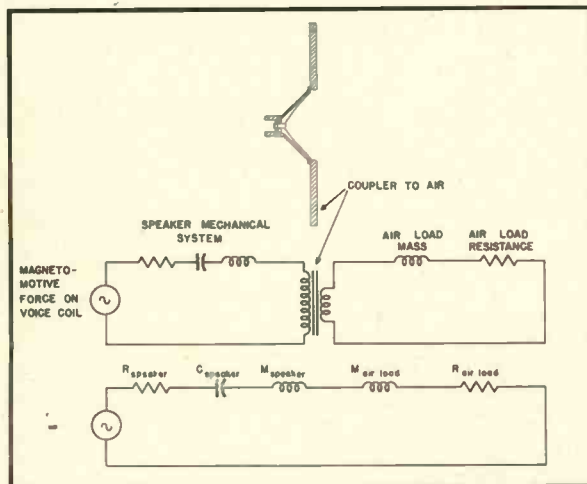

Fig. 11—1. Device coupling loudspeaker to air load, and electrical analogy.

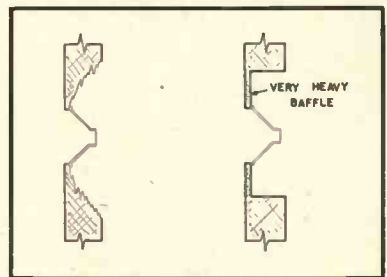

Fig. 11—3. Two methods of mounting a speaker in a wall.

The amount of energy transferred to the moving molecules of a given medium can be increased in two ways, by greater molecular displacement per cycle, or by displacement of a larger number of molecules. Since the excursion of a speaker cone is limited by its internal design it is necessary to make maximum use of the second method in imparting energy to the air. The more air that can be coupled to the speaker the more efficient the mechanico-acoustical con-



**IT MAKES Good Sound... AND Good Sense, TOO**

You buy good records so you can enjoy good sound. You fondle these records, and handle them ever so gently, because you know that once the surfaces are marred, the quality will be gone to you forever.

You must realize then, that your record changer becomes an all-important factor in the matter of record quality. It must treat with your records even more gently than you could yourself, and it must contribute nothing which might impair the quality of the sound. Its tone arm must track at

light stylus pressures and with free lateral compliance to protect the groove walls from wear.

Its speed must be constant for correctness of pitch, and to avoid 'wow'. It must be free from rumble, and from audible resonances. It must retain and reproduce all of the quality in the record, protect it for future plays, and it must contribute no distortions of its own.

In the light of these requirements, examine the features of the COLLARO, and see if they don't meet all the exacting specifications that make this

**The High Fidelity Record Changer for High Fidelity Reproduction**

- Model 3/522—Fully Automatic Intermix Model  
List Price.....\$65.00
- Model 3/521—Fully Automatic Non-Intermix Model  
List Price..... 54.50
- Record Changer Base —  
Wood, Mahogany Finish,  
Heavy Construction.  
List Price ..... 9.50



**ONLY THE Collaro INTERMIX 3/522 HAS ALL THESE HIGH FIDELITY FEATURES:**

- Intermixes 10 and 12 inch Records at All Speeds.
- Steady, Constant Speeds—No Rumble or Wow.
- Weighted, Rubber-matted, Rim-driven Turntable.
- Four Pole Motor with Self-aligning Oilite Bearings.
- No Hum Pickup.
- Molded Rubber Drives—No Belts to Slip or Replace.
- Automatic Muting Switch.
- Stylus Pressure Adjustment—Tracks at as little as 3 grams.
- Absolutely Jam-proof Operation.
- Ball-bearing Mounted Turntable and Tone Arm.
- Automatic Shut-off after Last Record.
- Tone Arm Clamp for Portable Applications.
- Base Dimensions: 14 1/4" x 12 1/4"
- Depth Below Base: 2 1/2"

Complete Service and Replacement Facilities Maintained for your Convenience.



Record Player 3 Speed Model 3/514 List Price \$33.60

Model 3/522

Collaro

*Fully Automatic* INTERMIX

3-SPEED RECORD CHANGER

FOR 7, 10, AND 12 INCH RECORDS

At Leading Distributors, or Write for Literature

**ROCKBAR CORPORATION**  
211 EAST 37th STREET • NEW YORK 16, N. Y.

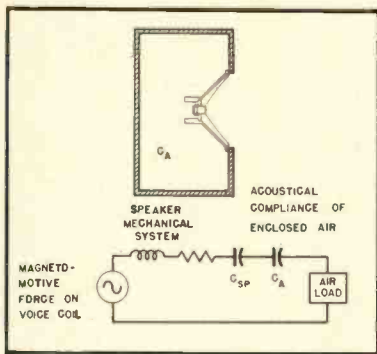

Fig. 11-4. Totally enclosed cabinet, and electrical analogy.

version will be, and the less will be the voice-coil excursion required for the same acoustical volume velocity.

A device which makes the speaker move an increased amount of air allows energy in the form of high volume velocity to be drawn from a source with limited velocity, and can therefore be called an impedance-matching acoustical transformer.

The air load may be incorporated into the analogous electrical circuit of the speaker mechanical system in two steps, as in Fig. 11-1, first showing the acoustical coupler as an electrical transformer, and then directly inserting the impedance reflected back into the circuit by the air load.

#### The Plane Baffle

A "doublet" source of sound consists of two adjacent (infinitesimally close) point sources, each radiating out of phase with the other. It is evident that not much total sound will be radiated from such a source, because rarefactions created by one half will be filled by the compressed air created by the other half, and vice versa. To increase the efficiency of the doublet it is necessary to insert a partition between the two halves to prevent the interflow of air currents.

A direct-radiator loudspeaker in free space acts as a doublet at low frequencies, when the cone itself is an inadequate separator between front and back. Air compressed by the front of the cone,

instead of working against the air of the room, leaks around the speaker edges to fill in the vacuum at the back. When the speaker is mounted on a baffle, however, as in Fig. 11-2, this leakage is prevented. Since the front of the cone can now work only on the air ahead of it, coupling between the cone and the air of the room is considerably improved, and the back of the cone receives an equal increase of air load.

Most plane baffles are not so large as to prevent all interaction between front and back. When the path between the front and back of the speaker is slightly less than one-half the wavelength of the frequency being reproduced destructive interference sets in. From this point on, output of the system falls off as the frequency is lowered at the rate of 6 db per octave in terms of pressure, assuming no speaker deficiency.

The required dimensions of a baffle for efficient acoustical coupling down

of phase with the front wave when the path distance is equal to one wave length. A very pronounced dip in output will therefore occur at the frequency whose wavelength is equal to the baffle diameter. Mounting the speaker asymmetrically in the baffle provides many paths of varying lengths at which such cancellation will occur, spreading out and effectively neutralizing the dip. Asymmetrical positioning of the speaker is only called for when there is a free acoustical path from front to back.

#### The Infinite Baffle

If the plane baffle is so large that all significant interplay between front and back is prevented it is called an infinite baffle. The effect of such a baffle may be achieved in practice by mounting a speaker in the wall of a room, a stairwell, or the door of a large closet (the clothes do not have to be taken out). Except for the architectural inconveniences involved this is a simple and ex-

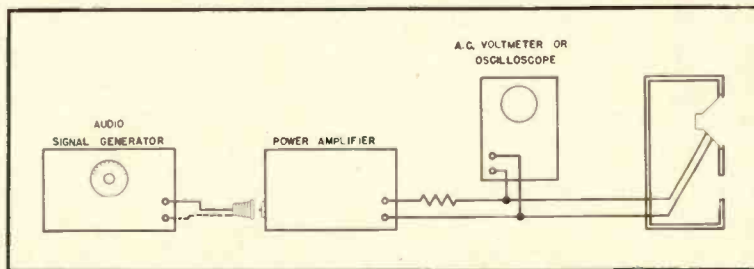

Fig. 11-6. Signal generator method of tuning a bass-reflex cabinet, or of determining the resonant frequency and  $Q$  of any speaker system.

to a given frequency may be calculated easily. First we find the wavelength of the desired cut-off frequency, which is equal to the speed of sound in air (about 1100 feet per second) divided by the frequency. The necessary baffle diameter will be approximately half of this wave length. A baffle with a diameter of  $5\frac{1}{2}$  ft., for example, will cause low-frequency droop to set in at about 100 cps, and the output of a perfect speaker, in dynes/cm<sup>2</sup>, will be down 6 db at about 50 cps.

Sound radiated from the back of the speaker will reach the front exactly out

cellent system of speaker baffling. The roll-off effect of the plane baffle is no longer present, the low-frequency roll-off point being determined by the resonant frequency of the speaker as mounted. Since the infinite baffle does not decouple the speaker from the air load at low frequencies, as a plane baffle of limited dimensions would, the benefits of the air load in lowering the speaker's resonant frequency and in damping voice-coil excursion in the low range are fully applied. The nature of the materials and of the air spaces involved are usually such that these benefits are procured without any new resonances being introduced into the system.

Care must be taken to see that the speaker does not face, either forward or backward, into a long pipe-like enclosure in which air-column resonance will be set up, or the column will itself tend to "speak" into the room when stimulated at its resonant frequency. Figure 11-3 illustrates two methods of mounting a loudspeaker in a wall. Although the pipe length formed by the thickness of the wall remains, not much sound will be reflected from the open end, as the impedance discontinuity between the large opening and the outside air is relatively small. The speaker should be anchored solidly to architectural members or to as heavy and solid a baffle as possible.

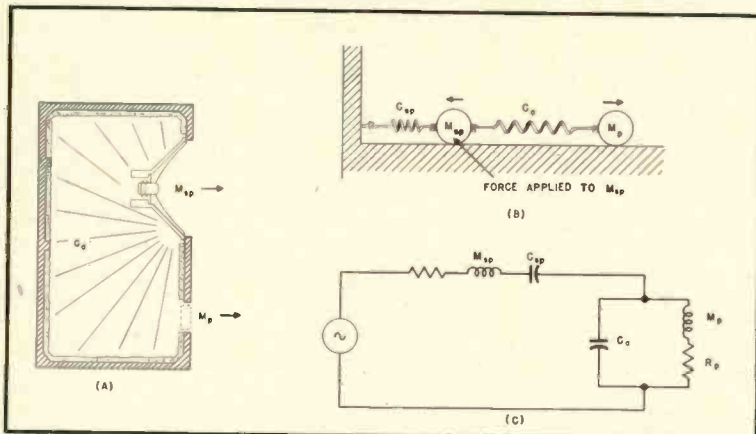
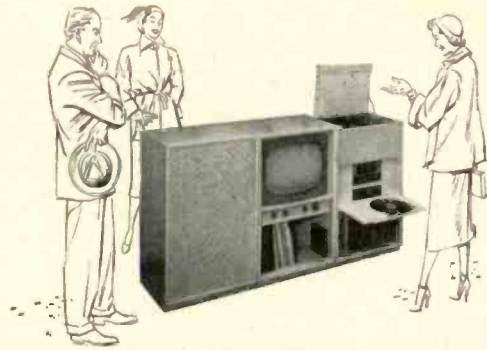

Fig. 11-5. (A) Bass-reflex cabinet; (B) Mechanical analogy to speaker—Helmholtz resonator system; (C) Electrical analogy. The elements representing mass and resistance include the air load on the front of the cone and port.





Here's where you can  
hear for yourself  
the superb musical perfection of  
**STROMBERG-CARLSON**  
*Custom Four Hundred*  
Hi-Fi Equipment

**LIST OF ALL DEALERS • ALPHABETICALLY BY STATES**

Montgomery, Ala., Nolin-McInnis, Inc.

Phoenix, Ariz., Ra-Tone Electronics  
Tucson, Ariz., Elliott Electronics, Inc.

Berkeley, Calif., Art Music Co.  
Fresno, Calif., Tingey Co.  
Hollywood, Calif., Hollywood Electronics  
Long Beach, Calif., K-T Electronics  
Los Angeles, Calif., Birkel-Richardson Co.  
Los Angeles, Calif., Electronic Engineering Co.  
Los Angeles, Calif., Hannon Engineering Co.  
San Diego, Calif., Music Service, Inc.  
San Francisco, Calif., Hale Bros.  
San Francisco, Calif., Monson Electric Co.  
Ventura, Calif., L. A. Snow

Denver, Colo., Associated Radio, Inc.  
Denver, Colo., Electronic Network  
Pueblo, Colo., L. B. Walker Radio Co.

Hartford, Conn., G. Fox Co.

Marshalltown, Del., Merritt-Armour  
Washington, D.C., Capitol Radio Wholesalers, Inc.  
Washington, D.C., Customcraft Radio TV Corp.  
Washington, D.C., Record Loft Custom Phonograph Corp.  
Washington, D.C., Shrader Manufacturing Co.

Jacksonville, Fla., Southern Distributors  
Jacksonville, Fla., Southwest Audio Co.  
Miami, Fla., Flagler Radio Co., Inc.  
Orlando, Fla., Miller Radio Co.  
Palm Beach, Fla., Salon of Music  
Pensacola, Fla., Grice Radio & Electronic Supplies  
Tampa, Fla., Burdett Reording & Sound Co.

Atlanta, Ga., Schiffer Distributing Co.  
Atlanta, Ga., Southeastern Radio Parts Co.  
Augusta, Ga., J. A. Gwin Sound Service  
Columbus, Ga., Radio Sales & Service Co.

Honolulu, T.H., Pacific Recording Co., Ltd.

Chicago, Ill., Allied Radio Corp.  
Chicago, Ill., Audio Arts Associates  
Chicago, Ill., Lyon & Healy, Inc.  
Chicago, Ill., Newark Electric Co.  
Chicago, Ill., Tri-Par Sound Systems, Inc.  
Chicago Heights, Ill., Voice & Vision, Inc.  
Chicago Heights, Ill., Hahn & Coe  
Peoria, Ill., Charley Kahler  
Quincy, Ill., Gates Radio Co.  
Rockford, Ill., Elmquist & Newburgh  
Springfield, Ill., Parsh Electronics

Indianapolis, Ind., Graham Electronics Supply, Inc.  
Lafayette, Ind., Lafayette Radio Supply, Inc.  
(Branch of Graham)  
Muncie, Ind., Seward B. Price  
Terre Haute, Ind., Midwest Radio & Supply Co.  
Valparaiso, Ind., Casbon Electric Co.

Davenport, Ia., Midwest-Timmerman Co.  
Des Moines, Ia., Gifford-Brown, Inc.

Wichita, Kans., Bennett Music House

Ashland, Ky., Better Home Appliances  
Louisville, Ky., Peerless Electronic Equipment Corp.

New Orleans, La., Custom Electronics, Inc.  
New Orleans, La., Radio Parts, Inc.  
Shreveport, La., Interstate Electric Co.

Auburn, Me., Radio Supply Co., Inc.

Baltimore, Md., Henry O. Berman Co., Inc.

Boston, Mass., DeMambo Sound Equipment Co.  
Boston, Mass., Radio Wire Television, Inc.  
(Branch of N.Y.)  
Springfield, Mass., Soundco Electronic Supply Co.

Battle Creek, Mich., Electronic Supply Corp.  
Detroit, Mich., Michigan Music Co., Inc.  
Detroit, Mich., C. A. Nutting Co.  
Grand Rapids, Mich., J & J Music Shoppe, Inc.  
Saginaw, Mich., Radio Center

Minneapolis, Minn., Background Music, Inc.  
Minneapolis, Minn., Harry Stark's, Inc.  
St. Paul, Minn., Hall Electric Co.

Jackson, Miss., Southern Distributors, Inc.

Kansas City, Mo., Engineered Sound  
Communications Co.  
St. Louis, Mo., Aeolian Co. of Missouri  
St. Louis, Mo., J. C. Gordon Co.  
St. Louis, Mo., King Radio Co.  
St. Louis, Mo., Lutz Radio & Television Co.

Billings, Mont., J. M. Hamilton Radio & Sound  
Engineering

Lincoln, Nebr., Program Service Co.  
Omaha, Nebr., Hi-Fidelity House (Branch Program)  
Omaha Nebr., J-B Distributing Co.  
Scottsbluff, Nebr., Joachim Radio Supply, Inc.

Las Vegas, Nev., Metcalf's Radio Supply  
Reno, Nev., Barnes Radio Service

Manchester, N. H., DeMambo Radio Supply Co., Inc.

Atlantic City, N. J., Almo Radio Co.  
Montclair, N. J., Perdue Radio Co., Inc.  
Newark, N. J., Continental Sales Co., Inc.  
Newark, N. J., Radio Wire Television, Inc.  
(Branch of N. Y.)

Paterson, N. J., Brey Electronics  
Phillipsburg, N. J., Carl B. Williams Co.  
Red Bank, N. J., Monmouth Radio Supply Co.

Albuquerque, N. Mex., Sound Engineering &  
Equipment Co.  
Roswell, N. Mex., Supreme Radio Supply

Albany, N. Y., Edwin E. Taylor Co.  
Batavia, N. Y., Bill Bird's Music Store  
Buffalo, N. Y., Music House  
Buffalo, N. Y., Radio Equipment Corp.  
Corning, N. Y., Fribley Radio Service  
Jamesstown, N. Y., Warren Radio Inc. (Branch Erie)  
Nelliston, N. Y., The Music Shop  
New York, N. Y., Harvey's Radio Co., Inc.  
New York, N. Y., Hudson Radio & Television Corp.  
New York, N. Y., Radio Wire Television, Inc.  
New York, N. Y., Sonocraft Corp.  
New York, N. Y., Sound Systems, Inc.  
New York, N. Y., Sun Radio & Electronic Co., Inc.  
New York, N. Y., Terminal Radio Corp.  
Port Chester, N. Y., Audio Systems, Inc.  
Rochester, N. Y., Rochester Radio Supply Co.  
Syracuse, N. Y., W. G. Brown Sound Equipment Corp.

Charlotte, N. C., Dixie Radio Supply Co.

Fargo, N. D., Wolter Electronic Co.

Akron, Ohio, Olson Radio Warehouse, Inc.  
Canton, Ohio, Hahn & Co.  
Cleveland, Ohio, Custom Classics

Cleveland, Ohio, Radio & Electronic Parts Corp.  
Cincinnati, Ohio, Oberrecht Distributing Co.  
Cincinnati, Ohio, U. S. Inter-Communication  
Systems, Inc.  
Columbus, Ohio, Universal Service  
Dayton, Ohio, Copp Radio Laboratories  
Massillon, Ohio, M. H. Martin Co.  
Mt. Vernon, Ohio, Bartlett Appliance Store  
Stuebenville, Ohio, D & R Radio Supply Co.  
Toledo, Ohio, Howard's Electronic Supply  
Youngstown, Ohio, Youngstown Television

Oklahoma City, Okla., Electronic Supply Co.  
Oklahoma City, Okla., Radio & Sound Clinic  
Tulsa, Okla., Sound Unlimited

Portland, Ore., Manchester-Chandler Co.  
Portland, Ore., United Radio Supply, Inc.

Allentown, Pa., Baker Communications  
Bethlehem, Pa., Buss Radio Electric Supply  
Erie, Pa., Warren Radio Inc.  
Harrisburg, Pa., Radio Distributing Co.  
Merion, Pa., Hi-Fidelity Electronics Sound Corp.  
Philadelphia, Pa., Almo Radio Co.  
Philadelphia, Pa., Audio Electric Co.  
Philadelphia, Pa., Edmar Communication Co.  
Pittsburgh, Pa., Cameradio Co.  
Pittsburgh, Pa., Modern Sound Co.  
Reading, Pa., Geo. D. Barbey Co.  
Scranton, Pa., Scranton Radio & Television Supply Co.  
Sharon, Pa., Sharon Electronics Supply Co.  
Wilkes Barre, Pa., George B. Jones  
Williamsport, Pa., Lomison Radio & Sound Service

Providence, R. I., DeMambo Radio Supply Co.

Columbia, S. C., Dixie Radio Supply Co.  
Greenville, S. C., Carolina Radio Supply Co., Inc.

Sioux Falls, S. D., Power City Radio Co.  
Watertown, S. D., Burghardt Radio Supply

Memphis, Tenn., Bluff City Distributing Co.  
Oak Ridge, Tenn., The Music Box

Amarillo, Tex., West Texas Radio Supply  
Corpus Christi, Tex., Electronic Equipment &  
Engineering Co.

Dallas, Tex., William Clalborne  
Dallas, Tex., J. Monroe Compton  
Dallas, Tex., Inman Radio Shop  
Dallas, Tex., Wilkinson Brothers  
Houston, Tex., Robert E. Franklin Co.  
Houston, Tex., Gates Radio Co.  
Houston, Tex., Gulf Electronics, Inc. ("Audio Center")  
Lubbock, Tex., Anderson-Young Electronics Co.  
San Antonio, Tex., Mission Radio, Inc.  
Texarkana, Tex., McGuire Television Center

Salt Lake City, Utah, Standard Supply Co.

Alexandria, Va., Coastal Corp.  
Norfolk, Va., Radio Parts Distributing Co.  
Richmond, Va., Walker C. Cottrell, Jr.  
Roanoke, Va., Leonard Electronic Supply Co.

Seattle, Wash., Seattle Radio Supply, Inc.  
Spokane, Wash., Columbia Electric & Manufacturing Co.  
Tacoma, Wash., C & G Radio Supply Co.

Wheeling, W. Va., General Electronics Distributors, Inc.

Appleton, Wisc., Valley Radio Distributors  
Fond du Lac, Wisc., Harris Radio Corp.  
LaCrosse, Wisc., Stark Radio Supply Co.  
Madison, Wisc., Satterfield Radio Supply, Inc.  
Milwaukee, Wisc., Radio Parts Company, Inc.

**STROMBERG-CARLSON**

Sound  Division

1219 Clifford Avenue  
Rochester 3, New York

### The Cabinet-Type Infinite Baffle

A second method for producing the effect of an infinite baffle is by mounting the loudspeaker in a large, totally enclosed cabinet. It is true that a sealed enclosure of any size or construction will stop the free path between the front and back of the cone, but several new, adverse results may be created. The most important of these is that the compliance of the speaker mechanical system is stiffened by the air of the enclosure. This air must be compressed for the cone to move back and stretched for the cone to move forward, and it becomes part of the entire mechanical resonant system (see the equivalent electrical circuit, Fig. 11—4). The resonant frequency of the system is made higher as a result, raising the low-frequency roll-off point, and shifting resonant emphasis to a region of the sound spectrum where it is more annoying.

The obvious way to avoid this effect is to make the enclosure stiffness negligible by providing sufficiently large volume. Unless the cubic capacity of the enclosure is great enough so that the added stiffness has little effect on the speaker resonant frequency the cabinet cannot properly be called an infinite baffle. A glance at Fig. 11—4 will indicate that the effect of a given acoustical stiffness ( $1/C_A$ ) on the whole system depends upon the value of the speaker's mechanical stiffness,  $1/C_{SP}$ . Speakers with lower resonant frequencies require larger enclosures. Cabinet compliance to speaker motion is also inversely proportional to the area of the cone (squared), so that larger speakers with the same resonant frequency need larger cabinets.

The resonant frequency,  $f$ , of a speaker in a totally enclosed cabinet is equal to:

$$\frac{1}{2\pi\sqrt{M_{TOTAL}C_{TOTAL}}} = \frac{1}{2\pi}\sqrt{\frac{C_{SP} + C_A}{M_{TOTAL}C_{SP}C_A}}$$

where

$M_{TOTAL}$  = mass of voice coil, cone, and air load, grams

$C_{TOTAL}$  = combined compliance of speaker and cabinet, cm/dyne

$C_{SP}$  = compliance of speaker suspension system, cm/dyne

$C_A$  = acoustical compliance of cabinet, cm/dyne

The cabinet compliance is equal to<sup>1</sup>:

$$C_A = \frac{V}{\rho c^2 S^2}$$

where

$V$  = volume of enclosure, cm<sup>3</sup>

$\rho$  = density of air, grams/cm<sup>3</sup>

$c$  = velocity of sound, cm/sec.

$S$  = effective area of cone, cm<sup>2</sup>

The general order of dimensions required for approximate infinite baffle mounting of typical 12- or 15-inch speakers is between 6 and 15 cubic feet, depending upon speaker characteristics. The adequacy of the cabinet volume may

<sup>1</sup> H. F. Olson, "Elements of Acoustical Engineering," 2nd ed. p. 152. D. Van Nostrand Co., New York 1947.

be checked by comparing the resonant frequency of the speaker in the cabinet with its resonant frequency in a true infinite baffle. (A method for finding the speaker's resonant frequency is described later in the chapter, in connection with tuning procedures for bass-reflex cabinets.) The increase in resonant frequency that can be tolerated depends upon how low this frequency is to begin with, and how much of a compromise between size and bass performance is to be made.

Additional considerations of speaker cabinet design will be discussed under the heading of cabinet construction.

### The Open-Back Cabinet

The open-back cabinet has pronounced acoustical resonances of both the air column and Helmholtz type. (The space between the cabinet and the wall of the room often forms the inductance element of the Helmholtz resonator.) The effect is to produce a "boomy" quality, undesirable for natural reproduction, but sometimes accepted commercially as simulating a rich bass.

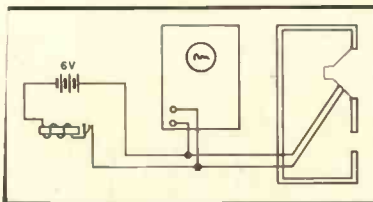

Fig. 11—7 Oscilloscope method of tuning a bass-reflex cabinet, or of determining bass transient response of any speaker system.

### The Bass-Reflex Cabinet

The space requirements of an infinite baffle cabinet are sometimes hard to meet. Smaller volumes may be used, and the stiffness of the enclosed air counterbalanced by a separate air mass coupled to the enclosure. This system<sup>2</sup> is most popularly associated with the name "bass-reflex", a trade name of the Jensen Mfg. Co. which has now been released by them for general use. Reflex cabinets are also called tuned-port enclosures, vented enclosures, and acoustical phase inverters. In the extensive literature on tuned-port enclosures it is possible to find the system alternately described as improving and degrading frequency range, evenness of low frequency response, damping, and distortion, and design data has variously included contradictory instructions.

The tuned-port enclosure, illustrated in Fig. 11—5, is a Helmholtz resonator. (See Chap. 4). The entire bulk of enclosed air acts like a spring, and the mass of air in the port like a connected mass. It is very important to remember that for ordinary cabinet sizes and

<sup>2</sup> A. L. Thuras, Patent No. 1,869,178: Sound Translating Device, July 26, 1932.

shapes the mode of resonance involved is not that of the air column; there are no paths between parallel surfaces within the enclosure large enough for oscillatory reflection and standing waves to be set up in the bass, and the reflection of higher frequencies is damped out by the cabinet lining. Although the above conditions are not realized in full the description is substantially accurate. The resonant frequency of the acoustical system is thus determined exclusively by the volume of the enclosure and the size of the port.

When the compliant volume of air in the enclosure is stimulated by the speaker cone at low frequencies it is almost *uniformly* compressed and expanded, alternately pushing and pulling the mass of air in the port. At the enclosure's resonant frequency the coupling between the cone and the air in the port is at its highest efficiency; that is, for a given cone excursion the air in the port will be moved the most. This maximum air excursion may be illustrated by the mechanical mass-elasticity system of the rubber band and suspended weight which was used previously, a system analogous to the Helmholtz resonator. If a stimulus is applied to the elastic member, by moving the hand holding the rubber band up and down, it can be readily seen that the weight is displaced the most (as a matter of fact, quite a bit more than the source of power) at the resonant frequency of the system.

The first principle of tuned-port operation may therefore be stated: at the resonant frequency of the enclosure and port the back of the speaker cone induces large motion in the mass of air in the port. This mass is sometimes referred to as a virtual piston or diaphragm because of the fact that it is made of air only, but it exerts real pressure against the outside air in the same way that a diaphragm of more substantial material would.

The second principle of the tuned-port enclosure is that at acoustical resonance motion of the air in the port is approximately 180 deg. out of phase with motion of the back of the cone. This too may be illustrated experimentally. When the hand holding the suspended weight and rubber band moves up and down at the resonant frequency of the system the weight will move down as the hand moves up, and vice versa. The phase shift is characteristic of the behavior of both the acoustical system and of its mechanical analogy at resonance; it has nothing to do with the acoustical path length between the back of the speaker and the port. (If the cabinet is made very long, however, the length of the air column may prevent pure Helmholtz or reflex operation.) On the basis of the principles described above we are now prepared to examine the performance of the reflex enclosure, and of its analogies illustrated in Fig. 11—5, at different frequencies.



ALL NEW, ALL IMPROVED



*It's the exclusive*

REG. U.S. PAT. OFF.  
**SCOTCH**  
BRAND

## "V" SLOT 7" PLASTIC REEL

Now—enjoy the ultimate in easy handling, in smooth performance on all machines with the all new, all improved "Scotch" Brand "V" slot 7" reel. It's the first truly *functional* plastic reel. 1200 ft. lengths of 111A and the sensational new 120 "High-Output" "Scotch" Brand Magnetic Tape are wound on this new "V" slot 7" reel—splice free.

*Check these exclusive features:*

- ⊖ "V" SLOT. Say goodbye to threading problems with the easiest, quickest threading device yet perfected.
- ⊖ LARGE 2 1/4" HUB. The only reel that accommodates standard lengths of all magnetic tapes and minimizes timing errors. Eliminates tape spillage in rewind.
- ⊖ WIDE SPOKES. 45% more plastic has been added for extra rigidity. Runs true, balanced to a whisper.
- ⊖ TAPERED FLANGES eliminate frayed tape edges. Get a smoother wind with this precision feature.
- ⊖ EASIER LABELING. Extra large unobstructed writing and labeling surface for added convenience.

Your electronic parts distributor has it!  
Order today!

● 111-AP Magnetic Tape also available on the "SCOTCH" Brand professional reel.

*Costs no more than ordinary reels*

REG. U.S. PAT. OFF.  
**SCOTCH** Magnetic Tape  
BRAND



High Output and  TM 3M Co. The term "SCOTCH" and the plaid design are registered trademarks for Sound Recording Tape made in U.S.A. by MINNESOTA MINING & MFG. CO., St. Paul 6, Minn.—also makers of "Scotch" Brand Pressure-Sensitive Tapes, "Underseal" Rubberized Coating, "Scotchlite" Reflective Sheeting, "Safety-Walk" Non-slip Surfacing, "3M" Abrasives, "3M" Adhesives. General Export: 422 E. 42nd St., New York 17, N.Y. In Canada: London, Ont., Can.



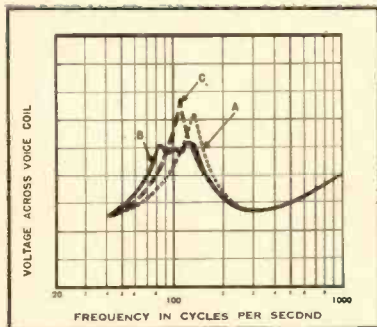

Fig. 11-8. Impedance-frequency characteristic of the 8-in. speaker used in Fig. 10-10 (A), Chap. 10. (A), mounted in a 2 cu. ft. totally enclosed cabinet; (B), mounted in the same cabinet but with a reflex port which is carefully tuned and damped; and (C), mounted in the same cabinet with the port mistuned and relatively undamped.

At resonance of the speaker mechanism the tendency is for maximum voice-coil velocity. At resonance of the Helmholtz enclosure the tendency is for maximum acoustical pulsation, with an instantaneous direction opposite to that of the voice coil. These two resonances, if they are matched, work against each other. Thus, at mutual resonance of the speaker and Helmholtz enclosure voice coil travel will be severely reduced from its former maximum. Acoustical output will be kept up, however, because of the fact that the port is also radiating sound, with an excursion of its air which exceeds cone excursion. Motion of air in the port is 180 deg. out of phase with motion of the rear of the cone, and port radiation is therefore in phase with direct speaker output.

At mutual resonance of the two mass-elasticity systems in the mechanical analogy the motion of  $M_{SP}$ , representing the mass of the speaker, will be reduced for the same applied oscillatory force.  $M_P$ , representing the acoustical mass in the port, will move in the opposite direction with maximum excursion.

In considering the electrical analogy, current must be substituted for velocity. The series L-C circuit and the parallel L-C circuit are anti-resonant to each other. At resonance the current through  $M_{SP}$  will be cut down because of maximum impedance of the parallel resonant circuit, but the "loop" current through  $M_P$  will be at a maximum. These two currents will have a phase relationship of approximately 180 deg. The presence of resistive components in the circuit changes the perfect out-of-phase relationship, as is the case in the acoustical-mechanical original.

At frequencies other than the resonant one the speaker and the Helmholtz resonator each assume a net character, either mass or compliant. At some frequency above, and at some frequency below resonance the net mass of one will resonate with the net compliance of the other, causing two new resonant peaks of voice-coil velocity, each less extreme than the original single peak which they replace. These peaks are in turn reduced by the acoustical resistance of the system. The acoustical re-

sistance within the system, in addition to damping the double peaks, controls the distribution of power between actual radiation of sound from the port and viscosity losses.

In the electrical analogy current flow through  $M_{SP}$  will exhibit the same double peaked behavior. The two new resonant frequencies are formed by the net inductance of one of the circuits and the net capacitance of the other. (Above resonance the series circuit is inductive, the parallel circuit capacitive; below resonance the opposite is true.) The effect of  $R_P$  is to lower the Q of the parallel circuit, reducing the double peaks at optimum value.  $R_P$  also allows more real power to be absorbed from the generator at low frequencies.

The Helmholtz resonator is not susceptible to harmonic operation. As the frequency of the reproduced signal is raised above the resonance region the port becomes progressively decoupled from the back of the cone, and sound radiated from the port shifts its phase relationship to that coming directly from the speaker. At higher frequencies the back wave is effectively damped out by the cabinet lining.

The output vs. frequency curve just below resonance is lifted by the lower of the two new peaks, but then speaker radiation falls off more quickly than it would in a totally enclosed cabinet. Motion of the air in the port shifts its phase relationship with motion of the speaker cone, and interflow of air currents between speaker and port, or doublet operation, sets in.

The most important advantages of a properly tuned reflex enclosure are: (1) relief from the effect of the acoustical stiffness of a cabinet of limited volume; (2) reduction of voice-coil travel at resonance, and the attendant reduction of speaker distortion; and (3) improved bass transient response associated with the reduction of the speaker's resonant

response peak. It is obvious that these effects will only take place fully if the enclosure has the same resonant frequency as the mounted speaker mechanism.

There is one very important disadvantage of the tuned-port enclosure. The use of anti-resonant devices, whether acoustical or electrical, must involve careful and controlled adjustment, or effects far different from those expected will result. One would not think of blindly installing trap circuits in a radio receiver, for example, without precise adjustments relative to the frequencies and Q's concerned. Yet reflex cabinets are often used without any consideration of the particular speaker to be mounted. Stating the size of the speaker is not enough, because commercial speakers of the same size have varying resonant characteristics. Uneven bass response, hangover, and a generally boomy quality may result from this lack of care.

The original patent papers of Thuras showed the enclosure as anti-resonant to the speaker mechanism, but did not emphasize matching of resonances, as is done here. This is probably due to the fact that in 1930, when the patent was filed, the problem of increasing bass was more pressing than that of reducing boom.

#### Design of Bass Reflex Enclosures

There are many combinations of values for enclosure volume and port size that will yield a given resonant frequency. The volume should be chosen as large as practicable (the selection of the reflex design is often based upon the limited enclosure volume that can be used), and the port size adjusted experimentally. Accurate matching of resonances is achieved by physically tuning the Helmholtz resonator, rather than by calculating exact dimensions beforehand.

(Continued on page 66)

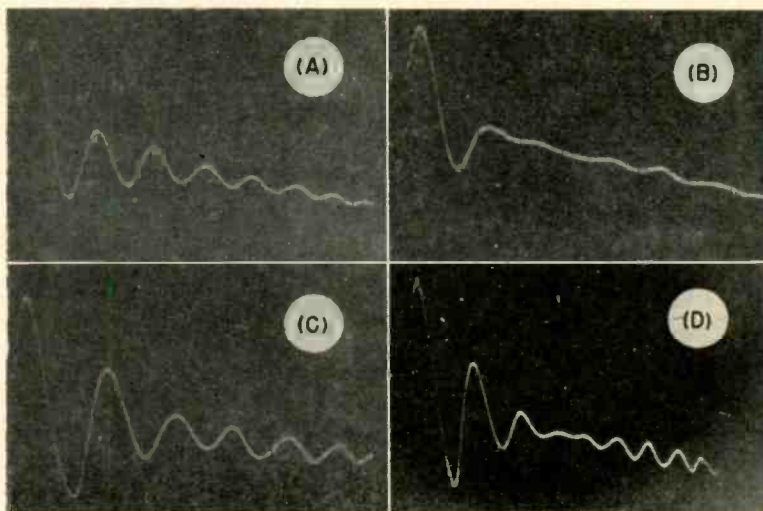

Fig. 11-9. Transient response, as indicated by oscillograms made as described in the text, obtained with the three conditions of Fig. 11-8 and shown by the correspondingly lettered sections. (D) represents the transient response of another bass-reflex system, whose port is tuned but inadequately damped. The beat effect created by the two separated resonant peaks is seen clearly.



# How Come?

## PILOT

*runs an ad for Hi-Fidelity  
Pilotuners and Amplifiers  
without listing features!*

Yes, — listing of features on hi-fi equipment is important. But — it would take a good four pages of fine type to list all the outstanding features of these superb PILOT instruments.

So may we suggest, — send in the coupon below for our beautifully illustrated, completely descriptive color folder. Read it in comfort, at your leisure. Compare PILOTUNERS and AMPLIFIERS, feature for feature, with any others on the market. See PILOT's superiority for yourself. You'll be glad you did!



PILOTUNER AF-821 U  
\$99.95



PILOTUNER AF-723  
\$79.95



PILOTONE AMPLIFIER AA-901  
\$99.50



PILOTONE AMPLIFIER AA-902  
\$46.95



PRE-AMPLIFIER PA-912  
\$49.95

*Write in today*

**PILOT RADIO CORP.**  
Dept. AE-4, 37-06 36th St., Long Island City, N. Y.

Please send me your free folder describing  
PILOTUNERS and Amplifiers.

NAME.....

ADDRESS.....

CITY..... STATE.....

### FAMOUS PILOT "FIRST!"

1927 ...  
First home  
short-wave receiver



### FAMOUS PILOT "FIRST!"

1937 ...  
First truly portable  
battery receiver



### FAMOUS PILOT "FIRST!"

1928 ... First  
Government licensed  
TV station, W2XCL



**PILOT RADIO CORP., "The Standard of Excellence," LONG ISLAND CITY, N. Y.**

# Equipment Report

## UTC W-20 "Williamson" Amplifier Kit

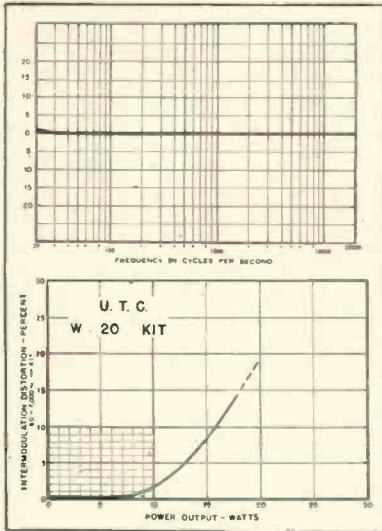

THOSE WHO ENJOY the construction of their own equipment will find considerable satisfaction in the announcement of the new "Williamson" amplifier kit made available by United Transformer Co., under the designation W-20.

This kit does not limit the builder to a specific form of construction, since the materials furnished include only the transformers, filter chokes, and chassis—the latter being punched to fit the equipment supplied in the kit. However, detailed instructions are furnished to show the recommended construction, which involves the use of Vector sockets.

The amplifier is designed along the basic principles of the original Williamson, but employs four 1614's in a push-pull parallel

output stage, thus providing adequate performance at conservative operating voltages.

The model tested was constructed by a member of *AE's* staff who is not particularly familiar with typical audio practices, and a total of nine hours was required to complete the work. Vector socket wiring is not considered particularly difficult by experienced personnel, but to the uninitiated it often presents some problems. With the detailed drawings accompanying the kit, the work was done correctly the first time, and with a minimum of trouble.

The circuit employs two 7N7's for the first three stages—involving four tube sections—and four 1614's in the output. Parasitic oscillation is effectively suppressed by the use of stopper resistors in both plate and grid circuits of the output tubes. The completed amplifier showed the characteristics indicated in *Fig. 1*. Provision is made on the power supply to furnish plate and heater current to a preamplifier-control unit, which is not included as part of the kit, but must be furnished separately. Two 5U4G's are used as rectifiers, ensuring ample current carrying capacity for the amplifier.

When constructed in accordance with the schematic, *Fig. 2*, the input signal required for 1-watt output is 0.32 volts at 1000 cps; for 10-watt output, the input signal is 1.12 volts. This permits full output power from conventional preamplifier-control units—most of which are capable of providing an output signal of approximately 2 volts without undue distortion. The input connection to the amplifier is through an Amphenol microphone connector, and connections to the speaker are available through a telephone jack. Output impedances ranging from 1 to 15 ohms may be obtained by suitable connections of the output transformer secondary.

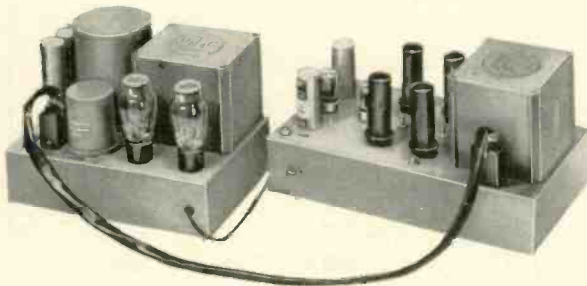

Left, the UTC W-20 Amplifier and Power Supply Kit, constructed according to instructions. Above, *Fig. 1*, performance data.

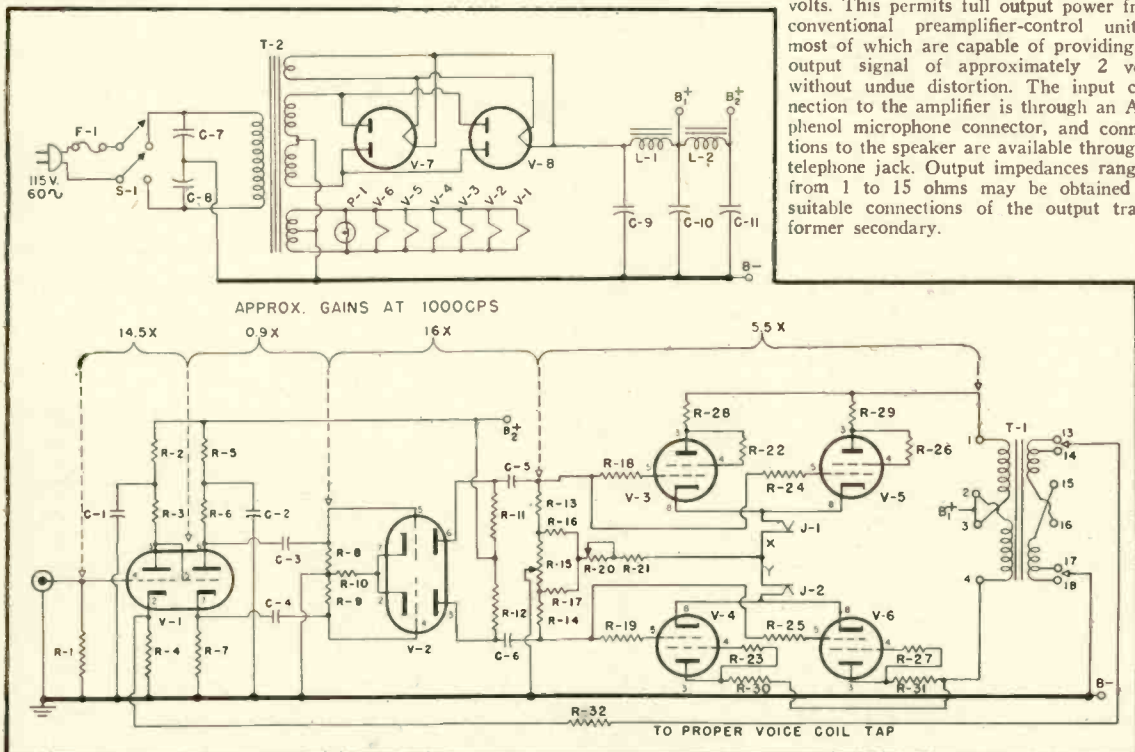

*Fig. 2*. Schematics of the power supply, above, and of the amplifier, below.





1928 Model DA-4  
First high efficiency auditorium speaker

# Jensen



1950 Model G-610  
First 3-way integral speaker

# 1<sup>st</sup>

*Precedents are a habit with Jensen*

*Since 1927, world's foremost manufacturer of fine loudspeakers*

The Jensen organization came into being a quarter-century ago, based on a new concept in loudspeakers. Since then Jensen has made history by consistent contributions to better sound reproduction through improved speaker performance. This record of achievements means that the Jensen speaker you buy today is a product of distinguished experience . . . your assurance that Jensen speaker performance is *always* way ahead.

Jensen Manufacturing Company—6601 South Laramie Avenue, Chicago 38, Illinois  
Division of the Muter Company—In Canada: Copper Wire Products, Ltd., Licensee



1931 Model PM-1  
First PM speaker in USA

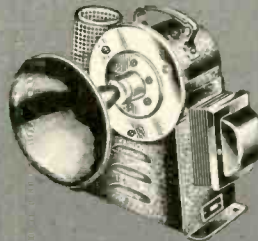

1933 Model Q  
First H-F unit "tweeter"

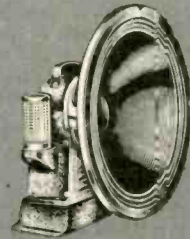

1935 Model L-18  
First 18" speaker



1937 Model KM-15  
First "bass reflex" cabinet



1940 Model JHP-51  
First commercially available coaxial speaker

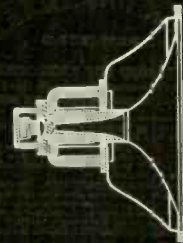

1946 Model HNP-51  
First articulated compression driver coaxial

Barton Browne Advertising

# RECORD REVUE

EDWARD TATNALL CANBY\*

## Sealed and Virgin

IN THE FEBRUARY issue of *Æ* I took a preliminary look at the possibilities for sealed phonograph records and the sad situation that now exists thanks to the unsealed disc of our present selling methods. Considerable interest in the subject has cropped up and so here I'll tackle it again. Since the advent of the scratchable LP and 45, complaints have been steadily mounting on this score—though so far not as rapidly as the sales of the discs themselves. There's no doubt about it, we must begin to face the plain fact that the plastic record is not suited to indiscriminate handling before sales. Far less so than the old shellac.

The shellac record, strangely enough, was a more durable article of merchandise—as long as it remained in one piece. The problem in shellac days was simpler. Breakage was the real trouble. Either a disc was broken, chipped, cracked—or it was not, and there was really very little difficulty in deciding about it. Now, a plastic record may be damaged and damaged again yet still remain technically playable; worse, the damage at the microgroove scale is far more difficult to detect upon eye examination, the plastic is extremely easy to mar, and the microgroove pickup is extremely sensitive to such injuries.

Yet we merrily continue the old fashioned system of record selling scarcely changed in any vital detail. Why? Only because, as I see it, the LP is merely five years old, the mass sales of plastic discs less than three, and after a half century of the old way, we haven't yet had time to think of change. But change there must be, eventually.

### Sealed Acoustics

Not that the idea of sealed records hasn't been tried, in the pre-plastic era. Mr. Louis Scriven of Brooklyn, N. Y., who now depends for his new records on the cooperation of a few trusted dealers well known to him, sends in a photostat of a Wanamaker Sealed Record, as of, perhaps, the early 1900's. (No date attached). Wanamaker discs—Victor and presumably others—were guaranteed absolutely new, tested at the factory, and were not exchangeable. Demonstrators were provided and replaced whenever necessary; they were not sold. A complete catalogue of sample records was kept in stock for the exclusive use of demonstrations and sales.

Evidently it didn't work, 'way back then. As Mr. Scriven suggests, even factory sealing is not a necessary guarantee of perfection. A lot more than just local sealing must be accomplished. But this, as I

say, was back in the early days of the breakable shellac. Times have changed, and so will we.

Among the numerous letters to this department, many recounting at length their writers' unpleasant experiences with "used" new records, one is worth quoting complete for its special viewpoint—the dealer's. It comes from Mr. R. E. Tillen, of Berry and Grassmuck, Pasadena, California.

"I am replying to your excellent suggestions in the February *Æ* on the need for a system which can present unplayed records to customers.

"With the final goal everyone agrees heartily. But the means of attainment involves the solution of one particular problem which I, as a record salesman, am in a position to perceive. . . . No record store could afford to so increase its inventory as to purchase one copy of every release for demonstration only. To do so would mean to increase inventories by 30 to 50 per cent, an impossibility if this increase were to be written off as a dead loss.

"Only if the manufacturer were to sell us this demonstration copy direct, at a price well under that which the wholesaler pays, could it be done. Is the manufacturer prepared to do this? Here I believe is the main objection.

"Two more matters might be mentioned. First, the manufacturers must definitely elevate their sense of responsibility in regard to the inspection of records before putting them in the containers. You would be amazed at the number of warped records and records with large bubbles that arrive at any retail store.

"Secondly, every retail store specializing in classical music has a small clientele of connoisseurs with fine equipment at home who purchase in such large quantities that listening at the store is impossible. To these few we grant the right to listen at home before purchasing, for two reasons. First, their equipment, more sensitive than ours, reveals flaws undetectable on our players. Second, the performance must be in accord with their taste and knowledge. (I.e., they deserve a chance to make their own choices, at home. E.T.C.)

"I believe that nation-wide discussion will finally persuade the manufacturers to initiate changes. Believe me that the retail stores are not a dead-weight of inertia, but are heartily on your side."

That seems to me a fine presentation of the case, not only directly but by the implications. There are, indeed, formidable problems involved in any sort of change from such a complex system as now exists.





# UNTHINKABLE

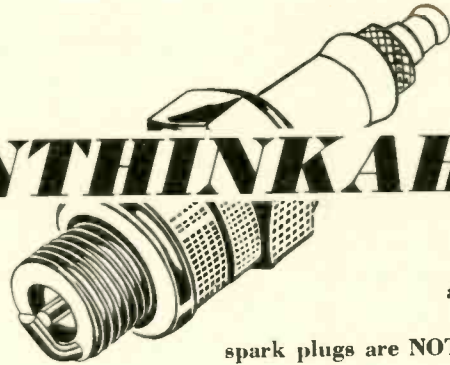

an automobile  
in which the  
spark plugs are NOT replaceable?

## Stylus Change, When?

No jewel-point is permanent be it diamond or sapphire. Therefore, for good reproduction and disc preservation, periodic checking is imperative. The microscope will show a flat on any diamond after 40 or so hours of play (sooner with a sapphire). Therefore it is less the presence of a flat than its extent and configuration that are important. This makes a microscope (\$25.00 to \$100.00) almost useless to the untrained. He can see but he cannot judge.

The Audax company has developed the Audax TEST-DISC, which makes home examination of any jewel point very simple. Neither the stylus nor the cartridge need be removed for the test. The simple playing of a few grooves will detect stylus-wear before it becomes dangerous to your records. The Audax TEST-DISC should have a useful life of 20 styli, a long time, indeed. At your dealers today, or write us.

... precisely so in a music reproducer. For years Audax has been pointing out that, for a reproducer to be practical, replaceability of the stylus—at home—is a MUST.

"Weil's 'Lets Talk About Diamonds' in HIGH-FIDELITY magazine, March issue\*, is the most useful, the most welcome article I have read in any magazine dealing with reproduced music. I was told that my diamond styli, bought 3½ years ago, is for a lifetime. But for the past year my records don't sound good at all. Had I known the facts, I would have been only too glad to *replace* my diamond with a new one. . . ." (Excerpt from one of the hundreds of letters on this article.)

\* Reprint of above article is free at your store, or write us.

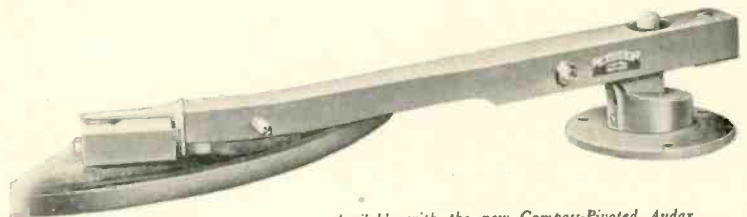

Available with the new Compass-Pivoted Audax arms and to fit the high quality record changers

No H P (hidden pull) see

\*1953 ELECTRONIC PHONO FACTS  
available at your favorite store

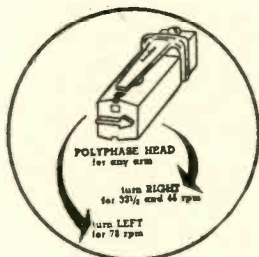

One single magnetite pickup  
plays all home records

## AUDAX COMPANY

500 Fifth Avenue Dept. AE New York 36, N. Y.

Creators of Fine Audio-Electronic apparatus for over 25 years

*"The Standard by Which Others Are Judged and Valued"*

The easy way is to maintain things as they are. But that would ignore what is bound to be a constantly increasing state of dissatisfaction all along the line.

#### Before Sealing . . .

I must agree with Mr. Tilenia that the technical first move necessarily must be at the manufacturers' level (though persuasion will come from elsewhere) and I follow him in noting the high proportion of imperfect discs that now arrive from shippers. I'm well aware that the troubles are not easy to track down and that, generally speaking, most companies make a conscientious effort to intercept duds and avoid damage, which is obviously to their own interest. In addition, they have been inclined to make liberal settlements as to taking back the defectives.

Nevertheless, as one who receives a large number of brand new records straight from the makers I can vouch for the surprisingly large number of defects that turn up, not only pops, warps, bubbles, but off-center sides and, most important, serious scratches that sound out loudly in the playing. I have to broadcast many of them and I should know. There's gravel in them that envelopes. How can I help but share the general feeling that something ought to be done—that American technology, which thrives on industrial miracles, should toss a few our way and bring us more uniform records?

What can the manufacturers do? Let's begin by revising the old saw, "where there's a will there's a way"—where there's an ultimate profit-prestige value, there will be a way. I am convinced, myself, that the ultimate need is for sealed records, untouched from maker to consumer. But I would not for an instant think that mere sealing of present discs is the whole answer. That must be a phase of the general improvement, its outward and positive embodiment. We must improve manufacturing and handling procedures first; then we can safely seal up the better records, ship them with less damage and, finally, set up our revised sales methods—sharply revised—accordingly. Nor do I think that, actually, the changes will come one by one in that order; in practice the entire development must work itself out more or less simultaneously through give and take.

Yes, every bit of all this will cost extra money. I hear the howls of anguish. More expense, when records are hard enough to sell as it is? Impossible. Well, if it's impossible now, it won't be when the trouble gets worse. But (to put a less ominous slant upon the matter) we must remember that the biggest competitive principle in business is investment, capital risk for a profit. If these added expenses should produce new economies elsewhere, greater efficiency all around, and better confidence in the buyer, then the extra cash might be considered a good risk.

The principle direct increase in costs for a rational and complete sealed record system would be (a) the higher cost of more careful manufacturing, better pre-seal handling, more rigorous inspection, then a satisfactory sealing process and a damage proof shipping technique. (The aim would not be perfection, but a reasonably high standard, good enough so that, given a little time, the record buyer would be willing to buy records unopened, with confidence. That's the minimum and the vital target.) (b) The cost of demonstrator records, not for sale. (And we might add the cost of better players, better needles—

which any self-respecting store should invest in anyhow.)

Where, then, might we find the increment of profit, savings, good will, and prestige that would pay for this? In plenty of ways, I say. We must look at the whole picture, Before and After.

#### Back to the Shelves

The biggest negative lump-factor in all in the record business at present is clearly the combined dead-weight of rejects, returns, exchanges, sales of substandard goods, which taken together, add up to a painful reverse impetus against the great current of business.

I'm not a statistics man, but first of all, it's my strong impression that the volume of unsatisfactory discs accepted back by the makers is unconscionably high. The competitive need for dealer good will makes a return policy necessary, but it surely is a heavy drain on profits. And the more liberal it is, the more obviously is it asking for trouble, for dishonesty and semi-shady operation. Think, too, of another drain—the numerous discs that are rejected even sooner, shipped back from the packaging to the pressing plants. Whole batches of imperfect discs are rejected here before they ever leave the record company. All of which represents a direct loss in effort, in inefficiency in the "power train," that costs a lot. Better records, made more uniformly and sealed, would eliminate much of it.

But there is a far worse evil that is involved here, the mounting number of unsatisfactory discs that are accepted back by dealers from their customers—then quietly returned to the shelves for another sales try. This really nasty business, now growing to a near-scandal in some large cities, is a direct and inevitable result of the non-seal system—and of plastic unbreakability. It is more prevalent each day as mass sales increase and new easy LP and 45 return policies take the place of the cumbersome listening booth. Free trial, at home! Buy your records in bulk, take them home and play them—and if you don't like them, bring them back for full refund credit, or exchange; they'll sell, eventually, to a bigger sucker than you. (If not, then the maker will have to take them back.) I have heard dismal first-hand reports on this score and I know that many a reader will document me, not so much as to the practice itself, which is obvious, but as to the increasing difficulty experienced in buying new records, never played. Our shelves are badly contaminated.

One correspondent writes from Cincinnati, "I am writing you in hopes of finding some dependable store where my mail orders for LP records will be filled by truly fresh, unused records. Can you suggest any in the New York area, or elsewhere?" What, I ask, does this imply as to the reputation of some nameless Cincinnati stores? And is it necessarily their fault? I'd hesitate to blame even the most unscrupulous dealer more than 50 per cent. The consumer, taking quick advantage of liberal return policies (or perhaps driven to desperation by bad luck in his purchases) is bound to take whatever he can get, and does.

Here, I've heard some shocking things. It is quite possible, I gather, to keep one's self nicely supplied with new recorded music month in and out, in some localities, entirely for free. Easy enough. When you're tired of your records, just take them back and exchange them for others—at full

credit. It happens. And who's to blame? Nobody, really, unless you can call this unofficial connivance between dealer and consumer! It's the system that is wrong. What more can you expect?

In other words, here is a sales and distribution arrangement which, thanks basically to the unsealed disc and the resulting counter-flow of substandard records, is expensive, cumbersome, rife with the chance for dishonesty all along the line, inefficient, breeding the worst sort of bad customer relations and ill will, an open invitation to short-sighted selfishness. For in the short, myopic view all of this activity pays off, as does any substandard merchandise sold as up to par. But in the long run the traffic is insidiously damaging to the entire industry and, most of all, the record dealer himself. I'd say it would be worth a lot of effort and a lot of cash risk, to make a basic change that would cut out this trouble. And I think the buyers of records are more and more disposed each day to accept the sealed record system which would do it. They're the ones who play the bad records.

#### Demonstrators

The biggest improvement, the largest savings from a sealed record policy, then, would turn up in the elimination of the evils of the free exchange, the lessening of the reject reverse-flow. That should pay for a lot of improvement expense. How about the cost of demonstrators—which Mr. Tilenia has said might be prohibitive? Yes—if there were to be no other change.

Let us assume, for argument, that record companies have taken the big step, improved their techniques of manufacture to a point where sealed discs are being packaged with reasonably high uniformity. Is the demonstrator then necessarily a major problem? Why should it be allowed to become one?

Now, again, I disclaim detailed knowledge of the selling profession. But I submit that the sample-demonstrator-floor-model plan of sales is everywhere to be seen in American life, in the utmost variety of situations. Some feasible arrangement covering these non-selling sales promoters clearly has been worked out in every case—from demonstration Packards to sample lolly pops, from TV sets, vacuum cleaners, cut flowers, clothes for store window mannequins to slot machine candy bars and hardware store tools. Whether paid for or not, the items in question are assumed to be expendable necessities, less their recovery price, if any, as used goods.

Why then, should phonograph records remain as a striking holdout against a principle of selling that has been applied successfully to such a vast number of products? Even the traveling salesman has his sample case! Surely there is enough ingenuity and enterprise in our business to allow for a similar set-up with profit for all. Split the cost 50-50? Allow so many demonstrators as "extras," per dozen or hundred stock items?

Don't ask me. But again, where there's a will (and a profit-prestige motive) there's a way. Granted that other major problems are solved, I don't see that the demonstrator problem is a headache at all. Perhaps this can be envisioned better, finally, if we look at the prime target for outward change, the record store itself.

#### Record Store—with Sealed Records

If we make two assumptions now, for argument, that we have both the sealed records and good enough quality to warrant the sealing, and also that we have evolved



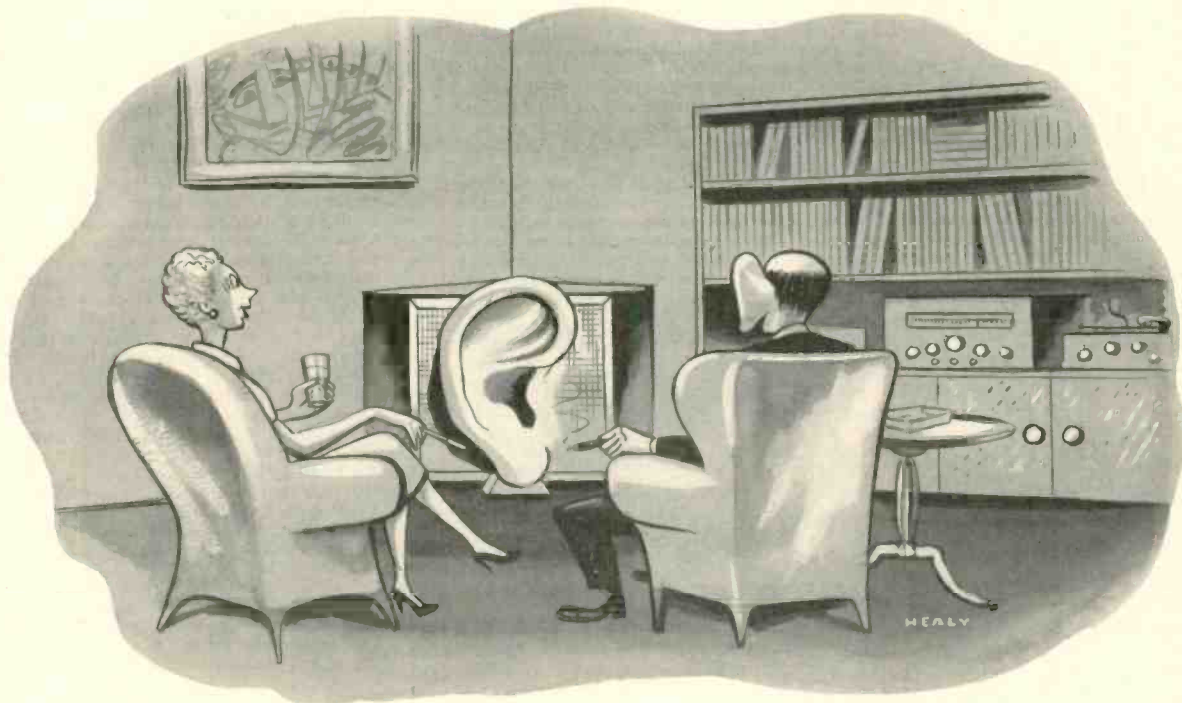

***"You certainly do have an ear for music, Chadwick"***

SERIOUSLY, though, a surprisingly large number of you seem to share our opinion that the days of music for one ear may be numbered. Partially buried beneath healthy controversy concerning what to name the baby is one inescapable truth: **SOUND REPRODUCTION FOR TWO EARS IS HERE TO STAY!**

The high-fidelity fraternity has one unusual characteristic which has always impressed us. In the five years of Livingston's growth we have yet to see an occasion when personal differences, commercial rivalry, and even editorial policies were not subordinated to one overwhelming common issue — improvement of the art.

The fabulous growth of the audio school and its rapid succession of improvements and refinements derive, we believe, directly from this constructive attitude. The audio art seems to attract the finest types of participant, both suppliers and consumers. We all benefit from this progressive technical philosophy.

Livingston's part in this open-minded program of improving the quality of the art has been slanted in a supplemental rather than a competitive direction. We are wholeheartedly behind this development — the most refreshing we have observed in these past five years.

The Cook Binaural disc excited our immediate interest and enthusiasm. That it translated a startling effect into a practical technique was enough to launch a serious program in our company.

Results are the Livingston Binaural Arm and a line of binaural recordings to augment the already growing catalog of Cook Laboratories and others. At this moment, however, we feel it more important to direct the attention of the audio enthusiast to the overall aspects of sound for two ears, rather than to plug our products. The primary purpose of this "ad-itorial" is to offer cooperation to any and all interested in this technique.

**LIVINGSTON ELECTRONIC CORPORATION • LIVINGSTON, NEW JERSEY**

some sort of demonstrator arrangement, then what would our new store look like?

Outwardly not so different. The same gaudy albums, mostly dummies, in the window, the same enticing interior, the same shelves and trays and stacks of records to play. But, on second glance we'd see some radical changes.

First, the bulk sealed stock would be shelved entirely away from the customers' prying fingers, neatly and efficiently as in a thousand other lines of merchandise. Every sealed disc would be considered the equal of each of its neighbors, unopened and untouched before sale. Imagine, then, the saving in confusion, in wear-and-tear on sales personnel that this would mean! More important, we would find space used more economically, where the sales force alone had access to the stock and where no searching for a "good copy" is necessary.

But much more interesting still, there would be a very large saving in inventory. How? Since there is to be no more pawing over the entire stock by customers in search of the elusive perfect disc, since there is no more of that dismal dilution of new stock by large numbers of doubtful copies, used but still sellable—maybe—I'd guess that *inventory could be reduced from a third to a half the present stock*, in the leading popular items, not nearly as many copies would have to be held, where each one is 100 per cent new and confidence is well established. Worthwhile?

Second, in this new-style store the playable sample copies of each item would be available to the customer in his section of the store, more or less as now. But with the basic stock well out of harm's way elsewhere, the demonstrator area could be smaller and certainly would be far easier to

manage, with much less work than now for the sales force. No more wear-and-tear on the seller's disposition as his stock is systematically destroyed in front of his nose; no more after-closing confusion as the piles of "used" items are patiently returned to stock, along with whatever new records remain on hand!

Naturally, the customers are going to scratch up the demonstrators and there would have to be replacements—quite often. But, with new stock forever intact and untouched, wouldn't it be worth it? Moreover, think of the customer's new attitude. If he is sure that *his* copy will be sealed and virgin new, he is not going to mind auditioning a scratched demonstrator. He'll take a lot more damage here without showing pain and disgust. At present, a scratch is instant evidence to Mr. Customer that the shop is out to gyp him. If one record is scratched—then how many more? He'll want to play everything through, to check for himself, and he'll insist on looking at every copy of each item on his list. He's not going to trust anyone, in this racket.

An all-too-familiar pattern. Multiplied by thousands and thousands, think what a vast number of man-hours of time are needlessly lost by this means. Figure for yourself what proportion of a shop's time and a customer's energy is spent on this sort of thing, that would be saved, with sealed records and confidence in them, unopened. Worthwhile?

And don't forget the vast number of records that are sampled but not bought, only to be returned for more sampling. Truly a vicious system, at best.

I figure, then, that our new-style store would find it profitable to provide demonstrator discs in an almost munificent manner—as the customer might see it. On popular items, perhaps five or six demonstrators a week might profitably be burnt up. Actually, the cost of stocking such an item, demonstrators included, still would stand to be lower than at present. If not in cash, then certainly in the enormous prestige value and confidence that the new policy would engender.

#### Guarantees?

Should there be any return policy at all, under such a system? Wanamaker's plan, long ago, offered no exchanges at all. What is the practice in other lines of sealed merchandise? There's no exchange on a new car, but many another product is guaranteed to be as claimed, and it is possible to exchange an obviously defective item for a new sealed one. Possible, but not easy.

It's not feasible to give a positive answer to this problem in black and white. The true answer, of course, lies in the records themselves—and we have assumed from the beginning here, that a *sine qua non* is the necessary improvement in manufacturing and packaging whereby, though perfection is not reached, the customer's confidence in the unopened goods is assured.

I myself feel that perhaps a limited exchange policy might be wise, at the option of the dealer. (That is not too far in principle from much present practice.) Not that the dealer will be able to tell whether the trouble was "added" by the consumer himself; there is no guarantee against this. But a certain number of returns, questions unasked so to speak, are generally accepted as good business with known customers. However—no resale as though new! Simple solution to this problem: toss the rejects in with the demonstrators, where they can be put to legitimate work.

\* \* \*

## The finest performance that money can buy no longer costs so much!

THE sensation in tape recorders will be introduced at the Chicago Radio Parts Show in May.

There, three incomparable new Crestwood Models will be seen—and heard—for the first time.

With them will come a new era in tape recording. The new Crestwoods offer the ultimate in high-fidelity reproduction—frequency response of 30 to 12,000 cycles at 7½" per second tape-speed. Sets with similar performance have appeared before—but at prices many times higher than the new Crestwoods.

These beautiful new recorders are priced from only \$199.50 to \$299.50. NOW CRESTWOOD GIVES YOU BY FAR THE GREATEST VALUE EVER OFFERED IN TAPE RECORDERS.

The new Crestwoods have two speeds—10-watt power output—complete dependability. Your dealer will have them in stock on or about August 10th. Watch for them. For further information, send coupon.

**Crestwood**  
BY DAYSTROM

**TAPE RECORDERS**

*open a brand new world of recorded sound*

Crestwood Division of Daystrom Electric Corp., Dept. AE-5, Poughkeepsie, N. Y.

Please send me complete information about the new Crestwood models.

My name \_\_\_\_\_

Address \_\_\_\_\_

City \_\_\_\_\_ Zone \_\_\_\_\_ State \_\_\_\_\_

My dealer's name \_\_\_\_\_

Address \_\_\_\_\_

City \_\_\_\_\_ Zone \_\_\_\_\_ State \_\_\_\_\_



# HARVEY the House of Audio



## The NEW **McINTOSH** 30 Watt AMPLIFIER Model A-116



Incorporates the famous patented McIntosh output circuit for extremely high quality performance. Frequency response at 30 watts is  $\pm .5$  db from 10 to 50,000 cycles. Harmonic distortion is less than .5% at 30 watts from 20 to 20,000 cycles. Intermodulation distortion, with peak below 60 watts, is less than 1%. Has two high impedance inputs for .25 and 2.5 volt signals, and four outputs: 4, 8, 16, and 600 ohms. Power supply is built in, with provision for furnishing power to McIntosh and other preamplifiers. Uses 6BG6 output tubes.

Complete with Tubes. **\$139.50**

## **McINTOSH** Model C104 PHONO PREAMPLIFIER and EQUALIZER



Provided with five inputs and selector switch, and accommodates FM-AM Tuner, crystal pickup, low level and high level magnetic pickups, low level microphone, and other signal sources. Phono section has three-position switch for selecting correct turnover, and a versatile treble control to provide required roll-off, to match most record characteristics. Separate bass and treble, boost and attenuation controls are effective on all input channels. A master power switch and volume control complete the attractive 5-knob panel. Power is obtained from main amplifier. Supplied with tubes and power cable.

Less Cabinet (with knobs and panel). **\$49.50**  
In Mahogany Finish Cabinet. **\$75.00**

## **TRIMM**

### EQUIPMENT For Audio Applications

**JACK PANELS** Provide maximum operating convenience and control. Terminating program lines, microphones, amplifiers, preamplifiers, equalizers, and a variety of other audio elements can be easily and quickly inter-connected and interchanged. Broadcast quality construction throughout.

Series 96—Uses standard twin-type patch cards. Has reinforced, solid bakelite panels. Dimensions: 18" long and 3 1/4" deep (height shown below).

No.	No. of Jacks	Height	Net
No. 96-01	12 pairs	1 3/4"	\$27.60
No. 96-02	24 pairs	2 1/4"	\$0.10

### **PATCH CORDS**

(Plugs Attached)  
Equipped with No. 506 plugs. Designed for three circuits: two signal and one ground. Rugged construction, and self-alignment feature assure long, reliable performance. High quality shielded cords employed.



No.	Length	Net	<b>PLUGS No. 506</b>
840-1-PP	1'	\$7.92	Standard twin plug as used on No. 840 Patch Cards. Spaced 3/8" center-to-center, and self-aligning.
840-2-PP	2'	8.05	
840-3-PP	3'	8.28	Notched for polarization. Supplied in red or black molded bakelite shells.
840-4-PP	4'	8.51	
840-5-PP	5'	8.75	
840-6-PP	6'	8.99	No. 506 <b>Net \$2.97</b>
840-10-PP	10'	9.90	No. 506-1 (red shell) <b>2.97</b>

## **WESTERN ELECTRIC 755-A SPEAKER (8" PM)**

Provides full frequency range coverage and wide angle high-frequency distribution. **SPECIAL \$24.60**

### Visit the **HARVEY** AUDIOTorium

If you want to See and Hear the finest . . . the widest selection of high fidelity equipment . . . be sure to visit the HARVEY AUDIOTorium. It will thrill you.

NOTE: Prices Net, F.O.B., N.Y.C. Subject to change without notice.



## The NEW **MINIFON** Miniature, Portable WIRE RECORDER



Measuring only 1 1/8 x 4 3/8 x 6 1/2, and weighing only 2 lbs. 7 ozs., the Minifon is just about the world's smallest sound recording instrument. Records, rewinds, erases, and plays back through either a pair of stethoscope type earphones or an external amplifier. Capacity 2 1/2 hours uninterrupted recording. Powered by 1 1/2 v. A battery, standard 30 v. B battery, and 7 Mallory RM-4Z mercury batteries. An ideal tool for executives, engineers, doctors, and wherever there is need for recording notes, interviews, and other data.

Complete with microphone, stethoscope type earphones, 1 hour spool of wire, tubes, batteries, and instructions. **\$289.50**

Morocco Leather Zipper Case. **\$10.00**  
Transformer-rectifier Unit for operation of motor from 117 v. AC line. **\$20.00**

**RECORDING WIRE** On spools, in dust-proof plastic containers, suitable for mailing.

1/4 hour	\$5.00	1 hour	\$9.00
1/2 hour	7.00	2 hour	17.00
	2 1/2 hour		21.50

## The NEW **ELECTRO-VOICE** REGENCY SPEAKER SYSTEMS



The **Regency** is a Klipsch-licensed corner horn enclosure, suitable for either corner or flat wall location. Superlatively styled in lowboy design, the Regency is available in either hand-rubbed mahogany or blonde Korina, and may be used with single 15" speakers, two-way, or three-way systems.

The **Regency II** consists of the Regency enclosure together with the EV 114A two-way system composed of a 15W-1 LF driver, an X-8 800 cycle crossover network, and a T-25 25 watt treble driver with 8-HD Hoodwin diffraction horn. The **Regency III** consists of the Regency enclosure together with the EV 114B three-way system, composed of a 15W-1 LF driver, an X-8 800 cycle crossover network, a T-25 treble driver with 8-HD Hoodwin diffraction horn, an X-36 3600 cycle crossover network, and a T-35 Super Sonax VHF driver.

<b>REGENCY</b> (enclosure only)	Mahogany	<b>\$114.00</b>
	Blonde Korina	<b>120.00</b>
<b>REGENCY II</b> with 2-Way System	Mahogany	<b>285.00</b>
	Blonde Korina	<b>291.00</b>
<b>REGENCY III</b> with 3-Way System—Mahogany		<b>324.45</b>
	Blonde Korina	<b>330.45</b>

## The NEW **MAGNECORD** VOYAGER

One-Case Portable TAPE RECORDER

Model PT6-VAH



A professional-quality portable unit designed for use wherever top-quality recording and reproduction are required. Operates at either 15"/second or 7 1/2"/second, with a frequency response within 3 db from 50 to 15,000 cycles at 15"/second. Has high as well as low impedance inputs. Output is 600 ohms. Provided with earphone monitor jack which is in the circuit for both record and playback. Dimensions: 7 3/4 x 17 1/2 x 19 1/2 inches. Weight: 42 lbs. **\$499.50**  
Power requirements: 110v., 60 cycles A.C.

# HARVEY RADIO COMPANY, INC.

103 W. 43rd Street, New York 36, N. Y. • LUXemburg 2-1500

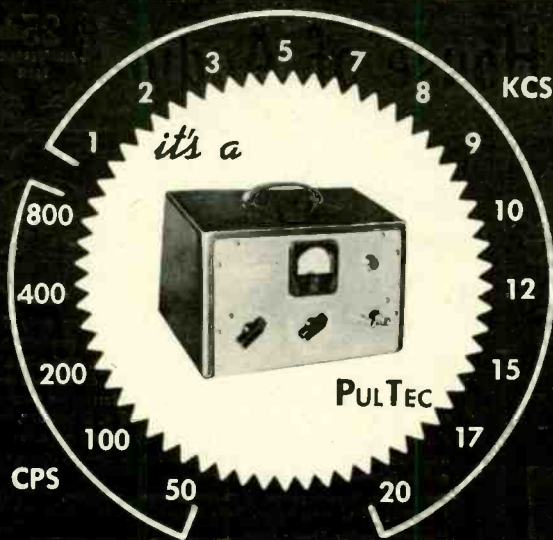

17 AUDIO FREQUENCIES  
at the  
TURN OF A SINGLE KNOB

*Constant amplitude*

FOR APPLICATIONS

requiring a reliable source of sine waves having excellent amplitude and frequency repeatability with low distortion, while at the same time being especially rapid and simple to use—

SUCH AS

- STUDIO AND RECORDING TESTS
- EQUALIZATION ADJUSTMENTS
- FIELD MAINTENANCE
- PROGRAM LINE CHECKS
- PRODUCTION RUN TESTS
- SUB-CARRIER CHECKS

*Repeatability*

SPECIFICATIONS

- TOROID coils in a stable L-C circuit.
- FREQUENCIES: As shown. Any 17 on request.
- STABILITY:  $\pm 0.2$  db over the entire frequency range.
- SIGNAL-TO-HUM: Over 70 db at all levels.
- DISTORTION: Under 1% at all frequencies.
- OUTPUT LEVEL: +8 dbm (2v rms) in 600 ohms.
- IMPEDANCE: 600 ohms, T-attenuator
- LOAD: May be 10 ohms to open circuit.
- WEIGHT: 7 pounds; 6" x 6½" x 10¾".
- PRICE: Net F.O.B. West Englewood, N. J.  
Model P-1, \$260.00 (No meter)  
Model P-1M, \$288.00 (with dbm/volt meter)

Please address Dept. 10 for full information or modifications to satisfy your special applications.

**PULSE TECHNIQUES, Inc.,**

*Electronic Design and Manufacture*

1411 PALISADE AVE., WEST ENGLEWOOD, N. J.

What do you say, record collectors, dealers, manufacturers? The impetus for a change must come entirely from you—this magazine is *not* in the record business. The first step towards improvement is bound to be an airing of constructive opinion, heated or otherwise, and there's no time like now. I'll be glad to have my speculations constructively demolished, in the interests of progress.

Final note: A letter from a record collector in Denmark, anent the February *Æ* article, suggests that sealed LP records may be expected as a matter of course there; the Danes don't appreciate "a cat in a bag"—merchandise of doubtful or concealed quality. My profuse apologies for stating that milk isn't safe in Europe; it is, at least in Scandinavia and Germany, though I ha' my doubts about some other countries. The Danes have sealed milk *and* sealed LP's.

**BATCH FOR ORCHESTRA**

• **Berlioz: Romeo and Juliet; complete orchestral score.** New York Philharmonic, Mitropoulos.

**Columbia ML 4632**

At the moment I'm ready to say this is the finest recording ever made—which merely means that I am rejoicing in the fact of a top-quality technical job, a wonderful piece of music, and an exceptional performance. This huge symphony is virtually never heard complete, with its many vocal movements between orchestral sections, but at least here is everything but the vocals. Parts—Fete at the Capulets, Romeo Alone, et cetera—are relatively familiar; other items are not.

Berlioz is a strange and difficult man to play well. A wild, moody, eccentric artist, he expressed the most original and highly personal feelings in terms of huge orchestra, with orchestral effects that were unheard-of at the time. He cannot be "just played"—even Tchaikowsky is relatively self-playing and automatic, compared to this music. It must breathe, palpitate, hesitate, gasp, swell with passion, shrink to nothing—and this via dozens and dozens of players! If you want an experience, then, see what Mitropoulos does to the Love Scene, and sample some of the most ideally balanced recording—for the type of music—that Columbia has yet achieved. Note especially the superb cello and violin playing and their recorded sound. Gummy? I wouldn't know; I only know that this is as near perfect recording musically as you'll ever hear. (Why is everyone talking about "gummy strings" these days? In some types of music—maybe. Not in this.)

• **Tchaikowsky: Mozartiana; Suite from "The Slippers".** Philharmonia Orch., Fishtouleri.

**M-G-M E 3026**

M-G-M continues its series of English recordings. This will be unfamiliar and intriguing Tchaikowsky to many who enjoy him. The Mozartiana, reflecting Tchaikowsky's rather sentimental idolization of Mozart, is a set of orchestral arrangements of Mozart movements—three quarters Tchaikowsky and a bit less than a quarter Mozart! If you know the originals you may squirm, but taken as pure T, the stuff is very fetching.

The Slippers is wholly new and nobody ever heard of it before, at least in these parts—which is no surprise in these days of LP premieres. An opera, and this is a derived suite. T thought it was pretty good as music; you'll find that it offers no surprises at all and a large slice of very expert ballet-style entertainment, not unlike Sleeping Beauty and the rest. No ranting and roaring here, as in the symphonies and tone poems. Good job of playing and of recording.

• **Elgar: Enigma Variations. Brahms: Haydn Variations.** NBC Symphony, Toscanini.  
**RCA Victor LM 1725**

This is a stunner! A concatenation of favorable factors converge here. First, musically speaking, there's something unique about Toscanini's Brahms (it applies to Elgar too) which brings to it all the warmth and sweetness that is lacking in his Beethoven, somehow leaves out the over-tense, over-fast drive that has alienated a few of us in many



Toscanini performances. I can't take his Beethoven—but the Brahms is tremendous. (These comments apply also to his recent Brahms symphonies for RCA.) If you have been a bit doubtful of Toscanini before this, give these performances a good try.

Secondly, we have here at last the combination of the new NBC Symphony sound, from Carnegie Hall, no longer dead and padded as of old but now full of life and liveness; and we also have the benefit of the New Orthophonic technique, which in RCA's case has really brought a fabulous improvement in technical quality. The New Orthophonic records are without a doubt in the running with the very best records from anywhere, which has not been the case for a good many years, according to my ear.

N.B. On the album cover the word "Toscanini" is printed in letters just twenty times as tall as "Brahms" and "Elgar." That's musical perspective for you.

**Ravel: Daphnis and Chloe; complete ballet. L'Orch. de la Suisse Romande, Motet Choir of Geneva, Ansermet.**

London LL 693

Yes, there's a chorus in this music. Here we have, not the suites #1 and #2 that are now quite familiar, but the entire original score, which includes a strange wordless chorus that wails and sighs in the background, blending so skillfully with the orchestra that you can't always be sure when it begins and ends. A lovely effect, rarely heard because of the difficulty of performance.

This is a nicely misty, live recording as the music requires for the most part. The sharp brass and extreme colors are softened—hi-fi listeners won't be as titillated as they might hope—but the atmosphere created is musically right. (It's a shame that, somehow, Ansermet's "Pelleas et Melisande," the Debussy opera, didn't come through via London's recording with this same live sound. Instead, that album apparently was done with a closer, deader, more literal quality of sound—and lost atmosphere accordingly.)

**Schubert: Symphony #7 in C Major ("The Great").** Vienna Philharmonic, von Karajan. Columbia ML 4631

An excellent performance of a great symphony—so much for the music. Of special interest here, however, is the anomalous recorded sound. We can wonder, sometimes, what goes on inside the complex mechanisms of big-company operation that could lead to this highly atypical disc which, if my ear is right, has not only an abnormally heavy bass (low turnover) but "flat" highs, without pre-emphasis—and this on the standard Columbia label.

I'd hazard a guess, as follows. In the first place, this may be from disc originals; the sound has an indefinable "disc" quality which immediately relates, in my mind at least, to the sound of vast numbers of older recordings in the shellac era. (If the original was taped, then I'm stumped.) A disc origin—perhaps in the early postwar period when large numbers of disc recordings were still made by English affiliates of Columbia—would explain a low turnover point, probably at 300 cps, and a flat high end with little or no pre-emphasis, since these curves were more or less standard in Europe in pre-tape days. This LP sounds as pre-war English discs sound. But why, then, must these effects appear on LP, when equalization in the transfer is possible?

One wonders, again. Is there a deliberate reason for leaving the heavy bass, the nonboosted highs that sound muffled with the usual LP playback? Or is this merely an illustration of official red tape of the non-magnetic sort? Does Columbia's right hand know what its (European) left hand is up to? Does the engineering department feel that in the absence of specific original curves a recording of this sort should be reproduced exactly as is, regardless of the sound to the ear? There are a hundred ways in which the discrepancy might get past, in the complex processing from original to final LP disc master—but one would think that, even so, an ultimate check by ear in comparison with Columbia's domestic output would disclose the difference at once.

Speculation on my part. If you think I must be wrong, go try the record and draw your own deductions. Just play it with AES, or worse, NAB playback settings, and see what happens.

Incidentally—for almost a century this has been entitled "Symphony number 7" with impunity, though some people obstinately call it number 9. But now look what has happened:



MODEL 50-R

**IT'S  
HERE!  
IT'S THE  
BEST!**

# FISHER

## FM-AM TUNER

■ We haven't the space here to give you *all* the details on the new FISHER 50-R. However, we can tell you *there is no other like it, anywhere, and at any price!* FEATURES IN BRIEF: Armstrong system, dual limiters, two IF stages, cascode RF stage, full limiting even on only 1 microvolt signal. Sensitivity, 2 microvolts for 30 db of quieting. AFC on switch and adjustable for locality. *Adjustable selectivity* on AM. Separate AM and FM front ends, fully shock-mounted. Response uniform, 20 to 20,000 cycles. Distortion less than 0.04% for 1 volt output. Hum level more than 100 db below two volts output. Cathode follower output. Fully shielded; bottom cover. Aluminum chassis. 12 tubes plus tuning eye and rectifier. **\$159.50**

*"The very best!"* —HIGH FIDELITY MAGAZINE

# FISHER

## PREAMPLIFIER EQUALIZER

■ "Either of these two units is of the very best," says *High Fidelity Magazine* of the FISHER 50-C Master Audio Control and 50-A Amplifier. The 50-C can be used with *any* amplifier. Intermodulation distortion is virtually unmeasurable. Complete phono equalization, loudness control, 5 inputs, 5 input level controls, cathode follower outputs. Self-powered.

Chassis, \$89.50  
With cabinet, \$97.50

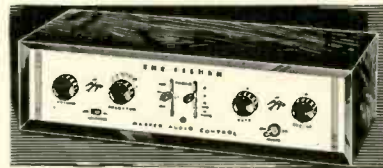

# FISHER

## 40-WATT AMPLIFIER

■ THE FISHER Laboratory Standard Amplifier Model 50-A is, beyond a shadow of a doubt, *the world's finest all-triode amplifier*—and yet moderately priced. FEATURES: High output—less than .3% harmonic distortion at 40 watts (.08% at 10 watts.) Intermodulation distortion below .8% at 40 watts. Uniform response within .1 db, 20-20,000 cycles; 1 db, 5 to 100,000 cycles. Hum and noise more than 96 db below full output. Quality components and beautiful workmanship throughout. **\$159.50**

Write for illustrated brochure

**FISHER RADIO CORPORATION**  
37 EAST 47th STREET • NEW YORK

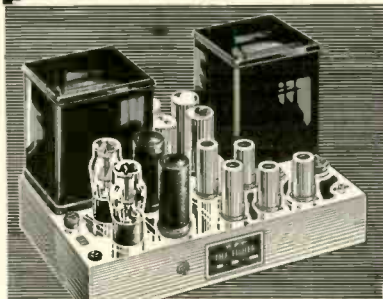

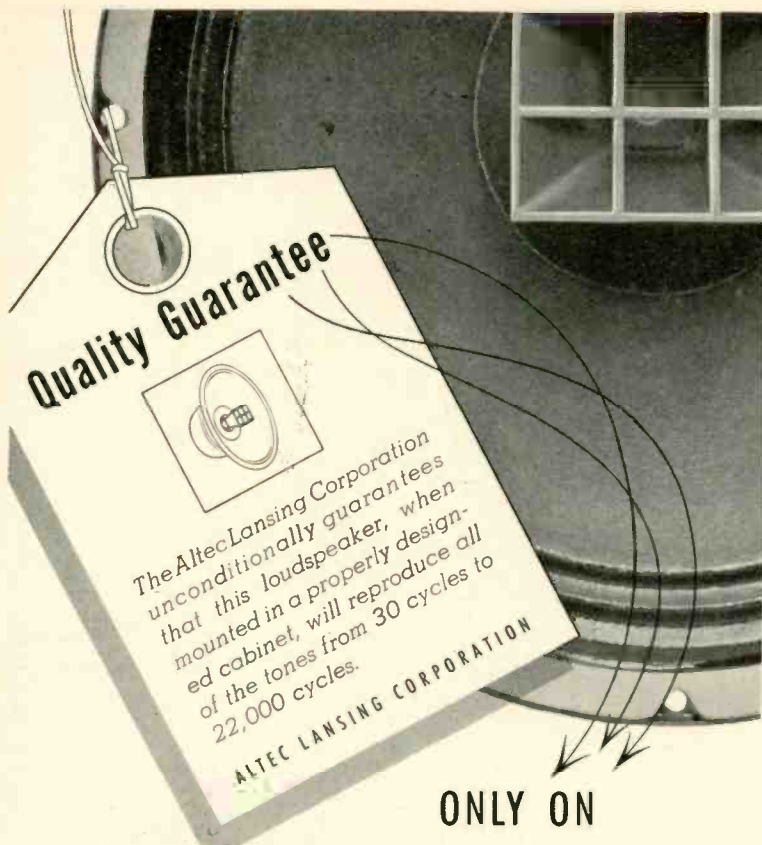

## ALTEC **DUPLEX\*** SPEAKERS

Altec Lansing Corporation is the only manufacturer that tests every loudspeaker in an acoustical laboratory to insure that the frequency response of each DUPLEX\* is held within 2½ db of the production standard throughout its entire range from 30 to 22,000 cycles.

This stringent quality control permits Altec alone to guarantee unconditionally the frequency range of every speaker.

**601A—12"**  
20 watts  
\$89.00  
with network

**602A—15"**  
20 watts  
\$114.00  
with network

**604C—15"**  
35 watts  
\$156.00  
with network

These DUPLEX\* speakers are the finest in the world. Hear them at your nearest Altec dealer's today.

\*Duplex: Mechanically and electrically independent high and low frequency loudspeakers mounted within the physical size of single frame.



9356 Santa Monica Blvd., Beverly Hills, Calif. • 161 Sixth Ave., New York 13, N. Y.

**Schubert: Symphony #7 in E Major. (arr-Weingartner). Vienna State Opera Orch., Litschauer. Vanguard VRS 427**

Here is the true symphony #7—written before the familiar "Unfinished," number 8, and left musically complete but unorchestrated by Schubert, who had a habit of going on from one unfinished project to the next. Actually, if you count the hypothetical "Gastein" symphony, also recorded by Vanguard and now a familiar item though previously unknown even in name to most of us, there are ten symphonies; the "Great" C major is number 10, not 7, nor 9!

This one is a miracle, considering that merely for lack of an orchestration it has been unheard for so long; it is a splendid work, midway between the big, weighty style of the last works, the "Unfinished" and the C Major, and the jaunty, light-footed manner of the earlier symphonies, numbers 1 to 6.

It will never cease to amaze me that we human beings can ignore our greatest treasures of art for centuries at a time merely because no one bothers to get around to them, because with our whopping sense of super-logic we put them aside as "unknown," in favor of the well established knowns. None of us have ever heard this work before and it most decidedly is, or was, unknown—but I can assure that it ranks right up among the top symphonies of any sort now available on records. It's beautifully played and Weingartner's carrying out of Schubert's sketched instrumentation is highly satisfactory.

### NEW AUDIO GROUP HAS FIRST MEETING

Record company executives, professional musicians, audio engineers, and amateurs interested in current audio developments, held their first meeting under the auspices of the newly formed Audio Club of Musicians and Music Lovers at 8 p.m. Sunday, April 19, at Carl Fischer Hall, 165 W. 57th St., New York City.

The first Audio Forum dealt with the topic, "The Musician's Approach to Audio." Among panel members who presented their views were David Sarser, audio equipment designer and violinist with the NBC symphony; Norman G. Pickering, engineer and director of research, Pickering & Co., and Charles Lichter, audio assistant to Andre Kostelanetz. The panel discussion was directed by Fred Grunfeld, music commentator of station WQXR.

Demonstrations included a live performance on stage of Bela Bartok's "Out of Doors" suite as played by pianist Leonid Hambro. Following the live performance, recorded versions of the same work were played on various sound systems. Members of the club and their guests participated in a listening experiment by registering reactions to the reproduction of these systems.

Members were told that they will be given a voice in the selection of future material for commercial recording. As an example, they were asked to comment on a new work now being considered for release, Michael Colicchio's "Fantasie" for violin and harp, which was performed by Elliot Magaziner and Gloria Agostini.

Mr. Pickering delivered a short lecture-demonstration on pickup design. The meeting was concluded with a period devoted to general discussion.

### ERRATUM

We are informed by R. H. Brown, author of "Hi-fidelity Phonograph Preamplifier Design" in the April issue of *AE*, of an error in the schematic Fig. 3, page 20. There should be a connection from the second 12AX7 plate to the line from 0.1-mfd. capacitor to bass compensation circuit.



## NEGATIVE FEEDBACK

(from page 30).

combinations of input and output circuits, even though the nominal impedances are all correct.

This effect can be divided into two parts: (a) the effect of external impedances on the characteristics of the feedback amplifier; and (b) the effect of the impedances presented by the feedback amplifier to the input and output circuits. From the present viewpoint, the former is the more important, and usually has the bigger effect. The feedback is calculated on the basis of constant resistances for input and output impedances, and with correct values of this kind the amplifier gives a wonderful response characteristic; but with a practical dynamic loudspeaker connected to the output, the load characteristic is quite different from a constant resistance, and the feedback loop may well be approaching its stability boundary, resulting in a pronounced peak in the response. Some amplifiers of this type confirm this fact by going into oscillation when the output load is disconnected altogether.

The author contends for this reason that a practical requirement for a good amplifier should be that it is completely stable, working into any load from open circuit to short circuit. This does not mean that it should be expected to deliver full undistorted output into impedances widely divergent from the nominal value. The nominal impedance should be within reasonable limits from the correct value, and then the inevitable deviations from nominal in the loudspeaker impedance frequency response (not to be confused with the loudspeaker's acoustic response) will not be likely to cause excessive variation in the amplifier from its nominal frequency characteristics.

This requirement would be difficult to meet, using large amounts of over-all feedback. For this reason the author recommends that feedback be taken over a shorter loop, including not more than two stages. This will avoid any possibility of interaction between input and output impedances directly due to the feedback loop. The difficulty is that it is not easy to employ the large amount of feedback over shorter loops because either the gain is insufficient, if feedback is taken from the output transformer secondary, or too much power will be absorbed from the plate circuit, if the feedback is taken from the primary.

One step to overcome this difficulty uses an output transformer either with tappings on the primary or a separate winding, in one of the circuits shown at Fig. 12. (This is shown single-ended for simplicity; in practice push-pull is used for high-quality work, using the same principles.)

Some single-stage positive current feedback can overcome deficiency of

# B&W Precise AUDIO TESTING

for designing, production checking,  
research or "proof of performance"  
FCC tests for broadcasters.

A low-distortion source of audio frequencies between 30 and 30,000 cycles. Self-contained power supply. Calibration accuracy  $\pm 3\%$  of scale reading. Stability 1% or better. Frequency output flat within 1 db, 30 to 15,000 cycles.

MODEL 200 . . . . . \$138



**AUDIO  
OSCILLATOR**

For fundamentals from 30 to 15,000 cycles measuring harmonics to 45,000 cycles; as a volt and db meter from 30 to 45,000 cycles. Min. input for noise and distortion measurements .3 volts. Calibration: distortion measurements  $\pm 5$  db; voltage measurements  $\pm 5\%$  of full scale at 1000 cycles.

MODEL 400 . . . . . \$168



**DISTORTION  
METER**

Combines RF detector and bridging transformer unit for use with any distortion meter. RF operating range: 400 kc to 30 mc. Single ended input impedance: 10,000 ohms. Bridging impedance: 6000 ohms with 1 db insertion loss. Frequency is flat from 20 to 50,000 cycles.

MODEL 404 . . . . . \$85



**LINEAR  
DETECTOR**

Speeds accurate analysis of audio circuits by providing a test signal for examining transient and frequency response . . . at a fraction of the cost of a square wave generator. Designed to be driven by an audio oscillator.

MODEL 250 . . . . . \$10



**SINE WAVE  
CLIPPER**

The instruments of laboratory accuracy

Bulletin AE-53 gives complete details

## Barker & Williamson, Inc.

237 Fairfield Avenue • Upper Darby, Pa.

For a Glorious  
**BIG TONE**

ON ANY STRINGED INSTRUMENT

*specify the Genuine*

**AMPERITE "KONTAK MIKE"**

THE ONLY NO-DISTORTION "KONTAK MIKE"



Anthony Antone, widely known as "the most versatile artist of the frets", is an enthusiastic user of Amperite Kontak Mikes.

Used with most amplifiers, including most electric guitar amps.

No changes in amplifier, instrument, or strings. Attached without tools.

The Amperite "Kontak Mike" improves the tone and volume of any Stringed or Fretted Instrument — also Pianos, Accordions, Harmonicas, etc. It is the only "Kontak Mike" that does not introduce peaks or distortion.

Model SKH, hi-imp..... List \$12.00

Model KKH  
(with hand volume control)..... List \$18.00

**AMPERITE  
STUDIO MICROPHONES**

at P. A. PRICES!

Ideal for **CLOSE TALKING**  
or **DISTANT PICKUP**

You can shout right into it, or stand away; in either case, the quality will be perfectly natural.

Model RBLG (200 ohms)..... List \$42.00

Model RBHG (hi-imp)..... List \$42.00



**AMPERITE CAROID  
DYNAMIC MICROPHONE**

Models PGH-PGL..... List \$32.00

**AMPERITE Company, Inc.**

561 Broadway • New York 12, N. Y.

In Canada: Atlas Radio Corp., Ltd., 560 King St., W., Toronto 2B

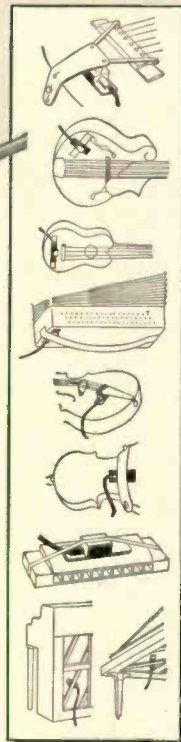

**SPECIAL OFFER:**  
Write for Introductory Offer, and 4-page Microphone Folder 53-M.

gain and provide impedance reduction. Positive current feedback could be used with the circuit of Fig. 13 to produce zero output source impedance without causing instability, provided the output is never short-circuited, but all positive feedback accentuates any distortion present. A compromise, using some positive current feedback combined with negative voltage feedback can achieve zero source impedance without excessive loss of gain, and with reasonable reduction in curvature distortion. The snag is that an extra winding is required on the interstage or driver transformer, and that for push-pull working the output transformer primary halves require to be separated at the center tap.

The extra winding on the interstage transformer is quite small, as it has practically no power to transfer, behaving in conjunction with the rest of the transformer as a current transformer of very high ratio, using the plate resistance of the previous stage to develop the fed back voltage at the grids. Having quite few turns, it can easily be wound on by hand with the older types of interstage job, where there is any room at all to spare.

Manufacturers already make lines of output transformer with provision for feedback, using either tappings or separate windings. It is suggested that drive or interstage types could also be introduced with a similar provision for the above purpose. The exact amount of positive feedback can be adjusted, where the number of turns is more than necessary, for the circuit used, by the arrangement shown in Fig. 14, without appreciably increasing losses anywhere.

**CONTOUR SELECTOR**

(from page 32)

system to satisfy his particular taste. Since there are still so many variables involved in high-fidelity system design, not the least of which is the fact that the amplifier may be used with any of a variety of loudspeaker combinations which differ widely in frequency characteristics, it is quite likely that the record equalizer setting may be used primarily as a point of departure for operation of the tone controls.

In the design of the DB20 we attempted to steer a safe course between the Scylla of not enough control for the sophisticate and the Charybdis of alienating his wife (who probably objected to investing in a hi-fi system when what they really needed was a new fur coat for her) by making the whole business of hi-fi too confusing. Our record equalizer was designed with this in mind, and we were on the point of simplifying the unit by providing either (but not both) a volume control or a so-called compensated loudness control when further study changed our thinking.

The Fletcher-Munson equal loudness curves, although they hold only for pure tones and not for the complex sounds



of music, definitely establish that some compensation for the losses of the ear at the ends of the audio spectrum is required as the volume of sound is diminished. Inexorably tied to the question of loudness is that of the physical nature of the room in which the listening is to be done.<sup>3</sup> Very few, indeed, of

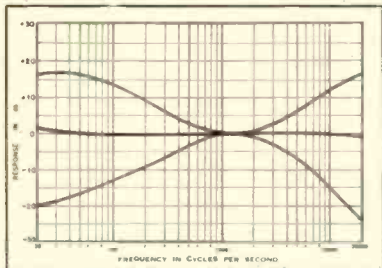

Fig. 5. Curves showing maximum ranges of tone controls.

those who listen to records or radio in their homes can possibly duplicate the conditions under which the record or program originated. The problem, then, is to evolve a system of loudness control which will adapt itself to a variety of listening conditions and yet be simple to operate.

#### The Difficulties of Continuous Loudness Control

The idea of designing a continuously acting compensated volume control under ideal conditions would be tempting, indeed. First, all we would have to do is assume the size and acoustical nature of the room in which the listening is to be done. Then we simply have to determine how many watts of acoustical power from the loudspeaker or speakers

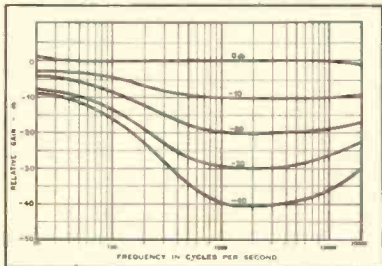

Fig. 6. Frequency response of amplifier for various positions of the Loudness Contour Selector switch.

are needed to produce a given loudness sensation. Knowing the efficiency of the speaker system our customer will choose, we could then determine the electrical power needed to produce the desired acoustical power. Now it is easy to adjust the inputs accordingly, and *voilà*, the loudness control operates perfectly. Unfortunately, the practicality of this method is dubious, at best.

If we wish to retain the continuous loudness control, another and more hopeful possibility presents itself, namely, giving the user an auxiliary method of control to adjust the volume

<sup>3</sup> G. A. Briggs, "Loudspeakers, the Why and How of Good Reproduction," pp. 57-60.



World's Toughest Transformers

**MOST WANTED FOR APPLICATIONS LIKE THESE—**  
Where **PRECISION** and **DEPENDABILITY** Count

#### Precision Audio Amplifier



This precision audio amplifier, designed and built by Summit Electronics, Inc., of Summit, N. J., is intended for highly accurate laboratory measurements or for high-fidelity home music systems. The unit combines high signal-to-noise and low distortion factors with high power output (distortion less than 1% at full rated 30 watts output). Uses negative feed-back on all stages. With high impedance output, response is flat  $\pm 0.2$  db over entire 30 cy to 15 kc range. **CHICAGO Sealed-In-Steel Power, Output and Input transformers** are specified throughout for the precise and dependable performance required of the instrument.

Specify  
**CHICAGO** for  
**PRECISION**  
**STABILITY**  
**RUGGEDNESS**

#### S-TYPE

Used in these equipments. Steel base cover fitted with phenolic terminal board. Convenient numbered solder lug terminals. Flange-mounted unit.



#### Video Distribution Amplifier

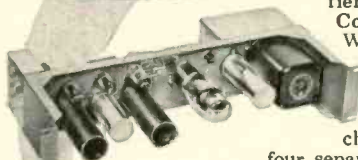

The VDA-2 Stabilized Distribution Amplifier is a product of General Communications, Fort Atkinson, Wisc. This rack-mounted video amplifier is designed to accept a video or pulse-type signal at its input and to supply the signal, unchanged in level or other characteristics, to a maximum of four separate channels. The VDA-2 is conservatively designed for maximum stability and continuous operation in TV broadcast service. To achieve absolute dependability, the filament transformer used is by **CHICAGO**. Where precision and ruggedness are required, you'll find **CHICAGO**—the world's toughest transformers.

#### Free "New Equipment" Catalog

You'll want the full details on **CHICAGO'S** New Equipment Line, covering the complete range of "Sealed-in-Steel" transformers for every modern circuit requirement. Write for your Free copy of Catalog CT-153 today, or get it from your electronic parts distributor.



**CHICAGO TRANSFORMER**

DIVISION OF ESSEX WIRE CORPORATION  
3301 ADDISON STREET, CHICAGO 18, ILL.



Export Sales Div.:  
Scheel International, Inc.  
4237 N. Lincoln Ave.  
Chicago, Ill., U.S.A.  
CABLE ADDRESS:  
HARSHEEL

*Yours for the Asking*

**FREE!!**

**COMPLETE VOLUME CONTROL  
and ATTENUATOR  
CATALOG SECTION**

as reprinted from Radio's Master

- Potentiometers • Volume Controls
- Attenuators • Rheostats

Send coupon today!



Represented in RADIO'S MASTER POTENTIOMETER and VOLUME CONTROL Booklet are the products of the following manufacturers:

**CLARISTAT**

**OHMITE**

**Centralab**

**MALLORY**

**SHALLCROSS**



Summary of Contents

- Controls
- Control Kits
- Exact Factory Replacements
- Audio Attenuators
- Rheostats
- Potentiometers

**MAIL TODAY**

**AUDIO ENGINEERING**

P. O. BOX 629, Mineola, N. Y.

Please send me, without cost or obligation, the **VOLUME CONTROL and ATTENUATOR** Booklet reprinted from Radio's Master.

Name .....

Address .....

City .....

to the point where the loudness control takes over. This can be accomplished by the use of separate gain controls for the various inputs—tuner, phono, tape, TV, and so on—so that each provides approximately the same signal level to the loudness control. This can be accomplished with a minimum of expense and complexity with screwdriver adjustments which can be properly set at installation, allowing the loudness control to function thereafter. Again we run into the ubiquitous problem of non-standardization in the recording industry. Record manufacturers display the same rugged individuality in the matter of recording level as they do in equalization curves. There are readily apparent audible differences in output level not only in records of the different companies, but even between records bearing the same label. This situation alone is enough to disqualify the screwdriver adjustment type of control as too seriously limited.

**The Loudness Contour Selector**

A new line of approach was obviously in order, resulting in experimentation leading to the Loudness Contour Selector, which is used in conjunction with a conventional gain control. Five step type positions are provided, designed to approximate the Fletcher-Munson curves, with steps of approximately 10 db at 1,000 cps. (See Fig. 6.) As a guide to simple operation by the uninitiated, the control positions are also labeled "Soft," "Medium" and "Loud."

It operates as follows: The user selects a contour suitable to the general level at which he proposes to listen, and then adjusts the actual volume level accordingly by means of the volume control. If he later wants to listen at another level, he can either adjust the volume control or choose a new contour or both. Since the LCS operates to provide a flatter curve at the louder position, the actual output of the amplifier increases as the control is turned in that direction.

The value of this system is immediately apparent both at extremely low and at moderate levels since good compensation can be obtained without the boominess which is encountered when only a single, poorly calibrated, control of the compensated type is used. Our experiments have indicated that even when set for one particular level of output and calibrated with reasonable correctness, the compensated type of control loses its calibration when turned to another level.

The problem of providing good sound without an overly complex system of controls promises to be with us a long time, probably to an increasing degree as more and more audio fans are recruited from among the non-technically minded. We feel, however, that the DB20, with its relatively few controls, simple and logical operational procedures, marks an important step toward a solution.



## PATENTS

(from page 6)

same as that of Fig. 1, with the addition of a cathode-follower input stage. The control circuit includes a triode amplifier (half of the first 6SN7-GT) and a 6H6 rectifier. The 0.5-megohm potentiometer is the expansion control. The time constant of the rectifier—which determines the speed of expansion—is determined by capacitor *C*, which may be altered to suit taste.

Figure 3 is a practical diagram for a compressor. Note here that the power supply of 250 volts has a tapped bleeder *R<sub>1</sub>-R<sub>2</sub>* across it, with ground at the tap point. This gives a voltage negative to ground for biasing the bridge tube. The entire supply voltage is 250 volts, which means that the voltage to ground is less than that for all the tubes. No negative feedback is included in Fig. 3. In Fig. 2 resistor *R* controls the amount of negative feedback; it may be enlarged if more gain is needed or if there is trouble with regeneration, or it may be omitted entirely, along with the .05- $\mu$ f blocking capacitor. The control voltage for the compressor is taken from the circuit output rather than the input to give an equilibrium action. The control circuit functions as a kind of feedback loop to keep things under control.

Push-pull expanders and compressors are also possible with this circuit idea. They give even less harmonic distortion and eliminate a slight tendency for the compressor circuit to thump, a common compressor trouble. The actual circuits are given in the patent. The trick is merely to duplicate the signal circuit and apply split-phase voltages from a phase splitter or previous push-pull stage to the two mirror-image signal paths.

A copy of this or any other patent may be obtained for 25 cents from The Superintendent of Patents, Washington 25, D. C. Many libraries also keep copies of all patents as well as of the Official Gazette of the Patent Office, which once each week lists and describes briefly all the patents issued.

## COMING EVENTS

May 18-21—1953 ELECTRONIC PARTS SHOW. Conrad Hilton Hotel, Chicago.

May 20-22—SOCIETY OF PHOTOGRAPHIC ENGINEERS' Third Annual Conference, Hotel Thayer, West Point, N. Y.

August 19-21—WESTERN ELECTRONIC SHOW AND CONVENTION, sponsored jointly by WCEMA and Western Sections of IRE. Municipal Auditorium, San Francisco, California.

September 1-3—INTERNATIONAL SIGHT AND SOUND EXPOSITION, combined with the CHICAGO AUDIO FAIR. Palmer House, Chicago, Ill.

October 14-17—Fifth Annual Convention of the AUDIO ENGINEERING SOCIETY, and THE AUDIO FAIR. Hotel New Yorker, New York City.

*a stirring event for the Audio Connoisseur*

**NOW you can hear the difference, you can see the difference in the new *Rauland* 1826 ultra-fidelity ensemble**



with the amazing new LIBRETTO remote control-preamplifier

More than 25 years of audio engineering skill and design ingenuity are embodied in the new RAULAND 1826 Ultra-Fidelity amplifier ensemble. The Master Amplifier is of unprecedented quality. The laboratory instrument tests of performance are a revelation, but the ultimate proof of superiority is in the thrilling listening experience. The completely unique self-powered "Libretto" Remote Control with its amazing flexibility and rare custom styling is an ingenious innovation. Specifications for the RAULAND 1826 Ultra-Fidelity ensemble appear below—the facts speak for themselves.



the master amplifier

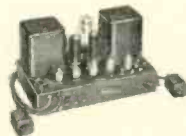

Rated Power Output... 20 watts  
 Frequency Response...  $\pm 0.3$  db, 20 to 40,000 cps at rated output  
 Harmonic Distortion... less than 0.5% at rated output, less than 0.3% at 10 watts  
 Intermodulation Distortion... less than 0.3% at 1/4 watt (home level), 0.7% at rated output—measured at 60 and 7,000 cycles, 4 to 1 ratio  
 Hum and Noise Level... 80 db below rated output  
 Output Impedance... 8 and 16 ohms  
 Input Selector... 4-position on 5-ft. extension cord: No. 1, magnetic pickup; No. 2, crystal pickup; Nos. 3 & 4, auxiliary.  
 Input Voltage... 0.5 volts for 20 watt output  
 Tubes... 2-12AX7, 1-12AU7, 2-6AL5, 2-6L6, 1-5U4G, 1-5Y3GT  
 Dimensions... 14" x 9" x 8" high  
 AC Power Switch... on 5-ft. extension cord

Custom-Engineered, Custom-Styled for Audio Connoisseurs

See the RAULAND 1826 Ultra-Fidelity ensemble with the unique "Libretto" remote control at your Hi-Fi dealer. Write for full descriptive details.



the LIBRETTO remote control



Uniquely fashioned in the form of a lavishly bound book, in rich Morocco leatherette with metallic gold-finished backbone and sides. Backbone lifts on piano hinge to give access to convenient tuning controls. Can be operated in either horizontal or vertical position. The LIBRETTO is a true remote control, completely self-powered, and capable of operation up to several hundred feet from the amplifier. The unit is amazingly compact—no larger than a book—only 8 3/4" x 11" x 2" thick. Uses 3-12AX7 tubes. Complete with 7' power cord and 7' connector cable and plug.

### CONTROL FUNCTIONS:

- No. 1. Bass Tone from +24 db to -20 db at cps (dial calibrated in db)
- No. 2. Treble Tone from +18 db to -30 db at 10,000 cps (dial calibrated in db)
- No. 3. Crossover Control: Flat, 150, 300, 450, 700, 1000 cycles (with chart for proper setting—see below)
- No. 4. Roll-off Control: Flat, -5 db, -8db, -12 db, -16 db, -24 db at 10,000 cps (supplied with chart showing proper setting applicable to various records)
- No. 5. Volume Control—instant choice of conventional volume control or loudness control (bass and/or treble Fletcher-Munson correction individually, or simultaneously selective)

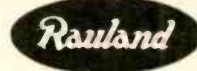

**RAULAND-BORG CORPORATION**  
 3515 W. Addison St.,  
 Dept. AD, Chicago 18, Ill.



SR Series Chandelier Baffles

## there's a **LOWELL** Speaker Baffle for ANY ceiling height

Overcome sound-system acoustical and installation problems... select speaker baffles from the complete Lowell line. Correct design, rigid construction, proper baffle loading and beauty combine to make Lowell speaker baffles the sound technician's first choice.

AL Series Flush Mounting Baffles for **LOW CEILINGS**. Available in six models for 6" to 15" speakers. Diffuser mounting through soft rubber grommets eliminates metallic resonance.



BL Series Speaker Baffles



AL Series Speaker Baffles

BL Series Surface Mounting Baffles for **NORMAL CEILINGS**. Five models for 6" to 12" speakers. Heavy gauge spun aluminum construction. Perfect speaker cone loading.

SR Series Chandelier Baffles for **HIGH CEILINGS**. Available in four sizes for 7" to 12" speakers. 18 gauge spun aluminum housing. Designed for railroad stations, etc.

Please write for specifications and prices.

### LOWELL MANUFACTURING COMPANY

3030 Laclede Station Rd.  
St. Louis 17, Mo.

In Canada: Atlas Radio Corp., 560 King St., West, Toronto, Ontario

### IF YOU ARE MOVING

Please notify our Circulation Department at least 5 weeks in advance. The Post Office does not forward magazines sent to wrong destinations unless you pay additional postage, and we can NOT duplicate copies sent to you once. To save yourself, us, and the Post Office a headache, won't you please cooperate? When notifying us, please give your old address and your new address.

Circulation Department  
RADIO MAGAZINES, INC.

Mineola, N. Y.  
P. O. Box 629

## NEW LITERATURE

● **Mark Simpson Mfg. Co., Inc.**, 32-28 49th St., Long Island City 3, N. Y. recently announced availability of Catalog CM-53, which describes in detail the new Masco "Concert Master" 20-watt high-quality amplifier with remote preamplifier. Will be mailed free upon request.

● **Ampex Electric Corporation**, 934 Charter St. Redwood City, Calif., is distributing a handsomely-prepared booklet which is designed as a non-technical presentation of the Ampex line of tape recorders and accessories. It is intended primarily for the general information of distributors and others interested in the tape recording.

● **The Middletown Manufacturing Co.**, 27A Stock St., Middletown, Conn., will mail free on request the finest catalog listing of metal chassis, cabinets, racks, and panels for electronic equipment that this desk has observed. File-size, Catalog 53 represents an excellent example of coordination between illustrations and descriptive copy. Highly recommended for those who use items of the type listed in their business.

● **Bakelite Company**, 300 Madison Ave., New York 16, N. Y., sets forth new information about the properties, applications, and methods of fabricating Bakelite polyethylene plastic in a handsomely illustrated and clearly written 24-page booklet. Two new data tables show the relatively high permeability of polyethylene film to oxygen and carbon dioxide and its low transmission of water vapor when compared to film of other materials. Properties of the material are described in detail, as are methods of fabrication—extrusion, calendaring, molding, casting, and coatings. Will be mailed upon request.

● **Bud Radio, Inc.**, 2118 E. 35th St., Cleveland 3, Ohio, presents descriptive and pricing information on a wide range of low-priced speaker housings for use in hospitals, restaurants, schools, and similar locations, in a four page folder which will be mailed on request. Included are housings for conventional wall and ceiling application, as well as models for recessed mounting in either old or new construction.

● **Minnesota Mining and Manufacturing Co.**, 900 Fauquier St., St. Paul 6, Minn., shows detailed drawings of output-versus-bias-current curves for Scotch brand magnetic recording tapes in "Sound Talk" Bulletin No. 21. Included are graphs on which are shown the curves of 12 different tapes, representing four basic tape constructions. Available upon request.

● **Eutherford Electronics Co.**, 3707 S. Robertson Blvd., Culver City, Calif., describes its new Model B-2 Pulse Generator in a new 6-page illustrated brochure. The B-2 is a general purpose instrument which produces pulses of accurately controlled widths, amplitude, and time delay at low impedance. Also it offers exceptionally high repetition rates, fast rise times, and narrow pulse widths. This is an exceptionally fine piece of descriptive literature, answering thoroughly all the pertinent questions of prospective users.

● **Dow Corning Corporation**, Midland, Mich., describes Silicone Varnish 994 in a preliminary data sheet which will be mailed on request. Recently developed, Silicone Varnish 994 establishes a new high in heat endurance among electrical insulating resins. Designed for coating glass cloth and sleeving and for bonding glass-mica combinations, it has more than three times the dielectric life of silicone varnishes now in commercial use. Initial dielectric strength is in the range 1600-1900 volts per mil, with 65 per cent of the strength still retained after 2000 hours at 250° C.

● **M. E. Cunningham Company**, 1025 Chateau St., Pittsburgh 33, Pa. describes and illustrates a wide variety of marking tools and devices in Catalog No. 100, one of the more lucid and complete publications to reach this desk in many months. Included are photographs, descriptive material, and ordering information which leave nothing to be desired. If you use marking tools in connection with your work, this catalog is a virtual necessity.

## MEASURE

### YOUR PHONOGRAPH'S PERFORMANCE

(no test instruments required)

**PHONO-TEST D-100** is the first of a series of test records offered by **THE DUBBINGS CO.**... Basically a Re-recording Service, we have always believed that a need exists for a reliable test disc. This new 12" long playing record is the result of our intensive research...

(look for this cover)

### HIT OF THE '52 AUDIO FAIR!

Now you can check:

**TRACKING • WOW • RUMBLE** with confidence in the signal source. Added feature: 13 bands of frequency response, 30-12,000 cps.



WRITE US FOR THE NAME OF YOUR LOCAL DEALER

or mail this coupon to:

**THE DUBBINGS CO.** • DEPT. AE-53  
41-10 45th STREET, LONG ISLAND CITY 4, N. Y.

ENCLOSED  CHECK  M. O. IS FOR:  
 **PHONO-TEST D-100** @ \$3.50, add \$ .50 postage

**FREE** Information on Re-recording Services

NAME.....

ADDRESS.....

ZONE (please print)



# PUSH-PULL THEORY

(from page 20)

of the lower triode, is negative with respect to the plate of the upper triode. The voltmeter needle meanwhile has moved over to the opposite side of the scale. The direction of current flow through the earphones is now from the plate of  $V_2$  to the plate of  $V_1$ . (or exactly in the reverse direction from what it was at 90 deg.)

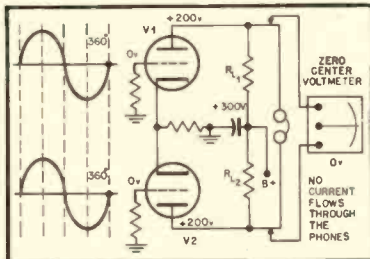

Fig. 8 The voltage picture at the end of the cycle—the 360-deg. point.

At 360 deg., we are back for the third time during this single cycle of the input signal to the voltage distribution pattern of the zero-signal state; i.e., where the same voltage exists at each plate with respect to ground. There is no potential difference from plate to plate, and there is a zero reading on voltmeter  $E$  and no flow of current through the phones.

Table I summarizes the situation for a pair of normal, out-of-phase push-pull input signals.

In short, without the use of the conventional push-pull output transformer, we have turned a pair of push-pull input signals—each 1 volt in amplitude but opposite in phase—into a single output signal having an amplitude of 28 volts.

We have chosen only five finite instants during the one cycle for this demonstration, but if we were to ex-

amine the output voltage pattern of the push-pull stage at every possible instant during a cycle, we would discover that the shape of the changing voltage across the push-pull plates is a sine wave—a sine wave, incidentally, having a peak-to-peak amplitude of 28 volts. (See Fig. 9). A graph of the changing current flowing through the headphones would likewise yield a sine wave.

Further, were it not for the factors of mechanical inertia and deliberate damping in meter design—with the consequent inability of meter pointers to follow rapid changes in input voltage—the zero-center voltmeter would describe an oscillating motion like that of a pendulum. And as everyone who has studied physics knows, the motion of the latter set down on paper in the form of a graph, has the form of a sine wave.

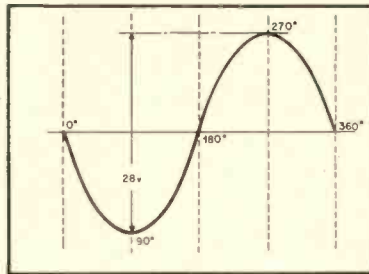

Fig. 9. The voltage waveform which appears across the headphones. Its amplitude is twice as great as the voltage swing between either plate and ground.

So far, we have examined what happens in a push-pull amplifier when two sine-wave signals—identical in frequency, shape, and amplitude, but opposite in phase—are fed to the grids of the tubes. In Part 2 we will examine the reasons for the cancellation of the even-order distortions which arise in the push-pull stage under consideration.

TABLE I

Summary of the voltage distribution pattern at five different instants for a pair of normal push-pull input signals—identical in wave form and amplitude, but opposite in polarity.

Phase angle of each input signal	$E_{\text{inst}}$ acting at the grid of $V_1$	$E_{\text{inst}}$ acting at the grid of $V_2$	$E_{\text{inst}}$ between the plate of $V_1$ and ground	$E_{\text{inst}}$ between the plate of $V_2$ and ground	$E_{\text{inst}}$ between the two plates	Which plate is positive with respect to the other?	Which way does current flow through the phones?
0°	0 v.	0 v.	+ 200 v.	+ 200 v.	0 v.	Neither	No flow
90°	+ 1 v.	- 1 v.	+ 186 v.	+ 214 v.	28 v.	$V_2$	$V_1$ to $V_2$
180°	0 v.	0 v.	+ 200 v.	+ 200 v.	0 v.	Neither	No flow
270°	- 1 v.	+ 1 v.	+ 214 v.	+ 186 v.	28 v.	$V_1$	$V_2$ to $V_1$
360°	0 v.	0 v.	+ 200 v.	+ 200 v.	0 v.	Neither	No flow

You are  
the Maestro  
with the NEW

## Bogen DB20 HI-FI AMPLIFIER



featuring

The Most Complete  
and Versatile Control  
of Sound Reproduction  
ever offered!

### NEW LOUDNESS CONTOUR SELECTOR!

An exclusive Bogen control providing compensated frequency response to match any listening level.

### ALL-INCLUSIVE RECORD COMPENSATION!

Seven positions for LP, AES, MAB, AM78, EU78, FFRR and Popular records, cover all normal requirements.

### NEW WIDE RANGE TONE CORRECTION!

Individual treble and bass controls of remarkable flexibility. Bass control +17 db to -18 db at 40 cps. Treble control +15 to -21 db at 15 kc.

### FOUR-POSITION INPUT SELECTOR

Provides complete selection of matched inputs for Magnetic Phono, Radio, TV and Tape Recorded program sources.

—plus the finest overall  
performance ever offered  
at a popular price!

The DB20 embodies all the advanced design features that have made BOGEN a by-word for quality. Power output is 20 watts with 5 feedback loops and partial cathode loaded output reducing distortion to a low, low 0.3%. Frequency response is 20 to 20,000 cps  $\pm 0.7$  db. D.C. on preamp filaments reduces hum to -75 db.

WRITE TODAY FOR BULLETIN F5



DAVID BOGEN  
CO., INC.

29 NINTH AVE., NEW YORK 14, N. Y.

A Quarter Century of  
Electronic Specialization

# NEW PRODUCTS

• **Self-Timing Leader Tape.** Many times stronger than paper, the new self-timing leader tape now being manufactured by Audio Devices, Inc., 444 Madison Ave., New York 22, N. Y., is made of a durable white plastic material which can easily be marked with pencil or ink. When used



with standard quarter-inch magnetic recording tape, it serves as a threading leader, protective outer wrap, and as a spacer for identifying and spotting of recorded selections within a reel. Spaced markings 7½ ins. apart provide a simple method of timing at all standard tape speeds. Available through Audiotape distributors in 150-ft. rolls, individually packaged in a self-dispensing container.

• **Lapsed-Time Indicator.** Limited panel space required makes the new Marion 2½-in. lapsed-time meter ideal for installation in standard or portable equipment. In the audio field its uses include checking wear

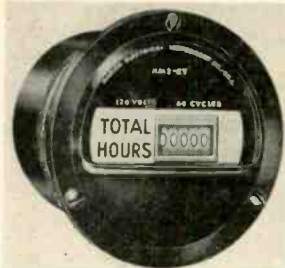

vs. use time for pickup styl and tape recording heads. It is available in one-tenth-hour steps to 9999.9 or one-hour steps to 99999. Self-starting synchronous motor is housed in drawn steel case which provides magnetic shielding. Marion Electrical Instrument Co., Manchester, N. H.

• **Household Circuit Breaker.** Short-O-Matic is the trade name of a device which prevents a short circuit from passing through the receptacle in which it has been placed, thus eliminating the need for



changing remote fuses because of appliance failure. In use Short-O-Matic is inserted into an electrical outlet, and equipment cords in turn are inserted into the female outlet of Short-O-Matic. When a

short occurs, instant disconnection takes place. Manufactured by Aldane Industries, Inc., Woodside, N. Y.

• **Eight-Hour Continuous Tape Player.** Growing importance of continuous background music in industrial and amusement fields is reflected in the new Ampex Model 450 tape playback machine. Capable of providing up to eight hours of program material without repetition, the machine will repeat the entire cycle as many times as desired without attention. Using pre-recorded tape at a speed of 3¼ ins./sec., the standard 450 has a frequency range which extends to 7500 cps. Another version, available on special order, operates at 7½-in. tape speed with frequency range to 15,000 cps, and affords continuous playing time of four hours. Maximum playing



time is afforded through use of 14-in. reels containing 4800 ft. of tape. Smaller reels may be played when desired for shorter repetition cycle. The 450 requires dual track recordings, with upper and lower tracks recorded in opposite directions. At the end of each four-hour program, a subsonic tone is recorded which operates the reversing mechanism. Complete details available from Ampex Electric Corporation, 934 Charter St., Redwood City, Calif.

• **Unfinished R-J Speaker Enclosure.** Although identical in performance and dimensions with standard floor-model R-J enclosures, the new model S-15-U is supplied in smooth-sanded unfinished mahogany, thus permitting purchasers to cus-



tom-match the furniture of their choice. Manufacturing economy is reflected in reduced price. Fine-furniture construction inherent in standard R-J models is also present in the new S-15-U. Information and literature may be obtained from R-J Audio Products, 164 Duane St., New York 13, N. Y.

• **Broadcast Transmitter Remote Control.** All FCC requirements are met in the new remote control system for AM and FM transmitters recently introduced by the Rust Industrial Company, Manchester, N. H. The equipment consists of a studio



unit and a transmitter unit connected by two lines. Up to nine remote meter readings can be made and up to nine operations controlled by simply dialing desired functions. Transmitter adjustment is made remotely while observing readings of appropriate meter. Through use of the equipment, station operating costs are lowered considerably due to reduction in personnel requirements.

• **Wow Meter.** Designers of recording and reproducing equipment, as well as servicing organizations and commercial users, will welcome the new Model 115-RA wow meter now being produced by Furst Electronics, 3322 W. Lawrence Ave., Chicago 25, Ill. Special attention has been paid the location and simplicity of panel controls so that the instrument will have equal usefulness in engineering laboratories, and on production lines where operation will be in the hands of unskilled personnel. Selector switch affords full-range sensitivity of 0.2, 0.5 and 2.0 per cent with linear meter scale. Descriptive sheet is available from the manufacturer.

• **Drive-In-Theater Replacement Speakers.** Designed especially for outdoor theater use, two new Permoflux speakers, with respective cone diameters of 4 and 5½ ins., are fully treated to withstand the effects of heat, humidity, rain, and other climatic



conditions which adversely affect speakers in outdoor installations. Cones are both water- and fungus-proof. Larger-than-normal gap insures against failure due to voice coil rubbing. To restore full sensitivity to the larger gap, a 1.47-oz. magnet is used in place of the 1-oz. size generally found in speakers of this size. Every metal part is given a dichromate treatment to prevent corrosion. Permoflux Corporation, 4900 W. Grand Ave., Chicago 39, Ill.



● **Record-Transcription Player.** Designed especially for small entertainment groups, the new Bell Model 2195 10-watt transcription unit contains three inputs—for microphone, musical instrument, and built-in phone—each of which has separate gain control to allow intermixing, such as is re-



quired for square-dance calling to recorded music. Tone controls are effective only of phono and instrument inputs, thus permitting control of musical background without affecting the quality of spoken announcements. The turntable may be operated at any speed from 30 to 80 r.p.m. A twelve-inch heavy-duty speaker is mounted in the removable lid and is equipped with 25-ft. extension cable. Frequency response of the amplifier is 30 to 15,000 cps  $\pm 1$  db and distortion is less than 3 per cent at rated power output. For further details write Bell Sound Systems, Inc., 555 Marion Road, Columbus 7, Ohio.

● **Variable Speaker Crossover.** Complete control of two-way and coaxial speakers is afforded by the new Scott 214-X8 variable speaker crossover. Entirely resistive-capacitive in circuitry, the 214-X8 is equipped with two controls. One provides

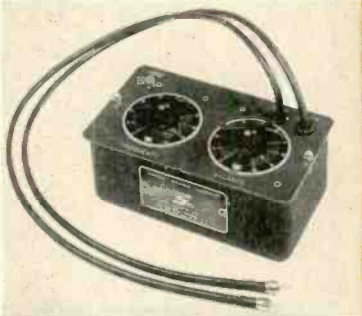

continuous adjustment of crossover frequency from 175 to 3000 cps, while the other allows control of acoustical balance for different speaker efficiencies. Free bulletin will be mailed upon request to between woofer and tweeter to compensate. Hermon Hosmer Scott, Inc., 385 Putnam Ave., Cambridge 38, Mass.

● **Comsol Alloy Solder.** Comsol is a soft silver solder with a melting point of 295 deg. C., approximately 115 deg. C. above



the melting point of average tin-lead alloys. Hitherto available only in ingot- or solid wire form it is now being manufactured

by Multicores Solder Ltd. of England in the form of standard Multicores solder. The new product is especially suitable for soldering processes in the manufacture of electric motors, projector lamps, and other products which normally operate at elevated temperatures. Comsol solder is used exactly as is tin-lead alloys, requiring no special technique or process. For samples and literature, write Dept. M, Multicores Sales Corp., 164 Duane St., New York 13, N. Y.

● **New Custom Converters.** Supplementing the famous Carter "Super" converters for which the company is well known in the electronics and communications industry, this new line of d.c.-to-a.c. "Custom" converters is available in 300, 400, and 500 watt a.c. output capacity, as contrasted with the 250 watt maximum capacity of the regular line. The new line is engineered for commercial and industrial applications requiring higher power output. The various models operate from battery power or line voltage of 12, 24, 28, 32, 64, 115, or 230 v. d.c. All "Custom" converters are available

with manual frequency control for professional broadcast recording, heavy-duty electronic measuring devices, and camera-tape recorder combinations which must be a.c. motor driven.



For full details and illustrated circular, write to Carter Motor Co., Dept. 6, 2640 N. Maplewood Ave., Chicago 47, Ill.

From Station Break to Feature... the NEW "BALANCED" TV Tripod is doing a whale of a job every day!

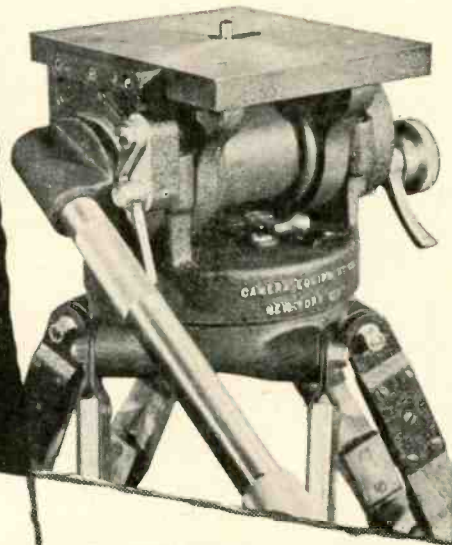

"BALANCED" TV TRIPOD mounted on 3-wheel portable collapsible dolly illustrated.



We THREW THE book away and engineered a brand new "BALANCED" Tripod for every photographic and video need. The result—a revelation in effortless operation, super-smooth tilt and 360° pan action.

PERFECT BALANCE prevents mishap if the lock lever is not applied. Quick release pan handle locks into desired position. Mechanism is enclosed, rustproof, needs no lubrication. Tension adjustment for Camera Man's preference. Built-in spirit level. Telescoping extension pan handle. We defy you to get anything but the smoothest, most efficient operation out of this tripod beauty.

WE CALIBRATE LENSES... Precision "T" STOP CALIBRATION of all type lenses, any focal length. Our method is approved by Motion Picture Industry and Standard Committee of SMPTE. Lenses coated for photography. Special TV coating.

WE RENT AND SERVICE CAMERAS \* MOVIOLAS \*

DOLLIES... Complete line of 35mm and 16mm equipment available for rental.

MITCHELL: Standard, Hi-Speed, BNC, NC, 16mm. Bell & HOWELL: Standard, Shiftover, Eyemos. MAURER: 16mm Cameras. ARRIFLEX. MOVIOLA: Editing machines, Synchronizers.

WE DESIGN and manufacture Lens Mounts and camera equipment for 16mm — 35mm and TV cameras.

FRANK C. ZUCKER  
**Camera Equipment Co.**  
1600 BROADWAY NEW YORK CITY

IF YOU WORK WITH FILM... It will pay you to get to know us. The country's foremost professionals depend upon our portable, versatile, adaptable equipment.

**Latest Hi-Fi Releases**  
in stock at **ALLIED**

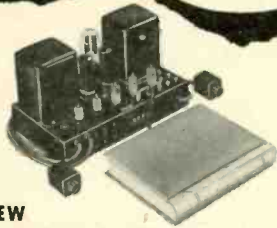

**NEW**

**Rauland 1826 Amplifier & Remote Control**

New, uniquely styled 20-watt remote-control high-fidelity amplifier. Self-powered remote-control unit is covered in rich, brown leatherette with gold trim—looks just like a beautifully bound book. Controls are accessible under hinged backbone. Remarkable authentic music reproduction, versatility and neat installation. Remote unit controls: Bass, Treble, Volume, 6-position Crossover, 6-position High-Frequency Cut-off. Also Input Selector switch and AC switch with separate remote-control cables. For 8 and 16 ohm speakers.

93-805. Net. . . . . \$232.26



**NEW McIntosh A-116 Basic Amplifier**

New 30-watt basic amplifier superseding the renowned 20W2—but at a new low price! A brilliant performer. Uses the famous McIntosh-patented output transformer. Exceedingly wide response— $\pm 1$  db, 10-100,000 cps at 15 watts;  $\pm 0.1$  db, 20-30,000 cps at 30 watts. Only  $\frac{1}{2}$  volt for full output. Output Impedance: 4, 8, 16 and 600 ohms.

93-895. Net. . . . . \$139.50



**NEW Browning RJ-42 FM-AM Tuner**

For the finest hi-fi systems. Only two panel controls (Tuning and FM-AM) to permit complete control of volume and tone with amplifier or remote preamp. Superb response and sensitivity—Armstrong detection and all-triode FM front-end. Automatic frequency control and drift compensation; AFC can be switched off. Cathode-follower output. AM whistle filter. 13 tubes, tuning eye and rectifier.

97-931. Net. . . . . \$166.50

**NEW! Scotch High-Output Tape**



MMM Type 120A Magnetic Tape—provides 8-12 db higher output, with no increase in distortion or noise and no increase in tape thickness. Output uniformity at 1 in. does not exceed  $\pm \frac{1}{4}$  db within a reel,  $\pm .5$  db from reel to reel. Splice-free, and "dry-lubricated."

No.	Size	Reel	1-11. EA.	12 or More, EA.
96-555	$\frac{1}{2}$ x1200'	Std. 7" (2 $\frac{1}{4}$ " hub)	\$4.67	\$4.20
96-558	$\frac{1}{2}$ x1200'	Prof. 7" (2 $\frac{1}{4}$ " hub)	4.34	3.90
96-556	$\frac{1}{2}$ x2400'	NARTB hub	8.67	7.80
96-557	$\frac{1}{2}$ x2400'	NARTB reel	10.57	9.51

**ALLIED RADIO**

833 W. Jackson Blvd., Dept. 17-E-3  
Chicago 7, Illinois

**COUPLED LOUDSPEAKERS**

(from page 23)

driver in the angular direction of a given point. This process is repeated at other points until the array pattern has been constructed. Obviously one must be furnished the primary pressure distribution patterns of the drivers taken under free field conditions.

It is not at all difficult to compute the pattern in the vertical plane, again knowing the primary patterns of the drivers used. More beaming takes place in the vertical plane. The writer did not use two drivers in each wedge (one above another) because the sound pressure pattern in the vertical plane would become too narrow even at relatively low frequencies, and the perfect symmetry of the array would be destroyed, as will be explained.

The multiple loudspeaker described in this article can be used with or without a tweeter. If four 12-inch drivers, such as the Western Electric type 728B or 754A are used, an excellent loudspeaker is obtained without the use of a high-frequency unit. For the initial tests the writer employed four WE 728B drivers in the wedges, and a WE 594A loudspeaking telephone with 31A horn for treble. The crossover frequency is 800 cps. One important asset possessed by this dual loudspeaker is that the sound pressure pattern in the azimuth plane for both the tweeter and woofer join smoothly at cross-over. Persons employing, for example, folded horns for bass like to forget about the problems arising from phase differences near the crossover frequency, abrupt discontinuities in the distribution pattern at crossover, and the phase difficulties associated with the sharp bends even at fairly low frequencies. None of these difficulties plagues the speaker described in this article.

Another feature of the coupled loudspeaker is its excellent mid-range response, i.e., response in the range of frequencies from say 300 to 800 cps. Apparently a folded horn works well only in the region from 30 to 300 cps. This necessitates crossing over at about 300 cps. But this is undesirable because it has been found an advantage, from the listening point of view, to have any effects due to out-of-phase conditions between the low- and high-frequency speakers come above the region of maximum energy transmission.<sup>3</sup> Evidently the use of a three-way speaker system, employing a folded horn for bass, does not obviate this difficulty.

**On the Choice of Acoustic Baffle Shapes for Multiple Loudspeakers**

Acoustic baffles having isosceles trapezoidal cross section have several highly desirable attributes. As pointed out in the last section, if four identical baffles are used, the angle between ad-

jacent speaker axes is only 22.5 deg., and if only one driver is installed in each baffle excellent angular dispersion of sound is assured. The choice of wedge-shaped baffles is important for other reasons. For one thing this array is symmetrical. If the four wedges are assembled in a corner formed by the floor and two rigid walls, the non-parallel sides of the enclosures cannot vibrate because there are no force differentials acting on them. The front panels are just wide enough to accommodate the drivers. These can be adequately braced. The back panel is only several inches in width. If it is properly secured to the non-parallel sides its vibration can be ignored. The top and bottom of each enclosure is small in area. The bottom certainly will not vibrate because of the load on it, and the top can be "held down" by a heavy tweeter.

The sides of a rectangular enclosure for several drivers will necessarily vibrate because the array lacks symmetry. This can be minimized only by construction of an enclosure of extreme rigidity.

Because of the symmetry of the wedge enclosures one can be certain that if identical drivers are installed in the four baffles that what one diaphragm does will be necessarily duplicated by the others at all frequencies. It does not follow that when four or more drivers (possibly of different sizes) are installed in a common rectangular enclosure that all cones will go in and out together at all frequencies. The mechanical constants of the diaphragm suspension system, the mass of the diaphragm and driving voice coil, the stiffness of the enclosures, and the coefficient of acoustic coupling between drivers may be of such value as to cause one diaphragm to move in irrespective of the fact that the polarity of the voltage applied to the driver terminals would normally cause the diaphragm to move out. This is not a new concept. In antenna array design it is not uncommon to measure a negative resistance at the terminals of one of the dipoles comprising the array. To achieve stability, i.e., minimize diaphragm slip, all multiple-loudspeaker enclosures should be compartmentalized and the drivers employed should be highly damped. The fact that highly damped identical drivers are used in the writer's multiple loudspeaker and that none of them is operated in a common enclosure insures that to within a few degrees all diaphragms do go in and out together. Observe that the use of wedge shaped enclosures is not optional. The symmetry afforded by this construction requires the acoustic forces acting on each diaphragm to be the same. These forces are not equal, for example, even when four drivers are operated in a compartmentalized rectangular enclosure.



sure. This fact may be verified immediately by applying the principle of acoustic images. It is a serious matter if any out-of-phase condition exists between diaphragms, because the chief purpose of a multiple loudspeaker is thereby lost; namely, that of achieving a good low-frequency performance. The phase relationship of the vibrating diaphragms can be checked by stroboscopic means, or by measuring the sound pressure pattern of the speaker in an anechoic chamber.

At first glance it might appear that a baffle of trapezoidal cross section lined with sound absorptive material would be more effective than the corresponding baffle of rectangular shape in damping out standing waves within the enclosure. Unfortunately, normal modes exist for trapezoidal shaped baffles as they do for rectangular, spherical, and other-shaped enclosures. The solution to this problem is to fill the wedge with small rectangular parallelepiped shaped blocks of fibreglas using strong perforated curtain material as a retaining wall to prevent the fibreglas from pressing on the driver diaphragm. The normal modes will now be damped out by the viscous drag of air particles oscillating in the small pores of the fibreglas and other absorbing material present. In addition the effective volume of the enclosure will be increased by the use of fibreglas because it can be demonstrated that a sound wave is propagated more slowly in fibreglas than in air. For a given frequency the wavelength of sound radiated from the back side of the diaphragm into the fibreglas filled enclosure is shortened; accordingly the inside dimensions of the baffle, in terms of the wavelength, are increased. The absorption of sound in a fibreglas filled enclosure is approximately an isothermal rather than adiabatic process. At low frequencies the effective volume of the enclosure is about 1.4 times the actual volume. At higher frequencies essentially free field conditions obtain on the back side of the diaphragm because no acoustic waves are reflected. Thus the enclosure may be regarded as one of infinite size. The impedance seen by the driver, looking into the enclosure, is the characteristic resistance of air. It is worth noting that at low frequencies very little power is radiated from the backside of the cone into the enclosure where it must be absorbed. This is because the baffle is small in terms of the wavelength, and the acoustic pressure is very nearly in time phase quadrature with respect to the particle velocity. Thus at low frequencies an enclosure may be represented as a lumped compliance (purely reactive element) in the equivalent acoustical circuit; a fact that is well known.

#### Construction of Multiple Loudspeakers

Baffles having the cross section of an isosceles triangle will serve equally as well as those having the cross section of an isosceles trapezoid. The angles of each baffle are fixed by the requirement

## The Connoisseur of Sound

SELECTS

DIACOUSTIC DEPENDABLE

DIAMONDS\*

for

R.C.A. - G.E. and other Reproducers  
Standard or Microgroove

Diacoustic Revolving Resharpen Service for  
Sapphire® Cutting Stylii

Custom Made and Guaranteed Under Capps Patents

Literature and Prices on Request

*Diacoustic Laboratory*

Since 1928

P. O. Box "P" Phone STate 4-0881

Encino, California

\*Synthetic

\*Genuine

NEW WILLIAMSON TYPE

## Heathkit AMPLIFIER KIT

### FEATURES

- Practically distortionless. Harmonic and Intermodulation distortion both less than one half of 1% at 5 watts.
- Frequency response  $\pm 1$  db from 10 cycles to 100 Kilocycles.
- Aftac Lansing PEERLESS or ACROSOUND transformers available.
- First Williamson type Amplifier supplied with matching preamplifier.

When selecting an amplifier for the heart of a fine high-fidelity audio system, investigate the outstanding advantages offered by the Heathkit Williamson type Amplifier. Here is an amplifier that meets every high-fidelity audio requirement and makes listening to recorded music a thrilling new experience through naturally clear, lifelike reproduction of sound at all tonal levels. Wide acceptance of the Heathkit Williamson type Amplifier by the most critical purchasers clearly demonstrates that high-fidelity can be coupled with low cost. For factual information regarding the Heathkit Williamson type Amplifier, consult "CONSUMERS RESEARCH ANNUAL CUMULATIVE BULLETIN 1952-53".

This outstanding amplifier is offered with the optional choice of the ACROSOUND output transformer or the PEERLESS output transformer. ACROSOUND features ULTRA-LINEAR circuitry, which is the exclusive development of the Acro Products Company and provides a greater margin of reserve power efficiency and increases power output. PEERLESS features additional primary taps to permit the optional choice of either the extended power circuitry, now enjoying current popularity, or all of the advantages of the original Williamson type circuit.

The construction manual has been simplified to the point where even the complete novice can successfully construct the amplifier without difficulty. Write for a free catalogue containing complete specifications and schematics of the Heathkit Williamson type Amplifier.



### PRICES OF VARIOUS COMBINATIONS

W-2 Amplifier Kit (Incl. Main Amplifier with Peerless Output Transformer, Power Supply and WA-P1 Preamplifier Kit) Shipping Weight 39 lbs. Shipped express only. **\$69.50**

W-2M Amplifier Kit (Incl. Main Amplifier with Peerless Output Transformer and Power Supply) Shipping Weight 29 lbs. Shipped express only. **\$49.75**

W-3 Amplifier Kit (Incl. Main Amplifier with Acrosound Output Transformer, Power Supply and WA-P1 Preamplifier Kit) Shipping Weight 39 lbs. Shipped express only. **\$69.50**

W-3M Amplifier Kit (Incl. Main Amplifier with Acrosound Output Transformer and Power Supply) Shipping Weight 29 lbs. Shipped express only. **\$49.75**

WA-P1 Preamplifier Kit only. Shipping Weight 7 lbs. Shipped express or parcel post. **\$19.75**

**HEATH COMPANY**  
BENTON HARBOR 25, MICH.

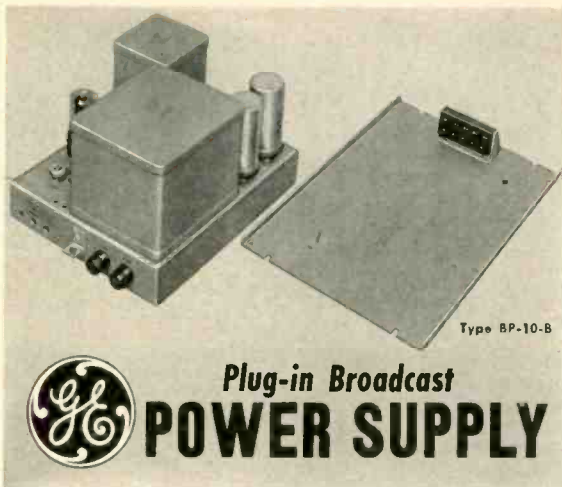

- POWER INPUT — 110/117/125 volts; 50-60 cycles.
- POWER OUTPUT —
  - D.C. — Adjustable to 300 volts with loads between 40 and 250 ma.
  - A.C. — 6.3 volts at 7.5 amperes.
- PLUG-IN DESIGN — simplifies maintenance.
- COMPACT... YET HIGHLY ACCESSIBLE.

The G-E Plug-in Broadcast Audio line includes:  
 BA-1-F      BA-12-C      BP-10-B  
 PRE-AMP    PGM/MON AMP    POWER SUPPLY  
 For information write: General Electric Company,  
 Section 4453, Electronics Park, Syracuse, New York

**GENERAL  ELECTRIC**

that four baffles must fit side by side in a corner. This fixes the angle between adjacent speaker axes at 22.5 deg. If three enclosures are employed this angle is 30 deg. which is probably excessive from the point of view of obtaining a good azimuth pattern at relatively high frequencies. If this three-speaker array is used as a woofer only, the 30-deg. angle between speaker axes is probably not too objectionable.

Driver specifications should be followed with regard to the required volume of each enclosure. Where the speaker system is used without a tweeter, the writer has found satisfaction with Western Electric Type 728B or 754A drivers. A smaller version of this multiple speaker could be made up using Western Electric Type 755A 8-inch drivers. Such a speaker would be about optimum for home use. Because of the 755's extended high-frequency response, no tweeters would be needed. Where the multiple speaker is used as a woofer only, experience has shown the Bozak B-199 to be a sound choice due to its low resonant frequency and correct damping.

The enclosures must be completely lined with Kimsul or other sound absorptive material. With certain drivers it is an advantage to fill the baffles completely with blocks of fiberglass 1 x 2 x 4 inches in dimensions. Type PF-314 fiberglass is recommended. The blocks of fiberglass will adhere to the Kimsul, thus preventing packing. Alternatively, to prevent packing the enclosure may be compartmentalized using cloth retaining walls. This treatment smooths out the speaker response, i.e., increases the speaker damping at low frequencies, and increases the effective volume of the baffle. It is recommended that fiberglass treatment be kept well clear of the diaphragm of the driver. The enclosures should be essentially air tight and no ports are permitted. The design should be such that the front panel is just wide enough to accommodate the driver mounted in the center. This insures close coupling of the drivers at low frequencies. The baffles will have to be approximately 4 ft. high in order to obtain the requisite volume. When they are set side by side and then jammed into a corner, excellent baffle effect is obtained. The polarity of each driver should be checked, using a small dry cell, before it is installed in its baffle. Naturally, the speakers are to be connected electrically so that all diaphragms operate in the same phase.

The series or series-parallel connection is recommended. It is worth mentioning that if four identical drivers having a nominal input impedance of 8 ohms are connected in series the nominal input impedance of the array is increased from 32 ohms to a somewhat higher value by virtue of acoustic coupling between drivers. This effect is not very pronounced when highly damped inefficient drivers are employed in a multiple loudspeaker, but is to be kept in mind when matching a highly efficient horn loaded driver to an amplifier. Readers are advised to conduct

*Introducing*  
**THE Self-Powered BROOK**  
**HIGH QUALITY AUDIO PRE-AMPLIFIER...MODEL 7**



**OTHER STANDARD BROOK AMPLIFIERS**  
 MODEL 10C4 30-WATT REMOTE CONTROL  
 MODEL 12A4 10-WATT REMOTE CONTROL  
 MODEL 4 PRE-AMPLIFIER

- ... BROOK know-how in transformer design paved the way to incorporate a power transformer in one chassis; yet, **HUM LEVEL IS MINIMIZED TO VANISHING POINT.**
- ... Ideally suited to any quality basic amplifier
- ... Famous BROOK 10-position stepped bass and treble controls; plus separate 9-position record playback control, equalized for virtually all records, offer the music and audio connoisseur an exceptionally wide range of flexibility in tone control.
- ... Five input channels for radio, TV or recorders; Including one channel to accommodate any type pickup; or microphone.
- ... In performance, the MODEL 7 offers the NATURAL, IMMEASURABLE TONAL QUALITY which built the BROOK reputation.

Write today for technical data on the complete line of Brook High Quality Audio Amplifiers; also name of nearest dealer. Dept. AF-3

**BROOK ELECTRONICS, INC.**

*First in the High-Quality Audio Field Since 1934*  
**34 DeHART PLACE, ELIZABETH 2, N.J.**



listening tests as an aid in deciding the best driver connections and the proper amplifier load taps. If incorrectly damped drivers are used, hangover effects are likely to be observed. This difficulty may be minimized or eliminated entirely by making a large felt washer for each driver with center hole of sufficient size to slip over the magnet frame. The periphery of the washer is secured to the front panel with carpet tacks. The air set in motion by the back side of the diaphragm must pass through the pores of the felt. Driver damping becomes, therefore, a function of the porosity and thickness of the felt used.

The baffles for the writer's multiple loudspeaker were made out of 3/4-in. plywood. The outside dimensions of each wedge are as follows:

Height—48 in.  
Width of front panel—14 3/4 in.  
Width of back panel—5-5/16 in.  
Slant depth—24 1/2 in.

These figures do not include the dimensions of the front panel frame.

A scaled drawing of the multiple loudspeaker is shown in Fig. 2.

The front panel of each wedge is removable, the other five sides being permanently secured. In the interest of obtaining a finished appearance it is desirable to construct frames to fit over the front panels as suggested by the drawing. A brass wire screen measuring about 13 x 36 in. should be stapled to the front panel to prevent accidental damage to the speaker cone, and then a suitable grill cloth tacked in place. If the frames have been properly recessed they will fit snugly over the edges of the grill cloth and wire. The frames may be secured to the front panels using small oval headed brass screws and brass cup washers that have been blackened by chemical treatment. Observe that different screws are used to secure the front panel to the enclosure and the frame to the front panel.

If wedges of trapezoidal cross section are constructed an air column will exist between the speaker and corner of the room. For enclosures 4 ft. high, resonance of this air column will occur at about 70 cps, and again at about 21 cps, etc. It should be filled with sound absorptive material. In making this elementary calculation no end correction for the pipe was applied.

#### Acknowledgment

The writer is indebted to Mr. H. F. Hopkins of the Bell Telephone Laboratories for making available certain information concerning multiple-speaker experiments carried out at the Murray Hill Laboratory.

The significant comments on the use of fiberglass in an acoustic baffle to improve speaker performance are due to Professor Jordan J. Baruch of the Massachusetts Institute of Technology.

Messrs. Theodore John Schultz, John Bouyoucos and A. A. Janszen of the Acoustics Laboratory, Harvard University, reviewed the manuscript and made useful suggestions for improvement.

## INDUSTRY LEADERS MEET—TALK OVER PROBLEMS

An informal conference of audio equipment manufacturers, their distributors, sales representatives, and advertising agencies was held recently at the Hotel New Yorker, New York City. The meeting was called through the offices of the editor of *AUDIO ENGINEERING*, to whom it had been suggested that the audio industry might explore the possibilities of creating an association for the purpose of coordinating effort in resolving industry problems.

It was agreed that existing organizations such as RTMA, AES, IRE, and NARTB are doing an excellent job, and that there is no present need for an additional association involving duplication of effort.

However, as a result of the meeting, Larry Epstein, sales manager, University Loudspeakers, Inc., was appointed chairman of a committee formed to examine industry problems and needs.

At a meeting of the committee on April 8, Mr. Epstein suggested that steps be taken to acquire, concurrently, factual data

and possibly statistics which would reflect the actual condition, trends, and attitudes of the various basic entities which go to make up the sound and hi-fi industry. He further stated that this was essential before any effort could be made to evaluate problems and seek their solution, and stressed the importance of complete objectivity if the work of the committee was to remain of value to the industry.

As a result of problems of industry-wide interest which had been brought to committee's attention, a sub-committee composed of industry leaders was appointed to carry out the survey program voted by the group.

Mr. Epstein stated that some arrangements had already been made to make available to the sub-committee the facilities of a number of trade publishers genuinely interested in helping the audio industry grow and prosper, and that he would welcome all other assistance which may be offered.

## No Competition...the Best!

*"Triumph"*

MODEL RC-80

Fully automatic  
with automatic  
stop!











INCOMPARABLY  
BETTER — YET  
PRICED TO COMPETE  
WITH THE ORDINARY!

# GARRARD

THE WORLD'S FINEST RECORD CHANGER

#### EVERY FEATURE TESTED FOR FINEST PERFORMANCE

<p><b>PUSHER TYPE PLATFORM:</b></p>  <p>It always works</p>	<p><b>TWO INTERCHANGEABLE SPINDLES</b></p>  <p>Plays records as intended</p>	<p><b>HEAVY DRIVE SHAFT:</b></p>  <p>No wows, no wavers</p>	<p><b>JEWEL MOUNTED TONE ARM:</b></p>  <p>Disturbing resonance eliminated</p>
<p><b>HEAVY DUTY SILENT MOTOR:</b></p>  <p>Absolutely no rumble</p>	<p><b>WEIGHTED TURNTABLE:</b></p>  <p>Gives flywheel action</p>	<p><b>MUTING SWITCH:</b></p>  <p>Silence between records</p>	<p><b>SIMPLE INSTALLATION:</b></p>  <p>Fits former Garrard cut-outs</p>

For complete information write to Dept. AE-5

**GARRARD SALES CORPORATION**

164 DUANE STREET, NEW YORK 13, N. Y.

THE  
R.T. **BOZAK** CO.

*Quality Loud Speakers*

introduces Model B-204

the first  
**BINAURAL  
SPEAKER  
SYSTEM**  
in one  
cabinet



The only Loudspeaker System designed for binaural and monaural playback with special acoustical separating filter and adjustable foldaway deflectors · Contemporary design in blond birch only · Traditional in dark mahogany · 36½ x 19½ x 33

Send for detailed information

114 MANHATTAN STREET STAMFORD • CONNECTICUT

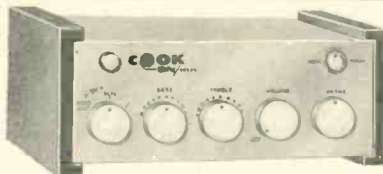

**NOW,**  
for the first time . .

**69<sup>50</sup>**  
net

A binaural preamplifier designed by COOK  
The new BN/mn dual purpose preamp.  
At no higher price than an ordinary unit

Built to the highest specifications, and engineered  
by the originators of the binaural record.

- Automatic built-in equalization for BN playback compensation.
- The finest for single-channel listening, too!
- Built-in 6 db/octave equalization down to 20 cps — 500 cycle crossover.
- Single unit ganged controls for volume, treble, bass (boost and droop).
- Focus control for balancing speaker volume levels.
- Channel reversing switch "puts strings on left."
- Selector switch provides for 2-speaker monaural playback.
- Cathode follower outputs for distortionless wide-range response.

**Build for BINAURAL now . . .**

It's no longer necessary to buy two of everything.  
Write for literature and specifications

**COOK Laboratories**  
114 Manhattan Street, Stamford, Conn.

## SOUND HANDBOOK

(from page 40)

Extension of the port inwards, forming a duct, increases the acoustical mass, thereby increasing the necessary cross-sectional area for the same frequency and enclosure volume. Dividing up the port area between smaller openings, as is done in the original patent specification, is entirely permissible, and has the advantage of increasing relative acoustic resistance. The port area may, as a matter of fact, consist of a large number of holes one half-inch or less in diameter. (Such a design suggests a simple method of progressively increasing port area). Further acoustic resistance may be introduced by tacking layers of cloth across the openings.

Considerations involved in the cabinet shape are the same as those for other type cabinets, discussed later in the chapter. For those who have had doubts about the irrelevance of enclosure shape to the Helmholtz frequency, the simple experiment referred to in Chapter 4, in which a partially filled bottle of water is stimulated acoustically by blowing across the top, is again suggested. The experimenter will note that the resonant pitch of the enclosure remains the same in spite of tilting the bottle at extreme angles. If the bottle is blown harder, however, air column resonance at a much higher frequency will be stimulated, and this higher pitch will vary with the changing angle of the water surface to the walls of the bottle.

### Tuning a Bass-Reflex Cabinet

The standard tuning procedure involves feeding an electrical signal from an audio signal generator and power amplifier to the speaker. A carbon resistor of 100 ohms or more is connected in series with one of the speaker leads to prevent electrical damping by the power amplifier during the test. (See Fig. 11—6.) The signal generator output is then varied over the range of frequencies close to speaker resonance, ordinarily somewhere below 100 cps.

The voltage directly across the speaker voice coil, which is an index of motional impedance and therefore of voice-coil velocity, is noted on an a.c. voltmeter or oscilloscope. When the enclosure has no port a definite voltage peak at a single frequency, the resonant one of the combined system, will be evident. With a port two smaller resonant peaks will appear instead. Adjustments of port size and/or enclosure volume are made until the two peaks are equal, indicating that speaker and enclosure resonances are matched. Damping is introduced by distributing the port area into narrow slits or holes, (increasing the viscosity of the total opening) and/or by tacking layers of burlap or similar cloth across the port. At optimum damping the voltage readings over the low frequency spectrum will have the least variation. It is the writer's experience that controlled



damping is at least as important as, and often more important than adjustment of port size, and that most enclosures will not perform properly with a simple opening even when tuned to the correct frequency. When port viscosity is optimum the exact matching of frequency becomes much less critical.

The above method of tuning has several disadvantages. An audio signal generator is not a common piece of equipment, particularly for the technician who is likely to be performing such a task. The procedure itself is painstaking and laborious, since it involves a frequency run after each adjustment, so another and simpler procedure is here described.

Optimum adjustment of the frequency and Q of the anti-resonant circuits will create a condition in which shock excitation of the speaker is followed by the least violent and least prolonged free vibrations. Each free excursion of the speaker is ideally opposed by an instantaneous countering pressure from the acoustical resonator. A method for tuning the bass-reflex cabinet has been suggested,<sup>3</sup> based upon the above principle, in which the speaker is shock-excited by the break of a simple d.c. circuit, and adjustments made from the quality of sound heard on release (whether it is a "tick" or a "boom"). The method is ingenious, but with these ears it was found to be extremely difficult, so much so as to be inaccurate. A visual method was therefore worked out by the writer, also based upon shock excitation and requiring no signal generator, which meets all of the objections enumerated above. Although the procedure uses an oscilloscope, the TV era has made this instrument fairly common.

The speaker is stimulated by a 6-volt battery, connected through a low-frequency circuit breaker, as illustrated in Fig. 11-7. Such a circuit breaker may consist of a modified common house bell, with the bell removed, the clapper weighted to reduce the frequency to about one-fifth the resonant frequency of the speaker system or lower, and the spacing adjusted for operation at the lower frequency.

When the d.c. stimulus is removed from the speaker the oscilloscope pattern is formed exclusively by the e.m.f. induced by free oscillations of the voice coil. Thus, if the oscilloscope is synchronized to the frequency of the circuit breaker, the pattern will be a stationary graph of the low frequency transient response of the mechanical-acoustical system. The bass-reflex cabinet may then be tuned and damped for optimum transient response, a characteristic or which the screen pattern proves a sensitive, instantaneous and reliable index. Figure 11-9 shows photographs of screen patterns made in this way. The improvement in transient response produced by insertion of the approximately correct inertance and viscosity into the acoustical system is evident from (1). (The beat effect of the two separated

<sup>3</sup> Benjamin B. Drisko, "Getting the most out of a reflex-type speaker," AUDIO ENGINEERING, 32, p. 24, July, 1948.

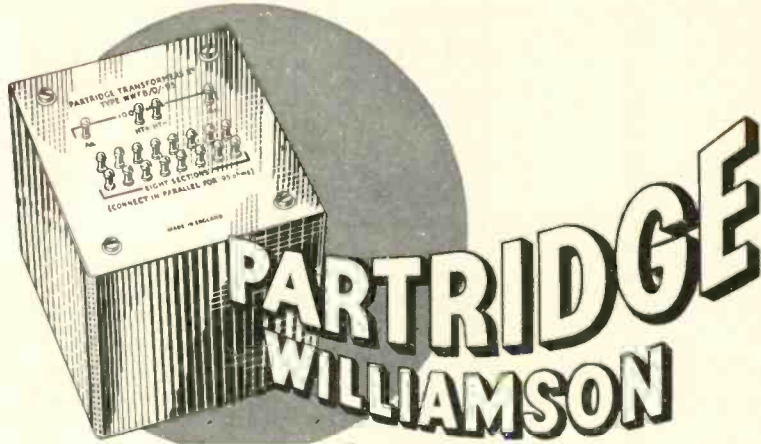

# PARTRIDGE WILLIAMSON

means

**AUTHENTIC WILLIAMSON PERFORMANCE**

**TYPE WWFB**

Individually tested. No WWFB leaves our works without being individually tested. Close limits set on shunt reactance at 50 c/s. Series reactance at 5 Kc/s; d.c. resistances and interwindings insulation resistances at 2 K.V.

Price  
**\$26.00**  
duty paid



Accepted as the most efficient output transformer in the world, and for which there is no U. S. equivalent, the Partridge Williamson Type WWFB ensures the performance intended by the designer. Covering the full audio range it has the lowest possible distortion. It is now available to all—off the shelf from all good jobbers. If in any difficulty write us and mention your jobbers name—Don't tolerate a substitute—get the transformer built for the job—the Partridge Williamson type

**AVAILABLE TO ALL IMMEDIATELY FROM STOCK**

**PARTRIDGE TRANSFORMERS LTD., TOLWORTH, SURREY, ENGLAND**

## -to Gratify Your Wish for Excellence



- SUPERB REPRODUCTION
- TECHNICAL SUPERIORITY
- HANDSOME STYLING
- OUTSTANDING PERFORMANCE
- EVERY OPERATING CONVENIENCE

### BOGEN R-701 FM-AM TUNER

The Model R-701 is a truly superb FM-AM radio receiver designed expressly for the discriminating listener. It provides a quality of performance so brilliantly real and so vastly superior to standard mass produced receivers that it must be heard to be believed. Handsomely styled for custom installation, it is easily adaptable to any wall or cabinet closure. Six position function selector switch, volume control, and separate bass and treble correctors centralize all operation on one panel . . . permit remote location of the audio amplifier.

**MODEL H010** — A superb all triode amplifier providing minimum distortion (less than 0.3% at 10 watts), maximum response (flat 10-50,000 cycles), tremendous dynamic range and overall balance. Ideal for use with the R701 Tuner.

**MODEL D010** — New popular priced Hi-Fi custom Amplifier, designed for use with the new R701 Tuner. Can be mounted directly behind the tuner in most installations. Ten-watts output at less than 1% distortion. Response flat 20-20,000 cps.

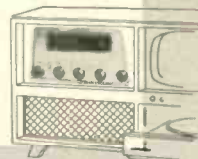

WRITE FOR LITERATURE  
**DAVID BOGEN CO., INC.**  
29 NINTH AVE., NEW YORK 14, N. Y.

*A Quarter Century of Electronic Equipment Specialization*

# Announcing THE "INVISIBLE MICROPHONES"



HEAD DIAMETER 3/4"

**SPECIFICATIONS**  
Frequency response  
Uniform—30—15,000  
cycles  
Source impedance  
200 ohms nominal,  
available in 50 ohms  
impedance.  
Output level  
-70 dbm re  
1mw/1dyne/cm<sup>2</sup>  
Directional  
characteristic  
Omnidirectional.  
Becomes unidirectional  
above 1000 cps when  
attaching baffle.

\$75.00 NET

DESK  
MODEL  
MD3T

**SPECIFICATIONS**  
Frequency response  
Uniform—30—15,000  
cycles  
Source impedance  
200 ohms nominal,  
available in 50 ohms  
impedance.  
Output level  
-70 dbm re  
1mw/1dyne/cm<sup>2</sup>  
Directional  
characteristic  
Omnidirectional.  
Becomes unidirectional  
above 1000 cps when  
attaching baffle.

FLOOR  
MODEL  
MD3  
STUDIO

\$75.00 NET

For information  
specifications and name of  
nearest distributors write to

**H. NEUBERGER**  
Room 1400

76 Eaver Street, New York 5, N. Y.

resonant peaks, each producing a small wave train of its own, is seen in the slight waxing and waning of the dying speaker oscillations.) The reason for the undeserved bad reputation which the bass-reflex cabinet has earned in many quarters is also evident, in the pattern of (D). The hangover note is radiated from both speaker and port.

Similar test results may be achieved with a square-wave generator, the standard instrument for measuring transient response, taking care to eliminate the effect of electrical damping by insertion of a carbon resistor between speaker and amplifier.

The author would like to express his appreciation to William R. Vollheim for aid with the oscilloscope pattern photographs.

Part II of Chapter 11 will follow next month.

## AUDIOLOGY

(from page 14)

### A Supplementary Method

Recently revised is a circuit developed abroad by A. D. Blumlein, patented in the U. S., No. 2,218,902, Oct. 22, 1940, in which the amplifier screen grid is connected to a tap on the primary winding of the output transformer, for various effects including improvement of amplifier linearity. The circuit principle, with arrangement for one form of feedback, is shown in Fig. 4. Depending upon the tube type and electrode potentials, the preferred tap position will be one-quarter to one-half the way from B plus to plate (taps on each side for push-pull operation).

With the screen tap between true pentode and true triode connections, one would expect intermediate operating character-

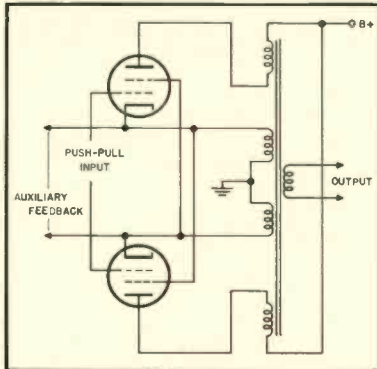

Fig. 3.

istics. As the tap position is varied, transition from pentode to triode is a smooth one, and no one tap location is best from all standpoints. For tube types 6L6 and 807, tap placement about 40% of the way from B plus to plate has been recommended as a good compromise.

Resulting variation of screen potential with signal is degenerative; the "feedback," however, is of calibrated rather than the more common closed-loop form. Thus the auxiliary influence upon output-transformer primary current is proportional to



## No Guess! No Skill!

Now, it's simple, speedy, sure to splice safety film the new electric "butt-welded" way without scraping, cement, brushes or drying out.

**Prestoseal splices magnetic film permanently in 10 seconds!**

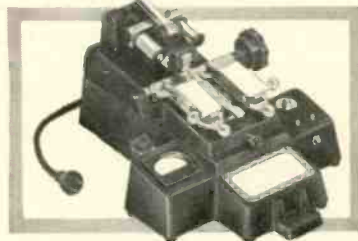

... replasticized! Eliminates drying out, no overlapping, no double thickness or distortion. Assures perfect frame alignment. No lights needed; splice lasts life of the film.

(Brochure on request)

**PRESTOSEAL** MFG. CORP.

3727 33rd st., Long Island City 1, L.I.

**Save! Save! Save!**  
Phenomenal savings and guaranteed satisfaction assured through amazing new merchandising plan. Write for complete details and list.

HI-FI GUILD, 45-E Grove Street, New York 14, N.Y.

### HI-FI WILLIAMSON TYPE AMPLIFIER KIT



Using STANCOR transformers. Easy-to-assemble amplifier kit. Comes with schematic and instruction sheet based on famous Williamson circuit. Frequency response 1 db. from 20-50,000 kc at 8 watts. Intermodulation distortion is only 3% at 8 watts output. Total harmonic distortion at 1000 cycles is non-existent below 10 watt power level.

**SPECIAL PRICE PER KIT \$44.95**  
Less Tubes  
TOTAL PRICE: \$52.75



**IRISH PLASTIC RECORDING TAPE**  
BRAND NEW! NOT SURPLUS. This First Grade recording tape is 1/4 in. wide. Frequency response: 50 to 8,000 cy. Plastic reel included with each.  
600 FT. \$1.35 1,200 FT. \$2.10

**FOR YOUR HI-FIDELITY REQUIREMENTS VISIT OUR NEW SOUND STUDIO.**

All orders F.O.B. Los Angeles. Minimum order \$5.00. 25% deposit required with order.

**OLYMPIC ELECTRONICS SUPPLY**  
7636 Santa Monica Blvd., Los Angeles 46, Calif.



# GROMMES AMPLIFIERS



Model 50 P

A high fidelity single unit amplifier with unusual performance. Power output, 10 watts, 30 watts peak. Distortion at 10 watts, 1% harmonic, and 5% intermodulation. Frequency response 8 to 20,000 cps to 30,000 cps. (Q 1 DB, 30 to 30,000 cps at 10 watt level).

\$550

Model 2158A  
15 Watt

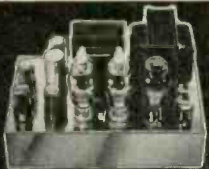

## ALL TRIODE BASIC AMPLIFIER

Response 10 to 100,000 CPS. Peak power 24 watts. Distortion at 8 watts, .07% H. and .2% I.M. 25 DB head-back from 3 loops, 2 direct coupled stages, cathode follower drivers.

\$995

WRITE FOR CATALOG

**PRECISION ELECTRONICS, Inc.**  
9101 King Avenue, Franklin Park, Ill.

Now Hear This New

*Jim Lansing*

D-130  
15" Speaker

New pure iron, "high intensity" casting structure

increases over-all efficiency 25%



The heart of a fine loud speaker is its powerful magnetic structure. Jim Lansing engineers have been able to produce in the new D-130 a more powerful magnetic beam across the voice coil than ever before possible. This unique design extends the high frequency response 25% and materially improves the dampening factor. Hear this new Jim Lansing D-130 today... at your audio dealer's.

Jim Lansing—first in fine sound!

**JAMES B. LANSING SOUND, INC.**  
2439 Fletcher Drive, Los Angeles 39, California

instantaneous primary voltage, rather than proportional to any discrepancy between signal input and output waveforms. However, through use of the screen tap, some interesting sets of tube characteristics are obtainable at low cost and with negligible complication.

### How Many Stages?

In principle, feedback should be applied back to an early portion of the amplifier where additional amplitude at low distortion is readily obtainable. Three stages are generally all that can be included readily in a highly degenerative loop, even with primary feedback, and still be stable with generalized load conditions. Also, for distortion reduction commensurate with the factor by which the gain is reduced, the gain around the feedback loop must be constant, and phase shift must remain at 180 deg., from the lowest fundamental frequency to the highest harmonic of importance.

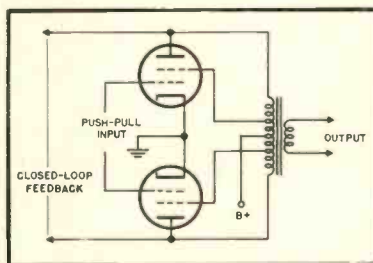

Fig. 4.

In view of these requirements, and the desirability of adequate stability margin with either resistive or reactive loads, one- or two-stage loops are the most popular, and enjoy the greatest commercial success.

Even with primary feedback, if more than two or three stages are involved in producing the desired amplification, separate feedback loops would preferably be employed. An alternative and powerful possibility is that of including a small broad-band loop within a larger narrower-band loop. An example of this approach is some form of cathode-follower output with auxiliary feedback to a preceding stage.

### Some Comparisons

While the output signal may be sampled at either primary, secondary, or tertiary winding, primary feedback permits some techniques of both economic and operational importance. The greatest single circuit distinction is that in secondary and tertiary feedback arrangements, the involved reactive structure of the output transformer at high frequencies appears as a series element in the feedback loop, whereas with primary feedback the transformer acts as a shunt element of less troublesome characteristics.

In general, for given specifications of amplitude and phase margins of stability, more feedback can be employed with primary connection than with the other principal forms. Also, more feedback with high stability may be applied over several preceding stages without resort to tricks troublesome in both manufacture and service. And last but far from least, with primary feedback, equipment performance is less dependent upon the high-frequency characteristics of the output transformer which are not subject to certain design calculation, or readily expressible in specification form.

Now! See It . . . Hear It . . .  
At LEONARD!



## The Amazing New Bozak Binaural 2 Way Speaker System

\$345<sup>00</sup> net

Developed after months of research . . . tested and proven in Leonard's famed sound studios . . . here at last is exciting new Binaural Sound . . . COMPLETE IN ONE CABINET!

Yes . . . this amazing new speaker system gives you the thrilling realism of binaural reproduction, the new Bozak speaker system adds a new stereophonic dimension to monaural recordings . . . changes over by flipping a switch!

### TWO WAY SOUND

Designed to give you the thrilling realism of binaural reproduction, the new Bozak speaker system adds a new stereophonic dimension to monaural recordings . . . changes over by flipping a switch!

### TECHNICAL DATA

Frequency response: 35-20,000 cps; Power rating: 25 watts per channel; Impedance: 8 ohms binaural, 4 ohms monaural. Phase-reversing switch provided; crossover network included in cabinet. Size: 36½" x 19½" x 33". Grill cloth easily changed to blend with any decor. In modern blonde birch or Georgian dark mahogany. MAIL AND PHONE ORDERS FILLED: 25% DEPOSIT . . . BALANCE COD.



FREE!

Send today for Leonard's fully illustrated guide to high fidelity . . . Music of the Masters. See what's new in hi-fi, radio, TV and tape recording! FREE!

## LEONARD RADIO INC.

Audio Mart  
69 Cortlandt St., N.Y.C.  
COrtlandt 7-0315

Altec — V-M — Brook — Bell — Jensen  
Superphono  
Ref. O. Kut  
National Hollywood  
Fisher  
Brociner  
tapeMaster  
Collins

— Hi-Fi — Electro-Voice — Praso — Scott — Stephens — McIntosh — Pilot — Weathers — Tannoy

# TEXAS-TV

"Southwest Sound Hq."



**PILOT AF723**  
**FM-AM HIGH FIDELITY TUNER**  
... First truly high-fidelity precision-engineered tuner in its price class. Audio response  $\pm 5$  db 20-20,000 cps. Ferrite loop antenna, phono and tv inputs, AFC switch, temperature-compensated driftless oscillator, cathode-follower output.

**PILOT AA901**  
**FULL WILLIAMSON AMPLIFIER**  
... finest of its type. Less than 1% distortion at 10 watts with pair KT66's in output. Frequency response 1 db 15-50,000. Output 8 and 16 ohms.

**PILOT PA911 PREAMPLIFIER**  
... High quality at lowest price. Mike input control, selector switch for 4 inputs, recording characteristic control, volume control and full bass and treble controls. Eight inputs to match any cartridge or microphone.

**\$79.95**  
**\$99.50**  
**\$29.95**

For prompt personal attention, write Jeff Smith at

## TEXAS-TV

506 W. Hildebrand Avenue  
**San Antonio 12, Texas**  
Clarkstan — University — Ampex — Cabinair

### for every application...

## ATLAS MIKE STANDS

most complete—  
most diversified  
line in the world!



From a professional boom stand to a flexible goose neck to a tiny fitting—whatever your need in mike stands and accessories—depend on it, ATLAS has it for you. Designed and manufactured for highest stability, quiet, ease of operation, durability. And backed up 100% by ATLAS—world leader in mike stands, public address loudspeakers and accessories for 21 years.

Compare them all at your distributor—You'll make your next mike stand an ATLAS.



**ATLAS SOUND CORP.**  
1448-39th Street, Brooklyn 18, New York  
In Canada, Atlas Radio Corp., Ltd., Toronto, Ont.

## Industry People ...

### I. R. E. CONVENTION HIGHLIGHTS

Jim Ford, Ampex Electric Corporation sales executive, officiated at East's first demonstration of three-channel stereophonic sound in recent years—showing was limited to press and professional groups . . . R. Stahl, formerly manufacturer of Ciroflex cameras, attended first convention in his new capacity as president of Ectro, Inc., makers of the Cub-Corder portable tape recorder . . . Tony Schifano and Frank Siaymaker, general manager and chief engineer, respectively, of Stromberg Carlson Sound Division, shared honors with Magnecord's president John Boyers, sales manager Spec Barker, and ad manager Dick McQueen, in hosting visitors to binocular exhibit which featured equipment manufactured by both companies. Let us here add emphasis to their efforts to keep the record straight—the fact that the two companies shared an exhibit should not be interpreted as an indication that they are amalgamated—in fact, they have no intention of doing so.

Phillip C. Kelsey, New England's leading custom builder, busy keeping up with technical advances in audio—the better to equip his fabulous cabinetry with sound performance in keeping with its matchless appearance, no doubt . . . Larry Epstein, sales manager, University Loudspeakers, Inc., and Irving Greene, vice-president Asco Sound Corporation, New York, huddled over lunch for confab on ways and means of stimulating interest in home music systems . . . Bert Briant, president, Berlant Associates, Inc., manufacturer of Concertone tape recorders, made worthy use of friend-associate Frederic March's visit to company's exhibit—enlisted his assistance in explaining Concertone features to curious visitors—surprising how few persons recognized March the academy-award actor as March the salesman.

Bryce Haynes, ad manager, Audio Devices, Inc., on receiving end of many compliments for interesting exhibit which tied in with current Audiotape advertising theme . . . Lou Hathaway, Joe Petit, Dick Edmondson, Ray Lafferty, Frank Spain and Don Castle were among members of the NBC TV- and audio-development groups to visit the show's Audio Center en masse—question: where were Buster Moffett and Jimmy Wilson?

### NOTES FROM HERE AND YON . . .

Hazard B. Reeves, president, Reeves Soundcraft Corporation, announces that the company's magnetic products division has acquired a new plant in Springdale, Conn.—will permit greatly expanded production of Reeves magnetic recording tape and film . . . O. L. Dupy, recording supervisor at MGM's west coast studios for past 24 years, has resigned to accept presidency of Minitape Corporation, Hollywood—is also in charge of research and development for Stancil-Hoffman Corporation . . . Bob Winston has been advanced to sales manager of commercial products division, Audio & Video Products Corporation, New York—will be primarily concerned with commercial users of A. & V.'s products and services.

Harold Becker, well known in technical writing circles, is new associate of George Gero Advertising, Paterson, N. J.—will be in charge of new New York office . . . Gordon J. Gow, vice-president, McIntosh Laboratory, Inc., Binghamton, N. Y., announces appointment of Edward P. Leech as advertising manager . . . Edward C. Hughes, Jr., with RCA since 1930, is new appointee as assistant to L. W. Teegarden, RCA executive vice-president—first joined company in 1930 in tube advertising department . . . Ed Wilder, broadcast pioneer, has been appointed sales engineer by Gates Radio Company, Quincy, Ill.—will operate in New York area . . . Norman Flickering, designer of the pickup bearing his name, is the proud and envied owner of a sparkling new home in Bellmore, N. Y. . .

## CLASSIFIED

Rates: 10c per word per insertion for noncommercial advertisements; 25c per word for commercial advertisements. Rates are net, and no discounts will be allowed. Copy must be accompanied by remittance in full, and must reach the New York office by the first of the month preceding the date of issue.

THE AUDIO EXCHANGE, INC. buys and sells quality high-fidelity sound systems and components. Guaranteed used and new equipment. Catalogue, Dept. AE, 159-19 Hillside Ave., Jamaica 32, N. Y. Telephone OL 8-0445.

50-Watt PRESTO 92-A Recording Amplifier \$200. 40-magnification microscope. Bausch & Lomb lenses, mount on any disc recorder, \$100. Brush 3-hour wire recorder, original cost \$800, only \$185. Reco-Art Company, 1305 Market Street, Philadelphia 7, Pa.

FOR SALE: \$307 Tapesonic Professional Tape Recorder, new, \$280. George Pasto, M.D. 815 Seeling Bldg., Portland, Ore.

PRESTO 16-in. Model 6N recorder, 1C cutter, Model 85E amplifier. Good condition, \$400. S. Mayo, 22 Michael Lane, New Hyde Park, New York.

FOR SALE—McIntosh 50W2 amplifier, \$190; AE2A preamplifier and equalizer for McIntosh, \$45; both units in perfect condition. Proctor Soundex pickup arm with three slides, \$24. Garrard variable-speed transcription table, gear driven, \$38. Leeds & Northrup decade resistance box, 0 to 999.9 ohms in steps of 1/10 ohm. \$24. Pilot AF-821A FM-AM tuner, \$70. Klipschorn loudspeaker, \$200. Write for full details, Jac Holzman, 139 W. 10th St., New York 14, N. Y. Phone ORegon 7-7137.

BACK LOADED folded horn for G-610, pictured in AE Dec. 52, p. 16. \$120, freight included. W. Florian, 3338 W. 64th Pl., Chicago 20, Ill.

TAPEMASTER PA-1 preamplifier, new, \$28; Electro-Voice 950 microphone, perfect condition, \$16. P. Reifschneider, 153 Rambling Way, Springfield, Penna.

FEATURED in our custom Williamson— $\pm 1\%$  W. W. resistors,  $\pm$  bathub capacitors, all hermetically sealed chokes, all oil filters, 12AY7, 5687, KT-60 tubes. Nicely Associates, Kenton, Ohio.

FOR SALE: Browning RJ-12B tuner with VR-tube regulated power supply, \$90; Fickering 132E Compensator, \$6; Scott 111A Dyna-ural converter, \$10. Robert Green, 46 Fellswood Drive, Livingston, N. J.

ULTRA-Linear Williamson's custom built to highest standards. Precisely matched coupling capacitors and resistors; oil-filled filter capacitors, two chokes, Aerosound output, test jacks, and balancing controls. Provision for preamp power with choice of a.c. or d.c. for heaters. Listening quality equal to the best regardless of price. My price is \$100, \$25 with order, balance COD. Frank Simonds, 33-73 164th St., Flushing, N. Y.

ENGINEER will equip complete plant for producing magnetic recording tape or supply proven formulas and production know-how. Box CN-1, AUDIO ENGINEERING.

WANTED: Good used tape recorder. Box CN-2, AUDIO ENGINEERING.

30% DISCOUNT on factory-fresh, guaranteed LP records! Send for free catalog and literature, SOUTHWEST RECORD SALES, Dept. AE, 4710 Caroline, Houston 4, Texas.

FOR RENT: Fully equipped recording studios, midtown Manhattan; air conditioned; J-M Acoustics. Box CN-3, AUDIO ENGINEERING.

FOR SALE: Used tape, disc-recording equipment, mikes etc.; good condition; send for list. Box CN-4, AUDIO ENGINEERING.



## PROFESSIONAL DIRECTORY

Custom-Built Equipment

### U. S. Recording Co.

1121 Vermont Ave., Washington 5, D. C.  
Lincoln 3-2705

"EVERYTHING IN HIGH FIDELITY"

From Primary Components  
to Completed Custom Audio Equipment

## KIERULFF

Sound Corp.

820 West Olympic Blvd. • Los Angeles 15, Calif.  
Richmond 7-0271 ZEnith 0271

### In Southern California it's HOLLYWOOD ELECTRONICS

(in The Audio Mile)

Distributors of Hi Fidelity  
Components Exclusively  
Webster 3-8208

7460 Melrose Ave. Hollywood 46, Calif.

### TAPE TO DISC!

HiFi Records from your tape or disc.  
12 inch D.F. (9 min.) \$3.00 @ 78  
12 inch D.F. (30 min.) \$6.00 @ 33-1/3  
Mail your tape with cues, returned same  
day. ALL SPEEDS.

ROBINSON RECORDING LABS.  
#35 S. 9th St. (WIP) Phila. 7, Pa.



## Employment Register

POSITIONS OPEN and AVAILABLE  
PERSONNEL may be listed here at no  
charge to industry or to members of  
the Society. For insertion in this col-  
umn, brief announcements should be in  
the hands of the Secretary, Audio En-  
gineering Society, P. O. Box 12, Old  
Chelsea Station, N. Y. 11, N. Y., before  
the fifth of the month preceding the  
date of issue.

★ Positions Open • Positions Wanted

★ **Chief Engineer**, for two recording  
studios in Westchester County, N. Y.  
Prefer draft exempt. Thoroughly experi-  
enced, heavy emphasis on maintenance.  
State salary required. Box 401, Audio  
Engineering.

★ **Physicists and Research Engineers**  
The Physics Department of Southwest  
Research Institute, San Antonio, Texas  
has several permanent staff positions for  
physicists and research engineers with  
B. S. or advanced degrees, and 2 to 10  
years of experience in acoustics, antenna  
design, electromechanical transducers,  
geophysics, nuclear physics, optical in-  
struments, pulse circuits, or servomech-  
anisms.



A MONTHLY SUMMARY of product develop-  
ments and price changes of radio elec-  
tronic-television parts and equipment,  
supplied by United Catalog Publishers, Inc.,  
110 Lafayette Street, New York City, pub-  
lishers of Radio's Master.  
These Reports will keep you up-to-date in  
this ever-changing industry. They will also  
help you to buy and specify to best advantage.  
A complete description of most products will  
be found in the Official Buying Guide, Radio's  
Master—available through local radio parts  
wholesalers.

### Books and Manuals

BRITISH INDUSTRIES CORP.—Added new publication  
"Sound Reproduction" at \$3.35 net.

### Miscellaneous Radio, TV and Electronic Parts

AMERICAN TELEVISION & RADIO—Added Model 11012T,  
inverter replacement vibrator at \$8.10 net.  
STANDARD TRANSFORMER—Added new ultra-miniature  
transformer transformers No. UM-110, interstage at \$7.35  
net. . . . No. UM-111, output or matching at \$9.00  
net. . . . No. UM-112, high imp. mic. input at \$8.25  
net. . . . No. UM-113, interstage at \$6.60 net and No.  
UM-114, output or matching at \$9.00 net.

### Recording Equipment, Speakers, Amplifiers, Needles, Tape, Etc.

GENERAL ELECTRIC—Discontinued Model RPX-051, triple  
play variable reluctance cartridge. . . . Model RPX-042,  
single variable reluctance cartridge and Model SPX-001,  
phono preamplifier. Increased price on Model RKP-009,  
replacement parts kit for triple play cartridges (less  
stylus assemblies) to \$1.19 net.

MARKET ELECTRIC PRODUCTS—Added No. A-7180 at  
\$9.98 net and No. A-7181 at \$9.98 net, both sapphire  
tipped Pfan-Tone cartridges. These models replace No.  
A-7157 and No. A-7158, metal tipped Pfan-Tone Car-  
tridges which are discontinued.

MCINTOSH ENGINEERING LABORATORY—Discontinued  
Model 20W-2, 20 watt amplifier.

OXFORD ELECTRIC—Discontinued weatherproof speakers  
Model 4CMWS and Model 6CMWS.

PERMOFLUX—Added outdoor theater speakers Model 4C-DI  
at \$2.73 net and Model 52C-DI at \$2.91 net.

RADIO CRAFTSMEN—Discontinued Model C300, equalizer-  
preamplifier for remote control of all tone compensation,  
phono equalization and audio channel switching and  
Model WM-3, mahogany wood cabinet and Model WB-3,  
blond wood cabinet.

### Test Equipment

ELECTRONIC MEASUREMENT CORP.—Discontinued Model  
300, vacuum tube volt-ohm-capacitance meter and Model  
300P, same as Model 300 with portable case and cover.

HICKOK ELECTRICAL INSTRUMENT—Added carrying case  
for Model 380A with shock proof mounting at \$23.00  
net.

JACKSON ELECTRICAL INSTRUMENT—Discontinued Model  
106, Challenger test oscillator and Model 112, Challenger  
capacitor tester.

PACIFIC TRANSDUCER—Increased price on Model 231,  
microscope groove analyzer to \$24.50 net.

### Tubes—Receiving, Television, Special Purpose, etc.

GENERAL ELECTRIC—Added industrial and transmitting  
type tubes GL-6146 at \$4.90 net and GL-6150 at \$4.90  
net, both beam-power amplifiers with high power sen-  
sitivity. Increased price on receiving tube 6AF4 to \$4.60  
list. Decreased price on receiving tubes 35B5 to  
\$1.95 list and 50B5 to \$1.95 list. . . . germanium  
diode 1N64 to \$6.97 net and industrial and transmitting  
type tubes GL-1B35A to \$11.50 net. . . . GL-1B37A  
(1B37) to \$15.00 net and GL-1B03A to \$56.00 net.

HYTRON—Added No. PT-2A at \$17.40 net and No. PT-2S  
at \$17.40 net, both pin-point transistors. Also added  
receiving tubes 12X4 at \$1.55 list. . . . 12AQ5 at  
\$2.00 list and 12V6GT at \$2.00 list. . . . germanium  
diode 1N133 at \$1.20 net and No. T-2, special glass-  
filled plastic socket at \$3.30 net, fitting both PT-2A and  
PT-2S transistors. Increased price on receiving tube  
6BY5G to \$2.90 list and germanium diode 1N51 to  
\$3.54 net.

RADIO RECEPTOR CO.—Added a number of new germanium  
diodes.

SYLVANIA—Added hydrogen thyristors HT-415 at \$101.15  
net. . . . HT-457 at \$21.55 net and HT-458 at  
\$28.75 net. . . . rocket tube RT-434, planar triode  
at \$35.95 net and microwave crystal diode 1N218M at  
\$14.40 net. Discontinued receiving tubes 1S6. . . . 1W5  
and 1X2.

## Unbelievable IS THE WORD FOR BROOK AMPLIFIERS

An achievement in Audio Quality  
at **TERMINAL**

### BROOK DE LUXE 30 WATT INSTRUMENT

Model 10C Basic Amplifier . . . . . **228.**

Model 10C4 Remote  
Control Amplifier  
(combines Model  
10C above with  
Model 4B Pre-Am-  
plifier) **331.50**



Sounds *incredibly lifelike*, thanks to new  
one-octave extension of low-frequency  
range, and 9-position *playback characteris-  
tic control* matching the characteristics  
of all type records. Frequency range 20-  
20,000 cps. Pre-Amp unit in de luxe  
gold-finished consolette.

### BROOK All-Triode 10 Watt Amplifier

Model 12A Basic Amplifier . . . . . **118.50**

Model 12A4 Re-  
mote Control Am-  
plifier combines  
Model 12A above  
with Model 4B  
Pre-Amplifier)



**222.**

A medium-priced amplifier which, ex-  
cept for lower power rating, equals the  
famous Model 10C4. Transient peak cir-  
cuit permits distortion-free power peaks  
considerably higher than 10 watts. Fre-  
quency response from 20-20,000 cps. Pre-  
Amp unit in smart, gold-tone consolette.

### NEW! BROOK Model 7 Pre-Amplifier



Has all features of Model 4B Pre-Amplifier,  
**PLUS BUILT-IN POWER SUPPLY.**  
May be used in combination with your  
present wide-range basic amplifier.  
Smart, gold-finished consolette. **119.70**

Hear these BROOK instruments in  
TERMINAL's complete audio dept.

**FREE!**

Terminal's 130-page AUDIO CATALOG  
Your Complete High Fidelity Guide

Investigate

TERMINAL'S LIBERAL TRADE-IN PLAN  
for your used, standard brand equipment

Open Thursday Eve's till 8 PM  
Ample Free Parking after 6 PM

# Terminal Radio Corp.

85 Cortlandt St., New York 7, N. Y.  
WOrth 4-3311

# Music to Your Ears

...with the **HARTLEY 215**  
LOUDSPEAKER

Whatever else may be said, this still remains the primary function of a loudspeaker. There are many graphs and curves, plotted and yet unplotted, which can support many claims—but nothing quite reveals the actual performance of a speaker as the experience of listening to the life-like reproduction of music and speech.

Use test instruments if you must . . . make measurements to your heart's content . . . but by all means, listen to the ten-inch Hartley 215, and compare it with any other speaker for clean, distortion-free performance. You will recognize the 215 for its natural smoothness of response over the entire audible spectrum . . . for its realism without the intrusion of strident 'highs' and boomy 'lows'. And you will marvel at the fact that the Hartley 215 is priced at only \$57.50.

*Hartley Products are now available  
in America through franchised Hartley dealers.*

For complete information regarding the Hartley 215, and the new Baffle Speaker Enclosure, Preamplifier, and Main Amplifier, write to Department AE-5.

*Prices slightly higher West of the Rockies.*



**H. A. HARTLEY CO., INC.**  
521 East 162nd Street, Bronx 56, N. Y.

## the Concertone NWR-1

Designed for  
**VERSATILITY**  
Built for  
**DEPENDABILITY**

The Concertone Recorder NWR-1 incorporates advances in engineering and performance found in no other tape recorder.

Specifically designed to meet all the requirements of broadcast, recording and industrial engineers, the NWR-1 features:  
★ Direct drive from dual speed hysteresis synchronous motor ★ Suitable for rack panel installation or portable cases  
★ Automatic brake system that needs no adjustment ★ Accommodates up to 5 heads  
★ May be serviced during operation  
★ Accepts up to NAB size reels without adapters ★ Full pushbutton remote control  
★ Meters input, output, & bias levels.



Model NWR-1

"just like being there"

Write for Bulletin 300

Manufactured by

**Berlant Associates**

4917 W. Jefferson Blvd.  
Los Angeles 16, Calif.

## ADVERTISING INDEX

Allied Radio Corp. . . . .	62
Altec Lansing Corp. . . . .	52
Amperite Co. Inc. . . . .	54
Ampex Electric Corp. . . . .	11
Arnold Engineering Co. . . . .	5
Asco Sound Corp. . . . .	14
Atlas Sound Corp. . . . .	70
Audak Co. . . . .	45
Audio Devices, Inc. . . . .	Cover 2
Barker & Williamson, Inc. . . . .	53
Bell Telephone Laboratories . . . . .	18
Bogen, David Co., Inc. . . . .	59, 67
Bozak, R. T. Co. . . . .	66
British Industries Corp. . . . .	65
Brook Electronics, Inc. . . . .	64
Brush Development Co. . . . .	4
Camera Equipment Co. . . . .	61
Cannon Electric Co. . . . .	6
Chicago Transformer Co. . . . .	55
Cinema Engineering Co. . . . .	13
Classified Ads . . . . .	70
Concertone Recorders . . . . .	72
Cook Laboratories . . . . .	66
Crestwood Div., Daystrom Elec. Corp. . . . .	48
Diacoustic Laboratories . . . . .	63
Dubbings Co. . . . .	58
Electro-Voice, Inc. . . . .	7
Fisher Radio Corp. . . . .	51
General Electric Co. . . . .	64
Hartley, H. A. Co., Ltd. . . . .	72
Harvey Radio Co., Inc. . . . .	49
Heath Co. . . . .	63
Hollywood Electronics Co. . . . .	71
Hughes Research and Devel. Labs . . . . .	1
Jensen Mfg. Co. . . . .	43
Kierulff Co. . . . .	71
Lansing Sound, James B. Inc. . . . .	69
Leonard Radio, Inc. . . . .	69
Lowell Mfg. Co. . . . .	58
Livingston Electronic Corp. . . . .	47
Maurer, J. A. Inc. . . . .	15
Minnesota Mining & Mfg. Co. . . . .	39
Neuberger, Hans Co. . . . .	68
Orradio Industries, Inc. . . . .	Cover 3
Olympic-Kassler Co. . . . .	68
Partridge Transformers, Ltd. . . . .	67
Peerless Electrical Products . . . . .	2
Pickering & Co., Inc. . . . .	17
Pilot Radio Corp. . . . .	41
Precision Electronics, Inc. . . . .	69
Precision Film Laboratories . . . . .	10
Presto Recording Corp. . . . .	33
Presto Seal Mfg. Co. . . . .	68
Professional Directory . . . . .	71
Pulse Techniques, Inc. . . . .	50
Radio's Master . . . . .	56
Rauland-Borg Corp. . . . .	57
Reeves Soundcraft Corp. . . . .	9
Rek-O-Kut Co. . . . .	3
Robinson Recording Labs . . . . .	71
Rockbar Corp. . . . .	35
Shure Bros. Inc. . . . .	12
Stromberg-Carlson . . . . .	37
Terminal Radio Corp. . . . .	71
Texas TV Stores . . . . .	70
Tung-Sol Electric Co. . . . .	8
U. S. Recording Co. . . . .	71
United Transformer Co. . . . .	Cover 4



# irish

ORRADIO *makes a grade of*  
**SOUND RECORDING TAPE**  
*for your SPECIFIC Requirements*



*If your tape recorder is intended for home or office use . . . we recommend:*

## IRISH Brown Band, No. 195 RPA

High quality, plastic-base tape, specially developed to reproduce with extreme fidelity, the frequency range between 100 and 8000 cps.

1200 Feet on plastic reel.....\$3.50

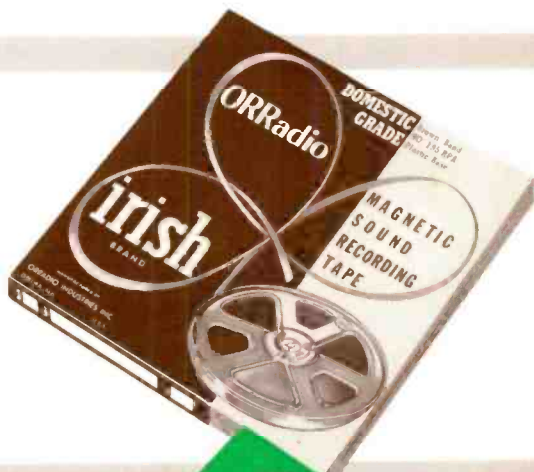

*If your tape recorder is designed for professional application, you should use . . .*

## IRISH Green Band, No. 211 RPA

Super-sensitive, long-life, professional tape, offering greater output volume, greater amplitude constancy and greater signal to noise ratio. Manufactured to exact standards set by NARTB and RTMA.

1200 Feet on plastic reel.....\$ 5.50  
 2400 Feet on metal reel..... 13.85



*If your tape recorder is intended for broadcast programming, professional dubbing, or any application where physical strength is an important consideration, ORRADIO offers you . . .*

## IRISH "Sound Plate," No. 220 RPA

New, revolutionary BREAK-PROOF tape. Will not tear or break at speeds up to 500 feet per second. Has the same high quality magnetic and audio features that have made IRISH 211 RPA the byword among professional tape users.

1200 Feet on plastic reel.....\$15.50  
 2400 Feet on metal reel..... 33.85



SOUND RECORDING

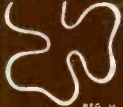

REG. U.S. PAT. OFF.

There are differences in magnetic oxides! Irish molecular lubricated oxides are more stable to coating conditions and turn out more uniform dispersions . . . that is one of the reasons for the growing acceptance of Irish Tape . . . for domestic, professional and broadcast applications.

Available at All Leading  
 Radio Parts Distributors and Photo Dealers  
 Manufactured in U.S.A. by

**ORRADIO INDUSTRIES, INC.**

OPELIKA, ALABAMA

World's Largest Exclusive Magnetic Tape Manufacturer

Support Division, Western Electric Co., 480 Broadway, New York 13, N. Y.



# ULTRA COMPACT UNITS...OUNCER UNITS

## HIGH FIDELITY... SMALL SIZE... FROM STOCK

UTC Ultra compact audio units are small and light in weight, ideally suited to remote amplifier and similar compact equipment. High fidelity is obtainable in all individual units, the frequency response being  $\pm 2$  DB from 30 to 20,000 cycles.

True hum balancing coil structure combined with a high conductivity die cast outer case, effects good inductive shielding.

Type No.	Application	Primary Impedance	Secondary Impedance	List Price
A-10	Low impedance mike, pickup, or multiple line to grid	50, 125/150, 200/250, 333, 500/600 ohms	50 ohms	\$16.00
A-11	Low impedance mike pickup, or line to 1 or 2 grids (multiple alloy shields for low hum pickup)	50, 200, 500	50,000 ohms	18.00
A-12	Low impedance mike pickup, or multiple line to grids	50, 125/150, 200/250, 333, 500/600 ohms	80,000 ohms overall, in two sections	16.00
A-14	Dynamic microphone to one or two grids	30 ohms	50,000 ohms overall, in two sections	17.00
A-20	Mixing, mike, pickup, or multiple line to line	50, 125/150, 200/250, 333, 500/600 ohms	50, 125/150, 200/250, 333, 500/600 ohms	16.00
A-21	Mixing, low impedance mike, pickup, or line to line (multiple alloy shields for low hum pickup)	50, 200/250, 500/600	200/250, 500/600	18.00
A-16	Single plate to single grid	15,000 ohms	60,000 ohms, 2:1 ratio	15.00
A-17	Single plate to single grid 8 MA unbalanced D.C.	As above	As above	17.00
A-18	Single plate to two grids. Split primary.	15,000 ohms	80,000 ohms overall, 2.3:1 turn ratio	16.00
A-19	Single plate to two grids. 8 MA unbalanced D.C.	15,000 ohms	80,000 ohms overall, 2.3:1 turn ratio	19.00
A-24	Single plate to multiple line	15,000 ohms	50, 125/150, 200/250, 333, 500/600 ohms	16.00
A-25	Single plate to multiple line 8 MA unbalanced D.C.	15,000 ohms	50, 125/150, 200/250, 333, 500/600 ohms	17.00
A-26	Push pull low level plates to multiple line	30,000 ohms plate to plate	50, 125/150, 200/250, 333, 500/600 ohms	16.00
A-27	Crystal microphone to multiple line	100,000 ohms	50, 125/150, 200/250, 333, 500/600 ohms	16.00
A-30	Audio choke, 250 henrys @ 5 MA 6000 ohms D.C., 65 henrys @ 10 MA 1500 ohms D.C.			12.00
A-32	Filter choke 60 henrys @ 15 MA 2000 ohms D.C., 15 henrys @ 30 MA 500 ohms D.C.			10.00



TYPE A CASE  
1 1/2" x 1 1/2" x 2" high

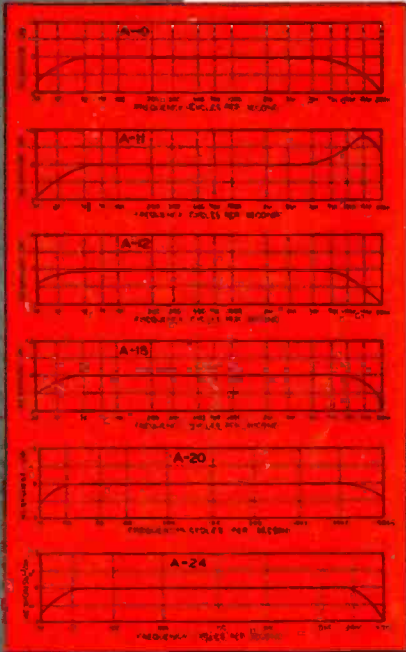

UTC OUNCER components represent the acme in compact quality transformers. These units, which weigh one ounce, are fully impregnated and sealed in a drawn aluminum housing 7/8" diameter...mounting opposite terminal board. High fidelity characteristics are provided, uniform from 40 to 15,000 cycles, except for O-14, O-15, and units carrying DC which are intended for voice frequencies from 150 to 4,000 cycles. Maximum level 0 DB.



OUNCER CASE  
7/8" Dia. x 1 1/8" high

Type No.	Application	Pri. Imp.	Sec. Imp.	List Price
O-1	Mike, pickup or line to 1 grid	50, 200/250 500/300	50,000	\$14.00
O-2	Mike, pickup or line to 2 grids	50, 200/250 500/300	50,000	14.00
O-3	Dynamic mike to 1 grid	7.5/50	50,000	13.00
O-4	Single plate to 1 grid	15,000	60,000	11.00
O-5	Plate to grid, D.C. in Pri.	15,000	60,000	11.00
O-6	Single plate to 2 grids	15,000	95,000	13.00
O-7	Plate to 2 grids, D.C. in Pri.	15,000	95,000	13.00
O-8	Single plate to line	15,000	50, 200/250, 500/600	14.00
O-9	Plate to line, D.C. in Pri.	15,000	50, 200/250, 500/600	14.00
O-10	Push pull plates to line	30,000 ohms plate to plate	50, 200/250, 500/600	14.00
O-11	Crystal mike to line	50,000	50, 200/250, 500/600	14.00
O-12	Mixing and matching	50, 200/250	50, 200/250, 500/600	13.00
O-13	Reactor, 300 Hys. - no D.C., 50 Hys. - 3 MA. D.C.		6000 ohms	10.00
O-14	50:1 mike or line to grid	200	1/2 megohm	14.00
O-15	10:1 single plate to grid	15,000	1 megohm	14.00

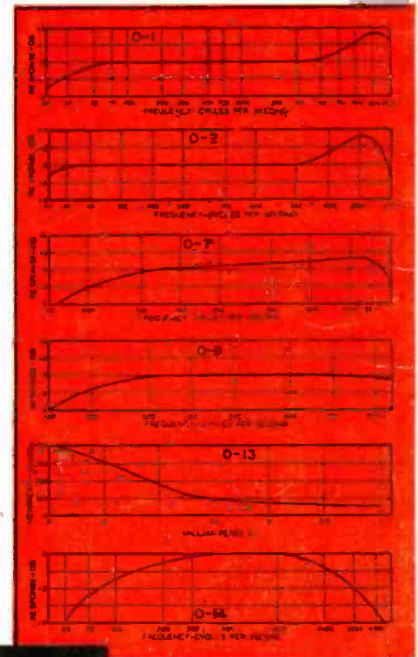

*United Transformer Co.*

150 VARICK STREET • NEW YORK 13, N. Y.  
EXPORT DIVISION: 13 WEST 57th STREET, NEW YORK 16, N. Y., CABLES: "ARLAB"