

Selection of Tone Control Parameters-See Page 22

AUDIO ENGINEERING

MARCH
1953
35c



THE WORLD OF SOUND

here are the
30 BEST SELLING RECORDS
OF 1952*



29 of them used
audiodiscs®
for the master recording

... and over 43% used
audiotape† for the original sound!

Like Audiodiscs and Audiotape, this record speaks for itself.

Of the thirty top hit records of the year, all but one were made from Audiodisc masters! And that one — a London Record — was made abroad.

It is significant, too, that the original recordings for over 43 per cent of these records were first made on Audiotape, then transferred to the master discs. This marks a growing trend toward the use of Audiotape for the original sound in the manufacture of fine phonograph records.

Yes — Audiodiscs and Audiotape are truly a record-making combination — in a field where there can be no compromise with Quality!

†Trade Mark

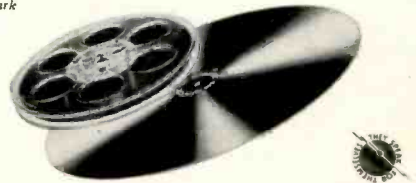

AUDIO DEVICES, INC.

444 MADISON AVE., NEW YORK 22, N. Y.
 Export Dept.: 13 East 40th St., New York 16, N. Y., Cable "ARLAB"

Record, Artist & Label!	Made from Audiodisc Master
BLUE TANGO (Leroy Anderson—Decca).....	✓
WHEEL OF FORTUNE (Kay Starr—Capitol).....	✓
CRY (Johnnie Ray—Okeh).....	✓
YOU BELONG TO ME (Jo Stafford—Columbia).....	✓
AUF WIEDERSEH'N, SWEETHEART (Vera Lynn—London).....	✓
I WENT TO YOUR WEDDING (Patti Page—Mercury).....	✓
HALF AS MUCH (Rosemary Clooney—Columbia).....	✓
WISH YOU WERE HERE (Eddie Fisher—Hugo Winterhalter—Victor).....	✓
HERE IN MY HEART (Al Martino—BBS).....	✓
DELICADO (Percy Faith—Columbia).....	✓
KISS OF FIRE (Georgia Gibbs—Mercury).....	✓
ANY TIME (Eddie Fisher—Hugo Winterhalter—Victor).....	✓
TELL ME WHY (Four Aces—Decca).....	✓
BLACKSMITH BLUES (Ella Mae Morse—Capitol).....	✓
JAMBALAYA (Jo Stafford—Columbia).....	✓
BOTCH-A-ME (Rosemary Clooney—Columbia).....	✓
GUY IS A GUY (Doris Day—Columbia).....	✓
LITTLE WHITE CLOUD THAT CRIED (Johnnie Ray—Okeh).....	✓
HIGH NOON (Frankie Laine—Columbia).....	✓
I'M YOURS (Eddie Fisher—Hugo Winterhalter—Victor).....	✓
GLOW WORM (Mills Brothers—Decca).....	✓
IT'S IN THE BOOK (Johnny Standley—Capitol).....	✓
SLOW POKE (Pee Wee King—Victor).....	✓
WALKIN' MY BABY BACK HOME (Johnnie Ray—Columbia).....	✓
MEET MR. CALLAGHAN (Les Paul—Capitol).....	✓
I'M YOURS (Don Cornell—Coral).....	✓
I'LL WALK ALONE (Don Cornell—Coral).....	✓
TELL ME WHY (Eddie Fisher—Hugo Winterhalter—Victor).....	✓
TRYING (Hilltoppers—Dot).....	✓
PLEASE, MR. SUN (Johnnie Ray—Columbia).....	✓

*According to Retail Sales, as listed in THE BILLBOARD.

audiodiscs • audiotape • audiofilm • audiopoints

Audiodiscs are manufactured in the U.S.A. under exclusive license from PYRAL, S.A.R.L., Paris

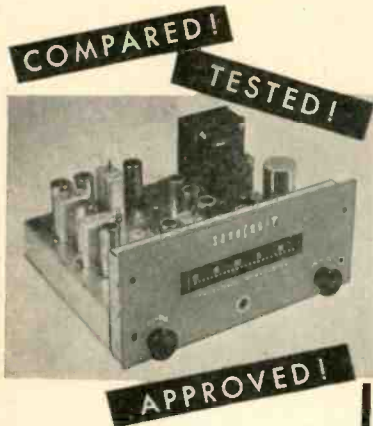

SONOCRAFT FM TUNER

America's Most Advanced Tuner

COMPARED . . . by engineers and critical music-lovers for audio-quality and technical advancements. Consensus of comment: "Amazing tonal quality" . . . "True fidelity of reproduction" . . . "Live programs really sound live!"

TESTED . . . and found consistently effective for fringe-area reception at distances from 40 to 80 miles from New York City . . . New, super-sensitive circuit assures perfect signal pick-up with sufficient quieting for excellent reception even in remote locations. Automatic Frequency Control (AFC) prevents station drift.

APPROVED . . . because of its superior performance, its compact dimensions for easy mounting into almost any enclosure, its new type tuning indicator (simpler to use) and many other exclusive features . . .

★ ★ ★

SPECIFICATIONS: New black-out tuning indicator; 3 gang inductive tuning; dual limiter; all coils slug-tuned; 5 microvolt sensitivity for 20db quieting; 200 KC bandwidth at 6db down; adjacent channel down 60db; eleven miniature tubes plus neon-tuning indicator; AFC with disable switch; compact size: 10" w., 4" h., 8" d.; new design for simplified installation.

SONOCRAFT FM TUNER \$89.95

Write for descriptive bulletin ER which contains a complete equipment report on this tuner.



Gift:

Come in and pick up or write for your free copy of "Sound Advice" written for Music Lovers, by Irving Greene. 124 pages of vital information in high fidelity.

ASCO SOUND CORPORATION

115 WEST 45th STREET, 3rd FLOOR
NEW YORK 36, N. Y.



AUDIO PATENTS

RICHARD H. DORF*

IT SEEMS that it is time once again to repeat a definition given a long time ago of the purpose of these monthly patent articles. The thought arises because among your letters sometimes appears one pointing out that for this and that technical reason one of the patents described here is not all it is cracked up to be, as far as performance is concerned.

Now, don't get me wrong: such letters are as welcome as other mail. They show knowledge and astuteness on the part of the writers, and they often give additional food for thought. But sometimes they say in effect (often between rather than on the lines) that since the deficiency is present we ought not to describe the patent. And there's the point of disagreement.

These articles are different from most others. They don't purport to give absolutely reliable information right from the writer's or other engineer's mouth; they don't mean to imply that the inventions described are either good or bad; they don't even indicate that the inventions will positively work. What they try to do is present ideas that seem interesting for any of dozens of reasons—because the approach to a problem is new or ingenious (or both), because there is an idea that could be developed further, because the invention shows a somewhat different—though not necessarily better—way of doing a common thing, because, although the object of the invention may be unnecessary or impractical, somebody did put together a weird brainstorm of a circuit, parts of which might give someone an idea that would be practical, and so on.

To a large extent, the technological history of the United States is represented by its patent files. Not many of us are ingenious and original enough to solve every design problem right from scratch; and the wealth of ideas present in the flood of patents issued monthly (to which most people don't have access and the time to spend) furnishes many a take-off point for

some really good thinking and problem solving. This column is a review rather than a normal article, selecting as many interesting (to the writer, anyway) patents as space allows and turning the abstruse patent-specification language into technical English. We make every effort to either reject or plainly label patent ideas that are truly unworkable, but—paraphrasing the common radio parlance—the opinions expressed are almost entirely those of the inventors.

While on the subject of mail, here is an answer for those who would like circuit component values in all the schematics. Whenever the patent furnishes them, we put them there in plain sight. If we haven't done so, they aren't available.

And now, on to this month's review.

Distortion Measurement

Owen E. DeLange's patent No. 2,618,686 shows a visual method of distortion measurement using the outphasing principle. The purpose (probably used in wideband amplifiers—the patent is assigned to Bell Labs) is to check distortion in terms of compression or expansion—nonlinearity—rather than in terms of harmonic production, though the two are, of course, rigidly related. The method is simple, requiring no precision equipment, and is shown in block form in Fig. 1.

The principle is to generate a wave of definite form, such as a sawtooth, and feed it through the system under test. The wave is simultaneously fed through a "balancing branch." The waves from the two branches are applied to a balancing circuit in which their levels are equated and the phases are made opposite. This produces cancellation provided both waves are the same (no distortion in the tested system). If there has been a change in waveform in the test branch, the resultant signal out of the balancing circuit contains the difference between the original and distorted forms, which is shown on an oscilloscope.

Operation is as follows: Attenuator A is adjusted so that the signal furnished the

*255 W. 84th St., New York 24, N. Y.

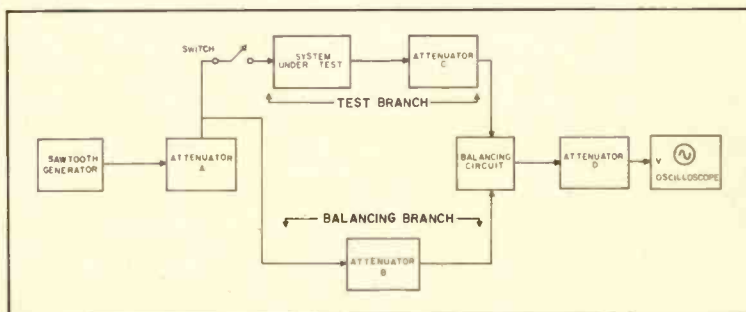

Fig. 1.

The Greatest Name
in Turntables
designed for Quality in Record Reproduction

REK-O-KUT

Record Reproduction begins with the rotating motion of the record! This motion expresses passage of time. And each rotation is an interval or segment of that time. This important function is entrusted to the turntable.

The faithfulness with which the turntable, a purely mechanical device, can perform this task, is related entirely to its design and construction. It is pretty generally known that any mechanical vibration will impose itself as undesirable elements of distortion in the reproduced sound, and that speed deviation will result in a variation in time or tempo, and in undulating pitch.

There is no compromise with turntable quality if the best in sound reproduction will be had. Engineers know this, and the name of REK-O-KUT is a byword in professional circles as the standard of turntable quality. But whether professional sound engineer or simply a lover of good sound, only a fine turntable can justify the fine equipment of a modern high fidelity system.

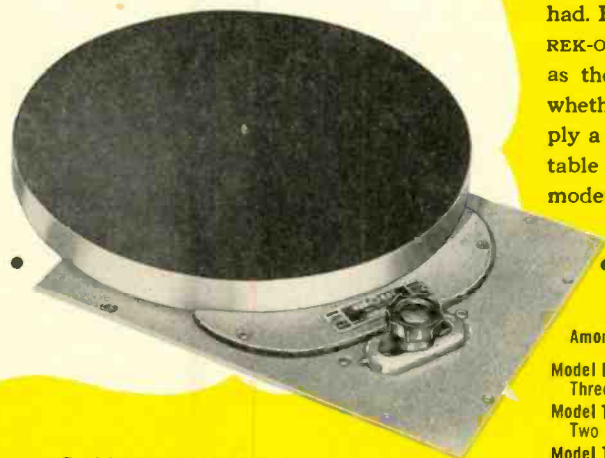

Among the seven REK-O-KUT Turntables available are:

Model LP743—Induction Motor Three Speeds, 33 $\frac{1}{3}$, 45 and 78.....	\$ 54.95
Model T-12H—Hysteresis Motor Two Speeds, 33 $\frac{1}{3}$ and 78.....	119.95
Model T-43H—Hysteresis Motor Two Speeds, 33 $\frac{1}{3}$ and 45.....	119.95

Sold by Leading Distributors

Write for Descriptive Literature

REK-O-KUT CO. 38-03B QUEENS BOULEVARD • LONG ISLAND CITY 1, NEW YORK

Export Division: 458 Broadway, New York 13, U. S. A. Cables: Morhanex
In Canada: Atlas Radio Corp., Ltd., 560 King Street W., Toronto 2B

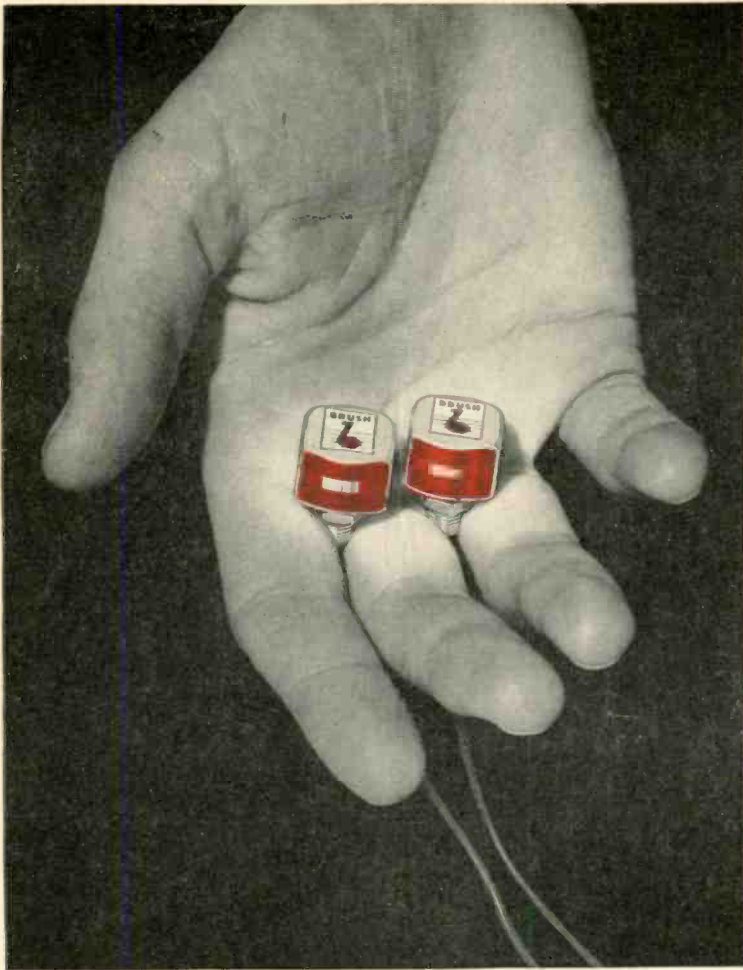

Meet the Redheads... tops for tape recording

See how the latest additions to the Brush family of magnetic recording components can improve your tape recorders!

The BK-1090 record-reproduce head has the standard track width designed for dual track recording on 1/4 inch tape. It provides unusually high resolution and uniformity over an extended frequency range. Cast resin construction assures dimensional stability, minimizes moisture absorption, and affords freedom from microphonics. Its balanced magnetic construction, precision lapped gap, Mu-metal housing, and single-hole mounting provide important design advantages.

The BK-1110 erase head has the same basic construction as the companion record-reproduce unit. Its outstanding feature is its efficient erasing at low power consumption—less than 1/2 voltampere.

Investigate these new "Redheads" for your magnetic recording. Your inquiries will receive the attention of capable engineers. Write Brush Electronics Company, Department ZZ-3, 3405 Perkins Avenue, Cleveland 14, Ohio.

BRUSH ELECTRONICS

INDUSTRIAL AND RESEARCH INSTRUMENTS
PIEZOELECTRIC MATERIALS • ACOUSTIC DEVICES
MAGNETIC RECORDING EQUIPMENT
ULTRASONIC EQUIPMENT



COMPANY

formerly
The Brush Development Co.
Brush Electronics Company
is an operating unit of
Clevite Corporation.

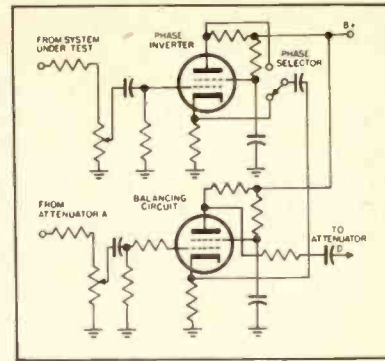

Fig. 2.

test branch is within the nominal capabilities of the tested system. Then the switch in the test branch is opened and attenuator B is adjusted so that the oscilloscope trace has a peak vertical deflection of 10 divisions. Next the switch is closed and attenuator C adjusted so that the two branch outputs are balanced by placing as much as possible of the center of the resultant wave on the zero horizontal axis on the oscilloscope screen. The peak deflection of the resultant wave then shows the amount of difference between the undistorted wave of the balancing branch and the distorted wave of the test branch. Since the original wave was set to 10 divisions peak value, each division for the resultant is equivalent to 10 per cent distortion. If the distortion is less than 10 per cent, the loss of attenuator D may be reduced by 20 db, which gives a factor of 10, making each division equal to 1 per cent distortion.

In high-frequency systems or video amplifiers time delay in the tested system may make coincidence of the outphased waves impossible. This can be cured by placing a variable delay line in the balancing branch to make the delays equal. At audio frequencies the delay would be very much smaller than the period of the test waveform, so that delay would not be a problem.

The balancing circuit might be any of several. The inventor shows a simple but quite suitable one, redrawn in Fig. 2. V_1 is a phase-inverter stage which allows selection of output from either plate or cathode, the one wanted depending on the output phase from the tested system. The input potentiometer is equivalent to attenuator C in Fig. 1.

The output of the phase inverter is applied to the cathode of the balancing (really simply a mixing) stage, while the test branch output coming through a potentiometer acting as attenuator B, is applied to the grid. The output of the stage can be fed to an oscilloscope, with the vertical amplifier gain control acting as attenuator D.

Phase Splitter

There are probably more phase-splitter circuits extant than any other device in the audio world. Almost all give unbalance problems at the extreme ends of the frequency range, which gives rise to response dropoffs and distortion. Here is a circuit the inventor claims will remain in perfect balance between 20 and 150,000 cps. Illustrated in Fig. 3, it was invented by Louis R. Bourget of Sacramento, Calif., and is the subject of patent No. 2,618,711.

The circuit uses three triodes (two of which may be, as shown, the halves of a dual-triode). The first is operated as a cathode follower, with R_1 the volume con-

**Here is the first basic advance
in tone arm design in
many decades!**



The GRAY "Viscous-Damped" 108-B Tone Arm

Gives you perfect contact and tracking on all records at lowest stylus pressure—virtually eliminates tone arm resonances—cannot damage record if accidentally dropped.



The entirely new suspension principle of the Gray 108-B makes it *hug the grooves* . . . prevents stylus skidding on worn records—overcomes groove-jumping caused by floor vibrations. Its "viscous-damped" design provides perfect tracking, virtually eliminates tone arm resonances, and prevents any possibility of record damage if the arm is dropped.

The 108-B satisfies every requirement of high fidelity reproduction. A plug-in feature permits instant change from 78-rpm to 33 $\frac{1}{3}$ -rpm or 45-rpm, *with automatic adjustment to the correct stylus pressure*. See and try this "viscous-damped" arm soon—solve all your transcription problems with this revolutionary, versatile arm!

GRAY

RESEARCH

AND DEVELOPMENT CO., INC., HILLIARD STREET, MANCHESTER, CONN.
Division of The GRAY MANUFACTURING COMPANY—Originators of the
Gray Telephone Pay Station and the Gray Audograph and PhonAudograph



Gray Research & Development Co., Inc.
Hilliard Street, Manchester, Conn.

Please send me your Bulletin RF-3 on the new Gray
"Viscous-Damped" 108-B Tone Arm.

NAME _____

ADDRESS _____

CITY _____

STATE _____

"Take it from me - they're Tops"

... says
RAY ANTHONY
"The Young Man With a Horn"

... about the famous new

SHURE slender gradient¹
high-fidelity bi-directional
microphones



For high-fidelity, true-tone reproduction of voice and music, these small and rugged microphones are destined to be the favorites of leading recording artists ... singers—instrumentalists—and bands everywhere.

● These microphones will outperform all other "slender" microphones—because of their advanced acoustical, electrical, and mechanical features. Both models provide a bi-directional pickup pattern—permitting greater performer freedom (performers can stand at a 73% greater distance from the microphone!) The "300" and "315" will pick up voice and music from front and back—yet discriminate against unwanted noises from the sides. They reduce reverberation and the pickup of distracting random noises by 66%!



Shure Patents Pending.

SHURE BROTHERS, Inc. ★ MANUFACTURERS of MICROPHONES
and ACOUSTIC DEVICES
225 West Huron Street, Chicago 10, Illinois • Cable Address: SHUREMICRO

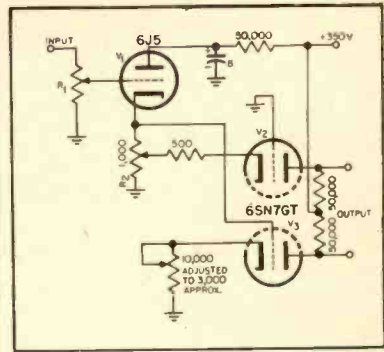

Fig. 3.

control and R_2 the cathode resistor. The secret of the circuit's success is said to be that the actual phase-splitter tubes V_1 and V_2 are fed from the same low-impedance source and the antiphase outputs are symmetrically obtained from identical plate circuits.

V_2 is fed as a grounded-grid stage by paralleling its cathode with that of V_1 ; the plate output is therefore in the same phase as the circuit input. V_2 is a conventional grounded-cathode amplifier but the low-impedance source effectively eliminates input capacitance effects. Its output is, of course, out of phase with the circuit input. The output capacitances of both V_1 and V_2 should be the same, causing no unbalance such as would be obtained from the "long-tailed" or "split-load" circuits. Miller ef-

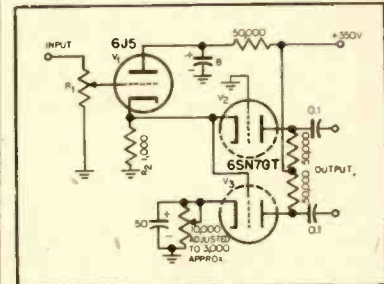

Fig. 4.

fect is probably less in V_1 than in V_2 because there is some cathode degeneration in V_2 .

The latter probability is cleared up in the modification of Fig. 4, where the cathode resistor of V_2 is left unbypassed. Cathode degeneration is then probably about equal in both tubes. This reduces the amplification of V_2 , which is compensated by tapping the input for V_2 down on R_2 and adding the 500-ohm resistor for bias compensation. The circuit of Fig. 4, by the way, is suitable for d.c. amplification because of the elimination of the V_2 cathode bypass capacitor and the output blocking capacitors. This may interest instrumentation workers and direct-coupling fends in the audio field. In either circuit, R_2 should be adjusted for equal plate currents through V_2 and V_1 . In Fig. 4, the tap on R_2 may also be touched up a little if necessary for equal audio outputs. R_2 need not be adjustable, of course (the best setting was found to be at 3,000 ohms) but may be useful when tubes get old or are replaced if precise balance is wanted.

Video Beckons

I should like to close this chapter with a suggestion which may provoke some audio engineers and enthusiasts (the terms are *Continued on page 56*)

The Inside Story

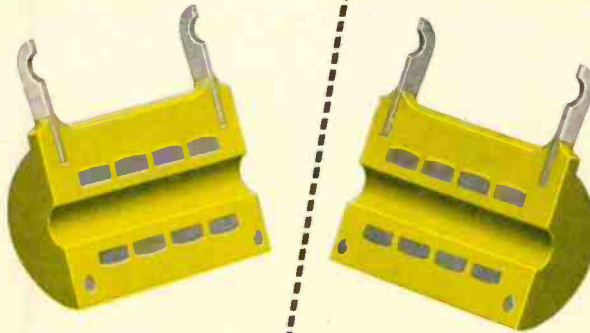

The NEW CE Series

ACCURATE WIRE WOUND RESISTORS

HERMETICALLY SEALED IN CAST EPOXY. EXCEEDS MIL R-93A SPECIFICATION

Scientific progress has made the demand and we believe the CE series resistors are the answer: —

In the cross-section above, we illustrate the single homogenous mass that means so much to stability and provides the ample moisture vapor barrier of this new resistor. Bobbin and encapsulation become one homogenous mass, surrounding the resistance wire with a minimum of strain.

Write today if your requirements are for a hermetically sealed resistor to withstand a wide variety of environments. Ask for the literature covering the CE series resistors.



CINEMA ENGINEERING CO

1510 WEST VERDUGO AVENUE, BURBANK, CALIFORNIA

IN NEW YORK:
Audio & Video Products Corporation
730 Fifth Ave. • Plaza 7-3091

EXPORT AGENTS:
Frazar & Hansen, Limited
301 Clay Street
San Francisco, California, U.S.A.

here's

absolute reliability

for heavy duty
audio
amplification



TUNG-SOL



BEAM
POWER
AMPLIFIER

If you've been looking for an audio output tube that's stable under the most severe conditions—completely dependable—then this is it! The Tung-Sol 5881 is rugged both mechanically and electrically—and directly interchangeable with the 6L6.

In creating the 5881, Tung-Sol engineers have made lavish use of the design and production techniques which have proved themselves over the past fifteen years—zirconium coating over the carbonized metal plate and pure barium getter to effectively absorb gas for the life of the tube—gold plated wire to minimize grid emission. These are but a few of the major design improvements in the 5881.

Tung-Sol produces the 5881 under laboratory conditions, to assure peak efficiency and maximum uniformity. You'll find this tube has the stuff to take the whole range of audio service requirements from protracted standby periods to repeated heavy overloads. So, if absolute reliability is essential in your audio circuits, the Tung-Sol 5881 is a "must." Order it from your regular supplier.

Write for characteristics and performance data

TUNG-SOL ELECTRIC INC., NEWARK 4, N. J.

Sales Offices: Atlanta • Chicago • Culver City (Calif.)
Dallas • Denver • Detroit • Newark

Tung-Sol makes All-Glass Sealed Beam Lamps, Miniature
Lamps, Signal Flashers, Picture Tubes, Radio, TV and
Special Purpose Electron Tubes.

LETTERS

Help Wanted!

SIR:

A number of months ago I took up the subject of beats and combination tones with the technical editor of *Radio and Hobbies in Australia*. We consulted L. L. Beranek's "Acoustic Measurements," E. G. Weaver's "Theory of Hearing," Watson and Tolan's "Hearing Tests and Hearing Instruments," and Harvey Fletcher's "Speech and Hearing." As yet we have not established where in the auditory system the difference between the two exists. We would appreciate any comments on this subject which your readers would care to put forward.

JOHN F. McDERMOTT,
Flat 36,
2 Anderson St.,
Kingsford, N.S.W.,
Australia.

Stereo Photos

SIR:

It is now a year since you first used stereo photos in the magazine, and I have been waiting for further use. I feel that they are a very good way of presenting devices that have interesting spatial features. I hope that you are continuing to solicit their use in future articles where they would be appreciated.

ROBERT P. ST. JOHN,
6606 Woodlawn Ave.,
Chicago 37, Ill.

(We still want stereo photos to illustrate articles if they will submit them, and if they do we will print them. However, it appears that few of our authors remember our offer, and we shall have to use this interesting form of photography to illustrate our own articles in the future. Ed.)

Editorial Distortion

SIR:

Figure 11 of "Distortion in Voltage Amplifiers" in the February issue is quite interesting. The "Horrible Example" shows about 0.1 per cent intermodulation distortion at 1 volt output, while the improved circuit shows 10 per cent. A circuit diagram illustrating the good engineering practice needed to achieve this result would be enlightening.

W. H. FROLICH, M. D.,
Steptoe Valley Hospital,
East Ely, Nevada.

SIR:

I have read W. B. Bernard's article "Distortion in Voltage Amplifiers," in the February issue, with great interest, and with some dismay, particularly in regard to the curve of Fig. 11, page 55. As I interpret the curve, the improved circuit gives very much more intermodulation distortion than the unimproved circuit. This is just the type of "improvement" that my little nephew makes in some of his experimental amplifiers.

It appears that the curve is either an extreme attempt at honesty, so that Diogenes can blow out his lantern and go back to his barrel; or that there is a drafting error somewhere. Which?

RONALD L. IVES,
5415 Main St.,
Williamsville 21, N. Y.

(Well, we did it again. But this time we can't blame the draftsman or the author. We rechecked the author's curve, and found that we had made an erroneous notation before sending it to the draftsman. We bow our editorial head in shame until the next similar error occurs. Seriously, we have requested Mr. Bernard to supply us with the improved circuit to enlighten our readers and ourselves. Ed.)

Frudd Resurrected

SIR:

The stripped-down, or utility model, circuit schematic exhibited in conjunction with the disquisition on the Frudd Audio System ought to prove no more baffling than the Frudd speaker enclosure disclosure. Detailed minutiae in a schematic are of little interest, anyway, to the intransigent audio enthusiast who invariably disregards trivia and introduces his own circuit modifications with the utmost savior savior. My particular modification, a highly heterodox one, consisted in constructing the circuit precisely as diagrammed. Of course, as in any high-quality audio system, care in construction pays off in performance. I can attest that in assembling the circuit only the best components should not be used.

I happened not to have available the pair of 211's specified. However, a search under the mattress (my habit of hiding my stock of components in this fashion derives from the war years



SOUNDCRAFT MAGNETIC RECORDING TAPE

Top quality for top fidelity. The kind of high-fidelity you always associate with professionals.

*“Bill, that’s what I call
professional
sound”*

You’ll never know how professional the sound you record on your tape recorder can be, until you use Soundcraft Magnetic Recording Tape. You’ll be thrilled by Soundcraft high-fidelity, delighted by the true-to-life reproduction.

Soundcraft engineers are engaged in constant research for new methods, materials, processes. As a result, sound engineers throughout the industry — recording studios, radio and television stations, motion picture studios — demand Soundcraft Magnetic Recording Tape for the *performance perfection* they need.

Next time you visit your nearest dealer, ask for Soundcraft Tape. *Hear for yourself* the professional results of the sound you record.

**FOR HOME MOVIE MAKERS!
Wonderful Way to Make
“Talkies”**

*Soundcraft Magna-Stripe** lets you make sound movies as easily and inexpensively as silent films. Add sound to old silent films. Erase and change the sound any time at all! Magna-Stripe service is available to you at your photographic store. Ask your dealer about it.



**REEVES
SOUNDCRAFT CORP.**

Dept. B, 10 East 52nd Street, N. Y. 22, N. Y.

FREE! SOUNDCRAFT BOOKLETS

Complete information on Soundcraft Magnetic Recording Tape and Magna-Stripe. Yours for the asking — just write!

*T.M.R.S.

CANNON PLUGS

get good reception

O SERIES



P SERIES

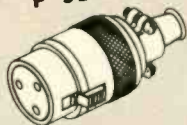

X SERIES



XK SERIES

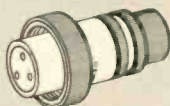

GB SERIES

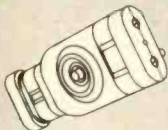

UA SERIES



XL SERIES



D SERIES



XKW-B1 SERIES



K SERIES



U SERIES



TELEPHONE RECORDER

WRITE FOR
PRICE FOLDER
C-109

K SERIES



TELEVISION

M1 SERIES



The high quality audio connectors shown above are available from all Cannon Franchised Distributors. In their great variety of sizes, shapes and contact arrangements there is no problem or technical requirement in the radio, sound, TV or related fields that cannot be met. Cannon plugs are standard on leading makes of audio equipment and microphones.

CANNON ELECTRIC

Since 1915



Factories in Los Angeles, Toronto, New Haven, Benton Harbor. Representatives in principal cities. Address inquiries to Cannon Electric Company, Dept. C-109, P.O. Box 75, Lincoln Heights Station, Los Angeles 31, California.

See Cannon Electric
Booth 2-512 Radio
Engineering Show,
March 23 to 26, Grand
Central Palace, N. Y.

during which electronic parts shortages drove the service shop next door to larcenous desperation) did turn up an old WD11. (That had been under the mattress since the first World War.) This proved to be quite satisfactory as a substitute for two 211's when operated Class AB $\frac{1}{2}$ in push pull with itself by means of an ingenious feedback circuit. Details of this circuit will not be given as it is felt that any audio man would prefer to design his own.

This system resulted in one which was far superior to any others I have employed, and I "felt" it give forth with pure, 100 per cent fidelity, quite unadulterated by anything else. It is also the first audio system I have encountered that can be operated at all hours without arousing the wrath of one's neighbors. With my previous installation, consisting predominantly of a one-kilowatt final feeding an unduly elaborate speaker network in a cathedral enclosure, I was continually beset by the neighbors' pounding on the floor and ceiling. As I was living by myself five miles out in the country, I found this puzzling and strangely disturbing. It has remained for the Frudd system to demonstrate that for once the experts were perfectly right and that any lowbrows who thought otherwise were laboring under a gross delusion.

I must close now because I have two visitors on the front porch. Apparently they think this is a formal affair, for they are both wearing white coats.

NORMAN F. STANLEY,
P. O. Box 895,
Rockland, Maine.

Book Review

FUNDAMENTALS OF AUTOMATIC CONTROL SYSTEMS, by G. H. Farrington. 285 pp. New York: John Wiley & Sons Inc., \$5.00.

Automatic control system design is rapidly becoming the most far-reaching branch of engineering, crossing the boundaries of all the other sciences. Although automatic control systems are not new, their study as a separate subject has only been begun recently. Audio engineers are most familiar with them in the form of feedback amplifiers and phonograph speed regulators. This book is both fundamental and comprehensive. It is divided into clear logical chapters which do not include material greatly detailed in other works. In particular it is assumed that the reader has some familiarity with transient response studies using the Heaviside Expansion Theorem and the unit function. The matter of Laplace transforms, which by now has been thoroughly labored in books on mathematics, transients, and servomechanisms, is not mentioned although it may be more familiar to many of the post War II engineering graduates. Much material on types of controlled systems controllers, and their respective transfer functions is discussed. These systems are not always electrical or electrically controlled but include hydraulic and mechanical controls. Three chapters of particular interest are Transmission Lines and Distributed Constants, Multiple Control, and Plant Analysis.

The book is well illustrated and includes numerous text examples but no exercises are given, which might limit its use as a college text.

—L. S. Goodfriend



in this room...

there's no room for doubt

There can be no room for doubt in the continuity and fidelity of your broadcast. Precisely the reason you demand—and get—the best in transmitting and studio equipment.

Nor should you compromise with quality in the tape recorder you select.

In AMPEX Recorders you will find the same matchless reliability and performance you expect of your transmission equipment... and for the same reason—they are engineered to the highest *professional* standards.



AMPEX
brings you these cost-saving operating advantages:

- **UNINTERRUPTED SERVICE**

Under the demand of heavy-duty programming, AMPEX Recorders deliver thousands of hours of unbroken service. Recently a set of AMPEX heads was returned from Honolulu for routine replacement after 11,000 hours continuous use, 17 hours a day. The heads were still within AMPEX specifications for new heads and had several thousand more hours of use remaining.

- **MINIMUM "DOWN TIME"**

AMPEX Recorders are designed for thousands of hours of continuous operation with minimum "down time," resulting in low maintenance costs and protection from sudden broadcast failures.

- **ACCURATE TIMING**

AMPEX split-second timing accuracy protects your programs and commercials from embarrassing time overlaps.

- **HIGHEST FIDELITY**

Even when programs are repeatedly transcribed from one tape to another, there is no noticeable build-up of noise level, "wow" or distortion.

- **LONG LIFE**

AMPEX Recorders are designed and built for years of service dependability. Its recordings match established NARTB standards. When you have an AMPEX, you have a machine built for years-ahead performance.

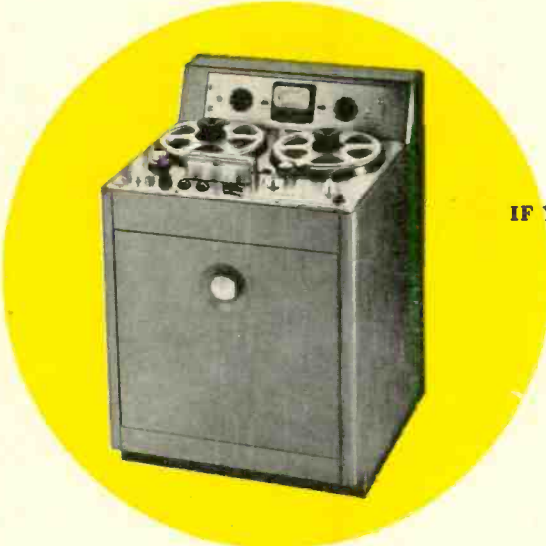

IF YOU PLAN FOR TOMORROW, BUY AN AMPEX TODAY

AMPEX

MAGNETIC RECORDERS

AMPEX ELECTRIC CORPORATION
934 CHARTER STREET • REDWOOD CITY, CALIF.

**YOUR PRODUCTION DEMANDS
THE EXCELLENCE OF**

Precision Prints

**STEP PRINTING
ELIMINATES
CONTACT SHIFTS**

The sharpness of a print depends on close contact between original and print stock. In step printing at Precision, the two films are absolutely stationary during exposure. Timing and effects are produced without notching original.



YOUR ASSURANCE OF BETTER 16_{mm} PRINTS

15 Years Research and Specialization in every phase of 16mm processing, visual and aural. So organized and equipped that all Precision jobs are of the highest quality.

Individual Attention is given each film, each reel, each scene, each frame — through every phase of the complex business of processing — assuring you of the very best results.

Our Advanced Methods and our constant checking and adoption of up-to-the-minute techniques, plus new engineering principles and special machinery

Precision Film Laboratories — a division of J. A. Maurer, Inc., has 14 years of specialization in the 16mm field, consistently meets the latest demands for higher quality and speed.

enable us to offer service unequalled anywhere!

Newest Facilities in the 16mm field are available to customers of Precision, including the most modern applications of electronics, chemistry, physics, optics, sensitometry and densitometry—including exclusive Maurer-designed equipment—your guarantee that only the best is yours at Precision!



NEW LITERATURE

• **Electro-Voice, Inc.**, Buchanan, Mich., will mail free upon written request copies of Bulletins No. 185 and No. 189, describing and illustrating E-V Aristocrat, Regency, and Baronet speaker enclosures, as well as complementary single and 2-way speaker systems. Also listed and shown is the E-V Peerage equipment console, together with a comprehensive table of various changers, amplifiers, and tuners with which it may be used.

• **Minnesota Mining and Manufacturing Co.**, 900 Fauquier St., St. Paul 6, Minn. discusses uses of "Scotch" electrical tapes in industrial and house wiring, underground cable splicing, and other heavy-duty applications in a new 12-page handsomely-prepared booklet. In addition there is an interesting passage which covers the use of "Scotch" glass cloth tape with thermosetting adhesive in sealing, holding, and insulating where elevated temperatures are involved. This booklet is an impressive example of effective industrial publishing. Available upon written request.

• **David Bogen Company, Inc.**, 29 Ninth Ave., New York 14, N. Y., under the title "Electronics for Audio-Radio-Television," is now issuing a handsome, 24-page three-color booklet revealing the design features, specifications, and prices of the company's extensive line of high-fidelity amplifiers, public-address systems, FM-AM tuners, boosters, and allied equipment. Irrespective of your interest in audio, this is a book you should have—truly one of the more worthy and complete listings of quality equipment to cross this desk in many months.

• **Hudson Radio & Television Corp.**, 48 W. 48th St., New York 36, N. Y. has just released a new catalog devoted to its entirety to sound reproducing equipment. Intended essentially for music lovers and high-fidelity enthusiasts, the catalog is a complete directory of fine audio equipment, including information on public address systems, intercom systems, and replacement parts. Available free upon request by mail or in person at Hudson salesrooms.

• **Wells Sales, Inc.**, 833 W. Chicago Ave., Chicago 22, Ill. describes and illustrates a wide variety of capacitor types in a new 16-page catalog. Of interest principally to quantity buyers, the booklet is designated Catalog C-10, and will be mailed on request.

• **Wasserlein Mfg. Co., Inc.**, 126 W. Cass St., Joliet, Ill. is distributing an illustrated brochure titled "The New Way to Solder," in which is described the rudiments of resistance soldering, as well as its uses for production and maintenance in industry. Also contained in the booklet are operating instructions for using the Wassco Glo-Melt resistance soldering unit. Requests for copy should specify Bulletin No. 105-D.

• **Acmiola Distributing Co.**, 602 W. 52nd St., New York 19, N. Y. lists the complete line of Acmiola film editing, film viewing, and sound reproducing machines for professional use in a new sales bulletin. All equipment is well described and effectively illustrated.

• **Equipto Division of Aurora Equipment Co.**, Aurora, Ill. recently announced an 8-page catalog especially for the electronics industry. Included in the listings are such items as work benches, chassis stands, sales counters, steel shelving and bins, test stands, and warm-up racks. All are priced. Catalogs are available singly for individual use and in quantity for jobber salesmen.

Easy, Reliable ACOUSTIC MEASUREMENTS

with the  SOUND-SURVEY METER

for Acoustic Engineers and Audio Enthusiasts

The Type 1555-A Sound-Survey Meter is a low-cost, portable and accurate sound meter. It enables every audio consultant or enthusiast to make measurements permitting proper installation of reproducing systems in theatres, halls, offices, plants, and living rooms. This

instrument is extremely useful to sales engineers, acoustical field engineers and consultants for preliminary survey work where the refinements of the larger Type 1551-A Sound-Level Meter are not necessary.

The G-R Type 1555-A Sound-Survey Meter permits —

- ★ speaker placement for best coverage
- ★ selection of optimum quantity of absorbing material for a given speaker housing
- ★ adjusting of base-reflex systems for best performance
- ★ detection of room absorption defects, enabling corrective measures
- ★ adjusting of cross-over networks, and correct setting of levels in multiple-speaker systems
- ★ determining levels for systems using tone-compensated volume controls



Finger-tip control turns instrument on and off, selects one of three frequency characteristics, checks batteries — sound-pressure level is simply the sum of meter and attenuator readings — range is 40 to 136 db. — flush-mounted crystal microphone has good characteristics — instrument has stabilized amplifier and level indicator.

G-R Type 1555-A Sound-Survey Meter
\$125

There is no substitute for a good frequency-response characteristic. Yet, the accurate determination of overall system response is not easily accomplished.

If sound-pressure level is measured at a fixed point in a room as frequency is changed, the response curve so obtained will be very irregular, even in regions of frequency where the system response is actually flat. Significant characteristics, such as a "notch" produced by an improperly adjusted cross-over network, may be completely obscured. This effect is a result of rapidly changing standing-wave patterns with changes in frequency. That is, combinations of in-phase and out-of-phase waves cancel and reinforce each other at certain frequencies, causing abnormal "highs" and "lows" in response curves.

With the aid of the pocket-size Sound-Survey Meter, measurements at each frequency may be made at several points within a room, and the results readily averaged. Results obtained may then be put in the form of a relatively smooth curve, representing the average sound level as a function of frequency, and illustrating the combined effects of speaker acoustic power output and total room losses. Such results represent the performance of the speaker system in its setting and thus help determine effects due to absorption, room-dimensions, speaker directivity, and standing-wave patterns.

For Complete Information Write for the G-R Sound Measurement Bulletin.

GENERAL RADIO Company

275 Massachusetts Avenue, Cambridge 39, Massachusetts, U. S. A.
50 West St. NEW YORK 6 320 S. Michigan Ave CHICAGO 3 1000 N. Seward St. LOS ANGELES 33

Admittance Meters ★ Coaxial Elements ★ Decade Capacitors
Decade Inductors ★ Decade Resistors ★ Distortion Meters
Frequency Meters ★ Frequency Standards ★ Geiger Counters
Impedance Bridges ★ Modulation Meters ★ Oscillators
Variacs ★ Light Meters ★ Megohmmeters ★ Motor Controls
Noise Meters ★ Null Detectors ★ Precision Capacitors
Pulse Generators ★ Signal Generators ★ Vibration Meters ★ Stroboscopes ★ Wave Filters
U-H-F Measuring Equipment ★ V-T Voltmeters ★ Wave Analyzers ★ Polariscopes

NEW!

3 Super Standard
Output
Transformers

±1 db 20—30,000 cycles
High Efficiency
Small Size

S-510-F, 10 watts
Pri: 10,000ΩCT-8,000ΩCT
Sec: 16-8Ω

S-526-F, 20 watts
Pri: 6,600ΩCT-5,000ΩCT
Sec: 16-8-4Ω

S-542-F, 40 watts
Pri: 5,000ΩCT-4,000ΩCT
Sec: 16-8-4Ω

	Dimensions Inches	Wt. lbs.
S-510-F	2 $\frac{1}{2}$ "-2 $\frac{3}{4}$ "-2 $\frac{1}{2}$ "	2
S-526-F	4 $\frac{3}{8}$ "-3 $\frac{1}{2}$ "-2 $\frac{3}{4}$ "	3
S-542-F	4 $\frac{1}{2}$ "-3 $\frac{3}{8}$ "-3 $\frac{3}{8}$ "	5 $\frac{1}{2}$



Now in Stock

Write
today
for the
new
1953
Peerless
Catalog



PEERLESS

Electrical Products

A DIVISION OF



9356 Santa Monica Blvd., Beverly Hills, Calif.
161 Sixth Avenue, New York 13, New York

Audio Photographer's Checklist

EUGENE F. CORIELL*

AUDIO TECHNICIANS and hobbyists are understandably proud of their equipment and of course want to photograph it for themselves and posterity. Unfortunately, even posterity won't be impressed if the pictures do not do justice to the installation. The following checklist is based on considerable experience in "shooting" audio facilities and while it will not make the reader an expert, it may help him avoid the more common errors of audio photography.

1. Decide in advance exactly what shots are desired and from what angles.
2. Make up your mind as to whether you are aiming for art or exposition. Both are certainly legitimate but this checklist is principally for the latter.

3. People add interest to pictures of equipment, but be careful they do not steal attention from the console, custom installation, etc.

4. Make sure the camera is level, except for angle shots, and that you get what the viewfinder shows. This usually calls for a tripod which will also avoid the blurring often resulting with a hand-held camera.

5. Resist the temptation to use a wide-angle lens on close-ups. It gets a wide area into the picture all right, but may introduce considerable distortion. You do not want your turntables leaning at odd angles and bulging at the top.

6. Some highlights are desirable. There's nothing like a lustrous sheen to convey the impression of quality audio gear. Carrying handles, knobs, switch-handles, hand-rubbed wooden cabinets—these are some of the items that should be shined up for highlights.

7. Be careful that highlights do not obscure equipment details you want to stand out. If flash bulbs are to be used, test for highlights in the wrong places by holding floodlamps in the proposed flash bulb positions. Attenuator dials and meter faces are often obscured by the glare of highlights. If changing the lighting positions or angles does not help, try a light film of vaseline on the offending areas.

8. Look out for undesirable backgrounds which have spoiled many a picture. Keep them out by careful choice of locale and angle, proper depth of focus, adjustment of lighting, and careful cropping (cutting out undesired border areas) with subsequent enlarging if necessary. An impressive speech-input

rack with gleaming panel assemblies is not helped by a cluttered test bench visible in the rear.

9. Make sure all meters and controls are in their desired positions. If a VU meter is to be shown with the pointer at mid-scale or other position, move it to the desired point by connection to a flashlight battery. If the shot is a close-up, make sure the channel and master gain attenuators and the VU range selector are set for the VU reading desired.

10. Clean up the equipment and the room. Make sure that wastebaskets, dangling wires, and other impedimenta are out of sight in the viewfinder.

11. Scratches and dents in panels, racks and table-mounted cabinets show up embarrassingly well on the finished prints, so take care of these beforehand. Soldering paste covers scratches in wooden and plastic cabinets, and grease pencils or crayons of appropriate colors do a pretty good job on metal rack surfaces. (But see item 25, just in case . . .)

12. Allow no smoking while the pictures are being set up . . . the smoke may fog the picture.

13. Is the hour of the day important to the photo? If so, be sure the clock appearing in the picture shows the desired time . . . or get rid of the clock.

14. Do certain elements in a close-up require emphasis—for example, the recording head of a disc recorder? Experiment with spotlighting to brighten desired areas.

15. In close-ups, is the apparatus to be shown alone, or in its normal setting? Sometimes a shot of a console is more effective if it is framed by portions of the adjacent racks and turntables normally associated with it.

16. What about shooting through control room windows? Such pictures are often spoiled by glare and multiple images reflected from the inclined double panes. Make sure the windows are clean, and then experiment with lighting on both sides of the glass. By using photo-flood lamps instead of flash bulbs, the lighting can be adjusted exactly as required before the shutter clicks. Images reflected to the bottom of the panes from unimportant surfaces like checkered-tile foreground floors can be eliminated by covering that portion of the floor with a dark rug.

17. If considerable detail is wanted on patch panels, omit all patch cords. If the latter must be used for effect, use

(Continued on page 70)

* Major, USAF; Radio Technical Officer, Armed Forces Information School, Fort Slocum, N. Y.

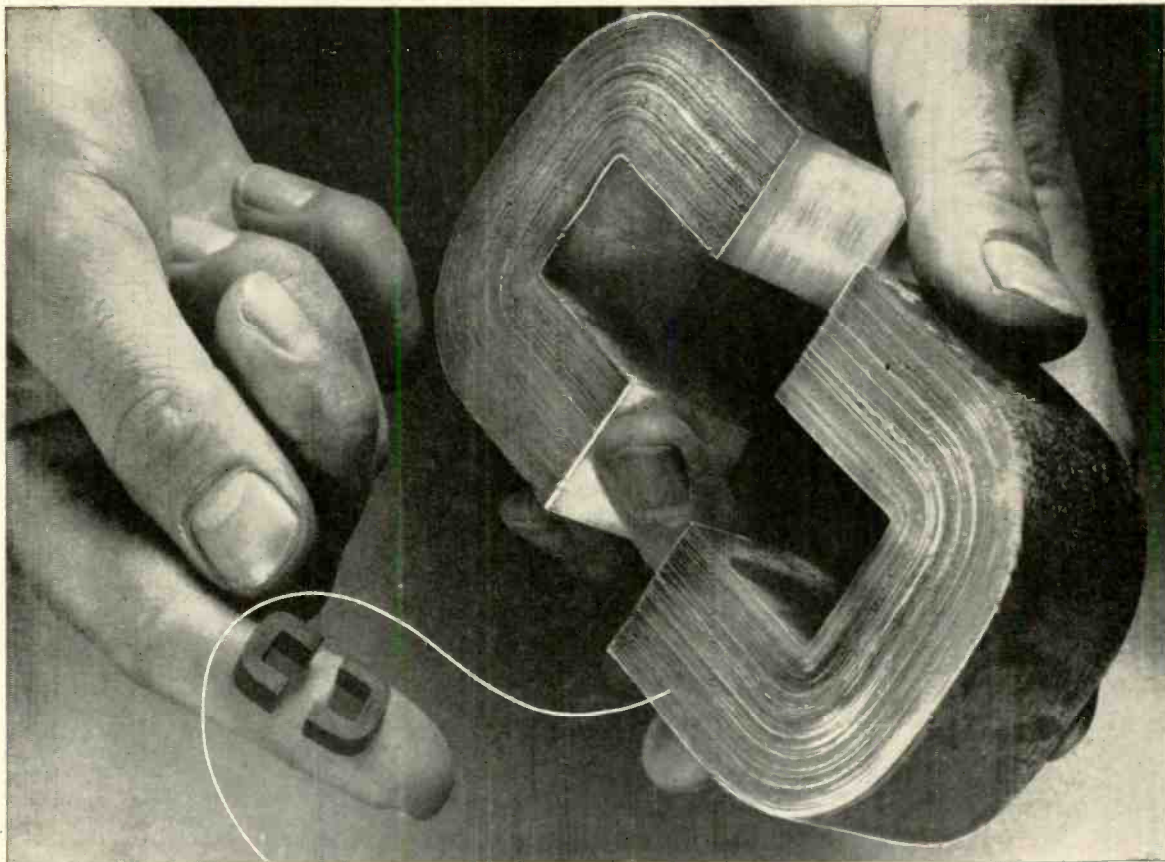

SILECTRON C-CORES... **BIG** or LITTLE

...any quantity and any size

*Wound from
precision rolled
oriented silicon
steel strip as thin
as .00025"*

For users operating on government schedules, Arnold is now producing C-Cores wound from 1/4, 1/2, 1, 2, 4 and 12-mil Silectron strip. The ultra-thin oriented silicon steel strip is rolled to exacting tolerances in our own plant on precision cold-reducing equipment of the most modern type. Winding of cores, processing of butt joints, etc. are carefully controlled, assuring the lowest possible core losses, and freedom from short-circuiting of the laminations.

We can offer prompt delivery in production quantities—and size is no object, from a fraction of an ounce to C-Cores of 200 pounds or more. Rigid standard tests—and special electrical tests where required—give you assurance of the highest quality in all gauges. • *Your inquiries are invited.*

THE ARNOLD ENGINEERING COMPANY

SUBSIDIARY OF ALLEGHENY LUDLUM STEEL CORPORATION

General Office & Plant: Marengo, Illinois

DISTRICT SALES OFFICES

New York: Empire State Bldg. Los Angeles: 3450 Wilshire Blvd.



WAD 4383

EDITOR'S REPORT

AUDIO FAIR—LOS ANGELES

WELL, THEY DID IT! After a series of impossible predictions as to the attendance they would have at the Audio Fair in Los Angeles, they even went further and beat the New York attendance record by almost 50 per cent. No matter what you say, you can't beat those Californians—and this from one who hails from there, many years ago.

We can't help taking our collective hat off to the boys on the West Coast, though, for their concentrated effort in putting over a new event in their city. Perhaps the four-year build-up of interest in the whole idea of exhibiting audio equipment in a situation where it could be heard as well as seen served to swell the desire of the Southern California audio hobbyists and music lovers into a great flood which was unleashed when the doors opened on the Audio Fair-Los Angeles for the first time.

The Los Angeles Section of the Audio Engineering Society deserves plenty of credit also for its establishment of an Industry Advisory Council to work with the Fair officials in putting over the entire show. It indicates what can be done when enough people put their shoulders to the wheel simultaneously with the benefit of the whole industry at heart.

SOLID LOUDSPEAKER ENCLOSURES

With what appears to be good reason, one of our British contemporaries has been talking for years of a conventionally shaped corner bass-reflex enclosure constructed of masonry as the ultimate in speaker mounting. From an abstract viewpoint, this idea of G. A. Briggs' seems to be valid, yet relatively few of us have the courage to try it out—perhaps because of not owning our homes, or perhaps because it seemed to be too much work, or perhaps because we weren't completely convinced. However, we can't help but feel a little sympathy for one of *Æ*'s readers who *was* convinced and who *did* have the courage to build such an arrangement in his Vancouver, B. C., home. This enclosure consisted of an eight-and-one-half cubic foot bass-reflex speaker cabinet constructed adjacent to a fireplace in the living room, and housing a well-known 18-inch British woofer with a free-air cone resonance of 27 cps. With a port area of 54 square inches—dimensions being six by nine inches—his enclosure exhibited two resonant peaks of equal intensity at 30 and 40 cps. The box (?) was constructed of Zonolite concrete poured around asbestos cement-board forms, and with the front panel of one-inch slate.

Nothing was wrong with this installation—except that our reader obtained a new position in Montreal, necessitating the sale of the Vancouver house. Removal of the enclosure would have involved considerable expense in new carpentry, painting, and so on, but leaving the 18-inch woofer was unthinkable, as we would all agree.

Therefore, using considerable ingenuity, this reader

removed the grille cloth and trim, increased the port dimensions to 11 by 22 inches, using a saw attachment on his electric drill, so as to permit getting his head and shoulders inside the box to unbolt the precious speaker. Remember, this front panel was a one-inch slab of slate.

The remainder of the box remains in the house, where its new owner is using it as a woodbox, since it is right next to the fireplace. And our reader is looking all around Montreal for a 30 by 40 inch slab of half to one-inch slate.

Our first reaction to this is that the enclosure must have been pretty good to warrant so much work, and we invite readers' experiences with similar installations. Our second reaction is simply one of reminiscence—we once sold a house which had an eight cubic foot bass reflex enclosure built in—wood, of course, but quite solid. The new owner sawed out the front panel and used the opening as a niche to accommodate his six-tube open-backed radio console.

At this late date, we wonder what the effect of such a niche was on the frequency response of the radio set.

FM STATION PROMOTION

One interesting method whereby listeners to a favorite FM "good music" station may help to ensure the continuance of broadcasting has been inaugurated by KISW-FM, in Seattle, Washington. In a letter addressed to subscribers to the monthly program magazine, KISW listeners are described as a minority among radio listeners in the area, but they are of the type of minority who support the symphonies, the art museums, the drama productions, and the good music programs in a city. Since the station's commercial revenue is insufficient to meet operational costs, some other means of augmenting the income is necessary.

One solution to this emergency that appears to be workable is the formation of a KISW Listeners' Committee which would purchase KISW broadcasting time. The Listeners' Committee will therefore become a KISW advertiser, and money raised by the Committee will not only meet the station's operating deficit but will enable the station to extend and improve its programming.

Listeners can join the Committee by mailing their subscriptions in care of the station. If KISW is worth the price of a one-dollar movie ticket per month, listeners are asked to send in twelve dollars; if it is equivalent to a theatre or concert ticket per month, they are asked to send \$36 or \$48. The first two dollars will be used for a subscription to the monthly program magazine—or a renewal thereof—and the balance goes into a fund to be used to purchase broadcasting time.

Many music lovers would welcome an opportunity to aid in the furtherance of this type of broadcasting, and if such a plan were put into effect in many stations of this type throughout the country, it is probable that some of the financial problems would be alleviated. We shall watch with interest the results of this plan.

"For those who can hear the difference"

Listen....

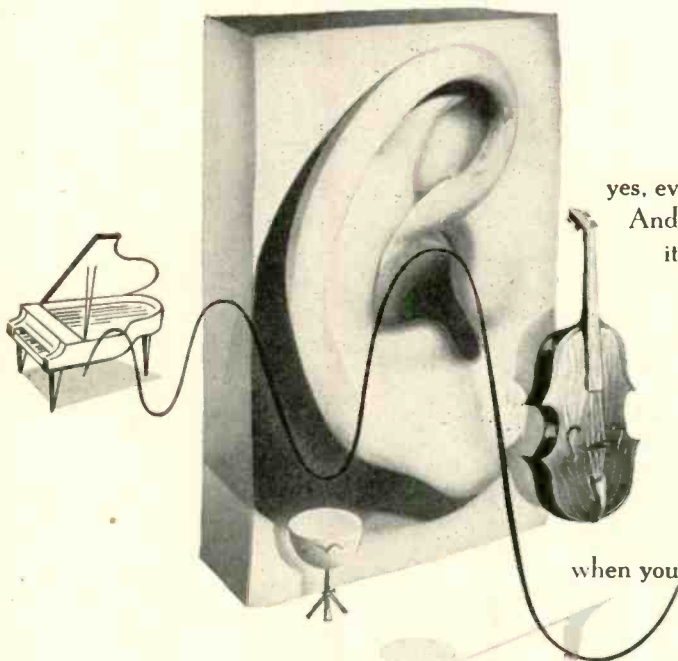

... it comes to you
in the subtle shading of a piano . . .
in the clean brilliance of violins,
the purity of a flute. Your ear detects
the sweet mellowness of cellos,
the roundness of a clarinet . . .
yes, even the iridescence of clashing cymbals.
And, as the symphony swells to crescendo,
its dynamic energy adds a flood of color
to your musical canvas.

For those who can hear the difference,
these are the elusive pleasures
that often remain hidden
in the grooves of fine recordings.
These are the thrilling
new listening experiences
that are released for your enjoyment
when you use quality components by Pickering.

PICKERING COMPONENTS

"for those who can hear the difference"

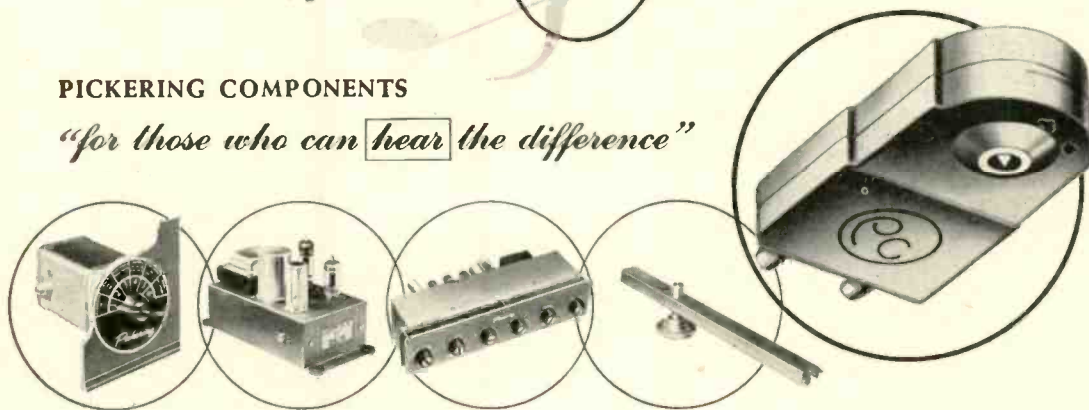

PICKERING and company, incorporated

● Pickering High Fidelity Components are
available through leading Radio Parts dis-
tributors everywhere; detailed literature
sent upon request. Address Department A 1

Oceanside, L. I., New York





“Check your air, Sir?”

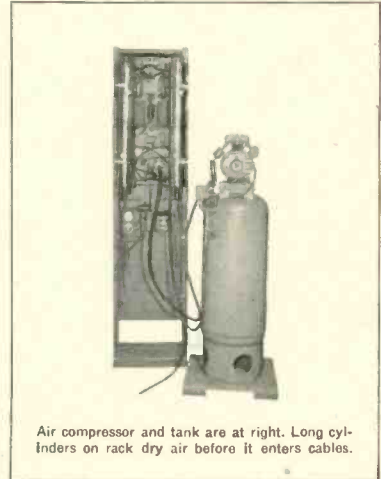

Air compressor and tank are at right. Long cylinders on rack dry air before it enters cables.

He's checking the air pressure in a branch cable, one of scores serving a town. The readings along the cable are plotted as a graph to find low-pressure points which indicate a break in the protecting sheath.



Master meters keep watch over the various cable networks which leave a telephone office in all directions to serve a community. Air enters the system at 7 pounds pressure, but may drop to 2 pounds in outermost sections—still enough to keep dampness out.

To keep voices traveling strongly through telephone cables, you have to keep water out. This calls for speed in locating and repairing cable sheath leaks—a hard job where cable networks fork and branch to serve every neighborhood and street.

At Bell Telephone Laboratories, a team of mechanical and electrical engineers devised a way to fill a complex cable system with dry air under continuous pressure. Pressure readings at selected points detect cracks or holes, however small. Repairman can reach the spot before service is impaired.

It's another example of how Bell Laboratories works out ways to keep your telephone service reliable—and to keep down the cost to you.



BELL TELEPHONE LABORATORIES

Improving telephone service for America provides careers for creative men in mechanical engineering

Effect of Load Impedance on Magnetic Pickup Response

NORMAN PICKERING*

A discussion of operating conditions for the four popular types of magnetic pickups, together with a series of useful curves showing the effects of resistance and capacitance across the pickup on the over-all frequency response.

AUDIO SYSTEMS DESIGNERS and users are always greatly interested in frequency response; in fact, one might say that they are obsessed with it. And well might they be, since nowadays it is taken for granted that any audio system worthy of the name will have a frequency-response characteristic which is asymptotic to perfection. Another more cynical reason has often been advanced to explain the general and devoted attention to frequency response: it is so easily measured.

The accepted procedure for measurement of this parameter is to apply an input signal of known amplitude and frequency and to measure the amplitude of the output signal at each frequency. The difference between input and output signal amplitudes is the absolute gain of the device, when due allowance for impedance ratio has been made. When all of these differences have been plotted against frequency, a frequency-response curve results. If the device being measured is an amplifier it is a simple matter to achieve great accuracy. As soon as a transducer is involved, however, the measurements become much less reliable, although hardly more difficult to make.

Transducers

For one thing, absolute gain has no meaning in transducer measurements. It is necessary to settle arbitrarily on a definition of gain in order to compare transducers. For a phonograph pickup, for example, "absolute gain" might be: microwatts output per centimeter per second r.m.s. velocity at the stylus tip. Even this is incomplete, though, since no allowance has been made for the mechanical impedance at the stylus tip.

Whenever such definitions are proposed they usually meet with an apathetic reception for one or more of the following reasons: 1. It is hard to agree on units, since metric and English units are all mixed up in the recording business. 2. Most engineers feel that pickup efficiency is not important, since amplifier gain is cheap. 3. Absolute gain measurements require much care and some relatively expensive equipment.

*Pickering and Co., Inc., Oceanside, N. Y.

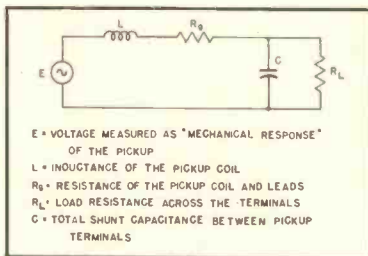

Fig. 1. Equivalent electrical circuit of a magnetic pickup.

Even if we ignore "absolute" response, then, how do we determine even the relative frequency response of a pickup to a fair degree of accuracy? The mechanical signal source is obviously of prime importance, and for practical measurements in the field is invariably a special phonograph record. This record may be an ordinary "frequency" record, a "glide-frequency" record or a "sweep-frequency" record. The usual frequency record consists of a number of bands of discrete frequencies recorded at what is hoped is a known amplitude. The glide record traverses the indicated frequency band at a slow rate, covering all of the frequencies between the starting and the final one. The sweep record does the same thing, but at a rapid rate (usually about 20 times per second) so that an oscilloscope can be synchronized to the sweep rate and the amplitude-frequency characteristic observed directly on the screen.

Each of these records is useful—and each is subject to considerable error. The fixed-frequency record is the only one which can be calibrated, and this procedure must be carried out on each pressing if precise results are to be obtained. The general willingness to rely upon frequency records indicates a lack of awareness, on the part of the user, of the many possible chances for error in this method of measurement, yet what is the poor fellow going to do? About all that is possible is to purchase a well-made record which shows a "flat" light-pattern and to discard it as soon as the noise level shows that severe wear has taken place. With some repro-

ducers, at certain frequencies, two or three playings may make a particular band unfit for further use. The mechanical impedance of many reproducers is such that at very high frequencies with small stylus radii, inelastic deformation of the record material may occur.

Mechanical Response

It is not the purpose of this paper to analyze the situation existing in the mechanical system of the pickup. It will be shown that whatever the basic response of the pickup, however, it will be altered by the following electrical circuit, and such modifications may have a harmful or a corrective effect upon the frequency response.

If a frequency record is played by a given pickup, the open circuit response at the pickup terminals gives the desired information about the way in which mechanical excitation of the stylus tip is converted to electrical energy. This, for lack of a better term, might be called the "mechanical response" of the pickup. This response curve must be added to the electrical response about to be discussed to give the complete frequency response curve of the reproducer.

Electrical Response

Figure 1 gives a very close approximation to the equivalent electrical circuit for a magnetic pickup connected to an amplifier.

The useful signal voltage is that developed across R_L .

Network Equations

The total impedance in the circuit is:

$$Z_t = j\omega L + R_0 + \frac{R_L \left(-\frac{j}{\omega C} \right)}{R_L - \frac{j}{\omega C}}$$

which becomes:

$$Z_t = \left(R_0 R_L + \frac{L}{C} \right) + j \left(\frac{R_L \omega^2 L C - R_0 R_L}{\omega C} \right) \frac{R_L - \frac{j}{\omega C}}$$

If E is assumed to be unity, the current

in the circuit is

$$\frac{E}{Z_t} = I = \frac{R_L - \frac{j}{\omega C}}{\left(R_0 R_L + \frac{L}{C} \right) + j \left(\frac{R_L \omega^2 L C - R_0 R_L}{\omega C} \right)}$$

The voltage across the parallel combination of C and R_L is $I Z_s$ where

$$Z_s = \frac{-j R_L \left(\frac{1}{\omega C} \right)}{R_L - j \left(\frac{1}{\omega C} \right)}$$

Multiplying I by Z_s , the signal voltage across the load becomes:

$$E \text{ out} = \frac{R_L + j\omega R_L^2 C}{[R_L + R_0 - R_L \omega^2 (2LC + R_0 C^2)] + j[\omega(R_L^2 C + 2R_L R_0 C + L - R_L^2 \omega^2 L C^2)]} \quad (1)$$

When $C = 0$, the expression becomes

$$E \text{ out} = \frac{R_L}{R_L + R_0 + j\omega L} \quad (2)$$

On inspection it can be seen that the output voltage in Eq. (2) will fall off at high frequencies unless R_L is very large compared to $2\pi fL$. It is not so easy to tell from Eq. (1) exactly what is likely to happen.

Practical Values

It is in order at this point to examine the equivalent circuit and assign practical values to the parameters. The user has no control over R_0 and L , so the values found in four popular pickups will establish the region of operation generally encountered.

TABLE I
Inductance and Resistance of Popular Pickups

Pickup	L	R ₀
Audak L-6	0.780 Hy.	630 ohms
G. E. RPX-050	0.470 Hy.	370 ohms
Pickering 140 G 120	0.150 Hy.	600 ohms
Clarkstan	0.720 Hy.	1660 ohms

Frequency Response with Resistive Load

When the load has no appreciable ca-

pacitive component, the frequency response may be calculated from Eq. (2). Figure 2 shows the results of such calculations for a pickup of 150 millihenries inductance and 600 ohms resistance. It will be seen that the response becomes asymptotic to 6-db-per-octave roll-off at the high frequencies, and this fact may be used to advantage in equalization circuits for pre-emphasized record characteristics. It will further be noted that the low-frequency level of the voltage output is uniformly attenuated because of the resistance R_0 of the pickup coil. This constitutes a practical limit to the amount of attenuation which can profitably be done with only a resistor

across the terminals. In cartridges which have a high ratio of L to R_0 , more high-frequency attenuation can be achieved before low-frequency losses exceed a practical maximum (say 4 db).

Figure 3 shows the frequency response for a cartridge with a high ratio of L to R_0 . L is 0.472 henries and R_0 is 370 ohms. It will be noted that the effect on low frequencies is very much less than in the cartridge of Fig. 2.

This information gives a good indication of the nominal "impedance" of the cartridge. Since the generator impedance is reactive, the load resistance for flat response will depend on the inductive element. This is usually specified by the manufacturer to include effects of mechanical response, but for a working figure, the nominal impedance of the cartridge will be the value of $2\pi fL$ at $\omega = 1.25 \times 10^5$ (approximately 20,000 cps). At this point the electrical response will be down 3 db. Figure 4 shows the nominal impedance as a function of coil inductance. This illustrates clearly how the pickup with 780 millihenries inductance can have a nominal impedance of 0.1 megohms, although its d.c. resistance is only 630 ohms.

Effect of Capacitance

It is impossible to have a cartridge connected to an amplifier without hav-

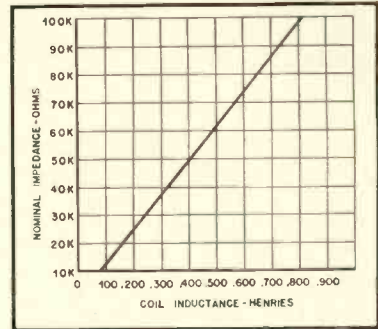

Fig. 4. Nominal impedance of a magnetic pickup as a function of coil inductance.

ing some capacitance shunting the pickup coil. Since virtually all high-impedance installations have one pickup lead grounded, it is the sum of all the capacitances from grid to ground which is the value of C in Fig. 1.

Referring to Eq. (1), it will be seen that C figures prominently in the frequency response of the cartridge, but since it appears both in the numerator and in the denominator, and both positively and negatively, it is difficult to see by inspection what the net effect will be.

Since C always occurs with R_L , it is apparent that the factor $R_L C$ is more significant than the absolute value of C . It may be of interest to examine actual installations in order to determine possible actual values of C encountered in practice.

Practical Values of Capacitance

The Miller-effect capacitance of various input tubes is listed in Table II. The tubes indicated are those usually encountered in phonograph preamplifiers used for magnetic pickups.

The input connection to the preamplifier is usually made by means of shielded wire. The capacitance per foot of various types of wire is shown in Table III. In addition to these capacitances, there is generally an additional capacitance of

[Continued on page 60]

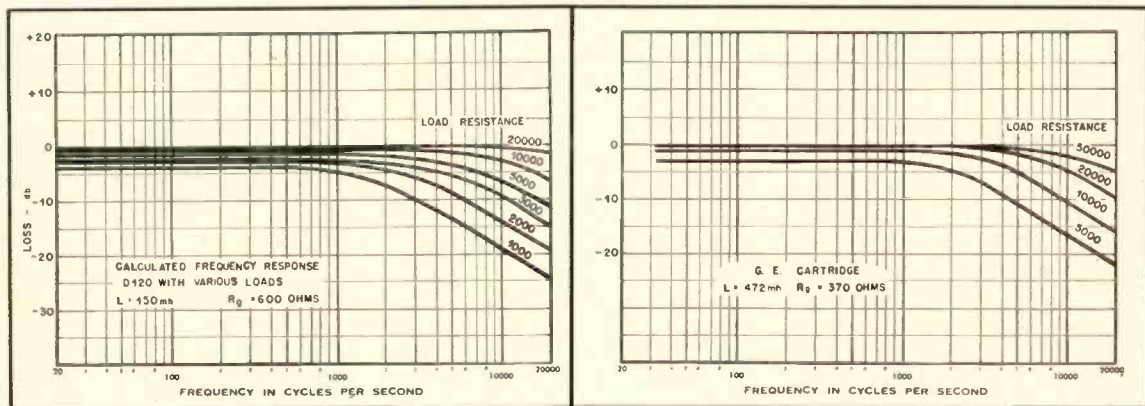

Fig. 2 (left). Curves showing the frequency response of a Pickering D120M pickup with various resistive loads. Fig. 3 (right). Frequency response of GE RPX-050 pickup with various resistive loads.

A Power Tube Figure of Merit

WARREN G. BENDER*

The author presents a simple method of evaluating power output tubes which takes into account most of the factors which are of importance in any tube application.

IT IS CUSTOMARY to define figures of merit in order to have a numerical means of examining how well a specific job is being done. Such figures of merit as the "Q" of a tuned circuit or the gain-bandwidth product of an amplifier stage are typical examples. This article attempts to define a figure of merit for power output tubes used in home amplifiers, and to compare on this basis the tubes commonly used for this application.

The following characteristics of power tubes are evaluated in the figure of merit: power output, driving voltage, distortion, and internal impedance. Other factors such as cost and ease of eliminating hum, for example, do not appear in the figure of merit, and must be taken into account separately.

Since amplifiers for serious home use are almost without exception, push pull in operation, the evaluation of the figure of merit is in every case for two push-pull tubes. Also since home amplifiers are considered, only A and AB₁ operation are tabulated.

The value of the figure of merit is given by:

$$F = \frac{P(100 - D)}{R_L E_a}$$

where

F = Figure of Merit
 P = power output in watts
 D = distortion at rated output
 R_L = load impedance in thousand ohms
 E_a = peak grid driving volts.

The available power appears in the numerator of the figure of merit; thus a larger amount of power results in a larger or more desirable figure of merit.

Conversely the peak grid driving voltage and the load impedance, which is a function of the internal impedance, appear in the denominator. Thus, the figure of merit is an index of the power available as modified by other factors which make the use of the tube more or less desirable. The larger the figure of merit the better is the tube.

A number of values for commonly used tubes is given in Table I.

The calculations for the 2A3 family show a marked preference for the use of fixed bias. However the choice of bias method must depend on the decision of the designer as to the return for the extra trouble of providing fixed bias.

Within this group of tubes are many differences which are not reflected in the common figures of merit. The 2A3,

while a standby for almost a generation, suffers from the need of a special filament voltage and old fashioned socket requirements. The six-volt equivalent—the 6A3—has almost been completely replaced by the 6B4G and 6A5G. Of these, the latter with its unipotential cathode brought out to a separate pin, is the more modern and probably more preferable tube.

The 6AS7G suffers because of the extremely high driving voltages required. The other triodes listed with their somewhat better figures of merit include those types whose use is becoming more and more popular.

Of particular interest is the triode-connected 6AR6, which in this evaluation seems to be a very desirable tube for future exploitation.

Beam-power tubes in general, with their modest drive requirements and good power sensitivity, average a bit better than triodes. It is significant to note the high figure of merit obtained by class A 6L6's which are very commonly used.

Non-beam-power pentodes which are less modern compare rather poorly with beam power tubes. Class A 6L6's at 10.5 watts output have a figure of merit of 1.75. The figure of merit of class A 6K6's at 9.8 watts is only 1.54.

If operation into AB₂ is allowed the figure of merit increases markedly, although this increase is attended with greatly increased difficulties of driving power, power supply requirements, etc. Fixed-bias 6L6's with 47 watts of output power have a figure of merit of 16.82. Similarly connected KT66's yield a value of 11.9.

It must be remembered that the Tube-Manual figures used to derive these values assume among other things, 100 per cent efficiency of the output transformer and perfect regulation of the power supply. The first condition will not effect the value of a comparison. The second condition however, will affect the validity of a comparison between class A and AB₁ operation if the regulation of the power supply is not perfect. From this point of view, when using a conventional power supply, class A operation, with its smaller current variations with signal, is distinctly advantageous, although schemes to regulate the screens of beam power tubes in class AB₁ do much to decrease the advantage of class A operation.

All reference to the triode *vs.* beam-power controversy has been purposely omitted. The figures do not show any clear advantage for either type. It is felt that this is a realistic representation of the situation. The high power sensitivity of beam power tubes makes the application of larger amounts of negative feedback easier, which makes up for the higher generator impedance of this type of tube.

It is interesting to note the correlation between high figures of merit and popularity of application. The use of this figure of merit enables a numerical comparison of the desirability of various tubes under consideration for a given amplifier. If it is desired to evaluate new tube types or other operating points, the calculations to obtain a figure of merit are straightforward and easy. Thus it is a simple matter to keep the table of figures of merit up to date.

TABLE I
Figure of Merit

Triodes	Class	Bias	Voltage	Power (watts)	Figure of Merit
2A3-6B4 etc.	AB ₁	Self	300	10	1.22
2A3-6B4 etc.	AB ₁	Fixed	300	15	3.94
6AS7G	A	Self	250	13	0.83
6AS7G	A	Self	200	11	1.47
300A	A	Self	450	35.6	4.90
KT66	AB ₁	Self	250	4.5	4.42
KT66	AB ₁	Self	450	14.5	4.38
807-1614	AB ₁	Self	400	15	5.40
6AR6	A	Self	400	20	14.5
Beam Power Tubes	Class	Bias	Voltage	Power (watts)	Figure of Merit
6V6	AB ₁	Self	285	14	4.45
6V6-6AQ5	AB ₁	Self	250	10	3.17
KT66	AB ₁	Self	250	17	11.30
KT66	AB ₁	Self	450	30	5.05
6L6-5881	A	Self	270	18.5	9.06
6L6-5881	A	Fixed	270	17.5	9.80
6L6-5881	AB ₁	Self	360	24.5	4.58
6L6-5881	AB ₁	Fixed	360	26.5	8.78

* 62 Park St., Tenafly, N. J.

The Selection of Tone-Control Parameters

EDGAR M. VILLCHUR*

Proper design of tone controls requires a study of the conditions which must be corrected. The author delineates these conditions, and explains the requirements for each.

VARIOUS TONE-CONTROL circuits with given transition frequencies¹ and rates of boost or cut have been extensively discussed in technical literature. Little has been written, however, about considerations involved in the selection of the response-curve parameters, which sometimes seem to be chosen more or less arbitrarily. While "flat" power amplifier stages are carefully designed for an audio-frequency response which is kept to a maximum random deviation of a fraction of a decibel, improper tone compensation (either manual or automatic) in the same amplifier may introduce, or leave uncorrected, very large inaccuracies of frequency distribution relative to the perceived original. These inaccuracies have on occasion completely overshadowed the benefits of the above-mentioned careful design, and have become a primary factor in determining over-all quality.

Fixed tone equalization is used when the frequency characteristics for which compensation is being made are constant. Modern home reproducing systems contain several fixed or automatically variable audio equalization circuits associated with FM pre-emphasis, recording characteristics, pickup frequency distortion, or changes of

* Contributing Editor, AUDIO ENGINEERING.

¹ The transition frequency is the intersection of the theoretical linear slope of the response curve (a slope which the actual curve only approaches) with the frequency axis—see Fig. 5.

Fig. 3. Resultant frequency response of an audio system using a commercial speaker in the \$50 class and the treble boost of (A), Fig. 1.

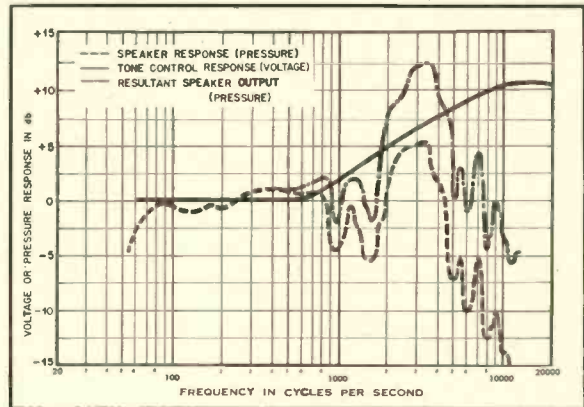

volume level. The inclusion of such circuits does not make variable tone control superfluous, since there are many unpredictable conditions for which it may be desirable to adjust the frequency response of the reproducing equipment.

The designer of fixed equalizers does not ordinarily have to worry about what parameters to use; with certain exceptions his transition frequencies, and the required rate of boost or cut, have been exactly determined by his problem. In contrast a tone-control designer must furnish the means for correction, by the same circuit, of all sorts of signal aberrations. He can either provide a complex control system

which allows for equalization of almost any frequency conditions, or he can reduce the flexibility of control, choosing compromise response curve parameters which are capable of producing approximate compensation for those conditions most likely to be encountered. The degree of tone-control complexity accepted in non-professional equipment has increased quite a bit since the day of the single treble-cut switch, and the most common arrangement in current audio amplifiers is a two-control, continuously variable system. This allows progressive cut or boost of either bass or treble, but no independent control of the reference frequencies at which the response curves begin their slopes.

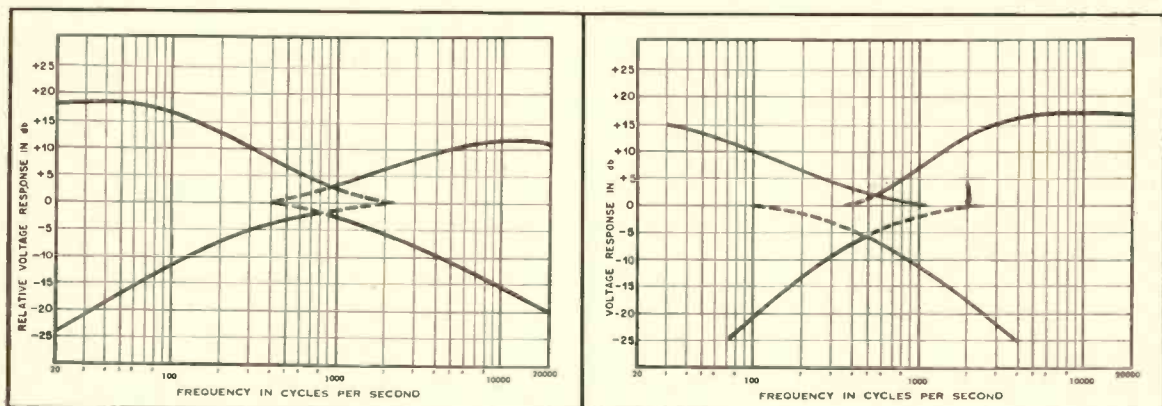

Fig. 1. (A), Voltage response curves of a typical commercial tone control circuit of the R-C type, maximum positions. (B), Voltage response curve of a commercial tone control circuit of the L-R-C type, maximum positions.

A circuit which introduces a progressive response slope rather than uniform elevation or depression of a whole band of frequencies, besides being of far simpler design, provides the desired form of compensation in most applications. It is common although not universal practice for dual tone controls to use approximately the same transition frequency region, usually at or below 1,000 cps, for both bass and treble variation. Figure 1 shows the response curves of two such tone control circuits employed commercially.

The justification for selecting this

operator's adjustment of tone controls is in the nature of a search for maximum fidelity to the perceived original, the psychological mid-point ceases to have much significance. Tone control becomes tone compensation, and the problem of response-curve parameters revolves about the question of what the controller must be equipped to compensate for. In the following discussion it will be assumed that the amplifier is being designed as an independent unit, and that the brands of components with which it is to be used are not known.

This factor, referred to as the Fletcher-Munson effect, will be discussed in the paragraphs devoted to bass boost.

Equipment treble deficiencies are usually most severe in electro-acoustic devices such as loudspeakers, pickups, and recording heads, but also occur in coupling circuits in audio or intermediate-frequency amplifiers.

The worst offender in a given system is ordinarily the loudspeaker. In Fig. 2 manufacturers' published on-axis response curves for six speakers in different price ranges are plotted. Although the performance represented by these curves will vary greatly under different acoustical conditions the graphs may be taken as indicators of a general trend. There is one feature which all may be seen to have in common, and which is characteristic of the great majority of cone loudspeakers with high-frequency droop; the frequency region of the first two octaves above 1,000 cps, far from being attenuated, is accentuated (because of the new resonances introduced by cone break-up), and treble droop does not begin before 4,000 cps or higher. This fact has a significance beyond the obvious implication concerning compensation for speaker deficiencies. Any losses in the first two treble octaves which are likely to be met with from other causes will probably be compensated or even over-compensated by speaker characteristics.

Crystal phonograph pickups have a typical velocity response above a few hundred cps which decreases with frequency quite regularly up to a rather sharp cut-off somewhere between 4,000 and 10,000 cps. When this regular droop does not conform to the desired recording characteristic further compensation is properly provided by a fixed R-C network rather than by the tone control. The comparatively smooth and accurately predictable slope lends itself to fixed equalization, and the recommended circuits or necessary data for their design are usually readily available from the manufacturer. But whether or not such a fixed network is provided, the treble boost control cannot be designed

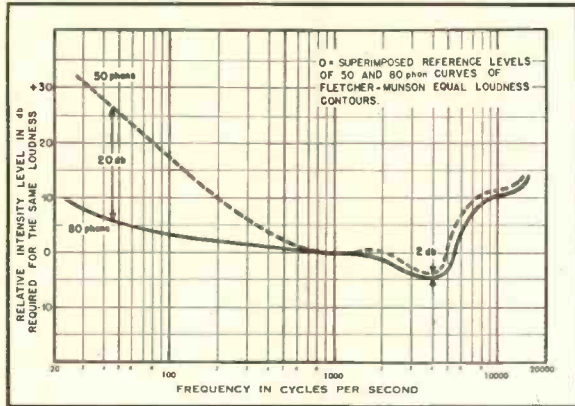

Fig. 4. The 50- and 80-phon equal loudness contours (from Fletcher and Munson) superimposed.

reference frequency region is that it is considered psychologically "neutral" in pitch. It has been pointed out that 800 cps is the geometric mean between 40 and 16,000 cps, frequencies which may be taken as nominal limits of hearing under average conditions. Since the perception of frequency, like that of amplitude, closely follows the Weber-Fechner law (in that the degree of sensation varies logarithmically with the stimulus) the geometric and not the arithmetic mean of the audible frequency spectrum is its psychological mid-point. Thus there are about four and one-half octaves of useful audio frequencies on each side of 800 cps.

If we assume, however, that the

Treble Boost

The most common purposes for which treble boost will be needed are:

1. Compensation for treble deficiencies in associated reproducing equipment.
2. Compensation for treble deficiencies in program material.
3. Compensation for discriminatory acoustic absorption with a frequency characteristic different from that of the hall or studio in which the sound originated.

An additional purpose for which treble boost has on occasion been considered necessary, but is not, is compensation for the variation in hearing frequency characteristics associated with changes of sound intensity level.

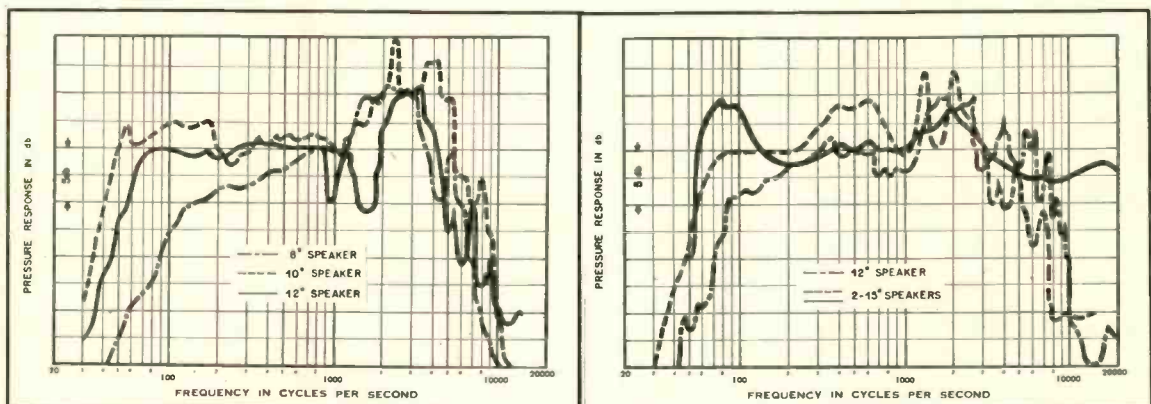

Fig. 2, (A) and (B). Pressure response curves of three commercial speakers in a price range of \$20 to \$150.

for correct crystal pickup equalization except for the second droop, because the required transition frequency would be well into the bass region.

The contribution of high-frequency losses by other components cannot, of course, be predicted, except as to one factor; it may be expected that losses will be confined to frequencies above the second treble octave. A survey of circuit components, recording heads, etc., will indicate that it is rare for treble droop to set in before 4,000 cps or so. Even AM broadcast band i.f. transformers provide, at worst, relatively even coupling to 3,000 cps.

Treble deficiencies in program material may result from low-grade studio equipment, from transmission circuits, and from old records. Such losses are almost always associated exclusively with the third and/or fourth treble octaves.

The writer has not found a quantitative study which compares the frequency transmission of typical living rooms with that of halls or studios, although methods for room transmission measurements have been outlined.² Therefore no comment will be made on the subject other than to mention the fact that room acoustics—notably the reverberation time *versus* frequency relationship—may be a factor requiring tone compensation. Reference is made to this factor under the heading of treble boost merely on the basis of subjective experience, but undoubtedly other compensations are also involved.

When treble boost is needed, then, a high transition frequency is usually desirable. The use of a lower transition frequency for the sake of increasing the amount of boost available at the upper end might prove satisfactory if it were not for the marked tendency of loudspeakers to emphasize the frequency region of the first few thousand cps. A transition frequency of 1,000 cps or lower may cause treble boost to accentuate a shrillness towards which the speaker performance is already inclined, and needed boost at frequencies above 4,000 cps may carry such a penalty that

²E. C. Wentz, "The characteristics of sound transmission in rooms." *J. Acous. Soc. Am.*, 7, p. 134, Oct., 1935.

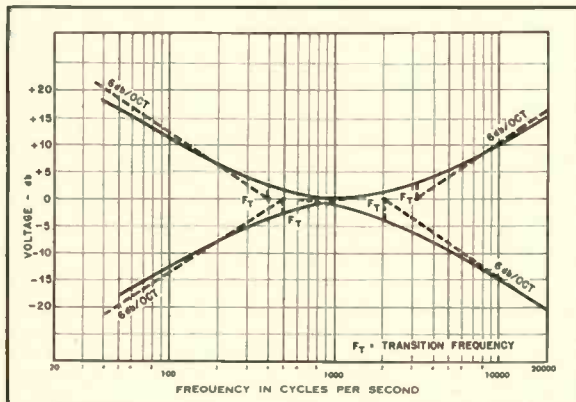

Fig. 5. Suggested tone control frequency characteristics, controls at maximum positions.

the compensation will not be used. This unhappy effect is illustrated by Fig. 3, in which the tone-control and speaker-response curves of two high-grade commercial units are combined.

Determination of an optimum transition frequency that will best suit the various requirements of treble boost cannot be made with precision, but it would seem that present commercial practice makes use of a frequency which is at least two octaves too low. The operator of the set may be impressed with the dramatic power of his treble boost but may still be loath to use it. (Some British manufacturers lean towards higher transition frequencies for treble emphasis—one manufacturer uses 3,500 cps.)

A single R-C network can approach 6 db per octave in rate of boost. The simplicity of the single network is one good reason for accepting this slope at the maximum, and it will prove ample for most purposes, particularly in view of the fact that treble emphasis brings to the fore harmonic distortion in the higher ranges. If the transition frequency is chosen as 3,200 cps—two octaves above 800 cps—an insertion loss of 20 db will produce something less than 12 db of maximum boost at 13,000 cps, including about 3 db of boost at the reference frequency itself. These characteristics seem to represent a reasonable compromise between the requirements of all factors. The use of an even higher transition frequency might be desirable, but would place a greater limitation on the maximum boost of useful frequencies that could be achieved with a single R-C network.

Treble Attenuation

Treble attenuation is required for:

1. Compensation for varying pre-emphasis in recording.
2. Reduction of record surface noise and high-frequency distortion.
3. Compensation for rising treble response of associated reproducing or studio equipment.
4. Tonal balance against a thin bass.

Treble pre-emphasis in recording varies considerably, and there is no standard, either of transition frequency or rate of boost, to which recording

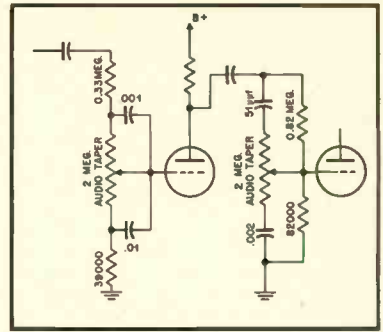

Fig. 6. Circuit values to approximate the curves of Fig. 5. As many of the values of the original \mathcal{R} circuit as possible have been retained.

companies subscribe. Table 1 lists some of the different ways in which the treble spectrum is or has been treated by record manufacturers.

Although treble recording characteristics are ideally equalized at the pickup, variable pickup equalizers are still the exception rather than the rule, and the tone-control designer must assume that at least some of the burden will fall on the treble-cut control. If the setting for minimum treble furnishes close to 6 db of attenuation per octave from a transition frequency of 2,000 cps, approximate compensation for any of the recording pre-emphasis curves can be achieved.

TABLE 1

Typical Transition Frequencies

Records	Transition Frequency (cps)	Rate of Boost (db/octave)
AES Standard Curve	2500	6
Columbia 78 G 33 1/3 ^a	1590	6
RCA 78 ^b	1000	2.5
London frr 78 ^c	3000	3
London 33 1/3 ^d	3000	6
EMI 78 ^e	—	none
Older records	—	none

Settings of the treble control which yield less than maximum attenuation will also, in most circuits, automatically shift the transition frequency higher, correcting equalization for some of the records with more gradual pre-emphasis slopes. The desirability of equalization for treble recording characteristics prior to the tone control is emphasized by the differences between the transition frequencies of some of these recording curves and the frequencies at which the equipment deficiencies previously discussed introduce treble losses. For example, an improperly equalized disc which has been recorded with a given treble characteristic can present an unsatisfying choice between shrill and muffled reproduction, because the tone

[Continued on page 68]

³Paul W. St. George and Benjamin B. Drisko, "Versatile phonograph preamplifier," *AUDIO ENGINEERING*, 33, p. 14, March, 1949.

⁴D. T. N. Williamson, "High-quality amplifier modifications," *Wireless World*, 58, p. 173, May, 1952.

Audio in the Year 1693

ALLEN H. FRY*

Accidentally discovered in the New York Public Library during a search for some early papers of Harvey Fletcher, this book compiles much of the audio knowledge of its day.

THE TREATISE ON SOUND whose title page is here reproduced was written in 1693 by Caspar Ringelmann, probably as a thesis for the doctorate. Both acoustical theory and a hypothetical engineering practice are covered. Although more profound work in the theory of vibrations had already been performed by Galileo and Newton, and although Bacon's *Novum Organum* had outlined standards of scientific method which Ringelmann did not always meet, the description of contemporary acoustical design makes absorbing reading, and is often prophetic of modern devices.

Following are selected passages from the treatise, translated from the Latin (the language then standard for all scholarly work).

The Nature of Sound and Hearing

Sound is an oscillatory movement of the air activating the ear locally.

The inner ear has the sensory function. The outer ear collects the sound and transmits it to the inner.

The motion of the air sets contiguous bodies in motion. Thus, air movements set the tympanum of the ear in motion; this in turn moves the Hammer which strikes the Anvil. From here on, the motion is carried by air pressure differences. (*Note: this is inaccurate; the sound is actually propagated through the cochlear fluid.*) These internal pressure differentials act upon the auditory nerves which transmit them to the brain.

Vitruvius¹ well explained the nature of sound where he says: "Sound proceeds outwardly in a series of increasing circular movements. It is as though we were to throw a stone into a pool of placid water. . . . Starting from the center the circles become larger and larger."

* Princeton, N. J.

¹ A classical Roman architect and writer.

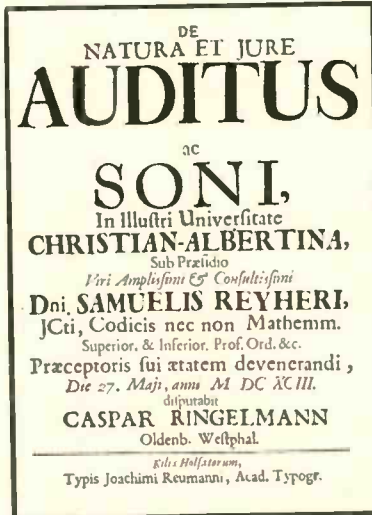

Fig. 1. Title page of the thesis "Of the Nature and Laws of Hearing and Sound" by Caspar Ringelmann, of Oldenburg, Westphalia, who "will dispute" (defend the thesis) on May 27th, 1693.

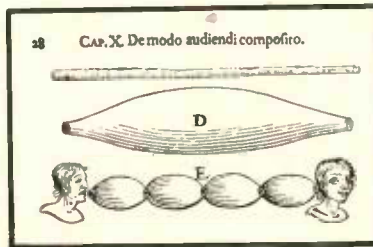

Fig. 2. Ear-tubes for voice communication.

The Collection and Transmission of Sound

Acoustical ear-tubes . . . work on the principle that sound is normally dissipated in the free and open air. By using such a tube the total vibratory movement is carried directly into the listener's ear. (*See Fig. 2.*) By listening to a sea-shell or large jug one can even hear the residual sound produced by the otherwise quiet ambient air.

Along this same line of reasoning, it is possible to construct a building so that if a person were in one central place he could hear everything going on throughout the entire building.

Kircher (*in Phonurgia Nova, 1673*) . . . discourses on some Acoustic devices of his which will enable one to carry on a conversation from one room to another inside of a house. (*See Fig. 3.*) Or, outdoors between two distant places.

Construction of an Artificial Mechanism

It will be noted that the device described below substantially constitutes the input system of an acoustical phonograph; it has a horn, a diaphragm stretched across the horn's throat, and a mechanical device attached to the diaphragm.

The term "artificial ear" refers to a device which is an actual working model of the human ear. (*Figure 4.*) It may be used to demonstrate the mechanism of the hearing process, or in the case of auditory deficiency, to bring about a certain degree of compensation.

1. Make a little ring of metal and form the leftover end-piece into a short appendage. Let the very end of this appendage be the Anvil (c).
2. Cover the ring with a lightly-stretched membrane.
3. Glue or fasten onto the membrane the

[Continued on page 56]

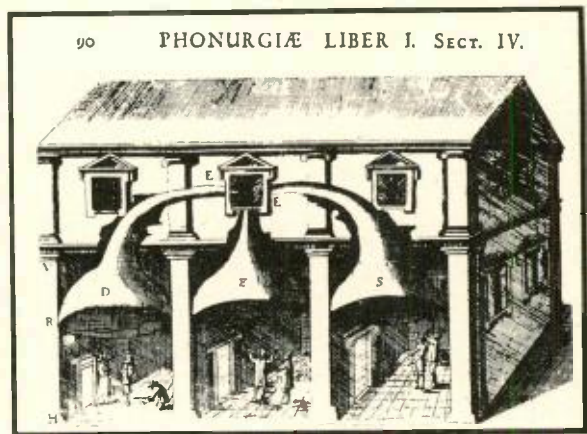
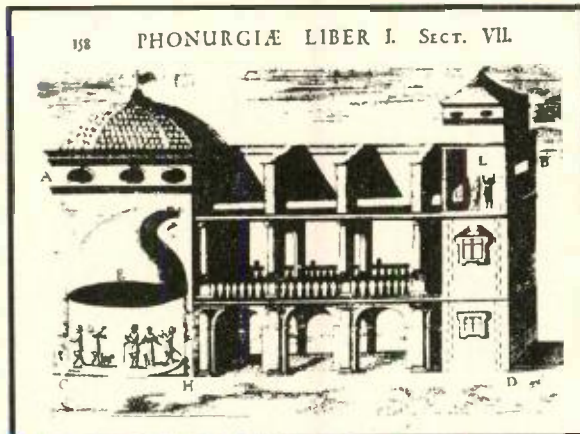

Fig. 3. Seventeenth century intercoms, also useful as spy systems.

Auxiliary or Emergency Broadcast Control Room

HAROLD REED*

For a total cost of \$125, one engineer equipped a small storeroom to extract double duty from idle remote equipment as a fixed studio installation.

IN THESE DAYS of intense competition in the radio broadcasting business, not to mention the additional bid for advertisers' dollars now being made by television, it often becomes necessary for radio stations to effect every possible economy in their operations. Yet the engineering department is frequently faced with increased program and recording activities in spite of so-called economic operations, making the technical facilities available entirely inadequate to meet the demands of the program and commercial departments.

There are usually enough studios available, but a serious lack of studio control facilities is generally encountered when numerous auditions, rehearsals, and recordings are scheduled, in addition to the program "on the air." Studio control equipment is costly, so if anything is to be done to improve the situation it must be on the basis of making the apparatus on hand do double duty and of using any spare or obsolete pieces, modifying these units to perform a satisfactory broadcast service. One such situation as outlined above was overcome in the following manner.

Adjacent to one side of the main studio was located a small room, 12 by 7 feet, which was being used for office supplies. Arrangements were made to house these supplies in other parts of the premises and a 48 by 30 inch window

* Chief Engineer WOL, 1000 Connecticut Ave., N.W., Washington 6, D.C.

was cut through to the main studio and three panes of glass installed to afford sound isolation. This wall, being a studio partition, was already treated for sound isolation. The cost for this work, including painting the window frame was \$88.00. Nothing more was spent on this room except for varnish to improve the appearance of the floor.

Several remote amplifiers were in the plant and rarely were they all in the field simultaneously. These field amplifiers are Western Electric 22D models. One of these amplifiers was installed on a small, badly scratched, desk which was given a coat of commercial-looking green paint. Four lengths of flexible, shielded, microphone cable were fed through the wall and terminated in microphone input receptacles mounted in Wiremold boxes. The control room ends were terminated in connectors suitable for the microphone inputs of the 22D amplifier. Two 600-ohm outputs are available on these amplifiers. Flexible cables were connected to these with the other ends terminated in twist-lock connectors. These connectors plug into receptacles mounted in Wiremold boxes and installed on the wall near the desk, from which two shielded pairs are taken to the main jack panel in the master control room. 600-ohm terminating resistors are normally across these pairs at the jack panel end. By means of patch cords, program

material fed on either of these circuits can be dispatched to any point, the terminating resistors being automatically removed from the circuit when the patch cord is inserted. Figure 1 gives the layout described above and shows the tape recorder setup outlined in the next paragraph.

A portable Magnecord tape recorder, normally used for remote recording work, was placed on a small table near the 22D amplifier. This recorder is equipped with a high-impedance bridging input and a 600-ohm output, both of which appear on screw-type terminal strips. For convenience in removing and replacing this unit, small connectors were installed at the rear of the chassis. The bridging input is connected across output #1 of the 22D amplifier and the 600-ohm output is fed to the 30-ohm microphone input channel #4 through a 600-to-30 ohm, 60-db pad. This provides for recording, through the bridging input, any program material going into the amplifier, and to feed to the amplifier, through #4 mike channel, any tape recording played on the recorder. In this way, three studio microphones and the recorder can be fed simultaneously into the amplifier or, if no recording is played, four studio microphone channels are available. The cable from the input of the recorder is terminated in the same type of connector as the microphone cables and they are, therefore, easily inter-

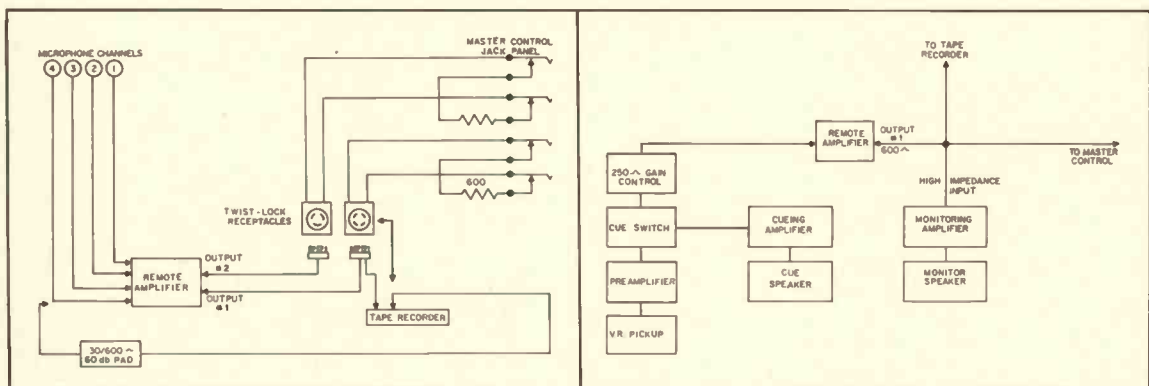

Fig. 1 (left). Diagram showing interconnections between WE 22D Remote Amplifier and a portable tape recorder to provide extra studio control facilities. Fig. 2 (right). Block diagram to show connections for transcription turntable and monitoring amplifier and speaker.

changed. Normally three microphones and the recorder input are kept in position. The 600-ohm output of the recorder can also be fed to either line to the master control jack panel.

For aural monitoring of programs and recordings an audio amplifier and loudspeaker are also bridged across the #1 output of the 22D Amplifier. No details are given here in regard to the monitoring amplifier as many published circuits would be satisfactory. However, one requirement of the amplifier used is that it must include a high-impedance input so that it does not load the 600-ohm output of the 22D amplifier across which it is bridged.

Transcription Facilities

An old transcription turntable which had formerly been used for audition purposes, was salvaged. It was in good condition mechanically, but was equipped with a heavy, obsolete pickup arm and cartridge. A lightweight, inexpensive, Clarkstan (Pacific Transducer) #212 arm was installed and fitted with a G. E. variable reluctance cartridge. The arm includes a quick-change weight adjuster so that standard or long playing microgroove records can be reproduced. The cartridge holder is of the slide-in type and can be changed quickly. Two cartridges are kept available, one with a 3-mil stylus for playing standard records, and the other with a 1-mil stylus for microgroove recordings. A G. E. phono preamplifier, #UPX003, with self-contained power supply was installed in the turntable cabinet to provide the voltage gain and equalization to operate the cartridge into the 22D amplifier. This preamplifier should be mounted on sponge rubber and kept as far as possible from the a.c. field of the turntable motor. In order not to use up another

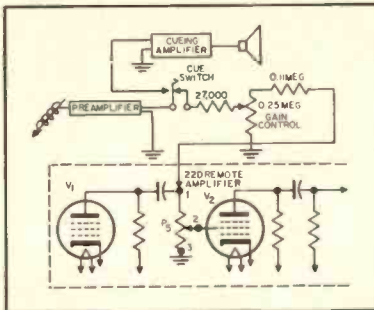

Fig. 3. Details of connections between transcription equipment and 22D remote amplifier.

microphone input channel on the amplifier and because these inputs are of a low impedance value, and as the additional gain of the first stage of the amplifier is not required, the high impedance output of the phono preamplifier was coupled into the second stage of the 22D through a standard phono plug and jack. A gain control was mounted on the turntable cabinet to control the preamplifier output.

So that the operator may cue up a record before feeding it into the control amplifier, a cue switch, amplifier and speaker are provided. The cue

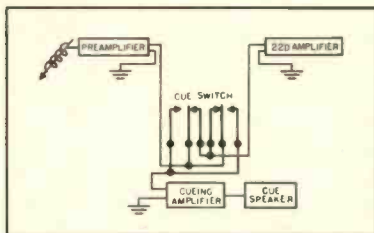

Fig. 4. Wiring of record cueing switch and amplifier.

switch, a push to listen, self-releasing type is conveniently located on the turntable top, the amplifier inside the cabinet, and the speaker on the wall near the operating position. Suitable circuits for the cueing amplifier can be adapted from published circuits.

A block diagram showing turntable and cueing arrangement and monitoring system is given in Fig. 2. Connection between the preamplifier and the 22D amplifier is shown in Fig. 3, and details of the record cueing switch wiring is presented in Fig. 4. It will be noted that dual contacts are incorporated in this switch to avoid continuity failure. The Western Electric type 92A switch is excellent for this purpose. A talkback system is contemplated so that the control operator or producer may talk to participants in auditions and rehearsals via of a small loudspeaker in the studio.

It is to be observed that special care was taken to have the principal pieces of equipment installed in such a way that they would be easily removed for other uses for which they were intended, although the apparatus is normally set-up as described. Inter-connecting cables are terminated in different type connectors making it unnecessary to label any of them to prevent the possibility of incorrect connections between units. It has been found that about 90 per cent of the time the equipment is available when required in this auxiliary control room.

The total cost, by utilizing component parts on hand, amounted to \$125.00. This low cost has provided another program and recording channel, relieving the pressure on the other control facilities. Noise, distortion, and frequency response characteristics will meet FCC specifications for radio broadcasting stations.

COMING EVENTS

March 23-26—INSTITUTE OF RADIO ENGINEERS, convention. Waldorf-Astoria Hotel, New York City. Held in conjunction with

March 23-26—1953 RADIO ENGINEERING SHOW. Grand Central Palace, New York City. See page 38 for details.

April 28-May 1—Seventh Annual NATIONAL ASSOCIATION OF RADIO AND TELEVISION BROADCASTERS' convention and 1953 BROADCAST ENGINEERING CONFERENCE. Burdette Hall, Philharmonic Auditorium, Los Angeles.

April 28-May 1—1953 ELECTRONIC COM-

ponents SYMPOSIUM. Presented through cooperation of AIEE, IRE, RTMA, and WCEMA. Shakespeare Club, Pasadena, California.

May 7-9—Forty-fifth Meeting of the ACOUSTICAL SOCIETY OF AMERICA. Warwick Hotel, Philadelphia, Penna. Featured subject: Sound Reproduction. Side trip to RCA Laboratories, Princeton, N. J., on May 8.

May 18-21—1953 ELECTRONIC PARTS SHOW. Conrad Hilton Hotel, Chicago.

August 19-21—WESTERN ELECTRONIC

SHOW AND CONVENTION, sponsored jointly by WCEMA and Western Sections of IRE. Municipal Auditorium, San Francisco, California.

September 1-3—INTERNATIONAL SIGHT AND SOUND EXPOSITION, combined with the CHICAGO AUDIO FAIR. Palmer House, Chicago, Ill.

October 14-17—Fifth Annual Convention of the AUDIO ENGINEERING SOCIETY, and THE AUDIO FAIR. Hotel New Yorker, New York City.

October 15-17—ACOUSTICAL SOCIETY OF AMERICA. Cleveland, Ohio.

The Columbia "360"

PETER C. GOLDMARK*

Presenting the inside information about an interesting instrument designed to offer high quality in a ready-made form.

AT THE END of the last war, one of the programs facing the Laboratories was to develop a method whereby recorded music of the highest quality and at the lowest cost could be brought to as many homes as possible. It was apparent that this meant a new system of music recording and music reproduction which, because of the magnitude of the task, we had to tackle sequentially. The first phase of our work culminated in the development of the LP record which became the almost exclusive medium for recorded classical music, at a fraction of the cost of the pre-LP albums.

We then entered the second phase of our development program, which involved creating the mate for the LP record. The latter can carry a sound quality which includes everything the average human ear is capable of hearing. Until now, commercial phonographs did little justice to these records and people in their homes wanted high quality in a compact, entirely self-contained, reasonably priced phonograph which can be placed almost anywhere in a room. He or she would also like to be able to bring the instrument home from the store, plug it into a wall socket, and play it. To fill these needs, at the same time reproducing virtually everything recorded on the LP record, the Columbia "360" has been developed.

The term "High Fidelity" is usually associated with wide frequency range,

* Vice-President in Charge of CBS Laboratories Division, 485 Madison Ave., New York 22, N. Y.

Fig. 1. The Columbia "360" phonograph, as described in the accompanying article.



yet this is not what the music lover is interested in. We were in search of something that would approach the ultimate in music reproduction and felt that the desired end effect could best be described as realism. The Columbia "360," shown in Fig. 1, which is the first one of a new series of music reproducers, represents the beginning to the solution of this problem and in the following paragraphs some technical details regarding the "360" will be discussed.

Realism in music reproduction involves many ingredients which, when

properly blended, will approach as nearly as possible a lifelike rendition of the music originally recorded. Sufficient frequency range naturally is one of these and the instrument has adequate response between 50 and 12,000 cps. Most records do not contain much usable information below 50 or above 10,000 cps, and thus reproducing equipment with excessive capability beyond these areas can—unless properly controlled—produce considerable rumble and surface noise.

Effects such as distortion and intermodulation in the "360" were kept down to a sufficiently low limit, but again we did not choose to go overboard.

A great deal of attention was concentrated on the most important processes involved in the translation of electrical impulses to sound waves. The phonograph is only 17 in. wide, 10 in. high and 13 in. deep, yet the sound produced compares favorably with many a large "High Fidelity" installation.

In designing this instrument, we found it best to make the loudspeakers "take a back seat" and let the enclosure do most of the work. The sound does not emerge from a loudspeaker in front of the instrument directed straight at the listener as has been the practice to date. We found that in order to approach the illusion of reality in a room, sound should be diffused before it reaches the listeners' ears. Thus, two speakers have been provided facing outward and mounted on opposite sides of the cabinet, as shown in Fig. 2 sound is now

Fig. 2. Internal arrangement of the cabinet with record player removed.

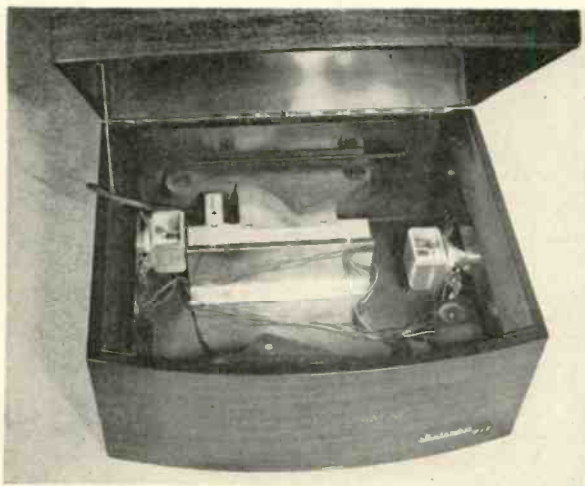



Fig. 3. Underside of the tone arm showing the rotating stylus assembly in the cartridge. The stylus is rotated to change from LP to 78.

radiated practically all around the instrument (hence the name "360") and arrives at the listener after it has been bounced around in the room, resulting in a mixture of many different phases and amplitudes.

The Record Compartment

The record itself is played in the middle of a sealed sound chamber represented by the solid half-inch-thick cabinet walls. Every available air space within this enclosure has been utilized to create the desired sound and the air pressure produced by the speakers has to be preserved during playing by keeping the lid closed. If, while playing records, one were to lift the top even a trifle, the bass would disappear almost completely.

The changer proper is a V-M three-speed type, floating on springs within the sound chamber in such a way that there is no acoustic feedback between the pickup and the loudspeakers. The arm and cartridge have been specially

developed; the arm, made of metal, produces a slight resonance of around 50 cps which plays an important role in the over-all frequency response of the system. The cartridge has been developed with the Sonotone Corporation and utilizes a ceramic element. A rotating needle assembly, Fig. 3, carries two sapphire points back to back, one with a radius of one mil and the other with a radius of three mils. Needles assemblies containing a diamond stylus for LP records will also be available. The frequency response of the cartridge-and-arm combination looking into a load of 1.0 meg. and 100 μ f, is within a few db of the required reproducing characteristic when using the Columbia No. 103 test record as signal source. The cartridge compliance is of the order of 0.9×10^{-6} cm/dyne and the voltage output, using the Columbia 103 test record, is approximately 0.5 volts at 1000 cps. The stylus can easily be changed by any layman by raising the arm, lifting out the entire stylus assembly and replacing it with a new one.

The "360" phonograph has a loudness control instead of the usual volume control, and it has a treble control instead of a tone control. At every setting of the loudness control, the tonal balance is automatically changed to give optimum reproduction for that given sound level. The treble control influences only the very high frequencies; for instance, the difference in output for the maximum and minimum treble positions is 12 db at 10,000 cps, but only 3 db at 3,000 cps. The circuit schematic is presented in Fig. 4.

The two six-inch loudspeakers are identical and have a resonance frequency of between 85 and 90 cps. Nevertheless, the over-all sound pressure output of the system is quite adequate below the speaker resonance frequency.

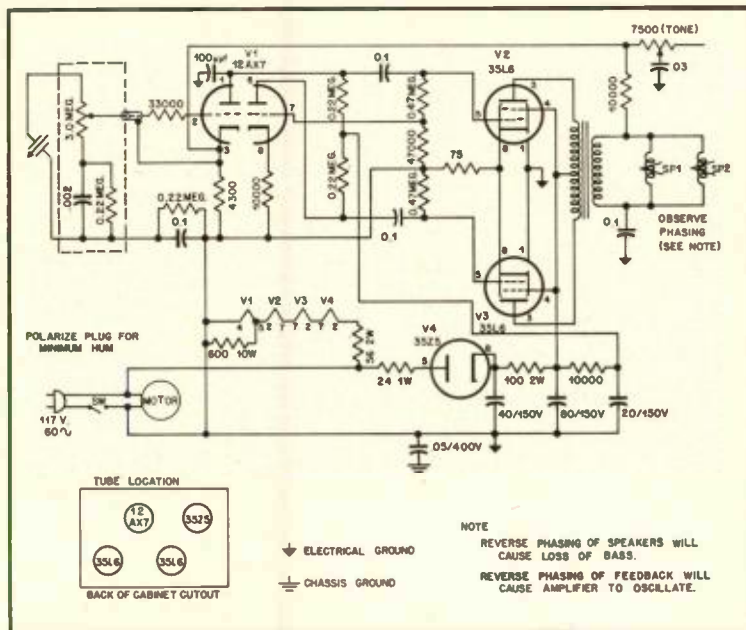

Fig. 4. Over-all schematic of the "360."

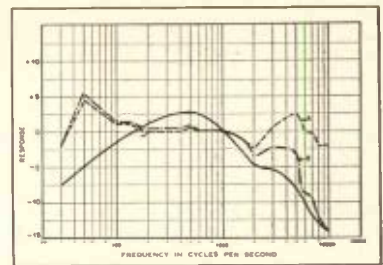

Fig. 5. Measured acoustic response curves, compared with electrical curve of Columbia 103 test record. Curve A is response with maximum treble; B is with minimum treble. Solid curve represents the test record.

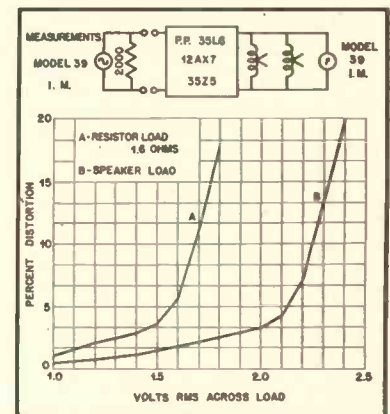

Fig. 6. Intermodulation distortion vs. power output.

Performance

It may be of interest to explain how the sound pressure curves of Fig. 5 were taken. Instead of placing the phonograph in a sound test chamber and carrying out measurements the conventional way, the player was set up in a room, the acoustic properties of which approached home listening conditions. A large number of sound pressure curves were derived using different dis-

[Continued on page 59]

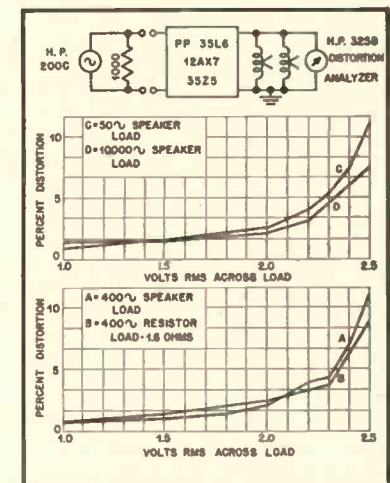

Fig. 7. Harmonic distortion vs. power output.

Theater Sound in a Small Package

THOMAS R. HUGHES*

Part 2. Continuing the description of a speaker enclosure which is claimed by the designer to be superior to any other type with which he has had experience. Constructional details are given in this installment.

IN THE PRECEDING ARTICLE, the writer discussed the many practical and technical reasons why he believes this system to be the only completely satisfactory means of properly reproducing classical music in the average-size living room, and this installment is devoted to the construction. The first assembly is illustrated at various stages during the building, but the views shown are just suggestions. The dimensions and proportions can be varied to fit the particular speaker and other materials at hand.

The first woofer had such a large field coil that the cabinet had to have considerable depth from the front, or face, back into the corner of the room. This meant that the face was wider also; as you can see, the base of an equilateral triangle increases with the altitude. The second assembly was built around a woofer with a permanent magnet and was scaled down somewhat in dimensions because the smaller magnet could be fitted into the corner more snugly.

The woofer may be built up by removing the frame from the permanent magnet structure of an old 12- or 15-in. speaker and replacing it with a sturdy 8-in. frame. However, a high-quality field-coil magnet can be used, if available, provided it has adequate wattage so as to provide a large magnetic flux—somewhere around 10,000 lines per sq. cm. It is necessary that the structure selected have a deep voice-coil slot, and that the pole pieces are long axially. The voice-coil diameter should be at least $1\frac{1}{4}$ in., and $1\frac{1}{2}$ in. or more would be even better.

* 3721 Hillcrest Dr., Los Angeles 16, Calif.

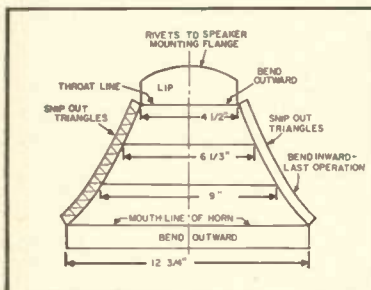

Fig. 3. Detail of one side of the metal horn covering the range from 450 to 1000 cps.

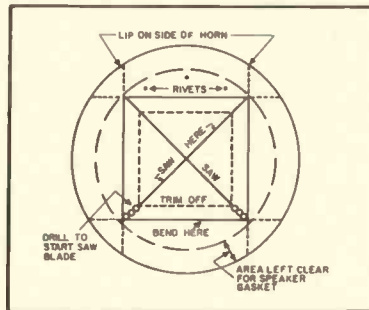

Fig. 4. Detail of the speaker mounting ring to be attached to the horn of Fig. 3.

Suitable speaker frames—including the magnet structure—can usually be obtained for a relatively low cost from a shop which specializes in reconing speakers. While many of the modern high-flux-density speakers would provide an ideal magnet for this purpose, it would be futile to suggest disassembling one of them for the special type of woofer we desire. It was stated previously that such speakers were relatively expensive, and that this design was economical.

Having secured a suitable magnet structure, it might also be possible to obtain from the same source a frame or "basket" for an 8-in. speaker. Remember that this basket should be as deep as possible—the one used on some of the earliest dynamic speakers is the type to obtain. Assuming that you succeed in obtaining a permanent magnet unit, be sure to cover the voice-coil opening immediately with Scotch tape—either the cellophane type or that known as masking tape—to preclude the slot being filled up with metal particles. Once these particles become lodged in the voice-coil slot, it is almost impossible to remove them—although one of the most effective ways to "try" to get them out is to fold a piece of this same tape over the end of a thin strip of metal, which can then be used to "wipe" the slot. A large percentage of the filings can be removed in this manner, although some are almost certain to remain.

After you have mounted the smaller frame on the magnet the rest is up to the speaker reconing expert. He must design a steep cone of stiff parchment, such as phenolic impregnated paper, and a voice coil to handle the wattage required for a small woofer. To match the average horn tweeter and utilize smaller

capacitors in the dividing network, the voice-coil impedance should be around 16 ohms at 400 cps. This isn't critical, however; a value of 8 ohms is still usable.

The most critical item is the suspension of this cone. It will have a much greater excursion than any normal 8-in. speaker, so both the center spider and outer surrounding ring should be of some plasticized cloth fabric or soft leather rather than the usual molded mat of paper. These suspensions must be free in movement (not stiff) but able to stand the punishment of the greater flexing. The effective working diameter of the cone proper—its outside diameter—will probably be around 6 in.

The Intermediate Horn

Bolted to the mounting ring of the 8-in. woofer is the direct-radiating intermediate horn. Through this horn passes the major portion of the fundamental notes and the drum and cymbal crashes, etc. For the low notes of the outside horn, the shape of the walls is not so important but for this intermediate horn we must carry the flare out in a smooth exponential curve.

To meet all requirements, a throat opening of $4\frac{1}{2}$ in. square works out best. Take a sheet of paper and draw an axis across the center. Then plot points on it starting with the $4\frac{1}{2}$ -in. throat, so that you will have a side elevation of the horn standing on its mouth, as in Fig. 3. Measure off three divisions of $1\frac{1}{8}$ in. each along the axis and strike off a chord at each division, perpendicular to the axis. The area of the throat opening is 20.25 sq. in. By doubling this area and extracting the square root, it is found that the span along the side at the first chord will be 6- $\frac{1}{3}$ in. Plot

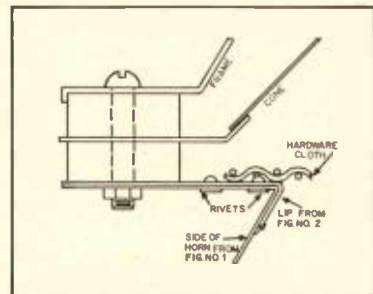

Fig. 5. Detail of the mounting of the speaker on the flange and horn.

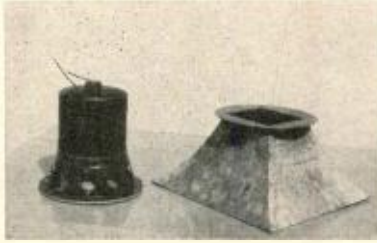

Fig. 6. Completed horn, shown with the early electrodynamic driver unit used in the first model.

half of this distance along the chord to each side of the axis. At the next chord the dimension will be 9 in. and at the mouth it will be $12\frac{3}{4}$ in.

Next, trace a smooth curve through the four points plotted on each side of the axis. This is best done with a "French Curve;" you may not find a curve that falls exactly on all four points but retrace the different sectors to get it as close as possible. Then use a flexible rule to measure the length of this curve to determine how long to cut the sheet metal side from throat to mouth.

To make these sides, get some 22 or 24 ga. furniture steel. 20 ga. is a little stiff for shaping but would give greater rigidity of the horn walls. On the steel, draw the axis again and then lay off the distance along the axis that was measured around the curve. Divide this distance into three equal divisions for the chords and lay off the former distances across the chords for the points of the curves.

The curves will be the same for all four sides of the horn, but two of the sides must have a $\frac{1}{2}$ -in. strip added along the edge as shown in Fig. 3. At the mouth of these two sides leave an extension of an additional 1 in. to bend over. At the throat of all four sides, leave an extended lip as shown. Cut out the two pairs of sides as drawn, and then snip out little wedge-shaped pieces from the $\frac{1}{2}$ -in. extended edge left along the curves of two of the sides.

The flange shown in Fig. 4 must be made from furniture steel of at least 20

ga. or heavier. Cut out a circular piece the same diameter as the outside edge of the 8 in. speaker frame. Scribe a circle on it which will just clear the inner edge of the speaker gasket where it bolts on to this flange. Then mark off the $4\frac{1}{2} \times 4\frac{1}{2}$ -in. square in the center of this circle and saw across the diagonals with a hacksaw, as shown. Drill two rows of $\frac{1}{4}$ -in. holes at the corners for starting a saw blade in the cuts.

Clamp the circular edge in a vise so that a $4\frac{1}{2}$ -in. side of the square is flush with the edges of the vise jaws. If the vise does not have jaws wide enough, the width can be extended by two small pieces of angle iron. Bend the triangular piece, between two diagonal saw cuts, inward to a 90-deg. angle against the vise jaw. Then trim off the triangle to leave a $\frac{1}{2}$ -in. lip as shown. Bend over the next triangle, being careful to choose the side that will let the tin snips clear the first lip just cut. Continue around for all four triangular segments so that a $4\frac{1}{2} \times 4\frac{1}{2}$ -in. mouth opening with $\frac{1}{2}$ -in. lips results.

The lip extensions, at the throat line of the horn sides, should be cut to match the portion of the flange they mate with, around the mouth. These lip pieces may be bent over at approximately 90 deg. and the extensions on the bottoms of two sides may be bent over in the same direction, to an angle of approximately 45 deg. Then the two sides without serrated edges may be clamped against the flange, facing each other, with the $\frac{1}{2}$ -in. lip of the throat extending inside the horn and their upper lip pieces against the flange on the side away from the speaker gasket, as in Fig. 5.

While these pieces are clamped along the edges, drill small holes and rivet small tinner's rivets or nail stubs, so that they fall within the circle you drew to clear the speaker gasket. After riveting the two sides on, they can be carefully shaped over a large pipe or other cylindrical surface, for the horn flare curvature. Next, form the horn flare in the two remaining sides and then bend over the saw-teeth edges to the proper angle with pliers.

These saw-teeth are to reach along the outside of the other two sides and

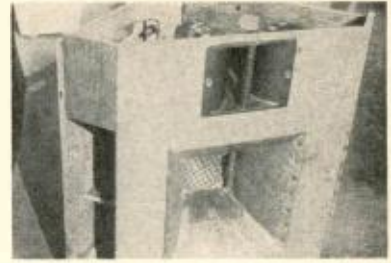

Fig. 9. Method of mounting horns to front of cabinet structure.

allow the soldering iron point to apply heat effectively and to flow the solder between mating edges. After you are sure every thing fits properly, these remaining two sides may be riveted to the flange at the speaker end. Some mechanics like to tin the mating surfaces before assembling. Use a little "cut" muriatic acid on the edges and solder with half-and-half solder and a large soldering iron. Solder an inch or two at a time while clamping the edges in snug position with "C" clamps or other suitable means.

After all corners are well soldered, place the throat opening over a flat extension of the vise or an anvil and use a hammer lightly to shape the inner $\frac{1}{2}$ -in. lip back against the inner surface of the horn for soldering. For riveting in tight places or for this shaping procedure, a stiff bar or angle iron can be clamped to extend out from a strong vise. This lip should be soldered to the horn wall to kill any chance for spurious vibration between the horn and flange sections. Figure 6 shows the finished appearance.

When you are through soldering there must be no visible air leaks up the corners of the horn or where the flange is attached. The speaker mounting ring must have a continuous gasket to mate with this horn flange, for completing this air-tight effect. Before the speaker is bolted to the horn, solder a piece of light hardware cloth across the throat of the horn flange, leaving no free edges to vibrate.

[Continued on page 64]

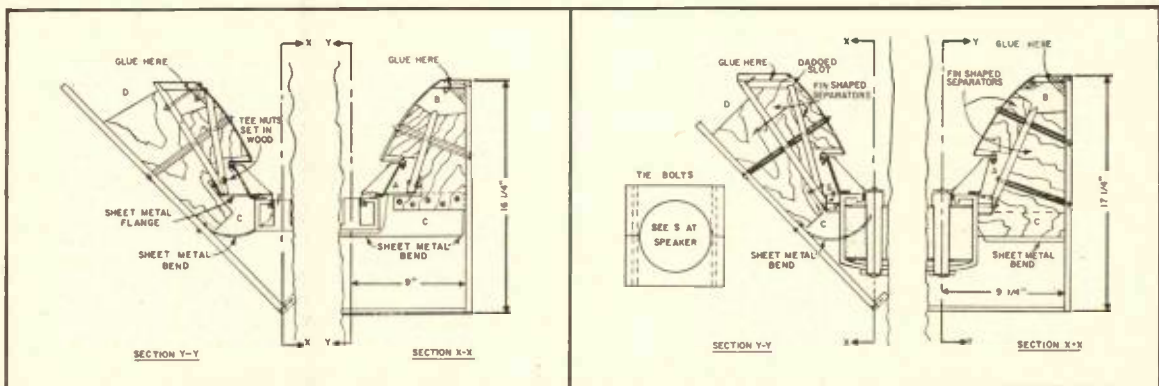

Fig. 7 (left). Horizontal and vertical sections through the center of the speaker unit for the second model, using a PM dynamic driver. Fig. 8 (right). Sections through first model, using the driver shown in Fig. 6.

Handbook of Sound Reproduction

EDGAR M. VILLCHUR*

A discussion of the basic structure of one of the most important elements of a sound system, with an analysis of the effect of constructional features on its performance.

Chapter 10. Loudspeakers. (Part 1)

L OUDSPEAKERS are electro-acoustic devices for converting the electrical output of audio amplifiers into mechanical and then acoustical energy. Modern loudspeakers are almost exclusively of the dynamic (moving-coil) type. The dynamic loudspeaker allows the electrical signal to pass through a coil which is free to move along its longitudinal axis, and which is suspended in a transverse, fixed magnetic field. Since the coil is made of non-magnetic material the static field exerts no force on it except when current flows. An electrical signal changing in the same complex way as the original sound pressure will set up imitative vibrations, and the moving "voice" coil is given a bite of the air by an attached cone or diaphragm. The efficiency of the conversion from mechanical to acoustical energy is increased by means of some type of acoustical coupler between the speaker and room, such as a horn or baffle.

It may be seen that the first step of the above conversion, from electrical to mechanical energy, is exactly analogous to the action of an electric motor, where current is passed through an armature free to rotate in a fixed magnetic field.

Figure 9-1 illustrates a typical direct-radiator loudspeaker, so called because of the fact that the cone, unlike

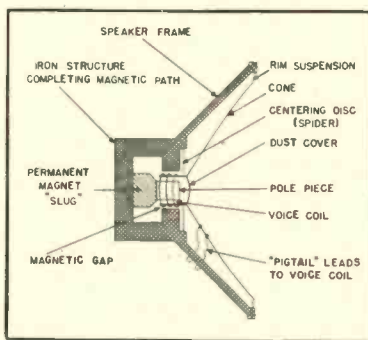

Fig. 10-1. Typical single-cone, single-voice-coil, direct-radiator speaker.

the diaphragm of a horn-type speaker, makes immediate contact with the air into which it radiates sound.

The Mechanical System of the Speaker

If the cone and voice coil were massless and perfectly rigid, and there were perfect freedom of motion for the voice coil, an analysis of cone vibrations would only need to be concerned with the electrical and magnetic characteristics of the speaker "motor". Unfortunately for speaker fidelity, however, the mass, elasticity, and friction of the mechanical system of moving parts have a strong influence on motion of the cone. When the voice coil is forced into vibration the inertia of the moving

Fig. 10-2. Mechanical system of a dynamic loudspeaker (ignoring air load) and electrical analogy.

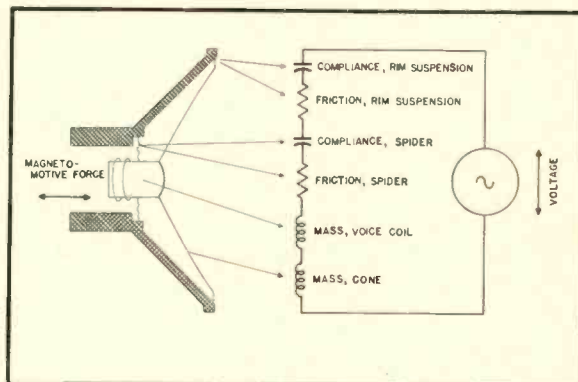
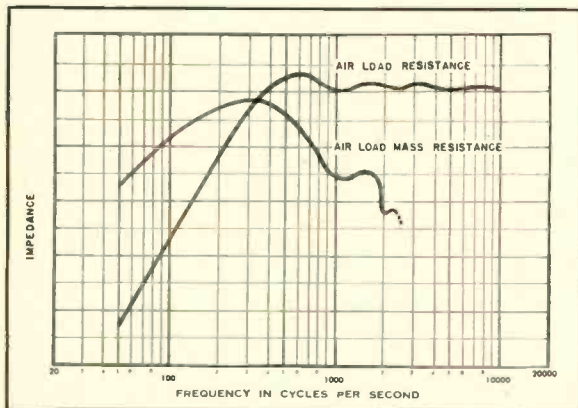

Fig. 10-3. Air-load impedance per unit area of cone in infinite baffle. After Olson.



mass and the springiness of the spider and rim suspension create forces of their own. The speaker mechanical system is a resonant source of sound in addition to an imitative one, and when stimulated it tends to oscillate at its own natural frequency independently of the controlling signal, especially when the stimulus is at a frequency at or near resonance. Behavior at other frequencies follows the laws of resonant systems unwillingly forced into unnatural vibration.

Speaker Dynamical Analogies

Dynamical analogies relating mechanical, acoustic and electrical phenomena prove helpful in the understanding and design of speakers. Many articles on elec-

* Contributing Editor, AUDIO ENGINEERING.

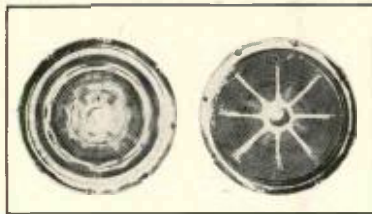

Fig. 9-4. (A), Cone break-up at 450 cps (photograph taken by dusting lycopodium powder on the cone, which is shaken off by the velocity loops and retained by the nodes). (B), Cone break-up at 2700 cps. After Corrington.

tro-acoustic devices have appeared which cannot be read intelligently without a knowledge of electrical analogies.

In order to draw the equivalent electrical circuit of the speaker mechanical system in Fig. 9-2 we must recall the basic elements of our analogical system, which are here reviewed:

Electrical	Mechanical
Voltage	Force
Current	Velocity
Inductance	Mass
Capacitance	Compliance (reciprocal of stiffness)
Resistance	Mechanical resistance (friction)

The mechanical system of a loudspeaker may thus be represented by the electrical analogy of Fig. 9-2 (assuming that the cone moves as a unit, and ignoring the effect of the air load.) The two inductances appear in series because both cone and voice coil add to the total mass, while if the inductances had been shown in parallel the inductance of each would detract from the total inductance of the combination. The two capacitors must also be shown in series (although the suspension compliances seem to be in parallel mechanically) because the stiffness of each of the elastic suspensions detracts from the total compliance, just as each capacitor reduces the total capacitance of the electrical system. Another way of seeing the necessity for representing the two cone suspensions with a series electrical connection is to think of one of them as frozen. Cone velocity would then become zero, in the same way that opening one of the series capacitors would stop all current flow. ("Frozen" implies infinite stiffness, and its reciprocal is zero compliance, which corresponds to zero, or open, capacitance.)

The inductive and capacitive elements of the electrical system form a series resonant circuit, presenting minimum impedance at resonance, and the exchange of energy between them follows the same laws as the energy exchange in the mechanical system.

We may now examine the behavior of the loudspeaker mechanical system when alternating magnetomotive forces of various frequencies are applied to the voice coil. The analogous electrical circuit will be referred to when it seems advantageous. Such references are only for the sake of clarification; they are not essential to the explanation. For simplicity we will at first ignore the influence of the internal impedance of the amplifier source and the effect of the extra load on the cone imposed by the air.

If the system is subjected to vibration at frequencies below resonance the inertial effect of the moving mass will be relatively small, and the predominant influence on motion will be the stiffness of the elastic suspension, or, to put it another way, the system will be compliance controlled. (In the analogous electrical system the generator will see a net capacitance.) Velocity will decrease with frequency, in the same way that alternating current through a capacitor decreases with frequency.

At resonance only friction must be overcome and the velocity of the cone will be at a maximum. Just as inductive and capacitive reactances balance each other out at resonance of the electrical circuit—leaving only resistance and allowing maximum current flow—the mass and compliance "mechanical reactances" balance out. Thus the opposing inertial and restoring forces are just equal.

At frequencies above resonance the system becomes mass controlled (the generator sees a net inductance). The effect of inertia increases with the more rapid changes of velocity, while the impedance of the suspensions decreases. (Inductive reactance increases, capacitive reactance decreases with frequency.) Velocity for the same applied force will therefore decrease as the frequency is raised, like current through an inductance, and force and velocity assume a reversed phase relationship.

The behavior described above would seem to dictate very uneven reproduction of the audible spectrum of sound frequencies, with peak output at the resonant frequency of the speaker's mechanical system. But there are certain factors that work in favor of level frequency response, and there are measures which may be taken to help achieve

this goal.

Below resonance, the output of the speaker falls off as sharply as we would expect it to unless special mounting devices are used. Above resonance, cone velocity also decreases with increase of frequency, but this effect is offset by the fact that the air load resistance increases with frequency at about the same rate. (See Fig. 9-3.) It is the air load resistance which determines how much speaker mechanical energy will be absorbed by the acoustic load, and so the acoustic output of the speaker is kept fairly uniform, in spite of decreasing velocity of motion, up to a frequency at which the air load resistance reaches its maximum and remains constant. This frequency is reached when the diameter of the speaker cone is about two-thirds the wavelength of the signal. For a twelve-inch speaker the critical frequency would be in the neighborhood of 700 cps.

Above this point speaker output should start decreasing in inverse proportion to the frequency, but an additional element mitigates and, in the lower treble octaves, even overcompensates the deficiency. At higher frequencies the cone ceases to move rigidly and "breaks up" into new modes of vibration, (see Fig. 9-4), so that the mass of each individually vibrating section is much less than the total mass. New, higher resonances come into play, and standing waves are formed. One of the purposes for which concentric corrugations are often inserted in the cone is to partly control this break-up, by creating high compliance at predetermined points along the line from base to apex. As in the case of other resonant modes of the speaker mechanical system, break-up resonances cause transient response and linearity of output to suffer, and peaks and dips are intro-

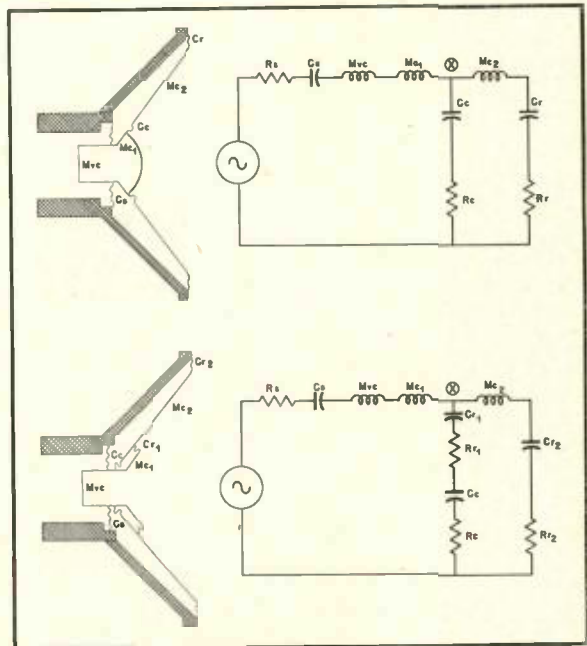

Fig. 9-5. (A), Mechanical system of a two-cone, single-voice-coil speaker and electrical analogy. (B), Variation of (A).

duced into the frequency response curve.

Other methods to subdue the speaker's bid for a life of its own are:

1. DAMPING.

In an electrical resonant circuit the presence of resistance dissipates energy in heat. Instead of energy merely being tossed back and forth between coil and capacitor, a certain amount of power is consumed by the system. The circuit becomes broadly tuned and has its resonant peak reduced, a condition in which it is said to be damped.

In a mechanical resonant system the same results are produced by friction, which takes its toll of energy during each exchange between inertia and restoring force. The violence of resonant oscillation for a given applied force, and the time required for oscillations to die out, are decreased. Speakers are not, of course, purely mechanical systems, and they are damped in three ways: internally, through mechanical friction in the suspension system and cone; acoustically, through the air load resistance; and electrically, through the source impedance of the amplifier, which acts as a shunt load to the electrical generator system of the voice coil and magnetic field.

Too much friction in the speaker suspensions will obviously cause a severe loss in efficiency, since the energy dissipated is entirely wasted. It is especially advantageous, however, to damp the rim suspension of the cone mechanically. This suspension is the termination of the path, beginning at the voice coil, that is followed by the sound when the cone ceases to move as a unit. If the rim is damped (internally or by an external application of viscous material) in such a way that sound waves reaching it encounter a minimum of impedance discontinuity, a good part of the energy that has not been radiated can be dissipated in the mechanical resistance of the suspension, instead of being reflected back along the cone. The formation of standing waves is thus discouraged, while vibration of the cone in smaller masses can still take place. Standing waves are also damped by the use of a soft, spongy cone material.

Energy absorbed by the air load resistance is being used precisely as in-

tended, and improving the air coupling has the dual benefits of effective damping and increased efficiency. Since the resistive component of the acoustic load impedance allows power to be permanently transferred to the medium, the resistance reflected back into the speaker cone is called *radiation resistance*.

Electrical damping by the amplifier, which will be discussed in detail in the chapter on power amplifier stages, is also very effective and does not create efficiency loss.

2. DESIGN FOR LOW RESONANT FREQUENCY.

The lower the resonant frequency of a speaker the more extended its low-frequency response, and the less annoying the resonant peak will be. In some cases it is possible to keep speaker resonance below the main band of frequencies being reproduced. Typical values for commercial speakers twelve inches and larger are from forty to eighty-five cps. Low-frequency resonance calls for higher compliance relative to the mass, or high mass relative to the compliance, but other design considerations must be taken into account before values of mass and compliance can be decided upon. For a given mass the compliance must exert enough relatively linear restoring force so that the voice coil is not carried out of the area of uniform magnetic field, or does not allow the voice coil to "bottom" against the flange of the pole piece. Another factor that must be considered is the influence of a large mass in impeding reproduction of the higher frequencies, or of the transients of lower frequency tones. The air load again comes to our assistance in this matter. At low frequencies the air load has a proportionately high "reactive" component, which is to say it adds mass to the speaker system and lowers the resonant frequency. Although we normally expect a mass reactance to increase with frequency, the air load is peculiar. Above a certain frequency (see Fig. 9-3) the reactance decreases with frequency, so that compared to the mass reactance of the cone and voice coil it is greatly reduced at higher frequencies. It is a case of having our cake and eating it too.

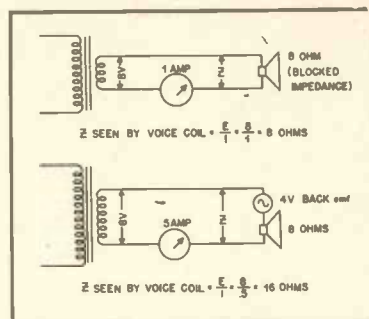

Fig. 9-7. How back e.m.f. increases the effective electrical voice-coil impedance seen by the amplifier (source impedance neglected).

3. DISTRIBUTION OF MASS OF THE MOVING SYSTEM.

The principle of inserting cone corrugations for controlling break-up may be followed through in a special design which uses definite segregated vibration systems in the cone and/or voice coil. In Fig. 9-5, (A) illustrates a speaker of this design, in current commercial use, which has an aluminum dome-shaped diaphragm for high-frequency sound propagation and dispersion. At low frequencies the entire suspended mechanism vibrates as a unit, but at high frequencies the small cone and diaphragm are able to vibrate by themselves because of their compliance with the cone proper.

The reader will find that tracing the equivalent electrical circuit of this speaker system increases appreciation of the way it works. In (A) of Fig. 9-5, the magnetomotive force must always overcome the friction of the spider R_s , the stiffness of the spider, determined by C_s , the mass inertia of the voice coil M_{vc} , and the inertia of the first section of cone and aluminum dome M_{c_1} . At this point, marked X on the diagram, there is a choice of path. At low frequencies C_c will have a high impedance (will remain mechanically stiff) and M_{c_2} a low impedance, so that current will flow through M_{c_2} rather than C_c . The current through M_{c_2} will be the same as that through M_{c_1} , which represents the fact that the two sections will have the same velocity and will move as one.

As the frequency is raised the impedances of the two paths approach each other in value. At some particular point they will be equal, and half of the current will be by-passed through C_c , which means that half of the energy supplied will be used up in vibrating M_{c_1} independently from M_{c_2} . The compliance of C_c relative to other components of the system is adjusted so that the impedances of the two parallel paths become equal at the desired frequency, called the cross-over frequency. The system of mass and compliance which determines the frequency of equal path impedance is sometimes referred to as a mechanical cross-over network.

At much higher frequencies C_c assumes a very low value of impedance. Current is short circuited through it, leaving little or no energy for M_{c_2} .

(Continued on page 66)

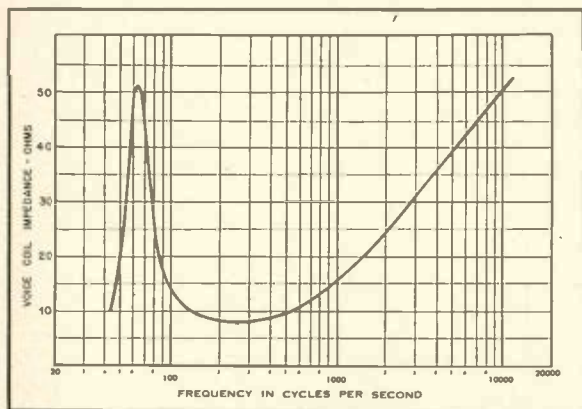

Fig. 9-6. Electrical voice-coil impedance of typical 8-ohm speaker. After F. Langford Smith.



**THE
MAURER 16mm
IN ROME**



When Ken Richter makes a foreign-location documentary for a firm like Reed and Barton, Silversmiths . . . you can expect to find the Maurer "16" on the job. To the public, this sequence illustrates "The Romance of Silver Design." To the professional it proves the better results achieved with the camera designed for professional use . . . the Maurer "16."

Ken Richter at work in Cinecitta Studios, Rome, on Roman Barquet scene.



THE MODEL F PRIME RECORDING OPTICAL SYSTEM AND GALVANOMETER. A complete light modulating unit for recording sound photographically upon standard film, requires no special servicing or spare parts (other than recording lamp).



THE MAURER 16MM, designed specifically for professional use, equipped with precision high-power focusing and view-finder. Standard equipment includes: 235° dissolving shutter, automatic fade control, view finder, sunshade and filter holder, one 400-foot gear-driven film magazine, a 60-cycle 115-volt synchronous motor, one 8-frame handcrank, power cable and a lightweight carrying case.

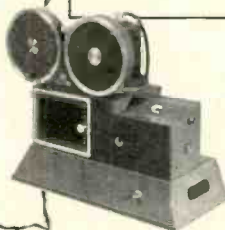

THE 16MM. SOUND-ON-FILM RECORDING SYSTEM combines the highest fidelity in 16mm. recording practice with wide flexibility and extreme simplicity of operation. For details on this and other MAURER equipment, write:

maurer means *finer motion pictures!*

J. A. MAURER, INC.

37-01 31st Street, Long Island City 1, New York
1107 South Robertson Blvd., Los Angeles 35, California

**16mm
maurer**

CABLE ADDRESS:
JAMAURER

8 db more

with no increase in noise

It's the new

REG. U.S. PAT. OFF.

SCOTCH

BRAND

Magnetic Tape

High  Output

TRADE MARK

● **NEW, IMPROVED COATING!**

"Scotch" Brand *High-Output* Magnetic Tape is coated with a revolutionary new magnetic material that offers unparalleled sensitivity.

● **UNEQUALLED OUTPUT LEVEL!**

Actually produces 8 db and up to 12 db more output than any conventional magnetic tape with no increase in harmonic distortion.

● **SPECIAL NEW COLOR!**

This new tape is colored a distinctive grey-green for easy recognition.

"Scotch" Brand No. 120A *High-Output* Magnetic Tape gives the recording engineer a new and potent tool for the production of truly high fidelity recordings. The 8 db minimum added output of *High-Output* Magnetic Tape increases significantly the available signal to noise ratio, making possible for the first time low background noise recordings of orchestral works having wide dynamic range. Besides offering unparalleled output at all audio frequencies (see graphs), this new tape retains all the physical and magnetic properties that have made "Scotch" Brand No. 111A the recognized standard of the recording industry: high tensile strength, freedom from elongation, stable anchorage, low noise level, excellent uniformity, ease of eraseability.

Freedom from squealing, cupping and curling is assured thanks to exclusive "Dry Lubrication" feature. *High-Output* tape is guaranteed 100% splice-free (up to 2400-foot reels)

The term "SCOTCH" and the plaid design are registered trademarks for Sound Recording Tape made in U.S.A. by MINNESOTA MINING & MFG. CO., St. Paul 6, Minn.—also makers of "Scotch" Brand Pressure-Sensitive Tapes, "Underseal" Rubberized Coating, "Scotchlite" Reflective Sheeting, "Safety-Walk" Non-slip Surfacing, "3M" Abrasives, "3M" Adhesives. General Export: 122 E. 42nd St., New York 17, N. Y. In Canada: London, Ont., Can.



output

or harmonic distortion!

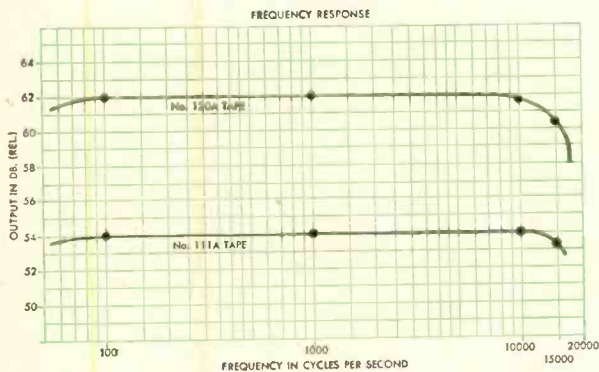

The frequency response characteristics of both No. 120A and No. 111A tapes are virtually identical at 15 ips tape speed. These curves were made with each tape set at optimum bias and an input level 15 db below 1% 3rd harmonic distortion.

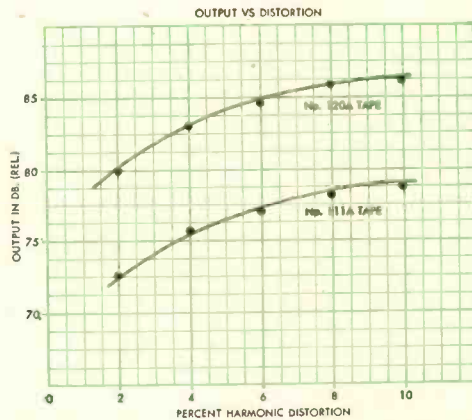

This graph shows the 8 db increase in output of High-Output Magnetic Tape No. 120A over No. 111A at any given distortion level. When compared with other brands of magnetic tape, the difference in output is as much as 12 db!

FREE BOOKLET tells the full story of the tremendous technical possibilities of High-Output Magnetic Tape. Address Dept. AE33, Minnesota Mining & Mfg. Co., St. Paul 6, Minn., and a copy will be sent promptly.

Available now on: 120-AP 1200-foot Professional Reel
120-A 2400-foot on NARTB hub or reel



High-Output and  TM 3M Co.

1953 Radio Engineering Show

GRAND CENTRAL PALACE, NEW YORK—MARCH 23-26

Year's largest exposition of electronic equipment again takes to the boards for its annual four-day stay—in conjunction with IRE convention which offers literally hundreds of technical papers.

MARCH INVARIABLY BRINGS four days of sightseeing to the electronic engineers, with its associated foot-tiring walking past and into myriads of booths, each holding some equipment of interest to everyone—some with displays of exceptional interest to those in audio. Although all branches of electronics are represented, a relatively small number of the exhibitors are concerned with audio, so the IRE show does not compare to an Audio Fair as an attraction to most of *Æ*'s readers. However, since there is no Audio Fair in March, many audio people will be there.

The Radio Engineering Shows are not open to the public at large, although there is nothing to keep anyone away—except the three-dollar admission charge, possibly. IRE members are admitted for one dollar, and are also privileged to attend the technical sessions.

A new feature this year, seminars are being presented which will undoubtedly bring forth many interesting discussions. Two sessions are being held on "Acoustics for the Radio Engineer" Wednesday morning and afternoon, with the following



papers: "Fundamental Theory" by L. L. Beranek, "Microphones" by Harry F. Olson, "Loudspeakers" by Hugh S. Knowles, "Phonograph Reproducers" by B. B. Bauer, "Tape Recording" by Marvin Camras, and "Studio Acoustics" by Hale J. Sabine.

A Thursday afternoon session on Audio will cover: "Sound Reinforcement System, General Assembly, United Nations" by L. L. Beranek, "A Variable Time Delay" by Kenneth Goff, "A Flux-Sensitive Head for Magnetic Recording Playback" by David E. Wiegand, "Uniaxial Microphone" by Harry F. Olson, John Preston, and John C. Bleazey, and "Sound Pressure Measurement between 50 and 220 db" by J. K. Hilliard. Three sessions are devoted to transistors, largely from a scientific viewpoint rather than practical, and several other papers will be of interest to the audio engineer.

Most of the audio exhibits are concentrated on the third floor of Grand Central Palace, and are listed at the left of the diagram below. Certain other exhibitors having considerable audio equipment are located elsewhere in the building, and are listed at the right. As usual, *Æ* will be there, being located this year on the third floor in Audio Center. Also on hand will be the 2nd Audio Anthology, as well as the first one, along with current issues, information about subscriptions, and anything else our readers are likely to ask.

AUDIO CENTER EXHIBITORS

- 3-317 Altec Lansing Corp. Amplifiers, tuners, loudspeakers
- 3-314 Amplifier Corp. of America Amplifiers, tape recorders
- 3-105 Audio Devices, Inc. Audiobooks, Audiotape, Audiotapes
- 3-310 Audicom, Inc. "High Fidelity" magazine
- 3-304A Berlant Associates Concertone tape recorders
- 3-400 Fairchild Rec. Egmt. Co. Phone pickups, tape and disc recorders, and transcription turntables
- 3-304A Fisher Radio Corp. Amplifiers, tuners, systems
- 3-309 Hycor Company Toroid coils, filters, etc.
- 3-506 Jensen Manufacturing Company Loudspeakers
- 3-301 Magnecord, Inc. Magnecorder tape recorders
- 3-506 The Muter Company Loudspeakers, components
- 3-306 Presto Recording Corporation Tape and disc recorders and playback equipment
- 3-315 Racal Electric Co. Loudspeakers, horns
- 3-316 Radio Magazine, Inc. AUDIO ENGINEERING, the Audio Anthologies
- 3-506 The Rola Company Loudspeakers, components
- 3-112 Tech-Master Products, Inc. Amplifiers, TV sets and kits
- 3-311 University Loudspeakers, Inc. Loudspeakers, horns
- 3-313 Waveforms, Inc. Amplifiers, test equipment
- 3-402 Ziff-Davis Publishing Co. "Radio & Television News" Magazine

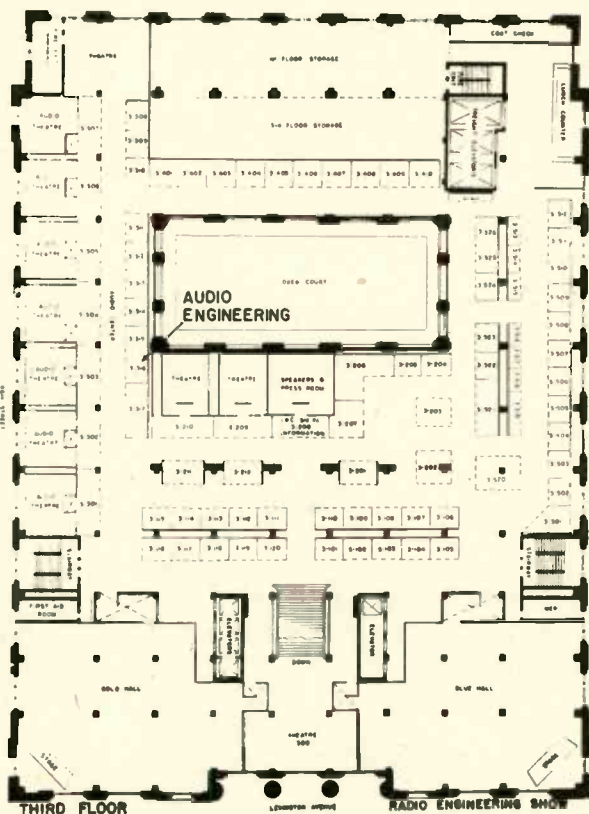

AUDIO EXHIBITORS ON OTHER FLOORS

- 4-405 Ampex Electric Co. Tape Recorders
- 1-406 Arnold Engineering Co. Magnetic materials, cores
- 1-112 Ballantine Laboratories Test Equipment
- 2-128 Barker & Williamson Audio test equipment
- 2-515 British Industries Corp. Speakers, amplifiers, solder
- 2-106 Browning Laboratories, Inc. Radio tuners, AM, FM
- 2-512 Cannon Electric Co. Plugs and connectors
- 1-801 Collins Radio Company Radio broadcast equipment
- 1-118 The Davon Company Attenuators, test equipment
- 1-109 Freed Transformer Co. Transformers, test equipment
- 2-324 Gates Radio Company Radio broadcast equipment
- 1-201 General Electric Company Loudspeakers, pickups
- 1-121 General Radio Company Laboratory and test equipment
- 1-402 Gray Manufacturing Company Pickup arms, transcription eqpt.
- 1-509 Hewlett-Packard Co. Test equipment
- 1-110 International Resistance Co. Resistors, potentiometers, etc.
- 2-327 Measurements Corporation Laboratory and test equipment
- 1-304 Radio Corp. of America TV equipment, tubes
- 2-210 Shalloson Mfg. Company Attenuators, switches, etc.
- 4-801 Standard Transformer Company Transformers, amplifier kits
- 2-146 Tech Laboratories, Inc. Attenuators, switches, etc.
- 4-602 Triad Transformer Company Transformers, amplifier kits
- 4-715 Tung-Sol Electric, Inc. Tubes—3891, 5687, etc.
- 1-132 United Transformer Company Transformers, amplifier kits

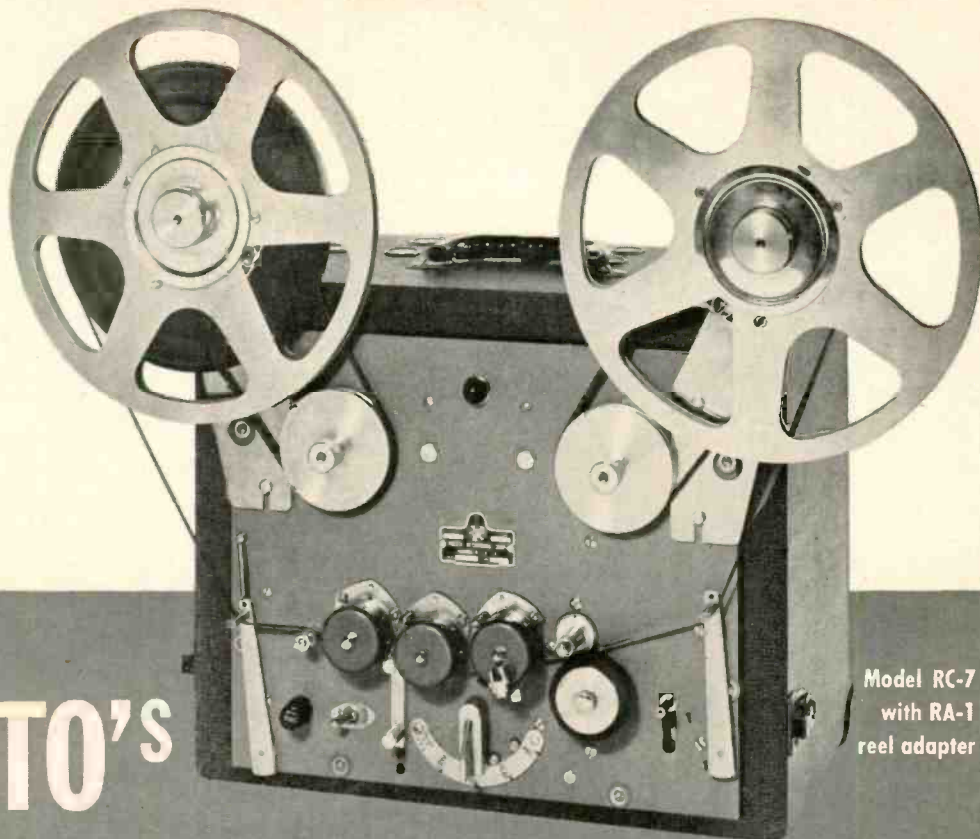

Model RC-7
with RA-1
reel adapter

PRESTO'S

"LONG PLAYING" PORTABLE TAPE RECORDER

The PRESTO RC-7 has already been acclaimed "the finest tape recorder of its size available." Although portable in size, the RC-7 embodies features and heavy duty construction found only in larger, more expensive, studio-type machines.

Now, with the new RA-1 reel adapter, this precision recording instrument becomes an indispensable piece of equipment for every station and recording studio. With this adapter, the RC-7 accommodates reels up to 10½" diameter, providing continuous long-period recording or playback.

If you are contemplating a portable tape recorder, don't buy any—until you see the PRESTO RC-7 with 10½" reel adapter (RA-1). Without a doubt, it's the *best buy in professional tape equipment!*

Present PRESTO RC-7 owners may convert their machines with this adapter for just \$39.00. Write today for details!

PRESTO RECORDING CORPORATION
PARAMUS, NEW JERSEY

Export Division: 25 Warren Street, New York 7, N. Y.

Canadian Division: Walter P. Downs, Ltd.
Dominion Square Bldg., Montreal

WORLD'S LARGEST MANUFACTURER OF PRECISION RECORDING EQUIPMENT AND DISCS

Compare the RC-7 with any studio-type recorder

- Instantaneous speed accuracy
- Dynamic range better than 50 db. at 3% distortion
- Three-motor drive
- No friction clutch or friction brakes
- Heavy duty construction throughout
- Separate erase-recording-playback heads
- Twin speed: 7½"/sec or 15"/sec.
- Frequency response to 15,000 cps.
- Reel size: to 10½" (with RA-1 adapter)

"First Inventor" Under the 1952 Patent Law

ALBERT WOODRUFF GRAY*

The validity of a patent often hinges upon small and apparently insignificant points. Herein is clarified the current law regarding inventions which are described in a patent application, yet not claimed specifically.

A PROVISION of the Patent Law that became effective last July is, "A person shall be entitled to a patent unless . . . (e) the invention was described in a patent granted on an application for a patent by another, filed in the United States before the invention thereof by the applicant of the patent."

The Senate Report on this bill before its enactment states of this provision, that it is the inclusion in the patent statute of, "Another well recognized condition imposed by a decision of the Supreme Court which was not expressed in the existing law; for the purpose of anticipating subsequent inventions a patent disclosing the subject matter speaks from the filing date of the application disclosing the subject matter."

The former statute, now supplanted by this new enactment, provided as a fourth defense to actions by a patentee for infringement, "Fourth: that he was not the original and first inventor or discoverer of any material or substantial part of the thing patented."

The former statute undoubtedly appeared to its framers to express clearly that a patentee had no grounds for an action for infringement of his patent if he was not "the first and original inventor." Unfortunately both for lawmakers and for the people, no words nor group of words possess the clear-cut definition possessed by figures in mathematical equations. They are understood by the reader according to their meaning to him, but that is not always the understanding of their author.

Here this difficulty occurred in the interpretation by the courts of this earlier patent statute; was the original and first inventor the patent applicant who first described the invention or the applicant who first claimed the discovery of the invention, when the discoverer of the invention and the claimant were not the same?

The echo of this confusion in the definition of "first and original inventor" was heard in patent litigation involving a radio patent issued in 1932 for an invention controlling volume in radio receiving sets. When suit was brought for infringement by an assignee of this patent a few years after its issuance, the discoverer failed to succeed in his ac-

tion. The discovery, the court pointed out, had been substantially disclosed in a patent application prior to the issuance of the action.

"The discovery," asserted the Federal Court, "was merely the result of the skill and knowledge of an electrical engineer."

When several years later the question of the validity of this same patent came again before the Federal Courts, the patent was sustained by the United States Circuit Court of Appeals and that decision appealed to the Supreme Court of the United States.

"One of the problems of the art," said Justice Jackson in the opinion of the court, "has arisen from the variations of the received signals. When the set is tuned from a weak signal to a much stronger one, the tendency is for potential to build up in the last amplifying tube, which results in what is known as blasting in the loudspeaker.

"Often the same signal varies in intensity. Weakening may result in fading where the sound (re)production weakens or disappears; and strengthening may beget distortion of the sounds emitted. (The patentee) essayed to obviate these objectionable features. It was known that the amplification of the carrier signal could be controlled by increasing or decreasing the potential upon the grid of a triode amplifier. This patentee proposed to vary this potential automatically so as to increase or decrease the degree of amplification and thus hold it at a substantial predetermined level.

"To this end he provided means to increase the negative potential upon the anode of the detector tube in step with the increased strength of the signal and to conduct a direct current from that anode to the grid electrode of one or more of the amplifying tubes. Thus an increase of the strength of the signal would automatically increase the negative potential on the grid of the amplifier and decrease the amplification; the reverse result would be effected if the signal weakened."

This description the Supreme Court supplemented with its conclusion that the patent was invalid. "We conclude that this patentee accomplished an old result by a combination of means which singly or in a similar combination were disclosed by the prior art and that, not-

withstanding the fact that he was ignorant of the pending applications which antedated his claimed date of invention and eventuated into patents, he was not in fact the first inventor since his advance over the prior art, if any, required only the exercise of the skill of the art."

Disclosure in Claims vs. Specification

The decision in this case as well as the enactment in the patent statute itself of this distinction between the status of an inventor who includes his discovery in the claims made in his patent application and one who incidentally disclosed his discovery in his application but failed to claim the discovery as a patentable invention, rests on a famous case involving the first patent relating to oxy-acetylene torches for cutting and welding metals.

Here the question was clearly presented under the former patent statute, of whether the first and original inventor could rest his right to a patent on disclosures made by him in an earlier application which were not included as claims, or whether he was restricted to the claims he had set out.

The inventors in this instance had discovered the efficacy of a mixture of oxygen and acetylene gases in the welding and cutting of metals. Patents were applied for and granted on the implement or tool employed in the use of this combination of gases but not on the process or use of this combination of gases.

The court said of the circumstances surrounding these applications, "It is reasonably clear that the patentees at the time did not recognize the full value of their invention, but the fact remains, whether they did or not, that they happened upon a device which became the accepted form which has displaced all others and which seems likely to be the final tool by which metals will be cut under this process."

When later the process that had been disclosed in these earlier patent applications, for which no patent claim had been made, became the subject of a later patent by others, an action for infringement was brought by the original patentees.

The Federal District Court held that the discoverer had no claim as an in-

(Continued on page 58)

* 35-36 76th St., Jackson Heights, N. Y.



Jensen

25 years of
leadership
in sound

You can choose with
confidence when it's a Jensen High Fidelity Loudspeaker

- 1 Because more people listen to Jensen than all other hi-fi brands combined — leadership achieved through proved superiority!
- 2 Because Jensen gives you a complete range of prices — with top performance in every price bracket — you can enjoy luxury listening no matter what your budget!
- 3 Because Jensen has the finest, best equipped acoustic laboratory in the business, carrying on a continuing, forward-looking research and engineering program — you can be sure Jensen products incorporate all the latest advances!
- 4 Because Jensen is the oldest and most experienced maker of loudspeaker equipment — and the standard of quality throughout the world — you can buy Jensen products with utmost confidence!
- 5 And because Jensen is the *only complete* line of hi-fi loudspeaker equipment, your selection is easily, quickly, *surely* made.

Jensen

Write for 20-page Book — "How to Choose Your High Fidelity System." Complete information on how to select components for your hi-fi basic phonograph system. Includes new, handy 5-step PRICE PLANNER worksheet that helps fit selections to your budget. Write for Brochure 103C today. Send 25c in coin.

Jensen Manufacturing Company
6601 South Laramie Avenue, Chicago 28, Illinois
Division of The Muter Company
• Canada:
Cooper Wire Products, Ltd., Licensee

Burton Brown Advertising

Audio Fair—Los Angeles Rated Huge Success

Record attendance exceeds New York Fair records by nearly 50 percent
—justifying Californians' claim to great interest in audio in that locality.

SURPASSING the expectations of nearly everyone in the industry—with the possible exception of those who were responsible for the show itself—the first Audio Fair in Los Angeles drew an attendance of 17,000 registered visitors, with an estimated 3000 more who did not register. Compared with the attendance at the 1952 Audio Fair in New York, this is somewhat of a record.

With more than 150 manufacturers represented by approximately 75 exhibitors, the Fair offered everything from wireless microphones of broadcast quality, to three-dimensional tape-recorded sound—the latter being remembered as the hit of the last two New York shows.

The Fair Directory included a page for comments from those who heard the stereophonic demonstrations held on the main floor of the Hotel, and such comments as these were noted by the enthusiastic listeners: "Very life-like—as near to the actual performance as I have heard to date—will do more for audio depth and the audio biz than hi fi by itself—extremely realistic—sound magic—for home enjoyment will be more than worth whatever the cost may be—a little too loud for the room and the audience—how will it be made available for the public—too loud in spots but I still enjoyed it—TOO LOUD (but OK)." Just a sampling of a few of the comments, but more importantly the indication of how much interest there is in audio among the general public—once they are introduced to real high-quality reproduction.

On the back of the sheet which provided space for comments was a questionnaire regarding where the visitor had heard of the Audio Fair—and the surprising result was that the majority of them had learned of it by radio, with newspapers rating a close second, and TV third. And for this attendance, the Audio Fair-Los Angeles could thank publicity director "Cap" Kierulff,



Left to right: "Cap" Kierulff, publicity director of the Fair; Boyd McKnight, chairman of the Advisory Committee and former Section Chairman; and Richard Hastings, Los Angeles Section Chairman of the Audio Engineering Society.

who topped off his two-month campaign of advertising, press releases, and radio announcements with a live telecast on the eve of the show over KTLA. On this TV announcement appeared several of the exhibitors, Fair Manager William L. Cara, as well as Mr. Kierulff.

AES Technical Sessions

In addition to the exhibits, the Los Angeles Section of the Audio Engineering Society—sponsors of the Fair—staged an impressive list of papers for the first two days of the convention. Credit for the nineteen papers given goes to the hard work of the Section Chairman Richard Hastings, Papers Committee Chairman Robert Hopkin, Advisory Committee Chairman Boyd McKnight, and the Chairman for the Technical Sessions Allan Wolff. In all, 19 papers were presented in the four sessions, covering Aircraft communications and recording-motor systems, Audio components and measurements, Audio amplifiers and equipment, and Recording.

Two papers of special interest at this meeting were those on stereophonic recording—one by Ross H. Snyder on "History and Development of Stereophonic Sound Recording," and the other on "Practical Binaural Recording Systems," by Otto C. Bixler and C. G. Barker. All aspects of audio engineering were covered by the convention papers, which will be published in the *Journal of the Audio Engineering Society*. The first issue of the *Journal* will cover the New York convention in 1952, and will be ready in a few weeks. The second issue will contain the papers of the Los Angeles convention, and will be published in the late spring. The *Journal of the AES* is a new activity of the Society and is headed by Lewis S. Goodfriend, Editor, and Jerry B. Minter, Chairman of the Publications Committee. Members will receive the *Journal* without extra cost, and non-members may obtain copies at a nominal charge.

The Exhibit Site

Despite the difficult parking conditions in the vicinity of the Alexandria Hotel in Los Angeles, and despite the inadequate elevator service during the heaviest rush hours of the three-day show, the rooms and corridors are admirably suited for the demonstration of audio equipment. The ceilings are high, and the rooms relatively large, so that the chance of claustrophobia was minimized. The wide corridors and the H-like arrangement of the hotel permitted relatively free movement of the visitors so that the show did not appear to be as crowded as the corridors of Hotel New Yorker in the original Audio Fair location. But taken from all its aspects, the Fair and the Convention may be called a huge success, and those who had a hand in this success are well deserving of a standing vote of appreciation.



William L. Cara, Fair Manager, before KTLA's TV cameras on the eve of the show, prepares to introduce Maximilian Weil, of Audak, in successful bid for attendance.

Everything in High-Fidelity

ALWAYS IN STOCK AT

ALLIED



get immediate delivery on this new deluxe equipment

FISHER AUDIO COMPONENTS

Model 50-A Lab Standard Amplifier. Deluxe all-triode amplifier of the utmost fidelity. Response: ± 0.5 db, 15-60,000 cps at 40 watts. Harmonic distortion: .05% at 5 watts, .08% at 10 watts, 0.3% at 40 watts. Intermodulation: 0.4% at 10 watts, 0.8% at 40 watts. Hum: better than 92 db below full output. Output impedance: 8, 16 ohms. Chassis size: 8 x 14 1/2 x 9" high. Complete with tubes. For 105-125 v., 50-60 cycles AC. Shpg. wt., 45 lbs.
98-628. Net \$159.50

Model 50-C Master Audio Control. For use with amplifier above or any other quality amplifier. Inputs: 3—for TV tuner, radio tuner, tape playback, 1—all magnetic cartridges; 1—high-imp. make. Outputs: 1—for amplifier; 1—for recorder. Response: ± 1 db, 20-20,000 cps. Harmonic distortion: .05% at 5 v., 0.4% at 15 v. Intermod: 0.2% at 5 v., 1.6% at 15 v. In mahogany cabinet, 15 3/4 x 4 1/2 x 6 1/2" deep. With tubes. For 105-125 v., 50-60 cycles AC. Shpg. wt., 9 lbs.
98-626. Net \$97.50

ELECTRO-VOICE 4-WAY SPEAKER SYSTEM

The Patrician. Features Klipsch type "K" indirect-radiator design for truly magnificent sound realism. Perfectly matched components include: 18WK 18" L-F driver (16-200 cps); 12W-1 L-F driver (200-600 cps); T-25 treble driver (600-3500 cps) exhausting through 6-2X5 cellular horn; SP8 BT 8" super-tweeter augmenting T-10 HF driver to full-powered 16,000 cps; X-26 1/4-1 4-way crossover (200, 600, 3500 cps). House-d in distinguished custom corner cabinet. All components installed and wired. 60" h, 41" w, 30" d. Shpg. wt., 500 lbs.

81-413. Mahogany. 81-414, Korina Blonde. Net, either model \$712.95

CRAFTSMEN 800 FM-AM TUNER

The famous tuner with the outstanding features: wider AM bandwidth; sharper IF bandpass "skirts"; built-in preamp with front-panel selected equalization for recordings; AFC, "magic-eye" tuning; tuned RF on AM and FM; separate triode converters; output, 2 v. at less than 5% distortion; output matches high- or low-gain amplifiers with input imp. of 10,000 ohms or higher; input for TV, recorders, etc.; dual tone controls. Chrome-plated chassis, 13 1/4 x 10 1/2 x 7". Complete with tubes and cables. For 105-125 v., 50-60 cycle AC. Shpg. wt., 17 lbs.
98-002. Net \$159.50

FREE 1953 CATALOG

Write today for our complete 236-Page Buying Guide listing the world's largest selection of High-Fidelity systems, amplifiers, tuners, speakers, changers and accessories—available for immediate shipment from stock. If it's anything in Hi-Fi, you'll find it in your ALLIED Catalog. Send for it today.

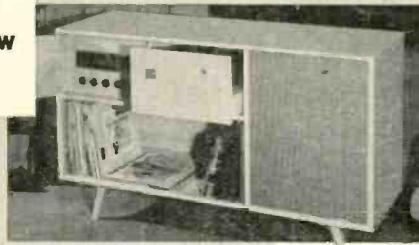

SOUND WORKSHOP'S CUSTOM 800 COMPLETE SYSTEM

An outstanding FM-AM Radio-Phono combination that excels standard type consoles selling at higher prices. Supplied complete—ready for operation. High-fidelity components include: Pilot FM-AM AF-821 Tuner; Webster-Chicago 3-Speed Changer; Jensen H-222 12" Coaxial Speaker; Grommes 100 BA 10-Watt Amplifier; G. E. Triple-Play Variable Reluctance Cartridge. Beautifully housed in outstanding modern cabinet, with acoustically designed speaker enclosure. Size: 53" w, 32 1/2" h, 18" d. Shpg. wt., 110 lbs.
98-641. Cordovan Mahogany. 98-642. Blonde. Either Model, Net \$391.50

ALTEC SPEAKERS

820A Corner Speaker System. Altec's finest speaker installation. Response exceptionally flat from 50-16,000 cps; 30 watts power rating; crossover 800 cps; output matching imp. from 6-12 ohms. System consists of 821 mahogany corner cabinet; 802B high frequency unit with H-808 multicellular horn, two 803A 15" low frequency speakers and N-800D dividing network. Cabinet 47 3/4" h, 42 1/4" w, 29" d. Shpg. wt., 230 lbs.
95-048. Net \$525.00

604C 15" Coaxial Speaker. Flat response from 30-20,000 cps. Has 15" cone for low frequencies; 6-cell high-frequency tweeter coaxially mounted for 60° hor., 40° vert. distribution. With N-1600A crossover network. Ratings: 50 watts peak, 35 watts continuous. Voice coil imp., 16 ohms. Depth, 11 1/8". Shpg. wt., 57 lbs.
95-057. Net \$156.00

602A 15" Duplex Speaker. 30-20,000 cps response. Has 15" bass cone and coaxially-mounted tweeter. With N-3000A dividing network. Sectionalized horn with 2 x 3 aspect ratio for smooth distribution. Power rating, 20 watts. Shpg. wt., 25 lbs.
95-084. Net \$114.00

BROOK 12A4 AMPLIFIER

Consists of Model 12A basic amplifier and Model 4A preamp. Response: ± 0.5 db, 20-30,000 cps at 10 watts. Harmonic distortion: 1.21% at 10 watts. IM: 2.56% at 10 watts. Output imp.: 2, 4, 8, 16, 500 ohms. Amplifier size, 17 x 6 1/2 x 8 1/2". Complete with tubes. Shpg. wt., 28 lbs.
98-701. Net \$222.00

Model 4A Preamp Only. Features new 9-position record compensator and loudness control. Requires power supply when used with amplifier other than Brook 12A. Complete with tubes. Shpg. wt., 10 lbs.
98-702. Net \$109.50

GARRARD RC-80 CHANGER

Plays all speeds (33 1/2, 45, 78 rpm) and all sizes (7", 10", 12") automatically. Changes 45 rpm records on special spindle—no adapters required. Shuts off automatically after last record is played. With 2 plug-in heads and hardware for G. E., Pickering or Clarkston cartridges. Less cartridges and preamp. Shpg. wt., 18 lbs.
96-422. Net \$41.45

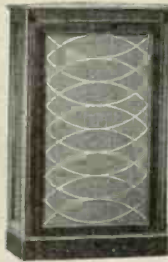
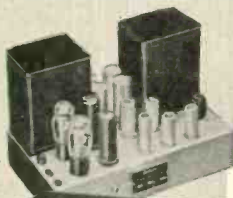

ALLIED RADIO CORP., Dept. 17-C-3
833 W. Jackson Blvd., Chicago 7, Illinois

Send FREE 1953 ALLIED Catalog.

Ship the following equipment:

Name

Address

City Zone State

ALLIED RADIO

Equipment Report

PILOTONE AA-901 Amplifier and AF-821A PILOTUNER

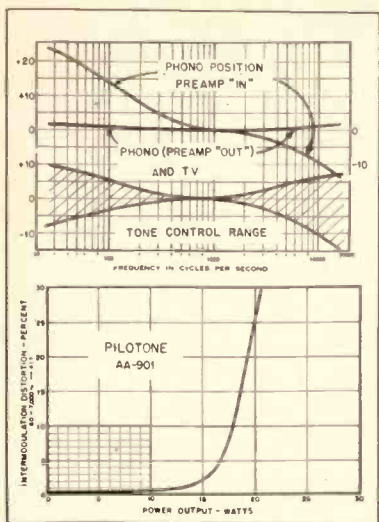

Fig. 1. Measured performance data for the Pilotone AA-901 amplifier and the AF-821 Pilotuner.

THE PILOTONE AA-901 amplifier employs the conventional Williamson circuit, with a number of desirable features. Means are provided for adjustment of bias on the output stage, as well as for balance between the two tubes. By connecting a voltmeter between a two-terminal strip and ground, output cathode voltage may be read, and a control permits adjustment of this voltage to suit the tubes. With KT-66's—normal equipment in the amplifier—40 volts is recommended; if the user wishes to change to 5881's, the correct bias is 38 volts. By removing the jumper from the terminal strip and connecting the meter between the two terminals, the plate currents of the two output tubes may be balanced by turning another control to obtain a zero indication on the meter.

Rated output is obtained with an input voltage of 1.0, which corresponds to a 0.25-volt input for the standard measurement output of 1 watt. IM distortion at the 15-watt output is 2 per cent, while up to

10 watts the distortion remains below 0.4 per cent.

The amplifier chassis is provided with a power switch, pilot light, and two convenience outlets for other equipment. Figure 2 shows some unusual features in the power supply section of the amplifier.

The AF-821 Pilotuner consists of a combination AM-FM tuner, tone and volume controls, and a phono preamplifier which may be switched in or out at will, thus making it possible to change from crystal to magnetic pickups with a minimum of effort. A jack is provided for TV sound input, and the selector switch permits selection of the desired source signal.

The built-in antenna connection for FM appears to provide good signal pickup, even up to 40 miles from transmitter locations; the AM pickup on the iron-core antenna coil is sufficient for most installations.

While tone control curves seem to be less severe than many others, they would undoubtedly be adequate for normal installations. The phono preamp has a fixed equalization curve which matches LP records quite closely, and tone controls permit minor trimming of the response curve. The circuit employed in the phono preamp is simple and effective, and might well be studied as an example of good commercial engineering.

A detector output is provided to feed a signal to a tape recorder without being affected by the volume control, or to an amplifier which was equipped with tone and volume or loudness controls of its own. Two convenience outlets on the tuner chassis can be used to accommodate the power amplifier and a turntable, and both are controlled by the on-off switch. The selector switch also controls dial lights—illuminating the one in use—or operates pilot lamps for the phono and TV positions.

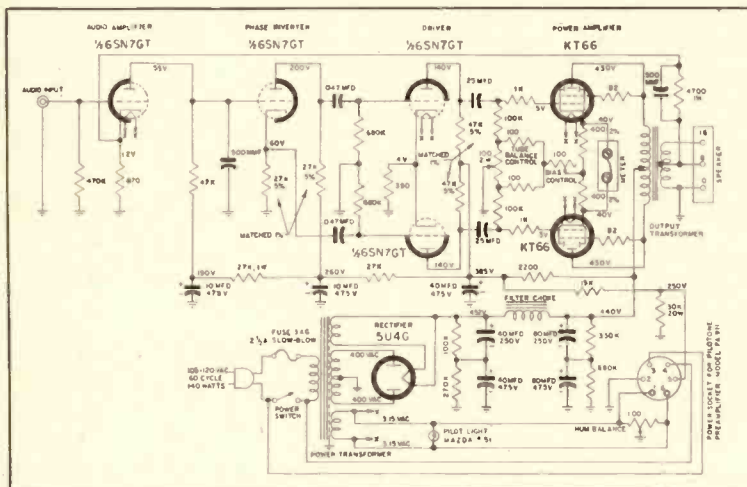
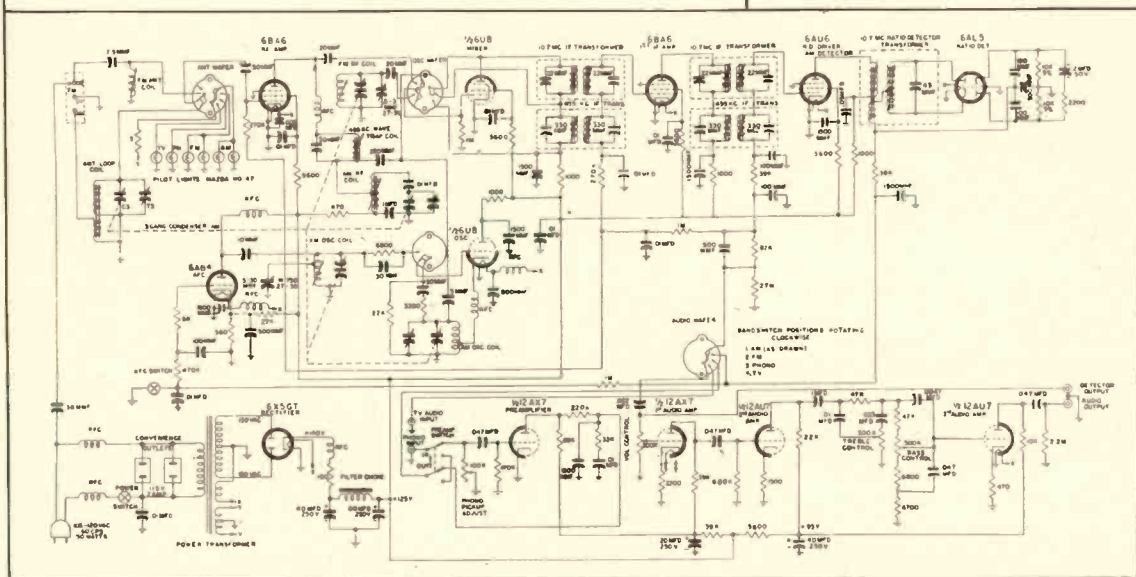

Fig. 2 (left). Schematic of the Pilotone amplifier. Fig. 3 (below). Schematic of the AF-821 Pilotuner.



HARVEY the House of Audio



The ORIGINAL WILLIAMSON HR-15 Amplifier Kit

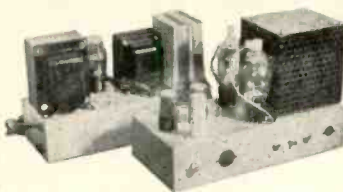

The famous, original Williamson HR-15... still acclaimed the leader... In kit form, with the Partridge Output Transformer specified by Williamson in his original design. Assemble this kit, and in 3 hours or less, enjoy the finest sound you ever heard. Operates from a tuner, phono-preamp, crystal pick-up, or other signal source. Absolute gain is 70.8 db with 20 db of feedback. Frequency response -5 db, from 10 to 100,000 cps. Output impedances to match all speakers from 1.7 to 109 ohms. Kit is complete with 5 tubes: 1-5V4, 2-6SN7, and 2-5881 (or 807 if requested), 2-Punched Chassis, 2-Resistor Mounting Strips, Sockets, Partridge WWFB Output Transformer, Assembly Instructions, and All Other Necessary Parts for Amplifier and Power Supply **\$76.50**

PARTRIDGE OUTPUT TRANSFORMER WWFB - Available Separately **\$26.50**
 HR-15T Williamson Kit - Furnished as above, with TRIAD Transformers and Chokes **\$69.50**

NOTE: HR-15 and HR-15T Kits may be had with British KT-66 Output tubes for \$3.00 additional.

The NEW McINTOSH LOUDSPEAKER SYSTEM



Housed in an attractive enclosure for either flat-wall or corner location. Provides a response ± 3 db, from 40 to 10,000 cycles/sec., and a useful response from 30 to 20,000 cycles/sec. Four 12" speakers are used for low frequencies, an 8" speaker for the mid range and four tweeters for high frequencies. Nearly 4 square feet of diaphragm area are thus provided for more efficient acoustical coupling, more closely approaching linearity in excursions, thereby reducing low frequency distortion to a minimum. Over-all width of the enclosure is 43 inches, and the height is 30 inches. Front width is 22 1/2 inches. Power Rating: 50 watts continuous operation. Impedance: 8 ohms.

Model F100 (blond finish) **\$374.50**
 Model F100A (Mahogany finish) **374.50**



CARTER SUPER CONVERTORS

Deliver clean 60 cycle AC power at 115 volts. Operate from storage batteries or other DC source, and available for 6, 12, 24, 28, 32, 64, or 115v input voltages. Ideal for on-location recordings with quality equipment. Write for complete data and prices.

CANNON PLUGS and CONNECTORS

The standard of quality for over 15 years. You'll find them wherever the ultimate is required in low level sound transmission, and general electrical and electronic applications. Write for complete data and prices.

COMPLETE STOCKS CARRIED AT ALL TIMES FOR IMMEDIATE DELIVERY



HARVEY is the HOUSE of AUDIO

Whatever it is in the field of Audio, you can be sure to find it at Harvey... in stock, and ready for immediate delivery wherever you may be. Your inquiries are invited.

NOTE: Prices Net, F.O.B., N.Y.C. Subject to change without notice.

The NEW MINIFON Miniature, Portable WIRE RECORDER



Measuring only 1 1/2 x 4 1/2 x 6 1/2, and weighing only 2 lbs. 7 ozs., the Minifon is just about the world's smallest sound recording instrument. Records, rewinds, erases, and plays back through either a pair of stethoscope type earphones or an external amplifier. Capacity 2 1/2 hours uninterrupted recording. Powered by 1 1/2 v. A battery, standard 30 v. B battery, and 7 Mallory RM-4Z mercury batteries. An ideal tool for executives, engineers, doctors, and wherever there is need for recording notes, interviews, and other data.

Complete with microphone, stethoscope type earphones, 1 hour spool of wire, tubes, batteries, and instructions. **\$289.50**
 Morocco Leather Zipper Case **\$10.00**
 Transformer-rectifier Unit for operation of motor from 117 v. AC line **\$20.00**

RECORDING WIRE On spools, in dust-proof plastic containers, suitable for mailing.

1/4 hour	\$5.00	1 hour	\$9.00
1/2 hour	7.00	2 hour	17.90
		2 1/2 hour	21.50

AUDAX POLYPHASE REPRODUCERS



One unit with two replaceable styli operating with one pressure (8 1/2 grams) for all three record speeds: 33 1/3, 45, and 78 rpm. Provides excellent coupling between stylus and record groove, with high stylus compliance and minimum mass. Response is from 20 to over 10,000 cps., with an output of about 20 millivolts. Needle-talk practically nil.

DL-6 Chromatic Head with Microgroove Diamond and Standard Sapphire **\$41.70**
 L-6 Head with two Sapphire Styli **20.70**
 KL-4 Head with Sapphire Styli **20.70** (for record changers)



R-J SPEAKER ENCLOSURES FLOOR MODELS

Designed for use with ANY 12 or 15 inch speaker, this new sensation in high fidelity has no counterpart in anything available today. The R-J is a new concept. Large enough only to accommodate

the speaker, it reproduces tones to the lowest limits of audibility, cleanly and without hangover. The R-J is the amazing solution to the problem of space versus quality.

Model FM (Mahogany) **\$49.95**
 Model FB (Blonde) **54.50**
 Model F15UM (Unfinished Mahogany) 15" only **43.35**
 Specify for 12 or 15 inch speaker.

hrc HARVEY RADIO COMPANY, INC.
 103 W. 43rd Street, New York 36, N. Y. • LUXEMBURG 2-1500

RECORD REVUE

EDWARD TATNALL CANBY*

Filling the Great Gap

THE COLUMBIA 360 hi-fi phonograph, pictured on the January cover of *Æ* and described in this issue, page 28, is not going to replace your present hi-fi system. It's not supposed to. Its speaker facilities will not compare with your Lansings and Altecs and Jensens and Klipsches, your EV, Brociner, Bozak, University, Wharfedale, Hartley, Barker (whew . . . I'm only trying to be impartial. . .) systems, nor should it. The amplifier is probably not in a class with the Williamson or McIntosh designs (though it is push-pull). The new ceramic cartridge is unlikely to unseat your present excellent magnetics (though it's not far behind them in sound quality). The changer is just a good changer, more or less like many another. I've had one of these machines for a week or so and I can vouch for the above.

Nevertheless, there hasn't been anything like this before. This machine is a phonograph intended to break the low-fi market wide-open, I'd say—and it is not hard to see why it might.

Lest we forget . . . there is a vast gap between the quality of the usual home machine in terms of sound and that of the hi-fi systems we've been assembling from separate units these last years. Need we expatiate? This is an old story, to most of us. The gap is the greater, moreover, because most hi-fi equipment sells at the nominal net level, whereas the usual home phonograph comes from a local dealer who sells strictly list. The two lines aren't even sold through the same dealers, nor via the same sales mechanisms.

As the hi-fi industry gets bigger, it inevitably must approach the mass-produced standard phonograph, in simplicity, convenience, above all what I might call one-piece-ness. This column had a lot to say last summer (*Æ* August, 1952) about the hi-fi cycle from unwired professional separate components through pre-wired and pre-plugged units (recommended here back in 1947, as I remember), "package" systems, the super-package mounted complete in your choice of cabinet, and finally the one-piece separate-unit machine, sold ready to play, a phonograph on the outside but a separate-unit, net-priced hi-fi system on the inside. That last development, as ads

in this magazine may have shown you, is well launched by now. The cycle is almost complete.

Almost—but for one very large and complex factor, the sales systems. The final dealers in phono equipment are now, as above-mentioned, ranged in two camps, championing the list and the net. Perhaps those terms no longer mean much, but the divergency of the sales camps, and of the entire systems behind them, is plain enough.

Hi-fi as we know it can't sell in retail shops. Not unless it is priced about the same as elsewhere (i.e. in wholesale houses, sound salons, etc.)—at net. We've gone too far to have two prices for the public at a 30 per cent differential. The list price is out. And, unfortunately, the net price isn't figured to allow the local dealer his relatively large cut on local, small-volume sales. In other words, the hi-fi business runs on a new basis that simply is not adaptable to the old system in any large way. Hi-fi has its own outlets.

Basic Redesigning

I'm no sales expert and I go no further in this path except to suggest that the way towards direct improvement of the home phonograph according to hi-fi concepts is *not* through present hi-fi components; not through any kind of juggling of present equipment, to compete with itself.

Instead, improvement must come from the other side, via a basic redesigning of the old-fashioned phonograph, via the development of new ways to incorporate hi-fi ideas, procedures, equipment, circuits, into "ordinary" phonographs that shall be no ordinary ones at all. That means high technical ingenuity, imagination, ability to make a brilliant compromise and a right one at every point—for this is a "best-under-the-circumstances" kind of job.

Who shall build such machines? Not a smaller concern; a large business potential is needed, to develop and product-engineer radically new types of components, to build the whole at an economical cost. Not likely a firm already in the business, either. Too much vested interest in things as they are.

Rather, it must be a big firm coming new, fresh and unprejudiced into the field, with its industrial hands untied. If that

firm, by chance, should have some other special interest in the phonograph—say in records—then so much the better. There aren't many large outfits that fill this reasonable description. Only one has showed up so far—CBS-Columbia.

Come to think of it now, it was inevitable that CBS should come to this. CBS launched the LP, then found itself selling LP players; the CBS-designed cartridge in them matched the LP record's quality pretty well—but the home radios and phonographs that took over the reproduction were obviously of the bottle-neck sort. Stressing quality, Columbia practically talked itself into completing the job, designing a complete improved system for the mass phonograph trade. This, then, is the first really planned attempt to break across the big barrier, between hi-fi and the standard phonograph. That gap has been this column's concern ever since it began and so this disquisition was also inevitable.

Stacking it up

How, then, does the 360 stack up? Again, it's not for you and me. But that isn't the point. Look at this as a home phono and study it for signs of genuine departure from the dismal norm.

To this day, most home phonographs practice the law of the 4000-cps top. No highs are better than distorted highs. A vast number of problems in distortion are thus simply avoided. The Columbia 360 easily encompasses the range to 10,000 cps, and that with low distortion by anyone's listening standards.

To this day, most home phonographs are open-backed (maybe I should say all . . . and produce no low bass. Even the big ones. This machine, with a closed cabinet—when the lid is down—gives a lower bass than most larger home-type consoles. Rigged, and definitely somewhat boomy bass, but it's there. The bass balances the extended high end, and a vital problem is solved.

The 360 shows at many points the kind of ingenuity that makes a gadget man beam. The best thing in it, to my mind, is the new cartridge. Ceramic, and the first to rate as wide-range, it has a revolving needle-shank with two points which rests very simply in a tiny yoke where the ordinary point would be. The entire assembly snaps out in your hand via a single clip;

* 780 Greenwich St., New York 14, N. Y.

the

HIDDEN 1

In music, listening quality is everything. It is the No. 1 MUST. Without it everything else becomes meaningless. The AUDAX CHROMATIC has that quality to a degree not equalled by anything known—this according to the thousands of AUDAX users, themselves.

PULL 2

Be it diamond or sapphire, every stylus has only a limited life span; the diamond of course, lasts the longer. Obviously, then, replaceability—at home—is of greatest importance. AUDAX is engineered for easy replaceability of the stylus—at home. Of further importance is the fact that each AUDAX CHROMATIC stylus is replaceable independently of the other.

3* The magnetic attraction between pick-up and steel turntable, known as the "HIDDEN-PULL", has always been a problem. When point-pressure was 100 or more grams an additional "HIDDEN-PULL" of 10 or 15 grams was of no consequence. Today, however, with point-pressure below 10 grams, the "HIDDEN-PULL" becomes a very serious factor. . . . The Audax CHROMATIC is free of "HIDDEN-PULL".
Only You can decide what sounds most pleasing—See and Hear the Audax CHROMATIC and—you be the judge.

Audax costs no more than ordinary pickups

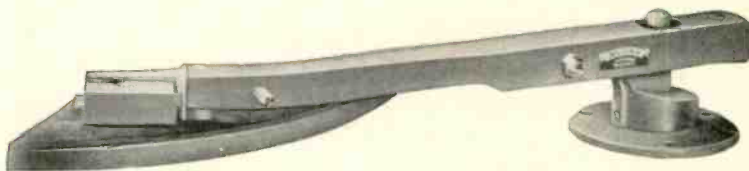

Available with the new Compass-Pivoted Audax arms and to fit the high quality record changers

*See Pointer 84 in 1953 ELECTRONIC PHONO FACTS obtainable from your distributor

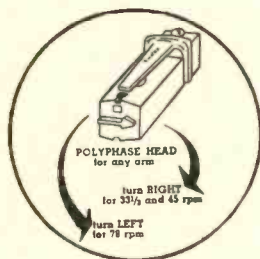

AUDAX COMPANY

500 Fifth Avenue New York 36

Creators of Fine Audio-Electronic apparatus for over 25 years

"The Standard by Which Others Are Judged and Valued"

Newest Member
of a famous
HI-FI family...

PILOTUNER



HI-FIDELITY FM-AM TUNER
Model #AF-723

Distinguished for maximum performance at the lowest price possible for a luxurious High-Fidelity Tuner. Engineered with the precision that has characterized all of the world-famous Pilot electronics instruments, over a period of 33 years. This magnificent new PILOTUNER incorporates many superb features hitherto unheard-of in its moderate price class. Write — now — for a full description of this outstanding Model #723 PILOTUNER... Selling price, \$79.95

PILOT RADIO CORPORATION
37-06 36th Street • Long Island City, New York

Now ready for immediate shipment The 2nd Audio Anthology

No bigger, no better than the original Audio Anthology—in fact, it's just the same size and a perfect companion to the most authoritative book you now have on the subject of home music systems. But it contains all new material—reprints of over forty of the valuable articles which have most interested *Æ*'s readers during the past two and a half years.

Customary discounts to distributors.

Board Cover \$3.00 Paper Cover \$2.00

Features—

- Amplifiers
- Preamplifiers
- Tone Controls
- Phonograph Equipment
- Loudspeakers
- Speaker Enclosures
- Tape Recorder Amplifiers

-----CUT OUT-----MAIL TODAY-----

Book Division,
Radio Magazines, Inc.,
P. O. Box 629, Mineola, N. Y.

Sirs: Enclosed is my check money order for copies of the
2nd Audio Anthology.

(Please check one) Board Cover Paper Cover

Name (print carefully)

Address

City Zone State

the two grooves are played without the cartridge moving at all. The entire unit is an inch or less long and less wide than a pencil. It fits standard mountings. The unit is made by Sonotone—another new entry in the field—and I'm told will be available separately. If so, it should make a good "front end" for replacement and other use. I haven't made direct comparisons but I'd say it equals or surpasses the CAC crystal, the former Columbia work-horse. It is far simpler than the twin CAC-D and should easily outmode it.

The 360 amplifier shows up in the final sound. Suffice it to say that a lot of imagination was needed to design a push-pull amplifier into an ordinary phonograph, where in a million earlier models a single-ended horror was considered quite sufficient! Don't lose our perspective on this.

How to get low bass from a small box? A familiar problem these days. The entire inside space here, with lid down, is a closed chamber for two six-inch speakers, one at each side of the box. Open the lid and the bass departs, rather dramatically. The two speakers, I gather, are alike except that the cone resonances are purposely slightly different, for smoother over-all response.

Sidewise Music

I find that the sidewise distribution of the sound via the two speakers, aiming away from each other, is the best and most dramatic aspect of this machine's sound. Look straight at the machine and the music comes not directly from it but instead seems to be "in the room," without a sharply defined source. Couldn't be better. (Of course the machine's position in the listening room is a large factor. A nearby corner or close-to side wall will do more drastic reflecting. The machine sounds best when there is a good distance to right and left of it, with good reflecting surfaces where the sound finally hits.)

Further indications of good thinking are in the controls. On-off is at the changer. The volume control begins at low (not off) and operates as a loudness control. Instead of the usual tone control, ranging from the middle downward to the familiar muffled sofa cushion effect, the tone knob here allows only a slight extra roll-off in the higher highs—mostly those above the top range of usual phonographs—to match records and to compensate for room conditions. Why no more? With low distortion (and good records) there is no need for the old tone control. It shouldn't be present; for habit-ridden listeners will immediately turn it down, out of sheer mental inertia. It was an intelligent idea to omit it, and intelligent, too, to put the on-off switch elsewhere than on tone or volume knobs where it invites wrong settings.

What else? A standard (V-M) changer, adequate and convenient; the same light arm as in the Columbia LP changer. Neutral components. A surprisingly good looking heavily built cabinet, bowed out in front. And that's the ordinary phonograph that may start the great gap a'filling.

P.S. It sells strictly through regular record-radio-phono dealers, right square in the middle of the standard brands. It'll soon have competitors, I'll wager.

CURIOSITY SHOP

Old Curiosity Shop. Helen Morgan, Sophie Tucker, Will Rogers, Gloria Swanson, Fannie Brice, etc. etc.)

RCA Victor LCT 1112

A wonderful memory teaser—reissues of a batch of very famous hits and familiar voices, ranging from the indomitable John Barrymore (Hamlet) to the indomitable Sophie Tucker, Helen Kane

the Boop girl, Will Rogers, Casey at the Bat . . . nuff said! Excellent technical restorations. Some date well back into the acoustical period; most are early-to-middle electrical.

* **Folk Songs of Hungary (Bartok-Kodaly)**, vol. 2. Leslie Chabay, tenor; Tibor Kozma, pf. **Bartok BRS 914**

Vigorous, masculine stuff, superbly recorded and full of excitement in Hungarian Chabay's lusty singing. Anyone who has fallen for gypsy or Hungarian rhythms as in the conventional semi-pops and the familiar Hungarian Rhapsodies et al will relish the genuine original here, set to brilliant modern accompaniments by Bartok and Kodaly. Folklore people will be interested in the piano settings—Bartok and Kodaly have not been equalled yet in this expert use of the modern dissonant idiom to set off folk music without in any way distorting the musical sense of the original. Would-be folk-style composers should study.

* **Pokroffieff: Peter and the Wolf**. Arthur Godfrey; André Kostelanetz & His Orch. **Columbia ML 4625 (1/2)**

Don't sniff too soon! Godfrey is Godfrey and you'll recognize him here all right—but his usual elaborately off-hand style has been well adapted to the Peter story in this recording, without too much slapstick, a fairly close adherence to the standard spiel that goes with the music. Won't do your extra-bright child a bit of harm. And the Kostelanetz music is unexpectedly warm and fresh. Part of that is due to the superb recording, but not all—evidently André has some personal feel for this music that he doesn't for many another war-horse put out by his Orchestra.

International Folk Music Festival (Eisteddfod). Auspices UNESCO. Jack Bornoff, narr. **Westminster WAL 209**

On-the-spot job by BBC of the international version of the ancient Welsh folk festival. Short

Key	
*	Outstanding record of its type
†	AES playback curve specified on record
††	NARTB (NAB) curve specified on record
^b	Big bass; European-type low (300) turnover; adjust accordingly
^d	Distortion
^{dd}	Distortion in loud passages only
^e	Extra treble preemphasis — use mgre roll-off
^f	Flatter-than-average high end — use less roll-off
^j	Injection moulded plastic, quite thin
ⁱ	Intimate, close-to recording in good liveness
^l	Big, live acoustics
^o	From older 78 discs
^u	Unresonant, deadish acoustics
^v	Voice is close-up, loud
^{vv}	Voice is at distance, blends into musical background
^x	Thin bass, high turnover point (600-800); needs bass boost over normal playback

to middling samples of music and dance, a few complete, most of them excerpts, faded in and out, with running comment "off-tape" (tape-edited in). There are some stunning things here and the recording is technically excellent. But the editing is a bit clumsy and the mike set-ups—probably beyond the operators' control most of the time—are often cock-eyed. Doesn't matter particularly; but more important is that the material is not well adapted to this kind of technique. Too many items are too long and must be faded in and out. Much, clearly, was for the eye. It is a bit exasperating to hear . . . "and now, here are the famous Whoosis Dancers from Ireland who have won countless prizes"—followed by a vast

thumping and banging, as though a large part of the stage props had collapsed! (The wooden platform used throughout was of a fabulous resonance.)

Musically, folklorists will find this a thorough hodge-podge of material—some is "authentic," untutored, primitive, much more is relatively polished and a great deal is about as folk song as a Radio City arrangement of My Old Kentucky Home. Or Schubert's setting of the 23rd Psalm, which is one of the loveliest items in the set! Assorted popular bands, choral arrangements by Elgar, Holst, and the like, round out the show. In short, this is no document of the folk music art, nor of any other kind of music, but it was a good show to be at, and it's fun to listen to.

* **Ibert: Concertino da camera for saxophone and chamber orch. Glazounov: Concerto for saxophone and orch.** Vincent Abato; instrs. cond. by Schulman, Pickering. **Philharmonia PH 103**

The sax was invented long before jazz. Here's an item from some time back that I didn't get to review that shouldn't be missed. The Ibert, from 1935 and with a nice feel of the 1920s in it, is short and amusingly skittish. The Glazounov is lushly romantic. The recorded sound is unusually fine, doing the maximum for the small group of instruments. Beautifully balanced sax tone, excellent strings and nice bass. Pickering? Who but our friend of the well-known pickup, Norman P. He's a musician, in case you didn't know, a top-rate horn player (I hear from good critical sources) as well as a conductor, as here.

* **African Tribal Music and Dances.** Sonar Senghor & Co. **Esoteric ES 513**

Super-hi-fi sounds of the Bush (or do I mean the "Veldt?"), recorded "on location"—in Paris, via a nite club hot spot! It may be a travelling troupe, but the stuff is pretty authentic sounding, notably the rasping voices. Not a trace of "training" here! This is a kind of halfbreed music, not too far removed from Calypso though more primitive (and far more complex). Native dialect,

PILOT

World leader and pioneer in electronics . . .
presents the world's finest High Fidelity line

NEW
PILOTUNER
FM-AM RADIO TUNER

Behind this brilliant new Tuner stands Pilot's 33-year-old, world-wide reputation for producing the most advanced communications instruments that science has yet developed. Once enjoyed only by a select circle of engineers "in-the-know" . . . Pilot sensitivity, selectivity, stability — are now yours, in this incomparable new PILOTUNER. No better tuner can be made at any price . . . yet the Pilotuner is modest in cost, at . . . **\$99.95**

★ Write for complete specifications



Model AF-821

The Pilot High Fidelity line is discussed and appraised in the practical new book, "High Fidelity Simplified", by Harold D. Webster



PILOTONE Amplifier Model AA-901

Designed for high fidelity audio reproduction from phonograph, AM or FM radio, television or microphone input. Full Williamson circuit. A supreme amplifier with traditional Pilot quality, exacting Pilot specifications . . . the last word for the discriminating music lover and hi-fi enthusiast, — priced at . . . **\$99.50**

★ Write for complete specifications



PILOTONE Amplifier Model AA-902

A compact, medium price, high fidelity unit for use where cabinet or other mounting space is limited. Can be operated with PILOTUNER model AF-821 and similar tuners for FM-AM radio, television or phonograph reproduction. **\$46.95**

★ Write for complete specifications or phone Stillwell 4-5455

Write for circular AE-2, describing these fine instruments in complete detail.

PILOT RADIO CORPORATION, 37-06 36th St., Long Island City, New York

AUDIO ENGINEERING • MARCH, 1953

YOU CAN RELY ON

SONOCRAFT

for

QUALITY, DEPENDABILITY, SERVICE

NEW *Magnecord* "VOYAGER"

**SINGLE CASE
Portable
Magnetic
Tape Recorder**

\$485 net

AVAILABLE IMMEDIATELY

This professional unit consists of the standard PTG-AH recording mechanism plus lightweight amplifier. Amplifier has two inputs—one microphone, balanced or unbalanced, 50 ohm impedance (easily converted to 200 ohm) and one high impedance unbalanced input. Output is 600 ohm, balanced or unbalanced, with maximum output of 6 dbm. Earphone monitor jack. Frequency response ± 2 db from 50 to 15,000 cycles at 15"/sec. Portable carrying case has amplifier and recorder mechanism back to back when closed. Unit is joined by slide hinges, and amplifier may be detached and operated beside mechanical unit. Weight 45 lbs., dimensions 19" x 7 $\frac{3}{4}$ " x 17 $\frac{3}{4}$ ".



You'll find all Magnecord equipment available at our offices. Trained engineers will give you expert advice and immediate service with genuine Magnecord parts.

NEW

UB ORDER

**PORTABLE BATTERY
TAPE RECORDER**

*Records Anything . . .
Anywhere . . . Anytime*

complete, \$295 net



Smaller than a portable typewriter . . . built into a handsome briefcase . . . completely battery operated! Wet cell battery for 1 $\frac{1}{2}$ hours operation, rechargeable from car or charger. Dry cell "B" battery good for 50 hours. Microphone with stop and start switch. Immediate playback through phones. Speed 7 $\frac{1}{2}$ " /sec. and 3 $\frac{3}{4}$ " /sec.; weight 12 $\frac{1}{8}$ lbs.; dimensions 5 $\frac{5}{8}$ " x 13 $\frac{1}{4}$ " x 12 $\frac{1}{4}$ ".

Write, phone or stop in for more information. Your sound and recording problems will receive prompt, courteous attention.

SONOCRAFT

CORPORATION

**Headquarters for Sound &
Recording Equipment
& Accessories**

115 WEST 45th STREET (3rd floor)
Next to Times Square **NEW YORK 36, N. Y.**
Luxemburg 2-1750

much shouting, drums, etc., but in between the catchy refrains are sung in thirds, not unlike Mexican and Latin American music. A good hi-fi stunt record to have around.

"El Pili" Flamenco. El Pili; Mario Escudero and Alberto Velez, guitars.
† Esoteric ES 2001 (10")

Another in the same series—Jerry Newman, who started Esoteric as an off-shoot to his New York record shop, sold the shop and bought him an Ampex-and-Telefunken. He's travelling. These are evidently famous names, but my ear detects a bit of international sophistication and show biz in the music. (They are also parts of travelling troupes.) Some too-slick harmonies, etc. Only a trace; the rest is fine and recording is excellent, if a bit close-to.

"Mr. President"—from FDR to Eisenhower. 1933-1953. Edited and narrated by James Fleming. RCA Victor LM 1753

The patch-it-together documentary history, combining commentary with the actual voices and sounds of the past, is now a familiar and irresistible medium. Columbia has been at it on LP for some time; this is RCA's follow up. In many ways this is a step forward. There is much new material here, little that is already familiar; all sorts of people pop up—Woolcott ("the Town Crier"), Sinclair Lewis, Huey Long, Ickes, Landon. The commentary is less editorial sounding (and less paternal in tone) than the CBS work, the excerpts more varied. Recorded voices succeed each other without intervening commentary, often answering each other, presenting different sides of arguments. Many voices speak only a few words, but they are usually very well chosen. The familiar New Deal years, build-up to war are covered with new material, the war is passed over rapidly.

Best work is side 2, where the pace lengthens out to cover the recent events in detail, with Dewey, Truman and Stevenson getting—or giving—an excellent accounting. How time flies! Main faults in this disc: some uneven timing (Fleming's voice is occasionally hurried or tired, between good stretches). The counterplay of voices is sometimes confusing; you lose track of who's who, or where we are, especially on the first side. Not serious, in a tremendous undertaking of this sort. Technical work on the older voices is excellent. (Or maybe NBC just has good recordings.)

♦♦ **Dvorak: Serenade, op. 44.** London Baroque Ensemble, Haas. Decca DL 7533

A novelty item by a familiar composer, a serenade not unlike the wind divertimenti of Mozart—this has a cello and double bass but the rest of its instruments are winds. 2 oboes, 2 clarinets, 2 bassoons, contra-bassoon, 3 horns. With that potent armament Dvorak produces some fine village-band stuff with a solid tone quality that is beautifully recorded as well as nicely played.

†† **Sixteen Sonnets of William Shakespeare.** David Allen; music by Curtis Bje-ver, played by Margaret Ross, harp.
Poetry Records PR 201 (10")

Good reading, the harp music an unobtrusive and legitimate way of coping with the difficult problem of a plain, unadorned voice on records—which never seems to work out well. Voice is somewhat tubby in quality, very slightly distorted. Allen should experiment on this score for future releases, to find where trouble is. Too close to mike? Too high a tape level? Tape alignment?

♦ **Gluck: Flute Concerto in G.** Corelli: Oboe Concerto. Paris Philharm. Orch., Leibowitz. Haydn: Toy Symphony. Orch. Radio-Symph., Leibowitz. OCS 29

Two pleasing concerto items—a concerto from Gluck is a decided novelty since we normally hear only his operatic music, and the Corelli concerto has in it a famous sarabande that you'll recognize from popular transcriptions. The Haydn Toy Symphony is for once done without putting those d--- watery bird whistles and rattles 3 inches from the nearest mike, and it sounds a lot better, remains as good fun as ever. Playing has that hard, chromium quality that Leibowitz likes so much (and I don't). Nice hi-fi, and the crow call (?) is out of this world.

* **Menotti: Amahl and the Night Visitors.**
Original cast of the NBC telecast (with Chet Allen).
RCA Victor LM 1701

If ever a modern classic was tossed off for eternity, this is it. Menotti has a peculiar genius for cutting across styles and tastes to appeal to almost any and everyone—his drama similarly seems to “work” in any modern medium, where other modern composers flounder abysmally with the technical difficulties. All of that shows here superbly; the pomp and circumstance of NBC super-TV can’t touch the simplicity and directness of this music and story! Records bring it through as movingly as TV or stage, or what-have-you. And this music, done in a hurry by Menotti, seems to hit the essential spot that earlier and more pretentious undertakings—the Consul, for instance—missed for most of us. I can guarantee enjoyment to absolutely anyone here. The recording, too, is superb. If RCA had chosen to do this sort of job throughout its modern catalogue, what hi-fi riches we’d possess. Terrific.

* **Zwei Herzen im ¾ Takt. (Two Hearts in Three-Quarter Time.)** Viennese Light Opera Co., Stolz.
Period RL 1902

* **Der Bettelstudent (The Beggar Student).** Viennese Light Opera Co., Stolz.
Period RL 1901

Viennese light opera, dating from the incomparable Johann Strauss, dies hard. The Beggar Student (Millocker) dates from 1882, the familiar Zwei Herzen from 1934, and the style is the same old melange of waltzes and nice, juicy, sentimental polkas. But an inquiring ear will find the Millocker of 1882 considerably better stuff, and nearer Strauss, than the dimly watered-down Zwei Herzen, which Stolz himself wrote in 1934, following the success of the song itself. Superb and natural recording, the words particularly clear, the voices undistorted.

CHORUS, ORCHESTRA, SOLOISTS . . .

♫ **Mendelssohn: Walspurgisnacht, op. 60.** Netherlands Philh. Choir & Orch., soloists, Ackermann. Mendelssohn: ^d **Five Songs.** Uta Graf, sop. Concert Hall CHS 1159

The list of major works that have rarely been heard until LP brings them back still isn't complete. Here is some of the very best Mendelssohn there is, a short oratorio or cantata based on the Goethe romantic tale of the night of devils and witches. This music is dramatic, like Elijah, but simple, intense, un-stuffy, like the Midsummer Night's Dream. Beautifully sung, in a well balanced recording. The five piano songs are tightly and expressively sung by a lovely high soprano voice, Uta Graf, with good piano accompaniment. Somewhat distorted. Chorus distorts a bit in loud parts.

♫ **Beethoven: Ruins of Athens, op. 113.** Neth. Philh. Choir & Orch., soloists, Goehr. Concert Hall CHS 1158

A companion Concert Hall restoration, again beautifully done and of considerable interest—this is one of those works of which we hear only the overtures, forget about the rest. The rest isn't great Beethoven but it's highly attractive and parts are priceless, the sort of music it is just impossible to imagine as unknown. Some fine pseudo-Turkish music, including the familiar Turkish March. This one, too, distorts in the louder parts. Too high a level at the tape recorder input stage, I'll bet. (Remember that the naturally complex “beats,” quick transients in vocal music, don't register properly on a damped meter.)

♫ **Prokofieff: On Guard for Peace, op. 124 (1950).** Combined Choirs, State Orch. of U.S.S.R., soloists, Samonsoud.
Vanguard VRS 6003

If you can hear to associate yourself with Stalin & Co., long range, you'll find our old friend Prokofieff, he of “Peter and the Wolf,” “Alexander Nevsky,” the Classical Symphony, in excellent form here. Politics haven't spoiled this man, by a long shot. There's a lot of bombast and a good deal of padding, to please the politicians, but in between, you'll find some of the most poignantly moving music you'll hear in a long time and some incredibly fine singing. The contralto soloist has a voice you'll hardly believe,

IN THOSE EXTRAORDINARY APPLICATIONS WHERE DEPENDABILITY AND PRECISION COUNT

you'll find

CHICAGO

the World's Toughest Transformers

A "LOCATOR" FOR SURGERY



The Kirby-Thurstone Cholelithophone is an ingenious electro-acoustic device for the detection and location of gallstones in the common and hepatic ducts. This fine aid to surgery is a joint development of the University of Pennsylvania Hospital and Pennsylvania State College. The precise and dependable instrument is manufactured by Centre Electronic & Mfg. Co. CHICAGO Sealed-in-Steel transformers are specified and used exclusively for the completely dependable performance required of the instrument.

C-TYPE

Sealed-in-Steel, with leads and flange mount



SAFETY FOR A SUPERLINER

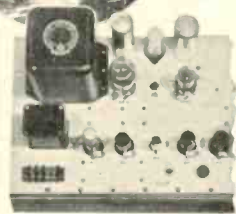

Photo Courtesy Newport News Shipbuilding & Dry Dock Co.

The S. S. United States—last word in Superliners—incorporates every known sea-going safety device. Among its electronic safety features is the Announcing System Amplifier, designed and built by Electronic Engineering Company, Inc., of Norfolk, Va. The power transformer specified and used in this super-dependable amplifier is by CHICAGO. Where dependability is an absolute requirement, you'll find CHICAGO—the world's toughest transformers.

S-TYPE

Sealed-in-Steel, with lug terminals and flange mount



Free "New Equipment" Catalog

You'll want the full details on CHICAGO'S New Equipment Line, covering the complete range of "Sealed-in-Steel" transformers for every modern circuit application. Write for your Free copy of Catalog CT-153 today, or get it from your electronic parts distributor.



CHICAGO TRANSFORMER

DIVISION OF ESSEX WIRE CORPORATION
3501 ADDISON STREET, CHICAGO 18, ILL.



Export Sales Div.:
Scheel International, Inc.
4937 N. Lincoln Ave.
Chicago, Ill., U.S.A.
CABLE ADDRESS:
HARSHEEL

Yours for the
Aspirings

- **FREE!** — 68 page catalog section from Radio's Master.
- Catalogs the products of 30 manufacturers of Recording, Phono Equipment and Accessories.
- Complete descriptions, specifications and illustrations of such products as: Recorders, Phono Motors, Turntables, Record Changers, Cartridges, Pickups, Discs, Tape, Needles, etc.



Actual size 8" x 10 1/4"

Represented in RADIO'S MASTER 68 page Recording & Phono Equipment Booklet are the products of the following manufacturers:

- Alliance Manufacturing Co.
- American Microphone Co.
- *Ampex Electric Corp.
- *Amplifier Corp. of America
- The Astatic Corp.
- Audak Company
- Audio Devices, Inc.
- Bell Sound Systems, Inc.
- Berlant Associates
- Bogen Co., Inc.
- Clarkston Corp.
- Duotone Corp.
- Electro-Voice, Inc.
- Fairchild Recording Equipment Co.
- Garrard Sales Corp.
- General Electric Company
- General Industries Co.
- Jensen Industries, Inc.
- Magnecord, Inc.
- Masco Electronic Sales
- M. A. Miller Mfg. Co.
- Minnesota Mining & Mfg. Co.
- Newcomb Audio Products Co.
- Orradio Industries, Inc.
- *Pantron Corp.
- Permo, Inc.
- Pickering & Co., Inc.
- Presto Recording Corp.
- Recordisc Corp.
- Recoton Corp.
- Reeves Soundcraft Corp.
- Reo-D-Kut Company
- Shurt Bros., Inc.
- V-M Corporation
- Walco Products, Inc.
- Webster-Chicago Corp.
- Webster Electric Co.

*These manufacturers not included in Radio's Master section. Separate catalog sheets will accompany each booklet.

MAIL TODAY

AUDIO ENGINEERING

P. O. BOX 629, MINEOLA, N. Y.

Please send me, without cost or obligation, the 68 page Recording & Phono Equipment and Accessories Booklet reprinted from Radio's Master.

Name

Address

City Zone State

You can obtain without cost or obligation, a complete 68 page catalog section as reprinted from the Industry's Official 1100 page Radio's Master, 16th edition.

This section catalogs in detail the products of the leading Recording and Phono Equipment manufacturers — all in 1 handy booklet. It is complete with descriptions, specifications, and illustrations as written by each manufacturer. Whether you buy, sell, or specify these products, you will find this booklet extremely helpful.

This offer is made possible by a special arrangement between AUDIO ENGINEERING and the publishers of RADIO'S MASTER. Be sure to get your copy now. Fill in the coupon below and mail.

combining tenor, alto and soprano in one vast and beautifully controlled instrument of unheard-of power; the contrasting boy alto solo and the children's choir, contrasting with the adult choir, are other elements in an unforgettable kind of listening. What a language that Russian is, for singing!

Yep, Prokofieff has his cake and eats it; he writes what the commissars ask for and manages to make it good music as well. The recent "Reforestation" oratorio of Shostakovitch (VRS 422), an outwardly similar big piece, is by comparison a servile toadying to the policy makers. Loud parts blast badly. Same story, probably.

REISSUES

Note: The reissue of notable 78 recordings on LP has been greatly stepped up; economics—thank Heaven—now favor this procedure and the sets that once were semi-white elephants (anyway, they cost a lot and weighed more) now reappear trimmed to LP (and 45) convenience. We are now getting into the big-set area, those huge tomes that, most of us thought, were gone for good except as collector's items. Best news of all for a lot of AE readers:

- ob **The Mikado.** D'Oyly Carte Opera Co.
RCA Victor LCT 6009 (2)
- obd **H.M.S. Pinafore: Trial by Jury.** D'Oyly Carte.
RCA Victor LCT 6003 (2)

At long last, the ancient and honourable G & S albums, beloved by generations, are up for re-issue! About time. Most Savoyards agree that these are better performances than the new hi-fi ones of recent date by the same troupe. Technically the operas rank upward from Trial by Jury, which is tubby and somewhat distorted at best, through Pinafore, similar but decidedly better, to the best of the three, Mikado—clear as a bell and surprisingly bright. All are intelligible and enjoyable. Better use 300-cps turn-over; the bass is pretty heavy.

- ** **Counod: Faust (Highlights).** Royal Philharmonic, Beecham; French soloists and chorus.
RCA Victor LCT 1100

Among a whole group of opera reissues this stands out as extraordinary. Throw out all your other Fausts and try the real French style! If you haven't discovered the wonders of the French vocal style, which makes the voice a musical instrument as accurate as an oboe or a violin, the astonishing Geori-Boue, also heard in Urania's new Thais (Massenet), try her and marvel. Faust with this treatment (and old Sir Thomas knows enough to get his singers straight from France) is believable, beautiful; in many U.S. performances it is dismally corny. Too bad the entire recording is not released. It ranks very nearly hi-fi, with fine edge and sibilants.

- xyv **Strauss: Der Rosenkavalier (abridged).** Lotte Lehman, Elizabeth Schumann, etc. Vienna Phil., Heger.
RCA Victor LCT 6005 (2)

A famous early recording by the now-retired first lady of song, along with her famous colleague, Schumann. This one is technically so-so, for two reasons: 1) the highs are dismally lacking—probably had to be filtered in the copying—the sound is muffled; and 2) the old technique of recording voices at stage distance was used; the singers are mere threads of tone at times, lost in the orchestral sound. For those who love Lehmann—and Strauss—the music will get through.

ORCHESTRAL SERIES

- elx **Strauss: Dance of the Seven Veils (Salome): Rosenkavalier Waltzes.**
Decca DL 4032 (10")
- elx **Tchaikowsky: Waltz, Polonaise (Eugene Onegin); Andante Cantabile.**
Decca DL 4033 (10")

All the above with N.Y. Stadium Concerts Symphony, Smallens.

The popular 10-inch LP's are issued too fast for any human reviewer to keep up with! Not in ones but in series. Best thing is to look at a group of a kind—since nowadays a recording session usually gets down a whole slew of works with a given musical combination and engineering set-up.

The Stadium Orchestra is the N.Y. Philharmonic in contractual disguise. This series features

high-quality recording, distant-mike technique, in a big, resonant liveness. A bit too distant, confused. Decca's recorded curve has sharp highs, a high (800?) turnover; adjust accordingly.

ex **Mozart Overtures, vol. 1** (*Così fan tutte, Don Giovanni, Magic Flute, Clemenza di Tito*). **Vol. 2** (*Seraglio, Marriage of Figaro, Idomeneo, Impresario*). Berlin Philh., Fritz Lehmann.

Decca DL 4035, 6 (10")

Lehmann should be a fine Mozart conductor—but space limitations wreck this series; they are all played impeccably, but too fast, and exactly alike, as though they were no more than so many brilliant curtain-raisers. One can carry this mania for overtures too far!

Mozart: Magic Flute, Don Giovanni Overtures. London Symphony, Krips.

London LD 9001 (10")

* **J. Strauss: Vienna Blood; Wine, Women and Song.** London Symphony, Krips.

London LD 9013 (10")

London might seem to give half-value—only two overtures instead of four per ten-inch disc; but this is a much wiser procedure. Here there is room for expansion, proper interpretation, and the engineers, too, aren't confined. Krips gives his overtures their full dignity, but the playing is a bit lack-lustre, lacking the intensity that should be here. But his Strauss Waltzes (see also *Blue Danube* and *Emperor*, DL, 9015) are superb—sweet, ethereal, yet solid too, without the usual exaggerations of tempi, the half-bored hacking-away at the old familiar tunes. London's black-label technical work is as good as any frr. Price is determined by volume sales, evidently.

* **Beethoven: Prometheus, Fidelio Overtures. Egmont, Coriolan Overture. Leonore #3, Consecration of the House Overtures.** London Philharmonic, van Beinum.

London LD 9024, 21, 22 (10")

Six major Beethoven overtures, well spaced out for unhurried playing. Somehow, van Beinum's performance misses much of the power of these giant works. Choppy, quite slow, but beyond that the lyric melodies are unphrased, don't flow, the continuity is not good, the string playing is weak. Fine recording, with some remarkable examples of low-level cutting—a thread of sound, no more—in *Leonore #3*. Surfaces allow it now. Fine technical quality may decide you to get this set.

* 10e **Mozart: Symphony #36 ("Linz"); German Dances, K. 600.** Winterthur Symphony, Coehr.

Mus. Masterworks MMS 1 (10")

* 10e **Mendelssohn: Symphony #4 ("Italian").** Winterthur Symphony, Dahinden.

Mus. Masterworks MMS 3 (10")

* 10e **Haydn: Symphony #96 ("Miracle"), Overture to Isola Disabitata (Uninhabited Isle).** Winterthur Symphony, Coehr.

Mus. Masterworks MMS 6 (10")

This is Concert Hall's new low priced line, on thin injection-moulded discs, and it's a musical bargain. The Winterthur Symphony plays with a peculiarly nice off-hand, intimate, chamber music style, very musical, soft-textured. Three splendid symphonies done in this manner, plus two Mozart dances and an unheard-of Haydn overture.

* **Mozart: Symphonies #1, #2, #5, #6. Symphonies #4, #10, #11, #14.** Winterthur Symphony, Ackermann.

Concert Hall CHS 1165, 66

* **Mozart: Piano Concert #1, #2, #3 (After J. C. Bach).** Winterthur Symphony, Ackerman.

Concert Hall CHS 1164

If you ever wondered about the early Mozart works in these categories—here's your music, in another fine series played as in the Masterworks records, above. These are youthful Mozart, the composer first finding his stride in the orchestral medium. He was nine years old for the earliest, eleven for the latest! But don't expect amateurishness—these are short, simple but astonishingly competent and expert pieces, easily equal to the mature works of his leading contemporaries in the same vein. Listen and try to believe your ears! A set for all Mozart collectors.



Just for records

For those interested solely in the finest possible reproduction of music from recordings this Altec system is beyond compare. The beautiful chairside control unit has a record crossover switch, fully variable bass and treble rise and droop controls and a switch for the selection of radio, tape or other sound sources. The 20 watt amplifier has less than 2% harmonic distortion and is completely controlled from the chairside unit. The famous Altec "duplex" completes the system. These "duplex" speakers are the finest in the world and are guaranteed to reproduce all of the tones from 30 to 22,000 cycles when mounted in the handsome Altec 606 cabinet. If you want the finest record reproduction you want this wonderful Altec system designed just for records.



1. "Duplex" loudspeaker
2. 606 corner cabinet
3. A-433A control unit
4. A-333A amplifier

See and HEAR the complete Altec "home music system" at your nearest high fidelity studio.

9356 SANTA MONICA BOULEVARD, BEVERLY HILLS, CALIF. • 161 SIXTH AVENUE, NEW YORK 13, NEW YORK

NEW PRODUCTS

• **Reverberation Unit.** Both the inconvenience and expense of echo chambers are eliminated through use of the new Model 40 Reverberation Unit, recently announced by Audio Instrument Company, Inc., 133 W. 14th St., New York 11, N. Y. An improved version of the Goodfriend-Audio Facilities Co. artificial reverberation generator which was first introduced three years ago, the unit is a multiple-head magnetic-tape-loop device which is compact, convenient, and flexible in adjustment. In operation, the input signal is recorded, then reproduced by several magnetic heads

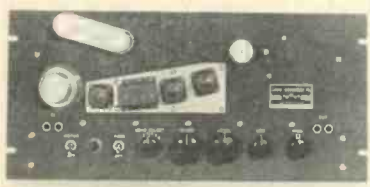

at different times. The reproduced signals are returned to the recording head, and passed around the recirculation loop again with diminished amplitude. In this manner, the signal is caused to decay in the same fashion as sound diminishes during multiple reflections from the walls of a room. A switch control permits changing the number and position of reproducing heads. Reverberation time is adjustable up to 10 seconds. Ratio of reverberant to direct sound may also be widely altered. The unit contains a zero-loss straight-through channel, as well as the tape-loop reverberation channel, so that no audio system circuit changes are necessary. Supplied for rack mounting on an 8 1/4 x 19 panel.

• **High-Output Magnetic Tape.** Many improved qualities are inherent in the new No. 120 "Scotch" recording tape recently announced by Minnesota Mining and Manufacturing Co., 900 Fauquier St., St. Paul, Minn. Offering more than twice the output of previous Scotch tape, the new tape is designed especially for use in radio, TV,



and recording studios, in computer work, and in other critical applications. It produces at least 8 db more output at a given distortion level over the full audio range than tapes previously marketed, thus permitting an 8-db greater signal-to-noise ratio on conventional professional tape recorders. Of particular value in the sound recording field, the new No. 120 tape will permit improved quality in recordings, with greater dynamic range. Aside from the fact that it is dark green in color, and employs a coating material with increased magnetic remanence, it is identical physically with conventional tape. It may be used interchangeably with conventional tape without bias adjustment.

• **High-Quality FM-AM Tuner.** Remarkable sensitivity permits excellent FM reception in areas where it has heretofore been impossible with the new Bogen Model E701 14-tube tuner. Designed for high-quality custom installations, the tuner requires only a 3-mv input for 30 db quieting. Push-button control permits switch-in or switch-out of a.f.c. action. Protection against drift is afforded by temperature-compensated oscillator. For AM op-

eration, the E701 features a variable bandwidth i.f. channel which permits selection of maximum wide-range response or maxi-

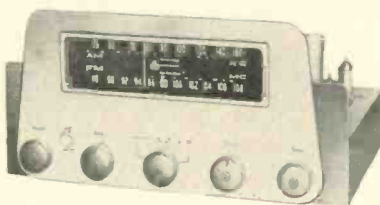

mum selectivity. A 10-kc whistle filter eliminates inter-station interference. The tuner is equipped with continuously variable bass and treble controls and a 6-position function-selector switch. Among other notable features are: a built-in preamplifier with compensation for GE, Pickering, and Audak pickups; cathode-follower output circuit, and automatic reduction of voltage on all but audio tubes when tuner is used with phono input. Audio output is 3 volts at 6000 ohms, with only 0.2 per cent distortion. Frequency response is within ± 0.5 db from 20 to 20,000 cps on FM, from 20 to 4000 cps on normal AM, and from 20 to 7500 cps on broad-band AM. Further information may be obtained from David Bogen Company, 29 Ninth Ave., New York 14, N. Y.

• **Compact High-Fidelity Amplifier.** An improved version of the Grommes Model LJ "Little Jewel" amplifier, designated Model LJ2, features frequency response within ± 1 db from 20 to 20,000 cps at 3 watts output. At rated power output of 8 watts, harmonic distortion is 1 1/2 per cent and intermodulation is 4 per cent. Inputs



are supplied for magnetic pickup, microphone, crystal pickup, and tuner. Treble control affords 18 db cut at 10,000 cps. Bass control permits 15 db boost at 50 cps. Hum level is 30 db below 8 watts. Output impedances are 4, 8, and 16 ohms. Complete information will be supplied by Precision Electronics, 9101 King Ave., Franklin Park, Ill.

• **Small Wire-Wound Potentiometer.** Designed for precise circuit trimming in miniaturized equipment, the new Bourns Model 120 Trimpot is so tiny that 40 of the units occupy less space than a standard package of cigarettes. Adjustments are made by turning an exposed slotted shaft with a screwdriver. Resolution as

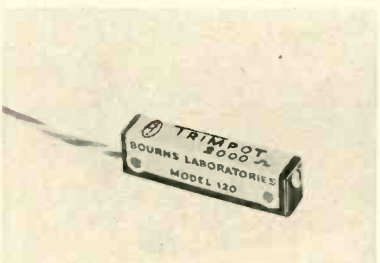

low as 0.25 per cent is obtained over the 25-turn adjustment range. Electrical settings are securely maintained during se-

vere shock, vibration, and acceleration. Available in standard resistances of 250 to 10,000 ohms with power rating of 0.25 watt. Trimpots are manufactured by Bourns Laboratories, 6135 Magnolia Ave., Riverside, Calif.

• **Preamp and Matching Tape-Transport Mechanism.** Designed for installation in custom cabinets, the new Pentron Model PRE-7 preamplifier and Model 9T-3M tape transport mechanism make up a complete tape recorder and playback assembly for use with any existing audio system. Preamp control panel is equipped with



motor switch, pilot light, magic-eye recording level indicator, tape-radio switch, volume-tone control, play-record switch, and jacks for phonograph, tuner, microphone, output, and monitoring. The transport unit permits choice of 3.75-in. or 7.5-in. recording speed. Separate record and erase heads have removable pole pieces which can be replaced as simply as a phonograph needle. Fast forward and rewind will transfer a 1200-ft. spool in 40 seconds. Both units are available together as Model PMC in a single luggage-type carrying case for portable use. Complete technical specifications will be mailed on request to The Pentron Corporation, Dept. AE-3, 221 E. Cullerton St., Chicago 6, Ill.

• **Low-Cost VIVOM Kit.** Frequency response as high as 2.5 mc, adequate for servicing TV circuits as well as audio equipment, is one of the features of the new Knight vacuum-tube volt-ohm-milliammeter kit recently announced by Allied Radio Corp., 833 W. Jackson Blvd., Chicago 7, Ill. Among its 29 ranges are six

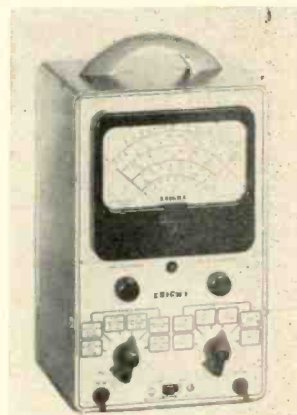

ranges for measuring a.c. peak-to-peak volts, six milliammeter ranges, and five capacitance ranges. Maximum d.c. range is 1000 volts, and maximum a.c. range is 2800 volts. Resistance and capacitance ranges

are 1000 megohms and 5000 microfarads, respectively. Special probes are available for extending the d.c. range to 30,000 volts and the a.c. frequency range to read r.f. to 200 mc. All voltage functions are electronically protected against burnout.

• **Intercom System.** A baseboard-mounted power supply, self-compensating to deliver required power to all or a selected group of stations, is featured with the new 20-watt Redi-Power Talk-O-Phone, recently introduced by Talk-O-Phone Co., 1512 S. Pulaski Road, Chicago 23, Ill. Although retaining the compact size of



earlier models, the new Talk-O-Phone offers a number of additional engineering features. Uni-Trans dictation control eliminates the need for operating any controls while dictating. Twelve, twenty, thirty, or forty station capacity can be housed in the same cabinet, and the system can be expanded or altered at any time without discarding the original equipment.

• **FM-AM Tuner.** Newest in the line of high-fidelity components manufactured by The Pilot Radio Corporation, Long Island City, N. Y., is the Model AP-123 Pilotuner, an 8-tube self-powered unit which incorporates a temperature-compensated oscillator for drift-free FM reception, also a.f.c. which may be switched in or out at will.



Inputs are provided for TV and phono. Tone control on the AP-723 may be switched out when the tuner is used with an audio amplifier which incorporates such controls. Cathode-follower output permits up to 100 feet of interconnecting cable to amplifier without detracting from audio fidelity. The tuner is supplied with a handsome bronze-finish escutcheon plate for custom cabinet installation. Over-all dimensions are 14 x 7 1/4 x 8 1/2 in.

ERRATA

Olan E. Kruse, author of "Circle Diagrams for Resistance-Capacitance-Coupled Amplifiers" in the February issue, advises us of erroneous figures on his Fig. 3. The values for T along the top should have been: 1.59, 3.18, 4.77, 6.36, 7.95, 9.54, 11.1, 12.7, 14.3, and 15.9. The values for F along the left side of the diagram should have been: 100, 50.0, 33.3, 25.0, 20.0, 16.7, 14.3, 12.5, 11.1, and 10.0.

Lewis S. Goodfriend, author of "The Wide Range R-C Oscillator," also in the February issue, advises us that the top cathode resistor in Fig. 2 should have been 68 ohms, and that the lead between the junction of this resistor and the 2500-ohm pot and the junction of R₁ and the 0.5-μf capacitor should be a 1.0-meg resistor rather than a solid wire. In Fig. 3, page 68, the top cathode resistor should have been 160 ohms, and the 1.0-meg resistor should have been shown as described above in Fig. 2.

DESIGNED FOR HI-FI PERFECTION!

TANNOY 12" DUAL CONCENTRIC SPEAKER

130.00 net

Internationally acclaimed for amazing response range, balance and definition, the Tannoy gives you uniform response from 35 to 25,000 cycles. Power capacity, 15 watts; Bass resonance, 35 cps; crossover frequency 1,700 cps.



15" speaker, 25 watt peak 159.00



GARRARD RC-80 RECORD CHANGER

41.45 net
Less cartridge

The Garrard plays all three sizes (7", 10", 12") and all three speeds (33-1/3, 45, 78 RPM)! Completely automatic, with switch off at end of last record. Tone arm returns to rest position. Adaptable to either 110 or 220 V. Complete with 45 RPM spindle and two empty shells.

BOGEN R701 FM-AM TUNER

145.20 net

Full frequency range of 88-108 MC on FM, 530-1650 KC on AM; frequency response of 20-20,000 cps. ± 5 db on FM; built in pre-amplifier, AFC, AFC defeat switch, low distortion; hum level - 65 db below. 14 tubes including power supply. Size 15" x 8 1/2" x 9". Weight, 17 lbs.



CONCERTONE 1501D TAPE RECORDER

345.00 net

New and improved! Separate heads for high frequency erase, record and play back, with simultaneous monitoring from tape while recording. Instantaneous choice of 7 1/2" or 15" per second tape speed. Three synchronous, dynamically balanced motors for dependable performance. Frequency response ± 2 db, 50 to 15,000 cycles at 15" per second. Available in single or dual track. Carrying case and monitoring amplifier with 8-in. speaker 82.50



BOGEN H010-RXPX REMOTE CONTROL AMPLIFIER

147.15

The famous Bogen Baton combines an all-triode power amplifier and remote control. Power output 10 watts, peaks to 25; frequency response: ± 1 1/2 db, 10-20,000 cps; Hum: 70 db below; speaker output: 12 ohms; 8 tubes; Inputs: GE, Pickering; tuner; Controls: bass, treble, power on-off, selector; size: 15" x 10" x 8"; weight: 32 lbs.

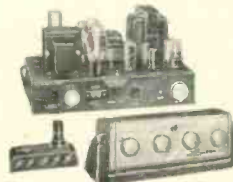

Amplifier only 93.79
Remote control and pre-amplifier 53.36



FAIRCHILD 215 SERIES CARTRIDGE

47.50

Here's unbelievable freedom from needle talk! Equipped with a diamond stylus . . . the cartridge is of the moving coil design. 1.0 mil tip
215C—3.0 mil tip 42.50
215B—2.5 mil tip 42.50
For vertical records 50.00

Mail & Phone Orders Filled . . . 25% Deposit, Balance COD
Send for FREE Catalogue, Music of the Masters



LEONARD-RADIO-INC.

69 CORTLANDT ST., NEW YORK 7, N. Y.

Audio Mart
CORTLANDT 7-0315-9

Dept. A 43

The House Built on Service

GE Plug-in Broadcast PRE-AMPLIFIER

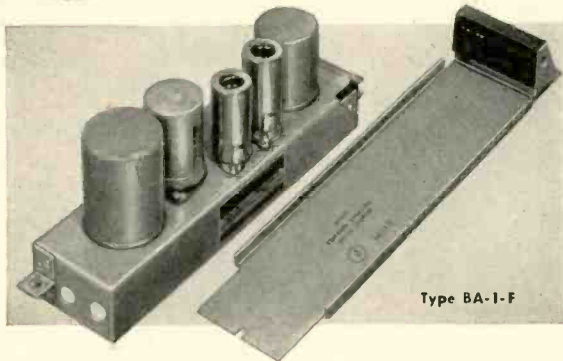

Type BA-1-F

- **PLUG-IN DESIGN**—simplifies maintenance.
- **TWO STAGE**—Ideal for microphone or transcription pre-amplifier.
- **EXCELLENT FREQUENCY RESPONSE**—Features low distortion and noise level.
- **COMPACT...YET HIGHLY ACCESSIBLE.**

The G-E Plug-in Broadcast Audio line includes:

BA-1-F BA-12-C BP-10-B
PRE-AMP PGM/MON AMP POWER SUPPLY

For information write: General Electric Co.,
Section 4433, Electronics Park, Syracuse, N. Y.

GENERAL  ELECTRIC

The High Fidelity Record Changer for High Fidelity Record Reproduction

Collaro

7, 10, AND 12
INCH RECORDS

Fully Automatic

3-SPEED RECORD CHANGERS

MODEL 3/522*
Intermixes 10 and 12-inch records
LIST PRICE \$65.00
(less base)

MODEL 3/521*
Non-Intermix Model
LIST PRICE \$54.50
(less base)

*Available in
cream, brown or
gray finish.

RECORD CHANGER BASE
Wood, Mahogany Finish, heavy
construction. LIST PRICE \$9.50

On Sale at Leading Dealers. Write for Complete Literature.

ROCKBAR CORPORATION • 211 East 37th Street, New York 16, N. Y.



PATENTS

[from page 6]

often synonymous!) into action. With high-quality audio going strong after the buildup in interest it has undergone since the war, many of us seem to be finding that the quality in the best audio amplifiers today leaves little to be desired and ourselves with little to do by way of improving it—except to try doing the same thing more cheaply. As audio has developed, we have built amplifiers with wider and wider frequency bands—up to 100 kc and more. In most cases the only value of such wideband response is in achieving better operation of the high-level feedback circuits and there is more than a suspicion that we have gone to such high-frequency response sometimes just through a desire to do "something more" even though the practical value is small.

Well, why not go the whole hog and start getting interested in video amplification? A video amplifier is essentially a resistance-coupled amplifier with extremely wide band—to at least 4 mc, generally, and sometimes a great deal more. As the word video indicates, the principal use for such amplifiers today is in amplifying television picture signals; but that is by no means the only use. Meantime, any good book on television will give the basic approach to wideband amplification, from which some audio might well jump off to new approaches and better results than present circuits.

The apparatus required is simple enough—the same old tubes, resistors, capacitors, and the like. A couple of new components come into play—coils with small inductances, up to a maximum of around 1 millihenry. They are easily wound or bought. Wideband oscilloscopes are available today, though they are a little expensive usually. But a long series of investigations, experimentation, and self-indoctrination can be had by playing with the family TV receiver. Better yet, get an old, second-hand receiver, derive signal from some convenient point in the good set (that won't harm it any way) and transmit video from the good set to the second-hand one via video amplifiers, attenuators, phase inverters, frequency-correction networks, and all the rest of the possible gimmicks. Video work is just an extension of audio and it has the perfect field of play for the audio man with widebanditis.

In future we are going to look for a few good video-amplifier patents. We'll write them up for *Æ*, see if Editor McProud will print them, then wait for the brickbats and bouquets in the mail!

(You're on your own, Mr. D. We'll run 'em, but on your responsibility. Ed.)

AUDIO 1693

[from page 25]

haft (m) of a small Hammer bone so that its head comes close to the Anvil which is part of the ring structure (ab).

4. To cause the diaphragm to have greater excursion, fasten a vessel (p) to the ring, and a funnel (y) to the vessel. The incoming sound will be carried to the diaphragm.

If one places the Anvil-forming appendage between the teeth he will pos-

sibly be able to perceive sound. At the very least, by looking sharply, he will be able to see the movement of the diaphragm and the action of the hammer on the anvil.

Reverberation and Damping

The principle of the anechoic chamber appears in this analysis.

There are various ways by which a body can be made to lose its sound: 1) when thrust under water, 2) when surrounded by soft and absorbent material . . . Cloth wrapped around clavichord strings, for example, will kill the sound.

High humidity and rain deaden sound; also heavy tapestries on the wall. Inside buildings, too, it is difficult to understand a lecturer or hear music well when the auditorium is full of people. Sound waves are absorbed and attenuated by the presence of people and their clothing.

It is possible to drape an auditorium with wool or straw to such a degree that the human voice can scarcely be heard. This is essentially the reason why the sound of bells is muffled during a heavy snow-storm. It is not so much that the sound of the bells is reduced by virtue of their being covered with snow as it is the fact that the roofs and streets are carpeted with snow. Normally, the sound would be reflected from the otherwise bare surfaces.



Fig. 4. Artificial hearing mechanism. The combination of horn and diaphragm is prophetic of 19th century phonograph design.

Military Applications of Sound

During wars, advance patrols report that they can hear the sound of cavalry over 1,000 paces away, if they dig a little pit and put their ears close to the earth.

The fabulous horn of Alexander the Great, made by Aristotle, was able to project a blast of sound 60,000 paces (about 35 miles). It was used to summon the Army and took 60 men to blow it. Another description of the horn says it was 5 cubits (6.8 ft.) across and could be heard 12½ miles away. (See Fig. 5)

Legal and Humane Considerations

When transferring a swarm of bees through a populated area one must give ample warning by banging on a brass kettle.

Nowadays, unless one gives ample warning when throwing something from an upper window out into the street, he may be sued for damages.

From which we may conclude that courtesy and grace were not unknown in 1693.

Legend and Hearsay

Ringelmann's thesis reflects a culture in which the scientific attitude was just emerging. It contains much perceptive analysis and insight, but the author also retains some of the disdain of Scholasticism for experimental verification, and he is often content to cite unchecked legend or hearsay, even when he could



Fig. 5. A military horn supposed to have been used by the Roman army to summon troops.

have easily determined for himself the accuracy of a claim. For example, under

"Strange Facts About the Behavior of Sound"

If one takes a large jug which has been rinsed out with wine and drops a piece of lighted paper into it a fantastic and awful sound is said to result.

The phenomenon referred to is that of a Helmholtz resonator responding to stimulation by a wide frequency spectrum of noise, and emphasizing those sounds which lie in the frequency range of enclosure resonance. Had Ringelmann been more of a scientist and less of a Scholastic he would have done that which seems, to the modern mind, clearly called for—he would have performed the experiment.

From Station Break to Feature . . . the NEW "BALANCED" TV Tripod is doing a whale of a job every day!

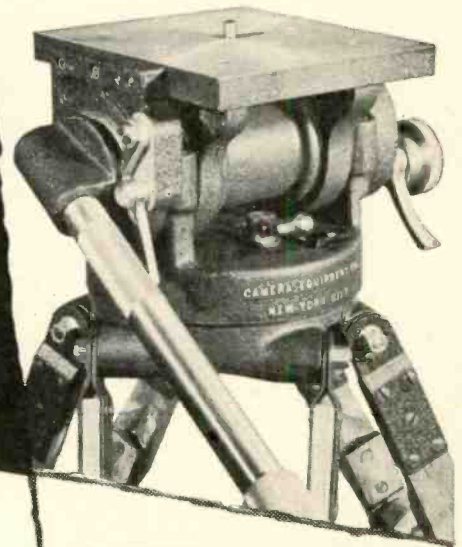

"BALANCED" TV TRIPOD mounted on 3-wheel portable collapsible dolly illustrated.



We THREW THE book away and engineered a brand new "BALANCED" Tripod for every photographic and video need. The result—a revelation in effortless operation, super-smooth tilt and 360° pan action.

PERFECT BALANCE prevents mishap if the lock lever is not applied. Quick release pan handle locks into desired position. Mechanism is enclosed, rustproof, needs no lubrication. Tension adjustment for Camera Man's preference. Built-in spirit level. Telescoping extension pan handle. We defy you to get anything but the smoothest, most efficient operation out of this tripod beauty.

WE CALIBRATE LENSES . . . Precision "T" STOP CALIBRATION of all type lenses, any focal length. Our method is approved by Motion Picture Industry and Standard Committee of SMPTE. Lenses coated for photography. Special TV coating.

WE DESIGN and manufacture Lens Mounts and camera equipment for 16mm — 35mm and TV cameras.

WE RENT AND SERVICE

CAMERAS * MOVIOLAS *

DOLLIES . . . Complete line

of 35mm and 16mm equipment available for rental.

MITCHELL: Standard, Hi-Speed, BNC, NC, 16mm. Bell & HOWELL: Standard, Shiftover, Eyemos. MAURER: 16mm Cameras. ARRIFLEX. MOVIOLA: Editing machines, Synchronizers.

FRANK C. ZUCKER
CAMERA EQUIPMENT CO.
1600 BROADWAY NEW YORK CITY

IF YOU WORK WITH FILM . . .

It will pay you to get to know us. The country's foremost professionals depend upon our portable, versatile, adaptable equipment.

WHY PAY RENT on your echo chamber?

Goodfriend—Audio Facilities

Reverberation Unit

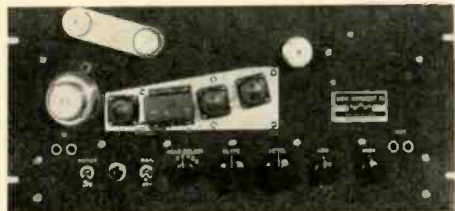

now made exclusively in improved form by Audio Instrument Co., Inc.

Simulates reverberation of a room of any size, using a magnetic tape loop system with FIVE HEADS (Model 40) or SEVEN HEADS (Model 42). Switching heads produces various special effects, as well as natural reverberation.

AN ECHO CHAMBER ON AN 8-3/4" x 19" PANEL

Compact: Single 8-3/4" x 19" panel.

Variable equalization: Built-in, for special effects.

Reverberation time: Continuously adjustable.

No pressure pads: Better tape motion, reduced head wear.

Delivery time: Six weeks.

Model 40: **\$985.00**

Pays for itself in 3 to 5 months.



Authoritative and Enlightening . . .



Acknowledged the Leading Publication in the Field of Sound Reproduction

If you are novice, hobbyist, experimenter, or engineer . . . if you are a lover of music . . . and in pursuit of sound, undistorted . . . Audio Engineering will be your faithful, reliable companion all the way. You will find no more pleasureable and stimulating reading than there is in AE; absorbingly interesting material, valuable and authentic data, workable detailed instructions . . . all comprehensively and yet practically presented.

"What to Do" and "How to Do" will guide your every move through this thrilling experience we call Audio.

Each new issue brings New Ideas, New Slants, and Latest Developments . . . month in and month out . . . twelve times a year.

BE SURE to get your copies **REGULARLY**.

**MAIL this
Coupon
NOW**

AUDIO ENGINEERING
P. O. Box 629, Mineola, N. Y.

Enclosed is Check Money Order for \$ _____
Please send a copy of each new issue of Audio Engineering for the next
 12 months; 24 months to:

Please Print

Name _____

Address _____

City _____ Zone _____ State _____

Subscription Price: U.S.A., Canada and Pan American Union: 1 year . . \$3.00 2 years . \$5.00. Other countries: 1 year . \$4.00 2 years . \$7.00.

FIRST INVENTOR

[from page 40]

ventor to discoveries disclosed in his application to which he had not made claim and that such discoveries were as a consequence, available to others.

"The question is, therefore, squarely presented," said that court, "whether on the issue of prior invention it is the claims or the disclosure which counts. On principle it would seem that the claims were the place to look for the invention. The disclosure, so far as it is only a description of the machine, process or composition, is certainly not the invention proper. It does not tell which of the various elements disclosed the patentee selects as the combination which it will be profitable to follow.

"Without some such selection the art is left without cue for omission and must reproduce the whole disclosure in all its details. The claims alone give any scope to the invention and some scope in essential to its value. It would seem that the 'invention' must lie in the act of selecting out of the possible combinations which will read upon the disclosure such as are new and useful.

"Therefore, at least presumptively, the 'invention' must be found in the claims and in the claims alone. If so, when the issue arises of prior invention between two persons, whether it be on interference or when raised by an infringer, it should be decided only by a comparison of the claims, i.e., of that part of the patent or application which sets out what combinations of the elements disclosed the applicant says are his new and useful contributions to the art."

The discoverers of this process for acetylene welding appealed and the decision of the Federal District Court was affirmed by the Federal Circuit Court of Appeals, which stated,

"Thus the question is narrowed to this, does the 'first inventor' of the fourth defense signify one who describes patentable matter or one who both describes and claims it. The question may be put thus, is mere disclosure (confidentially made to the Commissioner of Patents) and no more, in itself, sufficient evidence of invention? We think that it is not, for the reason that in the absence of an appropriate claim there is no evidence of the perfection of the mental concept which constitutes this intellectually a part of the invention.

"We hold that a 'first inventor' within the meaning of that phrase as used in the fourth defense, must be a person who perfects his invention. No invention can be intellectually perfected unless it is thought out and concluded and the only evidence of such perfected invention ordinarily derivable from any patent is a union of disclosure and claim."

When the appeal from this decision came before the United States Supreme Court a year and a half later the court

reversed the decision of the two lower courts on the opinion of Justice Holmes who established at that time the definition of 'first inventor' that is now made a provision of the patent statute itself.

"It is not disputed that the application gave a complete and adequate description of the thing patented but did not claim it. The patent law authorizes a person who has invented an improvement like the present, 'not known or used by others in this country before invention' to obtain a patent for it. . . . The fundamental rule, we repeat, is that the patentee must be the first inventor."

REFERENCES

Detrola Radio & Television Corp. v. Hazeltine Corp., 117 Fed. 2d 238; 313 U.S. 259
 Hazeltine Corp. v. Abrams, 7 F. S. 908; 79 Fed. 2d 329
 Davis-Bournonville Co. v. Alexander Milburn Co., 297 Fed. 846; 1 Fed. 2d 227; 270 U.S. 390

COLUMBIA "360"

[from page 29]

tances and locations. The resultant curves were integrated and then averaged to yield the one illustrated. Very close correlation can be found between the sound characteristic thus derived and the actual performance of the player in the home.

The amplifier has been designed to give adequate performance for a maximum power output of about two watts, as shown in the distortion curves, Figs. 6 and 7. The amplifier frequency response has been shaped so that when combined with the other components of the system, the over-all sound pressure diagram is the desired one. Figure 8 shows the frequency response of the pickup by itself.

During the development of the Columbia "360" in the CBS Laboratories Division we had to rely on the support and inspiration of many. In particular, the writer is indebted to Thomas Broderick, Richard Mahler and René Sneyvangers for their wholehearted cooperation and many useful suggestions.

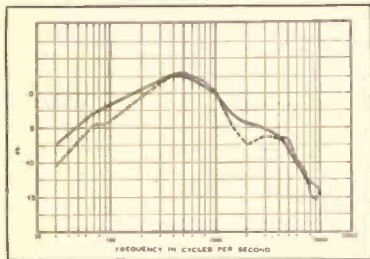

Fig. 8. Typical response plotted against the electrical curve of Columbia 103 test record.

REEVES APPOINTS NEELY

Products of Reeves Soundcraft Corporation, New York, will be distributed to the electronics industry in the Southwest by Neely Enterprises, Inc., Los Angeles, effective at once, according to Frank B. Rogers, Jr., Reeves vice-president.

Dimensional Sound

RESEARCH

DEVELOPMENT

SERVICE

on

Diamond* Sapphenoid\$ Sapphire\$

for

Acetate Disc - Sapphire Cutters
 Magnetic Film - Diamond Scribes
 Magnetic Tape - Sapphenoid Guides

To Your Specifications

Diacoustic Laboratory

Since 1928

P. O. Box "P" Phone STate 4-0881

Encino, California

\$Synthetic

*Genuine

NEW WILLIAMSON TYPE

**Heathkit
 AMPLIFIER KIT**

FEATURES

- Practically distortionless. Harmonic and intermodulation distortion both less than one half of 1% at 5 watts.
- Frequency response ±1 db. from 10 cycles to 100 kilocycles.
- Atlas Lansing PEERLESS or ACROSOUND transformers available.
- First Williamson type Amplifier supplied with matching preamplifier.

When selecting an amplifier for the heart of a fine high-fidelity audio system, investigate the outstanding advantages offered by the Heathkit Williamson type Amplifier. Here is an amplifier that meets every high-fidelity audio requirement and makes listening to recorded music a thrilling new experience through naturally clear, lifelike reproduction of sound at all tonal levels. Wide acceptance of the Heathkit Williamson type Amplifier by the most critical purchasers clearly demonstrates that high-fidelity can be coupled with low cost. For factual information regarding the Heathkit Williamson type Amplifier, consult "CONSUMERS RESEARCH ANNUAL CUMULATIVE BULLETIN 1952-53."

This outstanding amplifier is offered with the optional choice of the ACROSOUND output transformer or the PEERLESS output transformer. ACROSOUND features ULTRA-LINEAR circuitry, which is the exclusive development of the Acro Products Company and provides a greater margin of reserve power efficiency and increases power output. PEERLESS features additional primary taps to permit the optional choice of either the extended power circuitry, now enjoying current popularity, or all of the advantages of the original Williamson type circuit.

The construction manual has been simplified to the point where even the complete novice can successfully construct the amplifier without difficulty. Write for a free catalogue containing complete specifications and schematics of the Heathkit Williamson type Amplifier.

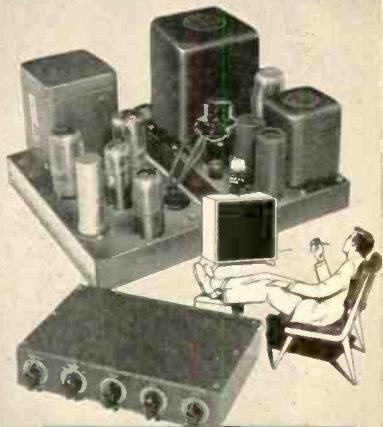

PRICES OF VARIOUS COMBINATIONS

- W-2 Amplifier kit (incl. Main Amplifier with Peerless Output Transformer, Power Supply and WA-P1 Preamplifier Kit) Shipping Weight 39 lbs. Shipped express only. **\$69.50**
- W-2M Amplifier Kit (incl. Main Amplifier with Peerless Output Transformer and Power Supply) Shipping Weight 29 lbs. Shipped express only. **\$49.75**
- W-2 Amplifier Kit (incl. Main Amplifier with Acrosound Output Transformer, Power Supply and WA-P1 Preamplifier Kit) Shipping Weight 39 lbs. Shipped express only. **\$69.50**
- W-2M Amplifier Kit (incl. Main Amplifier with Acrosound Output Transformer and Power Supply) Shipping Weight 29 lbs. Shipped express only. **\$49.75**
- WA-P1 Preamplifier Kit only, Shipping Weight 7 lbs. Shipped express or parcel post. **\$19.75**

**HEATH COMPANY
 BENTON HARBOR 25, MICH.**

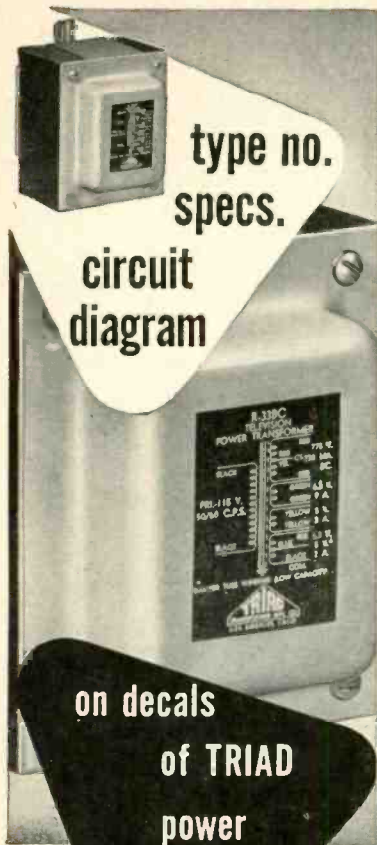

type no.
specs.
circuit
diagram

on decals
of TRIAD
power
transformers

Triad Power Transformers—like other Triad transformers—have the essential information right where you want it—on the decal. It simplifies installation—speeds servicing—makes reordering easy. Whether used for replacement, industrial applications, PA amplifiers or amateur gear, they offer small size, maximum efficiency, low temperature rise and low cost. Also, they are "Climatite" treated, both coil and core, for protection against moisture and for elimination of lamination chatter. Laminations are painted to prevent rust. Copper straps are used for static shields, grounded to case and core. Leads are color coded, UL approved. Final tests include checking for proper operation. Cases are finished in durable, attractive grey baked enamel.

Write for Catalog TR-52F



MAGNETIC PICKUPS [from page 20]

from 10 to 50 μmf in the input wiring, plug and socket, and switch (if used) in the preamplifier.

From all this, it is apparent that a total shunt capacitance of at least 100 μmf is assured for any installation. A long run of shielded wire between the turntable and preamplifier with the use of high- μ triode tubes can easily bring the total capacitance to 1000 μmf or more. Nearly all practical installations will fall within these limits. Since most values of R_L will fall between 1000 and 200,000 ohms, a working range of $R_L C$ will lie between 1×10^{-7} and 2×10^{-4} .

cutoff frequencies are shown in Fig. 5, for each of the four pickups calculated. For any cartridge at any desired cutoff frequency the values of R_L and C may be read directly from the left-hand scales.

Figures 6 to 9 inclusive show the effect of capacitance only on each of the four pickups. A wide range of values was used, to cover the range from 5000 to 20,000 cps in each case. From all of these curves it will easily be seen that significant changes in high-frequency response can occur as a result of the capacitance across the pickup terminals.

TABLE II

Miller-Effect Capacitance of Input Tubes

Tube Type	C_{G0}	C_{Gp}	Amplification	Total Capacitance— μmf
6SN7 (6J5)	3.0	4.0	15	63
6SL7	3.4	2.8	52	159
6S17	7.0	.005	100	7.5
6AU6	5.5	.0035	100	6.5
6C4	1.8	1.6	15	25
6SC7	2.2	2.0	40	83

Calculation of Frequency Response

Equation (1) was reduced to a series of graphs, which were then used to calculate the electrical response of the four pickups under various load conditions. The response calculations were divided into the following classifications:

- (1) $R_L = \infty$, C varied.
- (2) C fixed, R_L varied.
- (3) R_L and C chosen to provide the sharpest cutoff at certain frequencies.

It will be observed that L and C form a low-pass constant- K filter section, and that it is possible to choose values of C and R_L to satisfy the relationships:

$$L = \frac{R_L}{\pi f_c} \text{ and } C = \frac{1}{\pi f_c R_L} \quad (3)$$

The values of R_L and C for various

TABLE III

Capacitance of Various Shielded Wires

Wire Type	Capacitance— μmf per foot
Shielded hook-up wire	55 - 70
.140 O. D. Microphone cable	40
.200 O. D. Microphone cable	25
Heavy duty Microphone cable	33

The amount of rise at the peak depends, of course, on the Q of the circuit. The various pickups differ somewhat in that respect. Furthermore, the location of the peak depends on the inductance of the pickup coil, for a given capacitance. In general, therefore, the higher impedance (hence higher inductance) pickups are more sensitive to

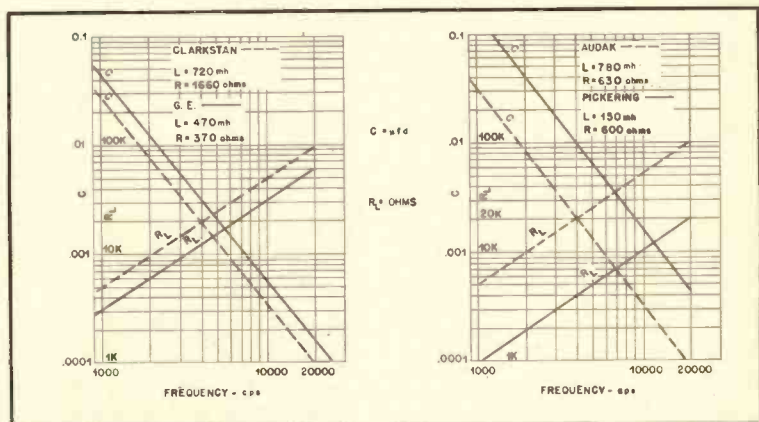

Fig. 5. Values of R_L and C for various cutoff frequencies for the four pickups.

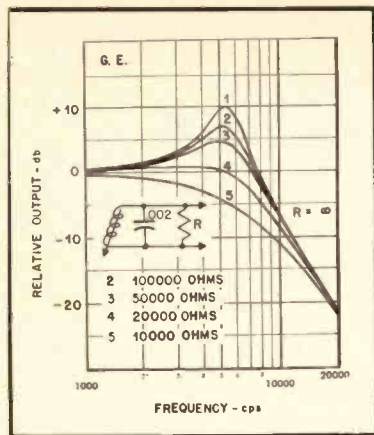

Fig. 12. Response of GE RPX-050 pickup with shunt capacitance of .002 μ f and various load resistances.

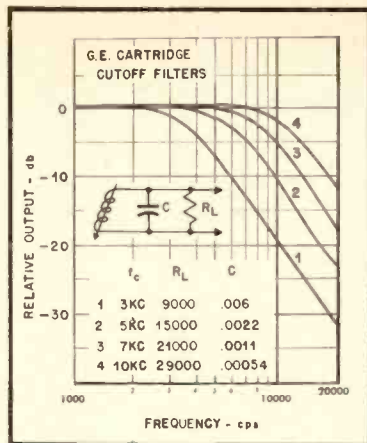

Fig. 15. Curves showing low-pass filter effect on response of GE RPX-050 pickup when shunted with capacitances and resistances indicated.

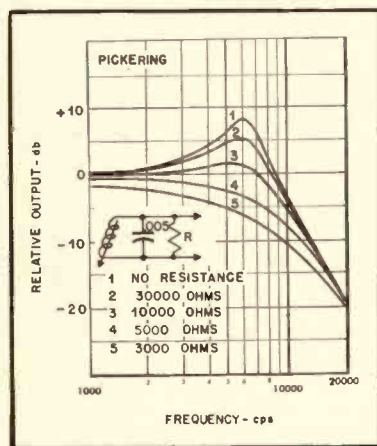

Fig. 13. Response of Pickering D120M pickup with shunt capacitance of .005 μ f and various load resistances.

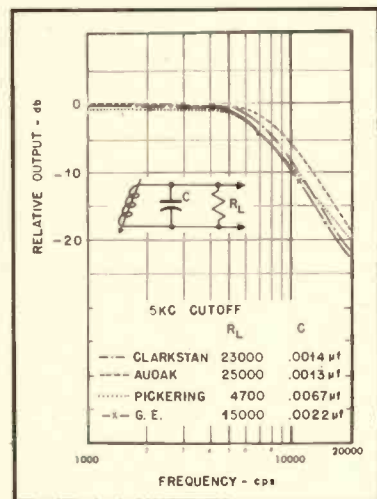

Fig. 14. Curves showing 5000-cps cutoff for the four pickups when shunted by resistors and capacitors shown in the legend.

on the frequency response of the device. This effect can be accurately calculated for a given pickup of known coil resistance and inductance. A resistive termination causes a general drop in output at all frequencies, the loss increasing at high frequencies. A capacitive termination causes a peak at a frequency determined by the LC product, of a magnitude depending on the Q of the circuit. A combination of resistance and capacitance will modify the peak, and at one specific set of values for each case will constitute a constant- K low-pass filter. When the resistive shunt has a low value compared to the capacitive reactance, the effect approaches that obtained with resistance termination alone.

The foregoing information can be used to guard against unwanted modifications of the pickup frequency response, to determine the highest usable frequency obtainable under a given set of conditions, to compensate for frequency effects in other parts of the system, and to reduce noise from records by using the low-pass filter effect.

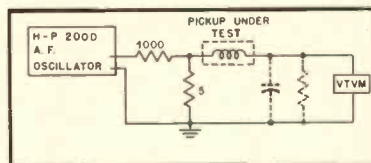

Fig. 16. Connection of equipment to obtain response curves shown. Values observed check with those obtained from frequency records.

REK-O-KUT FIRE

Serious damage by fire was suffered by the Rek-O-Kut Company, manufacturer of precision turntables, Long Island City, N. Y. on the night of January 31. Although production was entirely disrupted for a short time, the plant was back in operation within a matter of days, and is now functioning on a virtually normal schedule.

For as little as \$20
and no more than \$120,
your Hi-Fi system
can include the

Stromberg-Carlson

**EXPONENTIAL
Acoustical Labyrinth**

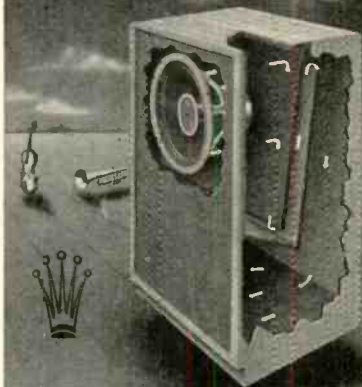

Smoother mid-frequency response. No more "booms" and "thumps" of ordinary enclosures. Your bass response extended downward an octave. That's all yours IF your present speaker is a high-fidelity coaxial type and IF you enclose it in the superb Acoustical Labyrinth. For complete technical details, see your dealer or write for Bulletin SED 2.40.

Labyrinth and Cabinet, (less speaker) in mahogany or blonde oak, \$120

Kit Only RE-485, to assemble your own Labyrinth with your own speaker, \$20

12-inch Coaxial Speaker, \$49.95

15-inch Coaxial Speaker, \$179.95

STROMBERG-CARLSON
Sound Division

1219 CLIFFORD AVE., ROCHESTER 3, N. Y.

AMPERITE

Studio Microphones
at P.A. Prices

Ideal for
BROADCASTING
RECORDING
PUBLIC ADDRESS

"The ultimate in microphone quality," says Evan Rusting, sound engineer of the Hotel New Yorker.

• Shows right into the row Amperite Microphone—reproduction is always perfect.

• Not affected by any climatic conditions.
• Guaranteed to withstand severe "knocking around."



Models
RBLG—200 ohms
RBHG—Hi-imp.
List \$42.00



"Kontak" Mikes
Model SKH, list \$12.00
Model KKH, list \$18.00

Special Offer: Write for Special Introductory Offer and 4-page illustrated folder.

AMPERITE Company, Inc.

561 BROADWAY • NEW YORK 12, N. Y.
Canada: Atlas Radio Corp., Ltd., 560 King St. W., Toronto

GROMMES AMPLIFIERS



Model 50 PG
\$55.00

A high quality single coil amplifier with unusual performance. Power output 30 watts, 50 watts with 100% duty cycle. 15 tubes, 2 1/2" beam tube and 12 1/2" electron-ray tube. Frequency response 20 to 20,000 CPS. 20 dB, 30 to 30,000 CPS at 100% duty.

Model
215BA
15 Watt

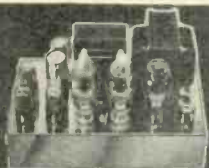

ALL TRIODE BASIC AMPLIFIER

Response 10 to 100,000 CPS. Peak power 24 watts. Distortion as low as 0.5% at 100% duty. 25 dB feed-back from 3 loops, 2 direct coupled stages, cathode follower drivers.

\$99.50

WRITE FOR CATALOG

PRECISION ELECTRONICS, Inc.
9701 King Avenue, Franklin Park, Ill.

THEATER SOUND

(from page 31)

Design of the Main Case

The surest way to cut and assemble the sections of the wood cabinet without mistakes is to make a plan drawing of its assembly to scale, similar to Fig. 7 or 8. This is especially true if the plywood is of different thicknesses. In the cabinets we constructed we used 1/2-in. plywood throughout, but the front of the cabinet, sides, top, and bottom could be made of thicker plywood if it is on hand. All pieces must be at least 1/2-in. thick, however.

Figure 9 shows the metal horn attached to the front by wood screws but this was our first assembly. In later models, the fin-like separator pieces project at right angles from the center of each side of the sheet metal horn, to act as struts between partitions, and they are slotted across one side to let the 3/16-in. truss rods pass through them. These pieces must be shaped to fairly well match the surfaces they are to push against, and to obtain a snug fit so that partitions will not be sprung out of position as truss rods are tightened.

A truss rod passes from the side of the sheet metal horn to the outside of the cabinet in each of the four directions, at the center of the sound passages. After partitions for folded horn sound passages have been cut and shaped to fit together correctly, these fin-like separators must be lined up with the direction of sound and tacked in place with small brads. As the horn partitions are assembled, a 3/16-in. rod (such as steel welding rod) can be threaded through the group to help line up the separators while they are tacked in place.

Finally each truss rod may be cut to length and threaded on each end. Screw a nut on one end with a thread or so sticking through; clamp the rod in the vise with the nut resting on the jaws; and rivet the end with a ball peen hammer. This end is used at the outside of the cabinet with a large washer to keep the nut from seating into the wood with the vibrations. The other nut is screwed on the end which sticks into the sheet metal horn, with a good lock washer to keep it from working loose. Allow plenty of thread on this end for tightening.

In installing an 8-in. speaker frame on the larger magnet an additional 16-ga. metal flange can be included in the assembly, as shown in Fig. 7, to form a tie or hub for the partitions of the sound chamber. This member seals off the passage of sound to the rear and gives a more direct support for the heavy magnet. With our first woofer we used a wooden collar, fabricated by gluing two layers of 5/8-in. plywood together, as shown in Fig. 8. One layer was given 1/4-in. slots to let a 3/16-in. tie rod pass through on each side of the speaker magnet.

Cancer
strikes
1 in 5

Strike
back

Give

Your gifts to the American Cancer Society help guard those you love.

Your dollars support research in a hundred laboratories and universities . . . spread life-saving information . . . ease pain and suffering . . . provide facilities for treatment and care of cancer patients.

It is a sobering fact that cancer may strike anyone tomorrow: strike back today with a gift to the American Cancer Society. You may mail it, simply addressed CANCER, c/o your local post office.

American
Cancer
Society



Where the metal horn fits through the front panel and where the partitions were fit to the wooden collar around the speaker, a thin layer of plastic (non-hardening) putty was applied between surfaces. This was to seal from passage of air and to prevent any spurious vibrations at joints.

No. 8 wood screws, of different lengths, were used in our first cabinet. Lengths were chosen so that 1 in. or more of thread was seated in the holding member and they were spaced 1½ in. apart in short runs and 2½ or 3 in. along the main sides. A small hole was drilled to guide each screw and prevent splitting of edges of panels. Then the hole through the held piece was enlarged for the shank and countersunk. A bit of floor wax was used to ease each screw home in its long run.

Arranging Inner Passages

In computing the sound passage area past the speaker mounting flange, the cross sectional area between partitions, at A in Fig. 7, is figured and the circular area of the speaker flange deducted. It will be seen that the sound waves have to turn a 90-deg. angle at the space marked A before departing from this chamber back of the mounting ring. Thus frequencies of the intermediate range are filtered out by acoustical resistance before they can cause much distortion in the folded horn passages.

Continuing along the inner sound passages, the cross sectional area at each change of direction is figured for doubling every 12 in. in axial length. Since there is no continuous 12-in. run in any part of it, this can only be a rough approximation, by proportions. Remember to allow for the same degree of expansion as the sound bends around the end of partitions because it may travel four or five inches axially in these bends. Leaving the sound chamber at A, the low notes pass toward the front of the cabinet and are bent back at B to pass rearward along the top and bottom panels to C.

Many corner speaker cabinets depend on the walls of the room to form the final folded passage, but this design uses complete side panels with the truss rods terminating in them. Pieces of ¼-in. hair felt were glued along the outside of these panels to prevent their making vibrating contact with walls of the room. Rubber feet were installed on the bottom. Thus, there is practically no sound transmission through the room walls at normal operating levels.

Curved inserts of sheet metal were bolted to the side walls and center separator to help the sound around the last bend at C and prevent possible distortion in this large chamber which surrounds the magnet. This sheet metal may be any gauge from 28 to 22, for easy shaping. Use lock washers on all bolts, which are 8-32 machine screws in most locations.

Before tightening the truss rod nuts in the metal horn, on the final assembly, twist a turn of small wire under each nut and allow the two ends to reach out the front like hairpins. Then take an old gauze or lace curtain and wad it up and pack it loosely in the horn to fill it almost to the mouth. Place a piece of light hardware cloth over this curtain and secure in place with these hair pins. If the hardware cloth is not light and pliable, its ends may receive vibrations from touching the metal horn.

The purpose of this curtain wad is twofold. Naturally, the direct radiated sound is much more effective than the lower notes which have to traverse the folded horn. So this material acts as a mute to cut down the intensity of the emerging notes and provide a distortion-free coupling with the outside air. Thus a fair balance can be obtained between the two horns and further experimenting may be resorted to in order to suit the needs of the particular speaker and horn assembly.

Don't be too concerned about the looks of the sheet metal horn or other features around that part of the cabinet because it will have to be covered with some cloth or other finishing. Picture molding was used to form open louvers over the horn on our first cabinet. There are many ways to dress up this cabinet to fit in with the surrounding environment. Do not run any wide molding up the edge of the horn opening against the wall at D, Figs. 7 and 8. Any molding which extends into this opening from the wall would curtail the annular movement of the lowest notes along this outer wall.

Like most experimenters, we have never gotten around to finishing our cabinet because we are too busy on other projects. Louvers should not be used over the tweeter and any cloth used over its opening should be of fairly loose weave and hard, wiry thread, preferably plastic.

Both the tweeter and the center horn must be mounted flush with the front surface of the panel (disregarding louvers which extend beyond). The reason for this is, of course, to avoid any discontinuities in the sound path where the horn joins the open air.

Sounds like a lot of work, doesn't it? It has taken years of struggling to achieve this ideal and the real listening satisfaction for a true music fanatic. Let's put it this way: A sextet of saxophones of different ranges can imitate the brass choir, but the comparison in texture is about the same as comparing an ordinary 12- or 15-in. resonator-boxed speaker with our system—except that the saxophones are a little muddier than the box speaker.

In the final article of this series, we will discuss the controls that go with the dividing network.

[To be concluded]

RADIO-ELECTRONICS
A Preview of Progress
I. R. E. CONVENTION
RADIO ENGINEERING SHOW

405
EXHIBITS

WALDORF-ASTORIA HOTEL
GRAND CENTRAL PALACE
NEW YORK CITY

MARCH 23-26 1953

COME AGAIN—

AUDIO MEN!

Welcome to the Radio Engineering Show—

March 23-26, 1953
at New York City

19 IRE Professional Groups have prepared skillfully organized symposia and technical sessions on all phases of radio, TV, and electronics. These papers will keep you up-to-the-minute on the developments which are to come in the next few years—for the IRE Convention Theme is:

Radio-Electronics

“A Preview of Progress”

The colorful Annual Meeting on Monday at 10 (opening morning) will feature the “Founders’ Award”. Social Events include the “Get Together Cocktail Party” Monday, and the Annual Banquet Wednesday, all at the Waldorf Astoria Hotel.

405 Exhibitors are using 58,680 square feet—the entire four floors of Grand Central Palace, to give you a “Preview of Progress” in the apparatus, components and instruments of Radio-Electronics. Registration: IRE Members \$1.00 Non-Members \$3.00. Register at Grand Central Palace, 47th & Lexington Avenue, or The Waldorf Astoria Hotel, 49th & Lexington Avenue, New York City.

**THE INSTITUTE OF
RADIO ENGINEERS**

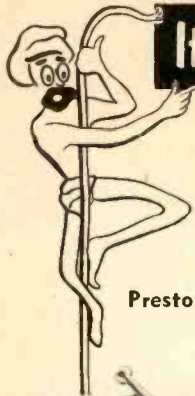

It's no trick!

No talent or training needed to splice any type of safety film, . . . forever, the new, electric "butt-welded" miracle device does it AUTOMATICALLY!

Prestoseal splices magnetic film permanently in 10 seconds!

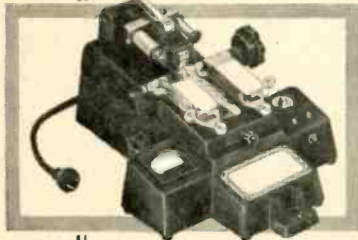

. . . replasticized! Eliminates distortion, drying out, no overlap or double thickness, no cement, brushes or scraping. Guarantees perfect frame alignment. No lights required.

Brochure on request

PRESTOSEAL MFG. CORP.
3727 33rd St., Long Island City 1, L.I.

EVERYTHING IN AUDIO!

HUDSON
RADIO & TELEVISION CORP.

- Largest Selection of ALL Standard Electronic and High-Fidelity Equipment.
- Ultra-Modern Audio Comparison Sound Studios
- LOWEST PRICES • FINEST SERVICE

FREE! 1953 Newest Most Complete HUDSON CATALOG



Over 196 pages . . . value-packed with the world's finest Radio, TV and Electronic Equipment. High-Fidelity and PA Sound Equipment. . . Amplifiers, Speakers, Tuners, Record Changers, Recorders, Packaged Systems, Custom Furniture, etc. for Professional and Home Installation.

Send for Your FREE Copy (Dept. D-3)

When you attend the IRE SHOW, be sure to visit our uptown Sound Studio, adjoining Radio City . . . only 4½ blocks from Grand Central Palace! Open until 9 P.M. during show time, March 23-26.

HUDSON
RADIO & TELEVISION CORP.

48 WEST 48th ST. • 212 FULTON ST.

New York 36, N. Y. • Circlet 6400 • New York 7, N. Y.

HANDBOOK [from page 34]

which is decoupled and remains at rest during purely treble stimulation.

Analysis of the circuit of (B) in Fig. 9-5, one of the possible variations of the two-cone, single-voice-coil design, is very similar, and is left to the reader as an exercise in using dynamical analogies.

Distribution of mass at different frequencies may also be achieved by the use of separate speakers. The frequency spectrum is divided into two or three parts and a speaker with appropriate mechanical characteristics is assigned to cover each band. These speakers may be mounted on the same axis, which gives the assembly the title of coaxial speaker.

The Magnetic System of the Speaker

After the suspended mechanical system of the speaker has been made suitable, to a greater or lesser degree, for forced vibration over a given band of frequencies, an electro-magnetic system for converting the electrical signal into mechanical force is required. The fixed magnetic field in which the voice coil is placed should be as intense as possible. The greater the magnetic flux of this field the more efficient the conversion, and the more effective will be electrical damping. It is also necessary that the field be uniform over the area through which the voice coil will move, so that a constant relationship can exist between the instantaneous amplitude of the signal and the magnetomotive force applied to the voice coil.

The usual magnetic structure is of the type appearing in Fig. 9-1, where only the slug is made of magnetic material. The field path between the north and south pole of the slug is directed by the U-shaped iron structure and the pole piece of mild steel. The low reluctance of this magnetic circuit, compared to that of air, confines almost all the lines of force to the metallic path, and the voice-coil gap then receives the full concentration of lines when they must cross the gap to complete the circuit. Other types of magnet structure are used, but aside from questions of cost the final merit of the structure is judged by the magnetic flux produced in the gap, and its uniformity over the path of voice-coil excursion. The strength of the magnetic field at the gap is determined by the material and weight of the slug, the degree to which the field is confined to the metallic circuit and gap by the magnet structure, the size of the gap, and the saturation limit of the steel.

Some years ago really powerful magnets could be produced only by field coils wound on soft iron cores. With modern magnetic compounds made of iron, aluminum, cobalt, nickel, and a small amount of copper (Alnico V) the permanent magnet type of slug is able to produce fields of high intensity. Earlier types of Alnico, designated by lower numbers, produce weaker fields.

A typical inexpensive "console" speaker of 12-inch diameter uses a 6.8 oz. Alnico V slug. Quality 12-or 15-inch speakers may use Alnico V magnets of several pounds.

The gap is made as small as can be afforded without danger of rubbing. The voice coil must therefore not warp easily, and the spider must have maximum radial rigidity to keep the coil in the narrow path prepared for it.

The Electrical System of the Speaker

Some years ago high-impedance speaker voice coils, connected directly into the output a. c. plate circuit, were used. High-impedance voice coils have one great advantage, in that the need for a matching output transformer—the most costly and critical part of an audio amplifier—is eliminated. The use of this type of voice coil was abandoned, however, for the greater convenience of low-impedance coils, which used fewer turns and heavier wire. Recently the high-impedance design has been revived, and new output circuits make possible lower requirements for voice-coil impedances.

The typical modern voice coil has a rated impedance of from 2 to 16 ohms. The common 5-inch table radio speaker has an impedance of 3 to 4 ohms, and large speakers are rated at 8 ohms or higher. The d. c. resistance of the wire is usually about three-fourths of these figures.

The value of the rated or nominal impedance represents the actual electrical impedance of the loudspeaker at about 400 cps and at that frequency only. The effective electrical impedance presented to the amplifier at other frequencies varies considerably. It is strongly influenced by what is called the *motional impedance* of the speaker, and the electrical inductance of the voice coil presents an increased impedance to signals of higher frequency. (See Fig. 9-6.)

If the voice coil were clamped so that it could not move the speaker would have an impedance, at a particular frequency, referred to as the *blocked impedance*. When the voice coil is allowed to move in the magnetic field it becomes the armature of an electric generator, and a back electromotive force is produced, opposing the input signal voltage. Effectively, then, it is more difficult for the source to send current through the voice coil, since back e.m.f. must be overcome in addition to the voice coil impedance, and the source "sees" an increased impedance between the speaker terminals. The increase of impedance may also be described in terms of Ohm's law; for the same signal voltage applied to the speaker, less current will flow. This is illustrated in Fig. 9-7.

The increase in the value of the motional impedance. Since in a given speaker it is determined by voice-coil

velocity, it is affected by all the components of the mechanical impedance, and of the acoustic impedance reflected into the speaker mechanical system, that influence this velocity. It is a maximum at speaker resonance, where voice-coil velocity is greatest.

The variation in amplifier load indicated in Fig. 9-6 has a serious effect on performance at different frequencies. Amplifier design which incorporates a very low source impedance, and a mounting which affords good acoustic loading for the cone, will counteract this effect to a large degree.

Part II will appear next month.



A MONTHLY SUMMARY of product developments and price changes of radio electronic-television parts and equipment, supplied by United Catalog Publishers, Inc., 110 Lafayette Street, New York City, publishers of Radio's Master. These Reports will keep you up-to-date in this ever-changing industry. They will also help you to buy and specify to best advantage. A complete description of most products will be found in the Official Buying Guide, Radio's Master—available through local radio parts wholesalers.

Recording Equipment, Speakers, Amplifiers, Needles, Tape, Etc.

ELECTRO-VOICE—Increased price on Model 6-BD diffraction horn to \$15.00 net.
FAIRCHILD RECORDING EQUIP.—Added Model 650-C preamplifier at \$47.50 . . . Model 651-B power supply at \$51.00 net, and Model 652-C preamplifier at \$47.50 net. Decreased price on Model 620-CL power amplifier to \$190.00 net.
GARRARD SALES—Discontinued multispeed transcription turntable Model 201/B5.
GENERAL ELECTRIC—Added Model UPX-009, pickup and transcription arm at \$9.33 net . . . Model RPX-051 triple-play variable-reluctance cartridge at \$5.28 net, and Model RPX-042 variable-reluctance cartridge at \$4.35 net. Discontinued Model RPX-046 broadcast type variable reluctance cartridge.
LOWELL MANUFACTURING CO.—Added "The Rheemond" series of wall-type speaker baffles. Decreased price on Model H-24 hi-fidelity decorative grille to \$10.50 net.
MAGNECORD—Discontinued Model PTT-A recorder mechanism for portable, rack or cabinet models . . . Model PTT-AX, same as Model PTT-A less case . . . Model PTT-CC, console combination.
PRECISION ELECTRONICS—Decreased price on Model 100-BA basic amplifier to \$41.25 net, and Model 215-BA high-fidelity triode amplifier to \$99.50 net. (West coast prices slightly higher).
REEVES SOUNDRAFT—Added Soundcraft 45-r.p.m. recording disc at \$4.50 net.
MARK SIMPSON MFG.—Increased prices on No. 52 series of tape recorders.

Test Equipment

RADIO CITY PRODUCTS—Added Model 345 super vacuum-tube voltmeter at \$47.50 net, and Model 8873 TV servishop unit at \$139.95 net. Discontinued Model 654 V.T. voltmeter . . . Model 449A pocket multimeter, and Models 447BK and 447BPK multimeter kits.
R.C.A.—Increased price on Model WO-88A, 5-in. oscilloscope to \$169.50 net.

Tubes—Receiving, Television, Special Purpose, etc.

GENERAL ELECTRIC—Added germanium diodes 4JA1A1 at \$1.95 net . . . 4JA1A2 at \$3.85 net . . . 4JA1A3 at \$4.80 net . . . 4JA2A4 at \$5.30 net . . . 1N81 at \$4.35 list and G70 at \$2.00 list. Discontinued G-10 series of transistors (G-10, G-10A, G-10B and G-10C).
RAYTHEON—Added special purpose tubes CK5670 at \$7.00 net . . . CK5750 at \$3.25 net . . . CK6212 at \$7.50 net . . . CK6247 at \$14.65 net. Also added germanium junction transistors CK721 at \$12.50 net, and CK722 at \$7.60 net.
SYLVANIA—Added TV picture tube 21ZP4A at \$40.00 net . . . special purpose tube 6BF7W at \$4.45 net. Also added radio receiving tubes: 6T4 at \$3.55 list . . . 6BQ7A at \$3.20 list . . . 6BK5 at \$2.45 list . . . 12B4 at \$2.00 list. Discontinued sub-miniature tubes 6BF7 and 6BG7 and receiving tube 6BQ7. Increased price on germanium crystal diodes 1N60 to \$7.75 net and 1N105 to \$7.75 net.

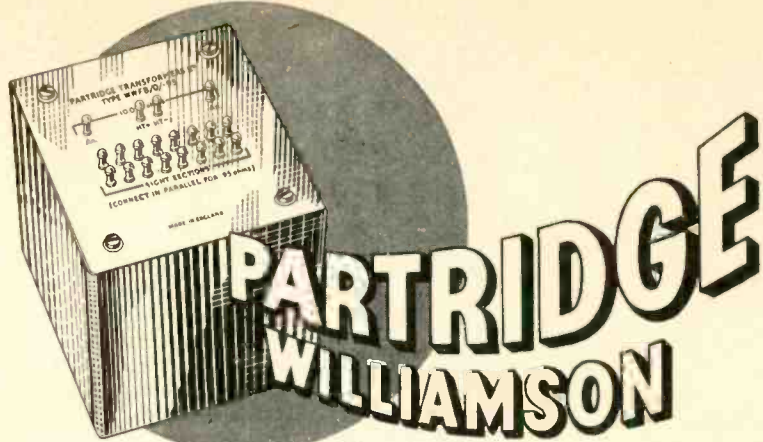

PARTRIDGE WILLIAMSON

means

AUTHENTIC WILLIAMSON PERFORMANCE

Accepted as the most efficient output transformer in the world, and for which there is no U. S. equivalent, the Partridge-Williamson Type WWFB ensures the performance intended by the designer. Covering the full audio range it has the lowest possible distortion. It is now available to all—off the shelf from all good jobbers. If in any difficulty write us and mention your jobbers name—Don't tolerate a substitute—get the transformer built for the job—the Partridge-Williamson.

AVAILABLE TO ALL IMMEDIATELY FROM STOCK

Individually tested. No WWFB leaves our works without being individually tested. Close limits set on shunt reactance at 50 c/s. Series reactance at 5 Kc/s; d.c. resistances and interwindings insulation resistances at 2 K.V.



Price
\$26.00
 duty paid

PARTRIDGE TRANSFORMERS LTD., TOLWORTH, SURREY, ENGLAND

IF YOU ARE MOVING

Please notify our Circulation Department at least 5 weeks in advance. The Post Office does not forward magazines sent to wrong destinations unless you pay additional postage, and we can NOT duplicate copies sent to you once. To save yourself, us, and the Post Office a headache, won't you please cooperate? When notifying us, please give your old address and your new address.

Circulation Department
RADIO MAGAZINES, INC.
 Mineola, N. Y.
 P. O. Box 629

for clear, controlled sound in corridors



SPECIFY

LOWELL Bi-Directional Speaker Baffles

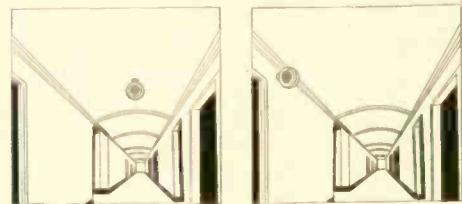

Corridor speaker installations, in ceiling or walls, give the best performance when equipped with Lowell Bi-Directional Speaker Baffles. Sound waves are directed in a concentrated beam along the length of the hall, permitting low level volume of clear, undistorted sound. Echoes are held to a minimum. Heavily loaded baffle housing reduces feedback, eliminates metallic resonance. Speakers are protected from dust and mortar. Bi-Directional baffles are easily installed in new or existing construction, available in five series to accommodate 6" to 12" speakers.

Please write for complete, illustrated installation instructions, specifications and prices.

LOWELL MANUFACTURING CO.

3030 Laclede Station Rd.,
 St. Louis 17, Missouri

In Canada: Atlas Radio Corporation, Ltd., 560 King St., West, Toronto, Canada

SAVE
33 $\frac{1}{3}$ %



This is our

GROUP SUBSCRIPTION PLAN

You and your friends and co-workers can now save up to \$1.00 on each subscription to AUDIO ENGINEERING. The more men in a Group, the more each saves. If you send 6 or more subscriptions for the U.S.A. and Canada, they will cost each subscriber \$2.00, 1/3 less than the price of a regular 1-year subscription. Present subscriptions may be renewed or extended as part of a Group.

AUDIO ENGINEERING is still

- The only publication devoted entirely to Audio—
- Recording
- Broadcasting equipment
- Acoustics
- Home reproduction systems
- PA systems
- Psychoacoustics

(Please print)

Name

Address

Position Company

Name

Address

Position Company

Name

Address

Position Company

Name

Address

Position Company

Name

Address

Position Company

Name

Address

Position Company

Add \$.50 to each Foreign subscription ordered

RADIO MAGAZINES, INC.
P. O. Box 629, Mineola, N. Y.

SELECTIONS [from page 24]

control may not be able to compensate for the characteristics of both the record and the reproducing equipment.

It has been established by several investigators that record-surface noise is fairly evenly distributed over the frequency spectrum on the basis of energy content per cycle. Since each arithmetic frequency interval has a similar amount of noise energy, the noise content will increase with each successively higher octave.⁵ It is therefore correct to think of perceived surface noise as increasing with frequency, and compensation for treble pre-emphasis in recording is very effective in reducing scratch, as the system intends it to be.

There is however, an advantage in being able to introduce sharp cut-offs at given points of the frequency band, since records which have little or no frequency content above the cut-off point can then have their surface noise reduced without the signal being severely penalized. Some types of distortion are also most pronounced in the range above 5,000 cps, and sharp cut-off helps reduce such effects with least change of the signal. Sharp cut-off at high frequencies, however, is incompatible with the other duties of the treble tone control, and should be accomplished by separate networks. The general tone control must be limited in its scratch reducing role to a more gradual attenuation of the treble band.

Certain microphones, if incorrectly equalized at the studio, have a rising treble response above one or two thousand cps. Attention is occasionally called to this characteristic when broadcast studio use of an incorrectly compensated microphone produces over-crisp and "hissy" speech. The compensation required for this type of emphasis is compatible with that already planned for records.

Tonal balance of bass and treble for the most satisfactory over-all result is an inherently subjective problem. Like compensation for the Fletcher-Munson effect, it involves a decrease of objective fidelity for the sake of an increase in apparent realism. The fact that the problem is one of perception rather than of reality indicates that investigation requires a statistical technique.⁶

⁵ B. B. Bauer, "Crystal pickup compensation circuits," *Electronics*, 17, p. 128, Nov., 1945.

⁶ It is suggested that a useful approach would be to compile judgment data in which the jury compares various conditions of tonal balance, both symmetrical and asymmetrical to 800 cps, with the full range of sound, indicating which condition seems more like the undistorted one. (Asking the jury to indicate preference between balanced and unbalanced conditions, without an ever-present standard, involves the danger of measuring factors other than apparent frequency distortion.)

Discussions of aural balance⁷ have indicated that approximately equal frequency distortion, geometrically relative to the frequency mid-point, is more desirable than unequal frequency distortion, but that there is considerable latitude in design for balanced response. The parameters of treble attenuation for achieving careful balance would be determined by a study of bass deficiencies likely to be met with. The treble attenuation discussed in previous paragraphs is fairly symmetrical to most of these low-frequency deficiencies.

It will be seen that the transition frequency suggested for treble attenuation is different from that for treble boost, and conditions are likely to exist in which both are required simultaneously. Such simultaneous compensation, however is inherently barred when a single control is used for both boost and cut.

Bass Boost

The conditions requiring bass boost are:

1. Decreased hearing sensitivity to bass frequencies at low sound intensities (Fletcher-Munson effect).
2. Recording characteristics whose bass turnover frequency is higher than the one for which the reproducing equipment is designed.
3. Bass deficiencies in records.
4. Bass deficiencies in reproducing or studio equipment.

The well known family of equal loudness contours published by Fletcher and Munson makes it evident that the apparent frequency distribution of energy in given program material will vary greatly at different intensity levels. If the amplifier has a correctly designed compensating network associated with its volume control this effect will be counteracted, but the volume control setting required for a desired intensity level is not necessarily an accurate index of the intensity level of the original program, and further adjustment may be necessary. The electrical level of an input signal does not have a constant relationship, in different program material, to the sound level which it represents.

The purpose of volume compensation is not, of course, to straighten out the curve of frequency perception, (that's the way the music sounds in the concert hall) but to shape this curve at the reproduced intensity level so that the perceived frequency distribution is similar to the perceived distribution at the original intensity. We may take 80 db⁸ as the average level of a 75-piece orchestra heard from a good seat, and 50

⁷ Hugh S. Knowles, "Loudspeakers and room acoustics," *The Radio Engineering Handbook*, Keith Henney, editor, p. 881, 3rd edition, 1941.

⁸ Ibid.

db⁹ as the lowest level at which this music is likely to be reproduced, with any concern for quality, in the living room. Superimposing the two appropriate curves on the same horizontal axis (Fig. 4), it will be seen that in order to achieve the original perceived frequency distribution in reproduction at the 50-db level, bass boost at slightly more than 6 db per octave, with a transition frequency of 400 cps, is required. This is, of course, for the extreme case of a 30-db difference between the original and the reproduced level. At this 30-db difference the bass boost required during orchestral peaks, when both levels may be increased by 20 db, is much less; during very soft passages the boost required will be more. We must work on the basis of the average levels.

The 50- and 80-phon curves, and the 60- and 70-phon curves in between, are practically identical in shape and slope from 500 cps up, meaning that a reduction of intensity level from 80 db to 50 db will produce no significant change in the apparent frequency distribution in the treble region. Even if it were desired to compensate for the 2-db maximum loss in treble, the ordinary R-C network could not produce the necessary shape of response curve, which may be read from Fig. 5 as a uniformly elevated plateau over most of the treble spectrum. Correct volume compensation should therefore involve no adjustment of treble frequencies.

If the record reproducing equipment has only a single turnover frequency a compromise value of 500 to 600 cps is usually chosen. Some records have been made with higher turnover frequencies as high as 800 cps. Thus a moderate amount of boost to add to that of the fixed equalization will on occasion be called for. Such equalization, however, is required by a relatively small number of records.

Acoustically recorded discs, and some electrically recorded ones, have a thin bass because of weaknesses in recording equipment and techniques. These ordinarily require boost below two or three hundred cps, although the drop in bass response is in general too sharp for adequate compensation.

Bass deficiencies in reproducing equipment, like treble deficiencies, also tend to occur towards the extreme of the frequency scale. Most moderate quality loudspeakers (see Fig. 2), pickups, etc., do not show a significant drop in bass response until frequencies below 100 cps, and then with sharply dropping curves. Here too compensation cannot be adequate.

Adjustment for the Fletcher-Munson effect is probably the most frequent function of bass boost. The transition frequency required for this equalization lies

⁹ "Frequency Range and Power Considerations in Music Reproduction," Jensen Technical Monograph No. 3, Jensen Manufacturing Company. Note that a level of 50 db is less than 10 db above the average random noise level in a city apartment.

between that for a high turnover frequency and for record and equipment deficiencies, and the compromise parameters that appear most reasonable to the writer include a transition frequency one octave down from the spectrum mid-point, or 400 cps, and the standard maximum boost rate of 6 db per octave.

Bass Attenuation

Bass attenuation may be required for the following conditions:

1. Recording characteristics with a bass turnover frequency lower than that of the reproducing equipment.
2. Accentuation and distortion of bass frequencies by reproducing equipment.
3. A weak treble which creates tonal imbalance.

The required compensation for equipment designed with a 500-cps turnover, and playing a record with a turnover frequency of 250, 300 or 400 cps (all of which values have been used) may be approximately achieved by a gentle attenuation of about 2 db per octave from 750 cps down, or by a sharper downward slope from a lower transition frequency of 500 cps. The second method is more consistent with the other requirements of bass cut.

Bass accentuation in reproducing equipment is most often associated with acoustical resonance of an open speaker enclosure at some frequency below 200 cps and with mechanical-acoustical resonance of the speaker system below 100 cps. The effects of tone-arm resonance and turntable rumble usually occur below 50 cps. As in the case of low-frequency boost, we cannot furnish accurate compensation for equipment frailties at the extreme low end, but we can alleviate the condition in some measure.

Aural balance of a weak treble appears to demand a low transition frequency. Probable treble droop occurs, as we have seen, at least two octaves above 800 cps, and geometrically symmetrical bass losses would begin at about 200 cps.

A reference frequency and slope to compromise between the various requirements for which bass attenuation will be needed are: transition frequency 500 cps, maximum slope, 6 db per octave.

Conclusion

Figure 5 is a graph of tone-control frequency characteristics chosen on the basis of the above discussion. The parameters vary from many of those in common commercial use in that the reference frequencies are shifted away from the spectrum mid-point, about one octave down for the bass, and two octaves up for treble boost. As a consequence the total amount of control is somewhat less than is often provided.

Figure 6 is a tone control circuit with values assigned to approximate these curves. Some allowance has been made for the fact that the transition frequencies are affected by the degree of boost or cut used by the operator.

Air-Tone

HEADQUARTERS FOR SOUND EQUIPMENT

INDUSTRIAL SOUND

for any and all installations. Continuous music or business message up to 8 hours.

Illustrated: MAGNE-CORD Units PT6J, PT6AH, 814, with automatic switching equipment, custom built by Air-Tone Sound & Recording Co.

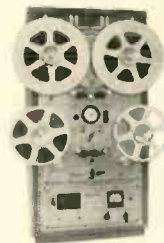

Air-Tone

SOUND AND RECORDING CO.

1527 CHESTNUT ST.
PHILA. 2, PA. • RI-6-8388

for every application...

ATLAS MIKE STANDS

most complete—most diversified line in the world!

From a professional boom stand to a flexible goose neck to a tiny fitting—whatever your need in mike stands and accessories—depend on it, ATLAS has it for you. Designed and manufactured for highest stability, quiet, ease of operation, durability. And backed up 100% by ATLAS—world leader in mike stands, public address loudspeakers and accessories for 21 years. Compare them all at your distributor—You'll make your next mike stand an ATLAS.

ATLAS SOUND CORP.
1448-39th Street, Brooklyn 18, New York
In Canada: Atlas Radio Corp., Ltd., Toronto, Ont.

NOW
Hear This NEW

Jim Lansing

D-130
15" Speaker

New pure iron,
"high intensity"
casting
structure

increases
over-all
efficiency **25%**



The heart of a fine loud speaker is its powerful magnetic structure. Jim Lansing engineers have been able to produce in the new D-130 a more powerful magnetic beam across the voice coil than ever before possible. This unique design extends the high frequency response 25% and materially improves the dampening factor. Hear this new Jim Lansing D-130 today... at your audio dealer's.

Jim Lansing—first in fine sound!

JAMES B. LANSING SOUND, INC.
2439 Fletcher Drive, Los Angeles 39, California

**OLYMPIC Hi-Fi Values!
Ultra-Lo Price!**

**HI-FI WILLIAMSON TYPE
AMPLIFIER
KIT**



Using Stancor transformers. Easy-to-assemble amplifier kit. Comes with schematic and instruction sheet based on famous Williamson circuit. Frequency response 1 db. from 20-50 kc at 8 watts. Intermodulation distortion is only 3% at 8 watts output. Total harmonic distortion at 1000 cycles is non-existent below 10 watt power level.

**SPECIAL
PRICE
PER KIT**
\$44.95

**KIT OF CBS HYTRON TUBES
FOR ABOVE AMPLIFIER**

Consists of: 2-6L807 2-6SN7GT 1-5U4G

SPECIAL ONLY \$7.95



IRISH BRAND RECORDING TAPE
BRAND NEW! NOT SURPLUS. This First Grade recording tape is 1/4 in. wide. Frequency response: 50 to 8,000 cy. Plastic reel included with each. 600 FT. \$1.35 1,200 FT. \$2.10

**BEST BUY OF THE MONTH!
AM-FM TUNER**

10 W. HI-FI PUSH-PULL AMPLIFIER Freq. response 20-20,000 cps. at less than 1/2 of 1% distortion. New \$32.95

COMING OUR WAY? Be sure and visit our new HI-FI, acoustically designed sound studio!

All orders F.O.B. Los Angeles. Minimum order \$5.00. 25% deposit required with order.

OLYMPIC ELECTRONICS SUPPLY
Distributors

1440 W. Olympic Blvd., Los Angeles 15, Calif.

CHECKLIST

[from page 14]

only two or three and have them make pronounced angles with each other and/or with the edge of the panel.

18. If a studio organ is photographed with an organist, make sure each of his hands is on a different manual (keyboard), the keys are depressed, some stops are drawn, and the organist is looking at his music and not at the camera. With or without an organist, use a diagonal shot and make sure the organ console and stop knobs or tabs are shined up for discreet highlights.

19. On long shots, diamond-shaped microphones like the RCA 44BX and 74B and the Electro-Voice V series show up best with one of their dead faces toward the camera and the microphone tilted slightly. On close-ups, these microphones and most others show up well in almost any position.

20. Turntables generally appear to best advantage when shot from an angle from above, with the pick-up in place well toward the center of the disc to emphasize the angle the arm makes with the edge of the motorboard.

21. Disc recorders also appear well from an overhead angle. Swing the lathe over the centerpost with a disc on the platen, and place the camera so that the lathe makes an appreciable angle with either edge of the cabinet.

22. Rack-mounted tape recorders show-up best head-on, of course. Those in floor cabinets are best photographed with the camera directly in front of and somewhat above the unit. Make sure both reels are on the machine and that the tape is properly threaded

23. Be careful of shadows. Reduce or eliminate them by careful positioning and selection of spotlighting, backlighting, sidelighting, etc.

24. Will enlargement and cropping improve exposition or heighten impact? They often do, especially when the photo is intended to show considerable detail, such as an in-place picture of a terminal block.

25. Have your pictures retouched if they are for publication. Surface blemishes, forgotten shipping tags and other embarrassing details can be removed in varying degrees by an expert re-toucher. Don't try it yourself.

26. Beware of even slightly-overdeveloped prints if the photos are for publication. Detail necessarily suffers when a photograph is reproduced on the printed page and dark areas often appear still darker. Make sure of good detail in both light and dark areas.

27. Try to get the proper exposure on the negative so that the pointers and scales on the meter dials show up plainly and clearly.

28. Glossy prints on contrasty paper, and of a size not smaller than 4 x 5, are required. Many editors will not accept prints smaller than 8 x 10.

29. Furnish brief but clear captions

CLASSIFIED

Rates: 10c per word per insertion for noncommercial advertisements; 25c per word for commercial advertisements. Rates are net, and no discounts will be allowed. Copy must be accompanied by remittance in full, and must reach the New York office by the first of the month preceding the date of issue.

THE AUDIO EXCHANGE, INC. buys and sells quality high-fidelity sound systems and components. Guaranteed used and new equipment. Catalogue. Dept. AE, 159-19 Hillside Ave., Jamaica 32, N. Y. Telephone OL 8-4445.

FOR SALE: Rek-O-Kut M-12, perfect condition with new LP feedscrew, Astatic WR-40 microphone. Chlp-Chaser, \$75.00. TR-12 optional, \$75.00. Beekman 3-6587 or Box CM-1, Audio Engineering.

MICROSCOPE, 40 MAGNIFICATION. Bausch & Lomb lenses, extension bracket and post for mounting on any disc recorder, \$100. Brush 3-hour wire recorder, original cost \$800, excellent condition, \$185. Reco-Art Company, 1305 Market St., Philadelphia 7, Pa.

ASSEMBLING A SYSTEM? Beat even wholesale prices! Custom installers write for quantity prices on our 30-watt Williamsons and complete systems. Nicely Associates, Kenton, Ohio.

30% DISCOUNT ON ALL LP RECORDS! Best mail order service in the country. All records factory-fresh and guaranteed. Specializing in HI-FI records. Send for free catalog and literature. Southwest Record Sales, Dept. AE-1, 4710 Caroline, Houston 4, Texas.

FREE HI-FI CATALOG and Bargain Price List. Chicago Electronics, 420 E. 87th St., Box 171, Chicago 19, Ill.

WANT used disc recorder with overhead lathe not driven from turntable center. Contact Box CM-3, Audio Engineering.

FOR SALE: Rek-O-Kut G-2 deluxe 16-in. turntable, \$135; Gray model 108-B viscous damped arm, \$40; Fairchild moving coil LP cartridge, new point, \$32.50; Aitec 602-A loudspeaker, \$86; 10-watt amplifier with Triad transformers, bass and treble controls, preamp, \$55. Robert Balluffi, 36 Wakefield Ave., Port Washington, N. Y.

FOR SALE: Aitec Lansing M-11 microphone systems (2) in perfect condition; in use one month. Consists of 21-B midjet condenser microphone, base, power supply, cable, \$100 per system. Box CM-2, Audio Engineering.

**SAVE! SAVE! SAVE!
ON ALL THE NEWEST
HIGH-FIDELITY EQUIPMENT**
Phenomenal savings and guaranteed satisfaction assured through amazing new merchandise plan. Write for complete details and list. HI-FI GUILD, 45-A Grove St., New York 14, N. Y.

WANTED: Used Meissner 9-1093 AM-FM tuner and amplifier or Browning AM-FM tuner. two selectivities. John Callan, 3810 Military Road, N. W., Washington 15, D. C.

PRECISION 1% LOW-NOISE RESISTORS, WILLIAMSON KIT: 1-47K 1w, 2-20K 1w, 2-47 meg 1/2w, 2-50K 2w, 2-1 meg 1/2w—\$5.00. Single resistors: 1w 434, 1w 694, 2w 884. Shipping charge 15¢. Edwin Bohr, Dayton Pike, Chattanooga 5, Tenn.



PROFESSIONAL DIRECTORY

Custom-Built Equipment

U. S. Recording Co.

1121 Vermont Ave., Washington 5, D. C.
Lincoln 3-2705

"EVERYTHING IN HIGH FIDELITY"

From Primary Components
to Completed Custom Audio Equipment

KIERULFF

Sound Corp.

820 West Olympic Blvd. • Los Angeles 15, Calif.
Richmond 7-0271 Zenith 0271

In Southern California it's HOLLYWOOD ELECTRONICS

(in The Audio Mile)
Distributors of Hi Fidelity
Components Exclusively
Webster 3-8208

7460 Melrose Ave. Hollywood 46, Calif.

ELECTRONIC ENGINEER

Audio high-fidelity development and application engineer. Thorough knowledge of current trends in audio field.

WRITE STATE SALARY DESIRED
Box AE 1784, 221 W. 41st St., N. Y. 36

Announcing the opening of the
BROOKLYN HIGH FIDELITY SOUND CENTER
2128 Caton Ave., Bklyn 26, N. Y.
(Cor. Flatbush Ave.)

Tel: BUckminster 2 5300
High Fidelity Components and Complete Systems
Write for Brochure

WANTED: DIRECTOR OF ENGINEERING

An outstanding opportunity for an electronics engineer of executive caliber to head up the development program for a nationally known manufacturer in the electronics field. A smaller firm with two well-equipped plants and excellent laboratory facilities, particularly in the audio and electro-acoustic fields, 70% of the company's business is civilian.

Starting salary \$12,000 with opportunity for increased earnings through bonus and advancement. Stock participation open. Appointee will be a member of small top management group.

QUALIFICATIONS: Must be a graduate engineer or physicist, preferably in communications field. Age: 30-50. At least 8 years of engineering experience with some supervisory activity. American citizenship and clearance for secret. Originality and creative thinking essential plus ability to plan, organize, and coordinate the efforts of various project groups.

CONFIDENTIAL PERSONAL INTERVIEW may be arranged during IRE meeting in March in N.Y.C. Address reply stating personal qualifications, including: education, employment and earnings record, patents and inventions, publications, interests, family status. Box DM-1, AUDIO ENGINEERING, P. O. Box 629, Mineola, N. Y. All replies treated in strict confidence. Our own staff knows of this advertisement.

fastened to the picture, preferably by pasting on the back. Editors, alas, are not mind readers. And don't ever use paper clips to hold together a number of photos.

30. Last, and of greatest importance, is to make sure that your pictures are sharply focused—"wire sharp" is the term often used by photographers. Remember that the best photos lose something in reproduction, and sharpness in the original is very important.

Industry People...

David Sarser and his sister Sebe, still appearing under the guidance of impresario Maximilian Well, president of Audak Company, repeated their New York Audio Fair success at the West Coast Fair... Debbie Ishion, director of public relations for Columbia Records, Inc., is assembling a brand new high-fidelity music system—the better to hear the fine records she publicizes, no doubt. Another disasther, Margaret Delano of Harper & Brothers, publishers, is plenty hep on audio as a result of handling the editing assignment on Edward Tatnall Canby's new book—scheduled for March 18 publication... Les Paul, Capitol Records star, is on verge of completing one of the country's most lavish recording studios, built as an addition to his New Jersey home—among its amenities are such audio hors d'oeuvres as six Ampexes, one disc recorder, Telefunken microphones, etc... Bob Silverman, program director, station WABF, busily preparing a special audio issue of the station's monthly program-listing magazine

GI Demsky, Anton Schmitt, and Jimmy Carroll, custodians of Harvey Radio Company sound department, are initiating campaign for improved broadcast quality of New York Philharmonic and NBC Symphony concerts—all three have been recording the concerts off the air for years, and are unanimous in the opinion that audio quality has deteriorated noticeably in recent months... Michael von Mandel, American legal and sales representative for Germany's Telefunken Company, off for three-week visit with company officials in Europe... George Silber, president of Rek-O-Kut Company, called home from California the night before opening of Audio Fair—Los Angeles due to fire which destroyed portion of company plant... Tom Dempsey is new ad manager for Reeves Soundcraft Corp.—formerly with J. M. Mathes ad agency... F. Sumner Kall, president of Audio Equipment Sales, has perfected a new telephone plug to end all plugs—contains many unique and original features... Entire audio fraternity well entertained and enlightened at February meeting of AES in New York—featuring many of the most prominent personalities in the audio field in a round-table discussion—on the platform were Wilfred B. Whalley, moderator, C. J. LeBel, Frank E. McIntosh, Jerry B. Minter, E. A. Pearson, Herman E. Scott, and Llewellyn Bates Keim... Elton Nachman, formerly with Audio-Video Products Corp. getting acclimated to new position with Sun Radio & Electronics Corp.

Yours... FREE!

TERMINAL'S COMPLETE
AUDIO CATALOG

TERMINAL'S
New, Illustrated, 130-page

AUDIO CATALOG

Your complete guide to the
Finest in Audio Equipment!

Write or come in for your
FREE Complimentary Copy!

Visit our Audio Dept.
Open Thurs. eves. till 9 P. M.
Ample Parking Space after 6 P. M.

Terminal Radio Corp.
85 Cortlandt St., New York 7

Compro EASY-HANDLING MAGNETIC TAPE REELS

Precision manufactured in accordance
with the exacting standards set by the
N.A.S.

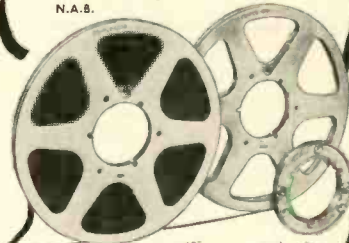

- Easy to handle because:
1. Burrs and sharp edges are smoothed away.
 2. Components assemble quickly, easily.
 3. Aluminum flanges stay flat. Eliminate tape rubbing.
 4. Hubs are die-cast to close tolerance.
 5. Grey, "write-on" finish available for editing notes.

TAPE REELS, STORAGE CANS, AND SHIPPING
CASES FOR EVERY PROFESSIONAL REQUIRE-
MENT ALWAYS IN STOCK

Write for descriptive literature and price list
COMPRO CORPORATION

Manufacturers of fine products for the Audio
Visual industry.
2251 W. St. Paul Ave. Chicago 47, Illinois



**YOU CAN NOW GET THE FAMOUS
HARTLEY 215 SPEAKER SO EASILY
AND IN THE UNIQUE "BOFFLE".**

Since our last advertisement we have been far from idle. Our factories in London and New York have been working hard to provide you with a Hartley service as satisfactory as Hartley reproduction. From now on we can deliver from New York stock, having done all the tedious work in importing, clearing customs, and acceptance testing. The 215 is HERE, ready to be shipped at once to any part of the country, without delay, without ocean hazards.

Concurrently, we have the unique non-resonant Boffle also available in a variety of finishes and styles, made from the finest American materials and workmanship. For extreme economy we have preserved the knock-down kit of parts, easily assembled in an hour or two; yet although of much finer quality than those we used to send from England, the price is actually less.

Boffles are made from half-inch stock, the front panel being three-quarter inch tough board; all joints are keyed and glued; polished or unpolished; veneered in oak, mahogany or walnut; also in unfinished pine, if you need a truly inexpensive housing for insertion in an existing cabinet.

And—for the finest possible results, regardless of expense, we introduce the double Boffle, which, with two 215's wired in simple series, will give you for \$200 a performance not to be equalled by any speaker ensemble offered elsewhere at prices up to more than \$1000. Demonstration will prove this claim. The double Boffle can be used horizontally or vertically and measures 30" x 18" x 18". The single Boffle remains at 18" x 18" x 18".

Prices

**THE HARTLEY 215 SPEAKER \$57.50
THE TRUE-BASS BOFFLE**

FINISH	SINGLE	DOUBLE
Veneered in oak, mahogany or walnut, completely finished	\$75.00	\$85.00
do do do do unpolished	\$50.00	\$55.00
do do do do kit of parts	\$40.00	\$45.00
Unfinished pine (can be stained and polished or painted)	\$40.00	\$45.00
do do do do kit of parts	\$30.00	\$35.00

HARTLEY TONE-CONTROL PREAMPLIFIER \$35.00

HARTLEY 20 WATT AMPLIFIER \$135.00

Complete with tubes.

If you have not already asked to be put on our mailing list, send a postcard to London today, so that you can be kept fully informed on all our new ideas.

**CANADIAN CUSTOMERS SEND TO LONDON FOR OUR
SPECIAL PRICE LIST.**

H. A. HARTLEY CO. INC.

521 East 162nd St., New York 56, N. Y. LU 5-4239

H. A. HARTLEY CO. LTD.

152 Hammersmith Road, London W.6, Eng.

**ADVERTISING
INDEX**

Air Tone Sound & Recording Co.	69
Allied Radio Corp.	43
Altec Lansing Corp.	53
Amperite Co., Inc.	64
Ampex Electric Corp.	11
Arnold Engineering Co.	15
Asco Sound Corp.	2
Atlas Sound Corp.	69
Audak Co.	47
Audio Devices Inc.	Cover 2
Audio Instrument Co., Inc.	58
Bell Telephone Laboratories	18
Brooklyn Hi-Fidelity Sound Center	71
Brush Development Co.	4
Camera Equipment Co.	57
Cannon Electric Co.	10
Chicago Transformer Co.	51
Cinema Engineering Co.	7
Classified Ads	70
Compco Corp.	71
Concertone Recorders	61
Diacoustic Laboratory	59
General Electric Co.	56
General Radio Co.	13
Gray Research & Dev. Co., Inc.	5
Hartley, H. A. Co., Ltd.	72
Harvey Radio Co., Inc.	45
Heath Co.	59
Hudson Radio & Television Corp.	66
Hughes Research & Dev. Labs	1
Institute of Radio Engineers	65
Jensen Mfg. Co.	41
Kierulff Sound Corp.	71
Lansing Sound, James B., Inc.	70
Leonard Radio Inc.	55
Lowell Mfg. Co.	67
Maurer, J. A. Inc.	35
Minnesota Mining & Mfg. Co.	36, 37
Olympic Electronics Supply Co.	70
Orradio Industries Inc.	Cover 3
Partridge Transformers, Ltd.	67
Peerless Electrical Products Div.	14
Pickering & Co., Inc.	17
Pilot Radio Corp.	48, 49
Precision Electronics, Inc.	64
Precision Film Laboratories	12
Presto Recording Corp.	39
Prestoseal Mfg. Corp.	66
Professional Directory	71
Radio's Master	52
Reeves Soundcraft Corp.	9
Rek-O-Kut Co.	3
Rockbar Corp.	56
Shure Bros. Inc.	6
Sonocraft Corp.	50
Stromberg Carlson Sound Div.	63
Sun Radio & Electronics Co., Inc.	61
Terminal Radio Corp.	71
Triad Transformer Mfg. Co.	60
Tung-Sol Electric Co.	8
United Transformer Co.	Cover 4
U. S. Recording Co.	71
Wholesale Radio Parts Co., Inc.	62

AT LAST!

no more unscheduled program breaks!

irish SOUND-PLATE

AN ENTIRELY NEW MAGNETIC RECORDING TAPE

It's break-proof...just what you've been wanting



(Produced and Sold Under the IRISH Label as 220RPA Red Band ORRadio Magnetic Tape)

No Other Tape Matches These Sound-Plate Features:

- SOUND-PLATE** has two times the tensile strength of acetate
- SOUND-PLATE** will not tear or break
- SOUND-PLATE** eliminates timing problems —programs on the nose
- SOUND-PLATE** is unaffected by moisture or temperature change
- SOUND-PLATE** is engineered for high speed operation, 15 to 500" per sec
- SOUND-PLATE** is not affected by static
- SOUND-PLATE** has a greater surface slip

Another Reason WHY SOUND-PLATE is Best For Professional Use!

There are differences in magnetic oxides. ORRadio molecular lubricated oxides are more stable in coating conditions and turn out more uniform layers, thus assuring you of the finest recordings possible. SOUND-PLATE is made in the ORRadio tradition.

Here, at last, the sum total of everything you have ever wanted in a professional magnetic recording tape. ORRadio IRISH 220RPA SOUND-PLATE eliminates your physical problems in magnetic tape recordings. It won't tear or break. It has all the excellent qualities that have made ORRadio IRISH 211RPA the most popular tape among professional engineers.

Yes, SOUND-PLATE costs a little more . . . but, in the long run, it will prove to be not only the most satisfactory, but the most economical magnetic recording tape you can use.

Try SOUND-PLATE at our expense! Buy a reel of SOUND-PLATE at your favorite Radio Parts Distributor. If you are not completely satisfied, return it to your distributor who has been authorized to refund your money.

1200 Ft. SOUND-PLATE on Plastic Reel	\$15.50 List	2400 Ft. SOUND-PLATE on Meta. Reel	\$33.85
--	--------------	--	---------

Manufactured in U.S.A. by

ORRADIO INDUSTRIES, INC. OPELIKA, ALABAMA

World's Largest Exclusive Magnetic Tape Manufacturer

SOUND RECORDING



RED U.S. PAT. OFF.



for Stock Hermetically Sealed Components

For over fifteen years UTC has been the largest supplier of transformer components for military applications, to customer specifications. Listed below are a number of types, to latest military specifications, which are now catalogued as UTC stock items.



RCOF CASE

Length 1 25/64
 Width 61/64
 Height 1 13/32
 Mounting 1 1/8
 Screws 4-40 FIL.
 Cutout 7/8 Dia.
 Unit Weight 1.5 oz.



RC-50 CASE

Length 1 5/8
 Width 1 5/8
 Height 2 5/16
 Mounting 1 5/16
 Screws #6-32
 Cutout 1 1/2 Dia.
 Unit Weight 8 oz.



SM CASE

Length 11/16
 Width 1/2
 Height 29/32
 Screw 4-40 FIL.
 Unit Weight 8 oz.

The impedance ratings are listed in standard manner. Obviously, a transformer with a 15,000 ohm primary impedance can operate from a tube representing a source impedance of 7700 ohms, etc. In addition, transformers can be used for applications differing considerably from those shown, keeping in mind that impedance ratio is constant. Lower source impedance will improve response and level ratings... higher source impedance will reduce frequency range and level rating.

MINIATURE AUDIO UNITS...RCOF CASE

Type No.	Application	MIL Type	Pri. Imp. Ohms	Sec. Imp. Ohms	DC in Pri., MA	Response \pm 2db. (Cyc.)	Max. level dbm	List Price
H-1	Mike, pickup, line to grid	TF1A10YY	50,200 CT, 500 CT*	50,000	0	50-10,000	+5	\$16.30
H-2	Mike to grid	TF1A11YY	82	135,000	50	250-8,000	+21	16.00
H-3	Single plate to single grid	TF1A15YY	15,000	60,000	0	50-10,000	+6	13.50
H-4	Single plate to single grid, DC in Pri.	TF1A15YY	15,000	60,000	4	200-10,000	+14	13.50
H-5	Single plate to P.P. grids	TF1A15YY	15,000	95,000 CT	0	50-10,000	+5	15.30
H-6	Single plate to P.P. grids, DC in Pri.	TF1A15YY	15,000	95,000 split	4	200-10,000	+11	16.30
H-7	Single or P.P. plates to line	TF1A13YY	20,000 CT	150/600	4	200-10,000	+21	16.30
H-8	Mixing and matching	TF1A16YY	150/600	600 CT	0	50-10,000	+8	15.30
H-9	82/41:1 input to grid	TF1A10YY	150/600	1 meg.	0	200-3,000 (4db.)	+10	16.30
H-10	10:1 single plate to single grid	TF1A15YY	10,000	1 meg.	0	200-3,000 (4db.)	+10	15.00
H-11	Reactor	TF1A20YY	300 Henries-0 DC, 50 Henries-3 Ma. DC,	6,000 Ohms.				12.00

COMPACT AUDIO UNITS...RC-50 CASE

Type No.	Application	MIL Type	Pri. Imp. Ohms	Sec. Imp. Ohms	DC in Pri., MA	Response \pm 2db. (Cyc.)	Max. level dbm	List Price
H-20	Single plate to 2 grids, can also be used for P.P. plates	TF1A15YY	15,000 split	80,000 split	0	30-20,000	+12	\$20.30
H-21	Single plate to P.P. grids, DC in Pri.	TF1A15YY	15,000	80,000 split	8	100-20,000	+23	23.30
H-22	Single plate to multiple line	TF1A13YY	15,000	50/200, 125/500**	8	50-20,000	+23	21.30
H-23	P.P. plates to multiple line	TF1A13YY	30,000 split	50/200, 125/500**	8	30-20,000 BAL.	+19	20.30
H-24	Reactor	TF1A20YY	450 Hys.-0 DC, 250 Hys.-5 Ma. DC, 65 Hys.-10 Ma. DC,	1500 ohms.				15.30

SUBMINIATURE AUDIO UNITS...SM CASE

Type No.	Application	MIL Type	Pri. Imp. Ohms	Sec. Imp. Ohms	DC in Pri., MA	Response \pm 2db. (Cyc.)	Max. level dbm	List Price
H-30	Input to grid	TF1A10YY	50***	62,500	0	150-10,000	+13	\$13.00
H-31	Single plate to single grid, 3:1	TF1A15YY	10,000	90,000	0	300-10,000	+13	13.00
H-32	Single plate to line	TF1A13YY	10,000****	200	3	300-10,000	+13	13.00
H-33	Single plate to low impedance	TF1A13YY	30,000	50	1	300-10,000	+15	13.00
H-34	Single plate to low impedance	TF1A13YY	100,000	60	.5	300-10,000	+6	13.00
H-35	Reactor	TF1A20YY	100 Henries-0 DC, 50 Henries-1 Ma. DC,	4,400 ohms.				11.00

* 200 ohm termination can be used for 150 ohms or 250 ohms, 500 ohm termination can be used for 600 ohms.
 ** 200 ohm termination can be used for 150 ohms or 250 ohms, 125/500 ohm termination can be used for 150/600 ohms.
 *** can be used with higher source impedances, with corresponding reduction in frequency range. With 200 ohm source, secondary impedance becomes 250,000 ohms... loaded response is -4 db. at 300 cycles.
 **** can be used for 500 ohm load... 25,000 ohm primary impedance... 1.5 Ma. DC.

United Transformer Corp.
 150 VARICK STREET • NEW YORK 13, N. Y.

EXPORT DIVISION: 13 EAST 40th STREET, NEW YORK 16, N. Y. CABLES: "ARLAB"