

# AUDIO ENGINEERING

November  
1952  
35c



THE WORLD OF SOUND

NEW 7" REELS OF  
audiotape\* give you

# EXTRA VALUE

*at no extra cost!*

## GUARANTEED SPLICE-FREE

## SPLIT-SECOND TIMING with New 2 $\frac{3}{4}$ " Hub

Timing errors are virtually eliminated by this improved reel design which minimizes tension and speed changes throughout the winding cycle. Ratio of O.D. to hub diameter is the same as on the standard NAB aluminum reel.



## PERFECTED ANTI-FRICTION PROCESS.

Reduces head wear—eliminates annoying tape "squeal" — prevents "tackiness" even under extreme temperature and humidity conditions.

## MAXIMUM UNIFORMITY OF OUTPUT.

All 7" and 10" reels of plastic-base Audiotape are guaranteed to have an output uniformity *within*  $\pm \frac{1}{4}$ db — and reel-to-reel-variation of less than  $\pm \frac{1}{2}$ db. What's more, there's an actual *output curve* in every 5-reel package to prove it.

With Audiotape, all of these extra-value features are *standard*. There's no extra cost—no problem of separate inventories or variations in tape quality.

For there's *only one* Audiotape — the finest obtainable anywhere. Test it — compare it — let Audiotape speak for itself.

The new 7-inch plastic reel with large diameter hub for greater timing accuracy is now being supplied on all orders unless otherwise specified. Because of increased hub diameter, maximum reel capacity is slightly over 1200 feet. Older style Audiotape reels with 1 $\frac{3}{4}$ " hub and 1250 feet of tape will continue to be furnished on request at the same price.

\*Trade Mark

## AUDIO DEVICES, Inc.

444 Madison Ave., New York 22, N. Y.

Export Department, 13 East 40th St., New York 16, N. Y., Cables "ARLAB"

audiorecorders • audiotape • audiofilm • audiopoints

Successor to **RADIO** — Established 1917

# AUDIO ENGINEERING



**C. G. McProud, Editor and Publisher**

Harrie K. Richardson, Associate Editor  
Eve Drolet, Production Manager  
Elizabeth Beebee, Circulation Manager  
Edgar E. Newman, Circulation Promotion

Edgar M. Villchur, Contributing Editor  
Henry A. Schober, Business Manager  
S. L. Cahn, Advertising Director  
H. N. Reizes, Advertising Manager

**Editorial Advisory Board**

Howard A. Chinn  
John D. Calvin  
C. J. LeBel  
J. P. Maxfield  
George M. Nixon



**Representatives**

H. Thorpe Covington, Special Representative  
677 N. Michigan Ave., Chicago 11, Ill.  
Sanford R. Cowan, Mid-West Representative  
67 W. 44th St., New York 18, N. Y.  
James C. Galloway, Pacific Coast Sales  
816 W. 5th St., Los Angeles 17, Calif.  
Technical Book & Magazine Co.  
297 Swanston St., Melbourne, C. I.  
Victoria, Australia

**CONTENTS NOVEMBER, 1952 Vol. 36, No. 11**

Audio Patents—Richard H. Dorf .....	2
Letters .....	6
The Frudd Audio System—D. B. Frudd .....	12
Editor's Report .....	16
The Maestro—A POWER Amplifier—David Sarser and Melvin C. Sprinkle Theory and Construction of a Harmonic Distortion Meter— George Ellis Jones, Jr. ....	19
Measuring up an Audio Transformer—N. H. Crowhurst .....	22
Record Improvement with H.F. Cut-Off Filters—Elliott W. Markow .....	24
Trade Secrets and Their Protection—Albert Woodruff Gray .....	27
New Medium Cost Amplifier of Unusual Performance— G. Leonard Werner and Henry Berlin .....	29
Cathode-Follower Audio Control System—G. B. Houck .....	30
The Violin—Part 3—Albert Preisman .....	32
Handbook of Sound Reproduction—Chapter 6—E. M. Villchur .....	36
Record Revue—Edward Tatnall Canby .....	40
Speech Clipper Aids Station Performance—R. S. Houston .....	48
Audio Fair Exhibit Directory .....	50
New Products .....	54
New Literature .....	68
The Golden Ear—Don V. R. Drenner .....	70
Technicana .....	81
Price and Product Changes—Radio's Master Reports .....	83
Industry Notes .....	90
Advertising Index .....	91
	92

**COVER**

Typical living-room arrangement comprising three custom-built cabinets provided by Harrison Associates, 17 W. 44th Street, New York 36, N. Y., and photographed in the residence of Mr. and Mrs. William J. Howell, Jr. At the left is a tape-recorder cabinet, designed for and housing a tapeMaster Model TH-25, and constructed of blond natural birch with a black lacquer top and black iron legs. The corner speaker cabinet, following in principle an early Æ design, is natural birch with a lacquer finish. This particular unit houses a 10-inch speaker, but in slightly higher form can accommodate a 12-incher. At the right is a radio-phonograph cabinet of black-lacquered birch and fitted with a Garrard changer and a Radio Craftsmen tuner and amplifier. The decorative touch is supplied by model Susan Sayers.

**RADIO MAGAZINES, INC., P. O. BOX 629, MINEOLA, N. Y.**

AUDIO ENGINEERING (title registered U. S. Pat. Off.) is published monthly at 10 McGovern Avenue, Lancaster, Pa., by Radio Magazines, Inc., Henry A. Schober, President; C. G. McProud, Secretary. Executive and Editorial Offices: 204 Front St., Mineola, N. Y. Subscription rates—United States, U. S. Possessions and Canada, \$3.00 for 1 year, \$5.00 for 2 years; elsewhere \$4.00 per year. Single copies 35c. Printed in U. S. A. All rights reserved. Entire contents copyright 1952 by Radio Magazines, Inc. Entered as Second Class Matter February 9, 1950, at the Post Office, Lancaster, Pa. under the Act of March 3, 1879.



You may own the finest pickup, amplifier and speaker that money can buy...yet you'll get poor reproduction if your **TURN-TABLE** has excessive wow, hum or rumble!

## REK-O-KUT

offers a complete range of 12" Turntable models. Not every sound system requires the most expensive Turntable...your Turntable must be chosen to complement your other components.

Every Rek-O-Kut Turntable is made of a heavy aluminum casting, which is lathe turned and balanced for smooth, wow-free operation.



**MODEL LP-743**  
3-Speed, 12" Turntable

The outstanding value for the buyer who seeks a quality turntable priced between deluxe and ordinary phono models. Dimensioned for replacement of obsolete motors in average consoles. Features instantaneous speed changes.

**MODEL CVS-12**  
All-Speed, Continuously-Variable Speed Turntable

Plays all records, 33 $\frac{1}{3}$ , 45 and 78's, not only at their recorded speed — BUT AT ANY SPEED FROM 25 TO 100 R.P.M. A "must" for serious music lovers, professional musicians, schools, dance studios, etc., etc.



**MODELS T-12H and T-43H**  
2-Speed 12" Turntables

The only 12", 2-speed turntable, recommended for use with ultra-high fidelity amplifiers and Speaker systems.

MODEL NO.	MOTOR	Noise Level	SPEEDS	PRICE
LP-743	4 Pole Induction	—30 DB	78-45-33 $\frac{1}{3}$	\$54.95
CVS-12	4 Pole Induction	—30 DB	Continuously Variable	84.95
T-12	4 Pole Induction	—40 DB	78-33 $\frac{1}{3}$	84.95
T-43	4 Pole Induction	—40 DB	45-33 $\frac{1}{3}$	84.95
T-12H	Hysteresis Synchronous	—50 DB	78-33 $\frac{1}{3}$	119.95
T-43H	Hysteresis Synchronous	—50 DB	45-33 $\frac{1}{3}$	119.95

See...Hear...Compare REK-O-KUT Turntables, Phonographs and Disc Recorders at leading Music Stores, Radio Parts Jobbers and Audio-Visual Dealers...or write for latest catalog.

**REK-O-KUT CO.**  
38-03 B Queens Blvd., Long Island City, N. Y.  
EXPORT DIVISION: 458 Broadway, New York City, U. S. A.  
CANADA: ATLAS RADIO CORP., LTD., 560 King St. W., Toronto 28, Ontario

**SOLVE** your hi-fidelity problems with  
**University**  
**CONE**  
**SPEAKERS**  
**-HIGHEST QUALITY!**  
**-LOWEST COST!**



**MODEL 6201 — COAXIAL SPEAKER SYSTEM.** Now generally acknowledged to be industry's finest value in a high quality 12" speaker. TRUE coaxial dual range system comprising clean sounding woofer with heavy exclusive Alnico 5W magnet, DRIVER TYPE tweeter with "Reciprocating flares" wide angle horn, and BUILT-IN crossover network complete with "Balance" control.

**DIFFUSICONE-12 — WIDE RANGE WIDE ANGLE 12" SPEAKER.** Exclusive "diffusicone" design utilizes the benefits of dual-horn loading, radial projection and diffraction principles to achieve unsurpassed quality and sound distribution from a single unit speaker. Enjoy full fidelity ANYWHERE in the room . . . at a surprisingly reasonable cost.

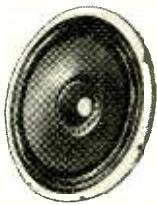

**DIFFUSICONE-8 — WIDE ANGLE 8" SPEAKER.** Same as the Diffusicone-12 except in 8" size. Remarkable fidelity and exceptional sensitivity and power handling capacity make this a truly outstanding eight. Ideal for use where space is limited, and is also a perfect selection for a mid-range speaker in 3-way systems.



**MODEL 6200—EXTENDED RANGE 12" SPEAKER.** Designed for general applications, capable of highly efficient FULL-BODIED response throughout the operating spectrum. May be used with equal facility to improve commercial radio, TV, phono sets, high quality sound re-inforcement in night clubs, churches, schools, etc., or as a woofer. The 6200 must be heard to be appreciated.

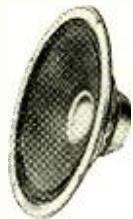

**MODEL C-15W—DUAL IMPEDANCE RANGE 15" WOOFER.** Brand new low frequency reproducer embodying many exclusive advance features. Its superior response and acoustic output is due, in part, to a newly University-developed cone and voice coil suspension system permitting the greatest axial movement ever achieved. The incredibly low distortion results from a new magnet assembly.



There is a UNIVERSITY Tweeter for every application and pocketbook. Write for descriptive illustrated literature. Address Desk A-11.

**University**  
**LOUDSPEAKERS INC**  
 80 SO. KENSICO AVE., WHITE PLAINS, N. Y.



# AUDIO PATENTS

RICHARD H. DORF\*

**W**HILE THE MERITS, from the standpoint of the discriminating listener, of wired-music systems are debatable, the fact remains that the trend toward them is growing. Restaurants, hotels, and many other places subscribe or want to subscribe to this kind of background music. One of the ways in which it is distributed is by way of FM radio. The venture is made profitable by inserting commercial or "public service" announcements between musical selections and then offering for rent receivers which, in conjunction with special signals from the station, cut out the announcements.

Patent No. 2,596,138, assigned by the inventors, Nathaniel Feiner and Samuel H. Gershater, to Functional Music, Inc., of Chicago, presents an ingenious method of cutting out the commercials by transmitting two supersonic tones. The circuit is actually an electronic switch using no relays or other moving parts and would be useful in many remote switching applications or radio-control uses, entirely aside from its intended function. The feature is that a single short transmission of one tone biases a tube to cutoff and leaves it there; transmission of the second tone for a second or so causes the tube to conduct again and remain in the conducting state.

The complete schematic diagram, with all the component values, appears in Fig. 1. According to the patent specification, the two tubes are a 6SL7 and a 6L7. The latter is obviously an error, however, and both tubes are probably 6SL7-GT's.

The radio receiver (or whatever input source is used in other applications) is shown as a box, the output of which, at

medium audio level, appears between a "high" terminal and ground. It is fed to  $V_2$ , the audio amplifier tube of the circuit, through blocking capacitor  $C_2$  (if needed) and to  $V_3$ , the control signal amplifier, through  $C_6$ .

Considering first the operation of  $V_2$ , the plate is supplied through load resistor  $R_8$ . The cathode is biased with positive voltage from the plate supply; there is a voltage divider of which one arm is  $R_7$  and the other is  $R_9$ ,  $R_9$  and  $R_{10}$  in series. The bias so obtained is normal for amplifier operation and the tube is conducting. The following circuits (power amplifier, etc.) are receiving the program and all is normal.

$V_1$  is the principal control tube. Its grid contains a tank circuit tuned to 20 kc and receiver output signal reaches this grid at all times through the control signal amplifier  $V_3$ . The grid of  $V_1$  is biased somewhat positive by a voltage divider  $R_3$ - $R_1$  across the plate-voltage supply, with  $R_2$  in series with the bias tap for isolation purposes. The plate of  $V_1$  is placed at a positive potential by its connection to the top of  $R_5$ . The same voltage divider ( $R_7$ - $R_9$ - $R_{10}$ ) which furnishes cathode bias for the amplifier tube  $V_2$  supplies plate voltage to  $V_1$  from the  $R_9$ - $R_{10}$  tap. The remaining resistor in series with this tap and the plate of  $V_1$  is  $R_6$ , which plays an important role.

The cathode of  $V_1$  is biased somewhat positive by still another tap on the same voltage divider, the point between  $R_9$  and  $R_{10}$ . This is of such value that the cathode of  $V_1$  is much more positive than is the grid; the grid is therefore effectively very negative with respect to its cathode and  $V_1$  is cut off. Since no plate current is flowing in  $V_1$ , there is no current through  $R_6$  and no d.c. voltage drop across it.

\* 255 W. 84th St., New York 24, N. Y.

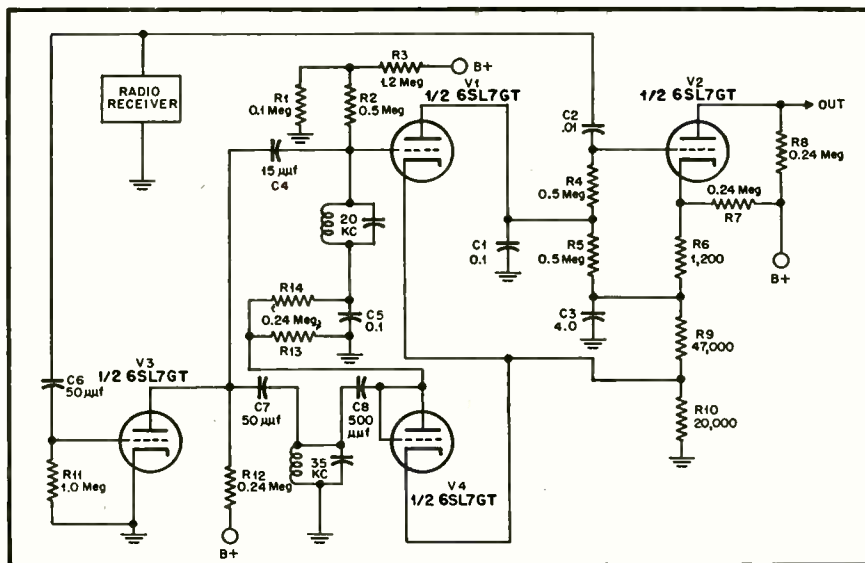
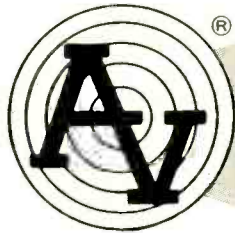

Fig. 1

**FOR QUALITY AUDIO EQUIPMENT**



**Audio & Video**  
PRODUCTS CORPORATION

**AMPEX ELECTRIC CORP.**

**MINNESOTA MINING & MANUFACTURING CO.**

**ALTEC LANSING CORP.**

**ELECTRO-VOICE INCORPORATED**

**McINTOSH LABORATORY, INC.**

**FAIRCHILD RECORDING EQUIPMENT CORP.**

**CINEMA ENGINEERING CO.**

**SPENCER-KENNEDY LABORATORIES, INC.**

**AUDIO & VIDEO CUSTOM INSTALLATIONS**

**A-V TAPE LIBRARIES, INC.**

**Audio & Video**  
PRODUCTS CORPORATION

730 Fifth Ave.  
New York 19, N. Y.  
PLaza 7-3091

261 Constitution Ave.  
Washington, D. C.  
REpublic 8566

*presenting*

**AT THE 1952 NEW YORK AUDIO FAIR**

THE

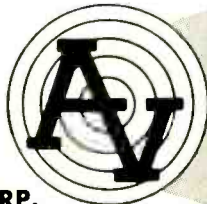

**NEW AMPEX 403-2A**  
**STEREOPHONIC**  
MAGNETIC TAPE RECORDER

**... it hears with two ears ...**  
**and speaks in infinite tones**

**AMPEX** again demonstrates its leadership in sound recording with the development of the *403-2A stereophonic recorder*—a superb mechanism patterned upon the dual hearing process of your natural listening instrument — the human ear.

Audio & Video Products Corp.  
730 Fifth Ave., N. Y. 19



Please send me information on:

- New Ampex 403-2A Stereophonic Recorder
- Audio products of the following manufacturers (see list above left)

NAME \_\_\_\_\_

ADDRESS \_\_\_\_\_





**"It's SONODYNE**  
**MULTI-IMPEDANCE DYNAMIC MICROPHONE**  
**at recording time!"**

**—say actual users\* in the field  
 and here are a few reasons why ...**

 "This microphone has been used for a variety of purposes—but mostly for tape recording fifteen-minute shows for future airing on a nearby radio station. We like it fine, and it does take a beating."  
*Speech and Drama Director  
 Indiana*

 "A wonderful little mike. Plenty of gain and normal voice."  
*Director of Radio Activities  
 Texas*

 "We are using this microphone with good results on our recorder."  
*Audio-Visual Librarian*

 "Wonderful for wire recording purposes and P.A. use. I use it mainly for recording."  
*Sound Service Massachusetts*

 "Used for recording organ music. Performance is very satisfactory; especially good on highs."  
*Recording Professional  
 Colorado*

 "Very good output and fidelity. Used for recording for broadcast purposes."  
*Producer and Director  
 Canada*

 "Excellent results in recording and for comments in the showing of motion pictures."  
*Amateur  
 New York*

\* Individual names available on request.



**SHURE BROTHERS, Inc. — Microphones and Acoustic Devices**  
 225 West Huron Street, Chicago 10, Illinois • Cable Address: SHUREMICRO

When the commercial is about to begin, the station sends out a 20-kc tone. The tone is inaudible, even though it is transmitted through  $V_2$  and the following amplifiers. It is also amplified by  $V_3$  and sent to the grid of  $V_1$ . Since the tuned circuit is resonant at this frequency, the positive grid-voltage peaks of 20-kc tone are enough to overcome the cutoff bias on  $V_1$  and cause it to draw some current. When it does so, current is drawn through  $R_5$ , making its upper end—and therefore the grid of  $V_2$ —negative. ( $C_1$  is a smoothing capacitor). As the grid of  $V_2$  goes more negative, the  $V_2$  plate current falls, reducing the current drawn by  $V_2$  through  $R_{10}$ . This reduces the cathode bias of  $V_1$ . The process continues (almost instantaneously, of course) until  $V_2$  is cut off and  $V_1$  is fully conducting. When that happens the voltage drop across  $R_3$  keeps the  $V_2$  grid negative enough to maintain cutoff. The 20-kc tone may be removed, but since  $V_2$  remains cut off, no audio is being transmitted to the output terminals of the system.

When the commercial is ended, a 35-kc tone is transmitted for a short time to restore operation. This passes through  $V_3$  and to the 35-kc tank circuit.  $V_4$  is connected across this tank as a rectifier, and develops a negative voltage across  $R_{13}$ . The negative voltage is connected to the grid of  $V_1$  through  $R_{14}$  and the 20-kc tank.

As the grid of  $V_1$  is made negative in this way, its plate draws less current through  $R_5$ , reducing the bias on the grid of  $V_2$  and allowing it to draw some current. When it does draw current, the voltage drop across  $R_{10}$  rises, adding to the bias on  $V_1$ . The action is again cumulative and  $V_1$  quickly goes to cutoff while  $V_2$  resumes its conducting condition. The circuit has then been restored to its original operative condition and the 35-kc restoring tone may be removed.

Other components of the circuit are:  $C_2$ , the  $V_2$  cathode bypass;  $C_3$ , a blocking capacitor prevent the 35-kc tank from shorting the diode load resistor  $R_{13}$ ; and  $C_5$ , which grounds the bottom of the 20-kc tank for r.f. but keeps it above ground for the rectified d.c. from the 35-kc restoring circuit.

*Is your answer  
 YES?*

Do you like clean, fresh copies of your magazines?

Do you like to keep a permanent file of **AUDIO ENGINEERING**?

Do you like to clip coupons, but hesitate because it defaces your magazines?

If your answer to these questions is **YES**, read our advertisement at the bottom of

**PAGE 87**

Radio Magazines, Inc., P. O. Box 629,  
 Mineola, N. Y.

*Check*  
**SERVICE**

SEE PAGE 76

Be Sure of Your Installations

Get the *Aptitude-Tested*  
**RG/U TRANSMISSION  
 LINE CABLES**

You know what you are doing when you use Belden RG/U Transmission Line Cables—they're aptitude rated. They are designed to provide desirable electrical characteristics, and rigid control assures constant quality. Specify Belden Radio Wires.  
 Belden Manufacturing Co. 4629-R.W. Van Buren St., Chicago 44, Ill.



To You,  
 Belden's Golden Anniversary Means

—product performance that can come only from a "know-how" that has grown through actual service since the inception of Radio.

—an ability to cooperate in a pioneering new wires to meet or anticipate industry's growing needs.

In the years that follow

This Belden Program Is—

—TO BE CONTINUED

APTITUDE RATING No. 8236		APTITUDE RATING No. 8237		APTITUDE RATING No. 8238		APTITUDE RATING No. 8239		APTITUDE RATING No. 8241	
Frequency (Mc)	Attenuation per 100 ft	Frequency (Mc)	Attenuation per 100 ft	Frequency (Mc)	Attenuation per 100 ft	Frequency (Mc)	Attenuation per 100 ft	Frequency (Mc)	Attenuation per 100 ft
100.	2.65	100.	2.10	100.	1.90	100.	3.10	100.	3.75
200.	3.85	200.	3.30	200.	2.85	200.	4.40	200.	5.60
300.	4.80	300.	4.10	300.	3.60	300.	5.70	300.	7.10
400.	5.60	400.	4.50	400.	4.35	400.	6.70	400.	8.30



**Belden**  
*Radio* WIRE

The  
*Aptitude-Tested* **LINE**

# LETTERS

## Patent Protection

Sir:

During recent years a certain looseness has been evidenced in the granting of patents which is cause for quiet alarm. Since the handling given patent claims is but a projection of the basic law, it would appear worthwhile to examine the situation which existed at the time the original statutes were enacted, particularly insofar as intent can be determined. When this is done it becomes clear enough that the original motivating force was the desire to foster technological development in the United States by granting such rights to an inventor as would protect him from exploitation and assure a return proportional to the value of his work. The whole idea was one of encouragement, and it is significant to note that the effect was to be cumulative. Thus while the grant was aimed directly at the inventor himself, the "chain reaction" type of effect upon other inventors was possibly of even greater importance than the first-order effect. Looking at today, we see the high level of development work in the electronics field as a fertile breeding ground for important inventions yet to come. Now this work cannot go forward if our engineers and experimenters find that important "tools" have been taken from them arbitrarily. By "tools" I mean the basic general knowledge which supports the state of the art as we know it, or—stated somewhat differently—the material that constitutes the substance of our engineering textbooks. When I find that patents are granted for "the exclusive right to make, use, and vend" circuits or devices which stem from the fundamental characteristics of ordinary circuit elements, or even theorems, then I see restrictive practices at their worst. As a group example I cite the various arrangements of resistors and capacitors into simple frequency-sensitive circuits, each based upon nothing more profound than the formula for capacitive reactance. Do the inventors recognized in these patents personally own the "tone controls" they claim? By law and by grant they do!

Categorically, the control of inventions by patent is essential in an industrial nation such as ours. Even so, I do not believe that the applicable laws were ever intended to operate in a manner which would permit an individual to "squeeze" his fellow workers. Engineering discipline and engineering freedom are both needed in a well balanced and healthy technology. Thus it would appear that those who administer the plan would be well advised to follow a two-point program aimed at over-all improvement and general good: specifically (1) a rededication to the aim of fostering the technological advancement of our country; and the corollary (2) a refusal to recognize legal claims resting solely upon a "twist" of common knowledge.

## Coming Up— Perfect Precision Prints

### WE CALL IT "VELVETING"

Every original submitted to the Laboratory is carefully cleaned at the outset and kept that way throughout every operation. Specially designed cleaning machines exclusive with Precision, do the work . . . supplemented by careful hand cleaning, or "velveting."



## YOUR ASSURANCE OF BETTER 16mm PRINTS

**15 Years Research and Specialization** in every phase of 16mm processing, visual and aural. So organized and equipped that all Precision jobs are of the highest quality.

**Individual Attention** is given each film, each reel, each scene, each frame — through every phase of the complex business of processing — assuring you of the very best results.

**Our Advanced Methods** and our constant checking and adoption of up-to-the-minute techniques, plus new engineering principles and special machinery

enable us to offer service unequalled anywhere!

**Newest Facilities** in the 16mm field are available to customers of Precision, including the most modern applications of electronics, chemistry, physics, optics, sensitometry and densitometry—including exclusive Maurer-designed equipment—your guarantee that only the best is yours at Precision!

*Precision Film Laboratories — a division of J. A. Maurer, Inc., has 14 years of specialization in the 16mm field, consistently meets the latest demands for higher quality and speed.*

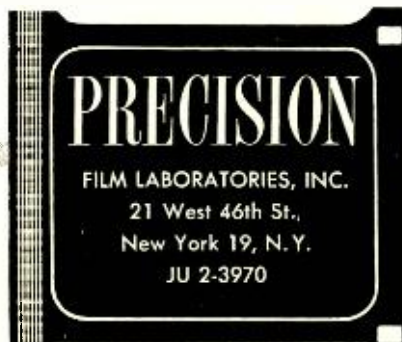



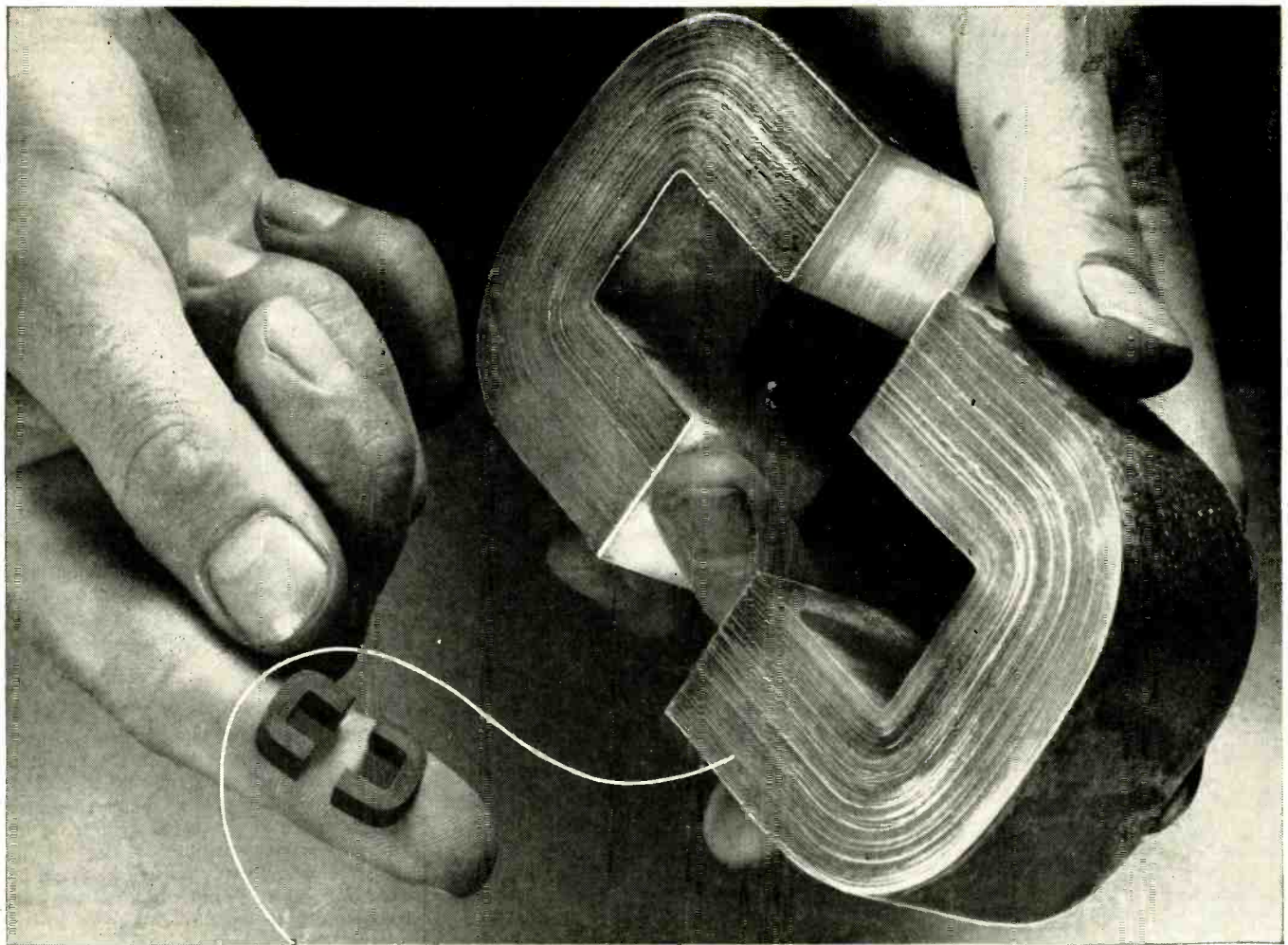

# SILECTRON C-CORES... **BIG** or LITTLE

*...any quantity and any size*

*Wound from  
precision rolled  
oriented silicon  
steel strip as thin  
as .00025"*

For users operating on government schedules, Arnold is now producing C-Cores wound from 1/4, 1/2, 1, 2, 4 and 12-mil Silectron strip. The ultra-thin oriented silicon steel strip is rolled to exacting tolerances in our own plant on precision cold-reducing equipment of the most modern type. Winding of cores, processing of butt joints, etc. are carefully controlled, assuring the lowest possible core losses, and freedom from short-circuiting of the laminations.

We can offer prompt delivery in production quantities—and size is no object, from a fraction of an ounce to C-Cores of 200 pounds or more. Rigid standard tests—and special electrical tests where required—give you assurance of the highest quality in all gauges. • *Your inquiries are invited.*

## THE ARNOLD ENGINEERING COMPANY



SUBSIDIARY OF ALLEGHENY LUDLUM STEEL CORPORATION

General Office & Plant: Marengo, Illinois

W4D 4363

for those who treasure

# the art of listening

STEPHENS TRU-SONIC SPEAKER SYSTEMS ARE SUPREME

Acceptance by the leaders both in the commercial and custom set building fields has been the award most prized by Stephens engineers through the years. They know this recognition is a verdict of the truly discriminating ear and it serves as a spur in Stephens' never-ending search for new peaks of perfection in sound reproduction components.

See us at the Audio Fair, Room 602

Stephens proudly presents . . .



**THE 106AX COAXIAL 2-WAY SPEAKER** for full, rich, natural sound across the entire tone spectrum at all volume levels. One compact assembly combining a cone-type, low-resonant, low-frequency unit with multi-cellular type, wide-angle high-frequency dispersion (eight cells,  $40^\circ \times 80^\circ$ ). A 1200-cycle crossover network channels high and low tones to units designed to reproduce them. Power rating—20 watts. Impedance—16 ohms. Frequency response—40 to 12,000 cps. Diameter— $15\frac{1}{8}$ ". Baffle opening— $13\frac{1}{2}$ ". Depth behind mounting panel— $10\frac{1}{2}$ ". Weight—30 lbs. Recommended for broadcast monitoring, motion picture sound, and—*especially*—FM and record reproduction.

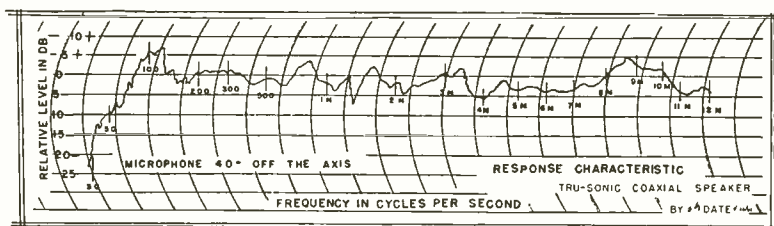

And

**THE MODEL 418 CORNER CABINET**, the finest custom-quality home reproducer in the Stephens TRU-SONIC line. It features two 15" permanent magnet speakers with extended range for low tones, plus the full coverage in the high ranges afforded by the use of a Model 824H 2x4 800-cycle horn, a Model 108 high-frequency driver, and a Model 800X crossover network. Cabinet dimensions: Width—41"; Depth—23"; Height—36"; Weight—155 lbs. Available in blond or mahogany.

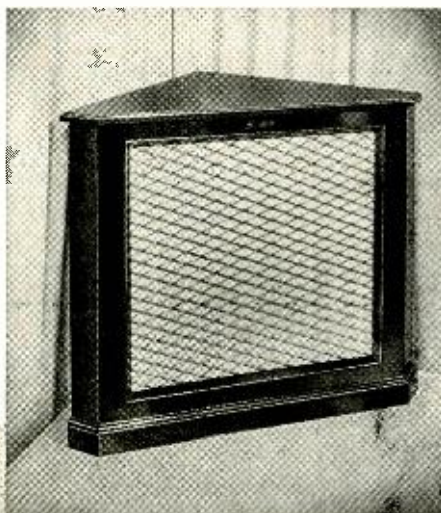

**STEPHENS**  
TRU-SONIC

WRITE FOR FREE LITERATURE TODAY!  
**MANUFACTURING CORPORATION**

8538 WARNER DR., CULVER CITY, CALIF.

Our present trouble seems to be one of "magnifying trifles while trifling with magnitudes."

JOE DICKEY,  
75 Roseneath Ave.,  
Newport, R. I.

## More Loudness Control Comments

Sir:

It seems evident that we are going to have discussions on loudness control as long as engineers continue to toy with infinitesimal details, intriguing curves, and pseudo-psychological reactions.

Mr. Schjelderup points out, in his September article, gross errors of interpretations on this subject by audio men, yet he—like all the others who fuss with this problem—seems lost in the details. They see the trees but not the forest, to quote an overworked cliché.

All the so-called solutions to this problem are based on the axiom that the input audio signals to the loudness control are equal and that the control is necessary to adjust the output loudness of the amplifier to a desirable level. Instead of analyzing the problem, they should scrutinize the axiom. Let's take a closer look.

Let us assume the input is from a tuner. Every radio engineer knows the output of any tuner is not constant—either AM or FM. Adjustment of the loudness control must be made to give equal speaker output. On the phono position of the selector switch a similar variation will be found because LP's and 78's are not cut at the same level—and even among LP's there will be a variation of as much as 10 db. This requires adjustment of the control to maintain the same output at the speaker.

It should be obvious at this point that since the input signal varies with the source, an adjustment of the loudness control has to be made to produce the same listening level, and since the loudness control is also tied in with tone compensating networks, we change the tonal balance when it should remain the same.

Many engineers assume that when we turn down the volume for background music, we still require hi-fi range and balance. Wired music and supersonic air music as received in restaurants, hotels, banks, etc. prove this is not so. We want a diminished range so that the music will be heard as a background and not interfere with conversations. And to assume that a diminished sound output can create the same listening sensation as a more realistic output is flirting with the imagination. The tone compensation required involves the psychological reaction of the individual—an indeterminate factor.

Of course, there is no harm in having a loudness control even though, for optimum results, we still have to change our tone controls with each record played, according to some of the leading record reviewers, but let's not kid ourselves into believing that this problem has a real solution until at least all records, tuners, and other sound sources are created equal.

EDWIN SCHWARZ  
P. O. Box 6  
Devon, Conn.

# "Pitch changes are no problem with this new tape reel!"

Says Bob Pappin, Chief Recording Engineer,  
Schmitt Music Company, Minneapolis, Minn.



**NEW LARGE HUB** on the "Scotch" Brand 7-inch professional reel produces a marked reduction in tension changes as tape is spooled off; this, in turn, reduces pitch changes remarkably. You can splice and dub from reel to reel with hardly noticeable changes in pitch. Timing errors are also reduced as much as 50%.

Diameter of the new hub is  $2\frac{3}{4}$ ", compared with the  $1\frac{3}{4}$ " diameter of standard 7" reels. This gives it approximately the same ratio of outside diameter to hub diameter as the standard NARTB  $10\frac{1}{2}$ " metal reel.

Another feature of this new reel is the single small threading slot instead of the usual three. This minimizes mechanical distortion of the layers of tape nearest the hub.

**SEE YOUR DISTRIBUTOR FOR A SUPPLY OF  
7" PROFESSIONAL REELS AND NEW  
DRY LUBRICATED TAPE!**



The term "SCOTCH" and the plaid design are registered trademarks for Sound Recording Tape made in U.S.A. by MINNESOTA MINING & MFG. CO., St. Paul 6, Minn.—also makers of "Scotch" Brand Pressure-sensitive Tapes, "Under-seal" Rubberized Coating, "Scotchlite" Reflective Sheeting, "Safety-Walk" Non-slip Surfacing, "3M" Abrasives, "3M" Adhesives. General Export: 122 E. 42nd St., New York 17, N. Y. In Canada: London, Ont., Can.



## *A greatly improved tape to match this greatly improved reel!*

- **"DRY LUBRICATING"** process gives you a tape that practically eliminates sticking, squealing and cupping... a completely dependable tape that turns in a flawless performance in extreme conditions of heat and humidity!
- **THINNER CONSTRUCTION** allows a full 1200 feet of tape to be wound on the new reel despite its larger nub. Magnetic properties of this new tape are identical with "Scotch" Brand 111-A, the industry's standard of quality.
- **100% SPLICE-FREE!** Tape supplied on the new 7" professional reel is guaranteed to be completely free of splices.
- **GUARANTEED UNIFORMITY!** Output variation of tape wound on the new 1200-foot reel is guaranteed to be less than plus or minus  $\frac{1}{4}$  db at 1000 cps within the reel, and less than plus or minus  $\frac{1}{2}$  db from reel to reel.

REG. U.S. PAT. OFF.  
**SCOTCH**  
BRAND  
**MAGNETIC  
TAPE**

IF YOU DO NOT  
COUNT THE COST



OR IF YOU DO

h. h. Scott

amplifiers are still the best



1st choice, remote-control amplifiers:  
H. H. Scott, type 214-A

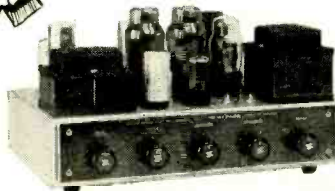

1st choice, single-chassis amplifiers:  
H. H. Scott, type 210-B

A strong statement? Actually it is based on impartial tests of high fidelity equipment by experts of unquestioned authority.

C. G. Burke, with a jury of critical listeners, tested, compared, and rated leading equipment for the new SATURDAY REVIEW HOME BOOK OF RECORDED MUSIC AND SOUND REPRODUCTION. Five music systems in different price categories were selected, each category listing equipment judged to be best in that price class. And H. H. Scott amplifiers are rated "1st choice" in all three top systems.

Price was no object in System I — musical performance alone was the criterion. Yet in System III — well within reach of most of us who count our dollars — an amplifier by H. H. Scott is still given top place.

May we suggest that you yourself appraise the method and results of these impressively complete, most authoritative comparison tests. For real help in selecting equipment, read the discussion in the SATURDAY REVIEW HOME BOOK OF RECORDED MUSIC AND SOUND REPRODUCTION.

**FREE BOOKLET**

"Controls and the Amplifier"

Sir:

Mr. Schjelderup seems to deal with the loudness control problem in an intelligent way, which also seems to support tacitly the views expressed in my previous letter (*Æ*, May 1952).

I see no objection to the provision of compensation as is here suggested—by a separate control that is not tied to the volume control. It should be pointed out that this kind of separate compensation control provides the listener with a highly desirable opportunity to select for himself the conditions under which he would like to imagine the recording to have been made. Mr. Schjelderup's example of symphonic music which has an original level of 90 db and which must be played back at 50 db to meet living room conditions indicates that the compensator be set at the "40-db" setting. Notice that if the compensation is so used, we have assumed that what we want is a "scaled down" reproduction of the balance that we hear at 90 db—that is, close-up to the orchestra. If a listener chooses to assume that what he wants in his living room is the sound of the orchestra heard at such a great distance that the level would be only 50 db (as might be the case well back in a large hall) the 50-db living room level is then correctly balanced without compensation. In other words, rotating the compensator will tend to move the sound source closer up or farther back. My choice would be to set the source's apparent distance to match its loudness level at my ears (that is, with no compensation) but others who might prefer otherwise would be able to make an adjustment accordingly.

This may seem too involved a concept to explain to the average home-music listener, but if he is simply told to adjust the volume control first to the desired level and then to adjust the compensator so that the music "sounds right" the desired purpose will have been achieved. The same results could be achieved with tone controls having the proper curves, but the single control adjusting both ends of the spectrum together probably has advantages and leaves the tone control action available to compensate for other deficiencies that may be present.

JOHN F. PILE  
615 Hudson St.,  
New York 14, N. Y.

(Mr. Pile's solution falls short on one point in our opinion. A given recording of an orchestra for example, has a single and fixed "distance" which is determined by the microphone placement. If a "close-to" recording, originally at a 90-db level, is played at a level equivalent to that at the back of the concert hall, it will still have the "close-to" acoustical quality. No amount of frequency compensation can make such a recording sound as though it was heard at the back of the hall without the addition of reverberation. Ed.)

**H H** **HERMON HOSMER SCOTT, INC.**  
"PACKAGED ENGINEERING"  
385 PUTNAM AVE. • CAMBRIDGE 39, MASS.

*Check*  
**VALUES**  
SEE PAGE 76



## THE MAURER 16<sub>mm</sub> TAKES THE HIGH ROAD, TOO!

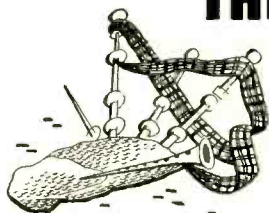

It's a high road to Scotland for a commercial documentary... high in time and expenses. Results must be perfect! So Ken Richter, filming "The Romance of Silver Design" for Reed and Barton, uses the Maurer "16"... as you'd expect. Professionals everywhere use the camera designed for professional work. Study the unique features of the Maurer "16."

**maurer**

*means finer motion pictures!*



**THE 16MM. SOUND-ON-FILM RECORDING SYSTEM** combines the highest fidelity in 16mm. recording practice with wide flexibility and extreme simplicity of operation.



**THE MODEL F PRIME RECORDING OPTICAL SYSTEM AND GALVANOMETER.** A complete light modulating unit for recording sound photographically upon standard film, requires no special servicing or spare parts (other than recording lamp).

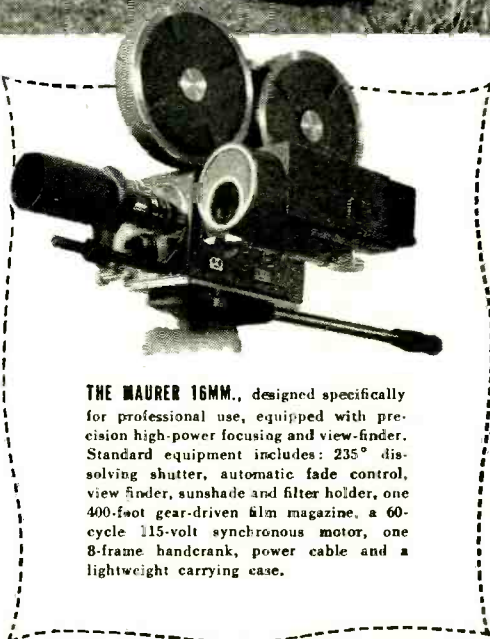

**THE MAURER 16MM.**, designed specifically for professional use, equipped with precision high-power focusing and view-finder. Standard equipment includes: 235° dissolving shutter, automatic fade control, view finder, sunshade and filter holder, one 400-foot gear-driven film magazine, a 60-cycle 115-volt synchronous motor, one 8-frame handcrank, power cable and a lightweight carrying case.

**J. A. MAURER, INC.**

37-01 31st Street, Long Island City 1, New York  
1107 South Robertson Blvd., Los Angeles 35, California

**16mm  
maurer**

CABLE ADDRESS:  
JAMAURER

Always in stock  
at **ALLIED**

Largest Selection of  
Professional and  
Home Quality Audio  
Components

The new ALLIED catalog is your best buying guide to the world's largest, latest and most complete selection of audio equipment. All important high-fidelity lines are featured. All equipment, including professional quality components, is available from stock. Whatever your needs, you can count on ALLIED for quick, intelligent, complete service . . .

NEW . . . send for it . . .  
236 page 1953 catalog



### Virtually an "Audio Fair"

- Complete home music systems
- All famous-make amplifiers
- Hundreds of speakers and enclosures
- Widest selection of tuners
- Everything in phono components
- Tape and disc recorders
- Fullest microphone listings

If it's anything in AUDIO—  
It's available at **ALLIED!**

SEND FOR  
FREE CATALOG

**ALLIED RADIO CORP.**

833 W. Jackson Blvd., Dept. 17-L-2, Chicago 7, Ill.

# The Frudd Audio System

D. B. FRUDD\*

A description of a unique audio system  
for those who really desire perfection.

**T**HE AUDIO SYSTEM presented here is definitely in a class by itself. Other systems have been advertised as 99.99 per cent perfect. This goes one step better. Hi-Fi men, are you with me?

Hundreds of articles have been written on audio systems; the author has simply taken the best features of all of them, in constructing his own. First, a brief word on theory.

What are the characteristics of a good sound reproduction system? A few moments spent on clarifying this subject will be of great value to the layman. To satisfy the requirements of the most discerning listener, the system must, of course, have "presence." In addition, it should be "crisp" and "clean" and should lack "fuzz" and "hangover." After considerable thought, the author has coined a new, over-all descriptive term, which is definitely a property of the author's system—that is, "feeling." Like presence, crispness, cleanness, etc., "feeling" fortunately cannot be measured too well in prosaic engineering terms, but to the sensitive souls, those with the golden ears, "feeling" will come as a revelation. "Feeling" may best be described as the ability of the audio system to place the listener inside the music. As one well-known musician said, on hearing a live FM concert on the author's system, "It is as if I were wrapped up in the G clef."

So much for theory. Now refer to Fig. 1 for the details. Unfortunately, no circuit diagrams could be included in this discussion, due to certain outstanding litigations on patents which have not been settled.

First, the output stage. Even though only ten watts output was required, it was felt that instantaneous power peaks attain values of several hundred watts. After considerable thought, it was decided to use a pair of 211's in push-pull. These have the advantages of being air-cooled triodes with ample power handling capacity. Also, air-cooled triodes are preferred over water-cooled tubes since they avoid unsightly water piping in the living room.<sup>1</sup>

Since the 211 requires a grid voltage of -100 volts, transformer coupling to the driver stage is preferable. This brings us to the subject of transformers.

\* c/o Eric Winston, 7814 Provident Rd., Philadelphia 19, Pa.

<sup>1</sup> D. B. Frudd, "Water-cooled triodes for the Hi-Fi fan," *Wireless Fantasy*, Sept. 1946.

After careful listening tests and measurements, it was found that no commercial transformers were adequate for the presence, cleanness, and feeling desired. Therefore, the author was forced to wind his own (input and output). Details of the construction may appear in a later issue, but suffice to say they are of hyper-toroidal, quadrifilar design, with a double feedback winding, wound on an old turret lathe which happened to be in the author's garage. (*Nearly everybody else uses cores to wind transformers on.* Ed.)

After considerable thought, 1642's in push-pull parallel were chosen as a driver stage. While this may seem a little unconventional, the superiority of this tube, with or without bias, is be-

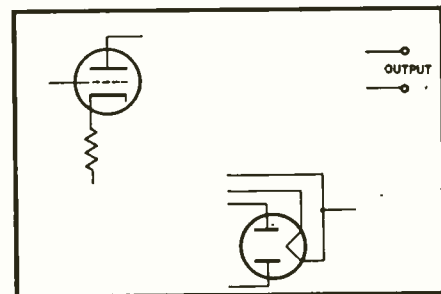
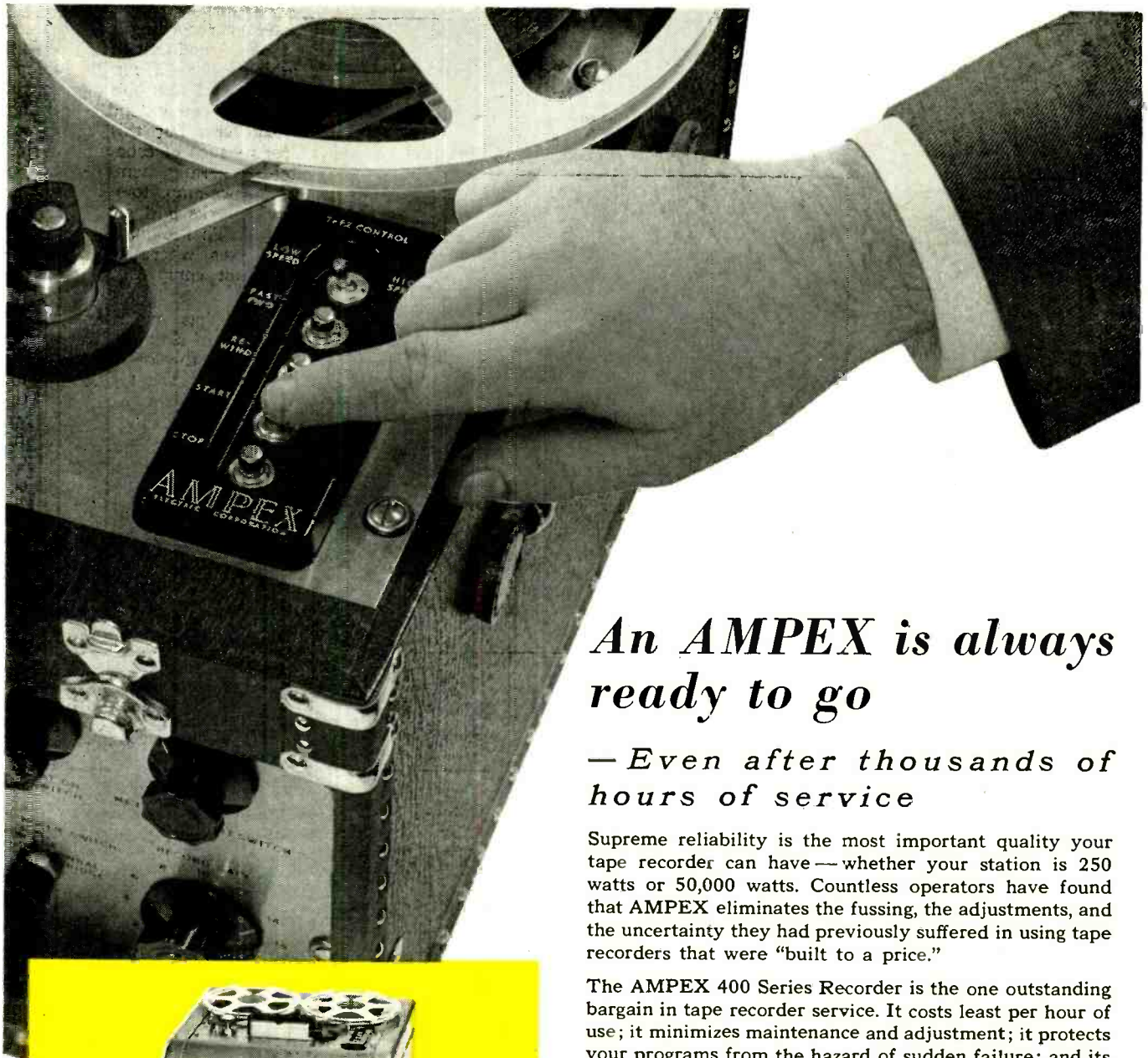

Fig. 1. Circuit schematic of the Frudd Audio System. Parts not shown are restricted because of patent litigations.

yond any argument. The driver stage is driven by a 6SN7, for reasons of economy. The 6SN7 is preceded by three 6SQ7 phase inverters. This particular departure from convention has really paid off in listening enjoyment. The three inverters are respectively cathodyne, floating paraphase, and voltage-tap feedback, and serve the purpose of balancing voltage fluctuations caused by filament deterioration.

The preamplifier unit was built after discarding dozens of circuits which simply did not reach the standards of perfection desired. The pre-amp consists of four 12AX7's, cathode coupled, with a simple switching system to permit removing the cathode coupling, and inserting plate coupling for those few records where turnover frequency is between 6 and 10 db below minimum. Cathode coupling simply won't do for



## *An AMPEX is always ready to go*

*— Even after thousands of hours of service*

Supreme reliability is the most important quality your tape recorder can have—whether your station is 250 watts or 50,000 watts. Countless operators have found that AMPEX eliminates the fussing, the adjustments, and the uncertainty they had previously suffered in using tape recorders that were “built to a price.”

The AMPEX 400 Series Recorder is the one outstanding bargain in tape recorder service. It costs least per hour of use; it minimizes maintenance and adjustment; it protects your programs from the hazard of sudden failure; and its reliability frees your engineer’s attention for other tasks.

Even after thousands of hours of service, your AMPEX Recorder will be reliable in these important ways:

- *When you press the button, it operates*
- *Program timing stays accurate*
- *Starting, stopping, and rewind will operate smoothly*
- *Fidelity will still be high*
- *Maintenance costs will still be low*

*For new broadcast application bulletin, write Dept.*



Model 403C

Model 403P

*If you plan for tomorrow, buy an AMPEX today.*

# AMPEX

## MAGNETIC RECORDERS

AMPEX ELECTRIC CORPORATION  
934 CHARTER STREET • REDWOOD CITY, CALIF.

# Astatic Announces

**EXTRA  
HIGH  
OUTPUT**

## PICKUP CARTRIDGES

**EXTRA HIGH** output, velvet-smooth response, superb tracking, low needle talk—all of the most desirable characteristics are present, to an unbelievable degree, in these new cartridges. They comprise two different Astatic Cartridge Series—models beginning with number 14 have regular crystal element, and those beginning with 15 employ a series crystal for still higher output. Check the performance data in the accompanying tables. Then, test and compare this fine new Astatic achievement.

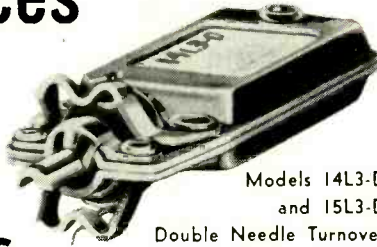

Models 14L3-D  
and 15L3-D  
Double Needle Turnover

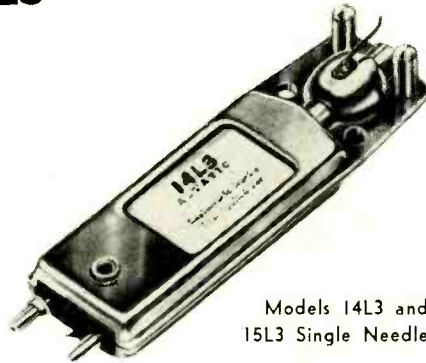

Models 14L3 and  
15L3 Single Needle

### SPECIFICATIONS

Model	Element Type	Minimum Needle Pressure	Output Voltage 1,000 c.p.s. 1.0 Meg. Load	Needle Type	For Record	Approx. Net Wt. in Grams
14L3-D	Crystal	10 gr.	2.8* 2.4†	R (Dual) R-78	33 1/3, 45 and 78 RPM	9
15L3-D	Crystal	10 gr.	4.0* 3.5†	R (Dual) R-78	33 1/3, 45 and 78 RPM	9
14L3	Crystal	10 gr.	2.4†	R	33 1/3, 45 RPM	9
15L3	Crystal	10 gr.	3.5†	R	33 1/3, 45 RPM	9
14L3-78	Crystal	10 gr.	2.8*	R-78	78 RPM	9
15L3-78	Crystal	10 gr.	4.0*	R-78	78 RPM	9
14L3-AG	Crystal	10 gr.	2.8* 2.4†	R-AG**	33 1/3, 45 and 78 RPM	9
15L3-AG	Crystal	10 gr.	4.0* 3.5†		33 1/3, 45 and 78 RPM	9

\* Audiotone 78-1 Test Record † RCA 12-5-31V Test Record \*\* All-Purpose Needle

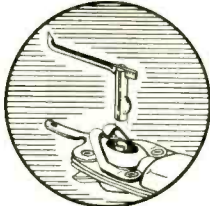

Figure 1

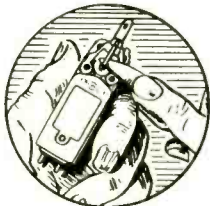

Figure 2

**EXPORT  
DEPARTMENT**

401 Broadway,  
New York 13, N. Y.  
Cable Address:  
ASTATIC, New York

### New Astatic "R" Needle Used

Especially designed for all 14L3 and 15L3 Series Cartridges. Tips are precious metal. The "R" Needle has one-mil tip radius, the "R-78" has all-groove universal tip. Have a keyed stem and friction sleeve holder, as in the famous Astatic Type "Q" Needle, for simple replacement. Figure 1 is a close-up of stem and sleeve. Figure 2 shows needle lifted from socket by gentle pry with penknife. Gentle pressure at base of needle shank with blade inserts new needle firmly.



Astatic crystal devices manufactured under Brush Development Co. patents

this case, RC filters in the plate circuits compensate for recording peculiarities; these are so designed that the phase shift is negligible between 12 and 16,000 cps. It has been found that the addition of another 12AX7 can extend this range to 10-16,000 cps, but this stage was omitted for reasons of economy. A simple switching arrangement is incorporated in the pre-amp, to eliminate the plate RC networks and substitute grid RC networks. This should be done for those few cases where turnover frequency has not compensated for roll-off.

The author has managed to cut through the fog of shibboleth and ignorance concerning the loudspeaker question. Undoubtedly, the speaker is the medium by which the "feel" of the amplifier is to reach the human ear. However, it is felt that the term "ear" has been oversimplified in the audio field. Tests have shown that the ear is only one medium of introducing sounds to the brain; often, sympathetic vibration of the parietal will seemingly intensify the lower registers. The author has found that an enclosure of eleven cubic feet in the shape of a logarithm is entirely satisfactory to accommodate both ear and parietal bone listening. Two fifteen-inch woofers, two eight-inch speakers, and a bi-axial tweeter are used in the author's system. It has been found that the speakers need not be mounted in the enclosure—merely piling them at random on the floor will ensure an unexcelled blend of tonal quality and "feel." Speakers should be electrically connected to the amplifier although this is not necessary. The inclusion of several unconnected speakers on the pile in the enclosure has often helped in achieving superior tonal balance.

What about feedback? Yes, feedback loops are an integral part of the author's amplifier. Seventeen internal, and three external loops result in the incredibly low value of .0001 ohms over-all internal amplifier resistance presented to the speakers.<sup>2</sup>

A word or two about construction. Utmost rigidity is a *must* for high-quality systems with "feel." The author has found that best results were obtained by building the whole amplifier unit in a solid block of aluminum 24" x 12" x 8", hollowing out where necessary for placement of parts. This gives freedom from vibration, good shielding, and a certain feeling of triumph when the parts are mounted.

Further details can be furnished for True Believers, and those not violently prejudiced by professional jealousy.

<sup>2</sup> D. B. Frudd, "The measurement of incredibly low impedances," *Wireless Fantasy*, Jan. 1948.

*Check  
QUALITY*

SEE PAGE 76



*to the* **E. E. or PHYSICS GRADUATE**

*with experience in*

## **RADAR OR ELECTRONICS**

*Hughes Research and Development Laboratories,  
one of the nation's large electronics organizations, is now  
creating a number of new openings  
in an important phase of its operation.*



*Here is what one of these positions offers you:*

### **1. THE COMPANY**

Hughes Research and Development Laboratories is located in Southern California. We are presently engaged in the development of advanced radar devices, electronic computers and guided missiles.

### **2. THE NEW OPENINGS**

The positions are for men who will serve as technical advisors to the companies and government agencies purchasing Hughes equipment. Your specific job would be to help insure the successful operation of our equipment in the field.

### **3. THE TRAINING**

Upon joining our organization,

you will work in our Laboratories for several months until you are thoroughly familiar with the equipment you will later help the Services to understand and properly employ.

### **4. WHERE YOU WORK**

After your period of training (at full pay), you may (1) remain with the company Laboratories in Southern California in an instructional or administrative capacity, (2) become the Hughes representative at a company where our equipment is being installed, or (3) be the Hughes representative at a military base in this country—

or overseas (single men only). Compensation is made for traveling and for moving household effects, and married men keep their families with them at all times.

### **5. YOUR FUTURE**

You will gain all-around experience that will increase your value to the company as it further expands in the field of electronics. The next few years are certain to see a large-scale commercial employment of electronic systems—and your training in the most advanced electronic techniques now will qualify you for even more important positions then.

### **HOW TO APPLY**

If you are under thirty-five years of age, and if you have an E. E. or Physics degree, with some experience in radar or electronics,

write to:

## **HUGHES**

**RESEARCH AND DEVELOPMENT LABORATORIES**

*Engineering Personnel Department*

CULVER CITY, LOS ANGELES COUNTY, CALIFORNIA



*Assurance is required  
that relocation of the applicant will not cause  
disruption of an urgent military project.*

# EDITOR'S REPORT

---

## THE AUDIO FAIRS

**F**OR FOUR YEARS NOW, we have devoted considerable space to each of the Audio Fairs as they come along.

Now, almost on the eve of the fourth—and biggest to date—there is little more to say. All the preparations are made, everything is in readiness, and by the time most of *Æ*'s readers see this page, it will all be over.

After a hectic four days, with much walking and talking and listening and looking, we ask ourselves, "What is this all about?" So we take a few minutes to think it over, and try to rationalize this new industry affair, and see what it does mean—to the manufacturer, the designer, the distributor, and the ultimate user. And we come up with some interesting viewpoints.

The manufacturer learns first-hand just what the buyer wants because he is able in just a few days to talk to more interested people than he would normally encounter in a year's contacts with his usual trade outlets and their customers. The designer finds out just what the buyer considers important in the search for the ultimate in sound quality, and he is able to direct his efforts toward satisfying the potential user. The distributor learns what equipment is favored by the buyer, and can determine how he will order for the ensuing season's requirements. And finally, the buyer—the ultimate user—can see *and* hear, all in one place and at one time, all the many products of all the manufacturers.

Visitors to the Fair will note an increased number of exhibitors—both manufacturers and distributors. They may wonder just how long this expansion can go on. The simple truth is that the demand for high-quality equipment has increased over the past five years more rapidly than the manufacturers' output. And while it may appear that everybody is getting into the audio act, there are still plenty of customers to absorb their products. Thus while the number of lines increases, the demand goes up just as fast, and a majority of producers of equipment are busy the year around.

Just how far the market can increase before the set manufacturer—the mass producers of radio and TV sets who have so long considered the "hi-fi" movement only a passing fad—see the handwriting on the wall is a matter for considerable thought. Frankly, *Æ* does not believe that the hi-fi market is suited to mass production and existing distribution methods in the home instrument field. Present distribution methods in the components field are adequate, and with some streamlining should serve for years to come. As to manufacturing, it must be admitted that hi-fi equipment is turned out with a higher standard of craftsmanship than the radio set manufacturers have yet achieved, and the quality of hi-fi components is far superior. Even the least expensive of the custom-type amplifiers is considerably better than most of the "carriage-trade" radio-phonograph combinations employ, and the real hobbyist wouldn't

consider paying less than ten to fifteen dollars for a loudspeaker—and many of them spend ten, twenty, or even fifty times that much for a speaker system in a good enclosure. Compare that to the cost of a typical speaker in the better radio sets. The answer is—in *Æ*'s opinion—that if you build a better anything than somebody else, you can well afford a four-lane highway to your factory door.

## BINAURAL BROADCASTS

One sure way to learn anything in this business is to make an observation in this column. If it's wrong, we are sure to be set right—and quickly. Some months ago, the binaural broadcast presented during the Chicago Audio Fair was referred to as the first to be staged by a commercial station. It appears we were slightly wrong. We have been advised from several sources—and most recently from Arkansas—that we didn't know what we were talking about.

The Arkansas contender—the earliest of which we have record so far—is KUOA, AM and FM, with the statement of their program for 11:45 a.m. on March 28 of this year. This program consisted of piano and organ, and was announced by Dick McCartney, then manager of the stations—which are owned by John Brown University of Siloam Springs, and operated commercially. They are affiliated with the Mutual Broadcasting System.

Can anyone beat that date? If so, we'll undoubtedly hear about it. Be that as it may, we have our eye on what may possibly repeat possibly be the first *network* binaural broadcast in the United States. Or should we play safe and say in the northeast? More about that in the December issue.

## HOW MUCH POWER?

While one reader says he won't connect a 25-watt amplifier to *his* speaker system, others are beginning to doubt that ten or even twenty-five watts of power is enough to provide a satisfactory margin for ordinary listening level in the home. In any case—whether you are satisfied with two watts, or whether you want fifty to ensure sufficient power to handle the peaks without distortion—you may find the Sarsler-Sprinkle article on the 6146 amplifier of interest. Perhaps we have all been using a clock motor where a locomotive would serve us better.

## COINCIDENCE?

For what it may be worth, and with no further comment, let it be here reported that a number of committees of the American Psychiatric Association are holding meetings at Hotel New Yorker from October 30 to November 1—the place and time of the Audio Fair. Does anybody wanta make something out of that?

*“For those who can hear the difference”*

*Listen....*

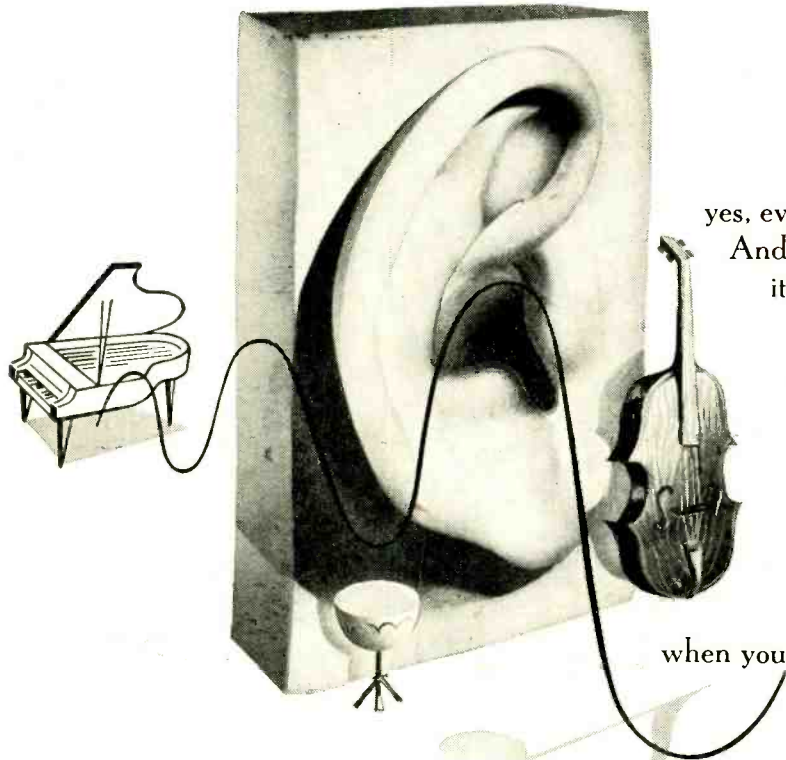

... it comes to you  
in the subtle shading of a piano . . .  
in the clean brilliance of violins,  
the purity of a flute. Your ear detects  
the sweet mellowness of cellos,  
the roundness of a clarinet . . .  
yes, even the iridescence of clashing cymbals.  
And, as the symphony swells to crescendo,  
its dynamic energy adds a flood of color  
to your musical canvas.

For those who can hear the difference,  
these are the elusive pleasures  
that often remain hidden  
in the grooves of fine recordings.

These are the thrilling  
new listening experiences  
that are released for your enjoyment

when you use quality components by Pickering.

**PICKERING COMPONENTS**

*“for those who can hear the difference”*

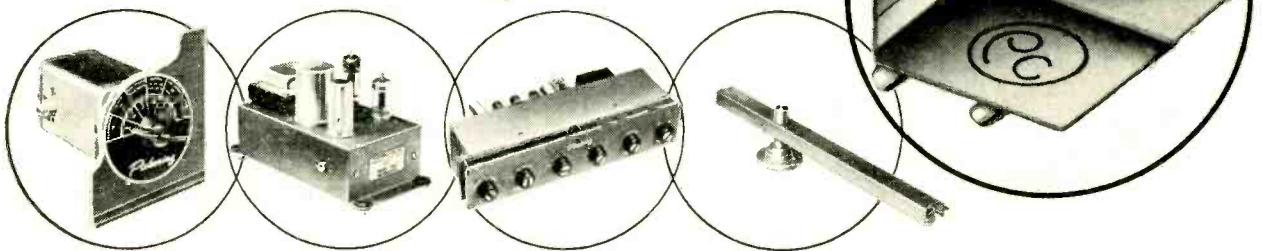

**PICKERING and company, incorporated**

● Pickering High Fidelity Components are  
available through leading Radio Parts dis-  
tributors everywhere; detailed literature  
sent upon request. Address Department A 1

Oceanside, L. I., New York



Starting electronic nose on its way. It is pulled from pole to pole by line extending toward the ground. Previously workmen had to paint the cable with soap solution, so bubbles would disclose leaks.

## THIS ELECTRONIC NOSE SNIFFS OUT LEAKS

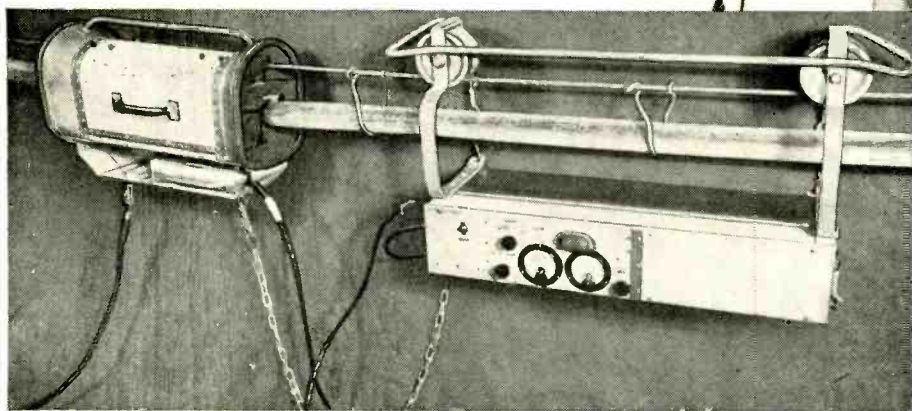

For test, the cable is cleared of protective nitrogen or air, and filled with Freon gas. Case at left collects escaping gas which operates Freon-sensitive detector underneath. At points where Freon escapes through sheath cracks, the box at right—a combined control unit and power supply—rings a bell. Workmen mark the point of leak for later repair.

AFTER years of buffeting by the wind, even tough telephone cable sometimes shows its age. Here and there the lead sheath may crack from fatigue or wear through at support points. Before moisture can enter to damage vital insulation, leaks must be located and sealed.

To speed detection, Bell Laboratories scientists constructed an electronic nose which *sniffs* out the leaks. Using an electrically operated element developed by the

General Electric Company, the device detects leaks of as little as 1/100 cubic foot per day. Sheath inspection can be stepped up to 120 feet per minute.

Thus Bell scientists add findings in other fields to their own original research in ways to make your telephone system serve you better. On the other hand their discoveries are often used by other industries. Sharing of scientific information adds greatly to the over-all scientific and technological strength of America.



## BELL TELEPHONE LABORATORIES

Improving telephone service for America provides careers for creative men in scientific and technical fields

# The Maestro—a POWER Amplifier

DAVID SARSER\* and MELVIN C. SPRINKLE\*\*

A new version of the now famous Musician's Amplifier which should satisfy anyone's desires for more power—and which uses a newly developed tube type with modest plate supply requirements.

**N**OAH WEBSTER, in his book of words, defines maestro as "a master in any art, especially music." This name is particularly appropriate to this amplifier, shown in Fig. 1, for it combines the best properties of the now famous Musician's Amplifier with a prodigious increase in power output. It is truly the master of the art of recreating music by electronic means.

The success of the Musician's Amplifier<sup>1</sup> is too well known to require repeating, but certain specialized applications have been encountered in which it did not fill the bill. We have in mind its power output, for its response, low distortion, and low noise level leave little to be desired for home music listening.

One application for which it is not entirely adequate is as a driver for a disc recording head. The low distortion makes the Musician's Amplifier attractive, but it falls short on power, especially when making LP discs where pre-emphasis is required. The considerations on power for disc recording are well known and have been mentioned by these writers previously.<sup>2</sup>

The development of FM broadcasting, modern LP records, and tape equipment has set new standards for dynamic range in reproduced music. It is now necessary to re-appraise the power required for critical listening. In the past, the pro-

\* 548 Riverside Drive, New York 27, N. Y.

\*\* Chief Engineer, Shrader Mfg. Co., 2803 M St., N.W., Washington 7, D. C.

<sup>1</sup> Sarser and Sprinkle, "Musician's amplifier," *AUDIO ENGINEERING*, Nov. 1949.

<sup>2</sup> Sarser and Sprinkle, "Musician's amplifier senior," *AUDIO ENGINEERING*, Jan. 1951.

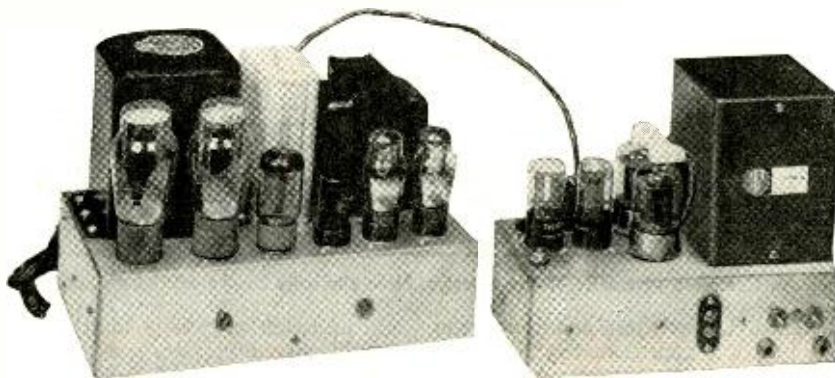

Fig. 1. The Maestro amplifier—a new contender for high-quality sound reproduction in the home, or for disc-recording cutter driving, or for any application where up to 90 watts is required.

gram material was compressed to a 35- or 40-db range and maximum power could be handled easily by the conventional "15-watt" amplifier. Today's trend is toward elimination of compression. Therefore it is necessary to increase the power delivery of the amplifying system.

A typical example is in a recent recording of Ponchielli's "Dance of the Hours." In this selection, the pianissimo cello solo passage is repeatedly interrupted by a crashing chord played by the entire orchestra. With the usual 10- to 15-watt amplifier, the chord is heard, but without sufficient definition to suit the fastidious listener. In order to distinguish between the various choirs of the orchestra playing this chord, which the trained ear can do in a concert hall, it is necessary that considerable power be available. A measurement of the peak produced by the chord shows around 22 db of change in instantaneous power. This is not, however, a true measure of the peak but is an integrated reading. This means that an amplifier of around

100 watts is required. Since this chord contains fundamental frequencies between 30 and 4000 cps, it may be seen that full power is required at these frequencies. In addition to power over this range, "clean" power is required up to at least 15,000 cps for disc recording as considered previously. Hence, we have looked toward the development of an amplifier which would combine the low distortion, low noise, and wide range of the Musician's Amplifier, with substantially increased power output.

While the Musician's Amplifier Senior<sup>2</sup> was a step in the right direction, it had several shortcomings: it is large in size; it requires a power supply much like a transmitter, and which can be lethal; it requires a power amplifier as a driver; and it is like all Class A amplifiers—inefficient. And in high-power amplifiers, efficiency becomes important.

## New Tube Gives Clue

The recent announcement of the type 6146 by RCA pointed toward a solution of the need for more power with comparatively simple circuit design. This tube is a beam-power amplifier tube primarily intended for transmitter use. As shown in Fig. 2 in comparison with the 5881 and the KT-66, it is small in size, sturdily constructed; and it has a high power sensitivity. It can be used in a number of transmitter applications, but RCA's data sheet indicates that it will also serve as an audio power amplifier or modulator, Class AB. This data sheet recommends—under ideal conditions such as perfectly regulated power supplies—that a pair of 6146's be operated with a plate voltage of 750 and a screen voltage of 200. This requires a fixed bias of 50 volts and a plate-to-plate load of

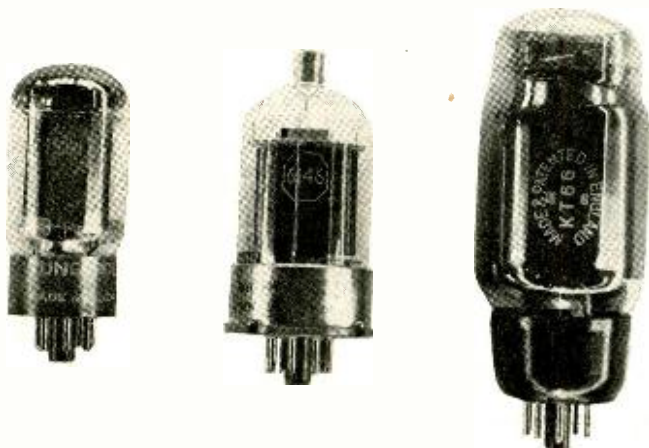

Fig. 2. Comparative size of the new RCA 6146 alongside the 5881 and the KT-66.

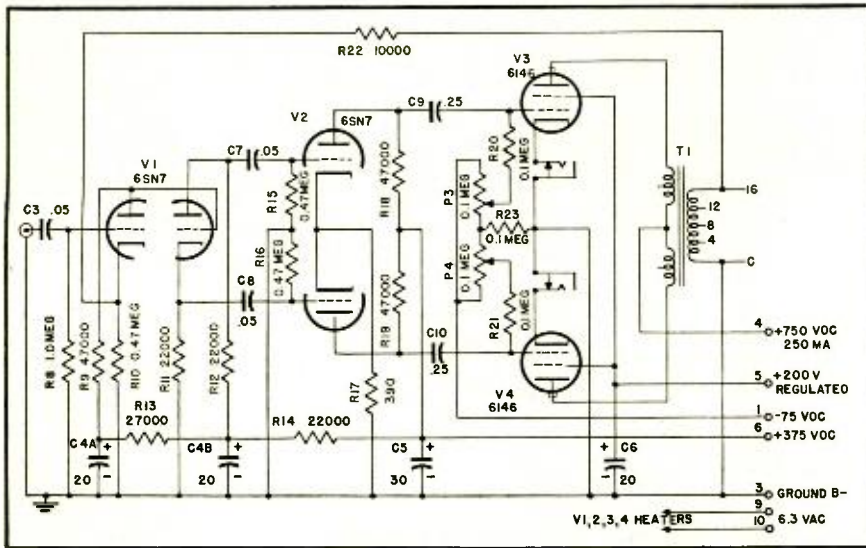

Fig. 3. Complete schematic of the Maestro. Note similarity to the Musician's amplifier.

8000 ohms. Under these conditions, the power output is approximately 120 watts into a plate-to-plate resistor. As a practical matter, we have departed slightly from these conditions and obtained a sine-wave power output of 90 watts from 25 to 30,000 cps. All this and Class AB, too, with no driver and no grid-current problems. The 6146 can be operated readily with resistance coupling from a voltage amplifier—and thus may be said to be a "jolly good bottle."

Having found a satisfactory tube type, the next problem was to find a suitable output transformer. Search of transformer catalogs failed to reveal one which would meet all requirements, so a conference was held with E. B. Harrison, of Peerless. On hearing the problem he said, "I think I can do it." Subsequently he has admitted it was a tough one. However, Harrison designed and built an output transformer for the 6146,

and although originally built especially for this first amplifier, it is now in the Peerless line as type S-268-Q. When tested in a matched network, the response is within 1 db from 10 cps to 100,000 cps. Primary impedance is 8000 ohms, and it will handle 50 watts at 20 cps, and at least 80 watts mid-range. When used in a feedback amplifier where the source impedance is 10 per cent or less of the reflected primary impedance, the transformer will deliver close to 80 watts with no visible distortion at 20 cps. Primary inductance at 5 volts, 60 cps, is greater than 200 henries, while at 80 watts the inductance is approximately 800 henries, yet the leakage inductance referred to the primary is around 7 mh. The d.c. resistance of the primary is 115 ohms, and the insertion loss around 7 per cent. Small in size for its power rating this transformer has proved to be excellent in perform-

ance, and will pass a 30,000 cps square wave with a vertical rise and a flat top.

### The Voltage Amplifier

Large triodes like the 845 have a high bias, and transformer coupling is almost a necessity. A power amplifier of some size is also required to produce the necessary voltage. The 6146, in common with other beam tubes, operates at a reasonable bias of 50 volts. It requires around 35 volts r.m.s. per tube, or 70 volts for a push-pull pair for grid excitation, and this is quite in line with the 807 or 5881 drive requirements in the Musician's Amplifier. Thus, the voltage amplifier of the earlier amplifier was adopted without change, as is observed from the schematic, Fig. 3.

Design of the power supply proved to be a bigger job. In the Musician's Amplifier Senior, the power supply resembled that of a small transmitter, and the problem was current capacity and high voltage. In the Maestro amplifier, the problem is regulation, since operation is Class AB. According to the data sheet, the plate current for a pair of tubes goes from a quiescent 57 ma to a peak of 227 ma, while the screen current changes from 1 ma quiescent to 27 ma at 120 watts. Another problem was to obtain the 750 volts with the choke input that good regulation dictates. One solution was found by using two receiver-type transformers with the high-voltage windings in series. The primaries are paralleled across 117 volts a.c. and the secondaries are phased so as to obtain 1600 volts r.m.s. from rectifier plate to plate. The two-transformer scheme also provides the several 6.3-volt heater windings which are required.

The rectifiers employed are the high-vacuum, high-voltage 5R4GY, ideal for heavy-duty use. Two are used in parallel. In preliminary work, a swinging choke was used as input to the filter but it was found that a conventional smoothing choke works just as well. The requirements of sufficient minimum inductance and low d.c. resistance are met by the unit selected. The single high-voltage filter capacitor is oil filled.

One of the important requirements in obtaining high quality from beam tubes is regulation of screen voltage. This is not always mentioned in connection with amplifier construction articles and so does not receive the recognition it deserves. In our preliminary work we used VR tubes to regulate the screen voltage but had poor luck. By the time the screen voltage was stable, the VR tubes were well past their rated currents. Therefore the VR tubes were abandoned and an electronically regulated supply installed. A triode-connected 5881 is used as a pass tube, and a 6SJ7 is used as the control tube, with a VR-75 supplying the reference voltage. Bleeder current is passed through the VR-75 so that changes in 6SJ7 current have no effect.

### Power Supply Circuits

Referring to the schematics for the power supplies—Figs. 4 and 5—it will

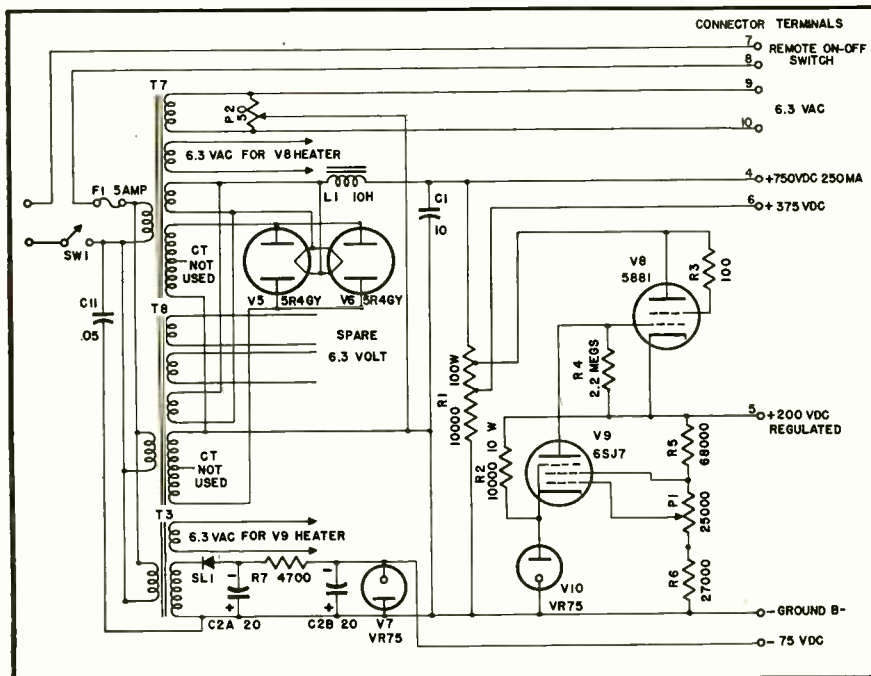

Fig. 4. Schematic of the No. 1 power supply, which employs two conventional receiver power transformers and the bias-supply transformer.

be noted that the screen supply circuits are similar. During the development program, two types of power supplies were constructed. The first type used two receiver-type power transformers, with the high-voltage windings series-connected. The second employed a standard type of plate transformer which delivers 900 volts each side of center tap. This latter unit has a streamlined appearance, and results in an attractive power supply, but a number of extra filament transformers must be employed. Figure 4 shows the schematic of the two-transformer supply, with a number of filament windings being available on the existing transformers. Figure 5 shows the unit employing the single plate transformer with a multiplicity of filament transformers. There are advantages to both arrangements, but aside from the differences in transformer connections, the remainder of the power-supply circuit is essentially identical in both types of construction.

Referring to the regulator circuit, it is seen that the potentiometer  $P_1$  is used to set the output voltage to exactly 200 volts—although it may be set anywhere in the range from 150 to 250 volts. Changes in input voltage have no effect. It will also be noted that the 6146's are operated with fixed bias. To provide this, a separate circuit is employed, using the 1-to-1 isolation transformer and a 75-ma selenium rectifier. Another VR-75 tube is used to stabilize this voltage, and enough current is drawn to make it steady. Two potentiometers,  $P_3$  and  $P_4$ , are used in the amplifier to balance plate currents as well as to set the bias. Note that the positive side of the bias supply is grounded; therefore, the anode of the VR-75 should be grounded, and the cathode connected to the negative side of the bias supply.

A 100-watt, 10,000-ohm bleeder resistor is used to supply the 400-volt requirements of the regulated screen supply and the 375-volt requirements for the voltage amplifier. Details of the circuit are seen in the schematic, with the parts listed at the end of the article. 10-contact Jones plugs are used to interconnect the amplifier and the power supply. No trouble has been encountered in cabling the 750-volt plate supply with the other wiring, but care should be taken to place all live connections on female connectors.

#### Performance

The performance of the Maestro amplifier fully justifies the name. The general requirements for frequency response, power output, distortion, and noise have been stated, and the results will be considered in that order.

The frequency response was measured with a 1000-ohm source resistance as this is typical of the source impedance of cathode followers used in the better "front ends." Under these conditions, the response is flat with no perceptible variation from 10 to 70,000 cps. There is a 1.5-db rise at 5 cps, and there is a droop of 0.6 db at 100,000 cps. These frequencies represent the limits of our present measuring equipment. From the smoothness and steepness of the square-

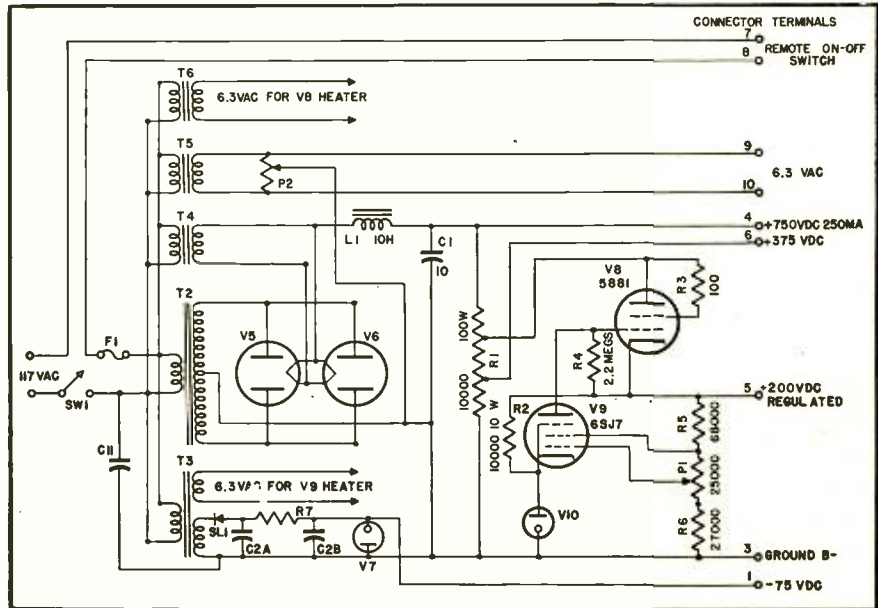
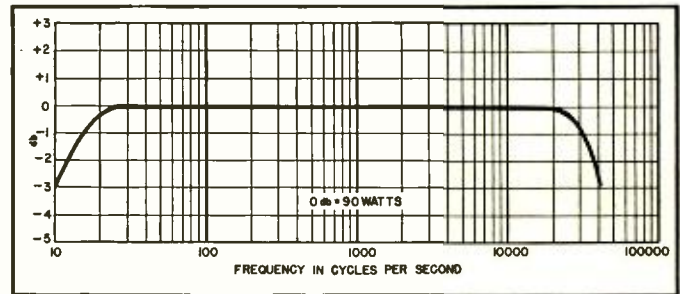

Fig. 5. Schematic of the No. 2 power supply, using a plate transformer and several filament transformers, in addition to the bias-supply unit.

Fig. 6. Power output vs. frequency curve for the Maestro amplifier.



wave transmission, it appears that the response is better than the measured value. The completed amplifier passes square waves even better than the Musician's Amplifier, up to a 10,000-cps fundamental. At 30,000 cps the rise time is still vertical while preserving a flat top.

The single-frequency power output at 1000 cps is 90.2 watts, as shown in Fig. 6. This is just before the sine wave begins to be clipped, and when clipping does occur the clip is clean and symmetrical. There is no "fuzz" when the amplifier overloads. Full 90 watts is obtained at all frequencies from 25 to 20,000 cps with a smooth decline beginning at 30,000 cps, the 3-db-down point being at 40,000 cps. At low frequencies, the 3-db-down point is at 10 cps. The low-frequency performance of the am-

plifier when feeding a speaker load is superb.

The low distortion of the Maestro makes it a worthy part of a high-quality music installation. Using the power output as read on the IM set meter shows an IM distortion of 4 per cent only 1 db below 90 watts; at 2 db below 90 watts, the IM distortion is only 2 per cent, as shown graphically by the solid curve of Fig. 7. An important consideration in analyzing IM curves is the location of the "break" from a low-distortion flat portion of the curve to the upward bend. The ideal curve as a function of power would be horizontal up to the break point, then would rise sharply upward. This is the type of curve obtained from the Maestro. The break occurs at around

[Continued on page 86]

Fig. 7. Intermodulation distortion curves for the Maestro. The solid curve represents distortion for power output as read on the IM set meter. The dotted curve represents the same distortion plotted against equivalent sine-wave power.

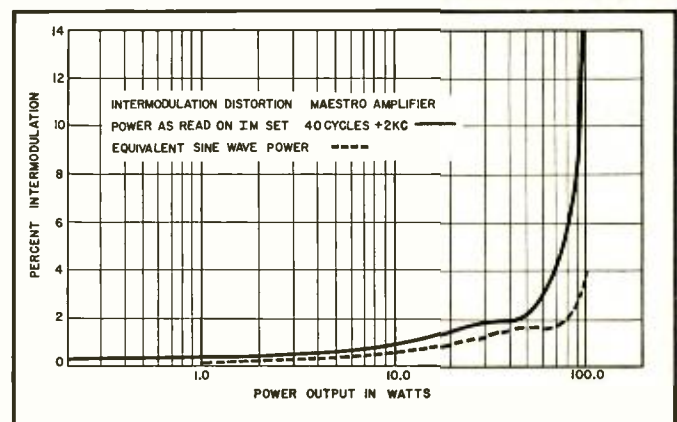

# Theory and Construction of a Harmonic Distortion Meter

GEORGE ELLIS JONES JR.\*

Measurements on amplifier performance require various types of equipment. The author describes an instrument which can be built readily by the experimenter and which will provide considerable information.

**D**ESPITE THE POSSESSION of relatively simple but effective intermodulation distortion equipment, the author wanted a harmonic distortion analyzer to round out his equipment line up. The unit whose design and construction are outlined herein is the result of this desire.

This instrument will measure distortion using fundamentals from 16 to 20,000 cps. Lack of an electronically regulated power supply and backlash in the tuning controls make the null adjustment too critical for convenient work with distortions below 1 per cent. Since the best power amplifiers available today will often not develop even that much distortion until but slightly below the level at which output stage grid clipping occurs, this meter is not well suited for checking really good amplifiers. However, by the same token, few of the available sine wave generators provide a pure-enough output for such testing. The author's generator produces about 0.5 per cent distortion (mostly seconds), and on more than one occasion less distortion has been obtained from a power amplifier than was present in the generator driving the unit. Although this distortion analyzer is more difficult to null than commercial equipment of comparable sensitivity, it does afford excellent selectivity and flexibility.

The technique for using frequency-selective feedback loops to improve filter action is well covered in the literature.<sup>1,2</sup> One such scheme is shown in the simplified schematic diagram of Fig. 3. Vacuum tubes  $V_1$  and  $V_2$  constitute an ordinary voltage amplifier. Degenerative voltage feedback, developed through resistor  $R_{f1}$ , helps to linearize this amplifier. A Wien bridge formed by  $Cw_1$ ,  $Cw_2$ ,  $Rw_1$ ,  $Rw_2$  floats between plate and cathode of  $V_2$ . When the plate load is twice the cathode load, a null in transmission will occur at a frequency,  $f_0$ , given by the relationships:

$$f_0 = 1/2\pi R_{w1}R_{w2}C_{w1}C_{w2}$$

Fig. 1. Panel view of harmonic distortion meter described by the author.

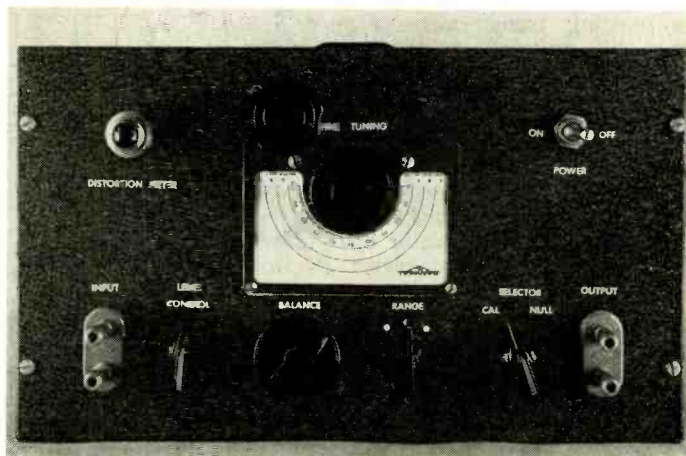

where

$$R_{w1} = R_{w2} \quad C_{w1} = C_{w2} \quad R_a = 2R_b$$

Following the Wien bridge is a third stage of amplification,  $V_3$ , and a cathode follower,  $V_4$ . A second voltage-feedback loop, this time around all four stages, is developed by having the first stage cathode resistor,  $R_k$ , also part of the cathode load resistor,  $R_{L2}$ , of  $V_4$ .

It will be easier to understand the operation of this circuit if its behavior when modified by removal of  $V_3$  is first considered. The gain from the grid of  $V_1$  (input) to the cathode of  $V_2$  (point L) will be determined by the ratio of  $R_{f1}$  to  $R_k$  and by the fact that  $R_b$  is half  $R_a$ . This gain is therefore approximately

$$A_L = R_{f1}/2R_k$$

Similarly the gain from input to the Wien bridge balance point (point D) will be given through the relationship:

$$A_D = A_L T$$

$$\text{where } T = \frac{1}{1 - 3j/[(f/f_0) - (f_0/f)]}$$

Here  $f_0$  is the null frequency of the bridge and  $f$  represents any frequency. It may be noted that when the input consists of only the null frequency, the gain to point D is zero. At frequencies far removed from this null frequency the gain to point D will rise from zero and approach as a limit the gain to point L. The first two tubes together with the bridge constitute a distortion meter of sorts. When the bridge is tuned to

Fig. 2. Chassis arrangement of the meter, showing the mounting of the dial and the main null-adjusting dual potentiometer.

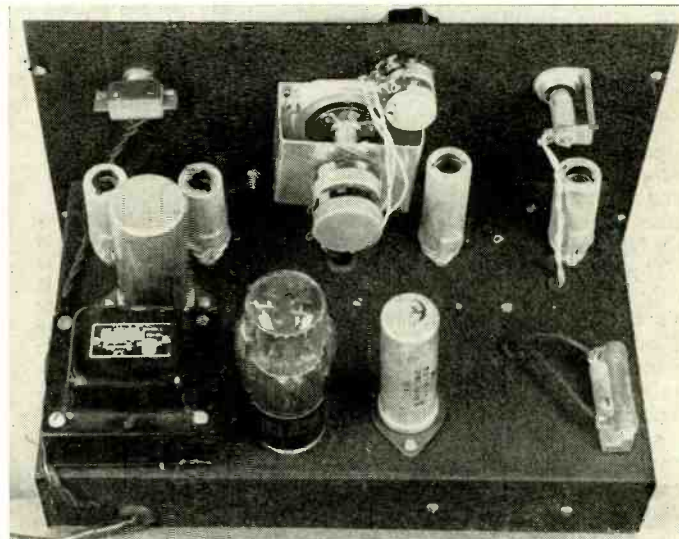

\* 73 Harwood Street, Pittsburgh 11, Pa.

<sup>1</sup> H. H. Scott, U. S. Patent 2,298,177, Oct. 6, 1942.

<sup>2</sup> G. E. Valley and H. Wallman, "Vacuum Tube Amplifiers," McGraw-Hill, 1948.



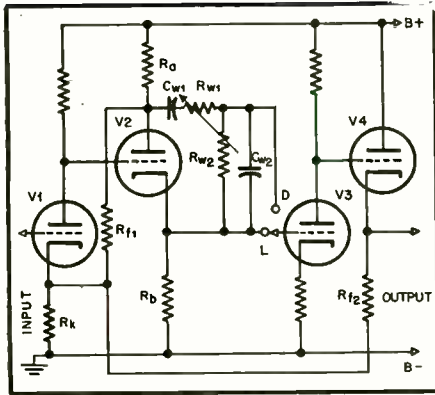

Fig. 3. Simplified schematic of harmonic distortion meter.

the fundamental frequency of the input signal we may measure the amplified input signal at point L and the amplified signal minus the fundamental at point D. Unfortunately the distortion components of the input signal will appear alone at point D with less amplitude than at point L, thereby giving an erroneously low distortion indication. This occurs because the bridge, in addition to nulling out the fundamental, attenuates adjacent distortion frequency signals. At twice or half the null frequency, about 7 db of attenuation will occur. Even at three times or one third the null frequency the attenuation will amount to about 3.5 db.

**Null Sharpening**

To improve the transmission away from the null frequency,  $V_4$  is inserted and the overall feedback loop becomes of moment. Letting  $A_3$  represent the gain of  $V_3$ , the following approximations are plausible. The gain from input to output (cathode of  $V_4$ ) when  $V_3$  is connected to point L will be:

$$A'_L = A_1 A_3 / [1 + A_1 A_3 (R_k / R_{f_2})]$$

However, when  $V_3$  is connected to point D the overall gain becomes:

$$A'_D = A_1 A_3 T / [1 + A_1 A_3 T (R_k / R_{f_2})]$$

If T were unity the two overall gains would be equal. At the null frequency  $A'_D$  will, of course, be zero. For distortion analysis it is desirable to pass all harmonics of the null frequency with equal facility when either the L or the D connection is made. Provided the second harmonic is adequately handled, all higher harmonics—assuming they are within the pass band—will be likewise well treated. It is therefore desirable that the ratio of  $A'_D$  to  $A'_L$  be near unity when  $f$  does not equal  $f_0$ . This ratio is given by the equations

$$A'_D / A'_L = \frac{A_1 A_3 / [1 + A_1 A_3 (R_k / R_{f_2})]}{A_1 A_3 T / [1 + A_1 A_3 T (R_k / R_{f_2})]}$$

When  $f$  is twice  $f_0$ :

$$T = 1 / [1 - 3j / (2 - 1/2)] = 1 / (1 - 2j)$$

$$A'_D / A'_L = 1 / \{1 - 2j / [1 + A_1 A_3 (R_k / R_{f_2})]\}$$

Provided the quantity

$$[1 + A_1 A_3 (R_k / R_{f_2})]$$

is large the magnitude of this ratio will be about:

$$A'_D / A'_L = 1 - 2 / [1 + A_1 A_3 (R_k / R_{f_2})]$$

In the author's instrument:

$$A_1 = 27/2 \quad A_3 = 100$$

$$R_k / R_{f_2} = 1/33 \quad A'_D / A'_L = 0.95$$

Figure 4 is a plot of the transmission characteristics for the entire unit, null connected, as compared to that of a Wien bridge alone. The increase in selectivity is obvious.

Essentially the gain of the unit is held constant by the overall feedback loop despite rather significant variations in the amplification inside the feedback loop until the transmission through the bridge network approaches and becomes zero. Then no amount of overall feedback will hold the gain constant.

**Operation**

In operation the signal appearing at the output when  $V_3$  is connected to L is

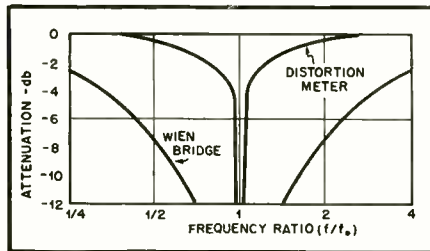

Fig. 4. Curves showing selectivity of Wien bridge and of the distortion meter using feedback around the bridge.

measured with an external a.c. meter. This signal is essentially identical with the input signal. The null connection is made by switching  $V_3$  to point D, the bridge is nulled, and the output again noted. The ratio of the two outputs reflects the ratio of distortion to fundamental-plus-distortion. For example if the L connection gave an output of 10 volts and the D connection an output of

0.1 volts the distortion would amount to 1 per cent. The author uses an a.c. voltmeter with full-scale deflections extending from 10 millivolts to 300 volts in 10-db steps. It is therefore convenient to set the input to give 10 volts output when the L connection is made. If a significantly greater output is taken a certain amount of internal distortion will be developed by the distortion meter itself.

Figure 5 is a schematic of the unit built by the author. Pentodes have been used instead of triodes for  $V_1$  and  $V_2$ , and triode-connected pentodes for  $V_3$  and  $V_4$ . The Wien bridge resistors are two pairs of ganged potentiometers, for coarse and fine tuning. Three pairs of capacitors give overlapping frequency ranges. The  $V_2$  cathode resistor involves a combination of fixed and variable resistors to compensate for mistracking of the Wien bridge. By a judicious selection of coupling capacitors it has been found possible to use a common plate supply for all four stages. The filter capacitor  $C_{10}$  and the two grid coupling capacitors  $C_2$  and  $C_3$  are the critical reactances so far as low-frequency oscillation is concerned.  $R_{14}$  serves to isolate the distortion meter from its output load.

Figure 1 shows the instrument panel. The selector switch  $V_3$  is marked CAL and NULL and provides the L and D connections already discussed. The dual concentric control marked BALANCE on the control panel appears on the schematic as resistors  $R_{15}$  and  $R_{16}$ , with the latter the larger value—being controlled by the outer knob. The dual 0.5-meg potentiometers,  $R_{15}$  and  $R_{16}$  are rotated by the vernier drive unit. Trimmer action is provided by the dual 10-meg potentiometers controlled by the uppermost knob. Figure 2 is a rear view of the unit showing the parts layout on the chassis.

[Continued on page 79]

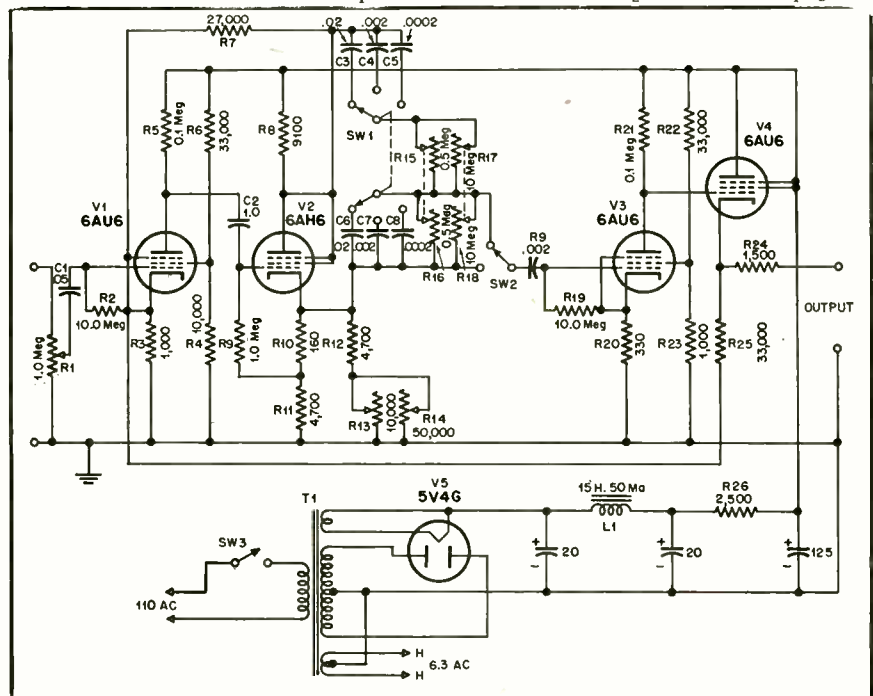

Fig. 5. Over-all schematic of harmonic distortion meter described by the author.

# Measuring up an Audio Transformer

N. H. CROWHURST\*

Proper selection of a transformer for audio applications often requires thorough measurement of its characteristics. The author describes the important measurements needed to determine its adaptability to certain uses.

IN THE PRECEDING ARTICLE<sup>1</sup> the various electrical properties having a bearing on its performance were introduced. This article covers the question of measuring up these electrical properties. A following one will deal with applying the information so gained to obtain the best performance from the transformer. Intelligent application of this method proves far more direct than the "hit and miss" method of trying various values in circuit, and results in ultimate time saving. The latter method may never find the best result.

Audio transformers can be divided into two groups from the viewpoint of the electrical properties contributed by the presence of a core of magnetic material: those in which no d.c. polarizing flows; and those with d.c. polarizing.

## No D.C. Polarizing

In components designed for use without d.c. polarizing, the core does not have an air gap, but is made up to give the lowest possible magnetic reluctance for the material used. As a result less turns are used on a winding for the same working impedance, causing the magnitude of core losses to affect performance appreciably. So for these components, core loss should be measured in addition to inductance, and at the same time equivalent harmonic generation should be investigated.

Measuring the impedance of a winding appears quite simple, using a comparison circuit such as that shown at Fig. 1. Impedance magnitude is calculated from the ratio between readings

$V_2$  and  $V_3$ , while phase can be calculated from the three-voltmeter formula known to power engineers. But in practice, results show inconsistency as different frequencies or amplitudes are explored. Even at the same frequency and amplitude of signal, discrepancies are noted when different values of series resistor are used. So the results are suspect. If an oscilloscope is used to examine the waveform across either the resistor or the winding, the reason will be revealed. Although the applied waveform has been checked as sinusoidal, the transformer magnetizing current is non-linear, with the result that the potential drop across the resistor, and hence also that across the winding, is not sinusoidal; so voltage readings are falsified by the irregular wave shape.

For practical application, only sinusoidal signals are of value, so the next method suggested uses the oscilloscope to trace a pattern when the applied voltage is sinusoidal. The circuit is shown at (A) in Fig. 2. The series resistor,  $R$ , used to obtain the Y deflection, has a value such that its potential drop is small compared to that across the winding. Thus the waveform across the winding is sensibly the same as the input waveform. Use of a 'scope amplifier for the Y deflection produces a trace similar to that shown at (B). To interpret this result, the trace is first transferred to squared paper. Then the ordinates are measured off and used to produce graphs against a time scale: a sinusoidal potential (or more strictly, e.m.f.) wave is plotted and used to locate X points along the time axis; at the same points, the Y ordinates for the original trace are set up, and these points give a magnetizing current curve, as at (C), in both wave-

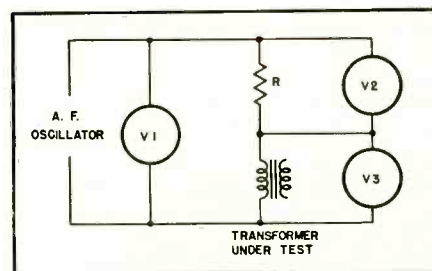

Fig. 1. The simple three-voltmeter method shown here can be used to find magnitude and phase of magnetizing current, but the waveform may invalidate the readings.

form and phase relation to the e.m.f. wave. This waveform can now be analyzed for magnitude and phase of fundamental, and percentage harmonic generated.

With care, time and patience, this method can yield good results. But something more direct is desirable. Without bothering with all the analysis, calibration of trace amplitude will find the magnitude of magnetizing current, and from this a rough approximation of inductance value can be calculated. Inductance varies widely over different amplitudes and frequencies, so this method is accurate enough for finding an inductance value only. But performance is affected more by the loss component of the magnetizing current than by its inductive component.

\* 82 Canterbury Grove, London, S.E. 27, England.

<sup>1</sup> "How good is an audio transformer," AUDIO ENGINEERING, March, 1952.

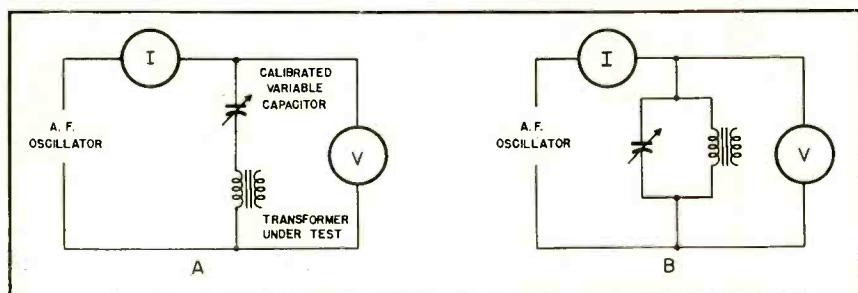

Fig. 3. Circuits such as these for balancing out the inductive reactance to find core losses are also invalidated because of waveform troubles, and other difficulties.

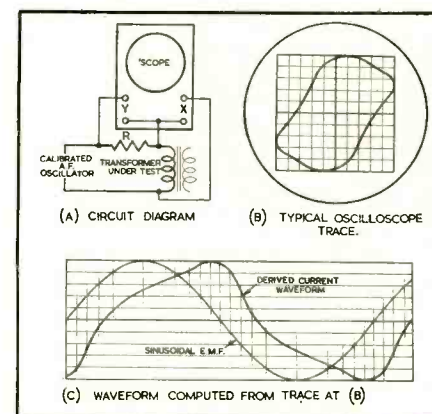

Fig. 2. This method, producing an oscilloscope trace that is graphically analyzed, can yield good results, but the analyses are arduous. Minimum equipment is required.

Coil loss may be isolated from its reactance by using a series or shunt tuning capacitor to balance out the reactance component, as shown at Fig. 3. In the series arrangement, as at (A), the loss current is sinusoidal, so the potential across the coil is not, nor is the potential across the series tuned circuit. This means the result does not conform with practical conditions. In the shunt arrangement, as at (B), the applied voltage is sinusoidal, so practical conditions are reasonably simulated, if satisfactory readings can be obtained. But with both methods of connection, definite readings are difficult to obtain: frequency is set, and the value of capacitor adjusted to obtain minimum  $V$  in (A), or minimum  $I$  in (B). It would be expected that variation of frequency, as a check for true tuning, would show a rise in  $V$  or  $I$  on either side of the set frequency; but instead, a new minimum is found in one direction. Never will adjustment of frequency for tune point coincide with adjustment of capacitance. This effect is due to the nature of the loss characteristic with frequency.

A highly successful method of making the measurements uses the bridge circuit of (A) in Fig. 4. Arms  $ab$  and  $bc$  are essentially the same as shown at (A) in Fig. 2, the low value standard resistance being used to obtain current waveform. The other arms are used to separate the fundamental component of magnetizing current from its harmonics, so that its phase can easily be read off from ellipse dimensions. To take the reading, the bridge is balanced for fundamental, so across the null points,  $bd$ , only harmonic appears. The potential drop across the combination arm  $ad$  is the same as the fundamental component of that across  $ab$ , in both magnitude and phase. The complete method is facilitated by the use of a Cossor double-beam oscilloscope, so the two Y quantities can be displayed simultaneously. Alternatively an electronic switching unit could be used.

The complete measuring circuit, including calibrating potentiometers, is shown at (B) in Fig. 4. The procedure for taking a reading at a given frequency and amplitude is as follows:

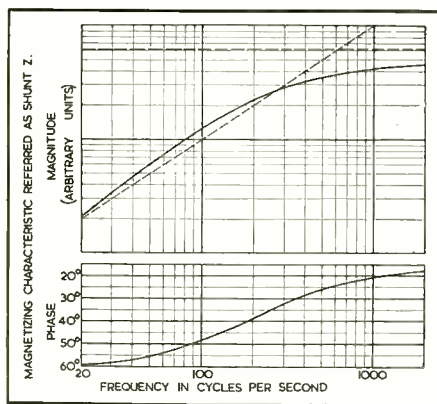

Fig. 7. Recommended method of plotting the results. The sloping dotted line represents pure inductance for comparison. The horizontal dotted line is loss due to eddy currents in the core.

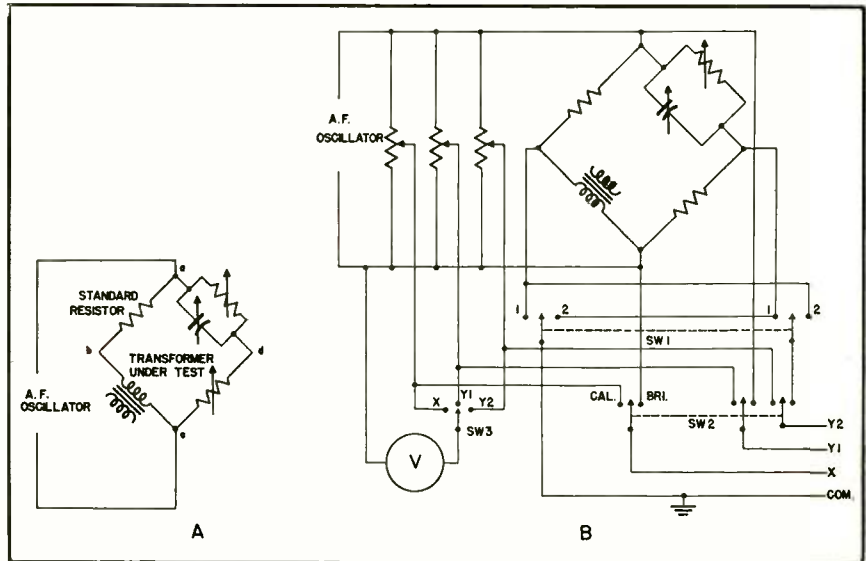

Fig. 4. This complete method, although requiring more equipment, speeds up measurement, and gives accurate results. Either a double beam scope, or electronic switching, may be used to display  $Y_1$  and  $Y_2$  traces simultaneously.

1. With  $SW_2$  in the CAL position and  $SW_3$  in the X position (the X potentiometer may be at or near its maximum), the input from the A.F. oscillator is adjusted at the required frequency to the correct voltage on the instrument scale, and the gain of the X amplifier or potentiometer on the 'scope set to produce a display of predetermined width on a squared transparency.

2. Switching over  $SW_2$  to BRI with  $SW_1$  in position 1, the input from the oscillator is adjusted until the trace is the same width again. The bridge circuit values, and the gains of the two Y amplifiers are now adjusted to make the two patterns fall between the same two horizontal rulings, as shown at (A) in Fig. 5, the one from  $Y_2$ , taken from the null point, touching each line in three places.

3.  $SW_1$  is moved to position 2, giving the traces shown at (B), and the dimensions of the ellipse used to determine the phase angle of the fundamental as indicated.

4. Return  $SW_1$  to CAL position, and adjust the three potentiometers to give the pattern shown at (C), the essential features of which are: (a) the Y deflection amplitudes are both the same as in patterns (A) and (B); (b) the phase relation between X and Y deflection voltages is zero, because both traces are straight lines. The cross pattern is due to phase reversal of one half of the double beam; use of an electronic switch will produce

two sloping lines that coincide when correctly adjusted.

5.  $SW_2$  is turned into its other two positions, and the voltage drop across the standard resistor, due to fundamental and harmonic components of magnetizing current, are read. From this the magnitude of the current is obtained by Ohm's law, and the harmonic percentage calculated from the ratio of the readings.

Considerably greater gain will be required of the  $Y_2$  amplifier, than of the  $Y_1$ . If an electronic switch is used, it may be well to incorporate an extra stage in the  $Y_2$  circuit, performing the dual purpose of giving the extra gain, and phase reversal, so the result is the same as using a double-beam 'scope.

Another interesting and useful check is to make the same measurements with a 90-deg. phase shift in the lead to the X deflection. Figure 6 shows a suitable phase-shift network. (D), (E), and (F) show the corresponding patterns for this modification. The 90-deg. phase shift is accurately set up by adjustment, using pattern (F), until the two ellipses coincide to form a circle. The interesting feature of this is the fact that one of the traces at (D) is the actual hysteresis loop (with H vertically and B horizontally, instead of the usual way). The useful part is that a check on phase is available by using a different ellipse.

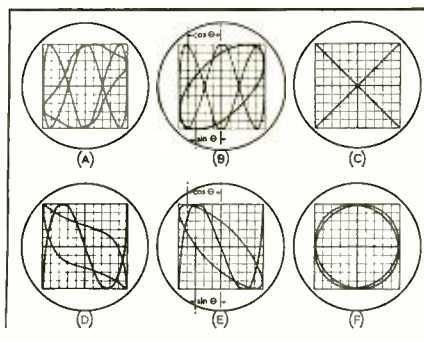

Fig. 5. Typical traces obtained using the method of Fig. 4. Significance and use of each is explained in the text.

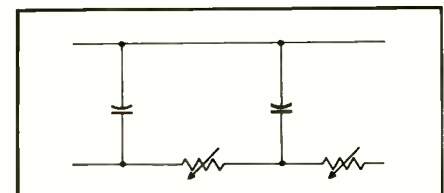

Fig. 6. This phase shift network enables the alternative traces of Fig. 5 to be displayed, giving the actual hysteresis loop, and a check on phase angle result. Exact 90-deg. phase shift requires adjustment for each frequency of measurement, using the method explained in the text.

The results of such a series of measurements can be analyzed and presented in any desired form. Probably a plot of impedance and phase angle, of which a typical example is shown at Fig. 7, is the most convenient. If desired, the measurements can be taken at different amplitudes, as well as at different frequencies, so the effect of amplitude on response can be seen. Harmonic content can be similarly plotted.

#### With D.C. Polarizing

Components designed for use with d.c. polarizing require more turns to produce the necessary inductance, so core loss due to a.c. magnetization is usually small enough to have negligible effect on performance. Inductance value does not vary so widely with amplitude and frequency of signal, but is principally dependent on d.c. polarizing current.

For measuring inductance with d.c. polarizing, the bridge circuit of Fig. 8 gives satisfactory results. The polarizing current is adjusted to a specific value, and then the bridge is balanced. The value of inductance is given by

$$L = R_1 R_2 C$$

The resistor  $R_3$  serves to balance the core losses in the inductor under test, and generally is used only to help find

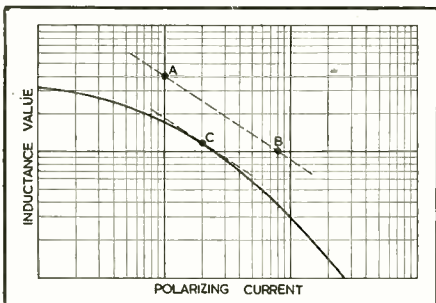

Fig. 9. By plotting inductance against current on log/log paper, the intended operating point can be located, and a useful record made for later reference.

the bridge null. If, however, the effective shunt loss resistance due to core losses is required, it is given by

$$R_p = \frac{R_1 R_2}{R_3}$$

If the inductance for various values of polarizing current is plotted, for small currents compared with that for which the core gap was intended, change of current will have only small effect on inductance; at larger values, it will cause the inductance to fall off more rapidly. If the design value of polarizing current is not known, a good method of finding it approximately is to plot inductance and current on log/log paper, as shown at Fig. 9. By connecting two points on the paper representing 4:1 inductance ratio and 1:8 current ratio, for example (A) and (B), find the 2/3-power slope. The designer's operating point is approximately where the inductance/current curve is tangential to this slope, as at (C). It is never economic to work at currents appreciably higher than this point, because inductance could

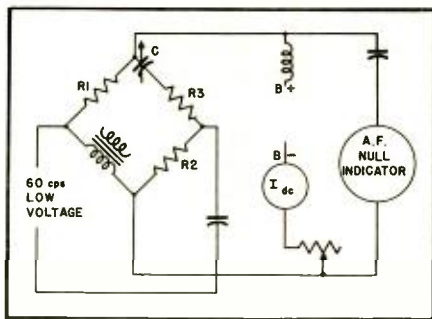

Fig. 8. Bridge circuit suited for measurement of inductance when there is d.c. polarizing current.

be improved by widening the air gap.

#### Leakage Inductance

This property is not directly dependent upon the core, but on the dimensions of the flux leakage paths through the windings themselves, so it will not possess any non-linear properties, nor will it vary with d.c. polarizing, if any.

It can be measured by an inductance bridge method. To make this measurement, one winding is short-circuited, and the leakage inductance measured at the terminals of the other winding. The measured value will be the leakage inductance referred to the winding at whose terminals it is measured.

An alternative method of determination is by resonance. Care must be taken to avoid invalidation of the result by winding capacitances. However, as winding capacitances cannot be measured independently, it is useful to determine the two quantities together, as outlined in the following section.

#### Winding Capacitances

Physical-interwinding or winding-to-ground capacitances can be measured by means of a capacitance bridge in the normal way, but this does not give the value effective in normal transformer working. The values that matter are the effective capacitances in shunt with each winding, referred to the whole winding, and that between "hot" points on the two windings. As stated in the previous article, capacitance between such hot points should be avoided—it is mentioned here only to emphasize the necessity for ensuring it is avoided.

As affecting winding capacitances, there are two important methods of connection: (1) single ended, in which one end of the winding is connected to ground, or has zero signal potential; (2) push-pull, in which the center tap of the winding has zero signal potential.

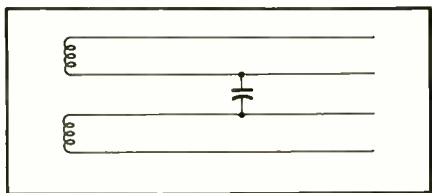

Fig. 10. In a simple transformer, the lumped interwinding capacitance is between the ends of the windings adjacent to each other. Where possible these ends should be operated as zero signal points.

Tests for winding capacitance must be made with the correct zero signal points on both windings connected to ground.

Where one or both windings are of the push-pull type, there can be no ambiguity about connection. In transformers with both windings for single ended connection, the internal construction usually consists of two simple windings, so arranged that one end of each is close to the other, shown diagrammatically at Fig. 10. These ends should be the zero signal points in their respective windings. Many manufacturers clearly indicate the correct method of connection, and in open types inspection can give the necessary information; but where neither means of identification is available, measurement of winding capacitance should include tests to find the correct method of connection.

The low-impedance winding of a transformer should be connected to an A.F. oscillator, one side of each winding being connected to ground; search is made for the resonant frequency between leakage inductance and capacitance, which is effectively a series circuit, producing a dip in input terminal voltage, or a peak in input current; having found the resonant frequency, try connecting the opposite side of the high-impedance winding to ground (the high-impedance winding is open circuited for these tests); if the resonant frequency is raised, the second method of connection is correct, otherwise the first was correct.

Next the correct connection for the low-impedance winding can be found by connecting the high-impedance winding to the A.F. oscillator, keeping its correct side grounded, and finding the resonances for the low-impedance winding (now open circuit) with leakage inductance, with its alternative ground connections. With high turns ratios, this test may be indefinite, if not impossible, but under these circumstances which side of the low-impedance winding is grounded is unimportant; although, in a practical circuit, phasing may matter. For lower turns ratios, the test will still be less definite than for the high-impedance winding, but should prove adequate.

Having thus found the correct method of connection, by inspection or test, the final stage consists in setting the transformer up, correctly connected, as a step-up transformer, and again checking the actual resonant frequency; additional capacitance is then added in shunt with the high-impedance winding until the resonant frequency is halved. The effective self capacitance of the high-impedance winding will then be one third of the added capacitance value.

Once the effective winding capacitance is known, the leakage inductance can be calculated quite simply from the resonance formula. The value given will be leakage inductance referred to the high-impedance winding. Referred to the low-impedance winding, it will be divided by the square of the turns ratio.

Some transformers may be required for "universal" use, that is, for some

[Continued on page 80]

# Record Improvement with H-F Cut-off Filters

ELLIOTT W. MARKOW\*

**Simplifying the design of practical low-pass filters for use with sound reproducing systems to eliminate unwanted high-frequency distortion and record scratch—with a few hints as to the construction of a simple and useful unit.**

CONSIDERABLE EMPHASIS has been placed on the design of suitable circuits and equalizers to compensate for the original amplitude levels of recorded music. One very important factor which has received comparatively little emphasis is the advantage of being able to cut off at a certain frequency. In fact, inability to do this actually nullifies to a great extent the benefits which derive from equalization. Commercial equalizers and preamplifiers are available which provide quite adequate bass and treble equalization, but few which provide the additional refinement of sharp cut-off.

It is commonly known that one of the most important factors in the pleasing reproduction of all reproduced sound is the lack of distortion in the extreme upper and lower ends of the audio spectrum. This distortion is particularly noticeable and most common in the upper end of the spectrum, and it is usually here that the present day reproduced music contains most distortion and noise. This is particularly true of recordings (and broadcasts of recordings) because of the high noise factors and harmonic distortions which are overemphasized when any attempt at treble boost is made. These factors, unfortunately, combine to make adequate treble boost difficult for the ear to take even though the brilliance and "presence" of the recorded reproduction has been improved and the recording obviously has highs which could profitably be used if distortion and noise factors were removed.

The solution to this apparent dilemma is obvious and is well known: use a sharp cut-off filter to eliminate all frequencies above a desired cut-off frequency—usually determined by the actual content of the record or program. This is rarely provided in commercial equalizer-preamplifiers designed for home use but is very necessary to get the utmost from recordings. An elaborate well equalized system that lacks this necessary feature is still incomplete.

It is quite important to emphasize the words "sharp cut-off." If sharp cut-off is not provided the circuit provides essentially only roll-off, which does not approach the effectiveness of sharp cut-off. Most so called "scratch filters" provide only a 6 db per octave roll off and

\* P. O. Box 145, Silver Spring, Md.

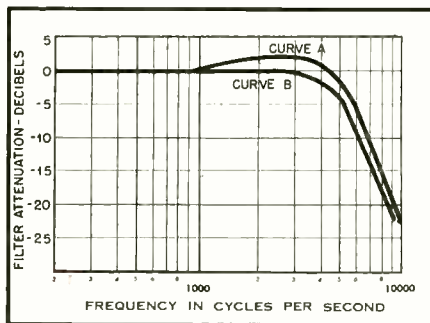

Fig. 1. Cut-off characteristic of a single-section filter designed for cut-off at 5000 cps. (A) represents the response of the filter using values of R and L given by Fig. 3; (B) response for values of R reduced to 2/3 of the Fig. 3 values or L increased by a factor of 1.5.

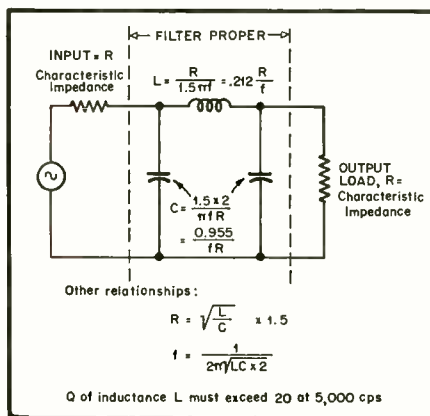

Fig. 2. Single-section low-pass filter which provides a slope of 22.6 db per octave attenuation beyond cut-off.

are not recommended for a high-quality system.

It is the purpose of this article to emphasize the desirability of adding a sharp cut-off filter to an otherwise well equalized system and discuss the design factors involved so that those interested can add a suitable filter to their present equipment or build it into new equipment. None of the mathematics or theory involved will be discussed; just presentation of design curves and information. Filters of this type do not come as cheaply or as easily as simple resistance-capacitance networks. The necessary parts will cost somewhere around \$15, but this seems small, in the writer's opinion, compared to the results obtained.

Proper cut-off makes many recordings

of normally poor quality sound surprisingly good and quite enjoyable. It will not remove distortion occurring in the transmission band but it will remove a lot of noise without removing a noticeable amount of music. Hi-fi extremists will argue that this is not high fidelity, but it is far better that the sounds please the esthetic sense than that a few extra cycles, with attendant noise and distortion, be reproduced to satisfy a theoretical curve. The pros and cons of this subject have been well covered in numerous other articles and need not be elaborated upon here. Let us simply say that personal preference dictates your course of action. In every case your non-technically minded listener—those listening just for the sake of the music—will invariably prefer a reasonable cut-off on imperfect sources.

Here is an important point: AN EQUALIZED SYSTEM WHICH CUTS OFF AT 5000 CPS AND WHICH DOES NOT OTHERWISE INTRODUCE DISTORTION WILL SOUND OF SURPRISINGLY HIGH QUALITY AND WILL BE ESTHETICALLY VERY SATISFYING. A 7000-cps system will sound somewhat better; a full 10,000-cps system will sound uncannily realistic and will approximate the "presence" of a live performance. Anything above this comes dearly and, with normally available music sources, very infrequently.

## Filter Design

The amount of cut-off provided by a single-section filter described here is shown in Fig. 1. The same general shape and amount of cut-off per octave prevails regardless of design cut-off frequency. Experience seems to indicate that cut-off frequencies of 5000, 7000, and 9000 cps are adequate for any home system, and for practically all available recordings. It is unfortunately much easier to design a filter on paper than to execute it in terms of actual equipment. A filter is not a complicated device, but in order for it to work properly it is quite fussy as to operating conditions—in particular the input and output impedances seen by the filter section and the relationship between the inductance in the filter and these impedances. The input and output resistances "seen" by the filter section should be equal; furthermore there is a rather strict relationship between these values and the value of inductance required.

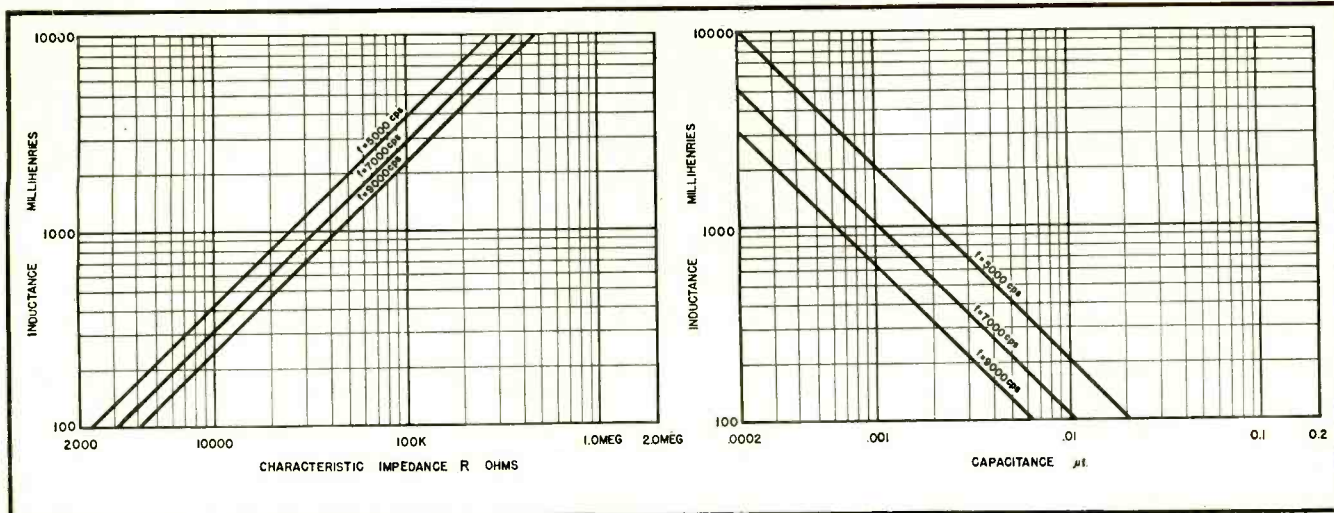

Fig. 3. (left). Chart showing relation between inductance  $L$  and characteristic impedance  $R$ . Fig. 4 (right). Chart showing values of capacitance  $C$  for indicated values of inductance  $L$  in Fig. 3.

The input and output resistances are commonly known as the characteristic impedance of the filter. It is around these values and the desired values of cut-off frequency that the filter components are determined. Fortunately the components need not be of close tolerance.

Without going into a lot of mathematics, one very practical circuit from the standpoint of transient response, sharpness of cut-off, and reasonableness of component values is that shown in Fig. 2. With correct selection of components this will provide about 22 db of attenuation per octave with only 3 db of attenuation at the design cut-off frequency. The precise sharpness of cut-off is, to a slight degree, a function of the "Q" of the inductance  $L$  but for values of  $Q$  above 20 there is very little increase in cut-off sharpness. More complicated circuits will give sharper cut-off but require additional components and usually have undesirable transient characteristics. The design formulas for this filter are also given in Fig. 2. Figures 3 and 4 show the relationships between characteristic impedance  $R$ , inductance  $L$ , and capacitance  $C$ .

This filter can be put in either the plate circuit or the cathode circuit of any medium- or low-gain triode amplifier or cathode follower and still have reasonable values of inductance and capacitance if certain factors are considered. Because of the loading effects of the filter it is almost impractical to insert the filter in the plate circuit unless the load resistance of the tubes is very low, so if at all possible it is much more preferable to operate the filter from a cathode-follower stage where loading effects can be practically eliminated. Where this filter can logically be inserted in an existing system is a matter of available gain, tube line-up, and physical layout. It is best designed into a new preamplifier and fed from a cathode follower, but it can be added to most existing amplifiers particularly if the preamplifier and power amplifier are connected through a cable. There are advantages in operating at as low an im-

pedance level as practical and this usually means operating from a cathode follower output. Hum pick-up and practical values of capacitance are the major reasons for using a low impedance. With a toroid coil the problem of hum pick-up is avoided. It is quite important that the filter characteristic impedance present a negligible load on the driving source, and as a rule of thumb the characteristic impedance should be a minimum of about 10,000 ohms.

There are several approaches to the selection of component values. Examination of Fig. 3 will show the relationship between inductance  $L$  and characteristic impedance  $R$ . In the usual case the filter is designed around a commercially available value of  $L$ , chosen to operate from some arbitrarily chosen characteristic impedance. Values of input and output resistance and capacitance are switched as necessary to change the cut-off frequency and the characteristic impedance. If we restrict ourselves to reasonable values of characteristic impedance and tuning capacitance, as can be determined from Figs. 3 and 4, it will be seen that the useful range of inductance values at 5000-cps cut-off varies between about 200 millihenries and 3 henries, all commercially available values. Characteristic impedance varies between about 10,000 and 100,000 ohms.

Suitable inductors are available from several manufacturers in a large range of values. One value of inductance  $L$  chosen to operate at the desired impedance level can serve for all three frequencies by merely switching resistors and capacitors as illustrated in Fig. 5. The inductor should have a  $Q$  of at least 20 at 5000 cps. It will cost somewhere between \$4 to \$10 depending upon value, type of winding, and shielding. Toroids are recommended, especially for high-impedance circuits.

#### Practical Filter Example

A typical circuit is illustrated in Fig. 5. Values of capacitor  $C$  may be taken directly from Fig. 4. Values of input resistance are not critical but selection

should be made on the low side of the design value rather than exceed the design value. As an example of how this filter was calculated, suppose a filter is required to operate in the cathode circuit of a triode, as in Fig. 5. The input impedance of the cathode circuit is usually given approximately by the simple equation  $Z = 1/G_m$ ; however, it should be remembered that this condition is true for an unbypassed cathode resistor and any capacitance in parallel with and approximating the value of the cathode resistor will change this relation. The characteristic impedance of the filter should therefore be higher than the cathode resistor to avoid by-passing. A good working value is to choose the characteristic impedance of about 20,000 ohms, as has been done in the example. If this value of characteristic impedance is chosen the input impedance of the cathode follower remains approximately  $1/G_m$  (about 500 ohms for most triodes) and no consideration need be given to either the actual cathode resistor or input impedance. High values of cathode resistance are usually used to keep the gain close to unity.

Having arbitrarily selected an approximate value of 20,000 ohms for the characteristic impedance, refer to Fig. 3 and select the nearest commercially available value of inductance which corresponds to a characteristic impedance of approximately 20,000 ohms, which in this case is 750 millihenries for the 5000-cps cut-off frequency. Selection of the inductance should be done on the basis of the lowest desired frequency of cut-off so that all succeeding impedances will be larger than that at 5000 cps. Values of characteristic impedance for frequencies of 7000 and 9000 cps are read directly from Fig. 3 and are seen to be 24,000 ohms and 33,000 ohms respectively. Similarly values of capacitance required for this value of inductance and for the chosen cut-off frequencies are read directly from Fig. 4, and are found to be .0027  $\mu\text{f}$ , .0014  $\mu\text{f}$ , and 850  $\mu\text{f}$ .

[Continued on page 82]

# Trade Secrets and Their Protection

ALBERT WOODRUFF GRAY\*

The acquisition of information in the course of one's employment does not automatically grant rights to use that information. The author delineates the legal obligations involved in a problem that is likely to confront anyone.

**A** RULE OF LAW was laid down a hundred years ago by the Massachusetts Supreme Court that, "If a man invents or discovers and keeps secret a process of manufacture, whether a proper subject of a patent or not, he has not an exclusive right to it against the public or against those who in good faith acquire knowledge of it, but he has a property in it which the court will protect against any one in violation of a contract or breach of confidence, undertakes to apply it to his own use or to disclose it to a third person."

This statement that court supplemented with, "A secret of trade or manufacture does not lose its character by being confidentially disclosed to agents or servants without whose assistance it could not be made of value."

A manufacturer of electric capacitors in the performance of World War I contracts had been compelled to rely to an unusual degree on the loyalty of his employees in the protection of the trade secrets involved in these war production contracts, that were not of a character that could be protected by the patent laws. With the end of the war some of the employees disclosed these secret processes to a competitor. Suit was brought for an injunction against the use or further disclosure by either this competitor or the employees.

In its decision of this action the Massachusetts court said, "The fact that an invention is patentable does not compel the taking out of a patent nor prevent the person entitled to it from keeping it secret nor bar him from relief against those disclosing its existence and details in violation of trust and confidence, nor as against those who obtain knowledge through such violation with notice and propose to make use thereof.

"The fundamental requirement for relief," concluded the court, "is a violation of trust and confidence. Any one who gets the knowledge honestly can use it provided he is not restrained by the relationship under which he acquired it."

## Confidence Implied in Employees

A New Jersey decision which was rendered half a century ago has since become authority in the application of the law to the protection of trade secrets.

An employee of a company in that state, dissatisfied after ten years, ac-

cepted another position with a competing company, taking with him for disclosure to this competitor for the mutual benefit of that company and himself, the trade secrets of this first employer.

In its decision of the lawsuit brought to prevent the use of this knowledge that court said of the duties of employee and rights of employer under circumstances of this character.

"The right of a manufacturer whose goods are made by an unpatented secret process, to protection by injunction against the divulging of his secret, is now established by a well considered line of cases. These cases establish the principle that employees of one having a trade secret, who are under an express contract or a contract implied from their confidential relation to their employer not to disclose that secret, will be enjoined from divulging the same to the injury of their employer, whether before or after they have left his employ.

"Other persons who induce the employee to disclose the secret, knowing of his contract not to disclose the same or knowing that his disclosure is in violation of the confidence reposed in him by his employer, will be enjoined from making any use of the information so obtained, although they might have reached the same result independently by their own experiments or efforts."

To this the court added a comment on the consequences which are meted out by the law to a competitor for such practices. "It would be quite impossible hereafter to decide how much of the improvement in the product of this competitor would be attributable to its own independent efforts and how much to the knowledge of the process fraudulently acquired by it. If the competitor suffers, it suffers only by reason of having been a party to the fraudulent disclosure of the secret."

In all contracts of this character, however, the courts have invariably insisted that no greater restraint be imposed on the conduct of the employee than is necessary for the safeguarding and protection from disclosure of whatever trade secrets may have been entrusted to him in confidence.

The provisions of a contract of one of the country's largest manufacturers of radio capacitors, with approximately 8,000 employees, for the protection of the trade secrets of that company, was involved in an action in the Federal Court a few years ago.

The agreement provided that the em-

ployee "will not at any time during said employment disclose to any one any information that he may acquire during said employment relating to any of the processes, formulae, plans, circuits, devices or methods, developed, acquired, manufactured or produced at any time by said corporation in its business and he will not use any of said processes, plans, circuits, devices or methods or his knowledge of the same, except in the course of his employment by the corporation."

This company claimed that employees who had signed this agreement had accepted employment with a competitor to whom they had disclosed trade secrets, not only in violation of this employment contract but of the confidence imposed in them by the company.

The court held this agreement void and unenforceable. "The agreement contains many of the vices condemned by courts in similar situations. First the prohibitions continue for the lives of the employees. Then there is no limitation on the kind of knowledge acquired while in the company's employ. There is no distinction between information that was old and well known; whether it was described in patents owned by others than the company. It makes no difference whether the employee was thoroughly familiar with the information before he went to work for the company."

As an authority for this decision holding the contract void as being too broad in its restrictions on the conduct of the employee, the court referred to an earlier New Jersey decision, holding agreements of this character to be void when the restrictions were too comprehensive, and added, that irrespective of a contract, it was implied in the confidential relationship between employer and employee that the employee would not be permitted to disclose trade secrets in violation of such confidence.

In that early New Jersey decision the employee had agreed, "that he will not at any time, directly or indirectly, during the term of this agreement or afterwards, divulge to any person, firm or corporation, any information of any nature now known to him or hereafter acquired by him during the term of this agreement, and that he will at all times hold inviolate the treatments, processes and secrets known to or used by him."

The court here said that the inevitable result of the enforcement of this con-

[Continued on page 89]

\*3536 Seventy Sixth St., Jackson Heights, New York.





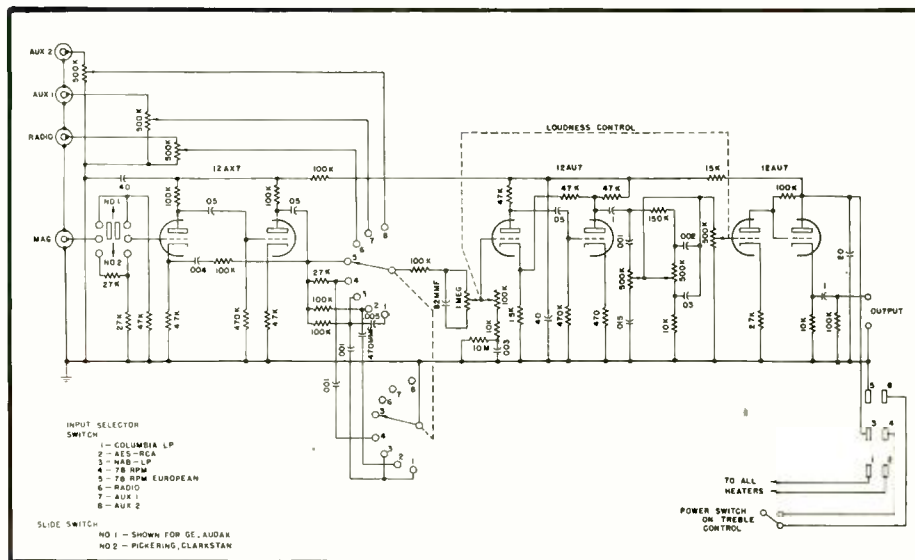

Fig. 2. Schematic of the control unit used with the basic amplifier of Fig. 1.

### The Basic Amplifier

A schematic diagram of the amplifier is shown in Fig. 1. Note that the circuits shown are, in today's advanced design practices, essentially conventional. A noteworthy exception is the use of direct coupling to reduce the phase shift or phase distortion usual in purely resistance-coupled amplifiers. In fact, the basic power amplifier employs only *one* R-C coupled stage. Excellent power supply regulation is achieved by means of paralleled 5V4G rectifiers, resulting in a low source impedance and sufficient power capacity to supply the extra-heavy power requirements for clean, undistorted bass reproduction.

Figures 3 through 6 indicate the power output, distortion, and response characteristics of the basic amplifier. Figure 3 shows power output of the amplifier versus percentage of harmonics. It will be noted that there is less than 0.2 per cent harmonic distortion up to 20 watts and no more than 2 per cent distortion at 25 watts.

Figure 4 indicates the frequency response at the 20-watt level—within 1/2 db from 10 to 50,000 cps. Usable output extends to well above 100,000 cps, being no more than 3 db down at 8 cps and at 100,000 cps.

Figure 5 indicates the response at the 1 watt level, 10 to 75,000 cps  $\pm 0.1$  db, and down only 3 db at 5 and 140,000 cps. This figure assumes practical significance when it is remembered that average room output level is 100 milliwatts. The amplifier is required to be able to deliver clean reproduction of the peaks—at least ten times the average power, or 1 watt. When it is noted that intermodulation distortion (Fig. 6) is so small as to be actually not measurable at 1 watt (intermodulation is no more than 0.2 per cent at 20 watts), and harmonic distortion as shown in Fig. 3 is similarly low, then it will be recognized that for practical purposes this amplifier is distortionless.

Stability has been achieved in this amplifier as a result of the wide frequency response and minimum phase

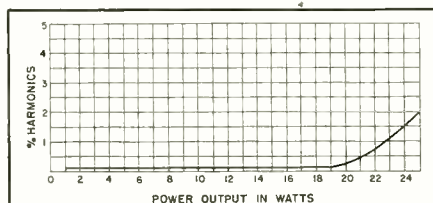

Fig. 3. Harmonic distortion vs. power output at 20 cps.

shift. Twenty-six db of feedback is applied around all three amplifier stages and the output transformer to achieve almost complete freedom from distortion, excellent stability, and a damping factor of 30. The effective output impedance at the 16-ohm tap is approximately 0.5 ohm.

Low hum and noise level (100 db below 20 watts on basic amplifier, 75 db below 20 watts with the preamplifier connected) are achieved by careful component layout and by use of an adjustable hum balancing network which biases the filaments positively to eliminate filament-to-cathode emission, a frequent cause of hum.

The basic amplifier has a sensitivity of 2.0 volts r.m.s. for 20 watts output

and is provided with its own volume control to compensate for higher input levels. One of the two amplifier inputs goes directly into the volume control for flat response, while the second input feeds the signal through a .03- $\mu$ f capacitor which reduces the response by 3 db at 50 cps for minimizing turntable rumble and other low-frequency disturbances, and also provides an input for blocking d.c.

For universal convenience, the amplifier chassis was designed so that it could be either rack-mounted or placed in either a bottom- or side-mounted position in a console.

### The Pre-Amplifier

The preamplifier (Fig. 2) was designed to be an ideal companion piece to the basic amplifier. Appearance was considered to be just as important as the technical aspects and a handsome, hand-rubbed mahogany cabinet was chosen to provide a unit that would quietly grace any living room. The pre-amp was so designed that the chassis could be easily removed to allow mounting it behind the panel of a console, with the black and gold control panel in the front.

Four standard input jacks were provided on the rear panel: Three marked respectively AUX 1, AUX 2, and RADIO, to allow connection of radio tuner, TV tuner, tape recorder, crystal pickup, etc. These are high-impedance, flat-response inputs and are each provided with individual controls available at the rear of the chassis for adjusting the input level of each program source so that the loudness control will work in the

[Continued on page 71]

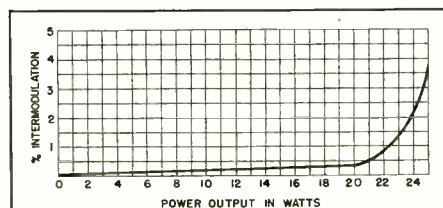

Fig. 6. Intermodulation distortion vs. power output, using 60 and 7000 cps mixed 4:1.

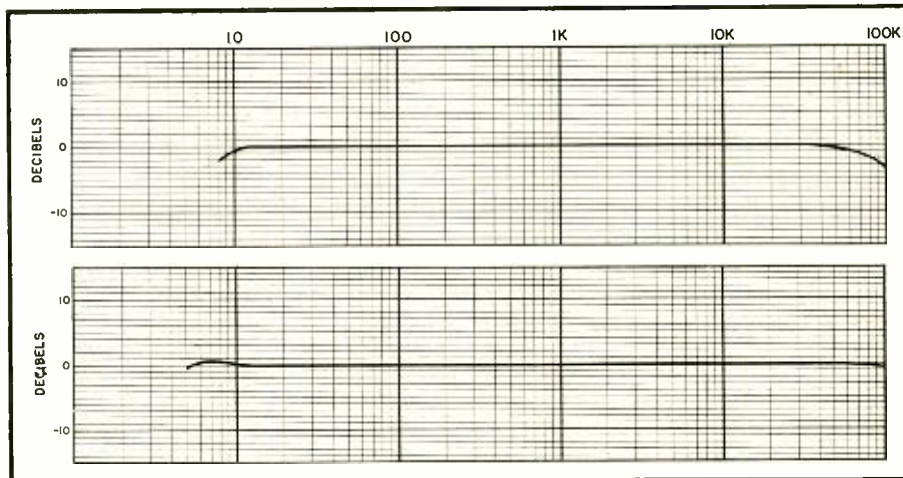

Fig. 4 (above). Frequency response of the entire amplifier at the 20-watt level, and Fig. 5 (below), at the 1-watt level.

# Cathode-Follower Audio Control System

G. B. HOUCK\*

**The connection of existing equipment to a typical high-quality amplifier and speaker system often poses difficulties in switching. The author outlines a method which makes it possible for anyone to operate the "system" without excessive indoctrination.**

**I**N THE CONSTRUCTION of many home audio systems, basic design fundamentals are often overlooked. Not only are some of these installations very expensive, but frequently difficult to operate and inflexible in use. Several designs have been illustrated recently which feature a confusing profusion of controls, located either where they are not easily seen, or where their manipulation is awkward.

In the past, when audio systems were designed for hobbyists and technicians, there was little objection to laboratory-type installations.<sup>1</sup> When non-technically trained persons such as professional musicians came in contact with audio they usually found it necessary to learn enough electronic and acoustic fundamentals to control the medium effectively.

Today the audio field has expanded, largely because of the availability of high-quality, low-cost components, and an increasing awareness among consumers that "hi-fi" systems can be much more satisfying than ready-made units. Apparently, however, the demand for such ready-made units has not diminished to the point where manufacturers are unduly concerned. On the contrary, the present market for consoles and combinations suggests possible advantages over those of custom-built systems.

Of course there are many factors influencing sales of ready-made units and audio components. Perhaps the features dwelt upon in this discussion are not those immediately apparent to the prospective customer. Nevertheless, as factors of good system design, they cannot be disregarded.

The designer of audio systems must realize that simplicity is not only a virtue of sound design, but a public demand. This fact has been demonstrated repeatedly in the sales of competitive merchandise. For example, a TV receiver was put on the market a while back which featured "one knob control." Regardless of its engineering merits or deficiencies it enjoyed a good sales record, primarily on account of its

control simplicity. Whatever the psychological implications may be, the fact remains that simplicity of operation is a most important consideration in audio system design. This may be qualified by stating that simplicity must be achieved provided it is not at the expense of quality. The qualification immediately reveals the weak point of most ready-made units, particularly in the case of tone-compensation control (a design drawback, not necessarily an engineering one).

One other point regarding the relative merits of ready-made and custom built systems should be brought out at this point in the discussion. Too many custom designers have the notion that the only obstacle in the way of increased sales and installations is a mere problem of packaging improvement. Perhaps this idea is prevalent for the reason that the expansion of the home audio business has coincided with an increasing proficiency in the techniques of installation both in furniture and in structures. Indeed, the ability of some designers in rendering electronic gear elegantly inconspicuous is legerdemain. Unfortunately, many installations are perpetrated by persons not primarily concerned with audio. If the decorator and cabinetmaker have no understanding of the operating requirements of sound systems, or if the professional designer considers them less important than novel cabinet design, it can be expected that the results will be anything but satisfactory. Controls will be located close to the floor,<sup>2</sup> labels will be non-existent, record changers will be inaccessible, etc. There is always room for improvement in packaging design when it meets the requirements of human engineering. The term in its truest sense implies an approach in which basic design fundamentals are applied in such a manner as to cause response and control by the instrumental and human mechanisms to be smoothly coordinated. The designer should understand that achievement of this goal is possible only when all the factors are carefully considered. The best designs will feature

careful choice of control types, clear control identification, proper arrangement, and most important, convenient operating location.

## Design Considerations

When the actual construction and installation of an audio system is contemplated the usual thoughts are directed to a design which presupposes starting from scratch. This may be the wrong approach. It effectively tags the owner's present equipment for disuse or even the junk-yard. It is also somewhat misleading in that it attempts to convince the owner that there is nothing worth retaining in his present equipment which may include a TV receiver, FM-AM radio, phonograph etc., of fairly good quality. These units may also represent a considerable investment. Furthermore, the custom-built system, when the costs of cabinetry are considered, is often prohibitively expensive, and usually cumbersome or simply immovable.<sup>3</sup> As such it may become a source of frustration to some homemakers, forever obsessed with the urge for periodic rearrangement of furnishings.

The approach to this problem presented here in its broadest scope is one which offers the builder the double advantage of retaining not only the operating features of his present equipment, but the actual equipment as well. At the same time, an increase in audio quality is made possible. These three features represented the initial goal when development of the cathode-follower control system was first undertaken. Other advantages, made apparent with the final perfection of the technique, will be discussed and evaluated later.

With the decision made to construct a high-fidelity audio system utilizing existing receivers, the task became to investigate the quality of the receiver units. Measurements of a typical AM table model radio indicated an audio frequency response of 20 to 7000 cps excluding the output transformer. Similar measurements with TV receivers

\* 21 Barton Place, Port Chester, N. Y.

<sup>1</sup> M. P. Johnson, "Multipurpose audio amplifier," *AUDIO ENGINEERING*, August 1947.

<sup>2</sup> Jeff Markell, "Cabinet design for Hi-Fi systems," Fig. 4, *AUDIO ENGINEERING*, May 1952.

<sup>3</sup> William C. Shrader, "Audio in the home," *AUDIO ENGINEERING*, May 1952.

and FM tuners led to the assumption that except for their audio output sections, most of these receivers could be classed as "hi-fi." The next step, then, was to devise a method of bypassing the audio output sections, apparently the principal sources of poor frequency response and distortion. This would be accomplished with an absolute minimum of circuit changes in the receivers. It was also obvious that some means should be available for using one high-quality audio power amplifier and speaker system for all of the units. The final step involved design of an adapter device for linking the receiver front-ends with the amplifier. With the completion of these design steps, several unique advantages became immediately apparent. There would be no modification of existing unit controls nor any change in operating procedures. No rebuilding of receivers nor extensive circuit changes would be necessary.<sup>4</sup> The various units could be located wherever desired. Total cost would be no more than necessary to purchase or construct the power amplifier, speaker and several adapters.

Four steps are involved in the realization of such a hi-fi system. The engineering and craftsmanship required are a minimum. The first step involves the addition of a few components to the power amplifier, as shown schematically at (A) in Fig. 1 and pictorially in Fig. 2. The second step is the "adaption" of the units. The third step is the construction of the simple adapter devices. The fourth step is the installation of the complete system.

#### Circuit

Before describing these four steps in detail, it is desirable to consider the circuitry involved, including purely electronic functions. The essence of the system is the connecting link between the receiver unit and the hi-fi amplifier. Basically, it is a cathode-follower device which effectively shorts out the regular output transformer and provides special low-impedance output from the cathode.<sup>5,6</sup> The pin connections shown are for output tubes similar to those shown at (B) in Fig. 1. Other tube types may be used with appropriate connections. In the power amplifier the d.c. component of the signal is used to energize a 5000-ohm d.c. relay which controls primary power for the amplifier. The audio signal passes through a blocking capacitor and a potentiometer adjusted for the proper operating level. The usual power switch remains in parallel with the relay contacts, providing manual power control in the event high-impedance sources are connected to the amplifier. The input terminal jack is wired to accommodate either high or low-im-

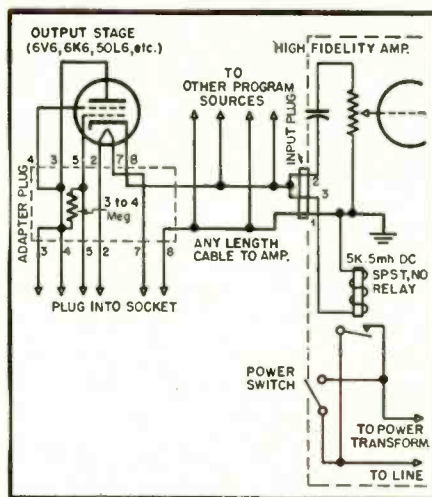

Fig. 1. Circuit schematic for the cathode-follower control system.



Fig. 3. Adapter chassis used with electronic organ, showing simple "add-on" unit which may be employed with tuner or any other sound source.

pedance sources. Figure 2 shows a Williamson type amplifier with relay installed.

As outlined a few paragraphs above, no modification of the receiver units is necessary in most installations. There are, however, a few cases where a simple addition to a receiver may be needed. If the tuner has no audio output section or terminates, for example, in a detector or discriminator output, a unit similar to the one shown in Fig. 3 may be constructed easily. The 6SN7 assembly illustrated is one particular type which

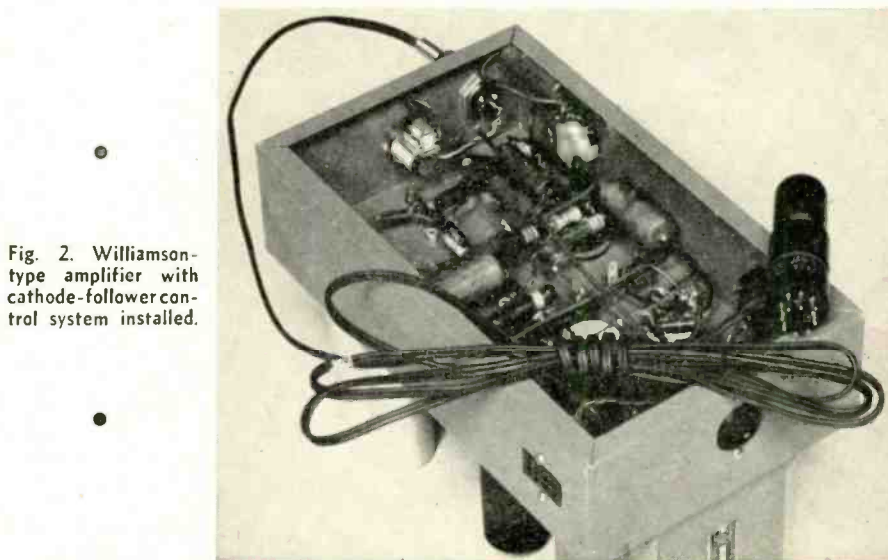

Fig. 2. Williamson-type amplifier with cathode-follower control system installed.

was added to an electronic organ for an echo amplifier and speaker arrangement. Miniature tube types such as the 12AU7, 12AT7, etc., result in a space saving. Figure 4 shows the schematic of such a unit. The assembly is simply mounted by fastening it to the chassis or securing it to the cabinet. The only caution to be observed is the need for an adequately filtered plate supply, as any hum present will be fed into the audio output. It is also recommended that an isolating transformer be installed in a.c. transformer-less sets to eliminate possible shock hazard.

Construction of the adapter plugs is not difficult. The socket should be similar to the type illustrated, in Fig. 5. The plugs, if unavailable from parts distributors, can be fabricated from old tube bases (containing a sufficient number of pins). The resistor and pigtails are soldered to the socket as shown in the photo and drawn through the plug pins along with the output leads which are passed through a small hole drilled in the side of the plug.

Installation of the complete system is simplicity itself. Since the line impedances are low, the interconnection may be made using ordinary zip-cord or bell wire. For under-the-carpet wiring, TV antenna lead-in ribbon is recommended, since it is flat and causes no lumps or bulges.

#### Phonographs

So far, nothing has been said about the use of a phonograph with this system. There are few hi-fi record playing devices these days which do not require preamplifiers and some means of equalization. In the case where the phonograph player has its own preamp and audio output, any of the previously mentioned adaption techniques can be similarly employed. If the builder has nothing more to start with than the basic player mechanism and pickup, he is advised to construct a preamp-equalizer, as shown in Figs. 6 and 7. The three requirements for such a device are proper load for the pickup, sufficient gain, and cathode-follower output

<sup>4</sup> Ulric J. Childs, "Why not use your present tuner?" *AUDIO ENGINEERING*, April 1952.

<sup>5</sup> G. B. Houck, "Gain chart for cathode followers," *Tele-Tech*, August 1947.

<sup>6</sup> Audio Design Notes—"The cathode follower," *AUDIO ENGINEERING*, June 1947.

impedance. The design illustrated provides a minimum of control. If the builder desires a more elaborate equalizer, several excellent designs have been presented in previous issues.<sup>7</sup>

#### Location of Units

There are practically no restrictions on the location of the units of the complete audio system. Because of the low-impedances and the need for only two conductors, the units may be placed as far apart as desired, without undesirable effects such as high-frequency attenuation or hum-pickup. In general, the TV receiver should be located where it can be viewed easily. In the case of the speaker, a corner location is usually preferred because loading is improved. There is certainly no reason why a TV receiver cannot be located directly above or even near the center of the sound source.<sup>8</sup> One serious objection to the

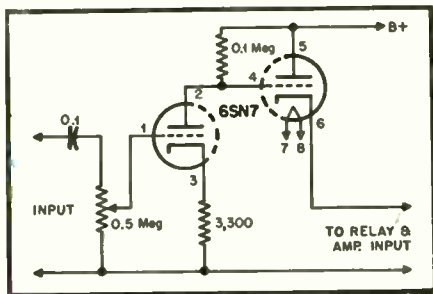

Fig. 4. Schematic of adapter chassis shown in Fig. 3.

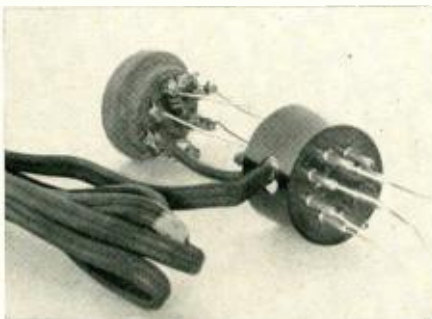

Fig. 5. Assembly suggested for adapter plug used with typical output tubes in AM, FM, or TV receivers.

location of any units close to the speaker cabinet is that it results in poor control. If the operator is forced to stand less than a foot or so from the speaker when adjusting the volume control, it is quite likely that the level will be unsatisfactory at other distances. As a matter of fact, it is most desirable to have the controls as near the listening position as possible. This, of course, is one of the principal features of the cathode-follower control system. It should not be difficult to place the FM or AM radio next to a comfortable chair, or the phonograph near the record storage space. With the power amplifier and its power supply located in a closet, in the cellar or attic, heat

<sup>7</sup> St. George and Drisko, "Versatile phonograph preamplifier," *AUDIO ENGINEERING*, March 1949.

<sup>8</sup> C. G. McProud, "A new corner speaker design," *AUDIO ENGINEERING*, Jan. 1949.

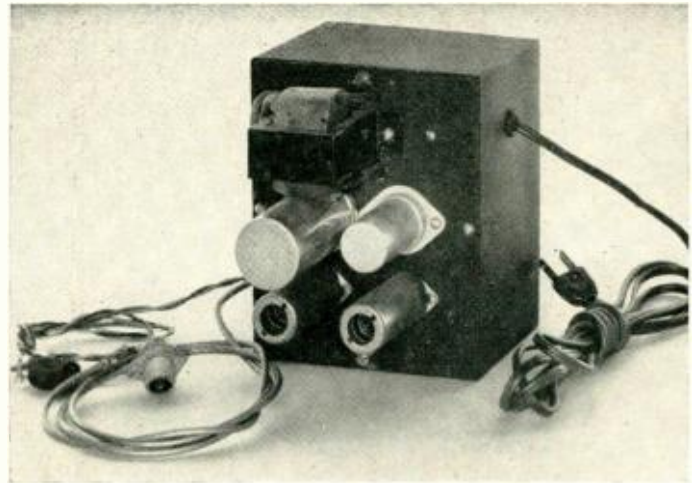

Fig. 6. Compact self-powered pre-amplifier-equalizer designed to feed a phonograph signal to the power amplifier in the same manner as described for other sound sources.

dissipation problems are solved, and there is little chance of hum produced by power transformer interference.

#### Performance

In discussing the performance of the system it is important to emphasize the functional aspects as well as electronic. Since the design calls for bypassing those portions of the receivers which represent the chief source of poor quality, it is obvious that better performance is achievable. It should be reasonable to expect the audio quality to be limited only by the capabilities of the power amplifier, provided there are no losses in the connecting link. If an amplifier comparable in quality to the Williamson is employed, it seems safe to assert that high-fidelity will be obtained. As for the connecting link, its impedance is generally less than 500 ohms. If the average level is approximately 1 volt and the hum and noise level as much as 100 microvolts, or 80 db down, it is

obvious that no loss of quality is observed. Although the output lines of every unit are wired in parallel, no harm is done if more than one unit is turned on at a time. In this case, the bias on the cathode-follower may be upset and the resulting sound is somewhat disagreeable, if not confusing.

The distinct advantages of this system are revealed when functional performance is evaluated. The control features of the separate receivers are retained, control of hi-fi audio selection is completely automatic, and there is very little chance of control confusion. Since most persons are familiar with the control arrangement of conventional receivers, the builder need not consider preparing an instruction manual for the system. Whereas there are some audio systems which can be operated only by their designers, the cathode-follower audio control system installed in the author's home and in several others is used with equal facility by visitors and family, including his five-year-old son.

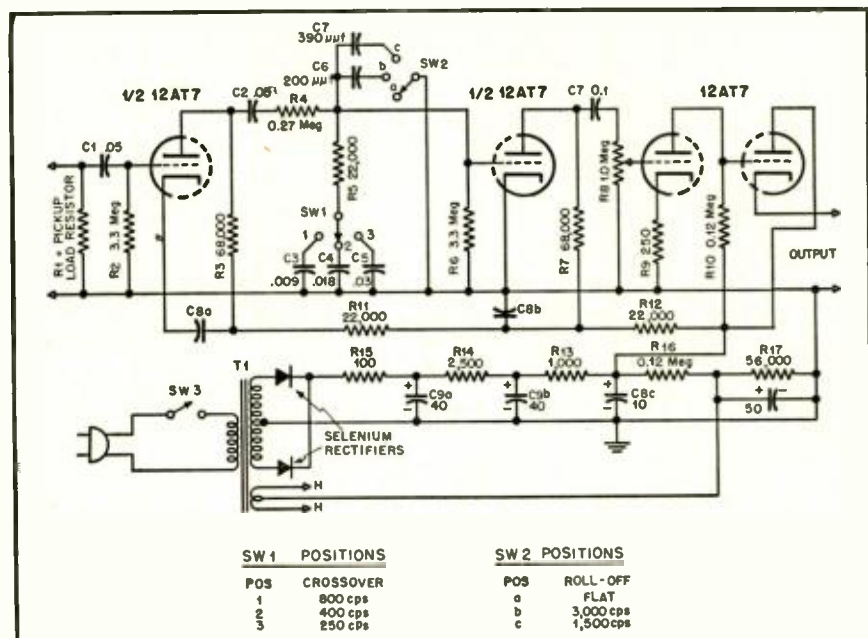
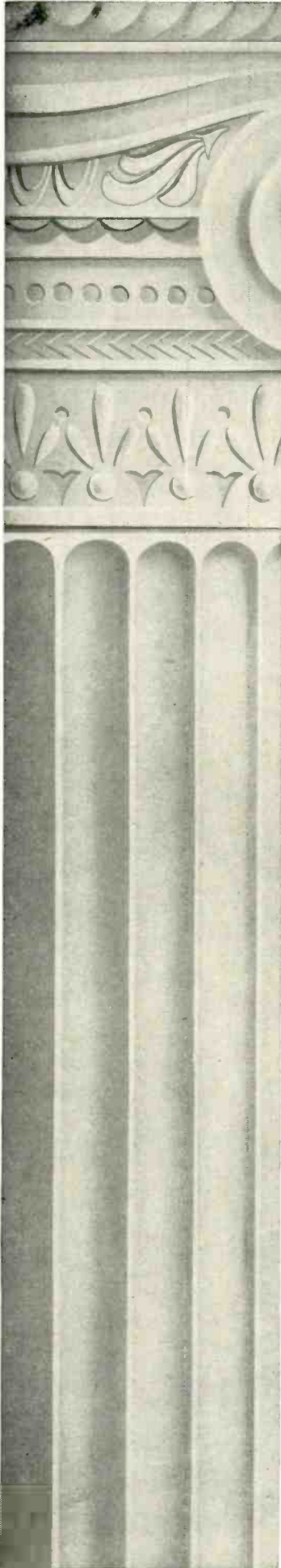

Fig. 7. Circuit of preamplifier pictured in Fig. 6.



*Unquestionably the greatest  
new contribution in years  
to reproduced music enjoyment*



The Classic 25, fidelity *sans pareil*  
25 watts with complete remote control

**modern Classics in sound by newcomb**

Designed exclusively for the connoisseur of music who wants to hear *all* of it, just as it was recorded . . . eight completely new custom home music amplifiers that not only sound better but are easier to install.

There is nothing, short of live music itself, to compare with the brilliant, clear, full-bodied tones of the Classic 25, the star of this amazing new series of fine amplifiers. Its galaxy of features include a remote control beautifully finished in rich, brushed brass, a dramatic accent to even the most tastefully appointed interiors. Distortion is reduced to the lowest limits of measurement, yet reserve power has not been sacrificed. Frequency response extends from below 10 to over 100,000 cycles. New

"Audi-balance" achieves perfect balance of output tubes in seconds. Exclusive "Adjust-a-panel" extends control shafts instantly for cabinet mounting. Six inputs are provided for radio, TV, tape recorder, crystal and magnetic (2) pickups. "Fletcher-Munson" compensated volume control maintains perfect aural balance. A cross-over selector simplifies attainment of correct playback response, includes foreign and domestic frequencies and the new A.E.S. standard.

*Send for our catalog describing all  
8 completely new amplifiers priced from \$39.50 to \$269.50 audiophile net.*

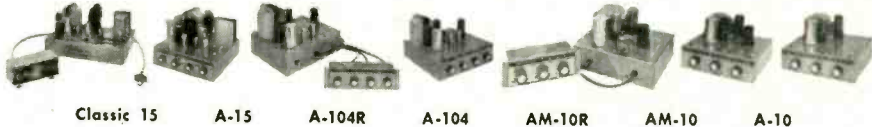

Classic 15    A-15    A-104R    A-104    AM-10R    AM-10    A-10

*Newcomb*

**15 years of quality leadership**

6824 LEXINGTON AVENUE, HOLLYWOOD 38, CALIFORNIA



*Write Dept. T for catalog C-20M*

# The Violin

ALBERT PREISMAN\*

**Part 3. Concluding the discussion of the history, construction, and musical characteristics of one of the most important musical instruments in the orchestra. This installment covers the technique of playing, and describes some measurements made on several violins.**

**T**HE TECHNIQUE OF PLAYING the violin consists in stopping or shortening the strings with the fingers of the left hand to raise the pitch, bowing the string or strings in a variety of ways, and plucking the strings with the left and/or the right (bowing) hand. From these basic methods results the beautiful melodies of the Strad played by a virtuoso and the horrible cacaphony of sounds of the beginner, who secretly is thrilled by the anguish he causes his long-suffering teacher.

It was mentioned previously that each finger of the left hand, as it presses the string down on the fingerboard, raises its pitch either a half or a whole note, as desired. The fourth finger on the string produces the same pitch as that of the next higher open string, and is often preferred to the sound of the open string. Sometimes the fourth finger is stretched to produce the next higher note corresponding to the first finger on the next string; this may be preferable in order to avoid swinging the bow to the next string for a single note. One trades the difficulty of the left-hand fingering technique for that of the right hand bowing technique.

When one gets to the E or highest string, the fourth finger yields the highest note that one can obtain in the first position. To play higher notes, the left hand must be shifted along the neck toward the bridge, whereupon the fingers will be able to stop the string to shorter lengths and hence higher pitch.

If the hand is shifted so that the first finger now falls on the string where the second finger previously touched it, we have shifted the distance of one finger or from the first to the second position. If the hand is shifted so that the first finger now touches the string where the third finger previously touched it, we have a shift to the third position.

Similar considerations hold for the fourth, fifth, and higher positions. To the novice, at any rate, the third and fifth positions seem more natural than the second and fourth, and of course, it is more difficult to play in the very high positions than in the lower ones because the left hand must stretch to reach those portions of the fingerboard, particularly on the G string. It is amazing how an experienced violinist can shift suddenly from the first to say the fifth position and hit the correct note with uncanny

accuracy. Nor is the feat of shifting rapidly from one position to the next in playing rapid passages any less marvelous.

In passing, we note that the higher positions are also used on the lower strings. The reason is that often the tone color of the lower string is preferred to that of the higher string, particularly in the case of the G and D strings. Sometimes such a shift on the same string facilitates the bowing, and is therefore employed.

## Chords

Chords consisting of two notes or double-stops, as they are called, are readily played by pressing the bow on adjacent strings. But the notes of chords on three or four strings cannot be played simultaneously because the arc of the bridge prevents the bow from pressing on more than two strings at a time. It will be evident that this arc is necessary to permit the individual strings to be played independently when desired.

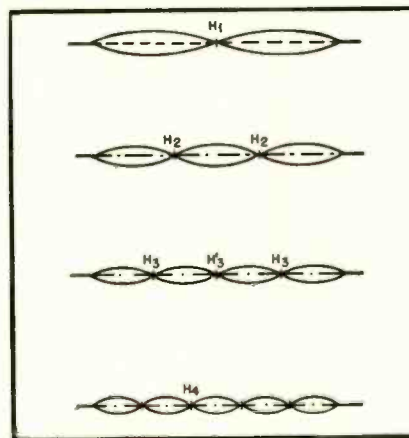

Fig. 9. Vibration of a string to produce harmonics.

To play a three- or four-note chord (assuming that the notes are such that they can be played on separate strings), the bow is first pressed on the two lower strings and then swung over to the two upper strings. The result is really two double-stop chords in rapid succession, somewhat like an arpeggio (in which the notes are played separately in succession). The result is a pleasing imitation of the chord as it would be played (simultaneously) on a piano.

As an example of the advantage of tuning the violin in fifths, suppose it is desired to play a double-stop of D and E. Both of these normally occur on the D string, but both cannot be played

simultaneously on this string. However, by placing the fourth finger on the G string and the first finger on the D string, we obtain the notes on two separate strings, whereupon they can be bowed simultaneously.

The maximum interval between two notes that can normally be played as a double stop is the open string and the fourth finger on the next higher string. The result is "ninths," which are not ordinarily used because the chord is not pleasing.

However, the use of "eighths," or octaves, is quite common, and is preferably produced by the first finger on the one string and the fourth finger on the next higher string. Successive chords are produced by sliding the fingers simultaneously one note at a time up (or down) the fingerboard. As one approaches the end of the fingerboard, the fingers must draw closer together because of the shortening of the strings; this is but one of a myriad of details of violin technique.

An even more difficult interval is "tenths." Here the fourth finger must stretch two notes beyond its normal position while the first finger on the adjacent lower string remains in the same position at any time as if an octave were being played. The great Paganini was a master of this, and it is said he used to practice on the mandolin so as to be able to stretch his fingers over such an interval.

## Harmonics

The next point to be discussed is harmonics. These are flute-like notes which in the higher register sound like a whistle. As might be surmised from this description, they are practically pure fundamental tones, with no harmonic overtones! The reason for calling them harmonics is that they are the harmonic overtones of the string, sounded individually instead of simultaneously with the fundamental, as is normally the case.

Figure 9 illustrates the manner in which they are produced. The string is bowed in the normal manner, and a finger (usually the fourth) is pressed lightly at the midpoint of the string. The string cannot vibrate in its fundamental mode because it would develop a loop at the center; this the finger prevents.

However, since the finger presses but lightly on the string, energy can be transmitted past it. Hence it vibrates in two halves, and develops the har-

\*Vice-President in Charge of Engineering, Capitol Radio Engineering Institute, Washington 10, D. C.

# NEW! SOUNDCRAFT professional magnetic recording tape

Professional Quality . . . for Professional Performance

New Soundcraft Professional Tape was created especially for professional use. It is tape of professional quality, for professional performance. It is produced by an entirely new formula that results in:

- 1. Greatly reduced distortion at the same output, or . . . higher output at conventional accepted distortion
- 2. Improved high frequency response
- 3. It is not necessary in any way to adjust your present equipment to get this improved performance.

New Professional Tape Available in 3 sizes  
 SPN-12P (1250')  
 SPN-25P (2500')  
 SPN-50P (5000')



Exclusive! New Soundcraft Professional Tape is **Micro-Polished!**\*

In addition to our own special buffing process, Soundcraft Professional Tape is Micro-Polished. This exclusive Soundcraft feature produces a new high in performance perfection:

1. Practical elimination of drop-outs
2. Superior high frequency response
3. Improved uniformity
4. Better head contact

PATENT APPLIED FOR.

REEVES  
**SOUNDCRAFT** CORP.

10 East 52nd Street, N. Y. 22, N. Y.

Makers of Magnetic Recording Tape, Magna-Stripe

THE ONLY RECORDING MATERIALS  
 PERFECTED AND MANUFACTURED  
 BY RECORDING SPECIALISTS

Please write for complete information.

Visit us at:  
 The Audio Fair  
 Room 508

monic  $H_1$ ; this is an octave higher than the open string. Had the finger been pressed down hard, only the lower half of the string would be able to vibrate, although in this case the tone would still be an octave higher.

If the string is stopped lightly at one third of its length from either end, such as by the fourth finger in the first position or the second finger in the third position, the string vibrates in thirds, and generates a frequency three times that of the open string, or  $H_3$ . This is a fourth above the previous harmonic.

If the third finger in the first position is pressed lightly against the string, it will be found to press at one-fourth of the length of the string. The string now vibrates in four segments, hence the fundamental frequency is two octaves above that of the open string. The same result is obtained by stopping the string lightly at one-quarter of its length from the bridge. This is indicated by the two values of  $H_4$ . On the other hand, if the string is pressed at the center ( $H_2$ ), it vibrates in halves rather than in quarters.

If more segments are desired in the string, the finger should be pressed lightly nearer either end. However, it is very difficult, if not actually impossible, to excite the string in these nodes, except for one case. If the third finger in the third position is pressed lightly against the string, it will be found to press at two-fifths of the string's length. In this case the string can be made to vibrate in five segments, as indicated by  $H_5$ , and a tone that is a major third above  $H_3$  is generated. Similar results are obtained at the bridge end of the string.

It would appear then that four harmonics of certain frequencies are all that can be produced on each string. This limitation, however, can be circumvented by a very simple trick. The first finger is pressed down hard on the string, thereby artificially shortening it enough to raise it one tone. Then the fourth finger is pressed down lightly on the artificially shortened string; it presses at one-quarter of the length. Thereupon a harmonic two octaves higher than the shortened string is produced, and this harmonic is one tone higher than the  $H_4$  harmonic of the open string.

We have thus obtained two harmonics or "whistles" one note apart. By sliding the first finger up a note each time and then pressing lightly with the fourth finger, we can produce harmonics of all notes. This is how the violin is made to whistle tunes. You have all heard this effect, if in no other selection than the "Hot Canary."

#### Vibrato and Glissando

Two other fingering effects are to be noted. One is the vibrato, or tremolo as it is known in the organ. The vibrato or "shake" is produced by rocking the left hand back and forth on the finger that is stopping the string. The result is a vibratory or throbbing effect just like in the case of the human voice, and

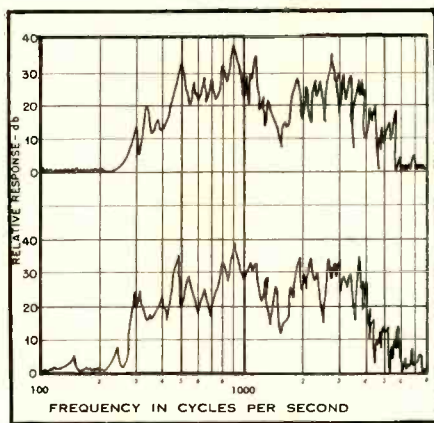

Courtesy of J. Acous. Soc. Am.

Fig. 10. Frequency-response curves for a cheap (upper) and a good-quality (lower) violin.

is the effect that helps to make the violin tone so beautiful and human-like in sound.

The vibrato is actually a kind of frequency modulation of the tone, occurring at a rate of about four or more times a second. Its rate and degree or deviation can be varied at the will of the player, and is one reason why the violin is so superb in the way in which it responds to the performer and makes him feel as one with it. The vibrato can also be employed in some other instruments, such as the cornet or trumpet, and the organ has a stop for that purpose, but in the latter case the effect is usually fixed by the design.

The last effect to be discussed is the glissando or slide. Since the pitch is determined by the fingers, one can go from one pitch to the other in a kind of gradual fashion, instead of abruptly, by sliding the finger from one note to the next. This is best done by sliding from say the first position to the third in playing a sequence of notes, and the result is an expressive effect very much like that of the voice singing a scale all in one breath. In the hands of a good player this is a very emotional effect, but in the hands of a player of poor taste this can be very "schmalzy." Even harmonics can be given a certain amount of vibrato with very nifty results.

As stated previously, bowing is the harder of the two arts, and much depends upon the bow arm. Notes can be played in separate bow strokes, or all "in one bow" as it is said. If the bow is started and stopped abruptly for each note, a so-called staccato effect is obtained. Each note can be bowed separately, or a series of notes can be played staccato all in one bow by drawing it along the string in a series of jerks. This is easier to do in up-bow, hence we find Paganini requiring the staccato down-bow in his Violin Concerto in D.

Then there are various forms of jumping bow techniques. The effect is a series of notes daintily tripping along in a light staccato fashion, and provides the violin with a variety of expressive effects. The bow may be made to jump by hammering it on the string; by employing the right amount of force it can be made to bounce a desired number of times per impact.

It can also be made to bounce or jump when playing a series of separate notes by jerking the wrist in the proper manner; this is known as spiccato bowing. Also, it can be made to bounce when playing arpeggios. These are chords in which the notes are played in sequence instead of simultaneously, and the bow is wrapped around the strings with a whip-like motion while the fingers are held fixed on the various strings just as if a chord was going to be played.

Space forbids further discussion of violin technique, but in passing let us note the trill, which is a rapid alteration of two adjacent notes. This can also be done when double-stops are played, but y'gotta be good! Some harmonics too can be played in double stops, but y'gotta be better.

Pizzicato, or the plucking of strings, can be done with the right hand even while it is holding the bow, by extending the forefinger and plucking the string. Or one finger of the left hand can be used to stop the string, and another finger of the left hand employed to pluck it. In addition, another string can be simultaneously bowed, so that it sounds like a violin accompanied by a guitar.

#### Experiments on the Violin

We now turn from violin technique to a discussion of some of the experiments that have been performed on the instrument in an effort to find out scientifically why one fiddle is better than another. It is perhaps here that the violin baffles us more than in any other way, for most of the experiments indicate little or no difference between a good and poor fiddle.

One of the first tests to be performed of a more scientific nature was that of analyzing the tones as played a semitone apart.<sup>5</sup> This method was then superseded by one in which the G string was replaced by a phosphor bronze wire with a diameter of 0.015 in., and tightened to the same tension as the G string.<sup>6</sup>

It was then placed in a powerful magnetic field, and audio currents of the desired frequency passed through it, which caused it to vibrate at that particular frequency. Soft absorbent cotton was placed between it and the fingerboard as well as between it and the other strings so as to damp the wire and make it have a uniform response.

The sound was then picked up by a microphone and its output recorded. This method enables the vibrations of the body alone to be studied, without reference to string resonances. Any frequency can be impressed, so that the response can be resolved to a much finer degree than semitone intervals.

Figure 10 shows the frequency re-  
[Continued on page 72]

<sup>5</sup> F. A. Saunders, *J. Acous. Soc. Am.*, 9, 81 (1937).

<sup>6</sup> Watson, Cunningham, and Saunders, "Improved techniques in the study of violins," *J. Acous. Soc. Am.*, Jan. 1941.



ONLY THE  
**Collaro**  
 INTERMIX 3/522  
 HAS ALL THESE  
 HIGH FIDELITY

FEATURES:

- Intermixes 10 and 12 inch Records at All Speeds.
- Steady, Constant Speeds — No Rumble or Wow.
- Weighted, Rubber-matted, Rim-driven Turntable.
- Four Pole Motor with Self-aligning Oilite Bearings.
- No Hum Pickup.
- Molded Rubber Drives—No Belts to Slip or Replace.
- Stylus Pressure Adjustment — Tracks at as little as 3 grams.
- Absolutely Jam-proof Operation.
- Automatic Muting Switch.
- Ball-bearing Mounted Turntable and Tone Arm.
- Automatic Shut-off after Last Record.
- Tone Arm Clamp for Portable Applications.

Base Dimensions: 14 3/4" x 12 1/4"  
 Depth Below Base: 2 1/2"

LIST PRICE \$65.00

Audio engineers and audio enthusiasts all agree that the quality of any sound reproducing system is the sum total of all of its components units. One weak link in the chain dooms the entire system to mediocrity.

In a record reproducing system, the record changer is the first consideration. If high fidelity is to be attained, the record changer should be the finest obtainable.

Consider the COLLARO. The COLLARO Intermix 3/522 was planned for perfection, and was engineered to the most exacting quality standards. It is truly the high fidelity record changer, and the perfect complement to any high fidelity system.

See the Collaro at the N. Y. Audio Fair—Room 607



Model 3/522  
**Collaro**  
*Fully Automatic* INTERMIX

**3-SPEED**  
**RECORD CHANGER**  
 FOR 7, 10, AND 12 INCH RECORDS

Model 3/521 Fully Automatic  
 Non-Intermix Model  
 LIST PRICE \$54.50

The High Fidelity Record Changer  
 for High Fidelity Record Reproduction

At your Distributor or Write for Details:

**ROCKBAR CORPORATION**  
 211 EAST 37TH STREET, NEW YORK 16, N. Y.

# Handbook of Sound Reproduction

EDGAR M. VILLCHUR\*

## Chapter 6. The Perception of Sound

A thorough knowledge of sound reproduction demands an equivalent familiarity with the fundamentals of hearing and the principles of psychoacoustics.

**T**HE DESIGN OF REPRODUCING APPARATUS must take into consideration the auditory mechanism of the listener as well as the physical nature of sound. The subjective factors of loudness, timbre, and pitch do not have a constant relationship to the objective reality of amplitude, wave form, and frequency. Although certain influences over perception can obviously not be categorized (a noise may appear unduly loud, for example, because of a state of anxiety on the part of the hearer), there are some patterns of perception which are characteristic of human hearing in general. When proper allowances are made for these patterns it is possible to avoid certain difficulties in creating an apparent naturalness in reproduced sound.

### The Fletcher-Munson Effect

It has been established that the various physical characteristics of sound do not each produce their own effect independently, and that the perception of a particular quality is affected by characteristics other than the one with which it is primarily associated. The pitch of a tone, for instance, is not determined exclusively by its frequency, but is also influenced by both intensity and wave form.<sup>1</sup> (See Fig. 6-1.)

The most important of such secondary influences which the audio designer must allow for is the relationship between loudness and frequency at different intensity levels. This relationship was given a definitive study by H. Fletcher and W. Munson, who published the well-known group of curves reproduced in Fig. 6-2. Each "equal loudness contour" plots the sound intensity required to produce the same sensation of loudness at different frequencies. The iden-

\* Contributing Editor, AUDIO ENGINEERING.

<sup>1</sup> Tones below 2,000 cps tend to decrease in pitch with an increase in intensity, while tones above 2,000 cps tend to increase in pitch with an intensity increase. This "normal illusion" is very much greater with rich tones than with pure tones.

Fig. 6-1. Variation of pitch with loudness level. The number on each curve represents the loudness level in phons. The change in pitch produced by a change of loudness from 40 phons is read on the vertical scale. Except for the 120-phon level, the maximum change occurs at about 100 cps. After W. B. Snow, J. Acous. Soc. Am., July 1936.

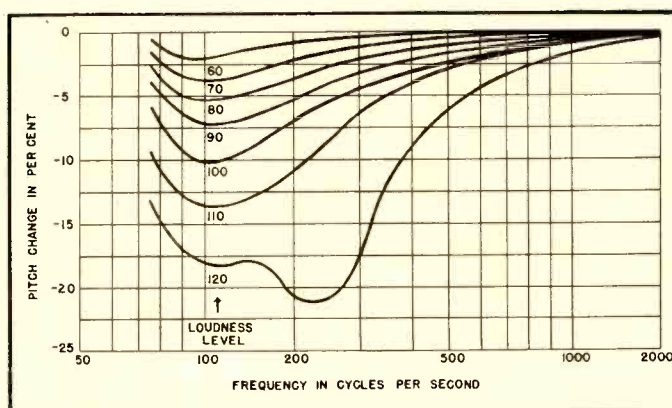

tifying number on each curve indicates the loudness level above threshold of the sound to which the curve refers.

There are two types of information that may be derived from this set of curves. The first concerns the shape of any one particular contour, a shape which indicates that hearing sensitivity at the corresponding loudness level varies radically over the frequency spectrum, and is maximum in the region from 3,000 to 4,000 cps.

If it were not for the fact that reproducing apparatus creates spurious components that do not exist in the original sound, this variation would

have only academic interest for audio technicians, since the same illusion exists for both the live and the reproduced music. It is necessary, however, to take into consideration the fact that spurious elements, whether due to noise sources or to harmonic distortion, have varying nuisance value depending upon their frequency. A 60-cps hum will be far less apparent than 120-cps hum of the same intensity, and intermodulatory products appearing around 3,000 cps need only be faint to be detected.

The second type of information which is contained in Fig. 6-2 has even greater significance for sound repro-

Fig. 6-2. The Fletcher-Munson equal loudness contours. Each curve plots the intensity in db required to maintain a constant loudness in phons (represented by the number on the curve) over the frequency spectrum. 0 db is the threshold of audibility. Courtesy Bell Sys. Tech. J.

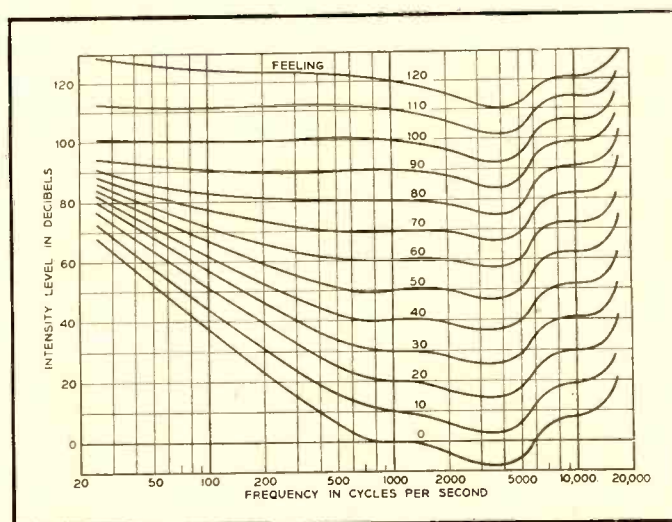

# how **BIG** is the **BEST** in plug-in audio amplifiers?

— only **3 1/2"** of standard panel space  
IF you use the **NEW Langevin 5000 Series**

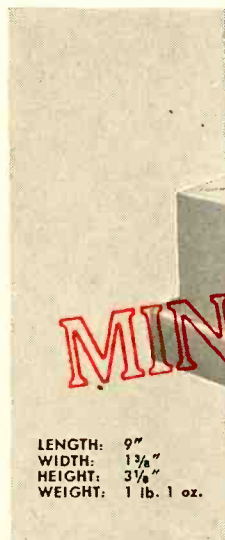

LENGTH: 9"  
WIDTH: 1 3/4"  
HEIGHT: 3 1/4"  
WEIGHT: 1 lb. 1 oz.



**TYPE 5116 AMPLIFIER**  
• 11 will fit across standard rack •

## TYPE 5117 AMPLIFIER

A plug-in, low-noise, low-distortion, fixed-gain unit for use as a program monitor or booster amplifier in broadcast audio facilities, recording, or sound systems.

**Gain:** 55 db, fixed.

**Input source impedance:** 150/600 ohms, center tapped.

**Output load impedance:** 150/600 ohms, with center tap on 600 ohm position.

**Output noise:** equivalent to input signal of -110 dbm or less.

**Output power:** +30 dbm (1 watt) with less than 0.5% RMS total distortion from 30 to 15,000 cps; 39 dbm (8 watts) with less than 1% RMS total distortion from 50 to 15,000 cps.

**Frequency characteristic:** ±0.5 db from 30 to 15,000 cps.

**Power requirements:** 70 ma DC at 300 v, 1.2 amps at 6.3 v.

**Tube complement:** two Type 6V6, two Type 5879.

## TYPE 5116 AMPLIFIER

A plug-in, low-noise pre-amplifier for use in broadcast audio facilities, recording, or sound systems. Can be used as a booster amplifier with +18 dbm output.

**Gain:** 45 db into unloaded input transformer, with provision for adjusting to 40 db.

**Input source impedance:** 30/150/600 ohms. Center tap available when strapped for 150 or 600 ohms.

**Output load impedance:** 150/600 ohms, with center tap on 600 ohm position.

**Output noise:** equivalent to input signal of -120 dbm or less.

**Output power:** +18 dbm (0.063 watt) with less than 0.5% RMS total distortion from 50 to 15,000 cps, only 1% at 30 cps.

**Frequency characteristic:** ±0.5 db from 30 to 15,000 cps.

**Power requirements:** 6 ma DC at 275 v, 0.3 amp at 6.3 v.

**Tube complement:** two Type 5879.

## TYPE 5117 AMPLIFIER

• 6 will fit across standard rack

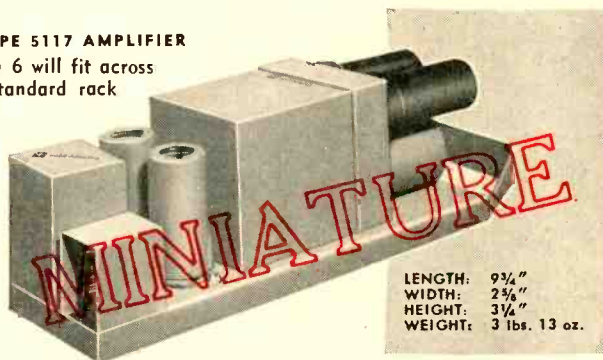

LENGTH: 9 1/2"  
WIDTH: 2 3/4"  
HEIGHT: 3 1/4"  
WEIGHT: 3 lbs. 13 oz.

## TYPE 5206 POWER SUPPLY

A plug-in unit capable of powering as many as 22 Type 5116 pre-amplifiers, or 10 Type 5116 pre-amplifiers plus two Type 5117 monitor amplifiers.

**Load current:** 210 ma DC at 300 volts.

**Filament current:** 6.5 amps AC at 6.3 volts.

**Ripple:** less than 2 millivolts pre-amplifier supply, less than 10 millivolts monitor amplifier supply.

**Power requirements:** 105-125/210-250 volts, at 50 to 60 cps.

**Rectifier:** two type 5Z4 tubes.

**TOGETHER FOR THE FIRST TIME!** Compactness beyond belief

• Top broadcast quality • Balanced output • Low-impedance input • Plug-in construction • Gold-plated plugs • Only 3 tube types • Tube-pull without plug-out • Plate-current-check switches.

Why not try Langevin for your transformers — custom-built to commercial or MIL-T-27 specs. Fastest delivery in the country on test samples!

SEE US IN ROOM 531 AT THE 1952 AUDIO FAIR



LENGTH: 9 1/2"  
WIDTH: 7 3/4"  
HEIGHT: 3 1/4"  
WEIGHT: 17 lbs. 6 oz.

**TYPE 5206 POWER SUPPLY**  
• 2 will fit across standard rack •



*means the finest in audio components.*

LANGEVIN MANUFACTURING CORPORATION

transformers • amplifiers • power supplies 37 WEST 65TH STREET NEW YORK 23, N.Y.

duction. This information is read from the relative shapes of two different curves, one representing the level of the original sound, and the other the changed level of the reproduced sound. It will be seen that if music is reproduced at an intensity level different from the one at which it was created, the relative perception of intensities over the frequency spectrum will not be the same as in the original, and the musical tones will suffer an apparent change of timbre.

Since it may be assumed that the instrument maker and the composer had in mind the timbres perceived at normal concert intensities, the reproduced sound is changed from the original musical conception. This may be corrected by a tone control of either the manual or the automatic "volume compensator" type.

There are certain misconceptions about the proper characteristics of the latter which have occasionally been used as the basis of circuit design. It is not the function of volume compensation to straighten out the equal loudness contours, but to equalize the curve at the reproduced level so as to give it approximately the same shape as the curve at the original level. The average level of a seventy-five piece orchestra is about 80 db<sup>2</sup> above threshold, and the average level of the lowest intensity with which sound is ordinarily reproduced with any legitimate interest in quality is about 50 db.<sup>3</sup> (Orchestral peaks may raise both of these figures by 20 db.) It we examine the two curves corresponding to these levels we will see that they run almost parallel from about 500 cps up, indicating that all compensation must concern itself with frequencies below this point. "Compensating" the treble ranges when there has been no significant change in perceived spectral distribution has the dual disadvantage of creating unnatural timbres and emphasizing harmonic distortion.

In connection with the lack of correspondence between loudness and objective sound intensity a special unit, referring to the *sensation* of sound intensity, is used:

The *phon* is the unit of loudness level. The loudness level of a tone in phons is numerically equal to a sound pressure level in db, (relative to .0002 dynes/cm<sup>2</sup>, the approximate threshold of audibility) of a pure 1,000-cps tone which is judged by listeners to be of the same loudness. Sound pressure in phons and in db would thus be the same if it were not for the variation of loudness with frequency.

It may be seen that the identifying numbers on the equal loudness curves are in phons, and that they correspond numerically to the intensity in db at 1,000 cps only. This unit makes allowances for two psychological influences, the Fletcher-Munson effect, and the

<sup>2</sup> Hugh S. Knowles, "Loud-speakers and room acoustics", *The Radio Engineering Handbook*, Keith Henney, ed., p. 881, 3rd ed., 1941.

<sup>3</sup> "Frequency Range and Power Considerations in Music Reproduction", *Jensen Technical Monograph No. 3*, Jensen Mfg. Co.

Weber-Fechner description of perceptible patterns which was discussed in Chapter 2.

Since the threshold intensity of sound varies so much from bass to treble the frequency limits of audible sound are not fixed, but depend upon the intensity level at which these limits are measured. The zero-db curve of Fig. 6-2 represents the audible threshold intensity at various frequencies, assuming an acute listener and no interfering noise. A tone 40 db above threshold will be barely audible at about 90 cps, but at no lower frequency. At high intensities the frequency range of pure tones for an average person under forty is usually considered to be about 16 to 16,000 cps, although in many cases this range is extended in both directions.

The high-frequency limit declines appreciably with age. When Madame Gadski, an operatic prima donna, visited the Carl E. Seashore psychological laboratory, the singer was tested and found to be deaf to tones above 12,000 cps while her young daughter could hear frequencies up to 20,000 cps.

#### Masking

The presence of one sound may *mask* another, or cause it to be less audible. The masking property of a sound (over another sound of a particular frequency) is defined quantitatively as the number of db that the threshold intensity level of a pure tone of that frequency is shifted upwards.

Figure 6-3 illustrates the masking properties of various tones and noises. It will be seen that in general the major part of the masking occurs at and above the frequency of the masking tone. Hum will mask mainly the bass octaves, and record-surface scratch the higher frequencies. Random room noise raises the threshold of audibility of all frequencies and reduces the range of perceivable frequencies at low intensities.

#### Minimum Perceptible Differences

The perception referred to so far has been in relation to absolute magnitudes rather than to changes. We must also be concerned with the perception of minimum differences, so that we will know when variations in frequency and amplitude, such as might be caused by

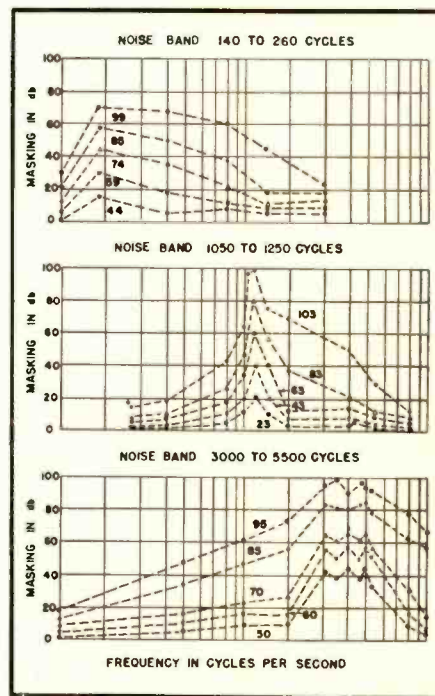

Fig. 6-3. Masking curves for various bands of noise. Each curve represents the masking effect, in db, of the band of noise at the numbered intensity level. After H. Fletcher and W. Munson, *J. Acous. Soc. Am.*, July 1937

the erratic operation of reproducing equipment, will become noticeable.

Figure 6-4 shows the minimum changes in intensity that may be perceived at different frequencies and intensity levels. At the level of most reproduced music a fraction of a db of change can be noted in pure tones, indicating the desirability of keeping the variation in equipment frequency response small.

The minimum change of frequency that can be discerned varies considerably with different individuals. As might be expected, the faculty for detecting frequency changes is usually most highly developed in professional musicians, some of whom have been able, in tests, to detect a change from middle *A* of one-tenth of a cycle. This is less than 1/500 of a whole tone. The average person is able to detect a frequency change from middle *A* of about 3 cps,

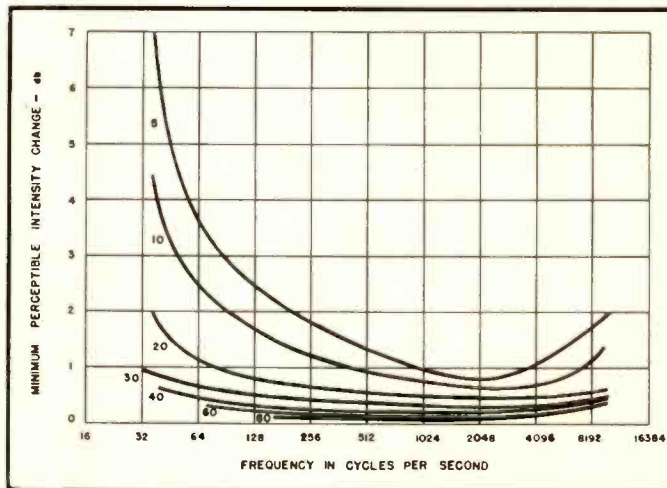
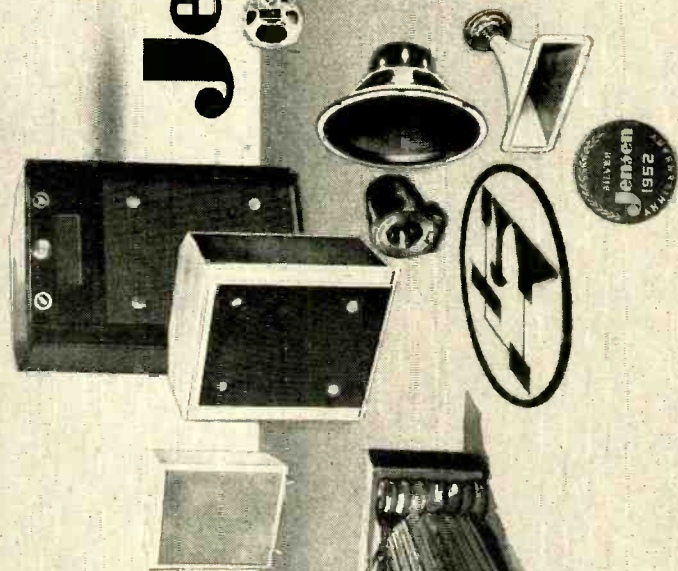

Fig. 6-4. Minimum perceptible changes in sound intensity level of pure tones. Each curve is identified by a number representing the loudness level in phons. After H. Fletcher, "Speech and Hearing," D. Van Nostrand Co.

THE OLDEST NAME IN HI-FIDELITY  
—THE NEWEST IDEAS. THE JENSEN  
COMPLETE LINE FOR HI-FIDELITY  
IN REPRODUCTION—TRI-PLEX.  
• TRIAXIAL • COAXIAL • 5 TO 15 INCH  
EXTENDED RANGE SPEAKERS • ULTRA  
HIGH FREQUENCY, HIGH FREQUENCY  
AND LOW RANGE UNITS • NETWORKS  
• CONTROLS • BACK-LOADING  
FOLDED HORN AND BASS REFLEX  
CABINETS. JENSEN MANUFACTURING  
COMPANY, 6601 SOUTH LARAMIE  
AVENUE, CHICAGO 38, ILLINOIS,  
DIVISION OF THE MUTER COMPANY.  
IN CANADA: COOPER WIRE PRODUCTS,  
LTD., TORONTO, LICENSEE.

BURTON BROWN ADVERTISING

# Jensen



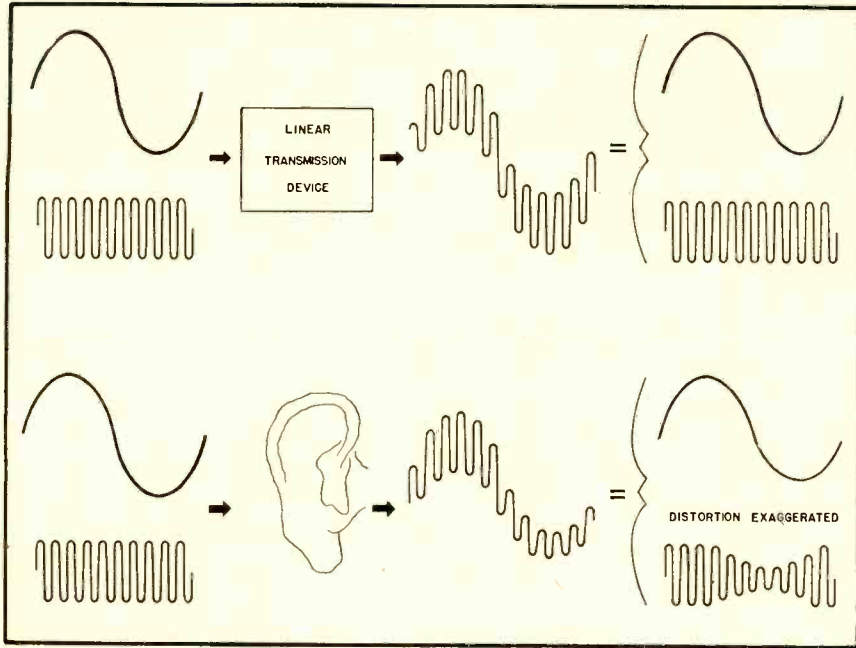

Fig. 6—5. Intermodulation produced by non-linearity of the ear.

and a few individuals cannot clearly differentiate notes a half-tone or even a whole-tone apart. The moral is for musicians and those with acute pitch perception to use record players whose turntable r.p.m. exhibits an exceptionally small amount of fluctuation or "wow."

The minimum time required for a pure tone to be sensed as such is about one-twentieth of a second, and appears to be independent of frequency.

#### Non-linearity of the Physical Mechanism of the Ear

We have seen previously that vibrating sources of sound break up into harmonic modes of vibration in addition to their primary or fundamental mode. Devices subjected to forced vibration also exhibit the tendency to produce harmonics of the frequencies at which they are stimulated, and since these harmonics are not present in the original stimulus they constitute distortion. Distortion of this type is called *non-linear* because the instantaneous response of the device to an input stimulus is no longer exactly proportional to the stimulus, and the graph which plots the instantaneous output response against the input stimulus is no longer a straight line.

The transmission mechanism of the ear is no exception to the category of mechanical devices which possess the above failing, especially when responding to sound of high intensity and low frequency. This may be inferred from two pieces of evidence:

1. If a pure tone of sufficient intensity is sounded, harmonics not present in the stimulus may be heard.
2. If two loud tones are sounded simultaneously, additional sum and difference tones may be heard.

The existence of these sum and difference tones in the ear, which are also

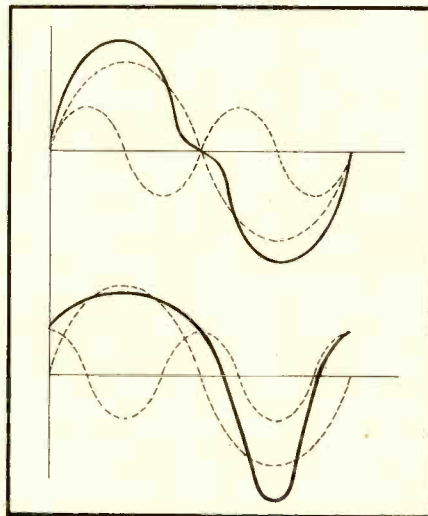

Fig. 6—6. Two sound waves whose partials are the same in magnitude but different in phase. Although the geometric wave forms are different, the timbres will be the same except for the slight influence of aural harmonic interference.

called "subjective tones,"<sup>4</sup> have a profound influence upon hearing. Certain instruments, like the piano, produce tone complexes in the lower notes whose fundamental component is inaudible, but which nevertheless can be clearly identified as being at the pitch of the fundamental. This identification proceeds from the many difference tones between successive harmonics, all at the frequency of the fundamental. The same phenomenon occurs in the apparent reproduction, by telephones, acoustical phonographs, or table-model radios, of tones whose fundamental frequencies are far below the low-frequency capabilities of the equipment.

The creation of sum and difference tones is not a beat phenomenon, and is not dependent upon the phase of one note alternately coinciding with and then opposing the phase of the other. Sum and difference frequencies exist as components of the combined wave form of the two original notes only when this wave form is distorted by a non-linear system.

The ear drum vibrates simultaneously at both low and high frequencies, so that the relatively large advances and retreats stimulated by the bass are accompanied by a smaller to and fro motion superimposed on the longer vibratory path. If, at the extended excursion of the lower frequency, the path of normal travel is checked by the imperfect compliance of mechanical elements, the high-frequency vibrations will also be restrained more than normally. They will therefore be of reduced amplitude during the entire period that the low-frequency wave peak is being clipped. This produces an amplitude modulation, as shown in Fig. 6—5. A Fourier analysis of an amplitude modulated wave reveals the existence of the familiar sideband components consisting of the sum of and difference between the carrier and modulating frequencies. These intermodulatory products have an

<sup>4</sup> "Subjective tone" is really a misnomer, because the sum and difference tones have a physical reality in the vibrations of the ear mechanism, and will exist in the output of any non-linear transmission device.

[Continued on page 74]

Fig. 6—7. Basic auditory mechanism of the ear.

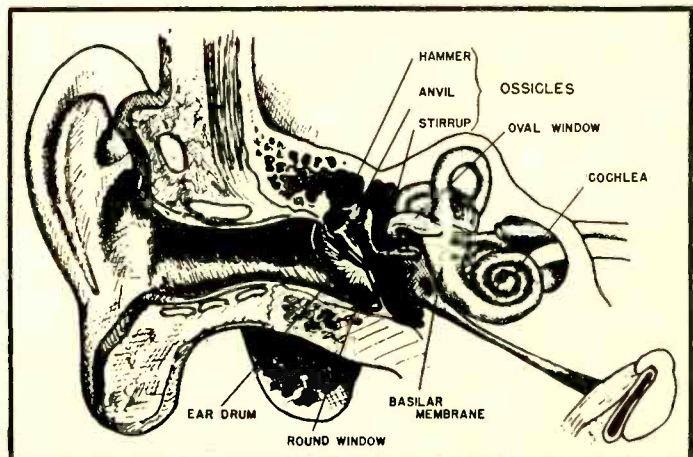

IN EVERY FIELD

*There is a Leader!*

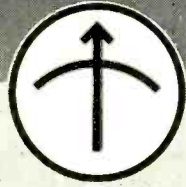

—and following every leader are those who would rather copy than create!

Substitutes are not acceptable where precision instruments are required, that is why engineers the world-over specify the MEASUREMENTS line. They know that—

**STANDARDS ARE ONLY AS RELIABLE AS THE REPUTATION OF THEIR MAKER**



Model 65-B  
STANDARD SIGNAL GENERATOR



Model 80  
STANDARD SIGNAL GENERATOR

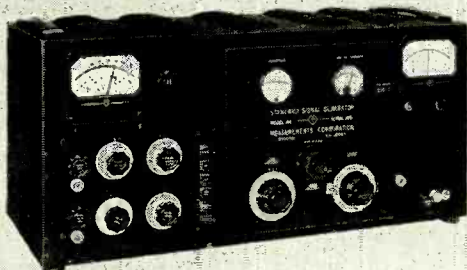

Model 84  
STANDARD SIGNAL GENERATOR

**MEASUREMENTS  
CORPORATION**

**BOONTON • NEW JERSEY**

**MEASUREMENTS  
"FAMOUS FIRSTS"**

in

*Laboratory Standards*

**1939 MODEL 54 STANDARD SIGNAL GENERATOR**—Frequency range of 100 Kc. to 20 Mc. The first commercial signal generator with built-in tuning motor.

**MODEL 65-B STANDARD SIGNAL GENERATOR**—This instrument replaced the Model 54 and incorporated many new features including an extended frequency range of 75 Kc. to 30 Mc.

**1940 MODEL 58 UHF RADIO NOISE & FIELD STRENGTH METER**—With a frequency coverage from 15 Mc. to 150 Mc. This instrument filled a long wanted need for a field strength meter usable above 20 Mc.

**MODEL 79-B PULSE GENERATOR**—The first commercially-built pulse generator.

**1941 MODEL 75 STANDARD SIGNAL GENERATOR**—The first generator to meet the need for an instrument covering the I.F. and carrier ranges of high frequency receivers. Frequency range, 50 Mc. to 400 Mc.

**1942 SPECIALIZED TEST EQUIPMENT FOR THE ARMED SERVICES.**

**1943 MODEL 84 STANDARD SIGNAL GENERATOR**—A precision instrument in the frequency range from 300 Mc. to 1000 Mc. The first UHF signal generator to include a self-contained pulse modulator.

**1944 MODEL 80 STANDARD SIGNAL GENERATOR**—With an output metering system that was an innovation in the field of measuring equipment. This signal generator, with a frequency range of 2 Mc. to 400 Mc. replaced the Model 75 and has become a standard test instrument for many manufacturers of electronic equipment.

**1945 MODEL 78-FM STANDARD SIGNAL GENERATOR**—The first instrument to meet the demand for a moderately priced frequency modulated signal generator to cover the range of 86 Mc. to 108 Mc.

**1946 MODEL 67 PEAK VOLTMETER**—The first electronic peak voltmeter to be produced commercially. This new voltmeter overcame the limitations of copper oxide meters and electronic voltmeters of the r.m.s. type.

**1947 MODEL 90 TELEVISION SIGNAL GENERATOR**—The first commercial wide-band, wide-range standard signal generator ever developed to meet the most exacting standards required for high definition television use.

**1948 MODEL 59 MEGACYCLE METER**—The familiar grid-dip meter, but its new design, wide frequency coverage of 2.2 Mc. to 400 Mc. and many other important features make it the first commercial instrument of its type to be suitable for laboratory use.

**1949 MODEL 82 STANDARD SIGNAL GENERATOR**—Providing the extremely wide frequency coverage of 20 cycles to 50 megacycles. An improved mutual inductance type attenuator used in conjunction with the 80 Kc. to 50 Mc. oscillator is one of the many new features.

**MODEL 112 U.H.F. OSCILLATOR**—Designed for the many applications in ultra-high frequency engineering that require a signal source having a high degree of frequency accuracy and stability. Range: 300 Mc. to 1000 Mc.

**1950 MODEL 111 CRYSTAL CALIBRATOR**—A calibrator that not only provides a test signal of crystal-controlled frequency but also has a self-contained receiver of 2 microwatts sensitivity.

**1951 MODEL 31 INTERMODULATION METER**—With completely self-contained test signal generator, analyzer, voltmeter and power supply. Model 31 aids in obtaining peak performance from audio systems, AM and FM receivers and transmitters.

**1952 MODEL 84 TV STANDARD SIGNAL GENERATOR**—With a frequency range of 300-1000 Mc., this versatile new instrument is the first of its kind designed for the UHF television field.

MAKE THE INCOMPARABLE LEAK "POINT ONE"

BRITAIN'S FINEST HIGH-FIDELITY AMPLIFIER

THE HEART OF YOUR MUSIC SYSTEM . . .

DISTORTION CERTIFIED TO BE ONLY

ONE TENTH OF ONE PERCENT!

COSTS ONLY \$192.00 NET

FOR AMPLIFIER

AND

PRE-AMPLIFIER

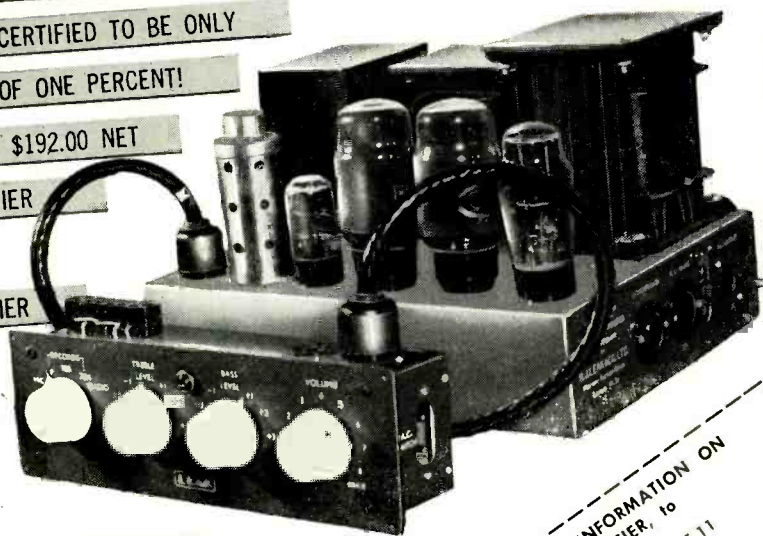

LISTEN . . . AND COMPARE!

EXAMINE TOP AND BOTTOM CRAFTSMANSHIP

BEFORE YOU BUY!

THERE'S A POWERFUL

DIFFERENCE!

MAIL THIS COUPON TODAY FOR INFORMATION ON  
HOW TO CHOOSE AN AMPLIFIER, to  
BRITISH INDUSTRIES CORP., Dept. AE 11  
164 Duane St., N. Y. 13  
Name \_\_\_\_\_ Address \_\_\_\_\_ City \_\_\_\_\_ State \_\_\_\_\_ Zone \_\_\_\_\_



*A Cordial Invitation from*  
**BRITISH INDUSTRIES CORP.**  
*to SEE and HEAR*  
**BRITAIN'S FINEST**  
**AUDIO EQUIPMENT**  
*at the AUDIO FAIR*

Place: Hotel New Yorker  
Time: October 29th to November 1st

Here is an opportunity to witness a thrilling demonstration of High Fidelity Sound . . . The Garrard, the world's finest record changer, playing through the Leak "Point One" Amplifier with a Wharfedale Loudspeaker housed in the revolutionary R-J Speaker Enclosure!

# WHARFEDALE

## SUPER 12 CS/AL

A single extended range speaker that outperforms many multi-speaker combinations!

A complete range of speakers is available for every application . . . all built by Wharfedale Wireless Works under the personal direction of G. A. Briggs, world-renowned audio engineer

Aluminum voice coil . . . extended range without "peaking"

Cloth suspension . . . reduced resonance — improved transients

Bakelized cone apex . . . amazingly clear "highs"



### BRITAIN'S FINEST LOUDSPEAKERS

Costs only \$61.95 net  
Send your name for free fact sheet telling why it will perform so well in your home.

Loudspeaker \$1.60 Amplifiers \$2.95 Piano, Pianists, Sonics \$2.50

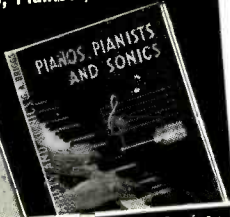
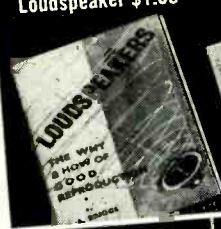

**NON-TECHNICAL SIMPLE LANGUAGE**  
Practical Informative  
Only books of their kind written expressly for the layman. Simple, easy-to-understand language. Many illustrations and diagrams. At your jobber or send check or money order.

Dept. AE 11  
**BRITISH INDUSTRIES CORP.,**  
164 Duane St., N.Y. 13, N. Y.

Loudspeakers—Baffles  
Acoustics—Frequency response, etc.

Amplifiers—Phase Splitters—Push Pull—Negative Feedback—Tone Compensation—Circuits, etc.

Piano, Pianists, Sonics—Touch and tone—Tuning—Timing—Oscillograms of sounds, etc.

THE AUTHENTIC R-J ENCLOSURE — only slightly larger than the speaker itself!



**BRITISH INDUSTRIES CORPORATION • 164 DUANE STREET, N. Y. 13**



**HEAVY DRIVE SHAFT:**  
A unique feature! Exclusive with Garrard!  
Drive shaft for 33 1/3 rpm and 45 rpm is heavy, thus obtaining more consistent quality at critical low speeds. Wows and wavers eliminated.

**TRIPLE SPEED SWITCH:**  
Speed changes are clearly marked, easily made. The RC-80 plays 33 1/3, 45 and 78 rpm. Records are placed on the player and simple settings made. Action is then completely automatic, including automatic shut-off after last record of any size.

**CONVENIENT START-STOP-REJECT LEVER:**  
Start, stop and reject lever are combined and located conveniently away from tone arm.

**PUSHER TYPE PLATFORM:**  
Adjusts simply to 7"-10"-12" records regardless of diameter or size of spindle hole.  
No record changing mechanism has been developed to equal the performance of the precision pusher platform. For records with standard center holes, the pusher platform is the only method that gives positive gentle record operation.

**PULL-AWAY IDLER WHEEL:**  
Avoids flattening of drive wheel when changer is not operating.

**AUTOMATIC STOP:**  
Insures positive and unfailing action at end of any type record.

**BALANCE-MOUNTED TONE ARM:**  
Parallel lift tone arm construction guarantees true tangent tracking. Disturbing resonance eliminated.

**INTERCHANGEABLE PLUG-IN HEADS:**  
Carefully engineered to accommodate user's choice of crystal or magnetic cartridges for standard and micro-groove reproduction, such as Astatic, Pickering, Audak and GE twist models.



**WEIGHTED TURNTABLE:**  
RC-80 turntable is heavily weighted to give flywheel action so that any variations in the drive motor are not reflected in record reproduction. No turntable rumble.

**HEAVY DUTY SILENT 4-POLE MOTOR WITH ABSOLUTELY NO RUMBLE:**  
Speed maintained throughout a wide variation in line voltage. There is no appreciable speed variation operating unit "cold" with a full load or "hot" with one record, regardless of weight, thickness or diameter of records.

**IMPORTANT!**  
Only a 4-pole motor can assure no hum when used with sensitive magnetic pickups.

**TWO INTERCHANGEABLE SPINDLES:**  
Easily inserted, the two Garrard Spindles accommodate all records as they were made to be played. (If user prefers one spindle can be used throughout simply by plugging center hole of 45 rpm records.) a: Typical Garrard spindle for standard center holes. b: Easily inserted wide spindle, for 45 rpm records, remains stationary when record is played. Only a small collar revolves, assuring longer center hole and record wear.

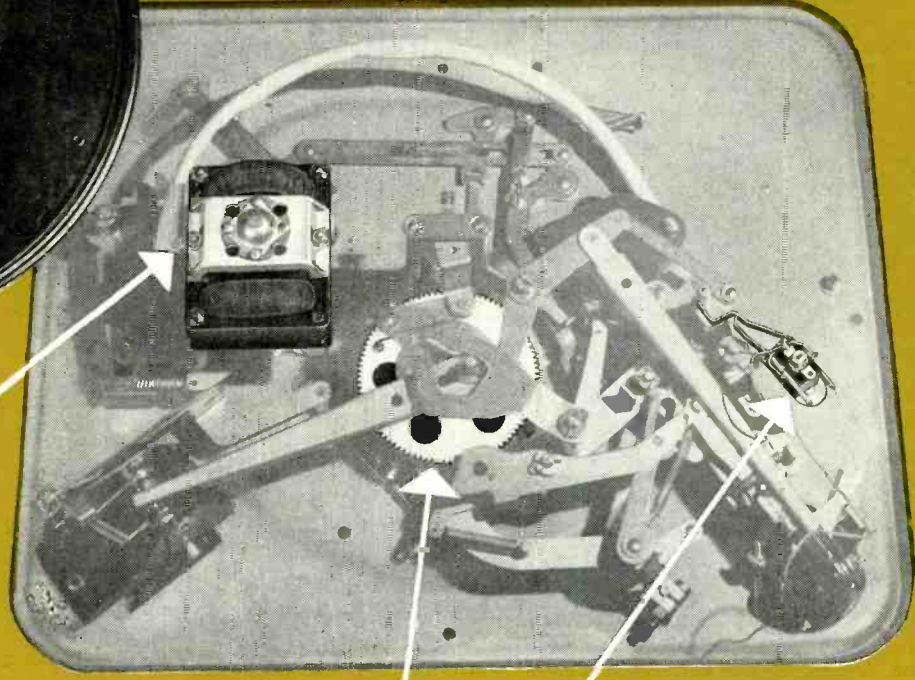
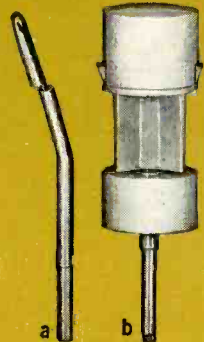

**PRECISION GROUND GEARS:**  
Perfectly meshed to insure constant smooth action and years of service.

**MUTING SWITCH:**  
No sound while changer operates on run-in or run-off grooves. Continuity of music undisturbed by noises.

**WATCH-LIKE CONSTRUCTION:**  
All parts are precision made, fastidiously assembled and simple to adjust.

A complete stock of replacement parts is readily available to all Garrard owners.

For an excellent description of what to look for in a record changer, we recommend the section devoted to changers in the new book "High-Fidelity Simplified", published by John F. Rider.

# GARRARD

## WORLD'S FINEST RECORD CHANGER

ON DISPLAY AT THE AUDIO FAIR • GARRARD RECORD CHANGER • MANUAL RECORD PLAYER MODEL M • STYLUS PRESSURE GAUGE • LEAK "POINT ONE" AMPLIFIER AND PRE-AMPLIFIER • WHARFEDALE LOUDSPEAKERS—5", 8", 10", 12" • KT66 TUBES • R-J SPEAKER ENCLOSURES: SINGLE BOOK SHELF MODEL, DOUBLE BOOK SHELF MODEL, FLOOR MODEL.

IF YOU CANNOT ATTEND THE AUDIO FAIR, MAIL COUPON:  
Garrard Sales Corporation, Dept. No. AE 11 164 Duane Street, New York 13, N. Y.  
Please send me literature on British Industries High Fidelity Sound Equipment.  
Name.....  
Address.....  
City..... Zone..... State.....

# RECORD REVUE

EDWARD TATNALL CANBY\*

## O Dry Those Tears—The Victorious 45

IT'S INTERESTING IN THESE DAYS of quick change in the record field, to watch the new developments and the old policies which go on and on, and to speculate on the reasoning—artistic and economic—that must go on behind the scenes. Official publicity serves to what the imagination—you have to read between the lines like crazy to figure out what really gives!

The funny thing is that recorded music is essentially an art product. The choice of actual sound-material—the very stuff of audio, whether popular, show tune or Beethoven—depends in the end upon the effect of the sound-sense that is music. You can't record gibberish, in speech or in music. Set up your fancy artist, place your mikes, roll the tape—and from then on, it's up to the sound itself to do the job. True, hi-fi has a bit to do with record appeal these days. There are a good many of us who will buy pure sound-effect material for our audio equipment to work on. Even so, it is strange how much better are the sound-effects you find in music than in any other form of recordable noise.

But there is one single, huge factor in non-musical causation for sound on records that still seems to dominate a goodly portion of the disc repertory—to my eternal astonishment. It used to be called the Star System, but it's a lot older than that, even on records. Under this system of sound-choice one plugs the performer—who is entirely invisible—not the audible sound which he makes. One decides first which performers to feature, then one scouts around for the necessary audio material—without which, unfortunately, your recording artist is mute and (minus TV) non-existent. The less obtrusive the audio-stuff is, the more familiar, the more innocuous, the better for all.

The theory is that the buying public doesn't acquire a record for the music but to "hear the artist"—which to my mind is the most incredible nonsense that man ever

thought up, such a walloping absurdity, such a contradiction of plain common sense—yet we swallow the whole idea joyfully to the tune of millions yearly and we've been doing it for ever and ever. One of the steadiest of big businesses.

It's good business to sell a maximum of artist with a minimum of music—witness the minimal number of serviceable tunes that go on through the years as an audio-foundation for artist worship. No need to change the music. It's only the artist roster that changes, in the mortal process of decay, not the immortal audio-stuff itself. Barcarolle, Melody in F, Humoresque, Home Sweet Home, The Lost Chord, O Dry Those Tears—new performers keep trotting them out for new display. They are as durable as mashed potatoes (and as flavorsome too). Traubel, Melchior, Anderson, Mario Lanza, Alma Gluck, Caruso, Kreisler, Yehudi Menuhin; young or old, they all do their stint at Home on the Range sooner or later, for this great trade in sound-without-music.

All of which has been inspired, as some will guess, by the latest from that triumphant maintainer of the tradition, the Victor Talking Machine—pardon me, RCA-Victor, which caps its leadership in this ancient field with the d-ndest super-example of all, "Great Combinations," on which most of the famed RCA stable is paired off into super-duets to bring us the same old mutton chops, not single but double. Marian Anderson and Gregor Piatigorsky in a touching "Home Sweet Home" . . . Mischa Elman and Jan Peerce (O Dry Those Tears), Yehudi Menuhin and Robert Merrill, Milstein and Pinza (None But the Lonely . . .)—phew! I can't help imagining, as this incredible disc (LP) plays merrily on, the wondrous scene in some studio X as the fabulous crowd of Greats gathered together to produce this earth-shaking musical bomb-shell. Straight faces?

Which leads me to a bit of observation of

a different sort, also headed up by RCA, which now is making a new 45-r.p.m. record that plays almost eight minutes a side. Interesting. Good possibilities, too.

A long while back we used to argue vehemently about the technical potentialities for good sound in LP vs. 45—an issue that now is as dead as it ever should have been. Other factors have been enormously more important as anyone now can see. Length of play, indeed, has turned out to be the very foremost factor of all—paradoxically because problems of quality, at least in the discs themselves, have been so nicely solved.

To the trained observer—any reader of this sheet—the immediate thought, *in re* this 8-minute 45-er should be—"Aha! So at last the 78 r.p.m. record is dead!" The obvious implication, between the lines, is that now RCA will issue 45's without direct reference to 78 sides. The original 45 was plugged as a 5½ minute record, but the plain fact was that every 45 was matched in the issue by a corresponding 78. Obviously there could be no 45 of importance that ran longer than its 78 mate. At least not one that ran, say, 1.2 times longer. LP was different—for its much greater length allowed enough flexibility so that almost any set of 78's could be adapted to some LP arrangement—anything but a single 78.

Classical LP is now virtually free, even in the big companies, from the 78 issue. 45 now begins to be freed similarly and it is only now that the 45 at last can reach its full potentiality.

There's more than this to it. LP has long offered an embarrassment of riches, time-wise, for the many short compositions that fit on 78 singles or on a pair of 78's. People object to the doubling-up on LP of short items, and with reason. The 7-inch LP was wrongly timed, wouldn't change on a changer, is now dead. LP's answer in the last year has been the arbitrarily short-

[Continued on page 65]

\*780 Greenwich St., New York 14, N. Y.

# THE MOST WANTED REPRODUCER

For it is a fact, that of the thousands of AUDAX users, more than 70% bought the AUDAX POLYPHASE—even though they already owned other makes of pick-ups.

The revolutionary new records are so true to the original that almost any pick-up is bound to give some results . . . but—it takes a reproducer of the highest order, one sensitized to the nth degree . . . a CHROMATIC POLYPHASE—to bring out every subtle shading, every nuance so essential to the real music of which these discs are capable.

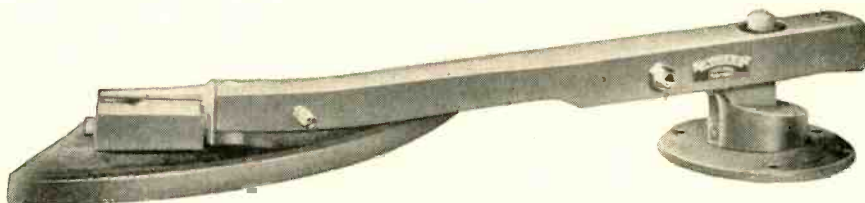

*Available to fit the new compass-pivoted AUDAX arms and to fit record changers.*

Never before such LISTENING-QUALITY, such FAITHFUL REPRODUCTION but YOU and only YOU can decide what sounds best and most pleasing. Therefore . . . SEE and HEAR POLYPHASE and—YOU be the judge.

*One single magnetic pickup plays all home records—replaceable Sapphire or Diamond styli.*

**Be sure to obtain a copy of 1953 ELECTRONIC PHONO FACTS from your distributor.**

**AUDAK COMPANY**

500 Fifth Avenue New York 36

*Creators of Fine Audio-Electronic apparatus for over 25 years.*

---

*"The Standard by Which Others Are Judged and Valued"*

---

# Speech Clipper Aids Station Performance

R. S. HOUSTON\*

Compressors and limiters both enjoy considerable use in broadcasting stations. The author describes a clipper which may be used in conjunction with these more familiar devices to improve station coverage under certain conditions.

WITH THE ADVENT of compressor amplifiers to the speech-input layout of broadcast stations, coverage and general dynamic characteristics of the output were considerably improved. Through the years, numerous improvements have increased the utility of the compressor, until today it seems that about the ultimate has been reached. Two major improvements came along about the same time to change radically the performance of the compressor. One basic fault with every limiter designed up to that time was the necessarily finite attack time, occasioned by the need for some sort of audio filter, as well as the need for a decay network to prevent a too-rapid restoration of full gain. This fault was overcome by a circuit which "anticipated" the audio peak, and reduced the gain of the amplifier before the peak came to the controlled stage, thus preventing surges.

In another design—a boon to announcer-operator type of operation—was an automatic "gain-rider" amplifier, whereby the instantaneous gain was constant, but the average gain could be changed, to accommodate varying levels from the studio. A standard limiter was incorporated after the gain-rider, to complete the system. With this latter combination, it was possible to keep a constantly high level of modulation, and still not require the active participation of the transmitter man for riding gain, thus freeing him for other work. With the combination of the gain-rider and the anticipator, theoretically a perfect system obtains, since then every possible function can be handled and compensated for automatically, be it erratic levels from the studio, or sudden peaks or surges in the audio signal. However, each of these systems is subject to one inherent characteristic. While it is sensitive to either rapid or gradual changes of level, it is likewise sensitive to high-level, transient peaks. Doubtless everyone has heard the result of a crack in a record going through the limiter. Although the normal level may be compressed only a few db, when the peak comes along—even though it is of short duration—the energy in the peak goes to limit the output, and because of the long recovery time of most compressors

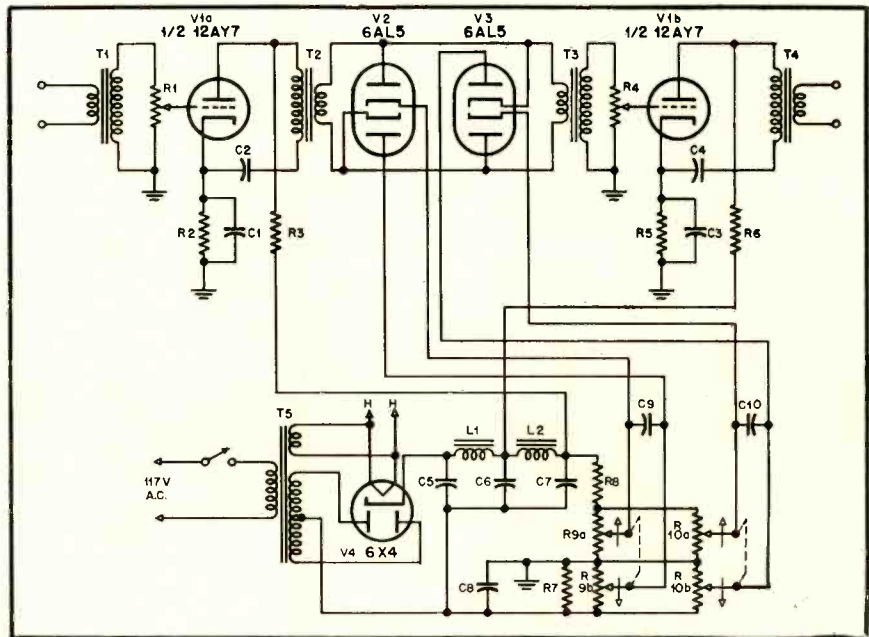

Fig. 1. Schematic for a speech clipper which will perform as described. Complete control is provided over input and output levels and amount of clipping.

there is a noticeable "hole" in the program. This is especially objectionable when the program is low level, or if the compression is over 5 db. Since the rate of recurrence of a crack in a record is only about once per second, this gives the limiter a chance to "pump," with a very undesirable result. Naturally every precaution is taken to prevent cracked records from getting on the air, but occasionally they must be used.

In the case of the gain-rider system, any peak of such rate of recurrence will tend to become a part of the program, as far as the memory circuit of the gain-control stage is concerned, thus reducing the gain, even though only slightly. There are other causes, however, that can cause a limiter to operate at undesirable and unwanted times. Most noise of this type is either a short-duration high-level pulse, or of sustained subaudible though high-level energy. Neither of these sounds add greatly to the over-all sound, but an ordinary limiting system, knowing nothing of the amount of intelligence conveyed by these forms of energy, will operate in its usual manner, and cut down the gain of the system. To the listener who can not hear these sounds,

the effect is one of a slight reduction in the program, rather than one of greater intensity, which the sound was supposed to convey. So the outcome has an inverse effect to the sound originally intended. All this may be a description of an extreme case, but it serves to illustrate the function of a limiter or gain-rider under various circumstances. In a more practical light, even a resonant voice can cause these transient peaks which will operate the limiter, but will add nothing to the general output.

## Justification for the Clipper

The difficulties imposed by such "sounds" can be removed easily and without apparent harm to the signal with a peak clipper. Long in use in communications channels, they have been used but sparingly in broadcasting, and then only by either intrepid or courageous experimenters. The reasons for their lack of use are obvious. They are the antithesis of broadcasting. Where broadcasters try to keep distortion down to a minimum, a peak clipper deliberately introduces distortion. For besides introducing wave-form distortion of the original, it also introduces harmonic

\* 2921 N. Woodstock, Philadelphia 32, Pa.; formerly Chief Engineer, KBNZ, La Junta, Colo.

the superb  
*Patrician*



“—no other speaker system offered such cleanliness of sound over so long a range.”

*“It (the PATRICIAN) is paramount primarily by the excellence of its balanced frequencies: no other speaker-system offered such cleanliness of sound over so long a range. It triumphs a vibrant vitality of timbre altogether unique in the reproduction of music.”\**

The Electro-Voice Klipsch PATRICIAN drew this unreserved commendation from Mr. C. G. Burke of The Saturday Review, recognized authority on High-Fidelity sound reproduction, as the result of critical tests he conducted before a “jury” of 26 audio-philés and manufacturers.

With its unique, separate, 4-way system, the PATRICIAN provides a sweep and brilliance of reproduction that is unsurpassed. No other speaker system produces such low intermodulation and transient distortion. “It is the finest system manufactured regardless of price,” owners report.

The PATRICIAN utilizes a scaled-up version of the Klipsch “K” type reproducer, housing an 18-inch E-V low-frequency driver (18WK) designed for the first three octaves, to 200 cps. A 12-inch E-V driver unit (Model 12W) takes over from the first crossover at 200 cps to 600 cps. This bass driving section is the largest, most highly developed now available.

From 600 to 3,500 cps, the PATRICIAN uses the T25 E-V midrange driver which exhausts into a 600-cycle cellular horn. It permits fullest transmission of music in the vital “presence” range—imparting to the listener the same exciting aural adventure as that experienced in the concert hall. Only the PATRICIAN gives this range maximum scope with a special driver unit.

Octaves from 3,500 cps. through those extending beyond the range of human hearing, are reproduced by two high-frequency drivers (E-V Models T10 and SP-8BT) which complement each other for maximum efficiency and clarity.

Each driving unit in the PATRICIAN receives only those frequencies for which it was designed, through the E-V Model X2635 4-way crossover network.

Since the PATRICIAN will be played at sound levels acceptable in the living or music room, E-V has developed in this instrument a reproducing characteristic which augments tones between 3,000 and 6,000 cps, offsetting human ear discrepancy at low sound pressures. The result is a naturalness of reproduction unparalleled in the art.

The PATRICIAN is made of finest hardwoods with hand-rubbed finish in either Mahogany or Blonde Korina veneer. Grill cloth is “bronze” Lumite with Mahogany finish and “écru” with Korina finish.

DIMENSIONS: 60" H x 41" W x 29½" D  
WEIGHT: 400 lbs. net, 470 lbs. shipping  
PRICE: List, \$1,212.50; Audio-philé Net, \$726.50

\*Page 203, The Saturday Review Home Book of Recorded Music and Sound Reproduction.  
†Licensed under Klipsch Patents No. 23102-3 and No. 2373692.

**Electro-Voice** Inc.,

425 Carroll Street, Buchanan, Michigan

Export: 13 E. 40th St., New York 16, U.S.A. Cables: Arlab

distortion, the aggregate of which is the same percentage as the clipping factor. However, with moderation, a clipper can be used to great advantage in keeping levels under control.

In order for transient peaks to be heard, they must necessarily be very high level, since they are of such short duration. Therefore, if they are clipped early in their rise to their peak, the energy contained in them will be lost. As long as they get no greater in intensity than the program, they will be masked by the program and therefore be inaudible. This is the secret of setting the clipper. The threshold is set so that it will not clip on the normal program level, or even on surges, such as sudden crescendos in music. But it is

set low enough that any peak of high intensity that comes along will be bypassed to ground through the peak rectifiers, and lost. Not only will the peak not be heard, but since it is no higher than the program level, it will cause no untoward operation of the limiter.

What of distortion from this type of operation? If clipping is confined to this type of signal—that is, peaks only—there will be no distortion except of the peak itself, which will make it one of a square-wave nature. Since the top will be so narrow, and will be imposed on top of other waves, there can be only a few cycles of higher frequency present even at the highest audible frequency, so at the lower harmonics there would

scarcely be one complete wave of energy. Although this will introduce some intermodulation distortion due to the non-linear element, the duration will be measured in milliseconds, and therefore will not be discernible to the ear. In the event of long-sustained periods of subaudible sound, these too will be clipped and will make for square wave output, and also giving rise to large numbers of harmonics. In the case of this type of sound, however, the intensity is not as great as the transients,

## FOR BALANCED FIDELITY

3 out of 4  
professionals  
choose



# magnecorder



From the highest to the lowest tone, Magnecorder captures the sound exactly as it was originally produced. Frequency response: 50-15,000 cps  $\pm 2$ db at 15"/sec. tape speed. Signal-to-noise ratio exceeds 50 db with less than 2% harmonic distortion!



the world's  
most versatile  
tape recorder

Recorder mechanisms and amplifiers are separate, distributing the weight when carried into the field for remote recordings.

Conversion kits are used to keep the equipment up to date, or to adapt it for any special purpose in rack mountings. For literature and a demonstration, see your Classified Telephone Directory under "Recorders."

write **Magnecord, INC.**  
Dept. A E - 11  
225 W. Ohio St., Chicago 10, Ill.

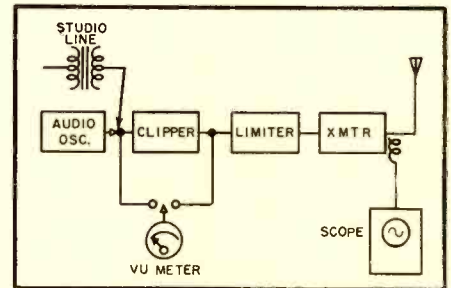

Fig. 2. Block schematic for set-up used in calibrating the speech clipper.

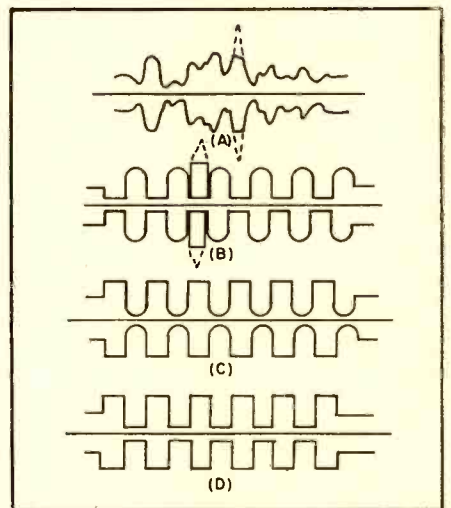

Fig. 3. Typical output waveforms obtained from the transmitter: (A) Normal wave with clipped transient; (B) Single wave with clipped negative peaks at 80 per cent modulation and with noise; (C) Sine wave with clipped positive peaks at 80 per cent modulation; (D) Sine wave with positive and negative peaks clipped 100 and 80 per cent respectively.

and the percentage of harmonic intensity is therefore not as great and will cause less trouble than the harmonics from the transients. So each has redeeming features. In the transient, there is a large content of high-intensity har-

[Continued on page 75]



# THERE'S PROFIT IN HIGH-FIDELITY

## More Money

Do you have spare time that you can use to make additional income, perhaps as a way to start a business of your own? Or do you have a radio service shop that can be expanded to handle additional, extra-profit work? Or a radio store where you can find space for fast-moving items that show a higher net?

If so, you should consider getting into the high-fidelity field, and fast, because the time to get started is RIGHT NOW! Already, public interest has reached the point where the dollar volume of hi-fi equipment sales exceeds that of conventional AM radio sets. The attendance at the recent audio shows in Philadelphia and New York far exceeded all expectations. The new Society of Music Enthusiasts reports a veritable avalanche of applications for membership who are forming local listening and discussion groups.

## How to Find Out

You can see how big and important the hi-fi business has become by looking at the latest copy of HIGH-FIDELITY Magazine. You'll be amazed to see what a big publication it is, and it's getting bigger with each succeeding issue!

The fact is that everything connected with hi-fi is expanding at an almost unbelievable rate. Sales of equipment for high-quality reproduction from FM radio, records, and tape are going up and up, and there is no levelling-off point in sight. Yet for all its progress in the last two years, the public is only beginning to discover the possibilities of fine musical entertainment at home. Relatively few people have had an opportunity to hear a hi-fi system.

How can you fit into this new business? Take two or three evenings to study the new issue of HIGH-FIDELITY Magazine. Go over it carefully, from cover to cover. Read the Noted-with-Interest columns, the Letters from Readers, the elaborately illustrated articles on equipment and installations, the news about recorded music, and the Tested-

in-the-Home Reports. Check the advertising. Note the companies and products represented.

By the time you have finished, you will know just what angle fits into your particular situation, and what your first move should be. For HIGH-FIDELITY covers all the aspects of this field, giving you a complete picture of the business, and the people who spend \$250 to \$5,000 for hi-fi installations, and they keep on spending for further improvements.

From your study of HIGH-FIDELITY, you will come to realize that this Magazine can serve you in three essential ways:

## Demonstration

First of all, you must be prepared to demonstrate high-fidelity, because people can only appreciate full-range tone by *hearing* it. It can't be described in words. It must be *experienced*. Only then can people realize how much it will contribute to their enjoyment and relaxation, what it will mean to their children, and how it will help to entertain their friends.

What kind of a demonstration setup do you need? You will find all kinds of answers to that question in HIGH-FIDELITY, together with information on the choice of equipment for FM, records, and tape. It covers the entire what-why-how of tuners, amplifiers, turntables, tape machines, speakers, and all the associated instruments required in a hi-fi demonstration system. That information you must have as your starting point.

## Choice of Music

Records provide the most convenient source of music for demonstrating high-fidelity. But you must choose your records with the greatest care. For example, if a prospect is a lover of Haydn's music, you would play the Haydn Society's HSL 2048, because it not only does justice to the composer but it is a particularly fine example of full-range recording.

Or if he prefers the melody of popular airs, you might choose Columbia's ML 4487, which is an excellent presentation of Morton Gould, or the collection of waltzes on a London LL 570, because they sound spectacular on hi-fi reproduction.

How do you find out about these things? Why, HIGH-FIDELITY has a 24-page section devoted to records in each issue, written by reviewers who are top authorities on both music and recording techniques.

## System Planning

When you have staged a first-class demonstration, you can expect your prospect to ask: "How can I arrange an installation like that in my living room so it will be as attractive in appearance as it is fine in performance?"

That question might give you trouble. Every home is different, and each person has his own ideas as to what will look most attractive.

But at this point, HIGH-FIDELITY performs a third essential service. In each issue there are six to eight pages of detailed photographs which show outstanding examples of hi-fi installations. They range from simple bookshelf arrangements to functional music walls, and on to elaborate cabinet designs.

Among them, any prospect will find a type of installation that can be adapted readily to his particular home, at a price he is willing to pay.

## Act Today

If you are interested in extra income or increased profits, look into this hi-fi business without delay. Your first step is to order a subscription to HIGH-FIDELITY. This is a large-size magazine, beautifully printed on fine paper, handsomely illustrated, published on the first of every other month. It may prove to be the biggest little investment you have ever made. It may pay back its cost to you many, many times. Use the coupon below.

# High-Fidelity

MILTON B. SLEEPER, *Publisher*

"THE MAGAZINE FOR AUDIOPHILES"

Charles Fowler, Editor  
HIGH-FIDELITY Magazine  
1311 Publishing House, Great Barrington, Mass.

Please enter my subscription to HIGH-FIDELITY for which I enclose:

- \$5.00 for 1 year (6 issues) SAVE \$1.00  
 \$10.00 for 3 years (18 issues) SAVE \$8.00  
(Single-copy price \$1.00)

Name.....

Address.....

Foreign postage: Add \$1.00 per year.

# THE AUDIO FAIR-1952

## Directory of Exhibitors

**ACRO PRODUCTS COMPANY** 542  
369 Shurs Lane, Philadelphia 28, Penna.  
**Products:** Acrosound output transformers, Acrosound Ultra-Linear amplifier circuits.

**IN ATTENDANCE**

David Hafler Herbert I. Keroes  
Harold P. Blumenstein

**ALCOTT LABORATORIES** 545  
Springfield Gardens, N. Y.  
**Products:** Alcott Supreme combination Radio-Phono-Tape Recorder-Microphone-TV.

**IN ATTENDANCE**

E. H. Alcott

**ALLIED SOUND CORPORATION** 512  
115 West 45th Street, New York 36, N. Y.  
**Products:** High-fidelity sound components from pickups to speakers. Tape recorders, Audio Consultant Service.

**IN ATTENDANCE**

Irving Greene Ozzie Reiter  
Arnold Wechsler Leslie Lee

**ALPHA WIRE CORPORATION** 639  
430 Broadway, New York 13, N. Y.  
**Products:** Wire & Cable.

**IN ATTENDANCE**

Peter Bercoe A. E. Bernardik  
Howard B. Saltzman Samuel Schaeffer  
Donald Rappaport Sidney Manners  
D. Litt Andrew Koi  
Marvin Wertheim Abraham Schwartz

**ALTEC LANSING CORPORATION** 619-620  
161 Sixth Ave., New York 13, N. Y.  
**Products:** Microphones, audio amplifiers, loudspeakers, transformers, FM-AM radio tuners, audio equipment for broadcasting stations, test equipment.

**IN ATTENDANCE**

G. L. Carrington A. A. Ward  
John K. Hilliard H. S. Morris  
M. C. Sprinkle L. D. Netter  
Marty Wolf R. E. Pierce  
C. S. Perkins J. J. Connolly  
Tom Gallatin R. W. Griffiths  
A. E. Byers

**AMERICAN ELITE INC.** 544  
1775 Broadway, New York 19, N. Y.  
**Products:** Microphones, amplifiers, speakers, radios.

**IN ATTENDANCE**

Michael von Mandel Fred L. Cunow

**AMPEX ELECTRIC CORPORATION** 505  
934 Charter Street, Redwood City, Calif.  
**Products:** Magnetic recorders (studio console, two-case portable, stereophonic portable, continuous music machine).

**IN ATTENDANCE**

E. G. Swanson Harrison Johnston  
M. J. Stolaroff R. J. Tinkham  
R. A. Miner

**AMPLIFIER CORP. OF AMERICA** 622  
398 Broadway, New York 13, N. Y.  
**Products:** Battery- and a.c.-operated tape recorders, audio amplifiers.

**IN ATTENDANCE**

N. M. Haynes R. Epstein  
M. R. Ellis Sidney Karr  
Frank Kosinski E. Heller  
S. Golden H. Robbins  
B. Ross

**ARROW ELECTRONICS** 650  
82 Cortlandt St., New York 7, N. Y.  
**Products:** High-fidelity ensembles, tuners, amplifiers, record players, tape and disc recorders, speakers, etc.

**IN ATTENDANCE**

Charles Ray Maurice Goldberg  
Oscar Kraut Abe Strauss  
Jack Kufeld Fred Steiner  
Irving Frisch

**AUDAK COMPANY, INC.** 629  
500 Fifth Avenue, New York 36, N. Y.  
**Products:** Electronic-acoustical apparatus.

**IN ATTENDANCE**

Maximilian Weil Geo. V. Sullivan  
Al Weberg Peter P. Bach

**AUDIO DEVICES, INC.** 651  
444 Madison Ave., New York 22, N. Y.  
**Products:** Audiorecorders (Recording discs); Audiopoints (Recording and Playback Points); Audiotape (Magnetic Recording Tape); Audiofilm (Magnetic Recording Film).

**IN ATTENDANCE**

William C. Speed Bryce Haynes  
Herman Kornbrodt Webster McNutt  
Brewster Freifeld David S. Gibson

**AUDIO ENGINEERING SOCIETY** 617

**IN ATTENDANCE**

Officers and Governors of the Society

**THE AUDIO EXCHANGE, INC.** 644  
159-19 Hillside Ave., Jamaica, 32, N. Y.  
**Products:** Audio and High-Fidelity Equipment.

**IN ATTENDANCE**

William Colbert John Colbert  
Miriam Colbert

**AUDIO INSTRUMENT CO., INC.** 630  
133 West 14th St., New York 11, N. Y.  
**Products:** Condenser microphones; laboratory microphones; bridgers; Disc-Noise Meters; Instrument Amplifier; microphone preamplifiers; Intermodulation Meters; Galvanometer Protectors; Loggers; Logarithmic Amplifiers Ultra-Speed Level-Recording System; Reverberation Units.

**IN ATTENDANCE**

C. J. LeBel Alan Bloch  
L. S. Goodfriend P. Bloch  
H. L. Hoffman

**AUDIO & VIDEO PRODUCTS CORP.** 615  
730 Fifth Ave., New York 19, N. Y.  
**Products:** Complete line of high quality audio components; Altec, Ampex, Cinema, Langevin, Lansing, EdiTall, Electro-Voice, Ekotape, Fairchild, McIntosh, and Minnesota Mining & Mfg. tapes.

**IN ATTENDANCE**

Charles E. Rynd W. Oliver Summerlin  
William Hazlett Elton Nachman  
Robert Winston C. Robert Paulson  
Edward Wilder David O. S. Ruark

**AUDIO & VIDEO PRODUCTS CORP. COMMERCIAL PRODUCTS DIVISION** 614  
730 Fifth Ave., New York 19, N. Y.  
**Products:** Stereophonic demonstration using Ampex Model 403-2, Altec speakers, and McIntosh amplifiers. Special music from the A-V Tape Libraries to be used to demonstrate this equipment.

**IN ATTENDANCE**

Charles E. Rynd W. Oliver Summerlin  
William Hazlett Elton Nachman  
Robert Winston C. Robert Paulson  
Edward Wilder David O. S. Ruark  
Kenneth E. Boothe

**THE AUDIO FAIR** 627  
67 West 44th St., Rm 510, New York 36, N. Y.

**IN ATTENDANCE**

Harry N. Reizes David Saltman

**AUDIO & VIDEO PRODUCTS CORP. INSTRUMENTATION DIVISION** 612

730 Fifth Ave., New York 19, N. Y.  
**Products:** Demonstrating Ampex d.c. recording system. Spencer-Kennedy Laboratories' variable electronic filters, Minnesota Mining data recording tape, Electro-Mechanical Research, Inc. electronic instruments and Altec-Lansing high-intensity sound pickups.

**IN ATTENDANCE**

Kenneth B. Boothe Paul Baran  
Charles H. Wirth A. F. Schonefeld, Jr.

**BEAM INSTRUMENTS CORPORATION** 603

350 Fifth Ave., New York 1, N. Y.  
**Products:** Tannoy Dual-Concentric loudspeakers, Duode (Barker) Natural Sound Reproducers, Accoustical Q.U.A.D. Amplifiers.

**IN ATTENDANCE**

T. Robinson-Cox T. R. Sheron  
J. Alan Biggs R. Haviland  
Don Brassineton

**BELL SOUND SYSTEMS, INC.** 524

555 Marion Road, Columbus 7, Ohio  
**Products:** High-fidelity Amplifiers, tape recorders, disc recorders, speakers.

**IN ATTENDANCE**

F. W. Bell H. H. Seay, Jr.  
E. D. Sisson S. C. Martin  
Wm. Parker W. E. Williams

**BERLANT ASSOCIATES** 529

4917 West Jefferson Blvd., Los Angeles 16, Calif.  
**Products:** Concertone professional tape recorders; Fisher high-quality tuners and amplifiers; and introducing the new Master Audio Control, Model 50-C, and high-quality amplifier, Model 50-A.

**IN ATTENDANCE**

James J. Parks Avery R. Fisher  
Paul Braun E. Berlant  
Harlan Thompson

**DAVID BOGEN CO., INC.** 632

29 Ninth Ave., New York 14, N. Y.  
**Products:** High-fidelity amplifiers, AM-FM tuners, AM tuners, FM tuners, transcription players, amplifiers, sound systems, radio console and TV cabinets, baffles, intercoms.

**IN ATTENDANCE**

Sidney Harman A. M. Zuckerman  
Mortimer S. Sumberg David E. Pear  
Lester Bogen

**BOHN MUSIC SYSTEMS CO.** 517

550 Fifth Ave., New York 36, N. Y.  
**Products:** High-fidelity music systems and installations, speakers, turntables, changers, tone arms, reproducers, pickups, amplifiers, tuners, speaker enclosures and custom building.

**IN ATTENDANCE**

William C. Bohn

**R. T. BOZAK & COMPANY** 649

90 Montrose Ave., Buffalo 14, N. Y.  
**Products:** Bozak loudspeakers, recording equipment—records & test records.

**IN ATTENDANCE**

R. T. Bozak Emory Cook  
Mildred E. Cook Eugene L. Shiro  
Sidney Reisberg



# NOW!

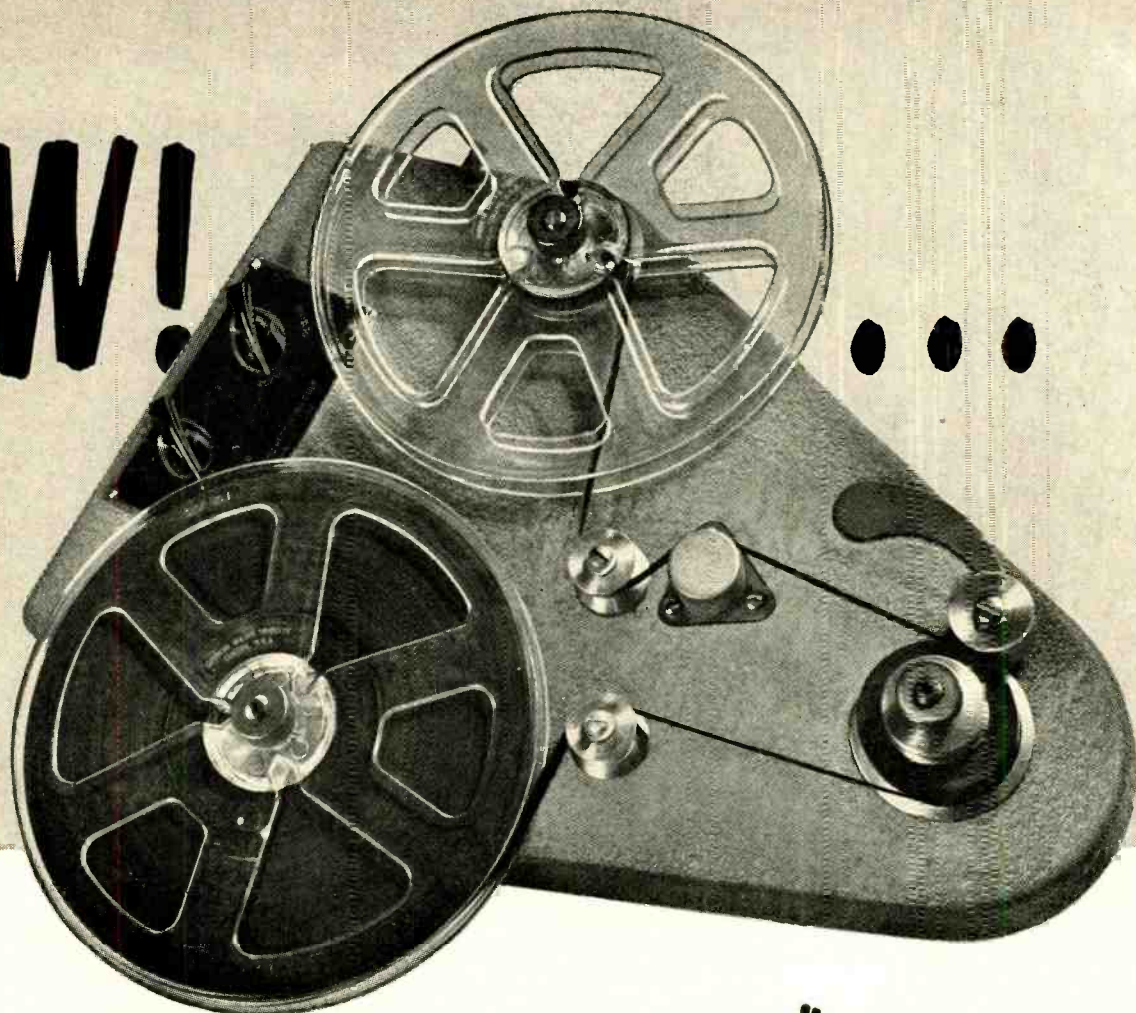

## perfect TAPE REPRODUCTION on a 16" TURNTABLE

Whether you're in a 250-watt local station in California . . . a 5,000-watt network outlet in Ohio . . . or a TV station in a large metropolitan center . . . you should own a PRESTO TL-10.

This unique unit immediately converts any 15" turntable into a tape reproducer of maximum accuracy. Mounted on a simple hinge arrangement, the TL-10 lowers on the turntable and is ready for instant use. Just as simply, it can be swung upward, out of the way, to free the table for disc playback. Tape speed can be selected by merely changing the capstan.

No more traffic problems with tape when regular recorders are tied up. No more fear of motor failures—the TL-10 has no motor. No need to buy an additional tape machine. The TL-10 will solve all your tape playback problems at a low cost.

Ask your PRESTO distributor for a demonstration today—or order your TL-10 direct. A limited quantity is on hand for immediate delivery.



### here's what it does:

Reproduces tape without tying up a regular recorder.

Attaches to any standard 16" turntable.

Speed: 7 1/2"/sec. and 15"/sec. with response to 15,000 cps.

Easy to operate and maintain.

Has the fidelity of high-priced machine at a fraction of the cost.



**PRESTO** RECORDING CORPORATION  
PARAMUS, NEW JERSEY

Export Division: 25 Warren Street, New York 7, N. Y.

Canadian Division: Walter P. Downs, Ltd., Dominion Square Bldg., Montreal

WORLD'S LARGEST MANUFACTURER OF PRECISION RECORDING EQUIPMENT AND DISCS

**20-20  
PLUS!**

**S-268-Q  
Output  
Transformer**

**±1 db 8—80,000 cycles  
80 watts 30—40,000 cycles**

**20 watts at 10 cycles  
40 watts at 15 cycles**

**Insertion loss  
0.3 db**

**Primary impedances  
8,000CT & 2,000CT**

Connected between halved impedances, frequency response is extended at each end; between doubled impedances, ±1 db 15—45,000 cycles.



Write today for the new 1953 Peerless Catalog

Perfect with KT-66 and 6146 tubes

**PEERLESS**  
Electrical Products

A DIVISION OF



9356 Santa Monica Blvd., Beverly Hills, Calif.  
161 Sixth Avenue, New York 13, New York

# Audio Fair Exhibitors

(Continued)

**BRITISH INDUSTRIES CORP.** 652-653  
164 Duane St., New York 13, N. Y.  
**Products:** Garrard record changers and phono units, Wharfedale speakers, leak amplifiers, KT66 tubes, R-J Enclosures.

**IN ATTENDANCE**

Franklin S. Hoffman	Leonard Carduner
Eugene Carduner	Wm. Lichter
Edward Kleeman	G. A. Briggs
H. J. Leak	Wm. Carduner
Arthur Gasman	

**BROCINER ELECTRONICS LABORATORY** 602

1546 Second Ave., New York 28, N. Y.  
**Products:** Model A100 Preamplifier-Equalizer; Model CA-2 Control Amplifier; Model UL-1 Ultra-Linear Williamson power amplifier; Model 250 Transcendent 3-way corner reproducer; Model 4 Corner Horn; Ductflex coaxial speaker cabinet.

**IN ATTENDANCE**

Victor Brociner A. Stewart Hegeman

**BROOK ELECTRONICS, INC.** 511

34 DeHart Place, Elizabeth 2, New Jersey  
**Products:** Brook high-quality audio amplifiers.

**IN ATTENDANCE**

Lincoln Walsh	Frank Hill
Jack Gentul	Ann F. Hall

**BROWNING LABORATORIES, INC.** 645

750 Main Street, Winchester, Mass.  
**Products:** AM-FM tuners, audio amplifier.

**IN ATTENDANCE**

G. H. Browning	R. L. Purrington
R. E. Lonnberg	S. S. Egert
Jack Fields	J. Mandel
Noel Mackay	Phyllis Epstein
Rita Blank	

**FRANK L. CAPPS & CO.** 647

20 Addison Place, Valley Stream, L. I. N. Y.  
**Products:** Condenser microphones, pre-amplifiers, recording styli.

**IN ATTENDANCE**

Dick Marcucci

**CINEMA ENGINEERING COMPANY** 611

1510 West Verdugo Ave., Burbank, Calif.  
**Products:** Cinema amplifiers, Cinema communication equipment, Cinema magnetic recording audio attenuators, equalizers and wave filters, Cinema resistance decodes, Cinema precision wire-wound resistors, Cinema rotary tap switches.

**IN ATTENDANCE**

Art Davis Robert Winston

**COLLINS AUDIO PRODUCTS CO., INC.** 547

Westfield, New Jersey  
**Products:** Complete Collins Pre-fab tuner kit line: FM tuner kit, FM/AM tuner kit, FM receiver kit, FM/AM receiver kit, FMF-3 tuning unit, IF-6 I.F. amplifier, FMF-2 tuning unit, AM-4 tuning unit, RD-1C FM tuner chassis.

**IN ATTENDANCE**

W. H. Collins Mrs. W. H. Collins  
Herman Elste

**COOK LABORATORIES** 647 & 649

R-2, Stamford, Conn.  
**Products:** Condenser Microphones, Pre-amplifiers, Recording styli.

**IN ATTENDANCE**

Emory Cook

**COWAN PUBLISHING CORP.** 627

67 West 44th Street, New York 36, N. Y.  
**Products:** Radio & Television Service Dealer—The Professional Radio-TVman's Magazine, CQ—The Radio Amateurs' Journal.

**IN ATTENDANCE**

S. R. Cowan	O. P. Ferrell
Samuel Marshall	Sanford Cahn
H. N. Reizes	David Saltman

**DANBY RADIO CORP.** 550  
2042 Chestnut St., Philadelphia 3, Penna.  
**Products:** Loudspeaker systems and amplifiers.

**IN ATTENDANCE**

Daniel K. Greenfield Joseph H. Norris

**THE DAVEN COMPANY** 616

191 Central Ave., Newark 4, N.J.  
**Products:** Attenuators; audio, video and R. F. attenuators; precision Super-Davohm wire wound resistors; rotary step-type switches; distortion and noise meters; transmission measuring sets; power-output meters; equalizers; vacuum-tube voltmeters; volume level indicators; electronic frequency meters.

**IN ATTENDANCE**

Lewis Newman	K. K. Garrison
E. L. Grayson	J. P. Smith, Jr.
C. F. Scott	R. J. Newman

**ELECTRONIC WORKSHOP SALES CORP.** 525

351 Bleecker Street, New York 14, N. Y.  
**Products:** Completely packaged high-fidelity sound systems, custom-built high-fidelity sound systems, high-fidelity audio components and cabinetry.

**IN ATTENDANCE**

Clifton M. Howard	Jay C. Carver
Maury Logue	Arthur Mellor
Ray Prohaska	Kenneth Wisner
Margaret Howard	Joseph Citroen

**ELECTRO-VOICE, INC.** 626

Cecil and Carroll Streets, Buchanan, Mich.

**Products:** Crystal and ceramic phono-pickups and cartridges; broadcast, public-address, recording, communication, amateur and special-purpose microphones; high-fidelity, full-range loudspeakers; low, mid, high and super-high-frequency drivers, cellular and diffraction horns, cross-over networks; speaker enclosures; broadband television boosters and distribution systems; public-address loudspeakers; equipment consoles; Compound Diffraction Projector; UHF Converters.

**IN ATTENDANCE**

Albert Kahn	Lawrence LeKashman
A. M. Wiggins	Howard Souther
Philip C. Erhorn	Vaughn Prentice

**FAIRCHILD RECORDING EQUIPMENT CORPORATION** 506

154th Street & 7th Ave., Whitestone 57, N. Y.

**Products:** Tape recorders, disc recorders, transcription tables, pickup cartridges & pickup arms, amplifiers, etc.

**IN ATTENDANCE**

J. H. Quinn Ray F. Crews

**FISHER RADIO CORPORATION** 529 & 538

45-41 Van Dam Street, Long Island City 1, N. Y.

**Products:** High-quality tuners and amplifiers. Introducing the new Master Audio Control, Model 50-C, and high-quality amplifier, Model 50-A.

**IN ATTENDANCE**

James J. Parks Avery R. Fisher  
Paul Braun

**G & H WOOD PRODUCTS CO.** 521

75 No. 11th St., Brooklyn 11, N. Y.  
**Products:** Radio, phonograph, loudspeaker cabinets for high-fidelity installations.

**IN ATTENDANCE**

Sidney Herbstman George Getzels  
Ben Herbstman

**GATELY DEVELOPMENT LABORATORY** 646

Box 2, Clifton Heights, Penna.  
**Products:** The Super Horn, a new patented corner horn loudspeaker enclosure.

**IN ATTENDANCE**

Edward J. Gately, Jr.  
Mrs. Edward J. Gately, Jr.

# HARVEY First with Audio's Finest!... as shown at the Audio Fair!

## NEW DELUXE PERFORMANCE

### JIM LANSING SPEAKER SYSTEMS

Employ newly designed enclosures, engineered to give clean, crisp reproduction to the lowest frequencies.

#### FULL FRONT-LOADED CORNER ENCLOSURE

One of the few truly front-loaded horn enclosures, augmented by two independent Helmholtz resonators to provide unusual realism of response to extremely low frequencies. Equipped with two Model 130B 15 inch low frequency units, one Model 175DLH high frequency driver, horn, and Koustical lens assembly, together with a Model N-1200 dividing network, the entire unit operates as an effective three-way system with balanced, clean response over the entire audible spectrum.

Height 50"; Depth 28"; Front Width 37".  
Shipping weight 215 lbs.

Model D-31050M (mahogany) ..... \$52200  
Model D-31050B (blonde) ..... 52950

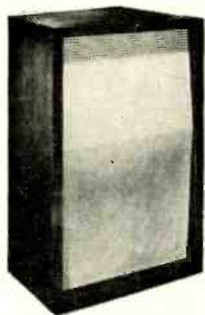

#### FOLDED HORN CORNER CONSOLE

An ideal quality system for smaller quarters. A true exponential folded horn has been incorporated to provide effective rear loading for reinforced response to lowest frequencies. Above 150 cycles, the speaker cone acts as a direct radiator. Equipped

with a Model 130A 15 inch low frequency unit, a Model 175DLH high frequency driver, horn, and Koustical lens assembly, together with a Model N1200 dividing network, this efficient two-way system provides sound reproduction for the utmost in listening enjoyment.

Height 39½"; Depth 23"; Front Width 23¼".  
Shipping weight 135 lbs.

Model D-34001M (mahogany) ..... \$33150  
Model D-34001B (blonde) ..... 33450

Other JIM LANSING Units and Systems in Stock.

Visit the **AUDIOTORIUM**  
See, hear, and compare sound  
equipment from the largest se-  
lection available anywhere.

NOTE: Price Net, F.O.B., N.Y.C.  
and subject to change without notice.

## The New

### CUB CORDER Portable TAPE RECORDER



More compact than an ordinary portable typewriter, and weighing only 12 lbs. 14 ozs. this complete battery-powered unit performs all of the functions required of a truly professional recorder. Frequency response at 7½"/sec. is from 200 to 6000 cycles/sec. A sensitive dynamic microphone 'doubles' as an earphone for playback. A high impedance output is provided for playback through an external amplifier. Furnished in two 2-speed models (3¾" and 7½"/sec. or 1⅞" and 3¾"/sec.) for either dual or single track, the Cub Corder can record up to one hour of uninterrupted recording on a 5" reel. A push button on the microphone acts as a remote operating control.

The Cub Corder may be used anywhere, and under any conditions: for taking notes, recording interviews, for dictating correspondence, covering news events, in the air, on the ground, or at sea... in a car or in a train... anywhere.

Complete with microphone/earphone, 5" reel of tape, rechargeable, non-spill wet cell and 67½ volt B battery, empty take-up reel, tubes, and instructions. .... \$295

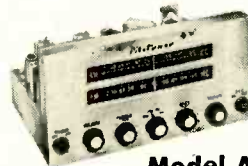

### The Completely New PILOTUNER Model AF-821 FM-AM TUNER

An amazingly versatile instrument, modestly priced, and yet offering features to be found only in the most costly tuners available. In addition to full coverage of both the FM and AM broadcast bands, the Pilotuner is equipped with a two stage audio amplifier furnishing a maximum undistorted output of 7 volts. Seven knobs provide the following controls. 1. 'On/off' Power Switch 2. Volume 3. Treble Boost and Attenuation 4. Selector Switch for AM, FM, Phono, and TV 5. Bass Boost and Attenuation 6. Tuning 7. 'On/off' AFC Switch

A two-stage preamplifier is built in for equalization of variable reluctance type cartridges. For crystal cartridges, a switch is provided to bypass the preamp.

The FM section has a built-in line antenna as well as a 300 ohm input for external antenna. The AM section has a built-in loop stick antenna. Audio output with tone controls in flat position is ± 2 db.

Height 7¼"; Width 14¼"; Depth 8½"; and Shipping weight 12 lbs. Complete with Tubes. .... \$9995



# HARVEY RADIO COMPANY, INC.

103 W. 43th Street, New York 36, N. Y. • LUXemburg 2-1500

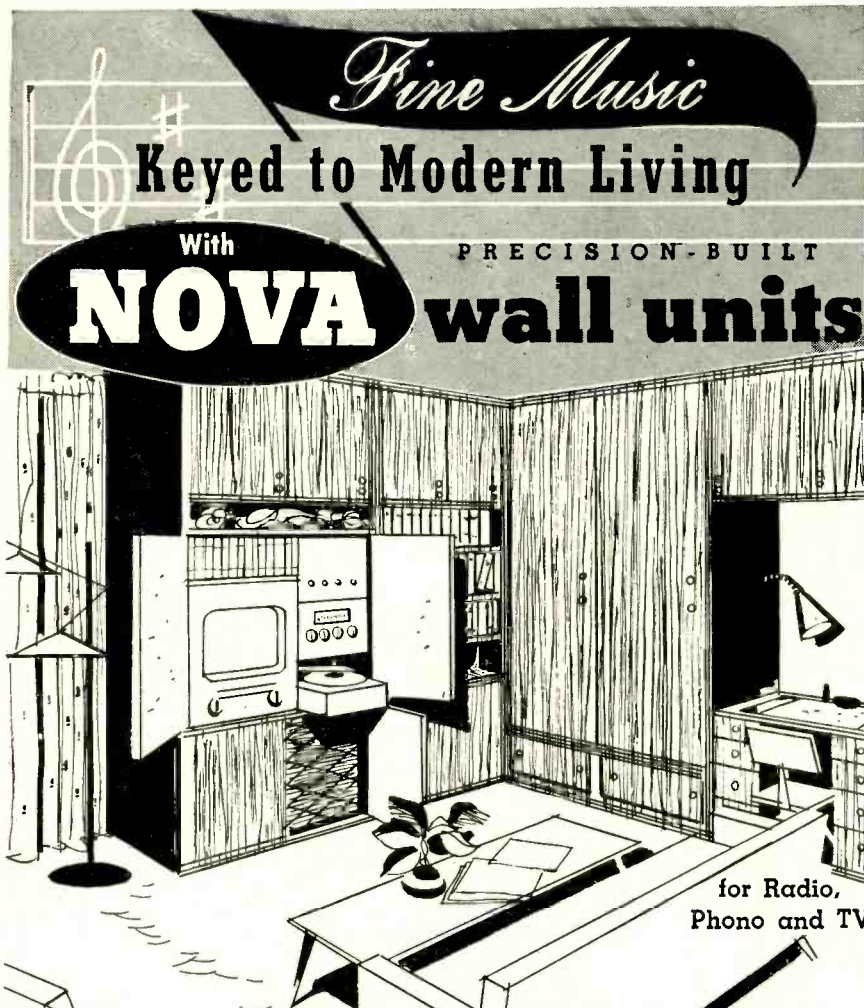

**On Display for the First Time  
ONLY at Hudson!**

Here's the home installation that will make you STOP, LOOK, and LISTEN! Smart, modern NOVA Wall units designed to hold the High Fidelity Radio, Phono and TV of your choice. These beautifully styled, sturdily constructed NOVA Storage WALL UNITS save space, save money . . . add to your listening pleasure, and enhance the decor of any interior. Available unfinished, primed, or in fine furniture finishes.

See the complete line of NOVA storage wall units at Hudson, and select your High Fidelity equipment from the largest and most complete stock of all nationally famous makes at lowest money saving prices!

**VISIT OUR SOUND STUDIOS**



Dept. D-11



**FREE!**

**NEW 1953**

**HUDSON HI-FI CATALOG**

Complete new buying guide . . . value-packed with the world's finest High-Fidelity and Audio Equipment . . . Amplifiers, Speakers, Tuners, Record-Changers, Recorders, Packaged Systems, Custom Furniture, etc. for professional and home installation.

Send for your **FREE Catalog today!**

Mail this handy coupon

**48 WEST 48th ST. • 212 FULTON ST.**  
New York 36, N. Y. New York 7, N. Y.

Circle 6-4060

- Please send **FREE** copy of 1953 Hudson Hi-Fi Catalog
- Please include **ELECTRONIC EQUIPMENT** Catalog.

- Please send details on **NOVA Wall Units**

Name.....  
Address.....  
City..... Zone..... State.....

**Audio Fair Exhibitors**

**GENERAL ELECTRIC COMPANY** 641  
Electronics Park, Syracuse, New York  
**Products:** Speakers, cartridges, tone arms, phono accessories.

**IN ATTENDANCE**

E. A. Malling M. E. Woodworth  
T. J. Nicholson R. Dally

**GRAYLINE ENGINEERING COMPANY** 549  
12233 Avenue O, Chicago, Illinois  
**Products:** Phono-Gard record players.

**IN ATTENDANCE**

Edward Gray Richard Gray  
John Schiele Ben Kainler  
Saul Lieberman

**GRAY RESEARCH & DEVELOPMENT CO.** 503  
Manchester, Conn.  
**Products:** Gray transcription equipment

**IN ATTENDANCE**

C. B. Hayes C. A. Snow

**HARRISON RADIO CORPORATION** 523  
10 West Broadway, New York 7, N. Y.  
**Products:** Complete high-fidelity home music systems, components and related accessories including cabinets, speakers, amplifiers, tuners, record changers and cartridges.

**IN ATTENDANCE**

William E. Harrison Ben Snyder  
Ben Pinz Charles Sarneck  
David A. Harkavy Mel Moss  
Ray Morris John Donaghy

**H. A. HARTLEY CO. LTD.** 533  
152 Hammersmith Road, London W6, England  
**Products:** Hartley 215 Speaker, tone-control preamplifier, 20-watt amplifier, Boffles—non-resonant box baffles; new auto-changer—3-Speed for all records mixed or straight; New 3-Speed phono motors, wow and rumble-free on any voltage and frequency; high-fidelity pickups.

**IN ATTENDANCE**

H. A. Hartley  
Hartley Agents in various cities.

**HARVEY RADIO CO. INC.** 631  
103 West 43rd St., New York 36, N. Y.  
**Products:** Distributors for complete high-fidelity home music systems and components, tape recorders, radio parts, and broadcast supplies.

**IN ATTENDANCE**

Harvey E. Sampson Roy Neusch  
George Zarrin Gilbert Demsky  
Barry Elliott James Carroll  
Abe Kobrin Anton Schmitt

**HIGH-FIDELITY MAGAZINE** 552-553  
Great Barrington, Mass.  
**Products:** High-fidelity magazine, radio Communication magazine.

**IN ATTENDANCE**

Charles Fowler Milton Sleeper

**HUDSON RADIO & TELEVISION CORP.** 634-635  
48 West 48th St., and  
212 Fulton Street, New York, N. Y.  
**Products:** High-fidelity components and installations.

**IN ATTENDANCE**

Sol Baxt Max Baume  
Herman Holstein Harold D. Weiler  
Ray Bellinger Harold Weinberg  
Clifford Rose Sid Krinetz

**JENSEN MANUFACTURING COMPANY** 518-519  
6601 So. Laramie Ave., Chicago 38, Ill.  
**Products:** Single unit, coaxial, and triaxial loudspeakers; Complete reproducers; Three-way system components; Low and high-frequency units ("Woofers" and "Tweeters") crossover and filter networks; level controls; transformers; back-loading folded horn and bass-reflex cabinets; commercial sound equipment.

**IN ATTENDANCE**

Charles Hansen Karl Kramer  
Horace L. White Philip B. Williams  
Harry L. Allen Daniel Plach  
Bruno Staffen

## Audio Fair Exhibitors

**KARLSON ASSOCIATES** 608  
1379 East 15th St., Brooklyn 30, N. Y.  
Products: Karlson speaker enclosures

### IN ATTENDANCE

John E. Karlson Wayne Green  
J. Dockum

**THE KELTON COMPANY** 509  
958 Massachusetts Ave., Cambridge,  
Mass.  
Products: 4-Loudspeaker enclosures

### IN ATTENDANCE

A. Bachmann H. C. Lang  
T. F. Murphy

**KLIPSCH EASTERN, INC.** 638  
420 Madison Ave., New York 17, N. Y.  
Products: Klipschorn, Rebel loudspeaker.

### IN ATTENDANCE

Paul W. Klipsch

**LANGVIN MANUFACTURING CORPORATION** 531  
37 West 65th St., New York 23, N. Y.  
Products: Audio amplifiers, power supplies, transformers.

### IN ATTENDANCE

E. F. Giguere F. K. Hankinson  
F. J. Neidig Le Roy Bremmer  
Donald S. Morgan John D. Galligan

**JAMES B. LANSING SOUND, INC.** 507  
2439 Fletcher Drive, Los Angeles 39,  
Calif.  
Products: Loudspeakers.

### IN ATTENDANCE

William H. Thomas George Halkides

**LEONARD RADIO INC.** 536-537  
69 Cortlandt, St., New York, N. Y.  
Products: Radio Craftsmen, Bell, Brook, Jensen, Electro-Voice, Precision Elec., H. H. Scott, Weathers, Bogen, Browning, Garrard, V-M, Pentron, Premier Tape-sonic, Concertone, Presto, Duotone, Audio Devices, Stephens, Altec, Newcomb, Wharfedale, Audak, Pickering, G. E., Minnesota Mining, Clarkstan, Brooks, Pilot, Hallicrafters, etc.

### IN ATTENDANCE

Lawrence J. Silverman Sidney Schugar  
Ellis Rosen Norman Sanders  
Leonard Levy Bernard Bernstein  
Gene Mantle

**MAGNECORD, INC.** 604-605-606  
225 West Ohio St., Chicago 10, Ill.  
Products: Professional magnetic tape recorders and reproducers, Magnecorder, Magnecordette.

### IN ATTENDANCE

C. G. Barker R. S. McQueen  
J. S. Boyers W. E. Farragher  
D. K. Hornbogen W. G. Blocki

**MAGNETIC RECORDER & REPRODUCER CORP.** 550  
2042 Chestnut St., Philadelphia 3, Pa.  
Products: Tape recorders and accessories, pre-recorded tape.

### IN ATTENDANCE

Albert L. Borkow Norman B. Burke

**JEFF MARKELL ASSOCIATES** 644  
108 West 14th St., New York 11, N. Y.  
Products: Residential audio equipment, cabinets.

### IN ATTENDANCE

Jeff Markell

**McINTOSH ENGINEERING LABORATORY** 606  
Water Street, Binghamton, N. Y.  
Products: Audio amplifiers.

### IN ATTENDANCE

Frank McIntosh Gordon Gow

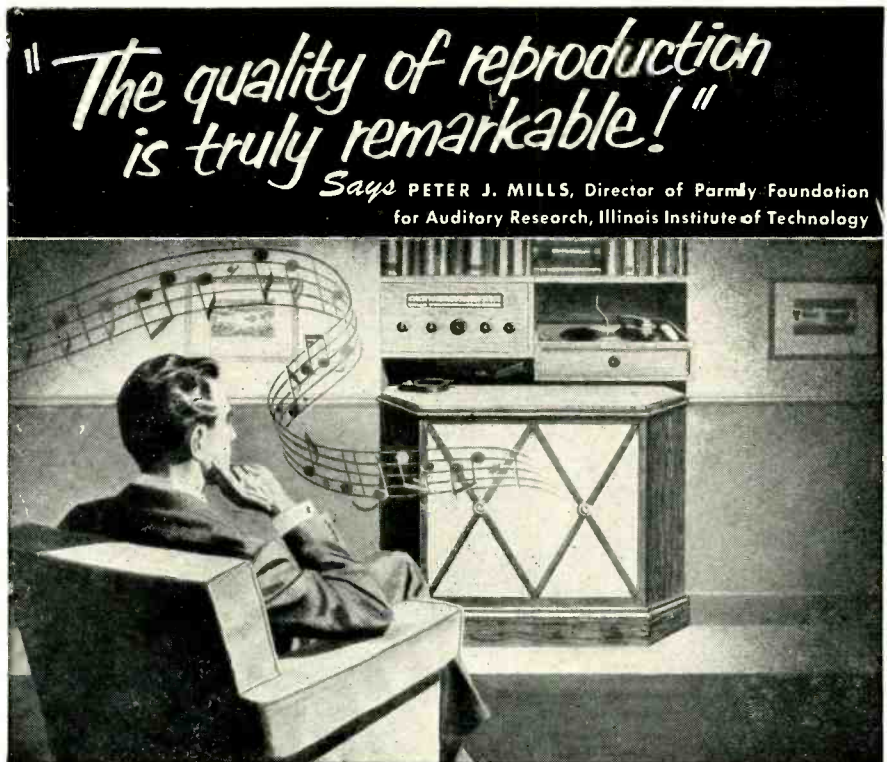

## High Fidelity SPEAKERS

● Peter J. Mills, Director of the Parmly Foundation for Auditory Research at the Illinois Institute of Technology selected a G-E Model 1201D speaker for his high fidelity home installation. Mounted in a room with difficult acoustical qualities, this General Electric speaker reproduces "with a clarity and crispness rivaling the original." Professor Mills, after reviewing the tests made on many speakers, found "the G-E Model 1201D offers excellent high fidelity reproduction at an economical price."

### OUTSTANDING FEATURES:

1. Exceptionally Wide Frequency Range—50 to 13,000 cycles.
2. Economy—Outperforms speakers costing many times as much.
3. Famous G-E Aluminum Base Voice Coil—Unaffected by moisture and temperature variations.
4. Husky G-E Alnico 5 Magnet for both maximum efficiency and sensitivity.
5. Specially Selected Cone—for tops in listening pleasure.

**GET THIS CATALOG FREE!**



General Electric Company, Section 44112  
Electronics Park, Syracuse, New York

Please send me your General Electric Loudspeaker Catalog.

NAME.....

ADDRESS.....

CITY..... STATE.....

**GENERAL ELECTRIC**

## AUDIO CENTER PROUDLY PRESENTS *Bogen* HI FI EQUIPMENT

Arrow Audio Center offers incomparable listening facilities for your selection of all high fidelity equipment. See and hear these superb Bogen units under simulated home conditions in Audio Center's modern Duplex Demonstration Studios. Our ingenious "Comparator-Control" panels provide the vital "A-B" test.



### R604 AM-FM TUNER

For magnificent reception over the full AM and FM bands, this R604 Tuner will deliver a continuously excellent signal to your high fidelity reproducing system. Splendid fidelity on AM and FM, highly sensitive and selective. Virtually drift, distortion, noise and interference free. Connect your phono, TV and amplifier to this unit for centralized control. AFC feature may be by-passed, if desired. Built-in AM loop. 9 tubes, plus rectifier. For 117 V. 60 cyc. AC. U/L Approved. 10" W, 11 1/2" D, 7" H. With mounting hardware, template, instructions.

R604 AM-FM Tuner—List \$162.25

NET **9550**

### BOGEN FM801 FM TUNER

One of the really fine high fidelity FM Tuners, and a "best-buy" in any category. Features AFC and temperature compensated oscillator for ideal drift-free performance. Dual limiter in a Foster-Seeley discriminator. Covers 88-108 MC. 50-15,000 cps  $\pm$  1 db. Two controls for tuning and a) Power Off, b) Phono, c) FM, d) TV. 7 tubes plus rectifier; 117 V. 60 cycles AC. U/L Approved. 10" W, 9" D, 7" H. Complete with mounting hardware, instructions.

Model FM801 Tuner—List \$115.00 NET **6762**



### H010-RXPX REMOTE CONTROLLED 10-WATT ALL TRIODE AMPLIFIER

This highly acclaimed all-triode 10-watt amplifier and remote controller represents the long sought after combination of the finest in high fidelity at moderate cost. Virtually distortionless output (.3% at 10 watts), and flat response from 10-50,000 cps at full rated output assures reproduction of radio and records designed to bring you music as you have longed to hear it. The H010 alone is perfect for your tuner having volume and tone controls. Or, achieve a fully matched remotely controlled system in conjunction with the superb RXPX control unit and pre-amplifier, operable up to 25 ft. away.

H010 Amplifier—List \$159.50 NET **9380**

RXPX—Remote Controller and Pre-Amplifier—List \$90.75 NET **5335**

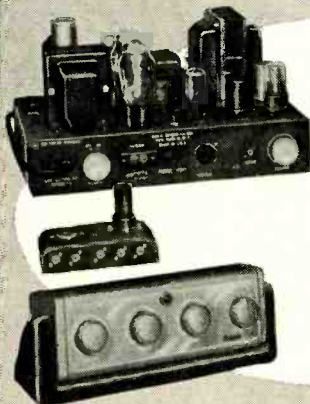

### BOGEN DB10-1 AMPLIFIER

This highly regarded, popularly priced, new 10-watt high fidelity amplifier provides unbelievable naturalness and presence of reproduction. Features completely variable separate bass and treble controls; shock-mounted built-in preamplifier for all cartridges; function selection switch requiring no additional harness. Flat from 30-18,000 cps  $\pm$  1 db. 4, 8, 16 ohm outputs. 117 V. 60 cycles AC. U/L Approved. 11" W, 7" D, 7-5/16" H. With complete instructions.

Model DB10-1—List \$90.75 NET **5335**



ARROW ELECTRONICS

*Audio Center*

BEAUTY IN SOUND

65 CORTLANDT ST., NEW YORK 7, N. Y., DIGBY 9-4714

## Audio Fair Exhibitors

### MEASUREMENTS CORPORATION 527

Boonton, New Jersey

**Products:** Audio instruments, intermodulation equipment, megacycle meters, and modulation equipment.

#### IN ATTENDANCE

Jerry B. Minter John M. van Beuren  
Cortland C. Smith Nelson C. Doland, Jr.

### MUSIC MASTERS 637

53 West 47th St., New York, N. Y.

**Products:** Custom-built amplifiers-front ends and associated audio Hi-Fi equipment, custom-built medium-priced phonos, cabinetry, loudspeakers, reproducers, arms, changers, turntables, etc., Hi-Fi and LP recordings and records.

#### IN ATTENDANCE

Lionel Rudko Dick Sequerra

### NEWCOMB AUDIO PRODUCTS CO. 623

6824 Lexington Ave., Hollywood 38, Calif.

**Products:** Custom home music amplifiers, phonographs, transcription players, public address equipment.

#### IN ATTENDANCE

Robert Newcomb Donald Warner

### PENTRON CORPORATION 548

221 E. Cullerton Ave., Chicago 16, Ill.

**Products:** Tape recorders and accessories.

#### IN ATTENDANCE

Irving Rossman

### PERMOFLUX CORPORATION 640

4900 W. Grand Ave., Chicago 39, Ill.

**Products:** High-fidelity loudspeakers, loud-speaker enclosures, high-fidelity headphones.

#### IN ATTENDANCE

R. S. Fenton F. J. Van Alstyne  
Bruce McNair Gene Hoge

### PICKERING AND COMPANY, INC. 624-625

309 Woods Ave., Oceanside, N. Y.

**Products:** Magnetic pickups, transcription arms, equalizers, preamplifiers, equalizer-preamplifier.

#### IN ATTENDANCE

Walter O. Stanton George P. Petetin

### PILOT RADIO CORPORATION 643

37-06 26th St., Long Island City, N. Y.

**Products:** Tuners, amplifiers, preamplifiers, speakers, TV chassis.

#### IN ATTENDANCE

Adolph C. Gross Robert Hertzberg  
Isidor Goldberg Dr. W. Auerbacher  
I. W. Wyckoff Richard Schottenfeld  
Solomean Abilock

### PRECISION ELECTRONICS, INC. 610

9101 King St., Franklin Park, Ill.

**Products:** Grommes Custom Line—50PG2, LJ2, 2050A, 215BA, 210PA and 100BA, and the "G" Line of public address systems.

#### IN ATTENDANCE

William S. Grommes Albert A. Hart

### PRESTO RECORDING CORPORATION 621

Paramus, New Jersey

**Products:** Disc and tape recording and reproducing equipment and accessories, lacquer-coated aluminum blank recording discs.

#### IN ATTENDANCE

George Saliba M. M. Gruber  
Thomas B. Aldrich Austin B. Sholes  
Alfred Jorysz Henry J. Geist  
Thomas Aye

### RADIO CRAFTSMEN, INC. 540

4401 No. Ravenswood, Chicago 40, Ill.

**Products:** AM-FM tuners, amplifiers, television tuners, complete television chassis, preamplifiers and front ends.

#### IN ATTENDANCE

John H. Cashman A. S. Johnston  
Edward S. Miller H. J. Christianson

## Audio Fair Exhibitors

**RADIO MAGAZINES, INC.** 627  
P. O. Box 629, Mineola, New York  
**Products:** AUDIO ENGINEERING magazine *Audio Anthology*.

### IN ATTENDANCE

C. G. McProud H. A. Schober  
S. L. Cahn H. N. Reizes  
E. E. Newman

**RADIO WIRE TELEVISION INC.** 543  
(LAFAYETTE RADIO)  
100 Sixth Ave., New York 13, N. Y.  
**Products:** High-fidelity tuners, amplifiers, speakers, preamplifiers, tone-arms, reproducers, pickups, turntables, changers, microphones and other high-quality sound and music reproducing equipment. High-fidelity audio and custom-built equipment.

### IN ATTENDANCE

A. Pletman Arthur Wohl  
Ray Pfeffer Jos. Schocken  
Robert Murray Michael Hricka  
M. H. Kranzberg G. Russell  
Lionel Zimmerman John Hughes  
Paul Savelli George W. Taylor  
Harold Sperber L. B. Leon  
J. A. Christianson

**RANGERTONE, INC.** 609  
73 Winthrop Street, Newark 4, New Jersey.

**Products:** Rangerette—portable tape recorder operating on 12 v. d.c. or 115 v. a.c. Ranjola—tape-to-film editing equipment. Allied electronic components.

### IN ATTENDANCE

R. H. Ranger Paul Vetter  
Richard Lewis Paul Brubaker  
Richard Boyer Arthur C. Willms  
C. Driza Wm. J. Haussler

**REEVES SOUNDCRAFT CORP.** 508  
10 E. 52nd St., New York 22, N. Y.  
**Products:** Magnastripe, Soundcraft recording discs, Soundcraft recording tape, Soundcraft professional recording tape.

### IN ATTENDANCE

Frank B. Rogers, Jr. William H. Deacy  
W. Rod Parvin, Jr. Donald E. Ward  
John E. Sines Thomas J. Dempsey

**"THE REPRESENTATIVES"** 528  
New York Chapter, New York  
**Products:** "Representatives" hospitality and service.

### IN ATTENDANCE

New York Chapter "Reps"

**REK-O-KUT COMPANY** 636  
38-01 Queens Boulevard, Long Island City 1, N. Y.  
**Products:** Recording and playback turntables—Challenger Deluxe disc recorder—Rhythmmaster Variable-speed portable phonograph—Recitalist 3-speed portable phonograph—12" and 16" overhead cutting lathes.

### IN ATTENDANCE

George Silber Avery Yudin  
Sydney Simonson Fred Moulin  
Philip Dubson

**REVERE CAMERA CO.** 648  
320 E. 21st Street, Chicago 16, Ill.  
**Products:** Magnetic tape recorders, synchro tape—8 & 16 mm movie-sound.

### IN ATTENDANCE

D. Gassner R. Moudry  
Lester Berger E. J. McGookin

**RIVER EDGE INDUSTRIES** 504  
5 River Edge Road, River Edge, New Jersey  
**Products:** Speaker cabinets, equipment cabinets (record player, AM-FM tuner, amplifier), television cabinets.

### IN ATTENDANCE

Walter Godfrey Henry Sherwin  
S. Alexander Gelburd Irving (Jiggs) Ferverman

**ROCKBAR CORP.** 607  
211 E. 37th Street, New York 16, N. Y.  
**Products:** Automatic record changers, single record players, cartridges.

### IN ATTENDANCE

Sydney Wimpie Jack E. Willson  
Tom Marchiano A. W. Pleasanton  
Harvey Salwen William McAteer



# TECH-MASTER

## HIGH FIDELITY

## AUDIO AMPLIFIER KITS

Tech-Master... first name in custom-built TV receivers and Kits... announces its entry into the field of audio. Tech-Master products have always been built to a standard—where price does not control quality. They are the result of advanced engineering and the honest determination to produce the optimum in performance!

The new Tech-Master ultra-linear Williamson Type Amplifier Kit and the Tech-Master Pre-amplifier Kit are made with the same "custom-quality" attention. There have been no compromises... every component used is the finest obtainable... workmanship is meticulous.

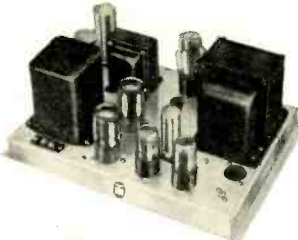

**Tech-Master TM-15A**  
**Ultra-Linear**  
**Williamson-Type Amplifier Kit**

Uses the famous WILLIAMSON circuit with unique modification for true high fidelity reproduction at increased power output. Features a specially wound Altec Lansing PEERLESS audio output transformer. Frequency response flat and smooth beyond the two extremes of the audible range, and distortion is less than .25% at normal listening levels, with excellent transient characteristics. The kit is furnished complete with punched chassis, transformers, tubes and all other components, and detailed wiring and assembly instructions.

Power Output.....15 watts undistorted  
Output Impedance.....4-8-16 ohms  
Input Impedance.....High for crystal pickups, tuners pre-amps, etc.  
Input Voltage.....1.1 VRMS (for 15W out)  
Intermodulation and Harmonic Distortion......25% at 2W .45% at 5W  
Hum and Noise Level 70 db below rated output  
Feedback......20 db  
Response at 5 Watts 8 cps to 80,000 cps ± 1 db  
Response at 10 Watts 12 cps to 56,000 cps ± 1 db  
Tube Complement...2 6SN7 2 5881 1 5V4G  
Power Requirements 105-125V, 50-60 cycles, 120 w

Dimensions .....9" x 12" x 6½"  
Net Price .....\$49.95



**Tech-Master TM-15P**  
**Four Channel**  
**Pre-Amplifier Kit**

Has four input channels and selector switch for high or low-level input. 3 position equalizer switch in high gain input circuit permits selection of turnover and roll-off characteristics to match most types of recordings. Two independent, continuous controls provide bass and treble, boost and attenuation. Power is obtained from main amplifier. AC outlet on chassis permits main amplifier and associated equipment to be controlled by master switch.

The Kit is furnished complete with punched chassis (pre-printed with pictorial diagram for easy assembly), all components, tubes, cabinet and detailed instruction.

4 Input channels  
1—Low level—high gain, 3—Hi-impedance  
Base Frequency control:  
±15 db boost or attenuation at 20 cycles  
Treble Frequency control:  
±15 db boost or attenuation at 20 KC

EQUALIZATION CONTROL

POSITION	TURNOVER	ROLL-OFF
1.....	300 Cps.....	none-flat } for 78 RPM
2.....	500 Cps.....	none-flat }
3.....	400 Cps.....	12 db at 10 KC for 33½ and 45 RPM

Tube Complement.....1—12AX7, 1—12AU7  
Power Requirement 125 volts DC at 6 ma, 6.3 volts at 600 ma  
Dimensions .....10¾" x 4" x 4"  
Net Price .....\$19.95

That the ultra-linear, Williamson Type Amplifier is one of the really great circuits available, is now too well established to require repetition. This is the first time, however, that the world-famous qualities of this practically distortion-free amplifier has been brought within reach of every audio enthusiast, through leading jobbers at the price of only \$49.95.



**TECH-MASTER PRODUCTS CO.**

443-445 BROADWAY, NEW YORK 13, N. Y.

Lafayette  
Presents



STROMBERG-CARLSON  
*Custom Four Hundred*  
WIDE RANGE · HIGH FIDELITY

High Fidelity Components for  
Your Custom Installation

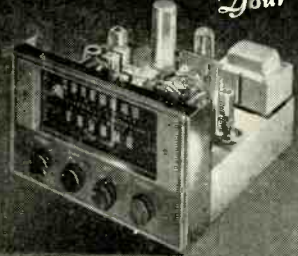

You'll want to see and hear this outstanding equipment. Yes, get to know the Stromberg-Carlson line. Write for more information about the numbers listed below or order direct from Lafayette, famous for High Fidelity for 20 years.

**STROMBERG-CARLSON AM-FM Tuner SR-401** has a sensitivity of 5 micro-volts on both bands. AM circuit has wide and narrow selectivity. Frequency response 20 to 20,000 cps  $\pm 1\frac{1}{2}$  db. Harmonic distortion less than 1%. 12 tubes plus rectifier and tuning eye. AFC switch on front panel. Completely ready to install with all hardware. Silver gray finish. Size  $11\frac{1}{4}'' \times 6\frac{1}{2}'' \times 11''$ . Shp. Wt. 12 lbs. 139.95



**STROMBERG-CARLSON Hi-Fi 10 Watt Amplifier AR-410.** The AR-410 Hi-Fi Amplifier provides 10 watts from a single chassis. Frequency response 20 to 20,000 cps with less than 1% distortion. Response flat,  $\pm 1$  db. Six input connections are provided for front panel selection. Treble control provides 5 db boost and 15 db droop at 10,000 cps; bass control provides 15 db boost or droop at 50 cps. Loudness control follows Fletcher-Munson curves. Gray panel matches tuner. Size  $11'' \text{ W} \times 7'' \text{ H} \times 8'' \text{ Deep}$ . Shp. Wt. 25 lbs. 79.95



**STROMBERG-CARLSON De Luxe Amplifier AR-425.** 25 watts. Designed as a dual chassis; controls are located on the pre-amplifier. Response 20 to 20,000 cps, less than 1% harmonic distortion; hum 80 db down. Tone controls provide 15 db boost and 20 db droop. 5-position brilliance control, 3-section loudness control. Input selector controls 7 positions; microphone, FFR, LP, AES, radio, TV, tape or crystal phono. With 6' interconnecting cable. Sizes: Power amplifier  $16'' \times 8\frac{1}{4}'' \times 7''$ ; Pre-amp  $12\frac{1}{2}'' \times 5'' \times 5\frac{1}{2}''$ . Finish brown mahogany. 189.95



**STROMBERG-CARLSON SPEAKERS. RF-475** 15" coax speaker provides exceptional wide range response of 30 to 16,500 cps, with a distribution angle of 90° vertical and horizontal. Capacity 40 watts of program material. Low frequencies are fed to 15" seamless cone with a 3" vc. The 5" tweeter in a parametric horn with acoustic lens. Input impedance 16 ohms, 8 lb. Alnico V magnet. Wt. 50 lbs. 179.95  
**RF-471** 12" coax speaker provides exceptional performance. The  $3\frac{1}{2}''$  seamless tweeter is suspended in Charpinchoe leather to eliminate violent peaks and dips in high frequencies up to 15,000 cps. The tone range down to 30 cps through a 12" seamless low frequency cone with a voice coil of  $1\frac{1}{2}''$  diameter. Power capacity 32 watts of program material. 8 ohm impedance. Wt. 15 lbs. 49.95

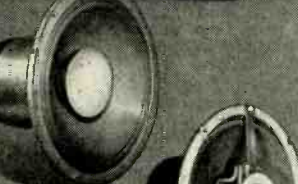

**STROMBERG-CARLSON Labyrinth RL-485.** With the RL-485 Exponential Acoustical Labyrinth Kit, any speaker cabinet, of sufficient size, can be converted to the famous Stromberg-Carlson Labyrinth. Will fit any cabinet with the following minimum inside dimensions: 39" H 24" W 20" D. Kit contains all necessary material and installation hardware and instructions. 20.00

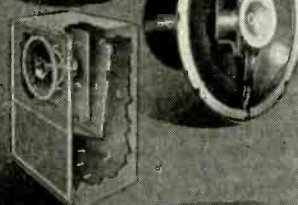

**STROMBERG-CARLSON Model TV-421 TV Chassis.** The TV Tuner Chassis TV-421 features a bright, well-contrasted picture and exceptional performance in fringe areas. Equipped with a 21" picture tube and designed to receive channels 2 through 13 (adaptable to U.I.F. channels). The chassis is supplied with 19 tubes plus 3 rectifiers, plus mask and all mounting hardware. Size 20-11/16" W 23 1/4" D 21 1/2" H (including picture tube). Shp. Wt. approx. 75 lbs. 299.95  
Send for free High Fidelity catalog and further information on the Stromberg-Carlson line. Write

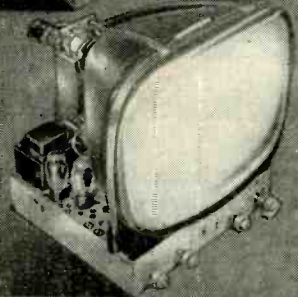

Lafayette  
Radio

NEW YORK	100 SIXTH AVE.
BRONX	542 E. Fordham Rd.
NEWARK	24 Central Ave.
BOSTON	110 Federal St.

Audio Fair Exhibitors

**HERMON HOSMER SCOTT, INC.** 628  
385 Putnam Ave., Cambridge 39, Mass.  
**Products:** Type 214-A remote control amplifier, Type 210-B Dynaural amplifier, Type 120-A equalizer-preamplifier, Type 220-A power amplifier, Type 221-A Laboratory amplifier, Type 410-B sound level meter, Type 420-A sound analyzer, Type 20-D power supply, Type 610-A production comparator, Type 140-A decade amplifier, Type 111-B Dynaural noise suppressor, Type 112-B Dynaural preamplifier.

IN ATTENDANCE

Hermon H. Scott  
Edmond J. Dyett, Jr.  
Victor H. Pomper  
D. R. von Recklinghausen

**MARK SIMPSON MANUFACTURING CO., INC.** 534-535  
32-28 Forty-Ninth Street, Long Island City 3, N. Y.

**Products:** Magnetic tape recorders, high-fidelity amplifiers, transcription players, complete line of amplifiers and inter-communication equipment.

IN ATTENDANCE

Miryan Simpson Henry Berlin  
David Libsohn Ralph Aasen  
William Wolfner Leonard Werner  
Salo Nachtigall

**SONOCRAFT CORPORATION** 514

115 West 45th Street, New York 36, N. Y.  
**Products:** Sound and recording equipment and accessories for professional, industrial and educational use.

IN ATTENDANCE

Howard Silver Harold H. Oppenheimer  
Fred M. Lissa Herbert H. Borchardt  
Joe Gschaar Gerhard M. Behrendt

**SOUNDCRAFTERS** 516

222 Fulton Street, New York 7, N. Y.  
**Products:** FM-AM Radios, tuners, amplifiers and phonographs.

IN ATTENDANCE

Dick Schoenberg

**SOUND WORKSHOP** 520

75 North 11th Street, Brooklyn, N. Y.  
**Products:** Packaged sound systems, phonographs, radio-combinations, sold through authorized parts distributors and dealers.

IN ATTENDANCE

Clifton Howard Sidney Herbstman

**STEPHENS MANUFACTURING CORPORATION** 642

8538 Warner Drive, Culver City, Calif.  
**Products:** Loudspeakers, loudspeaker enclosures, horn-loaded enclosures, condenser microphones, wireless microphone, multicellular horns, furniture speaker cabinets.

IN ATTENDANCE

Robert Lee Stephens Frank H. Gilbert

**STROMBERG-CARLSON COMPANY** 541

100 Carlson Road, Rochester, New York  
**Products:** Custom Four Hundred high-fidelity sound equipment, components and completely assembled units.

IN ATTENDANCE

A. G. Schifino F. H. Slaymaker  
R. H. Kingston J. W. Farrow  
M. T. Zegel F. W. Haupt

**SUN RADIO & ELECTRONICS CO., INC.** 601

124 Duane Street, New York 7, N. Y.  
**Products:** Stromberg-Carlson, Radio Craftsmen, Altec Lansing, University Loudspeakers, David Bogen, Meissner Manufacturing, Garrard, Webster-Chicago, Rek-O-Kut, Jim Lansing, Jensen Manufacturing, Stephens Trusonic, Bell Sound, Grommes, H. H. Scott, Browning.

IN ATTENDANCE

Samuel Schwartz Samuel N. Gerard  
Irving Hodas Robert Smith  
Joseph Greenfield Morris Brown  
Marco Karpodines Thea Katon  
Latney Hooker George Panayote  
Lou Aronowitz Paul Goldberg  
Al Goldberg Walter Zuckerman  
Robert Berger Arthur Liebschutz  
Harvey Gold Joseph Kroll



## Audio Fair Exhibitors

**TAPEMASTER, INC.** 551

13 W. Hubbard St., Chicago 10, Ill.  
**Products:** Tape transport mechanisms, preamplifier tape recorders, amplifier speaker matching unit.

### IN ATTENDANCE

John S. Margolin Sidney Wexler  
 W. L. Brooks R. M. Karet

**TELEFUNKEN PRODUCTS** 544

1775 Broadway, New York 19, N. Y.  
**Products:** Microphones, amplifiers, speakers, radios.

### IN ATTENDANCE

Michael von Mandel Fred L. Cunow

**TELE-SCOPIC PRODUCTS, INC.** 516

111 W. 42nd St., New York 36, N. Y.  
**Products:** The Tele-Tool Kit and the Tele-Toter.

### IN ATTENDANCE

Samuel L. Marshall Martin Nadler  
 Sidney Marshall

**TERMINAL RADIO CORPORATION** 526

85 Cortlandt St., New York 7, N. Y.  
**Products:** Newest audio equipment and accessories. Distribution of the Audio Industry's first most complete catalog satisfying the needs of home music enthusiasts, radio and TV broadcasters, professional and amateur recordists, public address equipment users and inter-communications equipment users in offices, factories and schools.

### IN ATTENDANCE

William Filler Frank Miller  
 Jack Simon Maury Freeman  
 Irwin Levy Gordon LeMay  
 Irving Cohen Nat Sinreich  
 Mario LaCognata Joe Kay  
 Pierce B. Collison Robert Corenthal

**THORENS COMPANY** 510

New Hyde Park, N. Y.  
**Products:** Swiss record changer, record players, radios, phonographs, reproducers, electric motors, spring motors, music boxes, and harmonicas.

### IN ATTENDANCE

R. K. Kind P. W. Kind  
 R. A. Thorens R. Thorens

**TUNG-SOL ELECTRIC INC.** 633

95 Eighth Ave., Newark 4, N. J.  
**Products:** Electron tubes, dial lamps.

### IN ATTENDANCE

John D. Van der Veer Harold F. Cook  
 John Corcoran Fred Warren  
 Robert M. Andrews

**ULTRASONIC CORPORATION** 546

61 Rogers Street, Cambridge 42, Mass.  
**Products:** Various demonstrations of the Ultrasonic Model U-25 loudspeaker.

### IN ATTENDANCE

J. Prewitt Wehle  
 Charles R. Coble, Jr.

**UNITED TRANSFORMER CO.** 522

150 Varick St., New York 13, N. Y.  
**Products:** High-fidelity audio transformer components, Williamson amplifier kits.

### IN ATTENDANCE

I. A. Mitchell S. L. Baraf  
 H. Russell T. L. Craig  
 Robert Mitchell S. Manville  
 Mike Martin Sam Rubin

**UNIVERSITY LOUDSPEAKERS, INC.** 501

80 South Kensico Ave., White Plains, N. Y.  
**Products:** Commercial, industrial, military and high-fidelity loudspeakers. Enclosures and accessories.

### IN ATTENDANCE

Irving Golin Arthur Blumenfeld  
 Sidney Levy Lawrence J. Epstein  
 Robert S. Reiss Seymour Blumenfeld  
 Saul White Abraham Cohen  
 Edward Reese

*Check*  
**EQUIPMENT**

SEE PAGE 70

# For a Glorious BIG TONE

ON ANY STRINGED INSTRUMENT

*specify the Genuine*  
**AMPERITE "KONTAK MIKE"**

THE ONLY NO-DISTORTION "KONTAK MIKE"

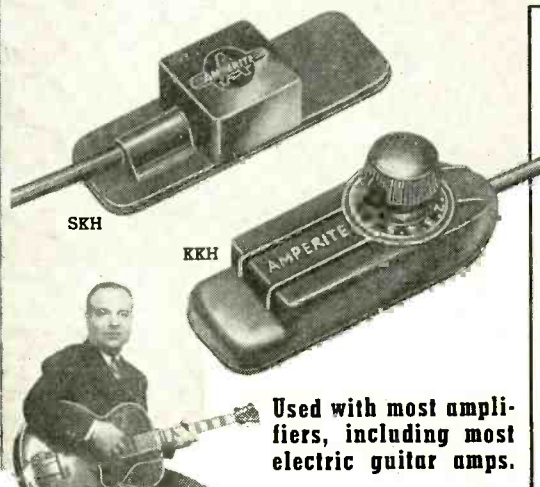

Anthony Antone, widely known as "the most versatile artist of the frets", is an enthusiastic user of Amperite Kontak Mikes.

Used with most amplifiers, including most electric guitar amps.

No changes in amplifier, instrument, or strings. Attached without tools.

The Amperite "Kontak Mike" improves the tone and volume of any Stringed or Fretted Instrument — also Pianos, Accordions, Harmonicas, etc. It is the only "Kontak Mike" that does not introduce peaks or distortion.

Model SKH, hi-imp..... List \$12.00

Model KKH  
 (with hand volume control)..... List \$18.00

## AMPERITE STUDIO MICROPHONES at P. A. PRICES!

Ideal for **CLOSE TALKING**  
 or **DISTANT PICKUP**

You can shout right into it, or stand away; in either case, the quality will be perfectly natural.

Model RBLG (200 ohms)..... List \$42.00  
 Model RBHG (hi-imp)..... List \$42.00



**AMPERITE CAROID DYNAMIC MICROPHONE**

Models PGH-PGL..... List \$32.00

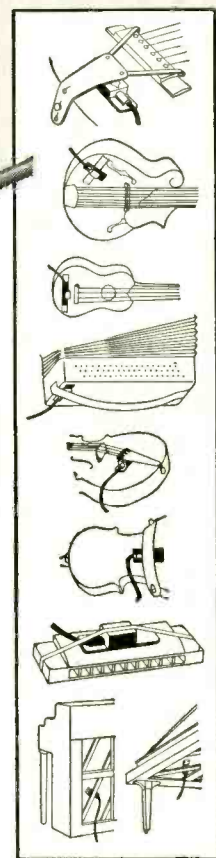

**SPECIAL OFFER:**  
 Write for Introductory Offer, and 4-page Microphone Folder 53-M.

**AMPERITE Company, Inc.**

561 Broadway • New York 12, N. Y.

In Canada: Atlas Radio Corp., Ltd., 560 King St., W., Toronto 2B

**NEVER . . .  
NEVER . . .  
NEVER . . .**

... has Radio Shack  
(or anyone else)  
been privileged to  
offer such a truly  
extraordinary exclusive  
special purchase of  
nationally known  
FM-AM high fidelity  
high quality  
Armstrong Circuit  
12-tube tuners . . .  
at a fabulously low  
price precisely 45.4%  
below Dealer Net!

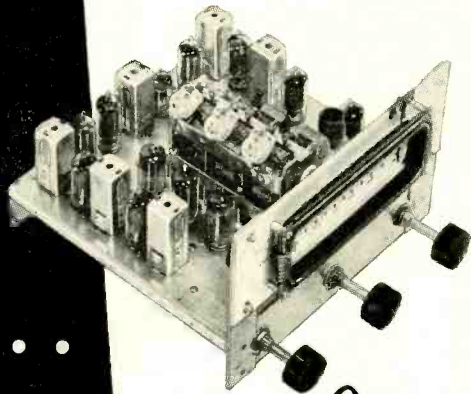

**Approved**

MODEL  
A-710

**FM-AM TUNER**

Regularly \$63.25 **\$34.50**

Outstanding features: 6-section tuning condenser; temp-comp trimmers on FM; separate FM and AM tuning and i.f. channels; tuned rf stage on FM and AM; 2-stage limiter FM circuit; genuine discriminator circuit; bandswitch/tuning/volume controls; 12 miniature tubes; compact chassis 8 1/4" wide x 5 3/8" high x 8" deep; 6 1/2 lbs. ship. wt. Requires external power supply: 6.3V AC @ 4 amps, 150V DC @ 40 ma., 170V @ 20 ma.

ORDER NO.	TYPE	DESCR.	SALE!
36-206	A-710	Tuner	\$34.50
36-207	A-620	Supply	12.05



**RADIO SHACK  
LOWER-COST  
Klipsch  
licensed  
FOLDED CORNER  
HORN ENCLOSURE  
\$132.50\***

\*Add \$20 for top enclosure shown on photo (optional), also add \$15 for crating if we are to ship. Radio Shack is the only distributor personally licensed by Paul A. Klipsch to build this horn for 15" woofers. Finished in brown mahogany lacquer, hand-rubbed, 5-ply select gumwood. 39x32x27" deep. Weight 150 lbs. Components and crossovers available from us!



HI-FI'S  
MISSING  
LINK!

**6-STEP PLAYBACK EQUALIZER  
FOR G-E CARTRIDGES, \$11.95**

Radio Shack's exclusive 6-position record compensator specifically designed for use with G-E variable reluctance pickups. The ONLY such unit available. Praised by leading audio experts. \$11.95.

**SPECIAL COMBINATION OFFER:**

Above equalizer with dual-stylus cartridge specially purchased by us, \$16.95. Cart. only, \$5.70.

**RADIO SHACK**

CORPORATION

167 Washington St., Boston 8, Mass.

NEW CATALOG!  
224 PAGES!  
FREE! WRITE  
US TODAY!



**Audio Fair Exhibitors**

**V-M CORPORATION** 618  
4th & Park Sts., Benton Harbor, Michigan

**Products:** V-M Tri-O-Matic record changers, V-M Tri-O-Matic phonographs, V-M Tri-O-Speed Phonographs, V-M PA or Hi-Fi combination 160-960.

**IN ATTENDANCE**

Roy Parr Irving Woolf  
Alan Woolf

**WQXR** 539

229 West 43rd St., New York 36, N. Y.  
**Products:** Broadcast Programs of Stations WQXR and WQXR-FM.

**IN ATTENDANCE**

James E. Kovach Miss M. R. Anderson  
William Travis

**WAVEFORMS, INC.** 502

333 Sixth Ave., New York 14, N. Y.  
**Products:** Audio amplifiers, wide-range audio oscillators, wide-range amplifier-type voltmeters, standard-signal generators (FM & AM), horn-type loudspeaker enclosures.

**IN ATTENDANCE**

Howard T. Sterling W. W. Chamberlin  
Frank Eisenhower Benjamin A. Bell

**WEATHERS INDUSTRIES** 530

66 E. Gloucester Pike, Barrington, New Jersey  
**Products:** Frequency-modulated phonograph pickup and associated accessories.

**IN ATTENDANCE**

Paul Weathers J. Alan Biggs  
M. D. Faige

**WEBSTER-CHICAGO CORPORATION** 532

5610 W. Bloomingdale Ave., Chicago 39, Ill.  
**Products:** Magnetic recorders, Phonographs and Diskchangers.

**IN ATTENDANCE**

Everett Olson Bob Fireman  
Norm Owen Sig Seaman  
Charles Castle Charles Dwyer

**ZIFF-DAVIS PUBLISHING COMPANY** 515

366 Madison Ave., New York 17, N. Y.  
**Products:** Radio and Television News magazine and others.

**IN ATTENDANCE**

Oliver Read Wm. A. Stocklin  
H. S. Renne Harold Becker  
Charles Tepler Ray Frank  
Lynn Phillips, Jr. Leonard L. Osten  
Murray Goldman Jerome Jacobs

**After the Fair—**

Plan to attend the

**West Coast  
AUDIO FAIR**

February 5-6-7, 1953

**Alexandria Hotel**

Los Angeles, California

*Check*  
**ABILITY**

SEE PAGE 76

## RECORD REVUE

[Continued from page 48]

ened 10-inch LP, at a lower price, made possible by the strange economics of modern manufacture and sales. It costs just as much to make, to all intents and purposes, but it fills a need and sells. If I am right, Capitol started the trend; now Columbia and, especially, Decca are booming the short LP right and left with singular success, judging by the number of releases in this form.

As I read between lines, RCA's people have wisely realized that, if the 45 could be cut loose from 78 timing, it could immediately fill a much-needed hole in this system, doing a more economical job than the short-10-inch LP's for a large number of compositions in every area. Moreover, it can tweak the short LP in its most dangerously exposed sector, the obvious fact that 10 inches of LP is space for a lot more music than one gets. Looks bad. And the long 45, at \$1.50, is a lot cheaper than the short LP. Good idea!

I don't know what repertory RCA has in mind for the new disc at this point (haven't heard it yet) and I'll keep fingers crossed. But, no doubt about it, here for the first time is a real new area of usefulness in other-than-popular music where 45 can beat LP fairly and squarely. Let's hope that if RCA doesn't fill the repertory need, others will turn to 45 to help out.

Maybe 45 is going to find a place in classical music after all. Now if the parent company would just adopt Capitol's ingenious knock-out 45 center, with small hole for standard spindle, the Record Peace (what with a million-odd 3-speed players now going) would be in the bag for good.

### KEY

- \* Outstanding recorded sound for the type of music
- b Big bass
- bb Brass and cymbals
- e Extreme treble pre-emphasis—use extra roll-off.
- f Flatter-than-usual high end. Add some boost.
- g Unusually good musical performance
- h Sharp, snazzy highs
- l Big, live acoustics
- m Interesting or unusual music
- u Unresonant, deadish acoustics

### AES Curve?

- 1) *Gilbert and Sullivan Overtures.* (Five) Boston Pops Orch., Fiedler.  
RCA Victor LM 7006
- 2) *Smetana, The Moldau; From Bohemia's Meadows and Forests.* Bamberg Symphony, Keilberth.  
Capitol L-8166
- 3) *Saint-Saens, Danse Macabre. Moussorgsky, Night on a Bald Mountain.* INR Symphony, André.  
Capitol H-8169

EASY LOW-COST WAY to own a  
PROFESSIONAL QUALITY

DUAL SPEED—HIGH FIDELITY

tapeMaster  
TAPE RECORDER



PORTABLE  
MODEL PT-125

Use with Your Own Audio Amplifier,  
Radio or Radio-Phono Combination,  
or with new tapeMaster Model  
SA-13 Power Amplifier and Speaker.

For the first time, a completely-flexible professional quality tape recorder like this—at such economical cost! Advanced engineering and customized design make the *tapeMaster* a natural choice of recording enthusiasts everywhere. Can be carried anywhere and used with an existing audio amplifier or combined with the SA-13 to make a complete tape recorder and playback assembly far superior to other more costly equipment. Ideal for home, school or commercial use.

Complete with 5" spool of plastic tape and 7" empty take-up spool, in sturdy carrying case covered with waterproof leatherette, less audio amplifier and microphone. Size: 12½" x 12" x 9½" high.

Net Price **\$9950**

Built to RTMA Standards • Dual Track—Manual Reversal • Dual Speed—7.5" and 3.75" sec. • Single Knob Instantaneous Speed Change • Fast Forward and Rewind • "A" Wind Tape • Direct Threading of Tape • Push-Pull Supersonic Bias-Erase • Response 50-8000 cps. ± 3 db at 7.5 and 50-5000 cps. at 3.75 • Inputs for Radio, Phono and Mike • Outputs for Audio Amplifier and Headphone • Full Monitoring • Neon Record Level Indicator For 105-125 V 60 cycle AC (Also available for 110-220 V 50 cycle AC) • Operates Vertically or Horizontally.

Send for FREE Bulletin 102-A

tapeMaster inc.  
13 W. HUBBARD ST. • CHICAGO 10, ILL.  
Export: Scheel International, Inc.  
Chicago 18, U.S.A. • Cable: Harscheel

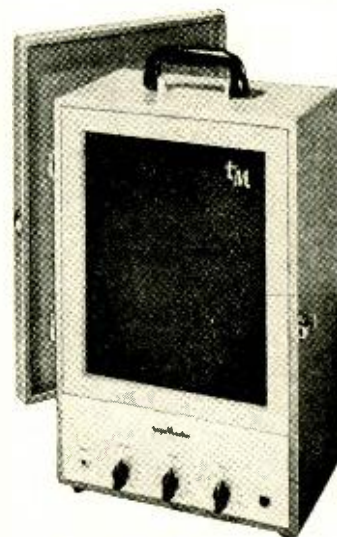

MODEL SA-13  
POWER AMPLIFIER  
AND SPEAKER

Portable companion to the PT-125 tape recorder. Combines a special type speaker, new amplifier design, and effective principle of baffling. Amplifier response ± 1 db 30-15,000 cps. Peak output 8 watts. Has separate bass and treble control. 12" x 9½" x 18½" high.  
Net Price..... **\$7950**



### FOR CUSTOM INSTALLATIONS

Model TH-25 Dual Speed Tape Transport Mechanism with Model PA-1 Matching Pre-Amplifier and Push-Pull Supersonic Bias-Erase Oscillator. Fully wired, ready to plug in. Without spool of tape, take-up spool and carrying case.  
Net Price..... **\$8850**

Units may also be purchased individually  
(Prices Slightly Higher West and South)



## 76 PAGE

ANTENNA CATALOG SECTION  
as reprinted from Radio's Master

**Antennas • Boosters • Accessories**

Catalogs the products of 32 leading  
Antenna and Accessory Manufac-  
turers

**FREE!** See coupon

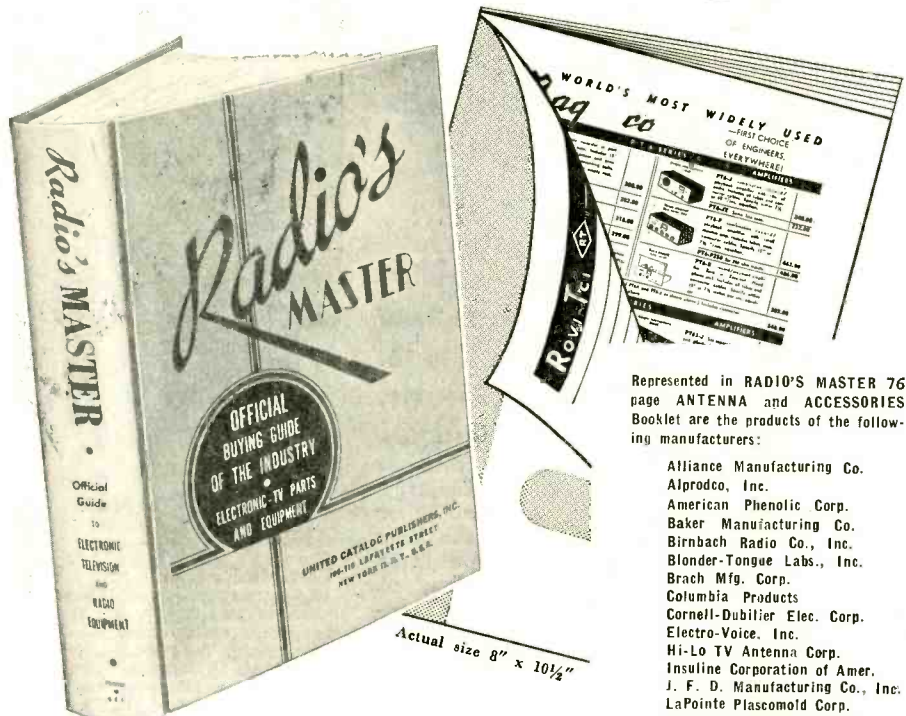

Actual size 8" x 10 1/2"

You can obtain without cost or obligation, a complete 76 page antenna catalog section as reprinted from the Industry's Official 1220 page Radio's Master, 17th edition.

Whether you buy, sell or specify, you will find this handy booklet extremely helpful for quick reference. It catalogs in detail the products of the leading Antenna and Accessory manufacturers with complete descriptions, specifications and illustrations.

This offer is made possible by a special arrangement between Audio Engineering and the publishers of RADIO'S MASTER. Fill in the coupon NOW and a copy will be sent you by return mail.

### CLIP and MAIL TODAY!

**AUDIO ENGINEERING**  
P. O. BOX 629, Mineola, N. Y.

Please send me, without cost or obligation, the 76 page AN-  
TENNA and ACCESSORY Booklet reprinted from Radio's  
Master.

Name .....

Address .....

City ..... Zone ..... State .....

- 4) \* Mendelssohn, A Midsummer Night's Dream Overture. Berlin Philharmonic, Fricsay. Weber, Overture to Oberon. Berlin Philharmonic, Eugen Jochum.  
Decca DL 4006

The above samples from the gratifying new flood of excellent 10-inch LPs of good semilight music illustrate one of the most confusing aspects of hi-fi—equalization vs. acoustics. The AES standard equalization (playback) curve is now gaining wide acceptance and we can assume that the records of the last six months have come a lot nearer uniformity in recording characteristics than in the previous year or so. The situation definitely is improving. However—all that is similarly curved does not sound the same.

Curve or acoustics? The above records are graded from (1)—muffled highs, through (4)—sharp, steely highs. In every one the highs are definitely present—no old-fashioned 5000-cps fade-outs. But the sounds are strikingly different. Are the curves?

It would take the FBI to ferret out the actual recording curves (assuming flat tapes—which is not always the case) used in each. Published curves, if any, are all very well, but . . . the plain listening facts are these. (1), Boston Pops, would seem, by ear, to have no pre-emphasis at all. With the usual roll-off it sounds remarkably muffled. Yet a full turn of the treble boost brings out highs—triangles, etc.—which are obviously there. (2) is a big, mellow sound but with a noticeably brighter string edge. Still on the soft, pastel side.

(3), on the other hand, really lets loose with all the brassy edge that Saint-S. and Moussorgsky possess—but still not the superedgy hard, brittle sounds of "demonstration" hi-fi. (This one is ideal, musically.) (4), finally, is pure firr-style, the close-up, velvety, steely string edge that has fascinated us for these many years. Too close, for my ear, too sharp. But undeniably an impressive sound.

All this—with the same curves? One would swear it could not be so. The best route towards aural analysis of this sort of collection is via the treble (and/or bass) control. Can one balance the sound, more or less, via "tone control"? Of course the differing acoustics cannot be made to sound alike—but that is the core of the matter. Equalization, in the hearing, is relative balance of highs and lows, as from one record to another. (Given the same listening room, same speaker system, and so on.) Tricky. For the listener, the engineer's equalization—a reproducing curve to match the exact recording curve—is, most of the time, impractical.

Musically these make a nice collection too. Big-orchestra G & S, sounding rather too full. Top-rank Saint-Saens and Moussorgsky from the sensitive INR-Andre team; top-rank Mendelssohn and Weber from the equally fine pair of conductors, Fricsay and Jochum—couldn't find better. Smetana, (2), a bit on the heavy side but genuinely lyric in the playing.

\* Old Netherlands Masters (Organ).  
Flor Peeters, Organ of St. Jans, Gouda, Holland.  
Renaissance X 39

This one is spotlighted for two minor but interesting audio points—aside from its excellent sound and its interest to all who have some familiarity with the music of the 15th century and early 16th.

(1): This church, with a nave 370 feet long, has a slow-period reverberation or decay (I'd judge about 4 seconds on the record) which is remarkably effective in this recording set-up. Normally we associate that sort of "echo" with a confused, blurred organ sound; yet this record brings the organ's details out with crystal clarity and no confusion at all. Is it a peculiarity of the building? I'd suggest that a good deal of the excellence of effect has to do with mike placement, balancing the close-up, direct sound with the reverberation component. That balance is crucial in all very-live situations.

(2): When is a tone a color? An old and fascinating musico-physical subject nicely illustrated in band 6, side 1 here, where the organist—about the fourth time I've heard the effect—uses what, if I am right, is called a quint stop, an octave-and-a-fifth (3rd harmonic) tone coloration

that gives a reedy effect. Unfortunately, it often happens on records that instead of blending into tone color, this stop stands out by itself as a separate melody running in parallel fifths with the fundamental. Musically quite disturbing.

I suspect that in this as in other cases the mike "heard" a different balance than did the organist. The ranks of pipes are often quite widely separated spatially and a proper balance at mike distance (plus proper liveness, as above) is difficult to achieve in mixture effects. Organist readers take note.

### TRY THESE ON YOUR HI-FI SYSTEM

\* <sup>b</sup> **Music for Meditation.** Virgil Fox, organ. Columbia AAL 20

ebb **Enesco, Roumanian Rhapsody #1. Smetana, The Moldau.** Los Angeles Philh., Wallenstein. Decca 4012

ebb **Berlioz, Overture to Benvenuto Cellini.** Berlin Philh., van Kempen.  
**Auber, Overture to Fra Diavolo.** Munich Philh., Fritz Lehmann. Decca DL 003

\* <sup>ee</sup> **Rossini, Overtures to Semiramide, The Italian Woman in Algiers.** Berlin Philh., Fritz Lehmann. Decca DL 4010

(Also others in the Decca "4000" overture series.)

f **Beethoven, Overtures to Egmont, Coriolan, Leonore #3.** Berlin Philh., Bamberg Symphony, Keilberth. Capitol P-8164

(Interesting performances—the solid, slow, heavy style that many prefer for Beethoven—extreme opposite of Toscanini, etc.)

u **Berlioz, Roman Carnival Overture. Ravel, Pavane pour une Infante Defunte; Alborada del Grazioso. Debussy, Three Nocturnes.** Minneapolis Symphony, Dorati. Mercury MG 50005

u **Borodin, Symphony #2. Stravinsky, Fire-bird Ballet Suite.** Minneapolis Symph., Dorati. Mercury MG 50004

(Recording technically tops—but dead, non-spacious. Performances by Dorati are note-perfect, incredibly mechanical. Best is Borodin, nearer to his ballet-type experience.)

h\* **Stravinsky, Petrouchka, Ballet Suite.** N. Y. Philharmonic, Mitropoulos. Columbia ML 4438

(One of the over-all greats of recent months, terrific both musically and technically. Big, full liveness plus an astonishing clinical close-up of each orchestral instrument—ultra sharp and clear. A taut, dissonant, modern playing by Mitropoulos.)

\* **Brahms, Symphony #4.** NBC Symphony, Toscanini. RCA Victor LM 1713

(Like the old Toscanini of the famous Brahms 1st—a fine reading. Recording is excellent, though sound is a bit narrow, bass in loud parts a trace uncomfortable.)

*Check*  
**RELIABILITY**  
SEE PAGE 76

## inside this package on your Jobber's shelf...



## is the world's toughest transformer



### S-TYPE

Steel base cover fitted with phenolic terminal board. Convenient numbered solder lug terminals. Flange-mounted unit.

there's nothing **TOUGHER** THAN CHICAGO "Sealed-in Steel" CONSTRUCTION



### H-TYPE

Hermetic sealing meets all MIL-T-27 specs. Steel base cover is deep-seal soldered into case. Ceramic bushings. Stud-mounted unit



### C-TYPE

With 10" color-coded leads brought out through fibre board base cover. Lead ends are stripped and tinned for easy soldering. Flange-mounted unit

CHICAGO "New Equipment" transformers (available in 3 mountings) feature one-piece drawn-steel cases—the strongest, toughest, best-looking units you can buy. The one-piece seamless design, enclosing an electronically perfect construction, provides the best possible electrostatic and magnetic shielding, with complete protection against adverse atmospheric conditions. For every application: Power, Bias, Filament, Filter Reactor, Audio, MIL-T-27, Stepdown—ask your electronic parts distributor for CHICAGO "Sealed-in-Steel" Transformers—the world's toughest with that extra margin of dependability.

### Free "New Equipment" Catalog

Get the full details on CHICAGO's New Equipment Line—covering "Sealed-in-Steel" transformers for every modern circuit application. Write for your Free copy of this valuable catalog today, or get it from your distributor.



**CHICAGO TRANSFORMER**  
DIVISION OF ESSEX WIRE CORPORATION  
3501 ADDISON STREET • CHICAGO 18, ILLINOIS

TRADE MARK REG

# NEW PRODUCTS

● **Equipment Enclosure.** Any combination of the popularly-known tuners, amplifiers, and record changers can be conveniently housed in the new Peerage cabinet recently announced by Electro-Voice, Inc., Buchanan, Mich. Pivoted tilting-top panel opens with brass pulls and mounts all conventional tuners. In open position, controls are at 65-deg. angle. Amplifier is mounted on back panel which is readily removed for servicing. Changer drawer is



directly below tuner panel and is mounted on roller-bearing slides for smooth operation. Designed originally to match the E-V Aristocrat speaker enclosure, the Peerage also complements furnishings of any conventional decor. Complete description is contained in Bulletin No. 192 which will be mailed free on request.

● **Miniature Connectors.** Although greatly reduced in size, the new Type D Cannon connectors carry more contacts than small standard counterparts. Contact complements range from 15 to 50, with the smallest unit having dimensions of 1.17/32 x 31/64 x 27/64 ins. plus a solder pot extension of 9/64 in. Nylon insulation makes possible high dielectric qualities for the

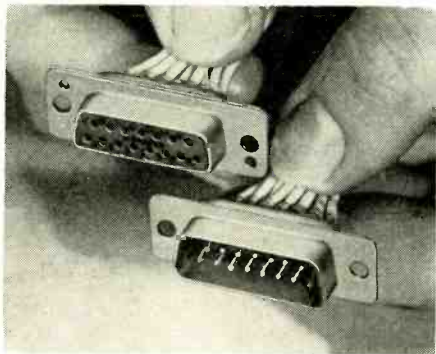

gold-plated 5-amp contacts which have a conservative minimum flashover point of 1500 volts r.m.s. Major applications of the new Type D connectors include small instruments, computer circuits, small amplifiers, and telemetering equipment. Photographs, dimensional drawings, and electrical characteristics are included in Bulletin D-1 which will be mailed on request. Write Cannon Electric Advertising Department, 420 W. Avenue 33, Los Angeles 31, Calif.

● **Corner Speaker.** The Model 4 horn is the newest in the series of high-quality loudspeakers manufactured by Brociner Electronics Laboratory, 1546 Second Ave., New York 28, N. Y. Unique in many respects, the Model 4 utilizes two horns, the smaller of which has its mouth at the grille at the upper portion of the enclosure, and covers frequencies from 150 to 20,000 cps. The range below 150 cps is derived from the back of the driver unit, through a folded horn whose mouth is directly below the speaker structure. This arrangement not only utilizes the space below the cabinet itself as an effective part of the speaker system, but also uses the walls of the

room as an extension of the folded horn. The driver unit is a twin-cone speaker with a field magnet producing 20,000 gauss. A 6-in. cone, capable of great ex-



cursion, covers the bass and middle register. A second, smaller cone, working through a mechanical crossover, covers the higher frequencies.

● **High-Quality Amplifier.** A continuously variable treble cutoff filter is included in the new Model A-20-6 amplifier recently announced by Waveforms, Inc., 333 Sixth Ave., New York 14, N. Y. Cutoff range is 2500 cps to full 20,000 cps response. Similar in most respects to the earlier

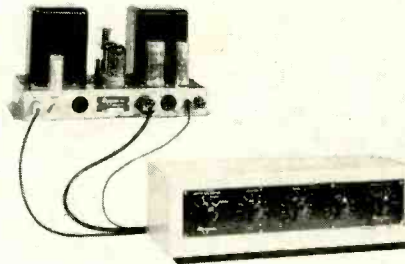

Waveform amplifier, the A-20-6 features a newly-styled control unit in a solid-wood blonde cabinet. Tone controls provide up to 20 db boost or cut of both treble and bass. Four input channels are provided with independent level controls. An output is provided for a tape recorder. Literature will be supplied on request.

● **Ultra-Sonic Tweeter.** Frequencies extending from 5000 cps well into the ultra-sonic range are reproduced by the new Stephens Model 214 tweeter. Designed to improve fidelity of reproduction from

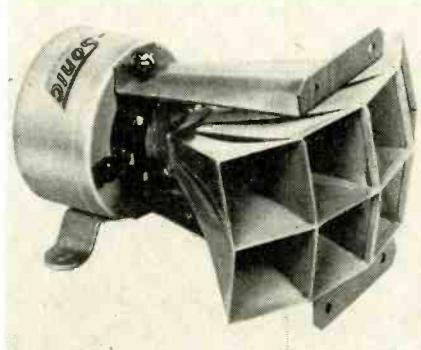

high-quality source material, the 214 assembly includes a 2x4 multi-cellular horn. Installation is facilitated by insulated spring-type binding posts. Stephens Manufacturing Corporation, 8533 Warner Drive, Culver City, Calif.

● **Magnetic-Tape Magazine.** Any standard make of tape recorder can be equipped for continuous repetition of a recorded message up to five minutes in length by means of a new tape cartridge and magazine adapter now being produced by Connecticut Telephone & Electric Corporation, Meriden, Conn. The adapter case is easily attached or removed and requires no



changes or adjustments in present equipment. By means of a patented helical twist, the 100-ft. double-coated tape will record and play-back both sides without interruption, thus giving 200 ft. of unbroken recording track. Unique sealed-in feature makes the cartridge easy to handle and load. Recorded cartridges can be duplicated, erased, and re-recorded.

● **Large-Reel Adapter.** Versatility of the Pentron tape recorder is expanded by means of the new 10 1/2-in. reel adapter which increases maximum recording or playing time of standard Pentron models to a full four hours. The unit will operate with either the large NAB hub or with smaller commercial-type hubs—this fea-

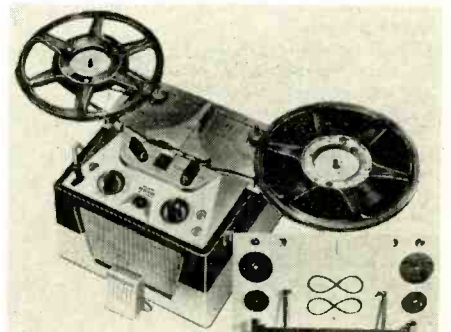

ture making it unnecessary to remove the adapter for operation with either 5 or 7-in. reels. A universal joint under each reel sprocket permits horizontal and vertical positioning for proper tape alignment. Attachment of the adapter requires less than two minutes. Manufactured by Pentron Corporation, 221 E. Cullerton St., Chicago 16, Ill.

● **High-Fidelity AM-FM Tuner.** A phono preamplifier as well as controls normally included only with high-quality amplifiers are inherent in the new Model C800 AM-

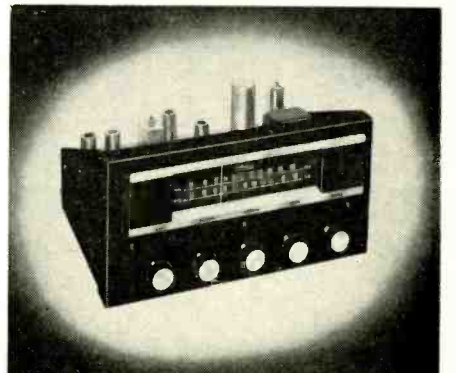

FM tuner introduced recently by The Radio Craftsmen, Inc., 4401 N. Ravenswood Ave., Chicago 40, Ill. Crossover selector permits equalization for AES, LP, or European recording characteristics. Continuously variable tone controls permit 15 db attenuation through 15 db boost with flat position clearly indicated. Also included in the CS00 are a double-shadow tuning eye and front panel control for disabling the AFC circuit.

• **Weatherproof Intercom Station.** Users of outdoor intercom systems will welcome this new unit which is both dustproof and weatherproof. Compactly built in



light-weight aluminum cabinet. Contains 4-in. speaker with 45-ohm voice coil. Dimensions 4x6x4½ ins. Cleveland Electronics, Inc., 6619 Euclid Ave., Cleveland 6, Ohio.

• **Microphone Foot-Switch.** Designed for use with communications systems, this control unit provides a convenient means of switching an operator's headset microphone from one system to another, simultaneously holding open the connection with the first system. Foot control of the unit leaves the operator's hands free for

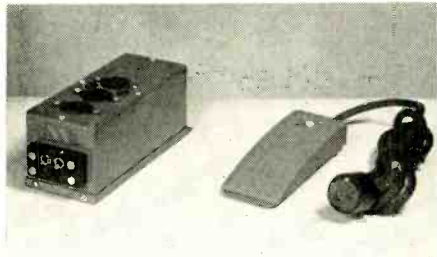

logging or other duties. The switch is especially suitable for use in dispatching stations where directions are received by land-line telephone and communicated to mobile stations by radio. Operator efficiency is increased through faster message transmission. Manufactured by American Radiotelephone Company, Inc., 3505 4th Street North, St. Petersburg, Fla.

• **Stroboscopic Disc.** The Berkshire "Phonostrobe" disc permits quick and accurate determination of the three standard phonograph turntable speeds when used with any 60-cycle light source. Made of durable plastic, the disc is impervious to deterioration through normal handling and usage. It is 4 in. in diameter. Descriptive data may be obtained directly from Berkshire Laboratories, 502 Beaver Pond Road, Lincoln, Mass.

**Check  
CONVENIENCE**

SEE PAGE 76

Look to **LEONARD** for Hi-Fi!

See Leonard at the  
**AUDIO FAIR - HOTEL NEW YORKER**  
SPECIAL SURPRISES for ALL Rooms 536-537

**PREMIER  
#70  
TAPE-SONIC**

A Professional Type  
Tape Recorder

**\$298.50** net  
CASE INCLUDED



It's the hit of the show! Yes, a complete, professional type tape recorder at an unbelievably low price! Complete specifications on request.



**NEWCOMB A-15  
AMPLIFIER**

Now, this major achievement in fine audio amplifiers combines technical perfection, startling tonal realism and many advanced features. The advantages of extended power range are provided without sacrifice of important low level characteristics. Here are both low distortion and plenty of reserve power. Only years of specialization could produce so advanced an instrument at so moderate a price.

Technical data: Power input: 15 watts; frequency response: ± .1db, 20-20,000 CPS; Noise level: 82db below; Inputs: low level mag., high level mag., crystal, radio, TV or tape; Controls: bass, treble, volume, selector; Speaker outputs: 8, 16 ohms; "Adjusta Panel" feature; Size: 10"x10"x7½"; App. shipping weight: 18 lbs.

**99.50** net

**NEWCOMB AM-10R  
AMPLIFIER**

The sensational new, value packed series of 10 watt, high fidelity phonograph amplifiers by Newcomb brings the music lover with a limited budget audibly greater listening pleasure per dollar invested. Particularly easy to install, they include many advanced operating features.

Technical data: Power output: 10 watts; Frequency response: ± .1db, 20-20,000 cycles; Noise level: 80db below; Inputs: low level mag., high level mag., crystal, radio, TV or tape; Controls: volume, treble, bass; Size: 8"x6½"x5½"; App. shipping weight: 11 lbs.

**54.45** net

AM-10 — Same as AM-10R without remote unit..... 45.00 net  
A-10 — Same as AM-10 with lower gain for crystal pickups..... 39.50 net

GOLDEN G. E. CARTRIDGE RPX-052.....	\$22.90	
MATCHED KT-66 tubes for Williamson Amplifiers..... pair	11.50	Mail & Phone Orders Filled
CABINART 12" folded horn kit # 61.....	19.95	25% Deposit
ACROSOUND Williamson-type output transformer, 20 watt, TO-300	24.75	Balance C. O. D.

**LEONARD RADIO** INC.

69 CORTLANDT ST., NEW YORK 7, N.Y.  
Cortlandt 7-0315 - 9 Dept. AE II

The House Built On Service  
Free! New High Fidelity Guide



Double installation of Gramplan Amplifier with Power Supply

## NOW AVAILABLE The GRAMPION Feedback Disk Recording Cutterhead Unit

Engineers and musicians now realize a perfect transient response of any recording system is of paramount importance—the Gramplan cutterhead with its precision-made true balanced armature and flux correcting feedback loop obtains this ideal.

Used by the BBC and other international broadcast networks where fidelity is of primary importance, you too, can be assured of the highest fidelity disk recording.

Many outstanding recordings, such as the LP Mercury Olympian Series, were recently produced with the Gramplan.

For more information, write to



REEVES EQUIPMENT CORP.  
10 EAST 52nd STREET • NEW YORK 22, N. Y., U. S. A.  
CABLE: REEVESQUIP, N. Y.

Wide frequency range  
30 c/s to 20 kc  
Low Distortion  
Superior transient response

*Unparalleled*

# "PRESENCE"

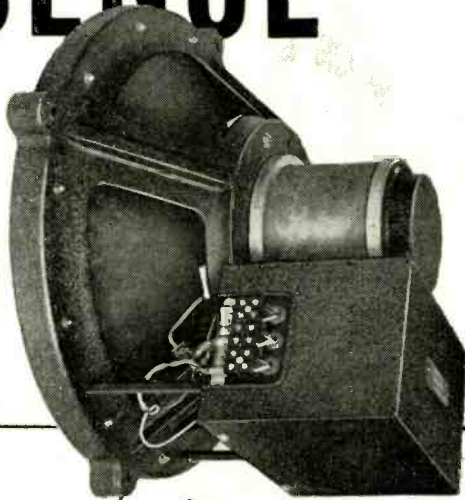
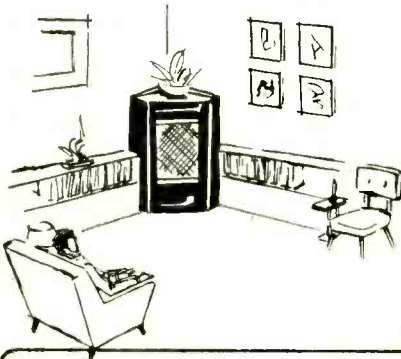

Famous

## TANNOY

DUAL CONCENTRIC  
LOUDSPEAKER SYSTEMS

**NOW AVAILABLE  
IN AMERICA!**

Now experience the amazing listenability of wide range response in *perfect balance*. Hear the world famous Tannoy Dual Concentric Loudspeaker System, providing *optimum fidelity* at any level from the audibility threshold up to full room volume. Features of the Tannoy System include:

*Substantially flat response from 40-20,000 cycles per second. Concentric sources for both HF and*

*LF components avoiding interference at crossover. HF horn formed by machined center pole and LF diaphragm, these combined with a special throat insure correct HF match. Intermodulation product less than two percent.*

Hear it to appreciate it! Write for free brochure and name of nearest distributor today. 12" and 15" types, handling 15, 25 watts.

SOME DISTRIBUTORSHIPS STILL AVAILABLE

## TANNOY

Hear Tannoy at the  
AUDIO FAIR  
BEAM INSTRUMENTS Rm. 603  
Hotel New Yorker

**BEAM INSTRUMENTS CORPORATION**  
350 FIFTH AVENUE NEW YORK 1 NEW YORK

## NEW LITERATURE

• **Allied Radio Corporation**, 833 W. Jackson Blvd., Chicago 7, Ill. announces the release of its new 1953 general catalog—a 236-page directory listing 18,000 items. Extensive listing of high-fidelity components features a selection of 22 complete music systems with or without radio tuner. In keeping with the record established by the company in former years, the new Allied catalog is superbly produced and should be in the hands of everyone interested in electronics. Free copy will be mailed on request.

• **Technology Instrument Corporation**, 531 Main St., Acton, Mass. will mail free on request a copy of Laboratory Report No. 6—an excellent paper on the subject "Precision Potentiometers and Noise." Written by Joseph R. Altieri, the treatise covers causes of potentiometer noise, definition of noise, and the use of the Ponogometer, a production testing device.

• **Mark Simpson Manufacturing Co., Inc.**, 32-28 Forty-Ninth St., Long Island City 3, N. Y. illustrates and describes a series of six new Masco tape recorders in catalog TR-52 which has just been published. Included are special models designed and recommended for schools and institutions. Known as the Series 52, the new recorders are available with or without built-in tuner.

• **Cinema Engineering Co.**, 1510 W. Verdugo Ave., Burbank, Calif. illustrates and describes an impressive assemblage of amplifiers and communication equipment in a new 16-page catalog prepared for professional recordists and audio engineers. The booklet is standard size and is adaptable for filing or loose-leaf binding. Contained are characteristics charts, a specification listing for each product, block drawings, and circuit layouts. Available on request.

• **Goslin Electric & Manufacturing Co.**, 2921 W. Olive St., Burbank, Calif. features typical examples of specialty transformers for airborne electronic equipment in a handsome new 2-color brochure. The product section of this booklet may well serve as an example to other manufacturers who face similar cataloging problems. Requests should be addressed to Dept. AT.

• **Kepeco Laboratories, Inc.**, 131-38 Sanford Ave., Flushing 55, N. Y. is worthy of congratulation for the excellent preparation of a new 4-page folder describing and illustrating Kepeco voltage-regulated power supplies. Although condensed in space, this brochure is remarkably complete in information, giving performance data for 16 different models covering a wide range of applications. Will be mailed on request.

• **Milwaukee Transformer Company**, 5231 N. Hopkins St., Milwaukee 9, Wis. illustrates and describes a varied line of transformers, reactors, filter networks, and other similar components in Brochure MTR-1, a new 2-color 16-page catalog which also pictures the company's manufacturing facilities. Available without cost to experimenters and student engineers.

• **General Cement Manufacturing Company**, 919 Taylor Ave., Rockford, Ill. impressively depicts the growth in recent years of its manufacturing facilities in a new 16-page brochure titled "The Story of G-C." Especially interesting is the extent to which the company has broadened the line of equipment it manufactures. Copy will be mailed free on request.

• **Jensen Industries, Inc.**, 329 S. Wood St., Chicago 12, Ill. is distributing a new phonograph-needle wall chart designed to simplify selection of replacement styli by record dealers and service technicians. Needles representing the requirements of 16 leading cartridge manufacturers are shown in silhouette, together with their Jensen equivalents. The chart measures 8x22 in., is attractively printed in two colors, and may be obtained from Jensen distributors.

• **Radio Shack Corporation**, 167 Washington St., Boston 8, Mass. is now mailing its 30th Anniversary catalog, the largest in the company's history. Included in the 224-page edition is a 32-page rotogravure section devoted solely to the components of high-fidelity home music systems. This catalog is an exceptionally complete buying guide—write for one by all means. Copy will be mailed free on request.



## NEW AMPLIFIER

[from page 31]

same way for each. Once these controls are set they need not be readjusted.

The fourth input, designed for various magnetic pickups, is independently equalized and compensated. This input is provided with a switch placed adjacent to it which adds or removes attenuation as required for use of either the low-output type of cartridge such as the GE or Audak, or high-output cartridges like Clarkstan or Pickering.

An eight-position selector switch with a dial of novel design works with the MAG input to provide almost every type of equalization possible in a single switch. Nearly every type of characteristic recorded on a disc may be equalized with this switch. Equalizations provided are as follows:

Position 1—Columbia LP (500-cps turnover, 16 db rolloff at 10 kc., playback equalization for constant velocity below 100 cps).

Position 2—AES-RCA (400-cps turnover, 12 db rolloff at 10 kc).

Position 3—NAB-LP (500-cps turnover, 16 db rolloff at 10 kc).

Position 4—78's (400-cps turnover, 6 db rolloff at 10 kc).

Position 5—European 78's (350-cps turnover, flat at high end).

Positions 6, 7 and 8 select the high-impedance, flat-response inputs.

The loudness control, as is well known, provides an essentially flat response at its maximum setting, and boosts the response at the low and high frequency ends as the loudness is reduced, in accordance with the curves of Fletcher and Munson<sup>1</sup> describing the variation of sensitivity of the human ear with both loudness and frequency. This control was incorporated purely as a means of providing added pleasure to music listening through realism of reproduction. Bass and treble controls are provided to allow variation of the response in accordance with individual tastes. *Figure 7* shows the extent of variation incorporated in these controls: 17.5 db boost and 13.5 db cut at 20 cps, 21.5 db boost and 22.5 db cut at 20,000 cps. Center positions of these controls provide flat response, and there is no interaction between the controls. Cross-over frequency is 800 cps.

In summary, we have described an amplifier and preamplifier system offering the flexibility and performance required for most high-fidelity applications, intended for the low- and medium-priced market and using standard, easily available tubes, yet surpassed by few if any similar commercially available units. The superiority of these units has been established not only by laboratory measurements as described, but also by comparative listening tests (the familiar A-B tests) with live material under similar conditions. In the present state of the art, it would be difficult to surpass the performance of this equipment.

Fig. 7. Frequency characteristics of the tone controls, showing response at maximum settings, as well as at the flat position.

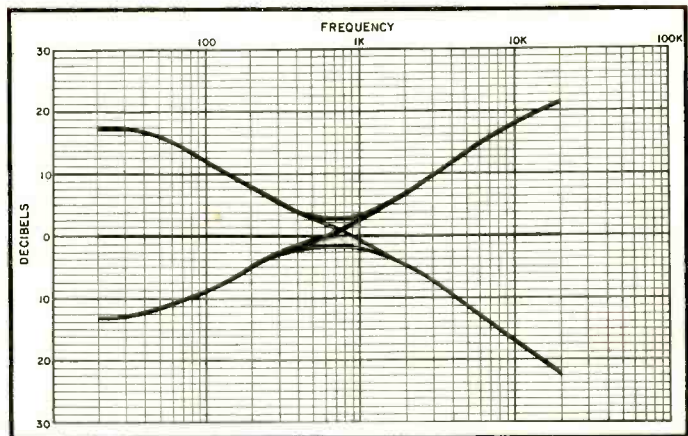

From  
Station Break  
to Feature ...  
the NEW  
"BALANCED"  
TV Tripod  
is doing @  
whale of a job  
every day!

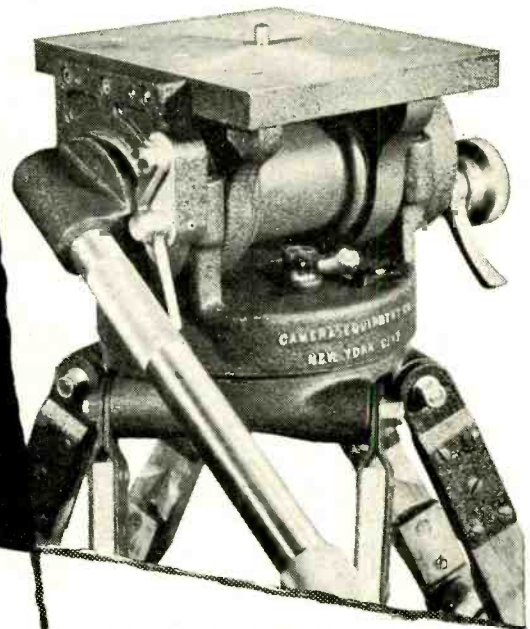

"BALANCED"  
TV TRIPOD  
mounted on  
3-wheel  
portable  
collapsible  
dolly  
illustrated.



We THREW THE book away and engineered a brand new "BALANCED" Tripod for every photographic and video need. The result—a revelation in effortless operation, super-smooth tilt and 360° pan action.

PERFECT BALANCE prevents mishap if the lock lever is not applied. Quick release pan handle locks into desired position. Mechanism is enclosed, rustproof, needs no lubrication. Tension adjustment for Camera Man's preference. Built-in spirit level. Telescoping extension pan handle. We defy you to get anything but the smoothest, most efficient operation out of this tripod beauty.

WE CALIBRATE LENSES . . . Precision "T" STOP CALIBRATION of all type lenses, any focal length. Our method is approved by Motion Picture Industry and Standard Committee of SMPTE. Lenses coated for photography. Special TV coating.

WE DESIGN and manufacture Lens Mounts and camera equipment for 16mm — 35mm and TV cameras.

WE RENT AND SERVICE

CAMERAS \* MOVIOLAS \*

DOLLIES . . . Complete line

of 35mm and 16mm equipment available for rental.

MITCHELL: Standard, Hi-Speed, BNC, NC, 16mm. Bell &

HOWELL: Standard, Shiftover, Eyemos. MAURER: 16mm

Cameras. ARRIFLEX. MOVIOLA: Editing machines, Synchronizers.

FRANK C. ZUCKER

**CAMERA EQUIPMENT CO.**  
1600 BROADWAY NEW YORK CITY

IF YOU WORK WITH FILM . . .

It will pay you to get to know us. The country's foremost professionals depend upon our portable, versatile, adaptable equipment.

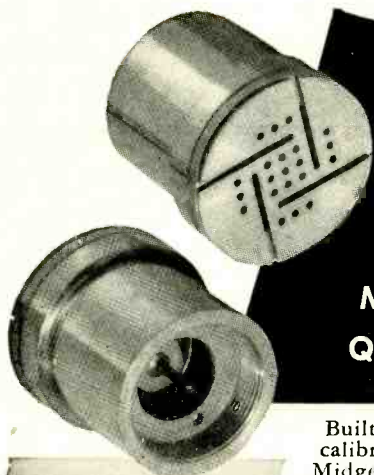

## MIDGET CONDENSER MICROPHONE

For Precision Sound  
Measurements and High  
Quality Sound Recording

Built to give years of service without change in calibration. Even without dessicators, Kellogg Midget Condenser Microphones show no detectable drift in laboratory service. Proven in use for optimum performance for more than 15 years.

- RUGGED CONSTRUCTION
- EXCEPTIONAL CALIBRATION STABILITY
- UNAFFECTED BY VARIATIONS IN HUMIDITY

### PRINCIPAL CHARACTERISTICS

	MODEL A	MODEL B
RESPONSE (Referred to 1 volt/dyne/cm <sup>2</sup> )	-59 db	-55 db
FLAT TO WITHIN	± 3 db from 20 to 11,000 cps, for closed cavity without grille.	± 4 db from 20 to 15,000 cps with or without grille for perpendicular incidence in free field.

Users Include government laboratories, universities, audio development laboratories, sound studios and industrial plants manufacturing sound equipment.

● SEND FOR FULL SPECIFICATIONS TODAY! WRITE DEPT. 27-K.

# KELLOGG



MIDGET CONDENSER MICROPHONE

SWITCHBOARD & SUPPLY COMPANY

Sales Offices:

79 W. Monroe St., Chicago 3, Ill.

An Associated International Telephone and Telegraph Corporation



introduces with great pleasure

a new series of High-Quality Audio Amplifiers featuring the COMPLETELY NEW Model 4A Pre-amplifier.

The new pre-amplifier, combined with BROOK world-famous power amplifiers, Model 10C or 12A, offers the music lover sound reproduction so lifelike and natural, it cannot be described. YOU MUST HEAR IT.



Model  
10C4  
30 watt

*New Features:*

- Record Playback Characteristic Control offers 9 positions to match all types of records.
- Complete automatic compensation for bass-loudness characteristics of the human ear.
- Greater range of bass boost and attenuation. Bass characteristics at 50 cycles adjustable from minus 18 db to plus 24 db, in addition to automatic bass boost. Slope continues down to below 20 cycles.
- Low Frequency Range extended down another octave.
- Lower Hum Level.
- Tubes: 1-6J7 (or 1620), 2-6SJ7's, 2-6C4's (all triode-connected).
- 10-position bass and treble controls employ stepped two-stage R-C networks.
- 5 input channels:  
4 inputs (two of which are 1 meg) for FM, AM, TV, Recorders, Crystal Pickups.  
1 hi-gain input for magnetic, variable re-

luctance capacitance pickups, or microphone.

- Higher gain for low-output pickups.
- Convenient connections on rear panel.
- Low impedance output of pre-amplifier, due to feedback circuit, permits use of line to basic amplifier up to 100 ft.
- Dimensions: 15" wide, 7" deep, 3 3/4" high.
- Output jack on rear panel for use with recorders, or "de-commercializer" furnished with amplifier.
- Luxurious gold-finished consolle, with highly polished solid walnut end blocks, has removable lucite escutcheon to facilitate cabinet or panel-mounting.
- ALL THE FINE PERFORMANCE AND WORKMANSHIP CHARACTERISTIC OF THE BROOK.

Model  
12A4  
10 watt

WRITE FOR COMPLETE TECHNICAL DATA, INCLUDING NAME OF YOUR LOCAL DEALER. Dept. AL-2



**BROOK ELECTRONICS, INC.**  
34 DeHART PLACE, ELIZABETH 2, N.J.

## THE VIOLIN

[from page 38]

sponse for a cheap and a good quality violin. The response is fairly uniform from 300 to 4000 cps for the good violin, and then falls off from 4000 to 6000 cps at a roughly linear rate. The cheap violin has a very irregular response and is particularly weak at the lower frequencies. On the other hand, it has more, or perhaps one should say excessive response in the higher frequencies.

In other words, the high-frequency response of the cheap violin is better than that of the good violin, but this only results in more scratchy and harsher tones! This points out an important point, namely that frequency response in a musical instrument is quite different from that of a reproducing system. It must be noted, however, that this test does not show up the nature of the starting and stopping transients which occur when the string is bowed.

The frequency response or steady-state response does not reveal much when several good violins are compared. Two Strads may vary more between themselves than when either is compared with a new violin, so that this test cannot be used as a guide in building a new violin.

The transient response was measured by suddenly making and breaking the circuit to the phosphor bronze wire. These seemed to indicate that the tones (at the air and body resonant frequencies) took longer to die away in a good violin than in an inferior one. Rapping the back of the violin with the knuckle elicited air and first body resonances, and these lasted longer for the better violins.

In a later series of tests Saunders<sup>7</sup> measured the average intensity of the emission of sound over intervals of roughly one octave and obtained the average of Strads and of new violins to be as shown in Table I.

The final conclusion was that Strad or new violin, high- or low-priced model, the frequency response is about the same in all cases! A "full" or "round" tone has more strength in the low frequencies than in the high, and a "biting" tone has more strength in the high frequencies than in the low.

### Loudness Range

So far as the loudness range of a violin is concerned, it is about 30 db, whether old or new, good or bad. But the rate of growth or decay of a Guarnerius violin was found to be about 25 per cent longer than that of a five-dollar fiddle. This may be a clue to the quality of a violin, although it is hardly amenable to passing on subtle differences.

Although one is tempted to dismiss the claims of musicians as so much emotional fervor, there are undoubtedly discernible differences between various violins. Also, the more a good violin

<sup>7</sup>F. A. Saunders, "The mechanical action of instruments of the violin family," *J. Acous. Soc. Am.*, Jan. 1946.

is played, the better it seems to get, at least up to a certain point. If it is not played for a time, its tone seems to become impaired, although it can be brought back to its previous superior condition by more playing.

Age improves its tone, provided it is played often, although the tone is not necessarily impaired, at least not permanently, if it is placed in a museum. A violin sounds better on a cold dry day, and it can be decidedly inferior on a hot humid day.

All of this, the writer feels, points to some nonlinearity in the vibration of the wood, which can be reduced by vibrating it often and forcibly. Perhaps the resins in the wood have a tendency of cold flow, and tend to gum the fibers together if the violin is allowed to be inactive for a while. Vibration seems to free the fibers and permit them to vibrate more readily, perhaps cutting down the damping in the wood. By the same token, moisture absorbed in the wood and making the fibers swell must introduce additional damping.

There is another type of nonlinearity existing in the violin. If a phonograph pickup be applied to the bridge, or body, or even scroll of the violin, and double-stops played with the bow, a difference beat frequency can be clearly heard in a loudspeaker unless the low-frequency response is unduly attenuated.

This appears to originate in the strings, since when their amplitude of vibration is finite rather than infinitesimal, the stiffness is no longer constant, and the usual differential equation of motion no longer holds. Hence cross-modulation is possible with the production of beat frequencies.

These beat frequencies are not heard when a violin is ordinarily played because the body is too small to radiate such low frequencies to any appreciable extent. The electrical system, on the other hand, can respond and reproduce them unless filters are employed.

Nor can the nonlinearity be attributed to the pickup and associated equipment, since these can reproduce double stops recorded on a record without appreciable beat frequencies. In this case the sound is air-borne to the recording microphone, and if the entire recording and reproducing system is reasonably distortionless, no beat notes are picked up or generated in the system. But they are present in the violin itself, and can be detected as explained previously by applying the pickup direct to the violin.

In connection with this, it will be found that pizzicato (plucked) double stops do not produce any difference beat notes in a pickup applied to the violin. The reason is that these tones are transient rather than steady-state in nature, and hence cannot very well beat with one another, at least in a recognizable fashion. It is for that reason that a pickup is satisfactory for reinforcing the sound from a guitar, and is not so satisfactory for performing the same function for a violin.

TABLE 1

Average frequency response over various intervals

Interval Frequency, cps	I 196-349	II 349-784	III 784-1568	IV 1568-3136	V 3136-4186	VI 4186-6272
Strads	14.1	23.7	25.7	25.9	23.6	10.9
New violins	12.9	23.8	25.4	25.9	24.6	9.9

#### Conclusion

In conclusion, we may note that the tone quality of a violin is so subtle a characteristic that it appears to elude our ordinary methods of measurement. It is also possible that much of the differences between various violins reside mainly in the minds of the musicians, who are supposed to be more emotional

than logical.

However that may be, the writer feels that the future development of the violin lies in the direction of electronic methods. These will enable us to separate the functions of tone generation and selection of timbre, amplification, and radiation so that each can be independently perfected. Whether or not you care

**HYCOR**

TYPE 4200

*Sound Effects Filter*



This unit has been developed to meet present day requirements for compactness. The filter requires only 3½ inches of rack space.

#### Features:

- **LOW HUM PICKUP** through the use of toroid coils. The unit may be used in circuits having signal levels as low as -40 dbm without the necessity for taking special precautions against hum pickup.
- **LOW DISTORTION:** The filter may be used at levels up to plus 20 dbm with negligible intermodulation distortion.
- **RELIABILITY:** All capacitors and inductors are hermetically sealed for lifetime service. Aging effects are negligible.

#### General specifications:

- DIMENSIONS:** Standard rack panel, slotted, 3½" high. Maximum depth 7½".
- CONTROLS:** Low frequency cutoff selector knob, high frequency cutoff selector knob, on-off key.
- RANGES:** Both low and high frequency cutoff controls cover 100, 250, 500, 1000, 2000, 3000, 4000 and 5000 cycles.
- ATTENUATION:** Approximately 16 db, per octave on both high and low frequency cutoff points.
- IMPEDANCE:** 500/600 ohms, in-out.
- FINISH:** Engraved panel finished in medium gray baked enamel. (Special colors available upon request.)

The filter has standard input and output jacks located on the front panel in addition to the terminal block at the rear.

**HYCOR**

*Company, Inc.*

Send for Bulletin S

11423 VANOWEN STREET, NORTH HOLLYWOOD, CALIFORNIA • SUset 3-3860

Manufacturers of Toroid Inductors, Decade Inductor Instruments, Wave Filters, Resistive Networks, and Precision Resistors

Eastern Representative: Burlingame Associates, 103 Lafayette Street, New York 13, New York

## PRECISION-FIXED WIREWOUND resistors



Forty-two types in all, from  $\frac{1}{4}$  Watt to 10 Watts. Three wire alloys. Accuracies to .025%. Resistance range from .1 Ohm to 15 megohms. All receive aging treatment for assured stability. A variety of impregnation treatments and installation mountings to meet your requirements. Shown actual size (left) are the new 412 HE and 413 HE types designed for direct replacement of carbon composition resistors where space is at a premium.

Write for Complete Catalog

N. Y. Stock:  
Audio & Video Products Corp. • 730 Fifth Ave. Plaza 7-3091



Export Agents: Frazar & Hansen, Ltd. • 301 Clay St • San Francisco, Calif., U.S.A.

### STATEMENT OF THE OWNERSHIP, MANAGEMENT, AND CIRCULATION REQUIRED BY THE ACT OF CONGRESS OF AUGUST 24, 1912, AS AMENDED BY THE ACTS OF MARCH 3, 1933, AND JULY 2, 1946

(Title 39, United States Code, Section 233)

Of AUDIO ENGINEERING, published monthly at Lancaster, Pa., for October 1, 1952.

1. The names and addresses of the publisher, editor, managing editor, and business managers are: Publisher: Charles G. McProud, 204 Front St., Mineola, N. Y.; Editor: Charles G. McProud, 204 Front St., Mineola, N. Y.; Managing editor: none; Business manager: Henry A. Schober, 204 Front St., Mineola, N. Y.

2. The owner is: Radio Magazines, Inc., 204 Front St., Mineola, N. Y.; Henry A. Schober, 204 Front St., Mineola, N. Y.; Charles G. McProud, 204 Front St., Mineola, N. Y.

3. The known bondholders, mortgagees, and other security holders owning or holding 1 percent or more of total amount of bonds, mortgages, or other securities are: none.

4. Paragraphs 2 and 3 include, in cases where the stockholder or security holder appears upon the books of the company as trustee or in any other fiduciary relation, the name of the person or corporation for whom such trustee is acting; also the statements in the two paragraphs show the affiant's full knowledge and belief as to the circumstances and conditions under which stockholders and security holders who do not appear upon the books of the company as trustees, hold stock and securities in a capacity other than that of a bona fide owner.

(Signed) HENRY A. SCHOBBER, Business Manager.

Sworn to and subscribed before me this 10th day of October, 1952.

(Seal) JOSEPH KNOTT, Notary Public.

State of New York, No. 30-7317700. Qualified in Nassau County. My commission expires March 30, 1954.

to call the device a fiddle is unimportant, so long as it is better than our present acoustical instruments.

And yet, one cannot help but be lost in admiration at what empirical geniuses like Stradivarius and Guarnerius were able to accomplish in a structure that seems simple and yet is actually extremely profound in its action.

## SOUND HANDBOOK

[from page 44]

objective existence in the ear, and can be heard as distinct tones. The effect may be demonstrated by sounding two musical tones which are separated by a pitch interval of a fifth (such as C and G) very loudly; the difference frequency of the C an octave below the lower note will be audible.

### Ohm's Law

Ohm's auditory law states that a complex tone is analyzed by the ear into its various frequency components, irrespective of phase. This means that timbre is the function of the absolute value of each component rather than of the total geometric wave form. The two waves of Fig. 6—6, which contain the same partials but which are entirely different in shape, would thus have the same timbre.

Ohm's law has been modified due to the increased understanding of distortion generated in the ear. The phase of the harmonic components of a sound may affect its quality to a certain extent by causing cancellation or reinforcement of aural harmonics.

### Structure of the Ear

The perceptive patterns described above may be at least partly accounted for by the physical construction of the human hearing mechanism. Figure 6—7 is a simplified diagram of the ear transmission channel, from the outer ear, which acts as a sound collector, to the round window where the sound is finally dissipated.

Sound enters the auditory canal and impinges upon the membrane of the ear drum. The vibrations of the ear drum are communicated to the oval window by a set of three bones (hammer, anvil, and stirrup) called the ossicles. The sound then enters the cochlea, a coiled, liquid-filled tube divided longitudinally by the basilar membrane into an upper and lower gallery. The sound is propagated into the liquid of the upper gallery through the oval window, passes to the lower gallery through an opening called the helicotrema, and is dissipated at the end of the lower gallery by vibrations of the round window.

The ossicles constitute a mechanical step-up transformer, matching the impedance of the air medium to the higher impedance of the liquid medium which is contained in the cochlea. The area of the stirrup which agitates the fluid of the cochlea is  $\frac{1}{20}$  that of the ear drum, resulting in the concentration of pres-

sure over a smaller area. This concentration, combined with the mechanical advantage of the lever system, increases the pressure per unit area exerted on the oval window from thirty to sixty times. In addition the ossicles act as a protective clutch mechanism, which disengages by slipping when pressure intensities become dangerously high.

The translation of mechanical vibration to electrical nerve impulses which are sent to the brain takes place in the cochlea. The basilar membrane is composed of about 24,000 tightly stretched fibres, varying in length from 1/15 to 1/170 inches, and which comprise a mechanism that has often been compared to the string system of a piano. There is good evidence for believing that the individual fibres are associated with definite pitch sensations, and that, moreover, the frequency handled by each one is the natural resonant frequency of the fibre's mass-electricity system. According to the "resonance" theory of hearing a separate nerve connects each fibre to the brain, carrying an appropriate signal when the fibre is set into sympathetic vibration by sound of a particular frequency.

The resonance theory of hearing is able to explain the separation of complex tones into their component frequencies, the variation of hearing sensitivity over the frequency spectrum, and other characteristic patterns of perception. Experiments with animals have confirmed the fact that the hearing of certain frequencies is localized to definite portions of the cochlea. This theory does not satisfactorily explain all hearing phenomena, however, and we do not as yet possess sure knowledge of the workings of the mechanism of hearing.

## SPEECH CLIPPER

[from page 52]

monics, but they are of such short duration as to make them inaudible. In the sustained subaudible sound, the harmonics are present longer (actually a matter of seconds at most) but they are of sufficiently low intensity as to make their effect negligible.

### Notes on Design

In the clipper shown in Fig. 1, provision has been made for controlling the over-all gain, the level through the clipping stage, and the positive and negative threshold levels. Two amplifier stages are incorporated much in the manner of a standard limiter. The input stage raises the level about 25 db so that the signal may be used at the right level in the clipping stage. The output amplifier restores the original level of the input, for in clipping part of the energy has been lost and must be compensated for. In the limiting stage, two sets of rectifiers have been used. This will provide for rectification of both positive and negative peaks, which is much more efficient. Also it permits balanced circuits, and a low impedance, which sim-

**TOROIDS**

SELF-RESONANT FREQUENCY AND DISTRIBUTED CAPACITANCE OF TYPICAL D&R TOROIDS

Inductance, Millihenries

f (kc)

C (μf)

DISTRIBUTED BY **Giannini**

SANTA BARBARA, CALIF.

BROCHURES AVAILABLE • G. M. GIANNINI & CO. INC. • PASADENA 1, CALIFORNIA

## Custom Built Hi-Fi Audio SPEAKER

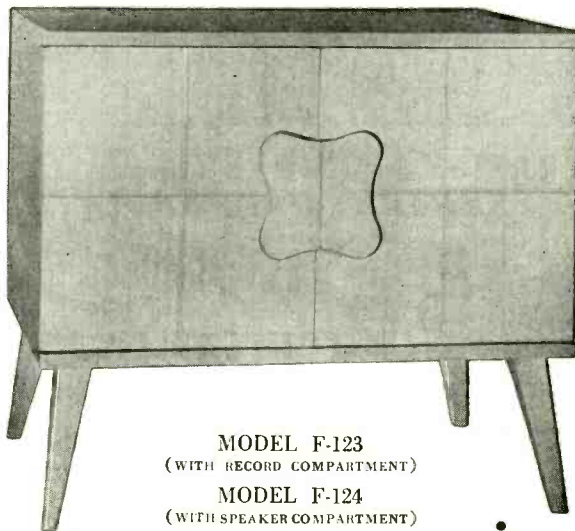

MODEL F-123  
(WITH RECORD COMPARTMENT)

MODEL F-124  
(WITH SPEAKER COMPARTMENT)

INSIST ON

**River Edge**  
INDUSTRIES

AVAILABLE IN MOST FINISHES

SEE YOUR NEAREST JOBBER

REQUEST FREE CATALOG AF

CABINETS  
•  
INSTRUMENT CABINETS  
•  
TELEVISION CABINETS  
•  
TRADITIONAL CABINETS  
•  
PROVINCIAL CABINETS  
•  
COMBINATION CABINETS

Visit Us At The New York Audio Fair Rm. 504

5 River Edge Road River Edge, N. J.  
N. J. ORadell 8-0900 • N. Y. CHickering 4-2120

IT'S NEW



**The MAGNEMITE\***

Designed by A. C. Shaney, internationally-known leader in tape recorder development, and built by Amplifier Corp. of America, leaders and pioneers in magnetic recorders since 1936 — the Magnemite\* is also a leader in its field — the first completely portable tape recorder, powered by self-contained dry batteries! Measuring only 11½ x 8½ x 5½ inches, and weighing only 9¾ lbs., the Magnemite\* represents ease and convenience in remote recording.

4 models available, including a unit designed to NAB recording standards. Priced from \$225. Write today for descriptive literature.

**THE 10-POUND PORTABLE BATTERY-OPERATED MIDGET TAPE RECORDER**

**New DRY CELL BATTERIES**

The Magnemite\* uses inexpensive flashlight-type batteries that last 100 operating hours. No wet cells that require re-charging or special handling.

**New SPRING-WOUND MOTOR**

The triply-compensated flyball governor-controlled motor runs at constant speed for 15 minutes with each winding.

**New 2-HOUR RECORDING**

Two full hours of recording at 1-7/8 inches per sec., using 2 sound tracks, are accommodated on a standard 5-inch reel of tape.

**New GREATER SENSITIVITY**

Crystal-clear recordings of normal conversations can be made from any distance up to 100 feet away from the microphone.

\*Trademark Reg.

**AMPLIFIER CORP. of AMERICA • 398 Broadway • New York 13, N. Y.**

You can bank on *Music Masters* for SERVICE, VALUES, QUALITY, EXPERIENCE, ABILITY, RELIABILITY, EQUIPMENT and CONVENIENCE.

And, by the way, you can get a check—worth money to you—by stopping in to see our exhibit at the Audio Fair. (RM. 637) If you're not interested in money (!!!), stop in anyway.

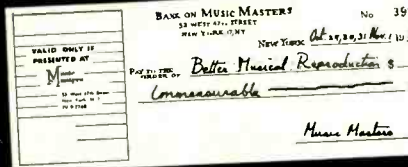

THE FINEST RECORDS AND HIGH FIDELITY EQUIPMENT

**Music Masters**

53 West 47th Street  
New York, N. Y.  
JU 6-2768

*New* SWISS CRAFTSMANSHIP BRINGS YOU SUPERB REPRODUCTION

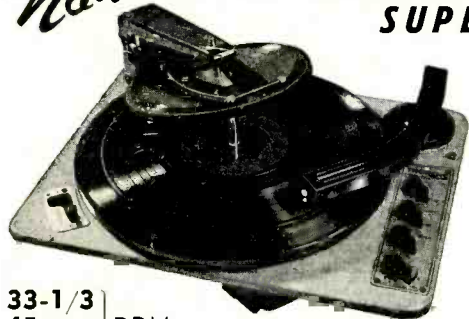

**THORENS CONCERT CD-43 3-SPEED RECORD CHANGER**

33-1/3  
45  
78 } RPM

Accommodates popular American and THORENS "duo" cartridges  
Intermixes automatically 10" and 12" records with special selector for 7" records  
Automatic last record shut-off switch, reject and repeat controls with variable pause selector

SEE OUR EXHIBIT AT THE AUDIO FAIR

Write for complete catalogue on THORENS record changers and record players.

THORENS CO.

NEW HYDE PARK, N. Y.

Compare these features:

- DIRECT DRIVE governor controlled four pole induction type motor provides completely silent wow-free operation
- EXACT SPEED maintained through specially designed centrifugal governor which automatically compensates for variations in line voltage, heat and load.
- CAREFULLY ENGINEERED long, low mass tonearm provides excellent tracking and complete freedom from parasitical resonances.
- PATENTED SPEED CONTROL for variable speed adjustments around each of the three main positions.

plifies the control and application of the biasing voltage to the rectifiers. The controls on the input and output permit the gain to be adjusted to approximately unity under conditions of no clipping, although there is sufficient gain that the clipper may be used as a booster amplifier ahead of the limiter, if the additional gain is needed. In that event, the level through the clipping stage may be lower than required for the clipping operation, and the threshold bias will have to be lowered accordingly.

The circuit shown is merely a suggestion, since there are numerous ways of greater and lesser complexity in which the desired amount of clipping may be accomplished. Some engineers may object to the lack of a low-pass filter, such as used in most commercial forms of clippers. However, it does not appear to be necessary in practice.

The voltage selected for the threshold of the clippers was five volts, which is high enough to give ample range of control. A high-impedance circuit could have been used, but the problems of getting a sufficiently high negative voltage for the threshold bias seemed to warrant a lower voltage circuit. The higher the voltage, the finer is the vernier of control, so the circuit design can be governed by the builder's requirements. The values shown are those used in a pilot model. In visits to other stations where a clipper was in use, the systems were found to vary widely, and no standard method seems to exist.

**Adjusting the Clipper**

When setting up the clipper for the first time, it is helpful to have on hand a gain-measuring set, or at least a VU meter that can be used to measure the input and output levels. A tone generator is connected to the input of the clipper, and an oscilloscope to the carrier output of the transmitter. The scope is essential to proper adjustment of the clipping level. The overall test setup is shown in Fig. 2. Adjust the input to the clipper to the peak level received from the studio. The threshold controls should be set tentatively about three-fourths open, that is, toward the high end of the voltage range. Set the input gain control to about one fourth open. Adjust the output gain control so that the transmitter is being modulated about 70 per cent. This low percentage is used to ensure against peak clipping by the transmitter. Then slowly advance the input control while keeping the modulation constant by decreasing the output control adjustment. A point will come where a flattening of the waveform will be observed. Both peaks may not reach the threshold at the same time, so stop when either one shows evidence of flattening. At this point, the two peak rectifiers may be adjusted for balance. This may be done by adjusting both peaks to the same amount of clipping on the 'scope screen, and then either backing both controls off the same amount, or more simply and accurately, by backing off the input gain control to a point just below that where clipping occurs. Then

the output control may be adjusted for 100 per cent modulation. The same adjustment may be made on the input control of the limiter, if desired. The VU meter on the output of the clipper is useful when adjusting the clipper for unity gain, which can not be done with only the aid of the scope. Having unity gain through the clipper makes it easy to patch around it in case of failure.

In certain cases, it may be desirable to have an unbalance between the positive and negative peaks. Such a situation is not unnatural, since it occurs in many sounds that have a non-symmetrical nature. Most voices are unsymmetrical, and if improperly phased can materially reduce the station's coverage. If the higher peaks are on the negative modulation cycle at the transmitter, the gain must be "ridden down" to prevent them from clipping, and as a result the positive peaks do not reach 100 per cent. If the higher peaks are put on the positive side, they can actually go over 100 per cent, while the negative peaks will reach only 98 to 100 per cent. A phase-reversing switch might possibly be installed somewhere along the line, and would aid in keeping the higher peak on the positive side. This can be determined by observing the transmitter output with a 'scope, or by testing the output of both positions while the modulation meter is set on positive for both tests. Phase reversal can also be accomplished by reversing the position of a velocity microphone in front of the person speaking. Automatic phase-reversing circuits have been described in the literature, and can be employed if their use is deemed necessary.

#### Final Application and Operation

In actual tests, it was determined that either peak of tone modulation could be clipped as much as 50 per cent without noticeable distortion, and both peaks together could be clipped up to 20 per cent before the clipping became apparent. Speech can be clipped even more. While it is legally impossible to use this much clipping, it proves that the small amounts used in the normal application of a clipper to station operation will not adversely affect the signal, and if properly applied will be a great asset. Air-time outages due to transient overloads can be reduced, since they are lost before they get to the transmitter. Figure 3 shows typical waveforms under different settings of the threshold controls.

It is obvious that in order to have any degree of controlled clipping, it is necessary to monitor the level of input to the clipper quite closely. In stations where an operator rides gain at the studio, this is no problem. But in announcer-operator combination operations, levels are oftentimes erratic, and it will be difficult to obtain the desired effect from a clipper. If the level is too high, the program may be rather severely clipped, although as previously mentioned, almost 20 per cent of the peaks can be clipped without noticeable distortion. On the other hand, if the level is too low, the noise-reducing feature is lost, since any noise might also be below the

**New**  
**WILLIAMSON**  
**TYPE**

**AMPLIFIER Features**

- First Williamson Type Amplifier supplied with matching preamplifier
- Uses Altec Lansing Peerless output transformer.
- Practically distortionless — Harmonic and intermodulation distortion both less than 1/2 of 1% at 5 watts output.
- Frequency response ± 1 db from 10 cycles to 100 kc.
- Output impedance 4, 8, or 16 ohms.

The new Heathkit Williamson Type Amplifier kit is the best obtainable in amplifiers today—the choice of the really discerning listener. You can hear the difference and measurements actually bear out the superior performance. Frequency response ± 1 db from 10 cycles to 100 kc allow you to hear the highs and lows with equal crispness and clarity. Harmonic and intermodulation distortion both less than 1/2 of 1% at 5 watts output eliminate the harsh and unpleasant qualities which contribute to listening fatigue.

The circuit is similar to the one published in *Audio Engineering Magazine* for November, 1949, and is considered by engineers throughout the audio field as one of the best ever developed. The Main Amplifier (which may be purchased separately) consists of a voltage amplifier and phase splitter using a 6SN7, a driver stage using a 6SN7, and a push-pull output stage using a pair of 807 tubes. The output transformer is manufactured by the Peerless Division of Altec Lansing and is built to their highest standards. Output impedances of 4, 8, and 16 ohms are available. The power supply uses a separate chassis with husky Chicago Transformer power transformer and choke, and 700V Mallory filters for long life-free operation. A 5V4G rectifier is used.

The high amplifier and power supply are each on a chassis measuring 7" high by 5 1/2" wide by 11" long.

**PREAMPLIFIER AND TONE CONTROL UNIT KIT**

The preamplifier kit consists of: a 12AX7 (or 12AY7) dual triode first amplifier stage with a turn-over control for LP or 78 record types, and a 12AU7 amplifier stage with individual bass and treble tone controls which each provide up to 15db of boost or attenuation. A switch on panel selects either magnetic, crystal, or tuner inputs. Preamplifier also is well suited to custom installations—it will operate in either vertical or horizontal position, and special notched shafts of the controls and switches allow a variety of shaft lengths to be selected. Dimensions: 2 1/4" high by 10 1/4" wide by 7 1/4" deep.



**Heathkit**  
**AMPLIFIER**  
**KIT**

WA-A1 Amplifier kit — Combination 1 — (Main Amplifier and Power Supply) complete with WA-P1 Preamplifier kit. Total Ship. Wgt., 34 lbs. (Shipped Express only) **\$69.50**

WA-A1 Amplifier kit only — Combination 4 — (Main Amplifier and Power Supply). Less WA-P1 Preamplifier. Total Ship. Wgt., 29 lbs. (Shipped Express only) **\$49.75**

WA-P1 Preamplifier Kit only. (less power supply) (Tubes included). Total Ship. Wgt., 7 lbs. (Shipped Express or Parcel Post) **\$19.75**

**WRITE FOR Free CATALOG**

**The HEATH COMPANY**  
**BENTON HARBOR 25, MICHIGAN**

*You SAVE BY ORDERING DIRECT*

**HARRISON AUDIO SHOP REPORTS . . .**  
**Sensational New ACRO TRANSFORMERS**  
**Sweeping High Fidelity Field in Sales!**

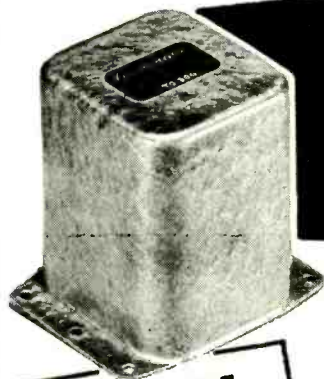

**FREE!**  
Write for 12 page ACRO data; Amplifier and conversion schematics.

All units fully potted in attractive grey hammertone case. Compact, only 3 1/4" x 3 1/4" x 4 1/4" high.

*Using a Williamson??*  
**Double your power output, and reduce distortion by 50%!!**  
**ACRO TO-300**  
*"The World's Finest Transformer"*

- Response ± 1 db 10cps to 100,000cps
- Rated to handle 40 Watts
- Resonance-free response
- Unequalled square wave response
- Low phase shift
- Most quality per dollar!

**\$24<sup>75</sup>**  
net

ACRO TO-310. Same ratings but 20 watts. For converting all popular 10-watt 6V6 amplifiers to the sensational Ultra Linear Operation . . . **\$18.75**

Convert to Ultra Linear Operation by simply changing three resistors and condensers! . . . **KIT \$1.00**

ACRO TO-290. For the original Williamson Amplifier. Performance equal to the finest, regardless of price. . . **\$15.75**

If C O D is desired, please enclose 25% Deposit

**HARRISON RADIO CORPORATION**  
**227 GREENWICH ST.**  
**NEW YORK 7, N. Y. • BRAnclay 7-7777**

Do you have any **Audio PROBLEMS?**  
Call or write Ben. Fritz, our Audio Specialist, for friendly, helpful advice. No obligation!

# INSTRUMENTATION MAGNETIC TAPE FOR DATA RECORDING

**MINNESOTA MINING & MFG. COMPANY**  
DATA RECORDING TAPE SUPPLIED IN HERMETICALLY SEALED  
MOISTURE PROOF PLASTIC WRAPPER. AVAILABLE FOR QUICK  
DELIVERY IN FOLLOWING SIZES:

1/4" x 1200'  
1/2" x 1200'  
1/2" x 4800'

1/4" x 2400'  
1/2" x 2400'  
1" x 1200'

1" x 2400'

**INSTRUMENTATION DIVISION**  
of the



**Audio & Video**  
PRODUCTS CORPORATION

Wash. Office  
261 Constitution Ave.  
Republic 8566

New York Office  
730 Fifth Avenue  
Plaza 7-3091

## NEW PERFORMANCE STANDARDS with the WEATHERS FM CAPACITANCE CARTRIDGE

20 to 20,000 Cycles Response

W-202 or  
W-202-C  
Cartridge  
Set



DO YOU REALIZE WHAT LOWER  
STYLUS PRESSURE CAN DO FOR  
REPRODUCTION FIDELITY AND  
RECORD LIFE?????

You can operate with stylus pressures  
down to one gram with the new WEATH-  
ERS Cartridge!



Get the NEW W-202-C Cartridge Set for your present  
record player (automatic or manual to enjoy unex-  
celled high fidelity reproduction).



For the ultimate in record reproduction, with  
one gram stylus pressure, combine the standard  
W-202 Cartridge Set with the new WEATHERS  
W-12 or W-16 Reproducer Arm.

W-12  
Reproducer Arm

Change to the WEATHERS Cartridge NOW and preserve  
your records for the years to come.

**WEATHERS INDUSTRIES**

Box 531 66 E. Gloucester Pike  
Barrington, N. J.

See your dealer or  
write for literature

threshold level. This will do no particu-  
lar harm to the transmitter, but the  
listener will have his volume up higher,  
and consequently all the undesired  
sounds will remain. It might seem from  
this that the ideal transmitter setup  
would be to have a gain-rider ahead of  
the clipper, and follow it by the limiter,  
if such a combination were possible.

There are a few minor deficiencies  
in a clipper that might be pointed out  
here. As with the limiter, a clipper has  
no way of distinguishing between the  
undesirable peaks of a steep wave form  
and the desirable ones such as might be  
encountered with guitars, certain per-  
cussion instruments, and similar sounds.  
Therefore, the peaks of these will be  
clipped, along with other noises. This  
could impair the timbre of the instru-  
ment, since its crisp quality depends pri-  
marily on this type of response. There-  
fore care must be exercised not to set the  
clipping level too close to the normal  
program level, lest it degrade the musi-  
cal quality of such sounds.

In the final analysis, it should be  
pointed out that the clipper destroys  
nothing that is usable as intelligence.  
Only with the finest reproduction sys-  
tems would any of the transient peaks  
be reproduced anywhere near their  
original wave shape. In radio trans-  
mission, most of these are either in-  
herently, or necessarily lost. The aver-  
age middle-priced receiver will not  
reproduce them, and in the low-priced  
table models—especially those having  
four-inch speakers or smaller—they  
make only for more noise, since this type  
magnifies such sounds unduly. And  
finally, the average listener is insensi-  
tive to noises of this type, so they add  
nothing to his enjoyment of the pro-  
gram. True, they are essential to realism  
and presence, and the clipper here de-  
scribed does not destroy all of them,  
but only those which would be deleteri-  
ous to a transmitter and whose loss  
would not be missed. Since the protec-  
tion of the transmitter is the prime ob-  
ject of the clipper, and since the sounds  
dealt with consume power without con-  
tributing to usable output, it seems only  
natural to dispense with them.

### Parts List

$C_1, C_3$	5 $\mu$ f, 10 v, electrolytic
$C_7, C_8$	0.5 $\mu$ f, 600 v, paper
$C_5$	40 $\mu$ f, 450 v, electrolytic
$C_6, C_7$	20 $\mu$ f, 450 v, electrolytic
$C_8$	10 $\mu$ f, 25 v, electrolytic
$C_9, C_{10}$	2 $\mu$ f, 400 v, paper
$L_1, L_2$	30-H, 40-ma chokes
$R_1, R_1$	50,000-ohm, potentiometer
$R_2, R_2$	1300 ohms, 1-watt
$R_3, R_3$	0.1 meg, 1-watt
$R_7$	820 ohms, 1-watt
$R_8$	0.27 meg, 2-watt
$R_9, R_{10}$	20,000-ohm dual potentiometers
$T_1, T_3$	600-ohm line-to-grid input trans- former
$T_2, T_4$	Single 10,000-ohm plate-to-line out- put transformer
$T_5$	Power transformer: 300-0-300 v at 40 ma; 6.3 v at 2 a.



## HARMONIC METER

[from page 23]

While true that a sensitive a.c. voltmeter is sufficient with this unit for measuring harmonic distortion, study of the nature of the distortion is facilitated by also connecting an oscilloscope across the output. The 'scope should be adjusted to present one or two cycles of the fundamental. If horizontal sweep synchronization is obtained externally, from the signal generator or direct from the output of amplifier being tested, a steady picture will be presented on the screen of either the signal (with the L connection) or the distortion (with the D connection).

### Parts List

$C_1$	.05 $\mu$ f, 600 v, paper
$C_2$	1.0 $\mu$ f, 600 v, paper
$C_3, C_6$	.02 $\mu$ f, 600 v, paper
$C_4, C_7, C_9$	.002 $\mu$ f, 500 v, mica
$C_5, C_8$	200 $\mu$ f, 500 v, mica
$C_{10}$	125 $\mu$ f, 350 v, electrolytic
$C_{11}, C_{12}$	20-20 $\mu$ f, 450 v, electrolytic
$L_1$	15 H, 50-ma filter choke
$R_1$	1.0-meg. potentiometer, log taper
$R_2, R_{19}$	10.0 megs, $\frac{1}{2}$ watt
$R_3$	1000 ohms, $\frac{1}{2}$ watt
$R_4, R_{23}$	10,000 ohms, 1 watt
$R_5, R_{21}$	0.1 meg, 1 watt
$R_6, R_{22}, R_{25}$	33,000 ohms, 2 watts
$R_7$	27,000 ohms, 1 watt
$R_8$	9100 ohms, 2 watts
$R_9$	1.0 meg, $\frac{1}{2}$ watt
$R_{10}$	160 ohms, $\frac{1}{2}$ watt
$R_{11}, R_{12}$	4700 ohms, 1 watt
$R_{13}$	10,000-ohm potentiometer, log taper
$R_{14}$	50,000-ohm potentiometer, log taper, ( $R_{13}$ and $R_{14}$ are made up from IRC Concentrikits)
$R_{15}, R_{16}$	0.5-meg dual potentiometer, log taper
$R_{17}, R_{18}$	10-meg dual potentiometer, log taper
$R_{20}$	330 ohms, $\frac{1}{2}$ watt
$R_{24}$	1500 ohms, $\frac{1}{2}$ watt
$R_{26}$	2500 ohms, 10 watts
$S_{W_1}$	2-circuit, 3-position wafer switch; Centralab 1473 or equivalent
$S_{W_2}$	SPDT wafer switch; Centralab 1460 or equivalent
$S_{W_3}$	SPST toggle switch
$T_1$	325-0-325 v at 40 ma; 5 v at 2 a; 6.3 v at 2 a, power transformer.
$V_1, V_3, V_4$	6AU6
$V_2$	6AH6
$V_5$	5V4G

## CLEVELAND AUDIO

A four-page section in the October 2 issue of The Cleveland Press is devoted entirely to Audio, and particularly to the new studios and display rooms recently opened by Pioneer Radio Supply Company of that city. According to Herb Farr, Pioneer's owner, three stimulants are needed to "sell" hi-fi—a salesroom with a display of up-to-date equipment, studios with adequate demonstration facilities, and an expert engineering staff to advise on the installation of equipment in the home—all of which Pioneer offers.

# IMMEDIATE DELIVERY!

## FISHER

**MODEL 50-A**  
THE WORLD'S FOREMOST  
**ALL-TRIODE AMPLIFIER**  
Unparalleled in specifications and performance.

**\$159.50**  
NET



DESIGNED FOR USE WITH  
ANY AMPLIFIER

**MODEL 50-C**  
**FISHER MASTER AUDIO CONTROL**

Write for descriptive literature **\$94.50**  
on above. NET



**WEST COAST HIGH FIDELITY CENTER**  
"IN THE AUDIO MILE"  
**HOLLYWOOD ELECTRONICS**  
7460 MELROSE AVENUE • LOS ANGELES 46, CALIFORNIA  
Webster 3-8208

## Order Your 1952 Bound Volume

SUPPLY LIMITED

**\$8.95**

AUDIO ENGINEERING      P. O. Box 629      Mineola, N. Y.

## BETTER INTERMODULATION METERS

### Highest Professional Flexibility at Reasonable Cost



Model 165D is the only commercial unit with extended Low Frequency range—for phono pick-up testing at 400 cps as recommended by H. E. Roys. Also useful for hearing aids, speech-range amplifiers, as well as wider range equipment. Modified analyzer filters permit Low Frequency range of 40-400 cps, from external source, as well as internal 60 cps. Otherwise like Model 165. Price \$350.00.

Model 165 IM Meter is especially suited for laboratories, broadcasters, recording studios. Signal generator, analyzer, voltmeter in single case. Reads % IM, amplifier output directly on meter. Provides for use of scope to analyze & cure IM causes: full graphic instructions supplied. Wide range of low & high test frequencies: 60 cps internally, 40-200 cps externally; standard 2, 7, 12 kc internally, 2-20 kc externally. Voltage ratio choices: for LF testing, 4:1; for more accurate HF testing, 1:1.  $8\frac{3}{4}$  x 19" rack-type panel;  $8\frac{1}{2}$ " deep. Price \$250.00.

**Do you have the data on our new GALVANOMETER-PROTECTOR?**

Write NOW for Catalog A2.



# Grommes Custom High Fidelity

## Triode Amplifier

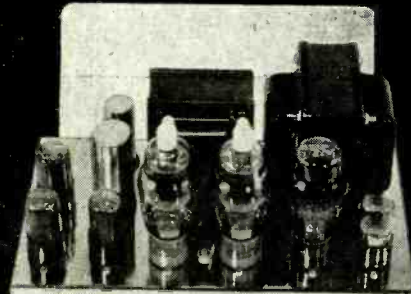

Model  
215BA  
**\$12500**  
NET

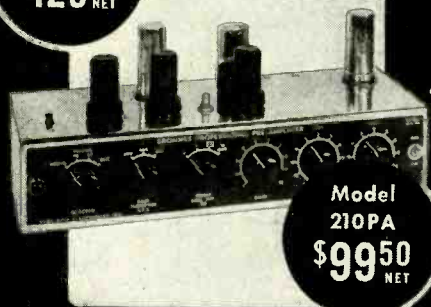

Model  
210PA  
**\$9950**  
NET

An all triode basic amplifier based upon the Williamson circuit... the last word in ultra high fidelity

Frequency response  $\pm .5$  DB 10 to 100,000 CPS at 8 watts. Distortions at 15 watts .1% harmonic; I.M. .25% at 10 watts; 20 DB feedback from 2 loops; damping factor 20; cathode follower driver, 2 direct coupled stages; fixed bias.

The ideal pre-amplifier for the 215BA. Completely variable feedback type equalization for reproducing records exactly as recorded. Frequency response radio input  $\pm .5$  DB. 6 to 100,000 CPS. Step type bass and treble controls; 25 DB equalization down to 20 CPS. For magnetic or dynamic pickups.

**PRECISION ELECTRONICS, INC.**

641-43 MILWAUKEE AVENUE • CHICAGO 22, ILLINOIS

## Authoritative and Enlightening...



*Acknowledged the Leading Publication in the Field of Sound Reproduction*

If you are novice, hobbyist, experimenter, or engineer... if you are a lover of music... and in pursuit of sound, undistorted... Audio Engineering will be your faithful, reliable companion all the way.

"What to Do" and "How to Do" will guide your every move through this thrilling experience we call Audio.

Each new issue brings New Ideas, New Slants, and Latest Developments... month in and month out... twelve times a year.

BE SURE to get your copies REGULARLY

MAIL this  
Coupon NOW

### AUDIO ENGINEERING

P. O. Box 629, Mineola, N. Y.

Enclosed is  Check  Money Order for \$ \_\_\_\_\_  
Please send a copy of each new issue of Audio Engineering for the next  
 12 months;  24 months to:

Please Print

Name \_\_\_\_\_

Address \_\_\_\_\_

City \_\_\_\_\_ Zone \_\_\_\_\_ State \_\_\_\_\_

Subscription Price: U.S.A., Canada and Pan American Union: 1 year... \$3.00 2 years... \$5.00. Other countries: 1 year... \$4.00 2 years... \$7.00.

## AUDIO TRANSFORMER

[from page 26]

purposes a winding may be connected single ended while for others a push-pull connection may be required. For such a case, the tests may be made with both methods of connection to find effective capacitance. Leakage inductance will not be affected by changing the grounded point, but capacitance will.

Integrated distributed capacitance effects, set up between individual layers of the same winding, will not change with method of connection, but effects due to lumped capacitance from end layers to core, the other winding, or to screens, if used, will change considerably with method of connection. No fixed rule can be stated as to which method of connection will give the smallest effective capacitance, because this depends on the arrangement of the windings. Some methods of construction give minimum effect with zero signal point at one end, and others with it at the center. Good designs naturally take this effect into consideration, so connecting in a way other than that for which the transformer was intended will generally be found to increase effective winding capacitance.

## Southwest Audio

Texas-TV Stores, San Antonio distributor is staging an Open House Week from Nov. 3 to Nov. 8, and the important part (to  $\text{\AA}$  readers) will consist of an Audio Show at which the products of over 35 manufacturers will be demonstrated. Believed to be the first such show to be held in the Southwest, this exhibit will introduce the new Altec 604C loudspeaker, the Pilot line of tuners and amplifiers, the Stephens transformerless amplifier, the Weathers FM pickup and the Gately Superhorn in addition to other well known products.

The Audio Show will be held in the new Texas-TV Sound Rooms—a group of air-conditioned, sound-proof studios of varying acoustic properties to match the different kinds of listening conditions. Latest type of acoustic construction has been employed in making these studios as completely up-to-date as the art permits, according to Jeff Smith, Texas-TV manager, and former New York network and recording engineer.

This showing is only one of many similar audio exhibits which are rapidly appearing throughout the country—distributor-planned and staged on a more or less permanent basis to offer their customers an opportunity to see how they can adapt standard audio components to their own requirements and listening conditions.

Once the urge for good quality is felt, the customers are sure to demand more places where they may see and hear before making their final selections.

## Erratum

M. V. Kiebert, Jr., author of the pre-amplifier story in the September issue advises us of an error in the schematic on page 23. The  $V_3$  cathode resistor should be 4700 ohms instead of the 47,000 shown. The correct value is given in the text. However, we agree that with two values given, it is difficult to choose the right one with any degree of assurance.

# The Golden Ear

Observations on the art of high-fidelity by one who has become sated with claims, super-claims, and the axia accepted by the hi-fi fraternity as the Word. Read and be guided as your conscience dictates.

DON V. R. DRENNER\*

**M**Y OWN MEASURED FREQUENCY RESPONSE extends from below 20 cps to 21,000 cps. This has been tabulated, and in a particular case an analysis attempted.

It would be expected that if the response of the person were that good, and an amplifier with equal or better characteristics was at hand, one might expect a personal choice of music fed into such a combination to be not only exactly reproduced, but equally pleasant.

It is further to be expected that if the amplifier, and its associated reproducing equipment—both input and output—have negligible distortion of whatever variety, then the curious and sometimes unbelievable combinations of sound which certain compositions or orchestras emit should be an equal and exact reproduction when fed through such an electronism. I am unhappy to report that my repeated reaction is simply that it is not.

I mean: High Fidelity has become the Higher Confusion, and the golden ear of audio somewhat less succulent than the good golden corn which civilization has canned and suitably labeled.

As an engineer I suppose I worship at the altar of perfection several nights each week; and I have some admiration for the various gods of electronics. There are always some minute adjustments to be made so that the central nervous system will go *click, click*, in the face of one's own behavior at the minor gods of Treble and Bass. Well, I also keep a god for foolishness, and

\* 513 Highland Road, Coffeyville, Kansas

one for reason!

If you are an Old Triodian you will assume that I am speaking of that other school; but the addenda of self pity doesn't permit one to gloat over the malfunction of that intricate escapement. The observable, and measurable by sensation, facts are that the junk box quite often yields a more *natural* reproduction of sound than the glittering chromiomed multitubed chassis; built—by all the gods!—to end all amplifiers.

The engineer's eye and green-lined graph paper has usurped the functions of the tympanum and its associated upper auditory system!

My quarrel is not with the flesh and blood, but with the blind projected curves, with the dominion of plus and minus db; and against the authority of intermodulation distortion and damping factor!

I have two sets of equipment in my home: the cleverly designed hi-fi gear feeding a reputable manufacturer's ultimate speaker, and a two-tube miniature teratologicae terminating in an eight-inch surplus bargain-counter speaker. I have my own private emotions well situated upon an extendable pedestal, capable of registering a compound of exact sensation. Which amplifier do you think excites them the more?

In my wrath I will suggest that your measurement meters remain immobile, your decades quiescent. I would suggest, (Oh, horrible pale blasphemy!), that the engineer who worships sound use his ears.

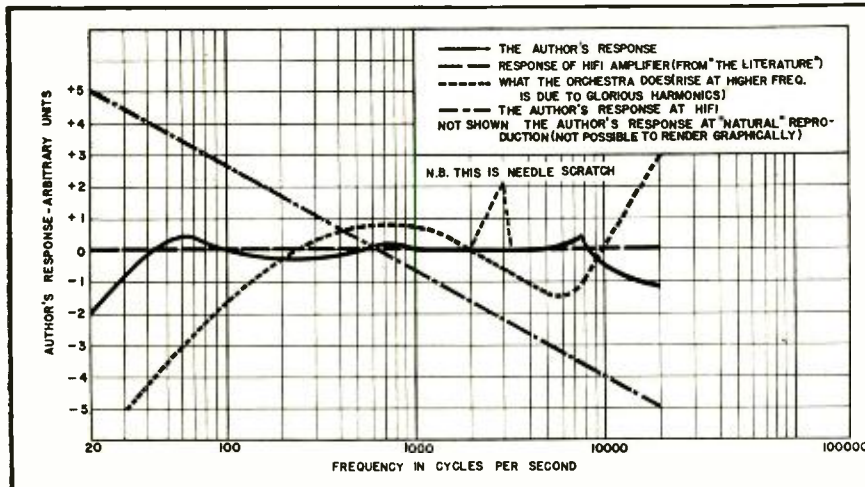

Fig. 1. Typical responses engendered in the author as compared to claimed performance of certain commercial equipments.

**TERMINAL**  
Cordially Invites you  
**TO SEE AND HEAR**  
Important New Developments In  
**HIGH FIDELITY**  
Home Music Instruments

**ALTEC**  
604 C  
DUPLIX  
SPEAKER



Newest version of the famous 604B speaker, with improved 15" cone and newly designed exponential multicellular horn. Frequency response 30-20,000 cps. Handles 50 watts without distortion. The ideal speaker for a high quality, high fidelity sound system.

With network, \$159

---

**ALTEC 602 A**  
DUPLIX SPEAKER



A complete high fidelity 2-way speaker system with 15" cone. Dividing network provides smooth crossover at 3,000 cps. Highly efficient 15" cone reproduces tones from 30-3,000 cps; tones from 3,000-22,000 cps are reproduced through exponential horn which gives smooth distribution over a wide horizontal angle.

Complete, \$114

---

**ALTEC**  
601 A  
DUPLIX  
SPEAKER



Substantially the same characteristics as the 602A, but with 12" cone. Slightly lower efficiency below 50 cps.

Complete, \$89

---

See and hear this new equipment in our complete audio studio.

Send for new  
**"TERMINAL'S AUDIO CATALOG"**  
a complete guide for true sound reproduction.

Take advantage of the liberal  
**TERMINAL TRADE-IN PLAN**  
on old standard brand equipment

Open Thursday Evenings till 9 P. M.  
Ample Free Parking after 6 P. M.

Terminal  
Radio Corp.

85 CORTLANDT ST., NEW YORK 7, N. Y.  
phone: WOrth 4-3311

★  
★  
**ULTRA-LINEAR**  
★  
**WILLIAMSON**  
★  
**Amplifier Kit**  
★  
featuring  
**ACRO TO-300**  
**TRANSFORMER**  
★

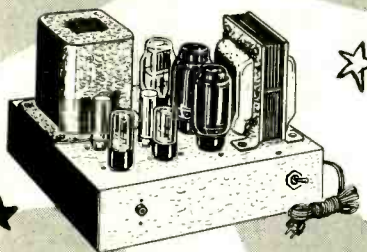

★  
**Send for Reprint**

"Ultra-Linear Operation of the Williamson Amplifier"  
Haffler and Keroes  
(Audio Engineering  
— June issue)

Build the finest amplifier ever developed. Ultra-linear construction gives you the ultimate in Williamson performance. Complete with all components, punched chassis, and easy-to-follow instructions.

- ✓ 30 Watts from an Ultra-Linear Williamson
- ✓ Frequency  $\pm .02$  db from 20 to 20,000 cps.  $\pm 1$  db from 2 cycles to 200,000 cycles
- ✓ Distortion less than 1% at 20 watts
- ✓ Phase shift—not over 4°—20 to 20,000 cps.
- ✓ Unexcelled square wave performance

ACRO TO-300 now available separately with conversion information to convert your Williamson to Ultra-Linear operation.

★  
**\$74.50**  
★

**KIT IS COMPLETE  
NOTHING ELSE TO BUY**

**Radio Electric**  
**SERVICE CO. OF PENNA., INC.**

7th & Arch Streets, Phila. 6, Pa.

Please ship complete Ultra-Linear Amplifier Kit

Check or Money Order enclosed (Include postage, shipping-wt. 25 lbs.)

ACRO TO-300 Transformer Only \$24.75

Name .....

Address .....

City ..... Zone ..... State .....

**FILTERS**

[from page 28]

Let us examine further the selection of coupling capacitor  $C_c$ . This capacitor is used in a moderately low impedance circuit, therefore its capacitance must be large if the bass response is to be adequate. For a 3-db loss at 50 cps 20,000-ohm circuit,  $C_c$  must be 0.17  $\mu$ f. By the selection of the correct value for  $C_c$ , bass response correction to correspond to high-frequency cut-off can be accomplished. It is well known that a system sounds best when the upper and lower frequency limits are both restricted so that the products of the limits equals approximately 400,000. As an example, if the treble response extends to 10,000 cps the bass response should extend down to 40 cps for the system to sound right. If bass is restricted the system sounds "tinny." If treble cuts off at 5,000 cps and bass continues flat to 40 cps the system sounds "boomy." The rule is that the product of bass and treble cut-off frequencies should equal 400,000 approximately. Therefore, for a system which cuts off at 5000 cps the bass should also cut off at 80 cycles.

The way to accomplish this partially is to select  $C_c$  so as to be just large enough to pass 40 cps (with only a 3-db loss) with the values of characteristic impedance chosen for 9000-cps cut-off. Using the example of Fig. 5, if  $C_c$  is chosen so that its reactance at 40 cps equals 33,000 ohms the attenuation will be 3 db. This same value of  $C_c$  will however provide an attenuation of 3 db at 100 cps (reactance equals 18,000 ohms at 100 cps) if the characteristic impedance is 18,000 ohms as for the 5000-cps filter, giving a product of upper and lower limits of 500,000 which will sound quite properly balanced. Similarly, balance is maintained for the case of the 7000-cps filter.

If plate coupling is selected, the selection of components is made in the same way. In this case the characteristic impedance of the filter should be high

compared to the load resistor of the tube. A characteristic impedance as high as 75,000 ohms at 5000 cps still gives practical values for inductance and capacitance; however at these high impedance levels the capacitance of the circuit and inductance itself becomes an appreciable percentage of the tuning capacitor and must be considered, particularly for the 9000-cps filter.

Because of the filter, there is an insertion loss which becomes noticeable as a difference in volume level as the filter is switched out of the circuit. To compensate for this difference in level the use of resistors  $R_0$  and  $R_1$  are suggested. The insertion loss will be about 6 db so that ratio of  $R_0$  and  $R_1$  should be about 1 to 1. If  $R_1$  is chosen to be about 33,000 ohms,  $R_0$  will also be 33,000 ohms. Since this is the value for  $R_1$ , the switch is wired so as to connect to  $R_1$  for positions a and b. This amount of loss may need some adjustment depending upon your personal preference regarding relative loudnesses with and without filters.

One other point of importance: with the input and output impedances given by Fig. 3, a treble boost of about 2 db is introduced to give slightly flatter overall response up to the cut-off frequency. It is fairly important that some form of roll-off equalizer precede the filter to reduce this slight peak. If no equalizer is used the values of inductance as specified by Fig. 3 can be increased by a factor of 1.5 (or the characteristic impedance reduced) to give a somewhat smoother roll-off at frequencies before cut-off. In either case the cut-off is of the order of 22 db per octave for a set of values correctly selected as described, as is illustrated in Fig. 1.

No other single factor will improve a high-quality, well-equalized system as much as a well-designed filter. It is difficult to appreciate just how good some of your older records can sound (and some radio broadcasts improved) when all the noise and distortion above a reasonable cut-off frequency are eliminated. Install one in your equipment and listen for yourself.

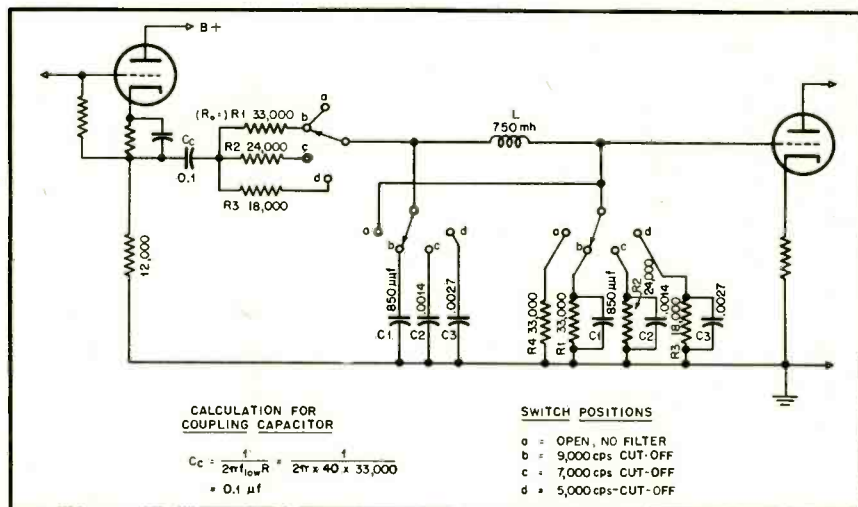

Fig. 5. Schematic of suggested filter to be connected between a cathode follower and the succeeding tube to provide cut-offs at 5000, 7000, and 9000 cps, together with a flat position.

# TECHNICANA

## Modifications of Williamson Preamplifier

D. T. N. Williamson, designer of the well known amplifier circuit bearing his name, writes an article called "High-Quality Amplifier Modifications" in the May, 1952 issue of *Wireless World*. The original article on this circuit that appeared in *Wireless World* dealt with a basic, fixed-gain amplifier. Later Mr. Williamson published design data for tone control and pre-amplifier circuits, but the preamplifier was only suitable for 78 r.p.m. recording standards. As a result the designs have been revised to increase circuit flexibility so that different recording characteristics may be compensated for.

Two alternative circuits are presented in this connection. One is a simplified arrangement which provides a choice between two bass turnover frequencies and has a fixed treble droop designed to match the British Decca characteristic. Further treble correction must be applied by the main tone control. The more complex circuit provides a choice between three bass turnover frequencies, and has a two-pole switch that varies bass and treble compensation simultaneously.

The type of equalization used is that of selective plate-to-grid feedback. A small capacitor is connected across the secondary winding of the input transformer to prevent any tendency to instability or to peaking at high frequencies, effects which might be caused by leakage reactance in the transformer.

A circuit which substitutes a resistive network for the transformer input also appears. (This circuit will probably be more popular in the United States than the first one described.) The network consists of two 0.1-meg resistors connected to the grid, one in series with the pickup and the other in series with the feedback loop.

At the conclusion of the article two very useful dummy circuits are presented for checking the frequency response of the pre-amplifier. These are designed so that if the constant voltage output of an audio oscillator is applied to their inputs, and the frequency varied over the audio spectrum, the circuit outputs will simulate the recording frequency characteristics of Decca or E.M.I. 78 r.p.m. discs and Decca 33 r.p.m. discs, respectively. This simulated record output may then be fed to the preamplifier, which should, if properly constructed, equalize the response curve to the original "flat" output of the oscillator.

## Recording Characteristics

The May issue of *Wireless World* also carried a report of a lecture on the nature of recording characteristics, delivered by P. E. A. R. Terry of the B. B. C. A disc recording characteristic is defined as "the

relation between the r.m.s. electrical input to the recording chain and the r.m.s. lateral velocity of the groove cut in the disc." The interpretation of a recording characteristic thus depends upon the definition of a recording chain. This term usually refers, in practice, to the recording mechanism and amplifier, and does not include the characteristics and placement of the microphone and the activity of the studio monitoring staff.

The search for an optimum recording characteristic is based upon the desire for the best signal-to-noise ratio. This optimum is ultimately determined by the average frequency distribution of signal energy (for example, too high an energy level at a pre-emphasized high frequency would produce recorded waveforms with radii of curvature too small to be followed accurately by the reproducing stylus). An international standard would be desirable, and would facilitate the exchange of broadcast programs, but one of the chief difficulties for such a standard is the diversity of power levels in the vowels and consonants which appear in different languages.

## Williamson Amplifier in Denmark

The international popularity of the Williamson amplifier is again attested to, in an article by John Gjetting appearing in the March, 1952 issue of the Danish *Radio Ekko*. The circuit and construction of the familiar design are described.

## Electrostatic High-Frequency Loudspeaker

*Toute La Radio* (France) reports, in the May, 1952 issue, on an electrostatic speaker designed for use as a tweeter, manufactured by a post-war German radio firm named *Grundig*. This speaker is intended to cover the range from 8,000 to 16,000 cps. Although the electrostatic loudspeaker is no novelty the Grundig design is distinguished by its practicality, by virtue of the fact that it requires a steady excitation of only 250 volts or thereabouts, easily obtainable from conventional radio equipment.

The loudspeaker consists of an extremely thin sheet of gold leaf applied to a plastic diaphragm, the whole mounted against a metal grille. The gold leaf and the grille form the two electrodes to which modulation is applied. The article states that the price of manufacturing this speaker ought not to be very great because of the simple and automatic processes followed in manufacture. The manufacturing processes are described briefly.

## Speaker Enclosure from France

An interesting new design for a speaker mounting device is described by Philippe Forestier in the February, 1952 issue of *TSF et TV*. The article is entitled "A Step



*At Last!*

## Music Reproduction which does Full Justice to Modern Recording Perfection

*If you've been listening to MODERN LP records on today's ordinary record-playing equipment, you're depriving yourself of at least half their beauty.*

*The great conductor, Leopold Stokowski, willingly accepted Stromberg-Carlson's invitation to test its new "Custom Four Hundred" high-fidelity equipment. These are his conclusions:*

*"For discriminating music lovers who wish to hear great music in its full beauty, I can recommend with confidence the Stromberg-Carlson reproducer, which I have thoroughly tested.*

*"It has a single stylus with diamond pick-up and long, light tone arm which reduces distortion to a minimum—a 25-watt amplifier and a pre-amplifier that incorporates the latest technical knowledge—and a 15" speaker with large enclosure.*

*"All these features create a reproducer of high quality that will give full musical satisfaction to the discerning music lover."*

LEOPOLD  
STOKOWSKI

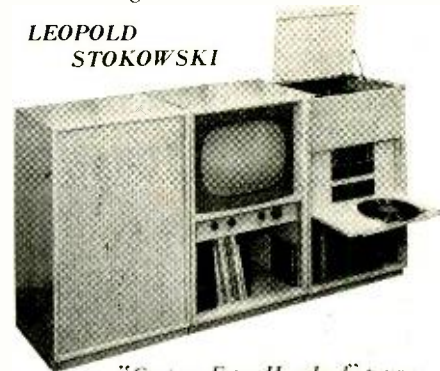

*"Custom Four Hundred" tuners, amplifiers, changers, speakers and cabinets are available either as component parts, to be assembled by the audiophile himself, or as a complete custom installation, such as is shown above. A free booklet describing either method will be sent free. Write to:*



1219 Clifford Avenue, Rochester 3, New York