

Coulon

JUNE
1952
35c

AUDIO ENGINEERING

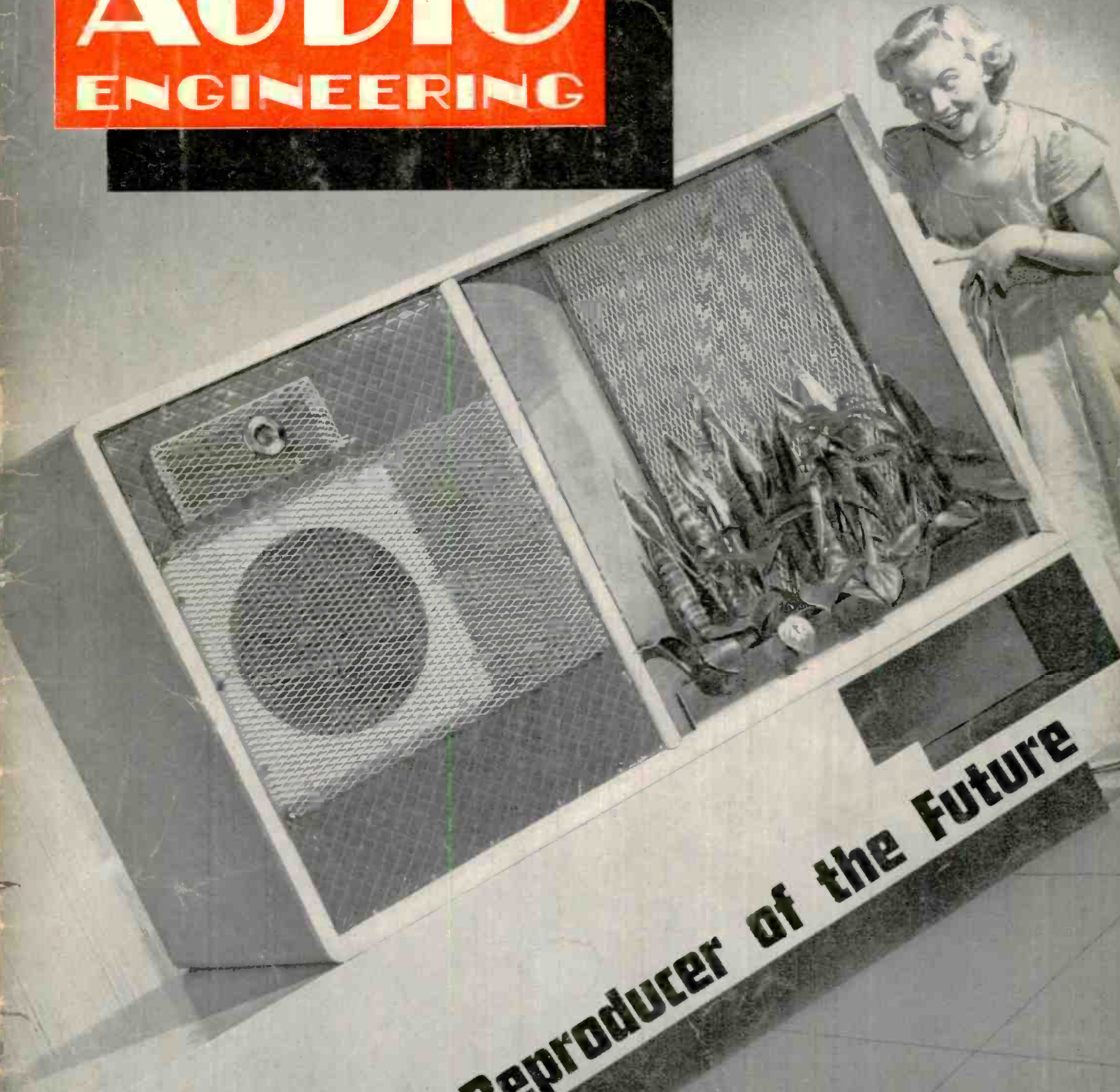

The Reproducer of the Future

THE WORLD OF SOUND



Behind the familiar blue label of WOR recording studios . . .

the finest in modern sound recording methods and equipment

Radio stations from coast to coast recognize this label as the mark of a top quality transcription. One that can be depended on to meet or exceed the extremely high broadcast standards of sound quality.

To maintain this reputation, WOR Recording Studios, one of the largest in the world, use the finest and most costly tape and disc recording equipment obtainable. And—what's equally important—their engineers have found that Audiotape and Audiodiscs are an ideal combination for meeting the exacting requirements of broadcast transcription and commercial recording work. This same record-making combination is also being used with outstanding success by America's leading producers of fine phonograph records.

With Audiotape and Audiodiscs, you can achieve this same sound perfection in *your* recording work, too. Their consistent, uniform quality is the result of more than 12 years of specialized experience by the only company in America devoted solely to the manufacture of fine recording media, both tape and discs.

AUDIO DEVICES, Inc.

444 MADISON AVE., NEW YORK 22, N. Y.
Export Dept.: 13 East 40th St., New York 16, N. Y. Cables "ARLAB"

...including

audiotape*



and **audiodiscs***



*Trade Mark

Successor to **RADIO** —Established 1917

AUDIO ENGINEERING



C. G. McProud, Editor and Publisher

Harrie K. Richardson, Associate Editor
Luci Turner, Production Manager
Lucille Carty, Circulation Manager

Edgar M. Villchur, Contributing Editor
S. L. Cahn, Advertising Director
H. N. Reizes, Advertising Manager

Editorial Advisory Board

Howard A. Chinn
John D. Colvin
C. J. LeBel
J. P. Maxfield
George M. Nixon



Representatives

H. Thorpe Covington, Special Representative
677 N. Michigan Ave., Chicago 11, Ill.
Sanford R. Cowan, Mid-West Representative
67 W. 44th St., New York 18, N. Y.
James C. Galloway, Pacific Coast Sales
816 W. 5th St., Los Angeles 17, Calif.
Technical Book & Magazine Co.
297 Swanston St., Melbourne, C. I.
Victoria, Australia

CONTENTS JUNE, 1952 Vol. 36, No. 6

| | |
|---|----|
| Audio Patents— <i>Richard H. Dorf</i> | 2 |
| Letters | 6 |
| Employment Register | 8 |
| New Literature | 10 |
| Editor's Report | 12 |
| Planning and Building a Radio Studio— <i>Eugene F. Coriell</i> | 15 |
| Handbook of Sound Reproduction— <i>Chapter 1—Edgar M. Villchur</i> | 18 |
| The OTL (Output-Transformer-Less) Amplifier— <i>Victor Brociner and Gerald Shirley</i> | 21 |
| Universal Amplifier for Magnetic Tape Recorder—Part 2— <i>C. G. McProud</i> | 24 |
| Ultra-Linear Operation of the Williamson Amplifier— <i>David Hafner and Herbert I. Keroes</i> | 26 |
| Audio in the Home— <i>William C. Shrader</i> | 28 |
| Phono Facts—1952— <i>Maximilian Weil</i> | 30 |
| Record Revue— <i>Edward Tatnall Canby</i> | 32 |
| New Products | 38 |
| Price and Product Changes— <i>Radio's Master Reports</i> | 47 |
| Advertising Index | 48 |

COVER

Jensen's "Reproducer of the Future"—shown for the first time at the Audio Fair in Chicago. This 46-cubic foot five-way loudspeaker employs four separate speaker units, three dividing networks, and one acoustic crossover (between front and rear radiation from the 15-inch woofer in the upper section). The sub-woofer in the lower compartment covers the range from 25 to 40 cps and is called a "Trans-Reflex"—a transmission-line bass-reflex—radiator.

RADIO MAGAZINES, INC., 342 MADISON AVE., NEW YORK 17, N. Y.

AUDIO ENGINEERING (title registered U. S. Pat. Off.) is published monthly at 10 McGovern Ave., Lancaster, Pa., by Radio Magazines, Inc. Henry A. Schuber, President; C. G. McProud, Secretary, Executive and Editorial Offices: 342 Madison Avenue, New York 17, N. Y. Subscription rates—United States, U. S. Possessions and Canada, \$3.00 for 1 year, \$5.00 for 2 years; elsewhere \$4.00 per year. Single copies 35c. Printed in U. S. A. All rights reserved. Entire contents copyright 1952 by Radio Magazines, Inc. Entered as Second Class Matter February 9, 1950 at the Post Office, Lancaster, Pa. under the Act of March 3, 1879.

EXACT EQUALIZATION

FOR EVERY STANDARD RECORD

MANUFACTURER'S CURVE...

another reason why we ask...
CAN ELECTRONIC CONSTRUCTION BE BEAUTIFUL?

Take a look at the under-chassis construction of the Maynard PR-2A... see the military type terminal board construction, the silver plated contact points, with every component clearly visible... see the compact space economy in the layout and parts placement... see the critical equalization assembly, forever protected from dampness and dirt by complete wax sealing—then—look at its performance record. Check the important features below—each superior virtue adds to your decision that there can be no other choice than Maynard.

62.50 FOB Chicago



- The PR-2A offers these superlative features:
- EXACT EQUALIZATION** for the curves of the following record manufacturers—FFRR (English 78), AES, RCA, Col. Covers all curves now in standard use.
- MINIMIZED PHASE SHIFT**—exceptionally clean square wave response.
- INAUDIBLE HUM LEVEL**—hum less than 8 microvolts of equivalent input signal—hiss less than 2 microvolts.
- MILITARY TERMINAL BOARD CONSTRUCTION** on silver plated contacts—easy servicing, each component clearly visible. Low noise deposited carbon resistors and 2% tolerance silver mica condensers.
- SELF-CONTAINED POWER SUPPLY.** No other connections other than input and output necessary.
- HINGED BASS AND TREBLE CONTROLS.** Frequency response raised or lowered from a fixed point on curve with exact proportions clearly marked on chassis.
- REMOTE LOCATION.** Distances up to 1000 feet from amplifier allowable with no loss in high frequency response.
- RESPONSE** not down at any point more than 1 db at 7 cps to 80 kcs.
- SWITCHING POSITIONS**—for microphone phono and radio inputs. Outlet for AC line supply to all associated components.

WATCH FOR MORE PRODUCT ANNOUNCEMENTS FROM OUR FAST-GROWING COMPANY

maynard ELECTRONICS INC.

1414 S. WABASH AVE. - CHICAGO 5, ILLINOIS

The **TURNTABLE**
is the **HEART**
of your
HIGH FIDELITY
SYSTEM

You may own the finest pickup, amplifier and speaker that money can buy... yet you'll get poor reproduction if your TURNTABLE has excessive wow, hum or rumble!

REK-O-KUT

... offers a complete range of 12" Turntable models to match your present high-fidelity equipment and your own pocketbook. Not every sound system requires the most expensive turntable... your turntable must be chosen to complement your other components. Each REK-O-KUT Turntable carries an engineering specification which enables your Sound Dealer to select the appropriate unit. The quality and workmanship of every REK-O-KUT Turntable, from our most economically-priced model, to our highest priced professional machine is identical... price differential is dependent solely upon the type of materials used.



MODEL LP-743

3-Speed 12" Turntable Induction type motor, designed for smooth, vibration-free operation. Instantaneous speed changes without stopping turntable or removing disc..... \$54.95 Net



MODEL CVS-12

All-Speed Continuously-Variable Turntable Plays all records, 6" to 16" and broadcast transcriptions, not only at the three normal speeds, BUT AT ANY SPEED from 25 to 100 RPM. You play your records at the EXACT SPEED at which they were recorded, or at any variation of speed or pitch which gives you maximum pleasure. A "must" for serious music lovers, pro musicians, schools, dance studios, etc..... \$84.95 Net

MODELS T-12H & T-43H

2-Speed 12" Turntables The only 12" dual-speed turntables that meet the standards for speed regulation and WOW content specified by the National Association of Broadcasters.



Recommended for use with ULTRA HIGH FIDELITY Amplifiers and Speaker Systems.

| MODELS | MOTOR | SPEED | PRICE |
|---------|------------------------|-----------|----------|
| T-12 H* | Hysteresis Synchronous | 78-33 1/2 | \$119.95 |
| T-43 H* | Hysteresis Synchronous | 45-33 1/2 | \$119.95 |
| T-12 | 4 Pole Induction | 78-33 1/2 | \$84.95 |
| T-43 | 4 Pole Induction | 45-33 1/2 | \$84.95 |

* Delivery limited to very short supply of Hysteresis motors.

See...hear...compare REK-O-KUT Turntables, Phonographs and Professional Disc Recorders at leading Music Stores, Audio-Visual Dealers and Radio Parts Jobbers... or write for latest, free Catalogue.

REK-O-KUT CO.

38-01 Queens Blvd., Long Island City, N. Y.

EXPORT DIVISION: 459 Broadway, New York City, U. S. A.
CANADA: ARLAS RADIO CORP., LTD., 560 King St. W., Toronto 28, Ontario



AUDIO PATENTS

RICHARD H. DORF*

THE CLASSIC METHOD of altering the frequency response of an audio transmission system is to insert lumped-constant reactive components—capacitors and inductors—in the circuit, in the form of filters of one kind or another. There are a number of disadvantages to this simple-appearing practice in many applications. Exact values for the desired results are not always easy to procure and trimming an inductor to the precise value is rarely an easy job. The exact shape of the curve—slope of attenuation or equalization and Q of a rejection or peaking circuit—is not always easy to attain in practice, routine though it may be in terms of paper design. And at least as important as any of these, variation of the shape and slope of the curve is difficult, especially when the inductance must be varied. Control of response at any distance from the main circuit is usually impossible without elaborate safeguards against line losses and hum pickup because the audio itself must be carried to the control point and back.

Ellison S. Purinton of Gloucester, Mass., has patented an extremely interesting idea along the lines of an electronic filter circuit which appears to overcome these difficulties. His patent No. 2,589,133, assigned to John Hays Hammond, Jr., employs vacuum tubes in a novel system using only resistors and capacitors to achieve the effects of constant-k, *m*-derived, and other filter types, with turnover and Q controlled by d.c. bias within a reasonable range. One of the useful features (not pointed out in the patent specification) appears to be that filter circuits involving sharp cutoffs and single-frequency peaks and nulls will not "ring" as will ordinary L-C circuits used for these purposes. This feature is not exclusive with the Purinton circuit, of course, being true as well of the

parallel-T feedback filter, but without the other advantages.

A basic practical circuit adapted from the patent illustrations is shown in Fig. 1. Signal from the source is fed to the grid of V_1 , which is a standard phase splitter of the type in which the cathode and plate-load resistors develop equal output voltages 180 deg. out of phase. V_2 and V_3 , which may be a pair of triodes in the same envelope, are excited out of phase by the phase-splitter signals but have their plates tied together. If such a circuit were used in the normal manner without the R-C filters indicated in the diagram, no output voltage would be developed across R_1 , assuming the phase inverter to be well balanced and V_2 and V_3 of identical characteristics, because the out-of-phase signals of V_2 and V_3 would cancel across R_1 .

The switch and bias cells, together with the associated resistor network, is an arrangement for biasing the two tubes in opposite polarities. With the switch in position 1, the only bias is that of the cathode resistor R_2 , and it is the same for both V_2 and V_3 . As the switch arm is moved to position 2, electrons flow in the direction of the arrows, making the grid of V_2 more positive and the grid of V_3 more negative than ground.

Suppose R-C Filter A has a high-pass characteristic, perhaps with the configuration shown connected by dashed lines, and Filter B is simply a large coupling capacitor without any frequency discrimination in the audible range. With the bias switch on position 1 (both tube conductances equal), there will be a constant relationship between the signal levels on the two grids at all frequencies above that at which Filter A begins to reduce low-frequency response. At those frequencies, therefore, output of the circuit will be zero (neglect-

* 255 W. 84th St., New York 24, N. Y.

[Continued on page 4]

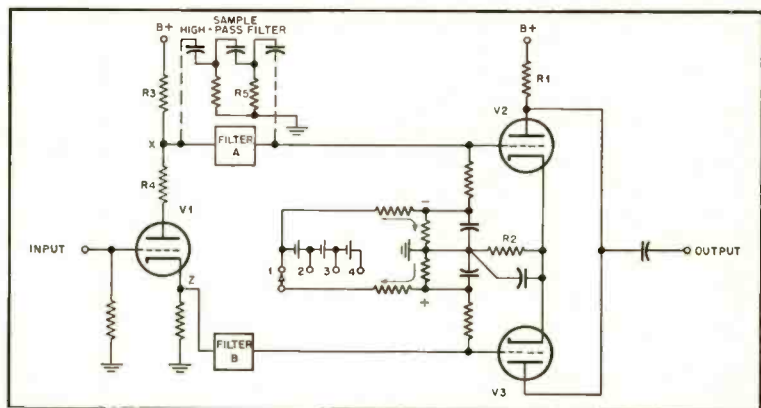

Fig. 1.

Memorandum from **rJ** AUDIO PRODUCTS, INC.

Dear Audio Enthusiast:

Thank you for your inquiry on R-J Enclosures and we trust that the enclosed literature will answer all your questions concerning these amazing new cabinets.

You will note the enclosures will be available less speaker and can be purchased in various models to accommodate any 8", 12", or 15" speaker of your choice. There is direct radiation of the highs so that you can use a coaxial speaker to the fullest advantage. Of course, if you wish, you can also use the cabinets simply to house the bass speaker (woofer) and use an external treble speaker (tweeter).

The 12" and 15" floor models will be available in unfinished, smooth sanded surfaces, as well as the Mahogany and Blonde (Korina) finishes shown in the enclosed literature, but will not be available in kit form. Also, it will be impossible to deviate from the sizes, finishes, or construction indicated here or in the enclosed.

We cannot at this time go any further into the principles of construction, or how these amazing results are achieved. We ask you to simply listen to R-J at your nearest top flight parts distributor or sound dealer and hear for yourself why engineers and critics who heard these cabinets at the Audio Shows gave them rave notices.

They should be available approximately the 1st of July and if you have any difficulty whatsoever in locating a source of supply of R-J Enclosures in your territory, please let us know and we will make immediate suitable arrangements.

Excellent acoustic loading for best reproduction of transients; perfect separation of percussive tones.

Reproduces maximum performance of any speaker, without annoying cabinet resonances.

Quality appearance and construction Mahogany or Korina

Simple installation of any loud speaker according to user's preference.

Versatile, decorative, inexpensive due to small size, good proportion.

Direct radiation of highs without obstruction.

Clean, smooth bass equal to performance of ordinary enclosures 3 times the size.

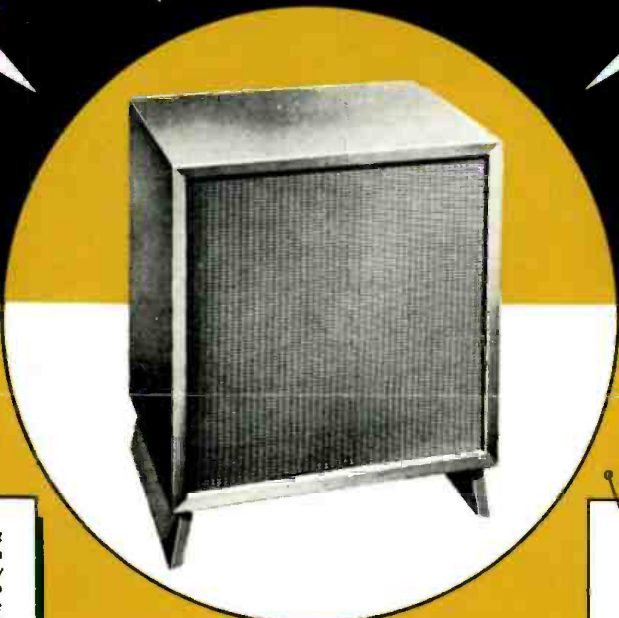

And now suddenly an enterprising friend of mine has looked at nature's "immutable" law and found a way around it, as simply as you please. So simple that it is just about impossible to believe that nobody in all these years has done it before. His speaker cabinet is tiny, just about big enough for a speaker to fit inside, with inches to spare. But it gives bass performance that challenges the huge monsters we've always thought were de rigueur. How?
Nature, it seems, does know how to produce bass without taking up space. The bullfrog, for instance. Adapt the bullfrog's ingenious bass-making system to the phonograph loudspeaker and you have the essence of the new "R-J" speaker enclosure, so named tentatively after its promoters, Frank Robbins and William Joseph. The "R-J" principle is simple, flexible, adaptable to myriads of special circumstances.
SATURDAY REVIEW

D'autres, abordant la question de front, tentent de combiner des éléments déjà connus de manière à diminuer l'encombrement sans riser sacrifier à la qualité musicale. Ce but semble avoir été atteint par deux ingénieurs américains, Frank Robbins et William Joseph, qui ont montré à l'Audio Fair de New-York, au début du mois de novembre, une nouvelle enceinte acoustique vraiment minuscule et cependant susceptible de soutenir favorablement la comparaison avec les meilleures réalisations existantes.
TOUTE LA RADIO PARIS

The R-J Company, New York City. Visitors to this display will probably be mumbling to themselves for months to come—at least until they have another opportunity to hear the R-J speaker. In action and verify the fact that they actually did hear a 10-cycle note coming from the innards of an 18-inch-square box. First introduced publicly through the pages of *EA* last month, the R-J enclosure already is on the way to commercial acceptance by major manufacturers of custom-built home music systems. The inventors, who conducted the R-J exhibit, were literally swamped with messages of congratulation on their having reduced speaker cabinet size without impairing low-frequency response.
AUDIO ENGINEERING

CRITICAL COMMENTS... IMMEDIATE, ENTHUSIASTIC INTEREST!

In the hi-fi area, the R-J enclosure may prove of tremendous importance to those buyers of high-quality equipment who have sumptuous but none-too-big living rooms and tend, even against engineering advice, to order those dreadful combination "arm-chair console" arrangements which sacrifice so much in acoustical response in favor of smaller size. The R-J enclosure can be used as a chair or a coffee table or a chairside stool; it beats any chairside conventional arrangement all hollow—and gives far superior quality. With such a speaker the objection to a separate box is largely nullified. Amplifier and controls—possibly remote—could then be stowed away with the greatest of ease. I see extraordinary possibilities here, in the ultra-custom department.
AUDIO ENGINEERING

The first impression of the layman listener upon hearing music come from this enclosure is that so much sound can come from so small an object. For this enclosure, called the R-J after its inventors, is barely larger than the speaker it contains. Yet, when fitted with a good quality speaker this R-J enclosure is capable of faithfully reproducing bass fundamental tones down to 30 cycles per second, that is, the lowest bass tones audible to human ears.
THE CATHOLIC EDUCATOR

Future development of the R-J is well worth watching carefully, as is the entire trend toward disproving the axiom that good bass reproduction requires giant size.
HIGH-FIDELITY

I grant that for the professional perhaps this matter of size is not of top importance. But think of the larger "market" for the entire range of audio equipment, from the hi-fi record collector and engineer right on down to the buyer of a miniature portable radio. Size is a vital thing for all of these people. Bulky equipment is tolerated and even welcomed by a good many, because it has been an unalterable rule that quality requires bulk. And if it is quality or nothing, then bulk is OK. But once you have so much as hinted that the eternal rule has been denied, even by ever so little—and anything may happen!
AUDIO ENGINEERING

This was the reason for the crowds around the Audio Fair exhibit marked "R-J Company." Messrs. R. and J. (Frank Robbins and William Joseph) had made a valiant effort to find a middle ground. Their cabinets (literally "under wraps"—burlap) were cubic and only a few inches bigger than the speakers they housed. A speaker in an R-J cabinet is sealed behind by a very small box but, to equalize this, it is front-loaded, too. The frontal air chamber is closed off but for a slot through which the sound comes. A slot distributes sound rather well. Organ-pipe makers found this out long ago.
THE ATLANTIC

Size for size all the way up and down, the R-J type of cabinet enclosure will give you excellent bass response and smooth over-all response equal to enclosures that simply dwarf it. If this principle works, then we can have our cake and eat it.
AUDIO ENGINEERING

R - J AUDIO PRODUCTS INC.

164 Duane Street • New York 13, N. Y.

**REMARKABLE !
INEXPENSIVE !
SMALL-SIZE !**

R-J SPEAKER ENCLOSURES

(Patent Pending)



Maximum Bass—Minimum Space!

Use it with ANY loudspeaker!

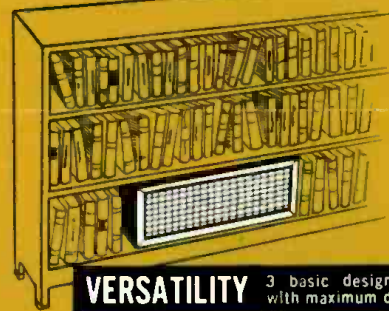

SINGLE SHELF MODEL
No. S-E-U
(For 8" Speaker).
To fit in bookcase.
Finish sanded, unpainted
11" high x 10" deep x
23½" long.

VERSATILITY 3 basic designs, combining finest performance with maximum decorative possibilities in the home

FLOOR MODEL
No. F-15-M
(For 15" Speaker, Mahogany)
No. F-15-B
(For 15" Speaker, Blonde)
No. F-12-M
(For 12" Speaker, Mahogany)
No. F-12-B
(For 12" Speaker, Blonde)
Beautiful, hand rubbed
Mahogany or Blonde finish.
20" high x 20" long x
16" deep, plus legs.

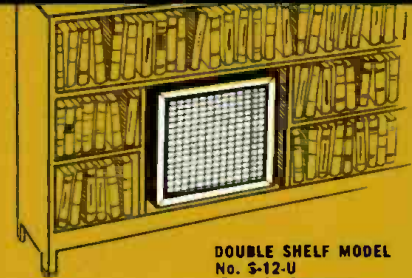

DOUBLE SHELF MODEL
No. S-12-U
(For 12" Speaker).
To fit in bookcase.
Finish sanded, unpainted
24" high x 21" long x
10" deep.

R-J ENCLOSURES WILL OUTPERFORM ORDINARY ENCLOSURES MORE THAN THREE TIMES THEIR SIZE!

Hearing is believing! Now available for the first time, R-J Speaker Enclosures have established an entirely new trend in audio design with thrilling performance from any loudspeaker in a cabinet only slightly larger than the speaker itself. R-J Enclosures are simple, flexible, low in price, and particularly adaptable in rooms where space must be conserved. Up to now cumbersome, costly speaker enclosures have been tolerated because their size was considered essential for good bass performance. This inconvenience has now been effectively overcome by the R-J construction principle, which has received the approbation of thousands of critical listeners with outstanding results. Long before R-J Speaker Enclosures were commercially available, enthusiastic comments and inquiries were received from every part of the world, from home listeners, critics, and broadcast stations alike. Listeners were fascinated equally by the outstanding performance of R-J Enclosures and by their decorative possibilities.

The R-J Enclosure will permit the user to realize the full potential of any speaker with which it is used. Even the

most inexpensive speakers will perform at their best in an R-J housing. With a well-designed speaker, an R-J Enclosure offers clean, smooth bass fundamentals, without peaks, down to low organ pedal notes. Distorting cabinet resonances are completely eliminated.

Remarkable though its bass performance may be, the R-J Enclosure is equally impressive in its unobstructed direct radiation of high frequencies. Excellent acoustic loading affords best reproduction of transients.

R-J Speaker Enclosures also offer the advantages of unusual versatility. Fine furniture construction is used throughout, suited in appearance to any room decor. Enclosures are expertly built of heavy, top-quality genuine Mahogany or Korina veneers, in fine, long lasting hand-rubbed dark or blonde finish. Special models are available with surfaces sanded but unfinished, to fit the shelves of bookcases and other similar installations. Cut-outs fit all standard loudspeakers, which may be installed quickly and simply without special tools.

Remember the speaker with the champagne glass?

Welcome news to the thousands who heard it at the Audio Fairs, and were amazed, and to other thousands who have written from every part of the world.

Now available for the first time:

**SOME CRITICAL COMMENTS
WHEN THE R-J WAS
FIRST DEMONSTRATED AT THE
NEW YORK AUDIO FAIR.**

The R-J Company, New York City. Visitors to this display will probably be mumbling to themselves for months to come—at least until they have another opportunity to hear the R-J speaker in action and verify the fact that they actually did hear a 30-cps note coming from the innards of an 18-inch-square box. First introduced publicly through the pages of *AE* last month, the R-J enclosure already is on the way to commercial acceptance by major manufacturers of custom-built home music systems. The inventors, who conducted the R-J exhibit, were literally swamped with messages of congratulation on their having reduced speaker cabinet size without impairing low-frequency response.

AUDIO ENGINEERING

And now suddenly an enterprising friend of mine has looked at nature's "immutable" law and found a way around it, as simply as you please. So simple that it is just about impossible to believe that nobody in all these years has done it before. His speaker cabinet is tiny, just about big enough for a speaker to fit inside, with inches to spare. But it gives bass performance that challenges the huge monsters we've always thought were *de rigueur*.
How?

Nature, it seems, does know how to produce bass without taking up space. The bullfrog, for instance. Adapt the bullfrog's ingenious bass-making system to the phonograph loudspeaker and you have the essence of the new "R-J" speaker enclosure, so named tentatively after its promoters, Frank Robbins and William Joseph. The "R-J" principle is simple, flexible, adaptable to myriads of special circumstances.

SATURDAY REVIEW

This was the reason for the crowds around the Audio Fair exhibit marked "R-J Company." Messrs. R. and J. (Frank Robbins and William Joseph) had made a valiant effort to find a middle ground. Their cabinets (literally "under wraps"—burlap) were cubic and only a few inches bigger than the speakers they housed. A speaker in an R-J cabinet is sealed behind by a very small box but, to equalize this, it is front-loaded, too. The frontal air chamber is closed off but for a slot through which the sound comes. A slot distributes sound rather well. Organ-pipe makers found this out long ago.

THE ATLANTIC

Future development of the R-J is well worth watching carefully, as is the entire trend toward disproving the axiom that good bass reproduction requires giant size.

HIGH-FIDELITY

Special 15" model available to accommodate RCA LC1A Loud Speaker.

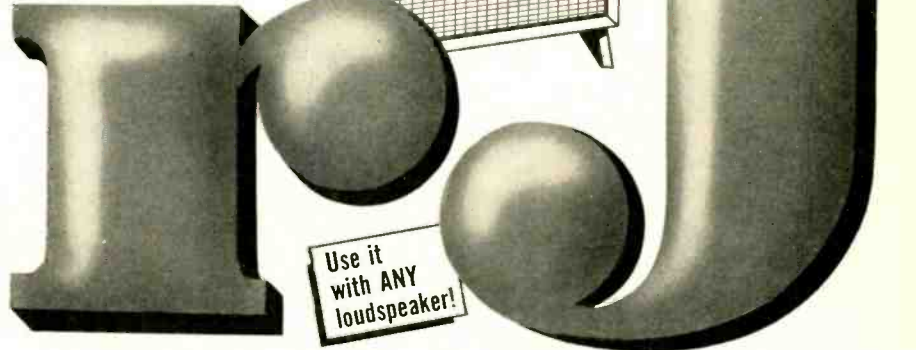

SPEAKER ENCLOSURES

MAXIMUM BASS... MINIMUM SPACE! (Patent Pending)

"Startling!" "Small in size, but mighty in performance!" Thousands of critical listeners who heard R-J Enclosures at the New York and Chicago Audio Fairs actually watched a delicate champagne glass, perched on a 20" x 20" speaker enclosure which was pouring forth the throbbing pedal notes of an organ. There was no cabinet resonance. No motion in the glass or its contents.

Hearing is believing! The R-J Speaker Enclosure, now ready for the home after long experiments and development, establishes an entirely new trend in audio design. Listen to an R-J... hear thrilling performance from your favorite loudspeaker in a cabinet only slightly larger than the speaker itself! Listen... and hear the R-J outperform ordinary enclosures more than three times its size!

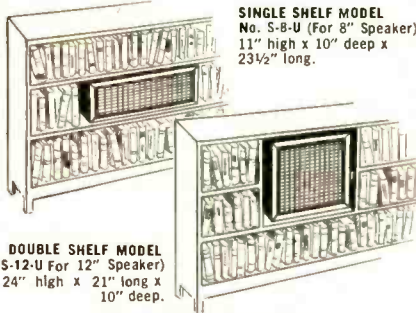

SINGLE SHELF MODEL
No. S-8-U (For 8" Speaker)
11" high x 10" deep x
23 1/2" long.

DOUBLE SHELF MODEL
No. S-12-U (For 12" Speaker)
24" high x 21" long x
10" deep.



FLOOR MODEL
No. F-15-M (For 15" Speaker, Mahogany)
No. F-15-B (For 15" Speaker, Blonde)
No. F-12-M (For 12" Speaker, Mahogany)
No. F-12-B (For 12" Speaker, Blonde)
20" high x 20" long x 16" deep, plus legs.

\$4995

Net.
Mahogany.
Slightly higher on
West Coast

R-J Enclosures are simple, flexible, low in price, and particularly adaptable for rooms where space must be conserved. Up to now, cumbersome, costly speaker enclosures have been tolerated because their size was considered essential for good bass performance. This inconvenience has now been effectively overcome by the R-J construction principle.

The R-J Enclosure will permit the user to realize the full potential of any speaker with which it is used. Even the most inexpensive speakers will perform at their best in an R-J housing. With a well-designed speaker, an R-J Enclosure offers clean, smooth bass fundamentals, without peaks, down to low organ pedal notes. Distorting cabinet resonances are completely eliminated.

Remarkable though its bass performance may be, the R-J Enclosure is equally impressive in its unobstructed direct radiation of high frequencies. It has excellent acoustic loading for best reproduction of transients.

R-J Speaker Enclosures also offer the advantages of unusual versatility. Fine furniture construction is used throughout, suited in appearance to any room decor. Enclosures are expertly built of heavy, top-quality genuine Mahogany or Korina veneers, in fine, long lasting hand rubbed dark or blonde finish. Special models are available with surfaces sanded but unfinished, to fit the shelves of bookcases and other similar installations. Cut-outs fit all standard loudspeakers, which may be installed quickly and simply without special tools.

Here is a brand new concept in speaker cabinet design... with many, many possibilities for your own home system—now or in the future. It is a treat for your imagination and a treat for your budget.

See and hear an R-J Enclosure at your favorite sound department. For literature and further information use the handy coupon.

R-J Audio Products, Inc., Dept. AR 6
164 Duane Street • New York 13, N. Y.

Gentlemen:

Please send literature and information on R-J Speaker Enclosures.

Name

Address

City Zone State

R - J AUDIO PRODUCTS INC.

164 Duane Street • New York 13, N. Y.

www.americanradiohistory.com



From the highest note... to the lowest...

It's the Sound Tape of Symphony Quality!



TECHNICAL ASSISTANCE on every phase of commercial sound recording is yours for the asking from your local 3M Service Representative. Call him today... or write us: AE-62, Minnesota Mining & Mfg. Co., St. Paul 6, Minnesota.

The term "SCOTCH" and the plaid design are registered trademarks for Scotch Recording Tape made in U.S.A. by MINNESOTA MINING & MFG. CO., St. Paul 6, Minn.—also makers of "Scotch" Brand Pressure-sensitive Tapes, "Underseal" Rubberized Coating, "Scotch-lite" Reflective Sheeting, "Safety-Walk" Non-slip Surfacing, "3M" Abrasives, "3M" Adhesives. General Export: 270 Park Ave., New York 17, N. Y. In Canada: London, Ont., Can.



WHEREVER FLAWLESS SOUND reproduction is required... in recordings by top-notch orchestras, concert artists, broadcasters... "Scotch" Sound Recording Tape is chosen for the job.

Recording engineers use more of this tape than all other brands combined. They recognize many points of superiority in "Scotch" Sound Recording Tape: *Lower noise level than any other tape • Greater output sensitivity than any other tape • Better reel-to-reel uniformity than any other tape • Erases cleaner than any other tape • No curling or cupping—always lies flat on head • Lubricated for longer tape life.*



ing phase shift for the moment) if the levels at points X and Z are equal, or it may have a finite value if R_s and R_t are proportioned so that the output of the phase splitter at X is somewhat less than at Z.

At frequencies below the point where Filter A takes effect, output of the circuit begins to rise, since opposition signal fed to the grid of V_2 decreases. The result is obviously a low-pass filter action.

The filter is easily controllable. If the switch arm is moved to position 2, the bias on V_2 is increased and that on V_3 is decreased. V_2 then transmits less opposition signal. Effectively the frequency at which the response of Filter A begins to rise becomes higher, and the frequency at which the total output begins to drop off does likewise, though the slope does not alter. When the switch is on position 4 (and if this biases V_2 to or near cutoff), there is no opposition signal at all through V_2 and response becomes flat. In practice, this would not be likely since it would be undesirable to operate a tube on the nonlinear portion of its characteristic near cutoff, but the drop point could be shifted to a very high frequency.

The explanation given is a simplified one in the sense that it does not take phase shift into account. Actually, there can be no null because of the unequal phase shifts in the two filters. The maximum attenuation of the highest frequency must be limited in the adjustments to a degree governed by the phase shift in whatever networks constitute the two filters.

From the above it is obvious how a controllable high-pass filter could be designed. Note that the controlling element is pure d.c. and the leads to the switch could be brought out to a remote control point without any effect on performance.

Band-pass, band-rejection, and single-frequency filters are also possible. Suppose a filter were desired to reject 5,000 cycles. Filter A might then consist of a high-pass filter with a 5,000-cps cutoff, and Filter B of a low-pass filter with cutoff at the same frequency. The circuit would probably be adjusted so that phase-splitter outputs at X and Z were equal. In addition, a phase-correcting element would be added to each filter (for instance, a capacitor across R_t in Fig. 1) so that at 5,000 cps the two filter output signals would have the same phase shift. Then at 5,000 cps the signals on the grids of V_2 and V_3 would be equal and exactly 180 deg. out of phase and the output would show zero signal, though at surrounding frequencies the signal output would rise again.

If the bias switch were then moved from position 1, the outputs of the two triodes would no longer be equal at the plates and a signal would appear at the "resonant" frequency. And, of course, sufficient bias inequality would remove the 5,000-cycle rejection completely, making the bias switch actually a Q control.

A band-rejection filter is obtained by using a high-pass filter at A or B and a low-pass filter at the other, and overlapping the cutoffs. The cutoff frequency of the high-pass filter is made equal to the low frequency of the rejection band, and the cutoff of the low-pass filter is made equal to the high rejection-band frequency. The method of looking at the band-rejection action is illustrated by the graph of Fig. 2, in which the two directions from the baseline are the two phases, 180 deg. apart, of the outputs of V_2 and V_3 . Since the curve represents a.c., zero output is represented by the baseline, while anything above or below it represents output

[Continued on page 44]

Be Sure of Your Installations . . . Use

Aptitude-Tested

MULTIPLE CONDUCTOR

CABLE

● You know what you are doing when you use Belden Multiple Conductor Cables — they're aptitude rated. They are designed to provide desirable electrical characteristics, and rigid control assures constant quality.

Specify Belden Radio Wires.

Belden Manufacturing Co., 4689-R W. Van Buren St., Chicago 44, Ill.

To You, Belden's Golden

Anniversary Means

—product performance that can come only from a "know-how" that has grown through actual service since the inception of Radio.

—an ability to co-operate in pioneering new wires to meet or anticipate industry's growing needs.

In the years that follow

This Belden Program Is—

— TO BE CONTINUED

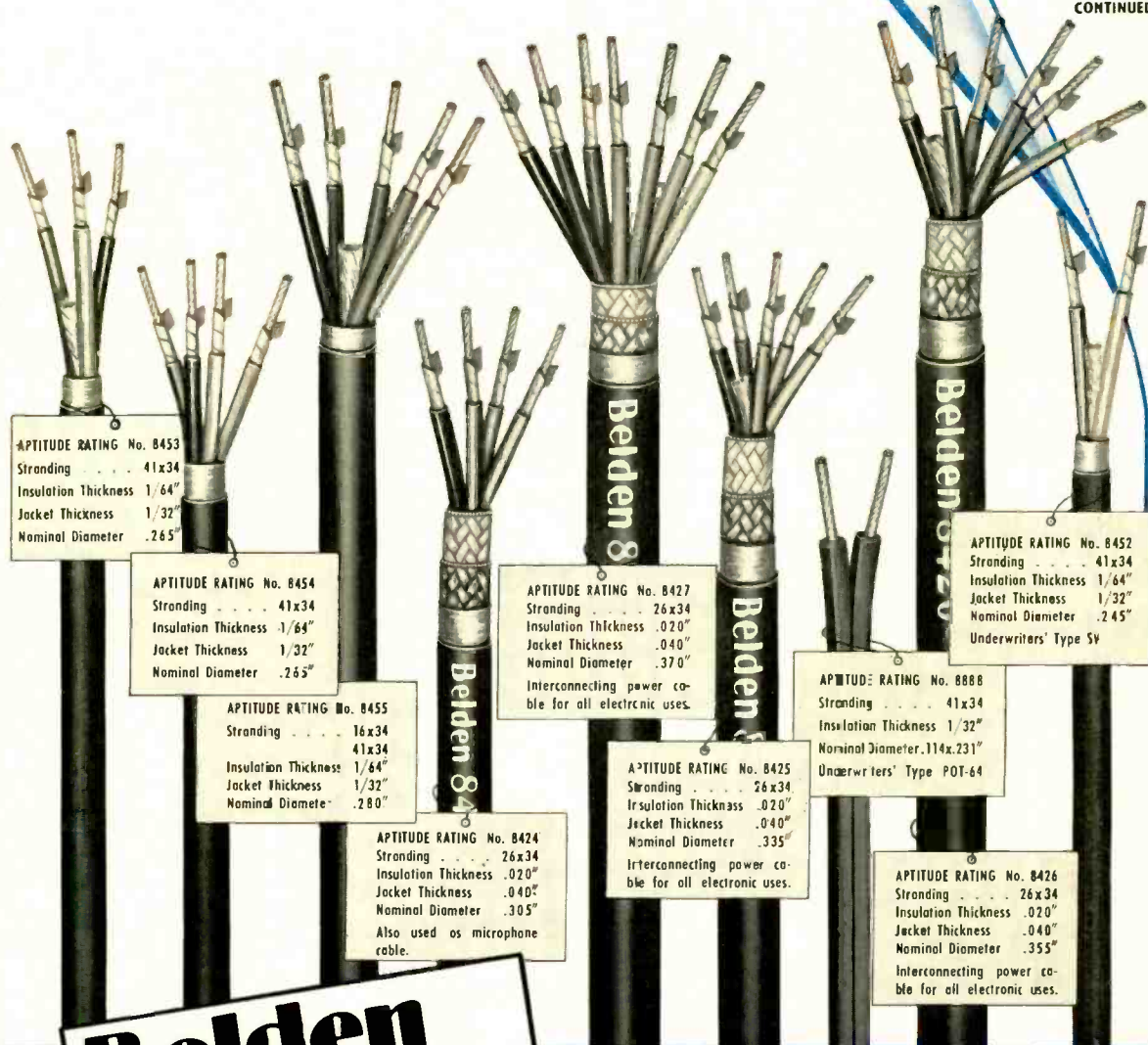

APTITUDE RATING No. 8453
Stranding 41x34
Insulation Thickness 1/64"
Jacket Thickness 1/32"
Nominal Diameter .265"

APTITUDE RATING No. 8454
Stranding 41x34
Insulation Thickness 1/64"
Jacket Thickness 1/32"
Nominal Diameter .265"

APTITUDE RATING No. 8455
Stranding 16x34
 41x34
Insulation Thickness 1/64"
Jacket Thickness 1/32"
Nominal Diameter .280"

APTITUDE RATING No. 8424
Stranding 26x34
Insulation Thickness .020"
Jacket Thickness .040"
Nominal Diameter .305"
Also used as microphone cable.

APTITUDE RATING No. 8427
Stranding 26x34
Insulation Thickness .020"
Jacket Thickness .040"
Nominal Diameter .370"
Interconnecting power cable for all electronic uses.

APTITUDE RATING No. 8425
Stranding 26x34
Insulation Thickness .020"
Jacket Thickness .040"
Nominal Diameter .335"
Interconnecting power cable for all electronic uses.

APTITUDE RATING No. 8888
Stranding 41x34
Insulation Thickness 1/32"
Nominal Diameter .114x.231"
Underwriters' Type POT-64

APTITUDE RATING No. 8452
Stranding 41x34
Insulation Thickness 1/64"
Jacket Thickness 1/32"
Nominal Diameter .245"
Underwriters' Type 5V

APTITUDE RATING No. 8426
Stranding 26x34
Insulation Thickness .020"
Jacket Thickness .040"
Nominal Diameter .355"
Interconnecting power cable for all electronic uses.

Belden
Radio WIRE

The
Aptitude-Tested LINE

here's

absolute reliability

for heavy duty
audio
amplification

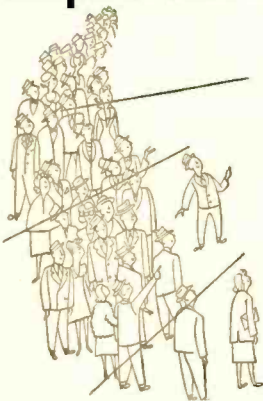

TUNG-SOL



**BEAM
POWER
AMPLIFIER**

If you've been looking for an audio output tube that's stable under the most severe conditions—completely dependable—then this is it! The Tung-Sol 5881 is rugged both mechanically and electrically—and directly interchangeable with the 6L6.

In creating the 5881, Tung-Sol engineers have made lavish use of the design and production techniques which have proved themselves over the past fifteen years—zirconium coating over the carbonized metal plate and pure barium getter to effectively absorb gas for the life of the tube—gold plated wire to minimize grid emission. These are but a few of the major design improvements in the 5881.

Tung-Sol produces the 5881 under laboratory conditions, to assure peak efficiency and maximum uniformity. You'll find this tube has the stuff to take the whole range of audio service requirements from protracted standby periods to repeated heavy overloads. So, if absolute reliability is essential in your audio circuits, the Tung-Sol 5881 is a "must." Order it from your regular supplier.

Write for characteristics and performance data

TUNG-SOL ELECTRIC INC., NEWARK 4, N. J.

Sales Offices: Atlanta • Chicago • Culver City (Calif.)
Dallas • Denver • Detroit • Newark

Tung-Sol makes All-Glass Sealed Beam Lamps, Miniature Lamps, Signal Flashers, Picture Tubes, Radio, TV and Special Purpose Electron Tubes.

LETTERS

Positive Feedback

Sir:

With regard to Ulric Childs' article which appeared along with mine in the May issue, I do not believe it is surprising that he found oscillation taking place at around 200 cps. The theory of the circuit predicts that, with increasing positive feedback, oscillation will occur near that frequency at which the performance of the amplifier as a negative resistance most nearly equals that of the speaker as a positive resistance. Speakers differ in performance and so do amplifiers. Two speakers might be identical in every respect except the magnet size. If one had four times the gap flux density of the other (commercially available speakers vary as much as that), it would have sixteen times the motional impedance at 200 cps. So it is misleading to speak of motional impedances in general as falling to a specified value at a given frequency range.

Speakers vary in many other respects. Not the least important of these is the manner of mounting. With different combinations of amplifiers, speakers, and baffling, I have encountered initial oscillation at various frequencies all over the audio band.

But with any speaker the motional impedance must fall to zero at zero frequency. Then it follows that from zero frequency to some specific frequency short of speaker resonance, say to 20 cps, the motional impedance remains less than it is anywhere in the rest of the audible range. If Childs found zero net-circuit-resistance at 200 cps rather than at (say) 20 cps, it was simply because the performance of his amplifier is impaired at 20 cps; it cannot be any other way. (Zero net-circuit-resistance is a necessary, though not sufficient condition for oscillation. Practical circuits involve the use of an amplifier with finite overload point so relaxation oscillations will generally occur, even if sine-wave oscillation does not.) My own findings were that a really wide-range amplifier with a Stephens P-52Lx will oscillate at around 5 cps.

On the basis of Child's earlier article there was good reason to suspect that he was running into oscillation at some extreme frequency. Readers will recall that he implied that he had made measurements showing that the point of oscillation coincided with the setting for perfect damping. This could not have been the case if oscillation took place within the audible range, since whenever a speaker makes a loud noise an appreciable motional resistance must be present to absorb the necessary electrical power. So either Childs was meeting oscillation at frequency extremes or his measurements were in error. The latter now turns out to be the case.

Not that the error need have been large. In general, the poorer the speaker and the heavier the air loading, the smaller the motional impedance (at a given frequency and in proportion to voice-coil resistance): And the smaller the motional impedance, the less the spread between the point of perfect damping and the point of oscillation.

One final note: there is no mystery as to where the power goes that is delivered to the motional impedance. It is dissipated in the resistive component; reactances do not consume power. Given the value of this component, one can compute the mechanical power with the aid of the equations given in my article.

However, the shunt reactive component cannot be overlooked. The latter will cause additional power to be consumed in plate dissipation and in the voice coil. If this circuit is to be used at a setting for near-perfect damping of an otherwise poorly-damped speaker setup, the output stage should be capable of delivering considerable reserve power. Even the magic of feedback will not provide something for nothing.

Warner Clements,
Box 969,
Sherman Oaks, Calif.

The April Cover

Sir:

Congratulations on *Æ*'s new menu! The dietary deficiencies of those of us suffering from electronic malnutrition are rapidly being remedied. The dish on the April cover looks especially appetizing—low skirt selectivity, no distortion, well balanced output, and an excellent set of characteristic curves. . . .

Jerome S. Miller,
1338 Washtenaw,
Ann Arbor, Mich.

SOUND OFF FOR..

SOUNDCRAFT*

FOR 3 SOUND REASONS!



1. Soundcraft Magnetic Recording Tape

You get superlative quality with Reeves Soundcraft Tape, the *only* tape manufactured by specialists with 20 years of continuous experience in the sound recording field. Reeves Soundcraft Magnetic Recording Tape *outperforms* all others . . . and *outlasts* all others!

2. Soundcraft 5 Drawer Tape-Chest*

You get a permanent filing cabinet for your reels, absolutely free, with the purchase of 5 reels of Soundcraft Tape. The remarkable pyroxylin-coated Soundcraft Tape-Chest, constructed of durable lined boxboard, stores either 5 or 7 inch reels horizontally, each in an individual drawer.



*Patent applied for.



3. Soundcraft Magna-Stripe**

The most revolutionary development in movie-making since "talkies"! Soundcraft Magna-Stripe is a new method of permanently bonding a magnetic sound track to motion picture film. Now you can make sound movies as quickly, easily and inexpensively as silent films. You can also add Magna-Stripe sound tracks to old silent films, giving them new life as "talkies". You can erase, and change a Magna-Stripe sound track as easily as you change your mind!

**Trademark Reeves Soundcraft.

REEVES SOUNDCRAFT CORP.

10 East 52nd Street, New York 22, N. Y.

***THE ONLY RECORDING MATERIALS PERFECTED AND MANUFACTURED BY RECORDING SPECIALISTS**

Please write for additional information.

where the world's toughest transformers
are a "must" for the toughest installations . . .

you'll find

CHICAGO

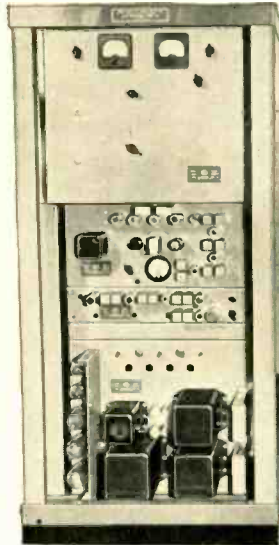

REL specifies and uses CHICAGO

You'll find CHICAGO "Sealed-in-Steel" transformers used throughout REL's FM Transmitting and Relay Equipment. Absolute dependability is a prime requirement in all REL equipment—and CHICAGO transformers contribute significantly to quality, superior performance and long time stability.

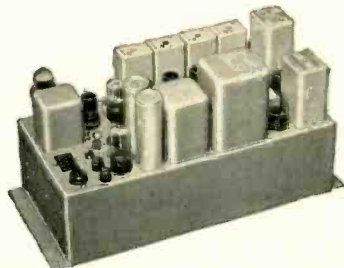

COLLINS specifies CHICAGO

This COLLINS MHF Single Frequency Communications Receiver utilizes CHICAGO "Sealed-in-Steel" transformers for trouble-free, continuous service under the most rugged operating conditions.

where the going's tough—specify CHICAGO "Sealed-in-Steel"
NEW EQUIPMENT TRANSFORMERS

CHICAGO "New Equipment" transformers (available in 3 mountings) feature one-piece drawn-steel cases—the strongest, toughest, best-looking units you can buy. The one-piece seamless design, enclosing an electronically perfect construction, provides the best possible electrostatic and magnetic shielding, with complete protection against adverse atmospheric conditions. For every application: Power, Bias, Filament, Filter Reactor, Audio, MIL-T-27, Stepdown—ask your electronic parts distributor for CHICAGO "Sealed-in-Steel" transformers.

Free "New Equipment" Catalog



Get the details on CHICAGO's full *New Equipment Line*—covering "Sealed-in-Steel" transformers for every modern circuit application. Write for your Free copy of this valuable catalog today, or get it from your distributor.

M-TYPE

Hermetic sealing meets all MIL-T-27 specs. Steel base cover is deep-seal soldered into case. Terminals hermetically sealed. Ceramic bushings. Stud-mounted unit.



S-TYPE

Steel base cover fitted with phenolic terminal board. Convenient numbered solder lug terminals. Flange-mounted unit.



C-TYPE

With 10" color-coded leads brought out through fibre board base cover. Lead ends are stripped and tinned for easy soldering. Flange-mounted unit.



CHICAGO TRANSFORMER

DIVISION OF ESSEX WIRE CORPORATION

3501 ADDISON STREET • CHICAGO 18, ILLINOIS



Sir:

The lovely lady on your April cover haunts me. Herewith permit me to nominate her as "Miss Audio of 1952." She is so sound of limb and body as to induce heart murmurs in the male. Irresistibly that old cliché comes to mind: "we could make such beautiful music together." A salute therefore, to Miss Audio, may she set the tone of the 1952 Audio Fair: "Lovely to look at, thrilling to hear."

John Luchaka,
1115 Belmont St.,
Pittsburgh 21, Pa.

(Even if we did have her phone number, we wouldn't publish such highly classified information. Ed.)

Tape Recording Information

Sir:

I am in the sound recording business, building my own electronic equipment associated with disc and tape recording and reproducing. To further my knowledge, I would like to get in touch with someone who is similarly engaged and who would like to correspond by means of 7½-in. tape for economy, either single or dual track, on subjects relating to recording, wide-range disc reproducing equipment, music—both classical and popular—and items of interest in respect to our countries. As I use all European equipment and accessories, such as Pyral, E.M.I., Simon, Decca, etc., much information could be exchanged on performance relative to American and European equipment.

J. I. Tidswell,
P. O. Box 194,
Dannevirke,
New Zealand.

"Let George Do It"

Sir:

Just a note of sincere appreciation for the editorial in the April issue. I am sure that many FM operators got the same "lift" that I did when they read "Let George Do It." The item was an extremely accurate blow at one of the obstacles FM has had to overcome since the beginning—public apathy. FMers do not expect sympathy, pity, or unearned praise, but we would really be most grateful for some sign that listeners do notice our efforts. Indeed I, for one, would be overjoyed to get even a scathing letter from a listener. It would show he was interested! Lest the impression be gained that there are no FM fans, I can show you stacks of mail we have gotten when a popular program is discontinued, but very little is received while it is on. People are funny.

Mark T. McKee, Jr.,
Radio Station WMLN,
Mount Clemens, Mich.

(You are so right. Ed.)



**Employment
Register**

POSITIONS OPEN and AVAILABLE PERSONNEL may be listed here at no charge to industry or to members of the Society. For insertion in this column, brief announcements should be in the hands of the Secretary, Audio Engineering Society, P. O. Box 12, Old Chelsea Station, N. Y. 11, N. Y., before the fifth of the month preceding the date of issue.

★ Positions Open • Positions Wanted

★ TRANSFORMER and electronics specialty firm in upstate New York anxious to hire engineer experienced in the design of transformers for communication equipment. Salary \$5000-6500. Box 601, AUDIO ENGINEERING.

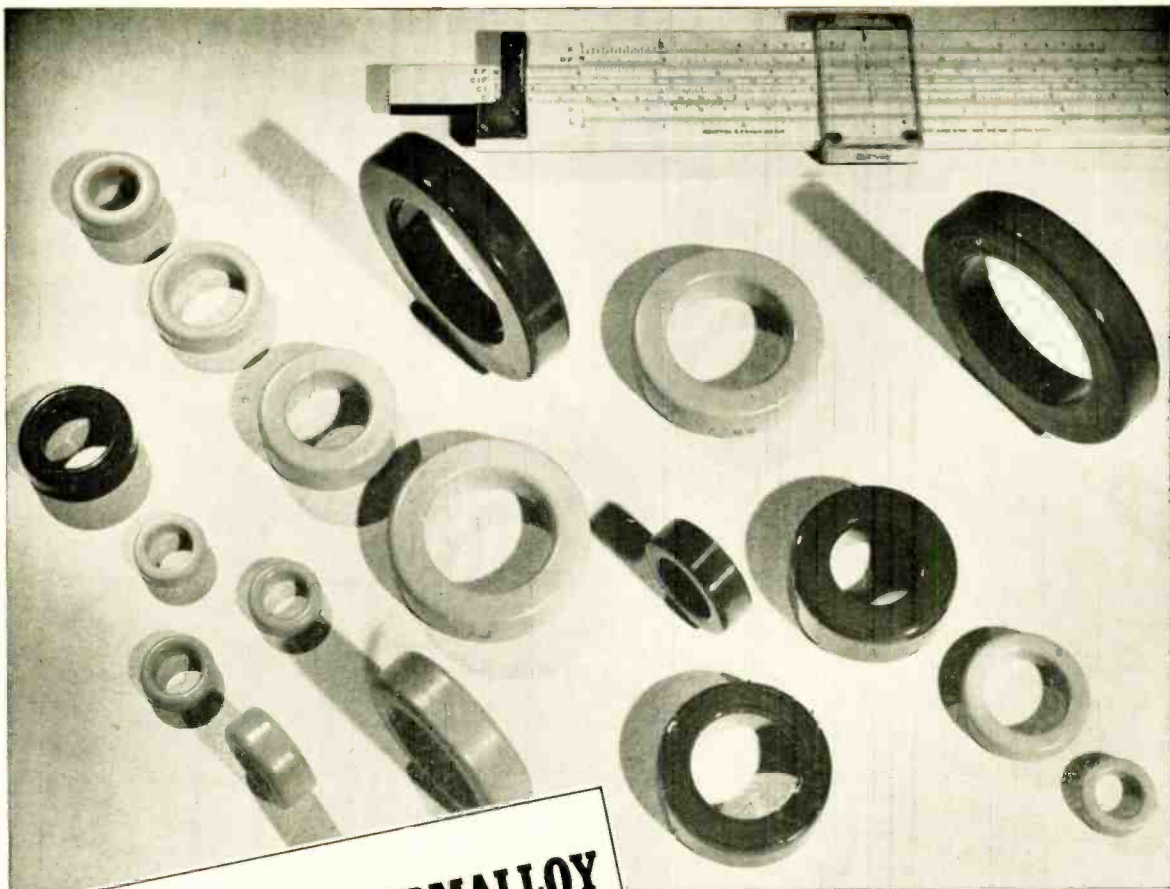

**MOLYBDENUM PERMALLOY
POWDER CORES***
(New technical data now available)

**HIGH Q TOROIDS for use in
Loading Coils, Filters, Broadband
Carrier Systems and Networks—
for frequencies up to 200 K C**

**COMPLETE LINE OF CORES
TO MEET YOUR NEEDS**

- ★ Furnished in four standard permeabilities—125, 60, 26 and 14.
- ★ Available in a wide range of sizes to obtain nominal inductances as high as 281 mh/1000 turns.
- ★ These toroidal cores are given various types of enamel and varnish finishes, some of which permit winding with heavy Formex insulated wire without supplementary insulation over the core.

For high Q in a small volume, characterized by low eddy current and hysteresis losses, ARNOLD Moly Permalloy Powder Toroidal Cores are commercially available to meet high standards of physical and electrical requirements. They provide constant permeability over a wide range of flux density. The 125 Mu cores are recommended for use up to 15 kc, 60 Mu at 10 to 50 kc, 26 Mu at 30 to 75 kc, and 14 Mu at 50 to 200 kc. Many of these cores may be furnished stabilized to provide constant permeability ($\pm 0.1\%$) over a specific temperature range.

*Manufactured under license arrangements with Western Electric Company

W&D 4127

THE ARNOLD ENGINEERING COMPANY
SUBSIDIARY OF ALLEGHENY LUDLUM STEEL CORPORATION
General Office & Plant: Marengo, Illinois

the new sub-miniature

CANNON PLUGS

tiny but rugged

Series D Cannon Plugs satisfy a long felt need of the Electronics Industry for a sturdy, versatile and extremely compact connector for use on miniaturized equipment of all kinds. These may be mounted as (1) rack and panel (2) box (3) wall, or (4) cord connectors. Junction shells with integral clamps protect the terminal ends of the connector when used as cord or wall mounted units.

Contacts are of the quality you expect to find in any Cannon Plug. Machined from copper base alloy, gold plated, they accommodate #20 or #22 AWG stranded wire. Rated

capacity 5 amps. High dielectric insulators. Minimum flashover, 1000 volts rms. The protective steel shells provide an integral mounting flange. The "keystone" shape of the shells gives positive polarization with friction type engagement.

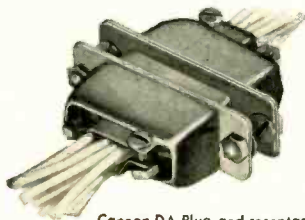

Cannon DA Plug and receptacle with junction shells.

CANNON DD
50 contacts

CANNON DC
37 contacts

CANNON DB
25 contacts

CANNON DA
15 contacts

RADIO COMPONENT OR INSTRUMENT

The 1/2-scale drawing above shows the new DA with 15 #22 contacts and junction shell compared with AN plug and receptacle having 14 #16 contacts and cable clamp. Saving of space outside the supporting unit is 1 1/2". The saving inside is 5/32". A side view of the DA would make the comparison even more startling.

For further information and performance data request Bulletin D-1.

CANNON ELECTRIC

SINCE 1915. Factories in Los Angeles, Toronto, New Haven, Benton Harbor. Representatives in principal cities. Address inquiries to Cannon Electric Company, Dept. F-109, P. O. Box 75, Lincoln Heights Station, Los Angeles 31, California.

NEW LITERATURE

● **RCA Victor Division of Radio Corporation of America**, Camden 2, N. J. has issued a new brochure entitled "The Electron Microscope at Work in Industry." Published to mark the tenth anniversary of the RCA electron microscope, the attractive two-color booklet is profusely illustrated, and describes in detail ten case histories in which the device aided in solving problems of quality control, product improvement, and new-product development. Copy may be obtained by writing for Form 2R8195. Address Scientific Instrument Section.

● **Riverside Manufacturing and Electrical Supply Company**, Dearborn, Mich. is offering free a brochure describing and picturing various products the company has designed and produced. Included are wiring harnesses and assemblies, cord sets, waterproofed toggle switches, sealed relay enclosures, and molded plastic and rubber components. Also described are the company's engineering service and its production facilities.

● **Keithley Instruments**, Dept. 205, 3868 Carnegie Ave., Cleveland 15, Ohio, is releasing a new eight-page bulletin which describes and illustrates the company's entire line of vacuum-tube electrometers. Included are instruments designed for a wide range of unique measurement functions. Application diagrams cover 17 basic uses.

● **Radio Club of America, Inc.**, 11 W. 42nd St., New York 17, N. Y. is making available to interested persons an 88-page booklet titled "Survey of Radio-Frequency Transmission Lines and Wave Guides," by E. S. Winlund. Issued as Vol. 28, No. 2, of the Club's Proceedings, it contains an excellent historical survey as well as technical data gathered from articles published between 1910 and 1936. Included also is an extensive bibliography. Requests for copy must include remittance of \$1.50.

● **Insulation Manufacturers Corporation**, 565 Washington Blvd., Chicago 6, Ill. presents practical information on characteristics, uses, and technical data for Permacel pressure-sensitive electrical tapes in a new 16-page illustrated catalog. Also included is a special section on non-electrical tapes. This book should be in the hands of everyone whose occupation calls for use of pressure-sensitive tape, both electrical and non-electrical. Requests should be addressed in care of Publications Department.

● **RCA Tube Department**, Harrison, N. J. is circulating through distributors a novel, 110p-type index designed to place basic performance and mounting information on RCA replacement radio and TV speakers at the fingertips of dealers and servicemen. Less than six inches square, the index provides data necessary for the selection and installation of 22 different types of RCA speakers. Included are such performance data as voice-coil impedance, power-handling capacity and resonant frequency, as well as dimensional drawings and photographs.

● **W. H. Brady Company**, Dept. 86, 1630 E. Spring St., Chippewa Falls, Wis., manufacturers of pressure-sensitive tapes and markers, is distributing a new 50-page products catalog illustrating and describing such items as wire markers, pipe markers, safety signs, reflective signs, masks and stencils, and printed roll tape. Prices are also included. Production engineers will find many ways of saving money wherever labeling is required. Copy will be mailed to interested parties on request.

● **Kato Engineering Co.**, Mankato, Minn., will mail without charge a four-page folder describing the company's complete line of a.c. generators, ringing-power machines, motor-generators, rotary converters, and gas-engine power plants. Kato equipment covers a wide range of power and frequency requirements—as a result this folder should be in the hands of every industrial engineer.

● **Littelfuse, Inc.**, 1865 Miner St., Des Plaines, Ill., is now issuing the first completely-illustrated price listing of fuses for various electronic applications. The four-page sheet includes full-size drawings of 25 fuse types, together with blowing characteristics. By matching a blown fuse with the corresponding picture on the chart, the jobber salesman or serviceman can determine with accuracy the correct replacement.

"These 3 for TV"

GATES offers three speech input consoles that fully meet every TV need. Whether you select the ultra complete SA-50 dual channel equipment, the much used SA-40 single channel console, or the very popular 52-CS studioette, you can be certain of top quality through advanced GATES engineering. For 30 years now, GATES has been building fine speech equipment — and for TV there is nothing finer!

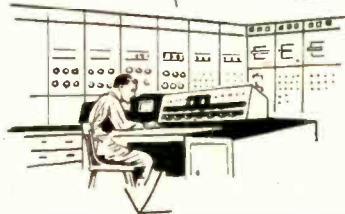

GATES SA-50 Dual Channel Console . . .

Nine mixing channels, dual program amplifiers, dual V. U. meters, 10 watt monitoring amplifier, self-contained cueing amplifier, five preamplifiers with room for two more where required. Complete remote, override, cueing and talk back facilities. Extremely low cross talk combined with high gain. Deluxe equipment all the way!

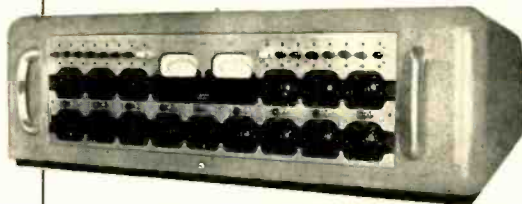

GATES 52-CS Studioette . . .

All GATES consoles have the same top quality components. This popular, modestly priced console is made possible by combining functions through key control. Many TV stations will prefer to use several 52-CS Studioettes instead of a single larger console. Every progressive TV engineer will find it worth while to investigate the 52-CS Studioette!

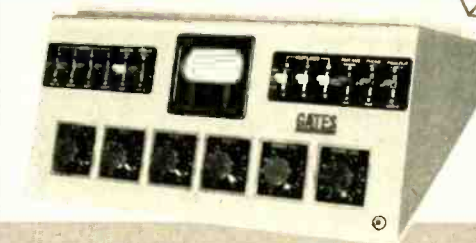

GATES SA-40 Single Channel Console . . .

Perhaps the most used speech input console in TV and radio today. Nine mixing channels, wide circuit selection, low cross talk, high gain and extreme ease of servicing are but a few of the SA-40's many features. GATES will gladly send detailed circuit data on request.



GATES Speech Input Catalog — Yours for the asking is a 44-page catalog on GATES speech equipment plus a new 12-page brochure on remote control apparatus. No obligation, of course. Why not write now?

SALES OFFICES

2700 Polk Avenue, Houston, Texas • Warner Building, Washington D. C.
International Division, 13 E. 40th St., New York City • Canadian Martoni
Company, Montreal, Quebec

GATES

GATES RADIO COMPANY

manufacturing engineers since 1922

QUINCY, ILLINOIS, U. S. A.

EDITOR'S REPORT

PICKUP POWER

AUDIO PEOPLE are wont to congregate and talk—endlessly it seems. But what audio man wouldn't talk as long as he could find anyone to listen to him? And with so much talk, new ideas and interesting controversies are sure to be brought to light occasionally.

Such a point arose during a conversation with a reader recently during some otherwise aimless surmising about phonograph pickups. The question—is there any difference in the loading on a pickup when the grid resistor of the first tube is of a low value, as compared to the same pickup working into an unloaded grid?

The subject developed following a discussion of the usual practice of shipping microammeters with a shorting wire across the terminals to damp the movement so that the shaking up that such an instrument gets during handling and shipping will not injure the moving coil and its bearings. Since a certain amount of power is consumed by the low-resistance shunt, and since this power is generated by the movement of the coil in the meter, it follows that the moving coil is damped critically, or even more; consequently, the pointer is not bounced around as much as it would be without the shunt.

Getting back to audio, it was suggested that perhaps a pickup would perform better without the loading resistor, although the resistor serves another purpose primarily. Considering a hypothetical pickup which generates a signal of, let us say, fifty millivolts—about the maximum of any current magnetic pickups—and delivers this signal to a 27,000-ohm grid resistor, we find that the power consumed in the resistor is slightly less than one-tenth of a microwatt. Next we began to get curious about the amount of power consumed by moving the stylus against its spring, and it was suggested that while some power is required to accelerate the stylus from rest to its maximum velocity in one direction, part of this power is returned to the record by the spring. Then we got bogged down in mathematics and changed the subject. Any solutions will be appreciated.

ULTRA-LINEAR AMPLIFIER

Some months ago, we mentioned trying out our own version of this circuit which is rapidly growing in popularity. We must admit that our patience gave out before we succeeded in making the cross-coupled phase splitter work to our satisfaction. However, we did convert our Musician's Amplifier, and we are "hobbling" along on that for the present.

"Hobbling" is actually a misnomer—since the con-

verted Musician's Amplifier is noticeably superior to the original design. We were quite skeptical, it must be admitted, when we first read the original article about the U-L amplifier, because it appeared that the measurements were not indicative of too great an improvement in distortion, and resulted in a relatively small increase in power output. Furthermore, the U-L's designers claimed that it "sounded better"—a purely subjective reaction. Anyhow, we tried it out and it *does* sound better.

The conversion to the Musician's Amplifier was suggested to us by Bill Shrader, who has been writing for *Æ* lately, and the change was so simple that it can be made in less than ten minutes—after you get the amplifier on the workbench. Mel Sprinkle and Dave Sarser, the designers of the Musician's Amplifier, have favored us with an article on this conversion—which will appear next month. However, we haven't given up on the cross-coupled phase splitter—but we are beginning to wonder if this device is as good as claimed.

TAPE EXCHANGE

We are asked from time to time if we know of anyone who has good tape recordings to exchange, and while we know a number of people who have good tape machines, we haven't found most of them willing to part with their most prized recordings. And on this same subject, we are amazed at just how many private individuals—people who have no professional use for the highest quality of equipment—have two, repeat two, studio model tape recording consoles. There is a definite advantage to having two machines—such as the ability to make dubbings, or to record a long program without breaks, or any such tricks as one might care to dream up, but we can't help but be surprised at how many of our acquaintances have two such machines.

Oh well, some people go in for trout fishing.

CATALOG DELAYS

Several readers will undoubtedly be disappointed in not receiving the Recording and Phono Equipment booklet which was offered in the May issue and again this month. When the requests come from *Æ*'s subscribers, it is not difficult to look up their addresses in case they write on a postcard and omit this important information—but when newsstand buyers request the booklets, we have no crystal ball to give us the mailing address. If you experience too much delay in receiving your copy, please write again—and please include your address in full.

THE **3** B'S... BEETHOVEN, BRAHMS AND BACH

they're different

they're improved

they're better than ever!



Yes, Bach, Beethoven and Brahms are now better than ever—we don't mean we've improved their music, but we do mean we've improved the reproduction of their recorded music.

It's the new, improved Pickering Cartridges that give credence to this claim. Yes, Pickering Cartridges are different. They're improved. They're better than ever. Pickering patented Cartridges with Dynamic Coupling* are superior in every way, by providing . . .

HIGHER FREQUENCY RESPONSE • NEGLIGIBLE INTERMODULATION DISTORTION • BETTER TRACKING CHARACTERISTICS

REMEMBER Pickering engineers and designers have but one objective . . . to produce products that will please the music lovers' insatiable appetite for the flawless recreation of recorded music . . . for the utmost in quality insist upon Pickering Audio Components. . . . Pickering diamond stylus cartridges . . . not only wear longer but, more important, they preserve the musical quality and prolong the life of your record library.

* *dynamic coupling*
assures

- constant stylus contact with the record grooves over the entire audio spectrum (20-20,000 cps)
- full frequency response • full transient response
- NO RESONANCES • NO MISTRACKING • NO GRINDING OF GROOVE WALLS

PICKERING *and company, incorporated*



• Pickering High Fidelity Components are available through leading Radio Parts distributors everywhere; detailed literature sent upon request. Address Department A

Oceanside, L. I., New York



THE TRANSISTOR

A picture report of progress



FIRST TRANSISTORS were of this point contact type (picture three times life size). Current is amplified as it flows between wires through a wafer of germanium metal. These transistors are now being made at the Allentown plant of Western Electric, manufacturing unit of the Bell System. They will be used in a new selector which finds the best routes for calls in Long Distance dialing.

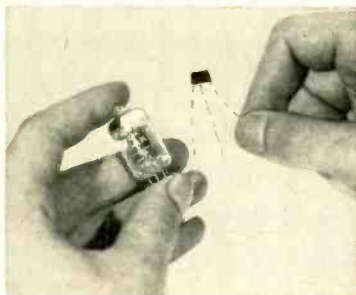

NEW JUNCTION TRANSISTORS, still experimental, also use germanium but have no point contacts. Current is amplified as it flows through germanium "sandwich"—an electron-poor layer of the metal between two electron-rich ends. This new transistor runs on as little as *one-millionth* of the power of small vacuum tubes.



MUCH HAD TO BE LEARNED, especially about the surface of germanium and the effect of one part in a million of alloying materials. Transistors promise many uses—as amplifiers, oscillators, modulators...for Local and Long Distance switching...to count electrical pulses.



ASSEMBLY PROBLEMS, such as fixing hair-thin wires to barely visible germanium wafers, have been solved through new tools and mechanized techniques. Finished transistors withstand great vibration and shock. Engineers see many opportunities for these rugged devices in national defense.



MOIST PAPER AND COIN generate enough current to drive audio oscillator using junction transistors. Half as big as a penny matchbox, an experimental two-stage transistor amplifier does the work of miniature-tube amplifiers ten times larger.

A tiny amplifying device first announced by Bell Telephone Laboratories in 1948 is about to appear as a versatile element in telephony.

Each step in the work on the transistor... from original theory to initial production technique... has been carried on within the Laboratories. Thus, Bell scientists demonstrate again how their skills in many fields, from theoretical physics to production engineering, help improve telephone service.

BELL TELEPHONE LABORATORIES

Improving telephone service for America provides careers for creative men in scientific and technical fields.



Planning and Building a Radio Studio

EUGENE F. CORIELL*

Major, USAF

Part I. Beginning a series devoted to the design and construction of a broadcast or recording studio following every step from preliminary planning to the first program on the air.

SOONER OR LATER, many broadcast engineers find themselves faced with the design and construction of radio studio facilities. It is the purpose of this series of articles to consider some of the problems involved in the planning and the construction of a studio installation. The points to be covered include: physical layout; acoustics; heating, ventilating and air-conditioning; construction problems; cooperation with the architect and the contractor; electric power considerations; audio block diagram; jack-field and rack layout; conduit diagrams, running sheets and inter-connection sheets; and tests of the completed installation. These articles do not cover transmitter facilities, and they begin at the point where the location of the studio building has been selected.

The writer wishes to acknowledge the pioneer writings in this field by Mr. John D. Colvin of Commercial Radio-Sound Corporation, whose articles in *AUDIO ENGINEERING* for July, August and September, 1947, were the basis for several studios built by the author and are also the basis for much of the audio layout portion of the present series.

It should be emphasized that the safest—and in the long run the cheapest—plan is to work closely with an architect

* *Technical Officer (Radio), Armed Forces Information School, Fort Slocum, N. Y.*

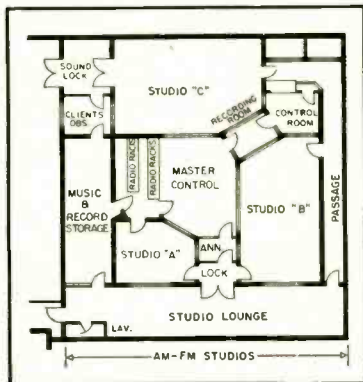

Fig. 1. Layout of AM-FM studios of WDSU, New Orleans. Note that all audio spaces except Studio C are completely surrounded by corridors, storeroom, etc., effectively isolating these spaces from outdoor noise.

Control Room "B,"
Armed Forces Information School, Fort Slocum, New Rochelle, N. Y.
(Official Defense Department Photo)



experienced in the studio field. His years in this highly specialized area are good insurance against the costly mistakes of inexperienced design in structural matters and physical layout. Equally important, the architect is familiar with local building codes, safety requirements, and the laws governing public buildings. Such provisions almost always apply to studio structures. However, since the architect is apt to rely on the station engineer as his contact with the management, the writer feels the data herein on layout and construction should be helpful to the audio man on his first station-building job.

The number, size, layout, and equipment of studios and supporting facilities ought to depend on the programming policies of the station. Is the station to ride the net most of the time? Or will the station be a big network-owned or comparable independent operation? If the former, there probably will be the barest minimum facilities for local live originations. If the latter, the programming will require facilities for full-scale musical and dramatic presentations, involving big studios, critical acoustic and spatial considerations, master control, etc.

Somewhere between these extremes are the programming arrangements for any station. The chief engineer should have the complete and final story on programming policies early enough to permit him to work up layout sketches and construction notes for the architect

who will draw the building plans. Sometimes, the chief engineer is given this programming information in final form and in good time, and sometimes, alas, he isn't. What started out as an announcer-and-separate-engineer arrangement with announcer-operated turntables in the studio is sometimes switched in the middle of construction to a one-man combination arrangement—with a recording rack and two cutting tables squeezed into the control room for good measure. Changes like this give the engineer ulcers, run the costs far above the estimates, and often result in an unsatisfactory layout.

Assuming that the programming policies are set, the first thing to do in planning the physical plant is to list the various spaces required, including offices and other non-technical areas. These latter are not, strictly speaking, the chief engineer's responsibility. However, as probably the only technical man of the station management group, he will almost certainly find himself the follow-up man—if not the layout man—for the entire construction project.

The spaces involved include some or all of the following: Studios, control rooms, master control, news room, auditorium, sound effects storage, recording room, disc and tape libraries, shop, supply room, clients' booths, offices for executives and for personnel of program, sales, continuity, traffic, and book-keeping departments; wash rooms and dressing rooms, employees' lounges,

lobby, reception rooms, corridors, machinery room for air-conditioners, blowers, pumps, etc.; transformer vault, and miscellaneous storage . . . and let's not forget space for stairs, elevators, closets and sound locks.

Studio sizes are determined by the requirements of staff, talent, audience and equipment. For musical studios, there are also optimum values of room volume given in the literature.¹ As regards studio proportions, avoidance of standing waves calls for an approximation of certain ratios among height, width, and length. These ratios cannot always be attained because of space limitations, and in the case of small speech studios are sometimes not important. However, for music studios, these ratios should be followed as closely as possible. These points will be discussed in greater detail in the section on acoustics.

Control room size cannot always be determined accurately until both the equipment and its physical disposition in the room are known. This is because there is always some waste space due to door swing, stairs, observation windows, operating and maintenance clearances, etc.; and various layouts of identical equipment involve different amounts of such waste space. The layout is determined by the number of studios served, window locations, sight lines into studios and other adjacent rooms, presence of producers and other non-technical personnel such as guests; presence of turntables and their expected use as transcription players, disc jockey facilities, or standby gear; number of racks, type of console, and possible use of a floor raised above that of the studio. This last is prompted by a desire to bring the eyes of the seated control operator and producer level with those

of a standing cast or orchestra conductor (on his podium).

The control room is laid out to scale on cross section paper and only after a lot of cut and try does an apparently firm layout appear dimly through the erasure smudges. It's a good idea to test this layout by making up a rough three-dimensional scale model. This mock-up will give a good check on such points as ease of entrance and exit, adequate working space in front of the gear and maintenance access in back of it, convenient placement of the equipment where it can be reached or watched with minimum arm-stretching and neck-twisting, and the amount of waste space involved. This last is quite important, especially in high-cost metropolitan areas, since rental varies as the square and construction costs as the cube.

Most of the control room factors above also apply to master control, along with some other considerations. Sometimes, this room is to be visible to visitors as a show-piece, in which case a whole wall must be given over to a large observation window. More often, the master control is simply one of the studio control rooms with a switching console alongside the studio board. This is almost always the case with smaller stations and sometimes requires visual contact with all studios. In larger plants, master control sits in remote dignity far from the bustle and tension of studio control rooms. In addition to switching and monitoring facilities for incoming and outgoing lines, master control sometimes contains standby turntables, spare amplifiers, and test instruments such as gain set, audio oscillator, etc. However, the presence of this gear need not unduly complicate the room layout since most of these items are used infrequently as compared to the operating equipment and can therefore be located in spaces not adapted to the latter.

If recording is not to be a major

activity, occasional recordings can be made on equipment sandwiched into the control room. This is especially true if only tape equipment is involved, since this can be mounted in a modest area of rack panel space. Disc recorders require floor space, suction gear and often privacy where the harassed technician can swear feelingly while performing the wizardry sometimes needed to get a clean, quiet cut. On the other hand, if recording is to be a major station activity, it deserves adequate space and convenient layout. Space is required for both tape and disc recorders, including spares. Utility playback turntables and tape editing gear must often be accommodated, along with racks containing amplifiers, radio tuners, limiters, distribution panels, and other control equipment. There is sometimes need for a

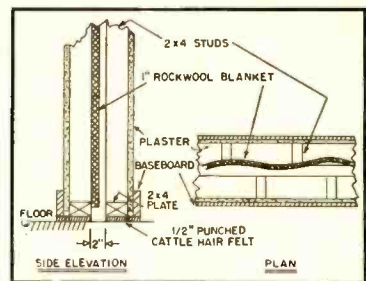

Fig. 3. Detail of staggered-stud wall.

desk and always need for storage space for tape and disc supplies. Since tape is sensitive to magnetic fields, tape storage facilities should not be located near 60-cps power distribution transformers or other sources of a.c. fields. The layout should provide space for simultaneous operation of most or all the equipment, and adequate space for maintenance access behind the racks. A common arrangement is to place the recorders along opposite sides of a room longer

¹ J. P. Maxfield, "Liveness in broadcasting," *Western Electric Oscillator*, January 1947.

| TYPE OF CONSTRUCTION | WEIGHT IN LBS PER SQUARE FOOT | AVERAGE DB ISOLATION FOR 128 - 4096 CYCLES |
|---|-------------------------------|--|
| SINGLE 2x4 STUD, PLASTERED ON BOTH SIDES | 19 | 30 |
| STAGGERED 2x4 STUD, ONE-INCH ROCK WOOL BLANKET FASTENED LOOSELY TO INNER EDGES OF ONE ROW OF STUDS, PLASTERED ON BOTH OUTER SIDES | 23 | 50 |
| SINGLE SOLID 6" CINDER BLOCK PLASTERED ON BOTH SIDES | 45 | 48 |
| DOUBLE SOLID 6" CINDER BLOCK, 6" AIR SPACE BETWEEN, PLASTERED ON BOTH OUTER SIDES | 90 | 60 |
| SINGLE HOLLOW 4" CINDER BLOCK PLASTERED ON BOTH SIDES | 30 | 39 |

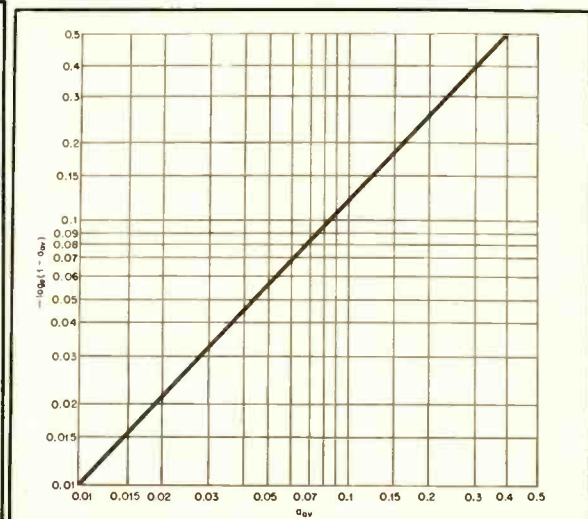

Fig. 2 (left). Wall isolation (transmission loss) values. Data are based on high-grade workmanship in construction. Fig. 4 (right). Curve showing the values of $-\log(1-a)$ of the Eyring reverberation-time formula in terms of a .

than it is wide, with equipment racks and perhaps a supervisor's desk at one end. The recording room should be free from building vibration. It should be air-conditioned, dust-conditioned, and held to close limits of temperature and humidity.

The maintenance shop should not be short-changed as to size. Stations grow, and the bench space in some dark corner deemed adequate for a part-time repair man becomes painfully inadequate for the full-timer plus spare parts, sound effects gear, and the usual miscellany that generally finds its way there. By the time you get around to enlarging the shop, any spare space that may once have been there will have been commandeered for the librarian—or for the ladies room that was somehow omitted from the original plans.

Spaces not so far considered are mainly the non-technical areas—news rooms, offices, etc. These are not ordinarily the responsibility of the chief engineer, as mentioned earlier, and are best left in the hands of the architect, except perhaps for one point: In the process of fitting together the various and sometimes conflicting claims of the programming, technical, and clerical departments, something has to give. May it not be the audio spaces. This pious hope brings up some general layout principles.

Put offices, corridors and other non-audio spaces between the outside walls and the studios, to minimize transmission of outdoor noises. Keep doors of adjacent studios as far apart as possible to reduce transmission between them. For the same reason, studios opening on opposite sides of a corridor should have their doors staggered rather than directly opposed.

Visualize the traffic patterns of the layout. It should be possible to go to or from any studio or control room without going through others, and without brushing shoulders with those you meet on the way. Entrances to studios and control rooms should be sound locks whenever space permits. In so far as possible, the principal flow of house

Fig. 7. Preferred studio dimensions and ratios of width and length. (Chart courtesy RCA).

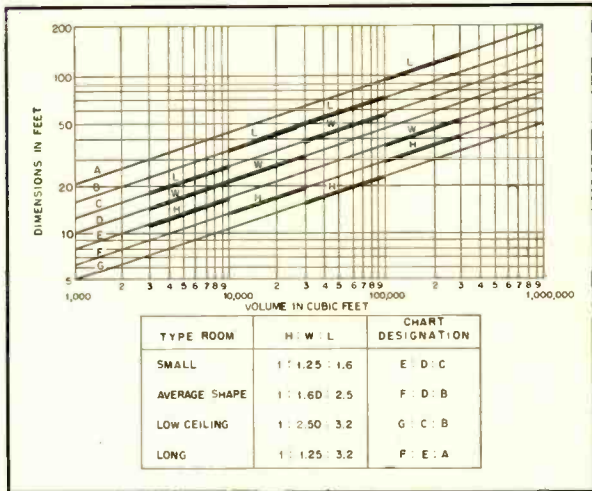

traffic should be kept separate from that of outsiders such as salesmen, studio audience guests, etc. The radio portion of the AM-FM-TV studio facilities of WDSU shown in Fig. 1 illustrates many of these principles.

In figuring floor space layouts, remember that dividing walls and air-conditioning column ducts have thickness. For example, a double six-inch cinder block wall containing a six-inch air space and finished on both sides with plaster and baseboards takes up the better part of two feet. In this connection, make sure your layouts show the architect the finished dimensions of the various spaces, labelled as such. The writer once nearly wound up with a control room glass twelve inches out of position because he failed to allow sufficiently for differences between rough and finished dimensions, and between nominal and actual measurements.

Plan for future expansion, and for the direction it should take. This latter may take some doing, but you don't have to be a prophet to know that the separate recording room in your future is going to go in the space you've allowed for it—that is, if you have allowed for it.

The point is that much of a station's growth can be anticipated and can therefore be considered in the evaluation of the space before rental or purchase, and allowed for in the original layout. It is also generally wise to allow for expansion when installing the initial electrical, heating and air-conditioning services. These should provide not only for adequate future capacity but also for accessibility of taps. It's a lot easier to connect future facilities to a duct turn-off brought out through the wall for the purpose and capped, than to tear into finished masonry and ductwork. It's true that such initial planning for the future is expensive, but it's a lot less so than the cost of unforeseen and therefore uncontrolled growth.

Acoustics

The acoustic phase of studio planning can best be handled by a professional consultant in this field. Some acoustic materials firms offer design services, materials, and installation as a package deal. Any extra costs under this arrangement can be considered as insurance against unsatisfactory acoustic [Continued on page 39]

| SURFACE | AREA SO. FT. | COEFF. | 1024 CYCLES TOTAL ABSORPTION SABINS | CALCULATED VALUES |
|--|--------------|--------|-------------------------------------|-------------------|
| CEILING (MATERIAL "ALPHA") | 476 | .30 | 143 | |
| WALLS (MATERIAL "ALPHA") | 870 | .30 | 261 | |
| GLASS | 30 | .04 | 1.2 | |
| FLOOR (MATERIAL "BETA") | 476 | .05 | 23.8 | |
| TOTAL SURFACE S | 1852 | | | |
| OCCUPANTS (5) @ 4 SABINS ea. | | | 20 | |
| TOTAL ABSORPTION (SABINS) | | | | 449 |
| VALUE OF α IN EYRING FORMULA (+ TOTAL ABSORPTION / S) | | | | .24 |
| $\log_e(1 - \alpha)$ | | | | .27 |
| $\log_e(1 - \alpha)S$ | | | | 507 |
| ROOM VOLUME In cubic feet V | | | | 4760 |
| REVERBERATION TIME - SECONDS ($\equiv \frac{.049 V}{-\log_e(1 - \alpha)S}$) | | | | .46 |

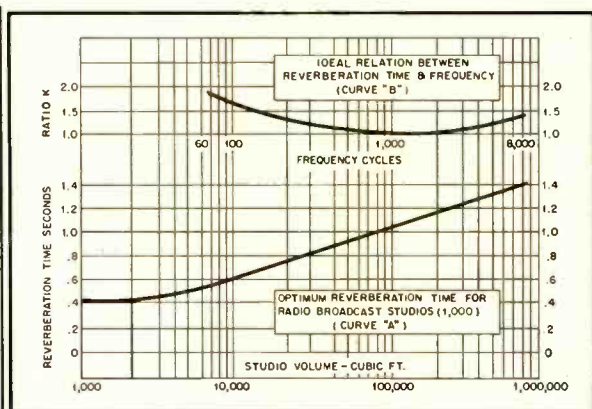

Fig. 5 (left). Sample calculation of 1000-cps reverberation time for studio 10 ft. high, 17 ft. wide, and 28 ft. long. Calculations are of sliderule accuracy. Log term was taken from Fig. 4. Fig. 6 (right). Morris-Nixon curves. The optimum reverberation time at any frequency can be computed by selecting the 1000-cps value from Curve A and multiplying it by the appropriate value of K from Curve B. (Redrawn from the Johns-Manville pamphlet "The Control of Sound in Broadcasting Studios.")

Handbook of Sound Reproduction

EDGAR M. VILLCHUR*

Beginning a fundamental reference work on all the aspects of sound reproduction, which will run serially until completion. The author covers the sound wave—the basic form of all sound—in this first installment.

Chapter 1—The Sound Wave

It is, of course, necessary to understand the nature of that which we wish to reproduce before discussing the technique of reproduction.

The sound wave is an impulse, traveling in an elastic medium, which causes the particles of the medium in its path to vibrate longitudinally, that is, back and forth along the path. In the course of this vibration the particles alternately crowd together and spread apart, creating areas in the medium which are in turn compressed and rarefied.

The source of sound is what Newton called a "tremulous body"—a vibrating string, diaphragm, or some similar device—which first pushes away the particles of air (or other medium) onto their adjacent neighbors, then draws back to form a slight vacuum. The area of intensified pressure exerts a repelling force on particles further from the source, making them in turn to crowd together and the pressure area to move; the rarefied air exerts a pulling force on neighboring molecules further from the source, and in bringing these in to fill the partial vacuum creates a new rarefaction further out. Thus the wave moves away from the source, but the particles of the transmission medium only vibrate, and never get anywhere.

If we were to analyze the pressure state of the medium a short while after the source had started to vibrate we might see a condition such as that illustrated at (A) in Fig. 1-1. This figure represents the pressure state pictorially. The condition of the medium may also be accurately represented symbolically by a graph, as at (B) in Fig. 1-1, where points of maximum pressure are recorded by the graph peaks, points of normal pressure by crossing of the horizontal axis, and points of maximum rarefaction by the troughs.

The pressure and rarefaction areas of Fig. 1-1 are moving away from the source. We could install a pressure meter at any one point in the path and we would find the alterations recorded with respect to time. It is therefore possible, and it is customary in representing sound waves, to use units of time rather than of distance as the horizontal axis. In other words we represent the activity of the medium at one point over a period of time, rather than concern ourselves with a whole section of the medium at one instant of time.

* Contributing Editor, AUDIO ENGINEERING.

Although the graphical representation of a sound wave physically resembles the pictorial representation of an ocean wave the two should not be confused. An ocean wave is of the *transverse* type (see Fig. 1-2); the medium particles vibrate in a direction perpendicular to the direction of travel of the wave itself. It is for this reason that the pictorial and graphical representation of the ocean wave have the same form. But since particles vibrating due to a sound wave do so in a line parallel to the direction of motion of the wave, sound waves are called *longitudinal*. Motion of the actual particle, referred to as its excursion, is very small. Ocean waves may displace the water dozens of feet, but most sources of sound have a maximum excursion of a small fraction of an inch, and by the time the sound wave has reached our ears the molecules of air are only displaced by an amount which is in the range of $\frac{1}{4}$ billionth of an inch to about .01 inch.

Definitions

The following expressions may be defined in terms of the graph (B) of Fig. 1-1.

Amplitude—Values represented along the vertical scale of the graph, which in this case stand for pressure in the medium. Amplitude may also refer to the amount of displacement of the vibrating source or of particles of the medium. Maximum amplitude refers to peak or trough values; instantaneous amplitude refers to the value at any desired instant or point. This characteristic is most important in determining the sensation of loudness.

Cycle—One complete series of changes, in this case of medium density. The part of the graph between points *a* and *b* represents one cycle.

Frequency—The number of cycles occurring per second. This characteristic determines, for the most part, the sensation of pitch.

Period—The time taken up by one cycle. The period is the reciprocal of the frequency, or numerically equal to one over the frequency ($1/f$).

Periodicity—The repetition of a number of successive cycles, each having the same period, as in Fig. 1-3, so that a definite frequency may be assigned to the sound for a certain duration. A periodic sound has pitch, and can be hummed or played. It is the kind of sound from which music is constructed,

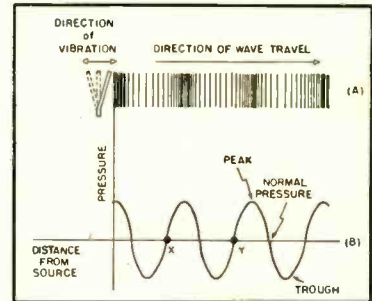

Fig. 1-1. (A) Pictorial representation of vibrating source of sound (without overtones) and the pressure state of the medium. (B) Graphical representation of the pressure state of the medium.

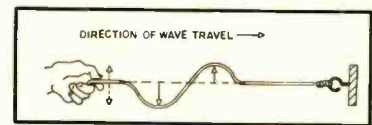

Fig. 1-2. A transverse mechanical wave traveling along a rope. The solid arrows indicate displacement of particles in the rope, the dotted arrows displacement of the source.

but periodicity is not to be confused with the regular repetition of sounds involved in rhythm. Non-periodic sound has no pitch and is called noise.

Phase—The relative position of the wave's graph along the horizontal axis. Two waves are said to be in phase if their peaks and troughs occur at the same point along the horizontal axis. They are said to be 180 deg. out of phase if the peak of one occurs at the same horizontal point as the trough of the other.

Wave Form—The shape of the wave. This characteristic determines, for the most part, the sensation of timbre or tone color. A sound wave of the pure sine form of (A) in Fig. 1-1 is unusual in nature, and has a very dead and uninteresting tone.

Wave Length—The physical distance in the medium between the peak or trough of one cycle of the wave and the corresponding point on the next cycle.

There is a definite relationship between the wave length and the frequency; in a given medium the higher the frequency the shorter the wave length, and vice versa.

The distance covered by a moving object is equal to the speed of the ob-

ject multiplied by the time elapsed. The wave length, the period, and the speed of sound may therefore be related as follows:

$$\lambda = V \times p = V/f$$

where λ = wavelength
 p = period
 V = velocity of sound
 f = frequency

The same curve as that of the graph (B) in Fig. 1-1, besides representing changes in medium density exactly as they occur, also describes the motion of the vibrating source which created those changes, or displacement of the vibrating particles of the transmission medium. Points of maximum pressure or rarefaction become points of maximum particle displacement away from or towards the source. It is obvious that greater pressure will be associated with greater displacement. The relationship between displacement and frequency is not as obvious, but assumes great importance in the study of mechanical devices like loudspeakers and pickups.

Oscillatory Motion

As the frequency of a vibrating source goes up the amount of displacement required to generate the same amount of sound power decreases proportionately, and, vice versa, the lower the frequency the greater the excursion required for the same power radiation. The actual average velocity of motion of the vibrating source thus remains constant for constant sound pressure, no matter what the frequency, a condition which will be referred to in a later chapter as "constant velocity." This is another way of saying that for equal sound energy at any frequency the mechanical energy of the source must remain the same.

The relationship between displacement and frequency, for the same sound power, may be expressed in simple form as follows:

$$\xi = \frac{K}{f}$$

where ξ = maximum displacement (during the period)
 f = frequency
 K = a constant

The graph of oscillatory motion of a source of sound or of particles of the medium may be expressed in a "wave equation." A form of this equation, and its derivation, appears in Appendix I. It describes displacement mathematically where we have here discussed it descriptively.

Electromagnetic waves such as light and radio waves differ in many respects from sound waves. They do not create changes in medium pressure but in "field" condition; the medium which transmits them, if such exists, is unknown; their frequencies are much higher than those of sound (light frequencies, for instance, are on the order of billions of times higher); the speed of electromagnetic waves is about 186,000 miles/sec, almost a million times greater than the speed of sound. Yet the design of the universe is such that the same wave equations apply to both types

INTRODUCTION

The Field of Audio

POPULAR INTEREST in high-fidelity reproducing equipment has become such that use of the technical jargon associated with audio matters is now widespread. Audio talk is often accompanied by impassioned opinions and preferences championing one or another brand, technique, or circuit. Devotion to the cause concerned, however, is often not matched by an equal degree of erudition.

The earliest audio engineers were the musical instrument makers. They were concerned with making devices which could produce pleasing sounds, sounds to evoke particular emotional responses. Along with the trade secrets handed down from one generation of craftsmen to the next were personal or traditional preferences for a particular tonal quality. For example, violins made by Guarneri tend to have a more robust sound than those of Stradivari. Lupo's instruments are known for their brilliance. Musical instruments have individual characters which may appeal to one performer or listener more than to another.

In an industry devoted not to the production of desirable sounds but to the duplication or re-production of sounds already created there is far less room for personal preferences. It is true that certain problems must involve personal factors. The problem of how close the fidelity of sound must be in a given reproducing system, or the problem of striking a balance in a necessarily imperfect system between one type of distortion and another, cannot be solved without taking taste into consideration. But most questions of concern to the audio technician must be answered without benefit of such preferences.

Nevertheless there are many popular legends and old wives' tales in the sound field. If we were to eavesdrop on the conversation (seemingly as esoteric as jive talk) between two audio initiates, we might hear the following:

"I just got a new woofer-tweeter."

"What's the fidelity?"

"30 to 13,000."

This conversation reflects two of the most common misconceptions in audio: one, that frequency response is practically synonymous with fidelity; and two, that frequency response is adequately described by a number or pair of numbers representing limits in the frequency spectrum. It will be seen that there are many factors, each one at least as important as frequency response, involved in the fidelity of sound reproduction, and that frequency response itself is a characteristic which cannot be described as simply as our audio friends have done; the variation between particular limits, for instance, often assumes more importance than the limits themselves.

It is hoped that the following pages, in addition to serving as a reference for various aspects of audio, will aid in providing an informed and rational approach to the field of sound reproduction. The subject matter will be divided into four main parts. Part 1 will deal with the basic nature of sound. Part 2 will discuss, in the light of Part 1, the requirements of faithful sound reproduction, and will include a brief historical survey of the phonograph. Part 3 will treat those aspects of recording which most directly influence reproducing procedures. Part 4, constituting the bulk of the work, will cover reproducing methods and components. The component parts of the reproducing system will be discussed in the same order as they are normally designed, from high level to low level. Thus room acoustics and loudspeaker systems will be considered first, and pickups and preamplifiers last.

TABLE I
VELOCITY OF SOUND

| Material | Velocity ft./sec |
|---------------------------|---------------------|
| Aluminum | 17,000 |
| Mahogany (with the grain) | 13,100 |
| Brick | 12,100 |
| Salt Water | 4,935 |
| Cellulose Acetate, molded | 4,300 |
| Hydrogen | 4,170 |
| Air, 20° C. | 1,130 |
| Air, 0° C. | 1,085 |

Chart of approximate sound velocities in different media. For data on other materials see: H. F. Olson, "Elements of Acoustical Engineering," 2nd ed., p. 8.

of energy, and sometimes problems concerning radio waves may be aided in solution by the use of parallels in sound. Experiments on antenna radiation patterns, for instance, have been conducted with a dummy antenna radiating sound instead of radio waves.

The vibrations of a source of sound are of two types, free and forced. Free vibrations occur when the source, after being given its initial stimulus, is allowed to vibrate at its own natural frequency, called the resonant frequency. A plucked string, or a cymbal responding to the blow of a drumstick, vibrate freely. The reeds of musical instruments or of human vocal chords also vibrate freely, even though a stream of air is continually directed against them, as the steady pressure of the air merely gives them the mechanical energy required, and does not determine the frequency of vibration.

When a source is subjected to forced vibration, on the other hand, not only is mechanical energy imparted to it, but control is exerted over the frequency and other characteristics of its oscillatory motion. The loudspeaker and the phonograph pickup are examples of devices subjected to forced vibration. In common with all mechanical systems they have resonant frequencies of their own, but they must vibrate in imitation of many different voices, and, like good actors, must submerge their own personalities in favor of the characters they play.

Appendix I

The Plane Wave Equation

The displacement of a vibrating source of sound (assuming no harmonic modes of vibration) at any instant of time is:

$$\xi = K \sin \omega t$$

Fig. 1-3. (A) Periodic wave energy (sound of a flute) composed of a fundamental and harmonics. (B) Non-periodic wave energy, composed of many random frequencies.

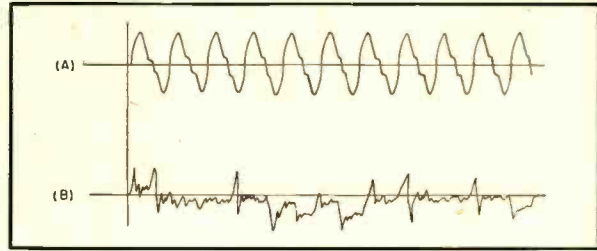

where ξ = displacement from rest position.

K = a constant (at a given power, and in a given medium).

$\omega = 2\pi \times$ the frequency.

t = time elapsed since source was at rest.

The sine function determines the wave form of a pure sound without overtones.

The expression ωt , or $2\pi ft$, is the number of degrees (in radian units)¹ that have been passed through in time t . The frequency, in cycles per second (cps), multiplied by the time, in seconds, gives us the number of cycles that have occurred during time t . 2π is the number of radians in one cycle. Thus:

$$\omega t = 2\pi \text{ radians/cycle} \times f \text{ cps} \times t \text{ sec.} \\ = 2\pi ft \text{ radians or } 360 ft \text{ deg.}$$

Multiplying t by ω converts the units of the horizontal scale from seconds to degrees. It is this conversion which allows us to use the sine function to give us the relative height of the graph at time t .

The height of the graph represents the displacement from rest relative to the extreme values for any sine function, 1 and -1. The term K will determine the absolute value of this displacement. Since maximum displacement on the relative scale is equal to 1 or -1, K must be numerically equal to the actual value of maximum displacement in centimeters or inches.

It is obvious that, for the same frequency, the greater the velocity of the source or particle the greater will be the displacement. V_{max} , the maximum velocity, may thus be used as an index of K , but it is nec-

¹ 1 radian = 57.3 deg.

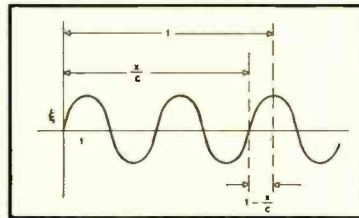

Fig. A

essary to adjust the units involved. Dividing V_{max} by ω accomplishes the required unit conversion,² and the equation becomes:

$$\xi = \frac{V_{max}}{\omega} \sin \omega t$$

V_{max}/ω , which is V_{max} expressed in cm./radian, is numerically equal to maximum displacement, and is the correct term for K .

The wave equation can be amended slightly to apply to a vibrating particle of the transmission medium at any distance from the source. The equation describing the behavior of such a particle is:

$$\xi = \frac{V_{max}}{\omega} \sin \omega(t - x/c)$$

Where x = distance of particle from source (with both particle and source at normal rest position)

c = velocity of sound

The expression x/c is the time required for the wave to reach the undisplaced particle (distance divided by velocity). This is $t = 0$ for the beginning of the particle's cycle. x/c subtracted from the total time elapsed, t , is the time elapsed since the particle went into vibration, as illustrated in Fig. A.

If we apply this equation to a particle in the source itself x/c is equal to zero and is eliminated, returning us to the original equation. The above equation is therefore a general one, applying either to the source or to particles of the medium.

² It can be shown, with the aid of more advanced mathematics, that V_{max} , in cm./radian, would be numerically equal to the maximum displacement:

$$\text{Let } \omega t = \theta \text{ radians} \\ \xi(\text{cm}) = K \sin \theta \\ \xi_{max} = K (\sin \theta)_{max} = K \\ V(\text{cm./radian}) = \frac{d\xi}{d\theta} = \frac{d}{d\theta} K \sin \theta = K \cos \theta \\ V_{max} = K (\cos \theta)_{max} = K \\ V_{max} = \xi_{max} \omega$$

V_{max} is converted from cm./second to cm./radian through dividing by ω . Multiplying units of time by ω , as we have seen, changes seconds to radians:

$$\frac{V_{max} \text{ cm./sec.}}{\omega \text{ radians/sec.}} = \frac{V_{max}}{\omega} \text{ cm./radian}$$

SCHIFINO PROMOTED

One of the audio industry's pioneers, A. G. "Tony" Schifino, has been elected an officer of the Stromberg-Carlson Company with the title of general manager of the Sound Equipment Division.

First with Stromberg-Carlson in 1929, Mr. Schifino operated his own business from 1931 to 1940 when he rejoined the company as sound engineer.

His latest promotion coincides with the introduction of the new Stromberg-Carlson line of high-quality custom sound equipment.

HARVEY REPEATS

For the second consecutive year, Harvey Radio Company has been chosen "Jobber of the Year" for the New York Metropolitan area, in an annual election conducted by *Parts Jobber* magazine. Voting participants are manufacturers' sales managers and factory representatives.

In acknowledging the unique honor, Harvey E. Sampson, president, stressed the important part audio and sound equipment had played in solidifying relations between the company and its suppliers and customers.

FINK JOINS PHILCO

Donald G. Fink, editor of *Electronics*, is joining the Philco Corporation, in an executive engineering capacity effective June 1.

In leaving *Electronics* Mr. Fink is resigning from the only job he has ever held. He assumed his first assignment with the magazine immediately after graduating from M. I. T. 18 years ago, and has been on its staff continuously except for a leave of absence during the war.

He is a member of ITAC and NTSC, as well as many professional societies.

The OTL (Output-Transformer-Less) Amplifier

VICTOR BROCINER* and GERALD SHIRLEY**

A survey of the possibilities for circuit arrangement to avoid the use of the output transformer in audio amplifiers—which may readily become the next big development in audio.

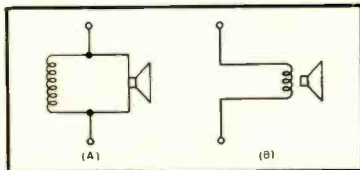

Fig. 1. Symbol proposed by the authors for high-impedance loudspeakers (A) compared with symbol used for conventional speakers (B).

FOR YEARS audio engineers and experimenters have been talking about the wonderful improvement in sound reproduction that *might* be obtained if the output transformer could be eliminated and the speaker¹ directly coupled to the output tubes of an amplifier. Recent developments in circuit and speaker design have at last combined to make this idea a practical reality.

In a paper presented at one of the technical sessions during the 1951 IRE Convention (March), a new single-ended push-pull output stage was first described by Sinclair and Peterson. In their paper the authors also accurately forecast the early advent of OTL amplifiers, pointing out that the only remaining problem was the development of speakers having impedances of several hundred ohms. Then at the 1951 Audio Fair (November) the first models of a new line of high-fidelity speakers with high-impedance voice coils were demonstrated by a leading speaker manufacturer. And almost simultaneously an article describing a complete OTL system was published in one of the technical journals.¹

Though most of the articles on amplifiers which appear in the literature are annoyingly redundant, the fact is that in the last five years the art of amplifier design and construction has advanced to a degree which few engineers would have believed possible in 1941 or, for that matter, in 1946 at the conclusion of active hostilities. Some of these advances will be incorporated in

or adapted to the OTL amplifier; others, perforce, will be abandoned. The subject of critical or optimum damping as related to speaker efficiency and acoustic loading has lately been receiving attention from various sources, and as further research brings the problems into clearer focus and begins to provide the needed answers, it can be assumed that both conventional audio systems and those using OTL amplifiers will benefit.

The chief and probably the only real victim of the technological progress represented in the development of the OTL amplifier is the OT—output transformer—itsself. In a way this is ironical

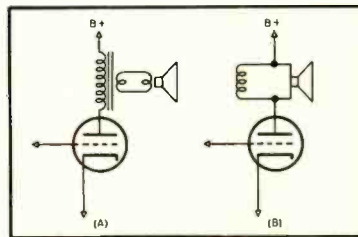

Fig. 2. Conventional single-ended output stage with low-impedance speaker (A) and with high-impedance speaker and no output transformer (B).

because the improvements that have been made in output transformers in the last few years have been startling indeed, and are, in fact, one of the chief factors in the aforementioned overall improvement in amplifier performance. Today there are transformers available which deliver full rated output from 8 or 10 cps to 100 kc or more within a couple of db, and with excellent square wave response at 20,000 cps. One is tempted to ask, "How close to perfection must we get?" The answer, of course, is, "As close as we can!" The elimination of any link in the chain of elements which makes up an audio reproduction system brings us that much closer to the goal of perfection.

In the past, improvements in overall amplifier performance were made without any particular reference to speaker performance. The amplifier was treated as an independent entity, and it could be assumed that with any given speaker or speaker system, the better the amplifier driving it, the better the reproduced sound. Development and improvement

of OTL amplifiers, however, is going to be paced mainly by the speaker manufacturers. The experimenter, designer and/or manufacturer of OTL amplifiers is going to have to base his choice of output tubes (and their number), single-ended or push-pull operation, direct coupling or shunt feed, etc., on what voice coil impedances are made available by the speaker manufacturers, and on whether center-tapped and perhaps multi-tapped voice coils can be made; also, possibly, secondary coils for feedback circuits. The tube manufacturers too can contribute to OTL progress by trying to develop higher permeance output tubes, both triode and beam-power, which require lower values of load impedance for proper matching.

In this article we will consider some of the various circuit configurations possible with OTL amplifiers. It is hoped that this will stimulate others in the audio field to start thinking about OTL amplifiers, building them and writing about them. It is important to find out as quickly as possible what are the optimum values of voice-coil impedance and the best configurations so that the speaker manufacturers can get started on the problems which they will have to solve when they try to meet the specifications theoretically required. Incidentally, the problem of designing speakers with sufficiently high impedance is made less difficult in certain cases where horn loading is employed, as this method causes the impedance looking into the voice coil to appear considerably higher.

Before beginning consideration of circuits, the authors would like to propose a new circuit symbol to represent a high-impedance speaker, as shown at (A) in Fig. 1. The chief difference between this symbol and the one used to depict a conventional, low impedance speaker, (B), is in the number of turns used to represent the voice coil. One

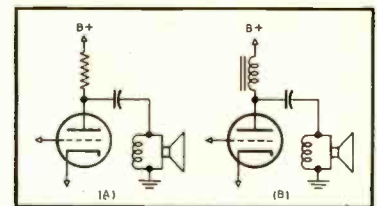

Fig. 3. Capacitance-coupled output stage may be shunt fed using resistor (A) or choke (B).

* Brociner Electronics Laboratory, 1546 Second Ave., New York 28, N. Y.

** Teleplex, 474 W. 238th St., New York 63, N. Y.

¹ Fletcher and Cooke, "Cathode-follower loudspeaker coupling," *Electronics*, Nov. 1951.

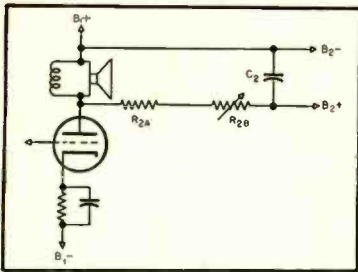

Fig. 4. D.c. bias on high-impedance speaker may be avoided by use of second B supply to buck out d.c. from main B supply.

other prefatory note: in all the illustrations where a single output tube is shown, it can be assumed that a plurality of tubes could be used in parallel so as to lower the value of the load impedance required in cases where speakers of sufficiently high impedance are not available. Similarly, push-pull stages can be elaborated into push-pull parallel operation to accomplish the same result.

Circuit Arrangements

The circuit illustrated at (A) in Fig. 2 is a conventional single-ended output stage in which the low impedance speaker is coupled to the output tube through a transformer. Assuming that this tube is properly matched with a 2000-ohm load and that we have available a speaker whose voice coil has a 2000-ohm impedance, the question is how to hook them up. The simplest and most direct method would be that shown at (B) in Fig. 2. Unfortunately, however, this method cannot be used because the d.c. flowing through the voice coil of the speaker will induce a magnetic field which will react with that of the speaker's own field, and cause the voice coil to move to a new reference or zero-voltage position which is off center both mechanically and magnetically. In this condition it is no longer a linear transducer and will produce distortion.

To keep d.c. out of the voice coil, we can use shunt feed as shown in Fig. 3. Each method has advantages and disadvantages. The resistor feed introduces no change in frequency response at either end of the spectrum. On the other hand, being in parallel with the load for a.c. means that useful output power will be wasted in the resistor. This loss can be reduced by using a larger resistor, but this means that a larger B supply must be provided. If carried too far it will also result in power loss caused by clipping due to the low ratio of a.c. load to d.c. load. By using a choke of sufficient inductance to permit shunt feed of the output tube, the amount of useful power dissipated in the shunt-feed element can be reduced to a negligible value and the need for an oversize B supply eliminated. But to maintain good response at the low end the inductance must be very large, distributed capacitance must be kept to a minimum to preserve performance at the high end, and it must be so constructed that there will be no core saturation. While a choke meeting these

specifications will not cost as much as a top quality output transformer, it will nevertheless be an item of expense and certainly cost considerably more than a resistor of the same power rating.

Using either a choke or resistor for shunt feed, there is still the coupling capacitor to contend with. Any leakage means that d.c. will be flowing through the voice coil, though this could be minimized by connecting the other end of the voice coil to B+ instead of to ground, which in the case of plate-loading would place a lower d.c. potential across the capacitor. Besides being frequency discriminative at the low end, the capacitor is also a significant item of expense. For a 500-ohm voice coil something around 100 μ f is a minimum requirement. Electrolytics are unsatisfactory for such application, and paper units of such large

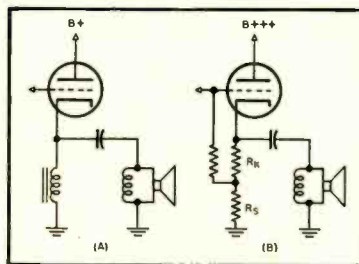

Fig. 5. Two methods of feeding high-impedance speaker from cathode of output stage.

capacitance are expensive. Distortion can also be introduced by hysteresis in the coupling capacitor. Direct coupling seems to be a desirable goal, from the standpoint of both cost and performance.

One method of making direct coupling possible—admittedly somewhat uneconomical—is shown in Fig. 4. Here there is an extra power supply which is completely isolated from the main power supply. The directions of current flow through the voice coil are opposite and the d.c. magnetic fields are cancelled out. A certain amount of useful power output will be dissipated in R_{2A} - R_{2B} - C_2 , but this loss can be kept to a minimum by having the second power supply pro-

vide a large value of filtered voltage which will in turn require a large value of R_{2A} to limit the bucking current to a proper range which can be closely adjusted by R_{2B} . Incidentally, if a gradually rising bass boost in the speaker is desired one can select the proper value of C_2 for the "crossover frequency" desired. If flat response is wanted, it is only necessary to make C_2 large enough.

Single-Ended Circuits

The next case to consider is that of a single-ended output stage with power taken off at the cathode instead of the plate. The d.c. resistance of the voice coil would be a convenient source of the self-bias for the output tube, but as pointed out earlier d.c. cannot be tolerated in the voice coil. Again we can resort to shunt feed, using a resistor or choke and a coupling capacitor. As in the case of plate loading, each has its advantages and disadvantages. If a choke is used, as at (A) in Fig. 5, it would ideally have a d.c. resistance such as to provide the proper self-bias for the output tube.

Using a resistor for shunt feed is not always as simple as might first appear. That is, one cannot simply use a resistor which gives the correct self-bias for the tube, because its impedance will be considerably lower than that of the speaker load. This would mean not only a severe mismatch—since the total a.c. load would be much smaller than it should be—but also the greater part of the reduced power output would be dissipated in the resistor instead of in the speaker. One solution to this difficulty is shown at (B) in Fig. 5, where another resistor R_s is connected between the bottom of R_k and ground. (R_k is chosen for correct biasing of the output tube.) If R_s is made two or three times as large as the speaker load, then the mismatch is reduced to tolerable proportions and the speaker will absorb the greater part of the power output. Note, however, that as R_s is made larger, the B supply must be increased proportionately to make up for the voltage lost across R_s . Actually, this is very similar to what happens when

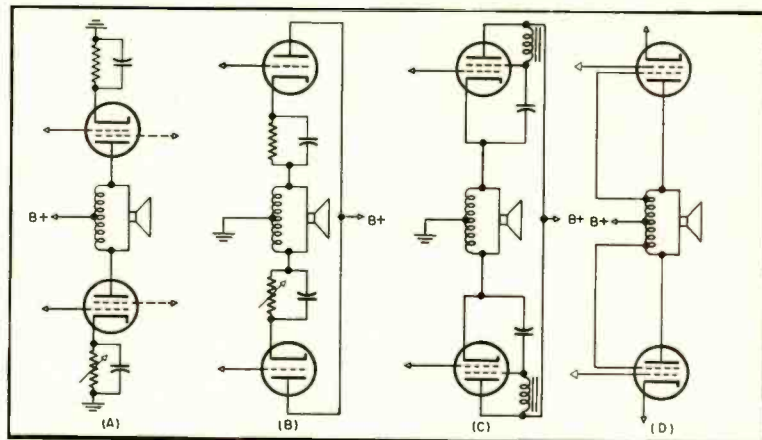

Fig. 6. Four possible circuit arrangements for push-pull output stage. Note that all such circuits require tapped voice coils.

the resistor and load are in the plate circuit. Incidentally, in the circuit of (B), direct coupling between driver stage and output tube could be employed, given proper selection of driver tube and plate-load resistor.

In general it appears that single-ended operation is not too well suited to OTL design because of the necessity for keeping d.c. out of the voice coil. Suppose, however, that a high-impedance speaker were to be constructed in such a way that with nothing connected to it the voice coil would be out of the gap a short distance in the forward direction. Then with the correct amount of d.c. flowing through the voice coil—i.e., the plate current of the output tube—it would move back into the gap to the same position occupied by voice coils in normally constructed speakers. The authors of this paper are not in complete agreement as to whether this type of construction would result in a condition of mechanical non-linearity in the cone suspension. If it did, however, it should be possible to control this effectively through a combination of efficient speaker design—i.e., a strong magnetic field concentrated in the gap and tight coupling to the voice coil—and a suitably low source impedance. Even with inexpensive speakers there might be a net gain in performance over that obtained with low-impedance speakers which are coupled by output transformers. The overall frequency range would certainly be extended, and if there were any distortion caused by possible mechanical non-linearities, this distortion might turn out to be no worse and

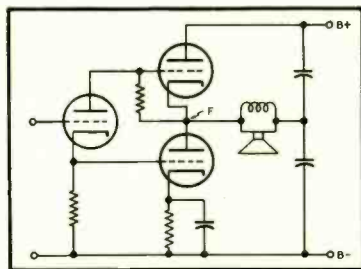

Fig. 7. Output coupling arrangement for single-ended push-pull output stage.

possibly less objectionable than the distortion introduced by cheap output transformers. Some experimentation by the speaker manufacturers with this type of construction would certainly seem to be warranted.

Push-Pull Circuits

We now turn our attention to push-pull OTL design. Figure 6 shows a push-pull plate-loaded OTL stage at (A). The screen grids have been drawn in dotted lines to indicate that either triodes or beam power tubes can be used. (If the latter are used, the screens could be fed in the conventional manner or as done in the Williamson arrangement.) Here direct coupling is practical because equal and opposite direct currents flow through the voice coil, and their magnetic fields cancel each other. For the

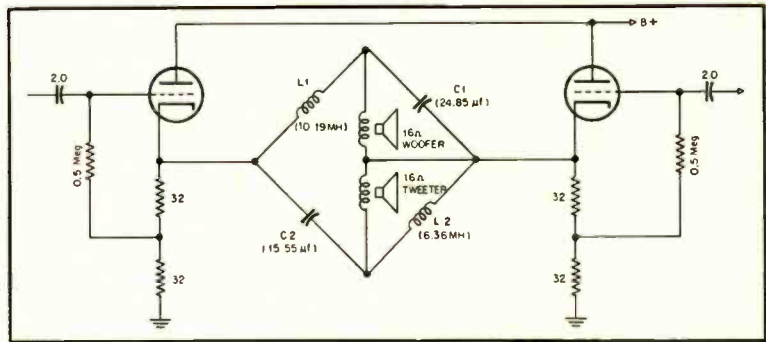

Fig. 8. Possible circuit arrangement for two-way speaker system driven by cathodes of output stage.

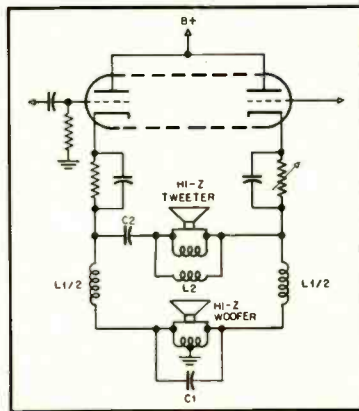

Fig. 9. Optional circuit arrangement for two-way speaker and cathode-coupled output stage.

same reason, direct-coupled cathode loading of a push-pull OTL stage is also practical. If the d.c. resistance of the voice coil is not sufficient to provide the correct bias for the output tubes, then bypassed resistors would have to be inserted at the cathodes, and as shown at (B) in Fig. 6 one of them could be made adjustable to permit balancing the zero-signal plate currents. A cathode loading circuit using beam-power tubes is shown at (C).

A possible adaptation of a new circuit development reported by Hafler and Keroes² is shown at (D) in Fig. 6. It was shown that the combined advantages of triode and tetrode operation could be obtained by providing a screen-load impedance of about 18.5 per cent of the plate-load impedance and closely coupled to it. This was accomplished by bringing out taps on the primary winding of the output transformer to feed the screens. Transference of this ingenious circuit to OTL design depends on the ability of some speaker manufacturer to design and build a multi-tapped voice coil.

It can be seen that the minimum requirement for direct-coupled, conventional push-pull OTL circuits is a center-tapped voice coil. However, when we go to such unconventional circuits as the Sinclair-Peterson single-ended,

push-pull output stage^{3, 4}, one version of which is shown in Fig. 7, we find that we can go back to an untapped voice coil since no d.c. is flowing through it. This circuit may well turn out to be the standard hi-fi output stage of the future—and the not too distant future at that. One of its outstanding advantages from the OTL standpoint is that its load-impedance requirements are only one quarter of those for the same tubes when connected in a conventional push-pull arrangement. For example, a pair of 2A3's which normally drive a 5000-ohm load now require only a 1250-ohm load in the Sinclair-Peterson circuit, and if four 2A3's are used, the requirement drops to 625 ohms which is already reasonably close to the presently available 500-ohm speakers. For a single 6AS7, the optimum load would be about 280 ohms. In fact, this figure might be one of those theoretically ideal standards of voice-coil impedance mentioned earlier which the speaker manufacturers might agree on and begin manufacturing as soon as possible.

The OTL system shown in Fig. 8 is the one mentioned in the second paragraph of this paper. The audible results were claimed to be superb, though the circuit does not appear to be a very efficient one, to put it mildly. Eight 6AS7's requiring 2000 ma at 200 volts delivered only 6.32 watts into the speaker system. (A single 6AS7 can normally deliver 8 to 11 watts.) Much greater efficiency could, of course, be obtained with high-impedance drivers, and if a center-tapped woofer were available, the circuit of Fig. 8 could be re-arranged as shown in Fig. 9. The values of L and C in the dividing network would of course have to be recalculated. Elaboration of the network for a three-way system would not be difficult. Also, the whole business could be transferred upstairs for plate loading if desired, in which case the woofer center-tap would be connected to B+ instead of to ground. If for any reason center-tapped voice coils are not practical, the circuits suggested in this para-

[Continued on page 45]

³ Sinclair and Peterson—IRE Group Paper.

⁴ General Radio Experimenter, Oct. 1951.

² Hafler and Keroes, "An ultra-linear amplifier," AUDIO ENGINEERING, Nov. 1951.

Universal Amplifier for Magnetic Tape Recorder

C. G. McPROUD

Part 2. Continuing the description of an amplifier which combines the ability to serve in professional applications as well as in a high-quality home music system. This installment details the circuit design.

THE PRELIMINARY DESCRIPTION of this amplifier covered only the basic philosophy of the design, without giving any of the details of the various circuits employed. In this article the complete circuit principles will be described.

Input Switching

With only two input amplifier stages, it seems obvious that only two separate inputs could be accommodated at once. In order to increase this facility even slightly, input switching was arranged to permit a third circuit to be connected to either of the transformers. A key switch was chosen which is, in effect, two separate DPDT switches, since two circuits are made in the neutral position of the switch, and each throw of the switch affects only one of the circuits. The outside contacts are paralleled and connected to the third microphone jack. The two pairs of arms are connected to the transformer primaries, and the inside contact pairs are connected to the first and second jacks respectively. Thus in the center position, jacks 1 and 2 are connected to the two transformer primaries; when thrown to either side, the third jack is connected to either the first or second transformer, as desired, opening the other input circuit. In use, the associated mixer dial is turned to minimum, the switch thrown, and the dial then turned to the required position. When the selector switch, SW_1 , is in the REC position, two playback heads may both be plugged in, one into J_2 and one into J_3 , and either machine may be used for playback by throwing the switch to the desired position.

Since it was desired to use this equip-

ment for professional applications, it is provided with low-impedance inputs, with 30 ohms being chosen so as to simplify equalization in the playback channel. The input transformers have a relatively high step-up ratio, and it is probable that more modern units would give better performance. However, one of the units chosen was already in the "junk" box, so it was natural that another of the same type would be secured.

In order to provide for a high-impedance input for any purpose for which it might be required, the secondary of the input transformer is connected to the contact of a closed-circuit jack, J_{47} , the spring being connected to the grid

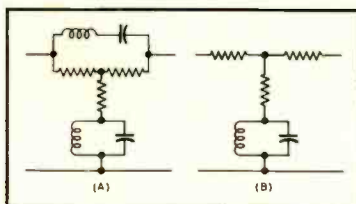

Fig. 5. Equalizer configurations: (A) as originally designed; and (B) as finally used for the 15-in./sec. speed. The 7.5-in./sec. equalizer is like (A).

of V_2 . The 3.9-meg resistor R_9 provides a grid return if crystal microphones should be used. The first stage employs a 6AU6 to provide sufficient gain, and it is coupled to the gain control in the grid circuit of the second stage. The latter is one half of a 12AX7 (the other half occupies a similar position in the second channel, with separate cathode and plate resistors). The small by-pass

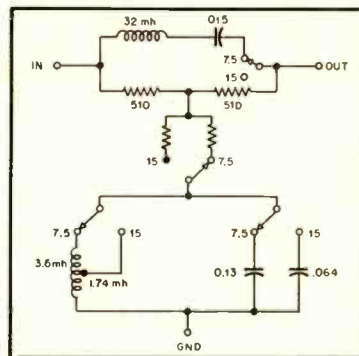

Fig. 6. Schematic of complete equalizer as used with this amplifier and the Presto RC-7 recorder.

capacitor serves a frequency-correcting element. The plate of V_{3b} is coupled to the mixing network—composed of R_{17} , R_{18} , and R_{19} —and the main gain control, R_{22} . The mixing network couples the high-impedance radio input, when used, to the main gain control without appreciable effect on the input stages. When two microphone stages are being used, they are coupled together and to the gain control by the same mixer network.

The output amplifier, V_4 and V_5 , will be recognized as being similar to the Williamson amplifier input circuits, and it serves equally well in this application. V_{4a} provides considerable gain, and is directly coupled to V_{4b} as a phase splitter, which drives the two halves of V_5 as a push-pull output stage. Feedback from the plate of V_{5b} stabilizes the output amplifier. It would have been possible to derive the feedback from the secondary of the output transformer, but this would have necessitated grounding the secondary, which is not desirable if the equipment is to feed a balanced line when acting as a remote amplifier. The tape recorder selected, a Presto RC-7, was designed to be fed from a 500/600-ohm transformer, and also some such impedance is desirable to feed a remote line. Actually, the equalization for the recorder is quite simple with this type of feed.

Output Switching

When used to feed a recorder, the 600-ohm winding of the transformer is fed directly to the output jack, J_8 ,

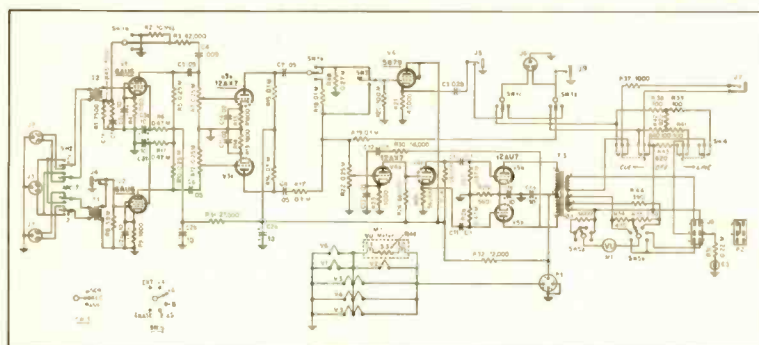

Fig. 3. Complete schematic of the amplifier chassis, repeated from last month.

ground being obtained in the recorder chassis. This ground is common to the power supply, so the circuit is properly grounded when so connected.

When used to feed a remote line, a dummy plug with terminals 2 and 4 shorted is placed on J_8 (which is a male Jones plug, actually) so as to connect the "high" side of the output circuit to the output switch, S_{w_2} . In the center or OFF position of this switch, the amplifier is terminated by $R_{1,2}$; in the LINE position, the amplifier is connected to a 6-db pad composed of resistors $R_{1,8}$ to $R_{2,2}$, inclusive, and thence to the line jack, J_6 , through two sections of S_{w_1} ; in the CUE position, the monitor jack is connected directly to the line jack so that cue may be heard from the station on the monitor phones. The output switch is the same type of switch used for the input switching.

VU Meter Switching

In order to provide for measuring the output level when feeding a remote line, or for the correct recording level, as well as to measure bias and erase current in the recorder, the VU meter switch, S_{w_5} , has six positions. Two positions provide for measuring bias and erase currents, and are labeled B and E respectively. Three output levels are provided—+4, +6, and +8—being so arranged that the level fed to the line at the output of the 6-db isolating pad is indicated at zero on the VU meter. The particular recorder used requires a voltage applied to the input of the recording equalizer of approximately 3.5 volts for full modulation (which is presumably

entire winding when the meter is connected across half of the secondary. The isolating pad has a loss of 6 db, so the level at its output would be +4, as indicated by the switch. Similar calculations and a voltage divider between the center tap of the secondary and a tap of lesser impedance permit adjustment of output to obtain additional levels of +6 and +8 at the line terminals.

For recording, the +4 position provides a level of 2.6 volts to the input of the recording equalizer; the +6 position provides 3.6 volts, and +8 provides 4.5 volts, giving a range of recording levels. A small arrow is placed on the panel at the +6 position to indicate that step is normal for recording. For piano recording, a lower level is desired, and the +4 step gives a cleaner tape. To date, no recording application has been found where the +8 position was found desirable.

The Recording Equalizer

The recorder unit of the Presto RC-7 contains the bias-erase oscillator with suitable resistors to provide indications on the standard VU meter and two leads are brought out for this purpose. In addition, the "constant-current" resistor of 500 ohms is in this unit, as is a trap circuit to keep the bias voltage out of the recording amplifier. One side of the recording circuit is grounded in this unit, and this provides ground to the entire output circuit since the same power supply feeds both sections. Therefore, in order to place the recording equalizer in series with the line, it is only necessary to bring out three



Fig. 7. Equalizer in its shield can is mounted inside the recorder case, and supports bracket for idler and capstan sleeve.

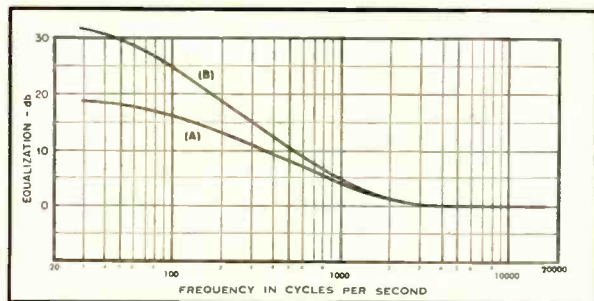

Fig. 8. Curves of playback equalization: (A) that due to feeding the 500-ohm playback head into a 33-ohm resistor; (B) total equalization obtained with addition of feedback network around first stage.

10 to 15 db below tape overload). The sixth position of the switch is marked EX, and connects the meter directly to terminals 1 and 6 of J_8 (with the 3600-ohm series resistor which is always in the circuit). Another plug, with leads connected to these terminals, may be used to check the meter from an external source, or to permit measurements on other circuits with the same meter.

For a given voltage across the meter, the voltage across the entire secondary will be twice that value if the meter is connected across half the winding, and if connected across less than half the winding, the total voltage would be still greater. Thus with a meter indication of 0 VU, which corresponds to a level of +4 due to the meter calibration, a level of +10 would appear across the

leads to connect to the equalizer—input, the "high" line from the amplifier; output, to the "constant-current" resistor followed by the trap and the recording head; and ground.

The equalizer configuration originally planned was that of a constant-impedance network, as shown at (A) in Fig. 5. Final adjustments of frequency response required a few changes, and the final configuration for the 15-in./sec. equalizer for a flat frequency response from input to tape output is as shown at (B); the 7.5-in./sec. equalizer follows the original configuration. The complete equalizer is shown in Fig. 6, with the necessary switching for the two speeds.

The coils used for these equalizers were made from unmounted toroids, with the windings being adjusted to

exact values by removing turns. The toroid coils used were wound in two sections, making it quite simple to obtain the correct values. Complete equalizers of this type are used in the Magnecorder, and are available in separate shield cans with a plug-in base, as described in an earlier article,¹ and could undoubtedly be employed with the Presto recorder if the effort of making the equalizer is considered too troublesome. However, the equalizer as constructed functions satisfactorily and occupies relatively little space.

In most professional-type circuits, the high-frequency equalization is provided in the recording function, while the low-frequency equalization is provided in the playback function. The high-frequency equalization compensates for gap width, and requires a boost of about 18 to 22 db at 7500 and 15,000 cps for the low and high speeds respectively. The curve of the equalizer is adjusted by the relative inductances in the series and shunt elements of the equalizer, and the amount of equalization is adjusted by the resistor network. It will be noted that the series resistors used are each of 510 ohms, and that the shunt resistors are employed to make final adjustments for frequency response. This construction does not follow accepted network practice rigorously, but the performance seems to justify the means taken. Frequency response is within ± 1 db from 30 to 15,000 cps at 15 in./sec., and within ± 2 db from 30 to 8000 cps at 7.5 in./sec.

The entire network, with the switch, is assembled in a Bud Minibox, $2\frac{1}{4} \times 2\frac{1}{4} \times 4$, and is installed inside the recorder case, as shown in Fig. 7. The

[Continued on page 34]

¹ C. G. McProud, "The interview amplifier," AUDIO ENGINEERING, Dec. 1951.

Ultra-Linear Operation of the Williamson Amplifier

DAVID HAFLER* and HERBERT I. KEROES*

The Famous "Williamson" can be improved simply by replacing the output transformer and making a few minor changes in other components. The results are well worth the effort and expense.

FROM THE TIME an article¹ appeared describing the principle of Ultra-Linear operation of power output tubes, considerable interest has been evidenced in the application of this new circuit improvement to the famous Williamson amplifier. The Williamson circuit has been publicized in several arrangements including at least one commercial one, and the configuration is undoubtedly the most popular high-quality audio circuit ever developed. For many people there is little necessity to attempt to improve this basic amplifier circuit. Its listening quality is excellent; it is easy to construct; and it provides top quality at a cost comparable with units which cannot measure up to its capabilities.

The one category in which the Williamson amplifier is significantly deficient is with regard to efficiency and power-output capabilities. Peak power output is less than 15 watts, and it takes a 450-volt supply at approximately 130 ma to achieve this power output. If this limitation can be overcome without deterioration of quality, a change in the original design is justified. If simultaneously it is possible to improve the amplifier both in measurable aspects and in listening quality, then a change is not only justifiable, it is mandatory.

It is difficult to improve on something which is really good. There are some audio enthusiasts who will scoff at the idea that the Williamson circuit can be improved. However, it has been five years since Mr. Williamson published his circuit; and in the course of five years, there is little which can maintain supremacy without change or renovation. When a basic circuit improvement—the Ultra-Linear output stage arrangement—came along, it was natural to see how it could fit in with the basic Williamson circuit.

The Ultra-Linear output stage is not a triode stage as is used with the Williamson circuit—nor is it a tetrode or pentode stage. It combines the advantages of both triode and tetrode by using an arrangement in which the

The authors' Ultra-Linear amplifier combined with the power supply on a single chassis.

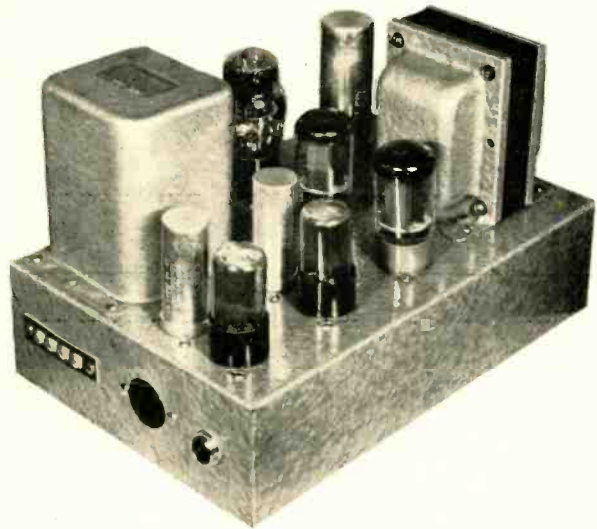

screen grids of tetrodes are energized from a tap on the primary of the output transformer. This connection, on which patents are pending, modifies the operating characteristics of the tube. Proper location of the tap results in optimum input-output linearity simultaneously with efficient operation, power capabilities approximately double those of a triode connection, and low-impedance output such as is offered by triodes. In short, it permits better performance than either triode or tetrode connection of the tubes, and this is substantiated in comparative listening tests and distortion measurements.

The unique merits of the Ultra-Linear stage are particularly applicable to the Williamson circuit. The mating of the two seems to have been inevitable. The simple substitution of an output transformer with primary taps for Ultra-Linear operation and a few minor changes in circuitry, which will be discussed below, combined the basic circuits into an amplifier which practically everybody agrees is an improved version in all respects. Obviously, we must gain improvement if we substitute a more linear output tube and use a transformer which exceeds the originator's stipulations for performance.

The original Ultra-Linear circuit utilizes a transformer, the Acrosound

TO-300, which was designed for use with tubes of the 6L6 type. Its 6600 ohms primary impedance therefore, is also correct for 5881's and 807's in the Ultra-Linear hook-up. In addition, KT-66's can be used without deterioration of quality as the slight mismatch is in a favorable direction with respect to distortion characteristics. Therefore, this transformer can be used with the tube types normally used in Williamson amplifiers without compromise of characteristics. It is of interest to note that the change in impedance to 6600 does not violate Mr. Williamson's design considerations. The modified tube characteristics of the Ultra-Linear connection require this impedance if we wish to preserve operating conditions similar to those of the original amplifier. In other words, the tubes are still matched for minimum distortion rather than for maximum power output. The transformer, therefore, can be placed in the circuit directly and the screens of the output tubes connected to the appropriate taps as shown in Fig. 1. This eliminates the two 100-ohm screen stopper resistors of the original circuit. The plate and screen leads of the transformer are color coded to avoid phasing difficulties.

Several additional circuit changes have been found beneficial for optimum

*Acro Products Co., 369 Shurs Lane, Philadelphia 28, Penna.

¹Hafler and Keroes, "An ultra-linear amplifier," *AUDIO ENGINEERING*, November 1951.

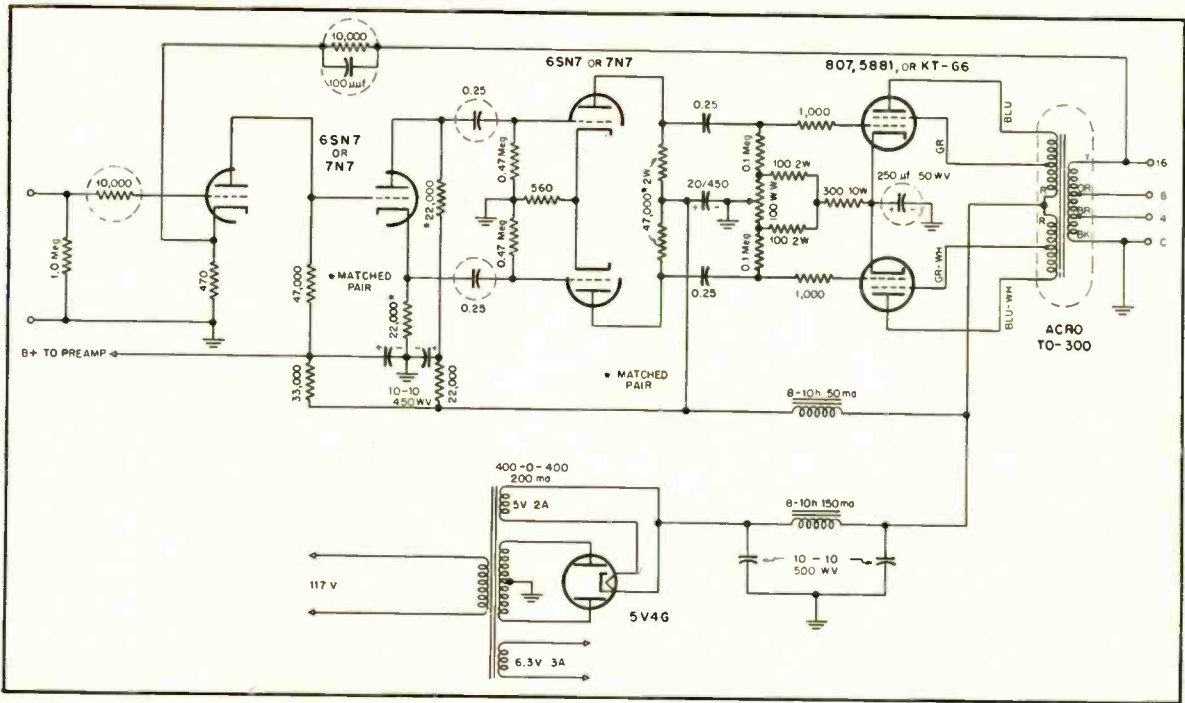

Fig. 1. Schematic of the Ultra-Linear Williamson amplifier. The components in dotted circles are those which are changed from the original circuit in making the conversion of an existing amplifier to Ultra-Linear operation.

performance. One of these is the change in value of the feedback resistor to 10,000 ohms in order to maintain 20 db of feedback. In the Ultra-Linear stage the gain of the stage is greater than for a triode stage. In addition, the change in primary impedance changes the proportion of voltage fed back. Thus the feedback is increased unless the feedback resistor is changed to compensate. The readjustment of this resistor to the desired value then permits the added gain of the Ultra-Linear output stage to increase the amplifier sensitivity. It can now be driven with a little over 1 volt as compared to almost 2 volts required for the original amplifier.

The feedback is taken from the 16-ohm tap regardless of the speaker connection. This tapped secondary arrangement is extremely convenient when shifting to speakers of different impedance as it does not require a change in the value of the feedback resistor. It is made possible by special transformer design (on which patents are pending) which permits equivalent response on

all taps of a tapped secondary winding.

The amplifier, as converted, now surpasses the original with respect to response, distortion, and transient characteristics. In addition, it was considered desirable to make certain other slight changes which primarily increase the stability under feedback conditions.

The low-frequency time constants of the original circuit's interstage coupling networks were the same for both such networks. This is not particularly desirable in a feedback amplifier since a given frequency loss is accompanied by maximum phase shift. Separation of the time constants permits less phase shift for the same frequency loss. In-

creasing one pair of coupling capacitors from .05 μf to .25 μf gives a five-to-one ratio of time constants for the two pairs of networks and increases the low-frequency stability margin at nominal increase in cost.

The insertion of a 10,000-ohm parasitic suppressor in the input grid and a 100-μf capacitor across the feedback resistor adds to the high-frequency stability margin and eliminates a slight ringing in the vicinity of 200 kc.

One last optional difference from Mr. Williamson's original circuit lies in the use of a bypass capacitor across the cathodes of the output stage. This has been found beneficial in both the Ultra

Fig. 3. Square-wave performance at 20 cps (left) and at 50 kc (right).

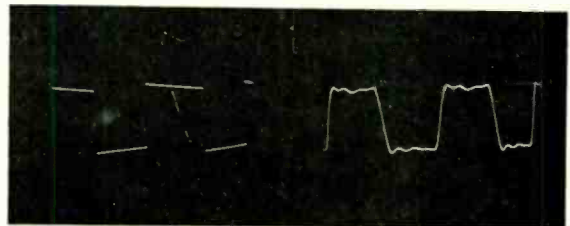
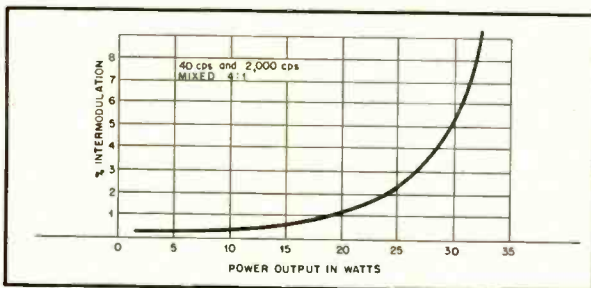

Fig. 2. Curve of intermodulation distortion vs. effective sine-wave-power output.



Linear conversion and in the triode Williamson² at high levels of operation as distortion at the overload point is diminished.

There are no changes required in the remaining stages nor in the power supply. Most of the publicized versions

[Continued on page 43]

² Keroes, H. I. "Building the Williamson amplifier," *Radio and Television News*, December 1950.

Audio in the Home

William C. Shrader*

A review of a number of the more popular amplifiers used for home systems, with pertinent pointers on performance of each. A truly useful compilation for anyone about to select this important component.

THESE ARTICLES have thus far discussed an inexpensive group of components, and ways in which they might be used to improve standard commercial consoles. We shall turn our attention now to those who wish to improve such a system or who are interested in obtaining sets that give good sound and can afford four to five hundred dollars for equipment. Improvements in an existing system almost certainly would be done a step at a time, and those who are just beginning to purchase have the option of buying units in steps or all at once. The end result for each group would be the same.

Since the amplifier has to magnify very small voltages and build them up to loudspeaker volume without distortion, and be able to compensate for various recording characteristics, room acoustics, hearing deficiencies (Fletcher-Munson effect), and the inability of the loudspeaker to radiate much power at extremely high or low frequencies, it is considered the heart of the system.

Although it is always desirable to have the speaker mounted in a compartment separate from the other equipment, this is sometimes impractical. Where they are together, microphonics due to tubes or to some kinds of pickup cartridges often give rise to complications with

even the leading brands of amplifiers. Two other problems that often arise in the installation of custom systems are pick-up of TV signals, and hum from ground loops. The adaptability of components to one another is also quite important. An amplifier that starts boosting at too high a frequency may give altogether too boomy and barrel-like results when used with one type of speaker design but may be perfectly satisfactory when used with another speaker. Changing either the amplifier or the speaker would result in reasonably satisfactory matches.

Analyzing the leading brands of amplifiers in alphabetical order, the writer feels that the suggestions hereunder may give greater satisfaction and prevent difficulties from arising.

Altec A-433-A Preamplifier and A-333-A Power Amplifier

The extremely good design of this amplifier facilitates ease of installation. The preamplifier is also readily adaptable to other power amplifiers such as the many versions of the Williamson circuit, notably the Musician's. If used with Audak pick-ups, however, it is suggested that the feedback capacitor, C_2 , be doubled in value. If whining or singing noises are apparent it is suggested that the 12AX7 and 12AU7 tubes be selected carefully for a minimum of this trouble. Motorboating may occur if the output tubes in the power amplifier are not well balanced. If this occurs, raising the value of the feedback resistor will reduce it.

Bell 2145A

Although the same in outward appearance as the 2145, this is actually a new model, since the latter has been completely redesigned. An all-triode ampli-

fier, it is the only truly remote controlled amplifier, having only one cable going to the remote control box. The record player and the FM tuner may be located with the power amplifier, while the front end is at some distance on an armchair, for example, for convenient adjustment of volume, tone, record compensation, and switching between radio, phono, and TV. It has one of the most versatile record compensating controls of any amplifier and has been endorsed by some of the nation's leading music critics.

Brook 12A3 and 10C3

Brook amplifiers were among the first available with remote controls for ease of installation. They have an all-triode circuit which many audio enthusiasts consider the only way of getting true fidelity of reproduction. It was the first amplifier in the high-fidelity field to be produced on a large scale with adequate tone controls, and it has been used for many years for demonstrating quality speakers and pick-ups at various audio shows. The difference between the 12A3 and the 10C3 is that the former is a 10-watt straightforward circuit, whereas the latter uses automatic biasing so as to get 30 watts from the same output tubes.

Leak "Point One"

This model is advertised as Britain's finest amplifier, and is highly endorsed by the National Physical Laboratory of Britain, which is similar to our National Bureau of Standards. It does not employ the famed Williamson circuit, but in units tested the distortion is as advertised, namely 1/10 of 1 per cent. This amplifier, using oil filled filters and coupling capacitors, has obviously been well thought out and is beautifully wired

[Continued on page 42]

*2803 M Street, N.W., Washington, D.C.

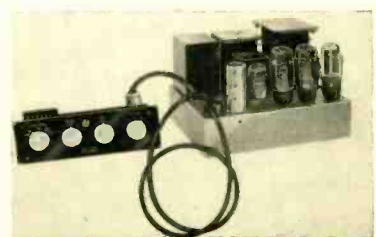
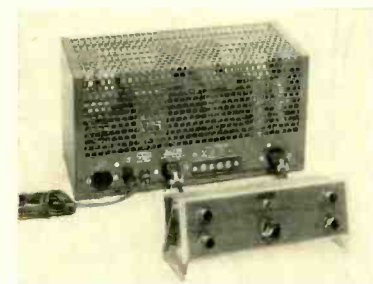

The amplifiers discussed by the author include, at left, the Altec Lansing A-333-A with the A-433-A preamplifier, and below from left to right, the Bell 2145A, the Brook 12A3, and the Leak "Point One."

FOR THE PERFECTIONIST

A COMBINATION that produces near perfection for the sound enthusiast . . . the White horn-loaded speaker, and the new, crossover amplifier, designed and built for White Sound, by Maynard.

YEARS of research and laboratory tests bring you this smooth-flowing peak-less sound without resonance, to mar its perfection. Two, separate, high-fidelity amplifiers (on one chassis), operate into this entirely new speaker that doesn't have to sit in a corner!

THIS IS the kind of sound that engineers dream of attaining; no peaks, no hangover or ringing effects. This amazing system results from perfect damping—and the frequency response of the speaker is flattened and unaffected by variations in its impedance during operation.

THE ENTIRE CONCEPTION of this smooth-working team is different—your own ears will tell you that this is the finest electronic sound yet heard. If you are a perfectionist, there can be no other choice than this decisively superior combination. Its listening result is pleasant beyond imagination!

ATTENTION CUSTOM-SOUND INSTALLERS! Here is a system that offers interior decorators a perfect solution to placement problems. Heretofore, corner-type speakers have made it necessary to violate principles of good room arrangement. The White speaker and associated amplifiers can be used anywhere in the room! No need to be forced into using corners. Speaker may be placed where good design ordains it should be placed—parallel to the architectural lines of the room.

THE WHITE HORN-LOADED SPEAKER

- Acoustical compliance of room volume taken into account in design of system
- Back-loaded horn, coupled to speaker through unique phasing device
- Flare cutoff of horn 20 cycles
- Nine foot horn, uniquely folded into non-resonant cabinet within 1% of true exponential forming
- Air mass loading on speaker, twenty times the mass of the speaker, resulting in a virtually mass-less driving system
- Beautiful custom finishes. Available in either blonde Korina wood, or dark Mahogany with hand-rubbed finishes. Bonded formica real-wood tops, alcohol and cigarette proof
- Dimensions: 35 1/2" high, 23" wide, 20" deep. 595.00 FOB Chicago.

THE WHITE SOUND, MAYNARD-ENGINEERED CROSSOVER AMPLIFIERS

- No crossover network used in **output** of amplifiers—non-resonant, distortion-free RC crossover network at the **input** of each section of the dual amplifier
- Sharp cut (18 DB per octave) Crossover network
- Separation of high and low frequency channels result in minimum of intermodulation distortion—so low, that it can be considered at the vanishing point
- Dual amplifiers make it possible to use high and low frequency speakers of different impedances, with efficiency differences of speakers compensated for exactly, by individual gain control in each amplifier
- Perfect damping. Frequency response of the speaker is flattened and unaffected by variations in speaker impedance. Amazingly clean transient response
- Less than .1 of 1% intermodulation distortion from below 3 cps to 100,000 cps. 250.00 FOB Chicago.

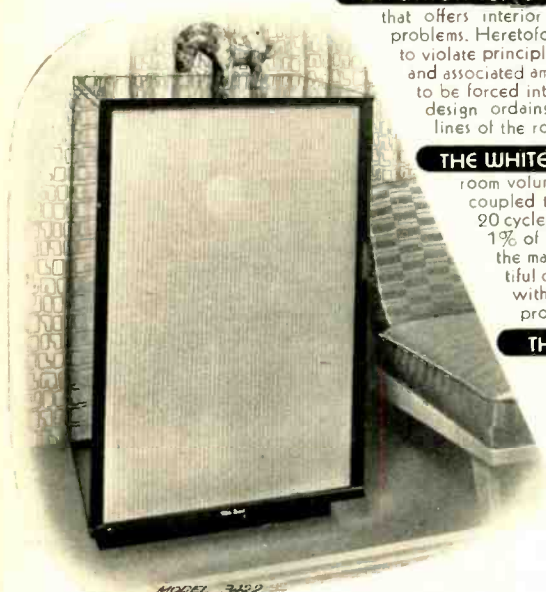

MODEL 3422
30 CFS - 13,000 CFS
595.00 FED. TAX INC.

MAYNARD ELECTRONICS, INC.

1414 SOUTH WABASH AVENUE
CHICAGO 5, ILLINOIS

AUDIO ENGINEERING • JUNE, 1952

WHITE SOUND, INC.

105 WEST MADISON STREET
CHICAGO 2, ILLINOIS

Neither

TRIODES

Tetrodes

permit the low distortion and high efficiency of

ULTRA LINEAR*

operation of the audio output stage. This new circuit principle and the Acrosound TO-300^o output transformer are designed to work together for the highest quality sound obtainable. The combination provides optimum performance resulting in the most linear output stage which can be made with conventional tubes.

The specifications and proven performance of the

Acrosound ★

TO-300

make it the world's finest output transformer.



\$24.75 net

At Leading Distributors

- ✓ response ± 1 db 10 cps to 100 kc
- ✓ 20 watts undistorted 20 cps to 30 kc
- ✓ 40 watts undistorted 30cps to 20 kc
- ✓ Unequalled square wave performance
- ✓ Resonance free response
- ✓ Uniformity of characteristics
- ✓ Compact, rugged construction

Complete data and characteristics of Ultra Linear Circuits and Acrosound Output Transformers on request.

* Patents Pending

ACRO PRODUCTS CO.

369 Shurs Lane, Roxborough, Phila. 28, Pa.

Phono Facts—1952

MAXIMILIAN WEIL*

If you wish to obtain the fine performance inherent in vinyl LP and 78-r.p.m. discs, you must give them the care they deserve.

ONE OF THE IMPORTANT FACTORS in the public acceptance of LP discs is the fact that they can be played with a total absence of surface noise, commonly referred to as "scratch," that has plagued music lovers for over 50 years. It is of vital importance, therefore, to prevent these discs from becoming scratched or marred in any way.

Extensive investigation shows that the owner himself unwittingly inflicts mechanical injury—scratches—on his records.

Anything rubbed over the record will scratch the groove walls by rubbing the dust and grit into the delicate glossy surface. In the case of a very dusty record, it is better to fluff the dust off with a loosely waving handkerchief. When playing, a stylus attracts the dust, lint, and other matter lodged in the grooves. Therefore, brush the dirt off the stylus after each play—it will help keep your records clean.

Oddly enough, no protective envelope that would entirely protect a disc from dust and grit has yet been introduced.

Stylus Alignment

It is highly important for the stylus to be exactly vertical on the record, when viewed from the front, and that it does not lean against the groove wall.

An investigation on this condition extended over a period of eight months and included pickups and arms of all makes. Out of 74 installations, 39 were found to be badly out of alignment; that is, the stylus was tracking the groove at an angle—either right or left. An excellent method of checking stylus alignment is offered for consideration:

Place a small unframed mirror (such as may be found in a lady's handbag)—on the turntable. Now, lower the stylus point to contact the mirror in the same gentle manner you would use to lower it onto a record surface. Standing squarely in line with the front end of the arm, so that you do not see the sides of the arm, you will be able to see the stylus alignment easily, because the mirror causes the angle of misalignment to appear twice as great.

As there must be some play in the mounting of a pickup in order for the parts to fit together readily, frequent misalignment is to be expected. A slight shift of the reproducer—clockwise or counterclockwise—will cause the stylus to lean against one of the walls of the groove.

The arm also may be out of alignment. It should be adjusted so that it has no tendency to swing to the right or to the left when the pickup is supported in such

RECORD CARE

1. Never use a cloth—moist or dry—to clean your records.
2. Never rub the record surface with anything.
3. When in doubt about using anything on a record—other than the stylus itself—just ask yourself if you would use it on a valued soft lacquer disc.
4. Correct any stylus-record misalignment.
5. Check stylus alignment every time the head is installed on the arm after being removed for repair, stylus replacement, or for any other reason.
6. Never play a record with a stylus out of alignment.
7. If your amplifier has no provision for proper de-emphasis, the maker of your pickup will supply the proper circuits for optimum results.

a way that it does not touch the record surface. Arm misalignment can be corrected easily by shimming up one side of the base with a piece of cardboard.

De-emphasis

Last, but not least, is the question of circuitry—principally that of the correct de-emphasis network. If LP records are played with a "flat" high end, there is likely to be some noise. Most users are of the belief that the record material alone is responsible for the normally lower noise level of LP's, but such is not entirely the case. While the record surfaces are naturally quieter, a large part of the noise reduction is due to the use of pre-emphasis in recording, and the corresponding de-emphasis in playback.

In practice, pre-emphasis boosts the recorded level of the high frequencies by a predetermined amount—16 db at 10,000 cps according to the standard LP curve, or 12 db at 10,000 cps with the AES curve. In playback, therefore, a similar amount of high-frequency attenuation—de-emphasis—must be employed to restore the frequency response to normal. However, since scratch is composed largely of the higher frequencies, the ultimate effect is that the scratch is reduced. Combined with the quieter record materials, the de-emphasis serves to reduce scratch to an almost inaudible level.

Properly played—and carefully taken care of—LP records offer the best quality and a minimum of noise, but since the surface is somewhat softer than shellac's, the element of care takes on a greater importance.

* Chief Engineer, Audak Company, 500 Fifth Ave., New York 36, N. Y.

AT HARVEY You can Hear Them All and Choose the Finest



SUPER SPECIAL MEISSNER 8C FM TUNER

- Covers full 88 to 108 mc FM band.
- Flat response: ± 2 db from 50 to 15,000 cps.
- Sensitivity: 40 microvolts.
- 8-tubes: 2-6AG6, 2-6BA6, 2-6C4, 1-6AL5, and 1-6X5GT.
- Can be fed to phono terminals of any radio or TV receiver, or high impedance input of any quality amplifier.
- Self-contained power supply . . . all in handsome Walnut cabinet.

List Price \$91.15 **At HARVEY . . . \$43.50**

McINTOSH AUDIO AMPLIFIERS

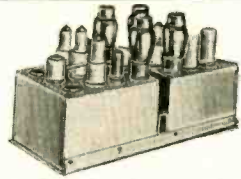

A novel and unique circuit design has been teamed with carefully selected components and superb construction to bring you amazing efficiency and clean, crisp reproduction at peak power. Distortion is less than 1% from 20 to 20,000 cps. Full bandwidth response is 10 to 200,000 cps with phase shift kept to negligible values. A Dynamic range in excess of 70 db and extremely low impulse distortion contribute to the wonderful listening quality of these amplifiers.

50W-2 — 50 watt amplifier (peak: 100)..... **\$249.50**
20W-2 — 20 watt amplifier (peak: 40)..... **149.50**
AE2-A — Preamplifier **74.50**



AUDAX POLYPHASE REPRODUCERS

One unit with two replaceable styli operating with one pressure (8½ grams) for all three record speeds: 33½, 45, and 78 rpm. Provides excellent coupling between stylus and record groove, with high stylus compliance and minimum mass. Response is from 20 to over 10,000 cps., with an output of about 20 millivolts. Needle-talk practically nil.

- | | |
|---|----------------|
| DL-6 Chromatic Head with Microgroove Diamond and Standard Sapphire..... | \$41.70 |
| L-6 Head with two Sapphire Styli..... | 20.70 |
| KL-4 Head with Sapphire Styli..... | 20.70 |
- (for record changers.)

PLUG-IN RECORD CHANGER ADAPTERS
for Garrard..... **\$2.70** for Webster..... **\$2.70**

CRAFTSMEN C500 AUDIO AMPLIFIER

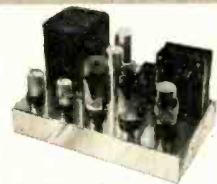

A top-performing, practically distortion-free amplifier, constructed by a leading manufacturer, and based upon the famous Williamson circuit. Total distortion is less than 0.1% at 10 watts, and frequency response $\pm .1$ db, 20 to 20,000 cps, and ± 2 db, 5 to 100,000 cps. Furnished with (5) tubes, including KT-66 output tubes. **\$99.50**

CRAFTSMEN 300 EQUALIZER-PREAMPLIFIER

A remote, completely self-powered unit with full-range bass and treble controls for tuner, phono, and other signal material; phono preamplifier for all variable reluctance pick-ups, with 5-position equalization switch; low-pass filter; loudness control; and cathode-follower for long line to main amplifier. Measures: 15 x 9 x 3 inches. **\$79.50**

WILLIAMSON HR-15 AMPLIFIER KIT

The famous Williamson HR-15 . . . still acknowledged the leader . . . in kit form, with original Partridge



Transformers. Assemble this kit, and in 3 hours or less, enjoy the finest sound you ever heard. Operates from a tuner, phono pre-amp, crystal pick-up, or other signal source. Has absolute gain of 70.8 db with 20 db of feedback. Frequency response: $\pm .5$ db, from 10 to 100,000 cps. Kit is complete with 5-tubes (1-5V4G, 2-6SN7GT, and 2- 807 or 6BG6G), 2-Punched Chassis, Pre-wired Resistor Board, Sockets, Genuine Partridge Output Transformer WWFB, Assembly Instructions, and All Other Necessary Parts..... **\$76.50**

HR-15, as above, but with Partridge CFB Output Transformer (Hermetically Sealed) **\$90.00**

PARTRIDGE OUTPUT TRANSFORMERS—Available Separately
WWFB..... **\$26.00** CFB..... **\$40.00**

HR-15T WILLIAMSON Kit—Furnished as above, with TRIAD Transformers and Chokes **\$69.50**

NOTE: HR-15 and HR-15T Kits may be had with British KT-66 Output Tubes for \$3.00 additional.

HARVEY'S New Catalog of High Fidelity Equipment is now AVAILABLE! Write Dept. A6

VISIT THE AUDIOTORIUM. Come in and visit our new sound department . . . all these items and many more on working display at all times.



The MAGNECORDette

A truly professional tape recorder for the discriminating listener . . . designed for home use.

- Quickly interchangeable speeds: 7½ or 15 inches/sec.
- Rewinds 1200 feet in 40 seconds.
- Frequency response: ± 2 db, 50 to 15,000 cps. at 15 inches/sec. and 50 to 7000 cps. at 7½ inches/sec.
- Dual AC motors for operation and rewind.
- Maximum flutter 0.3%.
- Housed in an attractive cabinet, natural or walnut.

\$385.00

10½ INCH REEL ADAPTER MECHANISM



Attaches simply and easily to all MAGNECORD and MAGNECORDette Tape Recorders. Permits playback, rewind, and high speed forward with 10½-inch reels. In stock for immediate delivery **\$35.00**

NOTE: In view of the rapidly changing market conditions, all prices shown are subject to change without notice and are Net, F.O.B., New York City.

Telephone **hrc** LUzsborg 2-1500

HARVEY

RADIO COMPANY, INC.

103 West 43rd St., New York 18, N. Y.

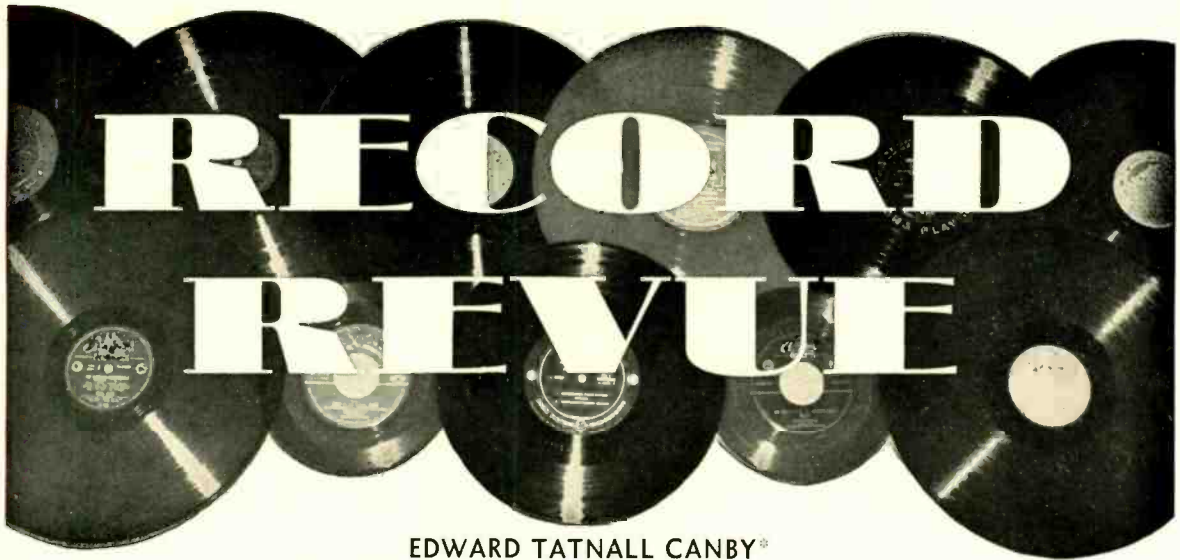

EDWARD TATNALL CANBY*

"The Well-Produced Commercial Record"

THERE'S NO DOUBT about it, high fidelity has become the major fad. By which I mean that everybody is talking about it, second hand, and only a few know anything about it, first hand. A fad is a fine thing in a way (though if we like it, we call it something else), but it has its disadvantages, principally in that misinformation and false attitudes spread faster than we who are in the business can stop them. Some of the most zealous promoters of unintentional misinformation are among those who just have to know better, the record critics.

Granted that a musician with reasonably sensitive ears has plenty to be hurt by in what goes on in the name of high fidelity. Even so, if that musician is a writer who must judge music as found in recorded form, he should be able to discount some of the nasty noises or explain them at least, to help the neophytes in the direction of more pleasing sound. Some items I've read recently from those in this category serve only to promote more confusion. The critic's ink is wasted if his righteous feelings concerning bad audio are tied to wrong explanations of the cause for the trouble.

One gentleman, a fine musician and composer and an aimable soul, has written an unsigned piece for "Listen" magazine called "Low Brow or Hi-Fi" which demands an answer from this department. Like plenty of musicians, this writer, whom we shall call Mr. X, doesn't too much like all the excitement over Hi-Fi. He is quite right; a lot of it can be chalked up as over-enthusiastic hot air. But the three points he makes in explanation of the trouble are not to my mind the sort that help clarify things.

1. "High-fidelity records reproduce sound best only on special hi-fi equipment. . . . Actually, the average machine sounds better with the well-produced commercial record than the special hi-fi disc."

Here is an old myth that will not die. These days, a "well-produced commercial record" is not to be distinguished from a "hi-fi" record, unless we count as hi-fi only those specially made discs in limited pressings, mostly of sound effects and other non-musical noises. They are ex-

cellent—but surely not the acme of hi-fi. An original tape is the only true hi-fi medium that can be held as potentially better than the best "well-produced" discs.

Moreover, it is to the best of my experience a myth that good recordings—the best "hi-fi" the industry can produce—sound worse on ordinary machines than those that are in some way tailored to fit cheap machines. It's true that the higher range on a good record cannot be heard on the usual machine. But neither can the lower end, and the resulting balance is usually correct for the listening ear. The only way that I know to tailor a record for low-fi use is to add a false peak somewhere in the middle-high range, to give a sort of brilliance, that may pass for clarity. A peak of sorts in the 3000-5000 range would do the trick perhaps. But is this really practicable or necessary?

For popular records, perhaps. But I suspect that even there, what counts in the sound is the presence of brassy, sharp close-to mid-highs in the actual music. Close-up trumpets, saxes, etc. The mike set-up does as much as any peak. And in the classical area, with larger, more blurred sounds, bigger orchestras, a necessarily more distant pickup (it's in the style) you can't do much in this respect without distorting the music itself.

I honestly don't think that a "well produced commercial record" is one with an exaggerated peak in its curve, around the middle. If not, then there can be only a difference in the pre-emphasis—not a peak but an all-over rise in the highs. And for that, within conventionally accepted limits, we can compensate by proper equalization in our quality equipment; on cheap machines a sharp pre-emphasis produces a sort of peak anyhow (the highs falling off above a certain point).

The plain fact is that a lot of *poor* recordings, notably those with distortion in them, sound better on cheap machines than on fancy equipment. Distortion is suppressed on the cheap machine; good and bad, all of the records come through the

same, distorted or not. *Good* records sound good on good equipment; on cheap equipment they sound about the same as the poor ones.

2. "Emphasis of the extreme registers in the hi-fi often leads to a neglect of the solid middle and gives a special tone picture which may be agreeable to some listeners but is quite removed from the reality of sounds as we hear it in the concert hall."

Two bogies here. First, the old, old business of equalization. How many times must we all repeat—if a recording is played with the proper equalization the sound will be properly reproduced; middle and all. Virtually all our records have pre-emphasized highs, a rising curve. The reasons for this should be clear enough to all record reviewers by this time. (In fact, it is this very pre-emphasis of the highs that makes the good record sound passable on the average machine with its deficient high response.) On good equipment wrongly used (as is too often the case), the good record may shriek and screech. But that is the operator's fault, not the record maker's. Nasty sounding highs, of the sort that hurt musician's ears and Mr. X's, are decidedly not a necessary part of our high fidelity.

Reality?

And secondly—never think that a good record is supposed to give us a concert hall sound. The record, remember, is monaural, not binaural. It gives us an *impression* of naturalness and it may provide stimulating and highly pleasing listening. But it will never give us the "reality" of concert hall sound—and sometimes, in my opinion, the recorded sound is preferable to the concert hall one, anyhow. The two are, at this point, on an equality, and we must all learn to evaluate recorded music in its own terms, as an experience that is *not* a mere substitute for the concert hall.

Good reproduction, hi-fi, will never do any harm to the sound captured on a recording.

Audio and Music

3. "The search for hi-fi often masks other features in a record such as music and
[Continued on page 36]

* 279 W. 4th St., New York 14, N. Y.



When POLYPHASE was first introduced, our ads gave detailed laboratory data. By now, however, POLYPHASE fame has spread far and wide—principally by word of mouth—and the thousands of POLYPHASE owners themselves speak. . . . "Never before such LISTENING QUALITY, such FAITHFUL REPRODUCTION." But, you and only YOU can decide what sounds best and most pleasing. Therefore, see and HEAR the Chromatic POLYPHASE and—YOU be the judge.

One single, superb-quality magnetic unit plays all home records . . . and it costs no more than ordinary pickups. Replaceable Sapphire or Diamond styli. Available with the new Audax compass-pivoted arms and for record changers. The new AUDAX literature gives details, and includes the now world-famous CHROMATIC Diamond POLYPHASE—send for it. Be sure to obtain a copy of Electronic PHONO FACTS from your distributor.

AUDAK COMPANY

500 Fifth Avenue

New York 36

"Creators of Fine Electro-Acoustical apparatus for over 25 years."

THE *New*
AMPEX SERIES 400-A
MAGNETIC TAPE RECORDER

SOLD AND SERVICED BY



Audio & Video
 PRODUCTS CORPORATION

730 Fifth Avenue • New York 19, N. Y.

PLaza 7-3091

LITERATURE describing this new portable equipment will be rushed to you as soon as we receive your request.

AUDIO & VIDEO also sells and services the fine products of the leading audio equipment manufacturers. We will be glad to supply you with descriptive literature, prices and delivery information.

CHECK those manufacturers whose products you would like details about. Use this advertisement as a convenient coupon.

Exclusive in Canada

Canadian General Electric Co., Ltd.
 212 King Street, West
 Toronto, Canada

In Washington, D. C.

Gallant Engineering Company
 261 Constitution Avenue
 Washington 1, D. C.

AMPEX STANDARD RECORDERS

AMPEX SPECIAL RECORDERS

- | | |
|---|--|
| Altec <input type="checkbox"/> | McIntosh <input type="checkbox"/> |
| Cinema <input type="checkbox"/> | M. M. & M. Tape <input type="checkbox"/> |
| Editall <input type="checkbox"/> | Pickering <input type="checkbox"/> |
| Electro-Voice <input type="checkbox"/> | Pre-Recorded Tape <input type="checkbox"/> |
| Fairchild Disc <input type="checkbox"/> | Recording Rates <input type="checkbox"/> |
| Langevin <input type="checkbox"/> | Teleflex <input type="checkbox"/> |
| Lansing <input type="checkbox"/> | |

AUDIO & VIDEO PRODUCTS CORPORATION
730 Fifth Ave., New York 19, N. Y.

Please send me literature and details concerning the products of those manufacturers whose names I have checked above.

Name _____
 Title _____
 Company Name _____
 Mail Address _____

TAPE RECORDER

[from page 25]

cable from the recorder-oscillator chassis is plugged into the receptacle on the equalizer box. If the recorder is to be used with its regular Presto amplifier, the two terminals of the plug are shorted. The ground lead is carried through the shell of the plug, and serves to ground the equalizer can. A bracket for the extra idler and capstan sleeve is mounted on the side of this can to keep them out of the way—their normal position is on the top panel of the recorder.

Two other changes were made in the recorder-oscillator chassis. Since the oscillator tube used in the regular chassis was a 6Y6, which has a recommended maximum voltage rating of 200, it was thought preferable to replace this tube with one designed for a higher voltage, because it works with a 300-volt plate supply. A 6V6 was tried, but insufficient erase voltage was obtained, so the tube now in use is a 5881, which draws the same cathode current and provides the same h-f output if the screen resistor is changed to a 2-watt 47,000-ohm value. This decreases the heating in the recorder case, since the 5881 draws 0.9 amps as compared to 1.25 for the 6Y6. In all fairness, it must be noted that no trouble had been encountered from the use of the 6Y6—it was just a whim that prompted the change.

The second change involved the installation of a padder capacitor having a range from 200 to 600 μmf in parallel with a 200- μmf fixed capacitor in place of the 560- μmf capacitor (C_{209} in the Presto diagram) to provide for variation of bias and erase current. Again, in fairness, it must be noted that little change in performance has been noted, but the designer's whims must be satisfied.

The Playback Channel

The second channel is almost identical with the first when the selector switch is in the AMP position, except that no provision is made for a high-impedance input. However, in the REC position of the switch, the input stage is connected so as to provide the remainder of the low-frequency equalization necessary for playback from the tape, and to feed the playback signal out to the radio circuit through J_6 .

Most of the low-frequency equalization is provided by working the 500-ohm playback head into a 30-ohm resistance termination across which the input transformer primary is bridged, as shown by curve A in Fig. 8. The required total equalization is shown in curve B. The small amount of additional equalization is obtained by the feedback network composed of C_{11} , R_{12} , and R_{13} , with some high-frequency correction obtained from C_{16} and R_{15} . This circuit is similar to that used in the Magne recorder amplifier, and previously used by the writer in the Interview Am-

plifier. However, the amount of equalization is considerably less in this application. The entire equalization set-up for this amplifier was determined in the following manner:

With the selector switch in the AMP position, both input channels were equalized to provide flat response to the top of the main gain control, R_{22} . Then the output amplifier was equalized for flat response to the secondary of the output transformer—this being necessary if the amplifier were to be used as a remote pickup unit. Then the playback channel was adjusted for flat response from a standard tape obtained with the Presto recorder. Finally, the recording equalizer was adjusted to provide flat playback from the tape recorded through this unit. It will be noted that considerable high-frequency compensation was required. It is believed that this is occasioned by the use of extremely small shielded wire which carries high-impedance circuits throughout the amplifier. This will become evident when the construction is described. Again judging from results, it should be stated that the over-all IM distortion of this unit from microphone input jack to tape output—thus including the tape itself—is less than 3 per cent at full recording level, i.e. with a 0-VU indication on the meter with the level switch set at +6, and with a playback output of 1.0 volts.

The second stage in the second channel is identical with that in the first channel, but the output connects to one section of Sw_1 . In the NOR and REC positions of this switch, the output of the second stage is fed to the grid of a cathode follower, V_6 . Sw_3 in this grid circuit permits choice of monitoring direct from the mixing network, or from the tape playback. The 5879 was chosen because of its low heater drain, and because it was less microphonic than the 6C4 which has the same drain. The seemingly high value of cathode resistor for V_6 was determined by IM measurements. In the original construction, a 10,000-ohm resistor was used, but IM distortion in the playback channel was over 4 per cent. As the value of this resistor was increased, the distortion decreased to less than 1 per cent.

(In Fig. 3 of last month's article, resistor R_{15} in the grid circuit of V_6 , connected to Sw_{1b} , should have been marked R_{18} , and its value listed in the Parts List as 0.27 meg, 1/2 watt. R_{15} is correctly listed as 1000 ohms, and is located in the feedback network of V_1 . This error has been corrected in the accompanying schematic.)

The output of the cathode follower stage is fed through a coupling capacitor C_9 to the closed circuit jack J_5 and thence through the REC position of Sw_{1c} to J_6 . In the NOR position of Sw_1 , the two terminals of J_6 are shorted, and in the AMP position they are connected to the output pad. Thus a single jack serves two purposes.

In connecting this unit to a radio system, usually at high impedance, it is suggested that the output of a control unit be fed into terminal 2 of J_6 , and

The BEST BUY in Recorders!

Complete PUSH-BUTTON CONTROL



- CUT TAPE COSTS IN HALF
- OUTPERFORMS EVERYTHING IN ITS PRICE CLASS
- HIGHEST QUALITY & RESPONSE EVER BUILT INTO A PORTABLE

15,000 cps at 15 & 7 1/2 inches per second

AMPEX

AMPEX ELECTRIC CORPORATION
Redwood City, California

Advanced Series 400-A

Write for Bulletin A-211

AA-77

Yours for the Listening

- **FREE!** — 68 page catalog section from Radio's Master.
- Catalogs the products of 30 manufacturers of Recording, Phono Equipment and Accessories.
- Complete descriptions, specifications and illustrations of such products as: Recorders, Phono Motors, Turntables, Record Changers, Cartridges, Pickups, Discs, Tape, Needles, etc.



Represented in RADIO'S MASTER 68 page Recording & Phono Equipment Booklet are the products of the following manufacturers:

- ALLIANCE MANUFACTURING CO.
- AMERICAN MICROPHONE CO.
- AMPEX ELECTRIC CORP.
- *AMPLIFIER CORP. OF AMERICA
- THE ASTATIC CORP.
- AUDAK COMPANY
- AUDIO DEVICES, INC.
- BELL SOUND SYSTEMS, INC.
- BERLANT ASSOCIATES
- BOGEN CO., INC.
- CLARKSTAN CORP.
- DIUTONE CORP.
- ELECTRO-VOICE, INC.
- FAIRCHILD RECORDING EQUIPMENT CO.
- GARRARD SALES CORP.
- GENERAL ELECTRIC COMPANY
- GENERAL INDUSTRIES CO.
- JENSEN INDUSTRIES, INC.
- MAGNECORD, INC.
- MASCO ELECTRONIC SALES
- M. A. MILLER MFG. CO.
- MINNESOTA MINING & MFG. CO.
- NEWCOMB AUDIO PRODUCTS CO.
- ORRADIO INDUSTRIES, INC.
- *PENTRON CORP.
- PERMO, INC.
- PICKERING & CO., INC.
- PRESTO RECORDING CORP.
- RECORDISC CORP.
- RECOTON CORP.
- REEVES SOUNDRAFT CORP.
- REK-O-KUT COMPANY
- SHURE BROS., INC.
- V.M. CORPORATION
- WALCO PRODUCTS, INC.
- WEBSTER-CHICAGO CORP.
- WEBSTER ELECTRIC CO.

*These manufacturers not included in Radio's Master section. Separate catalog sheets will accompany each booklet.

You can obtain without cost or obligation, a complete 68 page catalog section as reprinted from the Industry's Official 1100 page Radio's Master, 16th edition.

This section catalogs in detail the products of the leading Recording and Phono Equipment manufacturers — all in 1 handy booklet. It is complete with descriptions, specifications, and illustrations as written by each manufacturer. Whether you buy, sell, or specify these products, you will find this booklet extremely helpful.

This offer is made possible by a special arrangement between AUDIO ENGINEERING and the publishers of RADIO'S MASTER. Be sure to get your copy now. Fill in the coupon below and mail.

MAIL TODAY

AUDIO ENGINEERING
342 MADISON AVE., NEW YORK 17, N. Y.

Please send me, without cost or obligation, the 68 page Recording & Phono Equipment and Accessories Booklet reprinted from Radio's Master.

Name
Address
City..... Zone..... State.....

that the input of the power amplifier be connected to terminal 3. Thus this unit intercepts the circuit between the control unit and the main amplifier. This increases the length of shielded leads, but should cause no frequency discrimination if the output of the control amplifier is of sufficiently low impedance, such as would be obtained with a cathode follower. Then in the NOR position of the switch, the recording amplifier is out of the circuit; in the REC position the incoming signal is fed to the mixing network, is recorded, and the playback from the tape is fed back to the line and the main amplifier. *Sw.*, permits choice of direct or recorded playback monitoring. There is a loss in level of approximately 10 db, which can be compensated by an additional switch in the main amplifier if desired.

The concluding part of this series will cover the construction of the amplifier, the power supplies used, and the various possibilities of hooking up the unit for its many applications.

RECORD REVUE

[from page 32]

performance. It leads the collector down the garden path where his tastes become quite changed."

I certainly agree with this point in its main premise. "The business of Audio is music," this column has often before suggested. Highs without music (and low lows similarly) are of precious little interest to this reviewer. It is true enough that many a hi-fi enthusiast finds the musical values of his reproduced sound about the last thing to interest him. Many an engineer in audio, it might be remarked, has a similar viewpoint.

But I'd suggest to Mr. X that to think that hi-fi is leading the people away from musical values is unwise. I honestly do not believe that anyone "unlearns" music. One hangs onto whatever knowledge and love of music one has to begin with, and the practice of hi-fi either leaves that knowledge largely untouched and unaffected—or it changes it for the better. One can learn an enormous amount about music from listening to records well reproduced—or one can learn very little, which is most likely the normal state of affairs with the majority of phonophiles.

I am fairly sure that most newcomers to our so-called high fidelity will outgrow the rabid stage, where highs and equipment specifications mean everything and music very little. Most of us go through it for awhile—longer or shorter—as a sort of growing stage. Some poor souls never get through it at all. But then lots of people never grow up at all, either. The trouble is that the rabid hi-fi newcomers always make the most noise and do the most hurting. The agonized musician probably doesn't notice that every few months the turnover is complete—a new batch of noise-makers has discovered hi-fi and the old batch has graduated into intelligent, adult, sensible listening for real musical values.

And don't anybody think that high fidelity, rightly used, doesn't enhance musical values. Of course it does. For it is, after all, by its own name, *more music per given sound.*

KEY

* Outstanding recorded sound for the type of music. * Unresonant, deadish acoustics. * Big bass. * Big brass. * Close-to highs with sharp edge. * Some distortion in highs. * Flattish high end; needs boost over normal LP playback. * Live, rather distant mike pickup. * Recorded hum. * From older 78 disc originals. * Piano is excellent. * Some surface noise. * Tympani, drums, percussion excellent. * Violin (or other) solo very close-to. * Bass seems weak; will need boost over normal LP playback. * Lacks highs. * Fuzzy spots—imperfections.

Modern—good for hi-fi.

* Sessions, **The Black Maskers (1923)**. Amer. Recording Soc. Orch., Hendl.
Amer. Recording Soc. ARS-11

Acid, powerful early-twenties music, reminiscent of "Le Sacre," the Scythian suite, etc., but with Sessions' high pressure, almost violent expression. Wonderful hi-fi, but it'll hit you between the eyes.

* Rawsthorne, **Piano Concerto #2 (1951)**. Curzon; London Symphony, Sargent.
London LPS 513

Neo-Rachmaninoff stuff from a leading British composer, little known here. Romantic slant makes for easy listening, but I'd rate it as musically overstuffed and derivative, though basically well written.

Elliott Carter, * **Piano Sonata (1945-6)**; **Cello Sonata (1948)**. Beveridge Webster, pf.; Bernard Greenhouse, cello, Anth. Makas, pf. **Amer. Recording Soc. ARS-25**

The piano sonata is an outstanding example of good piano recording. Difficult, nervous, complex and jittery music, strictly an art sonata and scarcely for the novice listener—but the fine sound and expert playing may carry you away. The cello sonata, a similar idiom, is less accessible to average listening. But both are major works for those who can take 'em.

Ture Rangstroem, **Symphony #1 in C sharp minor (1914)**. Stockholm Concert Ass'n, Tor Mann.
London LLP 514

A hugely scored symphony in the best gloomy northern tradition, out of Sibelius—I'd call it a passel of cliches, and a poor work. Might do for a Garbo picture, some day. (But evidently this composer is much thought of in Sweden.)

Prokofieff, "Love for Three Oranges" suite (1921); **Russian Overture, Op. 72 (1936)**. Radio Berlin Symphony, Rother; Berlin Philharmonic, Steinkopf.

Urania URLP 5005.

Here coupled with the early and brassy "Oranges," now being heard more frequently, is a heretofore unknown (in the U.S.A.) big overture, a good-humored, tuneful, heavyweight product of P.'s Sovietized days—along with "Peter" and "Lt. Kije" and not unlike them. A good contrast, both well played (the "Oranges" very well), both well enough recorded—the "Oranges" would be outstanding except for the overloading, somewhere along the line, that is an occasional Urania hallmark.

Copland, **Music for the Theatre (1925)**. * **Moross, Frankie and Johnnie (1938)**. Amer. Recording Soc. Orch., Hendl; soloists. **Amer. Recording Soc. ARS-12**

The American Recording Society issues this and the others above via the Ditson Fund, non-profit; for such a venture the results are terrific technically (where so often we find dreadful work) and most interesting musically. Copland's 1925 shocker isn't quite as jazzy and wicked here as in the old Victor recording, one of my pets—a rather academic performance, this, though good. "Frankie and Johnny" you will find unusually interesting. Much of this type of concertized folk music is dreary and pretentious musically, but this is well written and ultra-dramatic. Three sopranos sing the story, to the old tune set in fancy modern style. This is the music for the ballet, which has appeared on and off for many seasons.



*If you "talk test"...
you talk Peerless*

PEERLESS 3-240-Q



Competitor No. 1



Competitor No. 2



Competitor No. 3



Competitor No. 4

**all tests demonstrate
PEERLESS
superiority**

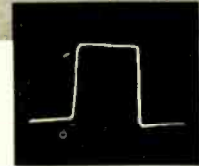

Square Wave

Comparative square wave tests on transformers shown all over the country have demonstrated Peerless superiority... Now Peerless emphasizes another very important property of transformers as shown by the "exciting current test." An output transformer's ability to deliver plenty of clean, low-frequency power (the goal of every music lover) is inversely proportional to the amplitude and distortion of its exciting current.

PEERLESS superior low-frequency power handling capacity is illustrated in these comparative oscillograms.

Write for complete data.

PEERLESS
Electrical Products



ALTEC
LANSING CORPORATION

9356 Santa Monica Blvd.
Beverly Hills, Calif.

161 Sixth Avenue
New York 13, N.Y.



DC to AC Converters



Dynamotors



Genemotors

DEPENDABLE . . . COMPACT . . . EFFICIENT

Carter Rotary Power

Carter DC to AC Converters, Dynamotors, Genemotors, Magmotors, and Inductor Alternators (inverters) are made in a wide variety of types and capacities adaptable to communications, laboratory, and industrial applications, of many kinds. Widely used in aircraft, marine, and mobile radio, geophysical instruments, laboratory work, ignition, timing and many other uses.

Carter Motor Co.

2648 N. Maplewood Ave., Chicago 47
Sales Offices in Principal Cities



Recorder Converters



Inductor Alternators



Magmotors

MAIL COUPON FOR CATALOGS

Please send catalogs containing complete information on Carter Rotary Power Supplies.

Name: _____

Address: _____

City: _____ State: _____

*Trade Mark Registered

NEW PRODUCTS

● **R-J Speaker Enclosure.** Long-awaited commercial introduction of the R-J cabinet was scheduled at this writing to take place at the Chicago Audio Fair. An exhibit of experimental models was shown at the Audio Fair in New York last fall. First introduced through the pages of *AE*, the R-J enclosure departs entirely from conventional concepts of design in that it



does not depend on large cubic displacement to achieve low-note reproduction. Large enough only to enclose the speaker it contains, the R-J virtually eliminates the factor of cabinet resonance in audio reproduction. Performance is governed entirely by characteristics of the driver. High-frequency tones are direct-radiated and low-frequency response is governed largely by cone resonance. Although exact technical specifications are not available, tests have shown the R-J capable of reproducing pedal notes of an organ with startling realism. The R-J is presently available for 12- or 15-in. speakers in a choice of mahogany or blonde finish. R-J Audio Products, Inc., Dept. HR, 164 Duane St., New York 13, N. Y.

● **Miniaturized Phone Plug.** Measurable reduction in operating space of audio-equipment is effected by the new "imp" phone plug recently introduced by Carter

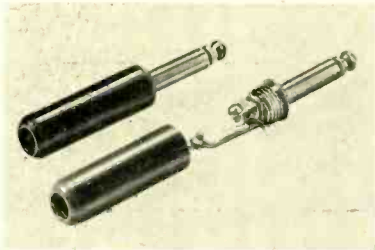

Parts Co., 213 W. Institute Place, Chicago 10, Ill. Tip and sleeve of the new plug fit standard 2-conductor jacks, but the molded Bakelite handle has been reduced to approximately half normal size.

● **Pre-Built Radio-Phono Cabinet Kit.** Ample space is provided for standard makes of tuners, amplifiers and record changers in a new custom-cabinet kit recently announced by Modcraft Cabinets, 64 Robbins Road, Arlington, Mass.



Constructed of $\frac{3}{4}$ -in. Philippine mahogany plywood, the new cabinet is available in two models—one with space for installation of a 12- or 15-in. speaker, the other with space for record storage. All parts, such as changer-drawer slides, hardware, glue, plastic wood, and grill cloth are supplied. Assembly and finishing instructions are also included. Complete details will be supplied on request to the manufacturer.

● **Medium-Priced Ampex Console.** Features that have long been inherent in more expensive models are included in the new Ampex console-type tape recorder designed for the moderate-price market. A professional, dual-speed recorder, the new Model 402-3 includes push-button control of all functions, built-in microphone pre-amplifier, and 15,000 cps response at $7\frac{1}{2}$ ins./sec. tape speed. Model 402 contains half-track heads while Model 403 is a single-track unit. Both models feature a newly-styled cabinet which, through use



of a unique tilt-hinged mounting of electronic and top-plate assemblies, permits quick, easy inspection of any component while the recorder remains in operation. Complete details and specifications are available by writing Ampex Electric Corporation, Redwood City, Calif.

● **Studio-Type Audio Console.** An entirely self-contained a.c.-operated unit, the new Altec Lansing 230B audio console is designed for two-studio broadcast-station use, as well as for professional recording studios and extensive public-address systems. There are four separate preamplifiers, two booster amplifiers, a line amplifier and a monitor amplifier all mounted on a single chassis. Also included are miniature plug-in power supplies for plates, filaments, relays, and signal lights. The console is equipped with six mixing potentiometers, four of which are connected through switching keys to eight low-level microphone or turntable inputs. The remaining two are connected with four line inputs. Thus is provided a total of twelve inputs, any six of which can be mixed simultaneously. An emergency



switch permits instant replacement of the line amplifier with the monitor amplifier. System gain is 100 db. Frequency response is ± 1 db from 20 to 20,000 cps, and signal-to-noise ratio is 74 db. Notwithstanding the 230B's many functions, dimensions are only $9\frac{3}{8}$ in. high \times $36\frac{3}{4}$ in. long \times 17 in. deep. Manufactured by Altec Lansing Corporation, Beverly Hills, Calif. and distributed by Graybar Electric Company.

● **Corner Speaker Enclosure.** Exceptional low-frequency response is achieved with



the new Permoflux low-cost corner cabinet, designed primarily for housing the Permoflux Royal Eight speaker but equally suited for improving performance of any other 8-in. unit. Handsomely finished in a choice of mahogany or blonde, the console measures only 25 in. high \times 20 in. wide \times 11 in. deep. Permoflux Corporation, 4902-A W. Grand Ave., Chicago 39, Ill.

● **Portable Turntables.** Variable speed control, permitting adjustment from 25 per cent below normal to 10 per cent above normal at speeds of 78, 45 and 33 $\frac{1}{3}$ r.p.m., is featured in two new portable turntables designed for modernization of sound systems, manufactured by Califone Corporation, 1041 N. Sycamore



Ave., Hollywood 38, Calif. Designated as Model 8V with turnover-type crystal cartridge, and 8V-P2 with dual-stylus magnetic cartridge, the units are housed in attractive leatherette-covered carrying cases with conveniently recessed controls.

● **Preamplifier-Equalizer.** Remarkable flexibility is inherent in the new 120-A preamplifier-equalizer recently introduced by Hermon Hosmer Scott, Inc., 385 Putnam Ave., Cambridge 39, Mass. Designed for use with most existing power amplifiers, the 120-A contains a record compensator for virtually all recording characteristics. Treble roll-off and bass turnover equalization are provided on eight positions, including five for standard 78's and three for LP's. Continuously-variable tone controls provide boost and attenuation of both treble and bass. Loudness control compensates for characteristics of the human ear. Provision is made for using the Scott Dynaural Noise Suppressor as an accessory. Frequency response is substantially flat from 19 to 35,000 cps. All heaters are d.c. operated to minimize hum. The 120-A is housed in a beautifully-finished hardwood case, the rear of which is open to permit instant removal of tubes for inspection or replacement. Descriptive literature will be supplied free by the manufacturer.



RADIO STATION

[from page 17]

conditions which are often expensive to correct later. However, there are some basic acoustic principles, and if the station engineer knows them, he will be able to cooperate intelligently with the acoustic consultant, architect, and contractor.

There are two general problems in broadcast acoustics. One is to minimize sound leakage into and out of studios; the other is to control the quality of the sound to be broadcast. Perhaps the best way to minimize sound leakage from outside the building is to build the studios in a relatively quiet area free from heavy traffic, airplane noise, etc. Noises from other parts of the building caused by heavy machinery like printing presses, pumps, etc. are best avoided by buying some other building. This is not an attempt to be facetious, but simply a restatement of the old proverb that prevention is better than cure. Having taken such precautions, the next thing is to consider the sound isolation value of various wall structures. Other things being equal, the sound isolation value—or transmission loss—of a single, solid wall is proportional to its mass in pounds per square foot of area. Airborne sound impinging on one side of a wall sets the wall in vibration, thereby imparting sound energy to the air on the far side. The more massive the partition, the less it will vibrate under a given level of airborne sound.

However, there are practical limitations to increasing the mass, namely weight and cost, and recourse can be had to another technique—that of interposing a barrier in the path of vibration through the wall. The most common method is to use a double wall enclosing an air space. Contrary to popular opinion, air is not a good sound insulator but it offers a high mechanical impedance, so to speak, to the transmission of vibration. Such a wall is called a discontinuous structure.

Aside from wall vibration, airborne sound leaks into studios through cracks and holes and is overcome by calking all openings, and sealing masonry pores by plastering. Some airborne sound also enters through electrical conduits and ventilating ducts; these problems will be discussed under the sections on electrical work and air-conditioning.

The table in Fig. 2 shows the approximate transmission loss of various types of wall constructions. Since the degree of isolation increases with frequency, these figures are the averages for the range of 128 to 4096 cps. Note that the table applies only to airborne sound, and not to solid-borne sound such as impacts. However, the latter are greatly minimized by the discontinuous or double-wall type of construction. In this connection, the staggered stud wall in the table gives remarkably good isolation as to both airborne and solid-borne noise, considering its relatively

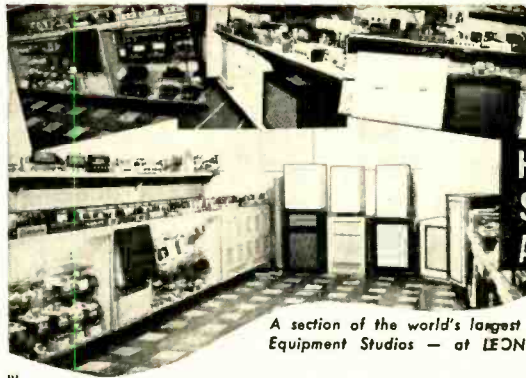

A section of the world's largest Sound Equipment Studios — at LEONARD'S.

Leonard

HIGH FIDELITY SOUND EQUIPMENT AT ITS FINEST

WHEN YOU LEND AN EAR YOU SHOULD GET IT BACK WITH INTEREST

Yes—when listening, you have a right to enjoy more interesting, more pleasurable sound reproduction. You will get it with these new units—at LEONARD'S!

NEW HIGH FREQUENCY UNIT

The JENSEN RP-302 High Frequency Unit makes a 3-way system from your present coaxial, or a 2-way from a single unit. This "super-tweeter" mounts flush on baffle or panel in 1-11/16" hole. Features include:

- Smooth clean "highs" from 4,000 cycles to 18,000 cycles.
- Small horn disperses sound to 120 degrees in horizontal and vertical planes.
- Impedance 16 ohms. Power rating 30-40 watts speech with music signal when combined with A-402 Crossover Network (illustrated below).
- Compact—Overall diam. 2-3/4", length 3-5/8". Model RP-302 . . . NET \$32.93

The JENSEN ST-901 H-F Balance Control is a variable 16 ohm L pad to adjust level of RP-302 High Frequency Unit . . . NET \$3.38

JENSEN A-402 Crossover Network
Divided into two channels (hi-pass, low pass) with crossover at 4000 cycles. The RP-302 companion unit connects to hi-channel, your present system or speaker to low channel. 180° constant resistance. Impedance 16 ohms input. Attenuation, 12 db per octave outside pass band. 4-3/8" high, 3-1/2" wide, 3-1/4" deep. Model A-402 . . . NET \$6.61



JENSEN RP-302



JENSEN A-402



ELECTRO-VOICE 18W

ELECTRO-VOICE Model 18W Very-Low Frequency Driver

Extends bass response to 32 cps. 224 sq. in. cone area. 5-1/2 lb. Alnico V magnet. Power input 20 W above 30 cps, 30 W above 100 cps. Impedance: 12 ohms nominal, 8 or 16 ohms optional. 18-1/4" diam. baffle opening 16-1/2". Model 18W . . . NET \$79.38

New WEATHERS One-Gram Capacitance Pick-Up (Cartridge Form)

At last—realism without noise, 20 to 20,000 cycles. Will improve and replace any modern phonograph pickup.

- One gram stylus pressure with ideal tone arm.
- Two grams pressure on modern Webster changers.
- Very low pressures with other players, including RCA 45 changer.
- Will operate properly with most good quality tone arms.

Oscillator requires 6.3 volts ac at 0.3 amp, and 250 volts dc at 2ma. Available from most amplifiers.

Complete with ultra-flexible cable, oscillator unit, tube, installation hardware and instructions

WEATHERS power supply, complete with power cord, for 117 volts, 60 cps. . . . net \$14.50

Mail Orders filled promptly. Write Dept. A6 for immediate, courteous service.



net \$37.50

Send now for our FREE 48 p. CATALOG of the latest and finest in Sound Equipment.

Cortlandt 7-0315

the house
built on
SERVICE

Leonard Radio inc.

69 CORTLANDT ST.,
NEW YORK 7, N. Y.

**Ampex + Terminal
= unrivaled
Performance ...
Reliability ... Service!**

* Terminal

DIRECT FACTORY DISTRIBUTOR
FOR ALL
AMPEX RECORDING EQUIPMENT
presents

the **NEW**

AMPEX '403' CONSOLE TAPE RECORDER



Here is the "standard setting"
400A in a beautifully designed
gray modern console cabinet.

Dimensions: 23 1/4" wide, 30 1/4" high, 25 3/8" front to back. **\$995**

- Available in full-track or half-track models.
- Remote control assembly optional at extra cost.

Brochures and engineering data on all AMPEX equipment available on request.

Visit our audio department for a recording and playback demonstration.



Terminal Radio Corp.

85 Cortlandt St., New York 7, N.Y.
WOrth 4-3311

low cost and light weight. This type of structure is shown in detail in Fig. 3.

One factor affecting the degree of isolation needed is the type of programming. Ideally, all studios should have dividing walls of 55 or 60 db transmission loss so that any type of show could be produced in any studio without fear of mutual leakage. However, it is sometimes necessary to cut corners to meet a budget and the wall isolation can vary with the type of program material. Between studios used only for conversational-level speech such as newscasts and dramatic shows, 45 db might be a minimum value. The same figure could be accepted for the wall between the studio and the control room where a higher loss would be difficult to achieve because of the leakage and vibration of the observation glass. Between two studios used for music or dramatics, 50 db is a minimum and 55 or 60 db is better.

Another factor affecting the needed isolation is the ambient level. This is the sound level that exists when no program is going on, and is due to leakage of outside noise, building vibration, ventilation system hiss, etc. The networks like to keep this down to 25 db (measured on the "A" scale of a standard sound level meter). However, this is sometimes an expensive ideal to attain and in the writer's experience, an ambient of 30 to 35 db can often be tolerated in practice.

Up to this point, we have been discussing the first half of the acoustic problem—leakage of sound into and out of studios. The other half of the problem is the control of broadcast sound originating in the studio. One of the most important factors here is reverberation. There are few real-life situations (except outdoors) wherein reverberation is not present to some extent. The naturalness of reproduction depends in large measure on the degree to which the reproduced material contains the reverberation the listener associates with the corresponding real-life situation.

Reverberation

Reverberation is not the same as echo. The latter is a separate and distinct repetition of the original sound. Reverberation is the extent to which the sound lingers after the source has been cut off, and is quantitatively expressed as "reverberation time." This is the number of seconds required for the sound to die away to one millionth of its original intensity, a reduction of 60 db. It is computed by the Eyring equation

$$T = \frac{.049 V}{-\log_e (1-a) S}$$

where V is the studio volume in cubic feet, and S is the total surface area including walls, floor, and ceiling. The term a is the noise absorption coefficient for a given frequency. It is obtained by multiplying the number of square feet of each type of surface by its coefficient at a specific frequency, adding the products so obtained and dividing the result by

AMPERITE

Studio Microphones
at P.A. Prices

Ideal for
BROADCASTING
RECORDING
PUBLIC ADDRESS

"The ultimate in microphone quality," says Evan Rusing, sound engineer of the Hotel New Yorker.

● Shout right into the new Amperite Microphone—or stand 2 feet away—reproduction is always perfect.

● Not affected by any climatic conditions.

● Guaranteed to withstand severe "knocking around."



Models
RBLG—200 ohms
RBHG—Hi-imp.
List \$42.00



"Kontak" Mikes
Model SKH, list \$12.00
Model KKH, list \$18.00

Special Offer: Write for Special Introductory Offer, and 4-page illustrated folder.

AMPERITE Company, Inc.

561 BROADWAY • NEW YORK 12, N. Y.

Canada: Atlas Radio Corp., Ltd., 560 King St. W., Toronto

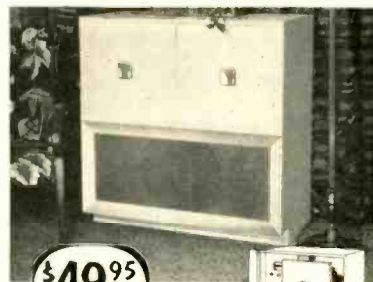

\$49.95
COMPLETE

ASSEMBLE THIS HANDSOME

Philippine Mahogany audio cabinet

AND SAVE 2/3 THE COST!



Minus grille, with big record storage space. **\$45.95 Complete**

At last, a cabinet worthy of the finest equipment at a price you never dreamed possible! Separate changer, tuner, amplifier compartments ample for all popular makes. Accommodates 12" or 15" speaker. 38" h. x 36 1/4" w. x 18 3/8" d., overall. Slide-out changer board cut out for Webster, Garrard or blank. Control panel blank. Pre-cut and sanded 3/4" Philippine Mahogany plywood. End grain veneered. All hardware, glue, assembly and finishing (blond or dark) instructions, etc. Dealer inquiries invited.

Send 25% down (balance and express charges C.O.D.) or write for details.

modecraft pre-built cabinets
64 ROBBINS ROAD • ARLINGTON • MASS.

the total surface area of the room. The coefficients for various acoustical materials are given in the trade literature² for the standard frequencies of 128, 256, 512, 1024, 2048, and 4096 cycles. The log of $(1-a)$ to base e can readily be obtained from the more familiar \log_{10} by multiplying the latter by 2.3026. However, as soon as a is known, the logarithmic work can be avoided altogether by picking off the value of the log term from the curve, Fig. 4.

Consider the sample calculation in Fig. 5 in which for simplicity, only three surface materials are involved. Given a studio 10 feet high, 17 feet wide and 28 feet long. The walls and ceiling are covered with material "alpha." The floor is covered with material "beta." One of the short walls contains thirty square feet of observation glass and five persons are assumed to work in the studio. The calculated time at 1024 cycles is 0.46 seconds.

Reverberation time can be made to vary with studio volume for a given frequency, and with frequency for a given studio volume, as shown in the Morris-Nixon curves, Fig. 6. Curve A shows desirable times for various studio volumes at 1000 cps. Curve B shows the ratio between the time for any given frequency and the time for 1000 cps. For example, in a 10,000-cu. ft. studio, the time at 1000 cps is 0.6 seconds from curve A. Curve B shows that for 100 cps, the time is 1.7 times 0.6 or 1.02 seconds.

The Morris-Nixon curves apply principally to music studios and provide relatively live acoustic conditions. Music is almost always heard in real life with considerable reverberation, and naturalness requires that this be provided in its transmission and reproduction. On the other hand, speech studios require somewhat less reverberation than is indicated in the curves. Reverberation times of 0.35 to 0.6 seconds are common for speech studios. The writer suggests that for speech, curve B remain flat at the 1000 cps value as the frequency decreases below that point—or alternatively, that it drop slightly below 1000 cps—and that it rise only slightly above 1000 cps. For very small announce booths, a flat curve is suggested, with a value under 0.4 seconds.

Another factor affecting tonal control of broadcast sound is the degree of diffusion or dispersion of reflected sound. When there are few reflecting paths between the source and the microphone, there is little diffusion, and as a result, there may be standing waves whose frequency depends on the dimensions of the studio. Sometimes reflected sound arrives at the microphone simultaneously with—and in or out of phase with—the direct sound. This results in reinforcements and reductions and a studio so plagued is said to have "live" and "dead" spots. This condition may be particularly bothersome in a studio which has two equal dimensions, since

²"Sound Absorption Coefficients of Architectural Materials." Booklet of Acoustic Materials Association. Bulletin X, 1948.

Men who know *Quality* . . . know **TECH-MASTER**



C. G. McPROUD,
Editor of **AUDIO**
Engineering, writes:

"I assembled my own home TV receiver from a standard Techmaster kit. I was amazed at the speed and simplicity with which this could be done. So gratifying was the result, that I have since

been obliged to assemble several more Techmaster receivers for friends who marvelled at the picture quality of my own. In each case the results were excellent and have provided their owners with uninterrupted top quality, trouble-free performance . . ."

been obliged to assemble several more Techmaster receivers for friends who marvelled at the picture quality of my own. In each case the results were excellent and have provided their owners with uninterrupted top quality, trouble-free performance . . ."

Experts Everywhere Concede the Superiority of the Techmaster 630 Type Circuit!

The TECHMASTER 630 has been advanced in every detail of modern engineering and design. Every component is the best available, and rigid factory and test standards are your assurance of years of trouble-free performance. Prefabricated unit construction, factory pre-adjusted and pre-aligned make assembly an utterly simple and enjoyable procedure with a minimum of tools.

More leading engineers and technicians have chosen Techmaster Kits and Techmaster Chassis, than any other television.

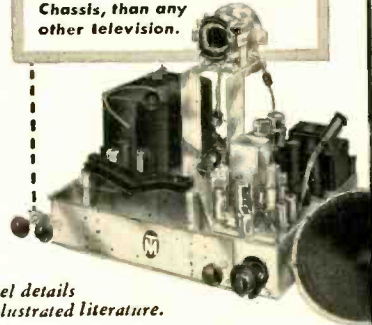

See your local Jobber for model details or write direct to factory for illustrated literature.

TECH-MASTER PRODUCTS COMPANY • 443-445 BROADWAY, N. Y. 13, N. Y.

Build YOUR OWN TEST EQUIPMENT

Heathkit AUDIO GEN. KIT \$34.50

Heathkit TELEVISION GENERATOR KIT \$39.50

Heathkit CONDENSER CHECKER KIT \$19.50

Heathkit SIGNAL TRACER KIT \$19.50

Heathkit IMPEDANCE BRIDGE KIT \$69.50

Heathkit HAND TESTER KIT \$13.50

Heathkit TUBE CHECKER KIT \$29.50

Heathkit PUSH-PULL . . . 5 OSCILLOSCOPE KIT \$43.50

Heathkit ELECTRONIC SWITCH KIT \$19.50

Heathkit BATTERY ELIMINATOR KIT \$24.50

Heathkit R.F. SIGNAL GEN. KIT \$19.50

Heathkit VACUUM TUBE VOLTMETER KIT \$24.50

HEATH COMPANY
BENTON HARBOR 23, MICHIGAN

EXPORT AGENT: ROCKE INTERNATIONAL CORP., 13 E. 40th St., NEW YORK CITY (14)

TWIN-TRAX* TAPE RECORDER



Official Magnetic Recorder of 1952 OLYMPICS

Selected in International Competition
by the Olympic Purchasing Commission

Because of their quality, dependability and exceptional value, Twin-Trax* Recorders were selected *exclusively* by the Olympic Purchasing Commission for all on-the-scene recording and subsequent rebroadcasting of this year's Olympic Games by sportscasters and commentators of every nation.

Yes, engineers of Finland's Olympic Purchasing Commission circled the globe while visiting every manufacturer of tape recorders and testing their products, to select the tape recorder that would not only guarantee perfect recording, but give them maximum value for their money.

You, too, can own a Twin-Trax* Recorder, discriminatingly chosen for the greatest and most historic recording project of our time. As a Twin-Trax* owner, you'll be in good company—with thousands of government agencies, broadcast stations, schools, critical music lovers and others who have also made Twin-Trax* their "official and exclusive" recorder.

*Trade Mark Reg.

Write today for Catalog #5324, containing complete specifications and direct factory prices.

AMPLIFIER CORP. of AMERICA • 398-4 Broadway • New York 13, N. Y.

Authoritative and Enlightening . . .



*Acknowledged the Leading Publication
in the Field of Sound Reproduction*

If you are novice, hobbyist, experimenter, or engineer . . . if you are a lover of music . . . and in pursuit of sound, undistorted . . . Audio Engineering will be your faithful, reliable companion all the way. You will find no more pleasurable and stimulating reading than there is in AE; absorbingly interesting material, valuable and authentic data, workable detailed instructions . . . all comprehensively and yet practically presented.

"What to Do" and "How to Do" will guide your every move through this thrilling experience we call Audio.

Each new issue brings New Ideas, New Slants, and Latest Developments . . . month in and month out . . . twelve times a year.

BE SURE to get your copies REGULARLY.

**MAIL this
Coupon
NOW**

AUDIO ENGINEERING
342 Madison Avenue, New York 17, N. Y.

Enclosed is Check Money Order for \$ _____
Please send a copy of each new issue of Audio Engineering for the next
 12 months; 24 months to:

Please Print

Name _____

Address _____

City _____ Zone _____ State _____

Subscription Price: U.S.A., Canada and Pan American Union: 1 year . . . \$3.00 2 years . . . \$5.00. Other countries: 1 year . . . \$4.00 2 years . . . \$7.00.

there can then be two sets of standing waves of identical frequency. When all three dimensions are equal, trouble is almost a certainty.

One way to avoid standing waves is to select room proportions which are neither square nor cubical, and which do not permit the ratio of any two dimensions to be a whole number. Most authorities suggest ratios among height, width and length based on the one-third or two-thirds octave principle. For example, consider a ceiling height of 12 feet. Two-thirds the octave of 12 is 8 which, added to 12, gives 20 feet as the preferred width. Recommended dimensions for various design conditions are given in the table in Fig. 7. Note that the dimensions reflect different ratios for different sizes and shapes of studies.

Standing waves can also be reduced by using splays and serrations in walls and ceilings to provide multiple reflection paths. Another way is to build opposite walls out of parallel, and to slope the ceiling with respect to the floor. Multiple reflection paths not only reduce the likelihood of standing waves but also provide a smoother decay curve. In studios having good diffusion, microphone placement is less critical.

Construction details on the acoustic features described will be discussed in the next issue. The writer would like to acknowledge the kind assistance of Mr. M. J. Kodaras of Johns-Manville, and Messrs. George M. Nixon and H. M. Gurin of the National Broadcasting Company in furnishing some of the acoustic material herein.

AUDIO IN THE HOME

[from page 28]

—a condition found in only our most professional equipment. As in the Brook amplifiers, tone controls are in steps and are rather abrupt. It has extremely low distortion and a high damping factor, and when used with the proper speaker and cabinet would be considered one of the best amplifiers available in this country today.

The Musician's Amplifier

This is the American version of the famed Williamson amplifier that was first published in *Wireless World* in April and May, 1947. Much credit should be given to David Sarser and Melvin Sprinkle for being the first to adapt this famous circuit to American components.¹ There have been many Williamson circuits attempting to capitalize on this publicity, but few have come anywhere near equaling it in popularity or in quality. The biggest difficulty for many who have built or obtained this amplifier has been the lack of a good quality preamplifier with adequate controls.

This is a resumé of some of the popular amplifiers in this country. There are, of course, many others available, but most of them lack tone controls sufficiently flexible for living room operation.

¹ David Sarser and Melvin C. Sprinkle, "Musician's amplifier." *AUDIO ENGINEERING*, Nov. 1949.

WILLIAMSON AMPLIFIER

[from page 27]

of the circuit utilize power transformers which furnish 400 volts at 200 ma. Since the drain of the circuit does not exceed 130 to 140 ma, the voltage obtained out of a capacitor input filter and 5V4 rectifier is about 450 volts. This is the correct value for the circuit as converted. Lower voltage will limit the power output capabilities.

Performance

Figure 2 shows intermodulation distortion versus power output. It can be seen that the power output of the circuit is effectively doubled over that of the original circuit for a given distortion. At low levels, around 1 watt, the IM hits such phenomenal values as .06 per cent. It is only 0.3 per cent at 13 watts. This curve is based on equivalent sine wave power in order to make it comparable with all the other published and advertised data on the Williamson circuit.³ The values graphed in Fig. 2 can be divided by 1.47 for those who wish to have direct comparability with the meter readings obtained on the intermodulation test equipment.

Figure 3 shows oscillograms of square-wave traces taken through the complete amplifier with repetition rates of 20 cps and 50 kc. Traces at intermediate frequencies approach theoretical perfection, and even such a rigorous test as the 50-kc wave shows up extremely well. The waveform has not "sined off," and the extent of ringing is less than that exhibited by the 5000-cps wave of many good quality amplifiers. These square-wave tests were made at a comparatively low level which makes the test even more rigorous. At low excitation levels, the inductance of an output transformer decreases, the phase shift increases and the tops of the square wave tilts. A high-level square wave will appear better than a low-level one at low frequencies. Similarly, high powers at high frequencies will clip any supersonic peaks in the response and improve the appearance of the square wave. The use of a high level of power can make a relatively poor amplifier appear better on square wave tests.

The frequency response of the converted amplifier is flat ± 1 db from less than 5 cps to 200 kc. Its phase shift reaches 3 deg. at 20 cps and at 20 kc, indicating symmetry of response with respect to the audio band.

The amplifier puts out 30 watts of power over a range greater than the audio spectrum. However, this type of power curve, as measured by response at high power levels, is not too meaningful. The important consideration is the amount of *undistorted* power available

³ Sarser and Sprinkle, "Musician's amplifier," AUDIO ENGINEERING, November 1949.



Model WBO-50

HERE'S A SUPERIOR SCOPE!

... AT A NEW LOW PRICE!

This superior LABORATORY instrument possessing many outstanding features. A vertical amplifier of 5-mc bandwidth; a sweep oscillator variable to 150 kc in 6 ranges; full 4" vertical deflection without overload. Excellent reproduction of 1-mc square waves. 30-cycle square wave tilt less than 5%. Slotted bezel for insertion of graduated scale and light filter. Calibrated continuously variable vertical gain control.

Never before could you obtain so many outstanding features in a laboratory precision scope at this low price.

Write for Bulletin.

The Vertical Amplifier has a sensitivity of 20 millivolts RMS per inch of deflection, a frequency response (sine wave) of 20 cycles to 5 megacycles that is down only 3 db at 5 mc. a square-wave response that is an excellent duplication of all square waves between 30 cycles and 1 megacycle with a maximum tilt of 5% for 30-cycle square wave. a maximum input potential of 1000 volts peak-to-peak, and an input attenuator of X1-X10-X100 positions, frequency compensated.

The Horizontal Amplifier has a sensitivity of 0.3 volts RMS per inch of deflection, and a frequency response (sine wave) flat to 300 kc.

The Recurrent Sweep Oscillator has a frequency range of 10 cycle to 150 kilocycles in 6 ranges, with excellent linearity over entire range. Expanded horizontal deflection.

EL-Tronics INC.

2667 N. Howard St., Phila. 33, Pa.

\$249.50*

F.O.B. Factory

* Price subject to change

HARRISON AUDIO SHOP REPORTS . . .
Sensational New ACRO TRANSFORMERS
Sweeping High Fidelity Field in Sales!



FREE!

Write for 12 page ACRO data; Amplifier and conversion schematics.

Using a Williamson??

Double your power output, and reduce distortion by 50%!!

ACRO TO-300

"The World's Finest Transformer"

- Response ± 1 db 10cps to 100,000cps
- Rated to handle 40 Watts
- Resonance-free response
- Unequaled square wave response
- Low phase shift
- Most quality per dollar!

\$2475
net

ACRO TO-310. Same ratings but 20 watts. For converting all popular 10-watt 6V6 amplifiers to the sensational Ultra Linear Operation **\$18.75**

Convert to Ultra Linear Operation by simply changing three resistors and condensers! . . . **KIT \$1.00**

All units fully potted in attractive grey hammertone case. Compact, only 3 1/2" x 3 1/4" x 4 1/4" high.

ACRO TO-290. For the original Williamson Amplifier. Performance equal to the finest, regardless of price..... **\$15.75**



HARRISON RADIO CORPORATION

227 GREENWICH ST.
NEW YORK 7, N. Y. BR 4-7777

If C O D is desired, please enclose 25% Deposit

Do you have any Audio PROBLEMS?
Call or write Ben Plack, our Audio Specialist, for friendly, helpful advice. No obligation.



where precision
matters...
THERMADOR



Transformers for Television
... Radar... Aircraft...
Geophysics... Radio

You will find Thermador ready, willing and fully qualified to handle your transformer requirements. Engineering experience and manufacturing know-how, developed over a period of 35 years, form the hard core that makes Thermador today's largest West Coast manufacturer of electrical appliances and transformers. We would like to work with you on your next project involving the design and production of transformers for specific requirements...including joint Army-Navy specifications.

transformers:

- Audio Auto Geophysical
- Driver Filament High-Fidelity Audio
- Input-Output Midget Plug-In
- Plate Power Television
- Tube to Line

...also Chokes and Reactors



**THERMADOR ELECTRICAL
MANUFACTURING CO.**

3-320

5110 District Boulevard • Los Angeles 22, Calif.

at various frequencies. The Ultra Linear Williamson arrangement puts out close to 25 watts at 20 cps and at 30 kc without clipping, attenuation, or other visual distortion of the waveform as viewed on a 'scope. By observing the transfer characteristic, it is possible to detect by eye harmonic distortion of less than 2 per cent. The power curve of the amplifier thus deviates from flat by less than 1 db over the range 20 cps to 30 kc.

As intimated above, the circuit has excellent listening qualities. This is a confirmation of the measurements. The additional power available shows up in cleaner and better articulated bass. The overall effect is of greater smoothness, more definition of detail in the sound, and better transient response. Ultra-Linear circuits seem to have a wider transient bandwidth—an audible benefit which is not readily susceptible to measurement. The combined effect of the Williamson circuit configuration—a wide-band, low-distortion arrangement—plus an output stage of decreased distortion and higher power capability, a stage which exceeds the original specification and operating parameters, must be heard to be appreciated.

AUDIO PATENTS

[from page 4]

in one phase or the other. Thus, the resultant, shown on both sides of the baseline, will come to the phase-insensitive ear merely as a curve shaped as in Fig. 3.

An approximate idea of the action of the circuit may be had by using this same method of preliminary plotting for any kind of filter. Single-frequency and band emphasis circuits may also be made by

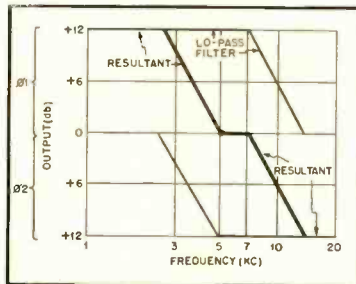

Fig. 2.

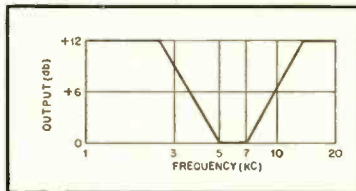

Fig. 3.

using a parallel combination of low- and high-pass filter both at A and at B, or at one alone, the slopes being steeper if both positions are used. A few minutes spent in plotting possible results as in Fig. 2 will give an idea of the full possibilities. And the patent specification itself gives the formulas which may be used to begin actual design. Like all other U.S. patents it is available for 25¢ from the Commissioner of Patents, Washington 25, D. C.

CLASSIFIED

Rates: 10¢ per word per insertion for noncommercial advertisements; 25¢ per word for commercial advertisements. Rates are net, and no discounts will be allowed. Copy must be accompanied by remittance in full, and must reach the New York office by the first of the month preceding the date of issue.

THE AUDIO EXCHANGE, INC. buys and sells quality high-fidelity sound systems and components. Guaranteed used and new equipment. Catalogue. Dept. A, 159-19 Hillside Ave., Jamaica 32, N. Y. Telephone OL 8-0445.

MAGNECOR, model PT6-A with PT6-J Amplifier, \$425; Presto disc recorder, model K, \$250; High-fidelity amplifiers—Altec, American Amplifier Corp., Stromberg Carlson, Goodell, from \$70 to \$180. H. Unfried, 3104 Main St., Buffalo 14, N. Y.

FOR SALE: Stephens 2-way system (103LX 15-in. woofer, P-15 tweeter, 824 horn, 800X crossover network). 15-watt Williamson Amplifier, custom built. RV-10A Browning FM tuner. Above equipment like new, used less than 20 hours. Price \$310. S. Villanti, Phone 11Avenmeyer 6-8724 (New York) after 7:00 p.m. weekdays.

FOR SALE: DuMont 185 electronic switch, \$65; DuMont 208 5-in. oscilloscope, \$135; RCA W-54a audio oscillator, NEW, \$65; RCA WV-73a audio voltmeter, NEW, \$65; RCA 170-a Audio Chanalyst \$135; Weston 769 Electronic tester, like new, \$150; Shallcross 638-1 Wheatstone-Kelvin bridge with 619-B d.c. supply, \$140. Adolph Hoeter, 8330 Kingsbury, Clayton 24, Mo.

WANTED: RCA 77-B, 77-D, 44BX microphones. D. R. Steele, 78 Shearer Dr., Atherton, Calif.

FOR SALE: Craftsmen C10 tuner and C500 amplifier, Pickering 230-11 preamp, Garrard RC-80 changer with GE heads and Radio Shack Compensator, Jensen H-510 speaker and Kilpsch Rebel horn enclosure. Matched for superb reproduction—including the first honest bass I've known in ten years of buying and building. New in February. Priced \$102 below net at \$400. Edward Burks, 7302 Birch Avenue, Washington 12, D. C. SLigo 3900 evenings.

CONVERT your Webster record changer with a 22X084 arm, GE RPX-050 Triple-Play cartridge. Installed in plug-in head. Your cost \$11.75. Send check or money order. FRIEND'S WHOLESALE DISTRIBUTORS, 106 N. 6th St., Philadelphia 6, Pa.

FOR SALE: Electronics 5/48-4/52 (48 issues), Proceedings IRE 12/50-4/52 (17), FM-TV 3/50-3/52 (23). All excellent condition. \$25 for lot, shipped express collect. C. Benson, 14 Hedge Lane, Westbury, N. Y.

PRESTO 900R1 tape recording mechanism (less amplifier and power supply) excellent condition \$300. RECO-ART, 1305 Market Street, Philadelphia, Pa.

FOR SALE: Browning tuner, RJ-20, \$75; Altec Lansing A-323-B amplifier, \$65; Electro-Voice SP-15 speaker, \$48; University 4402 tweeter, \$14; University 4405 high-pass filter, \$3. All in good condition. Ralph Ashworth, Charlton City, Mass.

THE ULTRA-LINEAR Williamson Amplifier with Aero transformer, world's finest. Custom construction, \$124.50. Albert Seligson, 512 E. Thompson St., Philadelphia 25, Pa. Phone—NE 4-6057.

SPECIAL INPUT EQUIPMENT—new but shopworn. W.E. Model 22E consisting of amplifier control unit and power supply, both with carrying cases and connecting cables. Price \$300. Minnesota Electronics Corp., 47 W. Water St., St. Paul 1, Minn.

STEPHENS P15 driver and horn, \$50. Paul Brown, 3418 NE Liberty, Portland, Ore.

KILPSCH speaker, brand-new, utility model. Reduced. Hugh McGaffin, c/o Fergus Motors, 444 W. 55th St., New York City. JU 6-2155.

NOW... YOU CAN AFFORD THRILLING

HIGH-FIDELITY MUSIC



OWN THIS HI-FI
CUSTOM PHONO-
GRAPH SYSTEM
ONLY
\$126.85

20
Watt
Amplifier



G.E.
Hi-Fi
12" Speaker



Webster-
Chicago
3-Speed Changer

AMPLIFIER } ± 1 db 20-20,000 cps.
RESPONSE }
Rated an outstanding value by a lead-
ing product research organization

Enjoy the brilliant record repro-
duction you've always wanted
... at a sensible low price. This
superb hi-fi phonograph system
gives you the top-value Knight
20-watt amplifier, G.E. S1201D
12" hi-fi speaker and Webster-
Chicago 106-27 3-speed record
changer with plug-in heads and
2 G.E. cartridges. Complete with
cables (no solder connections re-
quired), hardware and instruc-
tions. Hear your records as they
should be heard... order today!
Shpg. wt., 57 lbs.

93-328. Only... **\$126.85**



FREE 212 Page Hi-Fi, TV
& Radio Catalog

The complete Buying Guide
to everything in Hi-Fi, Radio,
TV and Electronic equipment.
Unsurpassed for quality ap-
paratus and fine values. Ask
for your FREE copy today.

ALLIED RADIO

833 W. Jackson Blvd., Dept. 17-F-2, Chicago 7, Ill.



have "HIGHS"
got you low?

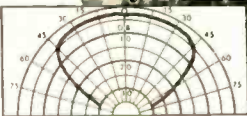

Directional characteristics of the
acoustical lens at 5000 cycles.

The new Jim Lansing acoustical lens gives the
highs a smoothness your ear will appreciate in-
stantly! The new lens, a natural development
brought about by the inadequacies of the multi-
cellular horn, distributes sound constantly and
uniformly over the entire audio spectrum... giv-
ing the highs a smoothness impossible to match
by any other method.
Drop into your high fidelity dealer and ask for
the full story today.

JIM LANSING → first in fine sound

JAMES B. LANSING SOUND, INC.
2439 Fletcher Dr., Los Angeles 39, California

THE OTL

[from page 23]

graph can always be rearranged to use
shunt feed with a center-tapped choke,
though this would be an unwelcome
compromise at best.

Feedback Considerations

In any OTL output stage negative
feedback can be taken from the voice
coil without the degree of concern about
low-frequency phase shift that plagues
the designer of conventional amplifiers
who likes to pick his feedback voltage
off from a secondary tap on the output
transformer. Where a single loop is em-
ployed, this can be carried back over at
least one extra stage, assuming careful
design.

In cases where d.c. must be kept out
of the feedback path, and if there is al-
ready a blocking capacitor in the circuit
to keep d.c. out of the voice coil, this
same capacitor can also serve the feed-
back circuit. In a Sinclair-Peterson cir-
cuit, feedback would be taken from the
point marked F in Fig. 7, and depending
on how and where the feedback voltage
is applied it might be possible to omit a
blocking capacitor. In a push-pull OTL
stage, such as the one at (B) in Fig. 6,
feedback would be taken off at the plates
in two balanced loops and carried back
to an earlier push-pull stage, and proba-
bly in a cross-coupled configuration.

The positive current feedback ap-
proach suggested by Clements⁵ and de-
veloped further by Childs⁶ does not seem
readily applicable to OTL design but,
it might be possible to obtain the same
or better results with a method sug-
gested by Tanner⁷. Analyzing the re-
quirements of speaker design and gener-
ator impedance for obtaining flat re-
sponse—i.e., in actual sound output—
Tanner concluded that the feedback
voltage should be a motional voltage,
and he obtained such a voltage "by the
simple expedient of winding a separate
feedback coil of very fine wire over the
existing voice coil." How simple an ex-
pedient this alteration and addition
would be for most audio experimenters
is questionable, but it should be fairly
easy for such coils to be included in
original speaker designs, for both low-
and high-impedance types. (Bifilar
windings?)

In addition to the advantages claimed
for this method of feedback by its author,
two other favorable considerations come
to mind. It eliminates the need for a
blocking capacitor where one might be
otherwise required, and secondly, for
conventional push-pull output circuits,

⁵ Clements, "A new approach to loud-
speaker damping," *AUDIO ENGINEERING*,
Aug. 1951.

⁶ Childs, "Loudspeaker damping with
dynamic negative feedback," *AUDIO EN-
GINEERING*, Feb. 1952.

⁷ Tanner, "Improving loudspeaker re-
sponse with motional feedback," *Elec-
tronics*, Mar. 1951 (p. 142).

Available from stock
at TRIAD
jobbers!



"The World's Smallest Hermetically Sealed Transformer"

Miniaturization has become increas-
ingly important in the design of all
types of electronic equipment. Use
of improved core materials and bet-
ter winding techniques in our JAF
series permits these great reduc-
tions in size and weight of low level
audio transformers. TRIAD JAF Trans-
formers, as listed below, are "the
world's smallest hermetically sealed
transformers." All have 45 db. shield-
ing and are available in MIL standard
AF case as shown above. Carried as
stock items at all Triad jobbers.

| Type No. | Impedance | | Req. Resp. | List Price |
|-------------|------------|------------|---------------|---------------|
| | Primary | Secondary | | |
| JAF-1 | 600/250/50 | 50000 | 100-10000 | \$14.50 |
| JAF-2 | 600/250/50 | 250000 | 300-3000 | 15.30 |
| JAF-3 | 600/250/50 | 60000 C.T. | 100-10000 | 15.30 |
| JAF-11 | 15000 | 50000 | 100-10000 | 13.60 |
| JAF-12 | 15000 | 60000 C.T. | 100-10000 | 14.50 |
| *JAF-13 | 15000 | 95000 C.T. | 350-5000 | 15.30 |
| JAF-21 | 15000 | 600/250/50 | 100-10000 | 14.50 |
| *JAF-22 | 15000 | 600/250/50 | 350-5000 | 14.50 |
| JAF-23 | 20000 C.T. | 600/250/50 | 100-10000 | 15.30 |
| JAF-31 | 600/250/50 | 600/250/50 | 100-10000 | 14.50 |
| JAF-101 | 50 h.-1 Ma | | | 11.60 |

Maximum level +10 dbm. *OC in primary.
except JAF-1, 2 and 3 (0 dbm.)

Write for Catalog TR-52C



Plant, General Offices: 4055 Redwood Ave.,
Venice Area, Los Angeles, Calif.
Address correspondence to: Box 17813
Los Angeles 34, Calif.

4 GOOD REASONS WHY

The New **MAGNEMITES***

Are The Perfect Tape Recorders for Portable Use



1 World's Smallest, Lightest Tape Recorders
 Letterhead size, weighing 10 lbs., the Magnemites* offer every desirable feature for field recording, compactly assembled in beautiful, precision recorders.



2 Record Without AC Power
 The Magnemites* are powered by inexpensive dry-cell flashlight-type batteries that last 100 operating hours. No wet cells that require daily recharging.



3 Playback and Monitoring Facilities Built-In
 An output connection which feeds ear-phones or an auxiliary amplifier and speaker during playback, is also used for monitoring while recording.



4 Exceptional Recording Quality
 4 Magnemite* models are available for any recording need. Designed to record music, interviews, or any type of sound effects with lifelike reproduction.



The Magnemite series consists of 3 dual-track models (1 $\frac{1}{8}$, 3 $\frac{1}{4}$, or 7 $\frac{1}{2}$ in. per sec.) and 1 single-track model (7 $\frac{1}{2}$ in. per sec.) designed to NAB standards.*

Many exclusive features distinguish Magnemites as the outstanding portable recorders. Write today for complete literature and direct factory prices.*

**Trade Mark Reg.*

AMPLIFIER CORP. of AMERICA • 398-4 Broadway • New York 13, N. Y.



NOW AVAILABLE

The **GRAMPLAN** Feedback Disk Recording Cutterhead Unit

Engineers and musicians now realize a perfect transient response of any recording system is of paramount importance—the Gramplan cutterhead with its precision-made true balanced armature and flux correcting feedback loop obtains this ideal.

Used by the BBC and other international broadcast networks where fidelity is of primary importance, you too, can be assured of the highest fidelity disk recording.

Many outstanding recordings, such as the LP Mercury Olympian Series, were recently produced with the Gramplan.

For more information, write to

Wide frequency range
 30 c/s to 20 kc
 Low Distortion
 Superior transient response

REEVES EQUIPMENT CORP.
 10 EAST 52ND STREET • NEW YORK 22, N. Y., U. S. A.
 CABLE: REEVESQUIP, N. Y.



IF YOU ARE MOVING

Please notify our Circulation Department at least five weeks in advance. The Post Office does not forward magazines sent to a wrong destination unless you pay additional postage, and we can NOT duplicate copies sent to you once. When notifying us, please give your old address and your new address.

Circulation Department
RADIO MAGAZINES, INC.

342 Madison Avenue New York 17, N. Y.

9205 DEGAUSSER

Demagnetizes magnetic tape and film to erase recording and residuals. Accommodates 5400 foot reels of 1/4" tape; 1000 foot, 35mm. Write for Catalogue. Net Price \$69.50

CINEMA ENGINEERING COMPANY
 1510 WEST VERDUGO AVENUE BURBANK, CALIFORNIA

Export Agents: Frazar & Hansen, Ltd. • 301 Clay Street • San Francisco, Calif., U. S. A.

whether plate or cathode loaded, it permits the use of a single feedback path instead of two balanced loops, and one which can be carried back beyond the phase inverter if desired.

One drawback which became apparent is that at the very high frequencies the mutual inductance between driving voice coil and the pickup coil has an increasing effect, resulting in attenuation of the highs. Tanner's solution to this difficulty involved an extra winding on the output transformer—not applicable to OTL design. On the other hand, in a two- or three-way speaker system, loss of highs in a woofer or mid-frequency driver would be of no concern and might even be advantageous by eliminating the need for shunt capacitance.

Studies by different investigators have shown that critical or optimum damping is closely related to speaker efficiency and to acoustic loading of the speaker. In a talk before the AES during one of the technical sessions held in connection with the 1951 Audio Fair, Mr. D. J. Plach of the Jensen Mfg. Co. showed the effects of under, over, and optimum damping on the actual sound output (free-field measurements) of a high quality 15-in. woofer mounted in a properly matched bass-reflex cabinet. With insufficient damping the characteristic twin peaks were present. With optimum damping they smoothed out and the response was practically flat down to about 40 cps. With too much damping, the response fell off badly at the low end.

In the light of the above, it seems to the writers that present practices in rating speakers may be revised considerably in the future. Some of the specifications which a manufacturer might provide for a woofer, for example, might include: resonant frequency (free air), impedances at several key frequencies within the normal operating range of the unit (including resonant frequency), d.c. resistance and inductance of the voice coil, efficiency, power handling capacity (again, at a low key frequency), and the optimum output impedances which the speaker should "see" when mounted in various types of enclosures—such as true horn, semi-horn (corner), bass reflex, infinite baffle, and R-J enclosure. Some of the aforementioned enclosures might require the same degree of damping.

If such information were made available by the speaker manufacturers, then perhaps more amplifier manufacturers would add to their present ratings the internal impedances or damping factors of their amplifiers, so that an ideal match between speaker, enclosure and amplifier would be assured. It is even conceivable that the amplifier of the future would have a selector switch on the rear panel which will permit the choice of any one of several "standard" damping factors. Such a selector would in all likelihood also compensate automatically for changes in overall gain as the feedback is varied.

Intermodulation Meter...

The most versatile and convenient test instrument for audio measurements...



MODEL IM3B

MEASURES distortion, hum, noise, power output, frequency response, pickup tracking.

COMBINES signal source, distortion meter, and VTVM in one instrument.

SIMPLIFIED OPERATION for faster measurements than possible with any other method.

Brochures available. d&R Ltd., designers and fabricators of magnetic and electro-mechanical products.



DISTRIBUTED BY
PASADENA 1, CALIF. • EAST ORANGE, N. J.

Giannini

PROFESSIONAL DIRECTORY

Custom-Built Equipment

U. S. Recording Co.

1121 Vermont Ave., Washington 5, D. C.
Lincoln 3-2705

DIAMOND NEEDLES \$10.50

plus postage

Our main business is the manufacture of diamond styli for broadcasting stations and high fidelity sound equipment. As a service to the general public we offer to retip your present replaceable needle with a genuine, unconditionally guaranteed broadcast quality diamond tip for either LP or Standard records. Send us your replaceable needle (or complete cartridge except Pickering) together with check or money order for \$10.50 plus 25¢ for shipping.

THE TRANSCRIBER CO.

172-4 Green St. Dept. R Boston 30, Mass.



A MONTHLY SUMMARY of product developments and price changes of radio electronic-television parts and equipment, supplied by United Catalog Publishers, Inc. 110 Lafayette Street, New York City, publishers of Radio's Master.

These REPORTS will keep you up-to-date in this ever-changing industry. They will also help you to buy and specify to best advantage. A complete description of most products will be found in the Official Buying Guide, Radio's Master—available through local radio parts wholesalers.

Miscellaneous Radio, TV and Electronic Parts

AMERICAN PHENOLIC (AMPHENOL). Added 4 type BNC connectors . . . 34 RF (series 82) connectors . . . 12 JHF (series 83) connectors . . . 16 replacement plugs.

BURGESS BATTERY CO. Advised a price differential no longer exists between east and west coast. The east coast price now covers the entire U. S. Also advised that electronic labeled batteries are replacing the hearing aid line now being sold to the radio and industrial trade. Burgess advises, however, that they have not discontinued the manufacture of hearing aid batteries.

INTERNATIONAL RESISTANCE (I.R.C.). 295 TV concentric dial controls for replacement in over 5000 TV models added . . . also added 47 outer shafts in types P1, P2, P3, and P4 . . . 44 inner shafts in types K1, K2, K3, and K4 . . . added 20 base elements for panel or rear carbon sections and 13 base elements for wire wound panel sections . . . 2 Concentrikits . . . 3 Concentrik-packs for Philco, RCA and Admiral . . . 2 universal shaft kits for Concentrik.

MALLORY & CO. Increased prices on their VA series of 7 power supplies . . . added 7 new 2 watt wire-wound front section controls . . . 8 new WP dry electrolytic capacitors . . . decreased prices of 3 WP electrolytic capacitors WP 505 to \$1.20 net, WP 510 to \$1.32 net and WP 540 to \$2.40 net.

VAN CLEEF. Increased prices on 60-yard rolls of Dutch Brand masking tape available in "bulk case packing."

Recording Equipment, Speakers, Amplifiers, Needles, Tape, Etc. . . .

ASTATIC CORP. Phonograph cartridges models MI-2-J and MI-2-J33 . . . pickups models 510-MI-2-33, 400-MI-2-33, 510-MI-2 and 400-MI-2 are discontinued.

ELECTRO-VOICE. Added "Baronet" folded horn corner loudspeaker enclosure for 8" speakers at \$35.70 net in mahogany and \$37.80 net in blonde.

GOLDRING GRAMOPHONES. Reduced price of #T17, head-master transcription pick-up to \$16.77 net.

KENT PRODUCTS. Added CB-400, steel base to fit G. I. record changer and CB-950, steel base to fit VM record changer at \$4.08 net each.

LANSING SOUND. Added 6 corner enclosures for D-1050 system and 6 corner enclosures for D-1001 system.

LOWELL MFG. CO. Added 10 items to their line of Ceiling Baffles and Parts.

MILLER MFG. CO. Added 3 new replacement cartridges for Astatic . . . 1 for Electro-Voice . . . 1 for Magnovox . . . 3 for Shure Bros. Withdrew Diamond Stylus M213 and M513 for Magnovox cartridges and PH413 (D) and PH413 (DS) for Philco cartridges.

PRECISION ELECTRONICS, INC. Added 6 new amplifier models . . . redesignated amplifier model L1 to L12 at \$36.50 net and 50PG to 50PG2 at \$55.00 net.

PRESTO RECORDING. Added Y-5 recorder (for low impedance mike) at \$71.00 list . . . T-99-II dynamic microphone at \$32.50 list . . . A-15-R floor stand at \$10.00 list and L-2 transcription player at \$290.00 list.

Tubes—Receiving, Television, Special Purpose, Etc. . . .

G.E. Increased prices on 51 radio receiving tubes, 9 transmitting and 7 industrial type tubes. Decreased prices on 52 radio receiving type tubes, 11 TV picture tubes, and 23 transmitting & industrial type tubes.

HYTRON RADIO & ELECTRONICS. Increased prices on 183 radio receiving type tubes and decreased prices on 34 others.

NATIONAL UNION. Added 11 radio receiving tubes . . . increased price of 263 and decreased price of 27.

R.C.A. Decreased prices on six 17-in. Kinescopes and two 21-in. Kinescopes . . . increased prices on 30 receiving tubes . . . added receiving tubes 6BL7GT, 12BH7 and 25BQ6GT.

RAULAND CORP. Decreased prices on 15 TV picture tubes . . . added picture tubes 21AP4 and 21AP4.

RESCO HAS THE FAMOUS ACRO MODEL TO-300 ULTRA LINEAR TRANSFORMER

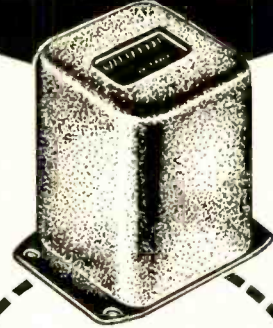

The World's Finest Audio Output Transformer

READ IN THIS ISSUE

ULTRA LINEAR OPERATION OF A WILLIAMSON AMPLIFIER

by David Hafler

ON PAGE 26

DOUBLE YOUR POWER OUTPUT — CUT DISTORTION IN HALF!

- Response — 1 db 10 cps to 100,000 cps
- Unequalled square wave response
- Low phase shift
- Rated to handle 40 watts
- Resonance-free response

ACRO TO-300 \$24⁷⁵ net

ACRO TO-310 \$18⁷⁵ net

20 watt (same rating) used to convert 10 watt amplifiers to ultra linear operation.

FREE Write for ACRO Catalogue showing amplifier schematics and conversion information.

Radio Electric
SERVICE CO. OF PENNA., INC.

701 ARCH STREET
PHILADELPHIA 6, PA.

Please ship ACRO Transformer

- No. 300 No. 310
 Check enclosed
 Money Order enclosed

NAME

ADDRESS

CITY ZONE STATE



IS TRUTH RELATIVE OR ABSOLUTE?

A letter has reached us from Denver. "I have been reading your \AE ads for some time now, and recently had an opportunity to listen to one of your speakers. Your unit was as good as any in its price class. It did not, as your ads imply, give anything remotely approaching the quality of the big multi-channel units. . . . I really would advise toning down your ads a bit."

A few days before we got another letter. "I have now lived with the 215 for a fortnight. It is mounted in a Boffle made to your specifications. The reproduction surpasses everything previously encountered. Why anyone should waste money on special reflex cabinets, cross-over networks, and so-called treble speakers, which are only, at their very best, makeshifts, is incomprehensible.

"Your claims for this reproducer are too conservative. It is the best that I have heard, and after trying out no less than five of the so-called 'hi-fi' speakers, all costing much more than the 215, and being very hard to please, I can only say how much I regret the money and time wasted on such inferior instruments, and not having tried out your reproducer five years ago."

G. Turner, Lancing, Sussex, Eng.

"Ah," we hear you say, "that is only an Englishman who doesn't know our big stuff." O.K. He doesn't. So what about the gentleman from Washington State who writes: "The more big claim speakers I hear, the better I like my 215. Recently I heard a demonstration of four famous speakers: a . . . corner cabinet containing two 15" woofers and a cellular tweeter; a . . . 2-way system; a . . . in a bass reflex cabinet; and a . . . in a corner cabinet. I was surprised at the rough and generally poor quality of sound given by all of these speakers. None of them can approach the 215 in faithfulness and smoothness of reproduction. The 215 can reproduce subtle transients as no other speaker—not even the finest movie theater system—can."

Let's get this straight. It strikes us as futile to say things in ads which we don't believe or which our readers couldn't believe. Our copy is based on what the user says, because our personal opinion has nothing to do with the case. Actually, we believe that understatement is a good business investment, and from your point of view, you will find the 215 speaker is also a good investment. The cost is only \$48.00 (plus \$6.00 import duty). Send for your free catalogue today.

Subscribers to our data service please note that at last we have completed our spring mailing. If you haven't had it by the time you read this ad, please let us know as it may have gone astray. This mailing contains information of very great importance to all audio enthusiasts.

Those not on this list can become members at the all-time subscription rate of one dollar bill.

H. A. HARTLEY CO. LTD.
152, Hammersmith Road
London W.6, England

ADVERTISING INDEX

| | |
|--|---------|
| Acro Products Co. | 30 |
| Allied Radio Corp. | 45 |
| Altec Lansing Corp. | 37 |
| Amperite Co., Inc. | 40 |
| Ampex Electric Corp. | 35 |
| Amplifier Corp. of America | 42, 46 |
| Arnold Engineering Co., The | 9 |
| Audak Co. | 33 |
| Audio Devices, Inc. | Cover 2 |
| Audio & Video Products Corp. | 34 |
| Belden Manufacturing Co. | 5 |
| Bell Telephone Labs | 14 |
| Cannon Electric Development Co. | 10 |
| Carter Motor Co. | 37 |
| Chicago Transformer Co. | 8 |
| Cinema Engineering Co. | 46 |
| Classified Ads | 44 |
| Daven Co., The | Cover 3 |
| D. & R. Ltd. | 47 |
| El-Tronics, Inc. | 43 |
| Gates Radio Co. | 11 |
| Harrison Radio Corp. | 43 |
| Hartley, H. A., Co. Ltd. | 48 |
| Harvey Radio Co., Inc. | 31 |
| Heath Co. | 41 |
| Hollywood Electronics | 48 |
| Lansing Sound, Inc., James B. | 45 |
| Leonard Radio, Inc. | 39 |
| Maynard Electronics, Inc. | 1, 29 |
| Minnesota Mining & Manufacturing Co. | 4 |
| Modecraft Pre-Built Cabinets | 40 |
| Partridge Transformers Ltd. | 48 |
| Pickering & Co., Inc. | 13 |
| Professional Directory | 47 |
| Radio Electric Service Co. | 47 |
| Reeves Equipment Corp. | 46 |
| Reeves Soundcraft Corp. | 7 |
| Rek-O-Kut Co. | 2 |
| R-J Audio Products, Inc. | 3 |
| Tech-Master Products Co. | 41 |
| Terminal Radio Corp. | 40 |
| Thermador Electrical Manufacturing Co. | 44 |
| Transcriber Co. | 47 |
| Triad Transformer Manufacturing Co. | 45 |
| Tung-Sol Electric, Inc. | 6 |
| U. S. Recording Co. | 47 |
| United Transformer Corp. | Cover 4 |

PARTRIDGE WILLIAMSON OUTPUT TRANSFORMER *Built to the original specification*

De-luxe model now available from stock from all important Radio Stores throughout the U.S.A. (Price \$26.00 duty paid)

This transformer is now accepted as the most efficient in the world. According to "Audio Engineering" (Nov. 1949), there is no U.S. equivalent. Thousands already sold in the U.S.A.

Partridge CFB Output Transformer, accepted as without rival. Series leakage induct .10 mh., primary shunt induct, 130 H., with "C" core construction and hermetically sealed. (Price \$40.00 duty paid)

The Following Stores are among those now Stocking Partridge Transformers.

| | |
|--------------------------|-----------------------------|
| Harvey Radio Co. Inc. | Terminal Radio Corporation, |
| 103 West 43rd Street, | 85, Corlandt Street, |
| New York 18. | New York 7. |
| Electronic Wholesalers | Gates Radio Company, |
| Inc. | 2700 Polk Avenue, |
| 2345 Sherman Ave., | Houston Texas. |
| Washington, D. C. | Wholesale Radio Parts |
| Radio Electric Service | Co., Inc. |
| Co. Inc. | 311 W. Baltimore St., |
| 5 North Howard Street, | Baltimore 1, Maryland. |
| Baltimore 1, Maryland. | Sole Agents in Canada: |
| Atlas Radio Corporation. | 560 King Street West, |
| Quincy, Illinois. | Toronto 2-B. |

If you are unable to purchase Partridge transformers in your city, write to us and mention the name of your dealer.

Fullest data, including square-wave tests, distortion curves, etc., together with list of U. S. stockists rushed Air Mail to you.

PARTRIDGE TRANSFORMERS LTD.
TOLWORTH, SURREY, ENGLAND

High Fidelity CENTER

On the West Coast
for the
Audio Specialist



ElectroVoice

AUDAK



McIntosh

JIM LANSING

RADIO craftsmen



Come in and See
Our New

Audio Listening Room
For a Friendly Demonstration

**HOLLYWOOD
ELECTRONICS**
7460 MELROSE AVENUE
LOS ANGELES 46, CALIF.

Q : Are all brands of Resistors similar in Quality, Specifications and Performance?

A : Naturally, no! That's why **DAVEN** has earned the right to add a superlative in naming its line

● Brands of Resistors vary as widely in the completeness of a line and in performance, as do brands of any other product.

DAVEN originated the first pie-type, wire wound Resistor more than a generation ago. Since that time, DAVEN has designed and manufactured Precision Wire Wound Resistors of every conceivable type to meet the increasing demands of the electronics industry.

SUPER DAVOHM RESISTORS are noted for their high stability and accuracy under extreme temperature and humidity conditions. DAVEN Resistors are made in accordance with JAN-R-93 specifications and are in use in all types of Army, Navy and Air Force electronic equipment.

DAVEN has developed special small precision Resistors for use in miniaturized assemblies. All types of mountings, sizes, tolerances and temperature coefficients are available from a large variety of standard types. That's why DAVEN can fill your precision Resistor needs.

Take advantage of DAVEN's advanced engineering and manufacturing techniques to help with any Resistor problem confronting you.

SUPER DAVOHM

PRECISION WIRE WOUND

RESISTORS

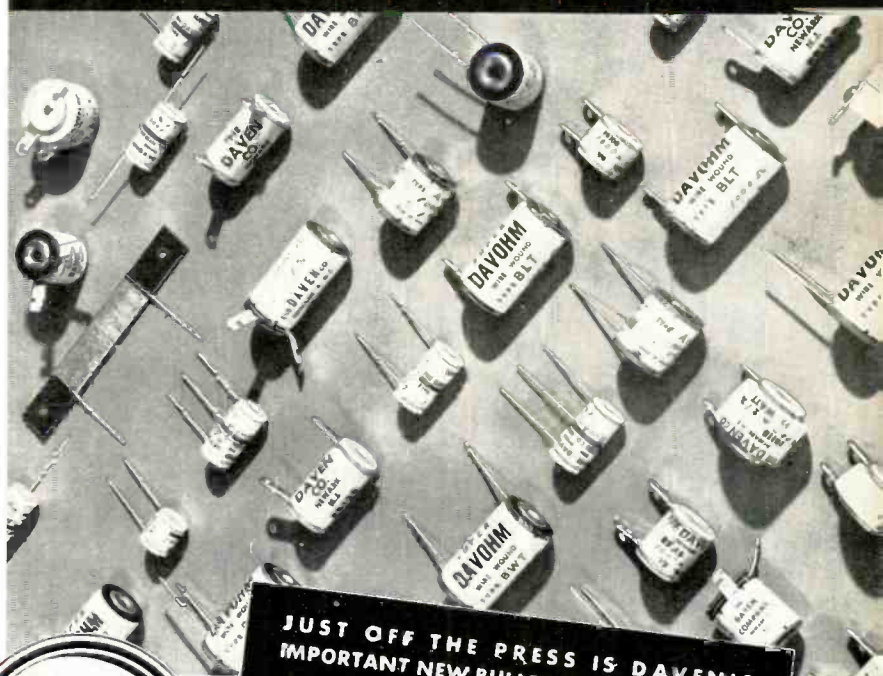

JUST OFF THE PRESS IS DAVEN'S IMPORTANT NEW BULLETIN ON RESISTORS.

Write for your copy today and prove to yourself, from the information supplied, that when you order Resistors you should specify only

SUPER DAVOHM Precision Wire Wound RESISTORS

THE **DAVEN** CO.

185 CENTRAL AVENUE
NEWARK 4, NEW JERSEY





Humidity . . . temperature . . .
altitude testing



Tracing filter curves electronically



Development tests . . . 1/2 cycle filter



Engineering Leadership

UTC has the reputation for exceptional quality and the ability to produce units previously considered impossible. This position of engineering leadership has been effected through a continuous program of research and development at the UTC laboratories. A few views of these laboratories are shown on this page.



Filter development



Audio development



Testing modulation transformer under
operating conditions



Q meter measurements on
low frequency coils



Pulse transformer development

United Transformer Co

150 VARICK STREET NEW YORK 18, N. Y.
EXPORT DIVISION: 13 EAST 40th STREET, NEW YORK 16, N. Y. CABLES: "ARLAB"