

AUDIO ENGINEERING

SEPTEMBER
1951
35c

Published by RADIO MAGAZINES, INC.



You don't have to look, because
THERE ARE NO SPLICES
in **audiotape***

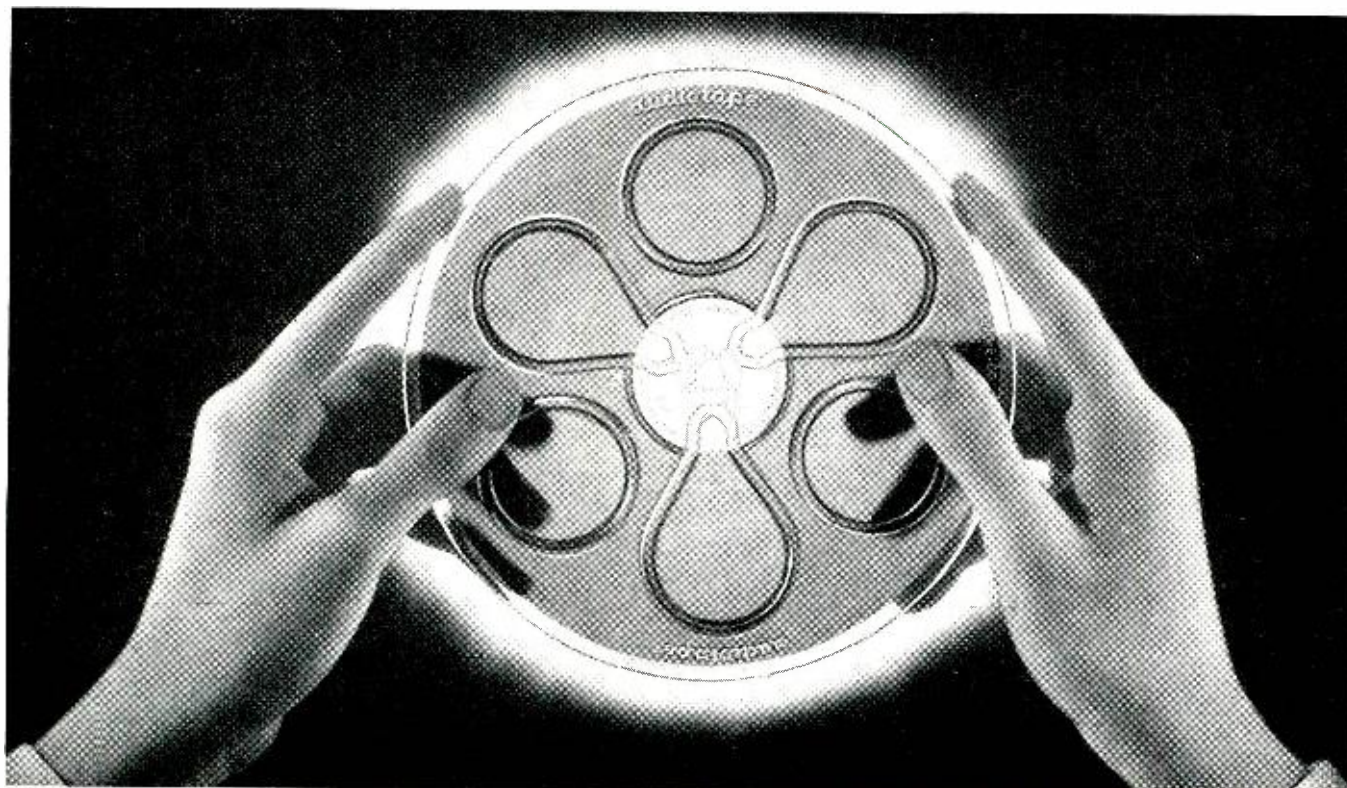

...but this "transparency test" shows some other important things about Audiotape quality

■ When you hold a reel of plastic base Audiotape up to the light, notice its extremely uniform translucency—free from dark rings or fuzzy areas. You can see your fingers right through it, sharply outlined against the light. This is proof of the clean, straight line slitting that makes Audiotape track and wind absolutely flat. There are no rough or turned-over edges which would lift the tape away from the heads, causing loss of high-frequency response. Of course this test also proves that the tape is entirely free from splices. But with Audiotape you can be sure of that without looking. For all 1250 foot and 2500 foot reels of plastic base Audiotape are *guaranteed splice-free!*

You can see the output uniformity of Audiotape, too. For every 5-reel package includes an Esterline-Angus output chart, showing the measured output of the entire length of one of the reels in the package. And since all 5 reels are slit from the same roll after coating, the chart actually measures the uniformity of all the tape in the package. This gives positive visual proof of Audiotape's unequalled output uniformity.

NO OTHER TAPE OFFERS YOU ALL OF THESE EXTRA-VALUE FEATURES:

- **Splice-Free Reels.** All 1250 and 2500 foot reels of plastic base Audiotape are *guaranteed* to be free from splices.
- **Unequalled Uniformity.** Plastic base Audiotape is guaranteed not to exceed $\pm 1/4$ db within the reel and $\pm 1/2$ db from reel to reel.
- **Output Curves** in every 5-reel package of plastic base Audiotape show actual measured output of the tape contained in the package.
- **Maximum Output with Minimum Distortion.** Oxide formulated to give high output at bias which results in low harmonic distortion.
- **Safe-Handling Package** for 2500 and 5000 foot reels permits loading onto turntable without danger of spilling tape from hub, simplifies attachment of reel flanges, and provides safe storage without flattening bottom of roll.

*Trade Mark

AUDIO DEVICES, Inc.

444 Madison Avenue, New York 22, N. Y.

Export Dept.: 13 East 40th St., New York 16, N. Y., Cables "ARLAB"

AUDIO ENGINEERING

Successor to **RADIO**

Established 1917

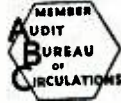

C. G. McProud, Editor

Ladd Haystead, Publisher

Harrie K. Richardson, Associate Editor

Luci Turner, Production Manager

S. L. Cahn, Advertising Director

Lucille Carty, Circulation Manager

H. N. Reizes, Advertising Manager

Editorial Advisory Board

Howard A. Chinn

John D. Colvin

C. J. LeBel

J. P. Maxfield

George M. Nixon

Representatives

H. Thorpe Covington, Special Representative
677 N. Michigan Ave., Chicago 11, Ill.

Sanford R. Cowan, Mid-West Sales
67 W. 44th St., New York 18, N. Y.

James C. Galloway, Pacific Coast Sales
816 W. 5th St., Los Angeles 17, Calif.

Technical Book & Magazine Co.
297 Swanston St., Melbourne, C. I.
Victoria, Australia

CONTENTS SEPTEMBER, 1951 Vol. 35, No. 9

Audio Patents—Richard H. Dorf	2
Hollywood Letter—C. A. Hissrich	6
Editor's Report	10
Letters	12
Space-Charge-Grid Amplifier—Melvin C. Sprinkle	15
Design Data for a Bass-Reflex Cabinet—J. A. Youngmark	18
New AM-FM-TV Studio Console—P. W. Wildore and G. A. Singer	20
Music and Mass Production—Jerome Goodman	23
A Studio Controlled Remote Amplifier—R. S. Houston	24

AUDIO engineering society SECTION

The Measurement of Audio Volume—Part I—H. A. Chinn	26
Record Review—Edward Tatnall Canby	30
New Products	38
New Danish Playback Machine—Svend Anker-Rasmussen	40
Technicana	41
New Literature	49
Industry Notes	51
Industry People	51
Advertising Index	52

COVER

The title of this month's cover illustration might well be *Dream of a Music Lover After Seeing a Flying Saucer*. The recordings are arranged to spotlight the many precision parts that make up the business end of the new Garrard RC-80 record changer.

RADIO MAGAZINES, INC., 342 MADISON AVE., NEW YORK 17, N. Y.

AUDIO ENGINEERING (title registered U. S. Pat. Off.) is published monthly at 10 McGovern Ave., Lancaster, Pa., by Radio Magazines, Inc., D. S. Potts, President; Henry A. Schober, Secretary-Treasurer. Executive and Editorial Offices: 342 Madison Avenue, New York 17, N. Y. Subscription rates—United States, U. S. Possessions and Canada, \$3.00 for 1 year, \$5.00 for 2 years; elsewhere \$4.00 per year. Single copies 35c. Printed in U. S. A. All rights reserved. Entire contents copyright 1951 by Radio Magazines, Inc. Entered as Second Class Matter February 9, 1950 at the Post Office, Lancaster, Pa. under the Act of March 3, 1879.

AUDIO ENGINEERING • SEPTEMBER, 1951

At Precision today
we're processing
the finest
EDUCATIONAL FILMS
for nationwide
showings



For your 16 mm. educational
film requirements
use Precision . . .

- Over a decade of 16 mm. industrial film printing in black and white and color.
- Fine grain developing of all negatives and prints.
- Scientific control in sound track processing.
- 100% optically printed tracks.
- Expert timing for exposure correction in black & white or color.
- Step printing for highest picture quality.
- Special production effects.
- Exclusively designed Maurer equipment.
- Personal service.

... no wonder more and more
of the best 16 mm. films today
are processed at...

PRECISION

FILM LABORATORIES, INC.

21 West 46th St.,
New York 19, N. Y.

JU 2-3970

REK-O-KUT

Specialists in Sound
Equipment for Broad-
casting and Public Use!
The World's Finest!



3 INSTRUMENTS IN ONE

1. A Professional Recorder
2. A High-Fidelity Phonograph
3. A High-Fidelity P.A. System

The Challenger, America's finest 13 1/4 Disc Recorder, is built to meet the respective needs of the professional recordist, musician, educator and recording enthusiast who wants to make permanent, professional recordings. Embodies the most advanced design, engineering and production techniques in the disc recording industry. The Challenger's many exclusive operating features simplify and improve the art of disc recording. NOTE: Tape recording enthusiasts need the "Challenger" to re-record their finished tape after it has been edited... input jack available, no special attachments required.

RECORDS disc from 6" to 13 1/4" masters.
PLAYS back disc from 6" to 16" transcriptions, standard or micro-groove.
With heavy duty synchronous motor..... **\$439.95**



CONTINUOUSLY VARIABLE-SPEED TURNTABLE OF BROADCAST QUALITY

Plays at ANY speed from 25 to 100 R.P.M.... without distortion. Ideal for record collectors, musicians, singers, disc jockeys, music schools, dance studios, general schools, broadcast studios, etc., wherever controlling pitch and tempo is required.

Model CVS-12, (illustrated) chassis, motor and turntable, assembly **\$84.95** net

Model CVS-12P, mounted in portable case with 16" dual stylus pick-up..... **\$124.95** net



MODEL LP-743 3-SPEED 12 INCH TRANSCRIPTION TURNTABLE

Recommended by leading sound critics. Induction type motor, designed for smooth, quiet, vibration-free operation. Instantaneous speed changes - 78, 45 and 33 1/3 - without stopping turntable or removing disc.

\$54.95 net.

See...hear...compare REK-O-KUT products at leading music stores, audio-visual dealers and radio parts jobbers... or write for literature.

REK-O-KUT CO.

38-01 Queens Boulevard
Long Island City 1, N. Y.



AUDIO PATENTS

RICHARD H. DORF*

LAURENS HAMMOND and John Hanert, between them, are probably responsible for more electronic music patents than any other two individuals. Hanert is the Chief Research Engineer of the Hammond Instrument Company which, headed by Laurens Hammond, is responsible for the Hammond Organ, the Solovox, and the Novachord of fond memory.

A Hanert patent, No. 2,514,490, brings to full development an idea which this writer had been carrying in the back of his head (too bad it wasn't nearer the front!) for some time—an electronic musical instrument to be played by anyone who can hum a tune, even though he may not know one key from another. It is a monophonic instrument which transforms the most inept humming (as long as it is

fairly well in tune) into clean, on-pitch sounds resembling trumpets, woodwinds, and others, complete with pleasant vibrato.

Briefly, the instrument uses the humming (or whistling) to key the output and to control the pitch of the oscillations which are generated electronically. The schematic diagram of Fig. 1 shows all the circuitry.

The "player" hums or whistles into one of two microphones, selectable with switch *Sw1*. The first is an ordinary one, suitable for whistlers. The second is a crystal mounted at the other end of a rubber tube. A glass tube serves as mouthpiece, with a flexible diaphragm closing it to prevent accumulation of saliva inside. The sounds are amplified by a stage which has a drooping frequency characteristic, as shown by the curve. Its purpose is to emphasize the fundamentals and attenuate the harmonics.

The amplifier output, taken through [Continued on page 4]

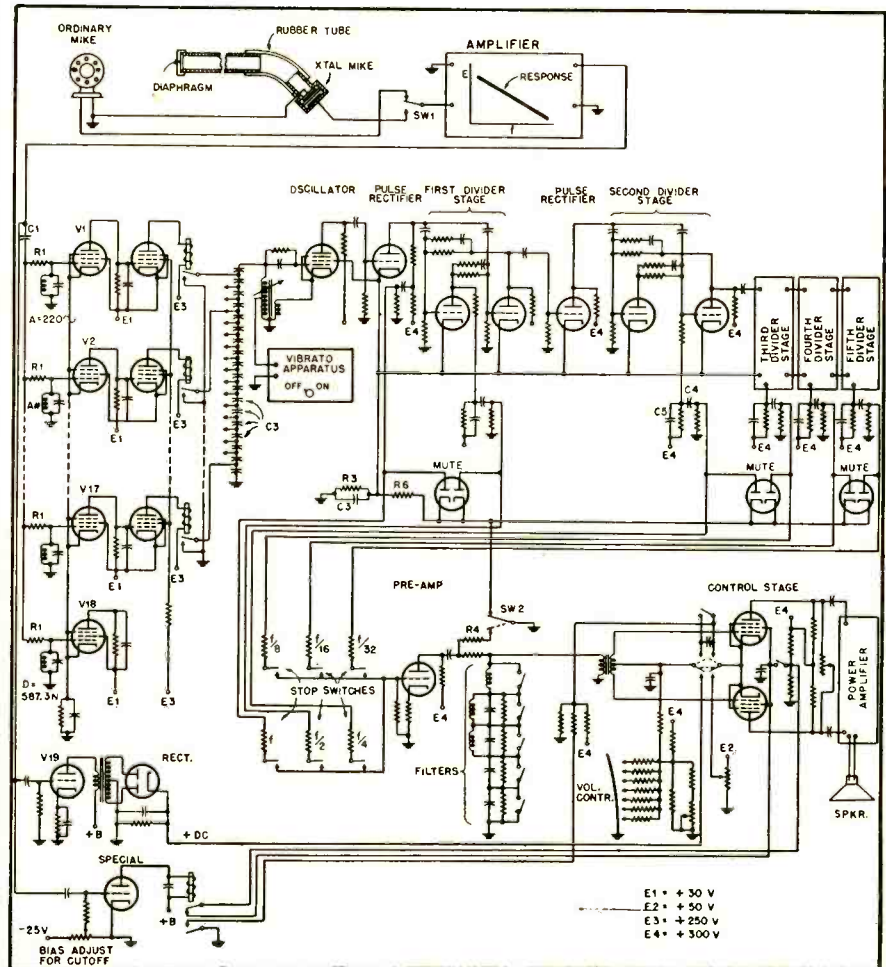

Fig. 1

VERSATILITY!



New *Gray* 108-B Arm for all records has new suspension principle . . . for perfect tracking without tone arm resonances

Perfect tracking of records and virtual elimination of tone arm resonances are only two advantages of this versatile, specially-designed arm — the finest yet developed! It satisfies every requirement of LP reproduction, permits instant changing from 78 r.p.m. to LP (micro-groove) or

45 r.p.m., and assures correct stylus pressure automatically. GE or Pickering magnetic pickup cartridges are interchangeable and slip into place quickly and easily. Maintains perfect contact with bad records, accommodates records up to 16" in diameter.



106-SP Transcription Arm —

Assures fidelity of tone for every speed record. Three cartridge slides furnished enable GE 1-mil, 2½ or 3-mil, or Pickering cartridges to be slipped into position instantly, with no tools or solder. Low vertical inertia, precisely adjustable stylus pressure.

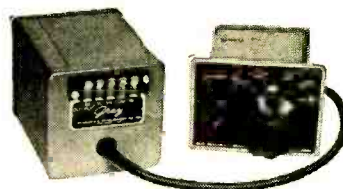

Gray Equalizers —

Used as standard professional equipment by leading broadcast stations, these specially-designed equalizers assure highest tonal quality . . . new record reproduction from old records . . . constant velocity frequency response for conventional or LP records. Uses GE or Pickering cartridges.

Please write for bulletins describing the above equipment.

GRAY RESEARCH
and Development Co., Inc., 16 Arbor St., Hartford 1, Conn.

Division of The GRAY MANUFACTURING COMPANY—Originators of the Gray Telephone Pay Station and the Gray Audograph



Walter E. Ostrowski
President

For a Glorious
BIG TONE
 ON ANY STRINGED INSTRUMENT
specify the Genuine
AMPERITE "KONTAK MIKE"
 THE ONLY NO-DISTORTION "KONTAK MIKE"

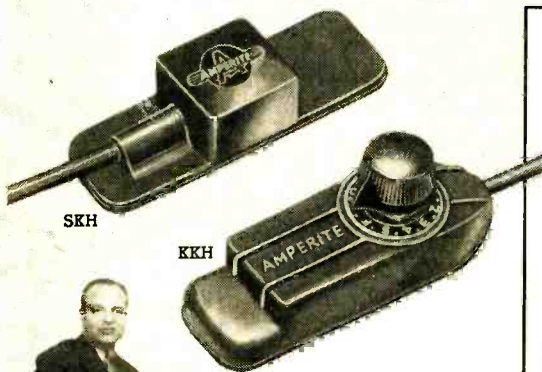

Anthony Antone, widely known as "the most versatile artist of the frets", is an enthusiastic user of Amperite Kontak Mikes.

Used with most amplifiers, including most electric guitar amps.

No changes in amplifier, instrument, or strings. Attached without tools.

The Amperite "Kontak Mike" improves the tone and volume of any Stringed or Fretted Instrument — also Pianos, Accordions, Harmonicas, etc. It is the only "Kontak Mike" that does not introduce peaks or distortion.

Model SKH, hi-imp. List \$12.00
 Model KKH
 (with hand volume control)..... List \$18.00

AMPERITE
STUDIO MICROPHONES
 at P. A. PRICES!
Ideal for **CLOSE TALKING**
 or **DISTANT PICKUP**

You can shout right into it, or stand away; in either case, the quality will be perfectly natural.

Model RBLG (200 ohms)..... List \$42.00
 Model RBHG (hi-imp)..... List \$42.00



AMPERITE CAROID DYNAMIC MICROPHONE

Models PGH-PGL..... List \$32.00

AMPERITE Company, Inc.

561 Broadway • New York 12, N. Y.

In Canada: Atlas Radio Corp., Ltd., 560 King St., W., Toronto 2B

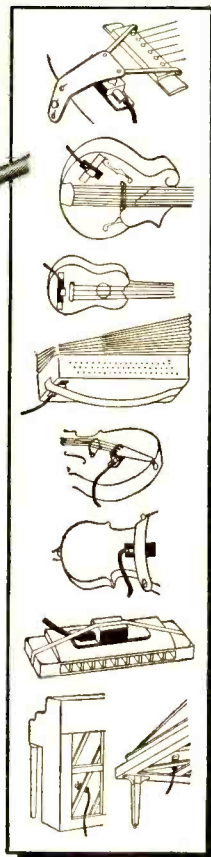

SPECIAL OFFER:
 Write for Introductory Offer, and 4-page Microphone Folder 53-M.

blocking capacitor C_7 , is fed across 18 parallel-tuned circuits with an R_7 isolating each from the others. (Four of the tanks are shown.) Each tank feeds the grid of a tube V_1 through V_{18} , and each tank is tuned to a different semitone of the scale between A-220 cps and D-587.3 cps. The cathodes of the tubes are biased by R_2 , and C_2 is the cathode-bias bypass. Each of V_1 through V_{18} is direct-coupled to a following tube, in whose plate circuit is a sensitive relay.

As the "player" hums a note into his microphone, the tank circuit whose pitch the humming corresponds to creates a resonant rise of voltage and energizes the grid of its tube. This makes more plate current flow in the tube and increases the current flow through R_3 , which has a rather high value, enough to increase the bias on the other tubes and make them less sensitive. In this way, only one tube is energized at a time. The relay tube following it is also energized and the relay closes.

The relay contacts control the tuning of a variable-frequency oscillator in much the same way as in the older version of the Solovox, which the latter parts of this instrument closely resemble. The capacitive portion of the tank circuit of the oscillator is divided into 18 series capacitors C_3 . In

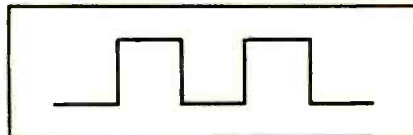

Fig. 2

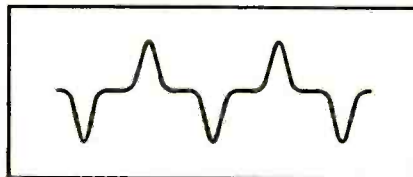

Fig. 3

the normal condition, with no relays closed, the net capacitance value is that of all the capacitors in series, which means minimum capacitance; so the oscillator frequency is at maximum. When one of the relays closes, it shorts the string to ground at some point, increasing the net capacitance value and reducing oscillator frequency. In practice, the pitch obtained is equal to the note the "player" is humming or whistling, but several octaves above it.

The oscillator output is fed through a pulse rectifier which transforms the sine waves into unidirectional pulses and feeds them to the first frequency divider. This is a modified flip-flop circuit, which produces square waves at a frequency one octave below the oscillator. From there the signal goes through additional pulse rectifiers, to second, third, fourth, and fifth frequency dividers, producing the original note in six different octaves. All the cathodes of the frequency-divider and pulse-rectifier tubes are connected together and through R_2 and C_2 to ground for bias.

An output is taken from each frequency-divider plate circuit and fed to a series of stop tablets. The output circuit of each divider includes capacitors C_1 and C_5 . C_1 , in series, attenuates lows, while C_5 , in parallel, attenuates highs. As a result, the output waveform appears, not like the normal square wave the divider generates (Fig. 2), but like Fig. 3. A square wave contains too much fundamental and is too complex; the waveshape of Fig. 3 is better music.

Across each output is one section of a

[Continued on page 47]

Be Sure of Your Installations... Next Year

Use *Aptitude-Tested*

MIKE CABLE

Now

● Now, you can be sure of your installations with Belden Microphone Cables. They are *Aptitude-Tested* and rated to give you safe and complete knowledge of their characteristics. Furthermore, Belden Mike Cables are built for maximum service. Put them to work for you now—and be sure... specify Belden.

Belden Manufacturing Co.
4689-R W. Van Buren Street
Chicago 44, Illinois



No. 8411
Nominal Capacitance 37 mmf per ft. Use particularly for lapel microphones.

No. 8401
Nominal Capacitance 25 mmf per ft. For crystal, ribbon, carbon microphones.

No. 8422
Nominal Capacitance 32 mmf per ft. Use specially for carbon microphones.

No. 8410
Nominal Capacitance 33 mmf per ft. For crystal, ribbon, carbon microphones.

No. 8412
Nominal Capacitance 68 mmf per ft. Use specially for carbon microphones.

No. 8423
Nominal Capacitance 54 mmf per ft. Use particularly for carbon microphones.

No. 8424
Use for interconnecting power cable for all electronic uses. Also microphone cable.

Belden
Radio WIRE

The *Aptitude-Tested* **LINE**



820-A CORNER SPEAKER SYSTEM

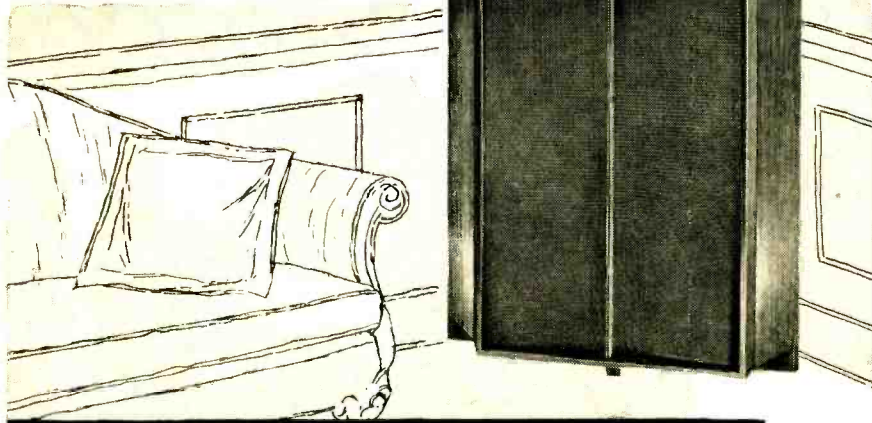

"-theatre quality for the home..."

to delight

the audio connoisseur...

In the motion picture industry where professional audio standards are highest and demands for faithful sound reproduction the most critical...Altec speaker systems are accepted as the "quality standard." More than 7000 theatres, recording studios and scoring stages utilize these finest of sound systems.

NOW... "theatre quality for the home" is a reality! These same professional components have been "engineered" into an attractively designed corner cabinet. Utilizing two bass speakers in an Altec *exclusive* direct radiating horn cabinet, there is no mid-range hole at crossover and the smooth, natural bass will delight the audio connoisseur. Frequencies from the crossover at 800 cycles up to the limit of audibility above 16,000 cycles are reproduced and distributed smoothly by a high frequency unit operating with a large multicellular horn...no third tweeter unit with its inherent phasing difficulties is required.

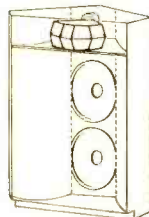

9356 Santa Monica Blvd., Beverly Hills, Calif.
161 Sixth Avenue, New York 13, New York



C. A. HISSERICH*

TWO PIECES of audio equipment recently demonstrated are possessed of extraordinary characteristics. These units were developed for the purpose of providing a measuring standard which would deliver 60 watts of power at less than 0.1 per cent total harmonic distortion in the audio frequency band from 20 to 20,000 cps.

This equipment has been under development for the last five years in the laboratory of Mr. Dunford Kelly of Los Angeles. It consists of a power amplifier and an audio-frequency oscillator. It is not in the scope of this letter to give a detailed technical description of this equipment but rather to report on the interesting aspects of the demonstration. It is hoped that detailed descriptions will be provided by Mr. Kelly in a later article.

The oscillator, mounted on a 7-in. relay rack panel, contains five vacuum tubes in the oscillator circuit, has three feedback loops (one of which is positive), and delivers 25 volts to a 600-ohm line. The measured distortion of the waveform over the pass-band is at all times under .001 per cent total harmonic content, the major component being .0006 per cent third. These figures were obtained on a General Radio Wave Analyzer. The output of the oscillator proper is adjusted to have zero source impedance, this output being built out by means of a precision 600-ohm resistor to match the output attenuator. The output attenuator covers a range of 100 db by means of a 10-db-per-step pot and a continuous slide-wire pot which has a 10-db range. The actual oscillator circuit is a modification of the well known phase-shift circuit with additional circuitry added to achieve complete correction for tube capacitances, wiring residuals, etc.

The power amplifier, mounted on a 14-in. panel, delivers full 60-watt output with an input of 1.0 volts across 600 ohms. The output stage consists of a pair of 6BG6's operated at 500 volts plate and 300 volts screen. The output transformer is a slightly massive (!) affair designed by Mr. Kelly, and is unique in that special feedback windings were incorporated to provide *only* those corrections which were required, as determined by preliminary measurements. At a 60-watt output the major distortion component as measured on the wave analyzer occurred at 5500 cps and was .011 per cent second harmonic. The amplifier contains a total of five feed-back loops (two of which are positive), and the loop gain around the major feedback path is flat to 3 megacycles. Mr. Kelly has provided a potentiometer so arranged that the feedback may be adjusted to provide zero output impedance. Under these conditions, the amplifier simulates a constant-voltage generator and the output voltage does not change when the load is removed or re-connected.

The writer was particularly impressed by the thoroughness and care exercised in the application of feedback in these instruments; apparently no "conditional stability"

* 954 Hancock Ave., Los Angeles 46, California.

problems exist, and a thorough understanding of Mr. Nyquist's criteria about the 0, -1, point is evident. In demonstrating the effect of feedback in this amplifier, one feedback control was increased to twice the value required to obtain minimum distortion, at which point the output impedance of the amplifier simulated a negative resistance. Even under this condition, no tendency toward oscillation was noted either with the load connected or disconnected.

Mr. Kelly also demonstrated the over-all efficiency of the amplifier to be very high; with no signal, the "coasting" power input to the amplifier is 75 watts, this figure approaching the ratio of 1/1 for standby power versus output power. At full power output of course, the line power requirement increases to approximately 175 watts on signal peaks.

Several unique problems encountered during the development of this equipment were discussed during the demonstration. When working towards low readings of harmonic content, the problem of input noise becomes predominantly important. The input tube finally selected for this equipment was the 6AB4, primarily because of freedom from microphonics and emission irregularities. Another problem brought out in the discussion, was the trouble encountered with capacitor due to a "hysteresis" effect. Normally such an effect would not be noted because of other masking distortions, but in attempting to clean up the residual distortion in this equipment a definite change in distortion readings was noted when a high-grade metal-cased, oil-filled capacitor was substituted for a standard commercial grade unit. Input resistors were also a problem from a noise standpoint, and the best found for this application were the "metallic film" type. Trouble was also encountered with microphonics in the tungsten control lamp used in the oscillator; this was finally cured by constructing a new lamp with adequate filament supports.

One may well ask, after viewing such a demonstration, "why?" The answer must certainly be that this equipment is definitely "laboratory" measuring equipment, and that its prime function is to enable measurements to be made without "measuring equipment correction." It was pointed out during the discussion following this demonstration that a measurement of 0.5 per cent harmonic distortion in an amplifier driven by an oscillator containing 0.3 per cent distortion does not necessarily mean that the amplifier is a 0.2 per cent amplifier.

L. D. Dialing Under Test

Residents of Englewood, N. J. will have more than eleven million telephones at their dialing finger-tips this fall when the Bell system inaugurates its first test of transcontinental subscriber dialing.

Results of the Englewood experience are expected to act as a guide in expanding the service to other major localities. Cities which may be dialed directly from Englewood are San Francisco, Chicago, Detroit, Cleveland, Boston, Philadelphia, Oakland, Milwaukee, Providence, and Sacramento.

Equipment has been developed which automatically records calling and called numbers, computes time of conversation, and prepares information for billing.

* MAGNECORDER Sound Performance



FOR BATTLE-FRONT... FOR BROADCAST! *

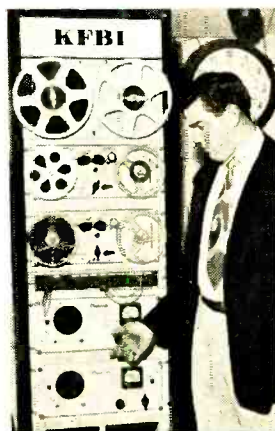

Minutes after being liberated from a Chinese Communist prison camp, this U. S soldier reports to Army Intelligence and to the world. Portable Magnecorder tape recorders are on the spot to record his courageous words. Serving all over the world, Magnecorders undergo "battle-front" conditions and still continue to record with high fidelity and dependability the moment they are needed.

Using Magnecorders, KFBI, Wichita, Kansas, handles delayed programs and "on location" recordings with complete confidence. In the field or at the station, dependable Magnecorders are the first choice of radio engineers everywhere.

MORE FEATURES

PT7 accommodates 10 1/2" reels and offers 3 heads, positive timing and pushbutton control. PT6 shown in console is available for portable or rack mount.

GREATER FLEXIBILITY

In rack or console, or in its really portable cases, the Magnecorder will suit every purpose. PT6 is available with 3 speeds (3 3/4", 7 1/2", 15") if preferred.

HIGHER FIDELITY

Lifelike tone quality, low distortion, meet N.A.B. standards — and at a moderate price. PT63 shown in rack mount offers 3 heads to erase, record and play back to monitor from the tape while recording.

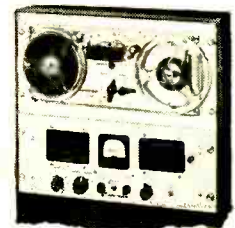
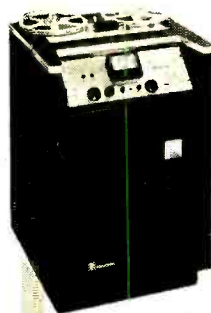

WRITE FOR NEW CATALOG
Magnecord, INC.

360 North Michigan Avenue
Chicago 1, Illinois, Dept. A-9

Send me latest catalog of Magnecord equipment.

Name.....
Address.....
City..... Zone..... State.....



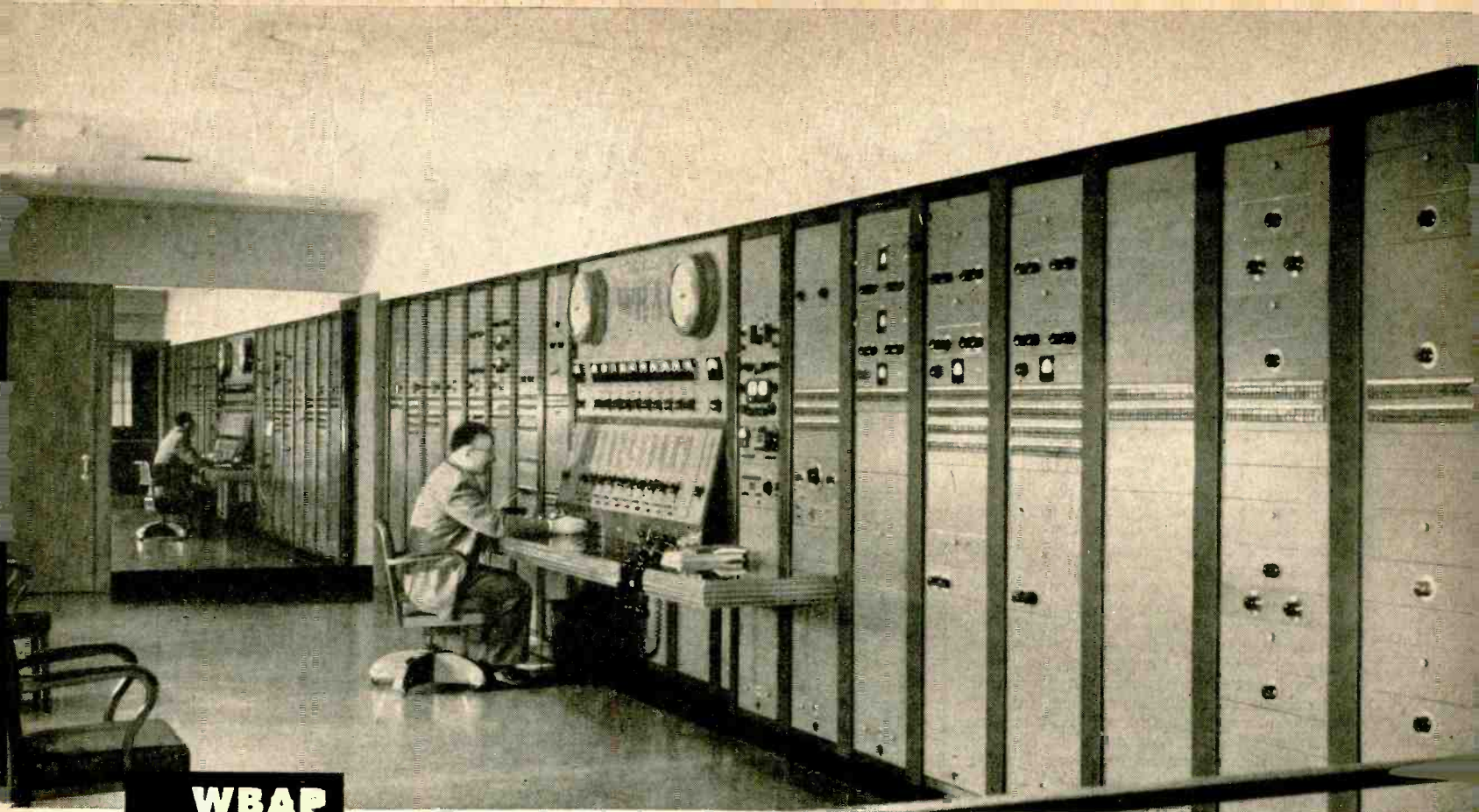

WBAP
FT. WORTH, TEXAS

This master control console, including 16 deluxe audio equipment racks, is part of a modern 6-studio layout—custom-built by RCA. Designed for AM, FM and TV opera-

tion, this "In-Line" design handles 16 studio inputs and feeds 10 output channels—simultaneously, or individually, by a pre-set relay system.

Unlimited audio

Two supervisory positions like this one handle 4 studios, 2 outgoing lines. It includes telephone ringdown, remote switching, talkback, monitoring,

and cueing. This set-up uses existing RCA Consolettes—makes studio and master control functions possible in one location.

WJAC
JOHNSTOWN, PA.





WJPG

GREEN BAY, WISC.

Master control handles 4 studio inputs, 4 output channels, 2 remote inputs, 3 turntable inputs, cueing, monitoring, talkback. This master control and one sub-master handle all program needs.

A few of the many de luxe units available

- Supplementary equipment for Consolettes—switching systems, extra inputs and outputs, jack strips, ringdown, sound-effects filters, and line equalizers
- Master control equipment—to handle any number of studios
- Matched custom wings for consolettes—for studio and master controls
- Custom racks for relay switching
- "One-man" control layouts
- Master control console combinations
- Studio control consoles
- Custom recording—for separate or simultaneous recording
- Custom recording control turrets
- Mobile recording equipment—disc recorders, tape recorders, record playbacks. Everything including the motor vehicle.
- Audio/Video equipment—custom audio, plus video switching, monitors, stabilizing amplifiers.

facilities.....for

SMALL STATIONS

MEDIUM STATIONS

LARGE STATIONS

RCA fine custom-built studio control systems

With RCA Custom-Built equipment you can extend your audio facilities almost without limit. No matter what size the system, experienced RCA design assures instant, fool-proof switching without program level "pops" or "breaks." Fidelity of sound meets the requirements of the world's severest critics.

Suitable for every AM, FM, and Television station—small, medium, or large—RCA Custom-Built Systems are "individualized" to handle all the studio-control operations anticipated by the

individual plant. Any number of station studios may be provided for... any number of remote lines... any type of master control... all the monitoring, talkback, and cueing facilities needed... every conceivable facility for controlling program operations and reproducing high-fidelity sound. True cabinet craftsmanship combines durability with function. Handsome styling and finish enhance station prestige.

Consultation on Custom-Built equipment is provided without obligation to every station—any size. Service includes

detailed layout proposals, diagrams of equipment and facilities, artist's sketches by RCA functional design experts, thorough counsel by RCA's experienced staff of broadcast specialists. Where plans are already down on paper, RCA will be glad to work from these—co-operate closely with your principals.

Your RCA Broadcast Sales Engineer can tell you about this service. For complete information call him, or write Department 16U, RCA Engineering Products, Camden, New Jersey.



AUDIO BROADCAST EQUIPMENT
RADIO CORPORATION of AMERICA
ENGINEERING PRODUCTS DEPARTMENT, CAMDEN, N.J.

In Canada: RCA VICTOR Company Limited, Montreal

EDITOR'S REPORT

THE AUDIO SEASON

WITH the advent of the fall months, interest in audio revives because of the end of vacations, the longer evenings in which entertainment is wanted, and an opportunity to work over last year's equipment to incorporate all the new ideas which have turned up during the summer months.

Then, too, there is the Audio Fair to look forward to—definitely the principal audio event of the year. For three days each devotee of this art—or science, depending upon how you look at it—can roam through the rooms and corridors of Hotel New Yorker and see, touch and *hear* the products of the leading manufacturers of amplifiers, speakers, tape recorders, phonograph pickups, and all the many items which go to make up the home music system of his dreams. He sees and studies the construction practices of leading professional equipment manufacturers, and determines ways in which he can adapt their methods of building to his own problems.

The technical sessions of the Audio Engineering Society Convention have been well attended in the past years, and the material to be presented this year should prove to be equally attractive. There need never be a dull moment for anyone who has a deep interest in audio—professional or otherwise.

EMERGENCY WARNING SYSTEMS

Increasing activity in the field of emergency warning systems has opened up a large vista for manufacturers and installers of audio equipment. While the use of sirens has become more or less universal in large cities, it can not be denied that it is difficult for a siren to make more than two kinds of noise—a warble tone or a constant tone—with its consequent inability to give any detailed instructions to large numbers of people. By virtue of the character of a siren's sound, it is alarming; panic at a time of emergency could easily be more dangerous than the event being warned against.

The installation of high-power voice-frequency speakers throughout the business district of a large city would permit some one in authority to give directions which would be of inestimable value at any time—not only during or preceding a war period. Such a system

could readily be arranged for instant use by proper authorities, and in case of fires, floods, hurricanes, or any other natural or man-made emergency, nearly everybody in the city could be told just what to do. By suitable arrangements, every radio station could carry the same announcements overriding its then current program, along with all wired music services. In a given area, it should thus be possible to contact a very high percentage of the people with a minimum of effort. Radio stations are, of course, set up now to tie together—in most instances by a radio link.

If it were possible for people to be so directed that their efforts in getting out of the danger zone were effectually coordinated with the needs of the area as a whole, it seems probable that the greatest good would result for the greatest number. Many manufacturers and installers are actively attacking this market, with excellent results being reported to date.

One other advantage that accrues to a system of this type is that strangers in a given city—and most large cities have a high percentage of tourists and visiting business men in their midst at all times—do not have to learn the meaning of signals. The use of the spoken word would leave no doubt as to what was expected of them.

The uses of sound have far outgrown the limiting title given to early installations—"public address." Yet a search for a sound system manufacturer, installer, or operator through the classified telephone directory under the term "sound" leads one to the cross reference "public address." We favor the more general term to describe an industry which is still growing by leaps and bounds.

STANDARDIZATION

While standardization in professional circles is progressing constantly, and with many loose ends being tied up, we hope for some standardization in the plugs, sockets, jacks, and cabling used in non-professional equipment. Input connections to amplifiers are semi-standardized with the adequate and inexpensive pin-plugs and jacks, but there is little uniformity in output connections or in inter-chassis or power supply connections. Any suggestions from individuals or manufacturers would be entertained with interest.

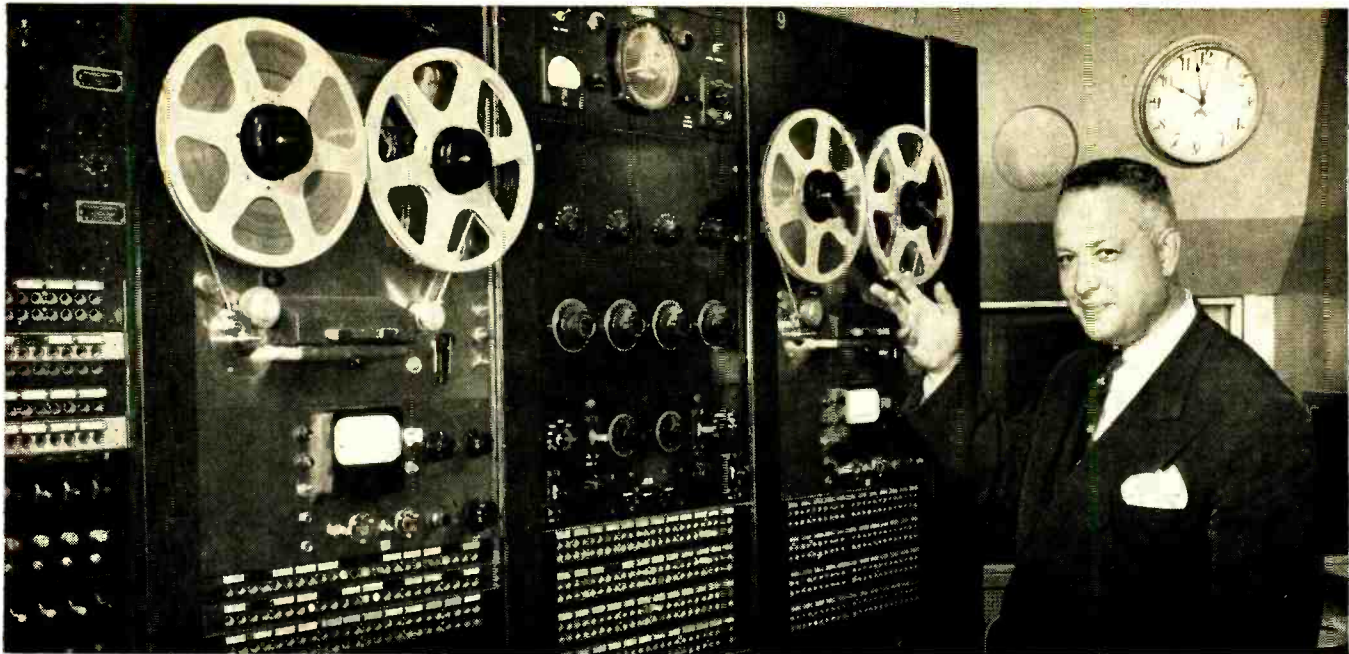

JIM BELOUNGY supervises the production of hundreds of commercials every week at WCCO.

"I've tried them all... and 'SCOTCH' Sound Recording Tape is tops with me!"

Says Jim Beloungy, Chief Engineer,
WCCO, Minneapolis-St. Paul

CHECK THESE NEW CONSTRUCTION FEATURES OF "SCOTCH" SOUND RECORDING TAPE!

Used by all major networks and for master recording by major record companies.

- ✓ Absolute uniformity in and between reels. No re-setting of output levels between reels.
- ✓ Thinner construction means unequalled resistance to temperature and humidity changes.
- ✓ By absorbing moisture uniformly on both sides, "SCOTCH" Sound Recording Tape does not curl or cup, always lies flat on recording head.
- ✓ Special new manufacturing techniques reduce distortion level and eliminate surface irregularities that cause high frequency drop-out.
- ✓ Exclusive lubricating process reduces friction and flutter, increases life of tape. Cuts wear on machine heads and guides.
- ✓ Greater output at 1% distortion than tapes of previous constructions.

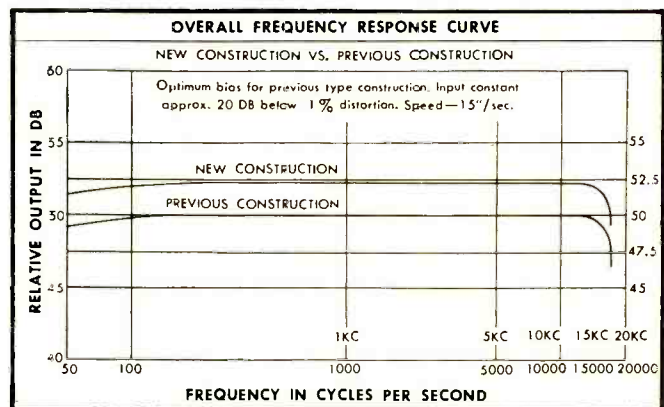

CHART SHOWS HOW new manufacturing improvements have increased overall sensitivity of "SCOTCH" Sound Recording Tape. Continuous laboratory and factory research keeps this tape ahead of the field.



Made in U.S.A. by MINNESOTA MINING & MFG. CO., St. Paul 6, Minn., also makers of "Scotch" Brand Pressure-sensitive Tapes, "Underseal" Rubberized Coating, "Scotchlite" Reflective Sheeting, "Safety-Walk" Non-slip Surfacing, "3M" Abrasives, "3M" Adhesives. General Export: Minn. Mining & Mfg. Co., International Division, 270 Park Avenue, New York 17, N. Y. In Canada: Minn. Mining & Mfg. of Canada, Ltd., London, Canada.

There's a NEW SILHOUETTE
on the Microphone Horizon...

THE NEW
**ULTRA-CARDIOID
DYNAMIC**
MODEL **55s**

"THE PERFECT PERFORMER"

SMALL
Unidyne



Model 55s
List Price \$72.50

The New Small Unidyne is approximately only half as large as the Standard Unidyne.



Model 556s
Small
Broadcast
Dynamic

Model 55s
Small
Unidyne

► Eliminates Feedback Problems

► Permits performer to stand farther from the microphone

THIS MIGHTY, though little, Microphone, is the *only* small-size, uni-directional moving-coil dynamic microphone—all the important directional qualities are retained. The 55s is actually a new Microphone retaining all the highly desirable features that made the Model 55 "Unidyne" world-famous.

Model 55s offers superior performance, featured in a streamlined, small, functionally-designed case. The moving-coil system has a high overall efficiency and smooth frequency response. A large air-gap clearance and a rugged coil construction provide immunity of the moving-coil system to abnormal atmospheric conditions and severe mechanical shocks.

The New Small "Unidyne," Model 55s and 556s, are not replacements for the current Models 55 and 556 "Unidyne." The Standard "Unidyne" are not being discontinued. You now have four outstanding, feedback-killing dynamic microphones from which to choose for the most severe acoustic applications.

Model 55s Small Unidyne
Model 556s Small Broadcast
Model 55 Standard Unidyne
Model 556 Standard Broadcast

Code: RUDOT List Price: \$72.50
Code: RUDOV List Price: 100.00
Code: RUMUL List Price: 72.50
Code: RUMUB List Price: 100.00

Patented by Shure Brothers, Inc.



SHURE BROTHERS, Inc.

225 W. Huron St., Chicago 10, Illinois

★ MANUFACTURERS OF MICROPHONES
AND ACOUSTIC DEVICES

● Cable Address: SHUREMICRO

LETTERS

Who'll Volunteer?

Sir:

Would one of your readers allow me to photostat his copy of the parts list for the McMurdo Silver *Masterpiece V*, or can someone please tell me where such a list can be found?

Frederick B. Davis,
12 Normandy Road,
Bronxville, New York

The KT66 Tetrode

Sir:

Your note announcing the arrival of this valve in the U. S. (NEW PRODUCTS, June) does not mention the important differences between the KT66 and the 6L6 when used as triodes. The first difference is that the KT66 as a triode has a maximum anode-dissipation rating of 25 watts compared to 10 watts for the 6L6, and the second is that the KT66 as a triode has an anode impedance about 20 per cent lower than the 6L6. Taken together, these two differences explain why the KT66 is the best choice in amplifiers such as the Williamson.

If any of your readers would like more information on the KT66, I suggest they write to The General Electric Co. Ltd. (of England), Magnet House, Kingsway, London, W. C. 2, England, and ask for Technical Publication TP3, which I can recommend as a useful and interesting booklet (except for the circuit suggested for a stabilized power supply).

To avoid any misunderstanding, I had better add that I am in no way connected with the makers of this valve.

E. F. Good,
Pale Manor Hostel,
Malvern, Worcs.,
England

Transients

Sir:

Advertisements and articles in some of the British journals often mention speaker transient response and the contradictory response-speed-vs.=overshoot design problems.

If the overshoot of a wide-band video amplifier is too great, it can be damped with resistance, or its peaking coil inductances reduced. This is accomplished at some sacrifice in bandwidth and rise-time. In other words, there is a compromise. Some involved compensating and filter-type coupling networks which are applied to pulse amplifiers produce a linear phase shift out to the limit of useful bandwidth, and result in good rise-time, relatively wide bandwidth, and no appreciable ringing. Where fast rise time is required to handle extremely short pulses, on the other hand, one must compromise in the other direction and use series or series-shunt peaking to permit about 2 per cent overshoot, which is tolerable enough for most TV and other pulse applications. Similar problems are encountered in electrical meter movement design where overshoot of 1 to 5 per cent is permitted to obtain the necessary practical response speed. Weston engineers, for instance, point out that by allowing about 5 per cent overshoot, one doubles the response speed of a meter movement. Hence a speaker that does no ringing whatever is not necessarily the ideal design from the transient-response viewpoint.

[Continued on page 44]

MAURER... AT HOME ANYWHERE



THE 16MM. SOUND-ON-FILM RECORDING SYSTEM. Capable of recording either negative or direct positive variable area and variable density sound tracks.

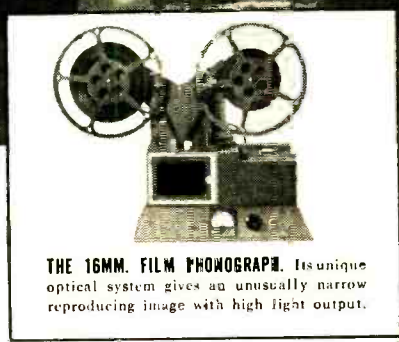

THE 16MM. FILM PHOTOGRAPH. Its unique optical system gives an unusually narrow reproducing image with high light output.



THE MODEL F PRIME RECORDING OPTICAL SYSTEM AND GALVANOMETER. A complete light modulating unit for recording sound photographically upon standard film.

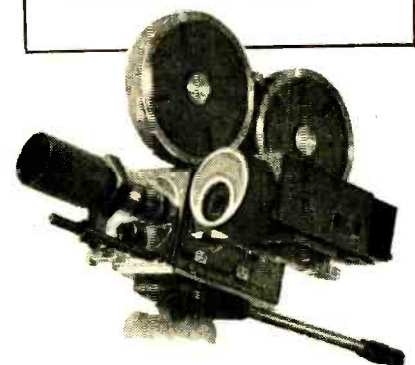

THE MAURER 16MM. CAMERA. Equipped with unique precision high-power focusing. Equipment includes: 235° dissolving shutter, automatic fade control, viewfinder, sunshade and filter holder, one 400-foot gear-driven film magazine, a 60-cycle 115-volt synchronous motor, one 8-frame handcrank, power cable and a lightweight carrying case.

The Maurer 16mm. camera is at home for every professional requirement—and little wonder since it's the only "16" specifically designed for professional use. The Maurer has many unique features—its simplified operation, hair-line accuracy, and job after job dependability, all make it the favorite choice of those who consider time and expense important—and a fine motion picture even more so.

For details on this and other Maurer equipment write:

J. A. MAURER, INC.
 37-01 31st Street, Long Island City 1, New York
 850 South Robertson Blvd., Los Angeles 35, California

16mm maurer CABLE ADDRESS: JAMAURER

bringing
a
giant
down
to
size

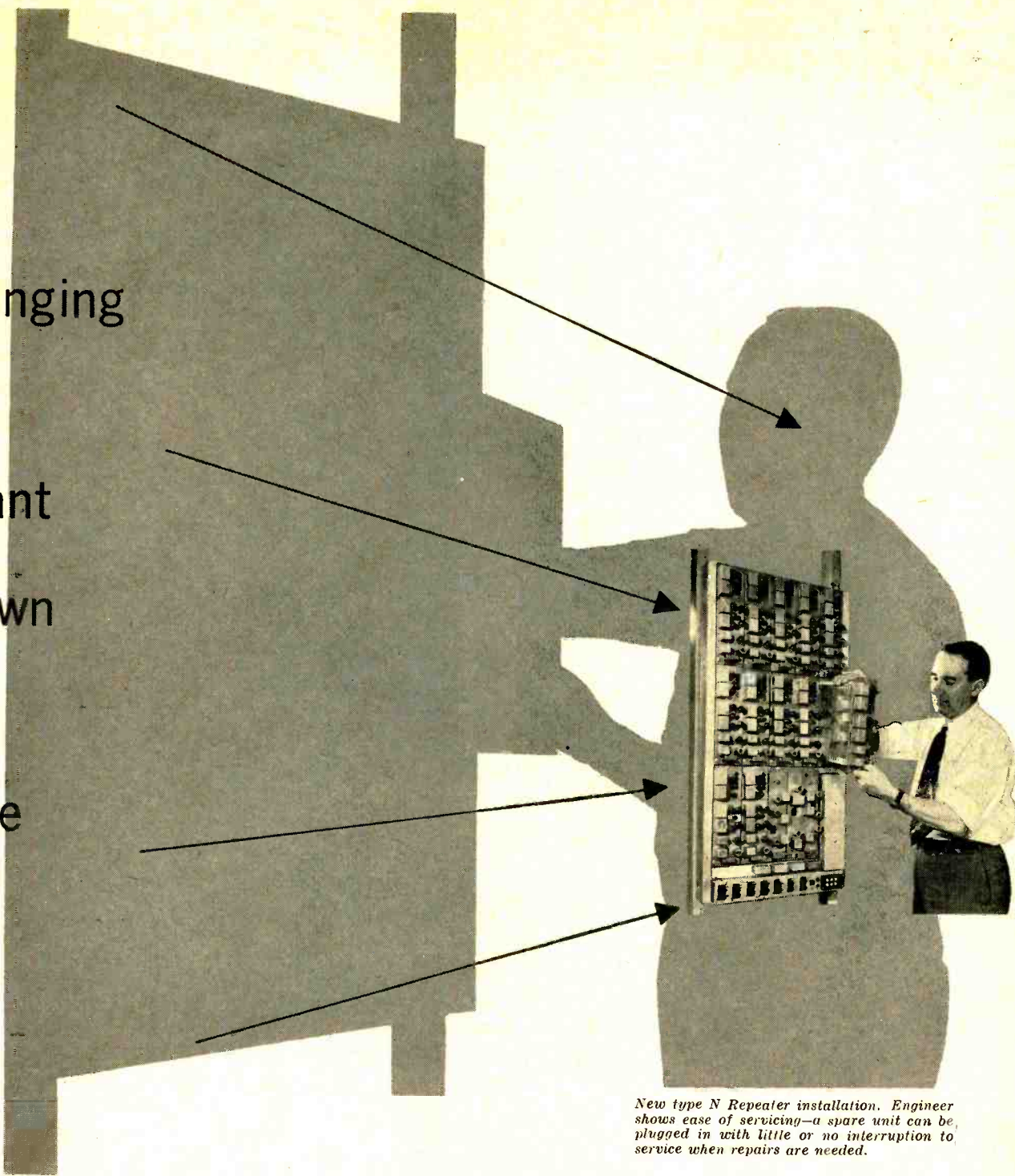

New type N Repeater installation. Engineer shows ease of servicing—a spare unit can be plugged in with little or no interruption to service when repairs are needed.

“CARRIER SYSTEM” telephony is economical, because many voices use the same pair of wires. But the extra equipment needed formerly limited it to the longer distances.

Now Bell Laboratories have developed new short-haul carrier, economical down to 25 miles, sending 12 conversations on two pairs of wires in a cable.

Keys to the new system are new circuits, miniature tubes, pocket-size wave filters and Permalloy “wedding ring” transformer cores that will barely slip over a man’s finger. New

manufacturing processes were developed in co-operation with the Western Electric Company. Components are pressed into a plastic mounting strip with heat, a score at a time, instead of being mounted separately.

With this new carrier system more service can be provided without laying more cables. Tons of copper and lead can be conserved for other uses. It’s another example of how science takes a practical turn at Bell Telephone Laboratories, to improve service and to keep its cost down.

BELL TELEPHONE LABORATORIES

WORKING CONTINUALLY TO KEEP YOUR TELEPHONE SERVICE ONE OF TODAY'S GREATEST VALUES



Space-Charge-Grid Amplifier

MELVIN C. SPRINKLE*

A new low-power amplifier using the space-charge-grid tubes first publicized as audio output tubes almost four years ago. By the designer of the Musician's Amplifier.

FROM TIME IMMEMORIAL, it seems, the audio enthusiast has been searching for wider frequency range and lower distortion in his amplifiers. These desirable features are expensive, and cost is an important consideration to the average audio fan. So, the effort has gone on to get the most for the least. The amplifier to be described represents what is believed to be the highest quality yet attained for the required financial investment. The remarkable performance is made possible by two important components: a new and radically different tube type and a high-quality low-cost output transformer.

In spite of its well known limitations which increase cost, the triode tube has for years been the standby of the audio crowd. The beam-power tube overcame a number of the limitations of the triode, but many builders never accepted the beam power tube as the equal of the triode. Thus the argument has raged for some years on the beam tube vs. the triode, with good points on both sides. Now, the National Union Radio Corp. has developed for commercial use a new tube type which combines the best features of the triode and the beam tube, and which opens a new era in high-quality amplifiers. This tube is known as the NU 2160 and is a space charge tube. Its plate family of curves resembles those of triodes, but its efficiency and drive requirements are like a beam power tube.

The space charge tube has been described in the literature,^{1,2} but for the

* Peerless Division, Altec Lansing Corp.
¹ Electronics, Vol. 20, No. 8, August 1947, p. 121.

² AUDIO ENGINEERING, Vol. 31, No. 9, October 1947, p. 20.



Fig. 1. Separate chassis for the amplifier and power supply simplify mounting in many applications.

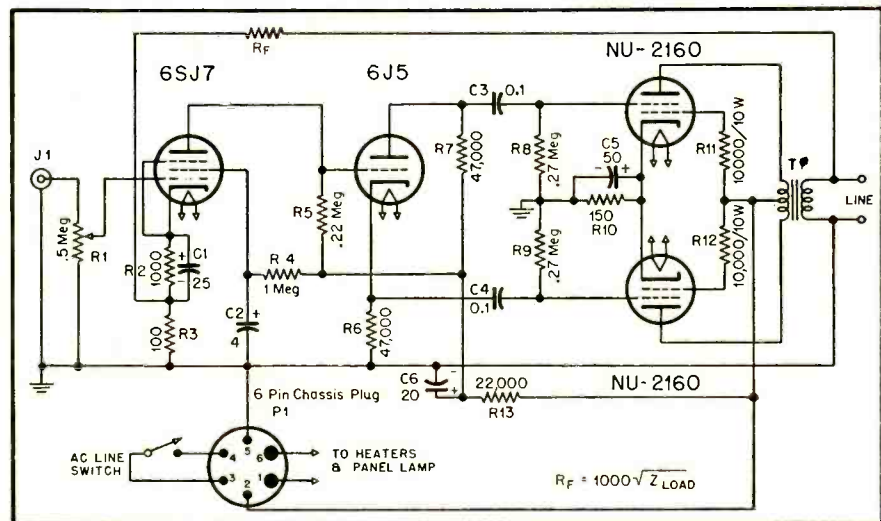

Fig. 2. Schematic of the space-charge-grid amplifier chassis.

benefit of those who do not have access to the references, its characteristics are briefly summarized. The space charge tube is a tetrode, with a cathode, two grids, and a plate. The grid nearest the cathode is operated at a positive d.c. voltage with respect to the cathode, the effect being to counteract the negative space charge and produce a larger cloud of electrons at the plane of the first grid. This cloud acts as a virtual cathode. The second grid is then the control electrode, being operated with a negative bias in the conventional manner. The operation of the space charge tube is similar to a triode with a large effective cathode. It should be pointed out that it is not possible to connect an ordinary tube as a space charge tube because so doing would cause excessive current in the first grid. In the NU 2160 the current in the first grid has been lowered by mounting a pair of side rods between the space charge grid and the cathode, and connecting these rods to the control grid. The side rods thus shield the space charge (No. 1) grid from the cathode except in the vicinity of the lateral wires of the grid. They also have an effect in reducing harmonic distortion.

The positive voltage on the space-charge grid is supplied from the plate supply through a 10,000-ohm resistor. The space charge grid is *not* bypassed, and the omission of the bypass capacitor produces three beneficial effects: the power output is increased slightly for a given average cathode current, the output is less affected by changes in external load impedance, and the odd har-

monic distortion is reduced. It has been mentioned that the plate current family resembles triode curves. To this must be added the fact that the plate resistance is low—2,500 ohms—the μ of 16 is medium, and the transconductance is 6,500 micromhos. The uniformity and regularity of the plate family indicate that these parameters are fairly constant and therefore the distortion is low. The tube is operated with a bias of about 18 volts on the control (No. 2) grid so that operation out of a resistance-coupled stage or phase inverter is very practical.

Through the courtesy of National Union, the writer was provided with a pair of NU 2160's for experimental use. As of the present, National Union is planning to market the NU 2160 through radio parts distributors, but material uncertainties make the general availability of the tube a question mark. It is also not known whether other tube manufacturers will make space charge tubes for sale through their distribution channels.

Design of Amplifier

Examination of the data sheets provided with the tubes, showed that the tube was ideal for a low-cost amplifier, the power output as calculated being of the order of 6 watts for two tubes in push-pull. The Peerless S-508-A output transformer, originally designed for type 6V6 tubes, has ratings as to plate current and primary impedance which suit it to the 2160. Its design, based on the 6V6 plate resistance, means that it will

perform even better at low frequencies with the low-plate-resistance space-charge tube. Its physical size is small, and its price—scarcely higher than a large replacement type transformer—puts it within the reach of the most modest budget. This transformer has low insertion loss, wide frequency response, and ability to deliver power at frequency extremes. The performance data on the complete amplifier to be given later attests to this.

The amplifier itself is simple and with the possible exception of the space-charge stage is conventional. As will be seen from Fig. 2 it consists of a pentode amplifier stage using a type 6SJ7, direct coupled to a 6J5 split-load phase inverter which drives the output tubes. The circuitry of the pentode stage is conventional, the only precaution being to use an adequate bypass capacitor on the screen. The split load phase inverter is also well known and conventional. The writer has found it to be about as good a circuit as is available, having none of the drawbacks sometimes ascribed to it. One of the big advantages is that it lends itself so well to direct coupling from a preceding stage. Use of direct coupling extends the frequency response of the stage to d.c. and eliminates coupling networks which can cause phase shift and low-frequency attenuation. There are only two coupling capacitors in the amplifier, from the phase inverter plate and cathode to the power amplifier grids. The low-frequency response in the entire amplifier is very good, much better than the transformer curves alone might lead one to believe. It should also be pointed out that the direct coupling system used here is almost automatic in its action to provide optimum operation for both stages once the plate voltage of the preceding stage is brought close to the positive voltage on the phase inverter cathode. There is plenty of good clean signal from the phase inverter to work directly into the space charge control grids and give full power output.

Output Stage

The space charge tube circuit differs from the usual push-pull beam power circuit in one respect. Two 10,000-ohm 10-watt resistors are used to provide the space charge grid voltage. It is necessary to use a separate resistor for each tube. As has been pointed out previously, these space-charge grids are *not* bypassed. The cathodes are tied together and go to ground through a 150-

ohm resistor, which is heavily bypassed. The tubes are operated more Class AB₁ than recommended by the manufacturer, as tests with intermodulation equipment showed that reducing the bias increased the distortion slightly at the higher output levels.

Inverse feedback around the amplifier is sufficient to reduce hum, noise, and distortion almost to the vanishing point at the usual levels. The source impedance is lowered to 2.5 ohms on the 16-ohm tap. Connections are available on the output transformer to match loads of from 4 to 16 ohms. Values for the feedback resistor for various load impedances are given in Fig. 2.

Construction

The amplifier is constructed on an aluminum chassis 5×7×3 in. There is plenty of room for all parts, most of which are mounted on two terminal boards. One board is used for the pentode and phase-inverter components, while the other holds the coupling capacitors and resistors for the space charge tubes. A ground bus is used with connection to the chassis at the input so as to avoid chassis currents and hum. The controls are simple—a volume control, a pilot lamp and an a.c. line switch.

The power supply, Fig. 3, is simple and conventional. The power transformer is rated at 120 ma, and the amplifier draws just about that current. After 12 hours continuous use in 75° F. ambient, the transformer is just warm. A 6-wire cable is used to connect the power supply to the amplifier. The a.c. power line is run to the amplifier so that there is no possibility of the power supply becoming energized, without its load being connected even if the a.c. power switch is not installed. If no switch is desired, terminals 3 and 4 of the plug must be wired together.

The two-chassis system was employed for this unit—one chassis being used for the amplifier and another for the power supply—so that the amplifier can be placed wherever desired and the power supply can be located at some remote point. Furthermore, they can be placed *side by side*, end to end, or even stacked if required. One large chassis can be used if the amplifier and power supply are to be constructed as a single unit.

Performance

At the beginning it was stated that this amplifier was intended as a high-quality, low-cost unit. It is believed that

this has been accomplished, as will be seen from the performance data. The NU 2160 was not intended as a high-power tube, and hence the power output is limited when compared with 6L6 tubes. The useful power output of the amplifier in a load resistor connected to output transformer secondary is about 5.5 watts, based upon the point where the intermodulation begins to climb rapidly. This power rating compares very favorably with the data sheet which gives the power in a resistive load connected from plate to plate as 6 watts for 2 per cent harmonic distortion, as shown in Fig. 4. The single-frequency sine-wave output power before the waveform begins to be distorted (about 5 per cent) is 7.5 watts. The power output as a function of frequency is given in Fig. 5. It is the power output at frequency extremes that makes an amplifier sound good and which is reflected in the low intermodulation distortion. Power output at frequency extremes is a function

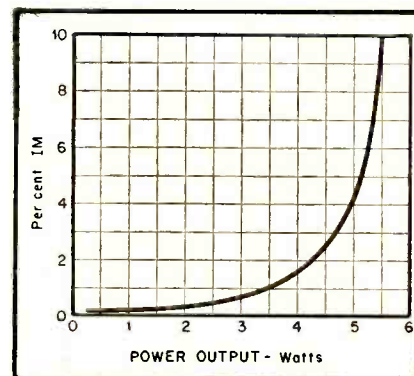

Fig. 4. Intermodulation distortion curves for the amplifier indicate its excellence for low-power applications.

of the output transformer, as tube manufacturers do not put frequency restrictions on their audio power tubes, their measurements being made on a resistive load connected directly to the plates.

The absolute gain of the amplifier is 81 db, and is practically constant from 20 to 20,000 cps., the maximum departure being about 0.2 db at the limits. It must be pointed out again that frequency response is not nearly as important in the "ear appeal" of an amplifier as power output as a function of frequency. The output transformer used has a rated frequency response of no more than 1 db down at 30 and 15,000 cps, yet the amplifier frequency response is much better. The answer lies in the fact that inverse feedback improves the frequency curve. However, inverse feedback will not help power output measurements as a function of frequency to a great extent. Hence the power curve is more important.

The total noise level, including hum, is -51.2 dbm which is 88.7 db below the rated output of 5.5 watts. The distortion was measured with an intermodulation set using frequencies of 40 and 2000 cps. Up to within 1 db of the rated power the IM distortion is no more than 2 per cent, and at 2 db below rated power the IM is 1 per cent or less. These are entirely negligible amounts.

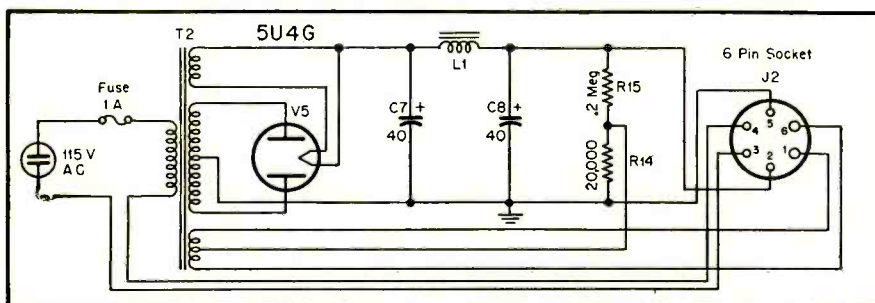

Fig. 3. Schematic of the power supply chassis.

An efficient speaker with 0.1 watt input at 1000 cps will produce a sound level of around 83 db. This sound level has been classified on the *Electronic Industries* sound level chart as "very loud radio in home." At a power output of 0.1 watt the IM distortion in this amplifier is about 0.15 per cent and at a 10 db higher level, which is roughly representative of peaks in the program material, the IM distortion is 0.25 per cent. Thus at all usable levels, the IM distortion is too small to worry about.

The total cost of the parts to build this amplifier and power supply, using the transformers specified for its performance and other parts of first grade is about \$35.00. This does not include the space charge tubes since no firm price has been put upon them. However, they should certainly be no more expensive than 6L6 tubes, for example. Thus the cost puts it well within the reach of the audio enthusiast who longs for a better amplifier but whose "Chancellor of the Exchequer" has other ideas on what to buy.

It was not intended that this amplifier take the place of a deluxe amplifier, such as the Musician's Amplifier, where the ultimate in quality is desired and where the performance requirements are rigorous. This amplifier "folds up" at power levels where the Musician's Amplifier is still below 2 per cent IM. However, this amplifier is especially commended for the average home, especially when cost is an important consideration. At the 1950 Audio Fair it was compared on A-B test with larger amplifiers of equal quality and until the level became so loud that it was deafening,

Fig. 5. Curve showing power output vs. frequency over the range from 20 to 20,000 cps.

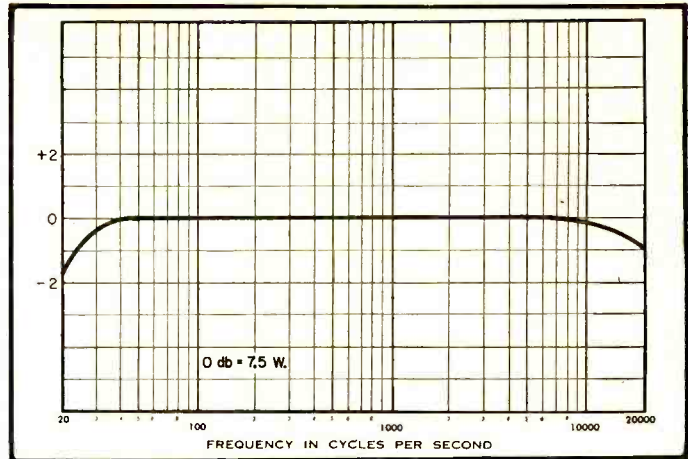

there was no audible difference. In the author's home it has done everything that a home amplifier is called upon to do. There is not enough gain to operate directly from a magnetic pick-up cartridge but with a preamplifier, many of which have been described in these pages, it reproduces all that is on a record. There is, however, plenty of gain for an FM tuner.

PARTS LIST

C_1	25 μ f, 25 v. electrolytic	R_1	0.5 meg, audio taper vol. control
C_2	4 μ f, 450 v. electrolytic	R_2	1000 ohms, 1 watt
C_3, C_4	0.1 μ f, 600 v. paper	R_3	100 ohms, $\frac{1}{2}$ watt
C_5	50 μ f, 50 v. electrolytic	R_4	1.0 meg, 1 watt
C_6, C_7	10-10 μ f, 450 v. electrolytic (FP type)	R_5	0.22 meg, 1 watt
C_8, C_9	40-40 μ f, 450 v. electrolytic (FP type)	R_6, R_7	47,000 ohms, 1 watt (5% or matched)
L_1	Peerless C-325-A filter choke. 10 H. at 120 ma; d.c. resistance, 240 ohms	R_8, R_9	0.27 meg, $\frac{1}{2}$ watt
		R_{10}	150 ohms, 10 watt
		R_{11}, R_{12}	10,000 ohms, 10 watt
		R_{13}, R_{14}	22,000 ohms, 1 watt
		R_{15}	0.22 meg, 1 watt
		T_1	Peerless S-508-A output transformer. Pri. Z: 8000 ohms plate-to-plate; Sec. Z: 4, 8, 12, 16 ohms. Frequency response ± 1 db from 30 to 15,000 cps.
		T_2	Peerless R-480-A power transformer. 350-0-350 v. at 120 ma; 5 v. at 3 amps; 6.3 v. at 5 amps.
		V_1	6SJ7
		V_2	6J5
		V_3, V_4	National Union 2160
		V_5	5U4G

Plans All Set For 1951 Audio Fair



Hotel New Yorker

Fair occupied only a portion of the New Yorker's sixth floor. Even though the '49 showing was considered a success, its most enthused supporters were forced to admit that, unless 1950 brought a great increase in both commercial support and in attendance, there was little chance for the Fair to achieve the prominence they had hoped for.

Came 1950 and things happened. The number of exhibitors nearly doubled, and attendance jumped almost 300 per cent. An inkling of how firmly The Audio Fair had

staked its position in the electronic industry is found in the graphic words of an *Atlantic Monthly* author who wrote, "... the mood of the visitors was exultant and anticipatory," and in review articles which appeared in such magazines as *Saturday Review of Literature*, *Pageant*, and *Pathfinder*, not to mention most of the recognized technical publications. Truly, The Audio Fair had arrived.

The Fair is held each year in conjunction with the annual Convention of the Audio Engineering Society. Growth of the Convention has paralleled that of the exhibit, and today it is regarded as a symposium of world-wide prominence in every aspect of audio engineering. This year AES members who attend the Convention will be treated to technical papers covering many departures from convention in the field of audio design and application. The technical sessions are assuming an international flavor with the announcement that engineering representatives of well-known European manufacturers will participate.*

Theme of the Fair for '51 is *Audio on the Contemporary Scene*. Exhibits are being planned to emphasize and dramatize the full stature of audio and the influence it exerts on people in all walks of life. Items on display will serve the interest of everyone from the music lover looking for an economical assembly of living-room equip-

ment to that of the government official whose responsibility lies in the use of sound devices for psychological warfare.

In addition to commercial displays, there will be a joint showing by Ohio State University and a segment of the Armed Forces. The university exhibit will be built around a dynamic demonstration of the newest in scientific instruments for checking hearing characteristics. The visitor who desires will be afforded the opportunity of using the equipment to determine the sensitivity of his own hearing. The Armed Forces' portion of the display will feature the use of similar devices in connection with various military projects.

It can thus be seen how thoroughly the 1951 Audio Fair will realize the prime objective of its founders—"... to provide an instrument of national research as well as a medium for bringing high-quality audio before the public's eyes and ears."

Irrespective of one's audio interests—whether he be a top-flight design engineer, a broadcaster, or a music lover—he must attend The Audio Fair to keep well informed in his chosen field. As in previous years, admission to all exhibits is free, and technical sessions of the Convention are subject to a small attendance charge.

More emphatically than ever the slogan of the first Fair prevails in '51—*The Audio Fair is YOUR Affair*.

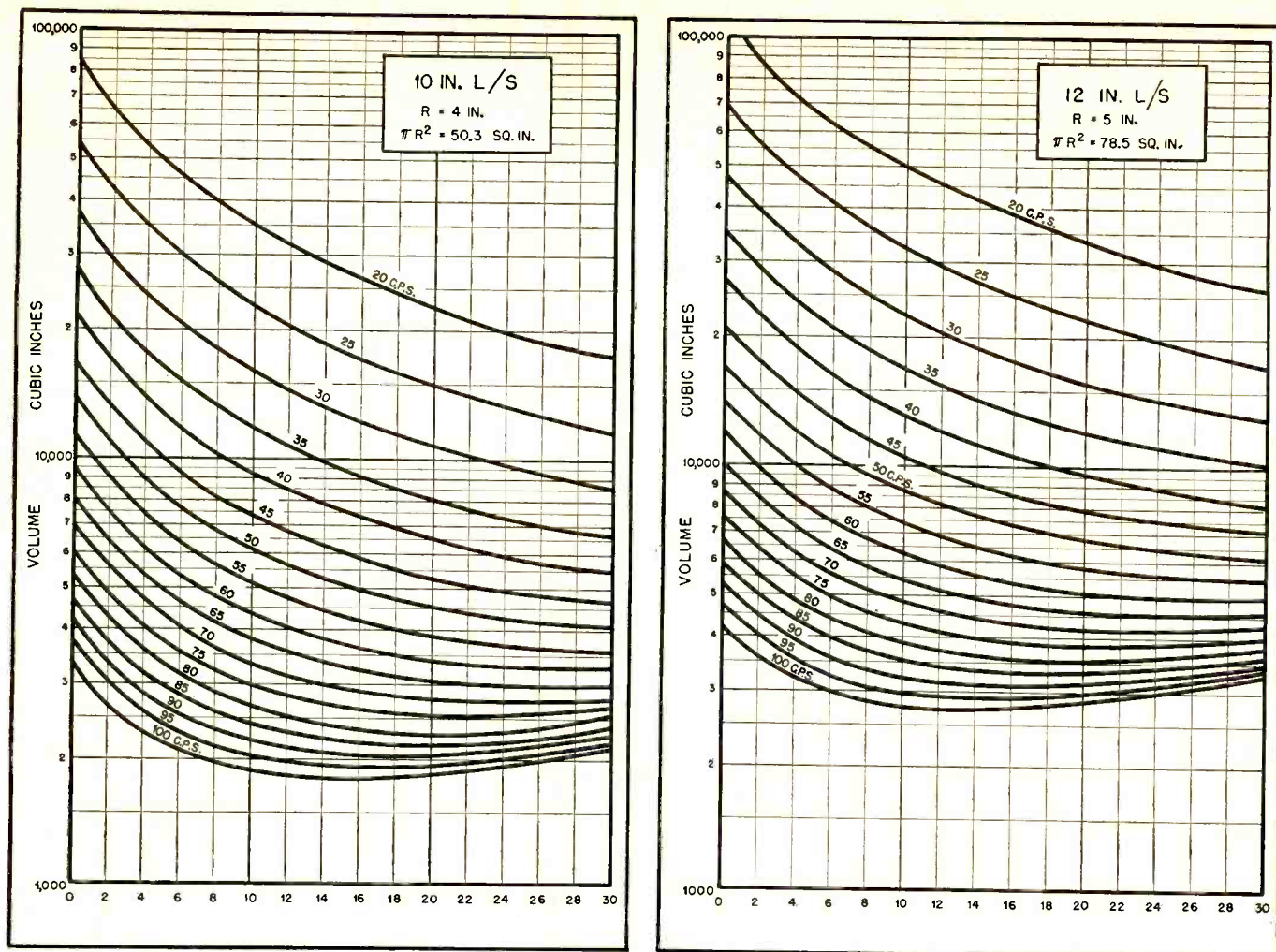

Fig. 1 (left). Curves showing tunnel length for 10-in. speakers resonant from 20 to 100 cps in a wide range of cabinet volumes. Fig. 2 (right). Curves for 12-in. speakers.

Design Data for a Bass-Reflex Cabinet

J. A. YOUNGMARK*

The charts presented by the author will simplify the selection of the dimensions for a satisfactory bass-reflex speaker cabinet.

IF THE FULL BENEFITS of a high-quality audio system are to be realised, it is, of course, vitally important to ensure that the loudspeaker system is equal to its appointed task. Fundamentally, this usually resolves itself into the provision of a suitable means of separating the radiation from the back and front of the loudspeaker cone, among certain other considerations, and the horn is notably efficient in such a connection. Unfortunately, the bulk of a horn such as would be required at the lower end of the audio range renders its use difficult, to say the least, and it is therefore obvious that some compromise must be made.

One such compromise between effi-

ciency and size can be made by using the corner of a room as the outer section of the horn and a noteworthy example of this is the Klipschorn. This consists of a frequency-divided system in which both the high- and low-frequency units are horn loaded. It is, however, rather complex in design and quite expensive to produce, whilst another arrangement, the Pyramid Corner Speaker,¹ is not very suitable where only a single unit is used.

In the normal domestic installation there is much to recommend the bass-reflex design first described by Thuras.²

¹ W. E. Gibson and J. J. Andrea, "A symmetrical corner speaker," *AUDIO ENGINEERING*, March 1950.

² A. L. Thuras, U. S. Patent 1,862,178 (1930).

Correctly designed, it gives increased power handling capacity, reduces the cone amplitude distortion at the resonant frequency, and at the same time gives additional output at this frequency. It may be built in a compact form and is relatively free from phasing difficulties. Although this type of loudspeaker system has never been so popular in Europe as in the U. S. it is now in fairly wide use there.

The theory of the reflex cabinet has been published, among others, by Hoekstra³ and Smith.⁴ The treatment which follows is based mainly upon their analy-

³ E. C. Hoekstra, "Vented loudspeaker enclosures," *Electronics*, March 1950.

⁴ F. W. Smith, "Resonant loudspeaker enclosure design," *Communications*, August 1950.

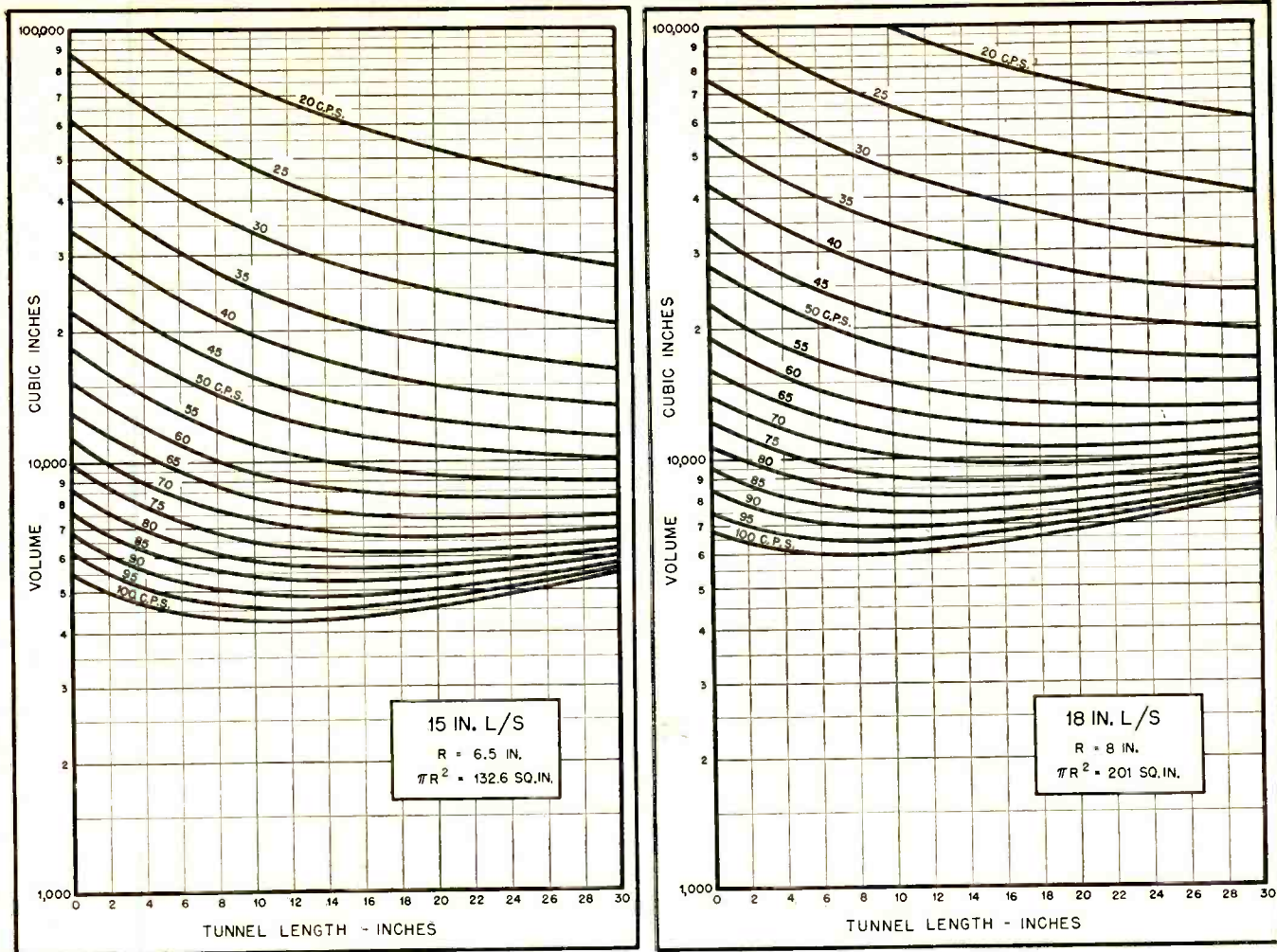

Fig. 3 (left). Curves of tunnel length for 15-in. speakers resonant from 20 to 100 cps in a wide range of cabinet volumes. Fig. 4 (right). Curves for 18-in. speakers.

sis in deriving an expression for the resonant frequency of any reflex cabinet and provides four sets of curves from which cabinets for the four most popular sizes of speaker (10, 12, 15, and 18 in.) can be designed without calculation.

The stiffness reactance of the air enclosed in a volume V is:

$$X_s = \frac{-j\rho C^2}{\omega V} \quad (1)$$

where

ρ is the density of the air,
 C is the velocity of sound,

and $\omega = 2\pi f$ (f being the frequency).

The cabinet is assumed to have a circular hole of radius R , provided with an internal tunnel of length L . The mass reactance of the air in such a tunnel mounted in an infinite plane baffle has been shown by Rayleigh⁵ to be:

$$X_m = \frac{j\rho W}{\pi R^2} \left(\frac{K_1(2kR)}{R^2 k^3} + L \right) \quad (2)$$

where

$K_1(2kR)$ is a Bessel Function of the first order

and $k = \frac{\omega}{c}$

Equation (1) represents the air load on the vent due to the air outside the cabinet, and equation (2) represents the mass of air in the tunnel. When the di-

mensions of the vent are small compared with a wavelength, this reduces to:

$$X_m = \frac{j\rho\omega}{\pi R^2} \left(\frac{16R}{3\pi} + L \right) \quad (3)$$

When this cabinet is resonant,
 $-X_s = X_m$

$$\frac{j\rho C^2}{\omega V} = \frac{j\rho\omega}{\pi R^2} \left(\frac{16R}{3\pi} + L \right) \quad (4)$$

$$V = \pi R^2 \left(\frac{C^2}{\omega^2} \times \frac{1}{1.7R + L} \right)$$

At the resonant frequency given by
 [Continued on page 46]

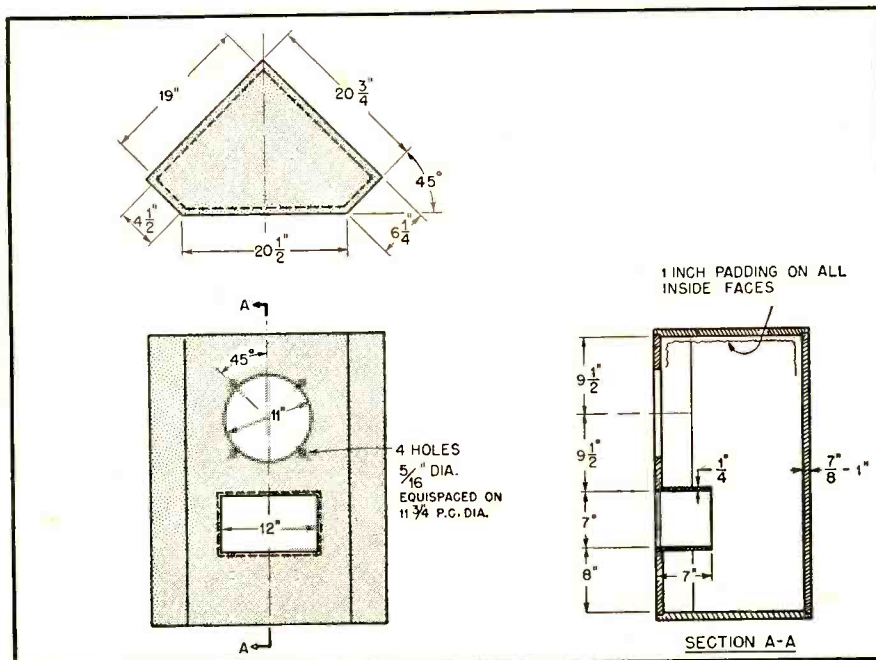

Fig. 5. Typical corner cabinet designed for a 12-in. Goodman speaker with a resonant frequency of 55 cps, which can be used with a speaker resonant at 75 cps by removing the tunnel.

⁵ Rayleigh, "Theory of Sound," Vol. 2, p. 306.

New AM-FM-TV Studio Console

P. W. WILDOW and G. A. SINGER*

Control facilities for small stations need not be as elaborate as those for network headquarters, but operation is expedited considerably if similar functions are provided, as in this newest addition to the broadcast field.

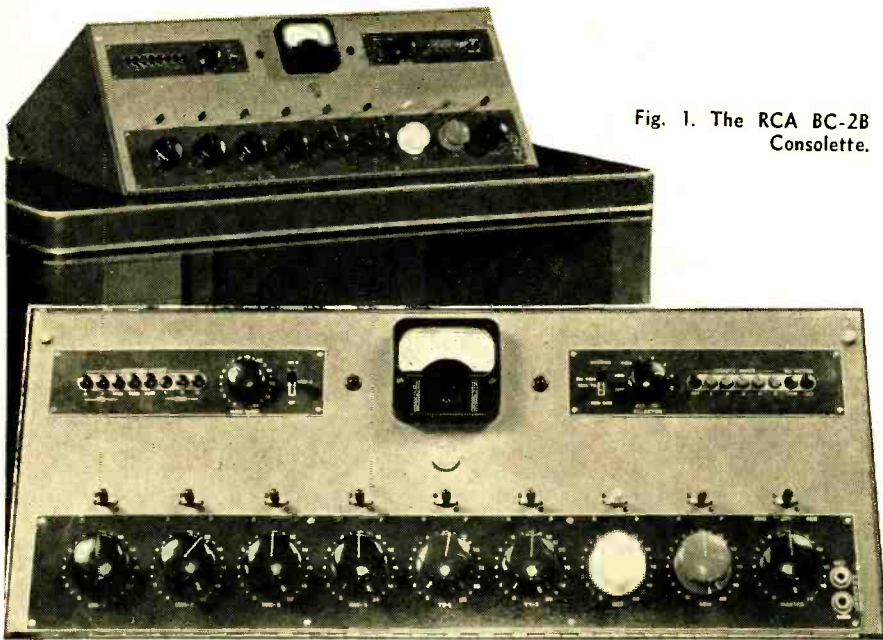

Fig. 1. The RCA BC-2B Console.

MANY DIFFERENT TYPES of audio systems are available for use in the broadcasting studio control room to perform the functions of amplification, mixing, switching, and regulating of the program. These systems may range from elaborate custom-built equipments utilizing rack mounted amplifiers with control desks containing only the operating controls, to very simple portable equipment adapted to studio use.

The console which is between these extremes offers the advantage of containing in a single package all the essential elements necessary for efficient programming. It requires a minimum of wiring at the installation and takes up little space. Because regular factory production methods are used, its cost is appreciably lower than that of more complex equipment.

The type BC-2B Console described in this article is a new design, engineered to fulfill the control room requirements of the majority of AM-FM and TV stations. The final design of this console reflects the combined thinking of broadcast engineers with long experience in the operation and design of broadcast audio equipment. As a result, several new operating features and recently developed tubes and compo-

nents are incorporated in its construction.

Facilities

The console may be used to control either one or two studios. In addition, it will serve an announce booth, a control room microphone, two turntables, a network and five remote lines. The monitor amplifier may be used for monitoring, auditioning, receiving and sending cues, talk back to studios, and as an emergency line amplifier. Except for the power supply, the console is completely self-contained.

The arrangement of circuits and controls is such that operation is simple and straightforward as shown in *Fig. 1*. Switches and faders are clearly marked with their function, and related control knobs are made of the same color plastic material. Electrical and mechanical interlocks are provided in the audio and control circuits to prevent improper operation. Even inexperienced or new personnel are able to learn quickly how to operate the console.

The console is designed to mount on a flat-topped desk or table, yet the sloping front panel design affords maximum visibility into the studio floor area. The console which is finished in two-tone umber gray will blend in

well with other RCA television studio control equipment.

All external connections are made to two terminal blocks which become accessible by lifting the top cover. As seen in *Fig. 2*, every electrical component is easily accessible for inspection, adjustment, cleaning and replacement.

The front panel swings forward bringing switches and attenuators in full view. The amplifiers are mounted on a movable frame which swings up, making the underside accessible. The amplifiers are on individual chassis which can be removed.

General Description

Figure 3 is the block diagram of the console. Of the six microphone inputs, three studio microphones are connected directly to the pre-amplifiers, and by means of a switch, the input to the fourth pre-amplifier may be selected from the control room, the announce booth, or the fourth studio microphone. The two turntable inputs connect directly to the mixers. In application where a booster amplifier is not included as part of the turntable, an additional dual-preamplifier may be installed in a space provided within the console. One input is reserved for a network line and one of five remote lines may be selected by means of a push-button switch. A line transformer is included for isolation and impedance matching.

Each of the eight possible simultaneous inputs is controlled by a high-level mixer. The mixer circuit is of the series-parallel type which offers the lowest loss. Both turntable mixers have "built-in" cueing switches which connect the turntable outputs to an external cueing amplifier when the mixer control is turned to the OFF position.

By means of key switches, the output of each mixer may be connected to either the program bus or the audition bus. The program bus is permanently connected to the input of the program amplifier. The output of the program amplifier is connected through the LINE-OUT switch and a 6-db pad to the output line terminals. The purpose of the pad is to equalize amplifier and line impedances.

The input of the monitor amplifier can be selected by means of a push-button switch. There are three talkback buttons which connect the control room microphone to the monitor amplifier and permit the operator to talk to Studio A, Studio B and the remote lines respec-

*Engineering Products Dept., Radio Corporation of America, Camden, N. J.

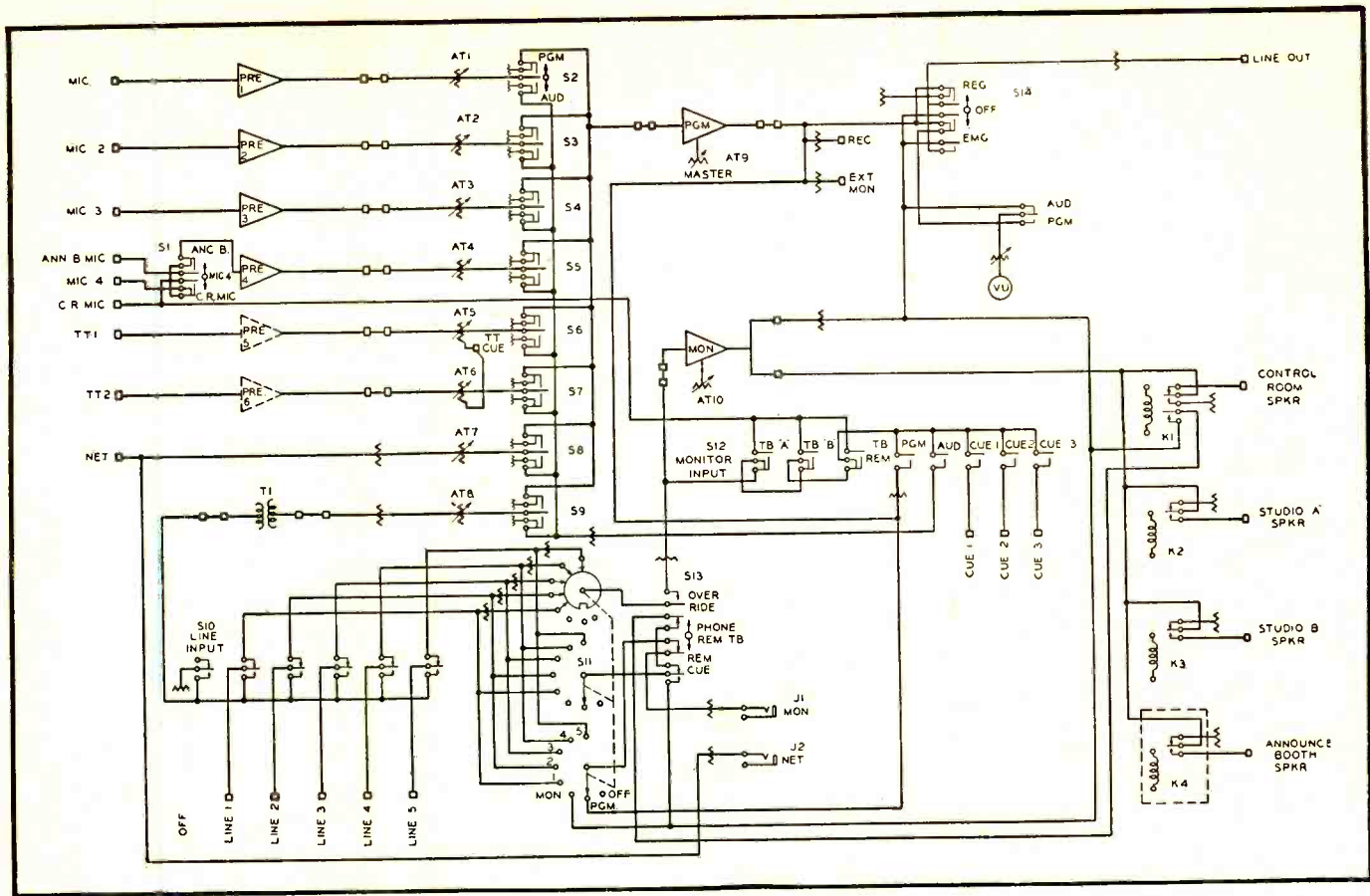

Fig. 3. Simplified block diagram of BC-2B Console.

tively. The fourth push-button bridges the monitor input across the output of the program amplifier for monitoring the outgoing program. The fifth button connects the input of the monitor amplifier to the audition bus and the remaining three push buttons connect it to cue lines.

Sometimes it is not known over which remote line a program will be fed. In such a situation, the "override" feature is helpful. By operating the OVERRIDE switch S_{13} all remote lines are connected to the input of the monitor amplifier and a call coming in on any one of the lines will override the signal coming from the monitor speaker.

The monitor amplifier may also be used to send cues over a remote line, and this is accomplished by throwing switch S_{13} to the REMOTE CUE posi-

tion. The remote line, over which the cue is sent, is selected by the switch S_{11} . An electrical interlock on the line selector switch S_{10} prevents cue from being sent over a line which is in use to receive a program from a remote location.

With switch S_{13} on the PHONE-REMOTE TALKBACK position, the monitor phone jack J_1 is connected through S_{11} to the remote lines, the program and the monitor amplifier. This position is also used to talk back over any remote line. It is thus possible to carry on a two-way conversation between the control room and a remote location.

Should the program amplifier fail, the monitor amplifier may be used as a line amplifier. To do this, the mixer output switches are thrown from the PROGRAM to the AUDITION position. The audition

button of the monitor input switch S_{12} is depressed and the line out switch S_{14} is thrown to the EMERGENCY position. The monitor gain control acts as the master gain control under those circumstances.

The VU meter can be switched to indicate the output level of either the program line or the monitor amplifier. Brightness of the lamps illuminating the meter scale is adjustable to suit operating conditions. This is of particular advantage in TV control rooms where the light level must be kept low. The two sets of push-button switches are of the cam-operated type with leaf-spring contacts which are inherently quiet, easy to maintain and give many years of reliable service.

Overall length of the console is 33 in., the depth $21\frac{1}{2}$ in., and the height $11\frac{1}{4}$ in. The total weight is 114 pounds. Knockouts for cable conduits are provided in the bottom and rear sides.

Amplifiers

The amplifiers are of a new design which utilizes miniature tubes in all stages except the output stage of the program and monitor amplifiers. Negative feedback is employed to stabilize gain and to reduce noise and distortion.

The preamplifier utilizes a 12AY7 twin triode for its two stages of amplification. This tube is designed especially for low-level amplifiers. It affords exceptionally low hiss and hum, and minimizes microphonics. The 12AY7 is also used in

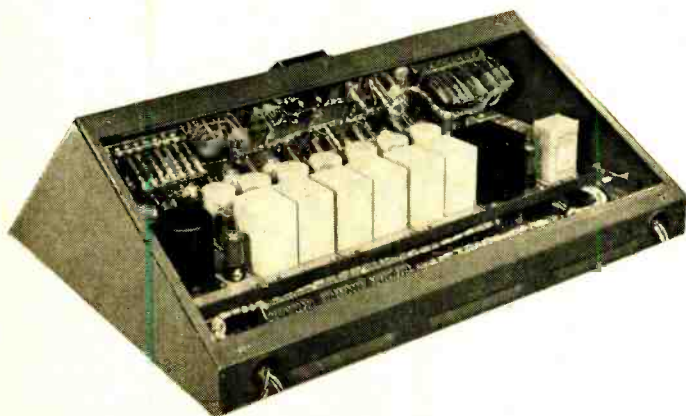

Fig. 2. Rear view of the console with the cover removed to show accessibility of equipment.

the first and second stages of the program and monitoring amplifiers. Two identical preamplifiers are mounted on a chassis.

The program amplifier consists of four stages, with a potentiometer gain control inserted between the first two. A 5879 pentode, which is also a low-noise tube is used in the third stage, and a 6V6 beam power tube is employed in the final stage. The first and second stages of the monitor amplifier are similar to those of the program amplifier. The third stage and phase inverter utilize a 12AX7 twin triode. The output stage consists of a pair of 6V6's in a push-pull circuit.

Long tube life was considered in the choice of all tubes and in the selection of operating conditions. Pin jacks provided for measuring the cathode voltages of the amplifier tubes facilitate checking the condition of tubes and circuits. The amplifier chassis float on rubber grommets which diminish the transmission of vibrations and further reduce microphonics.

Relay Circuits

As shown in the installation diagram, Fig. 4, a loudspeaker may be installed in each of the studios, the control room, and the announce booth. These speakers may be used for monitoring, cueing, and talk-back from the control room. In order to prevent acoustical feedback, it is essential that a speaker be turned off whenever a microphone is turned on in the same room. Also, when a studio is on the air, it should be impossible to talk-back or otherwise interrupt the program in progress.

Fast-acting speaker-muting relays are therefore provided for both studio and the control room speakers. Space and wiring are provided for the addition of a relay to control the announce-booth speaker if desired.

The relays are operated from a 24-volt d.c. supply which is part of the console power supply. Contacts on the microphone selector S_{11} , the mixer

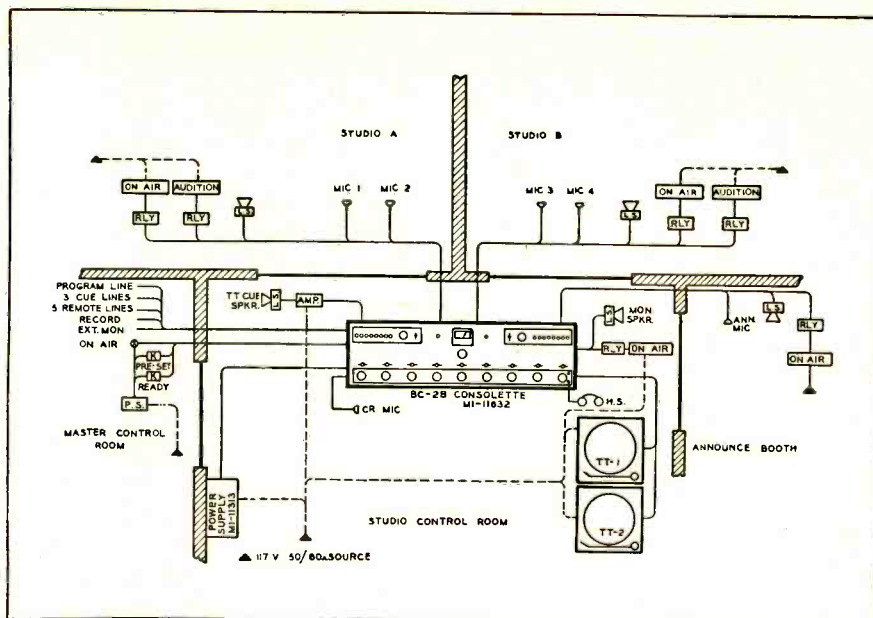

Fig. 4. Simplified diagram showing a typical two-studio station.

switches S_{21} , S_{31} , S_{32} , S_{33} , and the LINE OUT switch S_{11} , provide the necessary control and interlocking features.

If studio warning lights such as ON AIR and AUDITION are to be used, these lights may be controlled by a set of warning light relays. Power for actuating these relays is furnished by the console power supply and operation is controlled by the speaker relays and additional contacts on the console key and push-button switches.

The control circuits are normally connected for two-studio operation. If it is desired to use all microphones in a single studio, the circuit may easily be adapted for this type of service by changing a few jumpers on a terminal board.

Power Supply

The power supply, Fig. 5, furnishes plate and heater power to the amplifiers and 24-v.d.c. to the relays. It requires an

input power of 150 watts at 100-130 v., 50-60 cps. The B voltages are rectified by a 5R4 and filtered through separate RC filters for the preamplifiers, program amplifier, and monitor amplifier. Two potentiometers are provided to adjust the hum level to a minimum: one for the preamplifiers, the other for the program and monitoring amplifiers. Power for the relays is obtained from a separate transformer and rectified by a selenium rectifier. The power supply is housed in a dark amber gray cabinet which may be hung from a wall or, by means of suitable brackets, mounted on a standard amplifier rack. The power switch and fuses are accessible from the front. After opening the cabinet door, the chassis may be swung out to provide access for installation and service. The external dimensions are 10 $\frac{3}{8}$ in. high, 14 $\frac{3}{4}$ in. wide, and 8 $\frac{1}{8}$ in. deep, and the weight is 32 pounds.

Where extreme reliability of service is required, a standby power supply, of the same type as the regular power supply may be installed. A switch is used to transfer power from one supply to the other.

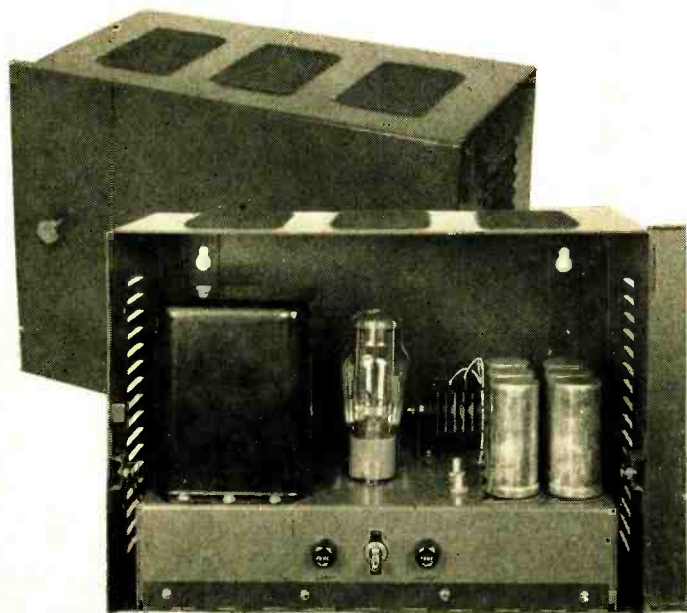

Fig. 5. Power supply used with the console.

Anyone Want to Page a Bee?

The tweeter to end all tweeters is included in a new English loudspeaker system which will be described in a technical paper at the Convention of the AES this Fall, and exhibited at the 1951 Audio Fair.

Claimed by the manufacturer to have a linear frequency response up to 30,000 cps, the tweeter consists of a 0.00025 in. thick aluminum ribbon suspended in a strong magnetic field, and horn-loaded to give both front and back radiation.

The system is known as the Corner Ribbon Loudspeaker. Although the high-frequency unit represents most radical departure from conventional design, the system contains many other features worthy of engineering note.

Music and Mass Production

JEROME GOODMAN*

A brief discussion of some of the factors influencing the planning and scheduling of a "music while you work" program.

BEFORE WORLD WAR II, about five hundred industrial workers listened to specially prepared music as they worked; today more than five million work with the aid of music¹. During the war more than six thousand American war plants used music², and the probability is great that a great many more will use it in view of the present national emergency. An example will suffice to show why the use of industrial music is so widespread. At the highly mechanized Lily-Tulip Cup Corporation 86.1 per cent of the employees agreed that music helped to reduce fatigue; 93.3 per cent said it broke up the monotony of the work; 95.2 per cent said it made the time go faster; 94.3 per cent said it made the work more enjoyable; 91.4 per cent said it gave them a lift; 82.8 per cent said it kept them from getting nervous and cross. Only 1 per cent complained of interference with work or nervousness caused by the music. Efficiency was up 10 per cent in the work of 63.4 per cent of the employees, while quality improved 35.7 per cent.³ These figures were collected after music had been in use for a period of six years.

It is the purpose of this article to show how the psychological responses of the individual are utilized by the supervisors of industrial sound and music systems

*79 Corbin Place, Brooklyn 35, N. Y.

¹R. L. Cardinell and Harold Burris-Meyer, "Music in industry today." *J. Acous. Soc. Am.* July 1947.

²E. J. Duck, "Music as a modern industrial tool." *Education*, March 1949.

³A. Flack, "Make your plant a safe, pleasant place to work." *Fact. Mgt. and Maint.*, Nov. 1949.

Typical industrial music installation in the mounting room of the Tube Division, Sonotone, Corporation, Elmsford, N. Y. The work performed in this department is well suited to the use of varied music periods.



to increase production and to cut costs. The conditions under which music serves as an aid to production are limited to specific manufacturing processes. These processes are varied and can be found in a great many industries. To see why this is so an examination of modern production techniques will be necessary.

Problems Due to Mass Production

The widespread mass production system sublimates the instincts of the artisan or craftsman who derives much satisfaction from creating an object and working on every detail of it from its inception to its completion. A worker in a large industry today does not occupy a position in which he can create something; he works, rather, on one small

detail of the object during his working day. His work may consist, for example, of turning one screw on a large object that passes by him, perhaps twice every minute. It is easily seen that such repetitious tasks, with the great fatigue and monotony that accompany them, can be emotionally unwholesome for the individual worker.

In order that this fatigue and monotony be kept to the lowest possible level, the workers chosen for tasks of the sort described above are screened by psychological testing procedures that determine their fitness for monotonous jobs. For example, taxi-cab drivers in some places are selected because they possess several psychological attributes that make them fit for driving in traffic. One of these "attributes" is an intelligence quotient (I.Q.) of about 90 per cent. Studies have shown that those with an intelligence quotient much above or below this figure have a tendency toward many accidents. The driver whose I.Q. is below 90 per cent does not have the ability to apply the concentration to driving in traffic that is necessary to avoid accidents; while the driver above 90 per cent does not have to apply his total mental capacity to the task of driving. This more intelligent driver is apt to daydream and in this way to be the cause of accidents.⁴ Normal I.Q.'s range from 90 to 110 per cent.

Fatigue and boredom manifest themselves in ways that are expensive to management. Workers come in late; they

[Continued on page 44]

⁴Richard W. Husband, "Applied Psychology." New York: Harpers, 1947.

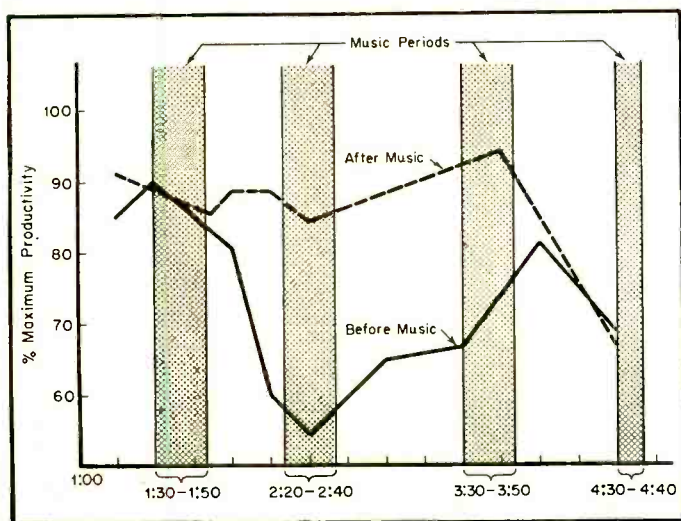

Fig. 1. Graphical representation of production efficiency before and after use of music in a typical plant. (After Burris-Meyer.)

A Studio Controlled Remote Amplifier

R. S. HOUSTON*

Describing a simple unit which eliminates the need for a control operator in two-microphone remotes by permitting individual control of the microphones from the main studio.

HERE COMES A TIME in almost every station's activities when an emergency remote comes up, and there is no manpower convenient to handle it. Or, in the case of numerous smaller stations, it is necessary to "ghost" remotes, as a manpower economy measure. On many remotes, two microphones are required. This makes mixing a difficult problem, without an operator present, since usually when one mike is in use, various unwanted sounds and disturbances are picked up on the unused one. If both mikes are in parallel, or fed through separate, fixed-gain faders, this problem becomes acute, since there is no way of controlling the blending of the two mikes. Only the output of the whole amplifier can be controlled by the remote fader at the studio. Numerous schemes have been devised to disable one mike, or even operate them alternately by impulses from the studio. However, with the system described here, it is possible to ride gain continuously on both mikes from the studio control room, thus controlling both the mixing and the output. In this way, the quality of the program can be improved considerably, without the expense or trouble of having a man present at the pickup point.

Circuit Analysis

The reader will recognize the input circuits of Fig. 1 as those used by a large manufacturer as a remote control device for public address systems. The circuit is employed for its intended purposes here, with variations. The cathode-coupled phase inverter-mixer was a contrivance of the author some ten years ago. Variations of it are seen frequently today. It will be discussed later in the text. The input and preamplifier circuit uses the two grids of a 6L7 to combine the audio signal with a variable bias voltage to control the gain of the tube itself. The signal is fed into grid 3, which is self-biased in the normal manner by connecting the grid return at the negative end of 1000-ohm resistor R_5 . However, through the bleeder circuit from the high voltage consisting of R_4 , R_5 , R_7 , and R_8 , the cathode of the 6L7 is raised to a potential of some 30 volts positive. The bias on the gain-controlling grid, G_1 , is varied by moving the

* Transmitter Engineer, WTUX, Wilmington, Del.

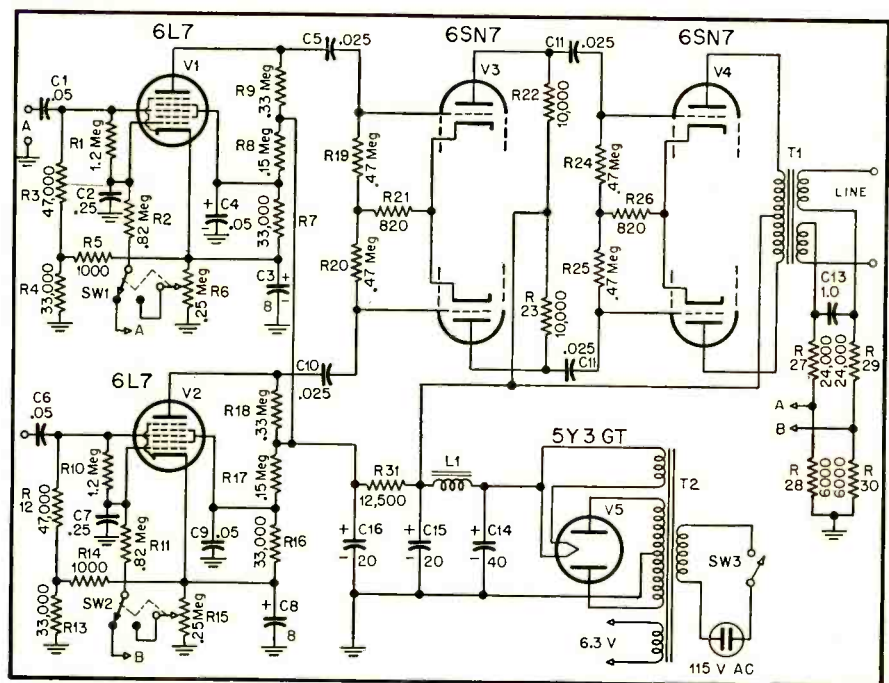

Fig. 1. Circuit schematic for remote gain controlled amplifier.

slider on potentiometer R_6 between the cathode and ground. Thus G_1 can be at cathode potential, allowing full gain, or at 30 volts negative with respect to the cathode, cutting off the tube. Resistor R_1 is the grid load and is bypassed to ground by C_2 . D.c. coupling of G_1 and G_3 through R_1 gives additional control of the output signal by applying bias to both grids. Under these conditions, the full output of the tube can be realized, thus allowing for extra gain for unusual situations.

The switches Sw_1 and Sw_2 are mounted on the back of R_6 and R_{15} respectively, and perform the operation of changing from local to remote control. When the controls are rotated away from the minimum settings, the switches connect the grid-biasing circuits to the internal bias supply, allowing normal manual operation. With extreme counterclockwise rotation, the switches connect the 6L7 grids circuits to the external control source, permitting operation from the studio. Voltage for these controls is supplied over each side of the metallic phone line, operating against a ground return. The line must be split to allow separation of the respective

control voltages, one side controlling channel A, the other side controlling channel B. This is easily accomplished by having a split winding on the output transformer at the amplifier, and on the terminating coil at the studio. Each side is connected through a voltage divider to ground, to give the correct voltage at the grids. The voltage drop is necessary because the control voltage is sent from the studio at 150 volts to overcome the possible effects of transient voltages on the line, such as might arise from crosstalk from dialing circuits, and from earth currents. Capacitor C_{13} provides an audio path around the bleeder circuits, completing the circuit of the line through the transformer.

The Mixer-Phase Inverter

The second stage, a 6SN7, is connected in what appears to be a dual-channel amplifier. The secret of this stage lies solely in the omission of the cathode by-pass capacitor. In so doing, any signal voltage is left on the cathode, and appears in both sections. Thus any signal in either section is coupled to the other section, mixing one with the other. However, the section opposite to that

into which the signal is fed operates like a cathode driven, inverted amplifier. Figure 2 shows the respective phase relationships on the various elements. Since there is no electron migration through the grid resistor of the section with no signal impressed, the effective resistance is zero, and this grid remains at ground for both d.c. and audio. When a negative signal is placed on the grid of section 1, a negative voltage appears on the cathode, and a positive voltage appears on the plate. However, with the grid of section 2 at ground, a negative potential on the cathode will produce a negative voltage on the plate. Thus it is easy to see that the two plates of the 6SN7 are out of phase, inversion having taken place. As has been shown previously, any signal on either grid will produce output in both sections, so this stage has effectively accomplished both phase inversion and mixing electronically.

As will be seen by further analysis, disregarding the bias, the total potential difference between the grid and cathode of the second section can be equal only to the rise and fall of the first-section cathode. Obviously, this will not be as great as the difference in the first section where it will be equal to the rise and fall of the cathode plus the impressed signal. Hence there will be some unbalance. In a low-gain stage such as this it will be negligible, and it can be disregarded largely in a class A stage. However, in the interests of fidelity, the cathode bypass was omitted in the output stage, and by the same action just described, the balance is restored.

Miscellaneous Circuit Details

Not much need be said about the power supply. It is completely standard, and uses receiver parts. That does not hold true, however, for the preamplifier stages. A number of the resistors are rather critical, and should be as close as possible to the value shown. While the values shown for C_2 and C_7 are those indicated by the original designer, some trouble has been found with a slight time delay when operating the controls rapidly. As a result, there may be as much as half a second delay when the controls are turned, and the circuit jumps into action with a resultant "thump." It is not therefore suited to instantaneous changes of gain. To correct this condition, smaller capacitors might be substituted for the values indicated for C_2 and C_7 . While very little decoupling is indicated, the first stages are fed from a decoupling resistor, R_{31} , in the power supply filter system. Inasmuch as the other two stages are out of phase with each other, and the voltage is fed in at a neutral point, decoupling these two stages should be unnecessary. A connection must be provided for an external ground which is very essential to operation of the remote control circuits. This ground should be some form of solid earth ground, such as a water pipe, or electrical conduit. With more modern wiring, it is often possible to pick up a good ground by securing a wire under the mounting

screw holding the plate on a light switch or convenience outlet. While it is not necessary that the ground be of zero resistance, it should be constant so that the gain will not vary during operation. Therefore it is necessary to have solid connections throughout.

Notes on Construction

An ordinary $5 \times 10 \times 4$ in. covered amplifier chassis was used. The bottom plate helps eliminate hum pickup from external sources. The original model was intended for use with high impedance mikes, so no input transformers have been shown. To provide for their possible future use, the power transformer was of the completely cased, shielded type, and was mounted under the chassis, at one end. This put it as far as possible from the mounting of any intended transformers, and also away from the input grids of the 6L7's. Observing this precaution, no trouble was experienced from magnetic hum. There is also the added feature of power-supply hum reduction by virtue of the connection of the preamplifiers through the mixer-phase inverter stage. Any hum in the plates of the preamplifiers will be fed into opposite sides of the mixer in phase and thus cancel in the output. If

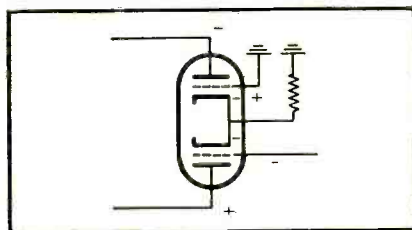

Fig. 2. Diagram of phasing of tube elements of mixer-phase inverter stage.

much local operation is contemplated, it may be desirable to install a VU meter and a headset jack for monitoring. Care must be taken not to let the d.c. flow through either the meter or the jack, which should be insulated from the chassis to prevent shorting out the control voltage on one side of the line.

Operating Suggestions

Power for control of the amplifier can be obtained from any well filtered d.c. source of around 150 volts. With the bleeder resistors shown (R_{27} , R_{28} , R_{29} , and R_{30}), the drain will be about 5 ma., so even a "B" battery would last for almost its shelf life. This current value is not critical, and can be made even lower if necessary. If a different voltage is to be used, the divider resistors R_{27} , R_{28} , R_{29} , and R_{30} should be adjusted to give 30 volts at the tap when the maximum voltage is applied to the line. The controlling pots can be mounted as permanent additions to the control board, or assembled into a portable unit which may also contain the terminating coil, and even the power supply if desired. Line polarity should be observed if it is necessary to know definitely which fader controls a given mike. This should be determined in the

original setup, and the operators should be familiarized with the program routine so that the proper mike will be open when necessary. Power supply polarity should be arranged so that the line is negative, and the ground return is positive. A log- or audio-taper control will give greater linearity of control action. Figure 3 shows a suggested studio control arrangement.

Two of these units have been in use by the author for about five years at various locations, and they have given excellent service in every case. Their most frequent use has been where two remotes are consecutive, both requiring more than one mike, but the operator was unable to travel between them in time. This system, in effect, gives the studio man a "long arm" by which he can twist the faders at the remote location until the regular remote operator can appear on the scene. In smaller stations, better production can ordinarily be had without the need for a man at the site. With the proper setup, and a short familiarization, anyone should be able to obtain perfect results, and with care in operation, every show can go off without any failures or errors. Actually, better mixing should be achieved, because there is not the distraction of local noise and no direct hearing of the program material to confuse the operator.

PARTS LIST

C_1, C_6	.05 μ f, 600 v.
C_2, C_7	0.25 μ f, 600 v. (see text)
C_3, C_5	8 μ f, 150 v. electrolytic
C_4, C_9	.05 μ f, 600 v.
$C_8, C_{10}, C_{11}, C_{12}$.025 μ f, 600 v.
C_{13}	1.0 μ f, 600 v.

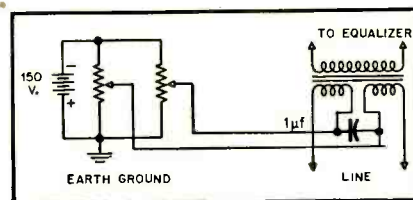

Fig. 3. Suggested connections of studio gain control unit.

C_{14}	40 μ f, 450 v. electrolytic
C_{15}, C_{16}	20-20 μ f, 450 v. electrolytic
L_1	15 H, 75 ma.
R_1, R_{10}	1.2 meg, 1/2 watt
R_2, R_{11}	0.82 meg, 1/2 watt
R_3, R_{12}	47,000 ohms, 1/2 watt
R_4, R_{13}	33,000 ohms, 1 watt
R_5, R_{14}	1000 ohms, 1/2 watt
R_6, R_{15}	0.25 meg pot, audio taper with SPDT switch
R_7, R_{16}	33,000 ohms, 1 watt
R_8, R_{17}	0.15 meg, 1 watt
R_9, R_{18}	0.33 meg, 1 watt
$R_{19}, R_{20}, R_{21}, R_{22}$	0.47 meg, 1/2 watt
R_{23}, R_{24}	850 ohms, 1 watt
R_{25}, R_{26}	10,000 ohms, 1 watt
R_{27}, R_{29}	24,000 ohms, 1 watt
R_{28}, R_{30}	6200 ohms, 1/2 watt
R_{31}	12,500 ohms, 2 watt
T_1	Plate-to-line, 15,000/500-600, split secondary
T_2	300-0-300 v. at 75 ma; 6.3 v. at 2 amps; 5 v. at 2 amps.



The Measurement of Audio Volume

H. A. CHINN*

A comprehensive discussion of the problems involved and the instruments employed to indicate program level and sine-wave tones in broadcast and recording circuits.

IN ALTERNATING CURRENT THEORY there are three related values of a sine wave by which its magnitude may be expressed. These are the average value, the r.m.s. (or effective) value, and the peak (or crest) value. Certain fundamental electrical measuring devices provide means for determining these values. Complex, non-sinusoidal periodic waves also have the same three readily measured values. As a rule, the problem under consideration determines whether the average, the r.m.s., or the peak value of the wave is of primary importance.

Concept of Audio Volume

In the field of communication engineering, waves which are both very complex and non-periodic are encountered. When an attempt is made to measure such waves in terms of average, r.m.s., or peak values, it is found that the results can no longer be expressed in simple numerical terms since these quantities are not constant but variable with time. Moreover, the values appear to be affected by the characteristics of the measuring instrument and the technique of measurement. The communications engineer, however, is vitally concerned with the magnitude of these non-sinusoidal, non-periodic waves since he must design and operate systems in which they are amplified by vacuum tubes, transmitted over wire circuits, modulated on carriers, and otherwise handled as required by the various communication services. He needs a practical method of measuring and expressing these magnitudes in simple numerical fashion.

This need may be better appreciated by considering a typical example—the communication systems employed for broadcasting. These are often very complicated networks spread over large geographical areas. A typical network may include 20,000 miles of wire line and hundreds of amplifiers situated both along the line and in the 100 to 200 connected broadcasting stations. Every 15 minutes during the day the component parts of such a system may be shifted and connected together in different

* Columbia Broadcasting System, 485 Madison Ave., New York 22, N. Y.

Responsibility for the contents of this paper rests upon the author, and statements contained herein are not binding upon the Audio Engineering Society.

combinations in order to provide for new points of origin of the programs, for the addition of new broadcasting stations, and for the removal of others from the network. In whatever combination the parts of the system may be assembled, it is necessary that the amplitude of the transmitted program waves—at all times and at all parts of the system—remain within the limits which the system can handle without impairment from overloading or from noise. To accomplish this, some convenient method of measuring the amplitude of program waves is needed.

These and similar considerations led to the conception of a fourth electrical quantity, known as "volume", whereby the magnitude of waves encountered in electrical communications, such as speech or program waves, may be readily expressed. This quantity is a purely empirical value, created to meet a practical need. *It is not definable by means of a precise mathematical formula in terms of any of the familiar electrical units of power, voltages or current.* Volume is simply the indication of an instrument known as a volume indicator, which has specified dynamic and other characteristics and which is calibrated and read in a prescribed manner. Because of the rapidly changing character of the program wave, the dynamic characteristics of the instrument are fully as important as the value of sine-wave power used for instrument calibration. The readings of volume have been customarily expressed in terms of decibels with respect to some volume level chosen as the "reference" level.

Volume Indicator Applications

Volume indicators are used extensively to indicate the correct transmission level for speech and program waves in audio systems employing amplifiers, program-actuated automatic devices, program wire circuits, modulators, sound recorders and reproducers, or wherever the transmission of speech and program waves are involved. In this capacity volume indicators serve as a guide to the avoidance of overloading. Equally important, they serve as a means of indicating approximately the comparative loudness with which various elements of a complete program will be heard when finally converted to sound.

Volume indicators are also used for checking transmission gains and losses in program networks and audio systems

by simultaneous measurements at a number of points on particular peaks or impulses of the program wave which is being transmitted. They are also used for sine-wave transmission measurements on audio systems and circuits.

In spite of its importance and its extensive and universal use, the volume indicator is probably the least understood of all audio measuring instruments. For this reason the standard volume indicator, its reference level, its method of calibration and the terminology used for volume measurements is covered in detail in the following paragraphs.

Peak vs. r.m.s. Volume Indicators

In the study that led to a standard volume indicator¹ the decision had to be made as to whether the standard volume indicator should be of the r.m.s. or of the peak-reading type. These two types of instrument represent two schools of thought. The peak-reading instrument is favored for general use by many European engineers and is specified by the F.C.C. for use as modulation monitors in this country. The r.m.s. type has however, been employed in this country on broadcast program networks and for general telephone use. In view of the importance of the decision and the difference of opinion that has existed, the basis on which the choice was made is discussed below in some detail.

In accord with common practice, the terms "r.m.s." and "peak-reading" are used rather loosely herein. The essential features of an r.m.s. instrument are a rectifier or detector and a d.c. milliammeter. The movement of the latter is not especially fast, generally requiring tenths of a second to reach substantially full-scale deflection. Obviously, if a wave of sufficiently low frequency is applied, say one whose frequency is one or two cps, the instrument can follow it and the true peaks of the wave will be indicated. But when much higher frequency waves are applied, such as the complex speech or program waves, the instrument is too slow to indicate the instantaneous peaks, rather, it averages or integrates whole syllables or words. As shown by tests and practical experience, it is of secondary importance whether the detector actually has an r.m.s. (or square law) characteristic, or has a linear or some intermediate characteristic.

[Continued on page 28]

¹ Chinn, Gannett and Morris: *Proc. I.R.E.*, Vol. 28, No. 1, p. 1, Jan. 1940.

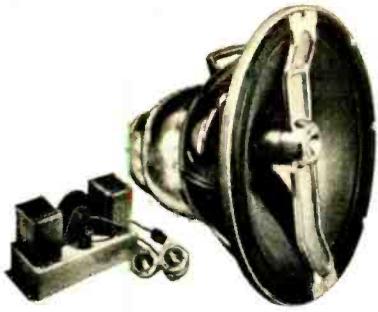

**G-610 Triaxial 3-way
World's Finest Loudspeaker (15")**



**H-510 Coaxial with Acoustic Lens
World's Finest Coaxial (15")**



K-310 Coaxial (15")



K-210 Coaxial (12")



**Single-Unit Direct Radiator Types
(5-15")**

how to choose a high fidelity loudspeaker

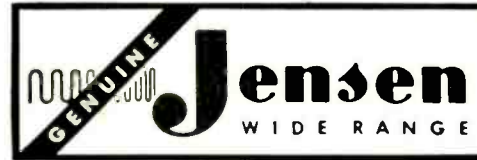

This trademark* denotes the most comprehensive series of high fidelity loudspeakers available today. Every unit has been designed with the same objective . . . the achievement of the finest possible reproduction of music attainable for the size and type. Every model in the series sets a new high standard of performance . . . a new value . . . makes listening a thrilling new experience.

what GENUINE JENSEN WIDE-RANGE means

Mere extension of response to high frequencies is not enough to insure truly satisfying reproduction . . . good listening which improves with closer acquaintance. Much more is required to make music come to life, free from annoying factors which might mar the illusion of reality. So, by application of the most modern principles of acoustics, confirmed by precise measurements and checked by exhaustive quality judgments and comparative listening tests, Genuine JENSEN Wide-Range loudspeakers give you all 7 Performance Points for enhanced listening pleasure: (1) Wide Frequency Range, (2) Balanced Frequency Response, (3) Smooth Reproduction, (4) Wide-Angle Distribution, (5) Low Distortion, (6) Good Efficiency, and (7) Adequate Power-Handling Capacity.

Thus Genuine JENSEN Wide Range means much more than wide frequency range — it means superior performance all the way — in every attribute that makes for enhanced listening pleasure.

Whatever the limitations on cost or size, the choice of a loudspeaker from the Genuine JENSEN Wide-Range series automatically insures a maximum of performance to today's new high standards . . . a judicious choice to meet exact needs. Only in the Genuine JENSEN Wide-Range series can you make such an exact choice.

*Write today for free booklet, "Let Music Come to Life."
It includes a complete listing of
Genuine JENSEN Wide-Range loudspeakers.*

Jensen
MANUFACTURING COMPANY
Division of The Muter Company

6601 SOUTH LARAMIE AVE., CHICAGO 38, ILLINOIS

BURTON BROWNE ADVERTISING



Fig. 1. An installation of twelve standard volume indicators, on an equal number of outgoing program circuits in the CBS shortwave master control room.

A peak-reading instrument capable of truly indicating the sharpest peaks which occur in a high-quality program wave would have to respond to impulses lasting only a very small fraction of a millisecond. Cathode-ray oscilloscopes or gas-tube trigger circuits are capable of doing this and consequently, might be used as a peak-reading volume indicator. However, the so-called peak-reading volume indicators used in practice, designed to give a visual indication on an instrument, are far from having the above speed although they are much faster than the r.m.s. instruments. They generally respond to impulses whose duration is measurable in hundredths or thousandths of a second. As a result they truly indicate the peaks of waves whose frequencies do not exceed say, 50 to 100 cps. They are similar to the r.m.s. instruments in that they are not fast enough to indicate the instantaneous peaks of speech or program waves but tend to average or integrate a number of peaks of the wave.

A feature of the usual peak reading instrument which is superficially impressive, but from which the analytical standpoint is of secondary importance, is that it is usually given a dynamic characteristic of rapid response coupled with very slow decay. This is usually accomplished by a circuit wherein a capacitor is charged through a full-wave vacuum-tube rectifier, the rates of charge and discharge being determined by resistances. A d.c. amplifier and instrument indicate the charge on the capacitor. The advantage of making the discharge rate of the capacitor very slow is that the indicating instrument itself need not then be particularly fast and, moreover, the ease of reading it is greatly increased.

From the above analysis it is seen that the r.m.s. and the peak-reading instruments are essentially similar and differ principally in degree. Both indicate peaks whose durations exceed some value peculiar to the instrument and both average or integrate over a number of peaks the shorter, more rapid peaks encountered in speech or program waves. Either may have an r.m.s. or square-

law detector, or one of some intermediate characteristic. The important difference between the two types lies in the speed of response as measured by the length of impulses to which they will fully respond, or what is the same thing, in the

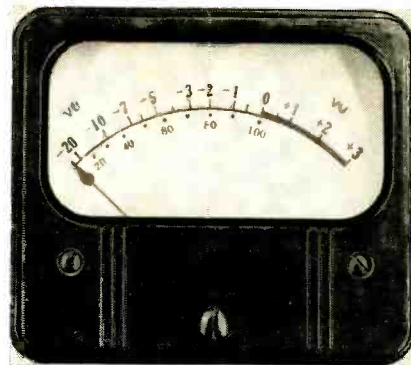

Courtesy General Electric Co.

Fig. 2. The "A" type standard volume indicator scale emphasizes the VU markings and has an inconspicuous voltage scale. This type of scale is commonly used for transmission measuring sets.

time over which the complex wave is integrated.

Peak Checking

An important use of volume indicators is that of checking the transmission losses or gains along an audio system or a program network by measurements made on the program material being transmitted. The circuits which make up broadcasting networks, for instance, are in continuous use for many hours each day and during that period are switched together in as many combinations as called for by the operating schedules. It is seldom possible to free a circuit for sine-wave transmission measurements. Therefore to check the transmission conditions during service hours, it is the custom to take simultaneous readings at two or more points in the program networks on particular impulses of whatever program wave is being transmitted and to coordinate these readings by means of telephone communication. On such readings, the r.m.s. type of instru-

ment is far superior to the peak-reading type. This is because phase distortion and slight nonlinearity in the program circuits (the results of which are too small to be detectable by ear) change the wave shape of the program peaks sufficiently to cause serious errors in the indications of the peak-reading instrument but have no noticeable effect on the r.m.s. instruments.

The effect of a long program circuit on the indication of the peak instrument is partly due to the cumulative effects of the slight nonlinearity in the many vacuum-tube amplifiers and loading coils in the circuit, and partly to phase changes which alter the wave front and amplitude of the peaks. It might be thought that phase changes which destroy some peaks would tend to create others. However, a Fourier analysis of a sharp peak will show that an exact phase relationship must exist between all of the frequency components. The probability that phase shift in a line will chance to cause all of the many frequency components of a complex wave to align themselves in the relationship necessary to create a peak where none existed before, is very slight, indeed infinitesimal compared to the probability of the occurrence of a peak in the original wave.

Data on peak checking showed such a marked advantage for the r.m.s. type as compared with the peak instrument, that it was decided to employ the r.m.s. type of instrument. Other considerations included the possibility of employing copper-oxide rectifiers and thereby eliminating vacuum tubes with their attendant need of power supply; an advantage not shared by peak-reading instruments. Thus, the r.m.s. instrument has advantages of comparative low cost, ruggedness, and freedom from the need of power supply, and can, moreover, be readily made in portable forms when desired.

Dynamic and Electrical Characteristics

It will be appreciated from the above discussion that for a volume indicator to be truly standard, both its dynamic and electrical characteristics must be controlled and specified so that different instruments will indicate alike on the

[Continued on page 36]

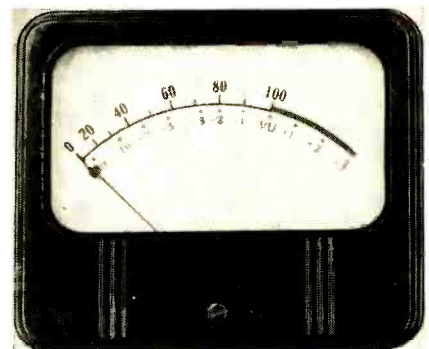

Courtesy General Electric Co.

Fig. 3. The "B" type standard volume indicator scale emphasizes the percentage scale. This scale is used extensively for program transmission applications.

New 1952 HEATHKITS

Heathkit
TELEVISION
GEN. KIT \$39.50

Heathkit
ELECTRONIC
SWITCH KIT \$19.50

Heathkit
AUDIO GEN.
KIT \$34.50

Heathkit
CONDENSER
CHECKER KIT \$19.50

Heathkit
R. F. SIGNAL
GEN. KIT \$19.50

Heathkit
A.C. VOLTMETER
KIT \$29.50

Heathkit
SQUARE WAVE
GEN. KIT \$29.50

Heathkit
INTERMODULATION
ANALYZER \$39.50

Heathkit
AUDIO FREQ.
METER KIT \$34.50

Heathkit 5" OSCILLOSCOPE KIT

- New "spot shape" control for spot adjustment — to give really sharp focusing.
- A total of ten tubes including CR tube and five miniatures.
- Cascaded vertical amplifiers followed by phase splitter and balanced push-pull deflection amplifiers.
- Greatly reduced retrace time.
- Step attenuated — frequency compensated — cathode follower vertical input.
- Low impedance vertical gain control for minimum distortion.
- New mounting of phase splitter and deflection amplifier tubes near CR tube base.
- Greatly simplified wiring layout.
- Increased frequency response — useful to 5 MC.
- Tremendous sensitivity .03 RMS per inch Vertical .6V RMS per inch Hor.
- Dual control in vernier sweep frequency circuit — smoother acting.
- Positive or negative peak internal synchronization.
- Multivibrator type Wide Range Sweep Generator.

A brand new 1952 Heathkit Oscilloscope Kit with a multitude of outstanding features and really excellent performance. A scope you'll truly like and certainly want to own.

The kit is complete with all parts including all tubes, power transformer, punched and formed chassis, etc. Detailed instruction manual makes assembly simple and clear — contains step-by-step instructions, pictorials, diagrams, schematic, circuit description and uses of scope. A truly outstanding value.

MODEL O-7
SHIPPING WT. 24 LBS.

\$43.50

Heathkit VACUUM TUBE VOLTMETER KIT

- New styling — formd case for beauty.
- New truly compact size — Cabinet 4 1/8" deep x 4-1/16" wide x 7 3/8" high.
- Quality Simpson 200 microamp meter.
- New ohms battery holding clamp and spring clip — assurance of good electrical contact.
- Highest quality precision resistors in multiplier circuit.
- Calibrates on both AC and DC for maximum accuracy.
- Terrific coverage — Reads from 1/2V to 1000V AC, 1/2V to 1000V DC, and .1 to over 1 billion ohms resistance.
- Large, clearly marked meter scales indicate ohms, AC Volts, DC Volts, and DB — has zero set mark for FM alignment.
- New styling presents attractive and professional appearance.

The 1952 Model Heathkit Vacuum Tube Voltmeter! Newly designed cabinet combines style and beauty with compactness. Greatly reduced size to occupy a minimum of space on your work-bench. Covers a tremendous range of measurements and is easy to use. Uses only quality components including 1% precision resistors in multiplier circuit for greatest accuracy. Simpson 200 microamp meter with easy to read scales for fast and sure readings.

All parts come right with kit, and complete instruction manual makes assembly a cinch.

MODEL V-5
SHIPPING WT. 5 LBS.

\$24.50

YOU SAVE BY ORDERING DIRECT FROM MANUFACTURER

EXPORT AGENT
HOCKE INTERNATIONAL CORP.
125 E. 40th ST.
NEW YORK CITY (16)
CABLE: ARLAN-N.Y.

The HEATH COMPANY

... BENTON HARBOR 25, MICHIGAN

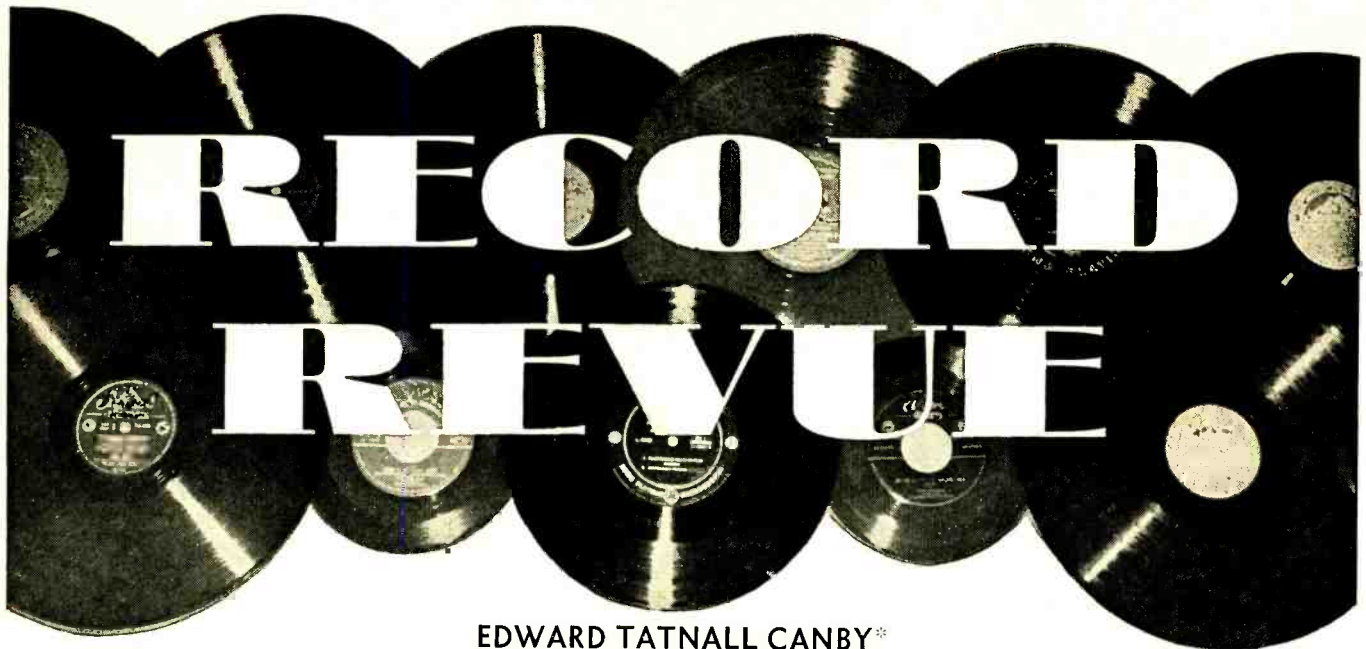

EDWARD TATNALL CANBY*

THE LP RECORD sailed past its third anniversary this last spring and now moves into its fourth year of active existence. They said it would take ten years, but in three the Microgroove Revolution is over, except for minor clean-ups. The Battle of the Speeds is a memory, with both new speeds settled in their rightful areas (much as this department suggested when 45 appeared, you will note); all is sweetness and light, RCA blissfully advertising 45's and selling LP's, Columbia happily advertising LP's and very quietly and on tiptoe, making lots and lots of 45's. Tape has completed its own occupation of the record industry, too. Small-company LP continues to expand, but that development has reached its full tide. All in all, after one of the fastest periods of change in record history, we've reached a relatively flat plateau at last.

Definitely a good time for a look around. And having taken it, I'm in the mood for some potshots at several aspects of the up-to-date recording business in which I've been displaying enthusiastic interest and approval up to this point. Sometimes things go a bit too far in a good direction.

Repertory

For the longest time I've been an enthusiast for unusual, out-of-the-way music and an objector to the standard repertory of concert works that get played over and over again. (Not so much an objection to them *per se* as an objection to the repetition.) There isn't the slightest doubt as far as I'm concerned that about nine tenths of the listenable good music—maybe 99/100—has been until very recently in the total-neglect category, dust-gathering in the corners of a thousand libraries. People like what they hear often; they hear what they like; which establishes a circular system that feeds busily upon itself, ingrowing, since the more a piece is heard the more people want to hear it. The singing ad people know that, and for that matter so do the concert managers. (Virgil Thomson of the *New York Herald-Tribune* wrote a killing series of articles last spring on the forced limitations of repertory put upon the big touring artists. Unbelievable.) It pays to keep overhead low—musical overhead

too. But it's bad for music and in the long run bad for people.

Long before LP, I was plumping away for the out-of-the-way, for that huge amount of music that we could enjoy if we'd only just play it. Records after all, are the very antithesis of concerts in this respect. It doesn't really matter in the slightest to *you*, a record owner, whether a piece is played a lot or a little in public. You own it, you can play it as much or as little as *you* want. Statistics as to how many other people have heard it, how often it has been done, can't possibly affect you and your own ear; only your own phonograph can do that. Music that may be utterly familiar to you, down through the years, can be utterly unknown to most people. Nothing but a "keep up with the Joneses" attitude can make you feel that you must know the music the Joneses know, or else!

I had a series of radio programs around 1944 or so that harped on this theme—and I had to hustle to find recordings to play on it. There was very little to be had in the way of "unknown music." When, after the war, several small companies appeared, making 78-r.p.m. records of unusual music, out of the beaten path, I rejoiced. Vox, Musicraft, Concert Hall Society, Disc, Alco, were the pioneers here, and the field was almost theirs. Only the foreign imports, at high prices, the execrable 78 jobs put out by a few struggling minor outfits for special purposes, and a trickle from the Biggies, like Victor's pre-war "Connoisseur's Corner," helped out.

When LP came and a year later the tremendous expansion of small-company LP boomed in, I was delighted and said so. Suddenly, unusual music was economically possible—and it could be turned out high fidelity too. Wonderful. Hundreds of odd items appeared where there was one before. A prodigious wealth of new music, overwhelming me with a fulfillment of my own argument that would have been utterly inconceivable a few short years earlier. Talk about out-of-the-way repertory—it was with us in a deluge!

Even so, I'm still basically enthusiastic, though new recordings which would have had me gasping with excitement back awhile, tend to stir me to just another weary sigh now. I've long since been operating at about 198 per cent capacity. I

still prefer to review, to discuss and to recommend the non-repertory works—an endless field of operation, after all, since the established conventional concert repertory is really very small.

But I must, at this point, join up at last with the opposite camp to some extent. In the recent flood I regretfully admit that I detect something more than enthusiasm for the unusual. Granted that unusual music is legitimate for a small outfit, since it's safe, won't be instantly duplicated and smothered by some larger company out for the kill. Granted that out-of-the-way music is all that's left to feed LP, even with dozens of repeats on the old warhorses. The record business is too big for the standard repertory now. Not enough music to go around. These things I don't mind.

But what is bad is the increasing tendency to sloppy choice—anything as long as it's hitherto unrecorded. Here is my warning and objection. Potshot number One. True, some companies are still quite above reproach. But others are not, decidedly. There's lots of good music left, but unimportant stuff has been issued by the ton—just because it's new on disc. Along with poor choice of music there is a most regrettable tendency to poor or mediocre performance. Tape is too easy. Anybody can record anything. Yes—I agree that small companies doing ambitious works cannot afford the long rehearsal that's possible with big-company operations. Even so, many smaller outfits have managed to issue well played, carefully processed records; the half-baked performances (and sloppy recording too) found on some other discs is more of a painful contrast. And it's not always the small companies that are guilty.

And so I reverse my engines for awhile and suggest that we'd better look to our repertories. Fewer records, please, and done with more care. No question about it, tape and LP have allowed quality standards to drop dangerously low. I'm hopefully sure that the company which puts out a few items, carefully chosen and lovingly prepared, will prosper more in the end than the rush-job outfit that plops stacks of LP's on the market so fast one can scarcely keep up with the announcements.

I was, and still am, an enthusiast for the things one can do with tape. It's a terrific

[Continued on page 32]

* 279 W. 4th St., New York 14, N. Y.

Phono Fact*

43

that's what the man says...

"... a vote of thanks to you, Mr. Weil, for your "PHONO FACTS". I have a method for Pointer 43 which is sure and simplicity itself—here it is—I own only LP records and both styli in my L-6 POLYPHASE are for microgroove but only one is used for playing. The other stylus I switch into play for a few seconds, about once a week, to compare the two. Not only does this keep a constant check on the condition of the playing stylus, but, when it finally needs replacement, the spare is always in position for instant use. The worn stylus I replace when convenient. My POLYPHASE is almost a year old, but the tone continues superb. I think that my method of checking helps keep it so. . . ."

(from a letter)

Audax **POLYPHASE** reproducers

"The Standard by which Others are Judged and Valued"

have won the acclaim of thousands of users everywhere—Never before such EAR-QUALITY, such FAITHFUL REPRODUCTION but . . . after all the reams are written about kilocycles and other laboratory data—when the chips are down—you and only you can decide what sounds best and most pleasing to your ears. Therefore . . . SEE and HEAR POLYPHASE—and you be the judge.

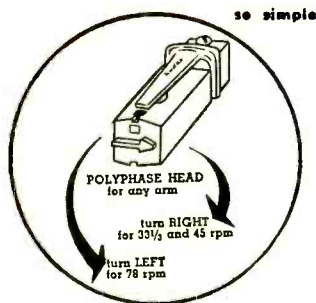

One single magnetic unit plays all records—**Replaceable** Sapphire or Diamond styli.

Special models for radio stations, including Vertical-Lateral units.

*When to change the stylus?
Weil in Audio Engr. June 1951



Available with the new Compass-pivoted Audax Arms and for Record Changers.

Write for editorial reprints on POLYPHASE principles also PHONO FACTS

AUDAK COMPANY

500 Fifth Avenue New York 18

"Creators of Fine Electro-Acoustical Apparatus for Over 25 Years"



NO. BO-11

The new CHICAGO No. BO-11 output transformer is now being used effectively in 40 to 60 watt high-fidelity amplifiers with outstanding success. Designed particularly for use with 807's, 3C33's (dual triode), WE300's, 6AR6's and similar tubes. Frequency response is essentially flat—within .5 db—from 20 to 20,000 cycles.

NEW CHICAGO

**40-60 WATT
FULL FREQUENCY
Output Transformer**

.5 db 20-20,000 CPS
for use with 807's,
3C33's, WE300's, 6AR6's
and similar type tubes

SPECIFICATIONS

Primary*—3000/2500 ohms CT
Secondary*—600/16/8 ohms CT and
150/4 ohms
*Split and balanced windings

Operating level—40 to 60 watts. Mounted in one-piece drawn steel case, 4 1/4" x 4 1/2" x 5 1/4" high; with mounting studs and convenient pin-type terminals. Weighs 9 1/2" pounds.

There's a CHICAGO Output Transformer for Every Full Frequency Use

Cat. No.	Application	Impedance	Max. Power
BO-1	Single Plate to line	Pri.—15,000 ohms at 0 to 10 ma d-c *Sec.—600/150 ohms CT	+20 dbm
BO-4	P.P. Plates to line	Pri.—7,500 ohms CT *Sec.—600/150 ohms CT	+43 dbm
BO-5	P.P. Plates to line	Pri.—10,000 ohms CT *Sec.—600/150 ohms CT; 16/8/4 ohms	+37 dbm
BO-6	P.P. Plates to voice coil	Pri.—7,500 ohms CT *Sec.—8/20 ohms	+43 dbm
BO-9	P.P. Plates to line or voice coil	Pri.—5,000/3,000 ohms CT *Sec.—600/16/8 ohms CT; 150/4 ohms	+42 dbm

‡Tertiary winding provides 15% inverse feedback. *Split and balanced windings

**HIGH Q
CHOKES**

for Dynamic
Noise Suppression Circuits

Two precision-built chokes with inductance values of .8 and 2.4 henrys respectively—accurate to within ± 5% with up to 15 ma d-c. Units have a minimum Q of 20. Remarkably compact, 1 1/8" x 2 3/8" x 1 1/8".

No.	Inductance
NSI-1	.8 h
NSI-2	2.4 h



**Famous "Sealed in Steel"
New Equipment Line**

The units described above are typical of CT's New Equipment Line featuring transformer engineering that's ahead of the trends in circuit design. Get the full facts on the complete line now. Check the features, and you'll see why CT is called the "Engineer's Transformer." Check the prices; see how little more these advanced units cost over ordinary transformers.

Write for Complete "New Equipment" Catalog Today



CHICAGO TRANSFORMER

DIVISION OF ESSEX WIRE CORPORATION

3501 ADDISON STREET • CHICAGO 18, ILLINOIS



medium. Editing, erasing, repeating-until-the-perfect-take are features of immense value.

Yet tape editing, I'm beginning to feel these days, is getting entirely too big for its boots. I'm having a definite conservative fit at the moment. The good old days. One can do miracles with tape in the way of achieving a good or excellent finished result via the patching of many takes—but I feel strongly that this method should never get out of hand—it should be in all cases regarded as a kind of emergency super-repair trick. Like Penicillin. It will cure many tragic mistakes that in the old days would have meant a complete new performance, beginning to end-of-side. It gives us the cream of numerous tries. But just as you can't live with permanent Penicillin to finish off all the bugs in you for life, so you can't take the patchwork symphony or concerto as a final work of art.

That's what is happening now. Tape editing has become so well entrenched that recording people no longer expect to record a piece of music as written, in one piece. Moving picture technique, cut and fill, slice and patch, is taken for granted. Miracles come forth, but the danger, artistically, is very great. And for no simpler reason than that music was never written to be put together thusly, and isn't written that way now.

A musical piece is a unity in the playing and should be in the recording—barring emergencies. Tape technique is there for the meeting of emergencies. Not for the creation of synthetic, patched-together artificially one-piece performances. Potshot number Two.

Potshot Three is just an opener. I expect to have more to say on the subject, indirectly, later on.

The "classical" record business began in America. When it went symphonic, the focus moved pretty much away. In the late 20's and in the 30's most of the great recordings were made in Europe, re-pressed in this country or imported in finished shellac. Only Victor kept the home fires burning, notably with the Philadelphia and New York Philharmonic orchestras. Record collectors knew the London, Berlin, Vienna Philharmonics better than their own American orchestras.

The approach of War turned the tide back—RCA had tried out the Minneapolis; Columbia suddenly started to learn how to record on its own in the U.S.A., with some pretty sad results for awhile. Remember how strange it seemed to see American city names, American artists, on the familiar red and blue classical labels? But it was good, and by 1948 or so American classical music was doing fine, both technically and musically.

Then came LP and the small company expansion. And the portable tape machine. Perhaps it is possible to look upon the tremendous influx of European-recorded music since that time as an unmixed blessing. I don't do so.

Certainly we have had not only a superb choice of music and a lot of top performances, not to mention the healthy (for us) introduction of European culture, European styles of performance, European names, to broaden our own perspective. It is good to listen every day to music played in France, Belgium, England, Austria, Germany, Italy, even Russia and Czechoslovakia, and to note the differences in ways of doing things; with high-fidelity recording, we are immeasurably lucky to be able almost to sit right in, a few feet away from a performance taking place in Prague, or Milan, or Vienna, and feel ourselves, after numer-

ous playings, so at home as to be almost a Czech or an Italian or a Viennese for the moment. Like a rewarding trip abroad. Good for our own musical taste.

But good for our own music—I mean, home-played? No. The reason we have European-made recordings is, alas, entirely removed from the cultural sphere! Our musicians cost too much. European musicians are absurdly cheap, easily available.

I have no judgments to make now. It's a complex situation. Clearly, we cannot lower our standards of living to compete directly in music with the European musician. He is poorly paid, but then, prices are not as high, perhaps, for him in his own country. The rate of exchange, making dollars worth so much more than in the past, puts a horribly artificial barrier between normal interchange of musical labor between countries. We can hardly expect the Musician's Union here to cut recording rates so that direct competition with European recordings can exist—it's just plain impossible, unless our government wants to subsidize music as do many foreign governments. A minimum wage must be held to, somehow, and it will never be low enough to meet foreign competition.

Keep out foreign music, then? A possible answer, like foreign beef. But with that I could never go along, however much some musicians would like the idea. An artificial barrier like that could do nothing but dire harm to music—for our music is unassailably tied to Europe's at this point by a thousand close artistic unities.

The key to the situation undoubtedly lies in the dog-and-tail effect of popular and big-time music, films, shows, radio, and TV, versus the microscopic tail of classical music, which does *not* wag the dog. Musician's rates, Union-determined, are geared to big-time stuff. They are high because there's big money in big-time. That money, you may be sure, would never reach the Union musician unless he had fought tooth and nail for it these many years. He doesn't get too much of it now. Not compared to what others get out of it. But classical music?

Classical music rates are no different than any other, speaking generally. And classical music, symphonic and the like, is therefore pretty much limited to what amounts to big-time operation—though there's nary a symphony or opera that doesn't lose money hand over fist every year. Big-time classical can get big-time sponsorship—sometimes—on the air; big record companies can afford to record it and pay for it through sales of records. But no small company can touch the field, in the U.S. Big-time rates apply anywhere and everywhere; there has been no attempt to set lower rates for small-scale, small-production efforts in music. Thus only a few major outfits do any classical recording here. Only a few musicians out of thousands are regularly employed in it. They are well paid—but they are few.

Whereas in Europe, classical recordings of every sort are being taped voluminously these days. Perhaps they are underpaid for; but business is obviously booming on all fronts. And at our own musicians' expense. European musicians are paid less on all counts, but more of them seem to be at work, more regularly. They're working overtime for us and they don't even get to hear their own product; the tapes are sent directly over here and almost never appear as records in Europe itself.

All of which leaves this operator, at least, with an uneasy feeling. Something is wrong. There must be a better adjustment possible than is now in force. It's hard to

Microphones

BY TURNER

QUALITY that speaks for itself

in every sound application

The Aristocrat Model 50D

The world's finest dynamic. For TV, FM, AM. Recording, public address and broadcast. Laboratory calibrated. No closely associated auxiliary equipment required. Response: 50 - 15,000 c.p.s. flat within $\pm 2\frac{1}{2}$ db. Level: 56 db below 1 volt/dyne/sq.cm. at high impedance.

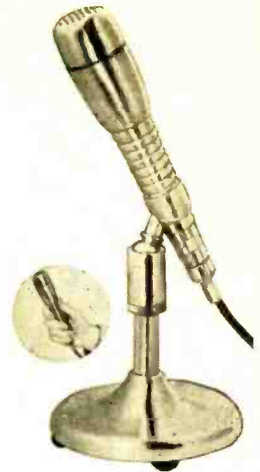

The "Competitor" Model 60X

A new low priced crystal desk and hand microphone for economical recording and sound systems, amateurs, dictation machines. Response: 70 - 7000 c.p.s. Level: 52 db below 1 volt/dyne/sq.cm.



The Dependable 33X-33D

A general purpose microphone that offers high quality performance at medium cost.

Model 33X Crystal

Response: 50 - 9000 c.p.s.
Level: 52 db below 1 volt/dyne/sq.cm.

Model 33D Dynamic

Response: 30 - 9000 c.p.s.
Level: 54 db below 1 volt/dyne/sq.cm. at high impedance.



The Professional Model U9S Dynamic

A rugged reliable microphone. 4 impedances at your fingertips. A smooth performer at all impedances and frequencies.

Response: 40 - 9000 c.p.s.
Level: 52 db below 1 volt/dyne/sq.cm. at high impedance.



THE TURNER COMPANY

929 17th Street N.E. Cedar Rapids, Iowa

In Canada:

Canadian Marconi Company, Toronto, Ontario and Branches

Export:

Ad. Auriema, Inc., 89 Broad Street, New York 4, N.Y.

Crystals licensed under patents of the Brush Development Company



HARVEY Features the Finest Brands

WILLIAMSON HR-15 AMPLIFIER KIT



The famous Williamson HR-15 amplifier circuit . . . now available with the original Partridge transformers built to Williamson's specifications. Build this kit in 3 hours or less, and enjoy sound of a quality you never heard before. The HR-15 is a 2-Chassis power amplifier for use with tuners or other front ends having own volume and tone controls. All American triodes, 2-6SN7GT, 2-807, or 68G6G in PP output, 5V4G rectifier. Response $\pm .5$ db, 10-100,000 cycles. Output impedances 1.7 to 109 ohms in 8 steps. Absolute gain 70.8 db. 20 db. of feedback around 4 stages and the output transformers. Kit is complete with Tubes, Punched Chassis, Pre-wired Resistor Board, Sockets, Genuine Partridge Output Transformer, and All Necessary Parts. **\$75.00.**

As Above, with CFB Transformer. **\$85.00**

PARTRIDGE OUTPUT TRANSFORMER
WVFB, as used in above Kit, available separately **\$24.50**

Now in Stock! New Partridge CFB Series



Frequency response 3db down at 3 cycles and 95,000 cycles. Power rating 30 to 30,000 cycles at 60 watts with less than 1% distortion without negative feedback. Write for descriptive literature.

\$35.00. net

WILLIAMSON KIT, with all TRIAD Transformers, using potted output transformers. **\$75.00**

As Above, with Hermetically Sealed Output Transformers **\$85.00**



MAGNECORD SERIES 6 RECORDERS AND AMPLIFIERS

PT6-JA Recorder and Amplifier . . . the only combination that offers such high professional quality at such a low price. Includes PT6-A Recorder plus Amplifier with low impedance microphone and bridging inputs, 10 watt audio amplifier with monitor, speaker and jack for external speaker, 600 ohms balanced line output terminal.

- PT6-JAH—MagneCORD Combination with high speed forward **\$564.00**
- PT6-AH—Recorder with high speed forward **316.00**
- PT6-J—Amplifier **248.00**
- PT6-P . . . Lightweight Portable Amplifier, including a record playback remote amplifier and power supply for use with the PT6-A Recorder **\$462.00**

McINTOSH AMPLIFIERS

We have McIntosh Amplifiers in stock for immediate delivery. Full information on request, or come in (if you're in town) for a demonstration.

- 20 W-2 Amplifier **\$149.50**
- 50 W-2 Amplifier **249.50**
- AE-2-A Equalizer Pre-Amp **74.50**



Complete Line of CANNON
Plugs and Connectors carried
in stock for immediate
delivery.

CANNON plugs have been standard equipment for more than 15 years wherever a high quality connector is required for low level sound transmissions or for general electrical and electronic use. You'll find them in quality microphones, sound systems, radio and TV stations, etc. CANNON is definitely a "must" for you. Write for literature and prices for connectors to fit your requirements.

A Truly Remarkable Value!

WESTERN ELECTRIC 755-A 8" PM SPEAKER

Will handle 8 watts of power. Uses a very heavy magnet. This speaker has built into it more loudspeaker quality than has been available in a unit of this size, power and cost. Only 3 1/8" deep, therefore, it offers extremely small space requirements for full range frequency coverage and wide angle distribution of high frequencies. **\$24.60**

WESTERN ELECTRIC 639 B MICROPHONE

Widely used by recording studios, broadcast stations and wherever a high quality cardioid microphone is required. **\$169.50**

VISIT THE AUDIO- TORIUM

Come in and visit our new sound department . . . all these items and many more on working display at all times.

Telephone: **3** Luxemburg 2-1500



103 West 43rd St., New York 18, N. Y.

NOTE: In view of the rapidly changing market conditions, all prices shown are subject to change without notice and are Net, F.O.B., N.Y.C.

believe that our Union musician is so tied up in big-time operations that he just doesn't care a hoot about the piffing little classical side line. It's no longer a piffing side line but a considerable business, and all-European. If he does care, then it seems to me he's being unrealistic and to his own detriment. One can't help feeling that there must be a way to get our own musician in on the classical LP field on a larger scale without hurting his basic rights, and to his own greater benefit; some compromise that would divert some of the flood of LP music to home production.

But how?

SPANISH SAUCE

Falla, Dances from The Three Cornered Hat; Palau, March Burlesque, Hommage à Debussy; Rodrigo, Homenaje a la Temperancia; Iturbi, Seguidillas; Chavarri, Interior from the Valenciannos.

Valencia Symphony, Iturbi.

RCA Victor LP
LM 1138

A Program of Spanish Songs.

Conchita Supervia; Frank Marshall, pf.
Decca LP
DL 7510

The RCA record with the long title looked interesting. It is, but only mildly so. Here's music from Spain by a number of unheard composers and we seldom get anything but the standard items from that country. Judging from these, however, Spain isn't getting along too fast in its musical evolution; most of this unfamiliar music is a semi-recasting of more or less familiar Spanish-Romantic idioms, with a bit of dissonance—a very small bit—here and there. Just above the salon level, but pleasant listening. The music recorded in England, is issued by RCA, at least in the LP version, with that curious limpness of highs and thinness of bass noticed often in the past.

Conchita Supervia, the superb singer-dancer-actress of days long past, briefly steps out of legend in this LP reissue or recordings dating originally from the early 30's. Those who saw and heard her will be thrilled in memory—but newcomers will deduce that she depended much on the eye and on her sense of drama, complete with seductive Spanish costuming; these mere recordings, minus the eye's aid, display a rather nervous and uneven voice, if a powerful and very Spanish one. The piano playing, unexpectedly, is outstanding—Frank Marshall. The ancient recording adequately restored. (Side 1: Seven Spanish Songs by Falla; side 2: Tonadillas, seven songs by Grenados.)

Try these on your hi-fi outfit

(Note: With the present flood of new LP's continuing unabated it's not hard to find examples of top-quality recording. Good records come a dime a dozen, so to speak—but even so, the number of slightly or definitely substandard offerings is quite appalling, as any owner of high-quality reproducing equipment knows, nor is it easy to determine in advance via the usual record-shop players! A condensed listing is continued here, for those who want to be reasonably sure that their records match their equipment in quality. Good musical performance is assumed, as is good microphoning for the type of music. Large numbers of LP's have been by-passed, though entirely listenable musically, the following being first-class and no less, according to my ear.

Big-Orchestra Stuff

Hanson, Piano Concerto in G. Firkusny, Eastm.-Roch.
Grieg, Holberg Suite.

Col. ML 4403

Smetana, The Moldau; From Bohemia's Fields

- & Groves. N. Y. Philh. Szell. Col. ML 2177
- *Bruckner, *Symphony #6*. Vienna Philh. Swoboda. Westm. WL 55-56 (2)
- Tchaikowsky, *Romeo & Juliet; Francesca da Rimini*. N. Y. Philh. Stokowski. Col. ML 4381
- Sibelius, *Finlandia; Chabrier, Espana*. Coteborg Symph., Berlin Philh. Cap. H-8138
- Hindemith, *Symphony in E flat*. Janssen Symph. Col. ML 4387
- *Prokofieff, *Love for Three Oranges Suite; Lt. Kije Suite*. Fr. Nat. Orch. Desormiere. Cap. P-8149
- Dvorak, *Symphony #2*. Berlin Philh., Schrader. Urania URLP 7015
- *Janacek, *Suite for Strings; Taras Bulba*. Wintertthur, Vienna Symph., Swoboda. Westm. WL 5071
- *Brahms, *Piano Concerto #2*. Ney; Berlin Philh. Max Fiedler. Decca DL 9536
- Tchaikowsky, *Symphony #5*. Phila. Orch., Ormandy. Col. ML 4400
- Schubert, *Symphony #4*. Vienna Symph., Sacher. Program EXLP 704
- Strauss, *Don Juan; Till Eulenspiegel*. Amst. Concertgebouw, Karajan; Berlin Philh. Fricsay. Decca DL 9529
- Mozart, *Piano Concertos #14, #22*. Badura-Skoda; Vienna Symph. Sternberg. Oceanic OCS 22
- *Dukas, *Sorcerer's Apprentice; Gretry, Cephele et Pocris Suite*. INR Symph. Andre. Cap. L-8135
- Bruckner, *Symphony #4*. Vienna Symph. Klemperer. Vox PL 6930
- Haydn, *Symphonies #52, #56*. Vienna Opera Orch., Symphony, Heiller. Haydn Soc. HSLP 1039
- Rimsky-Korsakoff, *Piano Concerto; Scriabin, Piano Concerto*. Badura-Skoda, Vienna Symph. Swoboda. Westm. WL 5068
- Schubert, *Symphony #6*. Austr. Symph., Woss. Remington RLP 149
- Brahms, *Symphony #4*. Berlin Philh., de Sabata. Decca DL 9536

* Outstanding sound quality.
 ° Old (disc) recording, reissued. Excellent quality.

Profs Practice What They Teach

Nineteen prominent professors—chosen from leading engineering colleges—are augmenting their academic knowledge with practical know-how this summer by working side-by-side with Westinghouse engineers and workmen in the company's Industrial Experience Program. Principal objective of the program is to assist colleges in the development of a more competent engineering school graduate, and one who can more easily make the transition from campus to industry. The program moves toward its objective by bringing professors face-to-face with the engineering needs and problems of American industry.

Professors participating in the program are paid a regular salary and are given assignments in their particular fields of study.

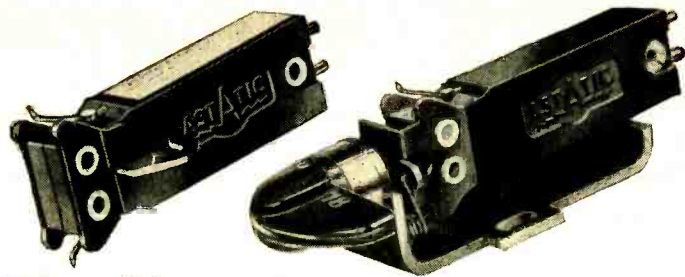

The Finest Lightweight Crystal Cartridge of Them All!

NOW AVAILABLE IN MODELS WITH
CERAMIC ELEMENTS

ASTATIC
"AC" SERIES

ASTATIC has never introduced a new cartridge that has won wider, more immediate acclaim than its "AC" Crystal Series. The new mechanical drive system of the "AC" Cartridges affords a new low inertia . . . smoother response characteristics, higher tracking excellence, lower needle talk resulting. Now, those who need immunity to extremes of temperature and humidity, along with such performance excellence, will find an optimum answer in the new Ceramic "AC" Models. External physical characteristics are the same. Performance characteristics of the Ceramic and Crystal models appear below. Note that output of the Ceramic units is entirely adequate for the two-stage audio amplifiers used in most radios and phonographs.

THE
Astatic
CORPORATION
CONNEAUT, OHIO
IN CANADA, CANADIAN ASTATIC LTD., TORONTO, ONTARIO

SPECIFICATIONS—CRYSTAL MODELS

Model	List Price	Minimum Needle Pressure	Output Voltage 1000 c.p.s. 1.0 Meg Load	Frequency Range c.p.s.	Needle Type	For Record	Code	
AC-78-J	\$ 8.90	6 gr.	1.0*	50-10,000	A-3 (3-mil sapphire tip)	Standard 78 RPM	ASWYN	
AC-J	8.90	5 gr.	1.0**	50-10,000	A-1 (1-mil sapphire tip)	33-1/3 and 45 RPM	ASWYJ	
AC-AG-J	8.90	6 gr.	1.0**	50-10,000	A-AG† (sapphire tip)	33-1/3, 45 and 78 RPM	ASWYH	
DOUBLE NEEDLE TURNOVER MODELS.								
ACD-J	9.50	6 gr. either needle	1.0**	50-6,000	A-1 and A-3 (sapphire tips)	33-1/3, 45 and 78 RPM	ASWYL	
ACD-1J	9.50	(Same as ACD-J except equipped with spindle for turnover knob. Replacement cartridge for ACD-2J assembly.)						ASWYF
ACD-2J	10.00	(Same as ACD-J except equipped with complete assembly turnover and knob.)						ASWYE

SPECIFICATIONS—CERAMIC MODELS

Model	List Price	Minimum Needle Pressure	Output Voltage 1000 c.p.s. 1.0 Meg Load	Frequency Range c.p.s.	Needle Type	For Record	Code	
ACC-J	8.90	5 gr.	0.4**	50-6,000	A-1 (1-mil sapphire tip)	33-1/3 and 45 RPM	ASWTN	
ACC-78-J	8.90	6 gr.	0.4*	50-6,000	A-3 (3-mil sapphire tip)	Standard 78 RPM	ASWTM	
ACC-AG-J	8.90	6 gr.	0.4**	50-6,000	A-AG† (sapphire tip)	33-1/3, 45 and 78 RPM	ASWTL	
DOUBLE NEEDLE TURNOVER MODELS:								
ACD-C-J	9.50	6 gr. either needle	0.4**	50-5,000	A-1 and A-3 (sapphire tips)	33-1/3, 45 and 78 RPM	ASWTX	
ACD-C-1J	9.50	(Same as ACD-C-J except equipped with spindle for turnover knob. Replacement cartridge for ACD-C-2J assembly.)						ASWTJ
ACD-C-2J	10.00	(Same as ACD-C-J except equipped with complete assembly turnover and knob.)						ASWTI

† "ALL-GROOVE" Needle tip of special design and size to play either 33-1/3 and 45 RPM (narrow groove) or 78 RPM (standard groove) records.

* Audiotone 78-L Test Record
 ** RCA 12-S-31V Test Record

Astatic Crystal Devices manufactured under Brush Development Co. patents

AUDIO VOLUME MEASUREMENT

[from page 28]

rapidly varying speech and program waves. In deciding upon the dynamic characteristics, an important factor included in the consideration was the ease of reading the instrument and the lack of eye strain in observing it for long periods.

For ease of reading and minimum of eye fatigue, the movement should not be too fast. As a result of observations under service conditions, and other tests, the requirement was adopted that the sudden application of a 1000-cps sine

wave of such amplitude as to give a steady deflection at the scale point where the instrument is to be read, shall cause the pointer to read 99 per cent of the final deflection in 0.3 second.

It was also noted that on speech and program waves, instruments which were critically damped or slightly overdamped had a more "jittery" action than instruments slightly underdamped. Consequently the strain of reading the former type is greater than for the latter. A theoretical study of the problem verified the validity of this subjective observation. The requirement was therefore adopted that the standard volume indicator movement shall be slightly less than critically damped, so that the pointer will overswing not less than 1 per cent nor more than 1.5 per cent

when the sine wave mentioned in the preceding paragraph is applied.

The question of whether the rectifier, which is a part of the standard volume indicator, should be half-wave or full-wave needs little discussion. As is well known, many program waves (particularly speech) show a marked lack of symmetry. Obviously, if an instrument is to give the same indication, no matter which way it is poled, a balanced full-wave rectifier is required.

Throughout this discussion, the term "r.m.s." has been used loosely to describe the general type of instrument under consideration. The equation that relates the instrument coil current to the potential applied to the volume indicator is:

$$i = ke^p$$

where i = instantaneous coil current.

e = instantaneous potential.

k = a constant.

The exponent p in the above equation is 1.2 for the standard volume indicator. Therefore its characteristics are intermediate between a linear ($p=1$) and a square-law or "root-mean-square" ($p=2$) characteristic.

In many applications *the rectifier law is just as important as the other electrical and dynamic characteristics* of the standard volume indicator. Unfortunately, there is a tendency to overlook this fact in many instances and to simply specify that the indicating instrument of some particular piece of measuring equipment "shall have dynamic characteristics identical to that of the standard volume indicator."

Instrument Scale

Among the more important features to be considered in the development of a volume indicator is the design of its scale. In broadcasting studios, volume indicators are under observation almost continuously by the control operators. Consequently, the ease and accuracy of reading, and the degree of eye strain are of major importance.

It is evident that the instrument scale should be easy to read in order that the peak reached by the needle under the impetus of a given impulse may be accurately determined. The instrument scale, therefore, should be as large as practical since, in the case of the broadcast and recording applications, attention is often divided between the action in the studio and the volume indicator.

Volume level indicators are used (a) as an aid to tailoring the wide dynamic range of an original performance to that of the associated transmission medium and (b) for locating the upper part of the dynamic range just within the overload point of an equipment during its normal operation. For the first of these uses, a scale having a wide decibel range is preferable. For the latter purpose, a scale length of 10 db is usually adequate. Since a given instrument may be used for both applications neither too large nor too small a range is desirable in volume level indicators for the above purposes. A usable scale length covering 20 db appears to be a satisfactory compromise.

You Are Invited to Attend the Third Annual AUDIO FAIR

Sponsored by the

AUDIO engineering society

in conjunction with its

Annual Meeting and Convention

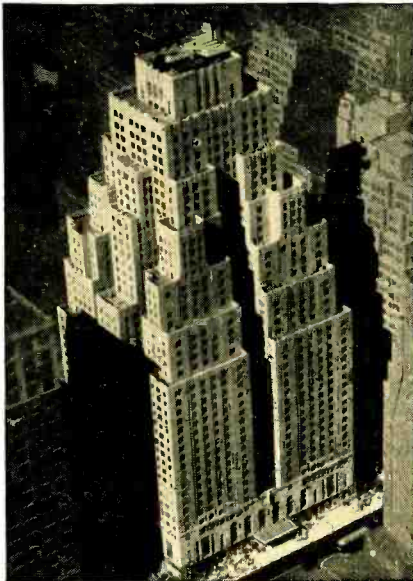

AUDIO on the contemporary SCENE

of utmost interest and importance to government and military agencies, Broadcast Engineers, Recordists, Sound-on-Film Men, Public Address Operators, Audio Hobbyists, Dealers and Distributors, and lovers of high-quality music reproduction

YOU WILL SEE and HEAR

industry-wide displays and demonstrations of the latest and best audio equipment, components, and accessories

AGAIN UNDER ONE ROOF

REGISTRATION FREE
for all Exhibits

Hotel New Yorker, New York City, November 1-2-3, 1951
Fifth and Sixth Floors



ANNUAL CONVENTION BANQUET

Thursday Evening, November 1, 7:30 p.m.

For further information and reservations,
write

Fair Manager, Room 920, 342 Madison Avenue, New York 17, N. Y.

Both vu markings² and markings proportional to voltage are incorporated in the new instrument scale. The need for the former is obvious, but the philosophy which lead to the inclusion of the latter may require some explanation.

It is evident, assuming a linear system, that the voltage scale is directly proportional to percentage modulation of radio transmitter or recording system upon which the program is finally impressed. If the system is adjusted for complete modulation for a deflection to the 100-per cent mark, then subsequent indications show the degree of modulation under actual operating conditions. In the interests of best operation, it may be desirable, of course, to adjust the system for somewhat less than complete modulation when the 100 per cent indication is reached.

In any event, the indications on the voltage scale always show the *percentage utilization of the channel*. This is a decided advantage because everyone concerned (both technical and non-technical personnel) has a clear conception of a percentage indication. Furthermore, since the scale does not extend beyond the 100 per cent mark (except in the form of a red warning band) and since it is impossible to obtain more than 100 per cent utilization of the facilities, there is less incentive on the part of non-technical people connected with program origination, to request "an extra-loud effect" on special occasions.

Actually, two scales, each containing both vu and voltage markings, have been standardized. One of these known as the type A scale, *Fig. 2*, emphasizes the vu markings and has an inconspicuous voltage scale. The second, known as the type B, *Fig. 3*, reverses the emphasis on the two scales. This arrangement permits the installation of the instrument which emphasizes the scale that is most important to the user, while retaining the alternate scale for correlation purposes.

Ever mindful of the possibility of eye fatigue even the color of the scale card has been standardized. It is a light orange-yellow, which seems to be a satisfactory compromise between high contrast and reduced eye-strain. This choice was based upon the preference of a large group of skilled observers and upon the reports of certain societies for the improvement of vision. The use of matte-finished instrument cases having fairly high reflection coefficients, such as light gray, is also desirable for ease of vision.

Finally in studio applications the scale must be properly illuminated so that the relative light intensity on the face of the instrument is comparable to that on the sound stage. Unless this condition prevails, the eye may have difficulty in accommodating itself with sufficient rapidity to the changes in illumination as the operator glances back and forth from the studio to the volume-indicator instrument.

(To be concluded)

² Terminology is explained in a following section.

NOW THERE ARE 3

They do everything you want!

They make tough jobs easy!

E-V Slim-Trim DYNAMICS

for TV... Broadcasting... Recording... PA

... for wide range high fidelity response ... for fixed position or man-in-motion ... for ruggedness and versatility ... for exclusive Acoustalloy diaphragm ... for pop-proof pick-up indoors and outdoors

You see ... and hear ... the E-V Slim-Trim on network and local telecasts and broadcasts. You find it in studios and on remote hook-ups. You find it on important PA jobs, too. And you know it's there *because* it has met the most exacting tests... *because* it serves so superbly in every way for voice and music. *First* in dynamic, it has features only *Electro-Voice* can provide. 3 models meet every need!

Ask your E-V Distributor or Send for Full Facts Now!

FOR TELECASTING-BROADCASTING

"655"—Response 40-15,000 c.p.s., ± 2.5 db. Power rating -53. Omnidirectional. Changeable low impedance. Removable swivel. List \$200

"654"—Response 50-14,000 c.p.s., substantially flat. Power rating -55. Omnidirectional. 50-250 ohm impedance selector. Swivel head. List \$90

FOR PUBLIC ADDRESS

"636"—Response 60-13,000 c.p.s., substantially flat. Power rating -55. Omnidirectional. High or low impedance. Swivel head. List \$65

Electro-Voice

400 CARROLL ST. • BUCHANAN, MICHIGAN

Export: 13 E. 40th St., N.Y. 16, U.S.A. Cables: Arlab

MICROPHONES • PHONO-PICKUPS • HI-FI SPEAKERS • SELF-TUNING TV BOOSTERS



NEW PRODUCTS

● **Explosion-Proof Speakers.** New Racon driver models XP-1 and XP-2 are Underwriters listed for use in situations contaminated by explosive gasses and dusts respectively. Both units are designed for

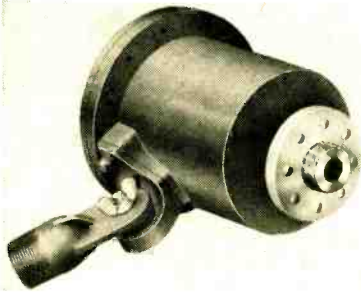

announcing and paging applications, and have a continuous power rating of 30 watts. Voice coils are wound of aluminum wire, and terminals are welded to dispense with the corrosive effects of solder. Housings are made of heavy cast aluminum and are tapped for standard 1/2-in. rigid conduit. Complete information will be supplied by Racon Electric Co., Inc., 52 E. 19th St., New York 3, N. Y.

● **Magnetic Recorder-Projector.** Direct recording of commentary or musical background on processed 16-mm film is achieved for the first time with the new Model 400 projector recently demonstrated by RCA at the annual trade show of the National Audio Visual Association in Chicago. The unit makes use of 16-mm film on one edge of which is a one-tenth-inch-wide strip of magnetic oxide. Recording, erase and playback are accomplished in a manner identical with that used in conventional tape recorders. In addition to magnetic reproduction, the Model 400 will also playback standard 16-mm film with

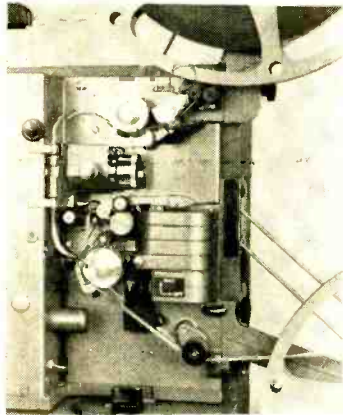

optical sound track. Especially significant is the fact that the equipment affords the advantages of magnetic recording and reproduction on 16-mm film where costs are restricted by the need for only a limited number of prints. Also of interest is the ability of the 400 to permit revision or replacement of sound on single prints without the cost and time required for laboratory processing. RCA Victor Division of Radio Corporation of America, Camden, N. J.

● **Voltage-Surge Suppressor.** Life of unprotected contacts used in relays, contactors, and similar electromagnetic devices, can be increased by at least 20 times through use of the voltage-surge suppressor recently announced by Federal Telecommunication Laboratories, Inc., Nutley, N. J. Developed in connection with Federal's research on selenium rectifiers, the suppressor is similar in protection char-

acteristics to the varistor. However, the selenium unit draws measurably less power when the circuit is energized. The difference in the current requirements of the selenium suppressor and the varistor represents an appreciable savings where a large number of relays are involved. For most telephone relays, the new Fed-

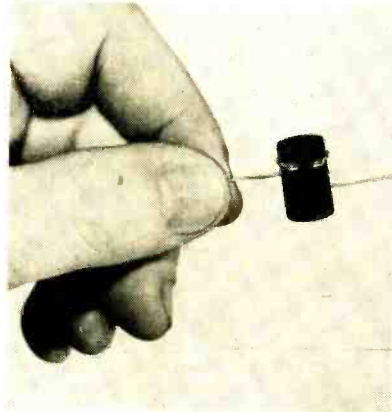

eral suppressor is small enough to be hung directly across the terminals. Suppressors for heavier devices are correspondingly larger. Tests of the suppressor have run in excess of fifty million operations without failure.

● **Inconspicuous Microphone.** Latest entry in the field of miniature microphones, designed to give audiences a clear, unobstructed view of performers, is the new crystal Model DK-1, manufactured by The



Astatic Corporation, Conneaut, Ohio. Finished in brushed chrome to reduce light reflection, the DK-1 is a non-directional high impedance unit with crystal element coated to resist the effects of high humidity. Output level is -55 db. Available with or without off-on switch.

● **Transcription Player.** Advertising agencies, schools, radio stations, and other users of portable playback equipment will find many uses for the Newcomb combination record player-p.a. system. Containing a 5-watt straight a.c. amplifier, 10-in. Alnico speaker, and a 3-speed turntable which accommodates records of all sizes, the Model R-16 offers great flexibility together with exceptional audio performance. Speaker section of case is removable



and is equipped with a 25-ft. extension cable. Panel mounted microphone input jack and mixing volume control make the R-16 a practical p.a. system. Overall size is 14 x 15 x 8 1/2 in., and weight is 22 lbs. Manufactured by Newcomb Audio Products Co., 6824 Lexington Ave., Hollywood, Calif.

● **Branching Networks.** Broadcast stations, motion-picture sound studios, laboratories, and recording studios will find many uses for the new Daven Series 1130 multi-

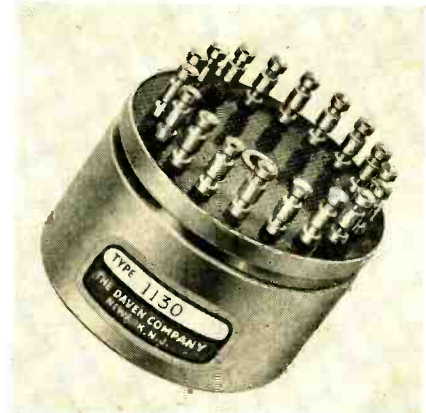

ple networks. Among their many functions are the equalization of incoming signal levels, the combining of two or more incoming lines into a single outgoing line, or the dividing of one incoming line into two or more outgoing lines. The networks are available in either balanced "H" or unbalanced "T" circuits. Resistors are precision wire-wound with ± 2 per cent accuracy. Maximum pad level is +24 VU. As many as ten inputs or outputs may be obtained. For most values frequency range is from zero to 50 kc. Full technical information will be supplied upon request to The Daven Company, 191 Central Ave., Newark, N. J.

● **High-Quality FM-AM Tuner.** Remarkably low AM detector distortion and an unusually effective 10-kc-interference fil-

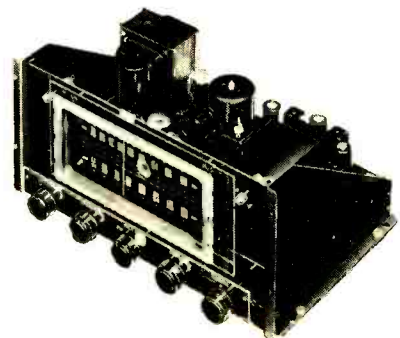

ter are features of the 14-tube circuit in the new Model SR-51 FM-AM tuner recently introduced by The Sargent-Rayment Company, 212 Ninth St., Oakland 7, Calif. Designed for custom installation, the SR-51 includes a unique two-tube tone-control system which varies the 600-cycle crossover frequency only 4 db when bass and treble controls are swung from maximum to minimum. The AM section consists of a pre-tuned r.f. stage and a broad-band stage of i.f. terminating in a detector with distortion limited to 0.48 per cent at 400 cps with 100 per cent modulation. A null-type filter has zero attenuation at 9 kc and 47 db at 10 kc, thus effectively limiting adjoining station interference. Wide-range FM section includes AFC and has sensitivity of 5 microvolts. Descriptive literature and engineering data will be supplied on request.

• **Sound Level Meter.** Improved low-frequency response and refinements in mechanical design are inherent in the new Model 410-B Sound Level Meter now being produced by Herman Hosmer Scott, Inc., 385 Putnam Ave., Cambridge 39, Mass. Sound level range of the 410-B is from 34



to 140 db above the standard ASA reference level of 0.0002 dynes/sq. cm. The instrument is both compact and rugged due to use of sub-miniature tubes and unique miniaturization techniques on which patents are pending. Power supply is self-contained and consists of standard hearing-aid batteries which have an operating life of 50 hours. Extension cables and vibration measuring equipment are available as accessories. Technical bulletin will be mailed without charge.

• **Ultrasound Intensity Meter.** A new instrument for the measurement of ultrasonic sound intensity is the Sonotest, recently introduced by the Radiological Cor-



poration of America, 18 Lackawanna Plaza, Orange, N. J. Produced by the Siemens-Reiniger organization, the Sonotest indicates transmitted ultrasonic power on a scale calibrated directly in watts. The Sonotest can be used for under-water measurements and will give indications in any desired position. Range is from 0 to 60 watts.

The Discriminating Eventually Come to Leonard's!

UNIVERSITY 12" COAXIAL LOUDSPEAKER MODEL 6201

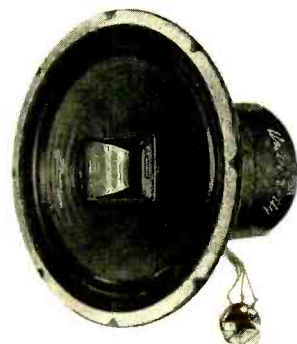

What Do You Look For in a Popular Priced High Fidelity Loudspeaker?

A dual-range coaxial system employing the famous UNIVERSITY "cobra" tweeter horn with its own driver results in excitingly realistic reproduction and uniform dispersion over the entire audible range. Built-in LC type crossover network divides program material handled by woofer and tweeter. A high frequency attenuator facilitates adjustment of response to suit personal preferences. Overall response—45 to 15,000 cps. Power Capacity—25 watts. Input Impedance—8 ohms.

NET \$44.10



The Famous **Bogen** DB 10

What Do You Look For in a Popular Priced High Fidelity Amplifier?

The magnificent performance and versatile adaptability of the DB 10 are the main reasons why it has established an unmatched record for sales and acceptance throughout the world. Incorporating a built-in pre-amplifier with inputs for all high fidelity

pickups and extremely effective bass and treble controls, it is considered by discriminating critics to be without peer in the popular price range. Power Output—10 watts at 3% Peak—15 watts. Frequency Response—30 to 18,000 cps. ±1 db.

NET \$53.36

Visit our Sound Studios to hear these and many other examples of fine audio equipment. Open Mondays through Saturdays—9:00 A.M. to 7:30 P.M.

WRITE FOR OUR LATEST
HI FI CATALOGUE

TELEPHONE: CORTLANDT 7-0315

Leonard Radio inc.

the house
built on
SERVICE

69 CORTLANDT ST., NEW YORK 7, N. Y.

APPROVED • ASTATIC • ATLAS • AUDAK • AUDIO DEVELOPMENT • BELL • BOGEN • BOZAK • BROOKS • BROWNING • BRUSH • CHALLENGER • ELECTRO-VOICE • JENSEN • ESPEY

PENTRON • PICKERING • RACON • RADIO CRAFTSMEN • REK-O-KUT • H. H. SCOTT • SHURE • SONAR • UNI-MODE • UNIVERSITY • V-M • WEBSTER - CHICAGO • WEBSTER ELECTRIC

FREE!
Send Now! FOR
NEW HIGH FIDELITY
GUIDEBOOK
 Full of Solid
 Information!



Tells All

the things you want to know about High Fidelity! Explains how to bring concert hall realism into the home. Tells what makes a real Hi-Fi Music System. Explains how to select individual components or complete ensembles. Pictures various types of installations - shows how easily you can have your own custom Hi-Fi System at modest cost! Illustrates and describes a complete range of the finest nationally known Hi-Fi units on the market. Prepared for the new enthusiast and for the advanced High Fidelityist. • Send for your FREE Hi-Fi Guidebook today!

GET BIG NEW 1952 CATALOG



OF TV • RADIO • ELECTRONICS
 Concord's all-new, complete Buying Guide will save you time and money! Brings you page-after-page of the latest values in world-famous guaranteed parts and equipment for every need! Send today for your FREE copy!

CONCORD
RADIO CORPORATION
 901 W. JACKSON BLVD. • CHICAGO 7

CONCORD RADIO CORP., Dept. AJ-51
 901 W. Jackson Blvd., Chicago 7, Ill.

- Rush FREE High Fidelity Guidebook
- Rush FREE Big, New 1952 Catalog

Name _____

Address _____

City _____ Zone _____ State _____

New Danish Playback Machine

SVEND ANKER-RASMUSSEN*

Laterally-modulated groove recorded in endless plastic tape provides 60-minute playing time.

SINCE THE ADOPTION of electro-acoustic recording technique some 25 years ago, there has been no radical departure from conventional disc recording methods. Electrically recorded gramophone discs made high-fidelity reproduction possible but still had the drawback of limited playing time. The U. S. answer to this problem

tape with 56 parallel sound tracks spaced at the ordinary rate of four tracks per millimeter. The groove oscillations are reproduced by a crystal cartridge pickup mounted in the turret, seen at the extreme right of the playback chassis, which may be positioned to play back any one of the tracks, or automatically operated to reproduce the tracks suc-



The Teflon tape recorder.

was the advent of LP records, but this was not a complete solution. The possibility of 15 to 20 minutes uninterrupted recording on one side still left a large number of music works which had to be "chopped up" with the resulting headaches to recording engineers and producers. There also remained the weak spot of rotating-disc recordings: the relative speed of the needle to the groove decreases as the spiral approaches the center.

Magnetic tape recording does away with limitation of recording length as far as a great majority of music is concerned, but high-fidelity reproduction requires rather costly apparatus, and magnetic tape recordings are not easily adaptable to mass production. Yet this type of recording procedure was undoubtedly the inspiration to Dr. Daniel, a German sound engineer and researcher. His new invention, the Teflon, constituted the technical sensation of two recent large-scale radio exhibitions. It was first introduced to the public simultaneously at Copenhagen, Denmark, and Dusseldorf, Germany.

The accompanying illustration does more to describe the new device than many words could. The recording medium is an endless polyvinyl-chloride

cessively. Its position is indicated by a pointer along a slide-rule dial. According to tape length and the number of grooves, the Teflon may be used for playing times of 24, 48, or 60 minutes, but if the tape is twisted half a turn it may be inscribed on both sides with a maximum time of 90 minutes.

A synchronous motor draws the tape past the pickup, which is designed to cut off sharply around 7500 cps, at a speed of 54.6 cm/sec, which corresponds to the linear speed of an LP record at a radius of approximately 6 in. The tape is housed in an enclosed cassette resembling a book, within which it passes over a number of spring-loaded rollers which serve to keep it taut against the guiding rollers in front of the pickup. The ends of the tape are "welded" together by radio-frequency heating and tapered so as to make a completely flush joint. The tape books are smaller, lighter, easier to use, and much better protected against breakage and mechanical molestation than conventional disc records. The groove speed of the pickup point is constant throughout the whole recording, and the hardness of the plastic tape in conjunction with almost complete freedom from grain ensure high quality of reproduction. Needle noise is reduced to a minimum.

While no details of the Teflon record-

[Continued on page 43]

* Deputy Editor, Radio Ekko, Copenhagen, Denmark.

TECHNICANA

Tuning Fork Filter

A method of extracting weak signals from random noise through the use of a tuning fork as a resonant filter element is the subject of an article in *J. Acous. Soc. Am.*, November 1950, by Karl N. Wulfsberg. An experimental tuning fork filter for 1,000 cps was made by fabricating the fork from cold rolled steel and driving it with high-quality coils.

The fork was mounted on small metal washers and had the tines drilled and threaded for adjusting screws. The driving and pickup coils were assembled on laminated silicon steel cores with headphone magnets as the source of flux. The driving coil was fed from a pentode amplifier and the insertion loss measured in the usual way. The Q of the system was obtained by measuring the time constant. Since a Q of the order of 10,000 with an insertion loss of the magnitude of 20 db is easily obtained, it is obvious that the filter is suitable for separating weak signals from random noise.

The band width of such a system is about one cycle for the fork described. Its temperature coefficient is about 100 parts per million per degree centigrade and the frequency variation with input level is about 20 parts per million per volt in the range measured. It should also be noted that the Q of the system is readily adjustable, and that frequencies far removed from resonance are highly attenuated. Frequency variation for tuning the filter is small, however, but may be had by adjusting the tine screws.

Adjustable Reverberation

In an article by Paavo Arni in the May 1950 *J. Acous. Soc. Am.*, the construction of a broadcasting studio having an adjustable reverberation time is described. Earlier work to devise studios having variable reverberation characteristics led to the design, in Copenhagen, Denmark, of a studio in which the reverberation time at 1,000 cps is constant and the slope of the reverberation curve versus frequency is varied.

In the present design carried out at Helsinki in the studios of the Finnish Broadcasting Company the reverberation time may be varied from 0.72 to 0.9 sec. at 100 cps, from 0.72 to 1.2 sec. at 1,000 cps, and from 0.8 to 1.0 sec. at 8,000 cps. The average value of the change in the middle audio range is of the order of 0.4 seconds, and the average slope is horizontal.

To accomplish this change, hinged panels of absorptive material are hung on the hard plaster walls of the studio in a pleasing symmetrical, but acoustically satisfactory pattern. When the units are closed half of the wall space is hard plaster and the remainder is the hard two-inch thick glossy painted surface on the back of the absorbing unit. When the absorbing units are open they expose the surface of a thin sheet of perforated plywood in back of which is a one-inch layer of rock wool and another sheet of thin plywood. This covers an air space backed by the two-inch thick cover. The back sheet of plywood and the air space form an absorbent vibrating system

for low-frequency energy, while the rock-wool balances the absorption for the high frequencies.

It should be noted that the even response which obtained at the low frequencies is attributed to polycylindrical diffusers in the studio. Variations within the limits of reverberation times specified are easily ob-

tained by opening the absorption units only part way. To facilitate the change from one condition to the other an operating rod has been provided.

The success of the design in the studio described has led to the inclusion of similar units in three new halls for broadcast pickup now in the design stages in Finland.

Positive Feedback

Thomas Roddam, writing in *Wireless World*, July 1950, describes the benefits and pitfalls attendant to the use of positive feedback in audio amplifiers.

Using the well known relations for feedback the distortion in an amplifier is found to be reduced by the factor $1/4\beta$ where A is the forward gain of the amplifier and β is the fraction of the output signal fed back. The above factor is of course an ap-

Presenting

GOODMANS
HIGH FIDELITY - 12" P.M.

TWIN CONE AXIOM 150

\$65.
LIST

GOODMANS
A TRADITION OF FIDELITY EFFICIENCY
FULLY DUSTPROOF

This 12-in. high fidelity unit has a twin-curvilinear diaphragm (British patent No. 451754). A carefully designed magnet assembly using anisotropic material provides a total flux of 158,000 maxwells on a 1½-in. pole. The back centering device is a dustproof bakelised linen disk with concentric corrugations. The combination of these features gives this precision-built instrument an outstandingly wide coverage from 40 to 15,000 c.p.s. free from bass modulation effects. An ideal high fidelity reproducer for the record enthusiast and the connoisseur of wide range musical reproduction, it gives exceptionally fine transient and frequency response.

U. S. NATIONAL SALES
WILLGOLD ELECTRONICS SALES CORP.
350 Fifth Avenue, New York, N. Y.

New England Office
Harold A. Chamberlin
31 Milk St., Boston 9, Mass.

Pacific Coast Office
Perimuth-Colman & Associates, Inc.
1335 Flower St., Los Angeles, Calif.

Chicago Office
Harry Halinton Co.
612 N. Mich. Ave., Chicago 11, Ill.

Canadian Office
A. C. Simmonds & Sons, Ltd.
100 Merton St., Toronto 12, Can.

Manufactured by:

GOODMANS INDUSTRIES LIMITED
WEMBLEY MIDDLESEX ENGLAND

SPECIFICATION

Frequency Coverage
40/15,000 c.p.s.

Overall Diameter
12 in.-31.3 cms.

Overall Depth
6 in.-17.6 cms.

Fundamental Resonance
55 c.p.s.

Voice Coil Diameter
1¾ in.-4.4 cms.

Voice Coil Impedance
15 ohms at 400 c.p.s.

Maximum Power Cap.
15 Watts Peak A.C.

Flux Density
14,000 gauss

Net Weight
12 lbs. 13 ozs.
(5810 grs.)

Finish—Grey Rivelling
Enamel.

PEERLESS...

while meeting the ever increasing priority demands of the Armed Forces, fully realizes the importance of the civilian, commercial and industrial economy to the present national emergency. To supply this civilian need of transformers, Peerless continues to keep available a line of "selected" transformers... chosen because of their characteristics to cover best the wide needs of civilian and commercial use.

This "selected" group consists of 59 types of transformers, with seven case styles. There have been included in this group, power, filament, plate, input, interstage, bridging, output, impedance matching transformers, reactors and power chokes... all with the same unsurpassed quality that has given Peerless industry-wide leadership. Write for descriptive catalog and price list—AL-1149-1.

PEERLESS

Electrical Products

Division

9356 Santa Monica Blvd.
Beverly Hills, Calif.

161 Sixth Avenue
New York 13, N. Y.



proximation which holds within a few per cent when $A\beta$ is large.

If positive feedback is now introduced into the amplifier thereby raising A by 6 db, and β remains the same the gain of the amplifier remains the same, but the value of $A\beta$ has doubled. That is, the gain of the amplifier with feedback is approximately $1/\beta$ so that A may be increased considerably without changing the external gain of the amplifier. However, since $A\beta$ has doubled and this appears in the denominator of our distortion reduction factor, we find that the distortion has been halved. This is a reduction of 6 db. Not only does the distortion drop when positive feedback is added, but the frequency response is also improved. There is, however, a steep price to be paid for this reduction in distortion and improvement in response, and that is the care with which the overall design of the feedback amplifier must now be carried out. This is brought about by the increase in phase shift in any stage in which positive feedback is employed, which may remove all phase and gain margins originally designed into the circuit.

Some of the trouble introduced by positive feedback may be obviated by using it over a limited band of frequencies. This may be done through the selection of an appropriate network for the introduction of the positive feedback signal. Figure 1

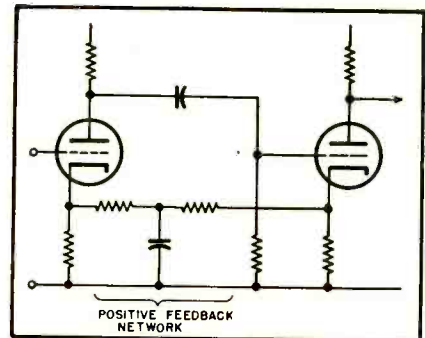

Fig. 1

illustrates a method of introducing positive feedback in the first two stages of an amplifier, provided the negative feedback signal is not also applied to the first cathode.

Modern Disc Recording

A survey article on new trends in disc recording by P. Gilotau appears in *L'Onde Electrique* for July 1950.

Modern methods of preparing stampers are reviewed briefly, followed by a discussion of the bandwidth required for high-fidelity reproduction. The general considerations of wavelength, velocity, amplitude, and acceleration in relation to groove diameter and disc speed, are covered, as well as the sources of surface noise and the effect of stylus burnish. The final section of the paper is an uncompromising evaluation of microgroove recording at both popular speeds.

Ultrasonics

A general treatment of the fundamentals of ultrasonics is presented in *Electronic Engineering* for January 1951 in an article by A. E. Crawford. This work does not, however, present the derivations of the various equations for velocity and amplitude. Following a discussion of longitudinal, shear, and surface waves is a brief consideration of the reflection of waves at a boundary.

The remainder of the article is devoted

1952 ALLIED CATALOG

free!

212 PAGE
BUYING
GUIDE

World's Largest Stocks
ELECTRONIC SUPPLIES
for INDUSTRY and
BROADCAST STATIONS



One Complete Dependable Source for Everything in Electronics

Simplify your purchasing—send your consolidated orders to ALLIED—the single, complete source for all Electronic Supplies. Depend on ALLIED for the world's largest stocks of special tubes, parts, test instruments, audio equipment, accessories—complete quality lines of electronic apparatus. Our expert Industrial supply service saves you time, effort and money. Send today for your FREE copy of the 1952 ALLIED Catalog—the only complete, up-to-date guide to Electronic Supplies for Industrial and Broadcast use.

ALLIED RADIO CORP.

833 W. Jackson Blvd., Dept. 17-J-1, Chicago 7, Illinois

We Specialize in Electronic
Equipment for Research,
Development, Maintenance
and Production Operations.

SEND FOR
FREE 1952
ALLIED CATALOG

to a survey of the various acoustical-mechanical and electro-acoustical generators and their ranges and adjustment.

Distortion Measurement

H. F. Olson and D. F. Pennie are the authors of an article in the *RCA Review* describing an automatic analyzer for the measurement and recording of harmonic distortion. By adding a device which automatically suppresses the fundamental frequency to a standard automatic frequency response curve tracer, it is possible to obtain the curve of the level of the distortion in decibels below the level of the fundamental plus distortion. This may then be converted into per cent r.m.s. harmonic distortion.

The heart of this system is the automatic means for suppressing the fundamental. The criterion of dependability was set for this device and led to the selection of mechanically switched filters having a steeply sloping high-pass characteristic. The ones used are 600-ohm, single-ended, *m*-derived, toroidal networks, each being padded out with resistance pads so that all the filter sections have the same insertion loss. Each of these filters is designed to work for half an octave, thus requiring fourteen of them to cover the range 40 to 15,000 cps. The point at which each of these high-pass filters is switched into the line is determined by the output of one of fourteen sharply selective bridged-T networks. These networks are tuned to the point at which the filters should be switched, and as the null frequency of the bridged-T is passed, a switching relay is closed and this in turn operates a stepping switch which does the actual switching of the high-pass filters.

The system is particularly adapted for loudspeaker measurements where continuous plots are needed to obtain information of real value.

LC Oscillator Stability

Tesla Technical Reports for December 1949 carries a thorough study of the oscillator stability problem under the title "LC oscillators and their frequency stability."

The frequency stability of an LC oscillator is controlled not only by the designed LC elements, but also by the variations in interelectrode capacitance with varying tube potentials, and variations in *Q* and transconductance.

These considerations lead to the design criterion that the plate and grid of the oscillator tube should be connected to points on the tuned circuit that are at low impedances as are consistent with the maintenance of oscillation. Oscillators of high stability have been developed which in general meet the conditions imposed, and include those of Gouriet, Clapp, Lampkin, and Seiler.

In analyzing these oscillators it is determined that the Clapp oscillator is very simple, but must be limited to a tuning range of 1:1.2 for any one set of component values. The circuits of Seiler and Lampkin have a tuning range of about 1:1.8, and all three circuits are exceptionally stable.

In order to extend the tuning range, O. Landini in Italy, and Tesla National Corporation in Czechoslovakia developed a circuit of high stability with a tuning range of 1:2.5. It combines the principles of Seilers circuit and that of the cathode follower oscillator.

A complete analysis of the circuit is given and the computation of the stability at various frequencies is carried out.

DANISH PLAYBACK MACHINE

[from page 40]

ing and tape-manufacturing processes are available as yet, the inventor's representative claims that recording costs are comparatively low, even though relatively few copies are required. Teflon transcriptions can be offered at attractive prices, but the main stress will be

laid on commercial exploitation of the new recording technique. Contracts are said to have already been made with a number of artists and conductors for recording of commercial tapes for mass-production as soon as a substantial number of Teflon players have been put on the market. The "tape-gramophone" may be used in connection with any ordinary broadcast receiver.

While not yet confirmed by backers of the new system, it is expected that a turntable and an ordinary pickup may be added to the Teflon player to bridge the gap between disc and the new player.

Floating Action!

for all TV Cameras

"BALANCED" TV TRIPOD

Pat. Pending

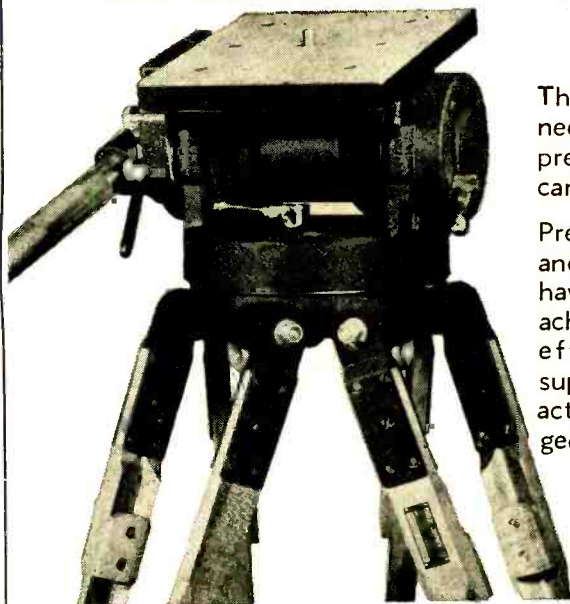

This tripod was engineered and designed expressly to meet all video camera requirements.

Previous concepts of gyro and friction type design have been discarded to achieve absolute balance, effortless operation, super-smooth tilt and pan action, dependability, ruggedness & efficiency.

Below:

3 wheel portable dolly with balanced TV Tripod mounted.

Complete 360° pan without ragged or jerky movement is accomplished with effortless control. It is impossible to get anything but perfectly smooth pan and tilt action with the "BALANCED" TV Tripod.

Quick-release pan handle adjustment locks into position desired by operator with no "play" between pan handle and tripod head. Tripod head mechanism is rustproof, completely enclosed, never requires adjustments cleaning or lubrication. Built-in spirit level. Telescoping extension pan handle.

Write for further particulars

CAMERA EQUIPMENT CO.
FRANK C. ZUCKER
1600 BROADWAY NEW YORK CITY

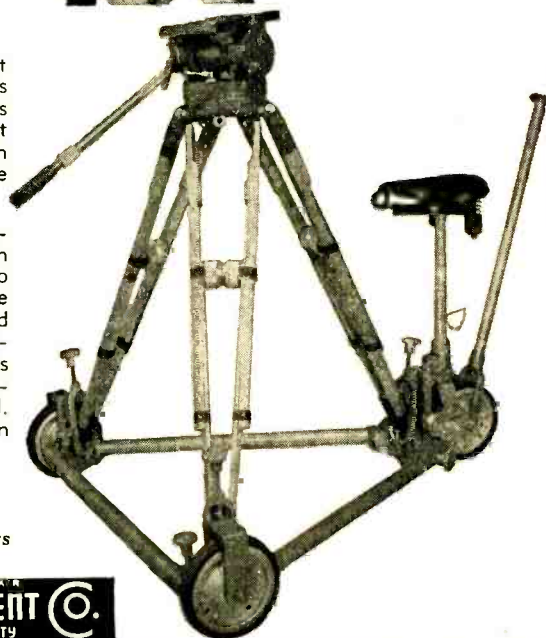

• **ATTENTION** •

Tape Editors — Sound Men

NEW* TAPE SPLICER

"EDITALL"

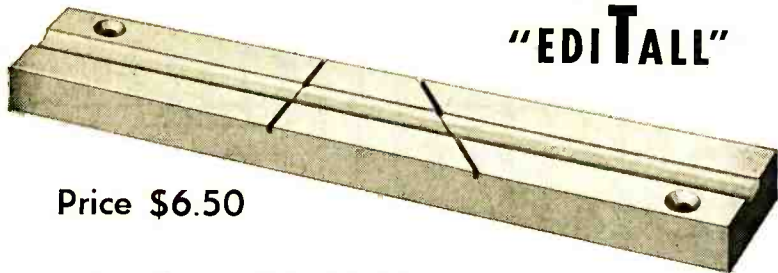

Price \$6.50

A new* tape splicing block has been developed by CBS's famous tape editor Joel Tall and recommended by the Minnesota Mining & Mfg. Co. This new precision Dural block will make a PERFECT SPLICE FASTER and is less tiresome to work with. Send for one today while still available. Manufactured exclusively by:

TECH LABORATORIES, Inc.

Box 148, Palisades Park, N. J.

New York Dist. Harvey Radio Co.

* Pat. applied for

LETTERS

[from page 12]

Transient response is determined by two performance factors—overshoot and rise time—if we may apply pulse-circuit theory. A speaker that is said to have excellent transient response on the basis that it develops no overshoot may achieve this by excessively heavy friction damping or excessive compliance, which in turn results in high-frequency cutoff and a slow rise time. Thus a highly damped speaker may not have any noticeable overshoot, but it cannot faithfully reproduce the steep wavefronts of percussive signals and will reproduce a square-wave as a distorted trapezoid.

If we speed up the rise time, we have excessive overshoot; if we reduce the ringing, we lose out on response speed. Truly a design dilemma. Using pulse-circuit theory, it can be shown that series-shunt juggling of the three mechanical circuit parameters and by holding them down to the lowest practical limits can give a wide bandwidth with a fairly linear phase shift at the high-frequency end. By holding down the frictional damping to the lowest possible level and allowing a few per cent of controlled overshoot, a fast rise time and wide bandwidth is achieved at the expense of a bit of transient distortion. On this basis, a single-cone, wide-band, low-distortion speaker appears to be out of the question.

Ted Powell,
42 Nassau Road,
Great Neck, New York

We're not saying AUDIO ENGINEERING is a MUST

You could undoubtedly live without it if you had to.*

BUT our many readers think of AE as a sort of institution, a necessity for their interests and way of thinking. Our readers tell us they think AE is worth its price and much more.

IF YOU ARE interested in Audio (and who isn't, these days?), you know that AE IS THE ONE MAGAZINE DEVOTED TO AUDIO AND NOTHING BUT AUDIO.

IF YOU WANT to know what is happening in your field of work or how to better the sound equipment you are making for your living room, you'll want every issue of AE.

SO, before you miss one of the stimulating issues we have scheduled for the winter months ahead, fill out the coupon below. That one back issue you need most is generally sold out.

* At last count, only one subscriber had widowed his wife because he forgot to renew his subscription.

AUDIO ENGINEERING

342 Madison Avenue, New York 17, N. Y.

Enclosed is my check money order for \$..... for my subscription to AUDIO ENGINEERING FOR 1 yr 2 yrs.

Subscription Price in U. S. A. and Canada and Pan American Union: 1 yr—\$3; 2 yrs—\$5. Add \$1. per year for foreign subscriptions.

Name (please print)

Address

City Zone State

Occupation (give title and department)

Firm name

MUSIC and MASS PRODUCTION

[from page 23]

are not enthusiastic about their jobs and often change employers to attain a degree of variety in equally monotonous jobs; they constantly watch the clock in order to rush away from their machines for rest periods or for departure from the plant; they are careless, causing accidents and delays that may slow down or halt production; they are nervous and restless; the quality of their work is poor; and they tend to absent themselves from their work.

With the ever increasing mechanization of modern industry fewer and fewer jobs requiring the slightest amount of mental activity are available. To make jobs interesting, music has often been applied successfully, and results similar to those obtained at Lily-Tulip are to be found in many parts of the national economy.

From the material presented so far, several conclusions may be drawn:

1. Music is of use only in monotonous jobs such as in repetitious assembly work, which is the basis of interchangeable manufacture (mass production).

2. Music is beneficial only where the intelligence level of the workers does not deem it to be a distraction.

Whenever music is used certain things

happen in the individual that affect his work. Extensive work on the subject by Diserens⁵ reveals.

1. Music tends to reduce or to delay fatigue and consequently increases muscular endurance.

2. Music has no definite effect on accuracy or precision of movement, if the movement is not adapted to the rhythm of the work.

3. Music speeds up such voluntary activities as typewriting and handwriting. It also accelerates respiration.

4. Music increases the extent of muscular reflexes employed in writing, drawing, etc.

5. Music seems to have a tendency to reduce the extent of illusions by acting as a distracting factor.

Burris-Meyer⁶ conducted a series of experiments demonstrating the efficacy of music as an aid to production by the application of the principles mentioned above. His results are shown in Fig. 1. Note that music impedes the effects of fatigue for most of the working period, but does not delay it indefinitely.

Up to this point the effect of music upon individuals only has been discussed. Modern industry depends upon teamwork and group action for its tremendous productive output. It is here that the phenomenon of empathy—defined psychologically as the principle of kinesthetic appreciation—becomes of importance. An example will illustrate the principle. The author attended a concert during the summer at Lewisohn Stadium in New York City when Brahms' First Symphony was performed. Out in the open, the ordinary restraints of the concert hall are not present and the audience expressed itself vocally when it has the emotional urge to do so. The beginning of the fourth movement is dramatic and somber; it rises to a highly emotional level and then becomes extremely lyrical. At this point the audience does feel bound by musical convention and "releases itself" by humming the main melody *en masse*. Music is seen, through the principle of empathy, as a means of bringing together in spirit a large group of people, provided they have the same taste in music.

The keynote of industrial music is variety and anticipation. "... expectation helps to create a favorable frame of mind. The thoughts of the workers, instead of being directed to long monotonous periods of drudgery, are diverted by anticipating the music."⁷ When music is played in industry it is not used continuously because it would become a part of the surroundings and would have no effect upon production. It is played intermittently (see Fig. 1 for a typical schedule) and in that way helps

⁵ Charles M. Diserens, "The Influence of Music on Behaviour." Princeton Univ. Press, 1926.

⁶ Barbara E. Benson, "Music and Sound Systems in Industry." New York: McGraw-Hill, 1945.

⁷ L. E. Broome, "Music while you work." *Indus. Welfare and Pers. Mgt.*, May-June, 1942.

Air-Tone

HEADQUARTERS
FOR
Magnecord.



↑ **MAGNECORD PT6-JAH
RECORDER & AMPLIFIER**
Complete Systems from \$564.00

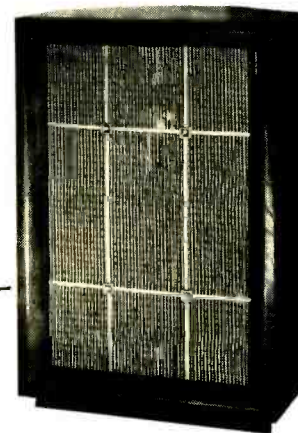

→ **ARISTOCRAT SPEAKER**

Direct front radiation of high frequencies for 12" full range driver. At least 1 full octave of added base range at full efficiency. Mahogany finish. Immediate delivery—in stock NET PRICE... \$59.70
SAME IN BLEACHED BLONDE FINISH
Immediate delivery—in stock NET PRICE... \$63.60

Air-Tone

**HIGH FIDELITY SYSTEMS
ON DISPLAY
AT OUR SHOWROOMS**

SOUND & RECORDING COMPANY
1527 CHESTNUT ST., PHILA. 2, PA. — RI. 6-8388

ANNOUNCING

Unusual Opportunities in SOUTHERN CALIFORNIA

Senior men with degrees and several years of proven accomplishment may achieve further personal growth by working with some of the nation's outstanding scientists in the West's largest laboratories.

CHALLENGE AND OPPORTUNITY

for physicists and engineers in the fields of electron tubes, computers, precision electronics, solid state, system analysis, servo-mechanisms, radar, guided missiles, microwaves.

HUGHES LABORATORIES OFFER

- New Air-Conditioned Buildings With the Finest Modern Laboratory Facilities and Equipment.
- Solid Long-Range Plans For a Continuing Future.
- Intriguing Vital Defense Projects Plus a Strong Program For Advanced Development of New Peacetime Products.
- Company-Sponsored Program For Advanced Education.
- Excellent Employee Benefits.
- Frequent Salary Reviews.

AMPLE GOOD HOUSING AVAILABLE

Send Resume To
HUGHES RESEARCH AND DEVELOPMENT LABORATORIES
Culver City, Calif.

to add variety to the working day. The worker waits for the music, speculates as to what will be played, and wonders how long it will continue. Some plants vary the music schedule to avoid what psychologists call the "butter-butter effect." When a word or act is repeated excessively the individual attaches no significance to the word or act after a short time. If music is repeated at the same time every day during the year it does not have the desired effect upon production that it should have and becomes a waste of time and money on the part of management.

The employee reactions mentioned in

the first paragraph of this article are not the result of the application of only one factor to the production process, and it must be remembered that music is only one factor. Mayo⁸ has shown that any change in working conditions that signifies to the worker that management has his interest at heart will increase production. Music is a welcome change in the work atmosphere that will remain for a long time and will help to bring beneficial results if not misused.

⁸ Elton Mayo, "The Human Problems of an Industrial Civilization." New York: Macmillan, 1933.

OVER **9000** COPIES SOLD
AND **STILL GOING STRONG!**

audio anthology

Paper cover . . . \$2.00

Distributors write for quantity discount

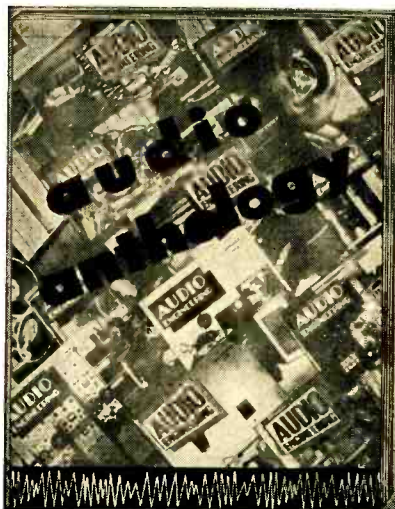

The long awaited compilation of reprints from early issues of AUDIO ENGINEERING, most of which are unobtainable.

Contains 37 articles on the following subjects:

- Amplifiers
- Speakers
- Noise Suppressors
- Phonograph Equipment
- Tone and Loudness Controls
- Dividing Networks

These articles have been of great interest to readers of AUDIO ENGINEERING over the past three years. Assembled in one volume, they comprise the most authoritative reference work for the audio hobbyist.

-----CUT OUT-----MAIL TODAY-----

Book Division, Dept. A9
Radio Magazines, Inc.
342 Madison Ave., New York 17, N. Y.

Sirs: Enclosed is my check money order for _____ copies of the Audio Anthology.

Name (print carefully)
Address
City Zone State

BASS-REFLEX CABINET

[from page 19]

this equation, the air in the tunnel moves vigorously, while a high impedance is presented to the walls of the enclosure where the speaker is mounted. It will be noted that the characteristics of the speaker itself do not enter directly into the equations at all, although for optimum results, ω should be equal to 2π times the resonant frequency of the speaker used and R should be equal to the radius of a piston equivalent to the speaker cone.

Tunnel Location

Practical cabinets have the tunnel inside the cabinet structure and the volume of the tunnel, R^2L , should be added to the volume V to obtain the total volume. In this case:

$$V' = \pi R^2 \left(\frac{C^2}{\omega^2} \times \frac{1}{1.7R + L} + L \right) \quad (5)$$

The velocity of sound C is 1130 feet per second or 1.356×10^4 inches per second at a temperature of 20° C.

If all dimensions are expressed in inches

$$V' = \pi R^2 \left[\frac{1.84 \times 10^8}{\omega^2} \times \frac{1}{1.7R + L} + L \right] \quad (6)$$

and this expression has been plotted for various practical values of R , L and f . Figure 1 shows V' , L , and f when $R = 4$ in. (10-in. speaker) and Figs. 2, 3, and 4 the corresponding values for 12-, 15-, and 18-in. speakers.

The volume occupied by the speaker itself is not included in V' , and must be added to this factor or subtracted from the cabinet volume (if this is already fixed) to obtain V' before L and f are read off. There are two advantages in making L reasonably large: (1), the cabinet volume for a given resonant frequency becomes less as the tunnel is lengthened; and (2), as the mass of air in the tunnel is increased, the proportion of the mass reactance due to the outside air load on the vent is less, and the resonant frequency of the cabinet depends less on its position in the room. The assumption that the vent is radiating into semi-infinite space is usually incorrect and though the errors are not large the use of a long tunnel reduces them.

Tunnel Length

The length of the tunnel is limited by three factors. First, it must be short compared with a wavelength at the resonant frequency. Second, it must not approach the back wall of the cabinet so closely as to restrict the circulation of air (a distance equal to R is advisable). Third, after a certain point there is no advantage in increasing the tunnel length, since the decrease in unoccupied volume of the cabinet eventually causes the resonant frequency to rise again.

On differentiating equation (6) above,

it is determined that the cabinet has a minimum volume when:

$$L = \frac{C}{\omega} - 1.7R. \quad (7)$$

This becomes:

$$L = \frac{2160}{f} - 1.7R$$

if dimensions are expressed in inches.

In general it will be possible to use this optimum tunnel length only for large speakers with a high resonant frequency. In other cases the tunnel will not be short compared with a wavelength. The dotted line on each set of curves represents the point at which the length of the tunnel reaches 1/12 of a wavelength and points on the main curves to the right of this line should not be used.

The tunnel need not, of course, be round. Any shape will do if its cross-sectional area is πR^2 .

Figure 5 shows elevation, plan, and sectional views of a correct reflex cabinet of about 8,000 cu.ins., designed for use with the Goodmans Axiom 12-in. speaker which has a bass resonance of 55 cps. The cabinet is constructed of 1-in. plywood and lined with soft felt 1-in. thick. It combines good performance with an appearance that is not out of place in the home.

Conclusion

The foregoing data has been prepared bearing in mind the over-all results which may be expected from the completed instrument and it is not out of place to stress the importance of the choice of speaker. This choice is affected not a little by the need for a unit with good top response, in the absence of a separate high-frequency speaker. It is of interest to note that, in such a correctly arranged system, the response to transients is considerably improved as a result of the increase of mechanical resistance due to the correct air-loading of the speaker.

In this latter connection it should be borne in mind that the actual reproduction of transients from any loud-speaker is largely affected by the room in which it is placed, quite apart from any other consideration. That is to say, the room usually has a period of reverberation which is very much longer than that of the speaker so that, in practice, quite large deficiencies in this respect on the part of the speaker may be of small moment, in unfavorable situations.

AUDIO PATENTS

[from page 4]

dual rectifier tube used for muting. (The term is borrowed from Solovox nomenclature, where these tubes were used for the same purpose.) The waveform of Fig. 3 is symmetrical, which means it is composed entirely of odd harmonics; this makes it suitable to imitate woodwinds. When the muting rectifier chops off the positive peaks, even harmonics become apparent as well and the tone is better suited for string, brass, and other sounds. Normally the

Finest in Audio Recording Reproduction

MODEL 300

...Every Ampex Model 300 is guaranteed to meet published specifications • Every Ampex Model 300 is guaranteed to give uniform performance • Precision manufacture assures quick interchangeability of parts • Model 300 is the recognized leader in the field of High Fidelity Recording.

Precision  Performance

Write for complete specifications today.

AMPEX
Magnetic Tape
RECORDERS

AMPEX ELECTRIC CORPORATION
Redwood City California

STANDARD OF THE GREAT RADIO SHOWS

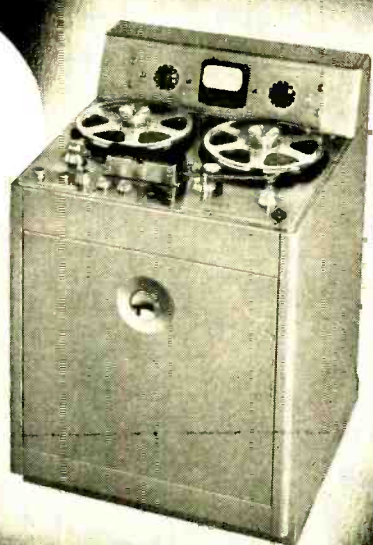

TOROIDS & FILTERS



Toroidal Powder Iron Cores in a wide variety of types and sizes for use over a broad range of frequencies.

Wound Toroidal Coils available with taps and multiple windings; cased or uncased according to your specifications.

Electric-Wave Filters of low-pass, high-pass, band-pass and band-rejection types. Response characteristics and housings to your specifications. Hermetically-sealed units illustrated.

Let Lenkurt help with your special core and coil problems; write:

Lenkurt

LENKURT ELECTRIC CO.
SAN CARLOS • CALIFORNIA

SAVE
33 1/3%



This is our
GROUP SUBSCRIPTION PLAN

You and your friends and co-workers can now save up to \$1.00 on each subscription to AUDIO ENGINEERING. The more men in a Group, the more each saves. If you send 6 or more subscriptions for the U.S.A. and Canada, they will cost each subscriber \$2.00, 1/3 less than the price of a regular 1-year subscription. **Present subscriptions may be renewed or extended as part of a Group.**

AUDIO ENGINEERING is still

- The only publication devoted entirely to Audio—
- Recording
- Broadcasting equipment
- Acoustics
- Home reproduction systems
- PA systems
- Psychoacoustics

(Please print)

Name
Address
Position Company

Name
Address
Position Company

Name
Address
Position Company

Name
Address
Position Company

Name
Address
Position Company

Name
Address
Position Company

Add \$.50 to each Foreign subscription ordered

RADIO MAGAZINES, INC.
342 Madison Ave., N. Y. 17, N. Y.

mute tubes' cathodes are grounded by the arm of switch S_{w2} , and the diodes produce the tone of Fig. 4. When S_{w2} is thrown to the dotted-line position, the positive voltage of the cathode-bias arrangement R_4-C_3 is applied through isolating resistor R_5 to the diode cathodes and conduction stops, so that the outputs of the dividers retain their original form as in Fig. 3. R_5 is an attenuating resistor to compensate for the volume rise when the diodes are disabled.

The stop switches are used to select whatever octave or octaves are desired for best artistic effect, and the combined tones are fed to a preamplifier tube. The plate

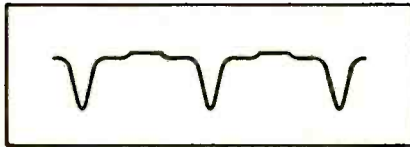

Fig. 4

load for the preamplifier is a series of $L-C$ and $R-C$ filters (just as in the Solovox) which can be switched in and out in combination to achieve different tone qualities. From here the tones go to the primary of an interstage transformer.

The transformer secondary feeds the grids of a pair of push-pull volume-control tubes. The arrangement, with the addition of a few small gimmicks, such as a provision for percussive as well as sustained volume envelopes, is the same in principle as in the Solovox and is thoroughly described in the patent.

Keying and volume control are dependent on the performer's voice volume. An additional lead from the output of the original sloping-response amplifier is fed to the grid of amplifier tube F_{10} , which supplies excitation for a full-wave rectifier. As the volume of the voice increases the rectifier puts out more positive voltage, which is fed to the centertap of the interstage transformer that supplies signal to the control stage grids. As the voltage becomes more positive, the output of the control stage increases; thus the performer's voice volume controls the output volume of the instrument.

This stage also controls keying. The control stage is normally at cutoff bias. As voltage from the rectifier comes to the grids, the cutoff bias is overcome. This is an especially good arrangement for reproducing normal musical attacks rather than depending on the attack characteristics of a fixed time-constant network.

The tube labelled *special* is used to create a percussive type of attack, and the switches not mentioned in and around the control stage are for more special effects.

Readers who would like more details on this circuit are referred to the patent, which, like all other U. S. patents, is available for 25 cents from the Commissioner of Patents, Washington 25, D. C. The circuits are fully explained, though no component values are given. To forestall any flood of mail to the Hammond company inquiring about circuit details or production plans, let us add that Mr. Hanert has already been queried and has replied—understandably—that it is Hammond policy not to disclose any future production plans or laboratory data relative to instruments yet to be produced commercially. Hammond holds a good many patents which it has not developed commercially. Whether or not this one will be it is impossible to say. But there is no doubt that it is the kind of new idea that will find a good home in many imaginative minds.

CLASSIFIED

Rates: 10¢ per word per insertion for noncommercial advertisements; 25¢ per word for commercial advertisements. Rates are net, and no discounts will be allowed. Copy must be accompanied by remittance in full, and must reach the New York office by the first of the month preceding the date of issue.

NEW WILLIAMSON AMPLIFIER—finest components, two chassis, power for pre-amp. Dr. Paul R. Nicely, Theatre Bldg., Kenton, Ohio.

SPECIAL SALE! PICKERING Diamond Stylus LP Cartridges, \$30. Only one to a customer. Skalamera, 435 E. 74th St., New York 21, N. Y. BU 8-2057.

SELL: UTC LS-61, new, \$17. Updike, Thornton Hall, University, Virginia.

WANTED—Jim Lansing h-f horn, model D-175H. Also Electro-Voice speaker, model 18W. Crossover networks, Belling, 4484 30th St., San Diego 16, Calif.

THE AUDIO EXCHANGE invites you to buy or sell tuners, amplifiers, record changers, recorders, etc. of high quality in perfect condition. John Colbert, 85-08 168th Place, Jamaica 3, N. Y.

FOR SALE: All in good condition—RCA 77D microphone, \$100; two Presto 92A recording amplifiers, \$245 each; two Presto 1D cutters, \$100 each. James Carroll, 58-30 80th St., Elmhurst, L. I. Tel HA 6-3984.

SELLING OUT PRIVATE STOCK. Radio Craftsman RC-10, \$105; Pickering diamond pickups (standard and microgroove) \$50; Stephens super high frequency tweeter, Model 107, with crossover, \$30. Above are all brand-new, unused. F.O.B. New York, money orders only, please. R. Bennis, Box CS-1, AUDIO ENGINEERING.

PRESTO 90—A three-channel recording and playback amplifier. Original cost \$500.00, will sell for \$250.00. Reco-Art, 1305 Market Street, Philadelphia, Pa.

No merry-go-round or ferris-wheel, but you'll have a wonderful time at

THE AUDIO FAIR

Nov. 1, 2, 3, 1951

Hotel New Yorker
New York City

You are most cordially invited!

PROFESSIONAL DIRECTORY

C. J. LEBEL

AUDIO CONSULTANT

Development, Test, Custom Equipment,
Complete Laboratory and Shop Facilities

133 WEST 14TH STREET
NEW YORK 11, N. Y.
CH 3-8082

Custom-Built Equipment

U. S. Recording Co.

1121 Vermont Ave., Washington 5, D. C.
LIncoln 3-2705

NEW LITERATURE

● **Shure Brothers, Inc.**, 225 W. Huron St., Chicago 10, Ill., is now issuing Replacement Manual No. 66 which lists over 1500 phonographs and radio-phonograph combinations, together with the Shure model number for each cartridge replacement. In addition to current models, listings go back as far as 1938 and include 123 manufacturers.

● **A-V Tape Libraries, Inc.**, 730 Fifth Ave., New York 19, N. Y., will mail free on request a copy of its initial catalog which lists selections available in the Company's library of music pre-recorded on magnetic tape. Along with titles are shown prices, which vary with playing speed and between single- and double-track recordings. A virtual must for all owners of tape equipment.

● **Magnecord Inc.**, 360 N. Michigan Ave., Chicago, Ill., has available a new illustrated catalog describing tape recording equipment for professional use, and introducing the firm's facilities for building equipment for unique applications. A special page is devoted to accessories such as special switches, adaptor panels, and spooling mechanisms. Booklet, together with a price sheet, will be mailed on request.

● **Centralab Division of Globe-Union Inc.**, 900 E. Keefe Ave., Milwaukee 1, Wis., is now issuing what is said to be the world's first Printed Electronic Circuit Replacement Guide for service engineers. Listed are 269 printed circuit plates as used by 69 manufacturers. Replacements are selected from a cross-reference chart which designates the Centralab catalog number for the original manufacturer's part number. Only 19 stock units are required to cover replacement requirements. Free copies available from Centralab distributors or by writing direct to above address.

● **Engineering Products Department, Radio Corporation of America**, Camden, N. J., has released a handsome booklet illustrating and describing the RCA Type RT-11A basic magnetic tape recorder, Type RT-12A console equipment, and custom-built recording and editing combinations for professional application. Accessories, such as remote-control units, metering panels, and vacuum equipment for cutting and splicing, are also covered. Because this equipment is entirely professional in nature, catalog distribution is limited to professional users and must be requested on company or station letterhead.

● **Standard Transformer Corporation**, 3594 Elston Ave., Chicago 18, Ill., is now distributing to the trade its mid-year catalog listing 441 Stancor transformers and related components. All listings contain electrical specifications, dimensions, weight, and list price. Illustrations show each mounting type in detail.

● **Sylvania Electric Products, Inc.**, Emporium, Pa., has recently completed a revised edition of the Sylvania Technical Manual in a new snap-open loose-leaf format. The manual now contains comprehensive technical data on 500 receiving tube types, including standard TV picture tubes. New data sheets on future tubes will be supplied to manual owners through the "Sylvania News." Included also in the manual are 84 pages of general information on vacuum tube operation. Priced at two dollars, the manual may be obtained from Sylvania distributors, or by remitting direct to the address shown above.

● **Keithley Instruments**, 1507 Warrensville Center Road, Cleveland 21, Ohio, has issued a 4-page bulletin illustrating and describing the Model 102 Phantom Repeater, a bridging amplifier for test instruments with unusually high impedance input. Titled "Quantitative Measurements on High Impedance Circuits," the bulletin includes, in addition to technical specifications, four excellent drawings which show the repeater in practical laboratory usage.

● **Superior Electric Co.**, Bristol, Conn., with its new Bulletin S351, has produced a catalog which adds distinct credit to the field of industrial publishing. Devoted to the company's line of Stabiline automatic voltage regulators, the bulletin is complete in every detail. Concisely drawn circuit diagrams and exceptionally fine illustrations combine with well-prepared text to make this a truly outstanding industrial catalog. May be obtained by writing the Company.

Audio **NEW** Intermodulation Meter and Set HIGHEST PROFESSIONAL FLEXIBILITY at Reasonable Cost!

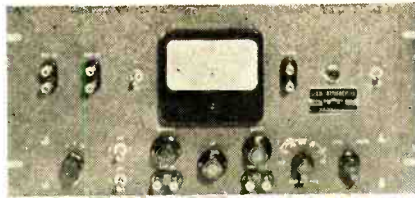

Model 165 IM Meter is especially suited for laboratories, broadcasters, recording studios. Has signal generator, analyzer, voltmeter in single compact case. Reads %IM, amplifier output directly on meter. Provides for use of oscilloscope to analyze and cure IM causes: full graphic instructions supplied. Wide range of low & high test frequencies: 60 cps internally, 40-200 cps externally; standard 2, 7, 12 kc internally, 2-20 kc externally. Only 0.1% residual IM due to accurate bridge-type mixing circuit for 2 tones & special analyzer wave filters. Voltage ratio choices: for LF testing, 4:1; for more accurate HF testing, 1:1. 8 1/2" x 19" rack-type panel; 8 1/2" deep. Price \$250.00.

With **Model 162 IM Set** and your own audio oscillator and oscilloscope, you measure %IM in any pickup, amplifier or system directly on your scope image-in just seconds. Identify wrong bias, wrong load Z, tube unbalance, regeneration, insufficient drive capacity, etc. Complete with graphic instructions for adjusting equipment for best performance. Price \$88.50.



WRITE NOW FOR CATALOG A

Audio INSTRUMENT COMPANY
Dept. T, 133 W. 14th St., N. Y. 11, N. Y.

NEED BACK ISSUES?

- | | |
|-----------------------------------------|-----------------------------------------|
| <input type="checkbox"/> June 1949 | <input type="checkbox"/> July 1950 |
| <input type="checkbox"/> September 1949 | <input type="checkbox"/> August 1950 |
| <input type="checkbox"/> December 1949 | <input type="checkbox"/> September 1950 |
| <input type="checkbox"/> January 1950 | <input type="checkbox"/> March 1951 |
| <input type="checkbox"/> February 1950 | <input type="checkbox"/> April 1951 |
| <input type="checkbox"/> March 1950 | <input type="checkbox"/> May 1951 |
| <input type="checkbox"/> June 1950 | <input type="checkbox"/> June 1951 |

1949 issues—\$1.00 each, 1950 issues—50¢ each, 1951 issues—35¢ each

Payment must accompany order.

Circulation Dept., Audio Engineering, 342 Madison Ave., N. Y. 17, N. Y.

GOOD NEWS TO MUSIC LOVERS — EXTRA PROFIT TO YOU

BELL Custom HIGH FIDELITY AMPLIFIER

with complete Remote Control

Model 2145-A

This unique, new Bell High Fidelity Amplifier adds the master touch to any type built-in or custom audio system. Its remote controls, in an attractive unit for table or console mounting, are amazingly selective. Include single selector for phono—AM, FM radio (or TV), all domestic and foreign records, 78, 45, and 33-1/3 rpm; also compensated volume control; plus smooth, continuously variable bass and treble with boost and cut. All-triode amplifier, 30 watts maximum, reproduces sound at all levels, naturally clear and life-like.

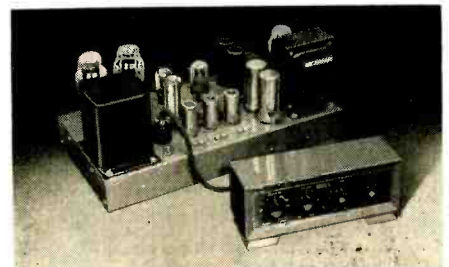

Frequency response plus or minus .25 db to 20 to 30,000 cycles. Distortion at normal listening levels is less than .2 of 1%. Elements can be separated 5 to 25 feet with only .1 db loss at 20 kc. All inputs (3 phono, 1 mike, 2 radio) connect directly to the main amplifier. For more details, write.

Also Ask About Bell's lower cost Hi-Fi Amplifier Model 2122-A.



BELL SOUND SYSTEMS, INC.

599 Marion Road, Columbus 7, Ohio
Export Office: 4900 Euclid Avenue, Cleveland 3, Ohio

SELECTED IMPORTS FROM ENGLAND

PRICES QUOTED ARE NET DUTY PAID, DELIVERED TO ANY ADDRESS IN AMERICA, GENERALLY FROM STOCKS HELD IN WASHINGTON, AND ARE SUBJECT TO CHANGE.

ADVANCE AUDIO GENERATOR

SINE AND SQUARE WAVE, 15 to 50,000 cps $\pm 1\%$ or 1 cps in 3 ranges. Output SINE-WAVE 20 μ v. to 20 v. ± 1 dB, under 1% distortion. SQUARE WAVE 40 μ v. to 40 v. with rise to 90% of peak in 3 μ secs. This generator has the performance of many costly laboratory instruments.

Price \$110.00

BAKERS SELHURST LOUD SPEAKERS

These speakers, long famous in England, now offered for first time in America. TWELVE INCH "TRIPLE CONE." Owing to the special arrangement of three cones in one, the simple cloth peripheral suspension, and the powerful magnetic flux of 14,000 to 15,000 lines per square cm., this speaker gives an unusually well balanced response from about 20 to about 15,000 cps at inputs of 10 W.

Price \$40.00

EIGHTEEN INCH "DUPLEX" 20 to 8,000 cps for use as a bass reproducer in multiple speaker systems or for large auditoria, supplied with corrugated suspension for 30 W. Input or cloth suspension for 15 W. Input.

Price, corrugated \$60.00, cloth \$63.00

PARTRIDGE OUTPUT TRANSFORMERS

Recognized as unequalled for high-quality amplifiers and are designed to develop the full merits of the WILLIAMSON amplifier circuit.

Model WWFB Price \$25.00
Model CFB Price \$35.00

COMING SHORTLY WILLIAMSON AMPLIFIERS AND CONTROL UNITS

Custom Built in London

"WILLIAMSON" amplifier, Model KT66DBS/CFB. Includes Partridge CFB output transformer, separate power supply for control unit or tuner, KT66 output tubes and selected components fully tropicalized. Model KT66/WWFB is of the same construction, omitting separate power supply and using Partridge WWFB output transformer.

WILLIAMSON CONTROL UNIT. Although virtually unknown in America, this preamplifier/equalizer is of very advanced design. It embodies source selector (AM-FM PHONO TAPE) ON/OFF switch controlling all associated apparatus, switch selecting any of six phonograph input characteristics to suit record response and crossover, volume control, bass and treble tone controls ± 17 db, five-position switch controlling "T" network, providing optional cutoff approximately 40 db per octave at about 4,000, 6,000, 8,000 or 13,000 cps (or no cutoff).

WIRELESS WORLD PUBLICATIONS

"The Williamson Amplifier" 30-page manual \$1.00

Annual subscriptions to Wireless World \$4.50

Manufacturers Requirements IN CLOSE TOLERANCE CAPACITORS and resistors for high-frequency applications, filters, and instruments (wholesale only), particulars on request.

For Orders or Further Information apply

BRITISH RADIO INDUSTRIES
IMPORTING AGENCY
ONE THOMAS CIRCLE, WASHINGTON 5, D. C.

Heads Magnecord Engineering



Otto C. Bixler is the new director of engineering for Magnecord Inc., manufacturer of professional tape recorders. At one time associated with the electrical research products division of Western Electric, Bixler is credited with development of the first professional magnetic recording system sold to major motion picture studios.

Magnecord recently has established a new engineering development laboratory in Chicago, which will be under Bixler's direction.

Tape Library Pioneer

Credit for preparing and merchandising the first library of magnetic tape recordings for retail distribution to music lovers goes



to Charles E. Rynd, Chairman of the Board of Directors of A-V Tape Libraries, Inc.

In his position as head of A-V, Rynd brings to focus a broad experience in the audio field. Educated at M.I.T., he rose to the position of vice-president of the American Broadcasting Company, resigning to engage in his present activity.

O'Bryan Joins Sylvania



Appointment of Dr. Henry M. O'Bryan as manager of the company's Physics Laboratories was announced recently by Sylvania Electric Products Inc.

Dr. O'Bryan has served as instructor in physics at Johns Hopkins University, Harvard University, and at M.I.T.

Prior to joining Sylvania he was in an executive post with the Research and Development Board in Washington.

**NOW...
CUSTOM QUALITY**
enters low price field



CLARKSTAN MAGNETIC PICKUP

At last a quality variable reluctance, balanced armature magnetic pickup is available at low cost. The Clarkstan Model 204 features removable and replaceable stylus, weighs one-half ounce and plays all popular makes of record changers having standard mounting holes $\frac{1}{2}$ " between centers. It is encased in a beautiful transparent case $1\frac{1}{2}$ " in overall length. It is velocity responsive (flat ± 2 db) from 50 cps to 12,000 cps, and delivers .030 volt from the average record.

PRICE: #204 cartridge only with sapphire needle \$9.00 list
#204 cartridge only with diamond needle \$35.00 list

CLARKSTAN ELECTRONICS DIVISION 3-A
11921 W. PICO BOULEVARD
LOS ANGELES 64, CALIFORNIA

THEY ALL
Sound
BETTER WITH A



McIntosh
WORLD'S FINEST
AUDIO AMPLIFIER

50 WATT AMPLIFIER



50 WATTS
(peak: 100)
50W-2
\$249.50

Unequalled for quality reproduction of any sound source, the McIntosh is the most advanced amplifier of the day. Its unique, compact design offers: HIGHEST EFFICIENCY—over 65%; LESS THAN 1% DISTORTION AT PEAK POWER; DYNAMIC RANGE: OVER 70 db; FREQUENCY RESPONSE: 20-20,000 cps.



AE-2 Amplifier
Equalizer - \$74.50



20 WATT (peak: 40)
20W-2 - \$149.50

SEND FOR Free CATALOG Dept. A-2

McINTOSH Engineering Laboratories, Inc.
320 Water Street, Binghamton, N. Y.

DIAMOND NEEDLES

\$10⁵⁰
PLUS POSTAGE

No doubt you have learned by now that the needle in your record player is not permanent. It is tipped with either sapphire or osmium metal which should be changed after about 20 hours of playing, in order to protect your valuable records.

This means that if you use your record player on an average of an hour a day these needles need replacing about every three weeks at a cost of between \$1.50 to \$3.50. Because of this frequent needle changing you have of course learned how to install a new one when required. Why not, then, retip your present replaceable needle with a genuine diamond, one that will give you at least 1000 hours of high fidelity, distortion-free record playing pleasure with the comforting assurance that your costly records will remain undamaged—particularly those long-playing micro groove records, so finely grooved and sensitive to a worn stylus?

Send us your replacement needle assembly now—today. Let us retip it with the highest quality genuine diamond stylus—exactly the same kind that we make for leading radio stations the country over. Save the difference between \$10.50 for 1000 hours of playing and up to \$3.50 for 20 hours. And save also because you deal directly with the largest manufacturers of diamond styli for broadcasting stations in America, who are in a position to offer the lowest price available for diamonds of this quality.

Our diamond tips are unconditionally guaranteed and are made for LP or standard records. Send check or money order for \$10.50 plus 25¢ for return postage with your needle assembly or complete cartridge if you cannot remove the replacement needle assembly (except Pickering non-replaceable type) to:

THE TRANSCRIBER CO.

Diamond Styli Manufacturers

172-4 Green Street Boston 30, Mass.

TWIN-TRAX* TAPE RECORDERS



...give you more

MORE MODELS

the most complete variety of recorders for professional, semi-professional and experimenter use.

MORE FEATURES

for better quality, smoother performance and easier operation.

MORE VALUE

because our direct sales policy saves you dealer markups.

Send today for our catalog 5109 which lists complete technical specifications and performance ratings for all recorder models and accessories. *Trademark Reg.

AMPLIFIER CORP. OF AMERICA

398 Broadway New York 13, N. Y.

Industry Notes--

Operadio Manufacturing Company, St. Charles, Ill., has changed its name to **Dukane Corporation**. No change in ownership or personnel. **Federal Telephone and Radio Corporation** announces appointment of **Graybar Electric Company, Inc.**, as national distributor of railroad communications and signalling equipment. **International Tel and Tel** has purchased **The Coolerator Company, Duluth, Minn.** and plans to add white goods to its present radio and TV lines. **J. A. Maurer, Inc.** has been awarded impressive U.S.A.F. contract for volume production of specialized camera for use in jet fighter aircraft.

Newark Electric Company, Chicago, campaigning to eliminate confusion resulting from change of name of **Newark Electric Co., Inc. of New York to Hudson Radio and Television Corporation**.

Dow Corning Corporation amuses editors with cute letter informing "our customers, the water department, the telephone company, the paper boy, our ever-loving spouses, and the receptionist's boy friends" that the firm's new address is 600 Fifth Avenue, New York 20, N. Y. **United Paramount Theatres, Inc.**, has appointed **Dana W. Atchley, Jr.** as coordinator of technical research—duties to include development of new techniques in theater TV field.

Sylvania Electric Products Inc. has placed **Karel van Gessel** in newly created post of coordinator of foreign manufacturing affiliates. **Stronberg-Carlson Company** has leased building at 1225 Clifford Ave., Rochester for enlargement of Sound Equipment Division. **True Recorder Company, Detroit**, has bought out the pre-recorded roller rink tape business of **Tape Recording Industries, East Lansing, Mich.** New and larger headquarters offices now occupied by **National Association of Electrical Distributors** at 295 Madison Ave., New York City.

National Bureau of Standards has named **Nicholas E. Golovin** as Assistant Director for Administration. **Westinghouse Electronic Tube Division** has named **Harold G. Cheney** as sales manager.

Industry People--

Jerome T. (Jiggs) Keeney, sales engineer of test equipment for 35 years, has retired from his spot with **Simpson Electric Company** to begin a career of fishing in Florida. **Bill Dubilier**, founder of **Cornell-Dubilier Electric Corporation**, in Europe for confirmation of decoration bestowed by French government in behalf of his efforts toward French recovery after World War II.

Dr. Arthur E. Middleton placed in charge of research of dielectrics at **Battelle Institute, Columbus, Ohio**. **Irving Schawb**, formerly president of **Art Radio Corporation**, announces formation of **Atlas Tel-Rad Parts**, wholesale distribution firm.

Gordon Groth appointed executive vice-president of **Eric Resistor Corporation**. **Dr. C. J. Breitwieser** named executive of **P. R. Mallory & Co., Inc.** **P. M. Pritchard**, formerly director of sales for **Victor Electric Products Inc.**, appointed general sales manager for Parts Division of **Sylvania**. **John H. Cashman**, president of **The Radio Craftsman, Inc.**, elected chairman of the **Association of Electronic Parts and Equipment Manufacturers**.

Roy Neusch, director of **Harvey Radio Company Sound Department**, taking a month's leave at doctor's orders. **Frank Thornton, Jr.**, winner of the 1950 James H. McGraw award, retires from **Westinghouse** after 42 years of brilliant accomplishment. **Ovid Riso** elevated to vice-presidency of **Philco International**. **Dr. Ivan A. Getting**, gives up post as prof. of electrical engineering at M.I.T. to become vice-president of **Raytheon Manufacturing Company**. **Jerry Kelly** taking up new duties with **Teleflex sales division of Audio & Video Products Corporation**.

F. Sumner Hall, president of **Audio Equipment Sales**, rapidly becoming country's leading "impresario" in field of jacks and jack-strips. Engineers everywhere elated at appointment of **Frank Falknor** as vice-president of **CBS**—started as control operator at **WBBM, Chicago**. **"Moe" Morris** of **Altec Lansing** pinch hitting as technical expert while **Mel Sprinkle** is vacationing. **Irving Greene**, director of **Sun Radio Sound Department**, among mid-August fugitives from steaming-hot Manhattan. **Fred Thrower**, vice-president of **ABC** and prominent in audio field, back on the job after session with M.D.'s.

NO. 1 SOURCE

MILO RADIO



LEADING BRANDS

ELECTRONIC TUBES and EQUIPMENT

for **ALL BROADCAST and INDUSTRIAL APPLICATIONS**

—For IMMEDIATE DELIVERY!



PURCHASING AGENTS!

CHIEF ENGINEERS!

Send For This!

FREE 1053 PAGE MILO CATALOG!

Write today on your company letterhead for your copy of our gigantic buying guide—an invaluable aid in your purchasing. Completely illustrated, with technical specifications. Address Dept. A9.

The NATION'S GREATEST STOCK!
CONDENSERS • RESISTORS • TRANSFORMERS
CONNECTORS • SWITCHES • RHEOSTATS
RELAYS • PLUGS • JACKS • CHASSIS
TUBES, etc.

★ For PROMPT, PERSONAL ATTENTION
PHONE • WRITE • WIRE—or TELETYPE!

MILO-RADIO & ELECTRONICS CORP.

200 GREENWICH STREET, NEW YORK 7, N. Y.
Phone BEekman 3-2980 • Teletype NY1-1839



Plays all speeds

GARRARD

"Triumph"

WORLD'S FINEST RECORD CHANGER

Fully automatic with automatic stop
Easily installed in your present set.

Write for FREE literature

GARRARD SALES CORP., Dept. 9E
164 Duane St., New York 13

Gentlemen:
I am interested in learning what to look for when purchasing a 3-speed record changer. Please send me, without obligation, your FACT SHEET.

NAME
ADDRESS
CITY ZONE STATE



HIGH-FIDELITY ADVERTISING

Particularly during the past six months we have had many letters paying tribute to our sort of advertising. A few correspondents have an idea that we are more-than-average cunning, and that in the manner of the more adept confidence trickster we put over a real heart-to-heart story that, if it doesn't reduce you to tears, reduces you to handing out your hard-earned currency.

But everyone else seems to think it is a very pleasant change from the professional layouts which adorn the pages of this magazine.

We don't show a picture of the 215 speaker because we can send you a much bigger picture in our catalogue, but in the case of a speaker the picture doesn't tell the story. Only the speaker can do that, and all we aim to tell you is what inspired us to produce the 215 rather than some other speaker.

But don't forget that as we have been making speakers since 1927 we could design all sorts of speakers at all sorts of prices—and we were the world pioneers of the two-unit speaker—but experience taught us that the design of the 215 gave the nearest approximation to reality.

And because the design is what it is, the price is \$48.00, no more, no less. And at that price our customers tell us it out-performs all the others (with one possible exception at \$600). We thought it would, but what futility to say "the world's best speaker." It isn't what we think, but what YOU think that matters, and many of you think the 215 is wonderful.

Indeed, only the other day we got an order from a music-lover who said, "I enclose \$50.00; \$48.00 for one of your fabulous speakers, \$1.00 for your technical data service, and \$1.00 for goodwill." That's the way our customers behave, and we like it. It is up to us to behave in such a way that they like it.

So, then, like our speaker, our advertising is high-fidelity. Read over our back ads, and please do believe that every word we wrote we meant and believed, not because we were conceited about our products, but because our business was built on the simple proposition that if you have something worth talking about, speak the literal truth, or else you will be found out as a windbag. And we don't need a professional to tell us how to speak the truth.

A dollar bill brings you our technical data service and "New Notes in Radio." But we will send you a free catalogue if you feel that way.

Illustrated literature is free on request.

H. A. HARTLEY CO. LTD.

152, Hammersmith Road
London W.6, England

ADVERTISING INDEX

Air-Tone Sound & Recording Co.	45
Allied Radio Corp.	42
Altec Lansing Corp.	6, 42
Amperite Co., Inc.	4
Ampex Electric Corp.	47
Amplifier Corp. of America	51
Arnold Engineering Co., The	Cover 3
Astatic Corp.	35
Audak Company	31
Audio Devices, Inc.	Cover 2
Audio Fair, The	36
Audio Instrument Co.	49
Belden Mfg. Co.	5
Bell Sound Systems, Inc.	49
Bell Telephone Laboratories	14
Berlant Associates	52
British Radio Industries	50
Camera Equipment Co.	43
Chicago Transformer Co.	32
Clarkstan Corp.	50
Classified Ads	48
Concord Radio Corp.	40
Electro-Voice	37
Garrard Sales Corp.	51
Goodman Industries Ltd.	41
Gray Manufacturing Co.	3
Hartley, H. A. Co., Ltd.	52
Harvey Radio Co., Inc.	34
Heath Co., The	29
Hughes Research & Development Labs ..	45
Jensen Mfg. Co.	27
LeBel, C. J.	48
Lenkurt Electric Co.	47
Leonard Radio Co.	39
Magnecord, Inc.	7
McIntosh Engineering Laboratory, Inc. ..	50
Maurer, J. A. Inc.	13
Milo Radio & Electronics Corp.	51
Minnesota Mining and Mfg. Co.	11
Partridge Transformers Ltd.	52
Precision Film Labs, Inc.	1
Professional Directory	48
Radio Corp. of America	8, 9
Rek-O-Kut Co.	2
Shure Brothers, Inc.	12
Tech Labs	44
Transcriber Co.	51
Turner Co.	33
U. S. Recording Co.	48
United Transformer Co.	Cover 4

PARTRIDGE WILLIAMSON OUTPUT TRANSFORMER BUILT TO THE ORIGINAL SPECIFICATION

De-luxe potted model now available from stock from all important Radio Stores throughout the U. S. A. (**Price \$26.00 duty paid**)

This transformer is now accepted as the most efficient in the world. According to "Audio Engineering," there is no U. S. equivalent.

Thousands already sold in the United States. A "must" for every high fidelity enthusiast.

New York Stockists:

Harvey Radio Co. Inc.
103 West 43rd Street

Terminal Radio Corporation
85 Cortlandt Street

If you are unable to purchase Partridge transformers in your city, write to us and mention the name of your dealer.

Fullest data, including square wave tests, distortion curves, etc., together with list of U. S. stockists rushed Air Mail to you.

PARTRIDGE TRANSFORMERS LTD.
TOLWORTH, SURREY, ENGLAND

The **ONLY**
truly high-fidelity high-
performance tape recorder
in the popular price
field!

Concertone
RECORDER



Model
1401

**"just like
being there"**
Has every feature
of the most expensive
professional equipment. Ready for
console instal-
lation. Write for
Bulletin #101. **\$345.00**
USER'S NET COST

Manufactured By

Berlant Associates

4917 W. Jefferson Boulevard
Los Angeles 16, California

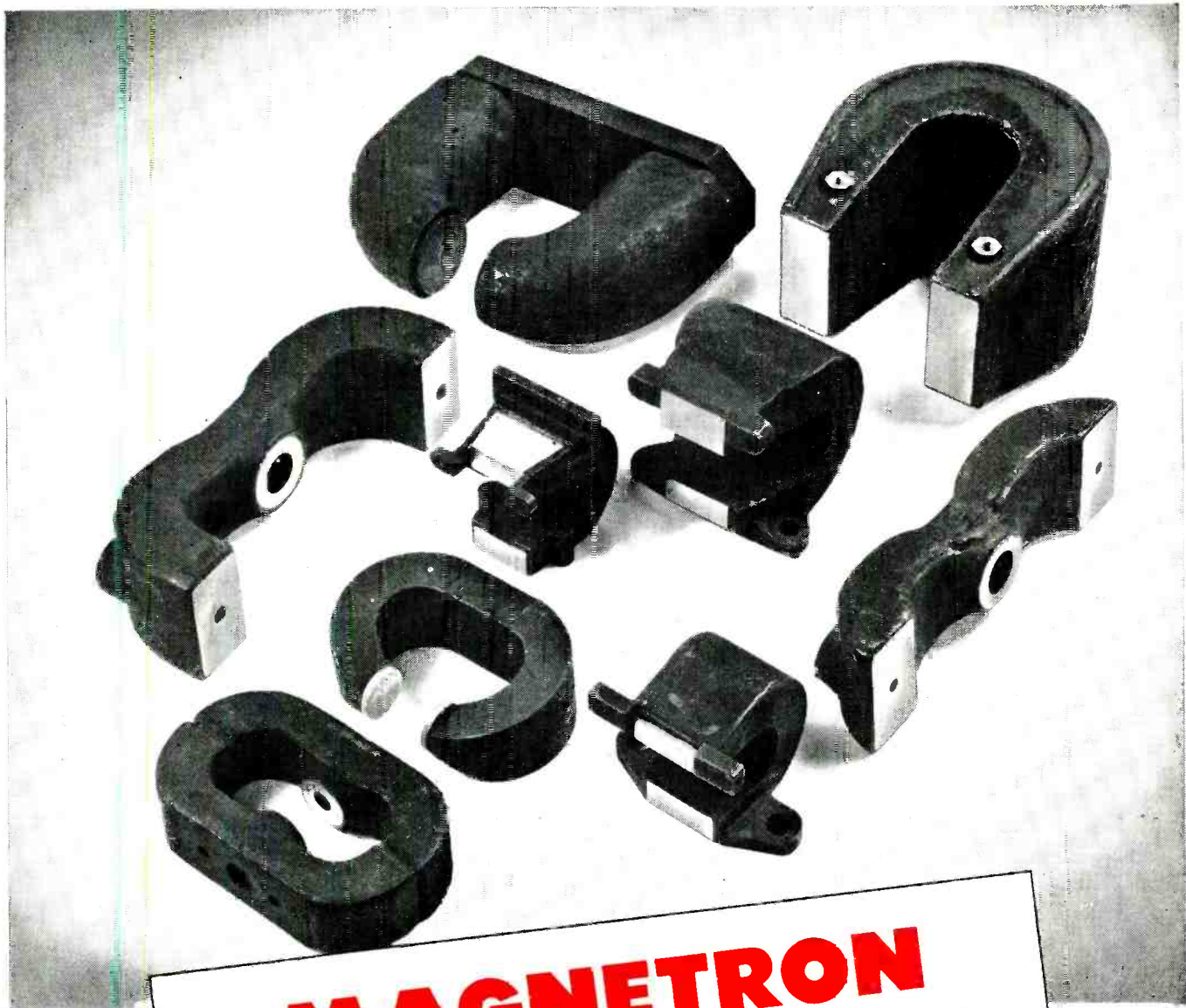

MAGNETRON PERMANENT MAGNETS AND ASSEMBLIES

with

- ☆ **Die Cast Aluminum Jackets**
- ☆ **Sand Cast Aluminum Jackets**
- ☆ **Celastc Covers**

Complete assemblies with Permendur, steel or aluminum bases, inserts and keepers as specified. Magnetized and stabilized as required.



THE ARNOLD ENGINEERING COMPANY

SUBSIDIARY OF ALLEGHENY LUDLUM STEEL CORPORATION

General Office & Plant: Marengo, Illinois



for Military Components

UTC was the largest supplier of transformer components in World War II. Present UTC production is on a similar basis. Illustrated below are a few of the thousand military types in UTC 1950 production.

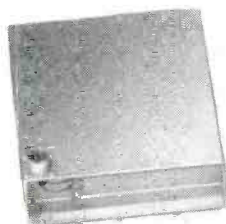
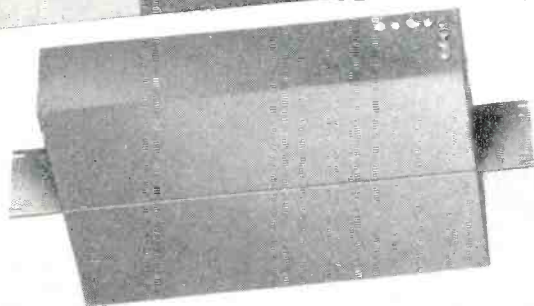

Carrier frequency filter..... Aircraft low frequency filter..... Plate transformer.



Typical hermetically sealed power transformers for 60 cycle service.



Hermetically sealed audio and pulse transformers.



60 cycle and 400 cycle components hermetically sealed and fosterized.



Miniaturized audio units, magnetic amplifiers, etc.

United Transformer Co.

150 VARICK STREET

NEW YORK 13, N. Y.

EXPORT DIVISION: 13 EAST 40th STREET, NEW YORK 16, N. Y.

CABLES: "ARLA"