

AUDIO ENGINEERING

MAY
1951
35c

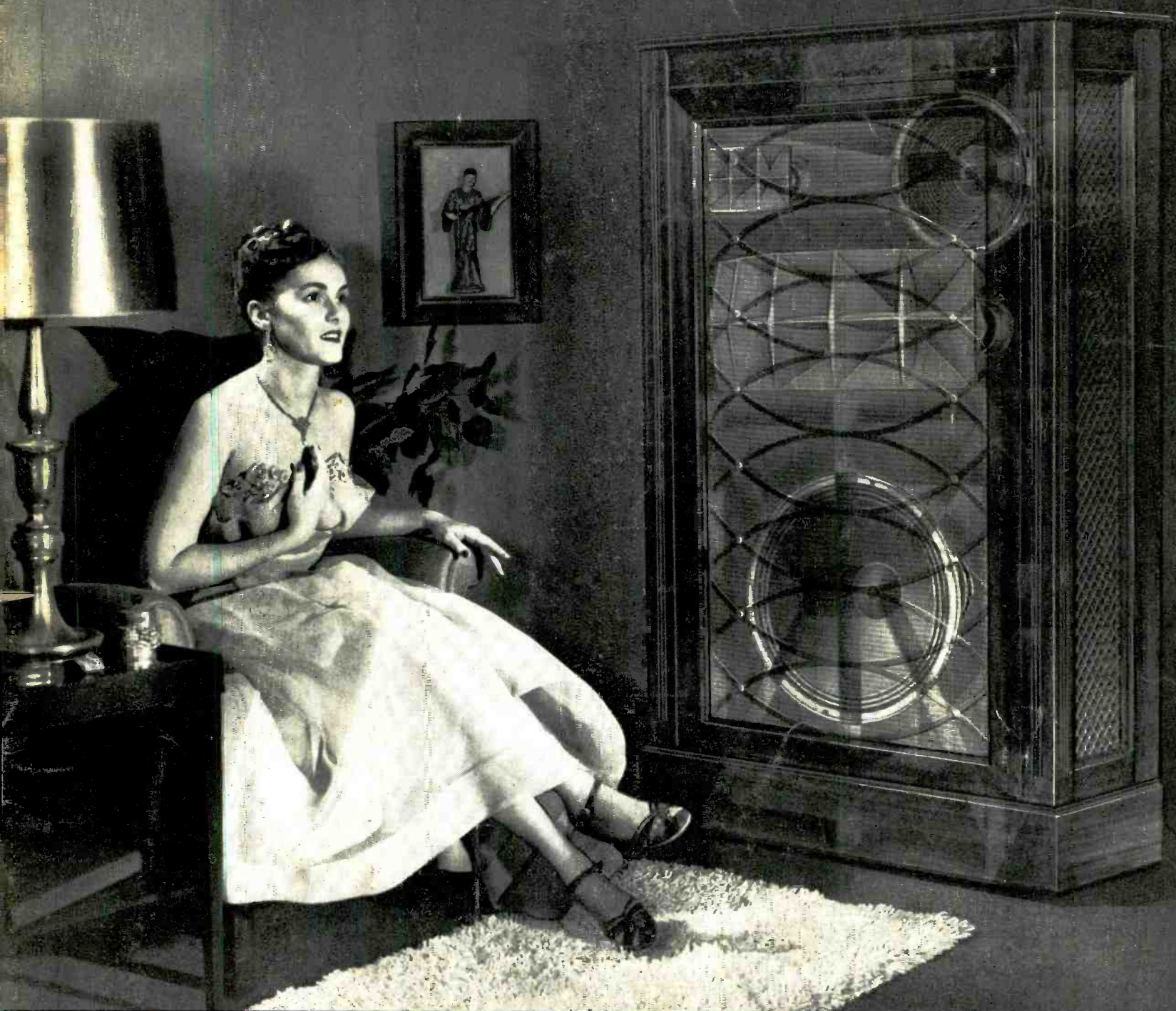

Published by RADIO MAGAZINES, INC.

CONSISTENT UNIFORM QUALITY

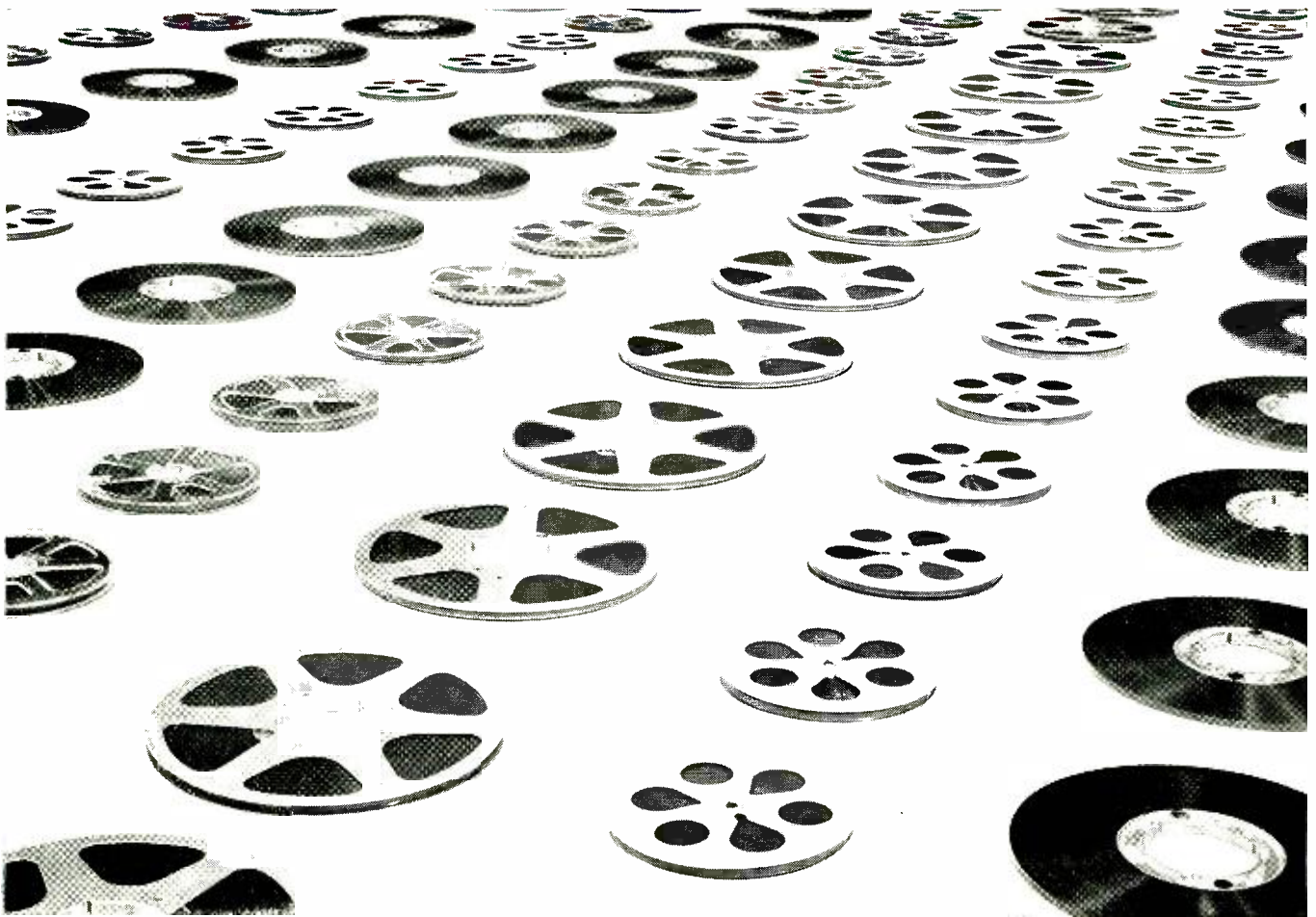

... reel after reel after reel!

That's just one of the EXTRA VALUES that you get in **audiotape*** made by audio engineers, for audio engineers

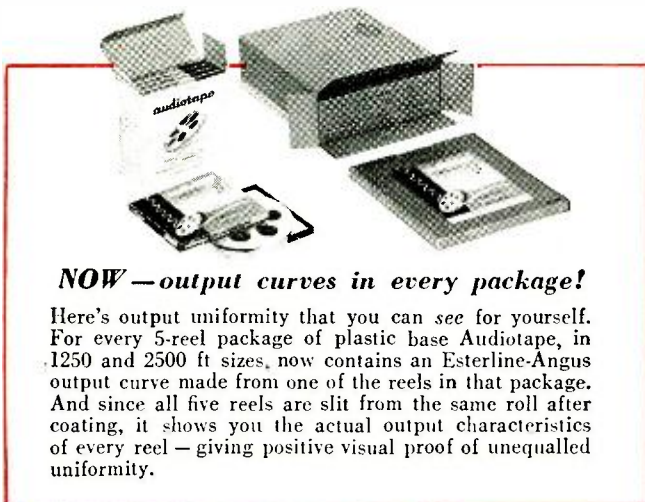

NOW—output curves in every package!

Here's output uniformity that you can see for yourself. For every 5-reel package of plastic base Audiotape, in 1250 and 2500 ft sizes, now contains an Esterline-Angus output curve made from one of the reels in that package. And since all five reels are slit from the same roll after coating, it shows you the actual output characteristics of every reel — giving positive visual proof of unequalled uniformity.

● Yes — when you reach for a reel of Audiotape, you can be *sure* that you will have the finest recording that your equipment can produce. You *know* that the output volume will not vary more than $\pm \frac{1}{4}$ db within every 1250 ft or 2500 ft reel of plastic base Audiotape. That is *guaranteed*. You *know* that these reels are entirely free from splices. That is guaranteed also. But, still more important, you know that you can depend on Audiotape for unequalled over-all performance — with maximum fidelity of reproduction and minimum surface noise and distortion.

In short, Audiotape *always* gives you the same consistent, uniform quality that has characterized Audiodiscs for more than a decade.

Have you heard about our new disc *recoating* service? We are now prepared to recoat your used discs for you — at a substantial saving over the cost of new discs. Your Audiodisc distributor will be glad to give you complete details.

*Trade Mark

AUDIO DEVICES, Inc.

444 MADISON AVE., NEW YORK 22, N. Y.
Export Dept.: 13 East 40th St., New York 16, N. Y., Cables: "ARLAB"

At Precision today
we're processing
the finest
ANIMATION FILMS
for nationwide
showings



For your special 16 mm.
film requirements
use Precision . . .

- Over a decade of 16 mm. industrial film printing in black and white and color.
- Fine grain developing of all negatives and prints.
- Scientific control in sound track processing.
- 100% optically printed tracks.
- Expert timing for exposure correction in black & white or color.
- Step printing for highest picture quality.
- Special production effects.
- Exclusively designed Maure equipment.
- Personal service.

... no wonder more and more
of the best 16 mm. films today
are processed at . . .

PRECISION

FILM LABORATORIES, INC.
21 West 46th St.,
New York 19, N. Y.
JU 2-3970



AUDIO PATENTS

RICHARD H. DORF*

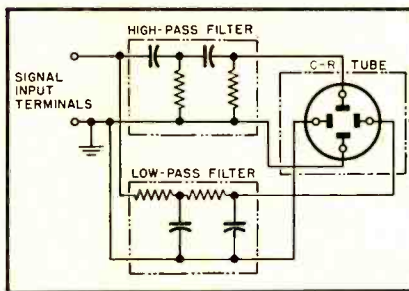

Fig. 1

AUDIO FREQUENCY measurement and spectrum analysis are not usually related in the same test instrument and the necessary equipment is usually far from simple if there is to be any accuracy to speak of in the work. A new patent has come to light, however, which puts both processes in the hands of any worker owning an audio generator and an oscilloscope, and having about fifteen minutes of time to put together what is needed. Rarely is it possible to get so much for so little, which is why this patent set fire to the writer's imagination (a fairly flammable one at any time, to tell the truth).

The patent is numbered 2,541,067 and the inventor is Edwin T. Jaynes, who has assigned the rights to The Sperry Gyroscope Corporation. To sneak up on the idea, let us remind readers of the common method

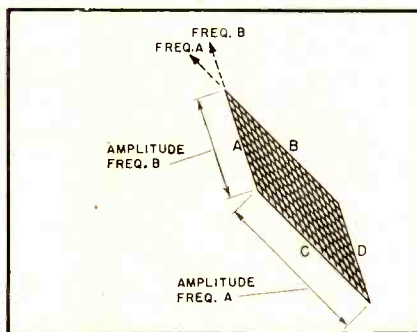

Fig. 2

of testing an audio amplifier for phase shift, in which outphased signals taken from a test generator and from the amplifier are fed respectively to the horizontal and vertical terminals of the scope. If there is no phase shift (or if it is 180 deg.) the pattern will be a straight line which, theoretically, should be leaning at a 45-deg. angle. The "theoretically" has been thrown in to good purpose—to remind you that the line leans at 45 deg. only if the signal level on both sets of deflection plates is the same. Actu-

*Audio Consultant, 255 West 84th Street, New York.

ally, by playing with the deflection amplifier gain controls we can make the angle anything between the horizontal and the vertical. Ordinarily that doesn't matter since we usually judge phase shift, when there is some, by the width of the ellipse that appears, compared to the long dimension of the pattern.

Mr. Jaynes, however, puts the varying angle idea to excellent use by employing the circuit of Fig. 1. The signal to be measured is connected to the paralleled inputs of a high-pass and a low-pass filter. The filter outputs are connected to the two sets of c-r-tube plates. Now, if the product of the resistor and capacitor values in one filter is

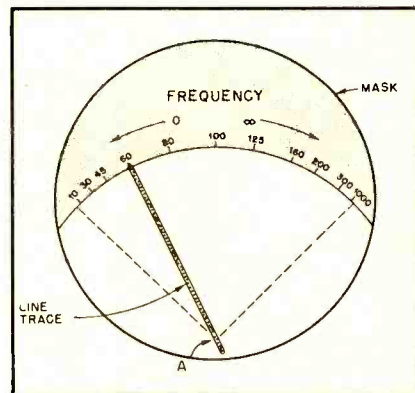

Fig. 3

equal to the product of those values in the other (meaning that both filters have the same cutoff frequency) the outputs will always be 180 deg. out of phase and a single line is always produced on the screen. The angle of the line, however, will vary with frequency. At higher frequencies, for example, the input to the horizontal plates is low and that to the vertical plates high. Since the vertical component dominates, the line becomes more nearly vertical. The angle of the line varies with frequency, so it is possible to calibrate the angular rotation from zero to 90 deg. directly in terms of frequency? Once the two networks have been put together, there is almost no possibility that the calibration will be upset, since the indication depends entirely on the ratio of the output levels, not at all on the input level or on anything else.

But the true beauty of the idea is yet to come. It is possible to measure two frequencies simultaneously—or as many as there are, actually, if there aren't too many to make them all difficult to see. Two simultaneous frequencies produce a four-sided light area on the screen which can be anything from a square to a thin diamond, but in any case a parallelogram, like that in Fig. 2. The angles of the sides indicate the two frequencies. For example, sides A and D are parallel, and so are sides B and C.

The angles to be noted are indicated by the dashed extensions of sides *A* and *B*, though of course *C* and *D* could be used as well. If more than two frequencies are present, the figure is an *n*-sided polygon, with two parallel sides for each frequency. Thus the number of frequencies equals $n/2$. The angles of the sides with the horizontal are used for the measurements, just as with one- and two-frequency figures. Obviously this is a first-class spectrum analyzer for waveform analysis, harmonic distortion measurements, and so on—just as long as sufficient signal is available to enlarge the sides enough for observation. The length of each side is a direct indication of its voltage level.

The inventor suggests one solution of the practical problem of calibration indication, shown in Fig. 3. He rotates the c-r tube on its axis 45 deg. so that the range of "horizontal" to "vertical" position of the line on the screen is as indicated by the dashed lines. Then he places an opaque, crescent-shaped mask over the top of the screen (shaded area in the drawing) and writes calibrations on it. Then, with the aid of d.c. voltages in series with the filter outputs, he positions the no-signal beam spot at the position marked A. For single-frequency measurement the affair resembles an ordinary meter, with the line trace acting as the pointer.

So much for the patent itself and on to a few additional touches from here. For the setup of Fig. 3 (and for any other way of using this system) there is no reason for not using an ordinary scope and putting the signals from the filters through the usual deflection amplifiers rather than straight to the plates. Even if the amplifiers are dissimilar enough to produce slightly elliptical "lines" at very high and very low frequencies, the disadvantage is small, though appreciable difference in frequency response does not contribute a thing towards accuracy.

A calibration idea that seems a bit more practical for simultaneous measurement of several frequencies is to prepare a transparent mask of acetate to go over the face of the c-r tube. Lines are drawn on this mask somewhat like those of Fig. 4. Each radial line emanating from point A shows the angle of one frequency. Now, whether the pattern is a single-frequency line or a multi-frequency polygon, the line or side to be measured can easily be moved into position with the usual scope positioning controls alongside the radial line whose angle most nearly matches it, and the frequency read off from the calibration figures.

The arcs, drawn in equidistant steps from A as a center indicate voltage levels so that the level of each signal present can be compared to that of the others by measuring the lengths of the lines or the sides of the polygon. The mask must initially be made, of course, with the aid of a calibrated oscillator. If the oscillator is around all the time, it can be used, each time the scope is converted to a frequency meter, to recalibrate by feeding in a known frequency and adjusting the amplifier gain controls for the correct reading. Alternatively, a small, one-frequency phase-shift oscillator could be built into a small metal box with the filter networks.

Just to see what would happen the writer took ten minutes out in the lab to set up the circuit of Fig. 1 using 15,000-ohm resistors and 0.1- μ f capacitors. Quick computation showed that the cutoff frequency was around 100 cps. It was found that reliable indications could be had over a frequency range of about 20 to 1. Ideal operation was from 30 to 600 cps but the actual operating range

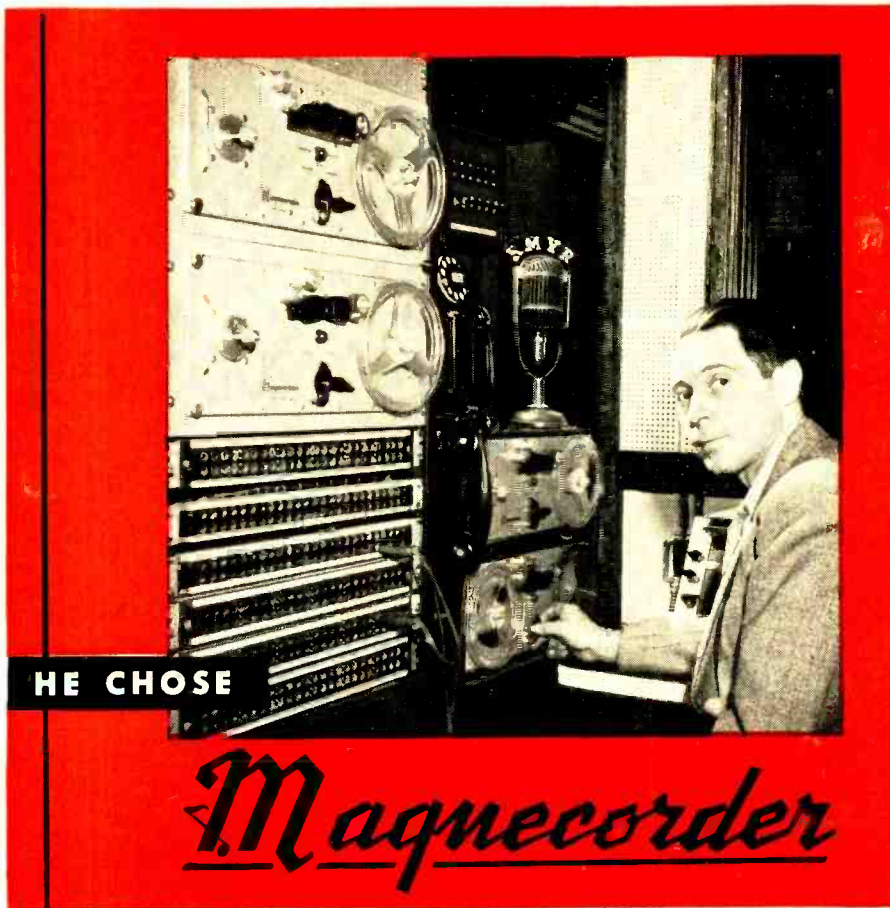

HE CHOSE

Magnecorder

THE FIRST CHOICE OF RADIO ENGINEERS



FLEXIBILITY

In rack or console, or in its really portable cases, the Magnecorder will suit every purpose. PT6 Series shown is the most widely used professional tape recorder in the world, and is available with 3 speeds (3/4, 7/2, 15") if preferred.

FIDELITY

Lifelike tone quality, low distortion meet N.A.B. standards — and at a moderate price! PT63 Series shown in rack mount also offers three heads to erase, record, and play back to monitor from the tape while recording.

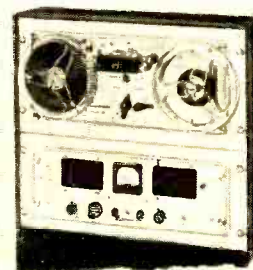

FEATURES

PT7 accommodates 10 1/2" reels and offers 3 heads, positive timing and pushbutton control. PT7 Series shown in complete console model is also available for portable or rack mount. For outstanding recording equipment, see the complete Magnecord line — PT6, PT63 and PT7.



WRITE FOR NEW CATALOG

Magnecord, Inc., Dept. A-5
360 N. Michigan Ave., Chicago 1, Ill.
Send me latest catalog of Magnecord Equipment.

Name.....

Address.....

City.....Zone..... State.....

Magnecord, INC.

360 NORTH MICHIGAN AVENUE
CHICAGO 1, ILLINOIS

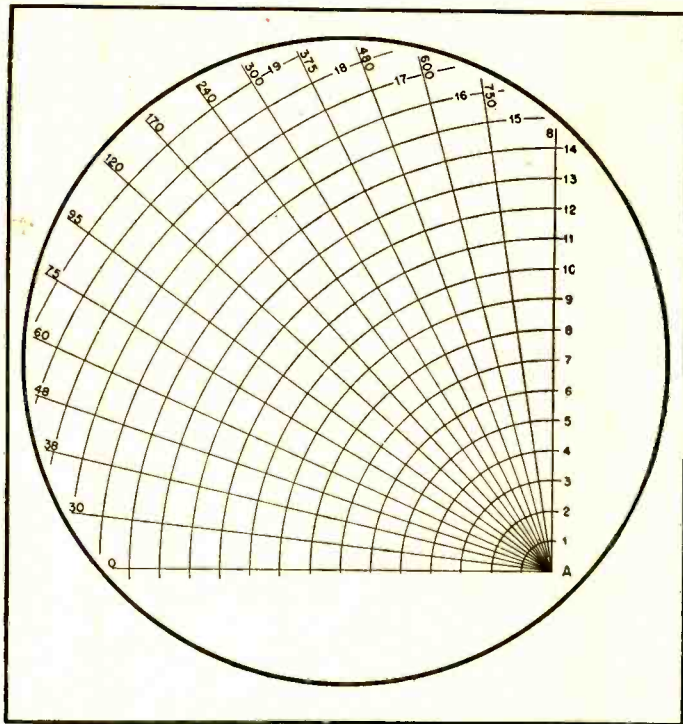

Fig. 4

could be shifted a fair amount by deciding just what frequency to use when setting the gain controls for a 45-deg. line. The components were only 20-per centers and the phase difference at the two inputs was not exactly 180 degrees, but the slight ellipse caused no trouble at all. As indicated in Fig. 3, the inventor claims that a 100-to-1 range can be covered, but a look at the scale shows that the frequency change for the last

few degrees on each end is so great that easy reading is not possible.

Limiting the range calibrations to something between 10- and 20-to-1 ratios makes for good accuracy. As much spectrum can be covered as the user desires by simply substituting different filters, with higher cutoffs, for higher-frequency ranges. Using a 10-to-1 ratio, which seems best, three ranges would cover 20 to 20,000 cps. Prob-

ably each filter should be designed for a cutoff at the frequency in the approximate geometric center of its range—for the 20 to 200-cps range, for example, the cutoff frequency might be about 60 cps.

Safety Stylus

We can't all own super-terrific-quality amplifiers and diamond-point pickups, but we ought to be able to feel that at least the pickup stylus will not damage the record grooves. Unfortunately, most styli do, for after the point wears it not only makes the music sound worse but it starts chewing grooves. William F. Smith of North Holly-

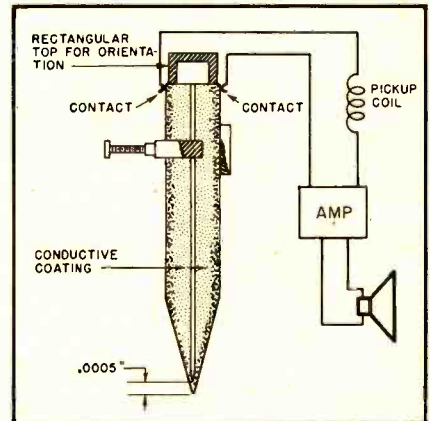

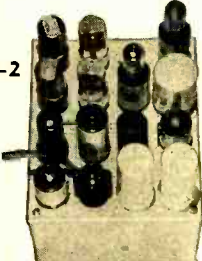

Fig. 5

wood, Calif., has come up with an ingenious anti-chewing system in Patent No. 2,493,466, assigned to RCA.

His phonograph stylus is shown in Fig. 5. It consists of a nonmetallic body sprayed or otherwise coated with a conducting layer.

[Continued on page 48]

 <p>Type 50W-2 \$249.50</p>	<p>load such as a speaker or cutter head, not just into an ideal resistive load. McINTOSH 50W-2 and 20W-2 amplifiers perform substantially the same under dynamic conditions into a speaker load, as into a pure resistive load.</p> <p>Full dynamic range can be realized only if the noise is low. McINTOSH amplifiers are designed so that the noise</p>	 <p>Type AE-2 \$74.50</p>
<p>AUDIO power peaks reach 200 to 400 times the average power of speech and music. The unique design of McINTOSH amplifiers provides adequately for such peak power requirements.</p> <p>A bass drum delivers 140 decibels above threshold at 20 cycles, and a cymbal delivers 120 decibels above threshold at 20 kc. McINTOSH amplifiers, delivering full-rated power at all frequencies from 20 cycles to 20 kilocycles with less than 1% distortion, satisfy this requirement of dynamic range.</p> <p>The ear is extremely sensitive to distortion. For completely enjoyable reproduction, intermodulation at peak powers must not exceed 1%. McINTOSH amplifiers type 50W-2 and 20W-2 meet that requirement for 100-watt and 40-watt peak powers, respectively, regardless of the frequency combination within the band of 20 cycles to 20,000 cycles.</p> <p>Here is another important specification: Be sure to choose an amplifier that works properly with a variable impedance</p>	<p>Type 20W-2</p>  <p>\$149.50</p> <p>components (rms) are 80 to 90 decibels below full rated output, which is an inaudible noise level.</p> <p>Factors of economy should not be overlooked. The efficiency of McINTOSH amplifiers almost equals class B, with the highest theoretical efficiency possible. They are the most economical on tubes and power requirements—the most watts at the lowest distortion at the</p>	<p>least cost. Service is simplified by plug-in circuits. Size is small because of the high efficiency.</p> <p>Performance of the control unit should compare with the amplifier. The McINTOSH AE-2 8-stage Amplifier-Equalizer provides stable, distortion-free performance that matches the performance of the 50W-2 and 20W-2 amplifiers.</p> <p>Engineers agree that McINTOSH amplifiers reach the practical limits of low distortion and high efficiency. Music lovers agree that the theoretical advantages are fully reflected in superlative audio reproduction. For further information write or telephone:</p> <p>McIntosh Engineering Laboratory Inc. 910 KING STREET, APRIL 7-1950, SILVER SPRING, MD.</p>

NEW! 24 Pages of Engineering Data
on **ARNOLD TAPE-WOUND CORES**

PROPERTIES OF...

**DELTAMAX
4-79 MO-PERMALLOY
SUPERMALLOY***

BULLETIN TC-100
March 15, 1951

Manufactured Under Licensing Arrangement with Western Electric Co.

THE ARNOLD ENGINEERING COMPANY

SUBSIDIARY OF ALLEGHENY LUDLUM STEEL CORPORATION
General Office & Plant: Marengo, Illinois



WRITE FOR YOUR COPY

PENTRON

Announces

a New
Professional-Type
ELECTRONIC
MIXER

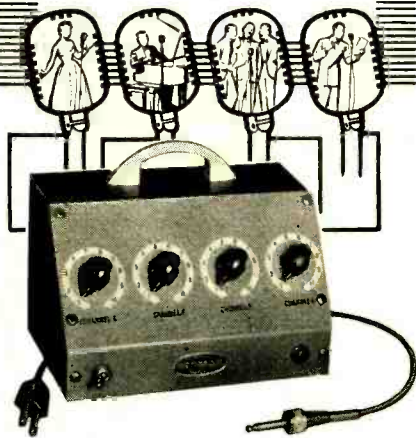

Meets Exacting Requirements for Multiple Mike Recording on Tape, Wire or Disc, and Public Address Systems

The New Pentron Audio-Mix, with its four individual controls, permits a wide range of audio blending applications on each of its four channels simultaneously. Output cord has a combination plug and screw-type coupling for easy connection to any audio system. Quality components and top engineering assure professional results and long life. **\$59.50**

Makers of the DUO-SPEED TAPE RECORDER

THE PENTRON CORP.
AUDIO-MIX
PENTRON
ELECTRONIC MIXER

226-A East Cullerton St.
Chicago 16, Ill.

Send detailed literature and name of nearest distributor.

Name
Address
City State

TECHNICANA

A SIMPLIFIED CHART for the computation of the magnitude and phase angle of the forces acting at the throat of a horn is described in a paper by Josef Merhaut published in the *Tesla Technical Reports* for December 1949 at Prague, Czechoslovakia.

In horn-type loudspeakers, it is usual to have active areas of the diaphragm larger than the throat cross-section area. This causes phase delays between waves arriving at the center of the throat, and thus causes loss of power. To determine the actual loss of power, it is necessary to construct the force polygon for each frequency for a diaphragm of any given radius. This provides an approximate solution which may be made accurate by taking infinitesimal elements and integrating. The polygon then becomes a continuous curve. If several such curves are constructed for various frequencies and points of equal radius are joined, it is possible to obtain directly the force vector at the center of the throat.

The application may be extended to cover subdivided throats by the addition of the force vector for each throat division.

The power loss is the ratio of the force vector at zero frequency to that at the frequency being considered.

Phase Inverter

A novel cathode-coupled phase inverter is the subject of an article by Jaques Lignon

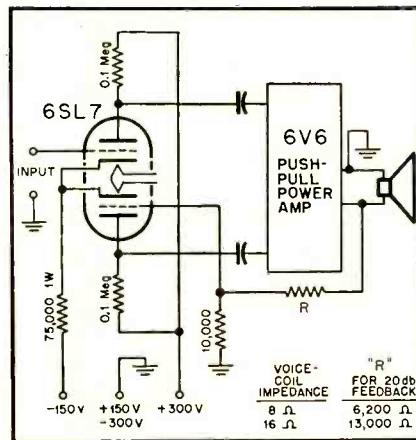

Fig. 1

in *T.S.F. Pour Tous* November 1950. The basic circuit for the phase inverter is shown in Fig. 1. An integral part of the circuit is the feedback connection to the second grid which, in the usual cathode-coupled circuit, is connected directly to ground. The feedback to this point eliminates the possibility of interfering with feedback networks in the preamplifier running from the plate of the preamplifier back, and includes an equalizing network. Also it permits the use of lower resistances than usually allowed because of the low-impedance voice-coil circuit, which it shunts, and the lack of limitation on the value of the grid resistor of the second tube section. Usually this value is

fixed in other amplifiers by coupling considerations. With low resistance values, feedback is affected less by changes in temperature and humidity than with high values. A chart is provided for determining the value of *R* for various available input levels. The two values given are for 20 db of feedback. Where it is desirable to substitute two 6SF5 tubes for the 6SL7 the plate load resistors should be reduced to 70,000 ohms each and the cathode resistor to 70,000 ohms.

The major drawback of this circuit is its use of the negative potential of 150 volts.

Stereophonics

J. Moir, in the March 1951 *Wireless World*, reviews the basic principles of stereophonic sound. There are five known important factors that appear to be the key indicators for the spatial localization by binaural hearing. They are the time delay between sounds as they strike the ears, the phase delay in repetitive sounds, the loudness difference between the ears, the sound intensity pattern due to diffraction, and, finally, the behavior of each ear when performing localization monaurally.

The spatial arrangement of an orchestra appears to be a desirable factor to carry over into sound reproduction. Study of two- and three-channel systems for this purpose indicates that the three-channel system gives excellent stereophonic quality to the reproduced sound, and the two-channel system provides a considerable improvement over a single channel.

To provide a stereophonic service in England, it is suggested that two of the simultaneous transmissions over different broadcast transmitters carry left and right sound signals, or that simultaneous uhf, or pulse modulation, could be employed to provide two- or three-channel signals. The use of the broadcast transmitters is immediately practicable in England. This would enable an improved quality in the received sound which is not attainable through the extension of the frequency-response range.

French Items

The November 1950 edition of *Toute La Radio* was a special export number which has much of the editorial material abstracted in English and Spanish. There are many articles in this issue of particular interest: stereophonic broadcasting of music, the automatic electronic switch, coil-block units, and background noise and sounds of continuous spectrum.

The article on stereophonic broadcasting details the techniques employed by J. Bernhart and J.-W. Garrett in broadcasting a program especially prepared for stereophonic broadcast under the direction of the well known director of French motion pictures, Rene Clair. The final equipment setup included two phonograph sources, three microphone channels, an echo chamber, and two tape recorders to prepare a left and a right stereophonic signal. The broadcasts

[Continued on page 39]

Something New

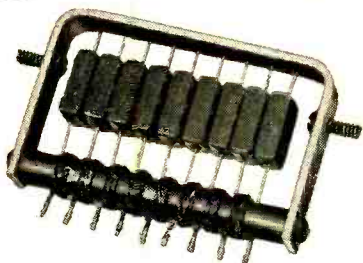

SPECIAL DELAY LINES

Lumped delay lines "tailored" to specific applications have been announced by the Shallcross Manufacturing Co., Collingdale, Pa. A typical unit consists of eight pie-section low-loss filters having a rise time of 0.04 microseconds and a total delay of 0.3 microseconds. Maximum pulse voltage is ± 100 volts and impedance is 500 ohms. Cutoff frequency is 8.5 megacycles and the maximum operating frequency approximately 2 megacycles based on a pulse delay error of not more than 2%. The unit consists of eight universally-wound coils of 3-strand #41 Litz wire and nine low T.C. silver mica capacitors. Many other types can be supplied.



NEW SHALLCROSS WHEATSTONE-MEGOHM BRIDGE

The new Shallcross 635-A Wheatstone-Megohm Bridge is a versatile direct-reading instrument for accurate measurements between 10 ohms and 1,000,000 megohms. It can be used to measure resistance elements and insulation resistance and to determine volume resistivity of materials. The instrument is basically a Wheatstone Bridge used in conjunction with a d-c amplifier. Two built-in power supplies operating on 115 volts, 60-cycles automatically provide the correct bridge voltages for the high and low ranges. Full information is available from the Shallcross Manufacturing Co., Collingdale, Pa.



METAL-ENCASED RESISTORS

Flat, metal-encased, Type 265-A wire-wound power resistors introduced by the Shallcross Manufacturing Company, Collingdale, Pa. are space wound, have mica insulation, and are encased in aluminum. At 175° C. continuous use they are conservatively rated for 7½ watts in still air and 15 watts mounted flat on a metal chassis. Write for Bulletin 122.

(Advertisement)

Really Smooth—Outstandingly Quiet—Fully Dependable

MANY TYPES
AVAILABLE FROM
STOCK
and through
Shallcross
parts distributors



Shallcross Precision ATTENUATORS

ALL STANDARD FIXED AND
VARIABLE TYPES

•
LADDER AND BALANCED
LADDER CONTROLS

•
"T" CONTROLS

•
BALANCED "H" CONTROLS

•
POTENTIOMETERS

•
VARIABLE IMPEDANCE
MATCHING NETWORKS

•
V.U. METER RANGE
EXTENDING ATTENUATORS

•
STANDARD AND SPECIAL
FIXED PADS

•
SPECIAL NETWORKS

Perhaps you've noticed how frequently Shallcross attenuators now appear in the finest audio or communications equipment? Or how often they are chosen for replacement purposes?

There's a reason! Improved design, materials and production techniques have resulted in a line that sets new, higher standards of attenuation performance for practically every audio and communications use.

Shallcross Attenuation Engineering Bulletin 4 gladly sent on request.

Shallcross Manufacturing Co.
Dept. A-51 Collingdale, Pa.

RESISTORS — INSTRUMENTS — SWITCHES — ATTENUATORS

For a Glorious
BIG TONE
 ON ANY STRINGED INSTRUMENT
specify the Genuine
AMPERITE "KONTAK MIKE"
 THE ONLY NO-DISTORTION "KONTAK MIKE"



Anthony Antone, widely known as "the most versatile artist of the frets", is an enthusiastic user of Amperite Kontakt Mikes.

Used with most amplifiers, including most electric guitar amps.

No changes in amplifier, instrument, or strings. Attached without tools.

The Amperite "Kontak Mike" improves the tone and volume of any Stringed or Fretted Instrument — also Pianos, Accordions, Harmonicas, etc. It is the only "Kontak Mike" that does not introduce peaks or distortion.

- Model SKH, hi-imp..... List \$12.00
- Model KKH
 (with hand volume control)..... List \$18.00

AMPERITE
STUDIO MICROPHONES
 at P. A. PRICES!
Ideal for **CLOSE TALKING**
 or **DISTANT PICKUP**

You can shout right into it, or stand away; in either case, the quality will be perfectly natural.

- Model RBLG (200 ohms)..... List \$42.00
- Model RBHG (hi-imp)..... List \$42.00



AMPERITE CAROID DYNAMIC MICROPHONE

Models PGH-PGL..... List \$32.00



SPECIAL OFFER:
 Write for Introductory Offer, and 4-page Microphone Folder 53-M.

AMPERITE Company, Inc.

561 Broadway • New York 12, N. Y.

In Canada: Atlas Radio Corp., Ltd., 560 King St., W., Toronto 28

LETTERS

Re: Shortages, 5U4C's

Sir:

Methtinks Mr. Cone is trying to put a very large tempest in a very small bottle. In the welter of asinity that we are pleased to call 20th Century civilization, the availability or lack thereof of 5U4G's holds but little import. As emergencies go, this is a small one, and if it should fold, any one of a number of others could be whipped up on a short notice.

Val Adams,
 Box 14,
 La Jolla, California

Re: Patents

Sir:

At last Æ has its comic page, with clever imitations of Rube Goldberg's output. Copleman's device described in the Patents column for March "solves" a complicated problem with super complications. Seriously, how can you swallow a pickup arm with six pivots, a rack and gear, and a yoke? And don't forget that you will need still more friction points for a compensated counter-balance.

If "good enough bearings" and proper balance were provided, you would have a pickup arm without tracking error, but there would still be side pull, depending on record speed and amplitude of recording.

Let's go back to "some contraption resembling a recording lathe." Drawings

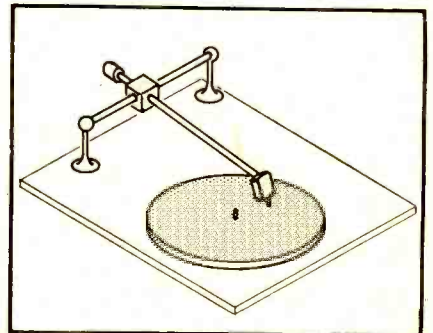
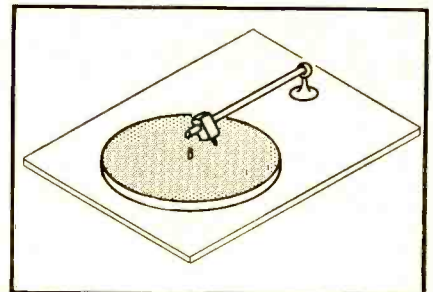

show two possibilities which feature the pickup travelling along a rigid wayrod. Any bearing manufacturer could design a trouble-free running device with little difficulty.

John E. D'Errico,
 1243A 23rd St.,
 Santa Monica, California

(No reader is constrained to buy or use such a device as Copleman's, even if it should ever reach the market, which is doubtful. Ed.)

A new model of Britain's best audio amplifier, with compensated settings for all recordings

LEAK "POINT ONE"

Distortion:
0.1%

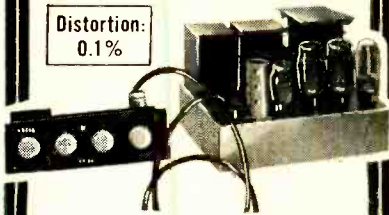

Leak "Point One" provides the ultimate in clarity and frequency response. Certified tests by British Nat'l Physical Lab. (equiv. U. S. Bureau of Standards) prove this triple loop power amplifier and pre-amplifier exceed manufacturer's performance claims.

In the TL/12 amplifier, hum and noise levels fall within -80 db and -72 db relative to 10 watts and are entirely inaudible. Feedback is taken from low side of output transformer and due to the magnitude of feedback, there can be no rise of voltage. The reproduction of transients, especially of low frequency, is astonishingly clarified.

At your dealer or write to
BRITISH INDUSTRIES CORP.
164 Duane St., New York 13, N. Y.

Magnificent WHARFEDALE SPEAKERS

Inexpensive
— but with
remarkable
response.



Assure clear,
undistorted
musical
reproduction.

Built by Wharfedale Wireless Works under the direction of world-famous engineer, G. A. Briggs. Brilliant performance approaching living sound.

OUTSTANDING BOOKS by G. A. BRIGGS

Renowned authority
on sound.

LOUDSPEAKERS
\$1.25

SOUND REPRODUCTION
\$2.25

Practical! Informative!
The only such books written expressly for the layman. Simple, easy-to-understand language and diagrams on principles important for every home audio system. At your jobber or send check or money order.

BRITISH INDUSTRIES CORP.
164 Duane St., New York 13, N. Y.

the
features
that bring
fine
music
home



TWO INTERCHANGEABLE
SPINDLES



WEIGHTED TURNTABLE —
HEAVY MOTOR
No wows. No wavers.



PUSHER TYPE PLATFORM
always works.
SIMPLE 3 SPEED SETTINGS

AUTOMATIC STOP
at end of last record

GARRARD

THE WORLD'S FINEST RECORD CHANGER



Easily, inexpensively installed
in your present set.

Write for FREE FACT SHEET —
what to look for when purchasing
a 3 speed record changer.

GARRARD SALES CORP. Dept AE5
164 Duane Street, New York 13, N. Y.

EDITOR'S REPORT

NARTB CONVENTION

CHICAGO, APRIL 18. The twenty ninth annual convention of the newly named National Association of Radio and Television Broadcasters offered a variety of technical papers which covered many of the current problems of broadcasters—both in radio and TV. Particularly interesting to the audio men in attendance was W. Earl Stewart's talk on "Trends in Audio Equipment," which compared early studio equipment with that currently in general use, and delineated the reasons for the gradual shift in type and appearance of the equipment. Mr. Stewart's paper was illustrated by a number of slides showing the differences in a way which left no detail to the imagination.

Most of the papers at the Engineering Conference dealt specifically with transmitter operation and maintenance, and with many aspects of TV—of growing importance in view of the possible "thaw" of the long freeze which has hamstrung the growth in TV stations for the past two years.

Harold Fellows, president-elect of NARTB to take office on June 4, outlined in one sentence what is needed for a broadcaster to achieve a position of leadership in its community. He said, "The progressive, intelligent use of a franchise to 'get a grip on' the community, to serve that community and its needs culturally, civically, and commercially is as worthy and should be as relatively profitable in Sunshine Valley, New Mexico, as it is in New York City."

That many broadcasters have not learned this basic principle of success and service is well known to any one who has spent a week listening to their offerings. FM broadcasters, as a class, have "carried the ball" culturally to a remarkable degree, particularly in the larger cities. Principal complaint of FM operators is that manufacturers have not kept up with the demand for FM receivers to the extent necessary for widespread popularity of this medium.

SWITCH TO AUDIO

Since the beginning of radio, experimentation in the art has attracted the interest of young and old alike. In the 20's, it was common practice to build radio receivers rather than buy them because it was possible to obtain better performance than could be secured from commercially available apparatus. Since those days, radio receivers have improved immeasurably, particularly as regards sensitivity, stability, and reliability, so that today it hardly seems worth while for the experimenter to attempt to build a radio tuner. The design and construction of a tuner is fraught with problems of tracking, of matching a tuning capacitor to a ready-made dial, of obtaining stability from a circuit on first attempt when

small variations in stray capacitance can cause a large change in performance.

For these reasons, *Æ* has rarely offered any constructional information on tuners. It is felt that the cost of materials and the time expended in building a radio tuner does not represent sufficient saving over the cost of a factory-built tuner to warrant articles of this sort.

With audio equipment it is different. Many good amplifiers are commercially available, and good ones can be constructed even by a novice. The assembly and arrangement of equipment offers an interesting and satisfying pastime to the experimenter, and the infinite variety of speaker housings and complete-system cabinetry is limited only by the imagination and skill of the builder.

What is important, most of all, is that the individual interest in experimenting is rapidly swinging from radio to audio. As we see it, one reason for this switch is that the equipment built by the audio hobbyist is enjoyed by his entire family. He assembles a complete system—builds some parts, buys others ready-made—and he, his family, and his friends all enjoy the result. The radio amateur, on the other hand, is likely to shut himself off from conversation with others in his own household—becoming practically a hermit—while he alone enjoys his hobby.

This switch to audio as a hobby is a healthy one, and one in which we feel we have had a hand. One definite indication is that jobbers are exhibiting a widening interest in this new market, with more and more outlets featuring new and modernized sound departments. *Æ* has spearheaded this switch and will continue to offer material which can be relied upon. This has been *Æ*'s aim over the past four years, and at the beginning of its fifth year, this credo is reaffirmed.

VISITOR FROM ENGLAND

We are pleased to have again had the opportunity to compare notes with W. S. Barrell, Managing Director of Electrical and Musical Industries, Ltd. (EMI), who spent a few weeks in the New York area recently. As outlined in Mr. Canby's column, we were privileged to hear a number of microgroove tests which may or may not presage the entry of EMI into this field. Be that as it may, one thing is becoming more apparent as time passes—it is increasingly difficult to distinguish good recordings from live programs.

Obviously, this is as it should be. The crucial test of an adequate recording job is that the listener should not be conscious of the recording medium, but should—as Mr. Canby says—hear "through" the recording to the original. When that is achieved, a recording may be said to be a re-creation.

PICKERING

RECORD PLAYING EQUIPMENT

*For flawless reproduction
of the works of the masters*

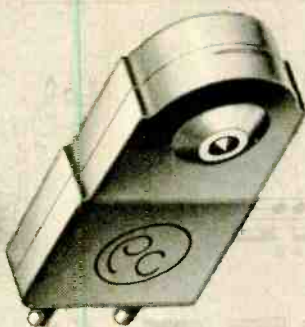

Pickering diamond stylus pickups and related components are the exclusive choice of musicians and lovers of music who insist upon the finest. Engineers acknowledge Pickering audio components as the best available. In every test and performance comparison, they demonstrate their superiority; recreating all the music pressed into modern recordings with the fidelity and realism of a live performance.

Pickering components are created for listening pleasure by Audio Engineers who know music and who know the tastes of discriminating listeners.



Pickering diamond cartridges have no equal. The wear and fracture resistance of the diamond styli in these cartridges is many times greater than that of styli made of sapphire, the next hardest material. Because resistance to wear preserves the precise shape of the stylus point, the life and quality of your valuable record collection is insured.

Don't impair the musical quality of your priceless records.



Use Pickering diamond stylus cartridges . . . they not only wear longer *but, more important*, they preserve the musical quality and prolong the life of your record library.

By all measures, Pickering diamond stylus cartridges are more economical.

PICKERING & COMPANY, Inc.
Oceanside, L. I., N. Y.



Pickering High Fidelity Components are available through leading jobbers and distributors everywhere; detailed literature sent upon request. Address Department A

This "gun" shoots wire around corners



Bell Telephone Company craftsman wraps a wire to complete a connection. Wire is inserted into the nozzle and a rotating spindle whips it around terminals.

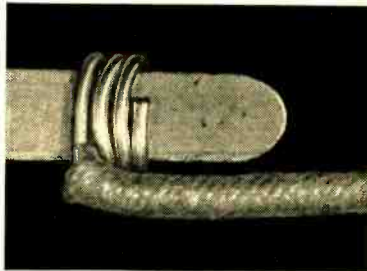

Close-up of connection made with new tool—neat, tight windings.

IT DOESN'T take long to wrap a wire around a terminal and snip off the end. But *hundreds of millions* of such connections are being made each year to keep up with America's growing demand for telephone service.

Now this job is done much more efficiently with a new wire wrapping tool invented at Bell Telephone Laboratories. This "gun" whirls wire tightly around terminals before solder is applied. The connection is better and there is no excess wire to be clipped off—perhaps to drop among a maze of connections and cause trouble later.

The new tool is being developed in different forms for specialized uses. The hand-operated wrapper in the illustration is for the telephone man's tool kit. Power-driven wrappers developed by Western Electric, manufacturing unit of the Bell System, are speeding the production of telephone equipment. The gun's small nozzle reaches where fingers couldn't—a big advantage these days when efforts are being made to produce telephone system parts smaller as well as better.

Bell Telephone Laboratories scientists devise many special tools that help your telephone system to keep pace with service demands economically—keeping your telephone service one of today's best bargains.

BELL TELEPHONE LABORATORIES

WORKING CONTINUALLY TO KEEP YOUR TELEPHONE SERVICE BIG IN VALUE AND LOW IN COST



Ultrasonics in the Loran Trainer

PHILIP D. STAHL*

Part I. Beginning the description of a unique device used for classroom training of personnel in the operation of loran navigation receiving equipment.

LORAN is the modern electronic method of navigation by which navigators of aircraft or sea vessels can determine accurately their geographical position by day or night. Loran can also be used for "homing"—following a pre-determined line of position. Loran is a term which was derived by combining the first two letters of LORan, the first two letters of RANge and the first letter of NAVigation.

The accuracy with which these positions may be obtained is dependent upon the distance between the aircraft or ship and the land-based loran transmitters, but in general, results can be expected which are comparable to positions obtained by conventional celestial navigation.

* Project Engineer, Presto Recording Corp., Paramus, N. J.

gational methods. Loran service permits the accurate determination of positions at distances from shore or land up to 1400 miles at night and 750 miles by day. The reason for the difference is that ground waves are used by day and sky waves by night. Such ranges are achieved by employing relatively low frequencies of operation—specifically, between 1900 and 2000 kc. This band was chosen for greatest reliability consistent with maximum transmitting range.

Loran transmitters are on duty 24 hours a day throughout most of the world's major air and sea lanes. The ultimate requirements for covering most of the earth's traveled routes are estimated to comprise a total of 70 transmitting stations. Most of these units are either built or in the process of being constructed at this time.

The basic principle involved in the operation of the loran system is the reception of two radio signals, each of which is radiated by a different transmitting station. Using a loran receiving set, an operator is able to measure the elapsed time between the arrival of the first and second signals. The difference in the time of arrival of the respective signals bears a direct relationship to the difference in distances between the navigator and the two transmitting stations. Since radio signals travel at a constant speed, a direct relationship between time of travel and distance traveled exists. Consequently, measurement of intervals of time is, in essence, a measurement of distance itself.

The transmitted signals emanate from high power transmitters in the form of pulses approximately 40 microseconds

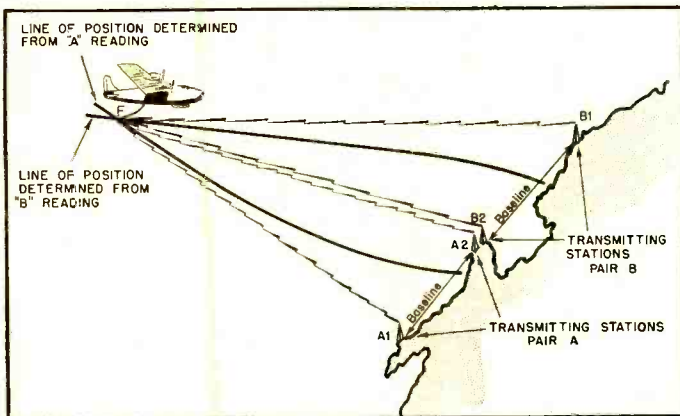
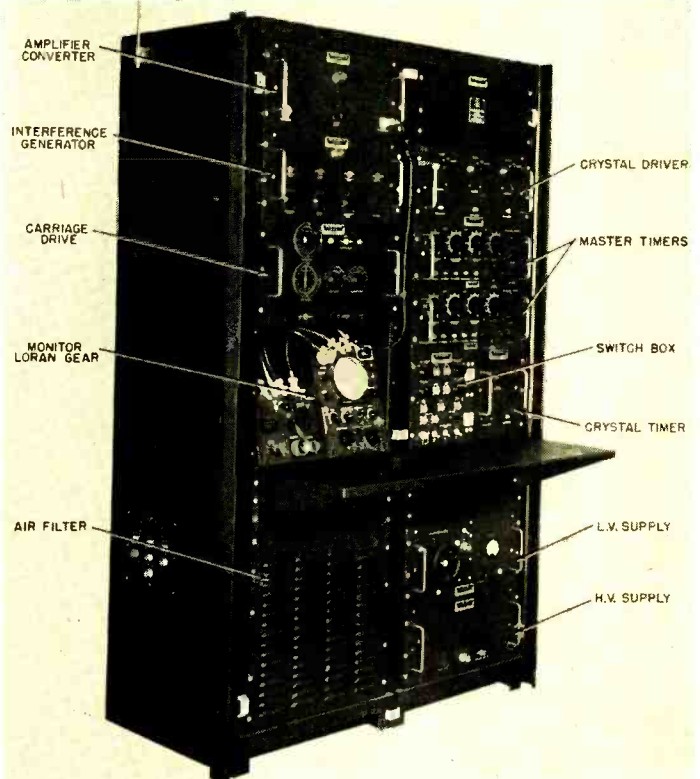
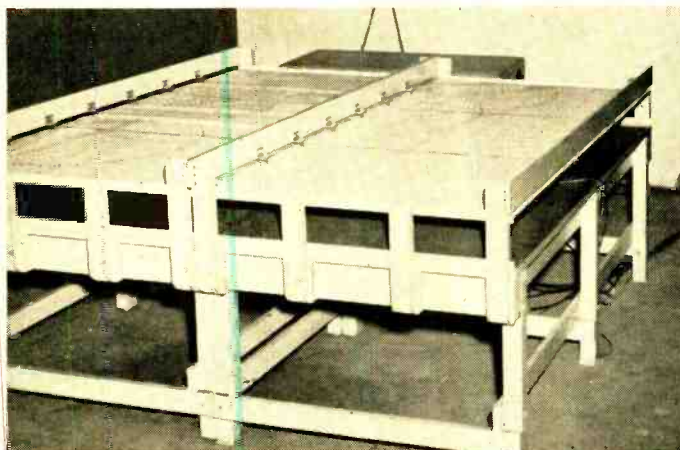

Fig. 1 (left). Navigator aboard loran-equipped plane at "F" establishes "fix" by determining two lines of position "A" and "B" by loran measurements. Line of position "A" is found by measuring the time difference between signals received from transmitting stations A1 and A2. Line of position "B" is found by measuring the time difference between signals received from transmitting stations B1 and B2. The navigator's fix is established at the point of intersection of the two lines of position. The latitude and longitude of the navigator's position is determined from the loran data by using either loran charts or loran tables.

Fig. 2. Loran Trainer installation. Below, trainer table with chart on top surface which represents the ionosphere. "Crab" travels on masonite-covered platform below chart, and indicates its position by a light beam projected upward from center of transducer. Right, control cabinet for the Loran Trainer.



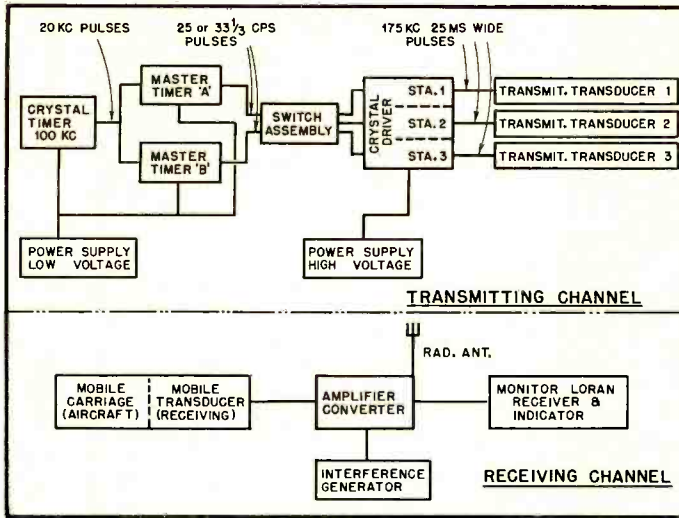

Fig. 3. Block diagram of complete Loran Trainer.

mately 40 microseconds wide, with the recurrence rate related to either of two bases, 25 or 33 1/3 per second.

Because the basic loran measurement evaluates the *difference* in the distances between the navigator and each of two fixed transmitting stations and not the individual distances themselves, there are many points at which the difference would be the same in spite of the fact that the distances themselves varied greatly. These points fall along a hyperbolic curve which is designated as a loran line of position. It is therefore clear that when a navigator obtains a reading from a particular pair of transmitting stations, he determines that his true position lies at some point on a particular loran line. By obtaining a loran reading from a second pair of stations, a second line of position has been identified and the navigator's true position or "fix" has been established at the point of intersection of the two lines.

Because loran is concerned with the measurement of signals from two separate sources, for purposes of identification, loran stations operate in pairs. The individual stations of a pair are designated "master" and "slave". These names are descriptive of the functions of each station. Specifically, the master starts the cycle of transmissions by sending a 40-microsecond pulse at 1950 kc. (channel 1 of the loran system) which is radiated unidirectionally. The signal is received by both the navigator and the slave station. After travelling the distance between the master and slave station, known as the baseline, the slave receives the signal and uses it as a time reference for the transmissions of its own signal. After the slave transmits its pulse the entire cycle becomes repetitive.

In order to provide the greatest possible number of loran station pairs and provide a foolproof method for distinguishing between pairs based at different geographical locations, two basic repetition rates, namely 25 and 33 1/3 cps, have been established. There are eight different repetition rates associated with each of the base frequencies or a total of sixteen possible repetition rates. Stations operating on the lower time base are pulsed at the rates of 25 cps, 25 1/16 cps,

25 1/8 cps, 25 3/16 cps, etc. through 25 7/16 cps while the higher time base stations are pulsed at 33 1/3 cps, 33 4/9 cps, 33 5/9 cps, 33 2/3 cps etc. through 34 1/9 cps. Thus, with a choice of six-

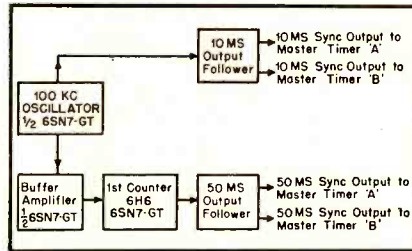

Fig. 4. Block diagram of crystal timer unit.

teen different repetition rates it is a relatively simple matter to identify geographically any unknown loran pair of stations received on the equipment.

To simplify the navigator's problem of interpreting the loran data in terms of

latitude and longitude coordinates, loran charts prepared by the U. S. Hydrographic Office are provided, which depict the "electronic lines" of position with respect to a particular map of the region in which the aircraft or ship is located.

To summarize, the loran system consists of three elements: (1) A series of land based loran transmitting stations; (2) receiving and time measuring equipment (loran receiving gear) accessible by the navigator on plane or ship; and (3) loran plotting charts. *Figure 1* illustrates the basic principles of determining position by means of loran.

Purpose of Loran Trainer

The trainer to be described was designed and built through the joint efforts of the Navigation Section of the Special Devices Center, USN, and the Presto Recording Corporation, which has been the sole producer of this equipment to date. The Loran Trainer enables otherwise difficult ground or classroom training of navigators and crewmen in the operation of any of the currently available loran receiving sets, and provides experience in observation of loran signals and in working navigational problems just as they would be seen and computed in actual service. It permits the training of comparatively large groups of students at one sitting without resorting to the use of aircraft or ship.

Description of Loran Trainer

A photograph of the complete trainer is shown in *Fig. 2*. (A) is a view of the trainer table, and (B) shows the control racks. The design of the trainer is based on the fact that the velocity of radio signals in air bears a constant ratio to the velocity of sound in air. Specifically, the velocity of sound in air at room temperature is approximately 0.186 nautical

[Continued on page 49]

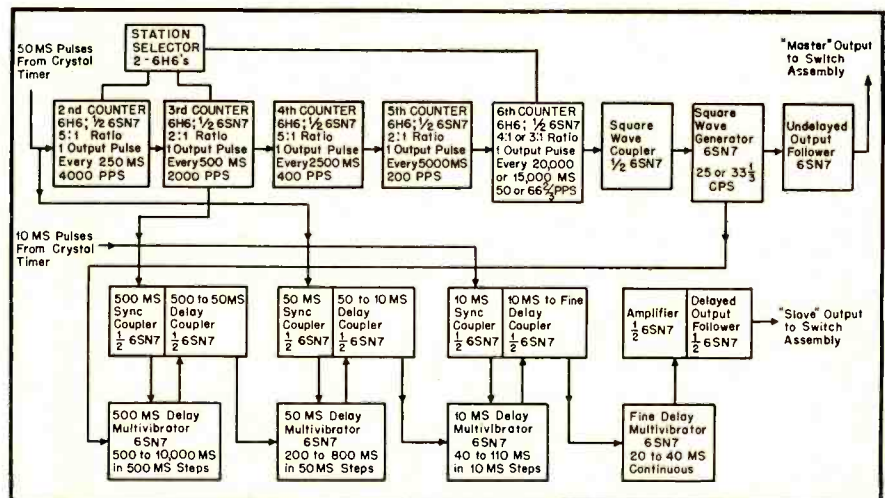

Fig. 5. Block diagram showing stages of master timer unit.

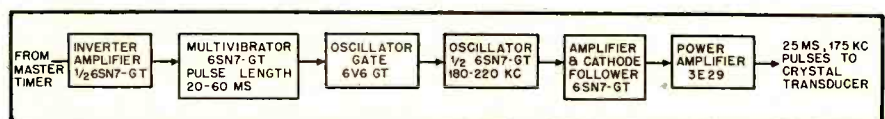

Fig. 6. Block diagram of ultrasonic crystal driver unit.

A Survey of Audio-Frequency Power-Amplifier Circuits

PETER G. SULZER*

A discussion of a number of amplifier circuits—both conventional and otherwise—along with the presentation of a “single-ended push-pull” amplifier.

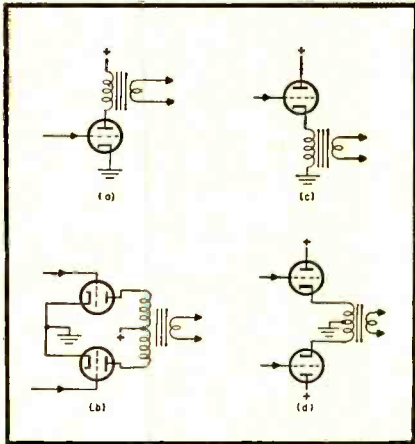

Fig. 1. Conventional single-ended and push-pull output stages.

IT IS THE PURPOSE of this paper to describe some circuits that are useful as audio-frequency power amplifiers. Although the use of several of the circuits in this application is uncommon, they appear to offer interesting possibilities of obtaining special characteristics. The discussion will be restricted to amplifiers employing output transformers since with present tube types it is economically impractical to obtain sufficient current to excite the voice coil of a loud speaker.

One of the first circuits employed as a power amplifier is that of Fig. 1(a), which is the plate-loaded, single-ended stage. The undistorted power output is comparatively low because class-A operation is required. The presence of d.c. flux in the output transformer is a disadvantage, as is the generation of even-harmonic distortion.

The push-pull circuit of Fig. 1(b) is an improvement, since the d.c. flux in the output transformer can be canceled. At the same time, class-AB or class-B operation becomes possible, as the tube characteristics are complementary. If symmetry has been attained, even-harmonic distortion will be very low.

These two circuits have been modified by the use of cathode loading, as shown in Figs. 1(c) and 1(d). Although the output impedance is decreased, no real advantage is gained that could not be obtained by employing inverse feed-

back.¹ In practice, distortion in an am-

¹ Howard T. Sterling, "The cathode follower as an audio amplifier," *AUDIO ENGINEERING*, p. 14, Dec. 1949.

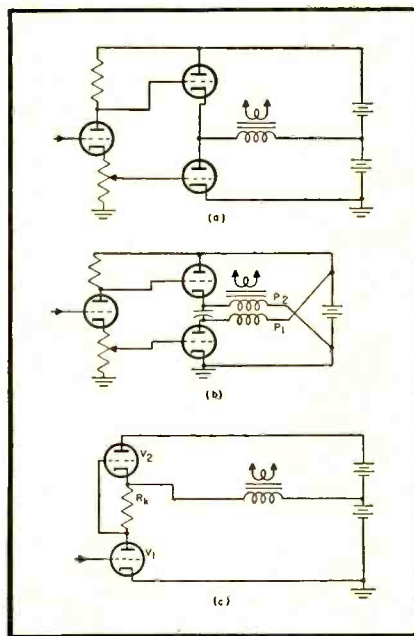

Fig. 2. Series-balanced output stage arrangements.

plifier employing a cathode-follower output stage may be severe because of driver distortion which is the result of the large driving voltage required.

Two-Tube Arrangements

In devising other two-tube power amplifiers, the following considerations should be kept in mind: (1) d.c. magnetization of the output transformer should be avoided; (2) the tubes should be connected in such a manner that the production of even-harmonic distortion is minimized; and (3) the lowest practicable output-transformer turns-ratio should be employed; this may be accomplished by adding plate currents rather than plate voltages in the output transformer. The last requirement permits the use of a lower turns ratio, which is highly desirable from the standpoint of output-transformer design.

Considering a two-tube power amplifier, nine combinations are possible, as follows:

- (1) Plates in push-pull, with grids driven in push-pull;
- (2) plates in push-pull, with cathodes driven in push-pull;
- (3) the push-pull cathode follower;
- (4) parallel operation with plate loading;
- (5) parallel, grounded-grid operation;
- (6) the parallel cathode follower;
- (7) plate loading of one tube and cathode

[Continued on page 46]

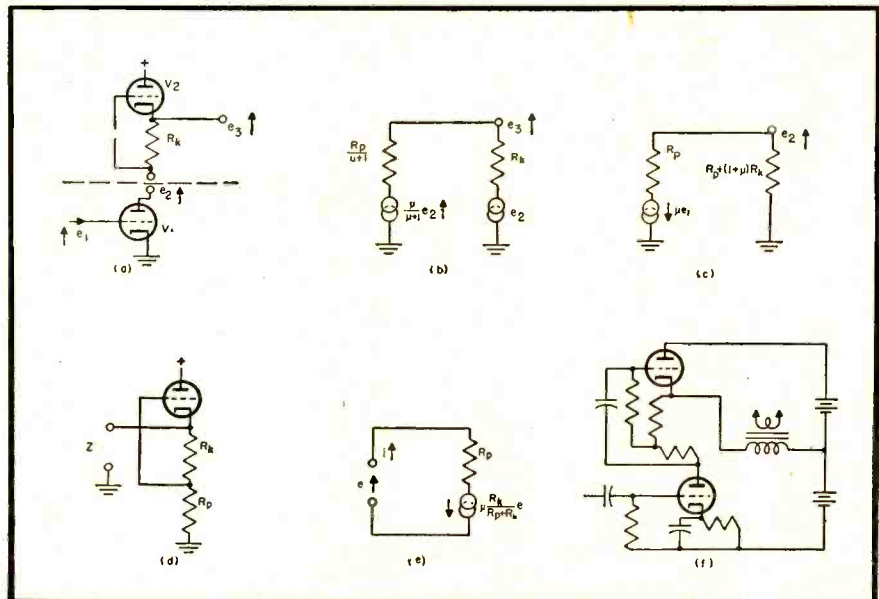

Fig. 3. Equivalent circuits for analyzing the series-balanced output stage.

* National Bureau of Standards, Washington 25, D. C.

Design Elements for Improved Bass Response in Loudspeaker Systems

HOWARD T. SOUTHER*

A frank discussion of the factors which influence the reproduction of low frequencies, and a description of means which may be employed to increase bass radiation.

IT HAS BEEN SAID that music is the only form of dissipation which may be engaged in to any degree by the individual without harm to his physical well being.

Recognition of this postulate helps to explain the accelerating interest in quality sound reproduction as evidenced by the growing ranks of high-fidelity enthusiasts. This enthusiasm constitutes a profitable market for the manufacturer. Accordingly, acoustic research has been spurred recently to satisfy this demand. The listening public, lacking the objectivity of the engineer, has found it difficult to articulate its needs, thus making it hard for the engineer to direct his efforts with any degree of certainty towards a problem the solution of which is primarily subjective. As in the formative stages of any art, much of what has been accomplished in high-fidelity reproduction was through trial and error methods. Exploratory tests conducted by two well-known audio authorities may suggest the objective criteria so necessary to the engineer, and disclose

* Manager, Speaker Division, Electro-Voice, Inc., Buchanan, Mich.

This paper was presented on March 22, Audio Day, at the I.R.E. Show in New York.

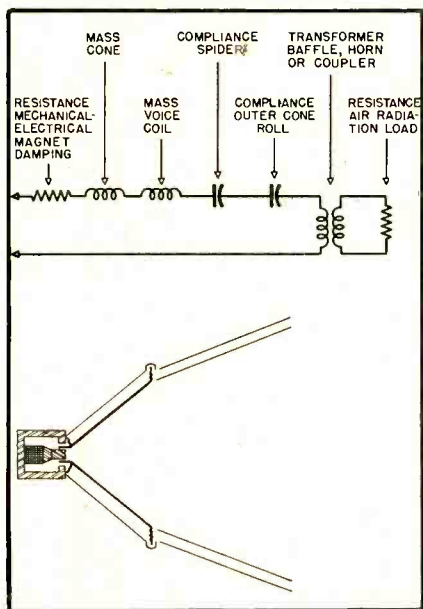

Fig. 1. Typical loudspeaker and its equivalent circuit for investigation of design requirements.

some important points which previously have been overlooked by the lay listener. It is the purpose in what follows to indicate that the incorporation of improved bass response in reproduced sound is probably the most important step in the further development of the art.

Listener Reaction Tests

Howard Chinn of CBS conducted a series of listener tests using reproduced

ciled by the progressive electro-acoustic engineer or he denies his reason for being. For sometime he has had virtually perfect wide-range reproduction in the laboratory, and has awaited only sufficient arguments to warrant presenting it to the public. The way to this presentation is paved by these facts:

1. *Public Acceptance*—The determination that the public desires high quality sound

Fig. 4. Cross-section of theatre-type folded horn—the C-5 "bin."

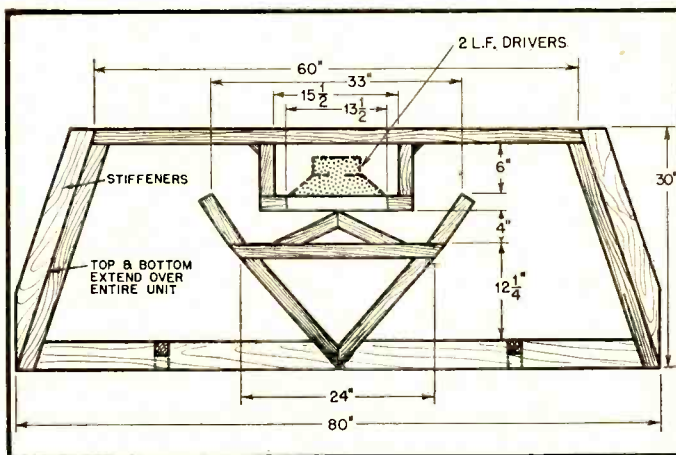

music. The general conclusion from this test was that listeners prefer a narrow, or at least a restricted band of frequencies.

This conclusion violated every aim of the idealist who instinctively believed his goal to be duplication of reality—including the reproduction of all frequencies between 16 and 16,000 cps.

In refutation of the previous test conclusions, Olson of RCA employed a live orchestra with acoustic low-pass filters to test listener range preference. The choice was incontrovertibly for the widest range response possible. The discrepancy in test results was shown to be principally the result of odd-order distortions introduced by the electro-acoustical system. Narrow band reproduction subdued this distortion, making the sound more tolerable.

An Indicated New Approach—The rather conclusive tests by Olson show that the frequencies from 16 to 16,000 cps are necessary for ultimate listening. A concomitant conclusion is that the widest frequency range must be accompanied by very low odd-order distortion or the band must be restricted to be tolerated.

This last compromise cannot be recon-

reproduction has been made. Note that this desire includes all the audible frequencies without balance from the bass range.

2. *Wide-Range Source Material*—New wide-range microphones, low distortion amplifiers, vinylite records, and magnetic tape will allow the wide-range speaker system to perform, sources no longer being a limiting factor.

3. *Treble Driver Units*—High-frequency driver units linear to 10,000 cps with less than 2 per cent harmonic distortion are available. "Super" high frequency drivers linear to 17,000 cps are obtainable. These are designed to supplement the average high-frequency driver.

4. *Low Speaker-System Distortion*—The principle of separating the driver units for reproducing only their respective portions of the spectrum reduces the transducer distortion to the region of acceptable limits.

The notable exception to the listing above is adequate bass in the reproducer response. The goal of good listening in the home cannot be achieved without full consideration being given to the reproduction of the first three octaves up to 130 cps.

Consider for a moment that at 50 cps, a quarter wavelength is 80 in. In order to reproduce down to this frequency only, just slightly below the third oc-

tave, a horn 80 in. across the mouth is necessary. Thus, the usual claim of response to 40 cps would appear specious, to say the least, much less the sometimes added phrase of "useable response to 20 cps."

Further need for better bass response lies in the fact that the system is generally called upon to reproduce program music in the home at a much lower level than that at which it was originally recorded. Reference to the ear sensitivity curves of Fletcher and Munson show that the usual playback level of around 80 db leaves the bass attenuated by about 20 db. The best commercial amplifiers seldom incorporate more than 12 or 15 db of bass boost, for this equalization is costly of final overall power output, especially at the extremely low frequencies where the amplifier ordinarily finds some difficulty in meeting its specifications.

It can be incontrovertibly shown that good extreme bass response is necessary for music reproduction, even though the particular fundamentals involved are not included in the passages being reproduced.

This is explained through the fact that music consists to a very large degree of transient signals which seldom approach a steady state. Thus, staccato passages on a flute with a fundamental of 500 cps will not be reproduced with the proper envelope shape if the low-frequency interruptions of the fundamental tone are below the pass band of the speaker system. Moreover, the mathematics involved will show that for perfect reproduction of this same staccato flute passage the band should be infinitely low and high. For practical purposes, however, it can be assumed that distortion will be minimized, even

Fig. 5. Front view of typical folded horn.

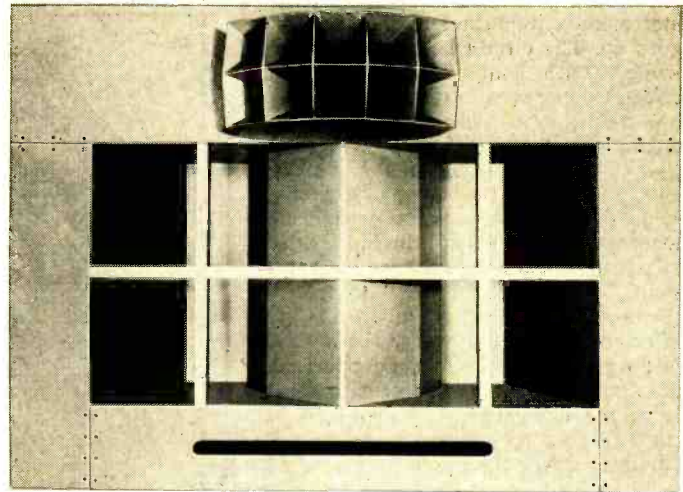

on narrow band sources, if the pass band of the speaker is as wide as possible.

It has been previously concluded that the widest reproducing range is important, and it may be assumed that the extreme low end of the spectrum in reproduced sound has been neglected. It is remarkable in view of the obvious and overwhelming importance of these low frequencies that so little has been done to accomplish this reproduction.

It is the purpose of the balance of this writing to disclose what *can* be done, and perhaps to point the way to the complete accomplishment of adequate bass.

The Reproducing System

A proper understanding of the reproducing system cannot be achieved unless we consider the elements with which we have to work. In Fig. 1, we observe these elements and the equivalent electrical circuit. For best comprehension of

what is to follow let us discuss the items shown in the circuit one by one.

(1) *Magnet Damping (Mechanical-Electrical Resistance)*—In an electrical circuit, resistance will lower the "Q" and broaden the transmission band. Exactly the same thing transpires in the acoustic circuit. High magnetic damping results in fine broad band efficiency and subdues the natural modes of the vibratory system. There are other forms of damping which could be grouped along with this item. For instance, a shorted turn in the voice coil would provide this same sort of smoothing action, but at the expense of efficiency. Low internal impedance in the associated amplifier is of great value in providing this desirable damping action and accomplishes this without lowering overall speaker efficiencies.

(2) *Mass of the Voice Coil*—A short analysis of the equivalent circuit will disclose that voice coil weight becomes

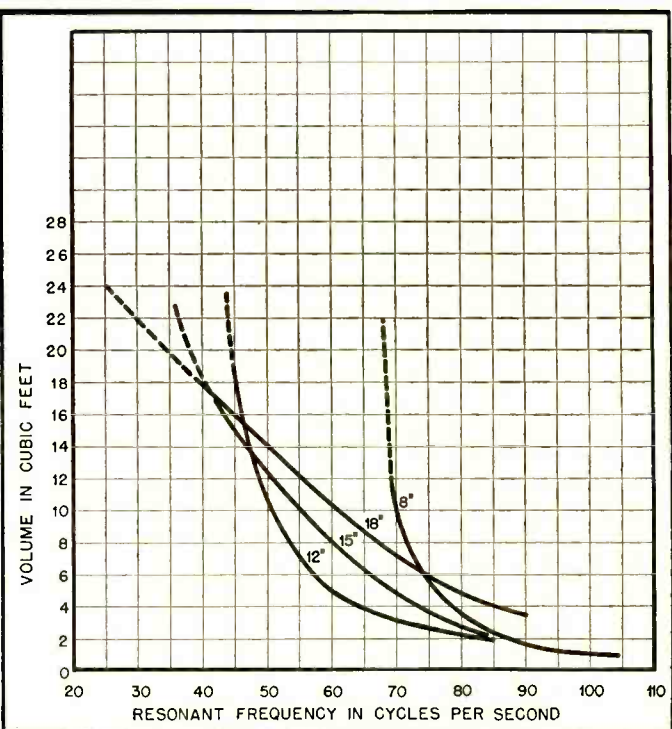
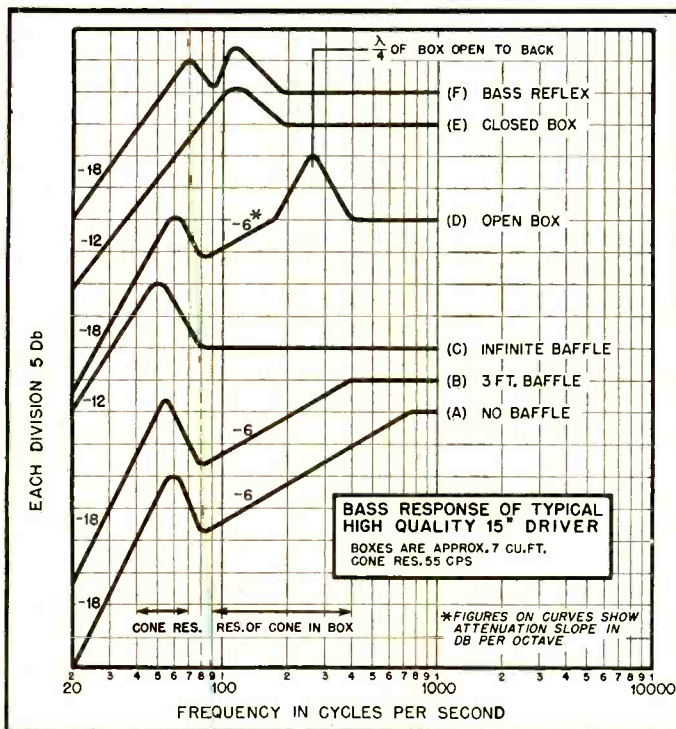

Fig. 2 (left). Comparison low-end response obtainable from various types of speaker mountings. Fig. 3 (right) Optimum size of speaker enclosure for speakers of various diameters and resonant frequencies.

increasingly important as the frequency goes up. The circuit becomes mass controlled, with compliances having less effect. Copper wire is used universally in low-frequency drivers because of increased conductivity irrespective of the weight disparity between it and aluminum. The higher resistance of aluminum is a disadvantage at low-frequencies, whereas, above 1000 cps the lighter mass offsets the disadvantage by a factor of some 35 per cent. At low frequencies, the mass of the cone and air load is little affected proportionately by the addition of 5 or 6 grams, due to the copper, with its attribute of high current capacity. It is in the extreme bass range that the current assumes high proportions. At 15 watts input, the current at 50 cps is on the order of 2 amperes in the voice coil.

(3) *Cone Mass*—Observation of the inductive element represented by the cone mass will lead the electrical theorist to assume that increasing the cone weight will lower the resonance and increase the bass range. This is correct, but an increase in cone weight of double the usual 25 grams will lower the resonance by only a few cps and decrease the efficiency by over 75 per cent. In a driver of top design using 5 lbs. of Alnico V, the iron of the structure is working at its economical limit, and this loss of efficiency cannot be made up in any practical way.

(4) *Compliance*—The next point of attack is logically the suspension system or capacitive element. The usual low-frequency driver has fairly stiff outer compliance rolls, as well as a stiff inner suspension, or spider. The reasons for this are quite practical. The resonance will naturally become lower if the compliances are increased. But here the manufacturer is faced with another dilemma. If he incorporates low compliances, the cone without adequate air loading will "bottom." This is caused by the voice coil hitting the flange on the nosepiece. In addition, non-linear response will ensue because of lack of restoring force when the voice coil rides

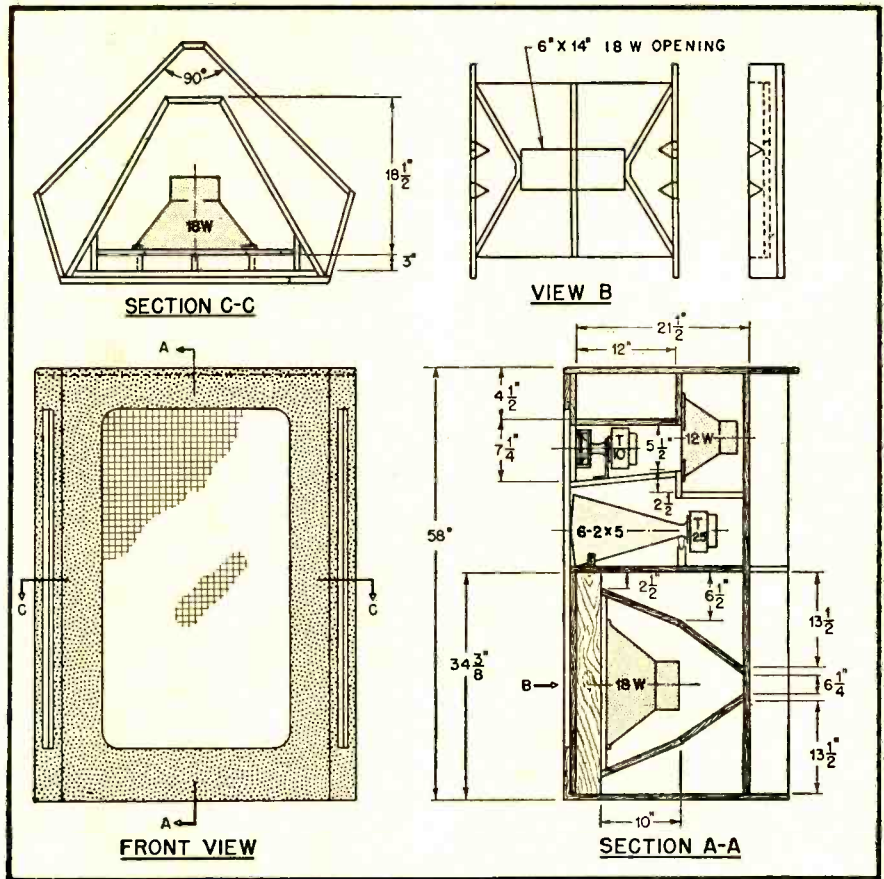

Fig. 7. Simplified constructional drawings for the "Patrician" four-way system.

out of the area of uniformly dense flux. A 30-watt rating for a driver becomes less than 3 watts when the suspensions are made more compliant without proportionately increasing the air load. But this, along with increased air loading, points the direction towards increased bass range and efficiency.

The average good 15-in. low-frequency driver has a free resonance of about 50 to 75 cps. Increasing the compliances reduces this resonance to about 35-50 cps. One 18 in. low-frequency driver on the market has a resonance guaranteed below 30 cps.

(5) *The Acoustic Transformer*—(4) above suggests that the operation of a driver unit cannot be treated on without consideration of its acoustic load. This load of very low impedance, i.e., the open air, must be coupled to the region of cone movement, an area of very high acoustic impedance. Considering the size of the wavelengths to be reproduced, we find that the "transformer" must deal in large surfaces and volumes. Hence, we must work with a baffle, box, and horn concept which is fundamentally architectural in nature. With no baffle at all a 15-in. speaker will begin to lose level from 800 cps down at the rate of 6 db per octave, as shown in curve (A), Fig. 2. This is due to the "doublet" effect of a dual radiator, for as the wavelength approaches the diameter of the cone, cancellation occurs because of the out-of-phase condition.

The Small Flat Baffle

Curve (B) represents a driver on a

small baffle. Note that the "doublet" action takes place at a lower frequency, determined once more by the wavelength of the frequency being reproduced and its size relationship to the diameter of the flat surface.

The Infinite Baffle

Continued increase in the size of the baffle involves another factor, however. If the baffle is large enough, or infinite, so that the critical frequency or wavelength of the diameter corresponds to the mechanical resonance of the driver, range response is extended to cone resonance, as shown in curve (C). But past the critical resonant wavelength of the driver cone, attenuation takes place at the rate of 12 db per octave, regardless of the size of the baffle. This is due to the stiffness, or low capacitive effect, of the driver cone mechanism, and indicates the value of a driver with low free-space resonance. From the practical aspect, it can be assumed that an 8-in. speaker with a free-space cone resonance of 62 cps will not benefit with a baffle larger than 5 feet in diameter.

The Open-Back Box

Operating like the infinite baffle when the proportions are large, the open box is quite adequate provided that the dimensions prevent cancellation of the front by the back wave. However, in the usual dimensions suitable for a living room, say 6 to 12 cubic feet, the resonance of the box itself causes a violent peak of perhaps 10 to 17 db around 175

[Continued on page 53]

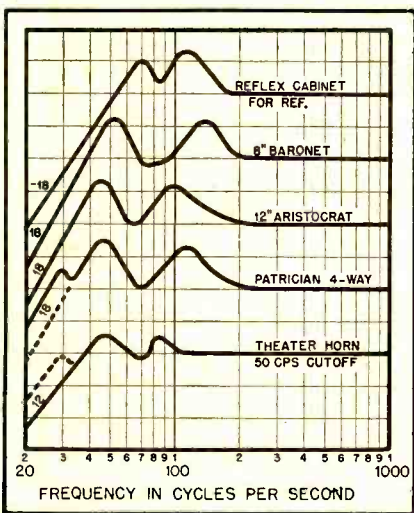

Fig. 6. Typical response curves of reflexed cabinet, several manufactured enclosures, and the folded horn.

The I. R. E. Show

A brief resume of most of the exhibitors' displays which would have been of primary interest to the audio field.

Retrospect seems to offer the only sound means of evaluating events, such as the 1951 version of the annual IRE Show in New York, whose real values and accomplishments are more frequently than not submerged in the frills and excitement which reign from the moment the doors are opened for the first admission until they are closed for the final curtain.

If this year's show were to be reviewed superficially, there would be little need for anything more than assembling the usual group of platitudes which are used in "selling" such affairs to prospective exhibitors and to those who are expected to attend. With a quick switch in tenses, of course. For example and to wit:

"The 1951 IRE Show will be bigger and better than ever." It was. "Attendance is expected to exceed all previous records." It did. "A new high will be reached in the value of equipment on display." It was. "More manufacturers will be represented than in any previous IRE Show." They were.

In digging beneath the obvious, however, and in looking back on the show with the detachment of the third morning after, it can be seen easily that the exhibition was governed principally by three dominant influences—military, television, and audio.

The Army, the Navy, the Air Force, and the National Bureau of Standards are to be congratulated on the intelligent assembly of one of the most interesting and informative displays of electronic equipment ever to be placed on public exhibition. Likewise, most of the equipment manufacturers are to be commended. And, speaking for the audio fraternity, the IRE Show management deserves blessings for apparent recognition of the fact

that audio is a distinct entity in the field of electronics, and worthy of treatment as such.

This year, for the first time in the history of the annual IRE exhibit, audio equipment manufacturers who desired were assigned space in a special section of the exhibition hall devoted solely to the display and demonstration of sound equipment. Such an arrangement works to the advantage of exhibitors and visitors alike, and the audio brotherhood as a whole is grateful to the show management for this gesture of thoughtfulness.

Herewith the reminiscent reflections of one foot-weary observer on but a few of the many fascinating exhibits:

United Transformer Company used the theme "Precision in Production" as a means of dramatizing the consistent high quality which is inherent in all UTC products. Displayed were many representative types of UTC transformers. Judged from the standpoint of planning and presentation, the UTC exhibit was one of the more inviting in the entire show.

Magnecord, Inc., and **McIntosh Engineering Laboratory, Inc.** combined their facilities to produce a demonstration of great effectiveness in which a Magnecorder and three fifty-watt McIntosh amplifiers were used in conjunction with a Baldwin electronic organ and three Lansing Signature speakers. The demonstration procedure consisted of playing the organ live, then switching instantaneously to the monitor head of the Magnecorder, and giving individual members of a seated audience the opportunity of deciding which was which. The number of red faces gave eloquent testimonial to the fidelity of tape recording.

Right: United Transformer Company, Magnecord, Inc., University Loudspeakers, Inc., Racon Electric Company, Terminal Radio Corporation, Sun Radio and Electronics Company, Inc. Below: General Radio Company, Reeves Soundcraft Corporation, Sheldon Electric Company, Arnold Engineering Company.

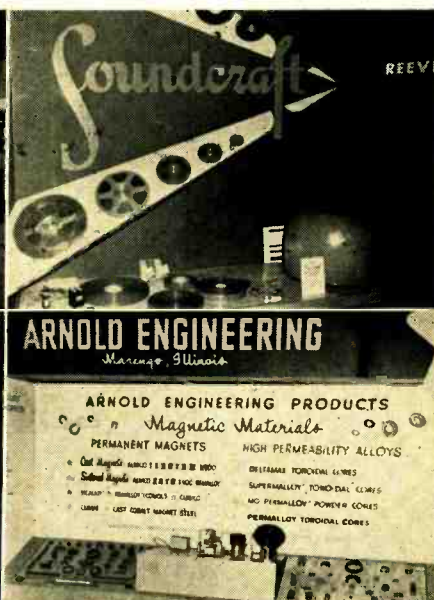
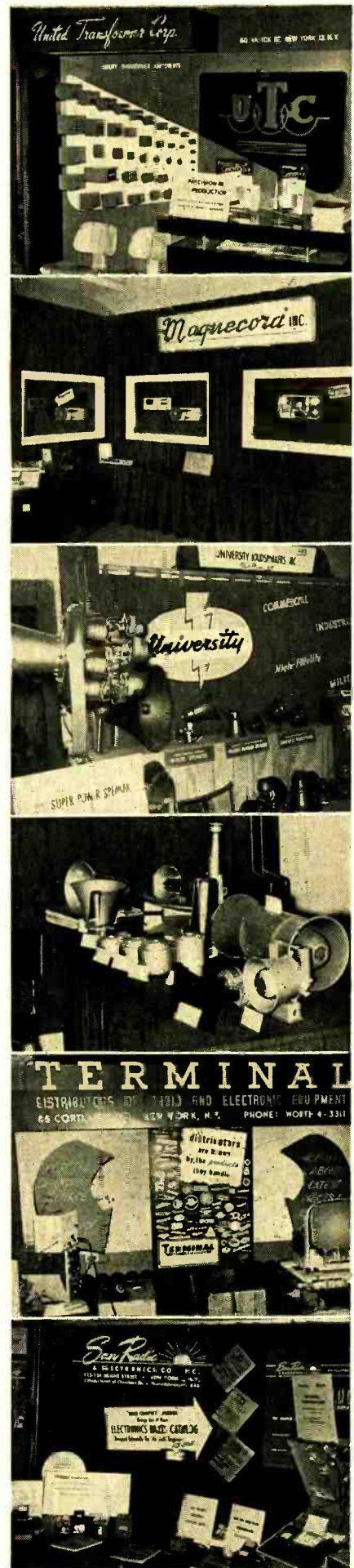

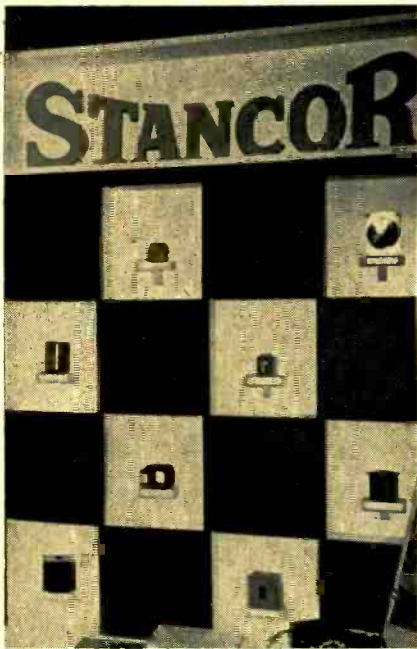

University Loudspeakers, Inc. presented a display of speakers which was entirely fascinating. Great interest was shown in the new Model B-12, a super-power horn-type unit capable of continuous operation with a power input of 300 watts. Also coming in for more than average attention was an explosion-proof unit designed for use in atmospheres contaminated with explosive gasses. The exhibit was rounded out with other types ranging from tweeters for high-quality music systems to submergence-proof speakers capable of complete immersion in water without impairment of operating efficiency.

Racon Electric Company, Inc. featured a showing of loudspeakers of specific interest to engineers occupied with the installation and maintenance of p.a. systems. Cutaways of various models illustrated clearly the quality of construction for which Racon speakers are well known. High-quality-audio enthusiasts were not overlooked in the fact that the display included an improved version of the Racon tweeter assembly for two-way speaker combinations.



Terminal Radio Corporation, pioneer among New York's leading jobbers and distributors, displayed a variety of equipment ranging from TV chassis to magnetic tape recorders, however the overall emphasis of the exhibit was placed on Terminal's reliability as a source of supply. The backdrop of the booth was dominated by a large placard bearing the legend "Distributors are Known by the Products They Handle", and listing a large number of prominent manufacturers whose equipment is stocked by Terminal.

Sun Radio & Electronics Co., Inc., one of America's most rapidly growing jobbers, introduced its new Electronics Parts Catalog, one of the largest independently-produced catalogs in the industry. Although located several blocks away from New York's famous "Radio Row", Sun has done a remarkable job of building up an enviable clientele in both consumer and industrial fields.

General Radio Company attracted a great deal of attention with an exhibit which emphasized the extent to which the GR line of test and measuring equipment had been broadened in recent years. Old-timers particularly, many of whom were virtually weaned on GR test equipment in the early days of radio, had their eyes opened by the growing variety of precision instruments with which GR is still maintaining a position of leadership in its field. Improved models of Variacs also came in for their share of attention.

Reeves Soundcraft Corporation attracted great interest with a showing of Magna-Stripe, a movie film on which is placed a sound track of oxide to permit magnetic tape recording either before or after the film is processed. Revolutionary in many respects, Magna-Stripe is expected to effect economies in the TV-film field by eliminating many of the expenses

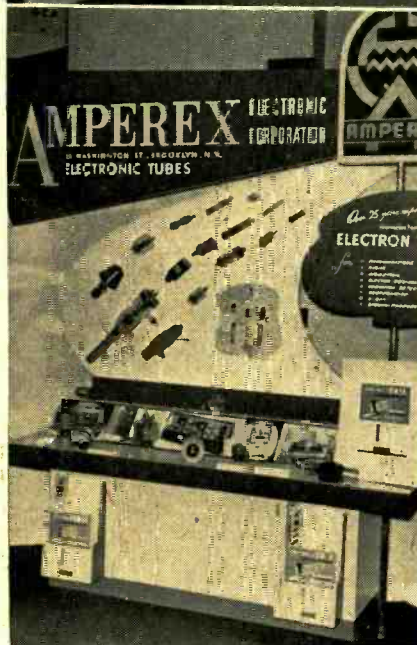

Far left: Standard Transformer Corporation, Tech Laboratories, Inc., Amperex Electric Corporation. Left: Radio Corporation of America, Par-Metal Products Corporation. Below: Partridge Transformers Ltd.

inherent in optical recording. Also displayed with effectiveness were the Reeves lines of magnetic tape, discs, and picture tubes.

Sheldon Electric Company created great interest with the only showing of an instrument designed for production testing of TV picture tubes. Adding to the effectiveness of the exhibit was the fact that the tester was displayed in operation, and visitors were permitted to manipulate it under the guidance of Sheldon officials. The instrument affords complete evaluation of a picture tube's characteristics within minutes after the tube is placed in its mounting.

Arnold Engineering Company did a remarkable job of building an interesting display around such inanimate items as cores for toroidal coils and small samples of permanent magnets. Intelligent arrangement of the various alloys on exhibit, together with carefully prepared signs to coordinate the overall effect, effectively brought out the underlying reasons for the company's leadership in this field.

Standard Transformer Corp. used its display to accentuate the company's position as one of the country's leading manufacturers of transformers for all types of electronic application. In addition to building transformers for use in original equipment, Stancor is now supplying distributors with a comprehensive line of replacement items. A recently-published Stancor catalog, for example, lists replacement transformers for more than 900 TV receiver models.

Tech Laboratories, Inc. captured the interest of broadcast engineers with a display of the Artificial Reverberation Generator. Developed by Audio Facilities Corporation, although manufactured and marketed solely by Tech, the ARG affords considerable economy by eliminating the need for costly echo chambers. In operation, it permits simulation of any desired echo effect through use of an endless magnetic tape in conjunction with an amplifier and controls. Both the degree of reverberation and the decay time are adjustable. Tech also had an impressive display of precision attenuators for operation at frequencies as high as 100 mc.

Amperex Electric Corporation built

Below: The Daven Company. Right: Approved Electronic Instrument Corporation. Far right: Jensen Manufacturing Company, Panoramic Radio Products, Inc.

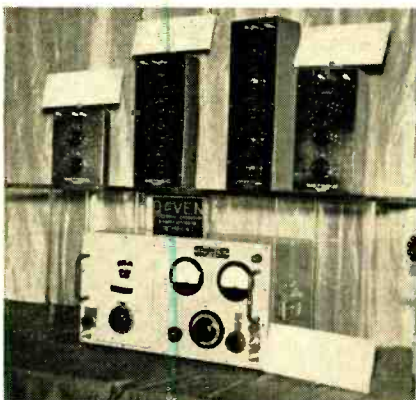

its exhibit around a new high-power transmitting tube. Said to be the highest power air-cooled tube in the world, the new Amperex type AX9906R/6078 is capable of power output up to 108 kw. It embodies a new patented air-cooling principle exclusive with Amperex.

Radio Corporation of America had its usual lavish exhibit which featured a wide variety of RCA products for industrial application, as well as several recent developments of the RCA laboratories. Among the former were operating demonstrations of the RCA industrial TV system, and of the RCA electron microscope. Included in the latter category was a cutaway of the RCA color-TV picture tube. Means were provided for observing the color-dot arrangement under magnification which greatly increased the effectiveness of the showing. Another source of unusual attention was a well-executed scale model of the TV-FM tower assembly now being completed atop the Empire State Building in New York. For the sake of the record, and particularly because these words are appearing in AE, it must be noted herewith that the exhibit also included a small panel on which loudspeakers were shown.

Par-Metal Products Corporation's display was of interest chiefly to electronic equipment manufacturers. Shown were metal cabinets ranging in scope from units suitable for small receivers to ones capable of accommodating complete transmitters or large p.a. systems. Especially noticeable was the trend toward improved appearance in the housing of professional equipment.

Partridge Transformers Ltd. made capital in its exhibit of the remarkable reputation achieved in this country by the Williamson audio amplifier circuit, the original model of which included a Partridge transformer in its design. Esthetic appeal has been considered along with constructional features in the latest model Partridges, which are attractively finished in metallic brown.

The Daven Company's exhibit was of interest chiefly to audio engineers.



Daven has branched out considerably within the past two years and, in addition to the precision attenuators for which the company has long been noted, is now supplying engineers with an extensive line of assembled instruments for test and development applications. Principal among these items are a new distortion and noise meter, an output power meter, a frequency meter, in addition to a new series of r.f. attenuation boxes.

Approved Electronic Instrument Corporation covered the field with such diverse items as TV service equipment, audio amplifiers, and a recently introduced FM-AM tuner. Priced quite reasonably, it appears that this tuner may well be the means of bringing FM-AM reception of excellent quality within range of even the most modest income.

Jensen Manufacturing Company, although displaying a number of replacement speaker models, featured in its exhibit the new high-quality Type G-610 Triaxial. Many observers were noticed, upon leaving the Jensen booth, to strike a bee line for the sound room in which the G-610 was

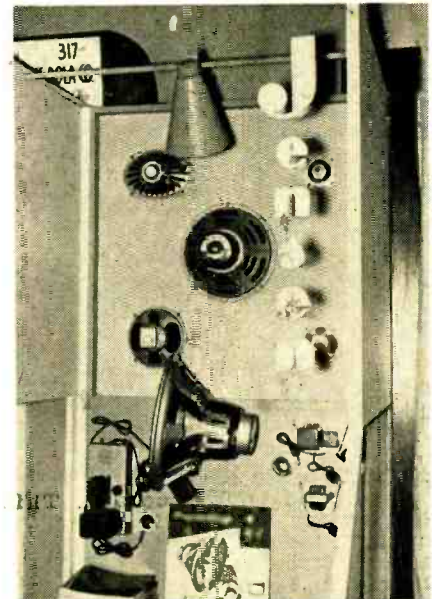

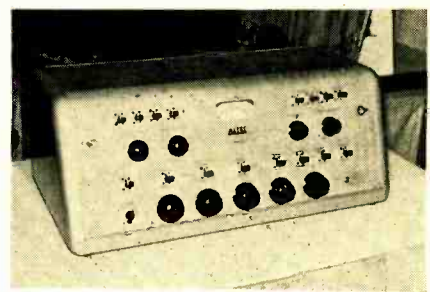
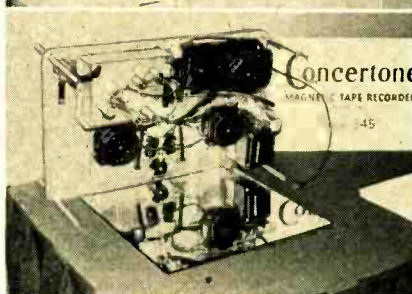
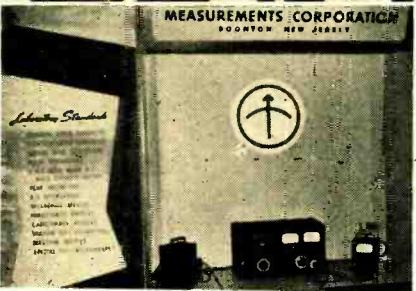
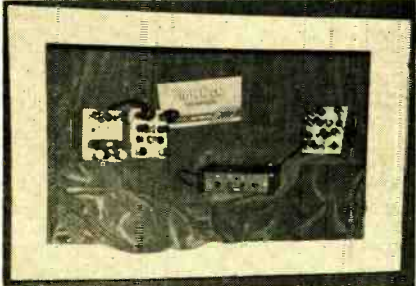
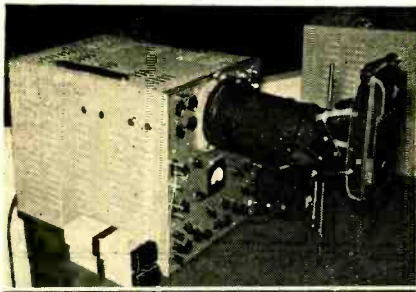

Far left: Fairchild Camera and Instrument Corporation, McIntosh Engineering Laboratory, Inc., Gray Research and Development Company, Measurements Corporation. Left: Audio Devices, Inc., Cannon Electric Company, Fisher Radio Corporation. Above: Altec Lansing Corporation, National Company, Inc.

demonstrated in conjunction with the Concertone tape recorder. This speaker, one of the newest developments in the audio field, came in for a great deal of attention during the entire course of the show.

Panoramic Radio Products, Inc. equipped its booth with several representative models from the extensive line of visual spectrum analyzers the company manufactures. Of more than usual interest was the working demonstration of the Ultrasonic Analyzer Model SB-7, shown performing as a telemetering system monitor.

Fairchild Camera and Instrument Corporation easily captured the interest of professional electronic engineers with a working display of the Fairchild-Polaroid Oscilloscope Camera. Using an audio signal generator feeding into a Textronix oscilloscope, booth attendants offered dramatic proof of the camera's effectiveness by photographing various types of wave shapes, then showing a finished positive print within one minute of exposure. The camera produces $3\frac{1}{4}'' \times 4\frac{1}{4}''$ prints with all traces recorded exactly one-half life size to facilitate comparison.

Gray Research and Development Company went overboard for TV with a unique demonstration of the CBS color system. The Gray exhibit on the first floor was used as the pickup point for a fifteen-minute program, presented two or three times hourly, which was transmitted by wire to a small auditorium on the third floor, where reception was by means of a group of receivers varying in picture size from twelve to fifteen inches. Interest in this demonstration was so great that the original plan of serving a seated audience had to be abandoned after the initial showing. Thereafter, viewers were kept moving slowly past the receivers in an effort to permit as many as possible to see the system in operation. The equipment used in the demonstration was designed essentially for industrial use and should not be confused with equipment intended for broadcasting which affords noticeably superior resolution.

Measurements Corporation used its display to keep uppermost in the minds of visitors the high degree of precision inherent in all Measurements products. Along with a colorful sign itemizing the various laboratory standards manufactured by the company, there was a display of the famous Type 80 signal generator, probably in greater use in laboratories throughout the world than any other instrument of its kind.

Audio Devices, Inc. came up with a unique device for attracting interest by using a sound room, not for demonstration of Audiotape and Audiodiscs as might be expected, but for the showing of a color movie made in the company's plant. The film was roughly fifteen minutes in length and carried

the viewer through the entire manufacturing process involved in producing Audiotape. Showings were continuous throughout exhibition hours, and many hundreds of visitors were deeply impressed by the quality control applied at each step of production, resulting in the consistency of fine performance for which Audiotape and Audiodiscs are noted.

Cannon Electric Company graphically showed how its line of connectors had been expanded and improved to keep pace with the stringent demands of military equipment. Prominent among the items on display was the Type AN firewall connector, designed to prevent the spread of an aircraft engine fire through the bulkhead into wing sections. Other Cannon products shown were coaxial connectors for various types of r.f. transmission lines.

Fisher Radio Corporation, in addition to displaying the Fisher Custom Sixty FM-AM Receiver, engaged a sound room for a working demonstration of the Concertone magnetic tape recorder, for which it is Eastern distributor. This demonstration was particularly impressive because it employed, along with the Concertone, the new Jensen G-610 Triaxial loudspeaker system. For many visitors to the show, this was an initial opportunity to hear each of these items demonstrated in conjunction with equipment of comparable quality.

Altec Lansing Corporation, while displaying its extensive line of high-quality speakers, laid particular emphasis on the display of a new model audio console designed primarily for broadcast stations but equally well suited for use with high-quality sound distribution systems. Evident in this console is the trend toward reduction in bulk of studio control equipment. Evident also in the Altec display was the fact that loudspeakers formerly manufactured by Western Electric



Above: Shallcross Manufacturing Company, Masco Sound Systems. Right: Barker & Williamson, Inc., Herman Hosmer Scott, Inc., International Resistance Company. Far right: Browning Laboratories, Inc., Presto Recording Corporation, British Industries Corporation, Gates Radio Company.

are now being merchandised as part of the Altec line.

The National Company featured a showing of its superb receivers. Of principal interest to audio engineers and hobbyists is the new National high-quality FM tuner.

Shallcross Manufacturing Co. effectively called attention to the great expansion which has taken place in its line of products in recent years. Along with selector switches and decade boxes for which the company has long been noted, Shallcross now produces a wide range of precision measuring instruments, also offers a custom building service for the development of instruments to meet unique requirements.

Masco Sound Systems, in addition to showing a variety of phono amplifiers and p.a. equipment, featured a new and greatly improved model of the Masco tape recorder. The fact that Masco's reputation for aggressive merchandising is not entirely undeserved, is well illustrated in the manner with which this new tape recorder is being introduced to the trade. Compact and tastefully designed, it falls in the modest price bracket.

Barker & Williamson, Inc. centered the interest in its exhibit in improved models of B & W test equipment and in the wide variety of coils and components which the company manufactures as stock items. Of unique appeal to audio engineers was the Model 400 distortion meter, an instrument which performs many of the functions of wave analysis usually expected only of units costing several times the 400's low price.

Herman Hosmer Scott, Inc. key-noted its exhibit around an acoustics-for-industry theme. Although the Scott dynamic-noise-suppressor amplifier was displayed, emphasis in the

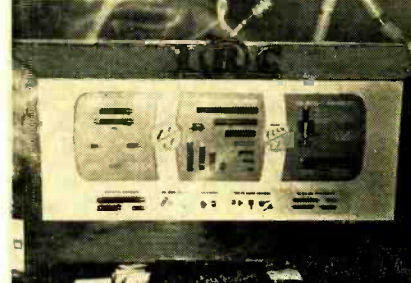

Scott booth was centered in the Scott sound level meter, random noise generator, and other instruments produced chiefly for industrial application. Interesting to note here that Scott, along with a number of other exhibitors, used its booth as a sort of classified ad in an effort to recruit engineering personnel. Prominent in several displays were signs proclaiming the opportunities awaiting technicians on the exhibitors' payrolls.

International Resistance Company, faced with the problem of building a display around objects which it must be admitted are a bit on the inanimate side, did a job which was thoroughly commendable. Various types of IRC resistors and controls were mounted on a large backboard in such fashion as to be both interesting and informative. Exceptional interest was displayed by engineers in the new Type LP water-cooled resistor for high-power high-frequency applications, and in the new IRC Loudness Control for audio amplifiers.

British Industries Corporation introduced in its exhibit a newly-improved model of the famous Garrard record changer. Already widely accepted in this country the new Garrard plays standard, LP, and 45 r.p.m. recordings, and is exceptional in the low amount of motor-induced hum when equipped with low-level magnetic-type pickups. While interest in the Garrard changer came mostly from audio engineers, manufacturers and service men were deeply impressed by a display of Ersin Multicore three-core solder, another product distributed in the country by British Industries.

Presto Recording Corporation cre-



ated intense interest with the first public showing of its new low-cost tape reproducer Type TL-10 (see **New Products**). The TL-10 is a spool-and-head assembly for use with standard 16-in turntables. Using the turntable spindle for driving power, it operates at 7½ and 15 in. per second, and has sufficient output for plugging directly into speech input equipment. It will greatly enhance the economy of using tape by eliminating the cost of an entire recorder where only reproduction is required.

Gates Radio Company stressed the high quality and clean appearance of its broadcast equipment in an exhibit which featured an improved audio control console and an air-cooled 10-kw transmitter. Both items were displayed in such a manner that internal construction features were clearly visible, and engineers were deeply impressed by the fine, workmanlike wiring, and placement of components which afforded unusual accessibility for maintenance and tube replacement.

Browning Laboratories, Inc., taking into consideration the professional aspect of the exhibition, placed empha-

[Continued on page 56]

Industrial Survival Sound Systems

H. S. MORRIS*

Describing a currently important application of sound systems with a new aspect of their use—personnel protection.

THE VALUE of the Industrial Sound System to efficient plant operation has become a one-sided argument.

Progressive Management agrees that the plant-wide sound system conserves payroll in many ways. The time-saving feature of paging facilities; centralized control of shift changes and rest periods; and music distribution for morale purposes and to stimulate production, are only part of the story. Personnel Managers have used the plant-wide sound system to broadcast skits on absenteeism, and these thought provoking burlesques have reduced absences noticeably. Department Stores have found that besides the things it was originally purchased for, the sound system is the only way executives can brief hundreds of sales personnel just before the store opens on such subjects as courtesy, special sales, and many other things; and after the store closes they have found that music drives away the emptiness of vast floors and timid cleaning women no longer fear to work alone among the drop-cloth enshrouded counters.

It was World War II which gave the Industrial Sound System its first real acceptance when it was demonstrated that increases of as much as 15 to 20 per cent in production could be effected

* *Altec Lansing Corporation, 161 Sixth Ave., New York 13, N. Y.*

by the judicious programming of music during periods when employees commonly tend to slow-down.

Now, evidence has already begun to appear that our present war-preparation period is going to bring many more calls for plant-wide sound systems from companies which have not heretofore had such systems or which have inadequate systems. But this time the accent is on protection—protection of personnel in case of atomic attack.

This growing interest is by no means confined to industrial plants. Inquiries are coming in from department stores, office buildings, banks, newspapers; in fact from all types of commercial establishments which normally harbor appreciable numbers of employees or the public.

Recall World War II and the elaborate measures which were taken at that time along the lines of civilian defense. Many of us were air-ward wardens with tin helmets, flashlights, and sand buckets. And at that time, our enemy had planes that could barely span the Atlantic and there were no such things as jets, guided missiles, and atomic bombs.

THIS TIME it will be Different

THEN—an attack would have consisted of TNT explosives with damage

and personnel danger limited to direct hits.

Now—an enemy attack would be much more devastating and there can be no question of such attacks on many industrial centers if we should get into a fighting war with a major power. Instead of confined direct hit damage, the atomic weapon of the next war will strike crippling destruction over a surrounding area of several square miles and danger to personnel over a still wider area.

It is this new and much more terrible hazard to human life that extends far beyond and for an *uncertain time after* the actual strike that is building the demand for the Industrial Survival Sound System.

Sirens cannot do the job. They cannot reliably penetrate buildings, pierce common industrial noise levels, and alert persons with ordinary hearing defects. At best, sirens and alarms only *alarm*. The uncertainty which follows their use breeds panic and hysteria.

In contrast, the Survival Sound System makes it possible for a Plant-Protection Officer to give voice directions throughout the entire duration of an emergency. Not only can the Plant Protection Officer, in whom the employees are trained to have confidence, immediately alert all employees of an impending attack, but he can also direct various



(Right) Typical installation of speakers in department store. Square grilles in the false ceiling over the aisles show a few of the 850 high-quality 755A speakers in Hess Brothers Department Store, Allentown, Penna.

(Left) Where installation of speakers in the ceiling is impractical, small enclosures may be attached to the walls or ceilings without disturbing the decor appreciably, as shown in another view at Hess Brothers Department Store.

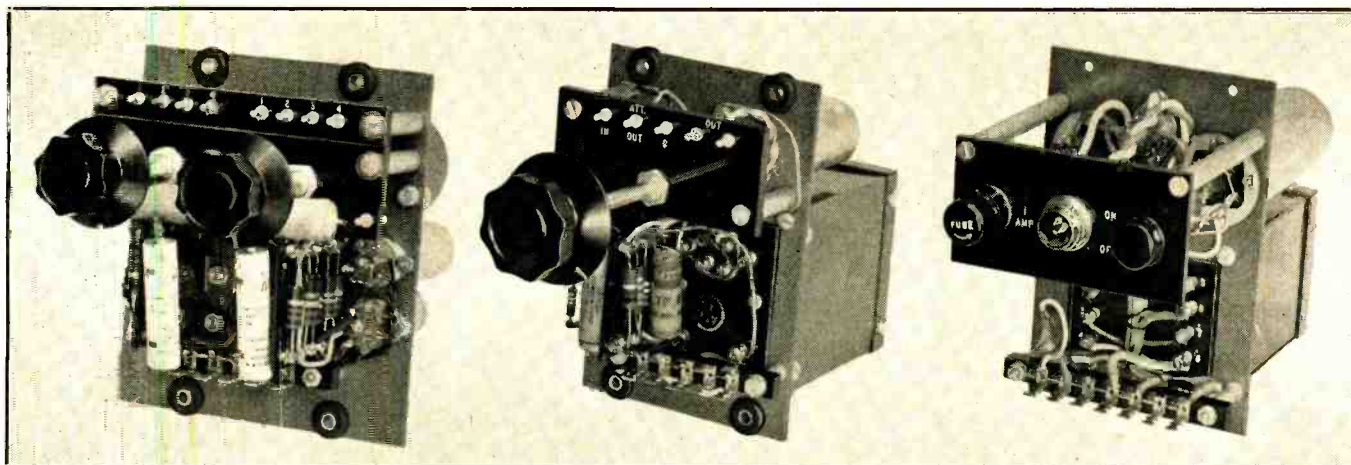

(Left) Two-channel mixer preamplifier; (center) line amplifier; and (right) power supply. All of these units are designed for mounting directly on power amplifier chassis, although they may be located at some point remote from the amplifier if desired.

groups to different places of shelter; and should a nearby atomic strike actually occur he can give voice directions to all under his charge to remain in their shelters and take whatever precautions are wise until such time as the properly constituted authorities have determined that danger no longer exists due to gamma ray contamination or other conditions.

The Survival Sound System is the most valuable tool of the trained Plant Protection Officer. In case of atomic attack, carefully planned moves can be quickly carried out to the finest detail by means of running voice instruction calmly given.

Amplifier Equipment

Just three months after the opening of the Korean hostilities, Altec Lansing announced to the market a new 1400 series of amplifiers which were specifically designed to the foreseeable needs of what is now known as the Survival

Sound Systems for personnel protection. The general amplifier requirements were compactness, great flexibility, economy of cost, simple installation. These requirements resulted in some unusual design features.

Two basic power amplifiers are provided, of 35 and 75 watt capacity, ample to cover floor areas of 25,000 to 100,000 square feet. These amplifiers have a total of 96 and 98 db of built-in gain, respectively, enough to operate directly from a low-impedance dynamic microphone, without the addition of a pre-amplifier. Thus, the cost of the simple Survival System with a single microphone input for small plants is low. Both amplifiers have master gain controls to complete the provisions for direct microphone inputs. Built-in high-pass equalization is provided to reduce bass response and to improve voice intelligibility when it is necessary to cut through reverberation or high noise levels. Outputs are available for 70-volt speaker distribution as

well as the usual voice-coil impedances.

Class AB design was selected to give longer tube life and to reduce power line consumption during periods of no signal or standby.

A small compact two-channel mixer pre-amplifier 1410A was designed for use where more than one input is required for additional microphones, wired music, turntables or other signals. The two-channel idea makes the cost of adding inputs very low. Again for compactness, the mixer pre-amplifier can be mounted directly on the power amplifier chassis. The 75-watt amplifier will mount two such pre-amplifiers, providing a complete amplifying system with four mixing inputs all in 14 in. of cabinet space. Up to six mixer preamplifiers (a total of 12 channels) can be powered by this power amplifier.

The preamplifier also has been designed to meet easily the infinite problems of remote mixing and control. The output of each of the channels in the amplifier is a cathode follower with an impedance of less than 1,000 ohms. Thus it can feed into a long line without introducing frequency errors. The outputs are combined in a network consisting of two potentiometers, two blocking capacitors and two building-out resistors. These components are arranged on a sub-assembly which can be removed from the 1410A and installed at some remote point where it is desired to control the system. No problems are involved in feeding the mixing network from the cathode followers and the network can be located as far as 400 feet from the preamplifier.

Input impedances are 30, 150/250, and 500 ohms, and by a slight RC modification one or both channels can be adapted to a variable reluctance pickup.

The 1400 Series of amplifiers is completed for all applications with a two stage Line Amplifier coded 1440A and a remote Power Supply coded 30A. Both units are of the same size as the Mixer Pre-Amplifier, $5\frac{3}{16} \times 3\frac{1}{2} \times 6\frac{3}{4}$ in. In a space of only $5\frac{3}{16} \times 19$ in., a complete four-channel remote mixer to drive telephone lines can be made up of two mixer preamplifiers, a line amplifier and a power supply.

[Continued on page 37]



Simple arrangement typical of medium sized Survival Sound System with 75-watt power amplifier and 632A microphone for use by telephone operator, who connects her microphone by means of a foot switch.

Filter Design Simplified

BERTHOLD SHEFFIELD*

Part II. Continuing the presentation of a method for calculating constants for filters, with special attention to band-pass and band-elimination types.

IN THE PRECEDING ARTICLE a simple method was shown for designing major filter types without reference to texts or charts. This method can be extended to band-pass and band-elimination filters, thus enabling the reader to design elements of the major filter types by applying simple, well known formulas.

In brief review, it was shown that T and Pi type configurations consist of identical L sections, whose two arms each have a reactance X which, at cut-off frequency, equals the termination R_o . This conclusion holds for T and Pi, low-pass and high-pass filters, and is shown schematically in Fig. 1.

The configuration of the basic L sections of m -derived types differs somewhat from the constant- k section, but the magnitude of the reactances of the arms are directly related to the constant- k type. Figures 2 and 3 show L type m -derived half sections.

Band-pass filter half section elements are designed as readily as the low-pass and high-pass types. For example, in the band-pass half section of Fig. 4 each element in the series arm has the reactance $Q_o R_o$ at center frequency, while each element of the shunt arm has the reactance R_o/Q_o at the center frequency f_o . Q_o refers to the ratio of the resonant frequency f_o and the bandwidth between half-power-point frequencies f_1 and f_2 ; i.e.,

$$Q_o = \frac{f_o}{f_2 - f_1} \quad (8)$$

A numerical example will illustrate the application of these formulas. A brief proof follows the illustration, showing the validity of these statements.

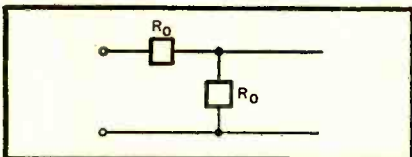

Fig. 1. Basic L section showing element values of reactances at cut-off frequency.

Numerical Example of Band-Pass Filter Design

Suppose it is desired to design a band-pass half section for an experimental noise suppressor of the type suggested by Dr. H. F. Olson, of RCA Laboratories. The bandwidth of the first octave is to be 1500 to 3000 cps, and the nominal termination of the half section is chosen as 6000 ohms. From this data the center

frequency, f_o , of the filter is $\sqrt{1500 \times 3000}$ or 2,121.32 cps. Using formula (8), $Q_o = f_o / (f_2 - f_1)$, or 1.414. The reactance of each element of the series arm is $R_o Q_o$, or $6000 \times 1.414 = 8484$ ohms. Since the series reactances are equal at center frequency, $X = \omega_o L = 1 / \omega_o C = 8484$ ohms. The elements are calculated by writing

$$L_1 = X / \omega_o = 0.636 \text{ henry}$$

$$C_1 = 1 / (\omega_o X) = 0.00885 \text{ } \mu\text{f.}$$

The series and shunt arms are inverse, hence

$$L_2 = R_o^2 C_1 = 0.318 \text{ henry}$$

$$C_2 = L_1 / R_o^2 = 0.0177 \text{ } \mu\text{f.}$$

The half section with these element values appears in Fig. 5.

Proof of Simplified Formulas

The midseries image impedance Z_{iT} of the band-pass filter is derived from the same formula which applied to constant- k filters in the preceding article, namely

$$Z_{iT} = \sqrt{Z_1(Z_1 + Z_2)} = \frac{\sqrt{Z_1 Z_2}}{\sqrt{1 + Z_1/Z_2}} \quad (9)$$

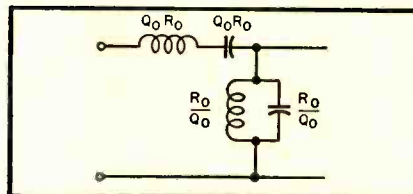

Fig. 4. Band-pass filter half section showing element values of reactances at center frequency.

The band-pass filter is to pass all frequencies between f_1 and f_2 and is to cut off below f_1 and above f_2 . At the boundaries, f_1 and f_2 , Z_{iT} should be zero. That the first term, $Z_1 Z_2$ cannot become zero at two frequencies is readily shown by noting that

$$Z_1 = j \left(\omega L_1 - \frac{1}{\omega C_1} \right) = j \omega_o L_1 \left(\frac{f}{f_o} - \frac{f_o}{f} \right)$$

$$= j \omega_o L_1 A \text{ and}$$

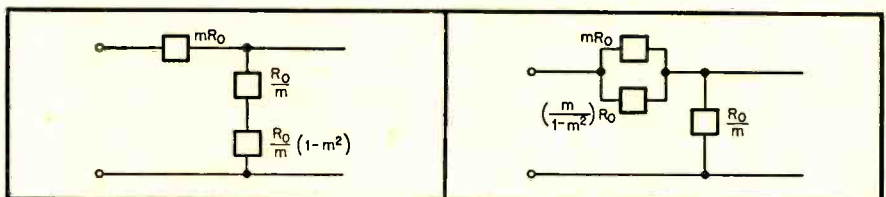

Fig. 2 (left). Element values of reactances at cut-off frequency for series m -derived half section, and Fig. 3, (right), for shunt m -derived half section.

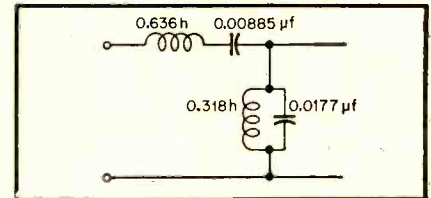

Fig. 5. Band-pass filter half section for 6000-ohm termination and a bandwidth from 1500 to 3000 cps.

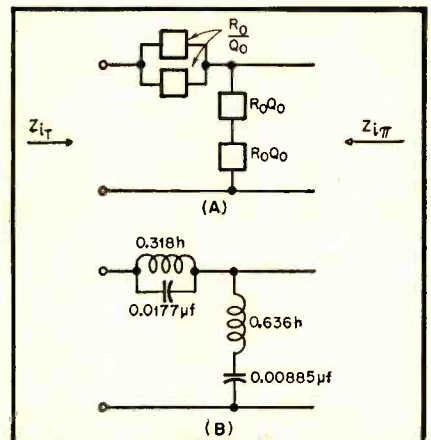

Fig. 6. (A) Basic half section of band elimination filter showing element values at center frequency, and (B) with element values for $f_1 = 1500$ cps, $f_2 = 3000$ cps, and $R_o = 6000$ ohms.

$$Z_2 = \frac{\omega L_2 / \omega C_2}{j \omega_o L_2 \left(\frac{f}{f_o} - \frac{f_o}{f} \right)} = \frac{1}{j \omega_o C_2 \left(\frac{f}{f_o} - \frac{f_o}{f} \right)}$$

$$= \frac{1}{j \omega_o C_2 A} = -\frac{j \omega_o L_2}{A}$$

$$\therefore Z_1 Z_2 = \frac{L_1}{C_2}$$

It is of interest that the last expression is identical in form to the expression (7) obtained in constant- k low-pass and high-pass filter analysis. The expression

$$Z_1 Z_2 = \omega_o^2 L_1 L_2 \quad (10)$$

shows that $Z_1 Z_2$ can be zero only at zero frequency—a trivial solution. However,

[Continued on page 28]

*RCA Institutes, Inc., 350 W. 4th St., New York 14, N. Y.

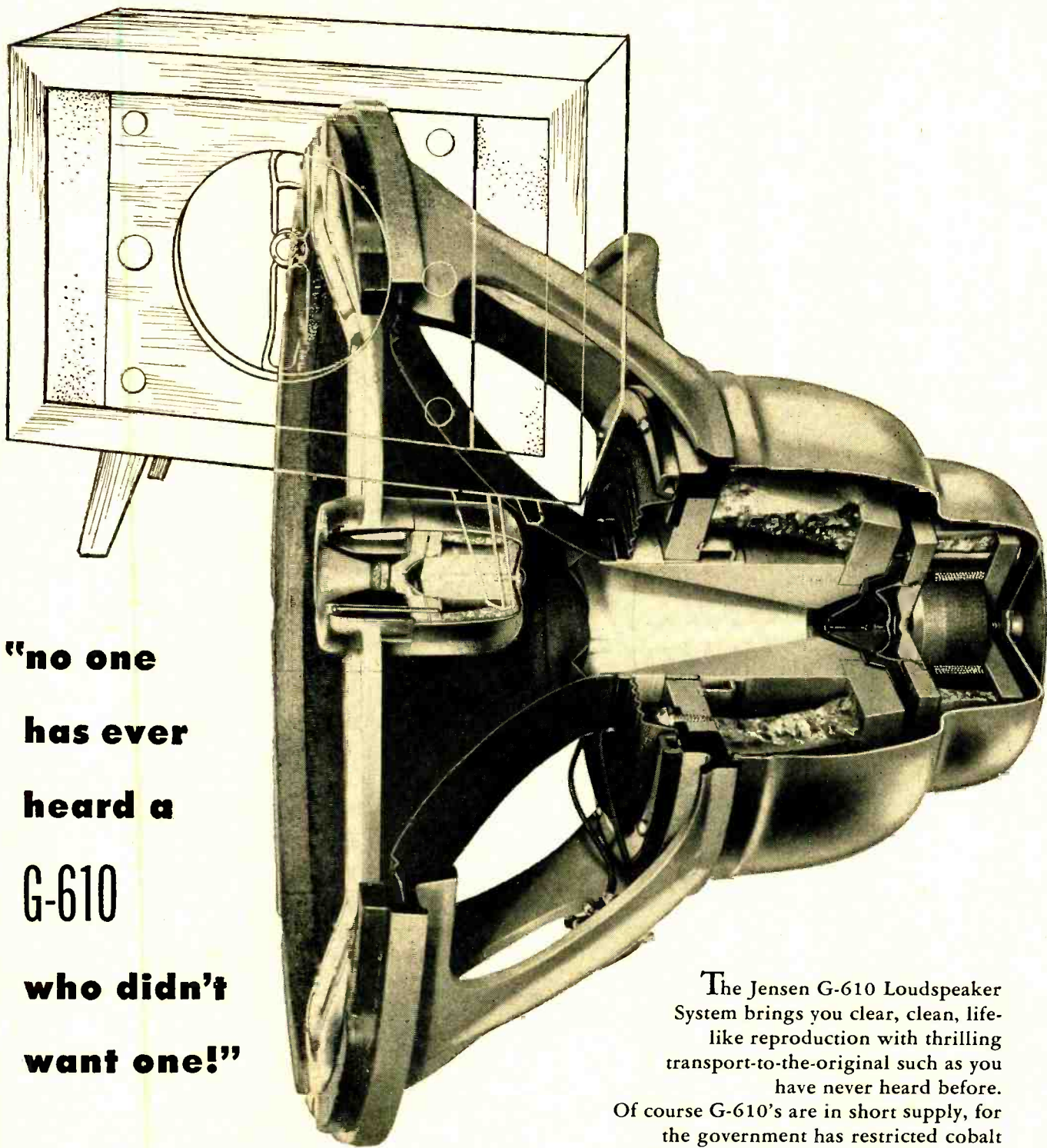

**"no one
has ever
heard a
G-610
who didn't
want one!"**

We believe this statement is literally true . . .

The Jensen G-610 Loudspeaker System brings you clear, clean, life-like reproduction with thrilling transport-to-the-original such as you have never heard before. Of course G-610's are in short supply, for the government has restricted cobalt for Alnico V magnets—and the G-610 has more magnetic energy than any speaker ever built. But when restrictions are relaxed and G-610's are again plentiful, then be sure you get a G-610 . . . NO ONE has ever heard one who didn't want one!

Illustrated with Blonde model M-253 cabinet showing accessory legs.



Jensen

MANUFACTURING COMPANY

DIVISION OF THE MUTER COMPANY

6601 SOUTH LARAMIE AVENUE

CHICAGO 38, ILLINOIS

BURTON BROWNE ADVERTISING

AUDIO ENGINEERING • MAY, 1951

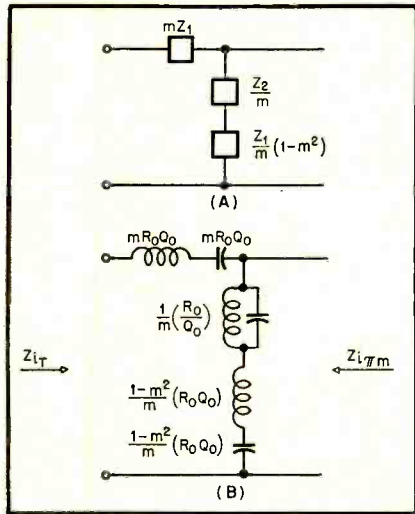

Fig. 7. Series m -derived band-pass filter half sections: (A) basic half section, and (B) element reactances at mid-frequency.

the binomial term of the radical $\sqrt{(1+Z_1/Z_2)}$ may become zero when the vector $Z_1/Z_2 = -1$, and for this value of Z_1/Z_2 , the image impedance $Z_{iT} = 0$. When the ideal filter is thus terminated in zero ohms there results complete cut off.

Determination of Center Frequency (f_0)

The expression $Z_1 = -Z_2$ yields the value of the center frequency f_0 in terms of the band edges f_1 and f_2 . It also yields an expression for the values of the inductors L_1 and L_2 , and for the capacitors C_1 and C_2 . Since $Z_1 = -Z_2$,

$$j\omega_0 L_1 A = -j\omega_0 L_2 / A, \text{ and} \\ A^2 (L_1/L_2) = 1, \text{ or} \\ A = \pm \sqrt{L_2/L_1} \quad (11)$$

For any frequency below f_0 , numerical substitution shows that A is negative. Hence at the low frequency boundary f_1 ,

$$\frac{f_1 - f_0}{f_0 - f_1} = -\sqrt{\frac{L_2}{L_1}} \quad (12)$$

Similarly at the high-frequency boundary f_2

$$\frac{f_2 - f_0}{f_0 - f_2} = \sqrt{\frac{L_2}{L_1}} = \frac{f_0 - f_1}{f_1 - f_0} \quad (13)$$

Equating the frequency ratios produces the desired expression,

$$\frac{f_2 + f_1}{f_0} = \frac{f_0 + f_2}{f_1 + f_2} \\ f_2 + f_1 = f_0^2 \left[\frac{f_1 + f_2}{f_1 f_2} \right] \\ f_0^2 = f_1 f_2 \quad (14)$$

This shows that the resonant frequency of either the series or the shunt branch is the geometric mean of the cut-off frequencies.

Determination of Element Values

For convenience the filter is terminated in

$$R_0 = \sqrt{Z_1 Z_2} = \sqrt{\omega_0^2 L_1 L_2} \quad (15)$$

At f_1 we obtain from expression (12)

$$\frac{L_2 (f_0 - f_1)^2}{L_1 (f_1 - f_0)^2} = \left(\frac{f_0^2 - f_1^2}{f_1 f_0} \right)^2 = \left(\frac{f_2 - f_1}{f_0} \right)^2$$

$$\therefore L_1 = L_2 \left(\frac{f_0}{\Delta f} \right)^2$$

Substituting for L_2 its value from (15)

$$L_2 = \frac{R_0^2}{\omega_0^2 L_1} \text{ it is seen that}$$

$$L_1 = \frac{R_0^2}{\omega_0^2 L_1} \left(\frac{f_0}{\Delta f} \right)^2$$

This leads to the final simple relation that at the center frequency f_0 , the reactance of either of the series elements is

$$X_1 = \omega_0 L_1 = 1/\omega_0 C_1 = Q_0 R_0 \quad (16)$$

The shunt elements are found in similar fashion, and the magnitude of either element of the parallel circuit at center frequency f_0 is

$$X_2 = \omega_0 L_2 = 1/\omega_0 C_2 = R_0/Q_0 \quad (17)$$

The last formula, (17), is usually not required because series and shunt arms

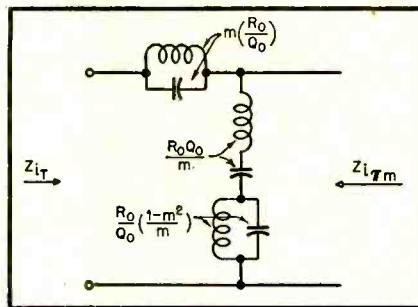

Fig. 8. Series m -derived band-elimination filter half section showing element reactances at center frequency.

are inverse. Thus the shunt elements are calculated from $L_2 = C_1 R_0^2$ and $C_2 = L_1 / R_0^2$.

Band-Elimination Filter

A band-elimination filter is designed by interchanging the series and shunt arms as shown in Fig. 6. M -derived band-pass and band-elimination filters are employed where sharper cut off is desired and where the impedance characteristics must be more constant than with the constant- k types. The m -derived sections are constructed in the same manner as the low-pass and high-pass sections, Fig. 7. A band-elimination filter half section, series m -derived, is shown in Fig. 8.

Numerical substitution will show that the elements of the m -derived band-pass filter of Fig. 7 are physically impractical. It is fortunate however that the entire shunt arm can be replaced by an equivalent parallel combination of two series connected LC circuits, Fig. 9.¹ The elements of the revised network, however, are not as simple as those of Fig. 7.

The band width between the two fre-

quencies of infinite attenuation, f_{∞} and $f_{-\infty}$, is found from

$$\Delta f_{\infty} = f_{\infty} - f_{-\infty} = \frac{f_2 - f_1}{\sqrt{1 - m^2}}$$

$$\text{or } \Delta f_{\infty} = \frac{\Delta f}{\sqrt{1 - m^2}}, \text{ where } \Delta f = f_2 - f_1$$

$$\text{For } m = 0.6 \quad \Delta f_{\infty} = 1.25 \Delta f$$

If only Δf_{∞} is given, then f_{∞} may be found from the equation

$$f_{\infty} = \frac{1}{2} [\Delta f_{\infty} + \sqrt{(\Delta f_{\infty})^2 + 4f_0^2}]$$

This and other relations are readily derived from

$$f_0^2 = f_1 f_2 = f_{-\infty} f_{\infty} \quad (18)$$

An illustration will clarify the use of these equations. Assume it is desired to design a 2000-cps band-pass filter with $f_2 = 2050$ cps and $f_1 = 1950$ cps, and $R_0 = 1000$ ohms. For $m = 0.6$, $\Delta f_{\infty} = 125$ cps and f_{∞} falls on 2062.5 cps. Hence $Q_0 = f_0/\Delta f = 2000/100 = 20$ and $Q_0 R_0 = 20,000$. Also, $(f_0/f_{\infty})^2 = (2000/2062.5)^2 = 0.935$. The series reactances $mX_{L1} = mX_{C1} = mQ_0 R_0 = 12,000$ ohms. The remaining calculations are straightforward as follows. The half section is shown in Fig. 10.

$$L_1 = \frac{mX_{L1}}{\omega_0} = \frac{12000}{(2\pi)(2000)} = 0.954 \text{ h.}$$

$$C_1 = \frac{1}{\omega_0^2 L_1} = 0.0066 \text{ } \mu\text{f.}$$

$$X_{L2} = X_{C2} = \left(\frac{1 - m^2}{2} \right) (Q_0 R_0) \\ \times \left[1 + \left(\frac{f_0}{f_{\infty}} \right)^2 \right] = 12,400 \text{ ohms}$$

[Continued on page 58]

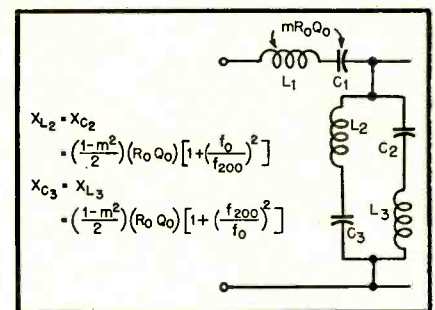

Fig. 9. Band-pass filter half section, series m -derived, showing reactance values in terms of center and upper infinite cut-off frequencies.

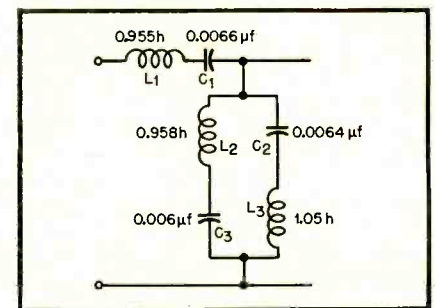

Fig. 10. Band-pass filter half section, series m -derived, showing element values for $f_1 = 1950$ cps, $f_2 = 2050$ cps, and $R_0 = 1000$ ohms.

¹ See, for example, T. E. Shea: "Transmission Networks and Wave Filters" D. Van Nostrand Co., New York

THE COMPETITOR



Model 60X Crystal
\$10.85 List

A new Turner unit for hand, desk or stand use. Designed especially to meet all competition where good quality speech reproduction is required and low cost is important. A natural for hams, economical public address and sound systems — an ideal microphone for home recorders. Attractive case finished in baked on beige wrinkle enamel. Compare the Turner "COMPETITOR" with any microphone in its class and you'll agree that dollar for dollar it's a terrific microphone value.

Model 60X Crystal. Response: 70 to 7000 c.p.s. Level: 52 db below 1 volt/dyne/sq. cm. Moisture sealed crystal. Complete with 6 ft. cable and stand adaptor\$10.85 List

Model S60X Crystal. With on-off slide switch\$12.85 List

Write for Complete Details.

Visit **TURNER**
 at the Parts Show
 Stevens Hotel
 May 21, 22, 23
 Booth 577
 Rooms 519A - 520A

THE TURNER COMPANY

929 17th Street N. E., Cedar Rapids, Iowa

In Canada: Canadian Marconi Co., Toronto, Ont., and Branches

Export: Ad. Auriema, Inc., 89 Broad Street, New York 4, N. Y.



Microphones **BY TURNER**

Crystals licensed under patents of the Brush Development Company

RECORD REVUE

EDWARD TATNALL CANBY*

Batch of Tests

SPENT AN EVENING recently *chez ye* editor, listening to assorted music via his own pride and joy, the McProud Corner Speaker, TV and Flower Stand. (New form of entertainment: tune the TV department to the juiciest and goriest TV fight that you can find, then turn off the TV sound and turn on the phono—with the William Tell Overture or other appropriate music. If you want real fun, try getting a team of comedians on the screen and backing them up with Gilbert and Sullivan on the phono! One runs into some strange coincidences between action and music.)

The point of the evening, (and the reason for this disquisition) was the music we heard after the TV subsided and business was got down to. Business was represented, so to speak, in a purely social manner, by Mr. W. S. Barrell, a most genial Britisher who happens to belong to EMI, the enormous record company that runs HMV and Columbia and a batch of other companies in the record field, in Britain and the Empire and elsewhere.

As you may know, there are now LP records in Britain, as of last spring or summer. They come from Decca, known hereabouts as London. EMI is making 78's. The announcement went out recently that EMI would give the British phonograph industry six months' notice whenever a change was decided upon in the speed of records, and therefore Britain—the announcement not having yet been made—will remain essentially a 78 r.p.m. country for a good while yet. It's as though, here, RCA Victor, Decca, and Mercury, plus perhaps M-G-M and Capitol, were still sticking to 78's only, and Columbia were still on its own (like Decca in England) with LP.

A Bit of Everything

Mr. Barrell brought with him a precious box of records. Tests, no less, ex-

* 279 W. 4th St., New York 14, N. Y.

perimental pressings of EMI music on slow speed. These tests he played to us. (There was of course a certain confusion because we were trying to judge the effect of the McProud System, complete with U.S. components, upon Mr. Barrell while he, natch, was busy fathoming our reaction to his records—and I, an outside listener, was trying hard to get used to the unfamiliar complex of acoustics, speaker, equalization, records, etc. in order to be able to react intelligently to about eighteen "unknowns" simultaneously!) We heard the tests, and I hereby react.

But first—don't look for any mystery, nor indeed a solution of the same. Yes, EMI has made test microgroove pressings. We heard 'em. EMI is doing what comes natural. Trying out a bit of everything. No commitments. Not for publication, anyhow, nor even for our inquiring private ears.

Christmas, 1948?

But what must strike you at once, in the above description of the present situation in Britain, with only one major company producing LP's, as a pioneer ("we'll show 'em") venture, is that over there things are about at the Christmas 1948 level in this country. Columbia then was where British Decca is now, roughly speaking (with some notable differences in respect to tape recording of originals, of course). A single major company, a single company-sponsored popular player attachment (it's the Deccola in England, I gather), the other major companies watching on the side lines, experimenting behind the scenes, preparing for a later change, when and if.

And that, in more specific ways, was the reaction I got from hearing and seeing Mr. Barrell and his test records. I was, perhaps, not as enthusiastically impressed as he may have hoped for, and I surely apologize here for any

[Continued on page 42]

Pops

RUDO S. GLOBUS*

SEVERAL MONTHS AGO, I received a review copy of a disc that should have received nothing but meritorious praise. Featuring two worthy names and released by a large recording outfit, it should have sold in the hundreds of thousands. It fizzled completely! Generally, I am not over-anxious to praise the record-buying public, a large group of people who would corrupt any business they poked their naive hands into. In this case, regardless of their motives, they justifiably stayed away from as clear a case of homicide as the recent history books contain. I did not review the disc because the policy of the column is to avoid, as much as possible, records which cannot be favorably reviewed, or which do not point to a significant moral.

But, lo and behold, the disc was used by a recording executive as a pointed reason for avoiding "high-class" pop recording. According to him, the public won't buy "hi-fi" pops, won't buy jazz names, won't buy good experimental stuff, etc. With a self-satisfied smirk, much rubbing of hands, and the healthy flush of a successful mortician, big wheel executive glibly dispensed with the necessity of any changes in the nirvana of pops recording. Pulling a quick switcheroo, he unremorsefully informed me that the American people know what they want and know what they like; if they don't buy an item, it's obviously because their judgment (their noble and sophisticated judgment) is superior to that of the minority of record critics who have been bombarding the industry with demands for this kind of thing.

In the first flush of early anger, I notified him that nothing on the disc vaguely resembled any of the stuff I've been screaming for. But, calming down and sticking my feverish temper back into the temper box,

[Continued on page 32]

* 15 Palm Lane, Westbury, L. I., N. Y.

if

Audax **POLYPHASE** reproducers

have won the acclaim of thousands of users everywhere—in all walks of life. For example, a college president (who, by the way, is a music editor too) states in a recent article:

“... for the pickup there is an obvious choice. The new AUDAX POLYPHASE is indispensable—if it's musical quality you're after”

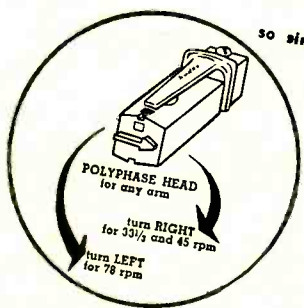

so simple

One single magnetic unit plays all home records—Sapphire or diamond styli

Never before such EAR-QUALITY, such FAITHFUL REPRODUCTION but . . . after all the reams are written about kilocycles and other laboratory data—when the chips are down—only you can decide what sounds best and most pleasing to your ears. Therefore . . . SEE and HEAR POLYPHASE and know first-hand the reasons for the spread of POLYPHASE fame—far and wide—within but a few short months.



Available with the new Compass-pivoted Audax Arms and for Record Changers. Other Audax models for every purpose.

Write for editorial reprint on POLYPHASE principles

AUDAX COMPANY
500 Fifth Avenue New York 18

“Creators of Fine Electro-Acoustical Apparatus for Over 25 Years”

it's
musical
quality
you're
after...

for OPTIMUM P.A. PERFORMANCE at moderate cost!

Specify

CHICAGO

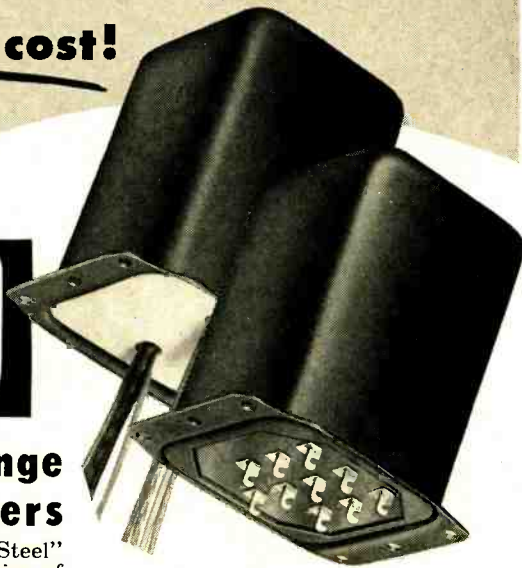

Public Address Range Audio Transformers

These famous CHICAGO "Sealed-in-Steel" Output Transformers are the choice of many leading makers of high-quality amplifiers. Unmatched for service in the Public Address range, they have a frequency response within .5 from 50 to 10,000 cycles, and will deliver their full rated output over this entire range.

Line and voice coil impedances used in the design of these output units are those recommended by RMA. All have tertiary windings to provide 10% inverse

feedback. Output and matching drivers are fully enclosed in one-piece drawn-steel cases. Available in choice of two dependable constructions: with wire leads—at surprisingly modest cost; with solder lug terminals, at slightly higher cost. Order from your electronic parts distributor. Be sure to ask for CHICAGO P.A. Range Audio Transformers.

OUTPUT TRANSFORMERS

Catalog No.	Typical Output Tubes	Class	Impedance Primary-Secondary	Max. D-C in Pri.	Power Level	List Price
PCO-80 PSO-80	P-P 6B4G's, 6L6's P-P 6V6's, 6L6's	A1 AB	Pri: 5,000 ohms CT Sec: 600/150/ * 16/8/4 ohms	120 ma.	20 watts	\$12.10 16.50
PCO-150 PSO-150	P-P 6V6's, 6F6's P-P 6K6's	AB AB†	Pri: 10,000 ohms CT Sec: 600/150/ * 16/8/4 ohms	200 ma.	15 watts	10.45 14.85
PCO-200 PSO-200	P-P 6L6's P-P Parallel 6V6's	B AB†	Pri: 6,000 ohms CT Sec: 600/150/ * 16/8/4 ohms	250 ma.	30 watts	13.75 18.15

DRIVER TRANSFORMERS

Catalog No.	Typical Driver Tubes	Primary Impedance	Max. D-C In Pri.	Ratio Pri./½ Sec.	List Price
PCD-10 PSD-10	P-P 6N7's, 6A6's, 6J5's, 6C4's, etc.	20,000 ohms CT	10 ma.	3:1	\$5.50 7.95
PCD-25 PSD-25	P-P 6N7's, 6A6's, 6J5's, 6C4's, etc.	20,000 ohms CT	25 ma.	3:1	5.20 7.70
PCD-100 PSD-100	P-P 6B4G's, 45's, 2A3's, 6L6's, etc.	5,000/10,000 ohms CT	100 ma.	5:1	9.35 13.20

* Has tertiary winding to provide 10% inverse feedback. † For low distortion, use fixed bias.



Write for "NEW EQUIPMENT" TRANSFORMER Catalog

The units described above are typical of CHICAGO'S New Equipment Line featuring engineering that sets the transformer trend in circuit design. Get the full facts on the complete line now. Check the features, check the quality. Check the price: see how little more these tougher, better units cost. Write for your free copy of the CHICAGO New Equipment Line Catalog today.

CHICAGO TRANSFORMER

DIVISION OF ESSEX WIRE CORPORATION

3501 ADDISON STREET • CHICAGO 18, ILLINOIS



I unveiled my latent investigatorial ability and did a job. The results of the job were highly illuminating and are revealed in what follows. 'Tis a sad tale and a typical one. Pay heed, oh mighty big wheels!

First step in the criminal investigation involved tracking down the arranger who was theoretically responsible for the junk. The soft shoe routine revealed a friend who, surprisingly enough, is one of the most competent guys in the business. Over a dime beer and some moderately stale free lunch, he told the story . . . and what a story it is! Is it true? Friend arranger is a particularly honest guy, who gladly accepts responsibility for bad jobs as well as good ones. But even if he were covering up, past experience points to the typicality of the story.

It all began in the microcephalic head of one of the wonder boys of the business. (Incidentally, I will have to recreate the story to avoid giving clues as to the actual record involved. So don't try to guess! The particular session described is a mere figment of my imagination. Only the procedure is historically accurate.) This fancy ignoramus decided to bring together two big names in the business, record them together in a lavish production. The date would, in one respect, refute the claims that the pops business was being run by a bunch of rock-heads; in another, it would demonstrate to the top echelon that melonhead was a financial wizard, a musical impressario, and a production genius. So, one day, friend arranger was called in and told to do big things for the two great people . . . told to really blow his top and let his creative imagination run wild. For two weeks, he did just exactly what he had been told to do. He figured that since both stars were small club personalities, the perfect arrangement would be subtle, intimate, scored for a small group with a tricky and supporting background.

Came the day of the session (lights, camera, faction)! The stars went through the arrangements and smiled the blissful smiles of contented cows. Their backing consisted of a six-man combo, every one of which thought the arrangements were great stuff. They ran through the business once. At this point all hell broke loose. Boy genius producer let out a shrill holler and cancelled the session. The arrangements were no good. What he wanted was something lush, something big . . . a production. All he got here was a six-piece band playing kid's stuff. He wanted a string section, a large wind and brass section, and none of this tank town recording, minus echo chamber, Theremin, tricky mike effects. The stars were too big for a two-bit recording date like this.

Friend arranger argued, the stars put up a feeble rejoinder. But, to no avail. How could they possibly be aware of what the public wanted. You have to make a buck, so friend arranger went home with a whole pile of manuscript paper and got to work on a production, with string section, French horns, tricky wind and brass effects, etc. A new date was scheduled and a large orchestra and a battery of engineers got together to turn out a slick, technicolor demon of a date, replete with the presence of the pin-stripe execs, a name conductor, and another arranger, called in to make last minute changes for which he is famous.

Before we go any further in relating this gory tale, a word about the two stars. Both were neither out-and-out jazz people or out-and-out straight pops. They specialized in a quiet, salon-type presentation which goes over especially well late at night under dim lights. Both were subtle in their work and had always relied on a piano and percussion patter to support their gentle im-

provisation. Both were (and are, incidentally) terrifically good at their sort of thing, which requires a gentle and cultivated touch. What happened to them in this case is bloody. Overpowered by a giant orchestra and fantastic manipulation, they covered. The engineers were called in and the usual stuff began happening. Instead of working together, one was placed at one end of the studio, the other in a corner by herself. The she of the story doesn't really sing, but quietly purrs. That wouldn't do. Boy wonder wanted a blast and so instructed the engineers. The he-star of the story, playing a delicate and gentle patter behind the vocal was muted out entirely because he crummed up the string background. The consultant arranger was, meanwhile, busily at work, slap-dashing the arrangement this way and that way. After five takes, the wonder boy was ecstatic. Several months later, the record was released, fizzled completely, and pretty nearly ruined the reputation of two marvelous people who were monstrously manhandled by a genius. The only critical comment that appeared noted that the engineer on the job had kept the strings "too far off in the background."

At the conclusion of the story, friend arranger smiled wanly and informed me that both stars and he are no longer on speaking terms. There's always a convenient fall guy, *N'est-ce pas?*

Correspondence

Off on another tangent, I have received a fantastic influx of mail from Texas which requires immediate and terse comment.

Beginning with the first letter to hit me from the grandiloquent state, let me emphasize, suggest, and rudely urge all controversy-minded readers that it is most advisable that they read the column before picking fights. First literary pugilist from Texas spent much time, much ink, and much paper in notifying me that everything I had to say about folk music was wrong and explaining why. I would like to slap back, but find after re-reading the letter that the slap would only mess up a batch of regular, ordinary air. Texas reader agrees with everything I have to say down to the last decimal point. My only conclusion is that he has either mis-read, not read, or dis-read the piece in question. I am in full, complete, agreement . . . to all obvious intents and purposes we have no folk music in this country. But mind that *obvious*. Our record literature and what passes as compendia of folk literature do not generally include any material which fits into the general category of "folk music." The synthetic stuff is mostly derivative from other national sources, or is merely the stylistic work of the craftsmen that abound on New York's 6th and 7th Avenues.

So what! We still have an enormous fund of folk music . . . except that it isn't operative on the sociological level that is characteristic of the folk music of other cultures. All this impressive sounding verbiage boils down to something as simple as what was originally indicated in the previous column. Until the country as a whole utilizes, becomes conversant with, and integrates the primordial folk music structure into an everyday, traditional, and practically instinctual cultural element, it lies dormant and inactive. The conditions of modern life preclude a non-mechanical process of integration and the repressions involved in the choice of our impressarios of material for dissemination cut off the folk literature at its source.

But . . . we have had a widely disseminated, active and pervasive folk-music literature. I point with pardonable pride at



CHURCHES



AUDITORIUMS



NIGHT CLUBS

The Super-Cardioid "Monoplex"

...kills feedback and reduces random noise energy pickup more than any other crystal microphone!

...REDUCES RANDOM NOISE ENERGY PICKUP BY **73%**

THE "MONOPLEX" is the only Super-Cardioid Crystal Microphone made. It employs the same type of acoustic phase-shifting network used in the highest cost Shure Broadcast Microphones. The "Monoplex" permits more volume without feedback—greatly improves sound systems using conventional cardioid microphones.

THE "MONOPLEX" is superior to conventional microphones: gives very satisfactory operation under the most adverse conditions of background noise, where conventional microphones would be practically useless. You are invited to test the "Monoplex" against all other crystal microphones. The results will speak for themselves . . .



"Monoplex"

MODEL 737A

LIST PRICE

\$39⁷⁵

Every "Monoplex" employs the famous Shure "Humi-Seal" moisture-proof element for protection from heat and humidity.

Manufactured Under Shure Patents.
Licensed Under Patents of Brush Development Company.



SHURE BROTHERS, Inc.

Microphones and Acoustic Devices

225 West Huron Street, Chicago 10, Ill. ★ Cable Address: SHUREMICRO

WHEN **QUALITY** OF RECORD REPRODUCTION IS ALL-IMPORTANT SPECIFY ASTATIC'S

CAC-J
CRYSTAL CARTRIDGES

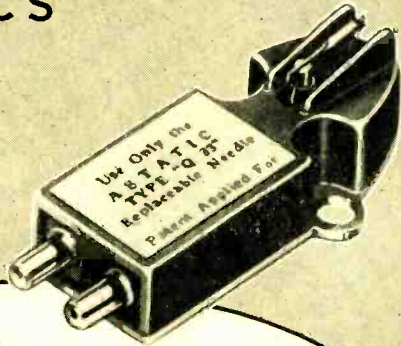

SOME FOLKS are just plain critics . . . others are super-critical in the sense that they have to have the best there is, no matter what . . . and still others want the best in record playing equipment merely because they can't stand serious music served up any other way. Regardless of which type they are, you are bound to please the fussiest with Astatic's CAC-J Crystal Cartridge. This is the cartridge which has been so highly praised in print by professional critics. Astatic developed the CAC-J in conjunction with the Engineering Research and Development Department of CBS to match the recording characteristics of LP records. Output is approximately 0.6 volt at 1000 c.p.s. on Columbia No. 103 test record, 1.0 volt on RCA 12-5-31-V test record. The resulting performance quality . . . with equal fidelity on either 33½ or 45 RPM records, truly sets today's standard of perfection.

ALSO AVAILABLE IN
MODEL FOR 78 RPM RECORDS

Model CAC-78-J has 3-mil needle for 78 RPM records, incorporates the same engineering advancements, and offers the same performance superiority of the CAC-J.



NOTE: Both CAC models are available with Diamond as well as Sapphire styli.

THE **Astatic** CORPORATION
CONNEAUT, OHIO
IN CANADA: CANADIAN ASTATIC LTD., TORONTO, ONTARIO

Astatic Crystal Devices manufactured under Brush Development Co. patents.

the jazz phenomenon . . . an element of folk culture, despite the pretentiousness of the tie-in. One level of folk-music—if we particularize the term to include a structure as described above—has thoroughly permeated the national consciousness and is as closely related to the pattern called the "United States" as is the national pride in tall buildings. However, jazz is merely an element of the folk culture and not the folk culture itself. It tends to be too closely related and associated with a particular segment of the population, as is the case with Gypsy music in central Europe.

The true, broad, generic level of folk music is limited to other "vested" interests. Whether we refer to the folk music of the Blue Hills or the music of the Okies, or the music of the cowboy, or the music of the farmer, or what not . . . the problem of integration and national penetration remains. This was discussed previously, and it was suggested at that time that the only practicable method involved the use of recordings. I refer to that original for the details. I needn't rehash them!

Letter No. 2 from Texas concerned the problem of reaching the mass of the American people with jazz if, as I indicated, records are inadequate. I am in complete agreement with my second Texas correspondent who maintains that it is impractical to consider live jazz in every hamlet throughout the United States. I was not emphasizing the divinity of New York, Chicago, and San Francisco as the only centers where the saintly people live and congregate. I was simply trying to track the problem to its source. If we refer to the situation of the potential jazz lover in El Paso, we track the problem, as follows:

1. Our El Paso citizen is dependent on radio or records for his jazz participation.
2. It is possible for our El Paso citizen to enjoy, to a great extent, all the benefits of jazz participation if the following requirements are fulfilled:

a. Playback equipment must be the best possible . . . carefully correlated with the acoustical qualities of the room in which it is being used.

b. Records must be the best possible. . . . Hi-Fi, if you will, and completely representing the ordinary musical conditions of a jazz session; this involves recording under live conditions and with an eye towards indeterminate length (LP, in other words).

c. Quality jazz to record. This last point is the specific place on which my argument hinges. If all the other requirements are fulfilled, we still are faced with a situation in which not only our El Paso citizen, but all others are thoroughly cut off from the jazz experience. Unless live jazz exists, the jazz product will continue to be mediocre. My previous columns amplify this point *ad nauseum*, and I needn't repeat it here. If the source is taken care of, the rest follows in the manner indicated.

Letter No. 3 doesn't come from Texas, but is worthy of some concern. Our 3rd letter writer is convinced that Yma Sumac is a phony, primarily because her name makes sense when spelled backwards . . . it comes out Amy Camus. Since Amy Camus is a more rational name for a human being, Yma Sumac is a phony . . . or so our reader reasons. This may be true . . . I don't know. What information I have leads me to believe that she is on the level. I recently heard and saw her on television and she is still being massacred by poor audio and poor orchestrations. In addition, Slim Gaillard (of Slim and Slam fame) has recently released a take-off based, ostensibly, on Yma Sumac's vocal antics. The steel of the satire can massacre the princess unless somebody takes her in hand

and makes worthwhile recordings and orchestrations. The vocal gymnastics accomplish only one thing . . . her classification as a freak or a mere novelty. About time that somebody put a stop to it. In any case, it's a toss-up . . . Amy Camus or Yma Sumac.

The Basic Pop Catalogue

At long last, we begin the herculean effort. The first basic group is particularly interesting from many points of view. Glenn Miller has become an American myth, thereby making it commercially feasible for various contemporary organizations to imitate the inimitable Miller style. The innovation of the clarinet-saxophone choir set off a whole epoch in modern American pops. Miller's success must be seen against the background of the the period in which the organization came to the fore. Records were bought primarily for dancing purposes by high school and college kids who did most of their dancing in gymnasiums and auditoriums (or mom and dad's living room) to the blare of p.a. systems and cheap record players. Cheek-to-cheek dancing (involving a sentimental and distinctly lush background) required an orchestration and a beat that no other band could produce as successfully as Miller. Despite their inadequacy in terms of any absolute audio standard, the Miller recordings were technical gems in terms of the requirements they were set up to fulfill. The blend of sax and clarinet was so successfully accomplished that a quick comparison with the same efforts as recorded today by Tex Beneke and Ralph Flannagan's organizations points to the genius of the responsible Victor engineers of the late 1930's. The beat was perfect for smooth, slow, dancing and the blend was amazingly right for p.a. use. Without the competent engineering characteristic of Victor on the Miller discs, it is a moot question as to whether Miller would have been as big as he was.

Instead of listing the discs on domestic Victor, I am going to list a few HMV pressings of outstanding Miller recordings. The HMV's are tremendously superior, both from the point of view of surfaces and clarity. They sell for \$1.05 (if you're asked for more, you're being rooked). If your local dealer does not stock them, they can be ordered from Victor. They are all available in good quantity in this country and are worth having. I know of no dance discs which fill the bill so satisfactorily for the type of dancing they were made for. These belong in a basic pops collection.

- HMV MH-104** Blue Orchids and A Cabana in Havana
- BD-5839** Glen Island Special and Pagan Love Song
- BD-5834** Moonlight Cocktail and Slumber Song
- BD-5850** A Nightingale Sang in Berkeley Square and My Prayer
- BD-5833** Rhapsody in Blue and Caribbean Clipper
- BD-5569** Careless and Indian Summer
- BD-5784** Let's Have Another Cup O' Coffee and Chip off The Old Block
- BD-5822** Blue Moonlight and Melancholy Lullaby
- BD-5654** Alice Blue Gown and Wonderful One
- BD-5854** Sold American and Moon Love



"The Only Good Doctor Is A Hoss Doctor!"

— Will Rogers

"... his patients can't fool him!", he added to make his point. The noted humorist's trenchant remark may be applied today to the skilled technicians in the recording field who have for many years used the tape and discs perfected in Reeves Soundcraft Laboratories. We haven't fooled them—nor have we tried. Perfection, nothing less, has won us the confidence of this exacting industry.

From Reeves Soundcraft Laboratories come magnetic tape offering users ten distinct features that add up to higher efficiency and fidelity; an assortment of recording discs to answer every requirement—all backed by the greater integrity and experience of the Reeves name, foremost manufacturer of recording and electronics accessories.



◀ Soundcraft tape is made in all types and lengths to accommodate all tape recorders.



▶ Soundcraft recording discs available in a variety of sizes, single and double face.



REEVES *Soundcraft* CORP.

TWENTY YEARS OF LEADERSHIP IN SOUND ELECTRONICS

10 EAST 52nd STREET, NEW YORK 22, N. Y.

EXPORT—REEVES EQUIPMENT CORP., 10 EAST 52nd STREET, NEW YORK 22, N. Y.

SONOCRAFT

Headquarters for SOUND - RECORDING EQUIPMENT

115 WEST 45th Street
New York 19, N. Y.



...invites you to visit
our new sound display studio
for demonstration of the following equipment
and accessories:

- | | | |
|-----------------|--------------------|---------------------|
| ● ALTEC-LANSING | ● MAGNECORD | ● SCHULMETRONIC |
| ● AUDIO DEVICES | ● MASCO | ● SHURE |
| ● ATLAS | ● MINNESOTA MINING | ● SOUNDCRAFT |
| ● BELL | ● PENTRON | ● UNIVERSAL REELEST |
| ● BOGEN | ● PICKERING | ● WEBSTER CHICAGO |
| ● BRUSH | ● PRESTO | ● WEBSTER ELECTRIC |
| ● CALIFONE | ● PROCTOR | ● WESTERN ELECTRIC |
| ● CAPPS STYLI | ● RADIO CRAFTSMEN | ● WILCOX-GAY |
| ● CARTER | ● RECOTON | AND OTHERS |
| ● ELECTRO VOICE | ● REK-O-KUT | |
| ● GRAY | ● REVERE | |

SONOCRAFT CORPORATION
115 West 45th Street, New York 19, N. Y.

LUxemburg 2-1750

Gentlemen: Please send us a free illustrated copy of the 1951 Sonocraft Review containing detailed information on sound recording equipment and accessories.

Name:
Address:
City: Zone: State:

RECENT RELEASES:

Journey Into Melody London LPB-213
Robert Farnon and Orch.

This is a particularly impressive ten-inch disc, deserving of praise from many angles. The recording job is amazingly good and totally devoid of the trickery characteristic of much of our domestic stuff. The general style is a hybrid mixture of Kostelanetz and Morton Gould, but decidedly lacking the vulgarities, over-orchestration, over-echo, and tricky mike-effects so often characteristic of the two. Nevertheless, the sound is luxuriant and smooth, with percussion admirably handled. This is a perfect demonstration of what can be done in the line of salon music without going overboard in orchestration tricks. The orchestra plays without woodenness and deals competently with a wide variety of styles. The arrangement of "Just One of Those Things" is the most tasteful in a long while and, because of a steady tempo, quite danceable. "Peanut Polka" is marvelously arranged and recorded and the best waltz recording for dancing and smooching purposes in a king's age is the "Invitation Waltz" which purrs like a contented kitten. Other neat bands include a decent job on "April in Paris," an expert job on "In a Calm" and a rousing job on "Popcorn Polka." One of the outstanding merits of the disc lies in the fact that one is not over-conscious of the expertness of the recording job, allowing a relaxed listen without the typical "anxiety neurosis" of the audio hound.

The New Sound Capitol H 226
Les Paul

Wow! What a recording! This one takes your breath away. From comments made out of the side of my typewriter for months, you may have gathered that I am not a particular admirer of Les Paul. He is a cutey, in the vernacular of the trade, and his pre-eminence as a jazz guitarist is totally undeserved. But this recording . . . The blurb on the sleeve coyly points out that Paul is playing eight guitars (simultaneously) and that how it was done is Paul's secret. We needn't bother ourselves too much probing for the secret because the method is obvious. What is important is that purely in terms of the instrument and the stuff recorded, this is one of the great engineering achievements of this age. The clarity of the recording is unbelievable. The usual overtone resonance in guitar recording is missing and the percussive nature of the pluck comes through clear as a bell. The dubbing of the eight guitar voices is magnificent, with a perfectly balanced blend throughout. Included are things like Brazil, Caravan, What Is This Thing Called Love, Lover, Hip-Billy Boogie, Swiss Woodpecker, and The Man on the Flying Trapeze. The arrangements are cute, amusing, and listenable. To Capitol, the "Top o' The Morning," the Croix de Guerre, the ribbon of the Legion of Honor and congratulations on one of the most splendiferous recordings these ears have ever heard.

RCA Victor Small Combo Hits
Popular Collector's Issue Series

Along with Victor's release of rare vocal items in its classical catalogue has come a selection of popular stuff which deserves

close attention. These are dubs of items in the Victor pop catalogue and are splendidly done. Available on both 45 and 33 1/3, my preference is for the 45 job because selection is of the greatest importance. Most of the recordings in this particular set were made between 1936 and 1940 and even in their dubbed state reveal the immense degree of striking accomplishment already achieved in the pre Hi-Fi period. Included are the Benny Goodman Quartet (including Teddy Wilson, Gene Krupa and Lionel Hampton); the famous 1937 Jam Session at Victor (with Bunny Berigan, Fats Waller, Tommy Dorsey, Dick McConough and George Wettling being righteous); the Bunny Berigan Crew in the 1938 recording of Bix's "In a Mist"; the massive and great "Body and Soul" of the "Hawk" (Coleman Hawkins); the Artie Shaw Grammercy Five job on "Smoke Gets in Your Eyes;" and Lionel Hampton, augmented by the King Cole trio and drummer Al Spiedlock doing the fabulous "House of Morgan." If you're interested in the stuff, buy it on 45; be assured that the dubs are good and, with moderate reservations, all the dates are distinguished by good music and good playing. What is more important is the impressive way that this stuff was recorded. In a five year span, the consistent quality of the recordings, in every respect deserves further comment. Instrumental sound is pure and clean. Balance is perfect, with percussion magnificently handled. Surfaces were invariably good, despite occasional rough spots.

SOUND SYSTEMS

[from page 25]

Although designed primarily for industrial use, all elements of the 1400 series amplifiers will more than meet broadcast standards as to frequency, distortion, and noise level. This was considered necessary because in the Survival Sound System we are dealing with "life or death" matters and nothing less than perfect articulation can be tolerated. It is bad enough when the quarter back's signals are misunderstood and the ball is passed one direction while the receiver mistakenly runs the other direction. The entire reason for the Survival Sound System is to prevent this from happening during an emergency.

The theme of high articulation is continued by a close-talking dynamic microphone for speech frequencies only, coded 632C. Its frequency response is designed to give a slightly rising characteristic up to 8,000 cps for maximum emphasis of the important intelligibility range of the voice spectrum. In physical appearance it looks like a shortened version of the well-known 633A "salt shaker" and has the same sturdy characteristics. The 632A is for speech only and, of course, more suitable microphones should be selected for music pick-up.

Loud Speakers

The loudspeakers are the last important element of the Survival System. Many suitable varieties of speakers are available, but again uncompromising emphasis must be placed on low distortion and high intelligibility of speech

NOW THERE ARE 3

They do everything you want!

They make tough jobs easy!

E-V Slim-Trim DYNAMICS

for TV... Broadcasting... Recording... PA

... for wide range high fidelity response ... for fixed position or man-in-motion ... for ruggedness and versatility ... for exclusive Acoustalloy diaphragm ... for pop-proof pick-up indoors and outdoors

You see ... and hear ... the E-V Slim-Trim on network and local telecasts and broadcasts. You find it in studios and on remote hook-ups. You find it on important PA jobs, too. And you know it's there *because* it has met the most exacting tests... *because* it serves so superbly in every way for voice and music. *First* in dynamic, it has features only *Electro-Voice* can provide. 3 models meet every need!

Ask your E-V Distributor or Send for Full Facts Now!

FOR TELECASTING-BROADCASTING

"655"—Response 40-15,000 c.p.s., ± 2.5 db. Power rating -53. Omnidirectional. Changeable low impedance. Removable swivel. List \$200

"654"—Response 50-14,000 c.p.s., substantially flat. Power rating -55. Omnidirectional. 50-250 ohm impedance selector. Swivel head. List \$90

FOR PUBLIC ADDRESS

"636"—Response 60-13,000 c.p.s., substantially flat. Power rating -55. Omnidirectional. High or low impedance. Swivel head. List \$65

Electro-Voice

400 CARROLL ST. • BUCHANAN, MICHIGAN

Export: 13 E. 40th St., N.Y. 16, U.S.A. Cables: Arlab

MICROPHONES • PHONO-PICKUPS • HI-FI SPEAKERS • SELF-TUNING TV BOOSTERS

TERMINAL
OFFERS THIS GREAT VALUE
IN THE FULL RANGE, VERSATILE

**BRILLIANTLY
ENGINEERED**

**PRECISION
BUILT**

Concertone

MAGNETIC TAPE RECORDER

BROADCAST STUDIO
QUALITY



No. 1401

Concertone
**MAGNETIC
TAPE RECORDER**

\$345⁰⁰ Net
LESS TRAY
F.O.B. N.Y.

A precision built and thoroughly tested instrument, capable of recording the full range of audible sound with full dynamic sweep and freedom from distortion.

Only the most expensive professional equipment rivals the tape handling ability of the Concertone recorder — and none equals its versatility and simplicity of operation. Especially designed for the most discriminating user, the basic recorder comprises a 14" x 22" rigidly ribbed, cast, aluminum plate carrying the tape mechanism, dual track heads, a shock mounted chassis containing erase amplifier, record amplifier, and playback preamplifier, a power supply chassis, mounting lugs for auxiliary equipment, and all necessary switches and controls, ready for use. Weight: 30 lbs. Easily connected to your existing high fidelity amplifier system. Monitoring directly from the tape while recording gives a constant check and control on what is being recorded while it is being recorded. A much prized program is never lost unknowingly, any departure from proper operation is immediately heard.

High speed rewind in either forward or reverse direction, firm, positive braking and fully interlocked controls assure rapid handling without damaging tape. A special circuit controlling a cathode "eye" gives accurate indication of the proper record level for best results. A special locking button prevents accidental erase of recordings.

The Concertone magnetic tape recorder uses any standard reel from the tiny five inch to the professional NAB 10½ inch reel, together with instantaneous choice of 7½" or 15" per second tape speeds, permitting matching frequency response and length of program to operating cost.

- Broadcast studio quality complies with NAB standards.
- Separate heads for high frequency erase, record and playback.
- Simultaneous monitoring from the tape while recording.
- Prealigned heads quickly interchanged for single or dual track.
- Instantaneous choice of 7.5 or 15 inch per second tape speeds.
- Plays standard 5 inch, 7 inch and NAB 10½ inch reels.

- High speed rewind, forward and reverse — 2500 feet in 60 seconds.
- Single or dual track optional.
- Size: 22" x 14" x 5" mounting depth below panel.
- Frequency response: ± 2 db from 50 to 12,500 cycles at 15"/sec.
± 2 db from 50 to 7,000 cycles at 7.5"/sec.
- Total harmonic distortion: Less than 2% at normal maximum signal level.
- Playing time: Up to 2 hours on dual track.

**CONCERTONE TAPE
RECORDER ACCESSORIES**

REEL ADAPTERS

No. 801 — Accurately machined to hold NAB 10½ reels on standard RMA spindles of recorder **300**

NAB 10½" REELS

No. 802 — Low inertia 2500 foot reels, flanged on both sides. Conform to NAB recommended standards **250**

**CARRYING CASE
NO. 501**

This handsome fitted custom case quickly and easily converts the basic recorder #401 into a complete system for portable use. Supplied with built-in monitoring amplifier #603, and eight inch high fidelity speaker mounted in detachable cover. Convenient to carry; 24" x 15" x 12". Weight: 15 lbs. **82⁵⁰**
CONSOLE TRAY AS ILLUSTRATED **14.95**



**TERMINAL VALUES ON QUALITY
PLASTIC RECORDING TAPE**

DOMESTIC		PROFESSIONAL	
600 FT.	\$1.35	600 FT.	\$1.65
1200 FT.	2.10	1200 FT.	2.70
2400 FT.	4.20	2400 FT.	5.40

Terminal Radio Corp.

Distributors of Radio and Electronic Equipment
85 CORTLANDT STREET • NEW YORK 7, NEW YORK
Worth 4-3311

through noise and other adverse conditions. Ten to twenty per cent of the personnel will suffer from serious hearing defects in various degrees, yet their lives are just as important as others. To accommodate these will require a speaker with plenty of smooth high frequencies that are not muffled by the all-too-common broad loudness peak which is present in the midrange of many low price speakers, and speakers generously located throughout every area where persons work or congregate.

Generally, the "low-level" system of many speakers at frequent locations is preferable for the usual plant or commercial establishment, and overhead ceiling mounting is generally preferable because variations in sound level due to the square-of-the-distance law are held to a minimum. Methods of ceiling mounting and appearance are usually no problem in factories but it is a matter of concern in stores and similar commercial buildings. One way of solving this in an attractive manner is shown in the illustration of how some eight hundred 755A speakers were installed in Hess Brothers Department Store in Allentown, Pa. This shallow 8-in. speaker requires only a two-cubic-foot baffle for optimum operation and has an unusually smooth high-frequency response up to 13,000 cps.

In a number of cases a source of emergency power supply is specified as a vital auxiliary to the Survival Sound System. The auxiliary source should be set up to throw over automatically on any interruption of the standard supply.

The Survival Sound System is definitely the need of the present and of the continuing future. Talk to a department store manager about an ordinary sound system and chances are you will get a glassy stare, but broach the subject of a Disaster or Survival Sound System and the department store man becomes all attention. Civilian Defense and personnel protection measures are matters of grave concern to most business heads.

This concern is not limited to Eastern or Western sea coasts, but extends to all industrialized areas. The National Civilian Defense Administration has designated approximately 200 locations as "Strategic Target Areas", half of which are further qualified as "critical" and almost 20 per cent as "super-critical". Although a list of these areas is not available for the asking, it is understood that information as to whether a particular location is rated as a strategic target for enemy attack can be obtained by residents of that location if they write to the State Civilian Defense office.

The idea of the Industrial Sound System cannot be classed as a fad which may pass with the apparent quieting of the world situation. Our top military leaders have given congressional testimony that the country must remain in a state of preparedness for a term of at least 10 or 20 years. With memories of Pearl Harbor still fresh, with jet ocean

crossings are made speedier and speedier and remotely guided missiles becoming more practical, our nation and our industries must be constantly prepared to cope as best they can with the devastating sneak attack. The Survival Sound System idea will quite likely become a standard consideration for architects in all future industrial construction.

Although the subject of this article is a specialized sound system application apropos the times, one must not overlook that investments in a Survival Sound System as such is by no means a loss should no enemy attack occur. Such a system, amortized as a protection measure, can only pay off with all the proven advantages of the ordinary plant sound system — time saving paging, music distribution for morale and increased production, and other proven benefits.

TECHNICANA

[from page 6]

were made over two transmitters on different frequencies.

The r.f. coil block units are essentially a French specialty. They are units of coils completely assembled and frequently designed for multiband use. The availability of several broadcasting bands to the French listener has probably been responsible for this design trend, but nonetheless these units appear to be rugged in construction and stable in operation, lending themselves well to designs in which stability and uniformity in mass production of high-fidelity equipment are of importance.

Transmission Measuring Set

J. M. Hudack is the author of an article in the December 1950 *Bell Laboratories Record* describing a new automatic transmission measuring set. This new instrument measures and records on a paper chart the transmission characteristic networks and amplifiers in the ranges 20 to 20,000 cps and 100 to 100,000 cps in a much shorter time than the old point by point method.

In this measuring set the input signal is generated in a beat-frequency oscillator in which the high frequencies are 650 kc and 650 - f kc. This signal of f kc is fed to the device under test and then into a receiving amplifier. The received signal is again heterodyned with the 650 - f kc signal from the first b.f.o. The output of the heterodyne circuit now contains a 650-kc signal—the amplitude of which is a function of the output of the unit under test—and a number of distortion products. This 650-kc output is fed to another heterodyne modulator, where it beats with a 553-kc signal from a local oscillator. Its output contains a 97-kc fundamental signal and the modulation products. The 97-kc signal amplitude is a function of the transmission characteristic of the unit under test. This signal is fed through a 97-kc crystal filter with a 20-cps pass band to a level recorder. The range of the instrument is 50 db. It occupies two rack frames mounted on a single casted base.

The transmission set may also be used to analyze amplifiers and networks for harmonic distortion and noise. Also with two extra oscillators measurements of intermodulation distortion products are readily accomplished.

ALTEC

Microphones



639



21B — stand, lapel or chestplate

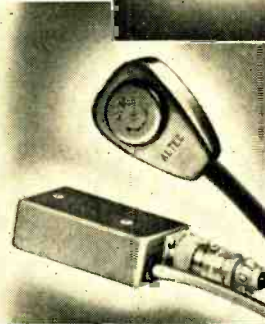

633



632C

the world's finest...

21B MICROPHONE

The ultimate in advanced microphone design and performance—omnidirectional, new pickup techniques with maximum fidelity for critical broadcast, recording, television, etc. Available in stand, lapel or chestplate.

639 MICROPHONE

Cardioid directional—for critical public address and broadcast use... an excellent all-purpose microphone, the solution to many troublesome and difficult microphone problems in studios and auditoriums.

633 MICROPHONE

Dynamic microphone for high quality general utility work... non-directional or semi-directional... for announcing, public address, broadcasting and sound distribution systems.

632C MICROPHONE

Specifically engineered to give maximum intelligibility for all close talking applications. Rugged and dependable for speech reinforcement, announcing and paging. May be used as stand or hand microphone.

This select group of high quality microphones is daily meeting every need demanded of microphones... they are products of the same Altec advanced designing, research, development and quality workmanship that have for many years set higher and higher standards of performance throughout the industry. For paging, public address, sound distribution systems or the more critical demands of television, broadcast and motion picture or phonograph recording—choose the finest, choose Altec!

ALTEC

LANSING CORPORATION

9356 Santa Monica Blvd., Beverly Hills, Calif.

161 Sixth Avenue, New York 13, New York

NEW PRODUCTS

● **FM Communications Monitor.** Designed for use by non-technical personnel, the new Model 337A-B FM communications monitor, manufactured by Hewlett-Pack-

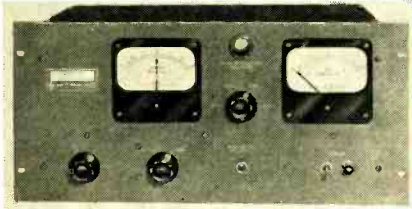

ard Company, 395 Page Mill Road, Palo Alto, Calif., is a unit equalling in performance similar equipment considerably higher in price. Using the same pulse-counter circuits employed in the company's monitors for commercial broadcasters, Model 337A-B does not require tuning of discriminators or frequent adjustment of voltage levels. The unit gives continuous indication of frequency and modulation swing, and includes a peak modulation indicator and an audio output for aural monitoring. Frequency range is 30 to 175 mc.

● **Dual-Channel Audio Control Console.** A high degree of flexibility suits the new RCA Type MI-12781 dual-channel console for an endless variety of applications in the field of industrial sound. Designed to provide a choice of radio programs, recorded programs, or locally-originated

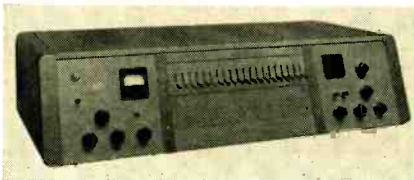

live program material to as many as 40 selected areas, the unit incorporates two complete audio channels which, when desired, may be connected together to furnish the same program to all areas. In addition to control facilities, the console incorporates two 30-watt high-quality amplifiers, matching transformers and monitoring speaker. Further information available from RCA Victor Division, Radio Corporation of America, Camden, N. J.

● **Wide-Frequency-Range Bridge Oscillator.** Intended for use in antenna and bridge measurements, the new General Radio Type 1330-A bridge oscillator is an excellent generator for all bridges oper-

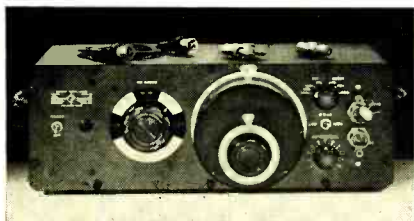

ating in its frequency range. A continuously-variable r.f. range from 5 kc to 50 mc is provided, also three audio frequencies including power-line, 400, and 1000 cps. Output voltage is approximately 10 volts, and more than one watt can be delivered into a 50-ohm load over most of the frequency range. The 1330-A is considerably lighter and smaller than its pre-war counterpart, yet covers a wider frequency range and supplies about ten times the output power at a lower impedance level.

● **Output Power Meter.** Covering the range from 0.1 mw to 100 watts, the new Daven Type OP-962 output power meter is designed for use at forty selected im-

pedances ranging from 2.5 to 20,000 ohms. Provision is made for use of a calibrated external amplifier to extend the range below 0.1 mw, also for connecting an oscilloscope to observe wave shapes. Featuring a large meter for ease in observa-

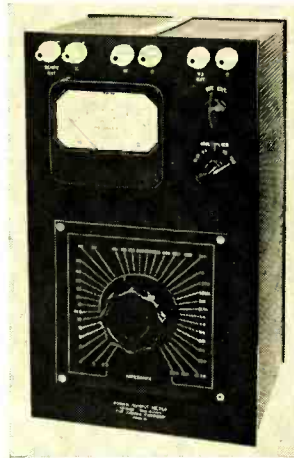

tion, Type OP-962 is enclosed in a ventilated metal housing 15¼ x 8½ x 8½ in. and weighs 20½ lbs. Full technical description will be supplied on request by The Daven Company, 191 Central Ave., Newark 4, N. J.

● **Public-Address Horn.** Designed with a low-frequency cutoff at 250 cps, the new Racon Model COB-11 "cobra" type horn provides a uniform sound field over a horizontal angle of 120 deg. and over a vertical angle of 40 deg. Exponentially flared for maximum efficiency, the COB-11 is especially effective where p.a. requirements call for clarity of sound with maximum concentration of energy in a horizontal plane. The horn may also be used as a middle-register or high-frequency tweeter in multi-speaker wide-range audio

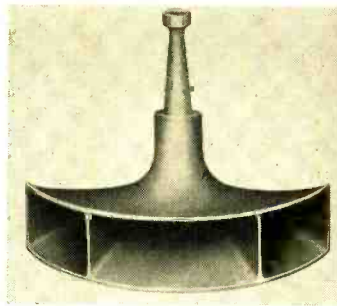

systems. Thread size of throat is 1¾"-18, permitting the use of any standard 25-35 watt driver. Further details of this model, as well as complete information on the remainder of the Racon line, may be secured by writing direct to Racon Electric Co., Inc., 52 E. 19th St., New York 3, N. Y.

● **Five-Range Treble Filter.** Designed for attenuating disturbances in the high frequency audio range, the Type OA-1 ad-

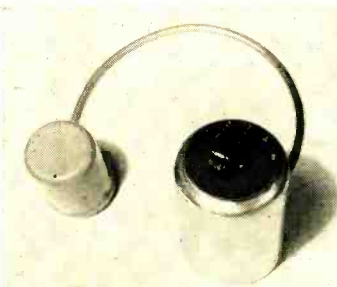

justable filter may be used for minimizing record surface noise, 10-kc heterodyne whistle etc. The filter connects between the outputs of typical tuners or phono pre-amplifiers and usual input circuits. Full description may be obtained by writing the manufacturer, Berkeley Custom Electronics, 2216½ Grant St., Berkeley 3, Calif.

● **Miniaturized Staple Tacker.** Small in size, yet equal in performance to a large industrial counterpart, this new tool will effect savings of both time and money in all sorts of wired sound installations. Using an improved staple available in a variety of colors, the tacker may be used for fastening wire to plaster, composition board, hard and soft wood, with holding power up to 64 lbs. Staples are driven to desired depth without injuring insulation.

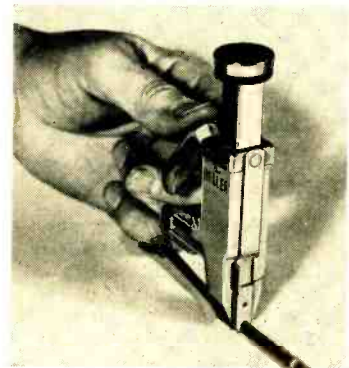

Both the tacker and staples are designed to A. T. and T. specifications and, according to the manufacturer, are now used for installation of low-voltage telephone wiring throughout the Bell System. Manufactured by The Heller Company, 2153-N Superior Ave., Cleveland 14, Ohio.

● **Univerter.** The new Type 207-A univerter, manufactured by Boonton Radio Corporation, Boonton, N. J., is an accessory instrument designed to increase the usefulness of the Boonton Type 202-B FM signal generator. While the 202-B normally covers a frequency range of 54 to 216 mc, in combination the 202-B and the 207-A provide continuous frequency coverage from 0.1 mc to 216 mc. Type 207-A univerter is a frequency converter having unity gain. It is provided with frequency increment dial calibrated in in-

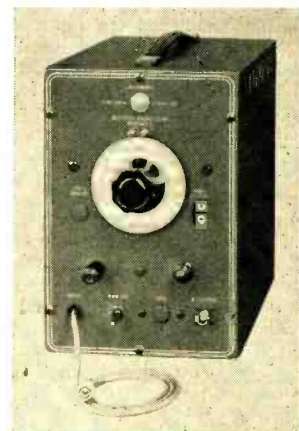

crements of five kc from plus 300 kc through zero to minus 300 kc. This feature permits making selectivity measurements on narrow-band receivers. Complete details may be obtained from the manufacturer.

● **Chairside Cabinet.** Manufacturers of radio-phono combinations will find interest in this unique cabinet recently placed in production by Standard Wood Products Corp., 43-02 38th St., Long Island City 4, N. Y. Although large enough to accomo-



date both a radio and standard-size record changer, the cabinet is made of Formica, and is available in a choice of blonde or mahogany finish. Overall dimensions are 20" high, 16" wide, and 18" deep. Features authentic Modern styling. Further details may be obtained by writing direct to the manufacturer.

• **Tape Transport Mechanism.** Designed solely for playback purposes, the new Presto Type TL-10 magnetic-type drive can be quickly installed on any standard 16-in. turntable, thus providing the user with a high-quality tape reproducing unit at low cost. Driving power is obtained from the turntable and equalized output level is high enough to be fed directly into standard speech input equipment. Performance specifications are governed by the equipment with which the TL-10 is used. Speed regulation is equal to that

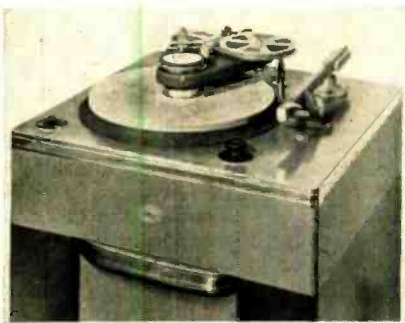

of the turntable alone, while signal-to-noise ratio is dependent primarily on the amplifier. Frequency response of the TL-10 head is uniform from 50 to 15,000 cps at a tape speed of 15 in. per second. Descriptive bulletin may be obtained by writing Presto Recording Corporation, P. O. Box 500, Hackensack, N. J.

• **Crystal Microphone.** Low cost and good audio quality are both featured in the new Turner Model 60X microphone. Equally well suited for hand, desk, or stand use, the 60X has a frequency range of 70 to 7000 cps and features a moisture-



sealed crystal making it ideal for use under varying conditions of humidity. Attractive case is finished beige wrinkle enamel. Supplied complete with 6-ft. cable and stand adapter. For complete details write The Turner Company, 900 17th St., N.E., Cedar Rapids, Iowa.

APPROVED • ASTATIC • ATLAS • AUDAK • AUDIO DEVELOPMENT • BELL • BOGEN • BOZAK • BROOKS • BROWNING • BRUSH • CHALLENGER • ELECTRONIC WORKSHOP • ESPEY • JENSEN • LEAK • LIVINGSTON • MARKEL • MASCO • NATIONAL • NEWCOMB • PENTRON • PERMOFLUX • PICKERING • PROCTOR • RACON • RADIO CRAFTSMEN • REK-O-KUT • H. H. SCOTT • SHURE • TURNER • UNI-MODE • UNIVERSITY • V-M • WEBSTER-CHICAGO • WEBSTER ELECTRIC

Here at Last!
UNEXCELLED BROADCAST QUALITY AT 7.5" PER SECOND

Sonar TAPE RECORDERS



MODEL RPA-1

RECORD PLAYBACK AMPLIFIER

- TAPE FREQUENCY RESPONSE—30 to 10,000 cycles ± 2.75 db with less than 2% total harmonic distortion. Overall usable response flat from 27 to 15,000 cycles.
 - AMPLIFIER RESPONSE—20 to 20,000 cycles ± 2 db zero db level. Output less than 2% total harmonic distortion.
 - WOW AND FLUTTER—0.25% at 7.5" per second.
 - FAST FORWARD AND FAST REVERSE—58 seconds for 2,500 feet of tape. 40 seconds for 1,250 feet of tape.
 - REELS—will accommodate 10½", 7", 5", and 3" reels.
- NET \$429.00



MODEL MPA 3 CHANNEL MIXER AND THIRD HEAD PRE-AMP

Mixer pre-amp makes possible mixing three microphones, low impedance as well as monitoring from the third head. Having its own illuminated V.U. meter, the third head can be individually controlled. May be mounted on top of RPA-1 Recorder. Available with PTM Mechanism in durable and attractive leatherette. Also for rack mounting.

NET \$170.00

TAPE MECHANISM MODEL PTM

Simultaneous use of three heads, full width track, erase, and playback, permits listening to recorded tape a fraction of a second after it is recorded, insuring perfect recordings. Three heavy torque, dynamically balanced motors. Electro-Dynamic braking system—exclusive with SONAR—is guaranteed to require no adjustment. Will accommodate 10½" (NAB or RMA), 7", 5", and 3" reels.

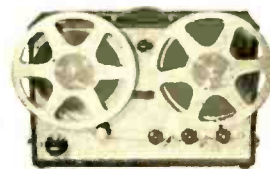

NET less carrying case \$209.00
 carrying case 30.00
 10½" NAB Reel adaptors (per pair) 9.00

You will want our new catalog. A penny postcard with your name and address will bring it to you.

Leonard Radio inc.

the house
built on
SERVICE

69 CORTLANDT ST., NEW YORK 7, N. Y.

RECORD REVUE

[from page 30]

seeming lack of appreciation of some very fine recorded sound. But certain anachronisms were quickly evident.

Remember, for instance, when we used to enjoy tossing plastic records around to show how they wouldn't break? That fad is now more or less over hereabouts, merely because untold millions of plastic records have taken the novelty away. But I remember well enough—it was only three years ago, though it seems ten—doing the same, with great glee. I remember proudly

carting around my first genuine LP's to show off, to the utter amazement of friends and relatives. Same with 45's a bit later. I remember (way back then), tossing 45s' like doughnuts, dropping LP's from a height of six feet while all eyes were averted in involuntary terror. . . . All of which was mildly re-experienced during the course of our social evening with EMI's new test pressings. Another era!

And the sound? There we come to the real point. Which is simple enough, and represents a very important line of thought, I'd say, for any of us today. The question in my mind was—am I supposed to be *listening to LP's—to 45's?* Or am I listening to *recordings*, which happen to be pressed in one of

the standard alternative forms now available?

Focus on LP

Perhaps my point isn't entirely clear, even after "all" these years. When LP began, over here, the great argument back and forth and through and through the industry was "how good are LP's?" How bad? Everything was tied to the LP itself. The ancient controversy upon "fuzziness" in LP's, which eventually proved pretty conclusively to be a matter of improper cartridge performance, was a fine case in point. The focus of all our attention was on the LP as a system. We listened to LP's and we judged them *as LP's*—not as recordings.

We judged the Whole instead of its Parts. We lumped all sorts of attributes under one heading—LP. Attributes that often were totally unrelated one to the other. LP's had "thin bass" (or thick); they had screechy treble (or no treble), they had wows, they buzzed, and so on. All of which were distinct and separate factors, elements in the total LP process, yes—but not *typical* of LP, as such. When 45 came along, we indulged in a new frenzy of comparisons that have since proved to be pretty pointless. Which had the most distortion or the least? It all depends! Theory as to optimum diameter vs. speed, etc. etc. is relatively unimportant, we now can see, in comparison with the enormously greater practical variations in many aspects of recording—some of which constitute values or problems common to both LP and 45, a few—a very few—being exclusive to one or the other.

And so, my impression in listening to the EMI test pressings was, again, one of a difference in viewpoint. I was being shown precious advance tests of a new system; they were, to me, physically like a hundred tests I've looked at and heard—that is, they were simply so many records. What was on the records was what counted.

And it happened that a good number of Mr. Barrell's LP tests were taken from disc, rather than from the tape that EMI, like everyone else, is using more or less exclusively for new recording. Nothing exceptional about that—EMI has some very fine discs hanging around and they no doubt made handy material for testing purposes. (Though, even so, I think that we here would tend automatically to use tape originals for testing a new system of any sort, these days. Disc is out of date, even at best, from the technical point of view.) Since the EMI tests were, then, from disc, I couldn't help listening to them as convenient reproductions of those fine disc recordings—to me they were a sort of transparent medium, a convenient method of hearing the original. (They were perfectly good microgrooves—why shouldn't they be, after all? I would have been astonished if they had *not* been good ones.) I listened as one listens to a good tape recording of a broadcast—not to the tape but to the broadcast itself.

Disc-ness of Sound

I became absorbed, as a matter of fact,



This 12-in. high fidelity unit has a twin-curvilinear diaphragm (British patent No. 451754). A carefully designed magnet assembly using anisotropic material provides a total flux of 158,000 maxwells on a 1½-in. pole. The back centering device is a dustproof bakelised linen disk with concentric corrugations. The combination of these features gives this precision-built instrument an outstandingly wide coverage from 40 to 15,000 c.p.s. free from bass modulation effects. An ideal high fidelity reproducer for the record enthusiast and the connoisseur of wide range musical reproduction, it gives exceptionally fine transient and frequency response.

U. S. NATIONAL SALES
WILLGOLD ELECTRONICS SALES CORP.
350 Fifth Avenue, New York, N. Y.

New England Office
Harold A. Chamberlin
31 Milk St., Boston 9, Mass.

Pacific Coast Office
Perlmuth-Colman & Associates, Inc.
1335 Flower St., Los Angeles, Calif.

Chicago Office
Harry Halinton Co.
612 N. Mich. Ave., Chicago 11, Ill.

Canadian Office
A. C. Simmonds & Sons, Ltd.
100 Merton St., Toronto 12, Can.

Meet us at the Canadian International Trade Fair,
Toronto, May 28-June 8, Group #17, Stand #4753.

Manufactured by:

GOODMANS INDUSTRIES LIMITED
WEMBLEY MIDDLESEX ENGLAND

SPECIFICATION

Frequency Coverage
40/15,000 c.p.s.
Overall Diameter
12 in.-31.3 cms.
Overall Depth
6 in.-17.6 cms.
Fundamental Resonance
55 c.p.s.
Voice Coil Diameter
1¾ in.-4.4 cms.
Voice Coil Impedance
15 ohms at 400 c.p.s.
Maximum Power Cap.
15 Watts Peak A.C.
Flux Density
14,000 gauss
Net Weight
12 lbs. 13 ozs.
(5810 grs.)
Finish—Grey Rivelling Enamel.

in an irrelevancy (from EMI's viewpoint), the "disc-ness" of the sound; one test was so good that I could have sworn it came from no disc, on first hearing, though on repeat there were some loud passages that might betray a disc origin for one looking very hard for evidence. Others, though excellent wide-range recording, had that unmistakable slight metallic resonance (if that's the word) which says "disc." Yes, I was thinking, the removal of the mechanical moving element in favor of all-electronic recording brings a sound to the best tape that is undeniably a step beyond the very finest disc—at least in the more heavily modulated sections. Only common sense to expect this . . . and, you see, in no time at all I was a thousand miles away from any consideration of LP or no LP. Forgot I was listening to LP.

Miraculous Intuition

I repeat—no offense to EMI and EMI's excellent tests. As a matter of fact, we've been hearing more extensive tests of the same, via the EMI-cut British Columbia LP's which have been pressed directly on the Columbia label over here right along with our own recordings. For all my irrelevant ruminations, I did get an excellent impression, too, of the EMI plastic material—very quiet and up to the best—which I gather is entirely made in Britain, via coal products from Wales. I was left without any clear idea of EMI's recording curve in the tests, because our adjustments were mostly aural and I don't have Editor McProud's (unmarked) controls memorized yet.

But may I remark in utmost seriousness, to Mr. Barrell and EMI, that top-quality microgroove recording these days over here, is no monopoly of the big-company label. The EMI tests were excellent. But I've heard dozens of just-as-good tests from tiny outfits whose total capitalization is perhaps one millionth that of EMI. Granted that it's the big outfits who make this possible—the tape manufacturers, the processing and pressing facilities that can be still bought or rented so cheaply today in spite of rising prices for everything. A good LP or 45 recording, speaking purely from an engineering viewpoint, is a commonplace almost. Or, to put it another way, standards of excellence have risen all along the line. A good *original recording*, however, is still a matter for miraculous intuition! The British have always been tops at that side of things—and so you can't blame me for listening, not to EMI's microgrooves, but simply to EMI's recording. Nice, too.

NEW RECORDS

Milhaud, *Serenade for Orchestra* (1921);
Five Studies for Piano and Orch. (1920);
 Maximilian Suite (1932), *Three Rag Caprices* (1927).

Vienna Symphony, Swoboda.

Westminster LP
 WL 5051

"Polytonality," they called it in the 1920's and people shuddered with horror. Polytonality it is still, today, at least

in a reasonable way, but strangely enough, it doesn't really hurt any more. This is a nicely representative collection of the snazzy youthful Milhaud, *enfant terrible* of French music, in the days before he became a relatively respectable middle-aged composer as now; but you'll hear in this music, perhaps to your surprise, a lot of familiar sound ranging from Gershwin to Leonard Bernstein ("On the Town") and Morton Gould; not to mention about half the film music ever written. It's dissonant music—as dissonant as ever any composed—but the system is simple and the tunes are catchy and even popular, the whole with a slightly delicious atmosphere of *scandale, à la Folies Bergères*. Can't help likin' this man.

Recording? Lovely, with fine brass edge, good acoustics. Comes pretty close to being one of those hi-fi demonstration discs. Remember *Ionisation*? He was French too.

Songs of the Auvergne, arr. Canteloube.
 Folk Songs. Susan Reed; instrumental ensemble.

Columbia LP:
 ML 54368

Some engineer-music-lovers will remember the famous Madeleine Grey recording of these, reissued a few years ago (on 78) by Columbia after much campaigning on the part of record buyers. The songs are fascinating, and are set to a sort of symphonic-poem accompaniment by Canteloube, the whole being



**NOW . . . HI-FI TONE
 AT ANY VOLUME LEVEL!**

New IRC Type LCI Loudness Control Gives Accurate Compensation in AM, FM, TV

Lets you hear every tone with almost perfect balance, even at whisper level.

Boosts highs and lows automatically as volume is decreased—maintains depth and brilliance of tone without expensive taps or multiple adjustments.

A true, continuously variable Loudness Control—replaces such makeshifts as tapped volume controls, stepped-type volume controls, bass and treble boost circuits.

Available as an inexpensive, completely assembled unit—or you can assemble it yourself in a few minutes with a few standard parts.

Only 3 simple connections needed to install in most AM and FM Radio, Television Sets and Record Players. Based on small 15/16" IRC Q Control—fits almost any size set.

Available now—from your IRC Distributor. (We'll be glad to send you his name and address.)

Full Details—Free Send today for complete technical literature on IRC Type LCI Loudness Control—including instructions for assembling your own Loudness Control Demonstrator Unit. No obligation.



INTERNATIONAL RESISTANCE CO.

401 N. Broad Street, Philadelphia 8, Pa.

Wherever the Circuit Says

quite unique in music. Susan Reed does a surprisingly nice job with them, though not as note-perfect as the highly trained Grey; her "orchestra" is a small group, about 4, but in quite respectable condensations of the original score. And the whole is, of course, hi-fi, so those who couldn't ethically accept the old low-fi records (some people just *won't* play a low-fi record) can take these without a qualm of hi-fi conscience! Susan's own renderings of U.S. folk songs, on the reverse, are a bit corny to my ear. She was a night club success with them, though—so suit yourself.

Music With Harp. (Ravel, Debussy, Saint-Saëns, Fauré) Edw. Vito, Stradivarius Quartet, etc.

**Stradivari LP
SLP 1007**

This small company has been doing excellent work in the French music area with a group of younger American musicians. This one gives you a fine glimpse at the masterful way in which the French use the exotic sound of the harp to top advantage. The recording is excellent, though not showy. Since first going over these I've made one discovery—with time that dampens my enthu-

siasm. The record material wears out in a very short time, if you give it hard treatment, as I do in rehearsals for broadcasts, etc. Probably a lot of fill in it—the sound is quite OK; it's merely a matter of wearing quality. This is cited as one example in an aspect of the business we must keep an eye on, for our own best interest. Other companies do the same, too, you may be sure. I noted a decided contrast in wearing qualities when I happened to work, at about the same time, with an RCA and a London record, neither of which showed unpleasant wear even after dozens of playings of the same spot.

Schubert, Unfinished Symphony.

a) NBC Symphony, Toscanini.

**RCA Victor LP
LM 54 (10")**

b) Bamberg Symphony, Heger.

**Mercury LP
MG 10034**

Schumann, Kinderscenen. Chopin, Mazurkas.

Horowitz, piano.

**RCA Victor LP
LM 1109**

Chopin, Sonata in B Flat minor. Barber, Sonata (1950).

Horowitz, piano.

**RCA Victor LP
LM 1113**

Mendelssohn, Trio in D. Ravel, Trio in A minor.

Rubinstein, Heifetz, Piatigorsky.

**RCA Victor LP
LM 1119**

Tchaikowsky, Trio in A Minor.

Rubinstein, Heifetz, Piatigorsky.

**RCA Victor LP
LM 1120**

The above recent RCA Victors represent a cross section of the RCA stable, lumped herewith merely because these all happen to be new representatives of the noticeably absent bass. Might be high turnover point and no more—but a lot of boost in the bass still doesn't seem to add anything really solid, on a big machine (though boosting reveals a nice absence of extraneous rumble, hum, thump, etc.). These'll all sound fine on most home machines that don't reproduce bass anyway and that's where most of 'em will go—so we can't complain. Just for the record.

The Schubert Unfinished (bass aside) is another typical Toscanini, most likely of a vintage with those issued last spring, and contrasts interestingly with the utterly different Bavarian version on Mercury. Toscanini's recording is dead, sharp, clear; his performance is accurate, intense, streamlined, tight, quite fast. The Bavarian job is big, slow, heavy, lyric, leisurely, schmaltzy, not always accurate in detail. If we could only get some mythical conductor who would combine the virtues of both—for the Bavarian style is probably nearer the real sense of the music—which is essentially South German music, remember, and not Italian. Lotta difference. Mercury's recording has big spaciousness, lots of highs and plenty of bass; also some most unpleasant taped hum or motor noise. (Its other side has the "Rosa-

HARVEY Features the Finest Brands

WILLIAMSON HR-15 AMPLIFIER KIT

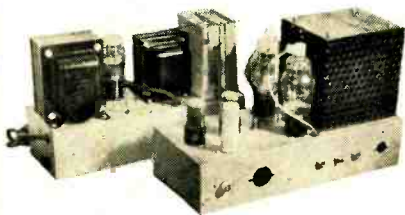

The famous Williamson HR-15 amplifier circuit... now available with the original Partridge transformers built to Williamson's specifications. Build this kit in 3 hours or less, and enjoy sound of a quality you never heard before. The HR-15 is a 2-Chassis power amplifier for use with tuners or other front ends having own volume and tone controls. All American triodes, 2-6SN7GT, 2-807, or 6BG6 in PP output, 5V4G rectifier. Response $\pm .5$ db, 10-100,000 cycles. Output impedances 1.7 to 109 ohms in 8 steps. Absolute gain 70.8 db. 20 db. of feedback around 4 stages and the output transformers. Kit is complete with Tubes, Punched Chassis, Pre-wired Resistor Board, Sockets, Genuine Partridge Output Transformer, and All Necessary Parts.....**\$75.00.**

PARTRIDGE OUTPUT TRANSFORMER
WWFB, as used in above Kit, available separately.....**\$24.50**



NOW IN STOCK! NEW PARTRIDGE CFB SERIES

Frequency response 3db down at 3 cycles and 95,000 cycles. Power rating 30 to 30,000 cycles at 60 watts with less than 1% distortion without negative feedback. Write for descriptive literature.
\$35.00 net

Jobbers... write for prices on the complete line of Partridge Transformers.

Western Electric 728B and 755A Speakers still available

VISIT THE AUDIO- TORIUM

Come in and visit our new sound department... all these items and many more on working display at all times.

Telephone: **7** LUXemburg 2-1500

HARVEY
RADIO COMPANY INC.

103 West 43rd St., New York 18, N. Y.

NOTE: In view of the rapidly changing market conditions, all prices shown are subject to change without notice and are Net, F.O.B., N.Y.C.



MAGNECORD SERIES 6 RECORDERS AND AMPLIFIERS

PT6-JA Recorder and Amplifier... the only combination that offers such high professional quality at such a low price. Includes PT6-A Recorder plus Amplifier with low impedance microphone and bridging inputs, 10 watt audio amplifier with monitor, speaker and jack for external speaker, 600 ohms balanced line output terminal.

PT6-JAH—Magnecord Combination with high speed forward.....**\$564.00**

PT6-AH—Recorder with high speed forward.....**316.00**

PT6-J—Amplifier.....**248.00**

PT6-P... Lightweight Portable Amplifier, including a record playback remote amplifier and power supply for use with the PT6-A Recorder.....**\$462.00**

McINTOSH AMPLIFIERS

We have McIntosh Amplifiers in stock for immediate delivery. Full information on request, or come in (if you're in town) for a demonstration.

20 W-2 Amplifier.....**\$149.50**
50 W-2 Amplifier.....**249.50**
AE-2 Equalizer Pre-Amp.....**74.50**



Complete Line of CANNON Plugs and Connectors carried in stock for immediate delivery.

CANNON plugs have been standard equipment for more than 15 years wherever a high quality connector is required for low level sound transmissions or for general electrical and electronic use. You'll find them in quality microphones, sound systems, radio and TV stations, etc. CANNON is definitely a "must" for you. Write for literature and prices for connectors to fit your requirements.

munde" music, with a 6000-cps apparent cut-off.)

Horowitz' LP piano has an absolutely astonishing lack of bass. No better description for it. His playing is brilliant, a bit too cold and objective for the highly personal Schumann and Chopin items. There is some tape flutter, here and there. The new "Million Dollar Trio," with Piatigorsky replacing the earlier Feuermann cello, is a stunning ensemble, but for my taste in the listening a bit too eclectic—i.e., they play almost everything alike, and one hears Heifetz, Rubinstein and Piatigorsky, each doing his own typically personal style. Nevertheless, few ensembles can match theirs in over-all projective power and brilliance. Again, no bass.

American Songs (18th century).

Margaret Truman, Robert Shaw Chorale, RCA Victor Orchestra.

**RCA Victor LP
LM 57 (10")**

Helen Traubel Sings Wagner (vol. 2).

With RCA Victor Orch., Weissmann.

**RCA Victor LP
LM 1123**

Just for the record—these two, for reasons not entirely clear, seem to have all the bass one needs, given a bit of tone adjustment. A certain percentage of RCA's continue to appear thusly. La Truman does a nice small job with some very simple and charming drawing room songs; the Chorale also does well (and is beautifully recorded) with the rougher, untutored sort of early American music. Traubel is a lot better here than those who may not fancy her singing are likely to expect. I've heard better Wagner, but not by a very large margin, all things considering. The characteristic Traubel heaviness of touch is minimized, the voice is at its best, the musicianship unexpectedly good. And a superb recording job, too. Flagstad fans had better try this, just to keep up with current events in the field.

Beethoven, Violin Concerto.

Francescatti; Phila. Orch. Ormandy

**Columbia LP
ML 54371**

Mendelssohn, Violin Concerto.

Stern; Phila. Orch. Ormandy.

**Columbia LP
ML 4363**

Beethoven, Piano Concerto #5 ("Emperor")

Serkin; Phila. Orch., Ormandy

**Columbia LP
ML 54373**

Here you have a trilogy of concertos with to my mind the most satisfactory answer to the problems of recording the solo-orchestra combination to date. Not only a wonderful, big, deep, live orchestra, but an "enveloping," surrounding effect that blends solo and orchestra without blurring the contrasts between

them. Not a concert hall effect at all, as a matter of fact—but an ideal recorded sound effect, the best one can do with the monaural situation, which is utterly unlike the binaural situation in an actual concert hall, as we all should know by now. Only the individual quality of solo instruments could here be questioned. Stern's violin playing is recorded with a huge sound, a bit blurred by the liveness; Francescatti's is the better effect, I'd say, with a sharper, cleaner sound, less exaggeratedly large. (But this is almost splitting hairs—both are excellent). Serkin's piano is strangely

distant, and lacks bass in the recording, though the orchestral bass is fine. Not a bad effect at all; just unexpected. As for the orchestra—Ormandy's playing is conditioned, it seems, by the qualities of his soloists. The Mendelssohn is more masculine and solid here than the Beethoven—because of Stern's playing in it; Beethoven is beautifully slick and smooth with Francescatti. Quite French, indeed. With Serkin at the pianistic helm, Beethoven's Emperor is as electric as Serkin himself, which is definite high voltage. Ormandy's an excellent accompanist, no doubt about it.

Floating Action!

for all TV Cameras

"BALANCED" TV TRIPOD

Pat. Pending

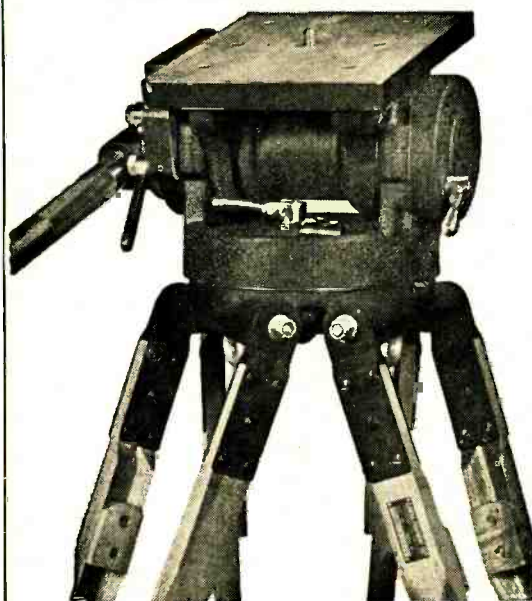

This tripod was engineered and designed expressly to meet all video camera requirements.

Previous concepts of gyro and friction type design have been discarded to achieve absolute balance, effortless operation, super-smooth tilt and pan action, dependability, ruggedness & efficiency.

Below:

3 wheel portable dolly with balanced TV Tripod mounted.

Complete 360° pan without ragged or jerky movement is accomplished with effortless control. It is impossible to get anything but perfectly smooth pan and tilt action with the "BALANCED" TV Tripod.

Quick-release pan handle adjustment locks into position desired by operator with no "play" between pan handle and tripod head. Tripod head mechanism is rustproof, completely enclosed, never requires adjustments cleaning or lubrication. Built-in spirit level. Telescoping extension pan handle.



Write for further particulars

FRANK & ZUCKER
CAMERA EQUIPMENT CO.
1600 BROADWAY NEW YORK CITY

CIRCUITS SURVEY

[from page 15]

loading of the other, with both grids driven; (8) plate loading of one tube and cathode loading of the other, with one grid and the free cathode driven; and (9) loading both plates and both cathodes, with the grids driven in push-pull.

The first six can be rejected with the aid of the above considerations, leaving but three circuits for analysis.

The seventh can be connected as shown in Fig. 2(a), with the tubes con-

nected in series across a split power supply. If the circuit is balanced, direct current does not flow through the output-transformer primary. Push-pull operation is obtained, since the plate current of one tube increases as the plate current on the other tube decreases. To satisfy the third requirement it will be noted that the alternating components of the plate currents of both tubes flow through the single output-transformer primary.

Disadvantages of the scheme are that twice the normal power-supply voltage is required, and that a large driving voltage is required by the upper tube.

It is of interest to note that the output impedance is very low—essentially that

of the upper tube operating as a cathode follower—while the plate load is computed as for parallel operation. If a split-primary output transformer is available, the two halves of the primary can be connected in parallel, with improved high-frequency response.

The method of obtaining grid drive shown is one possibility; it may not be the best.

The need for a double-voltage power supply can be eliminated by rearranging the circuit as shown in Fig. 2(b), and employing a transformer with two primaries, P_1 and P_2 . The other advantages are retained, as is the disadvantage of large driving voltage for one tube. The coupling capacitor between plate and cathode will improve high-frequency response if the coupling between the two halves of the output-transformer primary is not perfect.

The eighth circuit appears to be of no particular advantage, as grounded-grid operation of one tube will require additional driving power. The remaining grid, which is associated with a cathode follower, will still require a large voltage. However, an interesting combination of (7) and (8) exists,² as shown in Fig. 2(c).

It will be noted that V_1 is driven in the normal manner, while the drive for V_2 results from the voltage across R_k . Since this voltage will increase as the load impedance is decreased, one would expect the circuit to have a low output impedance. A practical advantage is that push-pull driving voltage is not required.

Gain and Impedance

It is of interest to derive the equations for the open-circuit voltage gain and the output impedance of the circuit. To obtain the voltage gain, the amplifier is split, as shown in Fig. 3(a). The equivalent circuits are shown in (b) and (c). Here V_2 is considered as a cathode follower with a resistance R_k connected between its grid and cathode, while V_1 functions as a grounded-cathode amplifier, with a load consisting entirely of V_2 . Assuming the tubes to be identical, and considering Fig. 3(b),

$$\frac{e_2}{e_1} = \frac{R_p + \mu R_k}{R_p + (1 + \mu) R_k}; \quad (1)$$

considering Fig. 3(c),

$$\frac{e_2}{e_1} = -\frac{\mu [R_p + (1 + \mu) R_k]}{2 R_p + (1 + \mu) R_k}. \quad (2)$$

Forming the product of (1) and (2), it is found that the overall voltage gain

$$\frac{e_2}{e_1} = -\frac{\mu R_p + \mu^2 R_k}{2 R_p + (1 + \mu) R_k}. \quad (3)$$

If $\mu \gg 1$,

$$\frac{e_2}{e_1} \approx -\frac{R_p + \mu R_k}{\frac{2 R_p}{\mu} + R_k} \quad (4)$$

Figure 3(d) shows that the output impedance Z of the amplifier consists of $R_p + R_k$ in parallel with the output impedance of V_2 , which must be evaluated

² Maurice Artzt, "Survey of direct-current amplifiers," *Electronics*, p. 112, Aug. 1945.

MAGNETIC RECORDING TAPES TO THE HIGHEST PROFESSIONAL STANDARDS

Now the well-known Duotone super-quality is available in magnetic recording tapes for commercial and home recorders. The six Duotone quality features assure finest sound reproduction for professional programming and the ultimate in home entertainment. For finest performance on any tape recorder, use Duotone professional quality magnetic tapes!

- Interchanges with Other Tapes
- Constant Tracking and Winding
- No Snarls or Backlash
- Low Inertia Plastic Wheel
- Low Friction—Long Life
- High Output—Minimum Background

DUOTONE SUPER QUALITY IS AVAILABLE IN TAPES FOR EVERY RECORDING NEED

Made with plastic or kraft paper base in extra long 625 or 1250 foot lengths. Plastic base is tough with high tear strength and special smooth finish for uniform coating. All kraft bases are super-calendered for perfect surfacing without fillers. For complete data on Duotone standard and special tapes, call or write for illustrated catalog.

Famous for Phono Needles, Recording Needles, Discs, and Quality Sound Accessories

DUOTONE

COMPANY INC.

Keyport, New Jersey

Canadian Representative: CHARLES W. POINTON, TORONTO, CANADA
Export Division: AD. AURIEMA, INC., NEW YORK CITY, N. Y.



— IN A
**RECORDING
TAPE
FOR EVERY
PURPOSE**

6 WAYS
to better
Recordings

separately. Figure 3(e) is the equivalent circuit for V_2 alone. Applying a voltage e as shown,

$$\frac{e}{i} = \frac{R_p}{1 + \frac{\mu R_k}{R_p + R_k}} = Z_e \quad (5)$$

Where Z_e is the impedance of V_2 alone. Paralleling Z_e with $R_p + R_k$ to obtain the output impedance of the amplifier,

$$Z = \frac{R_p (R_p + R_k)}{Z_e R_p + (1 + \mu) R_k} \quad (6)$$

Example

To study a practical example, one might consider the use of two 6L6 tubes with a 500-volt plate supply. If $R_k = 170$ ohms, $R_p = 22,000$ ohms, and $\mu = 135$. Substituting in (4) and (6), $e_2/e_1 \approx -90$, and $Z = 7300$ ohms. Inspection of a tube handbook³ shows the optimum load impedance to be 1250 ohms, with an output of approximately 14 watts. The required r.m.s. grid drive is 10 volts, while the r.m.s. signal current per tube is approximately 50 ma. Since this current flows through R_k , it is necessary to increase R_k to 500 ohms to obtain

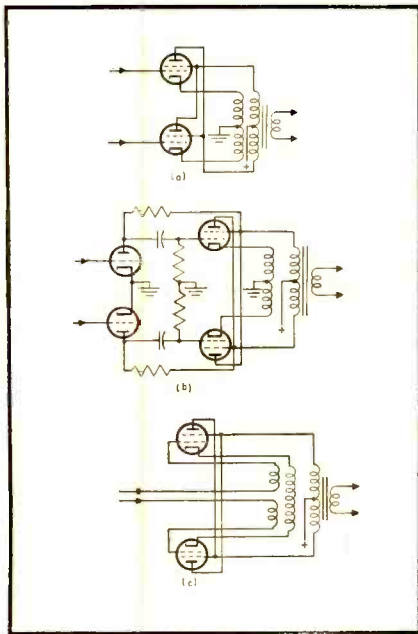

Fig. 4. Plate-and-cathode-loaded output stage circuits.

sufficient driving voltage for V_2 . The more elaborate circuit of Fig. 3(f) was employed to obtain the proper bias for V_2 with the increased value of cathode resistor. Substituting the new value of R_k in (4) and (6), $e_2/e_1 \approx -110$, and $Z = 4,500$ ohms. The output impedance is lower than that normally obtained with a pentode amplifier, which permits a good damping factor to be obtained with a moderate amount of feedback.

The amplifier of Fig. 3(f) gave good results; however, it was found that clipping occurred at the comparatively low level of 15 watts. This resulted from the fact that the drive from V_2 comes from V_1 ; and therefore, when V_2

overloads, there is a rapid deterioration in the output of the amplifier.

A disadvantage of the circuit is that the value of R_k for proper a.c. balance is a function of load impedance, with the possibility of even-harmonic distortion production when operating into a fluctuating load such as a loudspeaker.

Plate- and Cathode-Loaded Circuit

The last scheme to be considered employs plate and cathode loading of both tubes,⁴ as shown in Fig. 4(a). By using a bifilar output-transformer primary, ex-

⁴ Frank H. McIntosh and Gordon J. Gow, "Description and analysis of a new 50-watt amplifier," AUDIO ENGINEERING, p. 9, Dec. 1949.

cellent coupling is obtained between the two tubes, permitting class-B operation with very low distortion. Signal currents add in the transformer windings, permitting the use of a low load impedance, while the d.c. flux is canceled. However, because of the cathode loading, degeneration occurs, and a large driving voltage is required.

A resistance-coupled driver was tried with this amplifier; results were disappointing until the driver plate supply was increased to 500 volts. This disadvantage was eliminated by use of the "bootstrap" driver shown in Fig. 4(b). Here each of the driver plate-load resistors is returned to the plate of the opposite output tube which, to an approximation, has the effect of doubling

STANCOR High Fidelity OUTPUT TRANSFORMERS

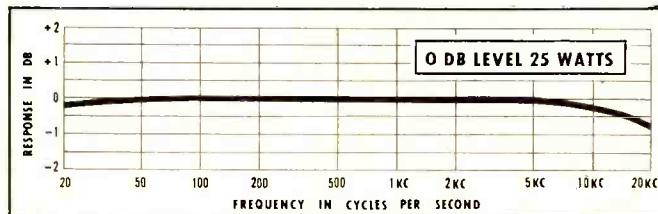

Curve represents an average response of the ten transformers in this series. Units used for this test were drawn at random from current Stancor stock.

±1db FROM 20 TO 20,000 cps

Premium Quality at Low Cost

Stancor has taken advantage of the most advanced design and manufacturing practices to bring you a series of output transformers combining outstanding audio response with very moderate cost.

Extensively interleaved "trifilar" windings, extremely tight coupling, and careful electrical balance result in audio fidelity to please the most critical specialist. An inexpensive, but thoroughly practical, type of mounting is used since elaborate shielding is not required at the audio output power level.

Listed part numbers have a maximum power level rating of 50 watts and provide a wide selection of impedances for popular amplifier applications.

PART NO.	PRI. IMP. (P-P) IN OHMS	SEC. IMP. IN OHMS*	MAX. PRI. D. C. PER HALF	NET PRICE
A-8050	1500	8, 16	200 ma	\$10.86
A-8051	2500	8, 16	150 ma	10.86
A-8052	3000	8, 16	175 ma	10.86
A-8053	5000	8, 16	150 ma	10.86
A-8054	9000	8, 16	100 ma	10.86
A-8060	1500	500	200 ma	10.86
A-8061	2500	500	150 ma	10.86
A-8062	3000	500	175 ma	10.86
A-8063	5000	500	150 ma	10.86
A-8064	9000	500	100 ma	10.86

For complete specifications and prices of more than 450 stock part numbers, including other high fidelity transformers, see the current Stancor catalog. Ask your distributor for a copy or write direct.

See us at THE 1951 PARTS DISTRIBUTORS CONFERENCE AND SHOW
May 21-23, 1951, Stevens Hotel, Chicago.

Booth 401
Suite 1005



STANDARD TRANSFORMER CORPORATION 3594 ELSTON AVENUE, CHICAGO 18, ILLINOIS

³ RCA Tube Handbook HB-3, vol. 3-4.

For Highest Quality and Beauty—
it's STANDARD WOOD
AUDIO CUSTOM CABINETS



The finest Standard of the Industry! Immediate delivery from stock! **Model RX Bass Reflex Speaker Cabinets** (right): for 15" & 12" speakers. Approximately 10,000 cubic inch capacity. Wider frequency & angle distribution; higher power-handling capacity. Lumite grille cloth: no sag or stain. **Model RP Radio-Phono Cabinets** (left): perfect companion pieces to Model RX. Top panel for all FM-AM tuners, middle pull-out drawer for all record changers (positions interchangeable); bottom compartment for amplifiers. **Both Models:** made of sturdy 3/4" stock; feature latest acoustic design, rich authentic furniture styling & beautiful high lustre in Mahogany, Cordovan Mahogany, Walnut, Ebony, Blonde, or Unfinished.

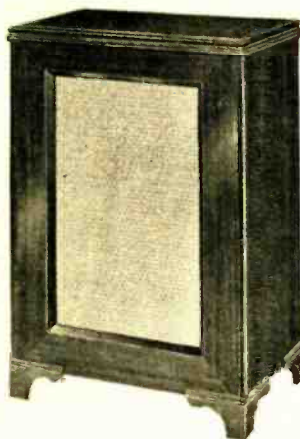

**STANDARD WOOD
 PRODUCTS CORPORATION**

See these magnificent cabinets at your jobber today. Write NOW for free latest Catalog A.

43-02 38th St., L.I.C. 4, N. Y. RAvenswood 9-6010
 SHOWROOM: 120 Wall St., N.Y.C. DIgby 4-8675

**audio
 anthology**

Paper cover . . . \$2.00

Distributors write for quantity discount

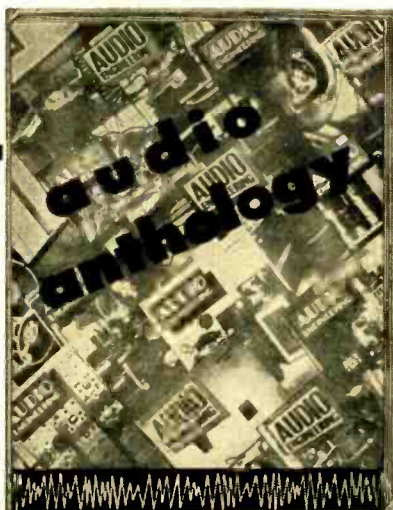

The long awaited compilation of reprints from early issues of **AUDIO ENGINEERING**, most of which are unobtainable.

Contains 37 articles on the following subjects:

- Amplifiers
- Speakers
- Noise Suppressors
- Phonograph Equipment
- Tone and Loudness Controls
- Dividing Networks

These articles have been of great interest to readers of **AUDIO ENGINEERING** over the past three years. *Assembled in one volume, they comprise the most authoritative reference work for the audio hobbyist.*

---CUT OUT---MAIL TODAY---

Book Division, Dept. A9
 Radio Magazines, Inc.
 342 Madison Ave., New York 17, N. Y.

Sirs: Enclosed is my check money order for _____ copies of the Audio Anthology.

Name (print carefully)
 Address
 City Zone State

the driver plate-supply voltage. An amplifier and special output transformer were constructed and excellent results were obtained provided that the output stage was operated without grid current. The effect of "bootstrapping" is to raise the equivalent driver impedance, which produces severe clipping when grid current flows.

A third modification of the plate-cathode output stage is shown in *Fig. 4(c)*. It is seen to be similar to that of (a), with the addition of a grid winding for each tube. Driving voltage is applied between the grid and cathode windings, avoiding degeneration, while the other advantages of the original circuit are retained. This driver impedance can be made low if the transformer resistance and leakage reactance are small. Satisfactory results can be obtained by using a trifilar winding. Driving voltage is obtained conveniently from a push-pull cathode follower, which eliminates the need for an interstage transformer. The principal disadvantage of the circuit is that a special output transformer is required. An experimental amplifier using this scheme was constructed, and tests showed that a total harmonic distortion of less than 0.5 per cent was obtained over the frequency range from 20 to 20,000 cps when employing 6L6 tubes. The power output was maintained constant at 25 watts.

Conclusions

After considering the several circuits discussed above, one is left with some doubt concerning the best application of each. Assuming that low distortion is essential, the circuit of *Fig. 1(b)* is satisfactory where the low-power output associated with class-A operation is sufficient. The special circuits of *Fig. 2* are also subject to this limitation; however, they have the advantage of operating the tubes in parallel rather than in series, permitting a less critical output-transformer design. The circuit of *Fig. 4(a)* permits class-B operation with low distortion, and is to be recommended where the maximum power output is required. The circuit of *Fig. 4(b)* will give good results with class-AB operation, but is not suitable for a class-B output stage because of the high apparent driver impedance. The capabilities of *Fig. 4(c)* have not been fully explored; however, with a good output-transformer design it should be similar in performance to (a), with the advantage of requiring a smaller driving voltage.

AUDIO PATENTS

[from page 4]

The conductor covers the entire stylus tip up to a height of .0005 inch. From there on upward, a nonconducting segment on each side of the body divides the conductor into two parts.

The upper end of the shank is rectangular and fits into a socket in the cartridge so that it can go in only two ways, 180 deg. of rotation apart. Then the two conducting segments are placed in series with the lead

going from one side of the coil or crystal element to the amplifier.

Normally the circuit is complete because of the small conducting area completely around the stylus tip. But as soon as that half-thousandth of an inch of tip is worn off the connection breaks and no more sound comes out of the speaker. The user either buys a new stylus or listens to the radio. In any case, he knows when the stylus is dangerous and his records stay in good condition.

THE LORAN TRAINER

[from page 14]

miles per second and the velocity of radio signals about 160,500 nautical miles per second or about 870,000 times as great. Consequently, it is convenient to scale down the actual radio loran system to a system of ultrasonic nature in order that a great portion of the earth's surface can be represented on a operating table of practical size. Using the previously mentioned ratio of sound to radio waves in air, the geography of the desired area on the trainer operating table is constructed to a scale of 1 inch equals 11.93 nautical miles. In other words, the trainer operating table becomes a miniaturized version of a complete loran system. The actual size of the table used is 8 feet by 8 feet and the working area represents approximately 1,300,000 nautical square miles of the earth's surface. The radio transmission in the actual loran system is replaced in the miniature one by 175-kc ultrasonic waves with pulse modulation characteristics essentially similar to those used in actual loran. An ultrasonic frequency of 175-kc is used because this is the lowest frequency readily convertible to the 1.95 megacycle frequency used in loran on channel 1. A higher frequency is not employed since above 175 kc the attenuation of sound waves in air becomes excessive even over short distances. The time base characteristics are identical insofar as repetition rates and frequency stability is concerned. The actual loran transmitters are replaced by ultrasonic transducers from which emanate pulse-modulated signals. These signals radiated over the scale area of the trainer table are picked up by means of an ultrasonic receiver called the mobile transducer, which actually represents the antenna of the aircraft or ship and performs the additional function of converting the ultrasonic energy to electrical energy which is subsequently fed into electronic gear to be described later. The mobile transducer is attached to a triangular shaped carriage or "crab" which represents the actual aircraft or ship. Through a unique electromechanical device the speed and heading of the crab can be controlled accurately by the instructor and can be made to "fly" over any predetermined course. The electrical impulses from the mobile transducer at the carrier frequency of 175 kc are converted to 1950 kc—channel 1 in the loran system—by the amplifier-converter, and then fed simultaneously into a radiating antenna and a monitor receiving set. The radiated signal is

The HIT of the I.R.E. SHOW!
Plays 10½" Reels!



Complete, for console installation with single or dual track heads: **\$345⁰⁰**

CONCERTONE

■ The professional quality tape recorder you have been waiting for! NAB standards; triodes throughout; 40-15000 cycles at 15", 40-8000 cycles at 7½". Three motors; flutter less than 0.1%; signal-to-noise better than 50 db. Three heads for simultaneous erase, record, playback. Quick change from single to dual track. Write for booklet.

FISHER RADIO CORPORATION • Distributors • 45 E. 47th St., N. Y.

SEND FOR IT!

1951 ALLIED CATALOG

free!
212-Page
Buying
Guide

World's Largest Stocks
ELECTRONIC SUPPLIES
for INDUSTRY and
BROADCAST STATIONS



One Complete Dependable Source
for Everything in Electronics

Simplify your purchasing—send your consolidated orders to ALLIED—the single, complete source for all Electronic Supplies. Depend on ALLIED for the world's largest stocks of special tubes, parts, test instruments, audio equipment, accessories—complete quality lines of electronic supplies. Our expert Industrial supply service saves you time, effort and money. Send today for your FREE copy of the 1951 ALLIED Catalog—the only complete, up-to-date guide to Electronic Supplies for Industrial and Broadcast use.

We Specialize in Electronic Equipment for Research, Development, Maintenance and Production Operations

ALLIED RADIO CORP.

833 W. Jackson Blvd., Dept. 17-E-1, Chicago 7, Illinois

SEND FOR
FREE 1951
ALLIED CATALOG

CABINETS • CHASSIS • PANELS • RACKS
Planning ELECTRONIC EQUIPMENT ?
Investigate the ECONOMIES
of PAR-METAL HOUSINGS !



We manufacture Metal Housings for every purpose — from a small receiver to a deluxe broadcast transmitter. And the cost is low!

Because we specialize in the Electronics field, Par-Metal Products excel in functional streamlined design, rugged construction, beautiful finish, and economy.

Remember, Par-Metal equipment is made by electronic specialists, not just a sheet metal shop.

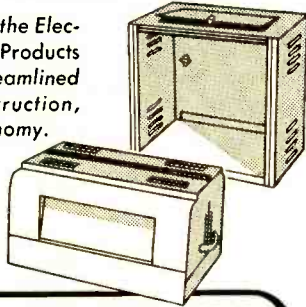

PAR-METAL

PRODUCTS CORPORATION
 32-62 — 49th ST., LONG ISLAND CITY 3, N. Y.
 Export Dept.: Roche International Corp.
 13 East 40 Street, New York 16, N. Y.



WRITE FOR CATALOG !

This May 1951 issue marks

—the Fourth Anniversary of

AUDIO ENGINEERING

To those of you who have watched AE grow during these four years, it is unnecessary to urge you to subscribe . . . you know that each month has brought new and authoritative articles which you had long wanted to read. If you have lost your friends and antagonized your cellmate by borrowing their copies, fill out the coupon below. Remember that most of our back copies are unobtainable.

AUDIO ENGINEERING
 342 Madison Avenue, New York 17, N. Y.

Enclosed is my check money order for \$..... for my subscription to AUDIO ENGINEERING FOR 1 yr 2 yrs.

Subscription Price in U. S. A. and Canada and Pan American Union: 1 yr—\$3; 2 yrs—\$5. Add \$1. per year for foreign subscriptions.

Name (please print)

Address

City Zone State

Occupation (give title and department)

Firm name

picked up by students with their respective loran receiving sets. The block diagram for the complete trainer is shown in Fig. 3.

The Transmitter Channel

To make for a clearer understanding of the operation of the Loran Trainer, it is convenient to divide the trainer into two major channels: the transmitting channel, and the receiving channel. The components in each will be taken up briefly in turn.

Figure 4 is the block diagram for the crystal timer. The purpose of this unit is to generate the basic timing pulses which are used to obtain the 25- and 33 1/3-cps pulses which drive the ultrasonic transmitting transducers. Fundamentally, the timer consists of a crystal-controlled oscillator which produces sine wave output at 100 kc, a buffer amplifier whose primary function is to isolate the oscillator from the first counter circuit, a 5:1 frequency divider; and two cathode followers which act as low-impedance output couplers. Two output signals are taken from the crystal timer unit—a 50- μ sec signal (one pulse every 50 μ sec, or

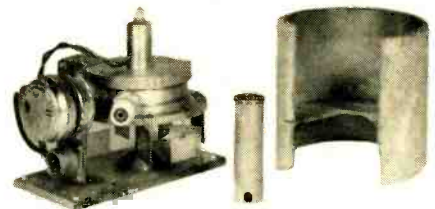

Fig. 7. Transmitting transducer with acoustic shield and projector lens removed to show splitting vanes.

20,000 pulses per second, pps) and a 10- μ sec signal (one pulse every 10 μ sec, or 100,000 pps).

Master Timers A and B, Fig. 5, are identical. To simplify analysis, the master timer may be divided into four main sections. The first or counter section consists of the 2nd, 3rd, 4th, 5th, and 6th counters which act as a series of frequency dividers; the second section consists of the station selector which changes the total frequency division of the counters in small increments to give the proper recurrence rates for the various pairs of stations. The third section is composed of the square-wave generator which is controlled by the output signals of the 6th counter-oscillator. The function of this generator is to produce square waves at half the frequency of the pulses at the output of the 6th counter oscillator. The square waves formed at one plate of the generator are differentiated to form sharp pulses which are fed into the delayed output. The square waves formed at the other plate pass through a second differentiator and the pulses thus formed are used to initiate the 500- μ sec delay multivibrator. The fourth or delay section consists of a series of multivibrators which provide a minimum of 760 and a maximum of approximately 11,000 μ sec additional delay between the two pulses from the square wave generator. Signals from the delay

circuits are fed into the delayed output follower.

The Switch Assembly unit provides a means of connecting the various outputs of the master timers to the inputs of the crystal transducer driver and provides direct access to test points in all timer units. It serves as a patch panel to facilitate connection to the video input of the loran indicator.

Figure 6 is the block diagram for the Crystal Transducer Driver which is made up of three identical sections on one chassis. Each section is used to supply the pulse-modulated signal required to operate one of the crystal transducers at the carrier frequency of 175 kc. Each complete driver section consists of: an inverter-amplifier which amplifies and inverts the incoming positive pulses from the master timers; a pulse-length

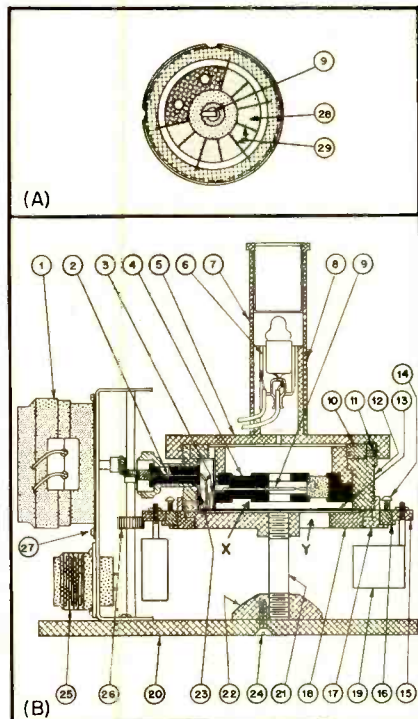

Fig. 8. (A) Plan view of crystal assembly in transducers, and (B) cross section of transmitting transducer.

multivibrator which varies the length of the pulse obtained from the inverter amplifier; an oscillator gate which modulates the oscillator at proper intervals (25 or 33 1/3 cps); an oscillator which operates at 175 kc; a voltage amplifier; and a cathode follower which provides a low-impedance source for the power amplifier which drives the crystal transducer.

The Transmitting Crystal Transducer, Fig. 7 is actually the heart of the ultrasonic end of the trainer since its function is to convert the pulse-modulated 175-kc electrical input to ultrasonic wave trains. The transducer radiates these ultrasonic waves throughout a spherical section 270 deg. in azimuth and 45 deg. in altitude. The radiation in altitude is used to simulate sky-wave transmission in conjunction with an artificial glass ionosphere mounted above the operating table. Provision is also made to simulate sky-wave "splitting," a super-



EDDIE CANTOR, "COLGATE COMEDY HOUR," NBC

**-without hiding the actor
RCA's "STARMAKER"**

... a ribbon-pressure microphone that is so slim ... so skillfully styled ... so unobtrusive ... you must look twice to see it.

Despite its slim construction, the STARMAKER meets the exacting quality standards of other RCA professional Broadcast microphones. Pick-up is non-directional. Frequency response is substantially uniform, 50 to 15,000 cps. It is free from wind rumble and air blast ...

and virtually impervious to mechanical shock.

The STARMAKER fits any standard microphone stand ... can be used in place of any RCA microphone. No extra attachments needed.

For delivery information call your RCA Broadcast Sales Engineer, or write: Dept. Q-7, RCA Engineering Products, Camden, N. J. (In Canada write: RCA VICTOR Limited, Montreal.)



RADIO CORPORATION of AMERICA

Air-Tone HEADQUARTERS FOR **Magnecord**

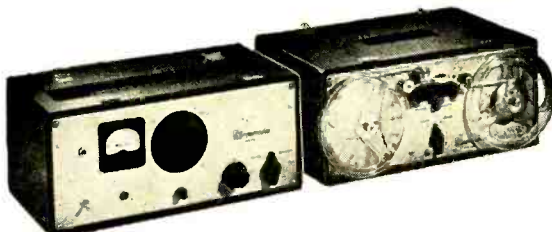

▲ **MAGNECORD PT6-JAH
RECORDER & AMPLIFIER**
Complete Systems from \$564.00

**ELECTRO-VOICE PATRICIAN
4-WAY SPEAKER SYSTEM** ▶

Authentically styled, enduringly beautiful custom construction. Hand rubbed mahogany with lacquered metal grille. Superb tonal realism.

IMMEDIATE DELIVERY—\$756.00 NET

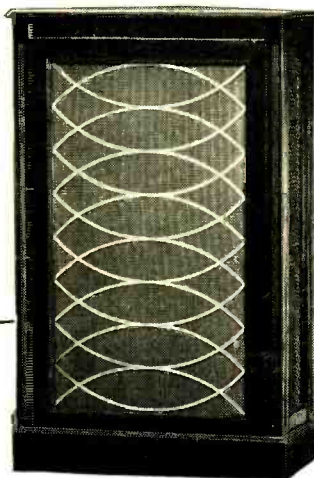

Air-Tone HIGH FIDELITY SYSTEMS ON DISPLAY AT OUR SHOWROOMS

SOUND & RECORDING COMPANY
1527 CHESTNUT ST., PHILA. 2, PA. — RI. 6-8388

• **ATTENTION**
Tape Editors — Sound Men

NEW* TAPE SPLICER

"EDITALL"

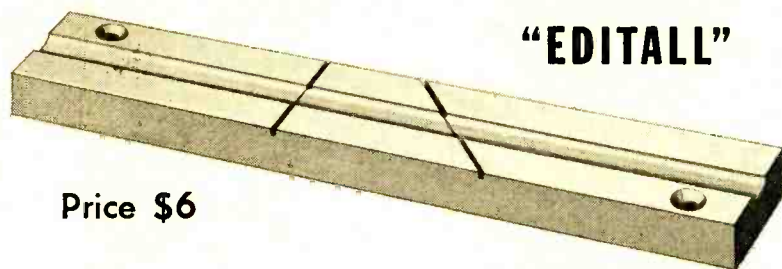

Price \$6

A new* tape splicing block has been developed by CBS's famous tape editor Joel Tall. This new precision Dural block will make a PERFECT SPLICE FASTER and is less tiresome to work with. Send for one today while still available. Manufactured and sold exclusively by:

TECH LABORATORIES, Inc.

Box 148, Palisades Park, N. J.

* Pat. applied for

MISSING AN ISSUE?

- June 1949 January 1950 March 1950 July 1950 September 1950
 December 1949 February 1950 June 1950 August 1950 October 1950

1949—June 1950—50¢ each July 1950—October 1950—35¢ each

Payment must accompany order

Circulation Dept., Audio Engineering, 342 Madison Ave., N. Y. 17, N. Y.

Audio NEW Intermodulation Meter and Set
HIGHEST PROFESSIONAL FLEXIBILITY at Reasonable Cost!

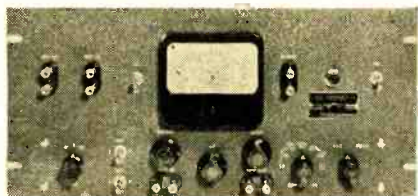

Model 165 IM Meter is especially suited for laboratories, broadcasters, recording studios. Has signal generator, analyzer, voltmeter in single compact case. Reads %IM, amplifier output directly on meter. Provides for use of oscilloscope to analyze and cure IM causes: full graphic instructions supplied. Wide range of low & high test frequencies: 60 cps internally, 0-400 cps externally; standard 2, 7, 12 kc internally, 2-20 kc externally. Only 0.1% residual IM due to accurate bridge-type mixing circuit for 2 tones & special analyzer wave filters. Voltage ratio choices: for LF testing, 4:1; for more accurate HF testing, 1:1. 8 3/4" x 19" rack-type panel; 10 1/2" deep. Price \$250.00.

With Model 162 IM Set and your own audio oscillator and oscilloscope, you measure %IM in any pickup, amplifier or system directly on your scope image in just seconds. Identify wrong bias, wrong load Z, tube unbalance, regeneration, insufficient drive capacity, etc. Complete with graphic instructions for adjusting equipment for best performance. Price \$88.50.

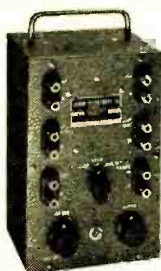

WRITE NOW FOR CATALOG A

Audio INSTRUMENT COMPANY
Dept. T 133 W. 14th St. N. Y. 11, N. Y.

position of reflections from two adjacent layers of the ionosphere. This is done by a series of vanes mounted on a geared ring which revolves about the transducer shell. How this splitting of sky waves actually occurs is explained later.

General Construction

In Fig. 8, (B) shows a section through a transmitting transducer, which consists of a cylindrical metal shell (12) sealed at one end by a thin aluminum diaphragm (13) and covered at the other end by a metal cap (5). Mounted concentrically inside the shell is a crystal assembly (4) which can be raised or lowered by means of a tuning ring (10) so that the space (X) between the bottom of the crystal assembly and the top of the diaphragm can be varied. The diaphragm is held in place by a clamping plate (18) from which a section (Y) having the shape of the crystal group is removed. Electrical connection is made to the crystal group through the inner electrode (9) and outer electrode (2) by means of the spring contacts (3) soldered to the ends of each electrode. A geared splitting ring (15) supports the splitting vanes (19). The teeth on the periphery of the ring engage with a spur gear (26) so that the ring is revolved slowly about the transducer by the motor (1). The height of the splitting ring can be adjusted slightly by the three screws (14). These screws raise or lower the seat (17) on which the ring rests. The transducer assembly is supported by a post (21) screwed into a reflecting cone (22) which in turn is fastened to a base plate (20). A lamp assembly (6) and light projection system (7) is mounted on the cap of the transducer. A top view of the crystal assembly is shown at (A) in Fig. 8. The crystal element is made up of a group of eight keystone-shaped crystals (28) so arranged in doughnut form that vertical faces of like polarity are adjacent. Thin foil strips (29) are cemented to the vertical faces of the crystals and strips of like polarity are soldered to the inner electrode while those of opposite polarity make contact with the transducer shell. The eight crystals are thus connected in parallel across the energizing voltage.

Theory of Operation

In its task of converting electrical to ultrasonic energy, the transducer makes use of the piezo-electric effect of the eight keystone-shaped X-cut Rochelle salts crystals (28).

Damping is required in order to eliminate spurious and unwanted oscillations in the crystals when they are shock excited by pulses with relatively steep wave fronts such as are used in the trainer. Another and important effect of undamped crystals is to lengthen the effective length of the pulse applied to the input of the transducer. The simplest method of mechanical damping is to immerse the crystals in a liquid.

Since Rochelle salt is soluble in water, it is necessary to use a liquid other than water. With few exceptions most liquids have similar acoustical qualities. Purified castor oil proves to be an excellent

IF YOU USE

GENERAL ELECTRIC MAGNETIC CARTRIDGES

... and want to hear your records CORRECTLY ... with their ORIGINAL proper balance between highs and lows ...

THIS IS WHAT YOU NEED

FIRST AND ONLY LOW-COST

G. E. Magnetic Cartridge PLAYBACK EQUALIZER

ORDER BY MAIL TODAY



TYPE HL-1-6
PRICE \$11.95

- For foreign, domestic discs
- For 78, 33 1/3, 45 rpm speeds
- A "must" for record lovers

Radio Shack's 6-step Playback Equalizer gives a professional touch to your audio system. Closely duplicates record manufacturer's original recording curve. Does what tone controls can't do! Designed for G.E. pickups using standard 500-cycle turnover preamp. Order now from Radio Shack Corp., exclusive national distributor. \$11.95.

RADIO SHACK

167 Washington St., Boston 8, Mass.

damping agent and since it has good electrical properties as well, it is employed in the transducer. In this application the entire crystal is covered with castor oil, covering the top surface where the damping action is required. The space between the crystals and the aluminum diaphragm is therefore filled with castor oil. The mode of vibration of the crystals is primarily in a vertical plane so that the sound waves must pass through the oil before reaching the air. The general effect of such an intermediate layer is described in any standard acoustics text. Briefly, the effect is two-fold. First, the high acoustic impedance of oil as compared to air introduces a considerable increase in damping of the oscillations of the crystals. Second, since castor oil has an acoustic impedance which is intermediate between that of the crystal and that of air, the acoustical match between the crystal and air is improved if the thickness of the intermediate oil layer is approximately one quarter wave length in oil. The wave length of sound in oil at 175 kc is approximately 8.0 mm and consequently 2 mm (1/4 wave length) turns out to be the thickness of the oil layer required to produce a satisfactory compromise between damping and matching.

The importance of providing a means to simulate the effect of ground and sky wave transmission into the trainer will be covered in the concluding article of this series, which will appear next month. The receiving channel will be described fully, and the method of overall operation explained.

(To be concluded)

IMPROVED BASS RESPONSE

[from page 18]

cps, resulting in a disagreeable boominess characteristic of commercial radio sets, juke-boxes and the like. As shown in curve (D), attenuation below resonance is at the usual rate of 12 db per octave plus 6 db per octave due to the "doublet" or phasing out effect of the back radiation. In general, any open-back box is considerably improved by closing off the rear.

The Enclosed Box

The simplest form of good speaker enclosure is the enclosed box, with the only energy radiated into the listening area being from the front, as in the case of the infinite baffle. The chief difference between this enclosure and the infinite baffle is that the capacitive load on the back of the cone increases the stiffness of the suspension system, raising the mechanical resonance. This causes the usual attenuation of 12 db per octave to start at a higher frequency. Curve (E) shows that the level just before attenuation is higher, or peaked. This is true because the cone mass is resonating with the low compliant mass within the cabinet. When this peak is objectionably high, holes, or acoustic resistances in

REK-O-KUT

Hi-Fi Phonographs and
Turntables By Which All
Others Are Judged!



REK-O-KUT Recitalist

Featuring the exclusive
Polyphonic Selector.

Equipped with
3-Speed or
Continuously
Variable
Turntable.

Plays
Records
6" to 16"
and broadcast
transcriptions.

Irving Kolodin, Music Editor of the Saturday Review of Literature, says, "... the Recitalist was conceived for schools, businesses, forums, etc., where high grade reproducing equipment is in demand ... appeals to a music-lover who wants accurate, undistorted reproduction. The special features are (1) Heavy rim-driven turntable, reliable at all speeds (2) Dual point pickup (3) Excellent amplifier (4) Speaker mounted in detachable cover of carrying case."

RP-43C (with 3-speed turntable) \$229.95

RP-43VC

(with continuously variable speed turntable) \$269.95

REK-O-KUT

Continuously Variable
Speed Turntable



The BROADCAST QUALITY turntable that plays at any speed from 25 to 100 R.P.M. without "wow". Plays all records from 6" to 16", standard and microgroove.

Used by broadcast stations, teachers, musicians, disc jockeys, dance studios, etc. Operates

on 50 to 60 cycles. Plays through any amplifier, phonograph, TV or radio set.

Model CVS-12P (illustrated) in portable case with 16" dual-stylus pickup \$124.95

Model CVS-12, chassis, motor and turntable assembly \$ 84.95

Model P-43C-3-Speed, 16" Dual-Stylus Pickup \$ 94.95

REK-O-KUT

Model LP-743
Three-Speed
12" Transcription
Turntable



Recommended by leading sound critics. Induction type motor, designed for smooth, quiet, vibration-free operation. Instantaneous speed changes—78, 45, 33 1/2—without stopping turntable or removing disc.

\$54.95 net

Yes, It Costs Less to Buy REK-O-KUT

... And Here's Why ...

QUALITY is the word for REK-O-KUT products—they perform better, last longer, provide more "extras" for the money. Your REK-O-KUT machine will serve you faithfully without maintenance, day-in and day-out.

REK-O-KUT Turntables, Phonographs, and Disc Recorders are sold by leading music stores, radio parts distributors, and audio-visual dealers.

Write direct to REK-O-KUT CO. for latest illustrated catalog, just off the press.

REK-O-KUT CO.

38-01 Queens Boulevard
Long Island City 1, N. Y.



HOW LEADING NETWORKS USE Carter CONVERTERS

Photo above shows NBC's Tommy Bartlett and Universal Recording Company engineers making transcriptions from STORAGE BATTERY POWER by means of Carter Frequency Controlled Converter.

Wherever 115v. line voltage is not available, or hard to get, Carter Converters supply dependable AC power to make on location recordings. Operates from storage batteries. . . . Used by leading networks, broadcast stations, and program producers.

Recommended by Brush and Magnecord

One model operates both Brush and Magnecord equipment. Delivers clean 60 cycle AC power. Requires no filtering. Frequency control feature compensates for 10% input voltage variation. Available for 6, 12, 24, 28, 32, 64, and 115v. DC input voltage. Size 8 1/4" x 5 3/4" x 7 1/2" high. Weight only 15 3/4 lbs. Performance Guaranteed!



New Converter catalog illustrates entire line of Carter Rotary Converters for recording, TV, sound projection and transcription players. SELECTOR CHART included tells model to suit your purpose. Mail Coupon now for your copy and name of nearest Carter distributor.



Carter MOTOR COMPANY

2648 N. MAPLEWOOD AVE., CHICAGO 47

Carter Motor Co.
2648 N. Maplewood Ave.,
Chicago 47, Ill.

Please send catalog #349 with information on Frequency Control Converters, and name of nearest distributor.

Name

Station or Company

Address

the back side of the cabinet will lower the peak, and consequently extend the bass range with another smaller peak before violent attenuation sets in.

Reflections with attendant reinforcements and cancellations within the box occur from about the fourth or fifth octave on up. These can be minimized with sound absorbent material generously applied to opposing surfaces.

Reflex Boxes

The currently popular vented enclosure utilizes a novel method of raising efficiencies in the last part of the 3rd octave around 100-130 cps. The front port, or vent, is tuned to allow for a delay of the back radiation. This permits an in-phase relationship resulting in a reinforcement just below the peak caused by resonance of the cone in conjunction with the true box resonance. Curve (F) indicates results to be expected with enclosures of the same relative size, approximately 7 cubic feet. Observe that attenuation past resonance is 18 db per octave versus 12 db per octave in the completely closed box. All other factors being equal, the range is not as great as the closed box. The peaks are higher and the valleys lower. Moreover, the characteristic boominess is objectionable to the discerning listener. But the fact remains that the added efficiency, in the more restricted spectrum that it does reproduce, finds considerable favor.

It is recommended as a guide that no less than 6 cubic feet be considered for satisfactory results. The depth of the box should be about one-half the length or height. Although formulas exist for computing the port size, the necessary data on cone weights, compliance, cone resonance, and other parameters are seldom available to the constructor. The most practical and by far the most accurate method of determining optimum port size in a specific box for a particular speaker is the procedure as follows:

Place a voltmeter across the voice coil and start with a port of about 150 square inches. Scan the first three octaves with an audio oscillator playing through the speaker system, gradually decreasing the port size until two peaks are observed in the reading of the highest intensities and at the lowest frequencies possible.

As a guide to the optimum box size for top results with a speaker of given diameter, see Fig. 3. Note that for the best results—insofar as extended bass reproduction is concerned in a medium size cabinet, (say up to 12 cubic feet)—the 12-in. cone has a considerable edge over the 15-in. model. The low-frequency driver of 18 in. is impractical and almost unuseable unless the volumetric capacity of the box is very large, or over 20 cubic feet.

Recapitulation

A study of the comparative designs offered above suggests that a rather poor job of bass reproduction is being effected unless large cavities, of the order of 12 cubic feet on up, are considered. The infinite baffle, combined with a cone resonance of 40-45 cps, does

by far the best job if it is feasible to employ it. The vented box lends a "muddy" quality to the music and restricts the range, but is generally preferred over the plain closed box of equal size in spite of the added purity and extended range of the latter. This can be explained by reason of the foremost requirement of efficiency for the bass, even if of more restricted range.

Of the utmost importance in any of the designs above is low cone resonance, which also involves high compliances, or values of *C* in the equivalent circuit.

Towards Better Bass Response

Theater Horns—With space not being a limiting factor, the folded theater horn, is preferred. Response with this almost ideal enclosure is flat to 50 cps. Below this point, attenuation is fairly rapid. However, this horn delivers the smoothest, distortion-free response down to 50 cps that the art has been able to develop. The difficulty presented otherwise by this system is the need for dual drivers, and the requirement for a rather expensive cellular horn and treble driver above 400 cps. Observe the very low portion of the curve for this unit, shown in Fig. 6 with the curves of a number of commercial enclosures. This curve shows what can be done by enclosing the backs of the drivers with a cavity of about 16,000 cu. in. If the Klipsch-type units with high compliances are employed, it is possible to resonate this back cavity with the frontal air load mass and achieve added response down to 30 cps.

The vast majority of living rooms, however, have no provision for a system approaching the size of this rather ungainly device. The basic principles can be adapted, however, as disclosed in the more practical enclosures to follow.

Corner Designs

As a rule folded horns are recommended for operation only up to 400 cps. At almost 500 cps and up, the higher frequencies find difficulty in following the circuitous path, unless supplemented by front radiation from the bass driver cone.

In several E-V designs, the folded horn loading is actuated from the rear of the cone while radiation of the higher frequencies takes place equally from the front. The important cavity directly behind the cone acts as an acoustic low-pass filter below 200 cps. This filter prevents phasing out of the front radiation by the back waves above this point. Some interference is measurable below 200 cps, but the generally smooth response to 65 cps overwhelmingly justifies the design. The sides of the room provide additional loading, acting as an extension of the mouth of the horn. This assists further in the formation of a spherical wave shape which promotes easy listening. Some radiation is effected, just barely useable, at 30 to 45 cps. The corner design proves itself an excellent substitute for the C-5 bin

where the larger space required is not available.

Completely Horn Loaded Corner Design

The "Patrician" 4-way system employs a fully horn-loaded driver for utmost purity and efficiency, as shown in Fig. 7. In addition, the feature of resonating the back cavity with the front air load mass is utilized. The complete assembly is slightly less than 30-in. deep, allowing it to pass through a standard door.

To insure optimum results the bass horn design is slanted towards the lowest part of the spectrum, and a crossover at 220 cps transfers the task of reproducing the 200-600 cps range to a 12-in. low-frequency unit with an independent horn. To maintain optimum throat-to-mouth relationships, part of the face of each driver is masked off to the proper size. Closing down these throats effects attenuation only of the higher frequencies, well beyond the pass band of these two units. From 600 to 3500 cps, the treble driver exhausts through the large 2x5 horn. High-end attenuation for this unit is only 6 db per octave above 3500 cps. This allows a reinforcement in combination with the small Model T-10 super-tweeter of the critical 5000-cps band which so vitally effects the "presence" quality. Dramatic increase in total apparent efficiency is achieved with a 4 to 6 db rise at this particular point. The T-10 Sonax Driver carries the high end through 16,000 cps.

The back cavity of the large driver comprises some 8000 cu. in. to match the high compliance of the 18-in. cone. Note that the small triangular cavities, four in all, are fed to the larger area behind the cone by notches. This makes use of all the space in the bass section. It is essential that the back cavity be absolutely airtight. Horn assemblies are tested in production with a pressure gauge for leaks. The equivalent of a 1/2" hole will raise the lowest radiation peak by almost 5 cps. Moreover, the driver itself is sealed from front to back with a solid dome, incorporating no "breather."

The impedance characteristic of a loudspeaker rises at the extremes of the spectrum. To more nearly match a 16-ohm crossover network at the very low frequencies, the special Klipsch-type driver has a d.c. voice-coil resistance of only 3.2 ohms, as opposed to the usual resistance of 11.6 ohms in a more conventional unit.

In listening to this system some rather startling effects are observed. When live tape is used as a source, it is possible for the spatial effect of the recording locale to be unconsciously evaluated, contributing materially to the illusion of reality. This is effected through the reproduction of extreme low-frequency effects, such as very low room noises and air rumble, more frequently felt rather than heard. Because all four drivers are loaded with columns of air, diaphragm excursions are held to a minimum, assuring high damping of the voice coils in the densest flux areas, and

the smaller excursions minimize diaphragm breakup. Perhaps the most important observation is a negative one—the lessening of listener fatigue. This contribution may be ascribed principally to the elimination of harmonic distortion through the multiple division of the spectrum by disparate drivers.

Summary

Bass response in currently available loudspeaker systems and enclosures is poor. By considering the spatial requirements and utilizing the corner of the room as an extension of the necessary air-load on the driver cone a considerable improvement in bass range and efficiency can be achieved.

Though the foregoing offers no complete solution to the perfect reproduction of the first three bass octaves, it is felt that perhaps an important improvement of at least 100 per cent is offered from the standpoint of range extension. Efficiencies are improved greatly.

Improvements resulting from the horn load are an appreciable decrease in diaphragm excursions, with correspondingly greater power handling capacity of the driver, decreased intermodulation distortion, and vastly improved transient response.

Subjectively, it is found that apparent gains in realistic reproduction are considerably greater than the bare mathematics would indicate. The masking effect of the more adequate bass prevents extended high response from seeming shrill and thin. The resulting tonal balance achieves a more adequate feeling of listening satisfaction.

NEW LITERATURE

● **Office of Technical Services**, U. S. Department of Commerce, Washington 25, D. C. is now releasing to the general public a 300-page illustrated report titled "Electronic Equipment Construction—New Objectives, New Techniques and New Components." Prepared by the Standard Research Institute and intended originally as an investigation of the means for minimizing maintenance of military electronic equipment, the report has been expanded to its present scope to meet the demand of the civilian electronics field. Of particular interest is a section in which the current research and development needs of the electronics field are summarized. Price is \$7.00; checks should be made payable to the Treasurer of the United States.

● **Cinema Engineering Co.**, 1510 Verdugo Ave., Burbank, Calif. has recently published Catalog 11-AY, a listing of jacks and other accessory equipment including the new Type 4137-B orthacoustic equalizer.

● **Thomas A. Edison, Inc.**, 511 Lakeside Ave., West Orange N. J. is now distributing a handsomely-produced and illustrated 12-page booklet describing the company's new Televoice system for remote control dictation. The Televoice system cuts dictation costs by making use of one to twenty telephone-like instruments wired to a central recording device.

● **Cannon Electric Development Company**, 3209 Humboldt St., Los Angeles 31, Calif. has available a four-page bulletin illustrating and describing its new line of hermetically-sealed plugs for aircraft relays and other sealed components. Requests should specify Bulletin RS-1.

● **Commodity Research Bureau**, 82 Beaver St., New York 5, N. Y. is now publishing a 32-page handbook on Social Security benefits, for distribution by companies to their employees. A sliding scale of quantity prices, based on the number of copies ordered, brings the average wholesale price to approximately 15 cents per copy.

● **Duotone Company**, Keyport, N. J., is distributing to jobbers and dealers a new complete needle guide. Lists all standard makes of record players and the correct stylus for each. Both needles and cartridges are clearly illustrated to simplify selection. Free wall-chart size will be mailed on request.

New! BELL Custom HIGH FIDELITY AMPLIFIER

with complete Remote Control

EXPRESSLY DESIGNED FOR MUSIC LOVERS...
FOR ANY TYPE BUILT-IN OR CUSTOM JOB

For extra value—without extra cost—in built-in or custom audio systems, install this unique, new Bell High Fidelity Amplifier. Its remote controls, in attractive unit for table or console mounting, are amazingly selective. Single selector for phono-AM, FM radio (or TV), all domestic and foreign records, 78, 45 and 33-1/3 rpm. Smooth, continuously variable bass and treble with boost and cut. Amplifier applies 100% negative feedback; reproduces sound at all levels naturally clear and life-like. Amplifier and remote control unit can be separated 5 to 25 feet with only .1 db loss at 20 kc. All inputs (3 phono, 1 mike, 2 radio) connect directly to main amplifier. For more details, write.

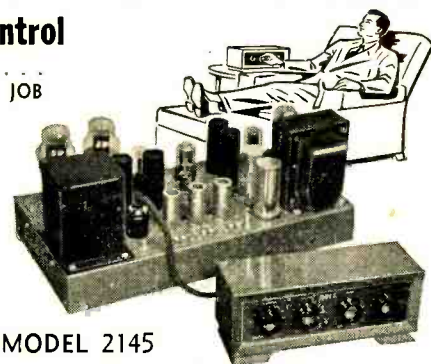

MODEL 2145

- Extremely wide power pass band
- Total distortion .5% or less at 10 watts
- All triode 30 watts maximum
- Compensated volume control



BELL SOUND SYSTEMS, INC.

559 MARION ROAD, COLUMBUS 7, OHIO
Export Office: 4900 EUCLID AVENUE, CLEVELAND 3, OHIO

CLASSIFIED

Rates: 10c per word per insertion for noncommercial advertisements; 25c per word for commercial advertisements. Rates are net, and no discounts will be allowed. Copy must be accompanied by remittance in full, and must reach the New York office by the first of the month preceding the date of issue.

FOR SALE: Speaker and amplifier. Bozak 201 Kettle Drum, net \$115, sell for \$85; Brook 10C3 with preamp, net \$315, sell for \$245; used less than 500 hours; demonstration in Washington (D. C.) area. Both for \$310. Box CN-1. AUDIO ENGINEERING.

FOR SALE: 1 UPA-004 GE tone arm; 2 DL-1RM-6C GE cartridges, .003 used as demonstrators; 1 RPN-041 GE cartridge, .001, new; 1 FP-8 Astatic tone arm and crystal cartridge; 1 E4P Astatic equalizer; 1 CGE-1 UTC equalizer; 1 VI-C15 UTC variable inductor; Amphenol Connectors, one each: 79-06F1, 79-P06M, 79-P06F, 79-06M, 79-08F1, 79-P08M, 91-MC4F1, 92-C1, 92-F1; Tubes, all new, some not in original cartons, standard brands: 1-1V, 3-6C6, 4-6C8G, 2-7C4, 1-7E5, 1-7E6, 5-12A6GT, 1-14N7, 1-14W7, 1-28D7, 1-36, 2-39, 1-55, 1-56, 1-58, 2-82, 1-85. Make offer for the lot, Curtis Radio Service, Box 266, Enterprise, Ore.

WANTED: Used Laboratory-type test equipment; Audio oscillator, A.C. Voltmeter, VTVM, Oscilloscope, etc. Gallant Engineering Company, 261 Constitution Ave., N.W., Washington 1, D. C.

WANTED: N. Y. tape hobbyist lucky with "Götterdämmerung", broadcast, Feb. 17, who may want to copy another broadcast or would accept copying fee. Box CN-2, AUDIO ENGINEERING.

PURCHASED six months ago, perfect condition: Altec Lansing 604B speaker \$125, original cost \$159. Also Newcomb HLP-14 amplifier \$50, original cost \$84. Tony Hoffmann, 11 Shady Hill Square, Cambridge, Mass.

UNIQUE opportunity: Disposing superb custom audio outfit: Klipschorn, Brook, Browning, Rek-O-Kut (hysteresis), Pickering arm, diamonds, in tawny mahogany cabinets. Phone CH 2-7762 or write Elliott, 9 Charlton St., New York 14, N. Y.

FOR SALE: All new, in original boxes, Cornell-Dubilier noise filters: 1 1F-7A, 2 1F-18, 2 1F-21, 1 1F-19, 3 1F-221B, 3 1F-22AB, 2 1F-20, 9 1F-6. Miller noise filters: 2-7875, 5-7804, 3-7803. Make offer for the lot, Curtis Radio Service, Box 266, Enterprise, Ore.

PRESTO 90-A amplifier: three mike inputs, switch for continuous and simultaneous record, high and low boost, 78 rpm, NAB record and playback, P.A., Phono, line recording, \$250.00. Brush three-hour wire recorder, 50-8000 cps with extras \$175.00. Reco-Art, 1305 Market Street, Philadelphia, Penna.

FOR SALE: Altec Lansing 605A speaker with dividing network, mounted in a Cameron Craft Blond Oak cabinet, \$190. 2 Rek-O-Kut G2 standard, \$75 each, including two Brush PL-20 arms. Entire lot for \$325. James E. Palmer, 3095 36th Place, Sandia Base, Albuquerque, N. M.



KT66
Now Available
WORLD'S FINEST POWER AMPLIFYING TUBE
At your jobber or write Dept. 5A
BRITISH INDUSTRIES CORP.
164 Duane St., New York 13, N. Y.

I. R. E. SHOW

[from page 23]

sis on laboratory test equipment. Design and development engineers, in particular, indicated keen interest in various types of Browning oscilloscopes. Latest models of Browning FM and AM-FM tuners were on display, though not as prominently as test instruments.

Federated Purchaser, Inc., although showing a variety of equipment, devoted the bulk of its space to a display of the names of manufacturers whose products the company handles, and to a series of mural-type photo-



Federated Purchaser, Inc.

graphs of its lavish new showroom in downtown New York. Interesting to note that, although the IRE show is general in character, jobbers and distributors who used their facilities to exhibit saleable items, displayed more audio components than all other types of equipment combined.

Federal Telecommunication Laboratories emphasized the diversity of its manufacturing facilities with a display embracing an impressive vari-



Federal Telephone & Radio Corporation

ety of electronic components. Foremost among the items featured was a flying-spot scanner, offered as a means of improving efficiency, at the same time reducing cost, of TV station operation. It affords a wide variety of effects such as laps, dissolves, fades, etc., and requires only one operator.

—H. K. R.

BENDIX RADIO DIVISION



ELECTRONICS ENGINEERS—At all salary and experience levels.

RESEARCH ON: Antennae, Servomechanisms, Microwave ccts. and other phases of communications and navigation equipment.

PRODUCTION DESIGN OF: Military and commercial communications and navigation equipment.

FIELD ENGINEERS — Supervise installation and maintenance of radio and radar equipment. Factory training will be given. Base salaries from \$4200 to \$6900 per year. 25% bonus for time spent overseas. Traveling and living expenses paid by Bendix. Insurance plan.

TEST AND INSPECTION ENGINEERS — Practical knowledge of radio, radar, or TV manufacturing processes. Good knowledge of radio fundamentals essential. Base salaries from \$3900 to \$5880.

TECHNICAL WRITERS — Knowledge of radar fundamentals or radio required. Work closely with engineers to gather material for instruction and maintenance manuals. Base salaries from \$3400 to \$4300.

LABORATORY TECHNICIANS — Require knowledge of radio fundamentals and skill in use of measuring instruments and laboratory equipment. Previous industrial experience essential. Salaries from \$262 to \$321 per month.

BASE SALARIES FOR ALL POSITIONS LISTED ABOVE ARE SUPPLEMENTED BY UP TO 30% FOR REGULARLY SCHEDULED 48 HOUR WEEK.

Housing is no problem in Baltimore. Excellent group insurance and family hospitalization plan.

Attractive retirement plan for professional personnel.

Write for application:

Engineering Personnel Supervisor
BENDIX RADIO DIVISION of
Bendix Aviation Corporation
Baltimore 4, Maryland
TOWSON 2200



AUDIO engineering society

Containing the Activities and Papers of the Society, and published monthly as a part of AUDIO ENGINEERING Magazine

Audio Engineering Society, Box F, Oceanside, N. Y.

OFFICERS
John D. Colvin President Bob Hugh Smith Western Vice.-Pres.
C. G. McProud, Executive Vice.-Pres. Lawrence Shipley Central Vice.-Pres.
Norman C. Pickering Secretary Ralph A. Schlegel Treasurer

NBC-Sponsored Unit Assigned Active Duty

THE MOBILE RADIO BROADCASTING company, part of the Army's Organized Reserve, which has been sponsored by the National Broadcasting Company through the Department of the Army's Industrial Affiliation Program, was scheduled at the time this was written to enter active military service May 1, 1951. Its recent activities have been supervised by Major General George L. VanDeusen (Retired), president of RCA Institutes.

The unit is composed chiefly of personnel from NBC and from RCA Institutes. The bulk of these men are specialists in some phase of broadcast communications or programming. The unit is part of a larger organization, which will operate as a psychological warfare group. The commander of the

group is Col. Ellsworth H. Gruber of the New York Daily News.

Primary mission of the unit will be mobile radio broadcasting for psychological warfare purposes. The men in the unit will be performing essentially the same type of work they did in civilian life, which will be operation of broadcasting studio facilities and high-power transmitters.

The NBC-sponsored unit is commanded by William B. Buschgen, Captain, Signal Corps-USAR, and was organized originally in November, 1948. The regular bi-weekly meetings and technical lectures have been held in NBC's Radio City studios, and other engineering facilities of the network were made available to the unit.

The unit will receive its initial training at Fort Riley, Kans.

Section Meeting Reports

Section	Speaker	Subject	Date
Cincinnati	Dr. Frank McIntosh	Design Considerations of High-Quality Output Transformer for Class AB ₂ Operation	11-14-50
Cleveland	H. B. Hoff	Program Circuit Equalization	1-17-51
Cincinnati	Kenneth Boothe	Use of Tape Recording for Telemetry	1-25-51
San Francisco	Peter B. George	Architectural Acoustics	2-12-51
S. Michigan	Howard Souther	High Fidelity Loudspeakers and Enclosures	2-20-51
Cleveland	Dr. S. J. Begun	Some New Equipment in the Audio Field	2-21-51
Cleveland	Paul Klipsch	The Klipsch Speaker	3-5-51
S. Michigan	C. F. Murphy and W. D. Moering	Slow Speed Tape Recording	3-20-51

Notice

Avoid delays in receiving meeting notices and Society news. Be sure to notify the secretary of any change in your mailing address.

Following are names of members for which we have no current mailing address.

Help!	
Douglas H. Baker	William B. Holleman
Norman K. Charland	John Krance
Leong J. Chun	Robert L. McKenzie
Donald F. Clearly	Bernard J. Migliaro
George S. Cohen	M. Madan Mohan
Lyle B. Dahms	Frederick J. Retschauer
Richard W. Dunham	William H. Rosier
Henry J. Haffmans	William L. Terry

the hands of the Secretary, Audio Engineering Society, Box F, Oceanside, N. Y., before the fifth of the month preceding the date of issue.

★ Positions Open ● Positions Wanted

★ **Wanted:** Approximately 250 electronic and electrical engineers, 30 physicists, and 10 technical writers to staff seven new plants of Westinghouse Electric Corporation. Permanent positions with assured future. Preference for men with minimum of two years experience in research, design or development. Salaries based on experience and ability. Interested engineers should get in touch with nearest Westinghouse office for confidential interview.

★ **Wanted:** Sylvania Electric has openings for engineers and physicists in all phases of electronic research, design, development, and application. These are permanent positions in a rapidly expanding program, and offer excellent growth possibilities. Several locations. For further information send resume or inquiry to D. W. Currier, Sylvania Electric Products, Inc., 1740 Broadway, New York 17, N. Y.



Employment Register

POSITIONS OPEN and AVAILABLE PERSONNEL may be listed here at no charge to industry or to members of the Society. For insertion in this column, brief announcements should be in



"just like being there"

Model 1401 Recorder installed in Model 501 Carrying Case

By any standard of comparison, the best buy in the tape recorder field. Model 1401 - Basic recorder ready for installation. Professional user's net price, \$345.00.

Write for Bulletin #101

Manufactured By

Berlant Associates

4917 W. Jefferson Boulevard
Los Angeles 16, California

"HAVE YOU HEARD THE SOUND OF QUALITY?"



NEWCOMB SOUND IS BETTER

Manufacturers of public address, mobile, phonograph, musical instrument and wired music amplifiers • Portable systems • Portable phonographs and radios • Transcription players • Rack and panel equipment.

Write today! Circle items of interest and indicate whether you are a Dealer, Parts Jobber or Sound Specialist.

NEWCOMB AUDIO PRODUCTS CO.
DEPT. T, 6824 LEXINGTON AVE.
HOLLYWOOD 38, CALIFORNIA

Diamond Phono-Needles

The one perfect phonograph needle is the Professional Diamond.

Professional, broadcast-station-quality Diamond Needle offers you: 1) elimination of record wear, 2) continuous high-fidelity reproduction, 3) savings up to several hundred dollars on sapphire or osmium needle replacements.

Purchase of a diamond needle can be the wisest investment you ever made... If you get the best available needle!

IMPORTANT FACTS TO REMEMBER—Under a different trade name we manufacture the great bulk of the diamond styli used in broadcast station equipment. Every stylus we make, regardless of its ultimate destination—radio station or individual user—is of the same unexcelled, unconditionally guaranteed quality. Our styli should NOT be confused with five and ten dollar 'diamond needles'.

We can supply Professional Diamond Needles to replace practically any removable needle. (GE styli we re-tip). Tandem-tip needles can be tipped with LP diamond only, if desired. In all cases send used sample needle(s) with order. \$15.50 each, less 10% if both LP and 78 are ordered at same time.

We can also supply cartridges with diamond styli, changers etc. Let us know your needs. Prices and information furnished without obligation.



TELEVEX 482 W. 238th St.
New York 63, N. Y.

AUDIO ENGINEERING SCHOOL

Practical engineering training in Audio fundamentals, Disc, Film, Magnetic Recording, and Audio frequency measurements.

Studio training simulates Broadcast, Motion Pictures, Television, and Commercial Recording work.

Approved for Veterans

Hollywood Sound Institute, Inc.
1040-A North Kenmore, Hollywood 27, Calif.
Correspondence Courses Available
Specify if Veteran or Non-Veteran

PROFESSIONAL DIRECTORY

C. J. LEBEL

AUDIO CONSULTANT

Development, Test, Custom Equipment,
Complete Laboratory and Shop Facilities

133 WEST 14TH STREET
NEW YORK 11, N. Y.
CH 3-8082

Custom-Built Equipment

U. S. Recording Co.

1121 Vermont Ave., Washington 5, D. C.
LIncoln 3-2705

RICHARD H. DORF AUDIO CONSULTANT

Sound Systems Recording Installations
Product Design Technical Literature

255 W. 84th Street Phone
New York 24, N. Y. Schuyler 4-1928

FILTER DESIGN

[from page 28]

$$\therefore L_2 = \frac{12.4}{12} (0.954) = 0.958 \text{ h.}$$

$$C_2 = \frac{12}{12.4} (0.0066) = 0.0064 \text{ } \mu\text{f.}$$

$$X_{L_3} = X_{C_3} = \left(\frac{1 - m^2}{2} \right) (Q_o R_o) \\ \times \left[1 + \left(\frac{f_{\infty}}{f_o} \right)^2 \right] = 13,250 \text{ ohms}$$

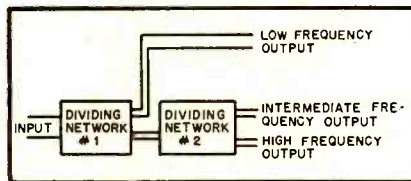

Fig. 11. Block diagram of three-way dividing network.

$$\therefore L_3 = \frac{13.25}{12} (0.954) = 1.05 \text{ h.}$$

$$C_3 = \frac{12}{13.25} (0.0066) = 0.006 \text{ } \mu\text{f.}$$

The simplified design of filter elements constitutes only a partial solution of the filter problem. The insertion loss of individual and composite sections usually is the desired criterion.² Many articles

² Useful practical curves for this purpose appear in "Simplified Filter Design" by J. Ernest Smith, pub. by *RCA Review*, Princeton, N. J.

have been written on the design of filter type dividing networks. The element values for these networks also may be designed using the simple methods described. For example, a three-way network³ may be evolved by noting that it is composed of two separate dividing networks, as shown in Fig. 11. The reactances of the elements are determined by applying the theory of fractional or x termination⁴ whereby series elements Z_{cd} in the low-pass filter may be omitted because they are represented to a good approximation by portion Z_{CD} of the high-pass filter for frequencies in the stop band region of the high-pass filter. Similarly, the series elements Z_{ab} of the high-pass filter may be omitted since they are represented in the circuit by the portion Z_{AB} of the low-pass filter for frequencies in the stop band region of the low-pass filter, as illustrated in Fig. 12, (A) and (B). The element values and the complete circuit of the Douglas three-way network are reproduced at (C).

Conclusions

In summary, it has been shown that elements of the major high-pass and low-pass filter types may be determined rapidly by letting R_o equal the reactance of each half-section element at cut off. Elements of band-pass and band-elimination filters are found by letting $Q_o R_o$ equal the reactance of each element of the series resonant branches at center frequency, the parallel branch elements being the inverse of the series branch elements. T-sections are formed by paralleling the pillars of two L sections, while Pi sections are formed by joining the series arms of two L sections.

³ As suggested by George A. Douglas in "Three-way speaker system", *AUDIO ENGINEERING*, June 1948, page 15.

⁴ *Radio Engineer's Handbook*, F. E. Terman, 1943 ed. p. 237.

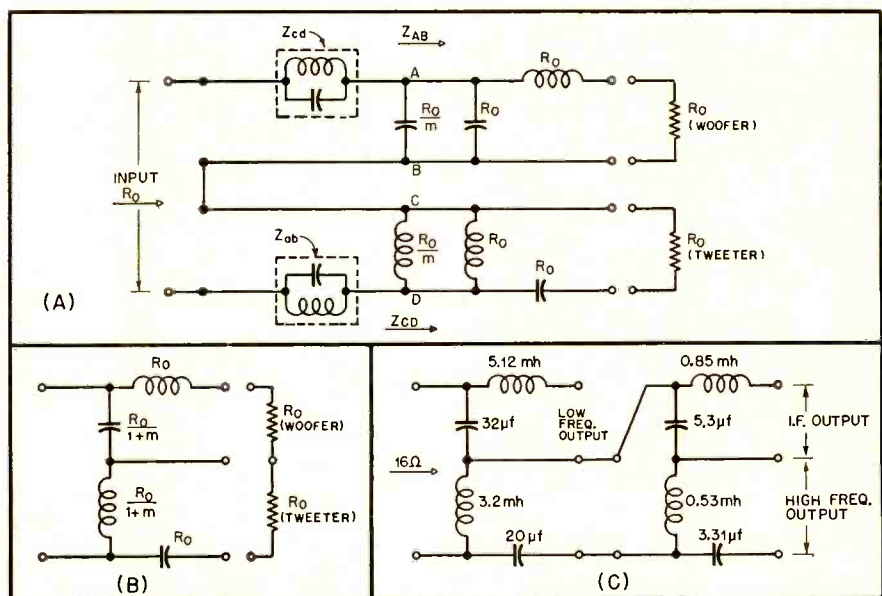

Fig. 12. (A) Evolution of a filter-type dividing network. The dotted networks are omitted when the two filters are series connected. (B) Reactance values of the elements of a two-way filter-type dividing network at crossover network. (C) 12-db per octave three-way dividing network showing element values. The crossover frequencies are 497 and 3000 cps.

WANTED **Engineers**

ELECTRONIC · ELECTRICAL · MECHANICAL

LAB TECHNICIANS: For Design and Development of Magnetic Tape Recorders used for Audio Work and Instrumentation. Creative ability essential.

ALSO: Electrical Draftsmen, Mechanical Draftsmen and Designers.

PERSONNEL for Purchasing, Expediting, and Production Control.

Please send complete information concerning education and experience.

Ampex

ELECTRIC CORPORATION
SAN CARLOS, CALIFORNIA · Telephone LYell 3-3128



**TWIN-TRAX
TAPE
RECORDER**

Available to you direct from the factory at savings that make TWIN-TRAX the only professional-type recorder in the popular-price field. More than a dozen model variations for portability, long-play, continuous operation, etc. For a better tape recorder that combines professional quality with operating ease and trouble-free construction, it's TWIN-TRAX. Write today for complete literature. *Trade Mark Registered*

AMPLIFIER CORP. OF AMERICA

398 Broadway • New York 13, N. Y.

SUBSCRIBERS—

Occasional delays in receipt of the issues of AUDIO ENGINEERING have been reported to the Circulation Dept. Mailing is normally completed each month by the 3rd, and reasonable time should be allowed for your copy to reach you before writing.

Music as
the Masters played it!
**THE Bogen
RANGE MASTER**



his new control permits your records to perform at their very best — an adjustable noise suppressor to correct for the particular condition of each record.

The Bogen PX15, fifteen watt high fidelity amplifier boasts eight other distinctive features, designed to multiply your listening pleasure.

Write for complete new FREE High Fidelity Catalog.

**David Bogen
CO., INC.**

663 BROADWAY, NEW YORK 12, N. Y.
Visit us in Suite 610-611, Hotel Stevens during the Radio Parts Show

Industry Notes--

Federated Purchaser Inc., 66 Dey St., New York City, will become nation's first coast-to-coast electronics distributor with opening of its fifth store, located at 911 S. Grand Ave. in Los Angeles wholesale district. New location will serve Pacific Coast, Northwest and Southwest. . . . **Globe-Union Inc.**, 900 E. Keefe Ave., Milwaukee 1, Wis., has purchased a building providing 158,000 sq. ft. of manufacturing space for use by company's **Centralab Electronics Division**—full occupancy planned for August 1 with 800 employees. . . .

Pacific Electronic Exhibit and Western meeting of IRE dates changed to August 22-24—location is Civic Auditorium in San Francisco. . . . **Federal Telephone and Radio Corporation**, Clifton, N. J., announces completion of 450-mile three-channel carrier-telephone system extending from Independence, Kans., headquarters of **Sinclair Pipe Line Company** to division office in Ft. Worth, Tex. . . .

Tetrad Company, Inc., 4921 Exposition Blvd., Los Angeles 16, Calif., has expanded into production of miniature and sub-miniature transformers meeting JAN and MIL spes. . . .

Westinghouse Television and Radio Division, Sunbury, Pa., awarded four contracts totalling \$12 million for manufacture of electronic equipment for Armed Forces—production of TV receivers will not be affected for time being. . . . **Cannon Electric Co.**, 3209 Humboldt St., Los Angeles 31, Calif., has opened a new plant in New Haven, Conn., to provide design consultation service for Eastern customers—assembly and manufacturing facilities are planned soon. . . . **Hytron Radio and Electronics Corp.** and subsidiaries, including **Air King Products Co.**, in process of being sold to **Columbia Broadcasting System** for \$20 million. . . .

Sylvania Electric Products planning new factory in Burlington, Ia., to cost \$1.5 million and employ 800—this will be company's second plant west of Mississippi, other being in Shawnee, Okla. . . . **NBC** making experimental use of new parabolic-type microphone said to afford high-quality pickups from distances up to 35 feet—called "The Big Ear." . . . **Milo Radio & Electronics Corp.** has installed teletype to permit more rapid contact with both suppliers and customers.

Industry People--

John S. Boyers, chief engineer and assistant treasurer since 1946, has been elected president of **Magnecord, Inc.** . . . **Leon Wortman**, formerly with Fairchild, appointed director of advertising and sales promotion for **Audio & Video Products Corporation**. . . . **Louis H. Niemann**, manager of sales engineering for tube division of **Sylvania**, on leave to serve as chief of **NPA's Electron Tube Section**. . . . **John K. Hilliard**, **Altec-Lansing's** chief engineer, in Europe for extensive study of foreign production and engineering in the sound equipment field. . . .

R. J. Neubecker, formerly with **Union Carbide and Carbon Corp.** chosen to head **Defense Division** of **American Molding Powder and Chemical Corp.** . . . **Robert T. Eakin** completes **Horatio-Alger** rise from student engineer to manager of **Allegheny Ludlum Steel Corporation's** largest plant. Only 35, he joined company in 1940. Succeeds **George Evans**, who remains as special consultant to vice-president in charge of operations. . . . **Arthur Priest** preparing new **Sound Equipment Catalog** for **Leonard Radio, Inc.**

**SAVE
33 1/3%**



This is our
GROUP SUBSCRIPTION PLAN

You and your friends and co-workers can now save up to \$1.00 on each subscription to **AUDIO ENGINEERING**. The more men in a Group, the more each saves. If you send 6 or more subscriptions for the U.S.A. and Canada, they will cost each subscriber \$2.00, 1/3 less than the price of a regular 1-year subscription. **Present subscriptions may be renewed or extended as part of a Group.**

AUDIO ENGINEERING is still

- The only publication devoted entirely to Audio—
- Recording
- Broadcasting equipment
- Acoustics
- Home reproduction systems
- PA systems
- Psychoacoustics

(Please print)

Name

Address

Position Company

Name

Address

Position Company

Name

Address

Position Company

Name

Address

Position Company

Name

Address

Position Company

Name

Address

Position Company

Name

Address

Position Company

Add \$.50 to each Foreign subscription ordered

RADIO MAGAZINES, INC.

342 Madison Ave., N. Y. 17, N. Y.



**THE IDEA BEHIND THE WORDS
HARTLEY-TURNER**

2. Living up to an ideal

Our only commodity is now called "high-fidelity sound reproduction." When we started business this ticket had not been thought of, for in those days no serious musician considered that canned cacophony could ever be anything else. A certain well-known figure said we invented high-fidelity. Maybe, but we certainly pioneered it, and we haven't done anything else since.

Our first product was a speaker, and it was better than the newly introduced dynamic speaker to the same extent that the latter was better than what had gone before. The dynamic speaker hinted at the great advance that could be made in sound reproducers; the Hartley-Turner realised it.

We found that a high-fidelity speaker could not be made by mass-production methods. We admit the miracles achieved by mass-production, but it was in the nature of things that a speaker free from distortion must be made in some other way. Nothing would have pleased us better than to devise a way of making such a speaker cheaply and in large quantities; over twenty years later the problem is still unsolved.

From the start we had to decide this matter of major policy; should we stick to the hand-made high-grade product, should we design something for the mass-market, or should we try to break into both markets? We decided on high-fidelity and nothing but. We fixed our ideal as making a nearly perfect speaker, and we have lived up to that ideal ever since.

We have never had a range of models. We do not make speakers with a range of impedances or a range of diameters. We have only one model; we have always had only one model—the best we can make. In our time we have tried duplex speakers, twin cones, duode voice-coils, and so on. All these were interim attempts to make the perfect speaker, and we are still short of the goal. But what we have in the 215 is a speaker which faithfully maintains our original aim. It is the best speaker we can make, and our best is very acceptable to most people.

It is still hand-made. It has to be. Its price is \$48.00. It could have been less if we had solved the problem of mass-producing it. It could have been very much more if we had worked on other lines of development. But it happens to be \$48.00. It also happens to have an impedance of 4 ohms, and it also happens to be 10" in. diameter. We say "happens" because the 215 is the outcome of thousands of experiments over more than twenty years directed towards perfecting the design. And what has emerged "happened" to be the best.

Send a dollar bill today to get on to our list for regular mailing of technical data. Many consider this the best spent dollar today. You will receive "New Notes in Radio" as well as data written by engineers who do not think in terms of "ad man jargon."

H. A. HARTLEY CO. LTD.
152 Hammersmith Road
LONDON W. 6, ENGLAND

**ADVERTISING
INDEX**

Air-Tone Sound & Recording Co.	51
Allied Radio Corp.	49
Altec Lansing Corp.	39
Amperite Co., Inc.	8
Ampex Electric Corp.	59, 60
Amplifier Corp. of America	59
Arnold Engineering Co., The	5
Astatic Corp., The	34
Audak Co.	31
Audio Devices, Inc.	Cover 2
Audio Instrument Co.	52
Bell Sound Systems, Inc.	55
Bell Telephone Labs.	12
Bendix Radio Division	56
Berlant Associates	57
British Industries Corp.	56
Bogen, David Co., Inc.	59
Camera Equipment Co.	45
Carter Motor Co.	54
Chicago Transformer Div.	32
Classified Ads.	56
Dorf, Richard H.	58
Duotone Co.	46
Electro-Voice, Inc.	37
Fisher Radio Corp.	49
Garrard Sales Corp.	9
Goodman Industries, Ltd.	42
Hartley, H. A. Co., Ltd.	60
Harvey Radio Co., Inc.	44
Hollywood Sound Institute, Inc.	58
International Resistance Co.	43
Jensen Mfg. Co.	27
LeBel, C. J.	58
Leonard Radio, Inc.	41
Magnecord, Inc.	3
McIntosh Engineering Lab, Inc.	4
Newcomb Audio Products Co.	57
Par-Metal Products Corp.	50
Partridge Transformers, Ltd.	60
Pentron Corp., The	6
Pickering & Co., Inc.	11
Precision Film Labs, Inc.	2
Professional Directory	58
Radio Corp. of America	1, 51, Cover 4
Radio Shack Corp.	53
Reeves Soundcraft Corp.	35
Rek-O-Kut Co.	53
Shallcross Mfg. Co.	7
Shure Brothers, Inc.	33
Sonocraft Corp.	36
Standard Transformer Corp.	47
Standard Wood Products Corp.	48
Tech Labs, Inc.	52
Televox	58
Terminal Radio Corp.	38
Turner Co.	29
U. S. Recording Co.	58
United Transformer Co.	Cover 3

PARTRIDGE

THE AUDIO TRANSFORMERS
that pass ALL tests

Time, no less than test, has proved Partridge Audio Transformers to be the most efficient and reliable in the world.

★ **WILLIAMSON** Output TRANSFORMERS, of which there is no U. S. equivalent (vide "Audio Engineering" Nov. 1949) built to the original specification, comes to you for \$21.00, mail and insurance paid.

★ **PARTRIDGE CFB** 20 Watt output type, accepted as without rival. Series leakage induct. 10 m.H.; primary shunt induct. 130 H, with 'C' core construction and hermetically sealed—to you for \$30.00, mail and insurance paid.

Fulltest data, including square wave tests, distortion curves etc., together with list of U. S. stockists rushed Air Mail to you.

NOTE: We despatch by insured mail per return upon receipt of your ordinary dollar check.

Jobbers are invited to handle the transformer that the States is eager to buy—remember, immediate delivery from large stocks in New York!

PARTRIDGE TRANSFORMERS LTD.
ROEBUCK ROAD, TOLWORTH SURREY, ENGLAND

1st.. IN
HIGH QUALITY RECORDING

★ **STANDARD OF THE GREAT RADIO SHOWS**

AMPEX
MAGNETIC TAPE RECORDERS
SOLD BY ...
BING CROSBY ENTERPRISES, Inc., Hollywood
AUDIO-VIDEO PRODUCTS CORP., New York City
GRAYBAR ELECTRIC CO., Inc., Principal Cities
THE HAWAIIAN NETWORK, Ltd., Honolulu
RADIO PARTS, Inc., New Orleans
Export: WESTREX CORPORATION,
New York City
SEND FOR BOOKLET
AMPEX
ELECTRIC CORPORATION
San Carlos • California



Many people realize and take advantage of the fact that "the tough ones go to UTC." Many of these "tough ones," while requiring laboratory precision, are actually production in quantity. To take care of such special requirements, the UTC Laboratories have a special section which develops and produces production test equipment of laboratory accuracy. The few illustrations below indicate some of these tests as applied to a group of units used by one of our customers in one production item of equipment:

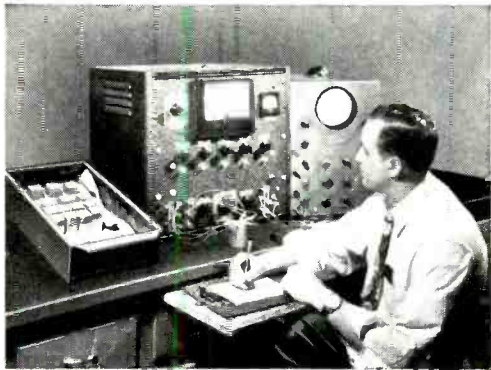

The component being checked here is a dual saturable reactor where the test and adjusting conditions necessitate uniformity of the complete slope of the saturation curve. The precision of this equipment permits measuring five widely separated points on the saturation curve with saturating DC controllable to .5% and inductance to .5%.

Servomechanisms and similar apparatus depend, to a considerable degree, on phase angle operation. The transformer adjusted in this operation requires an accuracy of .05 degrees phase angle calibration under the resonant condition of application. With wide change in voltage and temperature range from -40 to $+85$ degrees C., the phase angle deviation cannot exceed .2 degree. To effect this type of stability, specific temperature cycling and aging methods have been developed so that permanent stability is effected.



This test position involves two practical problems in a precision inductor. The unit shown is adjusted to an inductance accuracy of .3%, with precise (high) Q limits. It is then oriented in its case, using a test setup which simulates the actual final equipment so that minimum inductive coupling will result when installed in the final equipment.

The hermetic sealing of transformers involves considerable precision in manufacturing processes and materials. To assure consistent performance, continuous sampling of production is run through fully automatic temperature and humidity cycling apparatus. It is this type of continual production check that brings the bulk of hermetic sealed transformers to UTC.



United Transformer Co.

150 VARICK STREET NEW YORK 13, N. Y.
EXPORT DIVISION: 13 EAST 40th STREET, NEW YORK 16, N. Y. CABLES: "ARLAB"



All new

RCA Limiting Amplifier BA-6A

For high-fidelity AM and FM speech input systems

FEATURES

- No matched tubes required
- Choice of single or dual time constant
- Greater reliability—push-pull stages throughout
- High gain—Low noise level
- Adjustable T-pad in output
- Standard plug-in mounting—for new handling convenience

SPECIFICATIONS

- Output level at verge of limiting, 30 dbm
- Gain, 54 db
- Noise level—down 83 db at verge of limiting
- Frequency response ± 1 db, 30-15,000 cycles
- Distortion (12 db gain reduction), 1%
- Takes only $8\frac{3}{4}$ inches of rack space. Weighs only 37 pounds.

This represents the ultimate in useful performance...at lower cost

Save yourself hundreds of dollars when you buy your limiting amplifier. Specify a BA-6A. For complete details, call your RCA Broadcast Sales Engineer. Or write Dept. PA-19, RCA Engineering Products, Camden, N. J.



AUDIO BROADCAST EQUIPMENT
RADIO CORPORATION of AMERICA
ENGINEERING PRODUCTS DEPARTMENT, CAMDEN, N. J.

In Canada: RCA VICTOR Company Limited, Montreal