

AUDIO ENGINEERING

JULY
1951
35c



Published by RADIO MAGAZINES, INC

www.americanradiohistory.com

For **MAXIMUM OUTPUT** with **MINIMUM DISTORTION**

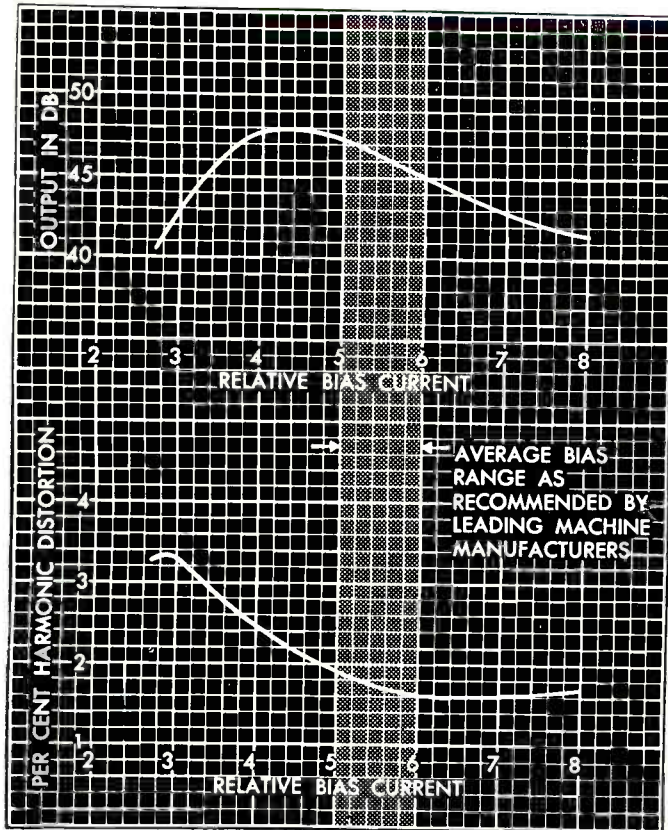

you can't beat
audiotape TRADE MARK



● As all professional recordists know, the proper operation of any tape recorder involves a compromise between *decibels* and *distortion*. And Audiotape has been especially formulated with this important relationship in mind—to give you higher output (and thus better signal to noise ratio) and lower distortion in the normal bias range of all machines.

Test it. Compare it with any other tape. Plot your own output vs distortion curves, similar to the ones shown above. You'll find that in the useful, low-distortion bias range, Audiotape combines maximum output with maximum fidelity and freedom from distortion.

That's just one of many reasons why more and more professional recordists are specifying Audiotape for their most exacting magnetic recording requirements. Remember—Audiotape is made by audio engineers, for audio engineers. *It speaks for itself.*

AUDIO DEVICES, Inc.

444 MADISON AVE., NEW YORK 22, N. Y.

Export Dept.: 13 East 40th St., New York 16, N. Y., Cables "ARLAB"

audiorecords audiotape audiofilm audiopoints

And there's **PROOF** of
UNEQUALLED UNIFORMITY
in Every Package

You GET an Esterline-Angus output curve in every five-reel package of plastic-base Audiotape. This curve, made from one of the reels in that package, actually measures the output characteristics of all five reels, since they are all slit from the same roll after coating. Now you can *see*, as well as *hear*, the exceptionally high output uniformity that you get only in Audiotape. What's more, every 1250-ft. and 2500-ft. reel is guaranteed **FREE FROM SPLICES!**

AUDIO ENGINEERING

Successor to **RADIO**

Established 1917



C. G. McProud, Editor

Harrie K. Richardson, Associate Editor

Luci Turner, Production Manager

S. L. Cahn, Advertising Director

Lucille Carty, Circulation Manager

H. N. Reizes, Advertising Manager

Editorial Advisory Board

Howard A. Chinn
John D. Colvin
C. J. LeBel
J. P. Maxfield
George M. Nixon

Representatives

H. Thorpe Covington, Special Representative
677 N. Michigan Ave., Chicago 11, Ill.
Sanford R. Cowan, Mid-West Sales
67 W. 44th St., New York 18, N. Y.
James C. Galloway, Pacific Coast Sales
816 W. 5th St., Los Angeles 17, Calif.
Technical Book & Magazine Co.
297 Swanston St., Melbourne, C. I.
Victoria, Australia

CONTENTS

JULY, 1951

Vol. 35, No. 7

Audio Patents— <i>Richard H. Dorf</i>	2
Letters	3
Hollywood Letter— <i>C. A. Hisserich</i>	4
Editor's Report	6
Characteristics of AM Detectors— <i>W. E. Babcock</i>	9
Loudspeaker Enclosures— <i>Daniel J. Plach and Philip B. Williams</i>	12
Adding Decibel-Expressed Quantities— <i>Alfred L. DiMattia and Lloyd R. Jones</i>	15
A Mixer and a Preamplifier for the Recording Enthusiast— <i>G. H. Floyd</i>	16
AUDIO engineering society SECTION	
A New Method of Measuring and Analyzing Intermodulation— <i>C. J. LeBel</i>	18
Record Revue— <i>Edward Tatnall Canby</i>	22
Pops— <i>Rudo S. Globus</i>	22
New Products	28
New Literature	29
Industry Notes	39
Industry People	39
Advertising Index	40

COVER

In this photograph, taken especially for *A. E. J. R. Poppele*, Vice-President in Charge of Engineering, Station WOR, explains to Diane Courtney, network singing star, the whys and wherefores of WOR-TV's unique audio control system. Reflecting the ingenuity of the station's engineering staff, the control unit is made up of two RCA remote amplifiers used in conjunction with a standard audio console to provide a total of fourteen input channels. The station has three such installations.

RADIO MAGAZINES, INC., 342 MADISON AVE., NEW YORK 17, N. Y.

AUDIO ENGINEERING (title registered U. S. Pat. Off.) is published monthly at 10 McGovern Ave., Lancaster, Pa., by Radio Magazines, Inc., D. S. Potts, President and Publisher; Henry A. Schober, Secretary-Treasurer. Executive and Editorial Offices: 342 Madison Avenue, New York 17, N. Y. Subscription rates—United States, U. S. Possessions and Canada, \$3.00 for 1 year, \$5.00 for 2 years; elsewhere \$4.00 per year. Single copies 35c. Printed in U. S. A. All rights reserved. Entire contents copyright 1950 by Radio Magazines, Inc. Entered as Second Class Matter February 9, 1950 at the Post Office, Lancaster, Pa. under the Act of March 3, 1879.

At Precision today
we're processing
the finest
SCIENTIFIC FILMS
for nationwide
showings



For your 16 mm. scientific film requirements use Precision . . .

- Over a decade of 16 mm. industrial film printing in black and white and color.
- Fine grain developing of all negatives and prints.
- Scientific control in sound track processing.
- 100% optically printed tracks.
- Expert timing for exposure correction in black & white or color.
- Step printing for highest picture quality.
- Special production effects.
- Exclusively designed Maurer equipment.
- Personal service.

... no wonder more and more of the best 16 mm. films today are processed at...

PRECISION

FILM LABORATORIES, INC.

21 West 46th St.,
New York 19, N. Y.

JU 2-3970

REK-O-KUT

Specialists in Sound
Equipment for Broad-
casting and Public Use!
The World's Finest!



THE
"Challenger"
Professional 13 1/4 DISC
RECORDER for Standard
and Micro-Groove
Recording

3 INSTRUMENTS IN ONE

1. A Professional Recorder
2. A High-Fidelity Phonograph
3. A High-Fidelity P.A. System

The Challenger, America's finest 13 1/4 Disc Recorder, is built to meet the respective needs of the professional recordist, musician, educator and recording enthusiast who wants to make permanent, professional recordings. Embodies the most advanced design, engineering and production techniques in the disc recording industry. The Challenger's many exclusive operating features simplify and improve the art of disc recording. NOTE: Tape recording enthusiasts need the "Challenger" to re-record their finished tape after it has been edited... input jack available, no special attachments required.

RECORDS disc from 6" to 13 1/4" masters.
PLAYS back disc from 6" to 16" transcriptions, standard or micro-groove.

With heavy duty synchronous motor..... **\$439.95**

★ ★ ★ ★ ★



CONTINUOUSLY VARIABLE- SPEED TURNTABLE OF BROADCAST QUALITY

Plays at ANY speed from 25 to 100 R.P.M. . . . without distortion. Ideal for record collectors, musicians, singers, disc jockeys, music schools, dance studios, general schools, broadcast studios, etc., wherever controlling pitch and tempo is required.

Model CVS-12, (illustrated) chassis, motor and turntable, assembly **\$84.95** net

Model CVS-12P, mounted in portable case with 16" dual stylus pick-up..... **\$124.95** net

★ ★ ★ ★ ★



MODEL LP-743 3-SPEED 12 INCH TRANSCRIPTION TURNTABLE

Recommended by leading sound critics. Induction type motor, designed for smooth, quiet, vibration-free operation. Instantaneous speed changes—78, 45 and 33 1/3—without stopping turntable or removing disc.

\$54.95 net,

See...hear...compare REK-O-KUT products at leading music stores, audio-visual dealers and radio parts jobbers...or write for literature.

REK-O-KUT CO.

38-01 Queens Boulevard
Long Island City 1, N. Y.



AUDIO PATENTS

RICHARD H. DORF*

IN SPITE OF the precautions which surround the making of motion picture sound tracks certain imperfections such as pinholes and small specks do occur sometimes. When they reach the theatre they are heard as loud pops and contribute very little to the enjoyment of the picture. For a long time the usual practice has been to scan the entire track by eye, looking for the imperfections. That is a slow and tedious process and it does not uncover all the imperfections, for many of them, though too small to be seen readily, still cause noise.

James P. Corcoran and John D. Stack of Los Angeles have come up with an electronic inspection system which is not only efficient but also extremely simple. The patent which describes it is numbered 2,538,354, and it is assigned to Twentieth Century-Fox.

The inventors provide a small playback system which they package neatly. It has

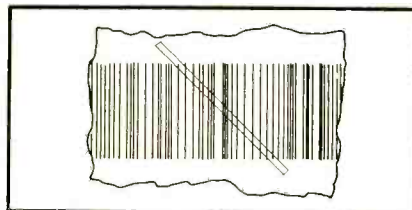

Fig. 1

one principal peculiarity—that the scanning slit, instead of being properly aligned with the track, is at an angle, as the drawing of Fig. 1 illustrates. The width of the slit is the same as usual though it may be a bit longer.

Now note what the inspector hears when he starts running film through the system. Since the diagonal slit covers a number of cycles of sound simultaneously, the phototube "sees" at all times an amount of light representing a rough average of the light appearing at each point along the track. There is, of course, little or no recognizable sound output, but only the relatively slow variations in input potential corresponding to the shifting of the average.

But when a pinhole or a speck comes along it becomes very apparent. The small point of excessive light (pinhole) or lack of light (speck) appears only once and only at one point in the slit area, so has no part in the averaging proceedings. That being so, it is heard as a pop and just as loud a pop as would take place if the slit were in its normal orientation. Since the output the operator hears from the actual sound track is so subdued, the pop is immediately apparent. By operating the reel cranks he can back the film up and quickly find the exact location of the trouble.

* Audio Consultant, 255 West 84th Street, New York 24, N. Y.

The angle of the slit with respect to the track has been made adjustable by the inventors. They find, however, that about 30 deg. is normally optimum.

Driving Crystal Cutters

The writer has seen (and designed) any number of amplifiers driving crystal record cutters, which employ a "power" tube at the output end. It seems normal to do that for we instinctively feel that substantial power is required to make the stylus swing.

Lawrence V. Wells has found that a simple voltage-amplifier triode will drive a crystal cutter as well or better than a 6V6 and similar types and has received Patent No. 2,541,393, assigned to Wilcox-Gay. His improvement is predicated on the fact that even though less than a half watt is required to drive a crystal, it is usual to use a power stage and terminate it in a dummy load and a series compensating resistor, both of which absorb—and waste—most of the power output.

The main requirement in using a crystal cutter is to obtain a crossover frequency. Normally a crystal is a voltage-responsive device and will cut constant amplitude if fed constant voltage. Reproducing systems in general, however, are set up for the combination of constant amplitude only below a 300 to 800-cycle crossover and constant velocity (decreasing cutter stylus motion

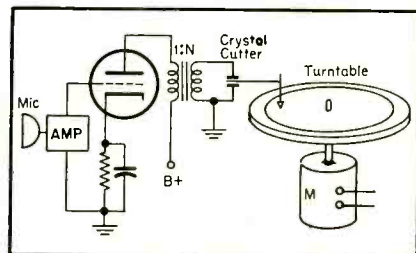

Fig. 2

with ascending frequency) above that. In usual practice with crystal cutters, which are almost purely capacitive devices, the idea is to figure the X_c of the cutter at the desired crossover, then place a resistor of that value in series with it. The action is then that of a voltage divider. Below crossover the cutter is the larger impedance and most of the voltage is across it. Above cutoff, the capacitive reactance gets smaller and smaller and the result is a good approximation of the standard curve (without pre-emphasis, which may be added elsewhere).

Wells' circuit is given in Fig. 2. He does not mention what the tube is but probably it is the old reliable 6J5 or 6C5. It is a normal voltage amplifier but has a transformer load. The circuit is represented by its equivalent in Fig. 3. This is the usual

[Continued on page 38]

LETTERS

Patents

Sir:

I should like to compliment you on your paragraphs on AUDIO PATENTS in the June EDITOR'S REPORT, and to comment on John D'Errico's letter in the May LETTERS column.

It is true that most patented ideas which are going to appear as manufactured products do appear before the patent is granted. That should make readers think twice before taking an inventor's claims for gospel.

But readers do take a strong interest in new patents. There are a great many factors other than technical impracticability which may prevent an invention from reaching the market—manufacture may be too expensive for a good profit, the need may not be sufficiently widespread to allow large sales volume, the device may be too bulky to appeal to most people, performance improvement may be too slight to interest most users, and so on. But many a reader may find in these inventions the germ of an idea which he can develop for himself, and to a good number of individuals high cost or space requirements are not bars to a piece of equipment, nor does the probability of only slight benefit deter them.

Some inventions, of course, are too involved or do not work at all. The latter are filtered out before the PATENTS column is written, but we do submit certain of the others because they contain a concept which we feel someone will want to develop further, perhaps along more practical lines. And, speaking of involved devices, what could be a more Rube Goldberg gadget than the common gasoline-powered, reciprocating, internal-combustion engine?

Richard H. Dorf,
255 W. 84th St.,
New York 24, N. Y.

Intermodulation—or not

Sir:

In his April column Edward Tatnall Canby asks after describing the beats due to tempered piano tuning, "Beats are intermodulation to you, aren't they?"

The answer, of course, is "No." And Mr. Canby, rather than demolishing what he calls a "remarkable misconception" seems to be displaying one of his own.

I don't think any of the more competent engineers are worried about intermodulation in music. But it is for good and sound reasons that they worry about the kinds of music that are particularly susceptible to having intermodulation added to them by being run through audio equipment. The foods that taste good right out of the oven are not necessarily the ones you would choose for a cold snack.

Warner Clements,
Box 969,
Sherman Oaks, Calif.



THEY CHOSE

Magnecorder

THE FIRST CHOICE OF RADIO ENGINEERS

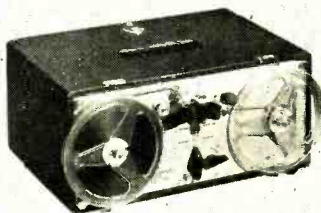

FLEXIBILITY

In rack or console, or in its really portable cases, the Magnecorder will suit every purpose. PT6 Series shown is the most widely used professional tape recorder in the world, and is available with 3 speeds (3 3/4, 7 1/2, 15") if preferred.

FIDELITY

Lifelike tone quality, low distortion meet N.A.B. standards — and at a moderate price! PT63 Series shown in rack mount also offers three heads to erase, record, and play back to monitor from the tape while recording.



FEATURES

PT7 accommodates 10 1/2" reels and offers 3 heads, positive timing and pushbutton control. PT7 Series shown in complete console model is also available for portable or rack mount. For outstanding recording equipment, see the complete Magnecord line — PT6, PT63 and PT7.



Magnecord, INC.

360 NORTH MICHIGAN AVENUE
CHICAGO 1, ILLINOIS

WRITE FOR NEW CATALOG

Magnecord, Inc., Dept. A-7
360 N. Michigan Ave., Chicago 1, Ill.
Send me latest catalog of Magnecord Equipment.

Name.....
Address.....
City..... Zone..... State.....

For a Glorious
BIG TONE

ON ANY STRINGED INSTRUMENT
specify the Genuine
AMPERITE "KONTAK MIKE"
THE ONLY NO-DISTORTION "KONTAK MIKE"

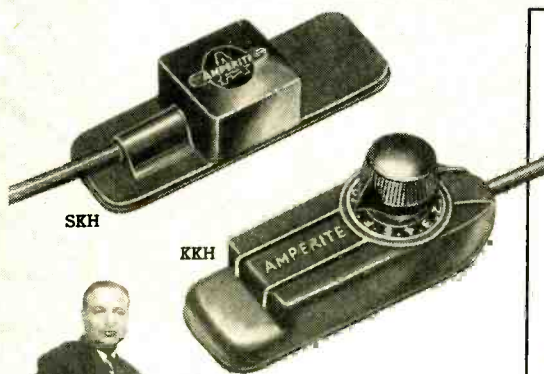

Anthony Antone, widely known as "the most versatile artist of the frets", is an enthusiastic user of Amperite Kontak Mikes.

Used with most amplifiers, including most electric guitar amps.

No changes in amplifier, instrument, or strings. Attached without tools.

The Amperite "Kontak Mike" improves the tone and volume of any Stringed or Fretted Instrument — also Pianos, Accordions, Harmonicas, etc. It is the only "Kontak Mike" that does not introduce peaks or distortion.

Model SKH, hi-imp..... List \$12.00
Model KKH
(with hand volume control)..... List \$18.00

AMPERITE
STUDIO MICROPHONES
at P. A. PRICES!
Ideal for **CLOSE TALKING**
or **DISTANT PICKUP**

You can shout right into it, or stand away; in either case, the quality will be perfectly natural.

Model RBLG (200 ohms)..... List \$42.00
Model RBHG (hi-imp)..... List \$42.00



AMPERITE CARDIOID DYNAMIC MICROPHONE

Models PGH-PGL..... List \$32.00

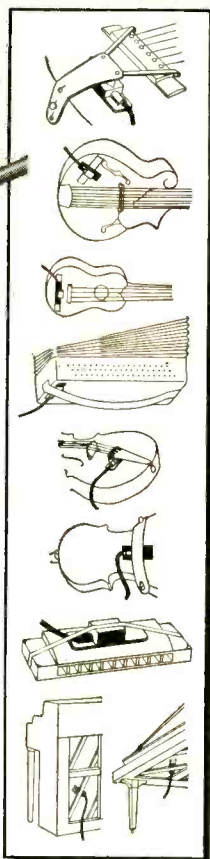

SPECIAL OFFER:
Write for Introductory Offer, and 4-page Microphone Folder 53-M.

AMPERITE Company, Inc.
561 Broadway • New York 12, N. Y.
In Canada: Atlas Radio Corp., Ltd., 560 King St., W., Toronto 28



C. A. HISSERICH*

SHORTAGES created by the present national emergency are being felt in the motion picture recording field. The most severe shortage at present is in the procurement of ball bearings suitable for precision spindle use. Previously, Grade 4 or better bearings were purchased and selected to yield minimum tolerances on the finished spindle run-out, and it was not unusual to achieve a "dead on" spindle with no measurable run-out on a .0001-in. indicator; the final cut being taken after the spindle was installed in its quill. At present, however, Grade 4 bearings are on six months or longer delivery schedule and several expedients have been tried. Extensive selection of the "open" type of magneto bearings will yield approximately 10 per cent suitable for spindle use with a .0001 to .0002-in. run-out, a slight amount of pre-loading being necessary to achieve this accuracy.

Transformers are also becoming scarce, especially high-grade input transformers which use #40 or finer wire. High-grade output transformers, utilizing special core materials, are also in short supply because of the shortage in nickel-iron alloys, and some manufacturers are reverting to the silicon steel core materials, attempting to maintain performance at the cost of size.

Synchronous camera and recorder motors have also been on a slow delivery schedule, and several "synchronous" systems have been installed using modified 5-G and 7-G surplus selsyn motors as drive units. The modification to these units consists of the installation of brass slip rings and brush holders for high-speed motor brushes. The 5-G units will drive a camera or recorder, and the 7-G unit is used as a "distributor", ordinarily being driven by a 1/4 h.p. "line-sync" motor. No trouble has been experienced in driving as many as four 5-G units in synchronism with a 7-G, the 5-G units handling a projector, two film playback machines, and a film recorder.

During the transition from optical to magnetic recording in the motion picture industry, many machines which were designed for optical recording were converted to magnetic recording by the simple expedient of installing recording and playback heads. Many of these machines were of the "tight loop" drive type, in which viscous damping was used to prevent oscillation in the mechanical filter unit. When this type of machine is converted to magnetic recording, the viscous damping may be materially reduced or in some cases removed entirely, effective resistance damping being supplied by the friction of the magnetic tape on the recording and playback heads.

Magnetic Amplifiers

Magnetic amplifiers are finding limited application in the recording industry; the most interesting application which the writer has seen was in a 12-volt, 10-amp. regulated d.c. lamp supply. The company producing this equipment was attempting to

[Continued on page 38]

*954 Hancock Ave., Los Angeles 46, Calif.

Be Sure of Your Installations Get the *Aptitude-Tested* RG/U TRANSMISSION LINE CABLES

● You know what you are doing when you use Belden RG/U Transmission Line Cables—they're aptitude rated. They are designed to provide desirable electrical characteristics, and rigid control assures constant quality.

Specify Belden Radio Wires.

Belden Manufacturing Co.
4689-R W. Van Buren Street
Chicago 44, Illinois

APTITUDE RATING No. 8236		APTITUDE RATING No. 8237		APTITUDE RATING No. 8238		APTITUDE RATING No. 8239		APTITUDE RATING No. 8241		APTITUDE RATING No. 8240	
Frequency (Mc)	Attenuation per 100 ft	Frequency (Mc)	Attenuation per 100 ft	Frequency (Mc)	Attenuation per 100 ft	Frequency (Mc)	Attenuation per 100 ft	Frequency (Mc)	Attenuation per 100 ft	Frequency (Mc)	Attenuation per 100 ft
100.	2.65	100	2.10	100.	1.90	100.	2.90	100.	3.75	100.	4.10
200.	3.85	200.	3.30	200.	2.85	200.	4.20	200.	5.60	200.	6.20
300.	4.80	300.	4.10	300.	3.60	300.	5.50	300.	7.10	300.	8.00
400.	5.60	400.	4.50	400.	4.35	400.	6.70	400.	8.30	400.	9.50



Belden
Radio WIRE

The
Aptitude-Tested **LINE**

EDITOR'S REPORT

COMPONENT TOLERANCES

CONSTRUCTORS of the many devices described in these pages often indicate in their correspondence that response curves submitted by the authors of the articles are not reproduced when the unit is built by a reader who follows the circuit and components list carefully. Most experienced constructors—and we like to feel that most of our contributors fall in this category—are aware of the fact that while a specific resistor or capacitor may be labeled with a certain value, there is always a tolerance between the nominal value of the component and its actual measured value.

Relatively little effect will be noticed if a plate or grid resistor has a measured value differing from the indicated figure by as much as 20 per cent, and it is unusual to select coupling capacitors on the basis of the actual pass band of the amplifier being built. However, in circuits in which resistors or capacitors may be used as frequency-determining elements, it is possible that a considerable difference may be obtained with those components which vary appreciably from their marked values, and are yet within the tolerance specified by the manufacturer.

Consider, for example, an RC circuit which is used to set the turnover frequency in a phonograph preamplifier. Suppose that the original constructor has picked out a .01 μf capacitor which is 20 per cent above the nominal value, and actually has a capacitance of .012 μf . He obtains a measured response which is the result he desires by using this component with a 10,000-ohm resistor which also happens to measure 20 per cent above its marked value. In reproducing the circuit, a reader happens to pick up a capacitor and a resistor which are both 20 per cent *under* their nominal values. In the original circuit, the RC product is 144; in the reader's circuit, the RC product is 64. Since the RC product determines the frequency of turnover in the usual circuit of this type, it is seen that the circuit as reproduced by the reader may possibly result in a turnover frequency 2.25 times that of the original circuit.

Obviously these are maximal cases, and it would be unusual if the variations indicated both happened to occur, but it is certainly possible. Not everyone has an accurate bridge for measuring component values—and this applies to both contributor and reader. Therefore, although this caution is seldom mentioned in his description by the original builder of the unit, it is suggested that anyone who reproduces a circuit from this or any other source should experiment with the frequency-determining elements in order to get the results claimed by the original author.

The importance of tolerances shows up principally in any circuit in which resistance and reactance are

used to set frequency response. While the required values can be calculated quite easily, at least one degree of tolerance must be considered in building the circuit. Even the use of 5 per cent components would not help if the same care has not been taken in the original construction, although it would reduce the error in cases where values were determined by calculation.

COLLEGE AUDIO TRAINING

In view of the interest in audio, it seems strange that no major college or university has yet offered a specialized course in audio engineering as a profession. Regrettably, audio engineering has been looked upon for too long as a branch of electronics or of radio engineering—which in itself is sometimes relegated to the general subject of electronics. Even the Institute of Radio Engineers recognizes audio with the statement in a recent advertisement that “‘Audio’ is 60% of Radio.”

Regardless of the medium by which the final result—the audibly reproduced program, be it music, speech, or what not—is transmitted to the listener, it must always be remembered that the important element is the sound itself. No listener cares whether the signal comes to his ears by AM or FM radio, u.h.f., light beam, or over the water pipes—he is only interested in hearing a program exactly as he imagines it sounds at the point of performance.

Audio—including as it does acoustics, electronics, construction practice, recording, and psychoacoustics—is a subject of sufficient magnitude to warrant specialized training at the university level. To date it seems that the subject is taught only at two institutions, hardly enough to recognize the full importance of the profession. Perhaps we are not well informed—there may be others, but we have not heard of them. To the end that there may be more educational opportunities in this profession, we shall continue to mention the need from time to time.

GO WEST, YOUNG MAG

\mathcal{A} E is a young mag(azine), being just slightly over four years old, and for the August issue will take Horace Greeley's oft quoted—and misquoted—advice. The Seventh Annual Pacific Electronic Exhibit is being held in San Francisco August 22–24, under the sponsorship of the West Coast Electronic Manufacturers Association, and jointly with the Western Convention of the I.R.E.

The August issue will therefore be devoted to California and the West Coast, with full information about the Exhibit, and with all articles from contributors in that area.

California, Here We Come!

It plays—45's, 33 $\frac{1}{3}$ fine-grooves', 33 $\frac{1}{3}$ standards', 78 standards'



The All-New RCA Pick-up and Tone Arm installed on a 70-C turntable.

HIGH-FIDELITY PICK-UP...one arm, all speeds!

RCA's All-New Tone Arm—with magnetic lateral plug-in heads—fits all standard turntables. Only two heads are needed for all speeds.

This versatile pick-up and tone arm combination... installed on your turntable... can play every record and transcription in your library. *Just plug in the head for the right record groove—and spin the platter.* It's as easy as that.

Designed for studio-quality at all standard speeds, this unique system has outstanding features over previous types. For instance, plug-in magnetic heads need no adjustments for stylus pressure. Visibility of the stylus (from the top of the head) permits accurate groove-spotting.

Anti-friction pivots and low inertia provide easy tracking on eccentric and warped records. Lower weight assures better record service—longer stylus life. Tracking error of the arm is less than 4 degrees.

Arm assembly MI-11885 is complete with tone arm, mounting plate, hardware, and the filter modification kit MI-11874 (for 70-series turntables).

You use plug-in head MI-11874-4 with the 1-mil stylus for fine-groove records. You use plug-in head MI-11874-5 with the 2 $\frac{1}{2}$ -mil stylus for standard transcriptions and 78 rpm records.

Order from your RCA Broadcast Sales Engineer, or direct from Dept. S-7, RCA Engineering Products, Camden, New Jersey.



AUDIO BROADCAST EQUIPMENT
RADIO CORPORATION of AMERICA
ENGINEERING PRODUCTS DEPARTMENT, CAMDEN, N.J.

In Canada: RCA VICTOR Company Limited, Montreal

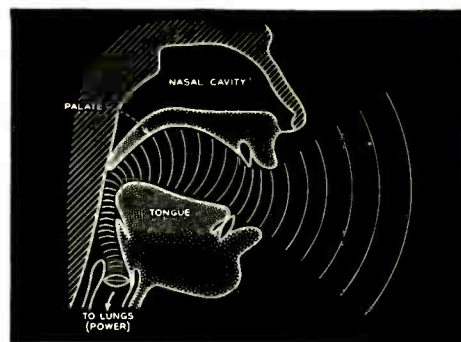
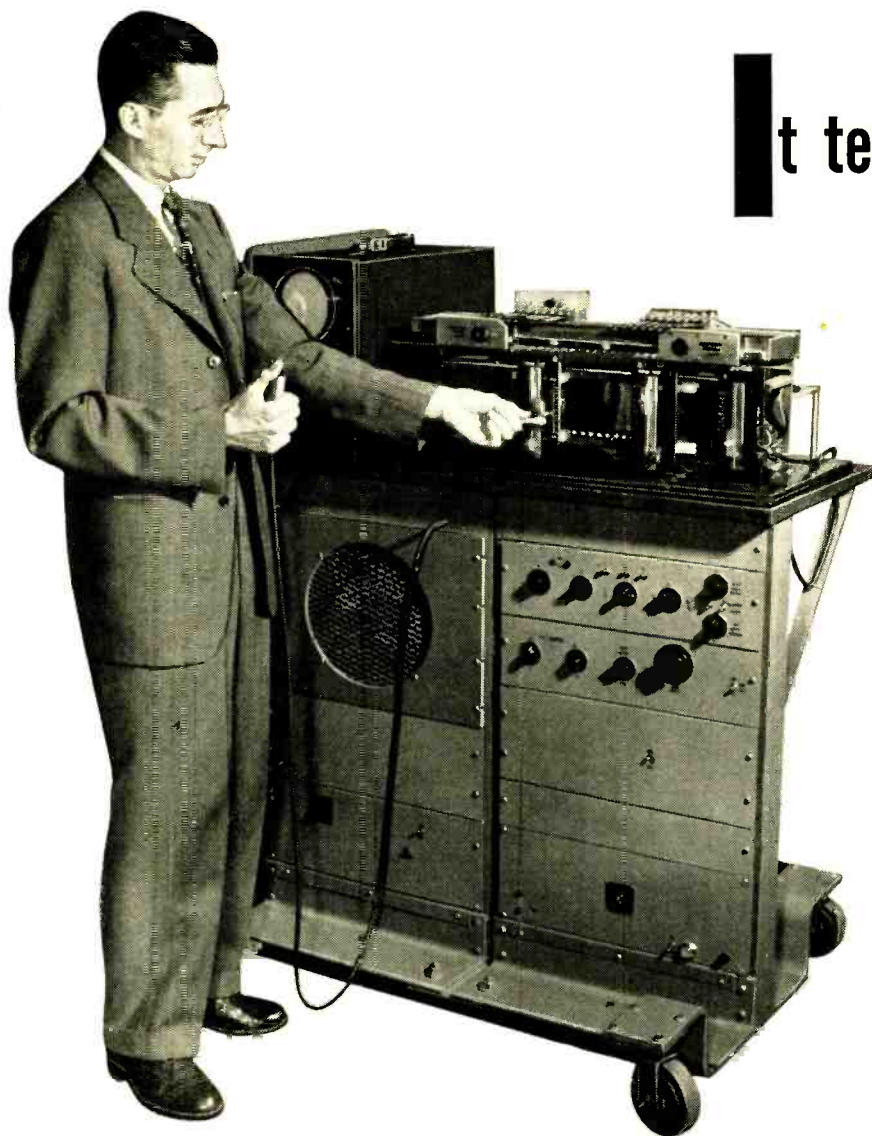

It tells how you talk

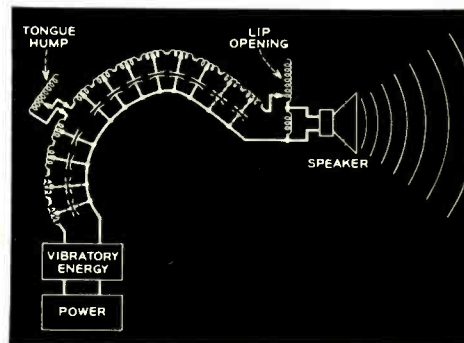

The machine at the left is saying "Ah!" It's the new electrical vocal system developed at Bell Laboratories. Top sketch shows human vocal system also saying "Ah!" The electrical model is sketched below it. Energy source at bottom of "tract" can emit a buzz sound, like vocal cord tone, or the hiss sound of a whisper.

No one else speaks exactly like you. Each of us uses different tones to say the same words. To study and measure *how* we make speech, acoustic scientists of Bell Telephone Laboratories built a model of the vocal system.

Electric waves copy those of the vocal cords, electric elements sim-

ulate the vocal tract, and, by adjustments, vowels and consonants are produced at pitches imitating a man's or woman's voice.

Using this electrical system, telephone scientists will be able the better to measure the properties of people's voices. Knowing more about speech they can find better

and cheaper ways to transmit it.

This is another step in the research at Bell Telephone Laboratories which pioneered the exact knowledge of speech. Past work in the field is important in today's fine telephone service. A still deeper understanding of speech is essential in planning for tomorrow.

BELL TELEPHONE LABORATORIES

Exploring and inventing, devising and perfecting, for continued improvements and economies in telephone service.



Characteristics of AM Detectors

W. E. BABCOCK*

When a radio receiver is used as a high-quality signal source, the detector circuit is of great importance. The author reviews the commonly used types, with emphasis on the distortion resulting from each.

IN THE CONSTRUCTION of a high-quality audio system for a receiver, a distortion-free detector circuit should be provided. As an aid to good design in this respect, a review of various AM detectors is of value. The diode detector merits detailed discussion because it can give good fidelity and because the factors involved in the choice of its circuit parameters apply in general to all detectors. The "infinite-impedance" detector also is of interest, for it has both high-fidelity and high-input-impedance characteristics.

Detection of Amplitude-Modulated Signals

Ideally, a detector should reproduce modulation signals with no distortion. Since all known rectifiers act as square-law detectors (with resultant distortion) at low signal inputs, a fairly high signal level is desirable. With present-day receiving tubes and circuits it is relatively easy to amplify the signal until a level of several volts is available at the detector input. In the discussion to follow, it will be assumed that the signal is sufficiently large to minimize distortion due to square-law detection.

Detection of a modulated r.f. signal may be accomplished by means of a non-linear impedance, i.e., any device in which the relationship between applied voltage and resultant current may not be represented graphically by a straight line. An electron tube is such a non-linear impedance. Other non-linear impedances are saturated iron-core inductances, electrolytic rectifiers, copper-oxide rectifiers, and "semi-conductor" crystals such as galena, iron pyrites, carborundum, and germanium. Such impedances act as rectifiers, producing a pulsating direct current varying in magnitude in accordance with the modulating signal. Germanium crystals are finding increasing application as detectors, especially in television applications, but most present-day receivers use electron tubes as detectors. Only electron-tube detectors will be considered, but the information on diode detectors is applicable to crystal detectors.

The Diode Detector

The basic circuit of a linear diode detector for the detection of amplitude-modulated waves is shown in Fig. 1, together with the current and voltage wave-forms. Near the crest of each positive peak of input voltage the tube passes a pulse of current, charging capacitor

C_1 to a value almost equal to the peak of that particular voltage cycle. The tube drop prevents the output voltage from actually reaching the peak value. When the input voltage drops to a value below that across C_1 the tube ceases to conduct. Capacitor C_1 then gradually discharges through R_1 until the next positive peak of input voltage occurs, at which time the tube again conducts and C_1 is recharged. The resulting modulation voltage across R_1 C_1 is, therefore, as shown in Fig. 1, somewhat jagged. However, since the r.f. voltage is very much higher in frequency than the modulating voltage, the jaggedness is not nearly so pronounced as it appears to be in the exaggerated waveform shown. Actually, the waveform across R_1 C_1 is essentially that of the modulating voltage.

The time constant R_1 C_1 should be

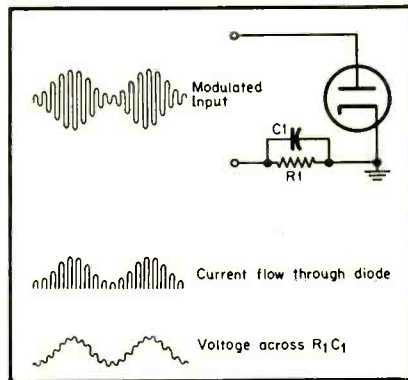

Fig. 1. Basic diode detector circuit.

large compared to the period of the r.f. cycle. However, if this time constant is too large, the output voltage appearing across R_1 C_1 cannot rise and fall as rapidly as the modulation envelope and will not truly reproduce the modulation envelope. The maximum permissible value of R_1 C_1 is given approximately by the following relationship:¹

$$R_1 C_1 = \frac{1 - m^2}{m W_m}$$

where W_m is 2π times the modulating frequency and m is the modulation factor. According to this equation, as the modulation factor approaches one, (100 per cent modulation) the required time constant and, therefore, the required C_1

¹ F. E. Terman and N. R. Morgan, "Some properties of grid leak power detection," *Proc. I.R.E.*, 18 (1930), 2160-2175.

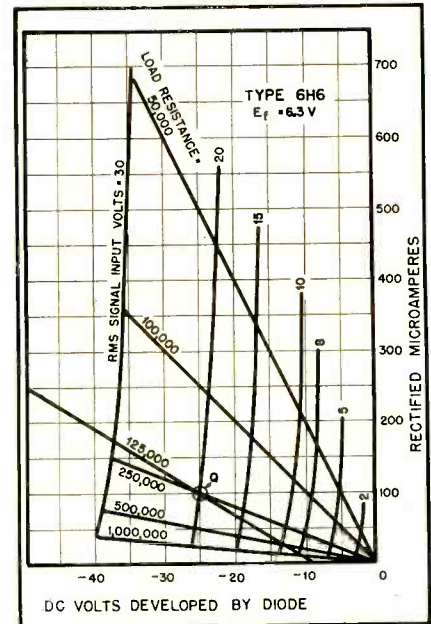

Fig. 2. Average characteristics of a 6H6 used as a single diode for half-wave rectification.

approaches zero. If C_1 approaches zero the output would contain both carrier and sideband frequencies and would not follow the envelope of the modulating frequency. However, it has been shown² experimentally that the distortion produced by the detector will not be excessive if

$$R_1 C_1 = \frac{1}{m W_m}$$

Graphical Analysis of Diode Detector

To analyze the behavior of a typical detector circuit, use is made of the diode rectification characteristics supplied by the tube manufacturer. Figure 2 gives the rectification characteristics of the 6H6. When a resistance load is connected in the plate circuit of the tube, a solution for the direct current and corresponding output voltage may be obtained by drawing a load line as for a triode amplifier. Since no direct voltage is applied the load line passes through the origin. The slope of the load line is the reciprocal of the load resistance. Figure 2 shows load lines for several values of load resistance.

To illustrate the operation of the circuit of Fig. 1, let us assume that the tube is a 6H6, that the load resistance is

² F. E. Terman and J. R. Nelson, "Discussion of some notes on grid circuit and diode rectification," *Proc. I.R.E.*, 20 (1932), 1971-1974.

* Tube Department, Radio Corporation of America, Harrison, N. J.

250,000 ohms and that a modulated-carrier input signal of 15 volts r.m.s. or 21 volts peak is applied. Figure 2 shows that at the quiescent point *Q* (zero modulation) the d.c. diode current is 75 microamperes and the d.c. output voltage is 19 volts (the peak voltage of 21 volts less 2 volts drop across the diode). If the input signal is modulated 100 per cent, the instantaneous input voltage varies between 0 and 30 volts r.m.s. The corresponding intersections on the 250,000-ohm load line show that the output voltage varies from 0 to 37.8 volts. Further analysis indicates that, along any load line, the direct-current output is very nearly proportional to the r.m.s. value of the input voltage and that the harmonic distortion is negligible.

Now if the audio output of the detector is coupled to an audio-frequency amplifier stage, the detector may be as shown at (A) in Fig. 3. When the detector output is coupled to a following amplifier stage, the audio-frequency impedance of the detector load is less than the d.c. impedance, the operating point of the detector will not follow the d.c. load line to the origin (a.f. load line coincides with d.c. load line only at quiescent point *Q*), and distortion will occur if the modulation percentage is high. If C_2 has negligible reactance at the modulating frequency, the a.c. impedance of the load is $\frac{R_1 R_g}{R_1 + R_g}$. If

$R_1 = R_g = 250,000$ ohms, the a.f. impedance is 125,000 ohms. With a modulated input, operation takes place along a line through *Q* having a slope corresponding to 125,000 ohms. Figure 2 shows that for such a case, with 100 per cent modulation, the output will go to zero, not when the modulation envelope goes to zero, but when it decreases to an r.m.s. value of about 6 volts. Consequently, appreciable harmonic distortion will result if the modulation envelope is such that it decreases to a level

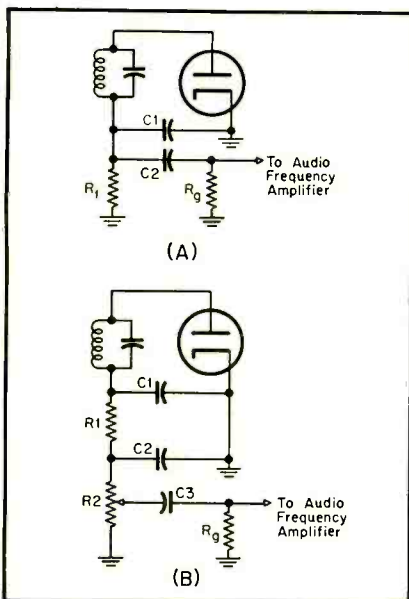

Fig. 3. Two methods of coupling a typical diode detector to the following audio amplifier stage.

below 6 volts. Therefore the maximum percentage modulation which the detector can accommodate without introducing distortion is

$$\frac{15 - 6}{15} \times 100 = 60 \text{ per cent}$$

If, however, the amplifier tube following the detector is a high- μ tube with grid-leak bias, R_2 may be as high as 10 megohms and the distortion introduced due to the difference between the a.f. and d.c. impedances of the detector will be negligible.

The circuit of (B) in Fig. 3 is perhaps more typical of the usual method of coupling the detector output to an audio-amplifier stage. In this case the diode load is split into two sections, the lower resistor serving as a volume control. For the same total value of diode load (neglecting the shunting effect of R_g and assuming $R_1 = R_2$), the audio output is only half that of the circuit of (A) in Fig. 3. With the volume control set near maximum, for low values of R_g the distortion at high modulation levels, although below that of (A), will be appreciable. However, in most receivers the audio gain is much higher than required for local stations, the volume control is turned to a low setting, and the resulting distortion is small. Furthermore, in most receivers R_g is high enough to have negligible shunting effect at any volume control setting.

Other Factors Affecting Detector Operation

It should be realized that the above

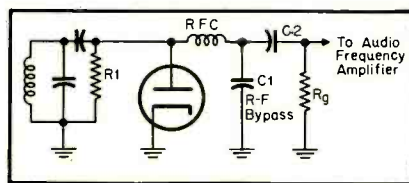

Fig. 4. Another type of diode detector circuit, with the load effectively in parallel with the diode.

analysis is approximate and does not include many of the factors involved in diode detection. For example, even though R_g in the circuit (B) is made extremely large, the a.f. impedance of the diode load may be considerably lower than the d.c. impedance because of the shunting effects of a.v.c. circuits or electron-ray indicator tubes. Another factor involved is that the diode and its load act as an impedance shunting the input and thus affect the selectivity of the input circuit. Distortion in the preceding r.f. amplifier stage may also result because of the inability of the r.f. amplifier to produce the required output voltage when loaded. The shunting impedance of the diode detector is predominantly resistive and is approximately

$$R_{diode} = \frac{R_1 + R_2}{2}$$

for the circuit of (B).

Another circuit which has been used

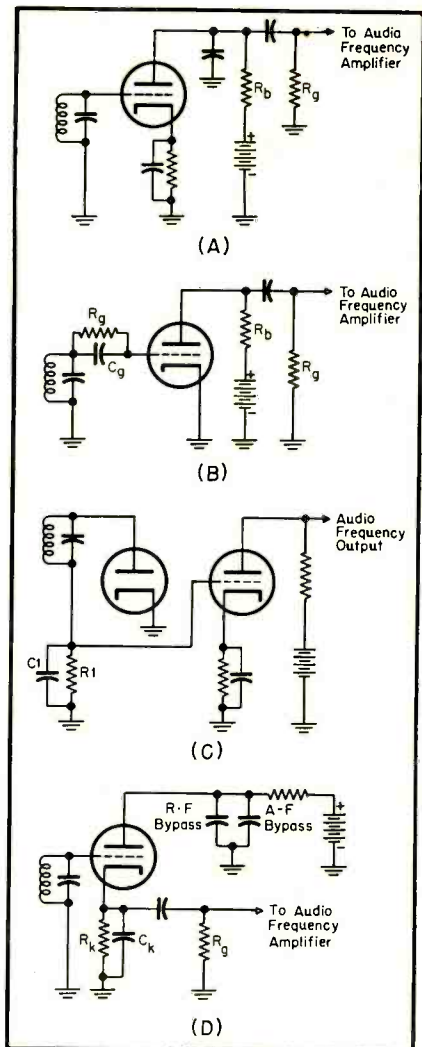

Fig. 5. Triode detector circuits: (A) bias, or plate-circuit detector; (B) grid-circuit detector; (C) combined diode detector and triode amplifier; and (D) infinite-impedance detector.

for diode detection is shown in Fig. 4. For this circuit the impedance in parallel with the tuned circuit is $R_1/3$ (R_1 in parallel with $R_1/2$).

Detectors Employing Multielectrode Tubes

Multielectrode tubes (triodes, tetrodes, or pentodes) may also be used as detectors. Several basic detector circuits employing triodes are shown in Fig. 5.

The circuits of (A) and (B) in Fig. 5 are similar to that of a diode detector, combined with a stage of audio amplification, but the input impedance and distortion characteristics vary considerably from those of a diode detector. (C), obviously, is a diode detector directly coupled to an audio amplifier stage. (D), the "infinite-impedance" detector, is similar to a diode detector in combination with a cathode-follower audio amplifier stage. As will be shown later, the infinite-impedance detector combines the low-distortion characteristics of the diode detector with the high-impedance characteristics of the triode detector.

The Plate-Circuit Detector

In the circuit of (A) in Fig. 5, the triode is biased to cutoff by means of

fixed bias, or more conveniently, by means of cathode bias. The manner in which detection occurs may be shown by reference to the following typical curve of the relationship between control-grid voltage and plate current for a triode. The shape of this curve is very similar to the plate voltage—plate current characteristic of a diode, except that it does not pass through the origin and may exhibit less curvature than the diode characteristic. Evidently, with the grid biased to cutoff, plate-current flow occurs only when the signal voltage is of proper polarity and magnitude to cause the grid voltage to rise above the cut-off value.

The operation is almost identical to that of a class B₁ amplifier. The signal should not be allowed to swing the grid positive (as in a Class B₂ amplifier) if distortion is to be avoided. If the degree

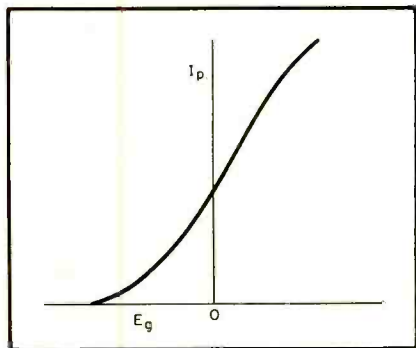

Fig. 6. Typical triode transfer characteristics.

of modulation is not too great and the applied signal is sufficiently large, the modulated envelope is applied to the straight portion of the $E_g - I_p$ curve and linear operation results. As the modulation approaches 100 per cent, distortion will result because of curvature near the extremities of the $E_g - I_p$ curve.

The bias voltage required to make the plate current nearly zero when no signal is applied to the grid may be obtained by means of a battery or a bleeder across the d.c. power supply. However, it is usually more convenient to obtain this voltage by means of a cathode resistor bypassed for both radio and audio frequencies. Cathode bias has an additional advantage in that it tends to compensate for changes in tube characteristics with life.

Distortion may result in the plate-circuit detector because of: (1) grid current flow when too large a signal is impressed; (2) clipping of negative audio peaks when the fixed bias is excessive; and (3) operation in the curved portions of the $E_g - I_p$ curve when the modulation percentage is high. The plate-circuit detector is also subject to distortion at high modulation levels when the grid resistance of the following audio amplifier stage is low enough to make the a.c. plate-circuit impedance of the detector appreciably lower than the d.c. impedance. The input impedance of the plate detector is extremely high as long as no grid current flows. Also, the output voltage is much higher than that of the diode detector. Because there may

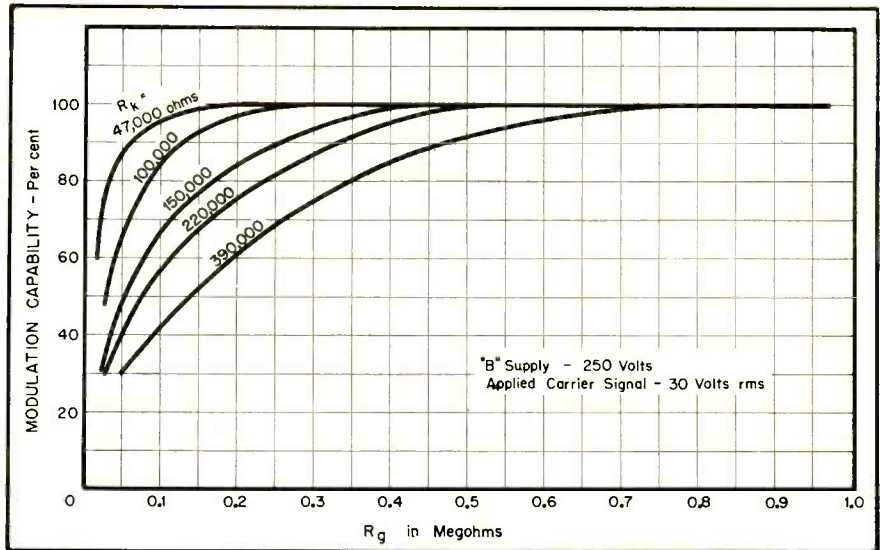

Fig. 7. Modulation capabilities of infinite-impedance detector using 6C4 tube.

be appreciable damping of the input circuit due to feedback through the grid-plate capacitance of the triode, it is often desirable to use a tetrode or pentode as a plate-circuit detector. In addition, the output voltage of a tetrode or pentode is much higher than that of a triode.

Grid-Circuit Detectors

In the grid-circuit detector of (B) in Fig. 5, more commonly called the "grid-leak detector," resistor R_g and the capacitor C_g correspond to the $R_1 C_1$ diode load impedance of Fig. 1. The grid-cathode circuit of this detector functions exactly in the same manner as the diode-detector circuit previously discussed, with the grid functioning as the diode plate.

The grid-circuit detector is very similar to a diode detector plus one stage of audio amplification. The time constant $R_g C_g$ is determined by the same factors affecting $R_1 C_1$ in the circuit of Fig. 1. Likewise, the input resistance and requirements for avoiding frequency distortion are determined by the same factors as for the diode detector. This circuit does have an advantage over the diode detector in that the a.c. load impedance and d.c. load impedance are the same, since the audio load resistor is in the plate circuit of the tube.

The grid bias of the grid-circuit detector is determined by the average voltage developed across $R_g C_g$ when a signal is impressed. Consequently, when no signal is impressed the grid bias is zero. The maximum plate voltage, therefore, that may be used with a tube operating in a grid-circuit detector is less than that which may be used with the same tube operating as a class A amplifier. Distortion may then be produced at the crest of the modulation cycle, since the tube overloads easily at low plate voltages. With optimum input signal the output is very nearly distortionless. Practically speaking, however, the grid-circuit detector is rarely superior to the diode detector. If the signal is too small, the diode section introduces distortion.

If the signal is too large, the amplifier section overloads.

Combination Diode Detector and Direct-Coupled Triode Amplifier

The circuit of (C) in Fig. 5 employs two tubes or one multipurpose tube. Because the grid of the triode amplifier is connected directly to the diode load, there is no difference between the a.f. and d.c. impedances of the diode load, and distortion is therefore reduced. However, if a.v.c. is not used, serious distortion will result with large signal inputs. The d.c. voltage developed across the diode load may be large enough to bias the triode to cutoff or at least to cause operation in the non-linear portion of the triode characteristic. In practice it is customary to isolate the grid from the d.c. voltage developed by the diode by inserting a blocking capacitor between the diode load and the triode grid. With this capacitor the circuit becomes that of (A) or (B) in Fig. 4 and the same considerations are involved for avoiding distortion as previously discussed under diode detectors.

Infinite-Impedance Detector

The "infinite-impedance" detector of (D) in Fig. 5 consists essentially of a triode having the audio load resistance, suitably bypassed for r.f. entirely in the cathode circuit. The circuit is degenerative for audio frequencies, but not for radio frequencies. Plate-current flow through the cathode resistor biases the tube nearly to cutoff. When a signal voltage is applied, this negative bias increases, thus tending to prevent the flow of grid current at the positive peaks of the modulation cycle. Consequently, a much larger grid signal can be accommodated without causing distortion than in other detectors employing multielectrode tubes. However, it is possible to increase the input voltage to a level at which the grid becomes positive with respect to the cathode, resulting in the flow of grid current and a reduction of the input impedance. It is, therefore,

[Continued on page 25]

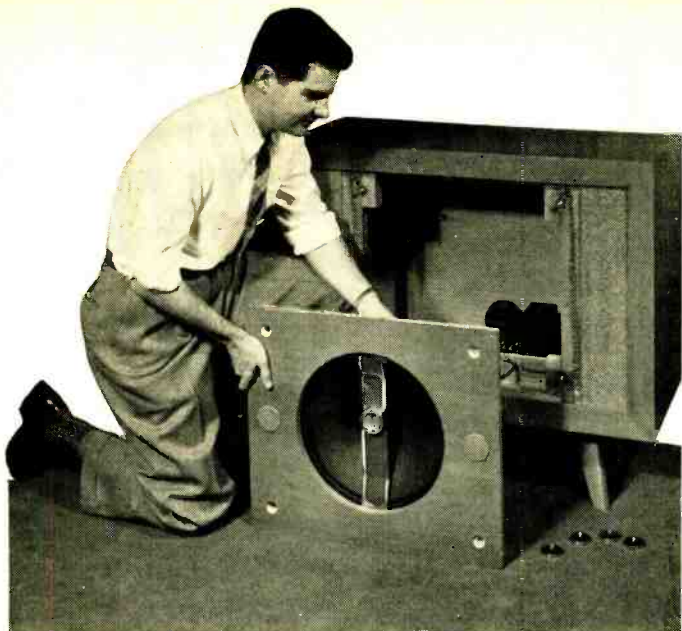

Loudspeaker Enclosures

DANIEL J. PLACH* and
PHILIP B. WILLIAMS**

Any evaluation of a speaker system must include the cabinet in which the loudspeaker unit is mounted; the authors analyze all commonly used enclosures with respect to size and performance.

ENCLOSURES must be considered as an integral part of an acoustic radiating system. The low-frequency performance of a loudspeaker system depends to a large extent on the enclosure—in many cases is governed by it. It is the purpose of this article to discuss the features of the more generally used types of enclosures, and factors that must be considered in order to obtain the best possible low-frequency performance. Charts and equations are given which will enable the constructor to design enclosures of various types with reasonable assurance of obtaining an optimum design.

As an aid to understanding the function and operation of enclosures, a review of the principal types of enclosures is helpful. These may be divided into five main types:

1. Flat baffle
2. Open back cabinet
3. Enclosed cabinet
4. Horn loaded
5. Bass Reflex

No one type will fit all purposes and uses. It must be decided from a study of the characteristics of the various types which enclosure or which combination of enclosures will be most desirable for the application.

Flat Baffle

To describe the behavior of a flat baffle, it is necessary to consider the concept of doublet and simple sources of sound. A doublet source is one in which two point sources of equal strength and opposite phase are separated by a small distance. This is exemplified by a loudspeaker cone operating at low frequencies without a baffle.

The power radiated by the acoustic doublet is proportional to the fourth power of frequency and to the square of the velocity of the diaphragm.

A direct-radiator loudspeaker is essentially mass controlled above its resonant

frequency so the velocity of the diaphragm is inversely proportional to frequency. The radiated power is therefore proportional to frequency, and increases 6 db per octave. Below resonance the speaker is stiffness controlled and the velocity is proportional to frequency so that the radiated power is proportional to the sixth power of frequency and falls off 18 db per octave. By comparison, the output of a simple source radiating into a semi-infinite medium—as in the case of a speaker cone in a large or infinite baffle—is proportional to the square of both velocity and frequency. Since the velocity is inversely proportional to frequency, the power output is independent of frequency as long as the diaphragm behaves as a simple piston. Below resonance, the response is proportional to the fourth power of frequency, falling off at the rate of 12 db per octave.

The radiation impedance of the diaphragm in the infinite baffle is considered as a simple mass in series with a re-

sistance whose magnitude is a function of frequency. In the region where $2\pi d/\lambda$ is less than 1, this condition is valid. (d is diaphragm diameter and λ is wavelength.) In this region the magnitude of radiation mass M_A for one side is given by

$$M_A = .00658d^3$$

where d is the effective diameter of the speaker in inches, generally .8 to .85 of the speaker nominal diameter. The radiation resistance for one side is given by the expression

$$R_A = 5.6 \times 10^{-6} f^2 d^4$$

where R_A is in mechanical ohms and f is frequency. The radiation resistance is

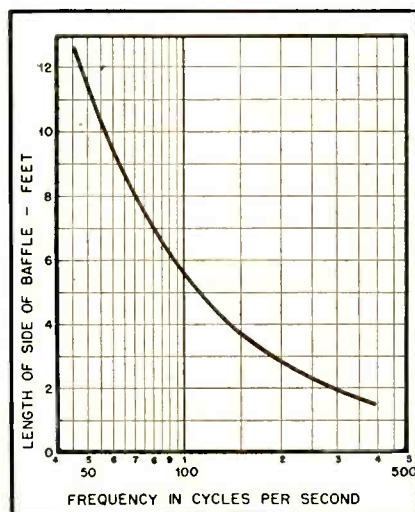

Fig. 1. Relation between low-frequency response and baffle size.

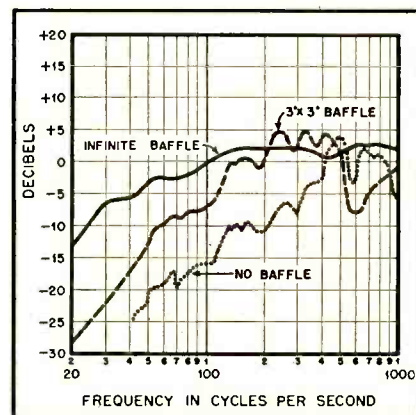

Fig. 2. Response of 15-in. speaker in different baffles.

of the magnitude of 360 ohms at 50 cps for a 15-in. speaker. This accounts for the poor damping and high distortion at resonance because of light speaker loading at low frequencies.

With an infinite baffle, good response may be maintained down to the resonant frequency of the speaker. The limiting factor in low-frequency performance is the resonant frequency of the speaker.

While a true infinite baffle does not

* Physicist, and ** Senior Engineer, Jensen Manufacturing Company, 6601 S. Laramie Ave., Chicago 38, Ill.

exist, it can be approximated for practical purposes by a baffle of dimensions equal to or larger than one-half wavelength at the lowest frequency to be reproduced. Figure 1 is a plot of baffle dimensions required for the lowest frequency to be reproduced. It can be seen from the chart that a baffle would have to be at least 11 ft. square for adequate reproduction at 50 cps. A good solution is to use the wall of a room as a baffle, permitting the speaker rear to radiate into an adjoining room. If the back of the speaker radiates into a relatively small volume, care must be taken to avoid enclosure resonances by addition of suitable damping materials. In addition, the volume of the enclosure has an effect upon speaker resonance, as described in the section on enclosed box operation.

If a flat baffle is used, the speaker should preferably be mounted off-center so that there is a variety of different path lengths for sound travel from front to back. This procedure avoids irregularities that may otherwise occur in the response curve.

Effect of baffle size on a 15-in. high-efficiency, low-resonance speaker is shown in Fig. 2. Where economy in space, good low-frequency response and good transient response are needed, flat

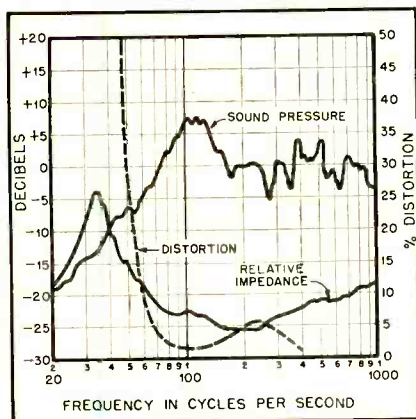

Fig. 3. Low-resonance 15-in. speaker in open-back cabinet 4 in. from wall.

baffles are impractical in most applications.

Open-Back Cabinet

Only a brief mention is to be made here of open-back cabinets widely used in commercial radio receivers. In the frequency region where the cabinet dimensions are large in comparison to wavelength of the sound, the system acts as a simple source. For a mass-controlled system, with constant driving force, the output is independent of frequency. Below this point, the transition occurs to the doublet source, and output falls off rapidly. Low-frequency performance is critically dependent upon positioning of the cabinet in the room. The action is that of a folded baffle. Typical response of a 15-in. speaker in an open-back 7-cu. ft. cabinet 4 in. from a wall is as shown in Fig. 3. The rise at 100 cps is caused by the cabinet acting as a resonant tube, and would be more pro-

Fig. 5. Increase in resonant frequency vs. cabinet volume.

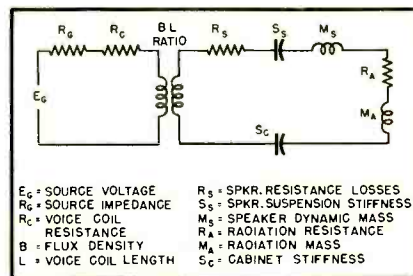
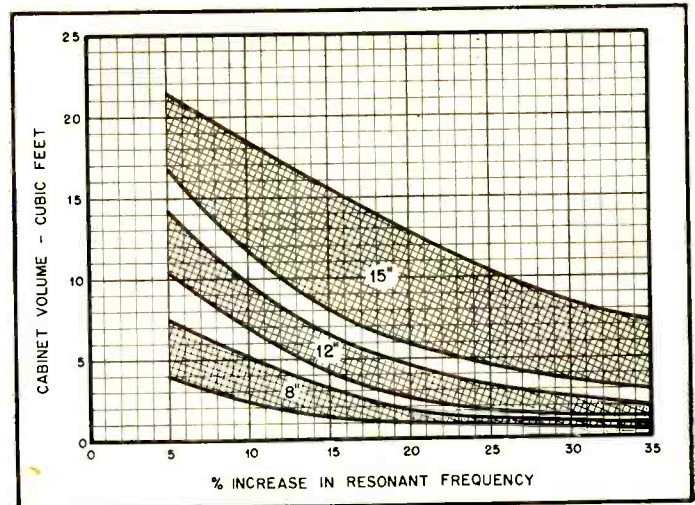

Fig. 4. Equivalent circuit of loudspeaker in closed-back cabinet.

nounced with a speaker of lower efficiency or if the cabinet frequency were placed at the resonant frequency of the speaker. The exaggerated output in this region may cause undesirable "boominess." This type of cabinet is not commonly used in high-quality reproducing systems today.

Enclosed Cabinet

The use of an enclosed cabinet with adequate volume makes it possible to attain satisfactory low-end performance, since a loudspeaker system with this type of enclosure operates essentially as a simple source. The output falls off much more slowly at low frequencies than with an open-back cabinet.

The impedance presented to the speaker is given by:

$$Z = -j\rho c \frac{A_s^2}{A_c} \cot \frac{2\pi L}{\lambda}$$

where A_s = effective speaker area
 A_c = cabinet area normal to L
 L = length of side normal to A_c
 ρ = density of air
 c = velocity of sound
 $j = \sqrt{-1}$

Expansion of the cotangent function in series form yields the stiffness S_v as contributed by the box to the speaker: $S_v = \frac{\rho c^2 A_s^2}{V}$ where V is cabinet volume.

The second term is a positive one that corresponds to a mass M of magnitude:

$$M = \frac{1}{3} \frac{A_s^2}{A_c} \rho L$$

Below the point where L equals $\frac{1}{4}$ wavelength, the box volume introduces

stiffness into the mechanical mesh of the speaker. Above this point, the box acts as a mass until L equals $\frac{1}{2}$ wavelength, at which point the first normal mode of the box occurs. These modes or resonances have the effect of reducing the stiffness in the limited region where L is less than $\frac{1}{4}$ wavelength. They occur at integral multiples of π and are points of high reactance as presented to the speaker. These resonances have the effect of introducing irregularities in the response of the loudspeakers. Since they generally occur at higher frequencies, it is possible to reduce their effect by addition of absorbent material in the box. This treatment—consisting of heavy felt, cellulose, glass fiber mat, or other damping material—is applied to at least one of each pair of parallel surfaces. Damping material makes the box appear as a resistance at high frequency and adds to the speaker damping.

A study of the cotangent function

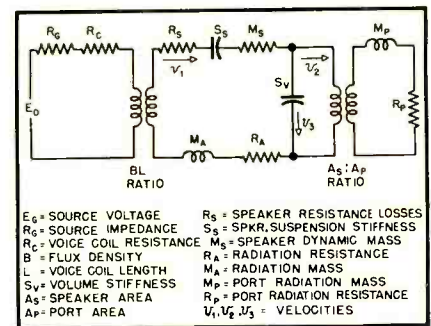

Fig. 6. Equivalent circuit of loudspeaker in typical bass-reflex enclosure.

shows that the box does not act as a simple stiffness at all frequencies. The box differs from this simple stiffness behavior even for values of L somewhat less than $\frac{1}{4}$ wavelength. However, if the linear dimensions of the box are less than $\frac{1}{8}$ wavelength, the error results in stiffness values somewhat smaller than expected. When the speaker resonance occurs at a frequency high enough so that the box dimensions are larger than $\frac{1}{8}$ wavelength, the more exact expression for stiffness must be used in calculations.

For most design purposes, the stiff-

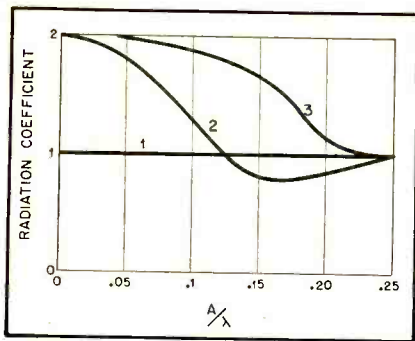

Fig. 7. Relative radiation from circular diaphragm combination. (1) single diaphragm; (2) two diaphragms 4A apart; (3) two diaphragms, in contact.

ness contribution due to the box as seen by the speaker is given approximately by:

$$S_v = \frac{2.26 \times 10^6 d^4}{V}$$

V is in cubic inches and S_v is in dynes per centimeter. This stiffness acts in series with the mechanical mesh of the loudspeaker as in the equivalent circuit in Fig. 4.

The effect of the compliance is to raise the resonant frequency of the loudspeaker above that which would exist when mounted in an infinite baffle. The effective system stiffness S_e resulting from the volume stiffness addition to the speaker then becomes:

$$S_e = S_s + S_v$$

where S_s is the stiffness of the loudspeaker vibrating system. The speaker resonant frequency f_e in the enclosed cabinet, has the relationship to f_b , resonant frequency in infinite baffle:

$$f_e = f_b \sqrt{\frac{S_s + S_v}{S_s}}$$

So as the volume is made large, S_v approaches zero and for practical purposes the conditions of an infinite baffle are attained.

From these equations, it is possible to calculate the volume required to limit the resonance shift to a prescribed value.

Figure 5 gives the relationship between enclosure volume and frequency shift in terms of speaker size. The chart is based upon suspension compliances of Jensen loudspeakers as listed by nominal diameter sizes. From a practical standpoint, the chart is adequate for use with most speakers of the nominal sizes listed. A resonance shift of 5 or 10 per cent is not excessive, if one considers that a shift of 10 per cent at 50 cps is only 5 cps. For

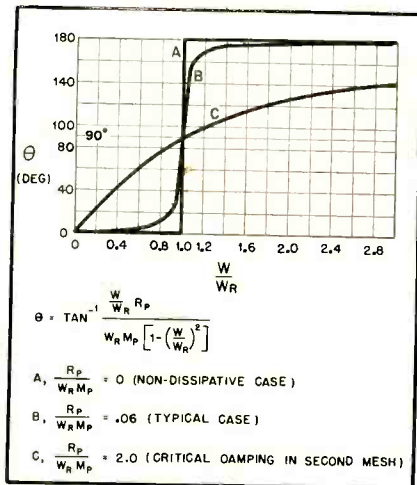

Fig. 8. Relative phase between currents (velocities) in two mechanical meshes.

each nominal speaker size, a shaded area is given. The upper limit of the area corresponds to speakers of least stiffness, and the lower limit corresponds to speakers with the highest stiffness. Information on the actual stiffness of loudspeakers is not usually available, so the upper limit of the shaded area should be used whenever possible to insure sufficient enclosure volume for all speakers. The geometry of the cabinet has not been found to be overly critical, if the longest side is not more than $\frac{1}{8}$ wavelength in the range under consideration. The stiffness contribution of the cabinet will, however, be somewhat dependent on the cabinet geometry.

In addition to precautions to be taken in placement of absorbing material, the cabinet wall conditions must be con-

sidered. High pressures exist in the enclosure in operation. It is desirable to use material at least $\frac{1}{2}$ in. thick for the enclosure walls to reduce vibration during operation, and special bracing may be necessary. Vibrating walls introduce a variable compliance and add dissipation, tending to produce irregularities in the response, as well as possible objectionable rattles. This phenomenon often shows up as irregularity in the impedance curve.

While satisfactory response can be attained with this type of enclosure in adequate volume, lower distortion and better damping characteristics can be achieved with other types of enclosures.

Horn Loaded

Due to some restrictive limitations, horn loading for direct-radiator speakers

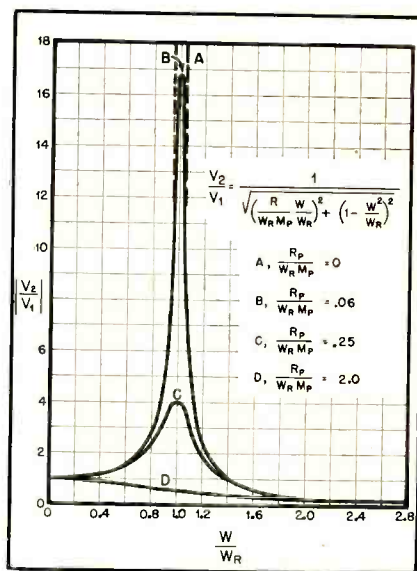

Fig. 9. Magnitude of the ratio of port velocity to diaphragm velocity.

is not used extensively, despite considerable advantages in performance. There are two main ways of horn-loading the speaker. One is to load the front end of

[Continued on page 33]

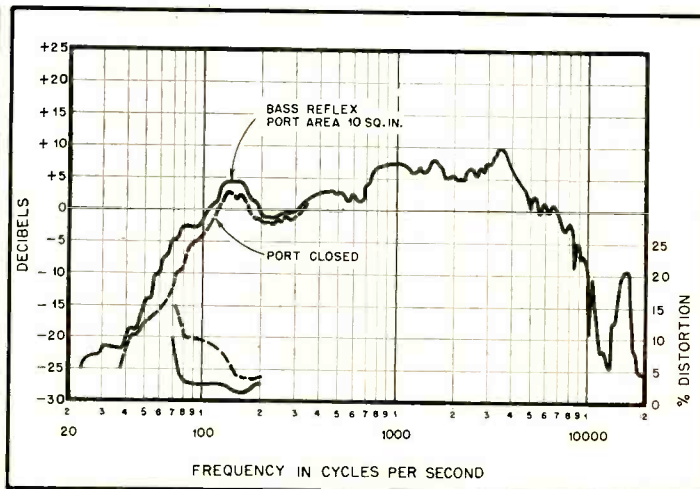
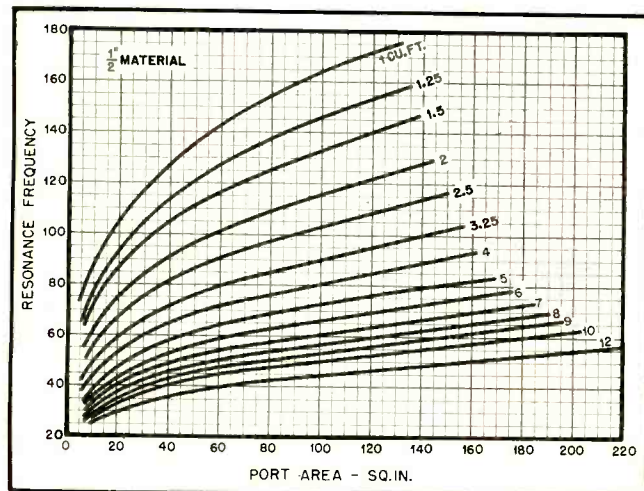

Fig. 10. (left). Port area vs. resonant frequency in bass-reflex cabinet. Fig. 11. (right). Sound pressure response and r.m.s. distortion of 8-in. speaker in 1 cu. ft. enclosure.

Adding Decibel-Expressed Quantities

ALFRED L. DiMATTIA* and LLOYD R. JONES*

The authors present a simple nomograph which reduces the work of adding levels to its simplest form.

WHEN QUANTITIES expressed in decibels are to be multiplied, it is an easy task to obtain the product (in decibels) by algebraic addition of the number of decibels.

A less common but important problem arises when two or more quantities expressed in the decibel notation are to be added. Ordinarily, this involves a tedious conversion of each quantity from decibels to the corresponding power ratio. Then the individual ratios must be added and the sum reconverted to decibels.

The nomograph eliminates the need for such conversions. The difference between any two decibel-expressed quantities is first determined by algebraic subtraction. This value is next found on scale A. The corresponding figure on scale B indicates the number of decibels to be added to the greater original quantity to yield the required answer. For example: supposing two powers expressed as 35.2 db and 37.0 db (relative to a common reference) are to be added. The difference is 1.8 db which, when located on scale A, corresponds to 2.2 db on scale B. This value is then added to 37.0 db to yield the resultant power of 39.2 db.

As another example, two voltages expressed as -2.0 db and +1.5 db have an algebraic difference of 3.5 db. The chart indicates that 1.6 db should be added to the greater original quantity, which in

this case is +1.5 db; thus the answer is +3.1 db.

Problems involving the addition of more than two decibel-expressed quantities also may be solved. Any two quantities are chosen and added by means of the nomograph. The result is then added to any one of the remaining quantities by repeating the operation; thus, each step reduces the number of quantities by one. A succession of such operations will yield the desired answer.

The nomograph can be applied equally well to expressions of powers, voltages, currents, sound pressure levels, and components of noise or distortion. By reversing the procedure, it is possible to evaluate the contribution of either of two added quantities to the total, when the other quantity and the total are known, if the difference between the total and the known quantities is equal to or less than 3.01 db.

When the difference between two added quantities is greater than 10 db, the contribution of the smaller quantity is generally neglected. However, the scale has been drawn to accommodate a difference of 20 db in order to satisfy more exacting demands for accuracy. Disregarding the smaller quantity when the difference exceeds 20 db produces an error of less than one per cent.

The nomograph scales are based on the formula:

$$B = \left[10 \log_{10} \left(1 + \log_{10}^{-1} \frac{A}{10} \right) \right] - A$$

where A and B correspond to points on the respective scales.

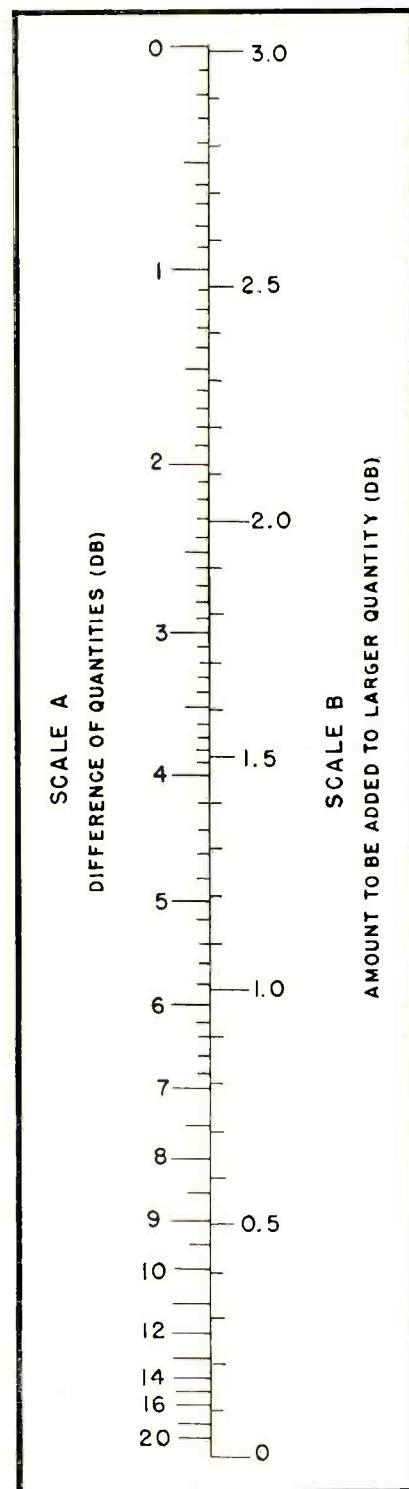

* Engineering Dept., Dictaphone Corporation, Bridgeport, Conn.



AES Board Meets to Plan '51 Convention and Audio Fair

At the close of the meeting shown here the 1951 Convention of the Audio Engineering Society, and The Audio Fair, were accomplished facts—waiting only for the grand opening on November 1 in the famous Hotel New Yorker.

Pictured from left to right are Harry N. Reizes, Fair manager, and AES officials F. Sumner Hall, acting secretary, C. J. LeBel, past president, C. G. McProud, executive vice-president, John D. Colvin, president, and Ralph A. Schlegel, treasurer.

A Mixer and a Preamplifier for the Recording Enthusiast

G. H. FLOYD*

Constructional details of two simple but useful items which will find many uses in the experimental work of anyone who works with audio in any form.

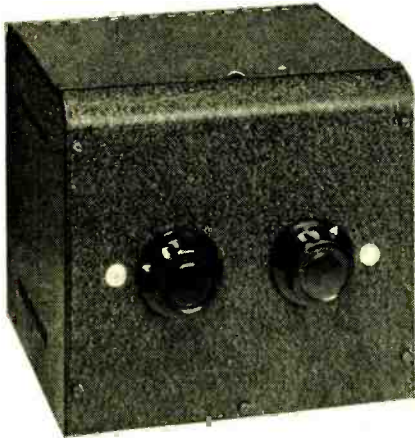

Fig. 1. The simplicity of the front panel of the mixer is made possible by mounting the connectors and switches on the chassis so they are accessible by opening the cabinet top.

A TWO-CHANNEL MIXER and a high-gain preamplifier are two necessary pieces of equipment if one does semi-professional recording work with a "live" pickup.

Two microphones are often needed if a large pickup area is involved. In order to use two microphones properly, a mixer is required. Further, when two pickup points are involved it is more than likely that at least one of the microphones will have to be placed at a point remote from the recorder. This is no great disadvantage if the microphone so placed has a low-impedance output, as the pickup cable can be run for several hundred feet without serious frequency discrimination. On the other hand, if the microphone has a high-impedance output the connecting cable must be kept short unless a preamplifier is used. Such a preamplifier can be designed so that a long connecting cable may be used between it and the recorder, the preamplifier being placed near the microphone.

A mixer is also invaluable for re-recording work. That it, it may be used to mix two different sources, feeding the output to a single recorder. With this setup it is quite simple to make an edited copy of similar recorded material. In addition, oral comments may be mixed with previously recorded material to form a sort of running commentary.

The purpose of this article is to de-

scribe how to build a one-tube two-channel mixer and a one-tube high-gain preamplifier. Since the design of these units is such that no audio transformers are required the use of expensive input and output transformers is avoided. The resultant performance is better than that obtained with all but the most expensive audio transformers.

One-Tube Two-Channel Mixer

Figure 2 shows the circuit diagram for the mixer to be described. Potentiometers R_1 and R_2 serve as individual gain controls for the two inputs. Each input feeds a control grid in the dual-triode 12AT7 miniature tube. Resistors R_3 and R_4 , together with capacitors C_1 and C_2 , form a frequency-compensated attenuator which will be discussed in more detail later. Two outputs are available, one being 20 db down from full output.¹

The power supply uses selenium rectifiers in a full-wave voltage-doubling circuit. Transformer T_1 has a 120-volt secondary as well as a filament winding. The output voltage under load is approximately 250-300 volts. An a.c. outlet is provided in the mixer as a convenience, because recording work usually involves a number of components requiring a.c. power.

Operating convenience is of great importance, so that the mechanical de-

¹In the schematics, photographs, and text, reference is made to voltage ratios, expressed in decibels. The decibel quantities stated are intended only as voltage ratios defined by the equation $db = 20 \log_{10} (E_1/E_2)$, and bear no particular relationship to the commonly understood zero reference level of one milliwatt in a 600-ohm load.

sign of the mixer should follow personal preferences of the user. Two features are desirable in any case, however. The cabinet should be large enough so that it cannot be moved or jarred easily. The knobs on the gain controls should be large and easy to handle, especially if they are to be used for long periods of time. The skirted knobs shown have raised indicator points so that the settings of the controls can be determined by touch.

The rest of the mechanical design as shown reflects the personal preference

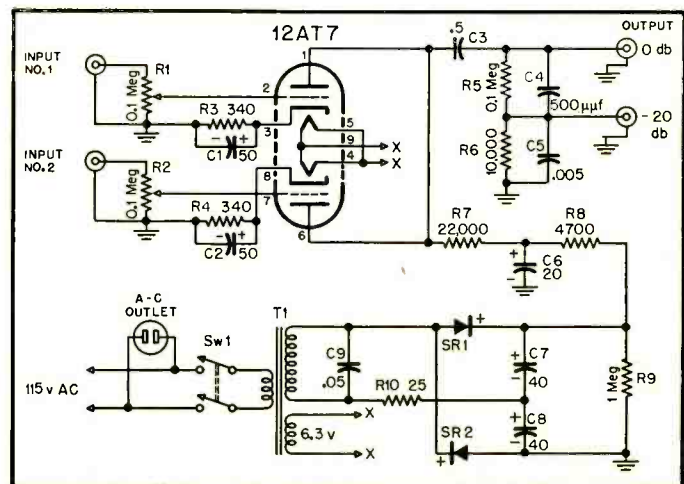

Fig. 3. Detail of the mixer chassis. The input connectors marked "L" and "R" correspond with the left and right gain controls.

of the author. The mixer shown in Fig. 1, for example, has no controls on the front panel other than the gain controls. The on-off switch and the input and output connectors are mounted on the chassis and accessible through the hinged top.

Rubber mounting feet are placed on the bottom and back of the cabinet so that the mixer can be used in one of two positions. Figure 3 shows how the

Fig. 2. Schematic of two-channel mixer and power supply.



*1109 S. Country Club Dr., Schenectady 9, N. Y.

chassis is mounted midway on the cabinet front panel, so that the gain controls are not so close to the bottom of the cabinet that they are difficult to handle.

Figures 3 and 4 indicate the placement of parts quite clearly. These parts are mounted on a conventional 5×7×2 chassis. The cabinet is 8 in. wide, 7½ in. high, and 8 in. deep.

Component layout is not critical but two precautions are in order. The first is an obvious one. Keep the input circuits separated from the output circuit. Secondly, use separate ground points for the two input circuits and output circuit. That is, the ground connection for R_1 , R_3 , C_1 and the Input No. 1 connector should be made at only one point on the chassis. Also R_2 , R_4 , C_2 , and Input No. 2 connector should tie together at a second point on the chassis. The same is true for R_6 , C_5 , C_6 and the two output connectors. If the circuit is wired in this way hum introduced by ground currents is avoided.

The potentiometers shown in the under-chassis view are actually dual units. These were used only because single units with a logarithmic taper were not

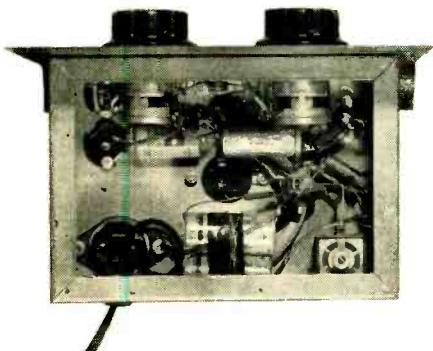

Fig. 4. Under-chassis view of the mixer.

immediately available at the time the mixer was built.

Shielded wire is used for one connection only, between the potentiometer at the right of Fig. 4 and its associated input connector. The use of shielded wire at this point may be unnecessary but it is a worthwhile precaution.

Output Attenuator

In any audio-frequency amplifying system which is made up of a number of units, flexibility of application is provided by fixed attenuation steps. The mixer incorporates a single 20-db output attenuator. In order to maintain constant attenuation over a wide range of frequencies, a frequency-compensated attenuator is valuable. This consists of R_5 , R_6 , C_4 and C_5 (see Fig. 2).

Although this type of compensation is not new, a brief statement of how it works might be in order. Assume that capacitors C_4 and C_5 were not in the circuit. Further assume that output cable with a total capacitance of 1000 μf is connected to the 20-db output connector. There is now a large amount of capacitance in shunt with R_6 , and only a very small amount of stray capacitance is shunt with R_5 .

Fig. 5 (above). Schematic of the high-gain preamplifier, and Fig. 6 (below), its power supply.

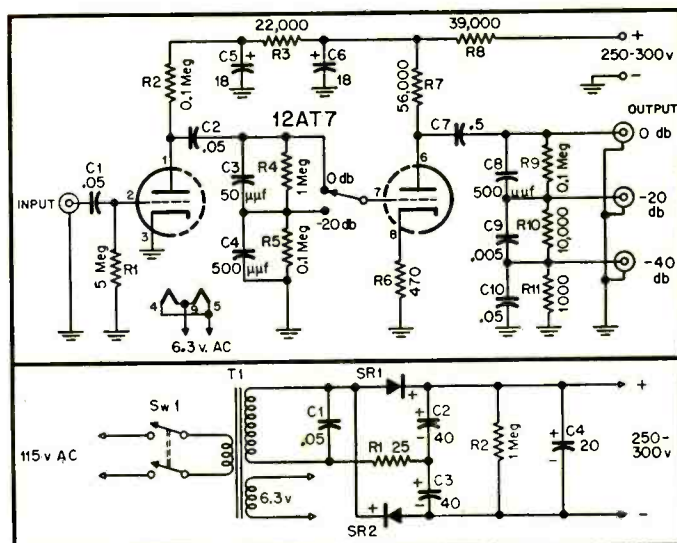

If a low frequency is impressed on this voltage divider the division of voltage is determined almost entirely by the ratio of $R_6/(R_5 + R_6)$. However, if a high frequency (such as 15,000 cps) is considered, the voltage division will no longer be proportional to the resistance ratio because of the capacitance added by the output cable.

Uniform attenuation can be accomplished by the addition of shunt capacitance such as C_4 and C_5 . In order that these capacitors divide the voltage in the same ratio as the resistors it is only necessary to make the products R_5C_4 and R_6C_5 equal.

An additional benefit accrues from the use of shunt capacitors in that moderate additional capacitance can be tolerated across the output connectors. This means that the capacitance of the output cable need not be of too great concern. For example, 500 μf can be tolerated across the -20 db output connector and 1500 μf across the 0 db output connector without seriously disturbing the frequency response. (Low-capacitance microphone cable has between 20 and 30 μf per foot. Some microphone cable may have a capacitance as high as 150 μf per foot.)

It is also possible to replace the fixed capacitance in the circuit with an identical amount of capacitance in the output cable, which means that 5,000 μf of cable capacitance could be added across the -20 db output if C_5 is removed. This is desirable only where a given cable of known capacitance is used. Of course, the capacitance represented by C_5 can be made up of any amount of external capacitance, up to 5,000 μf , and the remainder made up of a fixed capacitor in parallel with R_6 . Under any circumstances the important thing is to keep the product $R_6 \times (C_5 + \text{cable capacitance})$ equal to the product R_5C_4 when the -20 db output connector is used.

Performance

Working into a load of 100,000 ohms or more, the maximum voltage gain for either channel is 10. Under the same

conditions the voltage gain measured at the -20 db output point is unity.

When the mixer feeds a circuit of 0.1 megohm resistance shunted by no more than 1500 μf , the frequency response is uniform within ± 1.5 db from 20 to

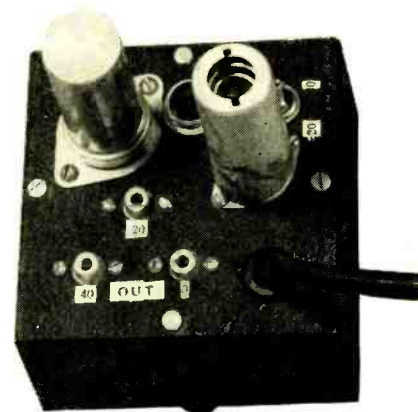

Fig. 7. The input connector for the high-gain preamplifier is located just to the left of the tube shield, with the interstage attenuator switch to the right.

20,000 cps at the 0-db output terminal. When using the -20 db output terminal with total capacitance (C_5 plus cable) as specified, the frequency response is uniform within ± 0.5 db from 20 to 20,000 cps.

HIGH-GAIN PREAMPLIFIER

Figure 5 is the schematic for the preamplifier proper, and Fig. 6 the schematic for the preamplifier power supply. These are shown separately because each is built as a separate piece of equipment.

The circuit of the preamplifier is quite usual in all respects, except for the interstage frequency-compensated attenuator. A single-pole double-throw switch is used to cut in 20 db of attenuation. This attenuation is desirable only if the input signal, after amplification by the first section of the 12AT7, is great enough to cause overload of the second section. The frequency compensation

[Continued on page 31]

Measuring and Analyzing Intermodulation



C. J. LEBEL*

The oscillographic method is developed to give quantitative results, based upon the experimentally found relation between total notch depth and IM percentage.

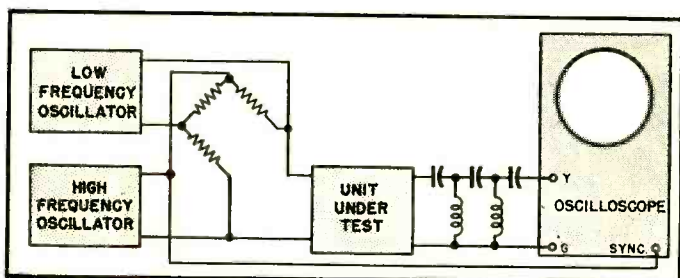

Fig. 1. Typical intermodulation analysis circuit.

THE INTERMODULATION MEASURING DEVICE to be discussed is a quantitative development of an oscillographic method hitherto considered only qualitative in nature. In the course of the research, gross inaccuracy was found in the traditionally accepted 4:1 relationship between intermodulation and harmonic distortion.

Intermodulation meters built according to Hilliard's design¹ have had provision for connecting an oscilloscope into the circuit, but the first published study of oscilloscope images in distortion measurement may be credited to McProud.²

Harmonic vs. Intermodulation Distortion—A Review

In typical audio applications, distortion measurement must yield a number which bears some relation to the offensiveness of the sound to the ear—for audio equipment is usually made to be listened to.

By this test, the harmonic method of measuring distortion may be unsatisfactory. It fails to indicate the bad effect of polishing a disc master, while the intermodulation method succeeds. The writer has found that poor tracking (of a phonograph pickup stylus in its groove) may produce hardly any effect on harmonic distortion, while the inter-

modulation and the aural effect rise greatly.

The harmonic method may be satisfactory if we measure the relative amplitude of the individual harmonics, then

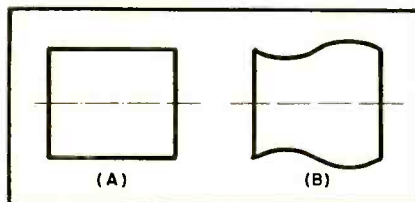

Fig. 2. Envelope of oscilloscope images without intermodulation (A), and with intermodulation (B).

multiply each by a weighting factor. This requires a wave analyzer, whose use is tedious and time consuming; and little has been published on the weighting factors which would equate the order of a harmonic and its offensiveness to the ear. An early step was the 1937 RMA proposal³ according to which

³ Radio Manufacturers Association: Specification for testing and expressing overall performance of radio broadcast receivers—Part 2—Acoustic tests;—p. 5; Dec. 1937 revision.

* Audio Instrument Co., 133 W. 14th St., N. Y. 11, N. Y.

¹ John K. Hilliard: Distortion tests by the intermodulation method. *Proc. I.R.E.*, vol. 29, no. 12, pp. 614-620, Dec. 1941.

² C. G. McProud: Simplified intermodulation measurement. *AUDIO ENGINEERING*, vol. 31, no. 3, pp. 21-23, May 1947.

Responsibility for the contents of this paper rests upon the author, and statements contained herein are not binding upon the Audio Engineering Society.

the amplitude of the n th harmonic would be multiplied by $n/2$, which leaves the second harmonic unchanged. A more recent proposal was made by Shorter,⁴ who proposed a weighting in which the amplitude of the n th harmonic would be multiplied by $n^2/4$, and in which harmonics weaker than .03 per cent would be neglected.

A fundamental problem of the harmonic method is that of achieving a pure waveform at the input to the equipment under test, for the harmonic measuring device cannot distinguish between an imperfection of the source waveform and one produced by the unit being tested. At any one frequency, pure waveform can be achieved by an inexpensive filter, but when testing over a wide frequency range the pure waveform source becomes more expensive than the distortion meter itself.

The intermodulation method presents no such waveform problem, for the waveform of ordinary laboratory oscillators

[Continued on page 20]

⁴ D. E. L. Shorter: The Influence of High Order Products in Non Linear Distortion. *Electronic Engineering*, vol. 22, no. 266, pp. 152-153, April 1950.

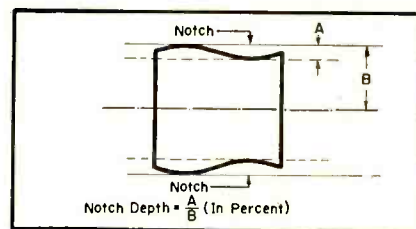

Fig. 3. Definition of notch depth.

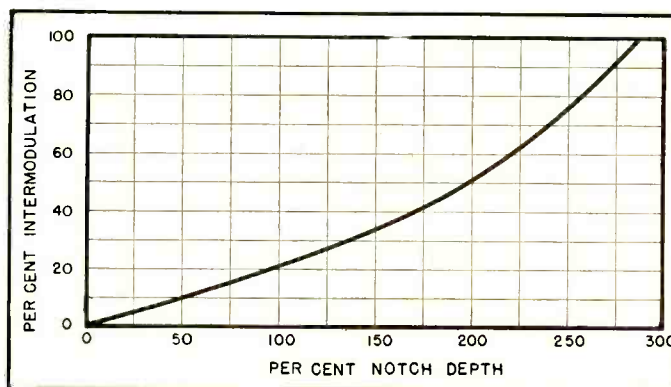

Fig. 4. Relation between notch depth and per cent intermodulation.



Now!

Hear those Bass Notes down to 35 c.p.s.

(and extended highs, too)



For the first time . . . one full octave of added bass range in a beautiful, small size, low-cost corner cabinet with direct front radiator of high frequencies for 12" full range speakers!



KLIPSCH-LICENSED*

Aristocrat

FOLDED CORNER HORN ENCLOSURE

- **EXTENDED BASS RANGE**—True reproduction down to 35 c.p.s. with full efficiency!
- **NO BOOMINESS**—Scientifically provides smooth, distortion-free, selective recreation of the disparate bass tones!
- **INCREASES POWER HANDLING CAPACITY** of any 12" speaker by as much as 50%—Greatly improves performance!
- **EXTENDED HIGH RESPONSE BETTER, TOO**—Proper balance of lows and highs now enable you to enjoy the full extended range of the finest quality sources!

You've never heard such amazing reproduction with a cabinet of this size, at such low cost. See it! . . . Hear it! . . . at your E-V Distributor. Write for Bulletin 180.

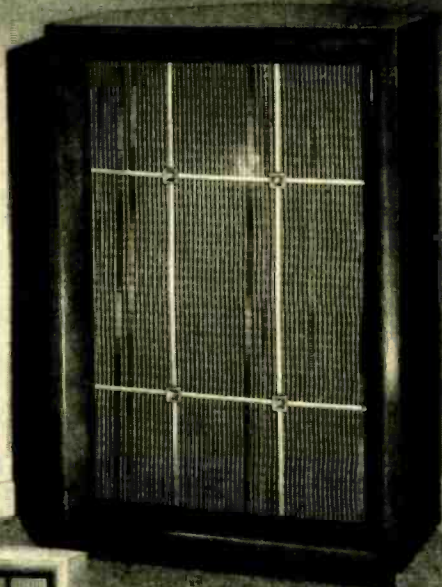

Authentically styled. Fits beautifully in any room. Exquisite veneers in lustrous hand-rubbed finish. 29 1/2" high, 19" wide, 16 1/2" deep.

Mahogany. Less Speaker. List Price . . . \$99.50
Bleached Blond. List Price . . . \$106.00



Electro-Voice

400 CARROLL STREET • BUCHANAN, MICHIGAN

Export: 13 East 40th Street, New York 16, N. Y., U.S.A. Cables: Arlab
HI-FI SPEAKER SYSTEMS • MICROPHONES • PHONO-PIC-UPS • TV BOOSTERS
Licensed under Klipsch Patents No. 2310243 and No. 2373692

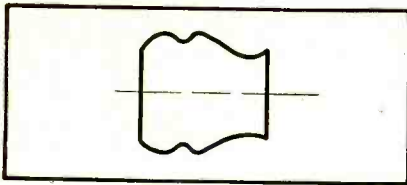

Fig. 5. Envelope of notch pattern with insufficient bias, for single-ended stage.

is satisfactory, and it is easy to mix two tones without creating the intermodulated source tone that would be a cause of error.

The intermodulation method was first used extensively in the film industry, after the harmonic method had failed to serve as a satisfactory guide to the ear's opinion of film distortion. Roys has made extensive use of intermodulation in various problems of disc recording and reproducing. He has shown that it is a reliable index to processing faults⁵ where the harmonic method is valueless, and is also very useful in judging the tracking of disc reproducers⁶ and in studying tracing distortion.

We may theorize that the intermodulation method more nearly correlates with the ear's opinion because the result is automatically weighted by the order of the distortion. There has been little attention to this, and it would be a real contribution to the art if someone were to study the action of high order distortions. From Frayne and Scoville's work it is evident that the weighting for higher distortion orders could be increased, if desired, by using a higher ratio of low- to high-frequency voltage than the four to one which is customary. A ratio of eight or ten to one would be worth studying.

It may readily be concluded that the intermodulation method deserves more intensive use than has been customary. One cause of the neglect has been the high cost of intermodulation measuring instruments; another has been the lack of realization of the value of oscilloscope images as a guide to corrective measures.

A New Method of Measuring Intermodulation

As may be observed, the following method deviates from prior practice only at the finish:

1. Mix two tones of different frequency, without intermodulation, in any standard circuit. Bridge networks and hybrid coils are the most obvious means.
2. Pass the two-frequency tone through the system under test.
3. Send the system output through a high-pass filter, which removes the lower

⁵ H. E. Roys: Intermodulation distortion analysis as applied to disc recording and reproducing equipment; *Proc. I.R.E.*, vol. 35, no. 10, pp. 1149-1152, Oct. 1947.

⁶ H. E. Roys: Determining the Tracking Capabilities of a Pickup; *AUDIO ENGINEERING*, vol. 34, no. 5, pp. 11 & 38-40, May 1950.

of the two frequencies. A typical circuit is shown in Fig. 1.

4. Observe the filter output on an oscilloscope whose sweep is synchronized to the low-frequency tone.

- A. If the high-frequency tone is not modulated by the low-frequency tone (i.e., a condition of zero intermodulation), the oscilloscope screen will show a smooth rectangle of light, like (A) of Fig. 2.
- B. If one tone affects the other (by definition an intermodulation condition), the rectangle of light will be marred by one or more notches, as in (B) of Fig. 2.

5. There is a quantitative relation between the size of the notches and the intermodulation percentage. Each notch has a notch depth, which is defined in Fig. 3, and which is best expressed in per cent. An image of this type will generally have more than one notch, each with its own depth. The following relation is then used:

$$\text{Total notch depth} = \text{Notch}_1 \text{ depth} +$$

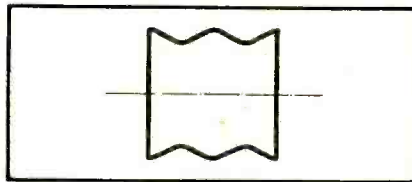

Fig. 6. Normal notch pattern for push-pull stage.

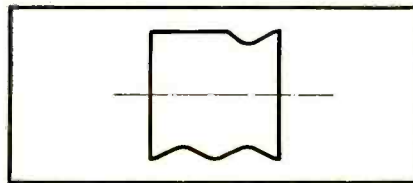

Fig. 7. Push-pull output stage with single-ended driver stage showing effect of driver overload.

notch₂ depth + etc. This may lead to a total notch depth of over 100 per cent if each notch depth is expressed in per cent.

The relation between total notch depth and intermodulation percentage is shown in Fig. 4. This was experimentally determined, using an intermodulation meter similar to that shown by Hilliard,¹ and typical experimental points are shown on the figure. The following types of amplifiers were used in various combinations: single-ended and push-pull, triodes and pentodes, voltage amplifier and power amplifier tubes, with and without negative feedback. All conform to the same curve within the limits of experimental error.

Since this relation is linear over the most important part of the range—the lower part—it is possible to use an oscilloscope screen with suitable calibration, reading the intermodulation effect of each notch directly on the scale. In the less used upper part of the range, the same screen scale may be used in conjunction with a corrective graph.

Analysis of Oscilloscope Patterns

The oscilloscope screen may show a variety of patterns. In a single-ended

stage either two or four notches in the pattern will ordinarily appear, depending on conditions. If the bias is too low, two narrow notches may appear toward one side of the patterns as in Fig. 5. If the grid is driven heavily toward cutoff, broader notches will appear toward the opposite side of the pattern. We have not used the words "right" and "left" to refer to notch position because the position depends on the number of amplifier stages and on the oscilloscope circuit. In a simple single-ended circuit with the most common oscilloscope characteristic, bias notches will be at the left side; and notches due to grid cutoff at the right side. If an amplifier is heavily overdriven, both bias and cutoff notches may appear—four in all.

In a push-pull stage, four notches are standard, as in Fig. 6; and in a perfectly balanced stage, the notches are equal in size. If the push-pull stage is driven by a single-ended stage which overloads easily, one of the notches will diminish in size and may even disappear, as in Fig. 7.

The fact that these notches occur on top or bottom of the pattern indicates that intermodulation can occur on either positive or negative half cycle of the high-frequency wave. Since the notches are not necessarily symmetrical, it becomes clear that the rectifier in an intermodulation meter must be full wave—else it may ignore intermodulation effects occurring in the half cycle which is not rectified.

This is sufficient to indicate the general nature of the information provided by the notches; a full description of the subject would be a paper in itself.

It has been customary to make most intermodulation tests with a 4:1 ratio of low- and high-frequency voltages. This

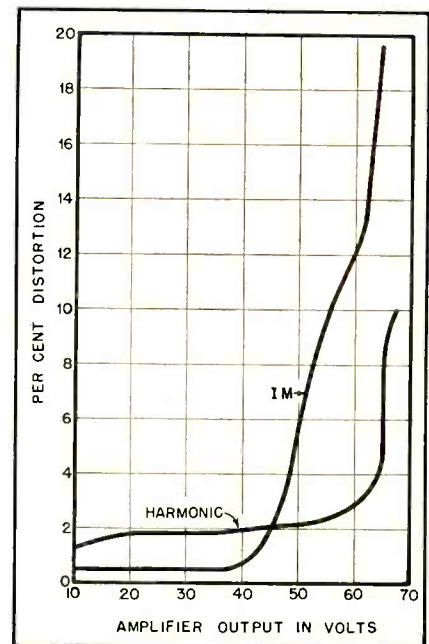

Fig. 8. Intermodulation (IM) and harmonic distortion characteristics of a push-pull amplifier showing that the ratio of the two parameters changes.

can lead to results of doubtful significance if applied universally—a matter which is evident from a brief consideration of the physical relationships involved. For example, if we use a test tone of 40 and 20,000 cps, in 4:1 ratio, with most amplifiers there will be real doubt as to whether low-frequency distortion or high-frequency distortion predominates in the measurement. If results are to have any significance, separate measurements of low- and high-frequency conditions must be made.

Applying this thought, low-frequency distortion should be checked by using a low frequency of 40 or 60 cps, and a high-frequency condition which would have relatively no distortion tendency. This might be a high frequency of 2000 cps, and a voltage ratio of 4:1. Thus the high frequency would be primarily an indicator.

A high-frequency measurement should be made with 7000 or 12000 cps and a low-frequency condition which would have minimum distortion tendency. This could be a low frequency of 100 or 200 cps, and a voltage ratio of 1:1.

A number of papers have compared the intermodulation method with the two-tone or CCIF method, claiming that the latter has a greater sensitivity to high-frequency distortion. We are inclined to attribute their result, instead, to the fact that they tried, unwisely, to measure high-frequency distortion with a low-frequency tone of four times the amplitude of the high frequency of which they were trying to determine the effect.

Background

The examination of oscilloscope images in conjunction with intermodulation tests was first suggested by Hilliard¹ in 1941, but he supplied no data on the types of images to be expected, and their meaning, so very little American use was made of the idea. Some European use was begun, however. McProud in 1947 described the use of screen images for distortion analysis, but stated that the relation between notch size and per cent intermodulation was only qualitative. As applied to any single notch, in McProud's fashion, this is correct, but when applied to the total notch depth as we have (a method not contemplated by McProud) his statement is in error.

In our experiments we observed a new effect: The oscilloscope pattern occasionally shows bulges instead of notches, a sign of regeneration, it may occur in multi-stage amplifiers if isolation and filter condensers are insufficient, or if an improperly designed feedback loop has been utilized. It seems to occur most often in the 5- to 35-cps range, and explains why some units test satisfactorily under conventional conditions, yet sound bad with low-frequency program material.

Relations between IM and Harmonic Distortion

It has been customary to assume that a fixed ratio exists between the inter-

[Continued on page 30]

the world's toughest transformers

wear these exclusive one-piece drawn-steel cases

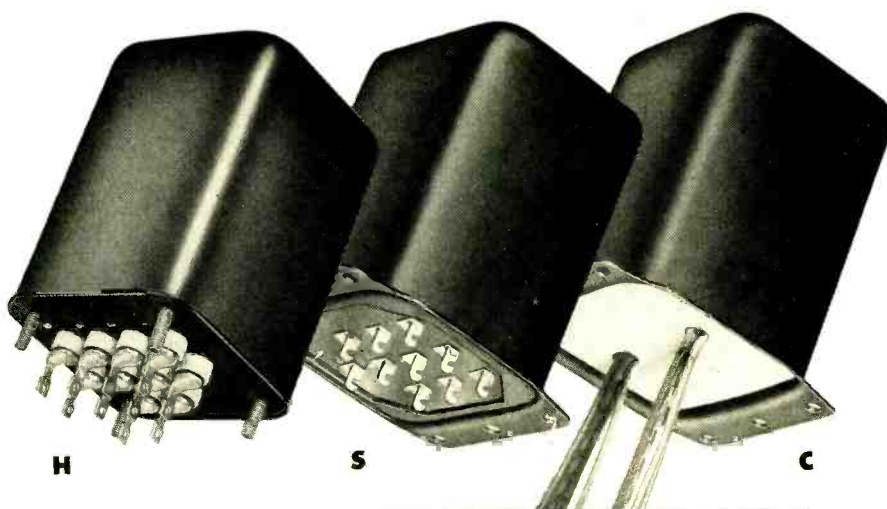

CHICAGO NEW EQUIPMENT TRANSFORMERS

THE ONLY COMPLETE*, VERSATILE LINE WITH TOUGH SEALED-IN-STEEL CONSTRUCTION**

When tougher transformers are made, CHICAGO makes them—in rugged, streamlined drawn-steel cases that provide the fullest enclosure and protection, that look well with other modern electronic components and enhance the appearance of the equipment. The exclusive CHICAGO one-piece drawn-steel case (no seams or spot welds) is the strongest, toughest type of mechanical construction. Further, the one-piece design provides a continuous electrical and magnetic path which means better electrostatic and magnetic shielding. Seamless construction assures maximum protection against adverse atmospheric conditions—means longer, more dependable transformer life.

Whether your transformers must pass the most rigid MIL-T-27 specifications or are intended simply for average, normal applications, it's wise to choose CHICAGO "Sealed-in-Steel" Transformers (the world's toughest) for that extra margin of dependability under all operating conditions.

***COMPLETE.** There's a CHICAGO "Sealed-in-Steel" unit for every application: Power, Bias, Filament, Filter Reactor, Audio, MIL-T-27, Stepdown, Isolation—all in one-piece, drawn-steel cases.

****VERSATILE.** Available in 3 constructions to meet most requirements—a type for every application.

H-Type. Steel base cover is deep-seal soldered into case. Terminals hermetically sealed. Ceramic bushings. Stud-mounted unit. Meets all MIL-T-27 specs.

S-Type. Steel base cover fitted with phenolic terminal board. Convenient numbered solder lug terminals. Flange-mounted unit.

C-Type. With 10" color-coded stripped and tinned leads brought out through fibre board base cover. Flange-mounted unit.



SEND FOR "NEW EQUIPMENT" TRANSFORMER CATALOG

Have the full details at your fingertips on CHICAGO'S New Equipment Line—covering "Sealed-in-Steel" transformers designed for every application and geared to today's circuit requirements. Write for your copy of this important catalog today, or get it from your electronic parts distributor.

CHICAGO TRANSFORMER

DIVISION OF ESSEX WIRE CORPORATION

3501 ADDISON STREET • CHICAGO 18, ILLINOIS





EDWARD TATNALL CANBY*

A STORY ABOUT LIVENESS

THE PROOFS for a record liner by me (notes on the back of a record case) recently came back from the printer, the article signed at the end—EDWARD TATNALL CANBY WIPE WITH A DAMP CLOTH.

A valid description of my bodily state after an extended bout, a few weeks back, with some of the tricks that liveness can play upon the recording engineer—amateur or otherwise! Old readers will remember experiences, a few seasons back, with problems of overload and intermodulation in the recording of a large chorus of voices. The new problems involve the same outfit, but this time the hot water was of a different sort. We recorded a program of early music originally composed for the Cathedral of Notre Dame in Paris—an echo chamber de luxe. Alas, Notre Dame is not available in New York, nor (since we used union musicians) was there a convenient local church in the acceptable "union hall" category—especially since we had to record on Sunday. Upshot was that we hired a studio—alas. Complete with super-modern, sound-proof, chrome decorated, glass-boothed, multi-miked modernity. Sounded fine to the chorus itself and the singing was good. Binaural tolerance again; almost anything sounds good with two ears.

It was a strange series of events then, which allowed what eventually turned out to be an ultra-dead, closet-like recording to reach the final pressing before the horror of it was realized. And all because of a much under-estimated factor in reproduction, the room liveness added to reproduced sound after it leaves the speaker.

Liveness at Home

Most of us listen to our music in one place. The ear has a remarkable and subtle ability to adjust to any repeated situation, discounting all sorts of abnormalities, distortions, and what-not simply by putting them beyond consciousness. We all know that strange sensation of hearing a constant sound, such as a ventilating fan, only after it suddenly ceases. So, too, can we disregard other constant factors when we get used to them. Over a long period we thus tend to neutralize to a great extent the specific liveness effects of our own listen-

ing rooms (and the qualities of our own equipment too), until the ever-changing liveness in numerous recordings that come to us can be judged quite as objectively as though our rooms did not actually enter the sound picture at all. But that takes time.

... And Abroad

However, try your music in an unfamiliar room and—if you work like I do—your judgments are thrown to the winds. For the plain fact is that added room liveness, room acoustics in general, exert a tremendous influence upon heard sound, possibly larger in most situations than anything else in the chain of reproduction—including the original liveness recorded with the music. This is a cardinal principle which every collector and judge of recordings should take to heart. It accounts for a million and one heart-breaking confusions and complexities and ambiguities. It is, I am sure, a far bigger factor in mistaken judgments in record purchasing than even the absurdly inadequate players found in most store listening booths. "But it sounded different in the store"—how many times have we heard that anguished cry! Why else, but that our home situation, however terrible our player, is the only one where our ears have acquired a true basis for comparisons.

Broadcast Monitoring

To go briefly further afield—*E's* editor has touched recently upon the importance of good monitoring facilities in broadcasting and recording. I must add that the problem is not only to provide good equipment and listening-room arrangements for the judging listener. A vital necessity is that he become thoroughly adjusted to the listening set-up—for only then can he hope to judge the sound he hears in any comparative fashion. I can state categorically that it is absolutely foolhardy to judge the naturalness, the liveness of any recorded music in an unfamiliar listening situation. I've been burnt too often not to know. (And this applies to judging speakers and other equipment in strange locations. Unless you are out to check purely technical details such as spottable peaks—and even

[Continued on page 24]

Pops

RUDO S. GLOBUS*

A REALLY UNPRECEDENTED situation has forced me to eliminate the usual lead-in and devote this whole section to a number of new recordings which tie in together neatly and prove a number of unprovable points. By way of introduction, I would point out that both musically and technically we have never been afforded evidence which packages as well.

The King and I	Decca DL9008
The King and I	Victor LK 1022
Pal Joey	Columbia ML 54364
Out of This World	Columbia ML 54390

The gumshoes in our midst will immediately recognize that something is amiss. I have never run a group of reviews together; I have never done a round robin on a batch of important or unimportant recordings. Therefore, the sharp eyed shamus will come to the conclusion that there must be an intimate relationship between all four of the above, which R.S.G. will utilize to tintinabulate his lesson of the month. But . . . what is the connection between a Cole Porter score (Out of This World) and three Richard Rodgers scores? Our discerning one will further inquire as to my insertion of an old Rodgers score into the above group.

One thing at a time! We'll take care of Rodgers first. Pal Joey was the joint product of Richard Rodgers and Larry Hart. A generally fine score, it is further distinguished by one of the all-time great pop tunes . . . Bewitched, Bothered and Bewildered. The King and I is the latest enterprise of Rodgers and Hammerstein Number Two. It is the poorest product of the Rodgers Musikum Individuum, generally characterizable as hackneyed, tired, banal, mediocre, and repetitious. The difference between the two Rodgers scores is eye-opening. One

[Continued on page 24]

*15 Palm Lane, Westbury, L. I., N. Y.

only you can decide

that's what the man says...

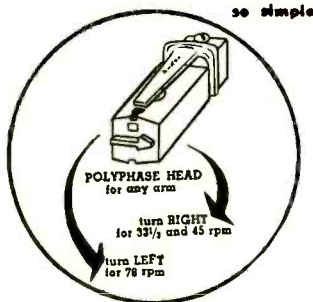

One single magnetic unit plays all home records—Sapphire or Diamond styli.

Special models for radio stations, including Vertical-Lateral units.

“... About a year ago, I purchased what I thought was the best cartridge. After following your ads for sometime, I recently replaced it with an AUDAX. Your claims are very modest, to say the least. . . . To me, the most powerful statement in your ads is—‘You and only you can decide . . . etc.’—In my estimation, this is the part that rates prominent type. . . .”
(from a letter)

Audax **POLYPHASE** reproducers

*“The Standard by which Others
are Judged and Valued”*

have won the acclaim of thousands of users everywhere—Never before such EAR-QUALITY, such FAITHFUL REPRODUCTION but . . . after all the reams are written about kilocycles and other laboratory data—when the chips are down—you and only you can decide what sounds best and most pleasing to your ears. Therefore . . . SEE and HEAR POLYPHASE—and you be the judge.



Available with the new Compass-pivoted Audax Arms and for Record Changers.

Write for editorial reprint
on POLYPHASE principles
and PHONO FACTS

AUDAX COMPANY
500 Fifth Avenue New York 18

*“Creators of Fine Electro-Acoustical Apparatus
for Over 25 Years”*

RECORD REVUE

[from page 22]

these, notably in the low end, may be strangely altered by room acoustics.)

And so back to my story. I heard the tapes of our chorus recording twice. First, in the making process, in an unfamiliar small control booth with a large speaker at least a foot from my head. Frankly, I didn't know from nothing, especially at the colossal volume customary in such rooms—producing enough distortion in the ear to throw any sane judgment awry. The monitored sound was utterly unlike anything I could conceive in my own familiar home listening spot. I heard the tapes again, weeks later, in the editing in a Columbia Recording studio. Was there too much bass, was the high end weak? I did my best, but I really hadn't an idea; the sound was entirely different, again, from that of the monitoring booth. I didn't like it much, but I really couldn't be sure. I was, as I later discovered, entirely unable to judge the true liveness of the recording. There seemed to be enough liveness to allow it to pass. But the liveness I heard, it turned out, was in the studio itself (glass panels, etc.?) and not, unfortunately, in the record.

But the pay-off, with respect to liveness, came later. We needed the conductor's musical OK—and he was after that Notre Dame Cathedral effect. The tapes were therefore played to him and several other musicians (I wasn't there) at a mutually convenient location where there was a player available. The conductor was delighted with the music and gave a quite enthusiastic approval, as did others present, including officials of the recording company. The music was splendidly live, and full as they heard it, and so the go-ahead was given. To save time, test pressings were not submitted, the evidence of the tape being what counted.

And then—finally—the finished record arrived at my listening room. Also at the conductor's home. And at several others. Dead. Absolutely dead. Horrible. Phones began buzzing, short and long distance, and amazement was rife. Must be the processing company's fault—how could they do such a thing, etc. etc. Production on the record was hastily stopped!

There was no doubt about it, this was the very same recording. But this wasn't what we had heard. You may imagine the bewilderment among the gentry concerned, especially the conductor of the chorus who had approved. He was furious—but at whom? No one was quite sure.

The sequel is another story. The record will appear and it will have all the liveness you can want when it does, I can assure you. Meanwhile, it's not hard now—after the fact—to see how the mistake was made. It wasn't until all participants *heard it in their accustomed listening places*, each his own, that true objective judgments could be made on the recording—and were, instantly. And they were all the same.

How come the conductor was so thoroughly bamboozled in his audition of the tapes? Simple. The recording company had been working in a local synagogue and had set up the tape player in a large stone room in its basement. That room added exactly the liveness the music needed to sound right. And not a soul there but would have sworn it came right out of the speaker.

You gotta be careful!

Debussy, Iberia; Ravel, Valses Nobles et Sentimentales.

INR Symphony of Brussels, Franz André,
Capitol LP
P-8132

Spanish Folk Songs.

Victoria de los Angeles; Renata Tarrego,
guitar.

RCA Victor
LM 63

The series of recordings of French-Spanish music with Franz André on Capitol has been most enjoyable. These two are beautifully played—"Iberia" being, of course, the ultimate evocation in classical music of the Spanish idiom, from a composer who scarcely had set foot in Spain! Recording is good too, though a bit thin, and with surfaces not too good. Sounds as though this might be from high quality disc originals.

De los Angeles, latest vocal sensation in New York, is a far more pure and elevated voice than the almost gutturally expressive Supervia. She has at times a Mozartian quality of tone, both striking and perhaps a bit out of place in these folk songs. The guitar adds a local-color authenticity; there is the usual dark, leisurely ornamented melody, in the phrygian mode (white-note scale E to E)—yet some of the songs, in this performance, sound a wee bit concert-aria. Inevitable when a trained concert voice turns to folk music. De los Angeles has an exquisite sense of pitch and her singing of simple melody, authentic or otherwise, is a delight to the ear. Recording? Interesting problem of balance—a big voice, plus the relatively weak guitar, dictates a mike placement that makes this sound like the "apartment" recording of some small companies, done *al fresco*, in the informality of a private living room. She is slightly off-mike, the room-sound very prominent, whereas the guitar is close-to and sharp. Funny effect, from RCA.

POPS

[from page 22]

is fresh, jubilant, and musically first rate. The other is, perhaps, habit forming, but I am afraid the habit is bad. In terms of lyrics, I prefer the amazingly intricate and violently *risque* efforts of Larry Hart to the coy, precious, and overhearingly simple verse of Hammerstein Number Two. The unexpurgated lyric to Bewitched, Bothered and Bewildered is entrancingly spewed forth by the magnificent Vivienne Segal. If you've never heard the original, you're due for a mild . . . no, make it stronger . . . a fantastic surprise. This goes for "In Our Little Den of Iniquity" as well!

Leaving Rodgers for a moment, we are confronted with Cole Porter's latest opus, "Out of This World," again a tired, banal, repetitious, and second-rate score. This is so decidedly a bad Porter score that one wonders where the mellifluous strains so characteristic of the great man at his best have gone to. There are only a couple of half-way decent songs in the score . . . such as "I Am Loved," and "Use Your Imagination." The boff—jazzed up show case for Charlotte Greenwood's talents, "Climb Up the Mountain"—finds more adequate expression in the hands of Peggy Lee and Dave Barbour on Capitol.

But . . . off on another tack. There are two "complete" recordings of The King and I now available, one on Decca and one on Victor. The Decca job features the original cast (Gertrude Lawrence, *et al.*) with the original orchestrations by Robert Russell Bennett. The Victor job includes the top

drawer Victor crew (Dinah Shore, Patrice Munsel, Tony Martin and Robert Merrill). Technically, the Victor disc is better, but not much. Both are lackadaisical, with Decca taking the prize for a dull sound and bad brass recording. There is almost a complete lack of resonance in the Decca job, despite good voice recording. The Victor baby is in the Al Goodman tradition, Al Goodman backing up some of the bands.

When we switch to Pal Joey, we immediately hit one of the superior Columbia show recordings, featuring a good, generally capable orchestration effort by Ted Royal. Brilliant, live and rational recording, featuring the marvelous vocal balance that Columbia demonstrated so well in the South Pacific masterpiece. The overall spirit of the Rodgers score is magnificently preserved with the marvelous support of another brilliant Columbia producing and engineering job.

What is true of Pal Joey, is also true of Out of This World. This is another first rate show recording (despite the musical deficiencies). But now we come to another major point. Robert Russell Bennett, who did the orchestrations for South Pacific and The King and I also orchestrated Out of This World. No matter what you think of Bennett as an orchestrator, he demands brilliant recording. His use of brass and his emphatic beat mosh up into a chaotic hodge-podge if not handled correctly. His orchestration of Out of This World stands out beautifully, as it did in South Pacific. Same technique, same general outlines were used in The King and I, but the result is dull . . . thanks to inadequate recording. An even better match is the original Columbia South Pacific and the Decca King and I. The music sounds pretty much the same, both flowing forth from Richard Rodgers tiring brain . . . but the general effect, on discs, is completely different. The muffled and imprecise handling of orchestra in the Decca job cancels out any of the virtues of the orchestration. Dull, static, dead, the recording mutes the show down. While the Victor job is more alive, the orchestrations are third-rate and the general handling by Dinah Shore, Martin, *et al.*, is in the mediocre pop tradition.

Now, we come to the moral of the story. Musically, we point to a general enfeeblement on the part of both Rodgers and Porter. I have never been too happy about the pseudo-folk efforts of Rodgers, and his fantastically cheap version of Siamese modalities is enough to throw a sturdier horse than I am. The general effort to inject into an essentially non-poetic medium (Popular Music) erstwhile major poetry, sentiments and profound expressions snacks of the banal to me. Nevertheless, from a simple musical point of view, both the Porter and the Rodgers scores are horribly mediocre. I have thrown in Pal Joey merely to point up a first-rate recording job and a first-rate score, and to clearly epitomize the precise qualities of a magnificent show recording.

But, even in the case of a poor score, Out of This World, the effect of good recording technique on good orchestration and of poor recording technique on good orchestration (sic, Decca King and I) becomes manifest. We therefore have four show recordings, three by the same composer, two orchestrated by the same man. Technically, two are top drawer and two are bottom. Musically, one is top drawer, three are bottom. The conclusions are:

1. Rodgers and Porter have lost a freshness and verve which is essential to a satisfactory musical score.

2. Columbia has mastered the psycho-

logical and technical problems involved in show recording.

3. Decca has not learned the tricks of good show recording, defeating the effort of Robert Russell Bennett to enliven a weak score.

4. Victor should let Dinah Shore *et al* stick to their respective fortes and should compare the orchestrations on their King and I date with Bennett's. The effort would be worth while.

The moral of the tale? Go out and buy Pal Joey.

AM DETECTORS

[from page 11]

advisable to adjust the input signal and cathode resistance to such values that the control grid does not draw current during any part of the input cycle. Actually, of course, the input impedance is never truly infinite. However, as long as no grid current flows, the input impedance is so high it may be considered infinite and to have no damping effect on the input circuit.

Detection in the infinite-impedance detector is accomplished in the same manner as in the plate detector. However, the audio voltage is developed across the cathode resistor instead of the plate resistor. This detector gives less distortion with high-level modulation than other types do and eliminates the loading effect due to grid current encountered in the grid-circuit or diode detector. The high-fidelity characteristics of the infinite-impedance detector and its ability to handle large signal inputs are due to the fact that it functions as a combined plate detector and cathode-follower amplifier. It can be shown analytically that in a cathode-follower type of amplifier, distortion introduced by the non-linear tube characteristic will be reduced much more than the desired signal. Distortion may still result if the grid resistance of the following audio amplifier stage is low enough to reduce the a.f. impedance in the cathode circuit appreciably below that of the d.c. impedance. However, with values normally used for grid resistors, the infinite-impedance detector will accommodate up to 100 per cent modulation without introducing distortion. Figure 7 shows the modulation capabilities of miniature triode type 6C4 connected as an infinite-impedance detector. Evidently, for cathode resistors between 47,000 and 220,000 ohms the modulation capability is 100 per cent for grid resistor values above 500,000 ohms. The lower values of cathode resistance are more favorable from the standpoint of distortion resulting from high modulation percentages, but the higher values enable the detector to accommodate higher carrier voltages without grid current flowing, because of the higher value of developed bias across the cathode resistor.

A family of curves showing the rectification characteristics of a tube connected as an infinite-impedance detector may be used to analyze the detector performance in the same manner as for the diode detector. Although no such curves are published by tube manufacturers, it is a relatively simple matter to obtain



"The Only Good Doctor Is A Hoss Doctor!"

— Will Rogers

"... his patients can't fool him!", he added to make his point. The noted humorist's trenchant remark may be applied today to the skilled technicians in the recording field who have for many years used the tape and discs perfected in Reeves Soundcraft Laboratories. We haven't fooled them—nor have we tried. Perfection, nothing less, has won us the confidence of this exacting industry.

From Reeves Soundcraft Laboratories come magnetic tape offering users ten distinct features that add up to higher efficiency and fidelity; an assortment of recording discs to answer every requirement—all backed by the greater integrity and experience of the Reeves name, foremost manufacturer of recording and electronics accessories.



Soundcraft tape is made in all types and lengths to accommodate all tape recorders.

Soundcraft recording discs available in a variety of sizes, single and double face.

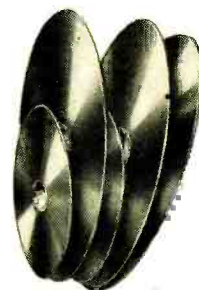

REEVES *Soundcraft* CORP.

TWENTY YEARS OF LEADERSHIP IN SOUND ELECTRONICS

10 EAST 52nd STREET, NEW YORK 22, N. Y.
EXPORT—REEVES EQUIPMENT CORP., 10 EAST 52nd STREET, NEW YORK 22, N. Y.

HARVEY for the finest in SOUND EQUIPMENT

THE EDITALL TAPE SPLICER



ONLY \$6.50 NET

Developed by the well-known CBS Tape Editor, Joel Tall. Shortens editing time, reduces fatigue, eliminates noisy or sticky splices. The rectangular rod is made of Duraluminum, with a longitudinal groove which has a curved bottom. Due to precise machining and dove-tail construction, the groove holds the tape firmly and securely. Complete with a sample of Minn. Mining 7/32" splicing tape.



CARTER SUPER CONVERTERS

Wherever 115v line voltage is not available or hard to get, Carter Converters supply dependable AC power supply to make on-location recordings. Operates from storage batteries. Recommended by Brush and Magnecord... one model operates both Brush and Magnecord equipment. Used by leading networks. Delivers clean 60 cycle AC power. Available for 6, 12, 24, 28, 32, 64 and 115v input voltage. Write for price list and complete information.

Browning FM Tuner, Model RV-10A

Designed for high fidelity reception in FM band, and incorporating Automatic Frequency Control. Receives signals on FM from 88 to 108 MC. Audio response flat from 15 to 15,000 cycles $\pm 1\frac{1}{2}$ DB. No drift after 2 minutes warm-up. Tuned RF stage. Phono-FM-TV Recorder switch permits instant transfer of input signals. Armstrong FM circuit. Tube complement: three 6AU6, one 7F8, two 6S17, one 6H6, one 6J6. Tuning eye indicator 6AL7, Type 5Y3 rectifier tube. $6\frac{1}{2}'' \times 11'' \times 8\frac{3}{4}''$.

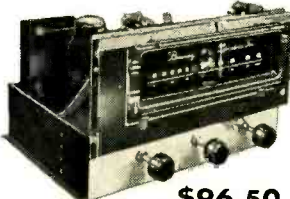

\$96.50

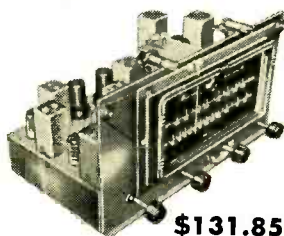

BROWNING FM-AM TUNER, MODEL RJ-12B

For high fidelity reception on FM band. The AM section provides high sensitivity and selectivity. Automatic Frequency Control. FM band from 88 to 108 MC. Standard band, 530 to 150 KC. Separate RF and IF systems on both bands, no coil switching. No FM drift after 2 minutes. FM audio response flat from 15 cycles to 15,000 cycles $\pm 1\frac{1}{2}$ DB. AM audio response flat from 20 cycles to 6600 cycles within ± 3 DB. Triple Tuned IF's. Phono-TV-Recorder switch. Armstrong circuit on FM. Tube complement, three 6AU6, one 7F8, one 6SK7, one 6SG7, two 6SJ7, one 6H6, one 6SA7, one 6J6. Tuning eye 6AL7Gt, one 1N54 crystal detector. $7\frac{3}{8}'' \times 13\frac{1}{2}'' \times 9''$.

\$131.85

HARVEY STILL HAS AVAILABLE

- Altec 604B Speakers
- Electro Voice, Lansing
- Western Electric 728B Speakers
- Western Electric 755A Speakers

In fact, we have almost all of the better grade speakers at the right prices. All with Alnico 5 PM Fields. Come in now, or order by mail... get your quality speaker while it is still available.

McIntosh Amplifiers

- Immediate delivery. Full information on request. Come in for a demonstration.
- 20 W-2 Amplifier.....\$149.50
 - 50 W-2 Amplifier.....\$249.50
 - AE-2A Equalized Pre-Amp.....\$74.50

VISIT THE AUDIO-TORIUM

Come in and visit our new sound department... all these items and many more on working display at all times.

Telephone:  LUXEMBURG 2-1500

HARVEY

RADIO COMPANY INC.

103 West 43rd St., New York 18, N. Y.

NOTE: In view of the rapidly changing market conditions, all prices shown are subject to change without notice and are Net, F.O.B., N.Y.C.

data for such curves experimentally. Such data is obtained in the circuit of (D), Fig. 5, by making C_k very large and measuring the direct voltage across and the direct current through R_k as R_k is varied, while keeping the plate supply and grid-signal voltages constant. Figure 8 shows the rectification characteristics of the 6C4 obtained in this manner. If a large electrolytic capacitor is used for C_k , the data may be obtained with a signal frequency as low as 60 cps. The data for the curves of Fig. 8, however, were taken at a frequency of 455 kc.

For purposes of illustration, let us assume that in the circuit of (D) the r.f. carrier level is 30 volts r.m.s. and the cathode resistor is 220,000 ohms. Thirty volts is much higher than normal for most detectors, but is used here to

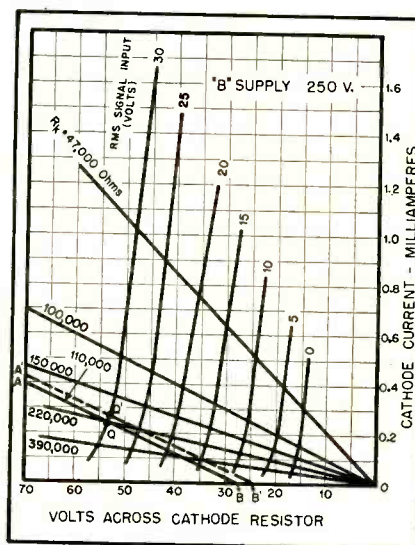

Fig. 8. Rectification characteristics of 6C4 in infinite-impedance detector circuit.

illustrate the large signal capabilities of the circuit. Figure 8 shows that at the quiescent point Q (no modulation), the d.c. voltage across the cathode resistor will be 53.8 volts. Now, if a grid resistor of 220,000 ohms is employed, the a.f. impedance will be 110,000 ohms and the detector operation will be along the line AQB . This analysis indicates that the detector output will go to zero at a carrier level of approximately 8 volts r.m.s., showing that the maximum percentage modulation which the detector will accommodate without distortion is approximately

$$\frac{30-8}{30} \times 100 = 73.3 \text{ per cent}$$

An examination of the curves of Fig. 7 shows that with the above-mentioned values of cathode and grid resistors, the detector will actually accommodate 78 per cent modulation without appreciable distortion. The reason for the apparent discrepancy between the two sets of curves is as follows: When the modulation exceeds the value which causes plate-current cutoff, even order harmonics are created. These even-harmonic currents in the cathode resistor have a d.c. component which adds to the existing direct current in the tube and

causes the line AQB to move parallel to itself along the curve $c_g = 30$ to a new position $A'Q'B'$. The net audio distortion then is decreased because of the effective decrease in the d.c. bias.

Although excellent results will normally be obtained with either high- or medium- μ tubes, the latter is to be preferred. The use of a medium- μ tube results in a much larger value of cutoff bias with zero signal. Thus, the medium- μ tube may be used with a larger carrier amplitude without drawing grid current. Also, the larger value of zero-signal cutoff bias permits the use of lower values of R_g without causing distortion at high modulation levels.

In any electron-tube circuit employing a cathode resistor which is not bypassed for the heater-supply frequency, heater-cathode leakage in the tube may cause objectionable hum output. If difficulty is experienced with heater-cathode hum, it may be desirable to try several tubes in the circuit until one is found which has very low heater-cathode leakage. Another method of minimizing heater-cathode hum is to bias the heater approximately 50 volts positive with respect to the cathode. Because the leakage currents between heater and cathode are very small, a relatively high-impedance bias supply may be used. This supply may take the form of a resistance divider of 200,000 ohms or more across the receiver high-voltage supply. The bias-supply filter may then employ a paper capacitor of about 0.1 μ f.

A disadvantage of the infinite-impedance detector, and of all the detectors discussed here with the exception of the diode, is that if a.v.c. is desired a separate channel must be used. Although the direct voltage across the cathode resistor of the infinite-impedance detector varies with the r.f. carrier amplitude, it is of positive polarity and cannot be applied directly to the r.f. grids for gain control purposes. The direct voltage across the diode loads of Fig. 3 is of negative polarity and is proportional to the amplitude of the r.f. carrier. It thus can be used as an a.v.c. voltage and be applied to the r.f. and i.f. grids in the receiver. Because of the added cost and circuit complexity which would result if a separate a.v.c. channel were used, radio set manufacturers almost without exception have in recent years used a multi-unit tube, such as the 6SQ7 twin-diode-triode as a detector-amplifier. However, if the experimenter is willing to spend the money and time to construct a set having a separate a.v.c. amplifier stage, and will take the necessary steps previously mentioned for reducing heater-cathode hum, he can realize a considerable improvement in fidelity by use of the infinite-impedance detector, as compared with the other types discussed in this article.

REFERENCES

1. W. N. Weeden, "New detector circuit," *Wireless World*, Jan. 1937, pp. 6-7.
2. "The infinite-impedance detector," *QST*, Oct. 1939, pp. 21 and 110.
3. H. J. Round, "Distortionless broadcast reception," *Radio News*, July 1924.

WOULD YOU LIKE THE FIRST COPY OF

High-Fidelity

THE NEW MAGAZINE FOR AUDIO-PHILES*

*People who enjoy fine Audio reproduction

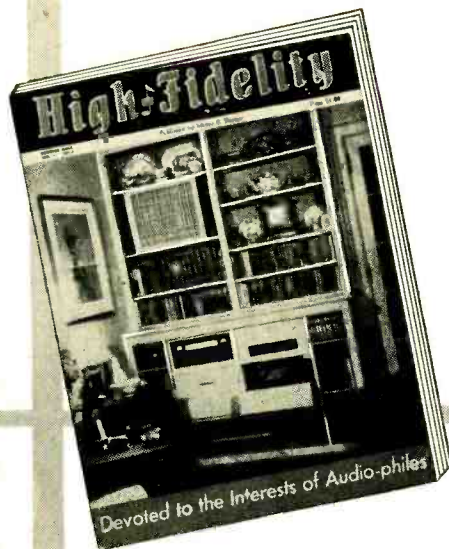

WHAT IS HIGH-FIDELITY?

A NEW MAGAZINE!
A NEW KIND OF MAGAZINE!

It fills the long-felt need for an authoritative publication devoted entirely to the interests of people who enjoy good phonograph and radio music reproduced correctly on home equipment. High-Fidelity is 8 $\frac{3}{4}$ " x 11 $\frac{1}{2}$ " in size, handsomely illustrated and beautifully printed.

WHY SHOULD I BE INTERESTED?

FOR LISTENING PLEASURE!

Whether you are a critical listener, a technically minded hobbyist, or an audio-expert, High-Fidelity is edited for you. It explains how to get greater enjoyment from radio, records, and television; what equipment to use; which new records are worth buying; what stations to listen to—in short... how to get the most out of your present installation, and how to make further improvements.

WHO ARE THE EDITORS?

EXPERTS! HIGH-FIDELITY is edited by Charles Fowler, who is qualified by an unusually broad background, technical knowledge, and work-shop experience.

You will find that your editor understands both the interests of those to whom music is most important... and those critical listeners to whom the technical perfection of their equipment is paramount.

High-Fidelity includes articles signed by authorities whose names have become synonymous with the growth of the high fidelity field: Philip Kelsey, C. G. Burke, Paul Klipsch, Alan Macy, Beatrice Landeck, Jack Index, Robert Newcomb, and others.

WHEN CAN I GET THE FIRST ISSUE?

IMMEDIATELY!

Copies are now being mailed daily to new Charter Subscribers. You can still get one by writing at once. A year's subscription (4 big quarterly issues) will give you a full 12 months' supply of information and new ideas; and a 3-year subscription will save you exactly \$6.00 over the single copy price. The coupon below will bring you your first copy by return mail.

Mr. Charles Fowler, Editor, High-Fidelity
Bank Bldg., Great Barrington, Mass.
I want to be a Charter Subscriber to
High-Fidelity Magazine. I enclose my remittance for:
 \$3.00 for one year (SAVE \$1.00)
 \$6.00 for three years (SAVE \$6.00)
Name.....
Address.....
Add 50¢ per year for Canada, \$1.00 foreign

PARTIAL LIST OF CONTENTS IN THE CURRENT ISSUE

How to Get Best Results with a Klipschorn, by Paul W. Klipsch

The originator of the Klipschorn discusses the principles of sound reproduction and the equipment which gives best performance with his system.

Audio Nerve Center, by Alan C. Macy

A discussion of the purpose, design, and performance of various types of pre-amplifiers and control units used in conjunction with audio systems.

Repertory Unlimited, by C. G. Burke

An authority on recorded music explains why so many classical and modern compositions are excluded from public performance, and tells how the recording companies are making these "lost" compositions available.

For Your Inspiration, by Philip C. Kelsey

Illustrations of custom installations; a discussion of their how and why.

New Designs for Speaker Enclosures

Suggestions from manufacturers for handling the speaker enclosure problem.

When You Buy an Audio Amplifier, by Robert E. Newcomb

The president of Newcomb Audio Products discusses factors of amplifier design which should be considered when purchasing high-fidelity equipment.

Improved Bass Reproduction, by Charles Fowler

A detailed review of the development and advantages of the FAS system.

Records for Children, by Beatrice Landeck

Wisely selected records can develop, as well as entertain, children.

New Method of Phonograph Mounting, by Irving Greene

A clever and original method of mounting a phonograph in a small space.

Factors to Consider in Buying a Speaker, by William H. Thomas

The author is president of James B. Lansing Sound, and is widely known as an engineer and designer of highest quality reproducing equipment.

The Viewer's Amplifier, by Melvin Sprinkle

Construction details of a compact amplifier which will improve TV audio.

Records in Review, by John F. Index

A detailed review of the outstanding record releases during the past months.

High-Fidelity

Published by Milton B. Sleeper
Bank Bldg., Great Barrington,
Massachusetts

NEW PRODUCTS

● **High-Frequency Speaker.** The "Audio-tron Jr." is a small speaker of unique design, manufactured in Europe and marketed in the United States by The Audio-tron Corporation, 1640 18th St., Santa Monica, Calif. Claimed to have frequency

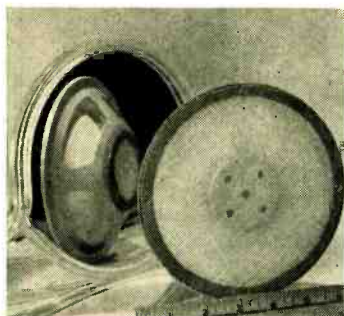

response beyond 15,000 cps, and a power rating of ten watts above 1200 cps, the unit is distinctive in its use of cloth for the compliant cone membrane. The Audio-tron Jr. is also unusual in construction, with the magnet and voice coil situated within the cone. According to the distributor, the speaker is low in cost, and will be available for delivery within approximately two months.

● **Resistance Comparator.** Builders of precision electronic equipment can achieve improved quality control as well as lower production overhead through use of the Type PR-5 Resistance Comparator, recently introduced by the Clippard Instrument Laboratory, Inc., Bank St., Cincinnati, O. The comparator permits unskilled



personnel to test as many as 17 resistors per minute. In operation the operator merely places resistors to be checked across terminals marked "unknown," and receives a direct reading on the panel meter. Scale is calibrated in percentage against a known standard. Accuracy is within ± 1.0 per cent over a range of 100 ohms to 100 megohms. Further information will be supplied upon request to the manufacturer.

● **High-Quality Preamplifier.** Suitable for both phonograph and microphone use, the new Fisher Model PR-4 pre-amplifier is a self-powered unit with uniform frequency response within 2 db from 30 to 20,000 cps. Special feedback circuit affords full low-frequency equalization, and output circuit design permits use of 50-ft. cable



without appreciable affect of over-all characteristics. Manufactured by Fisher Radio Corporation, 41 E. 47th St., New York, N. Y.

● **Labeling Tape.** Labelon is a pressure-sensitive adhesive tape which provides a waterproof, oilproof, and acid-resistant surface for labeling purposes. Made of two layers of acetate with a white, waxy substance sandwiched between, the tape functions in a manner similar to that of the familiar magic slate. Labelon, however, is not erasable. Writing can be done with any type of stylus. Supplied in a self-service dispenser for laboratory work, or in large rolls for industrial usage,

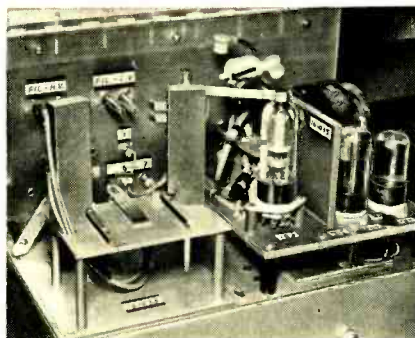

Labelon is unwound and applied exactly as is standard cellophane tape. Manufactured by Labelon Tape Co., 100 Anderson Ave., Rochester 7, N. Y.

● **Magnetic Tape Recorder.** The new Masco dual-speed dual-track tape recorder is a modestly priced unit well suited for many home, educational, and commercial applications. Choice of speeds is $3\frac{3}{4}$ or $7\frac{1}{2}$ in./sec. Available in six models, several with built-in AM radio, the recorder is housed in an aluminum cabinet finished in green hammertone. Among the unit's circuit features are a neon-bulb volume

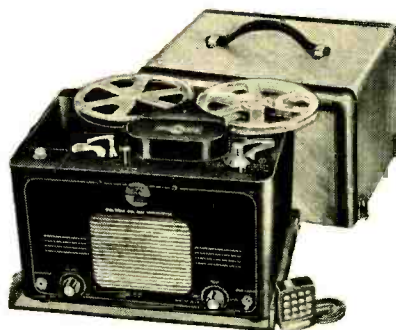

indicator, provision for headphone or speaker monitoring, and external amplifier output. Radio may be used separately if desired. Manufactured by Mark Simpson Manufacturing Co., Inc., 32-28 49th St., Long Island City 3, N. Y.

● **Tape Record-Playback Head.** Need of tape recorder manufacturers for a low-cost record-playback head is met with the



new Model TR6, recently made available to the trade by Shure Brothers, Inc., 225 W. Huron St., Chicago 10, Ill. Designed

for use in equipment where a separate a.c. or d.c. erase potential is available, the TR6 has good frequency response and output level. The unit is constructed to insure production control of gap dimensions and alignment, and includes a Mu-metal shield for minimizing hum pickup.

● **Mobile Remote-Pickup Equipment.** Virtual independence of program-line failure becomes a reality for broadcasters, with the announcement of the new REL Model 695 50-watt 153-mc FM remote pickup equipment. Intended to duplicate as nearly as possible in performance the broadcasters' fixed studio facilities, Model 695 equipment permits high-quality transmission of remote programs as soon as the pickup truck reaches the site of origination. The equipment is supplied complete with transmitter, crystal-controlled receiver and two horizontally polarized antennas. Although normally supplied for operation from a 117-volt a.c. supply, the equipment may be operated from a 12-volt d.c. source available as an optional accessory. Frequency range is 150 to 175 mc,

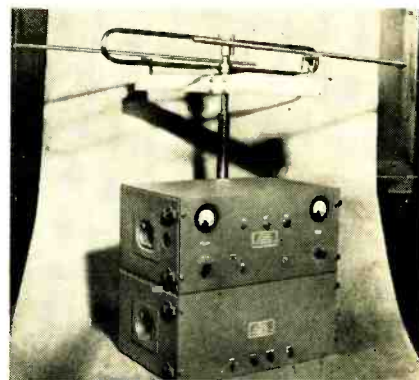

and audio response is ± 1 db from 50 to 15,000 cps. Full technical specifications may be obtained from Radio Engineering Laboratories, 35-54 36th St., Long Island City, N. Y.

● **Electronic Voltmeter.** Newest addition to the line of precision equipment manufactured by the Daven Company, 191 Central Ave., Newark 4, N. J. is the type 170 electronic voltmeter (vtvm), featuring a frequency range of 10 cps to 250 kc with an accuracy of ± 2 per cent. Internal regu-



lated power supply makes readings independent of normal power line variations. The unit may also be used as a wide-range high-gain amplifier due to its output jack and separate volume control. Effective input capacitance is 6 mmfd.

● **Corner Speaker Cabinet.** Created to meet the demands of audio connoisseurs who desire exceptionally fine reproduction in their homes, the new Altec Lansing Type 820A is a living-room counterpart of the company's "Voice of the Theater" speaker system. Housed in a direct radiating horn-type cabinet, the 820A consists of an 808 multicellular horn and driver, two 803 low-frequency drivers, and an N-800-D 800-cps crossover network.

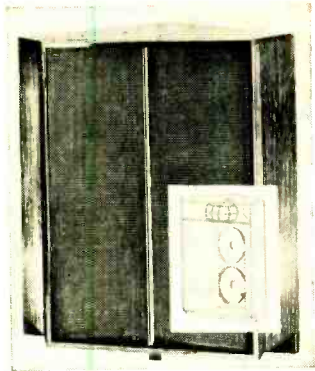

Cabinet is tastefully finished in mahogany. Altec Lansing Corporation, 9356 Santa Monica Blvd., Beverly Hills, Calif.

NEW LITERATURE

• **Carter Motor Co.**, 2644 N. Maplewood Ave., Chicago 47, Ill. has just published a new maintenance and parts catalog for Carter Genemotors, which is being mailed free on request to jobbers, users, and service technicians. Includes correct servicing procedure covering all vital parts such as commutators, bearings, brushes etc. In writing ask for Catalog 351.

• **Andrew Corporation**, 363 E. 75th St., Chicago 19, Ill. has assembled in chart form all salient technical specifications of Teflon insulated u.h.f. and v.h.f. TV transmission lines. Exceptionally complete, Bulletin 73 lists practically all data necessary for selection of a suitable transmission line for any TV transmitter installation.

• **National Information Committee on Lighting**, 1410 Terminal Tower, Cleveland, Ohio, is circulating, as a public service, a 24-page report titled "Lighting and the Nation's Welfare". Involving extensive research, the report summarizes the vital effect of illumination on industrial production, in public safety, in research, and in education. Single copy will be mailed for 25 cents.

• **Helipot Corp.**, 916 Sheridan Ave., South Pasadena, Calif. is now offering without charge an electrical slide rule, the reverse side of which carries pictures and descriptions of four standard Helipot products. May be obtained from Helipot representatives or direct from the factory.

• **Gates Radio Company**, Quincy, Ill. lists its complete line of transmitter parts and accessories in a new catalog prepared essentially for broadcasting and communications personnel. Supplemental to the listings is a section covering application of the various items illustrated and described. Available on request.

• **Westinghouse Electric Corp.**, 2519 Wilkins Ave., Baltimore 3, Md. has assembled a wealth of worthwhile technical information in a new 10-page railroad radio booklet titled "Analyze Your Adjacent Channel Problems." It presents a graphical method of evaluating the adaptability of FM equipment for adjacent channel application. Requests for copy must be on company letterhead and addressed to Mr. J. Schlig.

• **Standard Transformer Corporation**, 3580 N. Elston Ave., Chicago 18, Ill. is now supplying dealers and servicemen with the 1951 edition of the Stancor TV Transformer Catalog and Replacement Guide. Contains replacement information on more than 900 TV receiver models made by 71 manufacturers. Copy may be obtained from Stancor or from any of its distributors.

• **Eit McCullough, Inc.**, San Bruno, Calif. has assembled basic characteristics of all E-nac vacuum tubes manufactured by the company in a new catalog which will be supplied without charge. Requests should be addressed to Application Engineering Department.

• **International Resistance Co.**, 401 N. Broad St., Philadelphia 8, Pa. is now distributing four new catalog bulletins. Designated B-5, A-2, A-4, and F-2, they describe respectively IRC Type BW insulated wire-wound resistors, Type W two-watt potentiometer, new Type Q controls, and a new high-frequency high-power resistor for television, FM, and dielectric

The Discriminating Eventually Come to Leonard's!

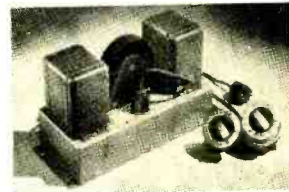
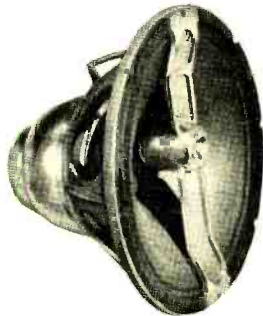

JENSEN TRI-AXIAL LOUDSPEAKER WITH CROSSOVER AND CONTROL NETWORK

The JENSEN Model G-610 is the result of twenty years of intensive research specifically directed toward the attainment of absolute and faithful music reproduction. Consisting of three independently driven units, each covering a portion of the total frequency range and a Crossover and Control Network which divides the electrical input at 600 and 4,000 cps, the G-610 brings to the listener the ultimate in listening pleasure. Frequency Response—20 to 20,000 cps. Impedance—16 ohms. Power Rating—35 watts.

NET \$224.91

ELECTRO-VOICE DYNAMIC MICROPHONE MODEL 655



LIST \$200.00
Standard discounts available

You see . . . and hear . . . the E-V Slim Trim on network and local telecasts and broadcasts. You find it in studios and remote hook-ups. You find it on important PA jobs, too. It's there because it has met the most exacting tests . . . because it serves so superbly in every way for voice and music. Response—40 to 15,000 cps, ± 2.5 db. Power Rating—53. Omnidirectional. Changeable low impedance. Removable swivel.

LEAK "POINT ONE" AMPLIFIER

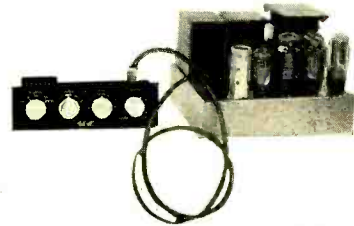

The amazing performance of this truly superb amplifier has prompted music lovers and critics to acclaim it as one of the finest amplifiers at any price! Both amplifier and preamplifier are built of heavy gauge steel, bronze finished. Built-in equalizer for Microgroove, FFRR, and American recordings. Controls—Bass, Treble, Volume and Selector. Frequency Response—20 to 20,000 cps. Power Rating—12 watts. Complete with 3 1/2 ft. connecting cable and plugs plus tubes.

NET \$188.16

You will want our new catalogue. A penny postcard with your name and address will bring it to you.

Leonard Radio inc.

the house
built on
SERVICE

69 CORTLANDT ST., NEW YORK 7, N. Y.

APPROVED • ASTATIC • ATLAS • AUDAK • AUDIO DEVELOPMENT • BELL • BOGEN • BOZAK • BROOKS • BROWNING • BRUSH • CHALLENGER • ELECTRO-VOICE • JENSEN • ESPEY

PENTRON • PICKERING • RACON • RADIO CRAFTSMEN • REK-O-KUT • H. H. SCOTT • SHURE • SONAR • UNI-MODE • UNIVERSITY • V-M • WEBSTER - CHICAGO • WEBSTER ELECTRIC

heating applications. These bulletins are excellent examples of descriptive technical literature at its best.

● **Seletron Division of Radio Receptor Co., Inc.**, New York 11, N. Y. is now distributing a new 16-page fully illustrated catalog of dimensions and ratings for Seletron selenium rectifiers. Included also is basic technical information covering principles of selenium rectifier operation. Copy will be supplied on request.

● **Sonocraft Corporation**, 115 W. 45th St., New York 19, N. Y. has available the 1951 edition of the Sonocraft Review, an illustrated catalog covering all types of sound recording equipment. Free copy will be mailed on request.

● **Electro-Voice, Inc.**, Buchanan, Mich. has recently published a complete phonocarctridge replacement chart which includes features which should be of value to both distributors and dealers. In addition to showing replacement type numbers it describes test procedures for determining whether cartridge replacement is necessary. Copy will be supplied free upon request.

● **Electronics Division, Sylvania Electric Products Inc.**, Emporium, Pa., has recently published a 54-page booklet in which are described 24 applications of germanium crystal diodes. Generously illustrated, the booklet was prepared especially for the hobbyist, experimenter, and modelmaker, and may be obtained by mailing 25 cents to the Advertising Department, care of address shown above.

● **Sun Radio and Electronics Co., Inc.**, 122 Duane St., New York, N. Y. is offering a new 130-page catalog designed especially for use by purchasing agents, research labs, colleges, trade schools, and service dealers. Page size is $8\frac{1}{2} \times 11$ " and full technical information is given on all items listed. Copy available upon request.

● **Wirt Company**, Box 640, 5221-27 Green St., Germantown, Philadelphia 44, Pa. has assembled in a new bulletin complete specifications of its comprehensive line of standard wire-wound resistors and accessories. Also included are photographs and details of each resistor style, together with sketches of terminals and mounting brackets. Requests should specify Bulletin 176.

MEASURING and ANALYZING INTERMODULATION

[from page 21]

modulation distortion and the harmonic distortion produced at the same operating point. Thus Frayne and Scoville⁷ in 1939 gave formulas which, for the usual four to one ratio of low- and high-frequency intermodulation inputs, gave intermodulation as 3.2 times the harmonic distortion for second order distortion. They concluded that the overall relation was 3.8 times.

Hilliard⁸ in 1941 originated the statement that the ratio was *approximately* four times. Unfortunately, the word "approximately" was lost when the phrase transferred to the engineering world's memory, so most engineers have incorrectly assumed a rigid four times ratio.

Warren and Hewlett in 1948 analyzed the relationship at greater length. For the distortion law they first assumed, the ratios became 3.2 times for single-ended stages, and 3.8 times for push-pull operation, but if another assumed distortion law were followed, they found that the ratio might drop to unity.

In 1950 Roddam⁹ assumed still another distortion law and found a 2.8 ratio for second order distortion. In the same year Callendar⁹ observed that tests on various tubes under various Class A and AB conditions gave ratios which did not agree well with computed values.

In a series of very interesting and significant observations on various amplifiers Pappas¹⁰ has observed ratios all the way from over 6 down to less than unity.

That the ratio can change under various operating conditions is shown by Fig. 8, which illustrates the performance of an ordinary push-pull amplifier with single-ended driver stage.

It is evident from Fig. 8 and the other data that no generalized relation exists between intermodulation and harmonic distortion. Under limited conditions a given ratio may apply, but its validity is very narrow in scope. The "four times" ratio is a dangerous error, and should be discarded from engineering thinking.

Conclusions

A new method of intermodulation measurement has been shown, involving

⁷ J. G. Frayne and R. R. Scoville: Analysis of measurement of distortion in variable density recording; *J. Soc. Mot. Pict. Eng.*, vol. 32, pp. 648-673, June 1939.

⁸ Thomas Roddam; Intermodulation distortion; *Wireless World*, vol. 46, no. 4, pp. 122-125, April 1950.

⁹ M. V. Callendar; The influence of high-order products in non-linear distortion; *Electronic Engineering*, vol. 22, no. 272, p. 443, Oct. 1950.

¹⁰ P. Pappas; Electronic Development Laboratory, New York, private communication, 1950.

Presenting

GOODMANS

NEW HIGH FIDELITY - 12" P. M.

TWIN CONE AXIOM 150

\$65. LIST

This 12-in. high fidelity unit has a twin-curvilinear diaphragm (British patent No. 451754). A carefully designed magnet assembly using anisotropic material provides a total flux of 158,000 maxwells on a $1\frac{1}{2}$ -in. pole. The back centering device is a dustproof bakelised linen disk with concentric corrugations. The combination of these features gives this precision-built instrument an outstandingly wide coverage from 40 to 15,000 c.p.s. free from bass modulation effects. An ideal high fidelity reproducer for the record enthusiast and the connoisseur of wide range musical reproduction, it gives exceptionally fine transient and frequency response.

U. S. NATIONAL SALES
WILLGOLD ELECTRONICS SALES CORP.
350 Fifth Avenue, New York, N. Y.

New England Office
Harold A. Chamberlin
31 Milk St., Boston 9, Mass.

Pacific Coast Office
Perlmuth-Colman & Associates, Inc.
1335 Flower St., Los Angeles, Calif.

Chicago Office
Harry Halinton Co.
612 N. Mich. Ave., Chicago 11, Ill.

Canadian Office
A. C. Simmonds & Sons, Ltd.
100 Merton St., Toronto 12, Can.

Manufactured by:

GOODMANS INDUSTRIES LIMITED
WEMBLEY MIDDLESEX ENGLAND

SPECIFICATION

Frequency Coverage
40/15,000 c.p.s.

Overall Diameter
12 in.-31.3 cms.

Overall Depth
6 in.-17.6 cms.

Fundamental Resonance
55 c.p.s.

Voice Coil Diameter
 $1\frac{3}{4}$ in.-4.4 cms.

Voice Coil Impedance
15 ohms at 400 c.p.s.

Maximum Power Cap.
15 Watts Peak A.C.

Flux Density
14,000 gauss

Net Weight
12 lbs. 13 ozs.
(5810 grs.)

Finish—Grey Rivelling Enamel.

much lower equipment cost and clearer illustration of equipment faults than has heretofore been possible.

It has been found that the traditional "four times" relation between intermodulation and harmonic distortion is of very limited significance. The only way to determine intermodulation distortion with certainty is to measure it.

MIXER and PREAMPLIFIER

[from page 17]

network is the same, in principle, as that described previously.

The output circuit also uses a frequency-compensated attenuator, capable of 0 db, -20 db and -40 db attenuation. The associated shunt capacitors are, respectively, 500, 5000 and 50,000 μf . Proper selection of output cable capacitance and subsequent readjustment of the associated shunt capacitor will permit the use of an output cable of almost any length.

Construction

The preamplifier has been made as small as practicable, since it is likely to be used in places where it might be con-



Fig. 8. Under-chassis view of the preamplifier to show details of the input side.

sidered unsightly. The smaller it is, the less obvious it is.

The entire unit is built on the removable top of a $4 \times 4 \times 2$ utility box. Input and output connectors, electrolytic capacitor, tube socket, interstage switch, and power cable all mount on the 4×4 top panel. *Figures 7, 8 and 9* show the parts placement. The under-chassis photographs have been taken from two points in order to show the wiring details more completely.

The same wiring precautions mentioned for the mixer should be observed in the wiring of the preamplifier.

The two 8- μf electrolytic capacitors shown taped together form a part of C_5 and C_6 (*Fig. 5*). Capacitor C_5 consists of one of the 10 μf sections in the mounted capacitor and one of the 8 μf capacitors. C_6 is similarly made up of two such capacitors. These 8 μf units

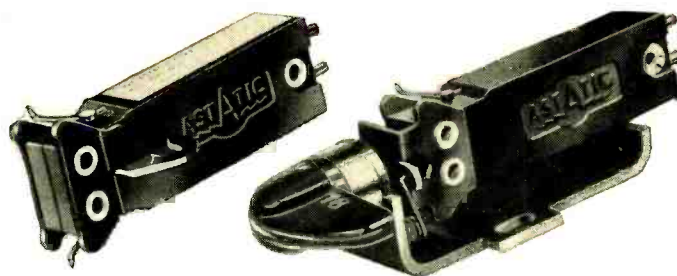

The Finest Lightweight Crystal Cartridge of Them All!

NOW AVAILABLE IN MODELS WITH
CERAMIC ELEMENTS

ASTATIC
"AC" SERIES

ASTATIC has never introduced a new cartridge that has won wider, more immediate acclaim than its "AC" Crystal Series. The new mechanical drive system of the "AC" Cartridges affords a new low inertia . . . smoother response characteristics, higher tracking excellence, lower needle talk resulting. Now, those who need immunity to extremes of temperature and humidity, along with such performance excellence, will find an optimum answer in the new Ceramic "AC" Models. External physical characteristics are the same. Performance characteristics of the Ceramic and Crystal models appear below. Note that output of the Ceramic units is entirely adequate for the two-stage audio amplifiers used in most radios and phonographs.

THE
Astatic
CORPORATION
CONNEAUT, OHIO
IN CANADA: CANADIAN ASTATIC LTD., TORONTO, ONTARIO

SPECIFICATIONS—CRYSTAL MODELS

Model	List Price	Minimum Needle Pressure	Output Voltage 1000 c.p.s. 1.0 Meg Load	Frequency Range c.p.s.	Needle Type	For Record	Code	
AC-78-J	8.90	6 gr.	1.0*	50-10,000	A-3 (3-mil sapphire tip)	Standard 78 RPM	ASWYN	
AC-J	8.90	5 gr.	1.0**	50-10,000	A-1 (1-mil sapphire tip)	33-1/3 and 45 RPM	ASWYJ	
AC-AG-J	8.90	6 gr.	1.0**	50-10,000	A-AG† (sapphire tip)	33-1/3, 45 and 78 RPM	ASWYH	
DOUBLE NEEDLE TURNOVER MODELS.								
ACD-J	9.50	6 gr. either needle	1.0**	50-6,000	A-1 and A-3 (sapphire tips)	33-1/3, 45 and 78 RPM	ASWYL	
ACD-1†	9.50	(Same as ACD-J except equipped with spindle for turnover knob. Replacement cartridge for ACD-2† assembly.)						ASWYF
ACD-2†	10.00	(Same as ACD-J except equipped with complete assembly turnover and knob.)						ASWYE

SPECIFICATIONS—CERAMIC MODELS

Model	List Price	Minimum Needle Pressure	Output Voltage 1000 c.p.s. 1.0 Meg Load	Frequency Range c.p.s.	Needle Type	For Record	Code	
AC-C-J	8.90	5 gr.	0.4**	50-6,000	A-1 (1-mil sapphire tip)	33-1/3 and 45 RPM	ASWTN	
AC-C-78-J	8.90	6 gr.	0.4*	50-6,000	A-3 (3-mil sapphire tip)	Standard 78 RPM	ASWTM	
AC-C-AG-J	8.90	6 gr.	0.4**	50-6,000	A-AG† (sapphire tip)	33-1/3, 45 and 78 RPM	ASWTL	
DOUBLE NEEDLE TURNOVER MODELS:								
ACD-C-J	9.50	6 gr. either needle	0.4**	50-5,000	A-1 and A-3 (sapphire tips)	33-1/3, 45 and 78 RPM	ASWTK	
ACD-C-1†	9.50	(Same as ACD-C-J except equipped with spindle for tuner knob. Replacement cartridge for ACD-C-2† assembly.)						ASWTJ
ACD-C-2†	10.00	(Same as ACD-C-J except equipped with complete assembly turnover and knob.)						ASWTI

† "ALL-GROOVE" Needle tip of special design and size to play either 33-1/3 and 45 RPM (narrow groove) or 78 RPM (standard groove) records.

* Audiotone 78-1 Test Record
** RCA 12-5-31V Test Record

Astatic Crystal Devices manufactured under Brush Development Co. patents

were added after the preamplifier had been placed in service, because additional filter capacitance seemed desirable. A neater job could be obtained if a dual 20- μf mounted capacitor replaced the combination just described. Rubber mounting feet are used on the bottom of the preamplifier case to reduce the effects of excessive shock or vibration.

The schematic of the power supply used with the preamplifier is shown in Fig. 6. The circuit is similar to that of the power supply used with the mixer. The preamplifier power supply is not shown in the photographs. The author's unit is made on a 4 by 4 by 2 inch

chassis. The center of the filament circuit should be connected to ground.

Performance

Working into a load of 100,000 ohms or more, the voltage gain at the 0-db output point is 600 (interstage switch at 0 db). The respective voltage gains at the -20 db and the -40 db output points are 60 and 6.

The frequency response of the preamplifier is ± 1.5 db from 20 to 20,000 cps when the output circuit is as described previously for the mixer.

The writer wishes to express his appreciation to D. E. Norgaard for his

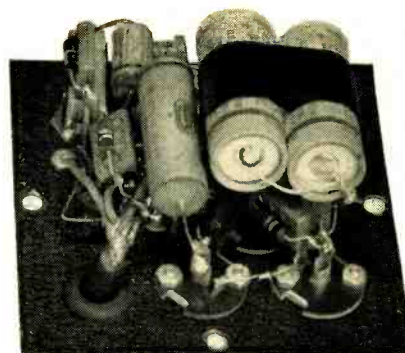

Fig. 9. Under-chassis view of preamplifier showing details of the output side.

work on the design and application of the units described in this article.

PARTS LISTS

Two-Channel Mixer

C_1, C_2	50 μf , 25 v. electrolytic
C_3	0.5 μf , 400 v.
C_4	500 μf , 400 v.
C_5	5000 μf , 400 v.
C_6	20 μf , 450 v. electrolytic
C_7, C_8	40 μf , 150 v. electrolytic
C_9	.05 μf , 400 v.
R_1, R_2	0.1 meg potentiometer, log taper
R_3, R_4	340 ohms, $\frac{1}{2}$ watt
R_5	0.1 meg, $\frac{1}{2}$ watt
R_6	10,000 ohms, $\frac{1}{2}$ watt
R_7	22,000 ohms, 1 watt
R_8	4700 ohms, 1 watt
R_9	1.0 meg, $\frac{1}{2}$ watt
R_{10}	25 ohms, 1 watt
Sw_1	DPST toggle switch
SR_1, SR_2	100-ma selenium rectifier
T_1	Power transformer, 120 v. sec. at 75 ma, 6.3 v. at 1.5 amps. G-E K68J661

High-Gain Preamplifier

C_1	.05 μf , 200 v.
C_2, C_{10}	.05 μf , 400 v.
C_3	50 μf , 400 v.
C_4, C_8	500 μf , 400 v.
C_5, C_6	18 μf , 450 v. electrolytic (see text)
C_7	0.5 μf , 400 v.
C_9	.005 μf , 400 v.
R_1	5.0 meg, $\frac{1}{2}$ watt
R_2	0.1 meg, $\frac{1}{2}$ watt
R_3	22,000 ohms, $\frac{1}{2}$ watt
R_4	1.0 meg, $\frac{1}{2}$ watt
R_5, R_9	0.1 meg, $\frac{1}{2}$ watt
R_6	470 ohms, $\frac{1}{2}$ watt
R_7	56,000 ohms, $\frac{1}{2}$ watt
R_8	39,000 ohms, 1 watt
R_{10}	10,000 ohms, $\frac{1}{2}$ watt
R_{11}	1000 ohms, $\frac{1}{2}$ watt
Sw_2	SPDT toggle switch

Power Supply

C_1	.05 μf , 400 v.
C_2, C_3	40 μf , 150 v. electrolytic
C_4	20 μf , 450 v. electrolytic
R_1	25 ohms, 1 watt
R_2	1 meg, $\frac{1}{2}$ watt
Sw_1	DPST toggle switch
SR_1, SR_2	100-ma selenium rectifier
T_1	Power transformer, 120-v. sec. at 75 ma, 6.3 v. at 1.5 amps. G-E K68J661

Floating Action!

for all TV Cameras

"BALANCED" TV TRIPOD

Pat. Pending

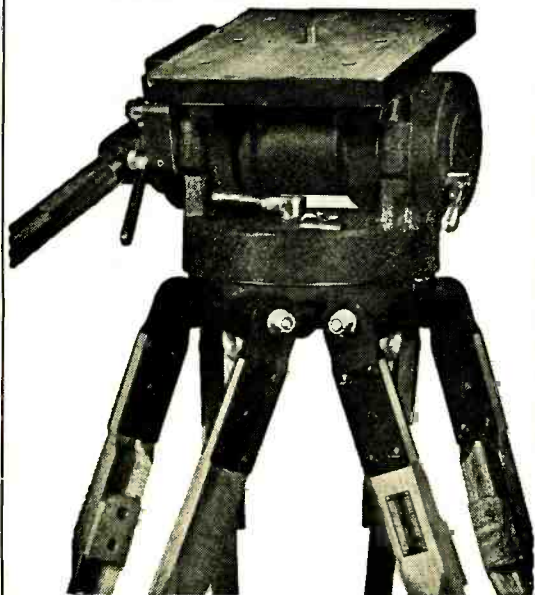

This tripod was engineered and designed expressly to meet all video camera requirements.

Previous concepts of gyro and friction type design have been discarded to achieve absolute balance, effortless operation, super-smooth tilt and pan action, dependability, ruggedness & efficiency.

Below:
3 wheel portable dolly with balanced TV Tripod mounted.



Complete 360° pan without ragged or jerky movement is accomplished with effortless control. It is impossible to get anything but perfectly smooth pan and tilt action with the "BALANCED" TV Tripod.

Quick-release pan handle adjustment locks into position desired by operator with no "play" between pan handle and tripod head. Tripod head mechanism is rustproof, completely enclosed, never requires adjustments cleaning or lubrication. Built-in spirit level. Telescoping extension pan handle.

Write for further particulars



LOUDSPEAKER ENCLOSURES

[from page 14]

the cone with a horn. A horn of the necessary dimensions is quite bulky, and to conserve space it is usually necessary to fold or otherwise change the geometry. The mouth diameter required is determined by the lowest frequency that must be passed, so it must be equal to or greater than $1/3$ wavelength at the lowest frequency. If mouth shape is other than circular, the corresponding area may be used. This gives the relationship that minimum diameter of mouth, in inches, is equal to $4000/f$, where f is in cps. Thus at 50 cps, mouth diameter must be 80 in. In some cases, the walls of the room are utilized as a continuation of the horn, thus affording very large mouth diameter. High-frequency performance is usually limited to frequencies of the order of 400 cps, because high frequencies are lost in the folded horn due to the tortuous path followed, and because of the shunting effect of the air chamber compliance at the horn throat.

In some cases, the front of the speaker is permitted to radiate directly into the air at high frequencies, and the back of the cone is horn loaded to improve efficiency below 400 cps. In the properly designed horn, fairly high efficiencies and good low-frequency response are possible in the transmission range. Because of the heavy loading, the distortion is low and transient response good.

Bass Reflex

The bass-reflex principle is one in which the back side radiation of the speaker is utilized to improve the low-frequency performance of the loudspeaker. This is accomplished by the addition of a simple acoustical network to the enclosed box and results in another degree of freedom for the equivalent circuit of the speaker and cabinet. Figure 6 shows the typical bass-reflex enclosure and its equivalent circuit.

It is seen that an additional degree of freedom is attained by placing a slit or port—for the back side radiation—at the front of the cabinet and near the speaker. At frequencies for which the maximum linear dimension is less than $1/4$ wavelength this unit can be considered a simple dynamical system having two degrees of freedom, or two meshes as shown in the equivalent electrical circuit which represents the mechanical system. The diaphragm is coupled through the stiffness S_p of the enclosure volume to the mass of the air load of the port area A_p .

The addition of a port of area A_p behaves as a second diaphragm since an effective mass of air oscillates in the opening. The mass of air M_p in the port

CABINETS • CHASSIS • PANELS • RACKS

Planning ELECTRONIC EQUIPMENT ? Investigate the ECONOMIES of PAR-METAL HOUSINGS !

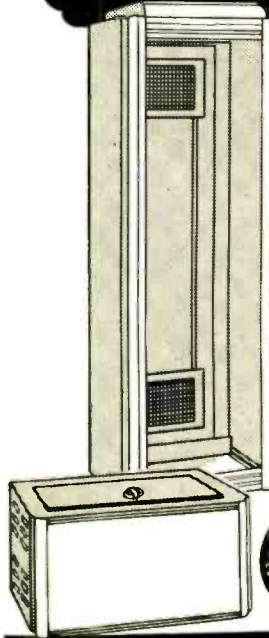

We manufacture Metal Housings for every purpose — from a small receiver to a deluxe broadcast transmitter. And the cost is low!

Because we specialize in the Electronics field, Par-Metal Products excel in functional streamlined design, rugged construction, beautiful finish, and economy.

Remember, Par-Metal equipment is made by electronic specialists, not just a sheet metal shop.

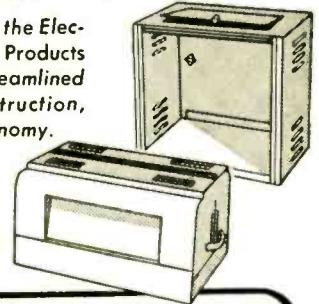

PAR-METAL

PRODUCTS CORPORATION

32-62 — 49th ST., LONG ISLAND CITY 3, N. Y.

Export Dept.: Roche International Corp.

13 East 40 Street, New York 16, N. Y.

WRITE FOR CATALOG !

• ATTENTION

Tape Editors — Sound Men

NEW* TAPE SPLICER

“EDITALL”

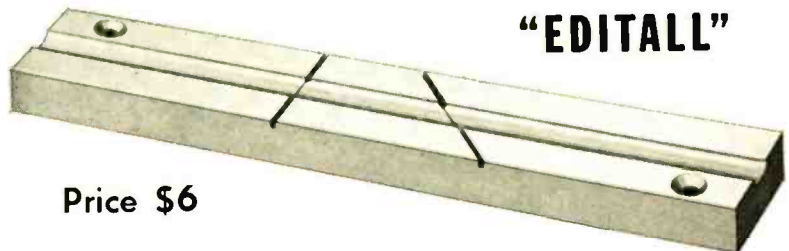

Price \$6

A new* tape splicing block has been developed by CBS's famous tape editor Joel Tall. This new precision Dural block will make a PERFECT SPLICE FASTER and is less tiresome to work with. Send for one today while still available. Manufactured and sold exclusively by:

TECH LABORATORIES, Inc.

Box 148, Palisades Park, N. J.

* Pat. applied for

includes the radiation mass on each side of the port as well as the mass of air in the port. In the range of interest where $2\pi a/\lambda$ is less than one-half, the radiation mass of the port is $M_A = \frac{16A_p \rho a}{3\pi}$ where a is the radius of an equivalent circular piston.

The radiation resistance of the port is

$$R_p = \frac{A_p^2 \omega^2 \rho}{2\pi c}$$

While these expressions apply rigorously in a circular piston, if the ratio of port length to port width does not exceed 2:1 the values calculated from formulas for a piston of equivalent diameter are a satisfactory approximation. The mass

contribution due to the thickness t of the walls of the port opening is

$$M_t = \rho t A_p$$

The total port mass then becomes

$$M_p = A_p \rho (t + .96 \sqrt{A_p})$$

The resonant frequency of the enclosure is then

$$f_r = \frac{1}{2\pi} \sqrt{\frac{S_v}{M_p}} = 2155 \sqrt{\frac{A_p}{V(t + .96 \sqrt{A_p})}}$$

It is seen from the above equation that the resonant frequency of the enclosure is determined by the volume of enclosure and also by the area of the port and mass of air in the port.

In many cases the area of the port

is made equal to the effective radiating area of the speaker so as to attain the maximum mutual impedance between the two radiating surfaces. When this is done, in order to make the volume V of reasonable value for a given resonant frequency, the length t is varied by the use of ducts. If a duct of volume V_d is used, the previous equation must be modified to the following extent:

$$f_r = 2155 \sqrt{\frac{A_p}{(V - V_d)(t + .96 \sqrt{A_p})}}$$

With the values of port radiation resistance and mass defined, the equivalent circuit can be simplified by referring these parameters to the mechanical mesh of the speaker by multiplying the port impedance by A_s^2/A_p^2 .

The exact analysis of the equivalent circuit is complicated by the fact that the mutual radiation impedance between the diaphragm and port is a function of the size and spacing of the radiating surfaces. If two surfaces of equal area are closely spaced and have the same phase and amplitude of vibration, the radiation resistance due to mutual coupling is increased, while the radiation mass is increased to a lesser extent. When the pistons differ with respect to amplitude and phase the radiation resistance of each diaphragm may be less than it normally would be. Figure 7 shows the difference in radiation when a second radiator is added.

The calculation of the total energy involves the calculation of radiation from a double source. In the general case this cannot be done, but by making simplifying assumptions regarding the boundary condition, a close approximation may be obtained in special cases.

The modes of the network with two degrees of freedom can be calculated or obtained by use of Mohr's circle.

If the resonant frequency f_r of the enclosure and port is chosen to coincide with that of the speaker as is usually the case, the modes of the network are given by

$$f = f_r \sqrt{\frac{(a+2) \pm \sqrt{a^2 + 4a}}{2}}$$

$$\text{where } a = \sqrt{\frac{S_v M_p}{S_s (M_A + M_s)}}$$

and the phase θ between the velocities v_1 and v_2 is given by

$$\theta = \tan^{-1} \frac{\omega R_p}{S_r (1 - \frac{\omega^2}{\omega_r^2})}$$

When $f = f_r$, analysis of the equivalent circuit shows that the impedance is resistive and has a maximum at this point so the excursion of the speaker diaphragm is very much less than it would be in an infinite baffle or type of enclosure other than the properly adjusted bass-reflex enclosure. At this frequency f_r , the radiation from the port predominates and is in quadrature with the diaphragm radiation. There are two frequencies f_1 and f_2 which are below and above, respectively, frequency f_r , and are determined by the quantity a

**MAGNETIC
RECORDING
TAPES TO
THE HIGHEST
PROFESSIONAL
STANDARDS**

Now the well-known Duotone super-quality is available in magnetic recording tapes for commercial and home recorders. The six Duotone quality features assure finest sound reproduction for professional programming and the ultimate in home entertainment. For finest performance on any tape recorder, use Duotone professional quality magnetic tapes!

- Interchanges with Other Tapes
- Constant Tracking and Winding
- No Snarls or Backlash
- Low Inertia Plastic Wheel
- Low Friction—Long Life
- High Output—Minimum Background

**DUOTONE SUPER QUALITY IS AVAILABLE
IN TAPES FOR EVERY RECORDING NEED**

Made with plastic or kraft paper base in extra long 625 or 1250 foot lengths. Plastic base is tough with high tear strength and special smooth finish for uniform coating. All kraft bases are super-calendered for perfect surfacing without fillers. For complete data on Duotone standard and special tapes, call or write for illustrated catalog.

Famous for Phono Needles, Recording Needles, Discs, and Quality Sound Accessories

DUOTONE
COMPANY INC.
Keyport, New Jersey

Canadian Representative: CHARLES W. POINTON, TORONTO, CANADA
Export Division: AD. AURIEMA, INC., NEW YORK CITY, N. Y.



**— IN A
RECORDING
TAPE
FOR EVERY
PURPOSE**

*6 WAYS
to better
Recordings*

Concertone

MAGNETIC TAPE RECORDER



"just like
being
there"

Professional quality at lowest cost. Available as the Basic Recorder alone, or with Console Tray, Carrying Case or Console Cabinet (illustrated). Model 1401 Basic Recorder ready for installation. Professional users' net price..... **\$345.00**

Write for Bulletin #101

Manufactured By

Berlant Associates

4917 W. Jefferson Boulevard
Los Angeles 16, California

STEREON

is still available to those who would enjoy the luxurious spaciousness of unrestrained symphonic colour. Two similar loudspeakers simply connected to STEREON in conjunction with your present fine amplifier will enable you to easily attain three dimensional sound reproduction.

STEREON, together with adequate connexion information, will be shipped to you post free for 14.00 dollars. A fortunate purchase of high-grade materials allows an indefinite extension of the previously limited order acceptance period.

LEYGHTON-PAIGE

215 Commerce Bldg., St. Paul, Minn.

previously defined. The mechanical impedance at these frequencies is a minimum and will produce an impedance maximum on the electrical side. It may be mentioned at this point that even though resonance occurs at frequency f_2 higher than that of the same speaker in a large closed cabinet, damping is better. This can be attributed to the increased mutual radiation impedance between port and diaphragm and a larger value of radiation resistance at the higher frequency. In most cases, however, the damping is largely dependent upon the magnetic energy of the speaker and the source impedance.

Below f_r , when dissipation is small the phase shifts very rapidly so that the radiation from port and diaphragm are out of phase by 180 deg. while above f_r the two radiating surfaces are in phase. Figure 8 shows the phase relationship existing between the velocities v_p and v_d in the two meshes for no dissipation, small amount of dissipation and for critical damping of the parallel mesh. The phase shifts are those existing in the equivalent circuit. From the radiation standpoint, since the front and back of the speaker are 180 deg. out of phase, phase difference between port and diaphragm approaches 180 deg. below ω_r and approach the in-phase condition above ω_r . It is seen that for critical damping, the phase shift becomes 180 deg. at zero frequency. As a result, the radiation below f_r will generally tend to fall off in transition from simple to doublet source, the exact behavior depending upon the amount of dissipation present. Above f_r the radiations are in phase, and contribution to frequencies as high as $2\omega_r$ can be expected from the port.

Figure 9 shows the ratio of the magnitude of port velocity to that of diaphragm velocity as a function of frequency for various values of damping in the added mesh. At higher frequencies the response from the port is reduced by the shunting effect of the cabinet volume and losses in the absorbing material in the cabinet.

In the application of the bass-reflex principle to loudspeakers, the speaker of the largest possible diameter should be chosen because the radiation resistance is proportional to the fourth power of effective diameter; the amplitude of motion of the diaphragm for a given amount of radiated power is less with a larger diaphragm, thereby reducing distortion that arises from non-linearities in the speaker.

The dimensions of the cabinet have not been found to be overly critical. Design charts given here hold very well for cabinets in which the longest side is not more than one eighth wavelength.

The port should be placed close to the speaker in order to take advantage of mutual impedance increase resulting from this close coupling. While port area is not critical, the port must be at least one quarter the effective speaker area. If smaller, the cabinet tends to act as a closed cabinet. Port area may be larger than the speaker area where the larger



GROUCHO MARX,
"You Bet Your Life," NBC

*Favorite of
Show Business*

**RCA's
"STARMAKER"**

... a ribbon-pressure microphone that is so slim ... so skillfully styled ... so unobtrusive ... you must look twice to see it.

Despite its slim construction, the STARMAKER meets the exacting quality standards of other RCA professional Broadcast microphones. Pick-up is non-directional. Frequency response is substantially uniform, 50 to 15,000 cps. It is free from wind rumble and air blast ... and virtually impervious to mechanical shock.

The STARMAKER fits any standard microphone stand ... can be used in place of any RCA microphone. No extra attachments needed.

For delivery information call your RCA Broadcast Sales Engineer, or write: Department S-7, RCA Engineering Products, Camden, N. J. (In Canada write: RCA Victor Limited, Montreal.)



**RADIO CORPORATION
of AMERICA**

Air-Tone HEADQUARTERS FOR Magnecord.



PT6-JAH Recorder & Amplifier
 Portable rig for professional, superb reproduction of all types of program material. 10-Watts output. Highest Quality, Greatest Value.
 Complete systems from \$564.00

IN STOCK NOW!

McIntosh Amplifiers

Highest quality, efficiency. Full dynamic range. Frequency range—20 to 20,000 plus or minus .2db; 10 to 200,000 plus or minus 2db. Lowest phase shift distortion, lowest noise level.

- 50 W-1 for less than 1% distortion
 - Continuous single frequency rating
 - 50 watts RMS—Peak 100 \$249.50 net
- 20 W-2 for less than 1% distortion
 - Continuous single frequency rating
 - 20 watts RMS—Peak 40 \$149.50 net

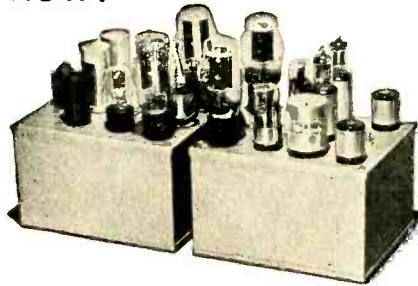

Air-Tone HIGH FIDELITY SYSTEMS ON DISPLAY AT OUR SHOWROOMS

SOUND & RECORDING COMPANY
 1527 CHESTNUT ST., PHILA. 2, PA. — RI. 6-8388

area gives the proper volume-port resonance.

With a port area in this range, and with resonant frequency of the speaker known, the volume of the enclosure can be found from Fig. 10. The correct port size can then be determined by observing experimentally the frequency placement of the modes for a given trial port size. These modes are always on opposite sides of the blocked port mode, and move in the same direction as the port area is changed. In practice, it has been found that the scalar impedance of the two

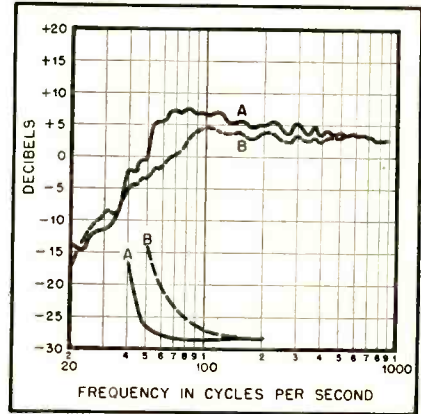

Fig. 12. Sound pressure and distortion, bass-reflex and enclosed cabinets of 7.3 cu. ft. volume, with 15-in. speaker. (A) solid curve, 66 sq. in. port. (B) dotted curve, no port.

resulting modes should be approximately equal in magnitude. If the port area becomes too small, a duct can be used to tune the enclosure to a lower frequency for the same port area.

A loudspeaker enclosure can be a bulky and even an expensive piece of equipment. In the case where economy and need for space dictate the use of relatively small enclosure volume, a properly tuned bass-reflex system helps to offset the effect of the small volume. In this case, where cabinet volume is small, it is best to tune the port exactly to the speaker resonance. Figure 11 shows the response and distortion characteristics of an 8-in. speaker in a one cubic foot cabinet, with and without port. This volume is small for this size speaker.

In the case where the cabinet volume allowable is more generous, a bass-reflex enclosure offers considerable gain in output at the extreme low end. Figure 12 shows the response and distortion characteristics of a low-resonance 15-in. speaker in a 7.3-cu. ft. cabinet with 66-sq. in. port, and the same speaker and cabinet without port. Figure 13 shows the effect of mistuning the port. Curves are shown for tuning to frequencies above and below the speaker resonance. It is seen that in this case, where enclosure volume is neither large nor small, the port should be tuned to the speaker resonance or slightly below.

There may be some instances where a cabinet to be used has a volume which is larger than necessary. If the volume is very large, it becomes difficult or impossible to tune the system to the speaker resonant frequency without a port of

HEATHKITS OFFER UNMATCHED ADVANTAGES

You'll find unmatched advantages in HEATHKITS—the most complete line of test equipment in kit form. Careful engineering and extensive laboratory testing in the development of each kit, coupled with the use of only highest quality components give you RUGGED, DEPENDABLE, and ACCURATE test equipment.

You SAVE MONEY when you build your own because all expensive factory wiring and construction costs are completely eliminated . . . All kits are COMPLETE and a real pleasure to build—Every part necessary is furnished—and the clear, detailed instruction manual makes construction easy and educational. (And, the finished kits are truly professional in appearance.) Order your HEATHKIT today and enjoy these tremendous advantages!

- Heathkit OSCILLOSCOPE KIT \$39.50
- Heathkit TUBE CHECKER KIT \$29.50
- Heathkit TV ALIGNMENT GENERATOR KIT \$39.50
- Heathkit VACUUM TUBE VOLTMETER KIT \$23.50
- Heathkit SIGNAL TRACER KIT \$19.50
- Heathkit ELECTRONIC SWITCH KIT \$19.50
- Heathkit CONDENSER CHECKER KIT \$19.50
- Heathkit AUDIO GENERATOR KIT \$34.50
- Heathkit IMPEDANCE BRIDGE KIT \$69.50
- Heathkit RF SIGNAL GENERATOR KIT \$19.50
- Heathkit BATTERY ELIMINATOR KIT \$22.50
- Heathkit HANDITESTER KIT \$13.50

HEATH COMPANY
 BENTON HARBOR 25, MICHIGAN

EXPORT AGENT: ROCKE INTERNATIONAL CORP., 13 EAST 40th STREET, NEW YORK CITY 16

excessive size. In this case, the best adjustment is to set the port size at about $1\frac{1}{2}$ to 2 times the effective speaker area, and allow the resonant frequency of the cabinet to be lower than the speaker resonance. There will be little effect on response or distortion at speaker resonance, but there will be improvement in both these factors in the region of the cabinet resonance.

Figure 14 shows what happens when an 8-in. speaker is used with a 12-cu. ft. cabinet with a port of 60 sq. in. The

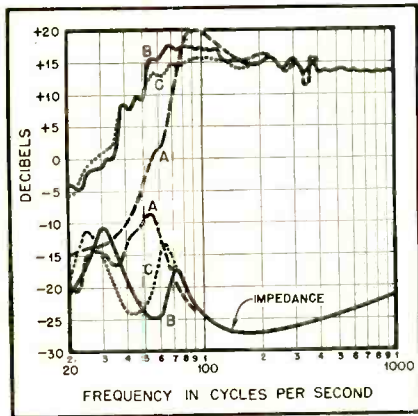

Fig. 13. 15-in. speaker in 7.3 cu. ft. cabinet. Port areas—(A) dashed, 132 sq. in. (B) solid, 66 sq. in. (C) dotted, 32 sq. in.

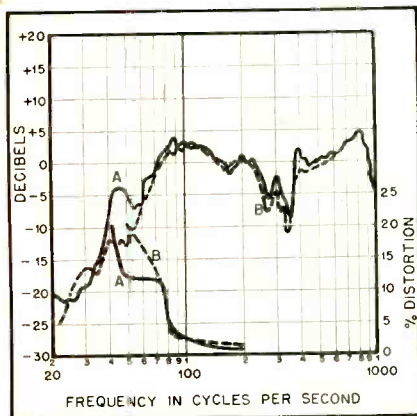

Fig. 14. 8-in. speaker in 12 cu. ft. cabinet. (A) solid curves, 60 sq. in. port; (B) dotted curves, no port.

speaker has a resonance of about 100 cps, the cabinet of about 40 cps.

The ratio of port area to speaker area can be used to determine when the cabinet volume should be considered large or small. If the port area required to tune the cabinet to speaker resonance is less than one-half the speaker area, the volume is small. If the port area is more than one and one-half times the speaker area, the volume is large.

The photograph, page 12, illustrates a modern bass-reflex enclosure with a removable front panel for ease of installation and adjustment.

Theoretical considerations and corresponding experimental work, combined with extensive listening tests, lead us to believe that the properly adjusted bass-reflex cabinet is the most generally suitable enclosure for loudspeakers.

Audio NEW Intermodulation Meter and Set

HIGHEST PROFESSIONAL FLEXIBILITY at Reasonable Cost!

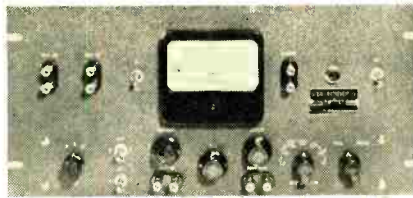

Model 165 IM Meter is especially suited for laboratories, broadcasters, recording studios. Has signal generator, analyzer, voltmeter in single compact case. Reads %IM, amplifier output directly on meter. Provides for use of oscilloscope to analyze and cure IM causes: full graphic instructions supplied. Wide range of low & high test frequencies: 60 cps internally, 40-200 cps externally; standard 2, 7, 12 kc internally, 2-20 kc externally. Only 0.1% residual IM due to accurate bridge-type mixing circuit for 2 tones & special analyzer wave filters. Voltage ratio choices: for LF testing, 1:1. $8\frac{1}{2} \times 19$ " rack-type panel; $8\frac{1}{2}$ " deep. Price \$250.00.

With Model 162 IM Set and your own audio oscillator and oscilloscope, you measure %IM in any pickup, amplifier or system directly on your scope image in just seconds. Identify wrong bias, wrong load Z, tube unbalance, regeneration, insufficient drive capacity, etc. Complete with graphic instructions for adjusting equipment for best performance. Price \$88.50.

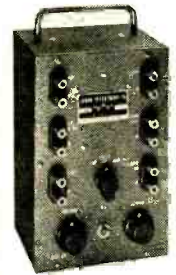

WRITE NOW FOR CATALOG A

Audio INSTRUMENT COMPANY
Dept. π 133 W. 14th St. N. Y. 11, N. Y.

ADDRESS CHANGES

Subscribers to AUDIO ENGINEERING should notify our Circulation Department at least 5 weeks in advance regarding any change in address. The Post Office Dept. does not forward magazines sent to a wrong destination unless you pay additional postage. We can NOT duplicate copies sent to your old residence. Old and new addresses MUST be given.

RADIO MAGAZINES, INC.
342 Madison Ave.
New York 17, N. Y.

NOTHING ELSE LIKE IT

ELEMENTS of SINGLE and DUAL TRACK TAPE RECORDING and 1001 APPLICATIONS



ONLY \$1.00 by A.C. Shaney POSTPAID

144 pages crammed with facts. Contains circuit diagrams, parts lists, construction hints, as well as elementary and advanced theory and design. Send check, cash, or M.O.

AMPLIFIER CORP. OF AMERICA

398 Broadway New York 13, N. Y.

Your Best Buy In A Medium Priced Top Quality HIGH FIDELITY AMPLIFIER

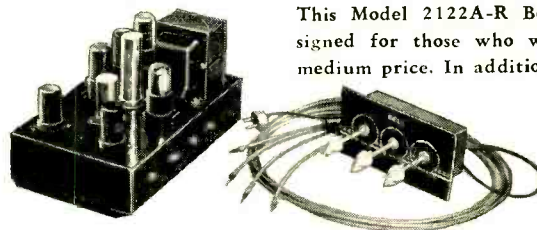

Specification Highlights

OUTPUT: 10 Watts at Less than 3% Peak Power 15 Watts.
FREQUENCY RESPONSE: $\pm .75$ db. 30 to 15,000 cycles with Controls Set for Flat Response.
GAIN: Radio (Hi-Z) 76 db; Xtal Phono (Hi-Z) 74 db; Mag #1 92 db; Mag #2 110 db.
HUM LEVEL: -65 db. Below Rated Output
INPUTS: 1-Radio; 1-Xtal Phono; 1-Mag #1; 1-Mag #2
DIMENSIONS: $7\frac{1}{2}$ " Deep; 6" High; $11\frac{1}{2}$ " Long

This Model 2122A-R Bell Amplifier is especially designed for those who want a quality amplifier at a medium price. In addition to having inputs for a radio tuner and any Crystal pickup, it contains two special inputs for the new type Magnetic pickups. Built-in pre-amplifiers and individual equalization of each of these Magnetic inputs assures proper match and response. Bass and Treble boost, plus attenuation, makes it possible for the operator to adjust the tone to his most exacting tastes. Adjustable output impedance permits proper matching to most types of speakers.



BELL SOUND SYSTEMS, Inc.
559 MARION RD., COLUMBUS 7, OHIO
Export Office: 4900 Euclid Ave., Cleveland 3, Ohio

SAVE
33 1/3%



This is our
GROUP SUBSCRIPTION PLAN

You and your friends and co-workers can now save up to \$1.00 on each subscription to **AUDIO ENGINEERING**. The more men in a Group, the more each saves. If you send 6 or more subscriptions for the U.S.A. and Canada, they will cost each subscriber \$2.00, 1/3 less than the price of a regular 1-year subscription. **Present subscriptions may be renewed or extended as part of a Group.**

AUDIO ENGINEERING is still

- The only publication devoted entirely to Audio—
- Recording
- Broadcasting equipment
- Acoustics
- Home reproduction systems
- PA systems
- Psychoacoustics

(Please print)

Name

Address

Position Company

Name

Address

Position Company

Name

Address

Position Company

Name

Address

Position Company

Name

Address

Position Company

Name

Address

Position Company

Add \$.50 to each Foreign subscription ordered

RADIO MAGAZINES, INC.
342 Madison Ave., N. Y. 17, N. Y.

AUDIO PATENTS

[from page 2]

vacuum-tube equivalent, showing a zero-impedance generator with series plate resistance.

The series plate resistance is used as the crossover-producing resistor if its value is right. In that case the transformer has a 1-to-1 ratio unit. Since there is no external resistor there is no power loss. In addition, since very little power is concerned the transformer can be small, inexpensive, and efficient. This is all true, of course, because

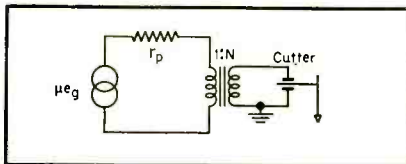

Fig. 3

resistance in the primary circuit of a transformer is reflected into the secondary.

The same fact can be used to advantage if the plate resistance of the tube does not happen to be correct for the job. In that case, the transformer to be used is one which has a turns ratio equal to the square root of the ratio between the desired resistance and the plate resistance. As an example, if the tube is a 6J5 with a plate resistance of 10,000 ohms and the reactance

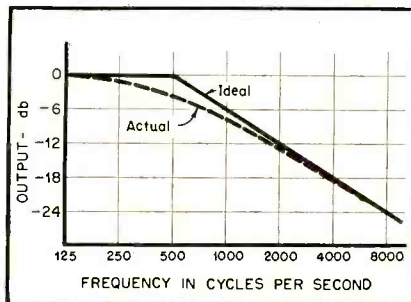

Fig. 4

of the cutter is 20,000 ohms at the desired turnover of 500 cps, for example, the desired resistance ratio is 2 to 1. The turns (and voltage) ratio, primary to secondary, is then the square root of 2, or 1.41. Assuming the crystal response itself to be flat, the recorded curve will be like the dashed line of Fig. 4. The solid line represents the theoretical ideal.

HOLLYWOOD LETTER

[from page 4]

run an exciter lamp at 3350° Kelvin, which is very close to the burn-out point, and had previously supplied a hand control rheostat for adjustment. Lamp burn-outs were excessive, so a development program was initiated to obtain a suitable regulated supply operating from the 115-volt a.c. supply lines. The only locally available supply was a large unit using mercury or xenon rectifiers, with electronic regulation. The magnetic unit which was finally developed for this job was wound on two of the large (4-in. diam.) Deltamax cores, had a gain of approximately 100,000, and used selenium rectifiers both for load rectification and for d.c. feedback. The final packaged unit was less than one quarter the weight of the electronically controlled unit and exceeded

CLASSIFIED

Rates: 10c per word per insertion for noncommercial advertisements; 25c per word for commercial advertisements. Rates are net, and no discounts will be allowed. Copy must be accompanied by remittance in full, and must reach the New York office by the first of the month preceding the date of issue.

FOR SALE: Altec Lansing 605A speaker with dividing network, mounted in a Cameron Craft Blond Oak cabinet, \$190. 2 Rek-O-Kut G2 standard, \$75 each, including two Trush PL-20 arms. Entire lot for \$325. James E. Palmer, 8095 36th Place, Sandia Base, Albuquerque, N. M.

TRANSCRIPTION TT OWNERS: Collection of original acetate recordings, including symphonies, Horowitz and Rubinstein piano works, Colman's "Tale of Two Cities," and others—over 200 total. Write for list. Box CK-4, **AUDIO ENGINEERING**.

LET ME improve your present amplifier to sound like Williamson's. \$49.00. Arthur Levine, 3405 Kossuth Ave., Bronx 67, N. Y. OL 2-6815, evenings.

FOR SALE—New A323B Altec Amplifiers; also ADC input transformers Type 210E. Custom Designs, 7311 Varna, North Hollywood, California.

FOR SALE: UTC LS-22, LS-57, like new; \$25. R. N. Johnson, 63 Olney Rd., Wethersfield, Conn.

FOR SALE: Lear Wire Recorder, specially modified. Flat to 10 kc. (Exceeds response of best-known magnetic cartridge.) Free from wow and flutter. With 135 spools *premium grade* wire. A \$1500 value for only \$500, or will sell wire in small lots at 45% to 60% discount. John H. Cone, 2327 Arthur St., Los Angeles 65, Calif.

FOR SALE: Leach 78-33 1/2 12-in. recording turntable, in case, \$19. UTC HA-101X input transformer, \$9. Box CL-1, **AUDIO ENGINEERING**.

FOR SALE: Rek-O-Kut 743 three-speed turntable, perfect condition, purchased April 3, 1951. Price \$45. Also Newcomb HLP-14 14-watt amplifier. Cost me \$81 eight months ago; perfect condition, \$50. Tony Hofmann, 11 Shady Hill Sq., Cambridge, Mass.

FOR SALE: PT900R1 Presto portable tape recorder used as demonstrator approximately 15-20 hours, 50-ohm inputs; Brook 10D 30-watt amplifier; Altec 323B amplifier; Presto L2 playback amplifier-speaker unit; two 6N recording cases; new PT6-BL loop mechanism; new PT6MA case; Presto 10A turntable; Presto 6N disc recorder. All in good condition. Shipping charges COD. **MASTERTONE RECORDING COMPANY**, Box 1060, Des Moines, Iowa.

SPEAKER REPAIRS for the trade, guaranteed work, lowest prices. Amprite Speaker Service, 70 Vesey St., New York 7, N. Y.

PRESTO 90-A three-channel recording amplifier \$250. Professional transcription arm with new G-E cartridge \$20. Reco-Art, 1305 Market St., Philadelphia, Penna.

FOR SALE: Two Presto 6-N's. Like new, just two years old. Also two RCA 50-watt amplifiers. Box CL-2, **AUDIO ENGINEERING**.

FOR SALE: One used Presto 1C cutter, one new Webster Electric cutter. Best offer. Peter J. Helfrich, 717 N. Ott St., Allentown, Penna.

WANTED: Magnecord recorders and Magnecord playback units. Write year, model no., condition, and price wanted. Radio Broadcasting Co., Inquirer Bldg., 18th Fl., Philadelphia 30, Penna.

IF YOU BUY ON SPECIFICATIONS



and tops in value, you'll buy the

TWIN-TRAX* TAPE RECORDER
 "Choice of Engineers Everywhere"

Compare the guaranteed specifications of a Twin-Trax Tape Recorder with any other recorder in any price class. You'll find that Twin-Trax gives you more features, better all-around performance and more value for your money. Complete specifications, performance ratings and direct factory prices in our catalog 5109. Send for it today.

*Trademark Reg.

AMPLIFIER CORP. of AMERICA

398 Broadway, New York 13, N. Y.

DON'T READ THIS

unless you keep and refer to your copies of **AUDIO ENGINEERING**. If you do, keep them in our binder—blue Fabricoid covered, rigid backbone, \$2.50 (add 50¢ per binder for foreign orders).

RADIO MAGAZINES, INC.

342 Madison Ave., New York 17, N. Y.

PROFESSIONAL DIRECTORY

C. J. LeBEL

AUDIO CONSULTANT

Development, Test, Custom Equipment,
 Complete Laboratory and Shop Facilities

133 WEST 14TH STREET
 NEW YORK 11, N. Y.
 CH 3-8082

Custom-Built Equipment

U. S. Recording Co.

1121 Vermont Ave., Washington 5, D. C.
 LIncoln 3-2705

RICHARD H. DORF
 AUDIO CONSULTANT

Sound Systems Recording Installations
 Product Design Technical Literature

255 W. 84th Street Phone
 New York 24, N. Y. Schuyler 4-1928

it in performance. The regulation from no-load to full-load was far in excess of the requirements and, in fact, was so good that it was difficult to detect any variation. The time constant achieved in the control circuit was less than two cycles of supply frequency, or 1/30 second.

Much of the TV material shown locally is recorded on film, and after listening to some of the programs it is obvious that either a change in technique or equipment is badly needed. Spot-commercials are interjected into the regular programs, and the timing of these is such that during the first 15 or 30 seconds the audience is listening to the sound head "settle down" to a non-flutter (?) condition. The motion picture industry solved this problem long ago with "spot" material by means of the "slip-sync" method, utilizing discs on a pre-rotating turntable. Possibly some such method could be devised for TV "spots," or a sound head which comes up to speed faster. The only alternative in technique seems to be just a little more leader on the film and a little more anticipation.

Industry Notes - -

Aerovox Corporation, New Bedford, Mass., taking over **Wilkor Products, Inc.**, Cleveland Ohio. Latter will continue to operate as separate entity in the production of precision resistors. **Harvey Radio Co.**, 103 W. 43rd St., New York City, chosen at RTMA convention in Chicago as "Jobber of the Year" for metropolitan area. **Bendix Aviation Division** sponsoring school to train Air Force personnel in maintenance of military electronic equipment—located at Pimlico Airport, Baltimore.

Russellcraft Company, 2633 W. Grand Ave., Chicago 12, Ill. taking over manufacture of Uni-Mode custom cabinets from **Grand Rapids Woodcraft Corp.**, Grand Rapids, Mich. **West Coast Electronic Manufacturers' Assn.** launching a materials exchange program under direction of O. B. Sundberg, Hewlett-Packard purchasing agent—will issue monthly list of materials wanted and surplus items on hand. **Milo Radio and Electronics Corp.**, 200 Greenwich St., New York 7, N. Y. has been appointed to distribute Westinghouse industrial tubes in metropolitan area.

RCA's new 17-acre tube plant in Cincinnati dedicated June 11—will be devoted exclusively to manufacture of miniatures and sub-miniatures. **Miniature Precision Bearings, Inc.**, Keene, N. H. astounded editors with publicity mailing of smallest ball bearing ever produced in quantity—makes the head of a tack look like a bass drum. **Minnesota Mining and Manufacturing Company**, St. Paul Minn. announces cost-of-living wage increase to 3500 office, technical, and engineering employees. **Telechron, Inc.**, heretofore an affiliate of **General Electric**, will become a department of the parent company—no change in management or personnel.

Plans nearing monolithic stage for annual convention of **Audio Engineering Society** and **Audio Fair** scheduled for November 1, 2, 3 at Hotel New Yorker. Webster-Chicago's new tape recorder a smash hit in initial showing at New York jobbers. **Leonard Radio, Inc.**, 69 Cortlandt St., New York 7, N. Y. has new Sound Equipment Catalog in the mails.

NBC following policy of giving audio engineers billing on certain major TV programs.

Industry People--

Robert L. Stephens, president, Stephens Manufacturing Co., Culver City, Calif. motored to New York for talks with reps and jobbers following RTMA convention in Chicago.

Dr. George J. Goepfert appointed Director of Research for Speer Carbon Co., St. Marys, Penn. **R. Morris Pierce** named executive engineer for The Voice of America—will be concerned especially with construction of new facilities.

Dr. Harry F. Olson, director of RCA's Acoustical Research Laboratories, elected president of the Acoustical Society of America for the year 1952.



GARRARD

"Triumph"

WORLD'S FINEST RECORD CHANGER

Plays all speeds

Fully automatic with automatic stop

Heavy duty silent motor
 Absolutely no rumble!

Heavy drive shaft
 No wows!
 No wavers!

FREE!
 Fact sheet
 for pointers
 on new record
 changers

At your
 dealer or
 write to
 Dept. 7E

GARRARD SALES CORP.
 164 DUANE ST., NEW YORK 13, N. Y.

NO. 1 SOURCE



LEADING BRANDS
ELECTRONIC TUBES
 and EQUIPMENT
 for ALL BROADCAST
 and INDUSTRIAL APPLICATIONS
 —For IMMEDIATE DELIVERY!



PURCHASING AGENTS!
CHIEF ENGINEERS!
 Send For This!
FREE 1053 PAGE
MILO CATALOG!

Write today on your company letterhead for your copy of our gigantic buying guide—an invaluable aid in your purchasing. Completely illustrated, with technical specifications. Address Dept. AE.

The NATION'S GREATEST STOCK!
 CONDENSERS • RESISTORS • TRANSFORMERS
 CONNECTORS • SWITCHES • RHEOSTATS
 RELAYS • PLUGS • JACKS • CHASSIS
 TUBES, etc.

★ For PROMPT, PERSONAL ATTENTION
 PHONE • WRITE • WIRE—or TELETYPE!

MILO RADIO
 & **ELECTRONICS CORP.**

200 GREENWICH STREET, NEW YORK 7, N. Y.
 Phone BEekman 3-2980 • Teletype NY1-1839



THE SHAPE OF THINGS TO COME

Our policy involves taking our customers into our confidence. In that way we foster the mutual trust that exists between us. Here is the shape of the near future as we see it today.

The 215 Speaker

When our present stock of magnets is exhausted, the price to us on new deliveries will be 50% up. We do not make enough profit now to enable us to carry that extra cost, and soon the price of the 215 will have to be raised. If we doubled the price, many would still think it a better buy than any other, for, according to the testimonials we regularly receive, the 215 at \$48.00 out-performs other speakers costing up to \$200.00. At least, that is what we are told.

But if you order now we will supply at \$48.00—even if our magnets cost us more—simply to keep our production steady through the summer (when British demands ease off). In the fall your 215 may cost \$10.00 more, and it will not be a better speaker, although still better than the rest.

The Hartley-Turner Record Catalogue

Three years more work has brought this unique work right up to date. This loose-leaf guide to the best recordings is essential if you want authentic lists of the best British and continental recordings. A few outstanding American records are included, but we don't try to compete with the excellent books of David Hall and the Gramophone Shop. But if you want the real low-down on records east of the Atlantic, it is yours for \$4.00. Owing to the shortage of supplies over here, only a very limited number of subscriptions can be accepted. Order now before it is too late.

Mailing List

All our subscribers will get a new mailing soon, technical data, news comments, and the sort of thing that makes up what subscribers say is the best dollar's worth for years. If you have not yet gotten on to our list, send \$1 bill today, and past mailings will be included. Sheer pressure of work has prevented us sending our spring bulletin before now.

Illustrated literature is free on request.

H. A. HARTLEY CO. LTD.
152, Hammersmith Road
London W.6, England

ADVERTISING INDEX

Air-Tone Sound & Recording Co.	36
Amperite Co., Inc.	4
Ampex Electric Corp.	40
Amplifier Corp. of America	37, 39
Arnold Engineering Co., The ...	Cover 3
Astatic Corp., The	31
Audak Co.	23
Audio Devices, Inc.	Cover 2
Audio Instrument Co.	37
Belden Mfg. Co.	5
Bell Sound Systems, Inc.	37
Bell Telephone Laboratories	8
Berlant Associates	35
Camera Equipment Co.	32
Chicago Transformer Co.	21
Classified Ads	38
Dorf, Richard H.	39
Duotone Co., Inc.	34
Electro-Voice, Inc.	19
Garrard Sales Corp.	39
Goodman Industries Ltd.	30
Hartley, H. A. Co. Ltd.	40
Harvey Radio Co., Inc.	26
Heath Co.	36
High-Fidelity Magazine	27
LeBel, C. J.	39
Leonard Radio, Inc.	29
Leyghton-Paige	35
Magnecord, Inc.	3
Milo Radio & Electronics Corp.	39
Par-Metal Products Corp.	33
Partridge Transformers, Ltd.	40
Precision Film Laboratories, Inc.	1
Professional Directory	39
Radio Corp. of America	7, 35
Reeves Soundcraft Corp.	25
Rek-O-Kut Co.	2
Tech Laboratories, Inc.	33
U. S. Recording Co.	39
United Transformer Co.	Cover 4

PARTRIDGE THE AUDIO TRANSFORMERS that pass ALL tests

Time, no less than test, has proved Partridge Audio Transformers to be the most efficient and reliable in the world.

★ **WILLIAMSON** Output TRANSFORMERS, of which there is no U. S. equivalent (vide "Audio Engineering" Nov. 1949) built to the original specification, comes to you for \$21.00, mail and insurance paid.

★ **PARTRIDGE CFB** 20 Watt output type, accepted as without rival. Series leakage induct. 10 m.H; primary shunt induct. 130 H, with 'C' core construction and hermetically sealed—to you for \$30.00, mail and insurance paid.

Fulllest data, including square wave tests, distortion curves etc., together with list of U. S. stockists rushed Air Mail to you.

NOTE: We despatch by insured mail per return upon receipt of your ordinary dollar check.

Jobbers are invited to handle the transformer that the States is eager to buy—remember, immediate delivery from large stocks in New York!

PARTRIDGE TRANSFORMERS LTD.
ROEBUCK ROAD, TOLWORTH, SURREY, ENGLAND

CRITICAL

Instrumentation

RECORDING

to
100,000
cps!



Standard Models to 50,000 cps.

Custom-built Models to 100,000 cps.

AX-41

PRECISION PERFORMANCE

Unrivaled in audio spectrum recording... pioneers in critical instrumentation recording... 1 to 14 channel models.

AMPEX

Ampex Electric Corp.
San Carlos, California

**Magnetic Tape
RECORDERS**

Standard of the Great Radio Shows

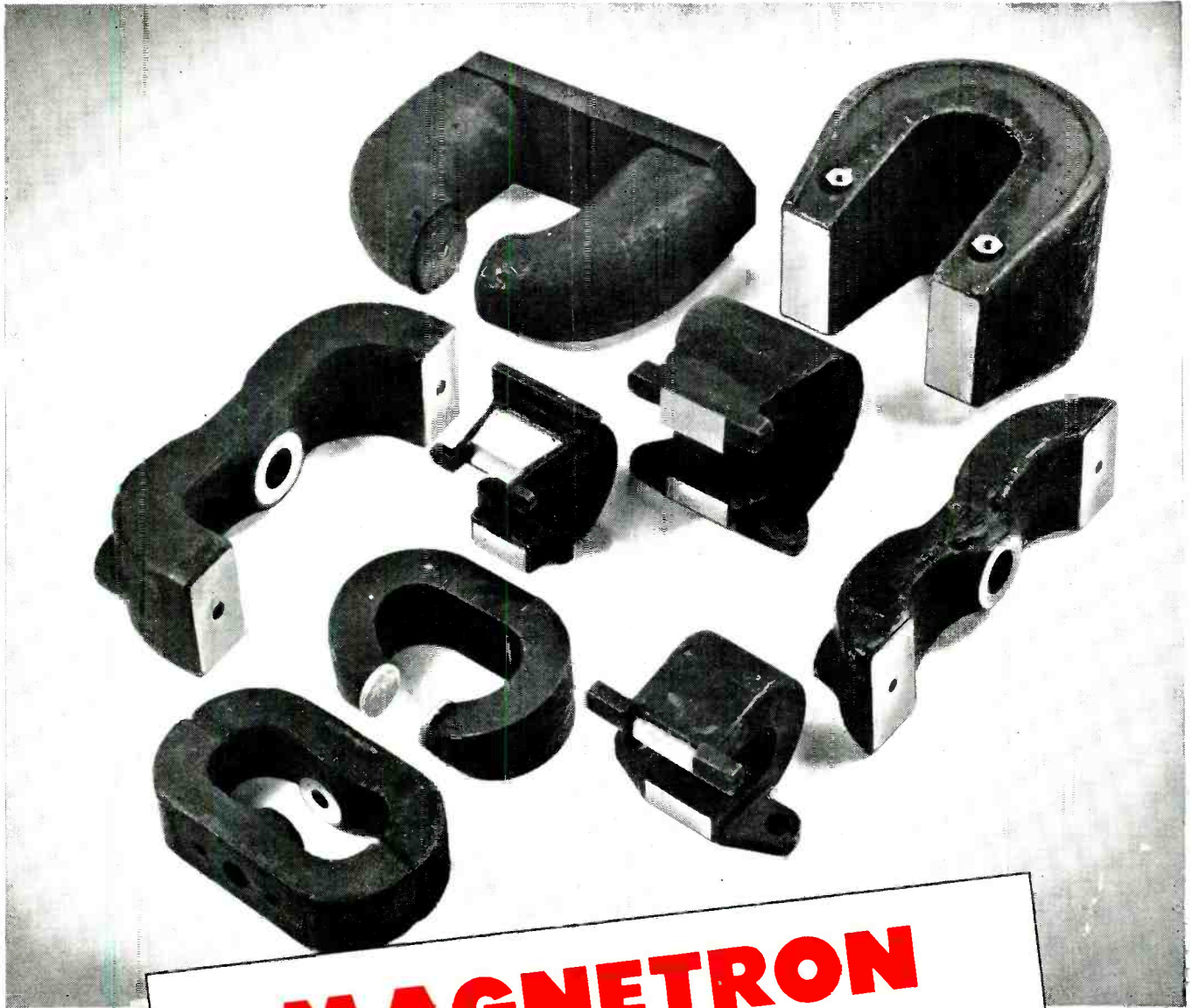

MAGNETRON PERMANENT MAGNETS AND ASSEMBLIES

with

- ☆ **Die Cast Aluminum Jackets**
- ☆ **Sand Cast Aluminum Jackets**
- ☆ **Celastc Covers**

Complete assemblies with Permendur, steel or aluminum bases, inserts and keepers as specified. Magnetized and stabilized as required.



THE ARNOLD ENGINEERING COMPANY

SUBSIDIARY OF ALLEGHENY LUDLUM STEEL CORPORATION

General Office & Plant: Marengo, Illinois



Linear Standard Units...

THE ULTIMATE IN QUALITY...

UTC Linear Standard Audio Transformers represent the closest approach to the ideal component from the standpoint of uniform frequency response, low wave form distortion, high efficiency, thorough shielding and utmost dependability.

UTC Linear Standard Transformers feature...

- **True Hum Balancing Coil Structure**... maximum neutralization of stray fields.
- **Balanced Variable Impedance Line**... permits highest fidelity on every tap of a universal unit... no line reflections or transverse coupling.
- **Reversible Mounting**... permits above chassis or sub-chassis wiring.
- **Alloy Shields**... maximum shielding from inductive pickup.
- **Hiper Alloy**... a stable, high permeability nickel-iron core material.
- **Semi-Toroidal Multiple Coil Structure**... minimum distributed capacity and leakage reactance.
- **Precision Winding**... accuracy of winding .1%, perfect balance of inductance and capacity; exact impedance reflection.
- **High Fidelity**... UTC Linear Standard Transformers are the only audio units with a guaranteed uniform response of ± 1 DB from 20-20,000 cycles.

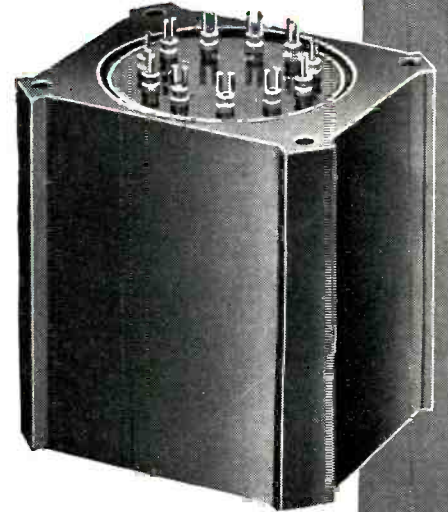

TYPICAL LS LOW LEVEL TRANSFORMERS

Type No.	Application	Primary Impedance	Secondary Impedance	± 1 db from	Max. Level	Relative hum-pickup reduction	Max. Unbalanced DC in prim'y	List Price
LS-10	Low impedance mike, pickup, or multiple line to grid	50, 125, 200, 250, 333, 500/600 ohms	60,000 ohms in two sections	20-20,000	+15 DB	-74 DB	5 MA	\$25.00
LS-10X	As Above	As above	50,000 ohms	20-20,000	+14 DB	-92 DB	5 MA	32.00
LS-12	Low impedance mike, pickup, or multiple line to push pull grids	50, 125, 200, 250, 333, 500/600 ohms	120,000 ohms overall, in two sections	20-20,000	+15 DB	-74 DB	5 MA	28.00
LS-12X	As above	As above	80,000 ohms overall, in two sections	20-20,000	+14 DB	-92 DB	5 MA	35.00
LS-26	Bridging line to single or push pull grids	5,000 ohms	60,000 ohms in two sections	15-20,000	+20 DB	-74 DB	0 MA	25.00
LS-19	Single plate to push pull grids like 2A3, 6L6, 300A. Split secondary	15,000 ohms	95,000 ohms; 1:25:1 each side	20-20,000	+17 DB	-50 DB	0 MA	24.00
LS-21	Single plate to push pull grids. Split primary and secondary	15,000 ohms	135,000 ohms; turn ratio 3:1 overall	20-20,000	+14 DB	-74 DB	0 MA	24.00
LS-22	Push pull plates to push pull grids. Split primary and secondary	30,000 ohms plate to plate	80,000 ohms; turn ratio 1.6:1 overall	20-20,000	+26 DB	-50 DB	25 MA	31.00
LS-30	Mixing, low impedance mike, pickup, or multiple line to multiple line	50, 125, 200, 250, 333, 500/600 ohms	50, 125, 200, 250, 333, 500/600 ohms	20-20,000	+17 DB	-74 DB	5 MA	25.00
LS-30X	As above	As above	As above	20-20,000	+15 DB	-92 DB	3 MA	32.00
LS-27	Single plate to multiple line	15,000 ohms	50, 125, 200, 250, 333, 500/600 ohms cycles	30-12,000	+20 DB	-74 DB	8 MA	24.00
LS-50	Single plate to multiple line	15,000 ohms	50, 125, 200, 250, 333, 500/600 ohms	20-20,000	+17 DB	-74 DB	0 MA	24.00
LS-51	Push pull low level plates to multiple line	30,000 ohms plate to plate	50, 125, 200, 250, 333, 500/600 ohms	20-20,000	+20 DB	-74 DB	1 MA	24.00
LS-141	Three sets of balanced windings for hybrid service, centertapped	500/600 ohms	500/600 ohms	30-12,000	+10 DB	-74 DB	0 MA	28.00

TYPICAL LS OUTPUT TRANSFORMERS

Type No.	Primary will match following typical tubes	Primary Impedance	Secondary Impedance	± 1 db from	Max. Level	List Price
LS-52	Push pull 2A5, 250, 6V6, 42 or 2A5 A prime	8,000 ohms	500, 333, 250, 200, 125, 50, 30, 20, 15, 10, 7.5, 5, 2.5, 1.2	25-20,000	15 watts	\$28.00
LS-55	Push pull 2A3's, 6A5G's, 300A's, 275A's, 6A3's, 6L6's	5,000 ohms plate to plate and 3,000 ohms plate to plate	500, 333, 250, 200, 125, 50, 30, 20, 15, 10, 7.5, 5, 2.5, 1.2	25-20,000	20 watts	28.00
LS-57	Same as above	5,000 ohms plate to plate and 3,000 ohms plate to plate	30, 20, 15, 10, 7.5, 5, 2.5, 1.2	25-20,000	20 watts	20.00
LS-58	Push, pull parallel 2A3's, 6A5G's, 300A's, 6A3's	2,500 ohms plate to plate and 1,500 ohms plate to plate	500, 333, 250, 200, 125, 50, 30, 20, 15, 10, 7.5, 5, 2.5, 1.2	25-20,000	40 watts	50.00
LS-6L1	Push pull 6L6's self bias	9,000 ohms plate to plate	500, 333, 250, 200, 125, 50, 30, 20, 15, 10, 7.5, 5, 2.5, 1.2	25-20,000	30 watts	42.00

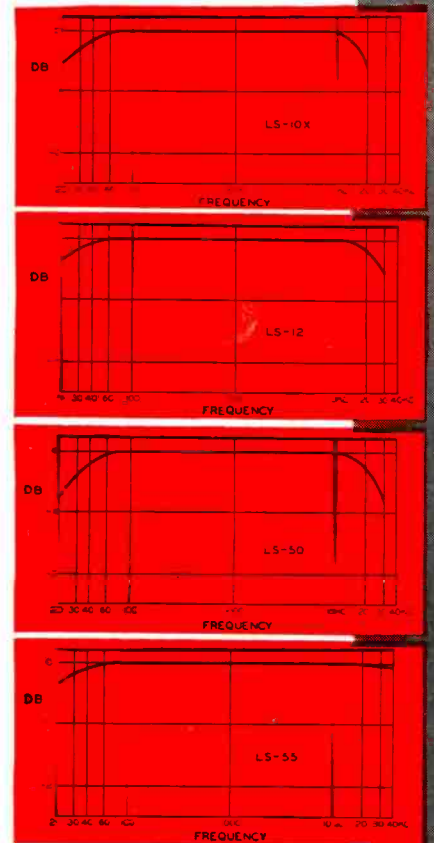

Write for our Catalog PS-510

United Transformer Co.

150 VARICK STREET NEW YORK 13, N. Y.
EXPORT DIVISION: 13 EAST 40th STREET, NEW YORK 16, N. Y. CABLES: "ARLAB"