

AUDIO ENGINEERING

Coulon
DECEMBER
1949
35c

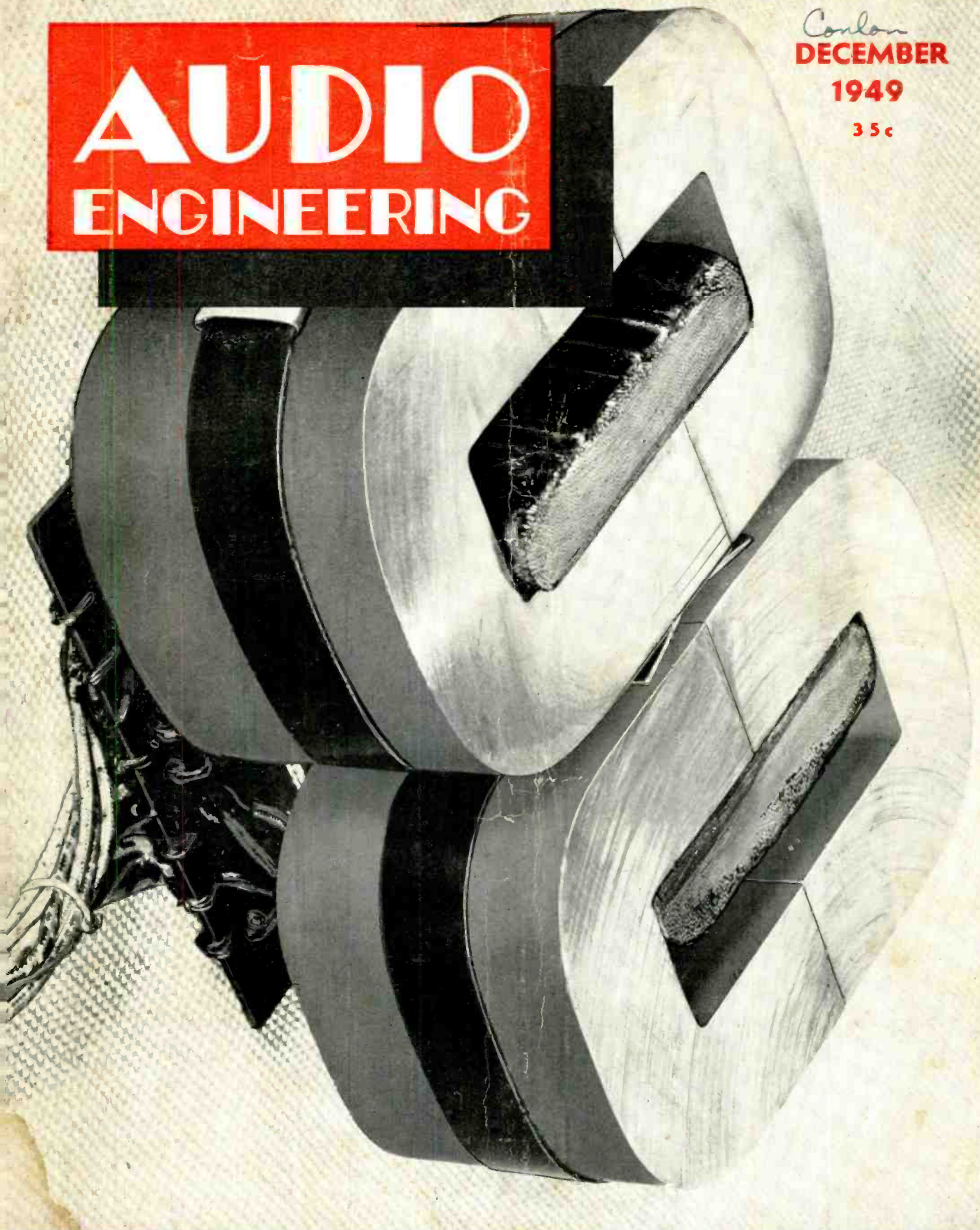

Published by **RADIO MAGAZINES, INC.**

audiotape

TRADE MARK

it speaks for itself

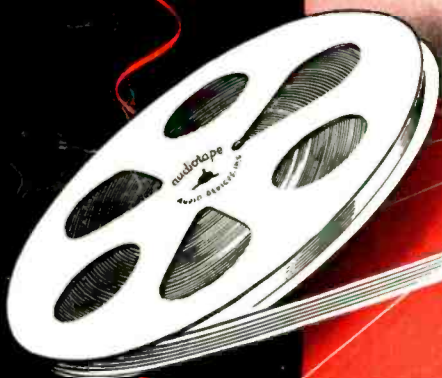

• You would have read this announcement two years ago — except for one thing. Our engineers were not content to offer you a recording tape that was merely “good” by existing standards of comparison. They wouldn’t put their seal of approval on Audiotape until it had been so perfected in every detail that it would match the quality and uniformity which have characterized Audiodiscs for the past decade.

Paper base Audiotape reached that goal last May, after more than 2½ years of research and development. And now plastic base Audiotape has also graduated from the laboratory — with a degree of engineering excellence which is an unqualified recommendation to all professional recordists. Try it yourself — and note particularly the *uniformity of output* for the full length of the tape. A request on your business letterhead will bring you a free 200-foot sample reel of the new plastic-base Audiotape, or two 200-foot reels of paper-base Audiotape, one with red oxide and the other with black oxide coating.

NOW AVAILABLE

on plastic or paper base
with red or black oxide

Audio Devices now offers you a complete line of highest quality magnetic recording tape — designed for matched performance in any tape recorder.



AUDIO DEVICES, INC.

444 Madison Ave., N. Y. 22, N. Y.

Export Dept.: ROCKE INTERNATIONAL
13 East 40th St., New York 16, N. Y.

AUDIO ENGINEERING

Successor to RADIO

Established 1917



C. G. McProud, Editor
Luci Turner, Edit. Prod. Mgr.
David Saltman, Production Manager
E. E. Newman, Circulation Manager

D. S. Potts, Publisher
S. L. Cahn, General Manager
H. N. Reizes, Adv. Mgr.
Harold J. Weisner, Asst. Circ. Mgr.

Editorial Advisory Board

Howard A. Chinn
John D. Colvin
C. J. LeBel
J. P. Maxfield
George M. Nixon
Winston Wells
S. Young White

Representatives

Sanford R. Cowan, Mid-West Sales
342 Madison Ave., New York 17, N. Y.
James C. Galloway, Pacific Coast Sales
816 W. 5th St., Los Angeles 13, Calif.
Dale International Publications, Ltd.
106 Bolsover St., London W. 1, England
Technical Book & Magazine Co.
297 Swanston St., Melbourne, C. I.
Victoria, Australia

CONTENTS DECEMBER, 1949 Vol. 33, No. 12

Editor's Report	4
Letters	6
Description and Analysis of a New 50-Watt Amplifier Circuit— <i>Frank H. McIntosh and Gordon J. Gow</i>	9
Using the Reactance Chart for Filter Design Problems— <i>H. B. Davis</i>	12
The Cathode Follower as Audio Power Amplifier— <i>Howard T. Sterling</i>	14
Below 50 Cycles— <i>Saul J. White</i>	16
Audio Engineering Society Section Report on the Convention	19
Audiana—Recording Characteristics	20
Record Review— <i>Edward Tatnall Canby</i>	22
Editorial Index—1949	46
Advertising Index	48

COVER

The cover picture is a cross section of the output transformer for the McIntosh 50-watt amplifier using a "take turn" primary which provides 100 percent coupling between the two halves of the primary. The unit utilizes four square inches of hypersil grain-oriented core material and a winding of special design permitting wide range 10 to 200,000 cycle transformation. The core weighs approximately 11 pounds. The terminal strip at the bottom includes connectors for the primary and secondary leads.

AUDIO ENGINEERING (title registered U. S. Pat. Off.) is published monthly at New York, N. Y., by Radio Magazines, Inc., D. S. Potts, President. Executive and Editorial Offices at 342 Madison Avenue, New York 17, N. Y. Subscription rates—United States, U. S. Possessions and Canada, \$3.00 for 1 year, \$5.00 for 2 years; elsewhere \$4.00 per year. Single copies 35c. Printed in U. S. A. All rights reserved. Entire contents copyright 1949 by Radio Magazines, Inc. Entered as Second Class Matter July 29, 1948 at the Post Office, New York, N. Y. under the Act of March 3, 1879.

you can
do it better

with the
revolutionary

ALTEC 21 B MINIATURE MICROPHONE

ACTUAL
SIZE

It achieves uniformity of response... provides greater tonal fidelity... it is omnidirectional... it is blastproof, shockproof... there is no false bass build-up... more net acoustic gain before encountering feedback... tiny size contributes to remarkable versatility of positioning... extends the fidelity of sound transmission.

*talent deserves
to be Seen
as well as Heard*



161 Sixth Avenue
New York 13, N. Y.
1161 North Vine St.
Hollywood 38, Cal.

RCA "PLUG-IN" amplifiers

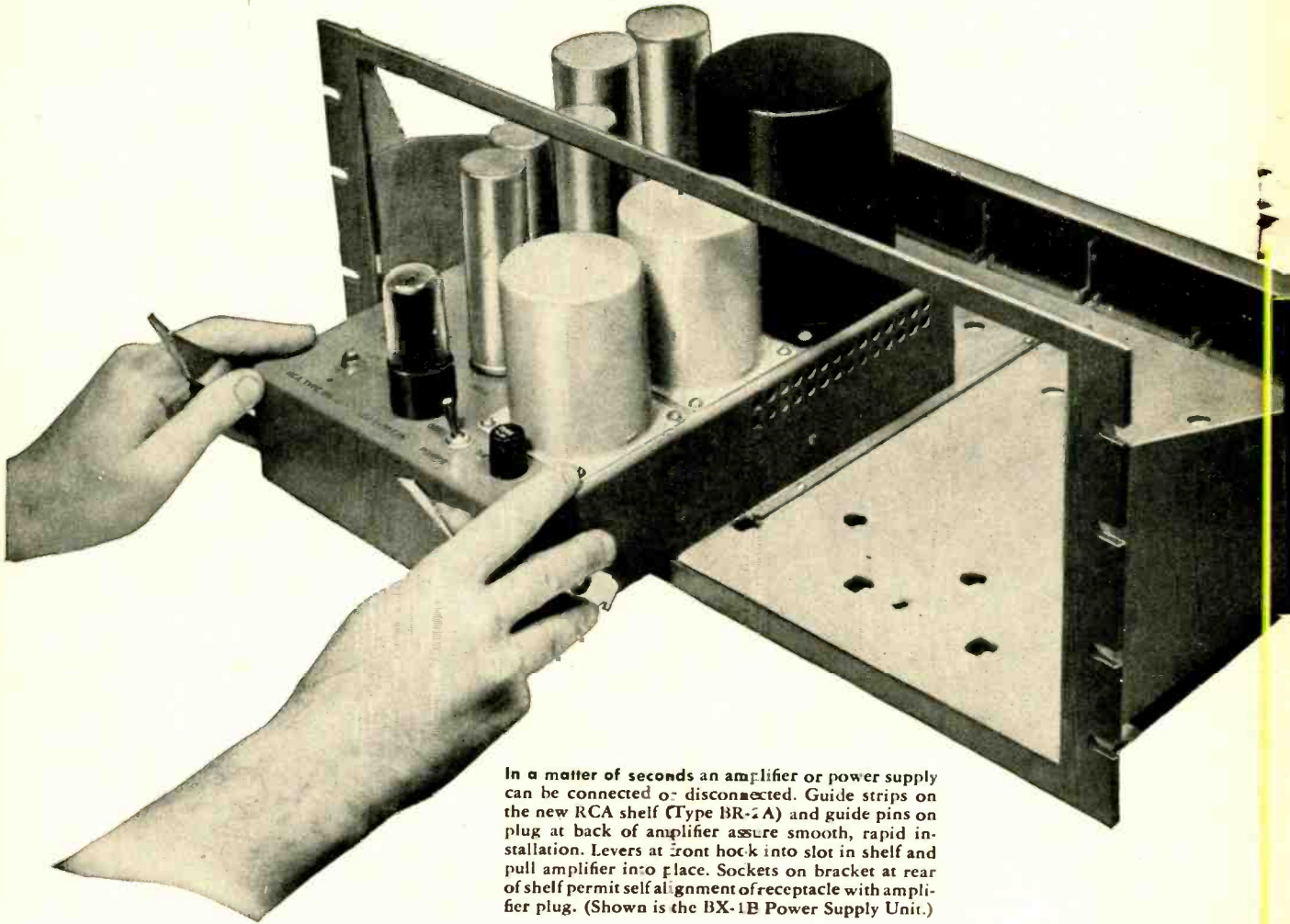

In a matter of seconds an amplifier or power supply can be connected or disconnected. Guide strips on the new RCA shelf (Type BR-2A) and guide pins on plug at back of amplifier assure smooth, rapid installation. Levers at front hook into slot in shelf and pull amplifier into place. Sockets on bracket at rear of shelf permit self alignment of receptacle with amplifier plug. (Shown is the BX-1B Power Supply Unit.)

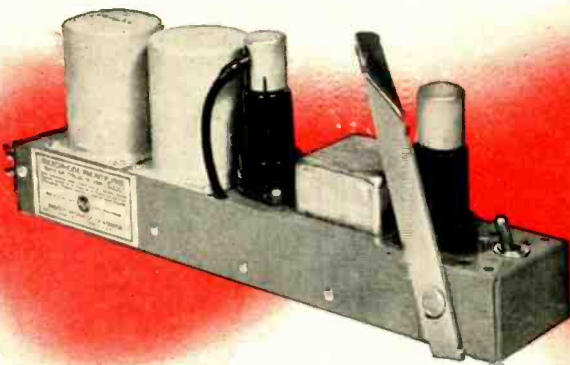

Two-stage Pre-amplifier (Type BA-1A)—ideal for use as a microphone pre-amplifier, turntable pre-amplifier, booster amplifier, or low-level isolation amplifier. *High gain:* 40 db. *High output:* +10 db. *Low noise level:* -80 db. *Low distortion:* 0.5% rms, 50 to 7500 cycles. *Isolation factor:* approx. 90 db; over 100 db with special Volume Control Kit. *Frequency response:* ± 1 db, 30 to 15,000 cycles. *Small size:* six units will fit on a 36-B or new BR-2A shelf!



Booster Amplifier (Type BA-2C)—A two-stage unit having applications similar to those for the BA-1A; also valuable where a high-gain amplifier between announce microphone and limiting amplifier is required. *High gain:* 50 db. *Low noise level:* -68 db. *Low distortion:* 0.75% rms, 40 to 15,000 cycles. *Frequency response:* ± 1.5 db, 30 to 15,000 cycles. *Compact:* two units can be mounted on one 36-B or BR-2A shelf. Features plug-in capacitors and built-in power supply.

for quick interchanges— and easy maintenance



The RCA Type BR-2A Shelf fits any standard rack; takes 8 3/4 inches of panel space. If desired, however, RCA Type 36-B panels and shelves now in use can be easily adapted for plug-in amplifier service.

All units available for immediate delivery

AS easy to install or remove as an electronic tube! Pull a lever near the front of the amplifier and the plug on the rear of the unit is smoothly withdrawn from its socket—automatically disconnected from the supply voltage. No longer is it necessary to crawl around to the back of hard-to-get-at racks and unsolder or unscrew countless connections. System changes can be made quickly; minutes can be slashed from inspection, servicing, and testing time.

This new RCA line now includes the four amplifiers and one power-supply unit shown. Others will be added in the near future. New, carefully selected characteristics make these units ideal for a large number of studio jobs.

All units use the same standard plug. To assure maximum convenience, a new shelf (Type BR-2A) has been designed. With a few easy changes, however, the conventional RCA Type 36-B panel and shelf can be used, if desired. The necessary accessories are available for this purpose.

Here, we believe, is a real opportunity to modernize your amplifier system—a quick, convenient way to get better performance at low cost. Descriptive leaflets are yours for the asking. Write: Dept. 7L Audio Equipment Section, Radio Corporation of America, Camden, N. J.



BROADCAST EQUIPMENT
RADIO CORPORATION of AMERICA
ENGINEERING PRODUCTS DEPARTMENT, CAMDEN, N. J.

In Canada: R.C.A. VICTOR Company Limited, Montreal

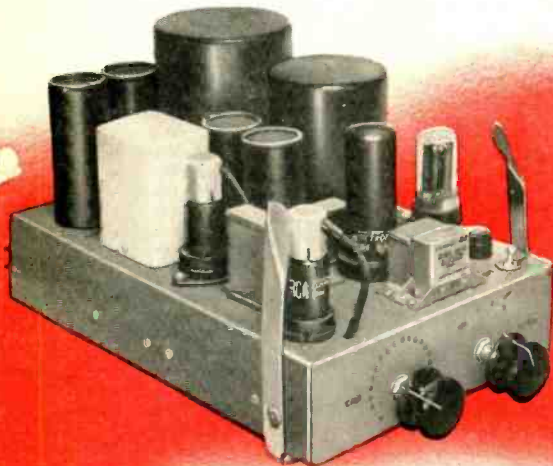

New Program Amplifier (type BA-13). The most versatile high-fidelity amplifier ever designed for broadcasting. Ideal as a program or line amplifier, bridging amplifier, isolator amplifier, cueing or monitoring amplifier. Improved layout for greater accessibility; "plug-in" electrolytics for ease in servicing. *Output* 2 watts (approx.). *Higher gain*, 65 db for matching input; 28 db for bridging input. *Lower noise level*, -82 db (with max. gain). *Lower distortion*, less than 0.5 to 1% rms, depending on output level. *Frequency response*, ± 1 db, 30 to 15,000 cps.

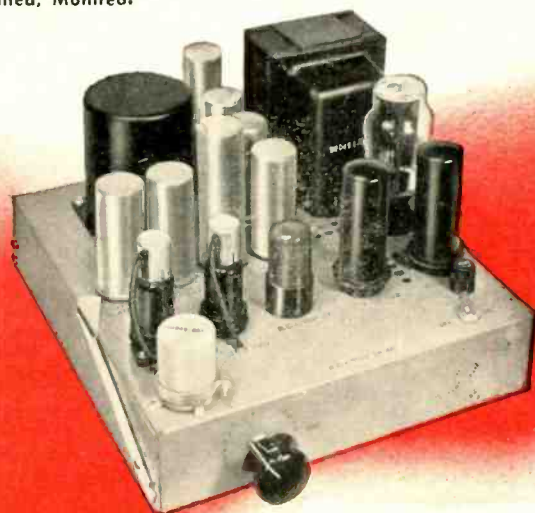

Monitoring Amplifier (Type BA-14)—Designed for operation at microphone levels. High output of 12 watts is sufficient to drive several speakers or, in some applications, a recording head. Other uses include application as line amplifier for portable and mobile transmitters. *High gain*: 105 db. *Low noise level*: -20 db (with maximum gain); -40 db (with minimum gain). *Low distortion*: less than 3% at 12 watts. *Frequency response*: ± 2 db, 30 to 15,000 cycles.

EDITOR'S REPORT

THE AUDIO FAIR

ON THE 29TH OF OCTOBER, the first Audio Fair passed into history. For the first time, an entire convention and the displays of 56 exhibitors were devoted solely to audio, with a total registration of 3022. This is more than four times the membership of the sponsoring organization, the Audio Engineering Society.

For three days the sixth floor hall of Hotel New Yorker was crowded with interested visitors—both members and guests—and music in varying degrees of loudness filled the air. It was a first audio exhibit, with no traditions to uphold, no preconceived ideas which had to be followed, no experience to lean on. The entire Fair was designed to show audio equipment to advantage—in a setting where those who came to see could also hear. Everyone—exhibitor, visitor, and Society officer—was enthusiastic.

The technical sessions of the convention offered a long list of papers, and attendance at these meetings averaged around 250. The Society may justly be proud of its first effort and of the interest shown by those who came to hear and see.

Of greater importance, however, is the justification shown to those who have had faith in audio for these past years. AUDIO ENGINEERING is the result of this kind of faith, and while the overwhelmingly large attendance may have been a surprise to many, it was not to those of our readers who were able to be present. Audio is established as a separate science or art—or a combina-

tion of both—and is beyond doubt one of the most interesting to those who follow it. The Fair did much to help this general recognition of Audio, and we now look forward to a bigger and better Fair in 1950—the one exhibit designed expressly for the unique requirements of audio equipment.

COMING ATTRACTIONS

Scheduled for the January issue is the first part of H. W. Augustadt's paper "Longitudinal Noise in Audio Circuits," recently presented at the Convention of the Audio Engineering Society. This paper treats a subject which is important to broadcasters and others who use program loops, particularly when such loops are subjected to external fields. Little has been published on this subject heretofore, and the paper deserves a place in every broadcast station.

In reply to many inquiries about the miniature tweeter which was pictured with the Ampex article in the August issue, Walter T. Selsted has prepared a paper on this unique addition to a high-quality speaker system. It will also appear in the January issue, along with a new method of obtaining an *apparent* stereophonic sound source in reproduction of music, one which can enhance the overall effect even though it is not a true method of stereophonic reproduction. Perhaps this is one way the music lover can make sure of getting a lot of "presence" in the months after Christmas.

And, in the meantime—

The Editors and Staff of Audio Engineering
wish you a very Merry Christmas
and a Happy New Year.

NEW G-E *Triple-Play* CARTRIDGE PLAYS ALL 3 SPEEDS

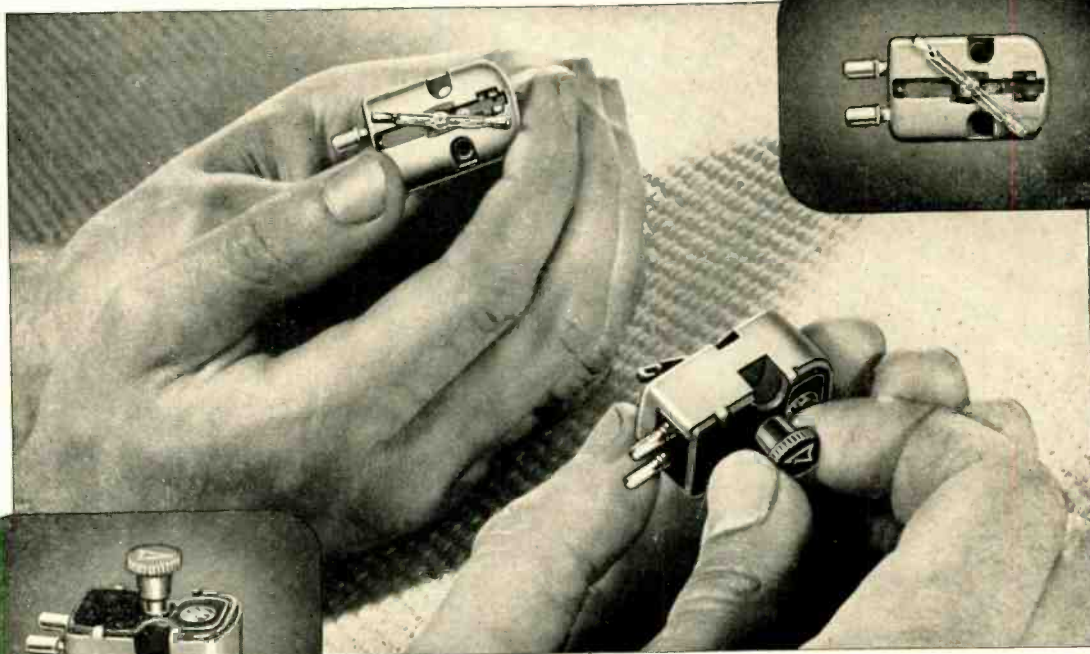

Latest Dual Stylus Unit Tracks 33-1/3, 45, and 78 rpm Records at Constant Pressure

Costs 25% less than Pickups it Replaces

A new General Electric "Triple Play" Cartridge that tracks any commercial record is now available to manufacturers, distributors, and dealers.

Simplicity is the key feature of this notable electronic advancement. Once installed in a tone arm, the cartridge will play all types of popular narrow groove and standard groove records *without replacement or even a change in position!*

ONLY ONE PRESSURE

The new cartridge retains the unsurpassed frequency response characteristics of the famous G-E Variable Reluctance unit and in addition, tracks the three types of records at 6 to 8 grams. Thus the pressure is constant regardless of the stylus you're using. The special design of the "Triple Play" permits precise adjustment of tone arm pressure. Weight changing and pressure compromise problems are eliminated. High compliance and low moving mass reduce record wear to a minimum.

TWO STYLI IN ONE CARTRIDGE

A single twist of a built-in knob turns either end of a dual stylus to playing position. A 1-mil stylus, mounted at one end, plays 33 1/3 and 45 rpm records, and a 3-mil stylus, at the opposite end, tracks standard 78 rpm records.

MANUFACTURERS NOTE LOW COST

Although it plays records that formerly required the use of two cartridges, the price of the "Triple Play" is 25% less than the price of two individual cartridges. It is adaptable to many types of tone arms and *its use as an initial component will effectively reduce set manufacturing costs.*

UNAFFECTED BY TEMPERATURE

The G-E "Triple Play" is unaffected by normal climatic changes in humidity and extreme variations in temperature. Needle talk and needle scratch are reduced to a minimum. Record reproduction—as always with G-E Cartridges—is superb. Mail coupon below for complete information.

You can put your confidence in—
GENERAL ELECTRIC

General Electric Company, Parts Section 1A
Electronics Park, Syracuse, New York
Send me full particulars on the new G-E "Triple Play" Cartridge.

NAME _____
ADDRESS _____
CITY _____ STATE _____

— Letters —

The Other Side

Sir:

Can you truly call the magazine "Audio ENGINEERING" if you run a series of articles as proposed by M. H. Schwartz in the September issue? Perhaps the need for such articles carries with it a sting for those of us who profess to be Audio Engineers. Either there are not enough of us to support such a magazine as you have been producing, or we are somehow to blame for not producing articles which should be published.

May I call the attention of the truly serious minded audio hobbyists to the book by L. B. Arguinbeau titled "Vacuum Tube Circuits." The mathematics are not difficult in general, and in my opinion it is the best book ever published for the audio engineer.

Wm. P. West
3910 Vaux St.,
Philadelphia 29, Pa.

Logarithmic Meters

Sir:

In the September issue Mr. LeBel in his article "New Developments in Logarithmic Amplifiers" states "this construction (shaped pole pieces) has been used for indicating meters, but not for recording meters, due to practical difficulties."

In 1944 we used an Esterline-Angus recording milliammeter with shaped pole pieces to give a response linear with temperature in connection with a radiation pyrometer. Since the energy radiated is proportional to the

fourth power of the absolute temperature, the profile of the pole pieces was cut to the second-power curve with corrections for the width of the moving coil. In this case the pole pieces were cut away instead of increasing the coil clearance as LeBel shows in his Fig. 2. To correct for sluggishness at the lower end of the scale, a magnetic shunt was placed across the pole pieces to reduce the peak field strength. To correct for the under-damping at the high end of the scale, a contoured aluminum vane was attached to the meter movement and fitted in the gaps of two fixed Alnico magnets. Three of these meters were modified at the time with much improved design in the subsequent modifications.

This work was done at the Research Laboratory Division of General Motors Corporation in connection with temperature measurements in an induction heating furnace.

W. James Trott,
Route 3, Box 4728
Orlando, Florida

Loudness Control

Sir:

In constructing the loudness control described in Mr. Turner's article in the October issue, several simplifications presented themselves. Being unable to locate the recommended pot, I used a 0.25-meg IRC audio-taper midget volume control. After removing the dust cover, four holes just large enough to pass a #22 wire were bored through the Bakelite at the proper points just inside the inner circumference of the resistance element. Small solder beads were put on the ends of four lengths of #22 wire and the

wires pulled through the holes until the heads were flush with the resistance element. A force fit of the wires is easy to make in this way. Although friction contact is made with the resistance element, continued contact was insured by putting a small drop of #1200 Carbon-X at each junction.

A small four-terminal strip was soldered to the dust cover, and the wires terminated on the strip when the cover was replaced. Additional stability was obtained by putting a drop of Bakelite cement at each of the four points where the wires came through the unit on the panel side. An eight-terminal strip also soldered to the dust cover and extending back away from the control provided ample terminals for the associated resistors and capacitors.

C. E. Hablutzel,
717 Linden,
Shreveport, La.

An English Booster

Sir:

I thought you might like to know how much your magazine is appreciated over here in England. As you may know, most of our magazines hardly touch recording.

Would it be possible at some time in the near future to include an article on the methods and equipment used by American recording companies? I realize that the number of English readers must be comparatively small, but I am sure our keenness makes up for it.

J. Curtis,
Tru-Sound Records,
41 Collingwood Road,
Northampton, England

When seconds count
YOU'RE THERE WITH...

**SAVES UP TO 500%
ON HANDLING TIME**

Handle up to 400 feet of mike cord with short cord ease

Here's one of the handiest tools ever made for the Radio-Audio Engineer—for either in studio or outside use. Rugged . . . light weight . . . Saves time . . . gets the job done easier . . . faster . . . with less confusion . . . fewer jangled nerves. A must for every special event and remote crew.

MAKES CORD LAST 5 TIMES AS LONG!

PORT-O-REEL pays for itself in cord saved. Cord size governs capacity. Some stations and networks use over 400-ft. of 2-wire shielded mike lead, other units equip for 120-volt power transmission. Unwind cord needed . . . set brake.

Reel turns with operator as cord is drawn off. Non-slipping . . . non-tipping. Re-wind 400 ft. of cord in only 40 seconds!

- Weighs only 9-lbs. without cord . . . Low, level-wind cord guide prevents kinks and knots.
- Available without cord or equipped with any standard cable and plugs to your specifications.
- Handy screw binding posts permit quick attachment or change of cord on unit.
- Available with receptacle in frame for plug-in of feeder cord or for attachment of feeder cord to screw binding posts.
- Moisture-proof running constant collector ring . . . reel out or wind while broadcasting . . . no audible sound through transmitter.

Patents and Patent Pending

Send for literature, prices and name of nearby distributor.

INDUSTRIAL ELECTRICAL WORKS, 1505 CHICAGO ST., OMAHA 2, NEBR.

PORT O REEL
CORD SAVER

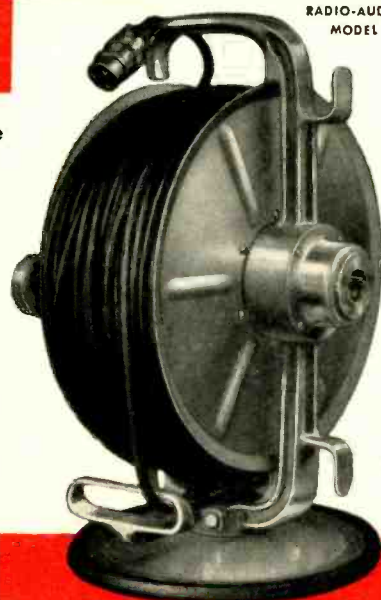

RADIO-AUDIO
MODEL

**TV Engineers:
Ask about the
3-phase
Heavy Duty
POWEREEL**

FREED "PRODUCTS of EXTENSIVE RESEARCH"

**OUTSTANDING ADDITIONS TO OUR LINES OF
Instruments & Components**

**NEW HI Q MINIATURE
TOROIDAL COILS**

Size $\frac{7}{8}$ D. x $\frac{3}{8}$ — Wt. $\frac{3}{4}$ ounce.
Type TI-5 Frequency range 1000 cycles-15,000 cycles
Type TI-7 Frequency range 10,000 cycles-100,000 cycles
High quality toroidal coils wound on molybdenum permalloy dust cores. Can be supplied in hermetically sealed cans, commercial type construction or open units.

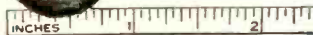

FAMOUS
FREED
QUALITY

**HIGH FIDELITY
OUTPUT TRANSFORMERS**



Type No.	Primary matches following typical value	Primary Impedance	Secondary Impedance	Full Power	Maximum Load
FT124	Push pull 1A7, 6X5, 6BE6, 300A, 300A, 6A3, 6A3, 6A3	1600 ohms	500 333, 250, 100, 100, 50	20-30000 cycles	15 watts
FT125	Push pull 2A7, 6X5, 6BE6, 300A, 300A, 6A3, 6A3, 6A3	1600 ohms	25, 20, 15, 10, 5, 5, 5, 5	20-30000 cycles	15 watts
FT126	Push pull 2A7, 6X5, 6BE6, 300A, 300A, 6A3, 6A3, 6A3	1600 ohms	500 333, 250, 100, 100, 50	20-30000 cycles	15 watts
FT127	Push pull 2A7, 6X5, 6BE6, 300A, 300A, 6A3, 6A3, 6A3	1600 ohms	50, 20, 15, 10, 5, 5, 5, 5	20-30000 cycles	15 watts
FT128	Push pull 2A7, 6X5, 6BE6, 300A, 300A, 6A3, 6A3, 6A3	1600 ohms	500 333, 250, 100, 100, 50	20-30000 cycles	15 watts
FT129	Push pull 2A7, 6X5, 6BE6, 300A, 300A, 6A3, 6A3, 6A3	1600 ohms	50, 20, 15, 10, 5, 5, 5, 5	20-30000 cycles	15 watts
FT130	Push pull 2A7, 6X5, 6BE6, 300A, 300A, 6A3, 6A3, 6A3	1600 ohms	500 333, 250, 100, 100, 50	20-30000 cycles	15 watts
FT131	Push pull 2A7, 6X5, 6BE6, 300A, 300A, 6A3, 6A3, 6A3	1600 ohms	50, 20, 15, 10, 5, 5, 5, 5	20-30000 cycles	15 watts
FT132	Push pull 2A7, 6X5, 6BE6, 300A, 300A, 6A3, 6A3, 6A3	1600 ohms	500 333, 250, 100, 100, 50	20-30000 cycles	15 watts
FT133	Push pull 2A7, 6X5, 6BE6, 300A, 300A, 6A3, 6A3, 6A3	1600 ohms	50, 20, 15, 10, 5, 5, 5, 5	20-30000 cycles	15 watts
FT134	Push pull 2A7, 6X5, 6BE6, 300A, 300A, 6A3, 6A3, 6A3	1600 ohms	500 333, 250, 100, 100, 50	20-30000 cycles	15 watts
FT135	Push pull 2A7, 6X5, 6BE6, 300A, 300A, 6A3, 6A3, 6A3	1600 ohms	50, 20, 15, 10, 5, 5, 5, 5	20-30000 cycles	15 watts
FT136	Push pull 2A7, 6X5, 6BE6, 300A, 300A, 6A3, 6A3, 6A3	1600 ohms	500 333, 250, 100, 100, 50	20-30000 cycles	15 watts
FT137	Push pull 2A7, 6X5, 6BE6, 300A, 300A, 6A3, 6A3, 6A3	1600 ohms	50, 20, 15, 10, 5, 5, 5, 5	20-30000 cycles	15 watts
FT138	Push pull 2A7, 6X5, 6BE6, 300A, 300A, 6A3, 6A3, 6A3	1600 ohms	500 333, 250, 100, 100, 50	20-30000 cycles	15 watts
FT139	Push pull 2A7, 6X5, 6BE6, 300A, 300A, 6A3, 6A3, 6A3	1600 ohms	50, 20, 15, 10, 5, 5, 5, 5	20-30000 cycles	15 watts
FT140	Push pull 2A7, 6X5, 6BE6, 300A, 300A, 6A3, 6A3, 6A3	1600 ohms	500 333, 250, 100, 100, 50	20-30000 cycles	15 watts

PRECISION LABORATORY EQUIPMENT

#1150 UNIVERSAL BRIDGE



Frequency Range — 20 cycles-20,000 cycles. An Indispensable Laboratory Instrument for measurements of Inductors, Capacitors, and determination of Resistive and reactive components of impedances. Used as Maxwell Bridge, Hay Bridge, Resonance Bridge, Series Resistance Condenser Bridge, Parallel Resistance Condenser Bridge. 1% accuracy.

FAMOUS
FREED
ACCURACY

**#1210 NULL DETECTOR AND
VACUUM TUBE VOLTMETER**



Designed for A.C. Bridge Measurements. Provides simultaneous measurement of the voltage across the unknown and the balance of the bridge. Vacuum tube voltmeter. Sensitivity .1, 1, 10, 100 volts. Input Impedance 50 megohms shunted by 20 mmfd. Frequency range 20 cycles-20,000 cycles. Null Detector—gain 94 Db. Selective Circuits for 60 cycles — 400 cycles — 1000 cycles. Frequency range 20 cycles-30,000 cycles.

**FREED HERMETICALLY SEALED COMPONENTS
CLASS A GRADE 1 COMPONENTS TO MEET JAN-T-27 SPECIFICATIONS.**



FAMOUS
FREED
DEPENDABILITY

- MANUFACTURERS OF**
- POWER TRANSFORMERS
 - FILTER REACTORS
 - AUDIO TRANSFORMERS
 - SUPERSONIC TRANSFORMERS
 - WAVE FILTERS
 - HI-Q COILS
 - DISCRIMINATORS
 - SATURABLE REACTORS
 - PULSE TRANSFORMERS
 - CHARGING CHOKES

SEND FOR THE *new* FREED CATALOG

FREED TRANSFORMER CO., Inc.
DEPT. D.A. 1718-36 WEIRFIELD ST., (RIDGEWOOD) BROOKLYN 27, NEW YORK



**CAST ALNICO V and VI THIN WALL RINGS
FOR MAGNETIC FOCUSING ASSEMBLIES**

Quality and Quantity - NO PROBLEM!

In TELEVISION SETS, magnetic focusing eliminates blur; gives clear, sharp reception even during warm-up, or line voltage fluctuations; and the *first* focusing adjustment is the *last*. The thin ring-type permanent magnets of Alnico V and VI produced by Arnold for this use (several sizes are pictured here) are *cast*, not sintered, in order to save on first cost. It's a difficult job, but Arnold's advanced methods produce these rings in the desired quality and any quantity, *without trouble*. —No matter what the application, in any grade of Alnico or other materials, you can depend on Arnold Permanent Magnets. We'll welcome your inquiries.

THE ARNOLD ENGINEERING COMPANY



Subsidiary of

ALLEGHENY LUDLUM STEEL CORPORATION

147 East Ontario Street, Chicago 11, Illinois

Specialists and Leaders in the Design, Engineering and Manufacture of PERMANENT MAGNETS

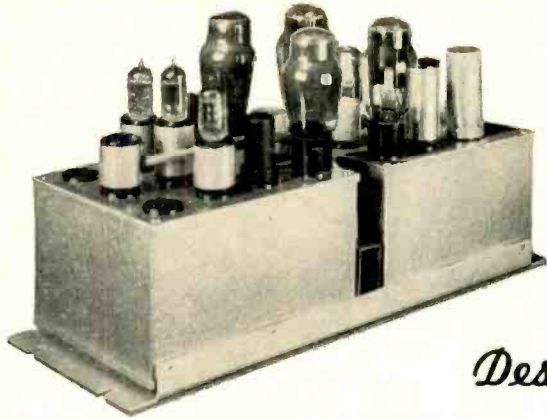

The first major change in years in amplifier coupling circuit principles is discussed, together with details of the components employed.

FRANK H. McINTOSH*
and
GORDON J. GOW*

Description and Analysis of a

New 50 - Watt Amplifier Circuit

AUDIO AMPLIFIERS—being one of the oldest forms of equipment built using the three or more element tube—are now one of the most difficult devices to improve, and perhaps no other field of electronic endeavor has been given more time or has been studied by more people. One of the major reasons sound amplifiers are difficult to design is the requirement for very wide frequency range, highest to lowest running up to 20,000 to 1 in order to meet the ever-increasing demand for

3,000 cps and higher the shunt capacitance across the primary circuit of output transformers becomes one of the major limiting factors, regardless of the mode of operation of the output stage. When the output stage is operated Class AB or Class B to improve the efficiency, then an additional problem growing out of the switching from one side of the circuit to the other in the output stage and thus producing a transient has been a barrier for over 20 years and has made practically useless such circuits except in applications where the harmonic content was not of great importance or where the range was limited over which such circuits are operated. This transient appears as

the ear to detect distortion, the range and power of speech and musical instruments, the impulse characteristics of sound, the load impedance variations and effects of loudspeakers and other devices. A treatment of these basic requirements must be reserved for a later discussion.

Output Circuit

Figure 1 illustrates the output circuit of the conventional pushpull amplifier in simplified form. It will be seen that the plates are connected in the conventional way to the primaries of the output transformer and the resistor forming the load is shown connected to the secondary. The plate-to-plate impedance in this circuit is 4000 ohms. This is about right for a pair of 6L6's as used in the McIntosh 50W-1 amplifier. Attention is called to the 1000-ohm impedance which corresponds to the circuit from the plate to the center tap of the primary of this output transformer. These impedances should be born in mind as later reference will be made to them as part of

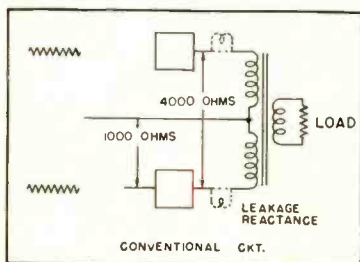

Fig. 1. Simplified output circuit of conventional push-pull amplifier.

more faithful reproduction of the audio range of from 18 to 20,000 cps. This wide range is probably the most rigid requirement for any electronic device regardless of its use. To satisfy the design requirements for an audio amplifier, several problems must be overcome. At the low end of the audio band the requirement for sufficient core material of proper magnetic properties must be weighed against core loss, weight, size, and expense. These quantities bear an inverse relationship to the total number of turns, but the total turns bear an inverse relationship to the leakage inductance and the effective shunt capacitance. At frequencies of

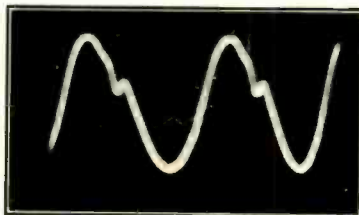

Fig. 2. Oscilloscope trace showing notches in output wave when operating between Class A and Class B.

a notch in the signal wave form and was first described in 1936¹ but for which no solution was suggested beyond that of reducing the leakage inductance of the output transformer or of biasing the amplifier stage back to Class A operation.

The basic circuit which we are about to describe grew out of an attempt to meet many considerations and requirements based upon tests and measurements made concerning the ability of

¹A. P. Sah, Quasi-Transients in Class B Audio Frequency Push-Pull Amplifiers, *Proc. IRE*, Nov. 1936.

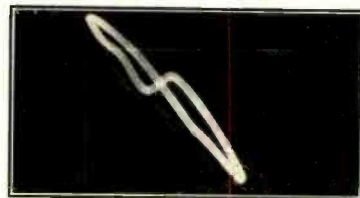

Fig. 3. Trace showing transfer characteristic of output tubes with discontinuity due to notch of Fig. 2.

the description of the new circuit. In the discussion to follow it is assumed that each of the tubes in the output circuit alternately cease to draw current during a portion of the audio

*McIntosh Engineering Laboratory, Inc.,
910 King St., Silver Spring, Md.

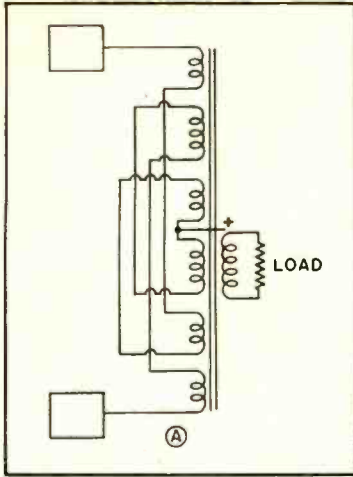

Fig. 4. One method of minimizing leakage reactance by use of sectionalized primary winding.

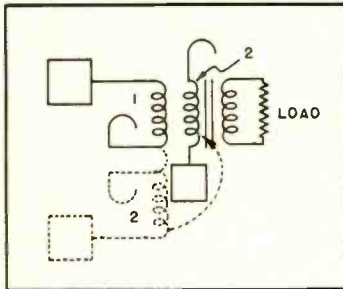

Fig. 5. Simplified form of new coupling arrangement for amplifier output stage.

cycle and, therefore, are operated somewhere between Class A and Class B.

Experience has shown that using the circuit of Fig. 1 and operating between Class A and Class B will result in a deformity, appearing as a "notch" as shown in Fig. 2 for all frequencies above approximately 2,000 to 3,000 cps. This waveform distortion measures 2 to 10 per cent or more depending upon the frequency and the leakage reactance existing between the two primary windings. This "notch" occurs because there is a residual leakage inductance in the plate circuit of each of the output tubes which becomes a source of voltage independent of that voltage driving the stage at the instance when one tube ceases to draw current and the other tube draws more current. This residual inductance or leakage reactance acts like an inductance through which the current has suddenly been cut off, and it generates a back e.m.f. which distorts the output wave. The value of this leakage reactance must be minutely small so that the distortion of the wave form at the highest frequency will not exceed 1 per cent. This effect has no panacea, so far as we know.

Negative feedback, the usual panacea,

does not improve the situation, as might be expected, but rather tends to make it worse. To cancel the notch in the waveform a current flow would be required through the tube in the reverse direction to that which the electron flow permits, at the time the tube ceases to draw current during the normal cycle of operation. Another way to describe what happens in the circuit is to consider Fig. 3. Here is shown an oscillographic trace of the transfer characteristic of the output tubes. The presence of leakage reactance between the two primary windings causes a discontinuity to exist in this characteristic. This is the barrier which has been the source of frustration of many engineers for years past and is perhaps the major reason that high efficiency and low distortion could not be made compatible.

Reducing Leakage Reactance

There are a number of approaches aimed at reducing the leakage reactance but the penalty has been so great that the value of the increased coupling between primary windings has been offset sufficiently to make these approaches no solution at all, or of little value. Figure 4 shows symbolically the sectionalizing of the two primary windings shown in Fig. 1. Here the primary is made up of many coils which are connected in such a fashion as to tend to make all the windings occupy the same space. This is an effective means of increasing the coupling between two coils and does increase the frequency at which the "notch" first appears. However, this approach has the disadvantage of increasing the shunting capacitance effects between the two plates of the circuit to such an extent that the high frequencies are by-passed. There doesn't seem to be any practical way to sectionalize and interleave these windings to eliminate the leakage reactance effect

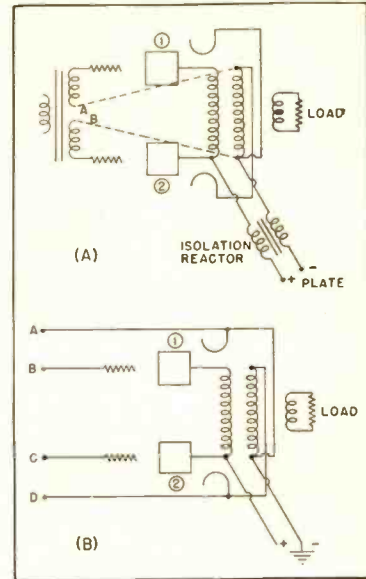

Fig. 6. Steps in development of coupling circuit.

and at the same time avoid the shunt capacitance effects. Another method which suggests itself as a result of the experience just described is to use a much larger core, permitting a reduction in the number of turns required in the windings of the primary circuit. This approach requires a very large core in the order of 125 pounds to effect a sufficient reduction in leakage reactance. This compares very unfavorably with the 11-pound core required in this new unity coupled output circuit for the same performance. It may be well to mention here also that the use of a large core has several other disadvantages among which is higher distortion, particularly at low output levels. This is due to the non-linear characteristics of the magnetic material and the relative-

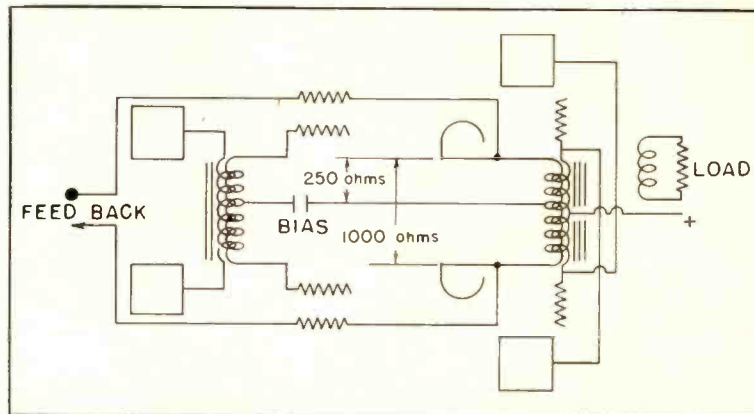

Fig. 7. Final basic arrangement employed to provide d.c. voltage for screen grid, but at the same a.c. potential as the corresponding cathode.

ly larger total loss in the larger core. It would be well to point out at this time that for 6L6 tubes operated in Class AB or Class B, the ratio of inductive reactance of the primary of the output transformer to the leakage reactance between the primaries must be 80,000 to one or greater to permit 1 per cent distortion at 20 kes and full output to as low as 20 cps.

From the above discussion it seems impractical to reduce the leakage reactance sufficiently to permit high-efficiency operation and the only hope, therefore, is to go back to a conventional Class A arrangement where a discontinuity in the current drawn by each of the tubes does not occur over the operating cycle. The solution for high efficiency operation requires an unconventional circuit which will effectively eliminate the leakage reactance between the primary windings.

Figure 5 illustrates the approach made to circumvent the problems described above. The conventional output primary circuit is again shown with the primary marked 2 in dotted form. For simplicity the power supplies are eliminated and the midpoint of this primary is shown connected to the associated cathodes. The solid position of primary 2 is shown adjacent to primary 1 and this illustrates the first step in the development of the unity coupled amplifier. These two primaries are wound

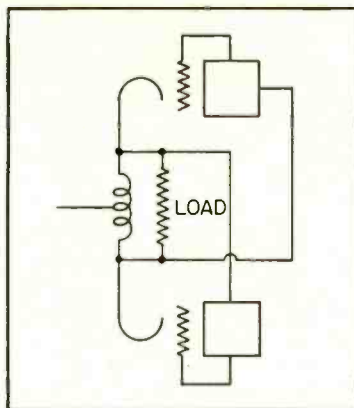

Fig. 8. Equivalent circuit simplified from Fig. 7.

together in a bifilar manner as if they were one winding and, therefore, there is between them both a capacitance coupling turn by turn, and a magnetic coupling due to the presence of the common core. Since the wires occupy practically the same space, the coupling is exceedingly high and measurements show that it is practicable to wind coils with a ratio of primary inductance to leakage reactance much better than 200,000 to 1. This, therefore, provides a way to eliminate the leakage reactance which in conventional transformers far exceeds the minimum ratio requirement

of 80,000 to 1. We now, therefore, have a system which appears to have promise by reason of finding a way to eliminate the leakage reactance between the primary windings which in turn removes the barrier which has blocked for so many years the use of high-efficiency circuits in high quality audio amplifiers.

It is obvious that other variations of approach have been considered which accomplish the desired purpose to some extent at least, such as winding the two primaries on a common core not bifilarly and utilizing a suitable capacitance for coupling the ends of these windings so as to maintain the two windings at proper and identical a.c. potentials. One advantage of the bifilar winding is, of course, a reduction of the number of components required, and it sidesteps some of the difficulties which grow out of the use of alternate approaches. It may also be obvious here that since the two primary windings are unity coupled there is no longer any need for sectionalizing the primary as is common in high quality transformers today. This results in an economy in manufacture.

Circuit Arrangement

To make Fig. 5 a practical circuit, the cathodes are connected to one coil and the plates to the other coil without changing their position in the circuit from an a.c. standpoint but permitting

[Continued on page 35]

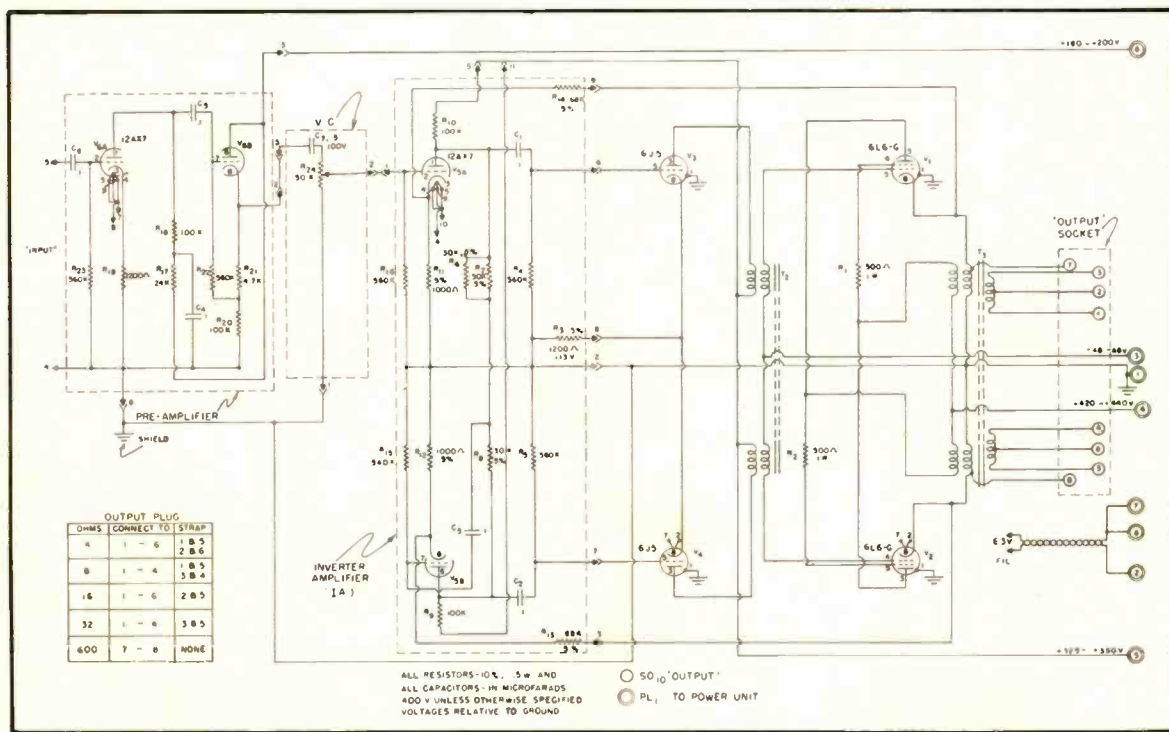

Fig. 9. Schematic of McIntosh 50W-1 amplifier.

Using the Reactance Chart for Filter Design Problems

H. B. DAVIS*

Calculations of components for various filter and equalizer circuits are simplified by graphical means.

THE VALUE OF the reactance chart such as that shown in Fig. 1 is becoming more and more widely recognized as time goes on. Although it was originally indicated by Slonczewsky that the chart could be used for other purposes than reactance and resonant-frequency calculations, it is still largely used for that purpose. The other short-cuts offered by the chart have been largely neglected.

It has been known for some time that these charts could be used for certain filter calculations. It is the purpose of this article to show why this is true and how it may be done for several popular types of filters. Although the material may not be new to many readers, it is felt that there are others to whom the information may be of value.

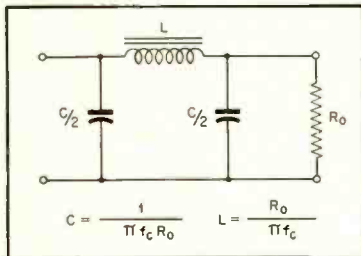

Fig. 2. Low-pass filter prototype, or constant- k section. R_0 is the terminating resistance; f_c is cut-off frequency.

The chart is designed to solve equations of three parameters in which 2π enters as a factor. Specifically it solves such equations as

$$X_L = 2\pi fL \quad (1)$$

$$X_C = \frac{1}{2\pi fC} \quad (2)$$

$$f = \frac{1}{2\pi\sqrt{LC}} \quad (3)$$

Solving for L and C in equations (1) and (2) gives

$$L = \frac{X_L}{2\pi f} \quad (4)$$

*7721 Old Georgetown Rd., Bethesda 14, Md.

$$C = \frac{1}{2\pi fX_C} \quad (5)$$

The chart may be used to solve these or other three-parameter equations having 2π as a factor if the equation to be solved can be put into one of these or an equivalent form.

Inductive and capacitive reactance have the dimensions of resistance. Therefore, without changing the form of the equations of the ordinate of the chart equations, (1) and (2) may be written

$$R_L = 2\pi fL \quad (6)$$

$$R_C = \frac{1}{2\pi fC} \quad (7)$$

Solving equations (6) and (7) for L and C respectively gives

$$L = \frac{R_L}{2\pi f} = \frac{1}{2} \cdot \frac{R_L}{\pi f} \quad (8)$$

$$C = \frac{1}{2\pi fR_C} = \frac{1}{2} \cdot \frac{1}{\pi fR_C} \quad (9)$$

Equations (8) and (9) are seen to be very similar to the equations for the low-pass filter prototype shown in Fig. 2. The equations indicate, however, that the values given by the reactance chart for L and C will be equal to one half of the value calculated from the prototype equations if R_0 is substituted for R_1 and R_2 and f_c is substituted for f .

For example, if it is desired to design a 10,000-ohm filter section with a cut-off frequency f_c of 1,000 cps, substituting these values in the equations of Fig. 2 give

$$L = \frac{10,000}{\pi \times 1000} = 3.18H, \text{ and}$$

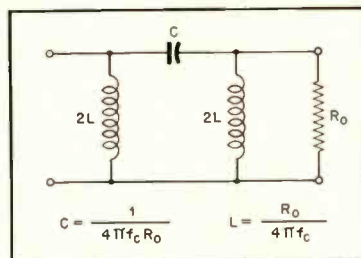

Fig. 3. High-pass filter prototype, or constant- k section.

$$C = \frac{1}{\pi \times 1000 \times 10,000} = 0.0318 \mu f$$

Using the reactance chart and entering the chart at $R_0=10,000\Omega$ at the intersection with the 1000 cps vertical, it

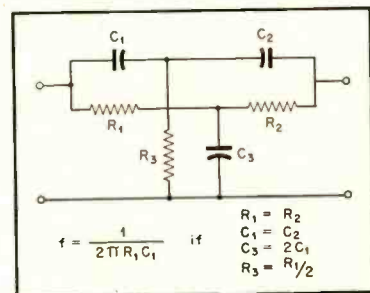
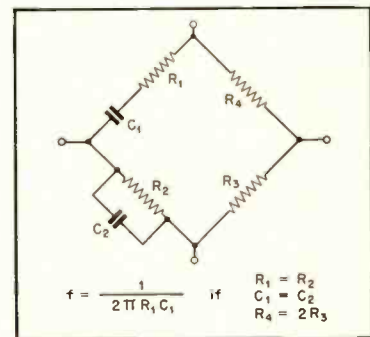

Fig. 4 (above). Parallel-T rejection or null network configuration.

Fig. 5 (below). Wien bridge circuit as employed in RC oscillators.



is found that L is given as 1.59 Henrys and C is 0.0159 μf . These values are exactly half of the values found from the equations.

In a similar manner, if f_c is substituted for f and R_0 for X_L and X_C in equations (4) and (5), equations (10) and (11) result.

$$L = \frac{R_0}{2\pi f_c} \quad (10)$$

$$C = \frac{1}{2\pi f_c R_0} \quad (11)$$

These equations are seen to be simi-

lar to the high-pass prototype equations shown in Fig. 3. Dividing both sides of equations (10) and (11) by two yields

$$\frac{L}{2} = \frac{R_0}{4\pi f_c}$$

$$\frac{C}{2} = \frac{1}{4\pi f_c R_0}$$

Solving these equations for L and C gives

$$L = 2 \times \frac{R_0}{4\pi f_c}$$

$$C = 2 \times \frac{1}{4\pi f_c R_0}$$

From these equations it is seen that the values of L and C obtained from

the reactance chart will be exactly twice the value obtained from the high-pass filter prototype equations. That this is true may be verified by solving the equations for the filters and comparing the results with the values obtained from the chart.

If equation (2) is solved for f and
[Continued on page 40]

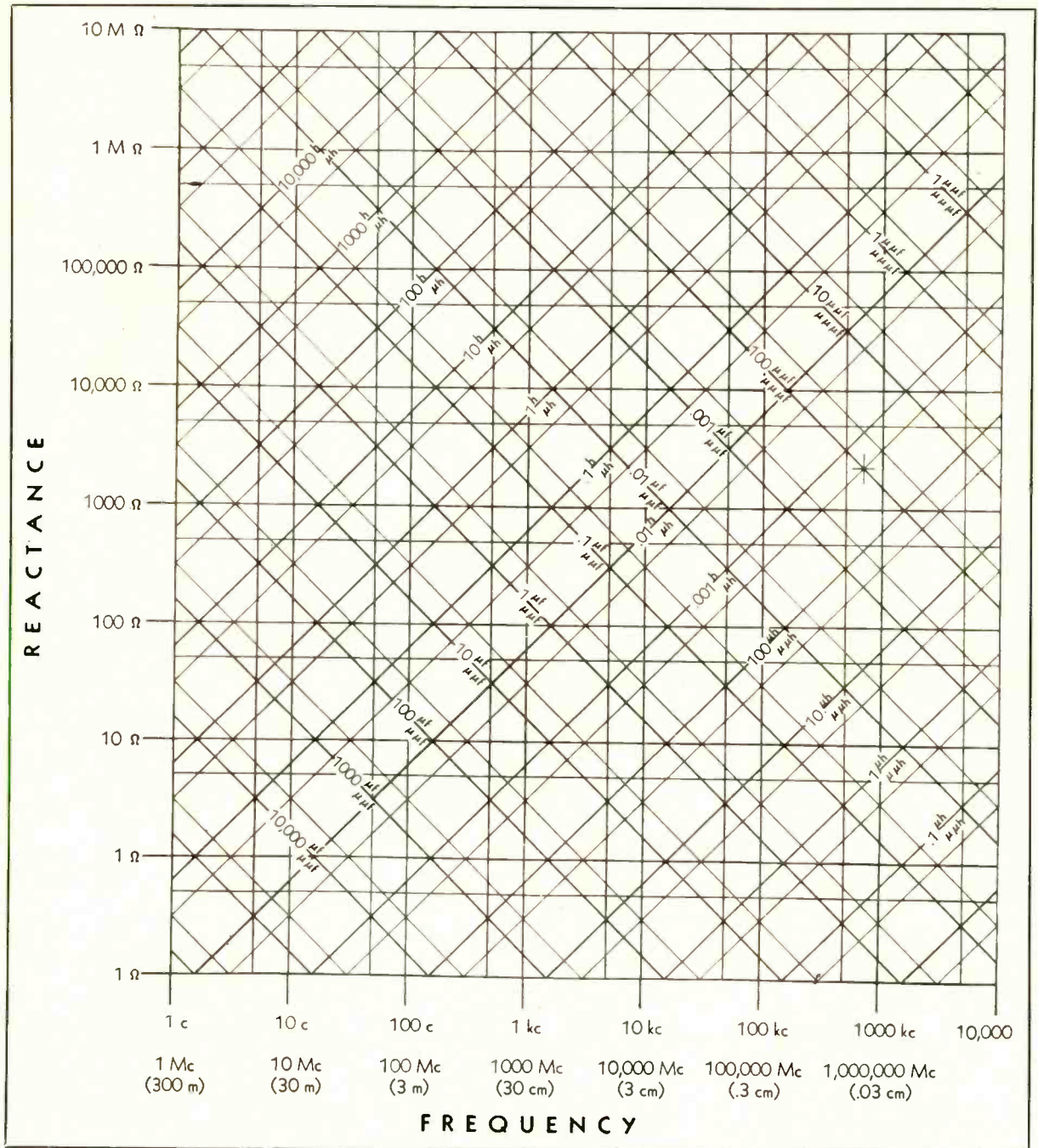

Fig. 1. The reactance chart, well known for its many applications in circuit calculations.

(Courtesy General Radio Company)

The Cathode Follower as Audio Power Amplifier

HOWARD T. STERLING*

As an output stage, the cathode follower is shown to be a feedback amplifier of special characteristics which can be duplicated in conventional amplifier designs.

RECENT YEARS there has been considerable interest in the use of the cathode follower for audio output applications. The proponents of the idea cite two principal advantages:

1. Lower distortion
2. Lower damping impedance
 - A. Providing better transient performance
 - B. Affording more independence of output transformer characteristics.

Assuming the validity of these proposed advantages, the principal disadvantages usually encountered are:

1. Extremely high driving voltages required
2. Relatively poor efficiency.

Drive Requirements

With regard to the poor efficiency encountered in the cathode follower output stage, let us consider the power relationships existing in such a stage. We must immediately realize that it is theoretically possible to get the same output voltage and current into a given value of load resistance as in the conventional amplifier, assuming sufficient driving voltage. In practice, however, the voltage output must necessarily be less than the driving voltage, and since the output current is limited by the tube, the power output will be proportional to the drive voltage available. If the output voltage is limited by the drive to some fraction of that which could be expected from a conventional amplifier, the power output will be limited proportionately.

This may be somewhat clearer if we compare the cathode follower with the conventional amplifier in a typical example. Suppose we use a pair of 2A3's. The

tube manual gives the following data for push-pull, class AB₁, self-bias operation:

E_b	300 volts
E_c	-68 volts
R_L	5000 ohms
Power Output	10 watts

The plate-to-plate output voltage under these conditions may be found by:

$$E^2 = PR = 5000 \times 10 = 50,000$$

$$E = 217 \text{ volts rms} = 317 \text{ volts peak}$$

or approximately 158 volts peak per tube. Now let us interpret this data in terms of cathode follower operation after the fashion of Fig. 1. Actually, in the case of the cathode follower, the peak E_c must exceed 158 volts by 68 volts (since there must be a signal voltage of this magnitude at the grid with respect to cathode) so that peak E_c must equal 226 volts per tube for equivalent power output.

A conventional driver using a 6J5 may deliver about 75 volts peak before running into serious distortion, or about $\frac{1}{3}$ the voltage required for full output. Since we can get about the same signal output current through the

*Chief Engineer, Electronic Workshop, 351 Bleecker St., New York City

tubes, the power output will be $\frac{1}{3}$ of 10 watts or 3.3 watts. Then the signal E/I ratio will also be $\frac{1}{3}$ and the cathode-to-cathode load should be $\frac{1}{3}$ of 5,000, or approximately 1670 ohms.

Drivers have been designed to operate from a 400-volt supply and deliver about 110 volts peak. Since this is half the drive required for full output, it should be possible to get an output power of 5 watts, representing about 50 per cent of the efficiency of the equivalent conventional amplifier.

With suitable tubes, and a high enough supply voltage on the driver, it is conceivable that one might realize the full theoretical output. If in the circuit of Fig. 1 a supply voltage of the order of 1200 were available, and tubes were used which would stand this supply voltage (the 2C53, or 807 with grid and screen tied together) adequate drive voltage could be achieved. There might be some question as to the economic practicability of such a solution.

Admittedly 2A3's are not the perfect tube for such an example, partly due to the fact that they are directly heated. There are, however, other considerations involved in the use of triode-connected pentodes, and 2A3's were chosen for the purpose of discussion in order to eliminate confusion.

If a beam tube is to be used as a cathode follower, with plate and screen tied to the supply (as shown in Fig. 2A), it is being operated as a triode and must be considered as such.

Triode Operation of Beam Tubes

In this connection, it should be pointed out that despite considerable

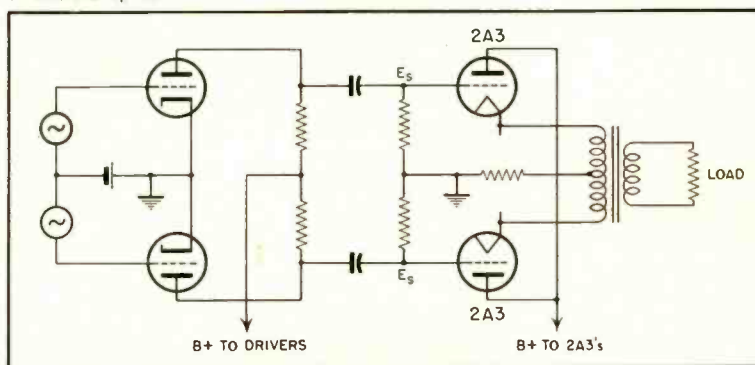

Fig. 1. The efficiency of 2A3's as cathode followers in a circuit of this type depends on the drive voltage available.

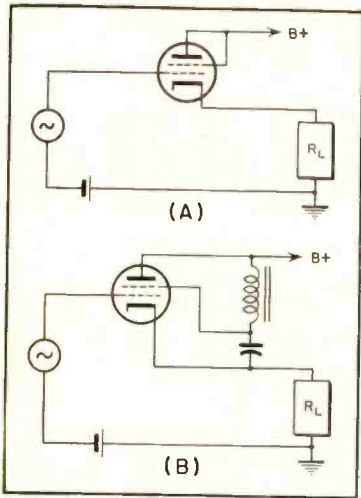

Fig. 2. (A) Triode-connected tetrode in cathode follower output circuit. (B) Tetrode connection for cathode follower.

experimental work which has been done in operating triode-connected 6L6's and 807's at voltages of the order of 400, this is operation in excess of ratings. The supply voltage should be limited to a potential which permits safe operation of the screen. It must be remembered that the screen grid accompanies the plate in its voltage excursions and reaches positive peaks equal to the sum of the supply voltage and the peak output voltage. These peaks should not be permitted to exceed published maximum screen voltage ratings.

A number of tube manufacturers consulted on this question say that while it is often possible to get away with operation in excess of rating and while many such amplifiers have been operating for years, there is no assurance of satisfactory tube life or dependability of characteristics.

If a triode-connected beam tube is operated as a cathode follower, it is still subject to triode characteristics, which are often less attractive than those for beam tubes. Only if the screen is decoupled from the plate supply and bypassed to the cathode (Fig. 2B) can the performance of the tube be determined on the basis of pentode amplifier operation.

There still remains the problem of supply voltage to the heaters. Since most indirectly heated tubes have a 100-volt heater cathode rating, and the signal at the cathode is likely to exceed this voltage, separate heater windings are necessary, and they should be well shielded electrostatically to avoid the introduction of hum into the load. Only the use of a tube like the 6AS7 with

its 300-volt heater cathode rating would eliminate this necessity. Indeed, the low-voltage and high-current characteristics of the 6AS7 would make it most suitable for the purpose.

This matter of ratings need not preoccupy the designer of a single amplifier, unless he is concerned with considerations of good engineering practice, but it must be observed in the design of equipment for production.

Feedback Amplifier

To return, then, if we wish the normal advantages of cathode follower operation we must use extremely high drive voltages, or accept a loss in efficiency which will be proportional to the deficiency in drive.

At this point one might ask whether it is not possible to obtain these advantages of cathode follower operation without the attendant disadvantages. With this thought in mind, let us analyze the cathode follower, considering it as a feedback amplifier. The expressions for internal impedance and gain in a feedback amplifier are:

$$R' = \frac{R_r}{1 - A\beta}$$

$$A' = \frac{A}{1 - A\beta}$$

where R_r is the plate resistance of the stage without feedback and A is the open circuit gain of the stage without feedback (equal to μ for a single stage). β is equal to the fraction of output voltage fed back, and for inverse feedback will be negative. If we take the case of the cathode follower (Fig. 3A) and substitute in these equations, taking β equal to -1 , then:

$$R' = \frac{R_r}{\mu + 1}$$

$$A' = \frac{\mu}{\mu + 1}$$

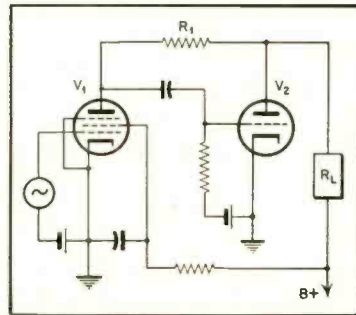

Fig. 4. Suggested drive circuit for Fig. 3B. V_1 is a pentode with $R_r \gg R_v$.

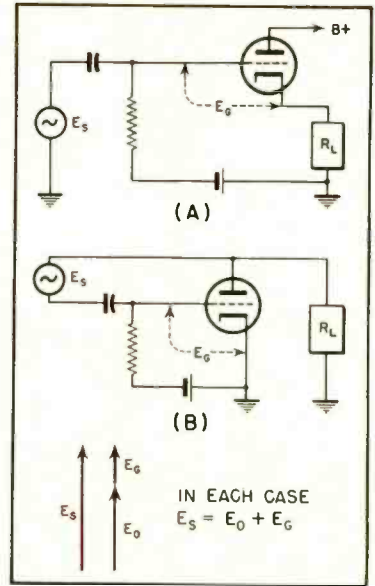

Fig. 3. (A) Conventional cathode follower. (B) Equivalent plate-coupled amplifier or "plate follower."

These will be recognized as the familiar equations for the internal impedance and gain of a cathode follower. Let us now take the case of the conventional feedback amplifier with β still equal to -1 . If we then solve for the gain and internal impedance of this circuit we get the same results as for the cathode follower. This is of some interest insofar as it shows the virtue of the cathode follower to lie not in a special circuit configuration, but rather in the fact that it has such a large amount of direct-coupled inverse feedback. Now, comparing the circuits of Figs. 3A and 3B, we see that in the cathode follower the feedback voltage appears in the cathode return to ground, permitting us to use a ground reference for our input signal voltage and hence conventional coupling of drive to the stage. In the conventional amplifier, however, the input voltage is referred to the plate, making input coupling rather difficult. A possible solution is indicated in Fig. 4, where a pentode with R_r much greater than R_v is used as driver. In any case E_s must be greater than E_o by a voltage equal to E_r .

Reference to the feedback equations will show that if A is constant then R' will be constant, so that if A is increased β may be decreased proportionately; R' will remain constant and A' will increase, and the required drive will then be reduced by the factor A' .

We can achieve this effective increase
[Continued on page 28]

Below 50 Cycles

SAUL J. WHITE*

In which the author relates some experiences with low frequencies while working toward their more realistic reproduction.

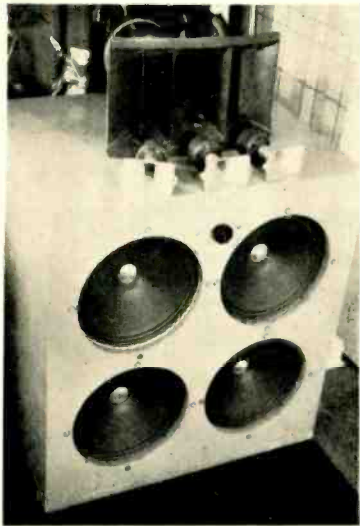

MOST HIGH-QUALITY reproducing systems terminate their *acoustic* linearity above 50 cps. Even with bass compensation and a goliath speaker-enclosure, the possibility of maintaining acoustic linearity below 50 cps is almost non-existent. While some auditory sensation can be had through exceptional equipment, the final level is so far below the mid-frequency level that ordinary bass boost cannot restore to the listener the low frequencies as they existed at the microphone position. This is because:

1. Microphone sensitivity falls off rapidly below 50 cps.
2. Losses at the low end in the modulating equipment of the broadcasting station. FCC standards require ± 2 db linearity to only 100 cps.
3. Improper compensation on recording or playback equipment or failure to adhere to NAB recording standards.
4. Severe cutoff in the loudspeaker. A speaker with its low-frequency peak at 65 cps (an excellent speaker at that) may be down as much as 30 db in sensitivity at 45 cps.
5. The poor sensitivity of the human ear to low frequencies at reduced volume levels. At normal room volume the loudness sensation of the ear may be down 20 db from its mid-frequency sensation. It will require a mere 100 times more watts compensation to restore physiological linearity. This factor will cause a quality audio system to appear deficient in lows.

Starting with the objective of bass compensation below 100 cps, the author wound up with a low-frequency booster system with a gain of 50 db between 20 and 100 cps. This bass system is fed in cascade from the output of a conventional wide-range amplifier, which drives a woofer-tweeter system as shown in Fig. 1. The special bass amplifier

*82 Elm Street, New Rochelle, N. Y.

drives a third speaker of special design which will be described later. Reproduction is thus obtained through a three-way system. Because of the excessive low-frequency gain and power output, many unexpected results followed. With reproduction capabilities down to perhaps 15 cps, observations were made of effects which contributed to greater fidelity and also served to measure the quality of broadcast equipment and technique. Certainly, sounds were reproduced never before heard over an audio system, and never intended by the broadcast stations to ever be heard. On the other hand, much flesh-and-blood program material almost lost by the transmitting equipment is restored.

The term "conventional system" when used in this article will refer to a woofer-tweeter system driven by an amplifier which is flat between 40 and 10,000 cps as measured on a resistor load. Though better than most single-speaker systems, this type of dual reproduction as yet does not give full and complete low-frequency accuracy to the original sounds. It is to this type of two-way speaker that the author has added a third speaker handling only low frequencies. (The original woofer speaker is here considered as a mid-frequency reproducer.) By cutting off the special bass system and listening only to the conventional system, an instantaneous comparison of the two types of reproduction was had. This, then, is a qualitative report of what may be heard from FM radio reception when bass compensation is lifted to ear linearity and far beyond . . . upward.

Live Programs

Live programs with speech origin develop a chestiness, somewhat pleasant if the bass boost is held within moderation. If exaggerated, huffs and puffs of breath become present. Words containing "aw" sounds as in *law* or *braun* are grotesquely deformed. Words having deep long syllables, such as *war*, *swallow*, *smoke* and *proof* are similarly distorted. Some words, with excessive boost, will start with an explosive sound, especially those starting with

"p" or "b." Even the breathing of a speaker can be made audible apart from the characteristic high-frequency hiss at the tweeters. A nervous person will reveal his condition by the rapidity of his breathing, adding a realism that is not felt over the conventional reproducing system. These vocal changes are not caused by the frequency content in speech, because the deepest voice is well above the operating range of this bass system. They are the result of pressure effects caused by pulses of breath and by the opening and closing of the lips known as labial characteristics.

The reproduction of live radio music with boost below 50 cps reveals the existence of much worthy material inadequately handled by the broadcasting stations. Of all live music, symphonic programs appear to be the most ill-handled, some instruments and notes not appearing at all when the special bass system is cut off to leave only the conventional woofer-tweeter functioning. Of course, if the bass boost is carried too far, bass drums, tympani, viola, contra bassoon and so on, become an overwhelming force, and the grill cloth in front of the bass speaker will flap like a sail in the breeze. However, the general character of the reproduction is never thick or muddy, as is the case with bass compensation systems that take hold at 200 or 300 cycles. Because of the extremely low frequencies at which this system functions, when judiciously handled, there is no

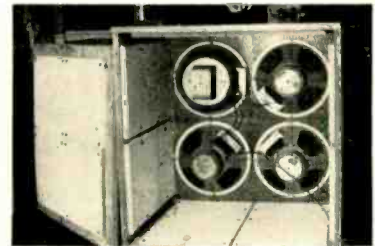

Rear view of bass speaker system described in text. Four 12-inch cones of similar efficiency and varying resonant frequencies are used.

alteration in the program bulk. This is because the time-frequency distribution of the added low frequencies is exceedingly small.

At no time is the tone boomy. When listening exclusively to the special bass speaker (pads in each speaker line permit individual attenuation), there is no recognizable melody. One hears only the true low-frequency beats. The release of a low-frequency pulse, occurring only occasionally as it does in some types of musical numbers, makes one immediately sense the improvement. Where the original conventional "flat" reproduction appeared satisfactory in handling bass, as in the percussion accompaniment of a swing number, the addition of boost brings a proud awareness to the improved quality. Furthermore, this type of boost will bring up that occasional extremely low note, below 50 cps, which otherwise could not be present. Unlike high-frequency boost with its likelihood of an increase in noise background, this bass compensation does not add any particular background or feeling of its existence while idling. However, its presence is felt with a start whenever switching of microphones or lines takes place at the station.

Compensation can be lifted to a degree where the hum level of the broadcasting station is audible. Remote pickup equipment of practically all stations is characterized by considerable 60-cps stray hum. It is possible to hear the switching of remote lines by the changes in hum levels. Even with a small amount of boost, it is possible to follow the monitoring procedure between programs. The handling of a microphone stand by a performer or announcer will easily come through. There are many unaccountable thumps tending to rupture the cone. Instrumentalists, especially guitarists, who keep time with their feet, send an unexpected rhythm along with their melody. Unfortunately it is neither precise nor clean. When first heard it was difficult to identify, sounding rough and variable in intensity. The character of certain sound effects is changed. The simulated closing of a door may sound as if the entire ceiling had fallen onto the living room floor. Pedal "thumping" never encountered on any other reproducing system can be heard on live piano numbers. Violent hand clapping carries with it a faint roar as if the mike were rocking.

Transcriptions

Programs originating with records or transcriptions need less bass compensation than live programs, although of course, they do not possess the realism of the latter. Turntable rumble can be

readily turned up, and from what has been revealed, much equipment in the New York area is due for overhaul. When listening over the conventional system, bass characteristics will appear more or less uniform between various recorded numbers or between different stations. In other words, most recordings seem to possess more or less similar bass feeling, such as it is. But when the special low boost is advanced, a considerable variation in bass content is encountered. This may vary between successive dance numbers from a given station. This is probably due to differences in bass compensation of different transcriptions, and in the region below 100 cps may vary between barely audible to over-pronounced. This difference in transmitted bass level is hardly detectable over the conventional reproducer, yet these differences widen when the low frequency system is included. This wide gap in low frequencies also appears in live programs, but to a smaller extent.

This may be accounted for by (1) different microphones or positioning even in adjoining studios; (2) deliberate bass attenuation because of preference by conductor, producer or engineer; (3) poor low-frequency response of the telephone lines (even Class A) when pickup is remote or out of town; (4) inadequate low-frequency acoustic output in the station monitoring reproducer which fails to show up these variations, the unbalance between programs therefore being inadvertent.

Sometimes with low frequencies adjusted for desirable response on a certain program, the following program from the same station will have so

much more bass as to throw the entire system into mechanical feedback or to develop hangover effects.

Low-Frequency Booster Amplifier

The low-frequency booster amplifier shown in elemental form in Fig. 1 consists of what was originally a conventional three-stage amplifier modified to reproduce only from 100 cps down. Its frequency vs gain characteristic is

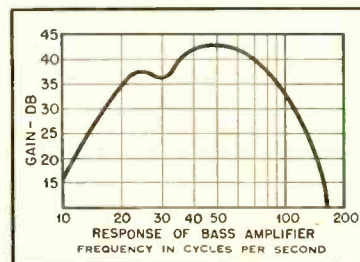

Fig. 2. Bass system amplifier of Fig. 1 provides large boost at frequencies where normal speaker response falls off.

shown on Fig. 2. It is a capacitance resistance coupled unit with push-pull parallel 6L6's in the output stage and having a power output of approximately 35 watts at 50 cps. Shunt capacitors with values to commence a 6 db loss at 100 cps were wired across each stage grid resistor. Coupling capacitor values of 0.1 μ f are adequate where the plate-load resistors are not under 50,000 ohms. No trouble was experienced with blocking effects at high signal voltages. A triple-shielded (magnetically) input transformer is used to couple the driver to the input stage grid. Since this is a bridging arrangement, it has a pri-

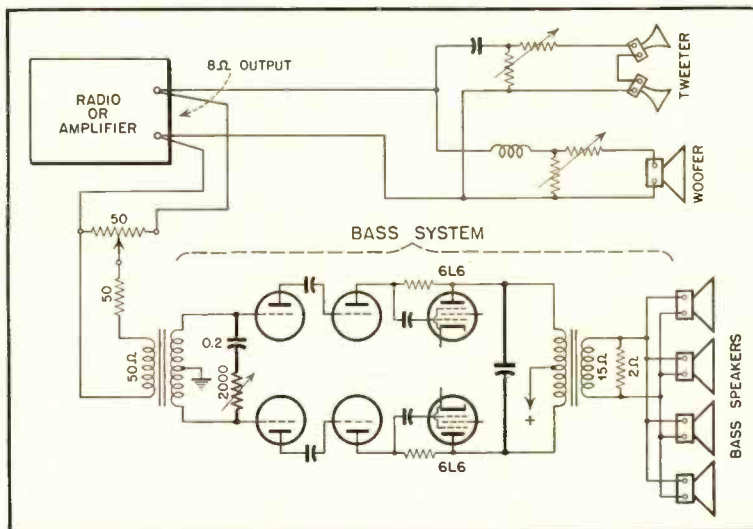

Fig. 1. Block diagram of multiple amplifier-multiple speaker arrangement used to enhance low-frequency output.

mary impedance of 50 ohms. The secondary is shunted with a 0.2 mfd capacitor and a series adjustable resistor. This forms a broadly tuned circuit at 40 cps. In operation the resistor may be adjusted to suit the character of the response sought. The output transformer primary is shunted with a capacitor to resonate at about 25 cps. The humps due to resonance are not sharp due to the low efficiency of the transformers at these frequencies. The two tuned circuits function broadly over a frequency area where the loudspeaker output would ordinarily disappear. However, this method of increasing low-frequency gain must be approached with caution since the results will vary with transformer Q. An excessive peak or trace of circuit resonance will give bad hangovers and disguise the fidelity of the original source. Needless to say, both the main amplifier and the bass amplifier must have lower-than-average hum level, or the performance will be unsatisfactory. Low line hum can be achieved by observing good design and construction technic, such as thorough shielding of all low-level wiring and components; direct current for heaters of the voltage amplifier stages, with all heater voltages about 10 to 15 per cent below nominal values; balanced push-pull tubes; well-filtered power supply with wide separation of input transformers from the power supply, large values of decoupling capacitors; and care in avoiding ground loops which pick up potential differences in the chassis and grounding leads.

The nominal 15-ohm output of the amplifier is shunted with a 2-ohm resistor for the purpose of damping the output, although this is attained at the expense of useful power. This achieves stiffening of the loudspeaker diaphragms at resonant frequency by electrical means. This system will be called upon to handle severe transients of high intensity and must do so without damaging the speaker. This is a stiffness controlled system, both electrically and acoustically, and while such systems are inherently insensitive at low frequencies, in this

case they are driven into the speaker by brute force.

The Bass Speaker

The low-frequency loudspeaker is composed of four 12-inch cones mounted as close together as possible in an enclosure of approximately six cubic feet. No reflex ports are used, the objective being to stiffen the cones acoustically by a not-too-large airtight enclosure. The four cones tend to act as a single diaphragm of large diameter, but it should not be assumed that they will perform, in a practical sense, as a single cone of four times the area, i. e., 24-inch diameter. During early experiments, excellent results were obtained with a single 12-inch speaker in a cabinet measuring 20 x 20 x 20 inches. However, it and a replacement were shortly ruptured by these experiments. Nevertheless, models of single 12-inch speakers with proportionately smaller amplifiers give impressive results when held to room loudness levels. A two-speaker system would probably be adequate for most disciplined experimenters interested merely in high-quality musical reproduction.

The effort behind this speaker design is to reduce the resonance peak of the cone and to achieve a slow roll-off in sensitivity. A loosely loaded cone, that is, one in an excessively large cabinet, will have the lowest resonant frequency, but this will usually be in the form of a distinct peak and a steep roll-off below this peak, making smooth equalization difficult. In large cabinets at frequencies above resonance, the diaphragm is mass-controlled, and it is a characteristic of mass-controlled transducers that output falls sharply below resonance. A small enclosure adds

stiffness, raising resonance and reducing low-frequency efficiency, as shown in Fig. 3. While the smaller enclosure will raise the resonant frequency of the speaker, seemingly giving it less bass, it is a preferable practice, since the peak is shifted to a higher point by the increased stiffening factor of the smaller rear volume and broadened by the change of mass-to-stiffness ratio. It was reasoned that amplifier power today is a cheap commodity, whereas high-efficiency, low frequency cone speakers, massive enclosures and horns are expensive. This system will surely appeal to those who wish greater bass output without placing a monstrosity in their home.

In this bass system it is important to suppress the amplitude of the speaker resonant peak, for unless this is done effectively, the whole reproducing system will develop acoustic feedback before adequate compensation is obtained. This develops because the mid-frequency speaker acts as an input transducer or microphone across the bass amplifier, and by virtue of the gain existing between the mid-frequency speaker and the bass speaker, acoustic feedback will set in. To some extent, this was overcome by attenuating the low end of the conventional amplifier and the high end of the bass amplifier so as to form an amplification crossover with a 10 db dip at the resonant frequency of the bass cones. It is clear also that it is impractical to place the two speaker groups too close together. If bass gain is carried too far, mechanical feedback may develop due to the microphonic sensitivity of the tubes and the physical coupling through the floor under low frequency stimuli,

even with the speaker unit located at the opposite end of the room from the amplifier or tuner. This regeneration occurs whenever the gain of the mechanically vibrating tube-to-speaker circuit is greater than the transmission loss through the coupling medium, i. e., floor, chassis, tube elements, and so on. This regeneration is preceded by severe hangover, flutter and instability typical of all positive feedback arrangements.

[Cont. on page 31]

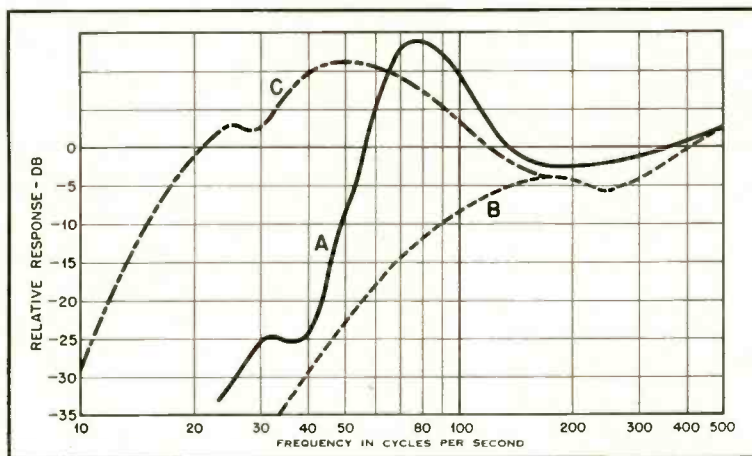

Fig. 3. Curves showing effect of adding low-frequency booster and speakers to normal system. (A) shows typical response of a so-called woofer in an enclosure of ample volume. (B) represents the same speaker enclosed in a small airtight cabinet. (C) represents speaker (B) with bass compensation added.



Audio Engineering Society,
Box F, Oceanside, N. Y.

AUDIO engineering society

Containing the Activities and Papers of the Society, and published monthly as a part of AUDIO ENGINEERING Magazine

OFFICERS

Theodore Lindenberg, President

J. D. Colvin.....Executive Vice-Pres. John G. Frayne.....Western Vice-Pres.
Norman C. Pickering.....Secretary Ralph A. Schlegel.....Treasurer

Report on the Convention and The Audio Fair

The Audio Fair and first annual convention of the Society was a pronounced success in all respects. 1463 persons registered on the opening day while registration on the second day was 895, and on the third day was 664. With the repeats on the second and third days, it appeared that the attendance approached 1500 for each of the three days. The number of exhibitors totaled 56, and the entire sixth floor at the Hotel New Yorker was devoted to exhibits. The technical sessions were held in the second floor ballrooms of the hotel, and attendance at these ranged between 200 and 400.

The meetings on the first day began with a business meeting at which various reports were read by the secretary, treasurer and elections committee. The new officers announced were: president, Theodore Lindenberg. Fairchild Recording Equipment Company; executive vice president, J. D. Colvin, American Broadcasting Company; secretary, Norman C. Pickering, Pickering and Company, Inc.; treasurer, Ralph Schlegel, WOR Recording Studios. The Western vice president for the new year is John D. Frayne. Newly elected to the board of governors were C. A. Rackey, National Broadcasting Company; C. J. LeBel, Audio Instrument Company; and F. Sumner Hall, Audio Equipment Sales.

The activities of the banquet highlighted the three-day session. On Friday night, after short remarks by the officers, Chairman W. L. Black of the awards committee announced the selection of Dr. Harry F. Olson of RCA Laboratories as the recipient of the newly established John H. Potts Memorial Award for "outstanding achievement in the field of audio engineering." The society has the privilege of selecting each year the person who is to receive the medal, which was named for the late editor of AUDIO ENGINEERING Magazine.

Dr. Olson, a leading authority on acoustics, was a pioneer in the research and development of directional microphones, including the velocity type. Directional microphones are now almost universally employed in radio, sound motion pictures, and television. Loudspeakers developed by Dr. Olson range in size from the smallest to the largest, and he developed the first successful electronic phonograph pickup. He is a fellow of The Institute of Radio Engineers and of the Acoustical Society of America, and a member of Tau Beta Pi, Sigma Xi, and the American Physical Society.

C. J. LeBel was presented with the Society



The John H. Potts Memorial Award

Award for his contributions to the Audio Engineering Society, and honorary memberships were bestowed on Harvey Fletcher of Bell Telephone Laboratories, Vern O. Knudson of University of California at Los Angeles, and Frederick V. Hunt of the Crut Laboratory at Harvard University.

The banquet concluded with an interesting demonstration of eleven high-quality loudspeakers in an A-B test. The audience was provided with rating cards, and the speakers were identified by letters only. The listeners individually rated each speaker on the basis of five types of program material, which included symphony, piano, and dialogue. No formal count was taken of the result. This portion of the entertainment was under the chairmanship of L. B. Keim, consulting radio physicist.

So successful was this three-day meeting that plans are already under way for a similar and possibly enlarged conference to take place at about the same time in 1950. Details will be announced in later months in this space.

RCA Institute Chapter Elects

The student chapter at RCA Institutes, in New York, announces the election of officers for the coming six months, with Lucien W. Marek being chosen as Chairman; Paul Bezold, vice chairman; Hagop T. Hatzakortzian, secretary; and Harry Weiss, treasurer. Committee chairmen appointed were: Cedric F. Lee, constitution; Frank Staffa, program; Lyle B. Dahms, publicity; Max B. Marek, membership.

The chapter is furthering its work by having regular meetings with prominent speakers, and by having close ties with the parent organization. Members are urged to

work on projects and to write papers on them to gain experience in the presentation of such work.

Los Angeles Chapter Organizes

On the evening of Tuesday, October 13, sixty-one engineers gathered at Los Angeles to organize the local chapter of the Society. Dr. John Frayne, now Western Vice President, acted as parliamentarian to start the operation, ably prompted by Robert J. Callen. John K. Hilliard was elected Chairman of the local chapter, with Harry Bryant and Arthur Partridge being chosen as secretary and treasurer respectively.

Committee chairmen appointed were: R. J. Callen, program; Richard Burgess, arrangements; and Miss Louise De Nio, membership. The members selected the first Tuesday of the month for regular meetings, with Dec. 6 as the starting date.

Employment Register

Positions open and available personnel may be listed here at no charge to industry, or to members of the Society. For insertion in this column, brief announcements should be in the hands of the AES Editor before the tenth of the month preceding the date of issue. Address replies to AES Editor, Audio Engineering, 342 Madison Ave., New York 17, N. Y.

- **Communications Engineer (MIT) 22**, single, with good theoretical background and some experience; interested in research, development, or teaching in audio, acoustics, electric circuits, and vacuum-tube circuits. Box 111.

- **Audio Engineer:** Three years experience in magnetic tape development including pigment research, coating formulation, coating techniques, pilot plant operation, manufacturing control equipment and techniques. Broad background in all phases of film and disc recording. Box 112.

- **Graduate Student** of radio and television desires Junior Engineering position in audio or recording industry. Age 23, married, child. Willing to travel occasionally. Prefer midwest or south. Box 113.

- **Recording Engineer.** Experienced mixer; superior knowledge of classical music. Knows motion picture and radio mixing techniques. 30, married, presently employed. Graduate of Hollywood Sound Institute. Box 121.

- **Audio Engineer.** Graduate Hollywood Sound Institute. 25, married. Now attending television production school. Desire position with broadcast or recording studio, evenings. N.Y.C. Free to travel after January, 1950. Box 122.

Recording Characteristics—1

A discussion of the various characteristics employed in making phonograph records, together with the reasons for their use.

THAT THE ULTIMATE in disc recording is to make the reproduced signal as near as possible to the original seems to go without further elaboration. This applies, of course, to any recording, but this discussion is solely about disc recording systems. To achieve faithful reproduction, therefore, it would seem that if all

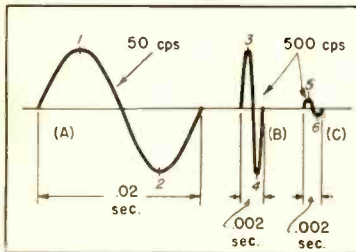

Fig. 1. Comparison between sine-wave signal plotted for 50 and 500 cps: at same amplitude, (A) and (B); and at same velocity, (A) and (C).

the components were made as perfect as it is possible to make them, it would suffice to record the signal and play it back with completely flat equipment. However, due to a number of limitations, this is not feasible, and the curve employed in recording is definitely not flat; consequently the curves employed in reproduction must deviate from uniformity. It is the purpose of this discussion to elaborate on the reasons for deviation in both the recording and the reproducing operations.

The principal variations from flatness in the recording process are due to mechanical limitations. In order to provide as high a signal-to-noise ratio as possible, it is desirable that the recorded level on the disc shall approach the maximum permissible value without overloading. Any further discussion of this problem necessitates defining certain recording terms, which will be done shortly.

It may be said, however, that low-

frequency equalization is employed to reduce the possibility of overloading and that the high-frequency equalization is resorted to in order to reduce surface noise. The resulting recording curve is one in which the low frequencies are reduced in level at a constant rate, beginning at some predetermined point called the "turnover" frequency, and that the high frequencies are increased in level at some predetermined rate. The high-frequency equalization is commonly called "pre-emphasis" and must be compensated for in reproduction just as the low-frequency equalization is.

Low-Frequency Equalization

There are two basic types of recording. One of these is known as "constant amplitude" and the other as "constant velocity." Both terms apply to the tip of the recording or reproducing stylus as it traces the groove. In constant-amplitude recording, the stylus tip at a given signal level moves a fixed distance each side of its center or rest position for any frequency. Thus the amplitude of the swing of the stylus tip is constant.

In constant-velocity recording, the maximum velocity of the stylus tip at a given signal level remains constant for any frequency. Considering a sine wave as being applied to the recording head, the maximum velocity occurring during each cycle is as the stylus tip is crossing its center or rest position. Figure 1 is used to clarify this point. (A) shows a sine wave at a frequency of 50 cps, requiring a period of time .02 sec. in length. (B) shows a sine wave at a frequency of 500 cps, requiring a period of time of .002 sec. Both of these are shown at the same amplitude, or displacement, of the stylus from its rest position. From these diagrams, it is seen that the stylus requires .01 sec. to move from 1 to 2 in (A), and .001 sec. to move from 3 to 4 in (B), and that both of these distances are the same. Therefore, the velocity of the stylus point must be 10 times as great for the higher frequency since it must move over the same distance in 1/10 the time. If the velocity of the stylus were held constant, then the displacement or amplitude of the swing would be re-

[Continued on page 24]

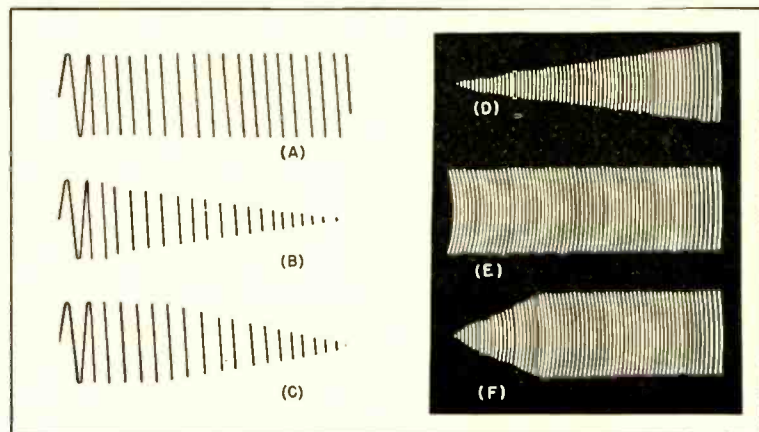

Fig. 2. Amplitude of stylus swing for swept-frequency signal at: (A) constant amplitude; (B) constant velocity; (C) commercial constant velocity. Corresponding light patterns are shown at (D), (E), and (F).

**WORKS LIKE NEW!...after 9 months of daily use
ON 30,000 MILE TREK
THROUGH AFRICAN JUNGLE**

with Arch Oboler Famous Radio Playwright.

**E-V CARDYNE Cardioid Dynamic Microphone
takes everything... from the heat and humidity
of the Congo to the rain-swept slopes of the
Mountains of the Moon, to the snow and ice of
16,000 foot Mt. Kenya's glacier fields!**

*"...trip was made by boat, pack horse, jeep and foot
under most difficult conditions...apparatus had to
endure penetrating dust and great variations in
humidity...used the Cardyne almost entirely...never
failed, during months of use and abuse...made
recordings of experiences on African safari for a
series of transcribed radio broadcasts...after return
to U.S., found the Cardyne to be in thoroughly
operative condition from every standpoint...
built-in ruggedness of E-V microphones means a
longer, more useful life at any time, anywhere."*

Arch Oboler...Author-Director.
Winner of Radio's Top
Awards, including the
Peabody Award
(Radio's Pulitzer).

Shown using E-V Cardyne
Cardioid Microphone in
recording the Ituri pygmies
in the Belgian Congo.

Write for Cardyne Bulletin No. 139

ELECTRO-VOICE, INC., BUCHANAN, MICH.

Export: 13 East 40th St., New York 16, U.S.A.

Cables: Arlc b

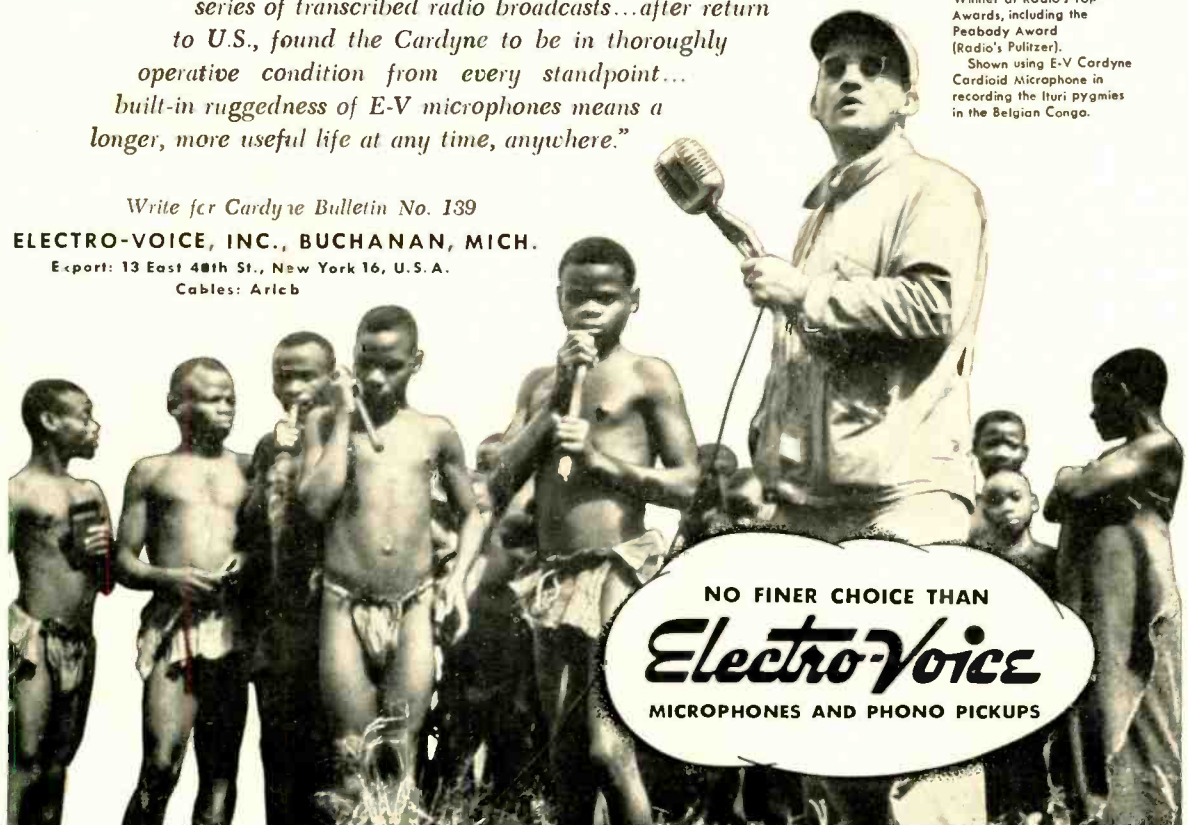

NO FINER CHOICE THAN
Electro-Voice
MICROPHONES AND PHONO PICKUPS

RECORD REVUE

STRANGE—AFTER WORRYING for months on end about inexplicable troubles with LP records (until I finally wrote out the whole story, inconclusive as it was, for the October issue) within a week or so I had found really satisfactory answers to most of my questions and doubts. Since then my whole "Department of Long-Playing Records" has been under drastic revision. The prognosis is good. (Thanks to a freak of publishing deadlines, some of the "answers" appeared for me in another journal on the same day that the questions came out in the November *AUDIO ENGINEERING*. It was not a put-up job—the other journal went to press two weeks later.)

It seems that the answers to the LP problems described are largely in the mechanical, not the electrical sphere, specifically in the fairly obvious matter of stylus compliance. And in that rather simple discovery lies a lot of straightening out in the way of judgments levelled against LP records that more properly should be laid upon the pickup involved in their playing.

Let's get one point straight at once. Of course LP records are heir to all the "normal" troubles of any recording process in the way of electrical distortions, in the original recording, and in the various phases of copying. All of the perplexities, too, of mike pickup and studio liveness apply just as much to the LP as to any other record. Pressing difficulties and the problems of noise crowd in on the LP maker (and the user) just as they always have. Perfection in LP is a bit harder to attain than on 78, but the troubles are the same old troubles, generally speaking. As always, some final results on LP will be better than others. Heretofore it has been my experience that most—indeed, practically all—difficulties of any sort with small-groove records have been ascribed to some one or another of these familiar factors, and notably the supposedly unarguable business of record-curve—which at least for Columbia is a matter of published information. (I've had letters, for example, that suggest my "buzzy distortion" is a matter of wrong equalization.) But right now we are dealing with a special situation and a brand of distortion that falls outside of the regular and familiar areas. Granted there are other LP problems too—but put them aside for the moment. Let's look at just one major trouble.

To review briefly, you will recollect that I discovered, painfully, some strange and irreconcilable phenomena concerning the played sound of LP's. For reasons then unfathomable, LP records that sounded clean with one type of pickup were buzzy, dis-

Fuzziness: Solved! EDWARD TATNALL CANBY*

torted, seemingly grossly overcut when played with a different pickup.

Discovery

The light came via a non-engineer friend (one of those non-engineers whose domicile is filled with enormously professional audio equipment, self-designed). Mr. Frank Robbins, whose profession is art—more specifically at the moment, comic strip creation—listened as had plenty of others to my tale of LP woe; then he casually showed me his GE cartridge. Looked like any other to me. But no. The stylus, it seemed, was a tiny bit different from those I had seen before. I produced my own cartridge . . . yep, the stylus assemblies were definitely different, now that it was pointed out to me. And both were different from still a third stylus that I had also been using. Since I have no official information from GE that these differences even exist at all, let's give them informal monickers. Type 1 (I think the first to appear) has a clear plastic square of damping material under the metal arm (armature). Type 2, the one I had been using all last summer for LP playing and on which many a review had been based, has a round black cylinder of rubber-like material just back of the stylus, replacing the clear plastic damping.

Type 3, the new wrinkle, was scarcely different. The two earlier models (there may have been more) had the twist of the metal ribbon armature about halfway across from the "pin" (magnet) at the center to the stylus. The new type 3 carried the vertically aligned section of the armature *all the way across* to just behind the stylus itself before the twist to a horizontal plane occurred. Closer study showed also a slightly taller black damping cylinder, holding the stylus a bit above and outside the two pole pieces. Tiny insignificant differences, so slight that almost no one I have asked has ever noticed them before.

But, the pay-off. Type 3. Mr. Robbins proceeded to demonstrate to me, all other things being exactly equal, was extraordinarily superior to Type 2 in the very respects that I have been groaning about. Loud, heavily recorded passages, especially near the inner grooves which on stylus 2 "blasted" (sounded fuzzy, broken-up, buzzy, or what have you), on stylus 3 came through clean as a breeze. We tried the experiment again and again, as I have since, with quick plug-in changes from one stylus to the other on the same record. There isn't the slightest doubt about it. The type 3 GE stylus,

mounted in the same cartridge that held the type 2 (all of these are of course the replaceable kind) will remove what have seemed to be a *distortion in the record*, but which was actually a distortion due to poor tracking of the stylus, to poor compliance in the stylus assembly. For the first time an inexplicable factor had been pinned down without the slightest doubt to one specific area of trouble—in the stylus itself, *not* in the record.

Withdrawal

It's clear to me now, though I may be wobbly on technical details, that this whole question of the mechanical action of the playing stylus has been grossly neglected by audio enthusiasts and that varying results with small-groove reproduction have been almost universally blamed on the records themselves, ignoring the pickup. Again, the records have their due quota of faults, to be sure; but until you, the user, have determined comparatively just what the various pickup cartridges will do on any given small-groove passage, until you can pin down and so eliminate the variable of differing mechanical characteristics among pickups, you are in no good position to judge apparent or alleged faults in the records themselves. Right?

To conclude on a personal note—at least three quarters, maybe nearer 90 per cent, of the LP records I had formerly judged unsatisfactory in the loud passages and had characterized as "buzzy" or distorted, are now already re-allocated to the "quite satisfactory" category. Many of these have also been the subject of complaints from others than myself. Moreover, until now I have not disposed of a single shellac duplicate of the incoming LP re-issues—I've felt that maybe the shellacs are better, after all, and I'd better hang on to them; as a result of these disclosures I now plan to move out a good proportion of the heavyweight 78's, relying henceforth on their LP versions alone.

Does that indicate the practical importance of stylus compliance?

Note: Here is a rough rule-of-thumb for the three types of replaceable GE styli I have so far observed (there may be more). Their effectiveness increases in this order: "Type 1": Metal armature ribbon twists from vertical to horizontal halfway across. Damping is a square of clear plastic beneath the armature. Least satisfactory. "Type 2": Metal armature same as Type 1 (twist is halfway across). Damping change!—a short cylinder of black rubber-like material just behind stylus. Improved, but still tracks badly in .001 model during loudest passages.

[Continued on page 41]

*279 W. 4th St., New York 14, N. Y.

Constant Groove Depth Solves Microgroove Problem

by D. E. Ward*

Whereas variation in groove depth as small as .0005" little affects the quality of ordinary disc recordings, such variation seriously impairs microgroove results. The fact that uniform depth is difficult to maintain in cutting ordinary aluminum-base transcription blanks or master discs is borne out by the operating procedures of prominent fine-line recording companies. Recording engineers have found it necessary for fine-line work to select only the flattest discs out of their supplies of blanks. Where fine-line cutting is the predominant phase of their business, so relatively few discs are found to be ideally flat, that excessive inventories of less flat blanks quickly accumulate.

To alleviate this selection problem partially, at least, some recording departments use 13 $\frac{1}{4}$ " or 17 $\frac{1}{4}$ " discs as originals for even seven inch pressings. Due to the fact that the large master size discs are commonly supplied with .050" aluminum bases, the chance of obtaining a better degree of flatness in these sizes is greater.

On the other hand, however, because of the dependence of all disc manufacturers on only one source of aluminum bases, there is no real assurance that even the heavy bases will be consistently flat from shipment to shipment. This fact has doubtless been a contributing factor to what has sometimes been termed inconsistent behavior of ordinary coated discs. When, because of surface run-out, the cut changes from light to heavy once per revolution, surface noise may develop a "swish" which is often erroneously charged to hard and soft areas, a condition which actually never occurs on discs manufactured by modern methods.

The best disc bases obtainable often run out of flat as much as .015" at a 12" diameter. The commonly seen wavering of the reflection in a rotating disc is, of course, the plainest evidence of this usual run-out, and is ordinarily the recording engineer's criterion for judgment of flatness.

To eliminate the lost motion of having the user select out the flattest discs himself, and to minimize the resulting accumulation of inventory, one disc manufacturer, REEVES SOUNDRAFT CORP., now offers a full solution to the flatness problem by new innovations in the familiar Soundcraft line made possible by the Soundcraft Electronic Selector, an ingenious device which rapidly tests discs for compliance with close flatness tolerances. Soundcraft, therefore, now offers two new lines, 'Micromaster' discs for fine-line originals and New 'Microflat Broadcasters' for high quality radio reproduction. *Advertisement.*

*Sales Manager—Reeves Soundcraft Corp.

THIS IS THE NEW

'MICROFLAT' 'BROADCASTER' DISC



FOR TRULY CRITICAL RECORDING
UP TO 500 LINES PER INCH!

- FORGET "STUDIO INSPECTION"
- ELIMINATE "TURNTABLE SCRUTINY"
- DON'T PLAY NUMBERS (LOT)

These blanks actually cut as quietly at the critical small diameters as ANY blank will cut at a LARGE diameter.

They have always been microscopically clean, free from surface imperfections, and INHERENTLY impervious to humidity.

Now AT NO EXTRA CHARGE, they are also

'MICROFLAT'

for uniform groove depth at all speeds and maximum lines per inch made possible by the

NEW SOUNDRAFT ELECTRONIC SELECTOR

For transcription and L.P. phonorecord processing use electronically selected

'MICROMASTERS'

"The discs that never fail"

Take advantage of these new products promptly by simply returning the coupon.

Gentlemen: Date: Today

Please send prices, discounts and names of the nearest of your 407 distributors of Soundcraft 'Microflat Broadcasters' and 'Micromasters.'

YOUR NAME _____

ADDRESS _____

Mail to _____

REEVES Soundcraft CORP.
10 EAST 52nd STREET • NEW YORK 22, N. Y.

Electronic Selector Picks Out Flat Discs

by A. C. Travis, Jr.*

To meet the urgent need for flatter-than-average discs for all fine-line applications such as 7"-45 RPM and 33-1/3 RPM LP microgroove recordings, an Electronic Disc Selector has been developed by Reeves Soundcraft Corp. for use in Soundcraft Disc production.

Among the many problems attendant upon the development was the determination of standards and tolerances, in other words, "how flat is flat?" Microscopically speaking, there is, of course, no such thing as a perfectly flat surface. For practical purposes, however, it was determined that even the poorest cutting head suspension would produce a uniform groove at any standard speed if the vertical rise and fall of the surface under the stylus was less than .005" provided this run-out was not caused by a sharp bend or bump. Flatness testing all sizes of disc bases further determined that the larger diameters, 13 $\frac{1}{4}$ ", 16" and 17 $\frac{1}{4}$ " averaged flatter than ten and twelve inch bases, which commonly run-out of flat as much as .015".

Obviously, many ways can be devised for checking discs for flatness, but to check them at production speeds without damage from handling is quite another matter. The disc can, of course, be touched only by the edges, and nothing mechanical can bear against the surface without marring it. The Electronic Selector, therefore, to borrow a political phrase, literally has to "look at the record". A combination of optics and electronics, the Selector takes advantage of the fact that the truly flat, broadcasting-quality disc is a perfect darkened mirror. The Selector, therefore, makes use of reflected light beams and photocells to check not only whether the deviation from a truly flat surface is within limits, but also whether the steepness of the curve of deviation is within an allowable tolerance. The Selector makes fast decisions to keep up with Soundcraft's high production rate without sacrificing safety in handling. It would hardly be fair to say that the Soundcraft Electronic Selector is a great invention. The truth is that as a gadget, it is only a new application of prior art. Of real importance, however, is the fact that its use makes possible the offer in commercial quantities of remarkably flat recording discs for critical work.

The new selected discs are available in two types: NEW 'MICROFLAT' SOUNDRAFT 'BROADCASTERS' and 'MICROMASTERS'. The premium-grade Soundcraft 'BROADCASTERS' are now and henceforth being furnished at no extra charge as 'MICROFLAT'. Electronically selected 13 $\frac{1}{4}$ " and 17 $\frac{1}{4}$ " 'MICROMASTERS' are now furnished for all fine-line originals at a slight increase in price over the popular 'Maestro' line commensurate only with the cost of the selection operation. *Advertisement.*

*Vice Pres.—Reeves Soundcraft Corp.

Dear Reader,

RUMOR?

ask for
bulletin U 17

if a three foot drum can move 972 sq. inches of air . . . and a 20 inch speaker only moves 256 sq. inches . . . it would obviously require four to displace the "Natural area" moved by the drum.

if you use a 36 inch speaker you will move enough air, but so slow . . . instead of a bang you get a boom, and a rim shot . . . sounds like a snap-dragon . . . not much snap, but plenty dragon . . . too much mass aids the well known . . . hang-over hence, mono-bass whither you play A or F you'll always get B flat.

got a solution

it was'nt found in a box, pipe, horn, reflex, infinite, or flat baffle . . . the unit measures 31 inches high, 41 inches wide, 12 inches thick . . . it moves 650 sq. inches of air in one plane, but quick . . . will operate up to 40 clean watts with no distortion . . . IT WORKS . . . from 27 cycles to 12 KC . . . FLAT . . . there is a complete absence of frequency doubling . . . the high frequency is beautifully clean to 12 KC . . . then rolls off . . . this unit was designed to operate with a feed-back amplifier having a minimum of 23 DB feed-back . . . the loop must include the transformer . . . the internal impedance of said amplifier should be one-half an ohm . . . the new speaker unit looks like 10 - 12 ohms power-wise . . . this unit has been brewing for 10 YEARS it is not necessarily new . . . shall we say simply over-looked . . . out of 49 various two and three way combinations this unit is the only one that gave true life like reproduction . . . in adding nothing to the original . . . such as metallic, harshness, and low frequency distortion.

"YOU CAN FEEL THE DIFFERENCE"

audio pacific co.

30 west colorado st.

pasadena 1, calif.

AUDIANA

[from page 20]

duced to one tenth of its previous amount, as at (C).

Thus, in a constant-amplitude recording the velocity increases with frequency, although the displacement of the stylus point remains constant. In a constant-velocity recording, the amplitude decreases with frequency, but the peak velocity of the stylus point remains constant. In all of this discussion, it is assumed that the signal level is held at a given fixed point.

Practically all phonograph records and transcriptions are made with a combination of these two characteristics, with the change from one to the other occurring at the turnover point. In order to limit the swing of the stylus at the low frequencies, recordings are normally made at constant amplitude from the lowest frequency up to the turnover point, and at constant velocity above the turnover point. Figure 2 shows a typical groove for a swept-frequency signal from 50 to 10,000 cps at constant amplitude at (A), at constant velocity at (B), and at "commercial constant velocity" at (C). Commercial constant velocity is the term given to a curve which is at constant amplitude up to the turnover, and at constant velocity above. If the actual record were viewed with a distant light illuminating the grooves, the pattern due to (A) would appear as at (D); that for (B) would appear as at (E); and that for (C) is shown at (F). This latter is the familiar "Christmas tree" pattern which is almost universally used to evaluate performance of recording apparatus. It is characteristic of this method of illumination that a constant-velocity recording will produce a light band of fixed width, and thus the width of the band at any point may be used to compare the actual "velocity" of the groove throughout the frequency spectrum.

Pickup Response

Different types of pickups respond to the recording methods in different ways. A velocity-actuated device—such as a magnetic pickup—will produce a constant voltage output from a constant-velocity recording. This is due to the fact that the voltage is generated by the movement of a conductor through a magnetic field, or by the variation of a magnetic field which passes through a coil. Since the voltage generated in this manner is proportional to the velocity with which the lines of force and the conductor move with respect to each other, the voltage output from a mag-

AUDIO FAIR AUDIENCE ACCLAIMS NEW PICKERING PRODUCTS

... declared to be significant achievements in the audio art

Thousands of engineers, musicians, audio enthusiasts and music lovers were unanimous in their enthusiastic approval of the new Pickering loudspeaker, preamplifier, record compensator and pickup arm, all of which were shown to the public for the first time at the recent Audio Fair. The extraordinary acceptance by this critical audience confirms the soundness of the basic design of these new products. All of these audio components were developed for the exacting listener; the psychological factors associated with listening were given as much weight as the measurable quantities, such as frequency response, intermodulation distortion and transient response. It is comparatively easy to design equipment which measures good. It is not at all easy to produce audio equipment which sounds good. The successful realization of this fact is largely responsible for the absence of "listener fatigue" in Pickering products.

Pickering High Fidelity Components — speaker, preamplifier, record compensator, pickup arm and pickup cartridges are available through leading jobbers and distributors everywhere . . . detailed literature will be sent upon request.

**Pickering
& Company, Inc.**

Oceanside, Long Island, N. Y.



NEW LOUDSPEAKER MODEL 180L

designed to satisfy the musical ear. A low-cost high quality loudspeaker with smooth wide-range response (within 5 db, 45 to 12000 cycles) and low distortion . . . the only loudspeaker with acoustically adjustable bass response . . . occupies less floor space than any other high quality loudspeaker — less than one square foot.

NEW PREAMPLIFIER MODEL 130H

This preamplifier represents the most advanced design ever achieved in phonograph preamplifiers . . . it equalizes the bass response of records and transcriptions and provides the necessary gain for high quality magnetic pickups . . . its intermodulation and harmonic distortion is exceptionally low — better than most professional equipment.

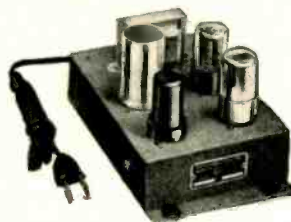

NEW RECORD COMPENSATOR MODEL 132E

This compensator, with 6 positions of equalization, provides the flexibility required to properly equalize for the different recording characteristics used by various record manufacturers . . . it is a most important addition to any record playing system using magnetic pickups.

NEW

PICKUP ARM — MODEL 190

The only arm specifically designed for optimum performance on both micro-groove and standard records.

- Statically balanced to eliminate tendency to skip when jarred.
- Minimum vertical mass to track any record without imposing extra vertical load on grooves.
- Sensitive tracking force adjustment.
- Magnetic arm rest.
- Rugged frictionless bearings.
- Plug-in cartridge holder.
- One-hole mounting — self-contained levelling screws.



Cartridges used with this arm require 50% less vertical tracking force than, when used in conventional arms.

PICKERING CARTRIDGES SERIES 120, 140 AND 150

For broadcasting, transcription and laboratory use, and for home playing. Series 120 and 150 for standard records . . . Series 140 for micro-groove records . . . the optimum in record response for discerning music lovers who want all of the realism and brilliance originally recorded. They track with phenomenally low record wear and virtually eliminate harmonic and intermodulation distortion as well as frequency discrimination . . . available with either sapphire or diamond stylus.

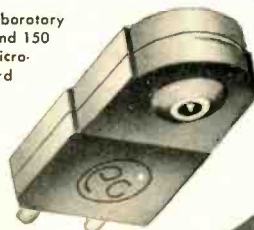

Floating Action!

for all TV Cameras

"BALANCED" TV TRIPOD

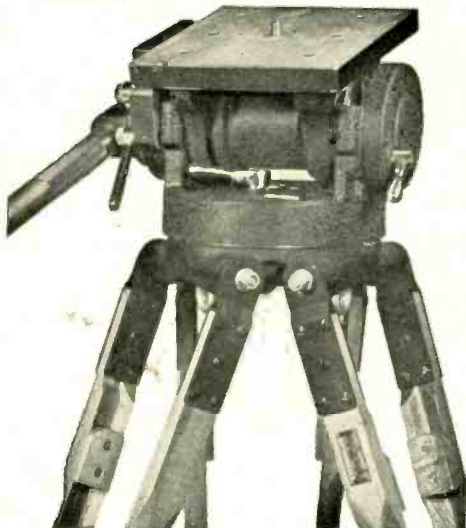

Pat. Pending

This tripod was engineered and designed expressly to meet all video camera requirements.

Previous concepts of gyro and friction type design have been discarded to achieve absolute balance, effortless operation, super-smooth tilt and pan action, dependability, ruggedness & efficiency.

Below:

3 wheel portable dolly with balanced TV Tripod mounted.

Complete 360° pan without ragged or jerky movement is accomplished with effortless control. It is impossible to get anything but perfectly smooth pan and tilt action with the "BALANCED" TV Tripod.

Quick-release pan handle adjustment locks into position desired by operator with no "play" between pan handle and tripod head. Tripod head mechanism is rustproof, completely enclosed, never requires adjustments, cleaning or lubrication. Built-in spirit level. Telescoping extension pan handle.

Write for further particulars

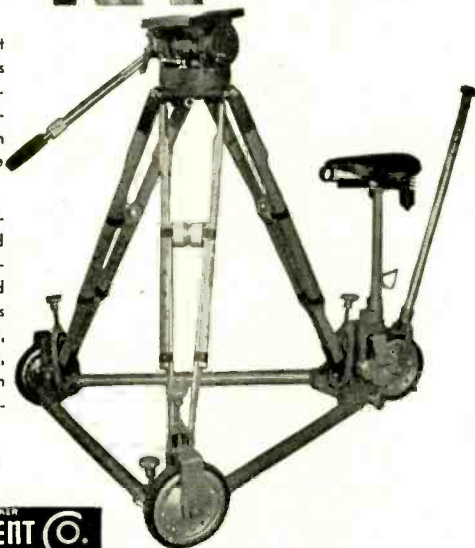

FRANK C. ZUCKER
CAMERA EQUIPMENT CO.
1600 BROADWAY NEW YORK CITY

NEED BACK ISSUES?

Only a few are available and the supply is limited

- August 1948
- September 1948
- November 1948
- December 1948

- March 1949
- May 1949
- June 1949
- August 1949

1948 issues

50c

1949 issues

35c

Payment should accompany order.

Circulation Dept., Audio Engineering, 342 Madison Ave., New York 17, N. Y.

netic pickup is flat over the constant-velocity portion of a recording, and droops at the rate of 6 db per octave over the constant-amplitude portion of the recording. Conversely, the voltage output from a crystal pickup is flat over the constant-amplitude portion of the recording, because the voltage generated by a crystal pickup is directly proportional to the displacement of the crystal, which is in turn actuated by the stylus.

There are a number of other factors which enter into the actual voltage output from a pickup, but these are functions of the mechanical characteristics of the device. The masses and compliances of the stylus and its supporting structure, of the pickup arm, and of any other moving elements, affect the output by introducing mechanical resonances which show up as peaks and dips in the frequency response of the pickup.

To clarify one point, however, it must be said that if a recording were made with a crystal cutter without any equalization, and played back with a crystal pickup, also without equalization, the output would be exactly like the input, provided both cutter and pickup were perfect. Similarly, if a recording were made with a magnetic cutter without equalization, and played back with a magnetic pickup—also without equalization—the output would again be exactly like the input, assuming that both pickup and cutter were perfect. However, pickups and cutters are not perfect, and in addition, the equalization previously referred to is normally applied, so some equalization must also be applied in the reproduction.

Equalization Required

Practically all commercial recordings are made with magnetic cutters, and consequently there is a certain amount of equalization introduced to limit the excursion of the stylus, during the recording, up to the turnover point. Thus the recording is constant amplitude up to this frequency, and essentially constant velocity above. Therefore, the reproduction by a crystal pickup is flat from the lowest frequency up to the turnover point without any equalization, and droops at the rate of 6 db per octave above that point. This demands that crystal pickups be equalized on the high end only, since it is a characteristic of these devices that they reproduce flat from a constant-amplitude signal. In order that they should actually be flat over the low end, the equivalent circuit of a crystal pickup as a generator must be investigated. The crystal may be considered as a constant-voltage generator in series with a capacitance equal to that of the pickup itself. This

capacitance is of the order of .0015 μ t, and therefore the load resistance must be chosen so that there is adequate transmission of the low frequencies. The circuit may be likened to that of the coupling capacitor between two amplifier stages, and it is remembered that the size of the capacitor affects the low-frequency response.

The capacitor and the grid leak or load resistor may be considered as a voltage divider, with the reactance of the capacitor acting as the top section and the load resistance as the lower, as shown in Fig. 3. At the frequency where the reactance of the capacitor equals the resistance of the load resistance, the response is down 3 db from the maximum. This accounts for the requirement that the load resistor for a crystal pickup shall be relatively high in value, usually at least 0.5 meg, and in many instances more than this. It also accounts for the statement that the low-frequency response may be controlled by the value of the load resistor.

To equalize the response above the turnover point, some arrangement similar to that of Fig. 3 (B) is generally

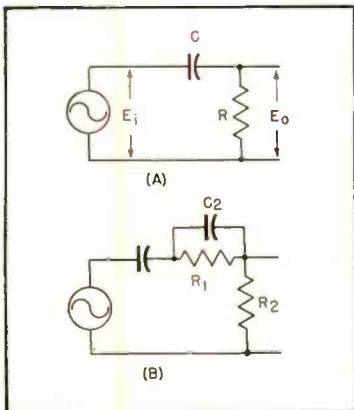
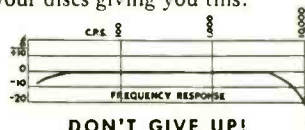

Fig. 3. Crystal pickup circuits. (A) is equivalent circuit when crystal pickup having capacitance C works into the load resistance R. (B) shows usual method of compensating for high-frequency droop.

employed. Assuming that the turnover frequency is 500 cps, the response at 1000 cps is down from the 500-cps level by 6 db; at 2000 cps it is down 12 db; at 4000 cps it is down 18 db; and at 8000 cps it is down 24 db. Thus if it is desired to equalize completely up to 8000 cps, it is necessary to introduce 24 db of loss to the low frequencies by means of a voltage divider R_1 and R_2 . This requires that $R_2/(R_1 + R_2)$ must equal 1/16, since this is the voltage ratio corresponding to a 24-db loss. Then, the low frequencies are reduced in level to the 8000-cps level, but this



When you've spent a lot of money for a Flat system but still find your discs giving you this:



DON'T GIVE UP!

Switch to Presto Discs

On Presto discs high frequencies stay up where they belong. They never roll off!



PARAMUS, NEW JERSEY

Mailing Address:

P. O. Box 500, Hackensack, N. J.

In Canada: Walter P. Downs, Ltd.,
Dominion Sq. Bldg., Montreal

World's Largest Manufacturer of Instantaneous Sound Recording Equipment and Discs

would also introduce a similar loss at 8000 cps, so this effect is counteracted by shunting a capacitor across R_1 with its reactance at the 3-db point being equivalent to the resistance R_1 .

Considering actual and typical values, let us assume that R_2 is taken as 0.1 meg; therefore, R_1 must be 0.1 meg. \times (16-1), or 1.5 megs. For the case under discussion, the curve is flat at 500 cps, and down 6 db at 1000 cps. By drawing this curve on a sheet of graph paper, it will be observed that the curve is down 3 db at approximately 700 cps. Thus it is determined that the reactance of the capacitor C_2 must equal 1.5 megs at a frequency of

700 cps. The actual value of the capacitance may then be calculated from the relation $C = 1/2\pi fX_c$, or it may be obtained from an inspection of a reactance chart (such as that on page 13). In this case, the required capacitance is approximately 130 $\mu\mu\text{f}$, and this value will give complete equalization for a crystal pickup at high frequencies up to 8000 cps, when used with these resistance values.

There is just one thing wrong with this equalization, however. Records are not normally cut with a flat frequency response all the way up from the turnover point. The NAB curve, for example, as well as the standard LP curve,

are both cut on the basis of a pre-emphasis of 100 μsec , of which more later. With this curve, then, the recorded signal is already boosted by approximately 14 db at 8000 cps, and the required equalization is thus reduced to only 10 db at this frequency, and the calculations must be revised.

This discussion should give a rough idea of how equalization is arranged for one type of pickup. Let it be said that if the response of any given pickup is known for a flat frequency record, it is fairly simple to determine exactly the equalization required to obtain flat response. It then becomes necessary to know the exact recording characteristic in order to make a good match. These characteristics differ appreciably, although there are a number of more or less definite curves in common use today.

Turning for a moment to the magnetic pickup, it will be remembered that the response for constant amplitude recording droops at the rate of 6 db per octave below the turnover point. This requires a boost of the low frequencies, in direct contrast to the crystal pickup, but for a flat recording above turnover, no high-frequency equalization is required. Actually this does not obtain in practice because of the pre-emphasis employed, and some high-frequency droop must be introduced intentionally.

Low-frequency equalization for magnetic pickups may be obtained in a variety of ways, all of them about equally effective, but differing appreciably in circuit design. The output signal from these pickups is usually quite low—ranging from 10 to 100 millivolts—and some amplification is required to boost the signal up to the level of radio tuner outputs, in order to facilitate switching. The common methods of equalization for magnetic pickups will be discussed in Part II of this series.

HARVEY presents

BELL TAPE RECORD-O-fone



Record from mike, external radio or phonograph on dual track tape. Speaker or headphone monitoring while recording. Output can be connected to amplifier or PA system. Records on 5" reels with lid closed, also takes 7" reels for up to 1 hour recording.

Model shown, with built-in radio \$126.34 net
Same, less radio 106.34 net
Shpg. Wt. 37 lbs.

RCA AUDIO CHANALYST



With the Audio Chanalyst you can test any complete sound system as well as the components. Four instruments in one, Audio Oscillator, Amplifier, Volt-Ohmmeter, Electronic Indicator. Sweep BFO ideal for speaker testing. Amplifier gain 110 db. Complete, with all leads, jumpers, etc., BRAND NEW, in original cartons. Regular Price \$345.00 — HARVEY SUPER SPECIAL, while they last, \$125.00.
Shpg. Wt. 50 lbs.

HR-15 AMPLIFIER KIT

The wondrous Williamson amplifier circuit ... now available for the first time with the Original PARTRIDGE transformer built to Williamson's specifications. Order this kit at once, build it in 3 hours or less and enjoy sound like you never heard before. The HR-15 is a 2-chassis power amplifier for use with tuners or other front ends having own volume and tone controls. All triodes, American tubes, 2-6SN7's, 2-807's in p.p. output, 5U4G rectifier. Frequency response \pm 5 db, 10-100,000 cycles. 5 db rise at 2 cycles, 2 db rise at 250,000 cycles. Harmonic distortion .025% at 10 watts at 400 cycles. Intermodulation distortion at 10 watts output less than $\frac{1}{2}\%$ using frequencies of 60 and 2000 cycles. Phase shift 20° , $\pm 10^\circ$, 20-20,000 cycles. Output impedances 1, 4, 9, 16, 25 ohms. Damping factor 50. Absolute gain 70.8 db. 20 db of feedback around 4 stages and the output transformer.

Kit is complete with tubes, punched chassis, prewired resistor board, sockets, genuine Partridge output transformer, and all necessary parts, \$84.50 net.

WESTERN ELECTRIC SPEAKERS

Here's another good buy from Harvey's. Genuine WE speakers at a new low price, all brand new in factory cartons.

12" — 728-B \$41.90
8" — 755-A 20.60

All in stock for immediate delivery.

NOTE: All prices are Net, F.O.B. N.Y.C. and are subject to change without notice.

Telephone: **7-HRC** LUXemburg 2-1500

HARVEY

RADIO COMPANY INC.

103 West 43rd St., New York 18, N. Y.

CATHODE FOLLOWER

[From page 15]

in 4 if an additional stage is included within the feedback loop.

If we add such a stage to the cathode follower (as in Fig. 5) we run into the same problem of ground reference for our input signal that we had with Fig. 3B and encounter rather serious power supply problems for this stage. If, however, we had a stage within the feedback loop for the conventional amplifier (as in Fig. 6) we would then have a solution to the problem which would provide the same improvement in

damping impedance and distortion achieved in the cathode follower, without requiring excessive signal voltage to drive. In other words, if we wish to design an amplifier with the advantages of the cathode follower, but which does not require excessive drive, we need

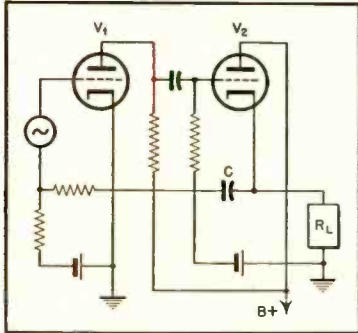

Fig. 5. Cathode follower with additional gain stage. Capacitor C may be omitted and direct coupling used in the feedback loop.

merely use a conventional amplifier with feedback from the plate and the same AB factor as the equivalent cathode follower. Additional overall feedback may of course be used from the voice coil, precisely as in a well designed amplifier using cathode followers.

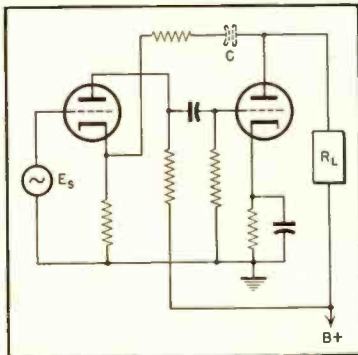

Fig. 6. Conventional feedback amplifier. If AB is equal to that of cathode follower, it will have the same impedance characteristics. Capacitor C may be necessary to maintain proper d.c. relationships.

We have shown, therefore, that a cathode follower is simply a feedback amplifier wherein AB is determined more or less automatically without any effort at design, but that other configurations can give identical results without the attendant disadvantages. The circuit of Fig. 6, familiar as it is, will provide more generally satisfactory results than the cathode follower, if subjected to the same feedback criteria.

PROBLEM:

How To Meet Varying Recording Channel Needs

SOLUTION:

Select from 14 Basic Units of the FAIRCHILD Unitized Audio System



You can assemble numerous combinations of complete recording channels with the Fairchild Unitized Amplifier System, which includes 14 basic units.

Related units are simply plugged in, or cabled together. It's that easy . . . that quick. Units can be combined to meet the special requirements of a given installation. If requirements change later, the units can be rearranged and the system expanded with no loss of initial investment. With this versatile Fairchild System, you get custom construction at production prices.

Consult us about your specific needs.

Write for series of helpful articles, "Design of Recording Systems and Actual Installations." Ask for Series M.

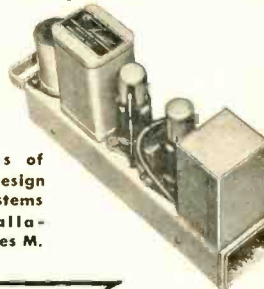

14 BASIC UNITS

- Power Amplifier
- Preamplifier
- Pickup Preamplifier-Equalizer
- Line Amplifier
- Output Switch Panel
- Input Switch Panel
- NAB Equalizer
- Variable Equalizer
- Diameter Equalizer
- Mixer Panel
- VU Meter Panel
- Bridging Device
- Auxiliary Power Supply
- Cuing Amplifier

 **Fairchild**

RECORDING EQUIPMENT CORPORATION

154TH ST. AND 7TH AVE.

WHITESTONE, L. I., N. Y.

Another big step forward

**the new Maurer 16-mm
MULTIPLE SOUND TRACK**

The average 16-mm sound projector introduces an appreciable amount of distortion into the playback of the usual bilateral variable area sound track.

Recent surveys have indicated that the amount of distortion so introduced by nonuniform illumination of the scanning light beam ranges up to 30 per cent. A maximum of 10 per cent is generally considered allowable in 35-mm reproduction.

The new Maurer multiple track, by replacing the usual single track with six, reduces the amount of this projector-introduced distortion to values of about 5 per cent—which is very good performance.

No changes in processing or in projection equipment are involved. The only change is in the recording galvanometer.

The very substantial improvement is quickly evident to the untrained listener as well as to the engineer.

Write for more complete information.



The new Maurer Recording System, incorporating the six-track galvanometer, will be commercially available early next year.

In line with the Maurer policy of protecting its customers against obsolescence

as far as is possible, all owners of the Maurer Model E System will be invited to convert their equipment to the new six-track recording, at a cost which will not exceed the difference between the initial costs of the two systems.

**16mm
maurer**

J. A. MAURER, INC.

37-03 31st Street, Long Island City 1, N. Y.

16-mm Professional Production Equipment

BELOW 50 CYCLES

[from page 18]

It is this mechanically stimulated feedback which finally limits the amount of low frequency amplification. The loudspeaker described utilizes a high value of resistance and acoustical capacitance to stiffen the vibrating cone. The load resistor shunting the speakers together with the crossover dip reduces the tendency toward feedback. Notwithstanding these measures, the full gain of the bass amplifier could never be turned up unless the speaker were located in some other building. At times during these investigations, footsteps on a thick rug caused a "thump" in the speaker. When the gain is turned just below feedback, almost any action in the room will result in a "bloop." However, for all rational and most irrational enjoyment of bass program material, the amount of gain required will be far below feedback.

On Speakers Generally

There is probably more misinformation the subject of loudspeakers than in any other branch of the communication art. In spite of manufacturers' ratings, few 12- and 15-inch cone speakers can reproduce 50-cps within 10 db of their output at 100-cps. Manufacturers' specifications for low-frequency cut-off probably means that their product will respond to this frequency within 10 of 20 db of the piston range level. Furthermore, the prevalent notion that one merely has to utilize a larger cabinet or baffle to increase lows is not strictly true. Beyond a certain volume there is insignificant improvement, as can be attested by the disappointment of those who have mounted speakers in the door of closets or even in the wall between rooms. In order to reduce the resonant frequency by one octave, the total stiffness must be reduced by a factor of four. The formula for resonant frequency shows that this varies inversely as the square root of all stiffness factors, the stiffness contributed by the cabinet enclosure being only one of many factors. The mechanical stiffness built into the cone rim and spider which operate below resonance is the largest factor, and over this the constructor has little control. The natural resonant frequency of a typical 12-inch cone, rated to handle 10 watts of audio, is between 70- and 80-cps as measured in a flat baffle of practically infinite size.

Speakers can be designed for 50-cps

HERE'S HOW TO *Save* ON Special Selector Switches!

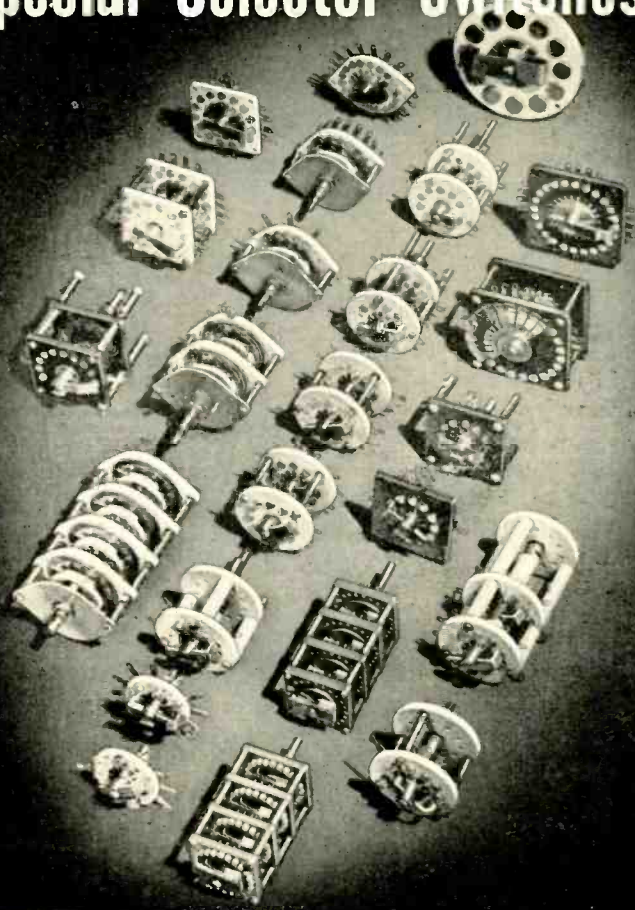

Shallcross

Shallcross can supply exactly the right precision-made selector switch for your application—at lower cost than you might expect for a "tailored" job.

Hundreds of Shallcross selector switch types permit inexpensive adaptations for specific needs. And back of these are many years of precision switch "know how" that have enabled Shallcross engineers to meet unusual and exacting requirements in hundreds of widely diverse applications.

SHALLCROSS MFG. CO.

Dept. A-129

Collingdale, Pa.

RESISTORS • INSTRUMENTS • SWITCHES • ATTENUATORS

BRITAIN'S BEST AUDIO AMPLIFIER

LEAK "POINT ONE"
DISTORTION: 0.1%

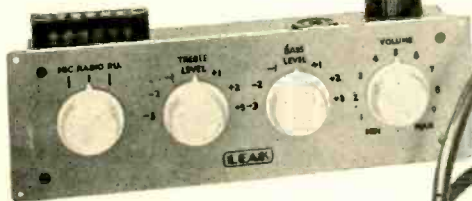

REMOTE CONTROL PRE-AMPLIFIER RC/PA

An original feedback tone-control circuit. No resonant circuits employed.

- Distortion: less than 0.05%.
- Switching for Pick-up, Microphone and Radio, with automatic alteration of tone-control characteristics.
- High sensitivities. Will operate from any moving-coil, moving iron or crystal P.-U.; from any moving coil microphone; from any radio unit.
- Controls: Input Selector; Bass Gain and Loss; Treble Gain and Loss; Volume. Output Impedance: 0-30,000 ω at 20 kc.p.s.

The unit will mount on motor-board through a cutout of 10 $\frac{1}{2}$ in. x 3 $\frac{1}{2}$ in., or it can be bolted to the power amplifier, when, with a top cover, the whole assembly becomes portable. For use only with LEAK amplifiers.



TL/12 12W. TRIPLE LOOP POWER AMPLIFIER

A Leak triple loop feedback circuit, the main loop giving 26 db feedback over 3 stages and the output transformer.

- Push-pull triode output stage. 400 V. on anodes.
- No. H.V. electrolytic smoothing or decoupling condensers.
- Impregnated transformers; tropically finished components.
- H.V. and L.V. supplies for pre-amp. and radio units.
- Distortion: at 1,000 c/s and 10 W. output, 0.1%; at 60 c/s and 10 W. output, 0.19%; at 40 c/s and 10 W. output 0.21%.
- Hum and Noise: -72 to -80db on 10 W.
- Frequency response: ± 0.1 db, 20 c/s-20 kc/s.
- Sensitivity: 160 mV.
- Damping Factor: 20. Input impedance: 1 Meg. Output impedances: 2 ω ; 7-9 ω ; 15-20 ω ; 28-36 ω . Phase margin 20° $\pm 10^\circ$. Gain margin 10 db + 6 db.
- 25 W. model available.

This is the famous Leak Amplifier successfully demonstrated at the recent Audio Show in New York. Available through your local supplier. Write for your copy of the 16 Page Brochure.

Address all inquiries to U. S. Agents:

BRITISH INDUSTRIES CORP.
164 DUANE STREET - NEW YORK 7, N. Y.

Standard U. S. tubes used

The Perfect Christmas Gift



All surveys prove that AUDIO ENGINEERING is preferred over all other technical magazines read by the best informed in the audio field, the broadcast, sound and reproducing engineers. Each issue brings you outstanding articles on five or more of the following subjects:

- Broadcasting
- Sound on Film
- Public Address
- Industrial sound equipment and applications
- Recording
- Phono Reproduction
- Acoustic treatment of studios, rooms, auditoriums, etc.

In addition . . .

each month, AUDIO ENGINEERING, presents latest improvements in sound reproducing equipment design, test methods, and technical news from here and abroad. The Editorial Staff includes top authorities in the sound field.

AUDIO ENGINEERING, the one and only publication devoted exclusively to the SOUND FIELD, has, since its inception in 1947, been acclaimed by its thousands of readers as well as the entire Audio Industry for its constantly superior editorial content. The standard of excellence set for feature articles and all departments will be more than maintained for 1950.

Use the handy Christmas reply envelope 

AUDIO ENGINEERING

342 MADISON AVENUE
NEW YORK 17, N. Y.

on a flat response basis, but this usually means a severe sacrifice in power handling ability and the use of an extremely large magnet. The compliant rim of the cone must be made thinner or more flexible in order to reduce the mechanical stiffness. Hence, the power handling ability and the life of the cone are reduced. Further, it must be capable of movement to extreme amplitudes under linear force, and the voice coil must remain in a uniform high-density flux field. Speakers of 12- and 15-inch diameter, as popularly made, have a voice coil length (winding length) of approximately .300 inches. To maintain such a voice coil within a field of uniform magnetic flux means that (for 10 watts excitation and 5 per cent efficiency) the axial gap length in the magnetic circuit must be about .600 inches at 50 cps. For a given flux density, the weight of the magnet will be proportional to the square of the increase in gap volume. This results in a magnet so costly as to place it outside the competitive field, a disastrous prospect for most manufacturers. It is widely considered in the speaker industry that high flux density in a long axial gap is so costly as to be hardly justified by what is thought to be only a slight increase in musical value. One of the most reputable 15-inch woofers on the market today—one selling for over \$100.00—has an axial gap length of only .400 in. Probably also the problem of designing a suspension system that has uniform high compliance over a .600 in. total displacement is rather formidable and discouraging, to say nothing of the need for adequate restoring force.

To the author, the logical solution was the use of a stiffness-controlled speaker system, driven by brute force to overcome the low-frequency deficiency of conventional cone speakers. By using four speakers, the input power is divided, and each speaker operates at reduced amplitudes, holding distortion to a minimum. The effective piston diameter is increased over that of a single cone, thus maintaining radiation resistance to a lower frequency and hence improving the efficiency.

In selecting speakers, it is not necessary that they be so-called woofers, assuming such can truly be found. It is only required that they have high conversion efficiency. The magnets in efficient cone speakers should weigh at least 16 ounces if Alnico V, or about 4 pounds if Alnico I or II. Actually, the grade of Alnico or other magnet material is unimportant so long as a flux density in excess of 10,000 gauss is realized in the gap. Voice coil diameter should preferably be at least two

FOR GREATEST

Flexibility

IN PROFESSIONAL TAPE RECORDING

**Get Magnecord
UNIT
CONSTRUCTION
FM STUDIO QUALITY
PLUS PORTABILITY
AND ECONOMY**

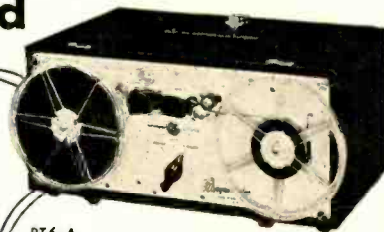

PT6-A

Recorder Mechanism

is the heart of Magnecord combinations for studio and remote recording. Weighs 26 lbs. in carrying case, easily removable for rack mount. Quick-change capstans for recording at 7½ or 15 inches/sec. High speed rewind. Frequency response 40 to 15,000 cps ± 2 db. **\$278**



PT6-JA Recorder & Amplifier

provides complete portable facilities for professional quality reproduction at a new low price. Includes PT6-A Recorder plus amplifier containing low impedance mike input with gain control, high level input, monitor speaker and 10 watt audio amplifier with jack for external speaker, zero level output terminal, VU type meter. **\$499.50**



PT6-P Portable Amplifier is a light weight record-playback-remote amplifier plus power supply designed for use with PT6-A Recorder. 3 low level independently mixed mike inputs plus bridging input for use with a line level input. Monitor amplifier and small speaker in power supply section. **\$462**

PT6-R Rack-Mount Amplifier

is a high fidelity, single channel amplifier for use with existing audio amplifiers and PT6-A Recorder. Uses only 14 inches of rack space. Recorder can be removed from carrying case and fastened to flush mounting in seconds. (Recorder not included). **\$383**

Write for complete specifications and name of nearest dealer.

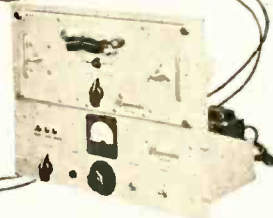

Magnecord, INC., CHICAGO 1, ILL.
360 NORTH MICHIGAN AVENUE

World's Largest and Oldest Manufacturers of Professional Magnetic Recorders.

NEW! THE CB AUTOMATIC AUDIO SWEEP GENERATOR

25 CYCLES TO 32,000 CYCLES IN ONE CONTINUOUS RANGE—WAVE FORM DISTORTION .005 (1/2%) OR LESS
—MANUAL OR AUTOMATIC OPERATION

Automatic Range adjustable from a minimum spread of 500 cycles to a maximum spread of 10,000 cycles. Sweep calibration is LINEAR and is adjustable from 2 to 10 sweeps per second.



CB MODEL 282A

The new CB Model 282A is built to highest precision instrument standards and has a wide application range.

For complete construction details and performance data, write for Bulletin 14A.



The CLOUGH BRENGLE CO.

6012 Broadway

Chicago 40, Ill.

GRAY TRANSCRIPTION ARMS and EQUALIZERS

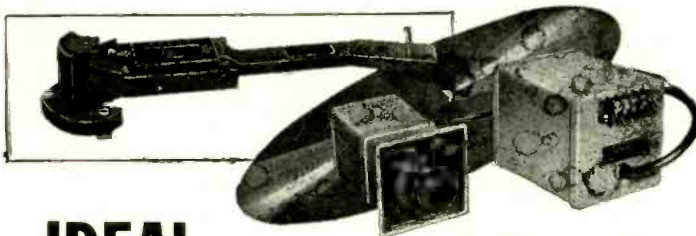

IDEAL for the New LP Records

The GRAY TRANSCRIPTION ARM 103-LP, with Selected GE Variable Reductance Cartridge with 1 mil Diamond Stylus, has been especially designed for use with the new LP Micro-Groove Records. Due to such features as adjustable stylus pressure, frictionless motion, self-leveling base and the accomodation of any standard cartridge, arm obsolescence is precluded.

The GRAY #602 4-position EQUALIZER for GE Cartridge, finest performance and workmanship, ideal response curves. Adopted by radio networks. Matches pickup to microphone channel.

Inquiries invited for development and manufacturing.

GRAY RESEARCH and Development Co., Inc.
16 Arbor St., Hartford 1, Conn.



inches. Large diameter voice coils exert a more uniform driving force to all surfaces of the cone, and besides handling more input power, may possess less distortion at high amplitudes. An attempt was made to select speakers having slightly different resonant frequencies to avoid an accentuated peak. Peaks and dips, inherent in all speakers, occur at slightly different frequencies in each speaker. When such speakers are combined in a group, the final output will be characterized by smoother response, the dips virtually disappearing.

Book Review

Acoustic Measurements by Leo L. Beranek, S.D., D.Sc. (Hon.) Associate Professor of Communication Engineering and Technical Director of the Acoustics Laboratory, Massachusetts Institute of Technology. John Wiley & Sons, Inc., New York, \$7.00.

Specific details on measurements in the field of acoustics have seldom been published outside of technical journals and mathematical treatises. This book, therefore, fills a much needed place in the literature of the science of acoustics. It is, as the author states in his preface, "primarily . . . a reference for graduate students and workers in the field of acoustics."

The first two chapters deal with the history and terminology of acoustics and mediums for the transmission of sound, with special attention being given to air and water. In the discussion of the medium are found the wave equation, diffraction, scattering, and non-linearity of the medium. Chapter Three details, both in theory and practice, the disturbance of plane sound waves by obstacles and by finite baffles. Included are analyses of the human body in a sound field and the behavior of loudspeaker baffles. In only sixty-six pages of the fourth chapter appears the most complete discussion of the absolute calibration of microphones ever presented. The most popular method used today, the reciprocity technique, is analyzed in terms of its electrical analogy and is then developed for the acoustical case.

The next eight chapters cover individual acoustical elements; among them are microphones and the ear, measurement of frequency, measurement of acoustic impedance, the audiometer, sound sources for test purposes, characteristics of random noise, indicating and integrating instruments for the measurement of complex waves, and analysis of complex waves.

The last eight chapters describe completely the methods of testing communication systems from the microphone through acoustical enclosures, concluding with sound level meters.

While Dr. Beranek has reduced much of the mathematical complexity usually associated with works on acoustics to a reasonable series of lucid expositions, he still uses calculus at the level of engineering graduate students. Nevertheless, this book should find a place in the library of all laboratory and research workers.

50-WATT AMPLIFIER

[from page 11]

the application of the d.c. plate supply between these coils.

Figure 6 (A) illustrates a further step in the development of the final circuit and shows a cathode-loaded arrangement with a required plate supply isolation reactance. Here it will be seen that the cathode loading results from the method of drive. For instance, tube 1 is driven from the control grid to the far side of its load which is, from an a.c. standpoint, at the same potential as its plate, and similarly tube 2 is driven in a like symmetrical manner. In order to drive the stage, it is necessary to do two things: to provide an input transformer or similar device and to provide an isolation reactor which has sufficient impedance to keep the plate supply and the amplifier stage isolated from an a.c. standpoint. It will be seen here that the entire stage is floating with respect to ground. At points A and B in Fig. 6(A) it will be noted that the full voltage developed across the output stage appears to add to the difficult problem of designing a driver transformer able to handle the large voltages needed to drive the output stage. These difficulties—as well as the requirement for wide frequency range, balanced coupling, and high impedance primary—make this transformer somewhat impractical if not impossible.

Deleting the isolation reactors from the circuit of Fig. 6(A) gives the circuit of 6(B) in which the two cathodes remain at the signal potential difference of the output transformer primary, but one cathode has been returned to ground while the other is left floating. Again the design of an input transformer is highly impractical.

An attempt, therefore, was made to get away from the four-terminal input circuit required by Fig. 6(B) and go back to the conventional three-terminal input if at all possible. This was accomplished by the circuit as illustrated in Fig. 7, which is similar to those of Fig. 6 except that instead of driving the stage fully cathode loaded, the point A of Fig. 6(A) was connected to the mid-point of the cathode winding which, of course, suggested that point B be connected to that same cathode mid-point. We now, therefore, have our three-terminal conventional drive circuit, and furthermore we find that this mid-point can be grounded, which immediately suggests that the plate supply can be similarly attached to the mid-point on the plate winding of the output transformer, and finally this elimi-

SOUND BUYS FROM BECK'S

San Francisco's Audio Specialists

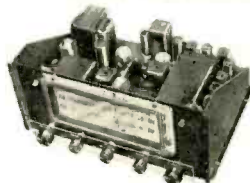

Left: AF-FM TUNER, Sargent-Rayment. Bandpass r-f input and one stage of i-f at 455 kc, terminated in tuned infinite-impedance detector, for standard broadcast. Tuned r-f stage, stable drift-free triode oscillator, two stages of permeability-tuned i-f at 10.7 mc, and fully-balanced static-free ratio detector for superior f-m performance. Input jacks for phono pickups—crystal or variable reluctance—and for tv. Smooth electro-acoustical control of bass and treble emphasis permits presetting amplifier controls . . . \$124.50 net

Right: 15-WATT 6L6 AMPLIFIER, Sargent-Rayment. Flat from 20 to 20,000 cps ± 2 db with 1.5 per cent distortion at rated output. Reflected load impedance of 3 ohms on 16-ohm tap . . . \$49.50 net

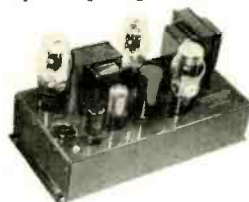

Left: SUPER-FIDELITY AMPLIFIERS, McIntosh. 40 to 100 db gain; universal input and output; plug-in components. 15-watt unit flat from 20 to 75,000 cps; harmonic distortion less than 0.5 per cent; efficiency 50 per cent; two 6V6's in take-turn circuit . . . \$199.50 net
50-watt unit flat from 20 to 40,000 cps; harmonic distortion less than 0.5 per cent, efficiency 60 per cent; two 6L6's in take-turn circuit. \$299.50 net

25% cash with COD orders—2% discount for cash with order

YOUR AUDIO NEEDS

are filled at Beck's with complete lines of sound equipment either by nationwide mail-order; from the Beck Soundmobile traveling the Pacific Coast; or direct from San Francisco Headquarters for sound. Beck's, at 90 Ninth St., has a well-equipped listening and demonstration studio.

BECK'S CARRIES THESE AND MANY OTHER LINES:

Magnecord	Newcomb	Meissner
V-M Corp.	Altec-Lansing	Browning
Webster Ekkotape	Stephens	Rek-o-cut
Webster-Chicago	Jim Lansing	Pickering
Brook	University	Lear
Thordarson	Racon	Electro-voice
Bell	Peerless	Cannon

R. M. BECK Co.

Everything in Sound

90 Ninth Street • San Francisco 3, California
Market 1-3330 Underhill 1-2025

when you use
the **Audax**
POLYPHASE...
ONE single unit
plays **ALL**
your records
SUPERBLY...
and at less
than the cost
of ordinary
magnetic pick-ups



Microgroove,
78 r.p.m., etc.

Only \$11.70
net cost to you—
believe it or not!

*"The Standard by which Others
Are Judged and Valued"*

Enjoyment of today's discs demands a single pick-up unit that yields such quality performance as you'd expect from two or more high grade magnetic units, each made expressly for a given type of recording.

Not only does Audax POLYPHASE accomplish just this -- exciting admiration when you hear it, and performing vital functions that no other pick-up does -- but it refutes the traditional idea that because Audax is so GOOD it costs more.

Wide range performance with ANY type disc; genuine sapphire or diamond, individually replaceable by YOU; needle radiation very low; ear quality *par excellence!*

Radio Stations—We have just the right POLYPHASE model for you, too.

See it at your local dealer — —

Write for Editorial
Reprint on
POLYPHASE Principles

AUDAK COMPANY

500 5th Ave., Dept. 44 New York 18
Fine Electro-Acoustical Units since 1915

notes the need for the isolation reactors. Concentrating first on the output transformer primary and taking for instance the a.c. current path from the

one cathode winding on opposite halves of these coils. Considering the upper tube, we find a similar situation. It is seen that half of the output winding

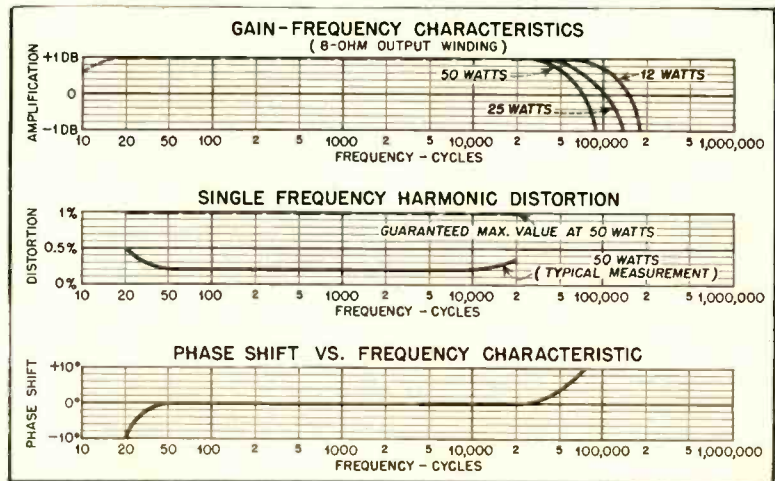

Fig. 10. Performance characteristics of 50W-1 amplifier.

plate supply at + upwards through the winding and to the plate of the lower tube, thence from its cathode through its winding to the center point and therefore back to the power supply, we have utilized one plate winding and

is in the cathode circuit and half is in the plate circuit for each tube, but since the two windings are coupled tightly from an a.c. standpoint, they become practically identical, and therefore we have an output stage which utilizes

PROCTOR SOUNDEX

"FLOATING DISC DRIVE"

PLAYBACK UNIT

ANY
RECORD - SPEED
CARTRIDGE - PRESSURE
INSTANTLY

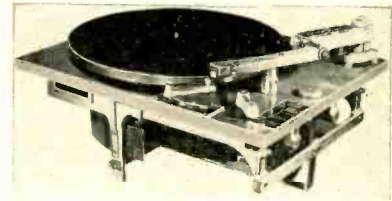

New Soundex Pickup Arm

- Uses interchangeable Cartridge Carriers
- Permits instant substitution of cartridges
- Adapts any regular standard or micro-groove
- Self-contained stylus pressure Scale
- Precise adjustment of pressure in grams

Mounting radius — 13"

Scale — 0 to 25 grams, Zero set indicator, Self Leveling Base

Floating Disc Drive Multi-Speed Turntable

- Instantly shifts to 33 1/3 - 45 - 78 r.p.m.
 - Obsoletes rim, gear, belt drives
 - Eliminates wow, flutter, speed variations
 - Uses faster starting light-weight components
 - 12" or 16" turntable is optional, same price
- Dimensions: 17" x 21" x 7 3/4" deep,
12" or 16" turntable, 25 lbs.

Write for Bulletin



133 NORTH SIXTH AVENUE MOUNT VERNON, N. Y.

essentially the same primary windings. Since this is so, it is obvious that there can be no leakage reactance between the output coils for the two tubes. In addition to the compatibility now possible between high efficiency and high quality, there are several other advantages of this circuit arrangement which are described.

Circuit Advantages

It is convenient with this circuit to use either pentodes or triodes. *Figure 7* shows the screen grid connected in a suitable manner to make use of the inherent efficiency in power conversion of pentodes or beam power tubes. The requirement that the screen be kept at a constant d.c. potential with respect to the cathode is fully met by virtue of the fact that the two windings are coupled so tightly that no a.c. potential can develop between the cathode of either tube and its corresponding screen. It is obvious also that a constant d.c. potential equal to the plate voltage, in this case, is provided for the screen. *Figure 8* illustrates a simplified equivalent circuit of *Fig. 7* that may clarify the use of the 'take turn' primary idea.

Referring back to *Fig. 7*, some of the additional advantages of these circuits will be described. The impedance between the tubes is now 1000 ohms instead of 4000 ohms shown for the conventional circuit in *Fig. 1*. The impedance between either side and ground is only 250 ohms instead of 1000 ohms. This 4-to-1 impedance reduction between the tubes reduces the effects of stray capacitances by a factor of 4, permits a wide extension of the audio pass band, and reduces the phase shift of the fundamental and the harmonics. Furthermore, since the two primary windings now look like one winding to the secondary, the effective turns ratio has been reduced by a factor of 2 to 1 between primary and secondary. This results in a 4-to-1 coupling advantage over the circuit shown in *Fig. 1*. Since both the shunting capacitance impedance advantage of 4 and the coupling advantage of 4 occur simultaneously, there is inherently a 16-to-1 advantage in this circuit over the conventional circuit. This advantage obtains regardless of the class of operation of the tubes. Therefore, not only has the barrier been crossed to permit the use of high efficiency at low distortion, but at the same time a substantial improvement in circuit characteristics has been found.

Figure 7 also shows that some direct-coupled negative voltage feedback is used. It will be seen that since half of the load is in the cathode and half of the load is in the plate, as before mentioned, almost the entire gain in this

final stage is lost by virtue of the feedback resulting from this method of loading. Additional feedback is achieved by connecting suitable resistors between the cathodes of the output tubes and the cathodes of the phase inverter stage. This combination of feedback results in improving the linearity of the amplifier and permits the manufacture of amplifiers on a regular production basis which can be guaranteed to have less than 1 per cent distortion over a wide range of frequencies.

This feedback also reduces the internal generator impedance to a value approximately one-tenth of the referred

load impedance. This means that the output circuit, say the 8-ohm winding, looking back into the amplifier would be 8/10th of an ohm. This low generator impedance provides two desirable characteristics.

Low Output Impedance

It is obvious that if the impedance of the load device—such as a speaker—should change, as it usually does over the range of frequencies for which it is used, then the effective amplification will likewise change, resulting in a limitation of the power output or serious distortion, or both. Therefore, it is important in the design of an

Save Time and Effort

New methods and unusual techniques simplify measurement of elusive circuit quantities.

THE BRIDGER

MODEL 100: For bridging measuring instruments across any part of a high-impedance electronic circuit through shielded cable without appreciable effect on circuit performance. Cable capacitance almost completely balanced out by use of improved cathode follower and special double-shielded cable. Input impedance is 100 megohms in parallel with 6 mmf at end of 3-foot shielded cable. Output impedance—200 ohms. Output/input voltage ratio = 0.98.

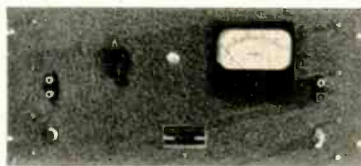

MODEL 121 LOGGER

Logarithmic voltmeter with 50 db linear meter scale; output may be used to feed direct writing recorder (via a suitable amplifier) for acoustical reverberation tests. Input impedance—50,000 ohms; output impedance—1000 ohms.



MODEL 140 DISC-NOISE METER

Overload-proof amplifier voltmeter for quality control of lacquers, phonograph records, transcriptions. New stable logarithmic element. 20-db linear meter scale. Minimum reading 75 db below 7 cm/sec. velocity with pickup cartridge supplied.



Miniature Preamplifiers for use with 640AA Condenser Microphone

MODEL 12: High gain, operates VTVM directly at normal room sound levels. Output: —40 dbm for 1 dyne/cm. Output Z: 250 ohms, balanced. Size: 10" long x 1 1/4" diameter. Low power drain. Available with insert calibrating resistor on special order.

MODEL 14: Medium gain for general broadcast and recording use, also to operate VTVM directly at sound pressures used in receiver testing. Output: —55 dbm for 1 dyne/cm. Output Z: 250 ohms, balanced. Size: 6 1/2" long x 1 1/4" diameter. Low power drain. Available with insert calibrating resistor on special order.

Both models also available with nose piece dimensions modified to fit Kellogg Miniature Condenser Microphone.

Write for further information and prices. Our complete catalog of audio instruments is now ready.

AUDIO INSTRUMENT COMPANY

1947 Broadway

New York 23, N. Y.

Peerless Indeed

The makers of the superb new "20-20" Peerless audio transformer line, a division of the Altec Lansing Corp., do not merely CLAIM the vast superiority of these units over other makes—they clearly DEMONSTRATE this superiority in square-wave tests. At the I.R.E. convention, at the recent Audio Fair and at many other shows throughout the country these units have been put to the square-wave test and have convinced audio engineers that here, for the first time ever, a standard make transformer is available with the frequency and power response characteristics formerly to be had only in custom jobs.

And the best way to buy these Peerless transformers is from Sun Radio—just appointed exclusive distributor for the greater New York area. Our stocks are ample, delivery is quick.



Get Your Free Copy

of Sun Radio's "1950 Audio Equipment" containing a brief discussion of high-fidelity home music systems by Irving Greene, Manager of our Audio Engineering dept., and member of the A.E.S., plus a listing of some choice items from our great high-fidelity line. This 68 page booklet was also a sensation at the Audio Fair. Write today.



amplifier that is to be used anywhere but on a test bench and working into a resistance load, that it should be made as free as possible of the effects of load impedance in order that the design performance of the amplifier can be realized in actual practice. The 50W-1 amplifier for all practical purposes isolates the effect of the load on the effective amplification of the output stage because of this low value of generator impedance. Furthermore, the tendency of the load device to continue motion after the initiating signals have ceased is effectively damped. This means that any back e.m.f. generated by the load device sees such a low resistance looking back to the amplifier that the counter e.m.f. resulting from this low resistance dynamically brakes the load device and quickly damps out any free oscillation. Theoretically there is no minimum limit to which this internal generator impedance can go to act as a benefit in both of the principles above mentioned. However, going from the damping factor of ten to zero for the use in audio devices produces only a minute improvement in damping since the load devices do not approach 100 per cent efficiency. For some applications the internal generator impedance has been made 1/100th of the nominal impedance.

One of the apparently conventional features of the amplifier is the driver transformer for the output stage. Since the direct current drawn from the power supply by the Class B stage is proportional to the input signal level, and since the power supply internal resistance can not economically be made to approach zero ohms, there will be a change in plate voltage with a change in input level. At best, change in level of a single-frequency signal from zero to full output, the change in plate voltage cannot be made less than 25 volts. If the driver plate voltage were to be derived from this varying source and the driver were resistance-capacitance coupled to the control grids of the Class B amplifier tubes, the change in plate voltage would appear as a change in bias adding to the bias for an increasing signal and subtracting from it for a decreasing signal. A 15- to 30-volt increase in bias voltage would shift both output tubes toward Class C operation and consequent current cutoff during both crossover periods for a length of time depending on the duration of the change in level and the time constant of the resistance-capacitance coupling circuit. The increase in bias signal level change will appear as transient distortion. To avoid this source of distortion either separate power supplies or transformer coupling is required be-

Stop listening to DISTORTED MUSIC

The connoisseur of music listening wants to recognize the clear brilliance of symphonic sound and

BROOK

All Triode High Quality AUDIO AMPLIFIER

Gives It To Him

(Also Model 10C-30 watts)
Also available Model 12A-10 watts

with

- Distortion and intermodulation at a new low.
- Reduction of listening fatigue.
- Brilliant, clear tone.
- Separate controls—stepped-for Bass and Treble.
- Extremely low volume without any loss of quality.

Write TODAY for FREE Technical Bulletin
and Detailed Distortion Analysis

BROOK ELECTRONICS, Inc.
Sales Agent
Dept. AL-9, 34 De Hart Place, Elizabeth, N.J.

Ready NOW ULTRASONIC FUNDAMENTALS

By S. YOUNG WHITE

The rapid increase in the use of ultrasonics during the last few years makes it natural that the well-informed sound engineer should want to learn something of the applications and potentialities of this amazing new field. But interest in ultrasonics is not confined to the sound engineer—it is of still greater importance to the industrial engineer for he is the one who will visualize its uses in his own process.

Elementary in character, ULTRASONIC FUNDAMENTALS was written originally as a series of magazine articles just for the purpose of acquainting the novice in this field with the enormous possibilities of a new tool for industry. It serves the double purpose of introducing ultrasonics to both sound and industrial engineers. The list of chapter headings will indicate how it can help you.

CHAPTER HEADLINES

Too Much Audio, Opportunities in Ultrasonics, Elements of Ultrasonics, Experimental Ultrasonics, Coupling Ultrasonic Energy to a Load, Ultrasonics in Liquids, Ultrasonics in Solids, Testing by Ultrasonics, High-Power Ultrasonics, Notes on Using High-Power Ultrasonics, Applications of Ultrasonics to Biology, Economics of Industrial Ultrasonics.

The applications of ultrasonics have already extended to many industries, and as its possibilities are explored they will increase a hundredfold. To keep abreast of its growth, engineers in all fields must know what they may expect from ultrasonics, how it is used, how the energy is generated, and the techniques of applying ultrasonic treatment to many processes.

ULTRASONIC FUNDAMENTALS is not a big book—it does not cover the entire field of ultrasonics with hundreds of pages of dull reading. But in the three hours it will take you to read it, you will get a down-to-earth glimpse into the far-reaching possibilities of a new art.

ULTRASONIC FUNDAMENTALS

By S. YOUNG WHITE
36 pages, 40 illustrations, 8 1/2 x 11,
paper cover. **\$1.75**

Book Division, Dept. A
RADIO MAGAZINES, INC.
342 Madison Avenue
New York 17, N. Y.

tween the driver and the output stage. The design of a high-impedance push-pull transformer along conventional lines is another impractical problem. To keep waveform distortion and current consumption low in the driver stage, the primary impedance of the driver transformer must be kept above 100,000 ohms from 20 cycles to 30,000 cycles. The response of the transformer from primary to secondary should not show more than a 0.1 db variation from 18 cps to 30 kes in order to function within a second feedback path in the amplifier. All of these requirements were met by resorting again to the bifilar construction where the input windings are wound together, giving practically 100 per cent coupling independent of frequency.

Figure 9 shows the schematic diagram illustrating the 50W-1 watt amplifier including the phase inverter, volume control and preamplifier. It will be seen from this circuit that the driver output stages are similar to those diagrammed in Fig. 7. The output transformer provides for 4, 8, 16, and 32 ohms balanced or unbalanced, as well as 600 ohms balanced. It will be noted that the 600-ohm tap is taken off the primary winding connected to the cathodes of the output stage, and since this winding is grounded at its midpoint, neither of these taps (7 and 8) can be grounded. If required, a 600-ohm winding can be supplied separate from any of the other windings of this transformer.

The amplifier is designed in a manner similar to that described for the power supply, namely, that the driver coil and output coil are potted in the box forming the unit, that the top includes a number of sockets which are intertwined to provide the proper circuitry and the other elements plug into these sockets to provide the proper amplifier arrangement. This permits easy "substitution method" servicing, fixes the relative position of components, providing for better uniformity in manufacture and permits unusual arrangement features. For instance, the input level to the amplifier is approximately zero db when connected into the phase inverter. The plug-in "preamp" provides an additional 34 db gain, and a triple-shielded input transformer provides an additional 20 to 30 db depending on which input connection is used 30, 150, 600 ohms or bridging input. A control console is available which includes tone control, additional preamps and necessary switching for microphone, phonograph, and radio inputs. An equalizer-amplifier which follows the NAB recording curve and with a gain of 20 db at 1,000 cycles may be plugged into the unit.

Figure 10 illustrates the average performance characteristics of the amplifier. The gain-frequency characteristics may seem abnormally wide, but since it was desired to provide a manufactured product which could be guaranteed to deliver 50 watts at any frequency from 20 to 20,000 cps with less than 1 per cent harmonic or intermodulation distortion, this wide band was found necessary to keep the phase shift reasonably low so that the feedback of the higher fundamental frequencies and their harmonics would be in proper phase relationship to cancel out, and therefore improve the linearity of the amplifier. If the phase shift at the pertinent harmonics is 90 deg. or more,

no benefit is obtained from feedback, and since the feedback varies inversely from one at zero deg. phase shift to zero at 90 deg. approximately as the cosine of that angle, it is seen that quite large phase angles are associated even with relatively small losses or variations in the gain-frequency characteristic. For instance, a change in response from 0 db to 0.1 db is inevitably associated with 10 deg. of phase shift. A change from 0 db to 3 db is always associated with a 45 deg. phase shift. It is instantly obvious that if these variations occur at the fundamental, they are substantially more at the harmonic frequencies and, therefore, the effect of feedback is reduced in proportion to

Enjoy High-fidelity
RADIO RECEPTION WITH THE
Browning FM or FM-AM Tuner

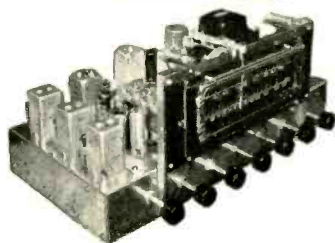

This is the new Model RJ-20 FM-AM Tuner . . . designed for high-fidelity reception on both FM and AM, and built to meet your highest performance requirements. Its features include:

- Armstrong FM circuit for maximum noise reduction and full frequency response to 15,000 cycles.
- Separate RF and IF systems for FM and AM . . . no coil switching.
- Variable bandwidth IF gives AM bandwidths from 9 kc. to 4 kc.
- Two-stage audio system allows 20 db. boost in bass or treble range.
- New 6AL7 tuning eye for precise tuning on strong or weak FM stations.
- Self-contained power supply.

See, hear, and handle this new Browning Tuner . . . and enjoy new satisfaction in your radio and music reproduction.

Write today for Data Sheet A-912

HERE'S PERFORMANCE to satisfy the man who knows radio . . . provable by both instrument and listening tests.

CHECK THESE CURVES and you'll see why Browning Tuners are chosen by those who insist upon the best.

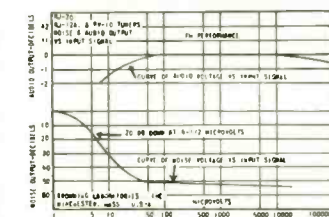
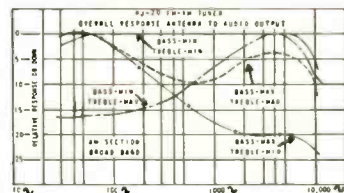
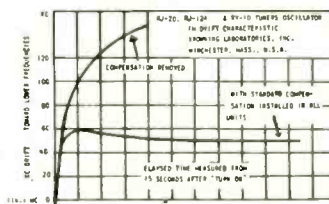

To feed a separate high-fidelity audio system, use the Browning RJ-12A for FM/AM or the Browning RV-10 for straight FM. They're all "tops" in the high-fidelity field.



BROWNING
LABORATORIES, INC.
WINCHESTER, MASS.

ENGINEERED FOR ENGINEERS

SOLVE your hi-fidelity problems with

University TWEETERS

WIDEST SELECTION • BEST VALUE • HIGHEST QUALITY

SINGLE UNIT TWEETERS

MODELS 4408, 4409—600 CYCLE TWEETERS: Recommended for highest quality reproduction systems requiring a low crossover frequency. Cobra shaped horn results in perfect wide angle distribution. Frequency response 600 to 15,000 cycles. Model 4408 handles 6 watts and 4409 25 watts.



MODEL 4407 ADAPTER MOUNTS 4401 TWEETER IN ANY 12" CONE UNIT: Converts any 12" cone speaker into a wide-range coaxial reproducer in a few minutes. Installation is extremely simple and results in a dual speaker occupying little more space than the original cone speaker. Complete with 4401 tweeter.



MODEL 4401—2000 CYCLE TWEETER: An economical 6 watt unit for converting any good 10-15" cone speaker for extended response to 15,000 cycles. Wide Angle horn. Compact design and low price bring excellent high fidelity well within the popular price range.



DUAL TWEETERS



MODEL 4402, MODEL 4404: Model 4402 reproduces to 15,000 cycles. Cross-over at 2000 cps. Horizontal dispersion 100°. Vertical 50°. Handles 12 watts. Compact design mounts in any radio, phono, or speaker cabinet. Model 4404 incorporates 4402 tweeter in handsome walnut cabinet complete with high-pass filter and high frequency volume control. Any one can install.

CROSSOVER NETWORKS



MODEL 4405 HIGH PASS FILTER: An effective and economical unit for preventing lows reaching the tweeter unit. Contains high frequency control to balance highs and lows. Cutoff frequency 2000 cycles.



MODEL 4410, 4420 LC CROSSOVER NETWORK: Genuine LC frequency dividers for segregating highs and lows. Not to be confused with ordinary high-pass filters. Crossover frequencies: Model 4410 600 cycles, Model 4420 2000 cycles. Attenuator controls included and wired.

Write for Illustrated Catalog Today — Address Inquiries to Department B

University LOUDSPEAKERS • INC
80 SO. KENSICO AV., WHITE PLAINS, N.Y.

the cosine of these phase shift angles. In some cases this may cause instability of the amplifier, particularly where large amounts of feedback are used. Experience has shown that the phase shift begins to be measurable at values 1/7th to 1/10th of the frequency at which the 2 db point shows up on a gain-frequency characteristic. Therefore, the designed bandwidth should be from 7 to 10 times the highest frequency for which it is desired to have distortion less than 1 per cent. The figure shows that the phase shift through the amplifier is substantially zero from 30 to 30,000 cps.

The circuit here described in part appears to open new fields of use or improvement in present fields permitting operation very near the theoretical maximum efficiency and yet provides a high degree of linearity with high stability for either impulse or steady state signals.

USING THE REACTANCE CHART

[from page 13]

R substituted for X, the equation becomes

$$f = \frac{1}{2\pi RC}$$

This equation will be recognized as the equation for the rejection frequency of the parallel-T filter, such as is shown in Fig. 4 providing $C_1 = C_2$ and $R_1 = R_2$ with R_3 and C_3 properly proportioned. This filter is electrically equivalent to the Wein bridge shown in Fig. 5; consequently, the chart may also be used to determine the null frequency of such a bridge, or the frequency of an oscillator employing the Wein bridge for the frequency-determining element.

Thus, it has been shown that the conventional reactance chart may be used without modification for determining component values for the low-pass filter prototype if the values of L and C read from the chart are taken for L/2 and C/2. In the case of the high-pass filter the values indicated by the chart are twice the values given by the filter equations. The value of the series elements of a parallel-T rejection filter or Wein bridge, such as is used frequently in oscillators, are indicated directly on the chart.

Although graphical methods are not recommended for highly accurate work, the results obtained by using the chart are sufficiently accurate for many engineering applications.

MERIT NEWS

MERIT TRANSFORMERS Lead Again for Sound Equipment! with NEW OUTDOOR TYPE

Universal Line Transformers. To couple various line impedances to voice coil. Universal mounting brackets. Designed specifically for maximum service in the outdoor sound field. Features: Universal mounting (may be bolted or clamped to speaker bracket); Weather-sealed at moderate cost to withstand outdoor conditions; Encased in one piece drawn metal can; Potted to resist moisture absorption; Terminal board mounted inside can.

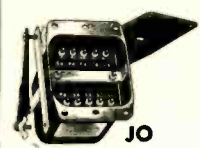

Mounting JO
Mtg. Center Case
2 3/4 x 3 3/8
Dimensions
I W D
4 1/4 4-7/16 3-9/16

TYPE NO.	LIST PRICE	OHMS IMPEDANCE PRIMARY	SEC. WATTS
A-4040	\$ 8.75	250-500-1000-1500-2000	4-8-16 8
A-4041	9.75	250-500-1000-1500-2000	4-8-16 12
A-4042	13.75	250-500-1000-1500-2000	4-8-16 25
A-4043	9.75	45-80	4-8 12

HEAVY DUTY OUTPUT TRANSFORMERS
High Level Type to Couple Line to Speaker
Sec. Impedances: 4-8-15-250-500 Ohms
OPEN MOUNTING D

TYPE NO.	LIST PRICE	TUBE	PR. IMPEDANCE	SEC. WATTS	PER SIDE	MAX. SIDE WATTS
A-3133	\$11.50	P.P. Par. 6L6, P.P. 807	3300 c.f.	240	55	
A-3131	7.00	PP6L6, 6Y6, PP2A3, 6A3, 6B4, 45, PP6N7, 46	5000 c.f.	80	30	
A-3128	8.00	PP6V6, 6F6	8000 c.f.	50	14	
*SEALED-IN MOUNTING H						
A-4033	16.50	P.P. Par. 6L6, P.P. 807	3300 c.f.	240	55	
A-4030	13.00	P.P. 6L6	6600 c.f.	80	34	
A-4028	12.00	PP6V6, 6F6	8000 c.f.	50	14	

*Weatherproofed, potted for outdoor use at 100% over list price.



For information on other transformers see the complete MERIT line in Sam's Red Book or ask for New MERIT Catalog No. 4911



EQUIP WITH MERIT OUTDOOR TYPE TRANSFORMERS TODAY



25th ANNIVERSARY
MERIT
FINE RADIO PARTS
COIL & TRANSFORMER CORP.
4415 NORTH CLARK ST., Chicago 40, Ill.

RECORD REVUE

[from page 22]

"Type 3": Metal armature changed—vertical alignment goes all the way across, twist to horizontal being just back of stylus. Damping is same black, rubber-like cylinder but taller, holding stylus higher. Greatly improved results, both .003 and .001, but particularly with the .001 LP stylus. (Compliance obviously increased by the longer vertical section.)

Beethoven, Symphony #9 ("Choral").

a) New York Philharmonic, Bruno Walter
Columbia LP: SL 156 (2)
78: MM 591 (8)

b) Philadelphia Orchestra, Ormandy
LP: SL 150 (2)
78: MM 900 (8)

• The Ormandy "Ninth," with the Westminster Choir, came out originally at the end of 1945, one of the first post-war releases. It reappeared in the LP form soon after the new records were introduced. Now Columbia brings out another Ninth, also on LP (both are available on standard records in 8-record albums), a fairly good indication that the LP record has come to stay; for recordings of the Ninth symphony, with its large orchestra, huge chorus and soloists, are few and far between and have always constituted monuments, or would-be monuments in the art.

The comparison is interesting here because the older version is actually quite up-to-date in the technical sense, with adequate tonal range and excellent acoustics—this is no replacement for "modernization" but strictly a musical matter, or so it would seem. There is no doubt about it at all: though the Ormandy-Philadelphia version is a good conscientious job, the Bruno Walter performance is a tremendous one, perhaps as good as the finest heretofore, the ancient and honorable Vienna Philharmonic recording under Weingartner, well into its later teens by now, I'd guess. It is impossible to say in a few words here exactly what the musical difference is, except to suggest that the Walter version, like all of his Beethoven, is not only the result of an almost fanatical dedication to Beethoven's music and a long life-time of study and performance of it, but it is, judging by the sound, also the product of a lot more careful rehearsal than the Ormandy. (If not, then Walter is an even bigger musician than I'd thought.)

The Walter Ninth uses the same chorus—the Westminster Choir—as the Ormandy, but the singing is definitely better, more precise, more focussed (in a work which is almost unsingable for chorus at best). The Ormandy soloists are super-mediocre: the Walter soloists are good to excellent (though again, no human soloist could sing the Beethoven music more than approximately perfectly!). In the first three movements, without voices, the Walter version is tempestuous and taut, or utterly serene, always in greater measure than the Ormandy—all of which could be illustrated by a thousand and one details in the music itself, could it somehow be played along with this article.

Technically the two Ninths are not far apart, the most vital difference (in the LP versions) being the mode of division of the



THE NEW *Astatic* MODEL JL-10

THE JL-10 PICKUP is a new Astatic achievement in tone arms for 78 RPM record reproduction — it's a new accomplishment in quality construction at a cost heretofore associated with vastly inferior equipment. The JL-10 has a rugged, drawn steel arm, modernly attractive in curved design with decorative ribs. Its styling and dark brown Hammerlin finish will make it a harmonious part of any phonograph. The L-10 Crystal Cartridge is specially designed for this tone arm and is available only in this combination. It provides high output of approximately 4.0 volts, ample for use with one-tube amplifiers. The response is ideal for general 78 RPM record reproduction. Needle pressure of 1½ oz. assures long record life. You will want the complete specifications and prices on this bright new Astatic Pickup for your records.

Write Today

Astatic Crystal Devices manufactured
under Brush Development Co. patents



Sound Values at Terminal Radio

TERMINAL'S OWN BRAND RECORDING WIRE

First quality, stainless steel wire for use with all standard wire recorders. On regular die-cast metal spools, attractively packaged. Specify plastic or nylon thread leaders when ordering.

1 Hour Spools, each.....	\$2.58
lots of 10, each.....	2.35
¾ Hour Spools, each.....	2.00
lots of 10, each.....	1.82
½ Hour, Spools, each.....	1.67
lots of 10, each.....	1.52
¼ Hour Spools, each.....	1.12
lots of 10, each.....	.92

TERMINAL'S OWN BRAND RECORDING TAPE

Best quality paper base 1200 ft. spools on standard metal reels for all tape recorders. Records ½ hour in one direction at 7½" per second, full hour with dual-track recorders. Specify inside or outside magnetic coating when ordering (or tell us your model recorder). Price per reel..... \$2.40
Empty metal reels, 1200 ft. capacity, each..... .39

THREE-SPEED RECORD CHANGERS

with Cartridges for LP and Standard Records

Webster-Chicago 356-27 GE, G.E. cartridges, sapphire styli.....	\$38.95
Webster-Chicago 356-27 PS, Pickering cartridges, sapphire styli.....	52.21
Webster-Chicago 356-27 PD, Pickering cartridges, diamond styli.....	88.21
V-M 406 GE, inter-mix changer, G.E. cartridges, sapphire styli.....	37.14

FEATURE ITEMS FOR AUDIO SPECIALISTS

Racon CHU-2 Tweeter Speaker	\$22.03
Racon CON-20 Inductive Crossover Network.....	13.13
RCA-Olsen 15-inch loudspeaker.....	32.34
MB Loudness Control (replaces volume control).....	9.95
Approved 4-tube AM Superhet Tuner, new AC model.....	19.50
V-M #100 3-Speed manual record player.....	22.72

Visit our Sound Department, the best in New York! All items are on demonstration—you can see, hear and compare before you buy!

TERMINAL RADIO CORP.

85 CORTLANDT STREET

NEW YORK 7, N.Y.

Phone: WOrth 4-3311

ASK FOR FACTS* LISTEN FOR PROOF

Speakers by
BOZAK

Give unsurpassed listening
pleasure

We invite the opportunity to prove our statements to critical listeners . . . with FACTS! You will receive promptly whatever evidence you ask, from characteristic curves, to a sample of our exclusive cone material. Meanwhile, ask your dealer for the most convincing test of all—a demonstration of the Bozak team at work. Listen for proof!

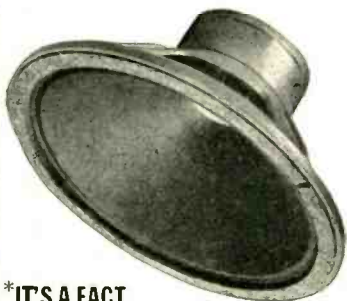

*IT'S A FACT

that the new Bozak Woofer (B-199) offers unsurpassed transient response, because of these design features:

- Low Resonance — Low Mass
- Smooth Response
- Free Moving Construction
- "Dead" Cone
- Highly Effective Damping



*IT'S A FACT

that the new Bozak patented Dual Tweeter (B-200) offers new realism of tone combined with genuine listening ease up to and beyond 13000 c.p.s., because of these design features:

- Exceptionally broad spatial coverage
- Clean, smooth response
- Highly effective damping
- Velocity of highs matched to woofer

WRITE FOR PROOF. Ask also for name of Bozak distributor in your area.

R. T. BOZAK
DESIGNER & MANUFACTURER

90 Montrose Ave. Buffalo 14, N. Y.

movements on the three records sides required. To my mind the old one has the best scheme. In it, the long and violent first movement occupies the whole first side; the equally violent scherzo (with tremendous tympani explosions gets favorable placing at the start of side 2; the long slow movement, never very loud, is adequately squeezed onto the rest of side 2. The new Walter version puts both violent movements, first and second, on side 1. The result is a tight fit, omitting repeats in the scherzo that should not be omitted. In order to accommodate the tympani bursts and the rest of the scherzo's violence the whole level is lowered. I don't like it, and the supremely fine sound of the slow movement, with side 2 all to itself, doesn't quite repair the damage.

Beethoven, Symphony #3 ("Eroica").
New York Philharmonic, Bruno Walter.

Columbia LP: ML 4228

• Just in time for inclusion in this issue, comes still another in the remarkable series of Beethoven recordings by Bruno Walter now appearing at intervals from Columbia. The Ninth (above) is the most impressive one yet—it always makes a big splash when it appears in any form—but the Eroica is an even better job. For not only it is a superb performance, but the recording is definitely a step better than that of the Ninth. Reasons are easy to guess at.

The Ninth is not only almost a super-human job of performance, but it is a nightmare for the engineer—what with a huge orchestra, chorus and all the rest, and perhaps more Beethoven violence than any other of his violent works. (Beethoven's favorite mode of energy production is the instantaneous change from very soft to ultra-loud and vice-versa. Nothing in all music is more difficult to record.)

The Eroica, on the other hand, though it has its bad moments for any engineer, is on the whole a smoother piece of music. Recorded without the impediment of cluttered chorus, it can be given a more favorable mike treatment. Hence, without much doubt, the superiority of sound in this recording compared even with the all-instrumental first three movements of the Ninth—same conductor, same orchestra, probably the same recording equipment in the same hall. It's terrific.

(Other recent Walter Beethoven's were the First Symphony and the Triple Concerto for violin, cello and piano.)

Beethoven, Symphony #5.

Boston Symphony, Koussevitsky.

RCA Victor DM, WDM 1313 (4)

• While we're at it, here's still more Beethoven. This is a familiar version of the Fifth, both in many performances by the orchestra itself and in the old Koussevitsky recording (pre-NBC Symphony) made with the London Philharmonic (VM 245). Compared with the ultra-electric Toscanini version it is fusty, heavyweight—but that is not necessarily the comparison you will make. If you like your Beethoven fairly pompous, with a huge-orchestra sound, in a large hall, this is your version. It is an excellent, solid, concert-style performance—but no definitive masterpiece of interpretation. The recording is up to the best in RCA Victor's long series of Boston Symphony albums. Naturally, it's on 45 and 78, standard-length records, whereas the last Fifth reviewed here, that

PROFESSIONAL DIRECTORY

C. J. LeBEL
AUDIO CONSULTANT

Sound Recording • Instrumentation

370 RIVERSIDE DRIVE
NEW YORK 25, N. Y.

Winston Wells

Designer and Consultant

Acoustical, Electronic and Nuclear
Research

307 East 44th St. MU 4-3487
New York 17, N. Y.

Custom-Built Equipment

U. S. Recording Co.

1121 Vermont Ave., Washington 5, D. C.

STerling 3626

Consultation • Design • Fabrication

Audio Facilities Corporation

608 Fifth Avenue
New York 20, N. Y.

RATES FOR
PROFESSIONAL CARDS
IN THIS DIRECTORY

•
\$10 Per Month.
Orders Are Accepted
for 12 Insertions Only

HERMAN LEWIS GORDON

Registered Patent Attorney

Patent Investigations and Opinions

Warner Building Washington 4, D. C. NAational 2497
100 Normandy Drive Silver Spring, Md. SHepherd 2433

from London ffr with the Paris Conservatory under Schuricht, was on Long Playing at 33-1/3. Comparison is thus not easy, but musically speaking, the ffr job is more intense, lighter in its "weight," faster in feeling (if not actual tempo), excellent as to general outlines, but sometimes a bit sloppy in detail. Try it if you want a "different" Fifth; otherwise the Boston version is what the doctor ordered—provided you have a 45 player. And so much for Beethoven. Debussy, Suite from "Pelleas and Melisande."

(arr. Leinsdorf)

The Cleveland Orchestra, Leinsdorf.

Columbia LP: ML 4090

78: MM 845 (3)

• It's strange that after the dozens of assorted suites from the Wagner operas, beginning 'way back with the celebrated Stokowski "Symphonic Syntheses," no one until now thought of synthesizing the "Tristan" of French opera. "Pelleas and Melisande," which has often been described as the greatest of Debussy's works, is virtually never heard except occasionally in what have been infrequent opera performances. (The opera has suddenly blossomed out with performances by New York's City Center opera group during the last year or so.) The idea was good, and Leinsdorf's treatment is excellent; three sections are included, with the briefest of pauses between, and each is a more or less continuous flow of music from a typical section of the opera, making for an almost symphonic three-movement pattern.

"Pelleas" is later, more acid, more concentrated Debussy than the familiar "Afternoon of a Faun," but not so advanced that it can't still rate as first class atmosphere music, Impressionist to the last note. It is, compared with Wagner, low in key, depending on subtleties and nuances rather than the Wagnerian torrent of sound; on first hearing it may seem rather neutral and colorless to you. But let it play three or four times—it makes first-rate background music—and it'll begin to catch.

Incidentally, this was one LP record I originally had consigned to the "buzzy distortion" category because of some loud passages in the third excerpt, near the inner groove. Now, with the GE "Type 3" stylus, it is perfectly OK, though I'd suggest that there is a bit of purely electrical distortion in those same loud passages. A good recording, technically, though not top rank.

Glazounoff, Violin Concerto in A minor,

Opus 82

Nathan Milstein; RCA Victor Symphony, Steinberg.

RCA Victor DM, WDM 1315 (3)

• This should theoretically be one of those chestnutty violin concerto recordings put out as convenient and innocuous vehicles for virtuosi—and in a way it is that. But even so, it turns out to be a surprisingly mellifluous and lovely item in the actual playing. Not that the concerto is anything of great musical importance. But RCA Victor here has hit an ancient and well-known stride, in which Victor has been a specialist for years and years: from the first note of this recording we are openly and effectively treated to schmalz. The recording engineers know exactly what's needed and they give it—a soft, romantic acoustical texture, a sensuous violin tone, close up (but never

Recording and Transcription Amplifiers by REK-O-KUT

Compare
for
Quality

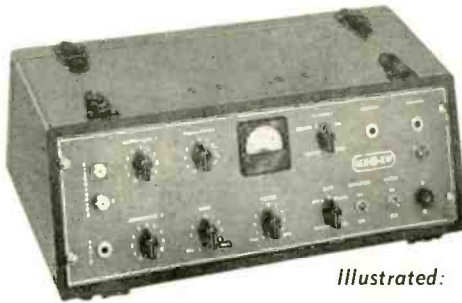

Compare
for
Value

Illustrated: R-8A in case

R-8A SPECIFICATIONS

(Powers Rek-O-Kut "Challenger" Deluxe)

Frequency Response: ± 1 db from 30 to 20,000 cycles at normal setting of equalizer controls.

Power Output: 13.5 watts at less than 3% total distortion.

Input Channels: Four: 2 high impedance microphones, phono channel compensated for G.E. or Pickering pick-up, radio.

Gain: Microphones: 120 db; Phono: 90 db;

Radio: 80 db.

Output Impedance: 4, 8, 15 or 500 ohms.

Hum and Noise: 64 db below 13.5 watts with all controls turned for maximum hum and noise output.

Tubes: (2) 6SJ7; (2) 6SL7; (1) 6SC7; (2) 6V6; (1) 5Y3.

RACK MOUNT PRICE, \$129.95 net
(including tubes)

R-5A SPECIFICATIONS

(Powers Rek-O-Kut "Challenger" Standard)

Frequency Response: ± 1 db from 50 to 15,000 cycles at normal setting of equalizer controls.

Power Output: 12 watts at less than 3% total distortion.

Input Channels: Three: high impedance microphone, high impedance phono pick-up and radio.

Gain: Microphone: 115 db; Phono: 76 db; Radio: 76 db.

Output Impedance: 4, 8, 15 or 500 ohms.

Hum and Noise: 64 db below recording level.

Tubes: (1) 6SJ7; (2) 6SL7; (2) 6V6GT; (1) 5Y3GT.

RACK MOUNT PRICE, \$89.95 net
(including tubes)

CASE OPTIONAL \$17.95

REK-O-KUT COMPANY, INC.

38-01 QUEENS BLVD., LONG ISLAND CITY, N. Y.

ANOTHER

TECH LAB FIRST!

NOW ON ALL
ATTENUATORS
AND
POTENTIOMETERS

Silver Alloy Contacts

New Silver Alloy contacts make possible improved Attenuators and Switches in smaller sizes.

- 1 Greater Creepage Distance—thus better insulation.
- 2 No silver migration.
- 3 Greater silver surface to carry current.
- 4 Lower contact resistance.
- 5 Better mechanical operation of switch.
- 6 Less capacity between contacts—better frequency characteristics.
- 7 Better clearance to ground.

TYPE 800 UNIT
with new contacts



TECH
LABORATORIES, INC.®

Manufacturers of Precision Electrical Resistance Instruments

BERGEN BLVD., PALISADES PARK, N. J.
Tel. LEonia 4-3106



RACON TWEETER

Highest Music Quality
At Low Cost!

Clean
Output to
15,000 Cycles!
Wide Distribution Pattern!

MODEL
CHU-2
\$37.50
List Price

Add this Racon tweeter to your present 12 or 15" cone speaker and enjoy concert hall music as you have always wanted to—rich, brilliant, life-like—right in your own living room.

Response is clean and smooth to 12,000 cycles, with usable output to 15,000 cycles. High frequency horn logarithmically expanded as two horns for wide, uniform distribution pattern. When used with crossover network, will handle amplifiers rated to 25-30 watts. Input impedance 4-15 ohms. Dimensions 10 3/4" wide, 7" high, 8 3/4" deep.

Cast aluminum throughout. Cutout template provided for easy flush mounting. Free wiring diagram and instructions to build an economical professional type 1,000 cycle crossover network.

Listen to the Racon tweeter at your nearest distributor or write for free Catalog A.

**ALL RACON PRODUCTS GUARANTEED
18 MONTHS**

ACOUSTICAL  EXCELLENCE

Racon Electric Co., Inc.

52 East 19th Street, New York 3, N. Y.

**NEVER
BEFORE**

**SUCH A PHENOMENAL
VARIETY OF FINE
TAPE RECORDERS**

within these pages: the tape recorder you want, at a popular price. Complete data on 2-speed recorders, 24 hour recorders, conference recorders, and many others. Accessories included. Write today for your free copy!



AMPLIFIER CORP. OF AMERICA

398-4 Broadway • New York 13, N. Y.

strident or metallic), a huge orchestra somewhere far off in the dim, rosy background, scarcely intruding at all on the soloist's domination of the mood. In any other concerto, especially one with real musical guts, this treatment is disastrous. Here it is luscious. That's the word for it.

Sibelius, Tapiola (tone poem).

Sir Thomas Beecham, Royal Philharmonic.

RCA Victor DM, WDM 1311 (2)

Haydn, Symphony # 73 "La Chasse."

Indianapolis Symphony, Seviatsky.

RCA Victor DM, WDM 1312 (3)

"Onward Christian Soldiers"

RCA Victor Chorale, Shaw. Carl Weinrich, organ.

RCA Victor DM, WDM 1314 (3)

• These three albums more or less set the tone of recent RCA Victor classical releases. The contrast with other large companies is quite astonishing, and one wonders whether RCA has decided to shift over largely to classical "pops" albums. Add to these the Glazounoff album (above) and a new Tchaikovsky Fourth Symphony, a new Beethoven Fifth—heroic warhorses but still war horses just the same—and the picture is for the moment completed.

"Tapiola" is one of those works on which, as of today, there is utter and complete disagreement. There are still those who assert that S. is one of the greatest of recent 20th century composers and that "Tapiola" is one of his finest works. There are plenty of others, and I'd say an increasing number, who find Sibelius the Prince of Dullness. For better or worse, my ear leads me in that direction. I concede a great skill and individuality of orchestration in this man's works. I allow a tremendously high score on the grounds of mood-creating, tone painting. But all of this is outside stuff. Music that is music should be foreground—not background. Not even background for day-dreaming (in a concert hall seat)!

And so, to my ear, "Tapiola" is a gorgeously dun-colored description of vague Finnish forests of the North, an excellent piece to put on and not listen to. Don't be discouraged by this—my requirements aren't necessarily yours, and no one said anyone didn't have a moral right to enjoy mood music, as millions obviously do. I'm merely stating the "facts" as best I can. Sibelius has his place and a good one—but no one has as yet persuaded me that these tortuous and gloom-ridden pages are any sort of masterpiece of musical construction, except perhaps in the relatively outward aspect of theme transformation. Well . . . let's not involve the engineering world in this ancient and hoary controversy of the musical area! Suffice it to say that the Beecham interpretation will not be surpassed, that RCA has somehow managed to remove virtually all the higher tones from this English recording at some point in the processing—leaving it more dun-colored than ever, though with excellent acoustics as far as mike pickup and hall resonance are concerned.

As to the others, the Haydn Symphony is an interesting piece, played in a hard, efficient and unmusical manner, with fine recording; lots of highs (here, at least) and an excellent liveness. The "Christian Soldiers" album will elicit the scorn of the

Virtually no distortion

You can get 15 watts Audio with virtually NO distortion from Push Pull 6L6's used as triodes and feed back from the Voice Coil line over 3 or 4 Stages — but you must choose your output transformer with considerable care.

★ Compare the guaranteed characteristics of our OUTPUT TRANSFORMER TYPE 2B36 with any of comparable price.

Impedance Ratios:- 10000 ohms C.T. to 1.25Ω, 3.8Ω, 6.8Ω, 10.6Ω, 15.3Ω or 20Ω.

Primary Incremental Inductance, at 5 volts 50₀₀₀, min. 100 hys.

Primary Leakage Reactance, to all secondaries shorted, at 1 volt 800₀₀₀ max. 25 m/Hys.

Primary D.C. Resistance:- max. 110 Ω + 110Ω.

Effective D.C. Resistance referred to primary:- 675Ω.

Size: 5 1/2" x 4" x 6" F.C. 4 1/2" x 3 1/4" x 3/16"

Weight: 12 lbs.

Price: You send us \$11.00 and pay the postman \$1.92 for import duties.

for the
discriminating listener

**SAVAGE TRANSFORMERS LTD.
DEVIZES, WILTS, ENGLAND**

NEED RECORDING TAPE IN A HURRY?

For emergency use, we will rush-ship (by Air, if outside N. Y. area) up to 20 reels from our New York stock of prices listed for such quantities.

CALL
OR WRITE

today for complete
Recording Tape price
list and a Free supply of
Program Identification
Labels.

**AUDIO & VIDEO PRODUCTS CORP.
1650 BROADWAY, N. Y. 19, N. Y.**

For back issues of AUDIO ENGINEERING, see our listing on page 26.

AUDIO ENGINEERING SCHOOL

Practical engineering training in Audio fundamentals, Disc, Film, Magnetic Recording, and Audio frequency measurements.

Studio training simulates Broadcast, Motion Picture, Television, and Commercial Recording work.

Approved for Veterans

Hollywood Sound Institute, Inc.

1040-A North Kenmore, Hollywood 27, Calif.

Correspondence Courses Available
Specify if Veteran or Non-Veteran

highbrow musicians, but it definitely fills a great need, and I can find no reason to complain. These are standard, familiar hymns, the like of which are sung by the millions come Sunday all over the land, and sung in varyingly dreadful performances too. Shaw's professional group here shows our choirs what they could do if they just had a mind to. The performance is accurate, peppy, fast-paced, musical. Each verse has a different choral arrangement—giving choir-masters a survey, so to speak, of the various ways in which a given hymn tune could be treated by the choir to give variety in the repeats of the music, verse after verse. Better call this album to your own choirmaster's notice.

Pinza in Operatic Arias (Bellini, Rossini, Puccini, Verdi, Halevy).

Ezio Pinza, Metropolitan Opera Chorus and Orchestra.

Columbia LP: ML 2060

• The fabulous Pinza here takes time off from "South Pacific" (see Columbia LP ML 4180) to project a few conventional operatic arias, via the Met. Most interesting thing here is a new mike technique that puts the Pinza at a considerable distance—stage-distance—instead of the earlier Columbia method which had Pinza and others "tongue-close" (as I once described it) with the orchestra in the liveness-background, giving a strange and not uninteresting distortion of perspective. But this is really better. More natural.

Note on LP

Columbia has now reissued so much of its past library of recordings that it no longer makes an attempt to count 'em, and doesn't bother to send out special LP announcements. But they still keep coming, and the latest batch includes monumental reissues of the huge Handel Concerti Grossi recording (on 4 large LP's, replacing three enormous heavyweight volumes of the old 78's) and the complete Brahms Requiem. There is considerable confusion now in placing all of these, for though some are obviously in the "reissue" category, Columbia—and others—tend now to bring out their standard and LP versions of a recording a month or so apart, sometimes with one ahead, sometimes another. This department therefore gives up trying to separate "reissues" from "new recordings" as a hopeless job. However, you are urged, if you are an LP collector, to keep regularly up to date on the continuing re-issue scene, since each recording that comes out on LP is a new factor, sometimes worse, sometimes better than its original 78 counterpart. I'll print an occasional roundup of unusually interesting items of reissue, to help.

Note that whereas LP reissues, both Columbia and elsewhere, are now almost un-numberable, the reissues on 45 from RCA and Capitol (the latter also on LP) are negligible in the classical field. So far I have noted roughly a dozen 45 reissues worth special notice—but then, that's according to my own taste, which is not monopolistic. Nevertheless, it's obvious that there is to be no immediate delving back into the huge RCA catalogue of available older recordings. And that is that.

TV SOUND MEN!

New problems of sound pick up; far-a-field from Broadcasting techniques, are now in your hands. No more microphone hugging performers. No more breathing down the neck of a ribbon microphone. A few of your problems we believe we can help you solve.

SOUND PERSPECTIVE:- Where broadcasting relies upon an ideal microphone pick up, you must accomplish sound pick up at distances up to 10 feet. Sound arrives at the microphone from every angle. The camera produces a "close-up" picture and the sound seems to be coming down a hallway. On this we believe we can assist you.

PRESENCE.- This psychological element in acoustical pick up is influenced by the presence and absence of high frequencies in a specific portion of the spectrum. Broadcasters again have the ideal pick up. "Presence" will drop out entirely in a 7 foot pick up in a TV studio. On this we believe we can assist you.

CINEMA EQUALIZERS will bring a solution to your problems. We know that each equalizer must perform a specific job. That is why we are making an entire line of equalizers for Television studio and remote pick ups.

Some Cinema equalizers do a single job while still others in variable types individually afford nearly 200 combinations of frequency response. Complete frequency characteristics control at your finger tips . . . plus a clickless, distortionless control!

Write today for the latest **CINEMA EQUALIZER** Catalogue 12E. It's complete with graphs, case studies, specifications and all details.



CINEMA ENGINEERING COMPANY
1510 WEST VERDUGO AVENUE, BURBANK, CALIFORNIA

Export Agents: Fraxar & Hansen, Ltd. • 301 Clay Street • San Francisco, Calif., U. S. A.

AMPERITE

Studio Microphones at P.A. Prices

Ideal for BROADCASTING

- RECORDING
- PUBLIC ADDRESS

"The ultimate in microphone quality," says Evan Rushing, sound engineer of the Hotel New Yorker.

- Shout right into the new Amperite Microphone—or stand 2 feet away—reproduction is always perfect.
- The only type microphone that is not affected by any climatic conditions.
- Guaranteed to withstand more "knocking around" than any other type mike.

Special Offer: Write for Special Introductory Offer, and 4-page illustrated folder.

AMPERITE Company, Inc.

561 BROADWAY • NEW YORK 12, N. Y.

In Canada: Atlas Radio Corp., Ltd., 560 King St. W., Toronto



Models
RBLG—200 ohms
RBHG—Hi-imp.
List \$42.00



"Kontak" Mikes
Model SKH, list \$12.00
Model KKH, list \$18.00

SUBJECT INDEX

Audio Engineering—Vol. 33—1949

A—M TUNERS

Tubeless Hi-Fi Tuner; Aug, 32.

AUDIANA

Recording Characteristics; C. G. McProud, Dec, 20.

AMPLIFIERS

Compact 6AS7G Amplifier for Residence Audio Systems; C. G. McProud: I, Mar, 17; II, Apr, 16.

Below 50 Cycles; Saul J. White, Dec, 16.

Cathode Follower as an Audio Power Amplifier; Howard T. Sterling, Dec, 12.

Low-Power Cathode-Coupled Amplifier; Raymond H. Bates, June, 30.

Practical Cathode-Follower Audio Amplifier; W. T. Gilson and Russell Pavlat, May, 9.

High-Power Triode Amplifier; Walter T. Selsted and Ross H. Snyder, Feb, 9.

Musician's Amplifier; David Sarser and Melvin C. Sprinkle, Nov, 11.

New 50-watt Amplifier Circuit, Description and Analysis; Frank H. McIntosh, and Gordon J. Gow, Dec, 9.

New Developments in Logarithmic Amplifiers; C. J. LeBel; Sept, 15.

New Portable Audio Amplifier for AM-FM-TV; W. W. Dean, July, 11.

Practical Aspects of Logarithmic Amplifiers; C. J. LeBel, Nov, 22.

Tweeter Amplifier; David Hancock, Nov, 47.

AMPLIFIERS, PRE—

Continuously Variable Equalizing Pre-amplifier; David C. Bomberger, Apr, 14.

New Developments in Preamplifiers; C. J. LeBel, June, 9.

Simplified Preamplifier Design; Howard T. Sterling, Nov, 16.

Versatile Phonograph Preamplifier; Paul W. St. George and Benjamin B. Drisko, Mar, 14.

BROADCASTING

Audio Technique in Television Broadcasting; R. H. Tanner, Mar, 9.

Construction of a Broadcast Station Record Turntable; Herbert G. Eidson, Jr., May, 24.

Disc Recording for Broadcast Stations; W. J. Mahoney, Apr, 9.

Instructional Broadcast Studio, An; Eugene F. Coriell, Nov, 14.

New Portable Audio Amplifier for AM-FM-TV; W. W. Dean, July, 11.

Studio Control Room Design; Robert V. Kinney, Jan, 21.

WMGM Master Control Equipment Design; M. E. Gunn, Mar, 24.

CATHODE COUPLING

Low-Power Cathode-Coupled Amplifier; Raymond H. Bates, June, 30.

Cathode Follower as an Audio Power Amplifier; Howard T. Sterling, Dec, 14.

Developments in Cathode Followers; C. J. LeBel, Aug, 11.

Practical Cathode-Follower Audio Amplifier; W. E. Gilson and Russell Pavlat, May, 9.

CONTROLS

Construction Details of a Continuously Variable Loudness Control; J. W. Turner, Oct, 17.

Flexible Dual Control System; Howard T. Sterling, Feb, 11.

Full-Range Loudness Control; John Winslow, Feb, 24.

Low-Loss Tone Control; James J. Faran, Jr., June, 31.

CHARTS

Magnetic Tape or Wire Speed vs Recorded Wavelength; "Stylus," Feb, 34.

Voltage Ratio vs Percentage Distortion; H. P. Meisinger, Jan, 24.

COMPONENTS

Omnidirectional Microphones, An; John K. Hilliard, Apr, 20.

Audio Transformer Applications; A. J. Avis, Nov, 20.

FILM RECORDINGS, Conversion Method to Increase Studio Facilities; Norman T. Prisant and Thomas F. LoGiudice, May, 15.

FILTERS

Crossover Filter for Disc Recording Heads; H. E. Roys, June, 18.

Using the Reactance Chart for Filter Design Problems; H. B. Davis, Dec, 12.

HEARING

Problems in Audio Engineering. Lewis S. Goodfriend: I, The Ear; May, 22. II, Effect of Sound on the Ear; June, 15. III, Articulation; July, 20.

Speech Association Convention, Report on; Apr, 28.

LANGUAGE of Audio, The; John D. Goodell, July, 25.

LOUDNESS CONTROLS

Construction Details of a Continuously Variable Loudness Control; J. W. Turner, Oct, 17.

Full-Range Loudness Control; John Winslow, Feb, 24.

LOUD SPEAKERS

Below 50 Cycles; Saul J. White, Dec, 16.

Corner Speaker Design. C. G. McProud: I, Jan, 14. II, Feb, 13.

Corner Speaker Cabinet for 12-inch Cones; C. G. McProud, May, 14.

Ground Loudspeakers; David Scott, Oct, 18.

New 15-inch Duo-Cone Loudspeaker; Harry F. Olson, John Preston, and D. H. Cunningham, Oct, 20.

MEASUREMENTS

Audio Frequency Measurements; W. L. Black and H. H. Scott: I, Oct, 13; II, Nov, 18.

Audio Sweep-Frequency Generator; G. A. Argabrite, May, 11.

Developments in Cathode Followers; C. J. LeBel, Aug, 11.

Developments in Logarithmic Amplifiers; C. J. LeBel, Sept, 15.

Practical Aspects of Logarithmic Amplifiers; C. J. LeBel, Nov, 22.

Electronic Audio Sweep-Frequency Generator. A New: H. Toomin (AES section), Aug, 23.

Measuring High-Resistance Values; Llewellyn Bates Keim, Oct, 36.

Measuring Procedures for Magnetic Recording; Apr, 19.

Simplified Transmission Set; J. P. Smith, Jr., and C. F. Scott, May, 19.

Test Record List; Sept, 14. Additional, Nov, 55.

Use of the Transmission Measuring Set; George W. Curran, Feb, 26.

MICROPHONE, An Omnidirectional; J. K. Hilliard, Apr, 20.

MOTION PICTURE Film Sound Reproducers; H. D. Hastings and T. F. LoGiudice, Jan, 18.

PHONOGRAPH PICKUPS

New Polyphase Reproducer System; Maximilian Weil, June, 13.

PHONOGRAPH RECORDS

Characteristics of the New 45-rpm Records; "Stylus," Mar, 6.

Test Record List; Sept, 14. Additional, Nov, 55.

PHONOGRAPH REPRODUCTION

Cartridge Adaptation, William J. Kessler, June, 31.

Construction of a Broadcast Station Record Turntable; Herbert G. Eidson, Jr., May, 24.

Continuously Variable Equalizing Pre-amplifier; David C. Bomberger, Apr, 14.

Importance of Groove Fit in Lateral Recordings; D. R. Andrews, July, 18.

New Polyphase Reproducer System; Maximilian Weil, June, 13.

Recording Characteristics (Audiana); C. G. McProud, Dec, 20.

Simplified Preamplifier Design; Howard T. Sterling, Nov, 16.

Versatile Phonograph Preamplifier; Paul W. St. George and Benjamin B. Drisko, Mar, 14.

PROBLEMS in Audio Engineering; Lewis S. Goodfriend: Introduction, Mar, 23. I, The Ear; May, 22. II, Effect of Sound on the Ear, June, 15. III, Articulation, July, 20. IV, Sound Waves, Aug, 19. V, Sound Generators, Sept, 18. VI, Musical Instruments and Human Speech, Oct, 23.

PSYCHO—ACOUSTICS

—Aspects of Higher Quality Reproduction; C. J. LeBel, Jan, 9.

Language of Audio, The; John D. Goodell, July, 25.

RECORDING, DISC

Crossover Filter for Disc Recording Heads; H. E. Roys, June, 18.

Cutting Stylus Problem in Microgroove Recording; "Stylus," Apr, 26.

Disc Recording for Broadcast Stations; W. J. Mahoney, Apr, 9.

Importance of Groove Fit in Lateral Recordings; D. R. Andrews, July, 18.

Improved Lacquer Disc Recording Head; H. E. Roys, Feb, 21.

Lateral Feedback Disc Recorder (AES Section); G. R. Yenser, Sept, 22.

Recording Characteristics (Audiana); C. G. McProud, Dec, 20.

RECORDING, MAGNETIC

Head Alignment with Visible Magnetic Tracks; B. F. Murphey and H. K. Smith, Jan, 12.

Low-Cost Precision Magnetic Recorder for Professional Use; Myron J. Stolaroff, Aug, 17.

Magnetic Tape and Head Alignment Nomenclature; N. M. Haynes, June, 22.

Magnetic Tape Erasure by Permanent Magnets; Robert Herr, Aug, 14.

Magnetic Tape or Wire Speed vs Recorded Wavelength (Chart); "Stylus," Feb, 34.

Making Magnetic Recordings Visible (Photos); Apr, 23.

Mass Production Tape Recording; Apr, 21.

Measuring Procedures for Magnetic Recording; Apr, 19.

SCHOOL Sound System, Modern; Arthur W. Schneider, Sept, 11.

TECHNI—BRIEFS

Cartridge Adaptation; William J. Kessler, June, 31.
Low-Loss Tone Control; James J. Faran, Jr., June, 31.
Low-Power Cathode-Coupled Amplifier; Raymond H. Bates, June, 30.

Measuring High Resistance Values; Llewellyn Bates Keim, Oct, 36.
Tubeless Hi-Fi Tuner; Aug, 32.
Tweeter Amplifier; David Hancock, Nov, 47.

THEATRE, Auditory Component Control for the Legitimate —; John H. Beaumont, July, 15.

TOPE CONTROLS Flexible Dual System; Howard T. Sterling, Feb, 11.

TRANSFORMER Applications, Audio; A. J. Avis, Nov, 20.

TELEVISION

Audio Technique in Television Broadcasting; R. H. Tanner, Mar, 9.
Improved Audio Quality from Standard TV Receiver; C. G. McProud, Oct, 28.

ULTRASONICS, Experimental; S. Young White: I, Mar, 20. II, Apr, 24.

AUTHOR INDEX

Andrews, D. R.
Importance of Groove Fit in Lateral Recordings; July, 18.
Argabrite, George A.
Audio Sweep Frequency Generator May, 11.
Avis, A. J.
Audio Transformer Applications; Nov, 20.
Bates, Raymond H.
Low-Power Cathode Coupled Amplifier; June, 30.
Beaumont, John H.
Auditory Component Control for the Legitimate Theatre; July, 15.
Black, W. L. and Scott, H. H.
Audio Frequency Measurements; I, Oct, 13; II, Nov, 18.
Bomberger, David C.
Continuously Variable Equalizing Pre-amplifier; Apr, 14.
Coriell, Eugene F.
Instructional Broadcast Studio; Nov, 14.
Cunningham, D. H. and Olson, Harry F. and Preston, John
New 15-inch Duo-Cone Loudspeaker; Oct, 20.
Curran, George W.
Use of the Transmission Measuring Set; Feb, 26.
Davis, H. B.
Using the Reactance Chart for Filter Design Problems; Dec, 14.
Dean, W. W.
New Portable Audio Amplifier for AM-FM-TV; July, 11.
Drisko, Benjamin B. and St. George, Paul W.
Versatile Phonograph Preamplifier; Mar, 14.
Eidson, Herbert G., Jr.
Construction of a Broadcast Station Record Turntable; May, 24.
Faran, James J., Jr.
Low-Loss Tone Control; June, 31.
Gilson, W. E. and Pavlat, Russell
Practical Cathode-Follower Audio Amplifier; May, 9.
Goodell, John D.
Language of Audio, The; July, 25.
Goodfriend, L. S.
Problems in Audio Engineering: Introduction, Mar, 23; I—The ear, May, 22; II—Effect of sound on the ear, June, 15; III—Articulation, July, 20; IV—Sound waves, Aug, 19; V—Sound Generators, Sept, 18; VI—Musical instruments and human speech, Oct, 23.
Gow, Gordon J. and McIntosh, Frank H.
New 50-watt Amplifier Circuit, description and analysis; Dec, 9.
Gunn, M. E.
WMGM Master Control Equipment Design; Mar, 24.
Hancock, David
Tweeter Amplifier, Nov, 47.
Hastings, H. D. and LoGiudice, T. F.
Motion Picture Film Sound Reproducers; Jan, 18.

Haynes, N. M.
Magnetic Tape and Head Alignment Nomenclature; June, 22.
Herr, Robert
Magnetic Tape Erasure by Permanent Magnets; Aug, 14.
Hilliard, John K.
Omnidirectional Microphone; Apr, 20.
Keim, Llewellyn Bates
Measuring High-Resistance Values; Oct, 36.
Kessler, William J.
Cartridge Adaptation; June, 31.
Kinney, Robert V.
Studio Control Room Design; Jan, 21.
LeBel, C. J.
Developments in Cathode Followers; Aug, 11.
Developments in Logarithmic Amplifiers; Sept, 15.
Developments in Preamplifiers; June, 9.
Practical Aspects of Logarithmic Amplifiers; Nov, 22.
Psycho-Acoustic Aspects of Higher Quality Reproduction; Jan, 9.
LoGiudice, Thomas F. and Prisant, Norman T.
Conversion Method to Increase Film Recording Studio Facilities; May, 15. —and Hastings, H. D.
Motion Picture Film Sound Reproducers; Jan, 18.
McProud, C. G.
Audiana: Recording Characteristics, I; Dec, 20.
Compact 6AS7G Amplifier for Residence Audio Systems, I, Mar, 17; II, Apr, 16.
New Corner Speaker Design, I, Jan, 14; II, Feb, 13.
Corner Speaker Cabinet for 12-inch Cones; May, 14.
Improved Audio Quality from Standard TV Receiver; Oct, 28.
Mahoney, W. J.
Disc Recording for Broadcast Stations; Apr, 9.
Meisinger, H. P.
Voltage Ratio vs Percentage Distortion (chart); Jan, 24.
Murphey, B. F. and Smith, H. K.
Head Alignment with Visible Magnetic Tracks; Jan, 12.
Olson, Harry F. and Cunningham, D. H., and Preston, John
New 15-inch Duo-Cone Loudspeaker; Oct, 20.
Pavlat, Russell and Gilson, W. E.
Practical Cathode-Follower Audio Amplifier; May, 9.
Preston, John and Cunningham, D. H. and Olson, Harry F.
New 15-inch Duo-Cone Loudspeaker; Oct, 20.
Prisant, Norman T. and LoGiudice, Thomas F.
Conversion Method to Increase Film Recording Studio Facilities; May, 15.

Roy, H. E.
Crossover Filter for Disc Recording Heads; June, 18.
Improved Lacquer Disc Recording Head; Feb, 21.
Sarser, David and Sprinkle, Melvin C.
Musician's Amplifier ("Williamson"); Nov, 11.
Schneider, Arthur W.
Modern School Sound System; Sept, 11.
Scott, C. F. and Smith, J. P., Jr.
Simplified Transmission Set; May, 19.
Scott, David
Ground Loudspeakers; Oct, 18.
Scott, H. H. and Black, W. L.
Audio Frequency Measurements; I, Oct, 13; II, Nov, 18.
Selsted, Walter T. and Snyder, Ross H.
High-Power Triode Amplifier; Feb, 9.
Smith, J. P., Jr. and Scott, C. F.
Simplified Transmission Set; May, 19.
Snyder, Ross H. and Selsted, Walter T.
High-Power Triode Amplifier; Feb, 9.
Sprinkle, Melvin C. and Sarser, David
Musician's Amplifier ("Williamson"); Nov, 11.
St. George, Paul W. and Drisko, Benjamin B.
Versatile Phonograph Preamplifier; Mar, 14.
Sterling, Howard T.
Cathode Follower as an Audio Power Amplifier; Dec, 12.
Flexible Dual Control System; Feb, 11.
Simplified Preamplifier Design; Nov, 16.
Stolaroff, Myron J.
Low-Cost Precision Magnetic Recorder for Professional Use; Aug, 17.
"Stylus"
Characteristics of the New 45-rpm Record; Mar, 6.
Cutting Stylus Problem in Microgroove Recording; Apr, 26.
Magnetic Tape or Wire Speed vs Recorded Wavelength (chart); Feb, 34.
Tanner, R. H.
Audio Technique in Television Broadcasting; Mar, 9.
Toomin, H.
New Electronic Audio Sweep-Frequency Generator (AES paper); Aug, 23.
Turner, J. W.
Construction Details of a Continuously Variable Loudness Control; Oct, 17.
Weil, Maximilian
New Polyphase Reproducer System; June, 13.
White, Saul J.
Below 50 Cycles; Dec, 16.
White, S. Young
Experimental Ultrasonics; I, Mar, 20; II, Apr, 24.
Winslow, John
Full-Range Loudness Control; Feb, 24.
Yenzer, G. R.
Lateral Feedback Disc Recorder (AES paper); Sept, 22.

The IMPOSSIBLE took 3 years!

McIntosh amplifier performance didn't just happen nor is it just another amplifier. It is the result of many thousands of hours of painstaking research and development resulting in a radically different, complete and rational solution to the problem both electrically and mechanically. This McIntosh circuit has better than a 16 to 1 advantage over conventional circuits.

It is the result that counts. Look over these performance characteristics which are fully met —

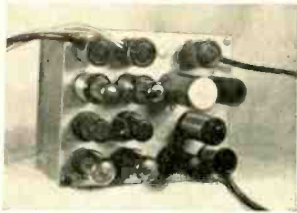

15W-1 McINTOSH AMPLIFIER

- 20 watts from two 6V6's without overload—20 cycles to 20 kilocycles.
- 1% or less intermodulation distortion up to 28 watts peak.
- 1% or less harmonic distortion at 20 watts on any frequency—20 cycles to 20 kilocycles.
- Small size—8-3/16 x 6 3/4 x 4 3/4.
- Adequate design margin for safety.
- High plate efficiency—60% at 20 watts; 70% at 28 watts.
- Low power consumption—40 watts no signal; 80 watts at 20 watts signal.
- Low internal generator impedance. 1/10 normal; eliminates distortion due to load impedance change and reduces "hang over" effects in load device.
- Simplified servicing—all plug-in elements.
- +2 db 10 cycles to 200,000 cycles.
- Negligible impulse distortion.
- Negligible phase shift (less than 2°)—20 cycles to 35 kilocycles.

The McIntosh 50W-1 Amplifier has similar characteristics except for maximum power output.

The McIntosh Engineering Laboratory is dedicated to produce only one line — THE BEST!

Ask your dealer for the McIntosh story or write to us.

McIntosh Engineering Lab., Inc.

910 King Street Silver Spring, Maryland
Telephone: Juniper 7-9200

HIGH-FIDELITY REPORTING

We have now had enough testimony from American users of the 215 speaker to be able to compile a report on what they think of it. This report is entirely factual and is specifically designed to help you. It contains the opinions of music-lovers and engineers, and includes response curves and other technical data.

Since we are but mortal we cannot please everyone, and so the report contains unfavorable comment as well as the opinions of those who think we have done a good job of work. Perhaps we are starting something new in publishing unsolicited testimonials from dissatisfied users, but why not? We can take it, and so can the 215.

But the fault may not be entirely ours. It is for you to judge and you will find the judging interesting. Those already on our mailing list will receive their copy without asking for it. Anyone else can have it free on request, but better still they should send a \$1 bill to get a regular mailing of data sheets and "New Notes in Radio".

New productions ready shortly include the final answer to the three-speed three-groove record problem and a new very light-weight pick-up at a modest price. This comes with a range of diamond and tungsten carbide needles of superlative quality. We are ironing out the bugs in high-fidelity phonographs. Again full details will be sent automatically to all our "New Notes" subscribers. Hadn't you better become one too?

Hartley-Turner 215 Speaker.....\$40.00
Push-pull output transformer.....\$11.00
Complete kit for Baffle.....\$28.00
Whistle and peak rejector.....\$18.00

Prices include postage, packing and insurance.

Prices slightly higher in Canada.

H. A. HARTLEY CO., Ltd.
152, HAMMERSMITH ROAD
LONDON W. 6, ENGLAND

ADVERTISING INDEX

Altec Lansing Corp.	1
Amperite Co., Inc.	44
Amplifier Corp. of America	44
Arnold Engineering Company	8
Astatic Corporation, The	41
Audak Company	36
Audio Devices, Inc.	Cover 2
Audio Facilities Corp.	42
Audio Instrument Co.	37
Audio Pacific Co.	24
Audio & Video Products Corp.	44
Beck, R. M. Company	35
Bozak, R. T.	42
British Industries, Corp.	32
Brook Electronics, Inc.	38
Browning Laboratories, Inc.	39
Camera Equipment Company	26
Cinema Engineering Company	44
Clough Brengle Co., The	34
Electro-Voice, Inc.	21
Fairchild Recording Equip. Corp.	29
Freed Transformer Co., Inc.	7
General Electric Company	5
Gordon, Herman Lewis	42
Gray Research & Dev. Co.	34
Hartley, H. A. Co., Ltd.	48
Harvey Radio Company, Inc.	28
Hollywood Sound Institute	44
Hycor Company, The	48
Industrial Electrical Works	6
LeBel, C. J.	42
Magnecord, Inc.	33
Maurer, J. A., Inc.	30
McIntosh Engineering Lab, Inc.	48
Merit Coil & Transformer Corp.	40
Partridge Transformers, Ltd.	48
Pickering & Co., Inc.	25
Presto Recording Corp.	27, Cover 3
Proctor Soundex Corp.	36
Professional Directory	42
Racon Electric Co., Inc.	44
Radio Corp. of America (Broadcast Equip. Div.)	2, 3
Reeves Soundcraft Corp.	23
Rek-O-Kut Company, Inc.	42
Savage Transformers, Ltd.	44
Shallcross Manufacturing Co.	31
Sun Radio & Electronics Co., Inc.	38
Tech Laboratories, Inc.	43
Terminal Radio Corp.	41
United Transformer Corp.	Cover 4
U. S. Recording Co.	42
University Loudspeakers, Inc.	40
Wells, Winston	42

PARTRIDGE

PRECISION
AUDIO-TRANSFORMERS
"To Specification"

Nearly two decades of specialized research is behind every Partridge Transformer. That specialization is at your service to fulfill your own specific requirements. Here are two typical "to measure" Partridge products.

Push-Pull Output Transformers

Provide full A.F. range with minimum distortion. Rating 12 W. for 0.5% harmonic distortion at 50 cycles. Six models available for accurate anode/anode load matching between 4,000 and 12,000 ohms. Please specify the tubes and speaker when ordering.

Unpotted (Style DN/404B)\$10.50
Potted (Style DN/404B)\$11.50
(including postage, packing and insurance).

Williamson Output Transformer

A "quality" 20 W. output transformer built in accordance with the Williamson design (see "Wireless World" August 1949) and regarded as the finest possible transformer of its type. Weight 12 lbs.

Unpotted (Style VDN/436B)\$18.50
Potted (Style VDN/436B)\$19.50
(including postage, packing and insurance)

The above transformers are available for IMMEDIATE DELIVERY. Technical literature free on application to —

PARTRIDGE TRANSFORMERS LTD.
Roebuck Road • Tolworth • Surrey
England

HIGH "Q" DECADE-INDUCTORS

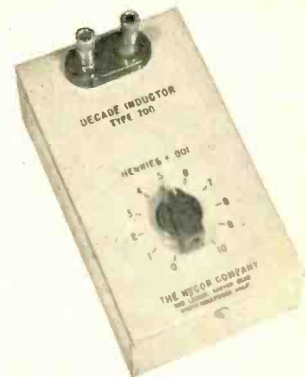

HYCOR DECADE —Inductor units are indispensable for design and experimentation work on audio filters.

The units are available in four ranges up to 10 henries. Units may be used individually or all four may be connected in series to obtain 11.11 henries in 1 milli-henry steps.

Toroid coils are used to obtain high "Q", stability and low pickup from external fields. Inductance accuracy is 2%.

The units are economically priced to bring them within the reach of all audio experimenters. Send for Bulletin D.

THE HYCOR COMPANY
7116 LAUREL CANYON BLVD.,
NORTH HOLLYWOOD, CALIF.



"Top Fidelity...the most dependable
Tape Recorder yet!" says WOR's STAN LOMAX

NEW PRESTO
PORTABLE TAPE RECORDER

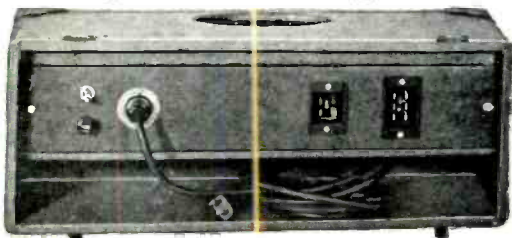
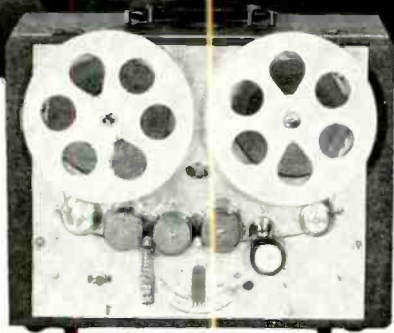

PRESTO'S PT-900 is the answer for delayed sports broadcasts - field recording - wherever there is a need for a portable recorder of complete broadcast quality. Look at these outstanding engineering features:

- Three separate heads for superior performance (and for monitoring direct from tape). One head each to erase, record and play back.
- 3 microphone channels with master gain control in recording amplifier.
- Large V.U. meter with illuminated dial to indicate recording level, playback output level, bias current and erase current, and level for telephone line.
- 2-speed, single motor drive system. Toggle switch to change tape speeds from 7½" to 15" per second.

Don't choose your tape recorder until you see the *new* Presto Portable Tape Recorder. Write for complete details today.



RECORDING CORPORATION
Paramus, New Jersey

Mailing Address: P. O. Box 500, Hackensack, N. J.

In Canada: WALTER P. DOWNS, Ltd., Dominion Sq. Bldg., Montreal

WORLD'S GREATEST MANUFACTURER OF INSTANTANEOUS SOUND RECORDING EQUIPMENT AND DISCS



FOR SPECIALTIES

The fields of frequency control, Servomechanisms, etc., are developing rapidly with increasing complexity. UTC is playing a principal role in the development of special components for these and allied fields. A few typical special products are illustrated below:

SMALLER POWER COMPONENTS

High temperature (class H) insulation, and, in many instances, short life requirements, can effect considerable weight and size reduction where these are important. The curve at the left indicates anticipated life versus temperature rise, using Class "H" insulating materials. The curve at the right illustrates on one typical type the variation in weight with permissible continuous operating temperature.

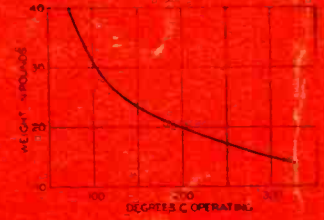
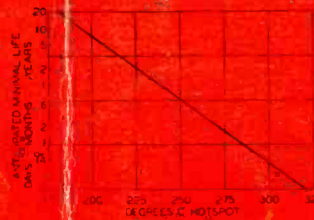

TOROID DUST HIGH Q COILS

UTC type HQ (permalloy dust) coils have found wide application because of their high Q, stable inductance, and dependability. Four standardized groups of stock coils cover virtually any high Q coil application from 300 cycles to 300 Kc.

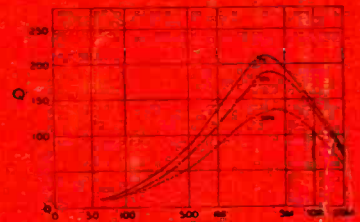
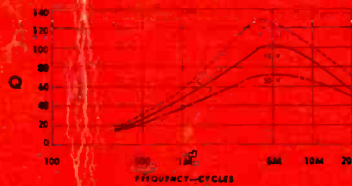

MAGNETIC AMPLIFIERS

Magnetic amplifiers are used extensively for both power control and phase control. The left curve shown is that of a sensitive saturable reactor structure controllable with powers below .5 milliwatt. The right curve is that of a moderate size power control reactor indicating power to the load with saturating DC.

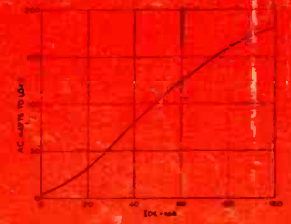
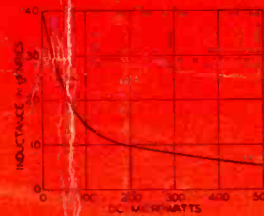

AUDIO FILTERS

The curve illustrated shows a group of filters affording sixteen separate bands in the audio and supersonic region with 35 DB attenuation at the cross-over points. These have also been supplied spaced further apart (40 DB cross-over), with intermediate bands, permitting flat top band pass action for any selected range from 100 cycles to 200 KC.



May we design a unit for your application problem.

United Transformer Co.
150 VARICK STREET • NEW YORK 13, N. Y.

EXPORT DIVISION: 13 EAST 40th STREET, NEW YORK 16, N. Y. CABLES: "ARLAB"