

# AUDIO ENGINEERING

APRIL  
1949

THE JOURNAL FOR SOUND ENGINEERS

# Which ingredient is the secret of **audiiodisc**\* leadership?

1. NITROCELLULOSE
2. PLASTICIZERS
3. RESINS
4. OIL
5. DYE
6. SOLVENTS
7. MOISTURE RESISTING  
AGENT

THE FIRST SIX of these ingredients are to be found in *any* lacquer for professional discs. The seventh is an exclusive AUDIODISC development that provides permanent resistance to humidity. This, however, is a fairly recent improvement, and therefore does not account for the consistent uniform quality that has made AUDIODISCS the first choice of discriminating recordists for the past 10 years.

The "secret" lies not in *any one* ingredient, but in the correct selection, exact proportioning, and precise chemical control of *all* of them. In the ultra filtration, quality control, uncompromising inspection, and patented precision coating process. All of these factors, backed by continual research and exhaustive production testing, assure matchless recording quality in *every* AUDIODISC.

\*Reg. U.S. Pat. Off.

Audiiodiscs are manufactured in the U.S.A. under exclusive license from PYRAL, S.A.R.L., Paris

**Audio Devices, Inc., 444 Madison Ave., N. Y. C.**

EXPORT DEPT.: ROCKE INTERNATIONAL, 13 EAST 40TH ST., NEW YORK 16, N. Y.

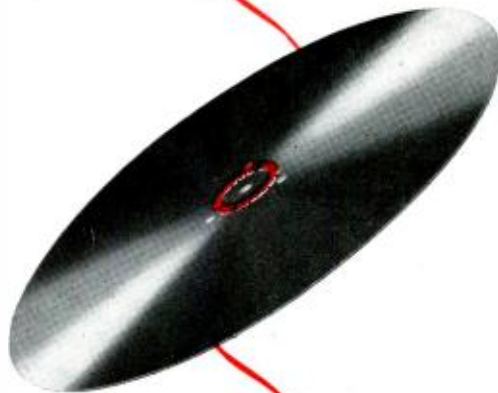

*they speak for themselves*

**audiiodiscs**



# DELTAMAX *-now available!*

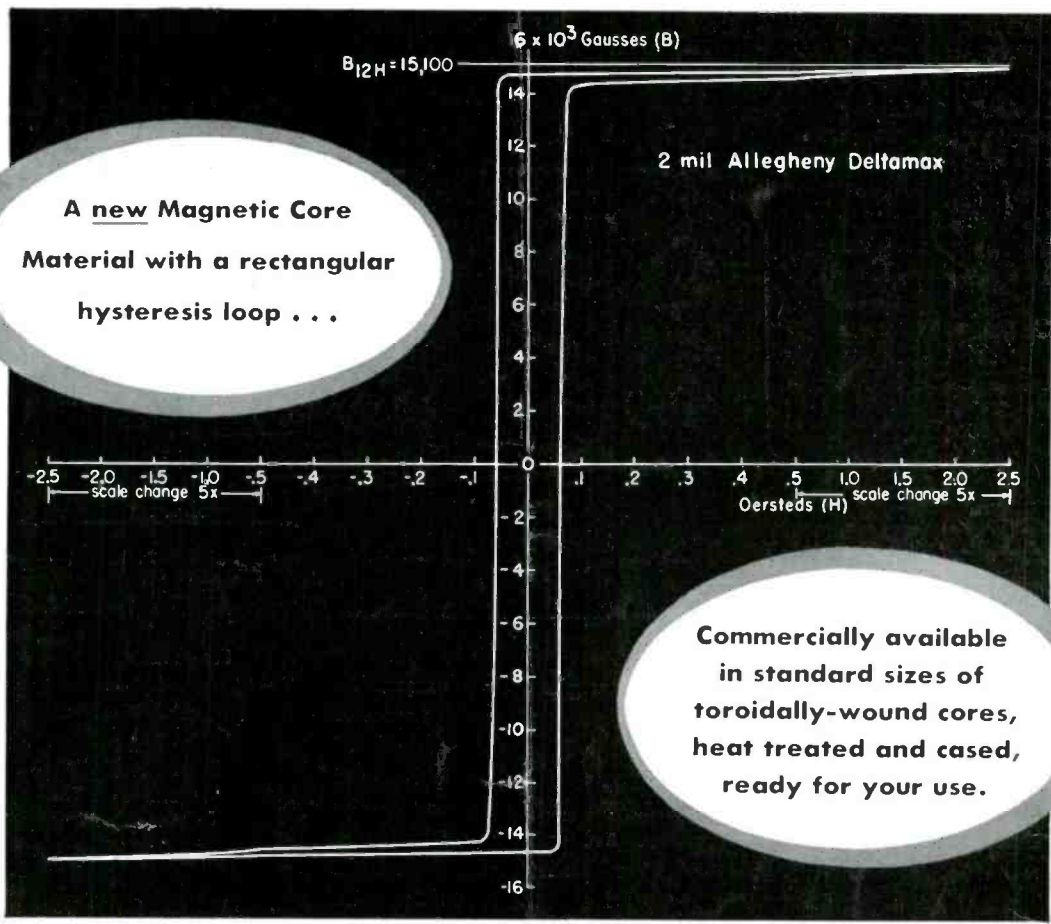

## Where can YOU use a Magnetic Material with these specialized, dependable characteristics?

The properties of Deltamax are invaluable for many electronic applications, such as new and improved types of mechanical rectifiers, magnetic amplifiers, saturable reactors, peaking transformers, etc. This new magnetic material is available now as "packaged" units (cased cores ready for winding and final assembly) distributed by the Arnold organization. Every step in manufacture has been fully developed; designers can rely on

complete consistency in each standard size of core. Deltamax is the most recent extension of the family of special, high-quality electrical materials produced by Allegheny Ludlum, steel-makers to the electrical industry. It is an orientated 50% nickel-iron alloy, characterized by a rectangular hysteresis loop with sharply defined knees, combining high saturation with low coercivity.

● Call on us for engineering data.



# THE ARNOLD ENGINEERING COMPANY

SUBSIDIARY OF ALLEGHENY LUDLUM STEEL CORPORATION  
147 EAST ONTARIO STREET, CHICAGO 11, ILLINOIS

W40 2379

AUDIO ENGINEERING ● APRIL, 1949

# SIX MEASURING INSTRUMENTS IN ONE!

This *-hp-* Audio Signal Generator does the job of six measuring instruments; saves time and space, eliminates extra equipment

**1. Audio Oscillator**

Range 20 to 20,000 cps. No zero set.

**2. Audio Amplifier**

5 watts output. Less than 1% distortion.

**3. Output Vacuum Tube Voltmeter**

Standardized output voltages, to 750 volts.



**4. Attenuator**

1 db steps, 110 db total attenuation of output signal.

**5. Output Matching Transformer**

Impedances of 50, 200, 600 and 5,000 ohms.

**6. Separate Vacuum Tube Voltmeter**

Measures external voltages.



## 205AG AUDIO SIGNAL GENERATOR

Here's the compact precision instrument that gives you the measuring capacities and scope of 6 individual instruments, yet occupies bench space of but one! This famous *-hp-* 205AG provides typical *-hp-* accuracy and ease of operation (no zero-set, for example) for almost any test job from 20 cps to 20 kc. It delivers 5 watts power with less than 1.0% distortion at the commonly-used impedance levels of 50, 200, 600, and 5000 ohms. Meter calibration, in volts and db, is based on a 600 ohm level, to conform with RMA standards. The instrument's output voltage ranges from 150 volts to 50 microvolts. Where input vacuum tube voltmeter is not required, the *-hp-* 205A is available. This instrument is identical in other characteristics to the 205AG. And, for supersonic measurements, the *-hp-* 205AH is provided. This instrument covers a frequency range of 1 kc to 100 kc and is similar to the *-hp-* 205A. For full details of any of these rugged, long-lasting *-hp-* instruments, write or wire today.

Hewlett-Packard Company • 1452L Page Mill Road • Palo Alto, Calif.

### MAKE THESE MEASUREMENTS WITHOUT EXTRA APPARATUS

Frequency Response

•

Audio Gain

•

Filter Transmission Characteristics

•

Audio Frequencies

•

Voltage Measurements

•

Speaker Tests (No amplifiers needed)

or

Drive Electro-Mechanical Equipment

### *-hp-* AUDIO TEST EQUIPMENT

Send for Catalog showing complete line of precision-built easy-to-operate *-hp-* equipment.



#### THESE *-hp-* REPRESENTATIVES ARE AT YOUR SERVICE

BOSTON, MASS.: Burlingame Associates, 270 Commonwealth Ave., Kenmore 6-8100 • CLEVELAND 12, OHIO: M. P. Odell, 1748 Northfield Ave., Potomac 6960  
 CHICAGO 6, ILL.: Alfred Crossley & Associates, 549 W. Randolph St., State 7444 • TORONTO 1, CANADA: Atlas Radio Corp., Ltd., 560 King St. West, Waverley 4761  
 DENVER 10, COL.: Ronald G. Bowen, 1896 So. Humboldt St., Spruce 9368 • FORT MYERS, FLA.: Arthur Lynch and Associates, P. O. Box 466, Fort Myers 1269M  
 LOS ANGELES 46, CALIF.: Norman B. Neely Enterprises, 7422 Melrose Ave., Whitney 1147 • DALLAS 5, TEXAS: Earl W. Lipscomb, 4433 Stanford St., Logan 6-5097  
 HIGH POINT, N. C.: Bivins & Caldwell, Room 807, Security Bank Bldg., Phone 3672 • WASHINGTON 9, D.C.: Burlingame Associates, 2017 S. St. N.W., Decatur 8111  
 SAN FRANCISCO 3, CALIF.: Norman B. Neely Enterprises, 945 Howard St., Douglas 2-2609 • NEW YORK 7, N.Y.: Burlingame Associates, 11 Park Pl., Digby 9-1240

# AUDIO ENGINEERING



Successor to **RADIO**

John H. Potts, Editor and Publisher

C. G. McProud, Managing Editor    S. L. Cahn, Adv. Director

Lawrence LeKashman, Asst. Editor    H. N. Reizes, Adv. Mgr.

Louisa B. Dresser, Edit. Prod. Mgr.    L. B. Devine, Circ. Mgr.

### Editorial Advisory Board

Howard A. Chinn

John D. Colvin

C. J. LeBel

J. P. Maxfield

George M. Nixon

Winston Wells

S. Young White

### Representatives

Sanford R. Cowan, Mid-West Sales  
342 Madison Ave., New York 17, N. Y.

James C. Galloway  
816 W. 5th St., Los Angeles 13, Calif.

Dale International Publications, Ltd.  
105 Bolsover St., London W. 1, England

Harris & Floyd, 297 Swanston St.  
Melbourne C. 1, Victoria, Australia

Established 1917

CONTENTS

APRIL, 1949

Vol. 33, No. 4

Editor's Report .....	4
Letters .....	6
Disc Recording for Broadcast Stations— <i>W. J. Mahoney</i> .....	9
A Continuously Variable Equalizing Pre-amplifier— <i>David C. Bomberger</i> .....	14
N.A.B. Convention .....	15
Compact 6AS7C Amplifier for Home Reproduction Systems, Part II— <i>C. G. McProud</i> .....	16
Measuring Procedures for Magnetic Recording .....	19
An Omnidirectional Microphone— <i>John K. Hilliard</i> .....	20
Mass Production Tape Recordings .....	21
Record Revue— <i>Edward Tatnall Canby</i> .....	22
Making Magnetic Recordings Visible .....	23
Experimental Ultrasonics, Part II— <i>S. Young White</i> .....	24
The Cutting Stylus Problem in Microgroove Recording— <i>"Stylus"</i> .....	26
1948 Convention of the Speech Association of America .....	28
New Products .....	30
Advertising Index .....	48

### COVER

Ultrasonic fountain in transformer oil, created by an immersed quartz crystal excited by 150 watts of energy at 400 kc. Converted BC-375, surplus transmitter employed as generator, is seen in the background. Photo by Lewis S. Goodfriend.

AUDIO ENGINEERING (title registered U. S. Pat. Off.) is published monthly at New York, N. Y., by Radio Magazines, Inc., J. H. Potts, President; Lawrence LeKashman, Vice Pres. Executive and Editorial Offices at 342 Madison Avenue, New York 17, N. Y. Subscription rates—United States, U. S. Possessions and Canada, \$2.00 for 1 year, \$5.00 for 2 years; elsewhere \$4.00 per year. Single copies 35c. Printed in U. S. A. All rights reserved. Entire contents copyright 1949 by Radio Magazines, Inc. Entered as Second Class Matter July 29, 1948 at the Post Office, New York, N. Y., under the Act of March 3, 1879.



**John H. Potts**

1892-1949

It is with profound regret that this page—which for every issue since the inception of this publication has brought to you the Editor's Report—must be devoted this month to chronicling the untimely passing of John H. Potts, co-founder, editor, and publisher of **AUDIO ENGINEERING**.

John Potts, one of the early pioneers in the development and progress of the electronic arts, devoted his entire life to our industry as editor of some of its leading publications, as author of innumerable articles, and in engineering capacities with the Radio Corporation of America, the General Electric Company, Westinghouse Electric Corporation, and the Sperry Gyroscope Company.

Mr. Potts was president of Radio Magazines, Inc., and editor of *CQ* and *Radio*. The latter was succeeded in May, 1947, by this publication, and on December 1, 1948, Mr. Potts became publisher of both *CQ* and **AUDIO ENGINEERING**.

John H. Potts, born November 8, 1892, died March 16, 1949.  
Author, editor, publisher, engineer. R. I. P.



# AMPEX

MANUFACTURERS OF THE WORLD'S

## *Finest Tape Recorder*

PRESENTS

### the NEW SERIES '300'

a worthy companion to the Famous Model 200

After 100,000 hours of continuous commercial operation by broadcasters and recording companies, the AMPEX MAGNETIC TAPE RECORDER has conclusively proved its overall superiority. Because of this fine instrument's ability to maintain a unique high-level of fidelity, the AMPEX TAPE RECORDER is now in continuous use by Bing Crosby, numerous other leading entertainers, the major networks and record manufacturers.



*Designed for Radio Stations*

Model 200

\$3825

F. O. B.  
San Carlos, Cal.



Model 300

approx.

\$1500

F. O. B.  
San Carlos, Cal.



*Designed for Network and Recording Companies*

### AMPEX NEW SERIES '300'

**Precision engineered for faithful reproduction and unmatched service.**

**SPEED:** Operates at 15 and 7.5 inches per second from a switch on the top plate. One half-hour playing time at 15 inches per second and one hour at 7.5 inches per second. AMPEX new Model '300' is better than NAB recommendations for over-all performance.

**FREQUENCY RESPONSE:** Plus or minus 2 db. from 50 cycles to 15,000 cycles at 15 inches per second, and plus or minus 2 db. from 50 to 7500 cycles at 7.5 inches per second.

**RANGE:** Better than 60 db. dynamic range and less than 2% total harmonic distortion at the operating point.

**MODELS:** The basic electronic and drive units are available in portable, rack-mount, and studio console models. Console is same size and height as a standard, transcription-playback-turntable. A playback only unit is available in console form. *Write for completely illustrated brochure today!*

ATTEND THE EXCITING AMPEX DEMONSTRATION AT THE NAB CONVENTION APRIL 6-12, Hotel Stevens, Chicago!

Manufactured by the AMPEX ELECTRIC CORPORATION, San Carlos, California  
WORLD WIDE DISTRIBUTOR

**AUDIO & VIDEO PRODUCTS CORP.**  
1650 Broadway, New York 19, N. Y. • Telephone PLaza 7-0780



CALIFORNIA  
**BING CROSBY ENTERPRISES, INC.**  
9028 SUNSET BOULEVARD, HOLLYWOOD 46, CAL.  
Telephone CRESTVIEW 11171

# ADC Quality Wins Again

## ADC

An important part of WESTERN UNION's nationwide plant mechanization program is the new Type 20 FM Carrier Channel Terminal equipment. Designed to provide telegraph message channels for the interconnection of telegraph offices, this new equipment was ordered in large quantities from the Radio Corporation of America in the fall of 1946. ADC was chosen to provide the transformers and inductors—over 85,000 coil assemblies were produced by ADC under rigid specifications and on individual test inspection only 14 were rejected.

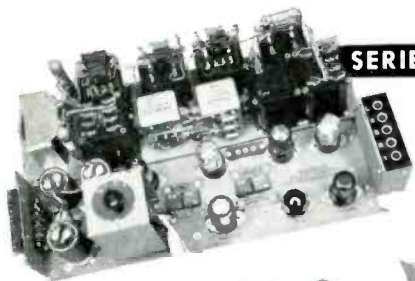

### SERIES 550-50 TRANSCEIVER

When Western Union recently ordered additional quantities of this equipment, Radio Corporation of America again won the contract award and ADC was again chosen for the transformers—inductors.

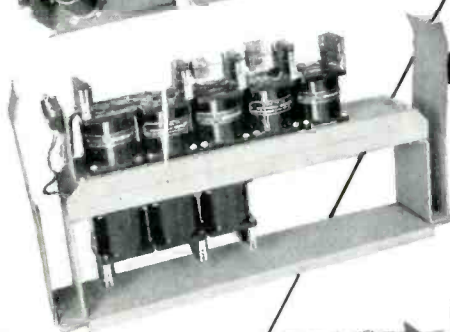

### SERIES 550-50 TUNER

The accompanying photographs show three of the principal components of Western Union's Type 20 FM Carrier Channel Terminal equipment.

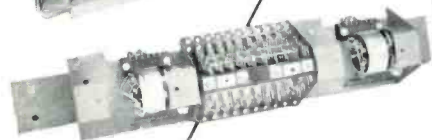

### SERIES 2-A

### CARRIER COUPLER

Series 550-50—Tuner

Series 550-50	} Transceiver
Series 2-A	
	} Carrier Coupler

This proven dependability of ADC QUALITY PRODUCTION is available to you . . . submit your specifications or problems for prompt attention.



**Audio DEVELOPMENT CO**  
*Audio Develops the Finest*  
2851 13th AVE. SOUTH - MINNEAPOLIS 7, MINN.

## — Letters —

### Tone Controls

Sir:

In reading over the Feb. issue, I was no little amused by one of the letters. Speaking of wordage wandering and confused implied thinking—Take “Does the fidelity rating go higher directly as the number of controls?” Obviously they have one purpose only . . . to give the listener his own tonal balance choice. If he were concerned with just one source of program material or better still *one* record, he would need no controls whatsoever . . . not even an On-Off switch . . . he could just pull the plug!

If the listener could take his own recorder to a concert for example, secure his own balance and handle its processing all the way down, his task would also be much simpler. However, when the many music sources are considered, AM, FM, different size and quality ET's and records are made by twenty or thirty different manufacturers who use two or three different cross-over frequencies and recording characteristics, these controls come in handy!

From Letters in the Oct. issue “Let your musical sense determine the curve and your engineering its ultimate reproduction result,” let us pose another problem to further confuse the thinking! The musician or the average ear or better attends the same concert with a person who has a “tin ear.” Same seat, same music, same everything except ears and they will come away with different impressions of that concert. Suppose their ear impressions were converted exactly to a record and they both build amplifiers, etc. and accurately recreate their impressions . . . which is high fidelity?

Absolute tonal balance . . . what is the standard? Whose ear is the criterion? The conductor has his own balance and each listener has his. If the two coincide, then the whole performance will be more pleasing. Pitch? . . . Orchestras in different countries tune up to different pitches . . . they are not standard as yet!

All this is so well known that I might as well sign off and stop annoying people!

J. P. Cook  
2609 Buena Vista  
Bakersfield, Calif.

### LP Reactions

Sir:

Canby has scored a triumph in his March column! In his discussion of long-playing records he has hit the nail right square on the head—and

[Continued on page 46]





**THE FORMULA:**

PROPERLY COMPOUNDED RECORDING LACQUER

MINUS { FOREIGN MATTER IN LACQUER  
MICROSCOPIC DUST IN DRYING  
AIR  
EQUALS NEW IMPROVED QUIETNESS  
IN CUTTING

**THE ANALYSIS:**

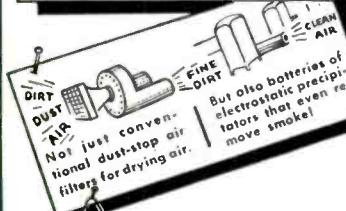
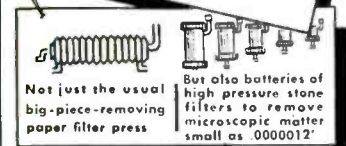

**PROF. SOUNDY SAYS..**

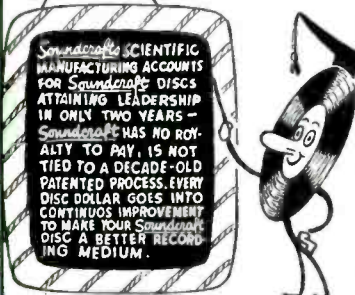

**REEVES Soundcraft CORP.**  
10 EAST 52nd STREET • NEW YORK 22, N. Y.

**REDUCING EXTRANEIOUS NOISE IN RECORDING**

By A. C. Travis, Jr.\*

Discussing disc recording with experts in broadcasting and sound studios off and on for ten years brings one inevitably to the point of trying to generalize the recording engineer's problem. Inadequate as making statistics out of memory may be, so overwhelming is the impression of unanimity that a simple summary promptly springs to mind. Regardless of what high-fidelity ambitions may haunt the recording engineer, his soul-searing fear is simply that of making a sub-standard recording of irreplaceable material.

The commonest single cause of sub-broadcasting-standard disc recordings is extraneous noise. So complex are the reasons and cures for this destroyer of otherwise good broadcasting material that they transcend the possible scope of a short article. To oversimplify, however, it is noteworthy that recorded extraneous noises behave somewhat like breakfast foods. They may hiss, swish, crackle, or pop. Since even these few categories of noise cover a lot of Puffed Rice, space requirements hold us down to a limited discussion of "hiss".

The blame for excessive hiss level in disc recordings is generally shared by the blank record and the sapphire stylus. At this point buck passing reaches championship proportions. Most often, however, neither suspect is ever definitely exonerated. The trouble simply disappears by itself. The history of recording disc manufacture, of course, allows little doubt of the fact that with some brands "grey cutting" discs crop up unpredictably from time to time. It is also an admitted fact that sapphire styli may vary so greatly as to make up to 12 db difference in surface noise level. Such variation, while unintentional, usually occurs where low prices dictate loose microscopic tolerances in sapphires.

Some of the more tricky causes of "hiss" include cutting cold discs fresh from the delivery truck, allowing smog (fog-borne soot & dirt) to settle in the grooves, and misalignment of the cutting stylus. Nitrate-coated discs (so-called "acetates") seldom cut quietly unless the aluminum bases are at a temperature between 70° and 90°. Fine or coarse airborne dirt, moisture, or damp dust can spoil the polishing action of the best stylus. Stylus misalignments to be avoided include more than a degree or two off vertical and twist of the shank in installing the stylus in the cutting head.

Today, except for occasional tricky recording problems, the most nervous engineer can fortunately forget his worries. With the new, constantly-improved Reeves Soundcraft discs and Soundcraft styli combining to keep extraneous noise 55 to 65 db below peak signal, it's mighty hard to muffle a recording. Soundcraft products have indeed established disc recording anew on a standardized predictable basis.

Advertisement

\*Vice Pres., Reeves Soundcraft Corp.

**How to CUT YOUR DISC DOLLAR**



SOUND CRAFT discs are made in 25 types and sizes. You don't wear your Sunday go-to-meeting clothes to work in the garden. Why use unnecessarily expensive disc grades for everything?

Unlike some brands, Soundcraft discs are all coated with the same high-fidelity lacquer. The grading differences are based on the nearness to microscopic physical perfection.

Three grades in five sizes plus single or double face, and oversize masters, are tailored to every budget.

**STANDARD NET PRICES TO RADIO STATIONS AND RECORDING STUDIOS (In Standard Packages)**

**THE 'BROADCASTER'**

A MASTER selection in instantaneous sizes for vitally important recordings.

10" Double Face	\$.84
12" " "	1.32
16" " "	2.37
10" Single Face	.54
12" " "	.90
16" " "	1.65



**THE 'PLAYBACK'**

A standard broadcasting-quality, blank record for all professional uses in radio stations, recording and motion picture studios.

10" Double Face	\$.69
12" " "	1.14
16" " "	2.07
10" Single Face	.48
12" " "	.84
16" " "	1.44



**THE 'AUDITION'**

A selection from the runs of "BROADCASTERS" and "PLAYBACKS" having minor physical defects outside of the recording areas.

6 1/2" Double Face	\$.27
8" " "	.42
10" " "	.60
12" " "	.93
16" " "	1.59



Standard Soundcraft economy packages of only 20 discs permit stocking wide variety of grades and sizes while simultaneously holding inventory value down.

**ELECTRONIC ELECTRONICS CO.**



**301 252** foremost radio parts distributors in principal cities and towns deliver Soundcraft discs from local stocks.

**REEVES Soundcraft CORP.**  
10 EAST 52nd STREET • NEW YORK 22, N. Y.

For the finest sound,  
just pick from  
this line...



755A—8" direct radiator,  
8 watts, 70-13,000 cycles.



756A—10" direct radiator,  
20 watts, 65-10,000 cycles.

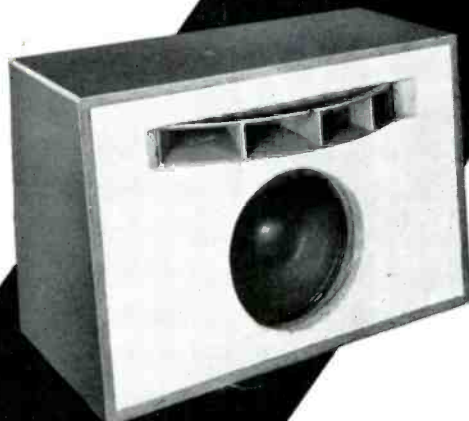

757A—dual unit system,  
30 watts, 60-15,000 cycles.



728B—12" direct radiator,  
30 watts, 60-10,000 cycles.



754A—12" direct radiator, extra high  
efficiency, 15 watts, 60-10,000 cycles.  
754B—12" direct radiator, for out-  
door use, 50 watts, 60-10,000 cycles.

★ NO MATTER what your loudspeaker needs may be, one of these five Western Electric types will fit like a glove!

If you're looking for *superlative* reproduction, you can't beat the dual unit 757A, with its unequalled combination of efficiency, frequency response and power capacity.

If you want the finest in direct radiators, you'll get just that in any one of the four Western Electric types—simply pick the *power* you need. All types are available for immediate delivery. Call your nearest Graybar Representative or write to Graybar Electric Company, 420 Lexington Ave., New York 17, N. Y.

**Western Electric**  
— QUALITY COUNTS —

DISTRIBUTORS: IN THE U.S.A.—Graybar Electric Company. IN CANADA AND NEWFOUNDLAND—Northern Electric Company, Ltd.



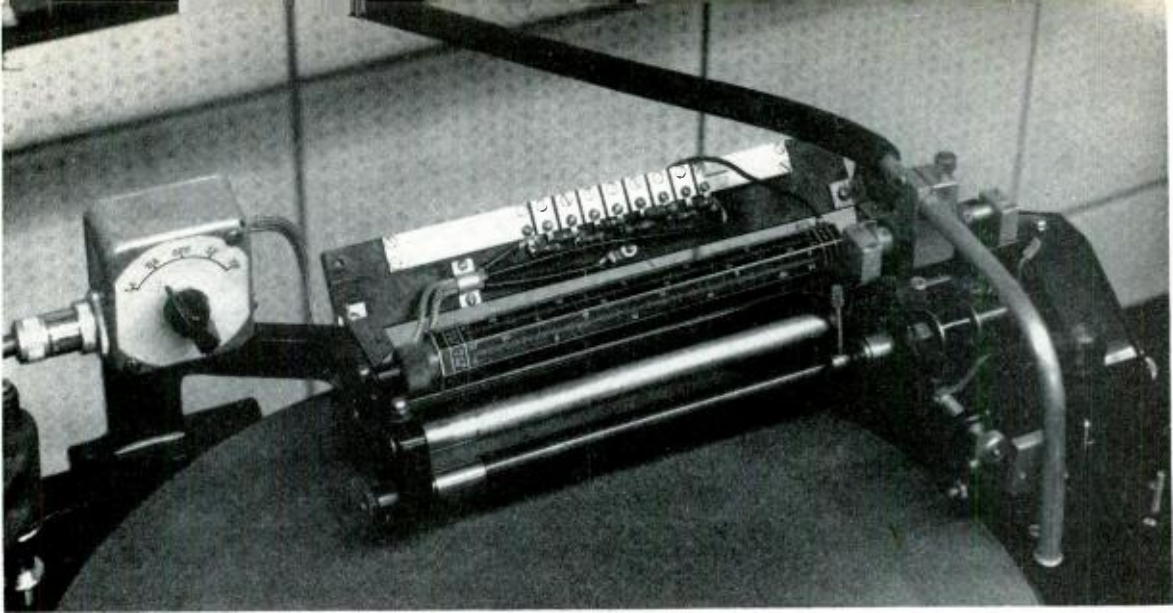

Fig. 2. Automatic radius-equalizer fabricated for Fairchild 199 recorder. Control switch is located at left of equalizer.

# Disc Recording for Broadcast Stations

W. J. MAHONEY\*

Technical details of a successful, high-quality studio installation.

**W**ITH THE RECENT IMPROVEMENTS made in recording and reproducing equipment, it is now possible for medium-size broadcast and recording studios to obtain results comparable with the finest in the industry, within limitations of their acoustical studio facilities. However, there is little information available to guide the recording engineer who wishes to custom-build his installation to obtain maximum performance in each of the various services it must perform. In furtherance of this cause, the author wishes to describe the flexible recording system designed for the new studios of WSAI, Cincinnati. This paper also includes a discussion of a number of the practical problems involved in designing a complex system of recording equalizers.

The first requirement of the system was simplicity of routine operations, such as transcribing network and studio presentations for delayed broadcast or file. The second requirement was ability to record transcription masters, phonograph record masters, composite dubbings and all the various services required of a studio. In each of these special applications the proper equalization and levels must be employed. The final requirement demands

a rapid method of providing substitution when equipment failures arise.

Two RCA 73-B recorders and two Fairchild 199 recorders with magnetic cutters were considered adequate to handle the volume of work. Duplicate sets of amplification and control equipment were provided for each pair of machines. The only variation was the necessity to mount controls and amplifiers in one rack for the Fairchild position, duo to space limitations, and the use of separate control turret and amplification rack for the RCA machines.

## Program Sources

The amplification layout itself is unique. The studio control systems were complete and totally independent of the recording installation, so it was only necessary to design the recording amplification from the output of the studio system. At WSAI, which has separate control rooms, it was decided to make the recorder bus connection to shunt the channel-amplifier input at the channel side of the interlock system. Feeding from the input side of the channel was necessary because the recorder bus connection consisted of a bridging pad, which in absence of a line or 600-ohm resistive load, would not provide proper loading for a channel amplifier. The values of the series arms of the pad were 1300 ohms,

the shunt arm was 500 ohms, providing a total loss of 15 db. These recording pads are permanently located in the transmission racks and provide the dual purpose of isolating the recording busses in case of short circuit, and minimizing the loading effect of paralleling many amplifier bridging-inputs.

The same type of pads was used to bridge a radio tuner system, the incoming network, and a "remote" jack on the master control bay. This remote position is used for all additional sources of program material.

Referring to the block diagram shown in *Fig. 1*, note that the input-selector switching system allows both recording and monitoring circuits to be bridged independently or in tandem across each recording bus. Following the switches are 16,000/500 bridging transformers, which provide the proper circuit for location of the standard 500-ohm "T" attenuators. The monitor and booster amplifiers fed by each attenuator are identical, with a power output of +30 dbm, and a maximum gain of 70 db.

With a normal attenuator setting, 21 db, the total losses up to the input of the monitor-booster amplifiers will be approximately 52 db. Assuming the studio is feeding a level of +8 vu, the output of the booster-monitor will be +14 vu. The monitor amplifier works

\*3148 Queen City Ave., Cincinnati 11, Ohio.



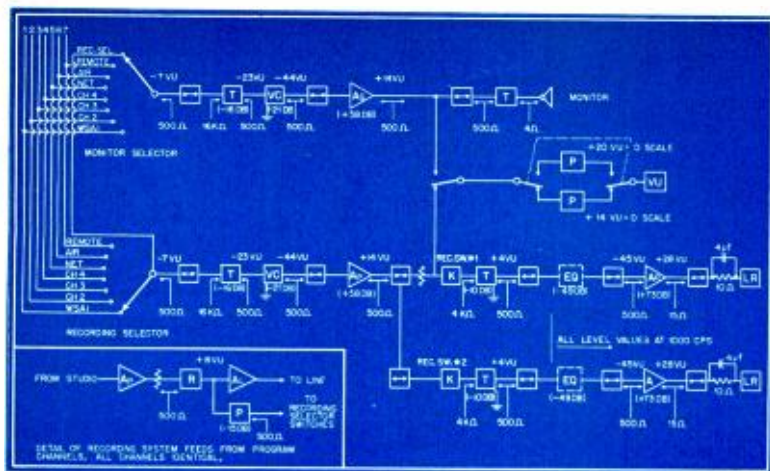

Fig. 1. Block diagram of recording installation. Program sources are fed to bridging-input pads at 8 vu.

into a speaker-matching transformer, the booster amplifier into a 500-ohm resistive load.

The volume indicator is bridged across the output of the booster, with a standard pad designed to permit the meter to read 0 vu when the booster is providing +14 dbm on steady tone. An additional pad is available on the switch, to shift the 0 vu point to +20 dbm from the booster. The additional 6 db output, obtained by advancing the master fader, is used when cutting phonograph or transcription masters. The vu meter and pads may also be transferred to the output of the monitor amplifier by a momentary-push switch. This feature, along with the ability to switch the input of the monitor amplifier independently, allows the operator to predetermine the levels to be encountered on a subsequent program from another channel without interrupting the recording in progress.

#### Power Amplifiers

Shunting the booster load resistor are the power amplifier input switches. The 4000/500 bridging transformers connected to these switches feed the various equalizers. The input impedance of each power amplifier is 500 ohms, with the secondary loaded by a potentiometer calculated to reflect the proper impedance. The amplifiers, Brook 12D, have a maximum gain of 80 db and a power output of 30 watts.<sup>1</sup>

The losses in the equalizer system are of the order of 50 db. This may seem high, but it must be remembered that some of the equalizing positions are capable of producing as much as 25 db rise at 10,000 cycles. At 200 cps, the power into the cutters is about +28 vu for instantaneous transcriptions, +34

<sup>1</sup> J. R. Edinger, High Quality Audio Amplifier with Automatic Bias Control. *AUDIO ENGINEERING*, June, 1947.

vu or better for master recording, at 200 cycles. The equalizers have been designed so that there is no change in the level at 200 cps on any of the positions.

It will be noted that the patch field allows considerable flexibility. A tip, ring, and sleeve system is used throughout, all with double jacks in parallel except "Recording Switch #1 & #2." Substitution for input selector switch, bridging coil, fader, booster amplifier, equalizer network and power amplifier may be made by appropriate patching. Also, by use of a single patch cord from "Monitor Amplifier Output" to "Recording Switch #2," the bridging coil, #2 amplifier, and cutter may be connected to the output of the monitor-amplifier system, across the normal loudspeaker transformer. This will allow emergency use of the two recording machines as completely independent channels. The vu meter may be transferred momentarily to the monitor channel for occasional checks of the program level.

#### General Design

In designing the recording system, it was felt that sufficient care should be taken to enable the installation to handle complex re-recording work and still maintain a faithful likeness to the original material. Obviously, such a system must have an accurately controlled frequency response, minimum distortion, low noise level and speed variation, and last, but not fully as important as any, an intelligent operating procedure.

The distortion, noise level, and speed variation factors are inherent in the original equipment. The frequency response is reasonably subject to the control of the system designer, assuming that first-class equipment is used throughout.

In planning the equalizers, some alteration was made to the basic NAB pre-emphasis curve to provide for radius equalizing, at least on the transcriptions cut for instantaneous playback. This is a radical departure from accepted practice and, with the present degree of standard pre-emphasis (100  $\mu$ -sec), admittedly difficult to apply to all types of program material. Consequently, a compromise design was employed to permit substantially flat playback up to 5,000 cycles at the inside radius of 3 $\frac{3}{4}$  inches, corresponding to 15 minutes at 128 lines per inch.

Surprisingly enough, there seems to be a difference in interpretation of the NAB curve. Some authorities maintain that the present standard was set up, not only to improve the signal to noise ratio, but to compensate for the poor response of the cutters and pickups in use at that time. A new committee of standards is at work on a revision of the recording section of the NAB code, and it is hoped that a more realistic approach to the radius and pre-emphasis problem will be presented. Certainly there is no valid basis to the belief that a fixed pre-emphasis curve will overcome, in any way, the serious losses encountered with a varying radius.

In addition to the NAB equalization for transcriptions, it was desirable to have a separate pre-emphasis network for phonograph records, and a setting for flat response of the system with optional radius-equalizing.

#### Automatic Radius Equalizing Device

RCA has manufactured a simple automatic equalizer which has proven quite practical. It consists of several resistors, totalling 4600 ohms, soldered to a segmented rod, which in turn is wiped by a contactor attached to the cutter carriage. The contactor is wired to two different capacitance values, available through a switch, making in effect a potentiometer having capacitance in series with the variable arm. A similar device was fabricated in the shop for use on the Fairchild machines, Fig. 2. It consists of a dual-section RC network encompassing both radius and pre-emphasis functions and includes the automatic equalizer described above. However, it was necessary to treat the Fairchild and RCA cutters as separate problems, due to the difference in crossover frequencies of the two makes. The Fairchild, and most standard cutters, have a crossover at 500 cps. The RCA heads cross-over at slightly above 1000 cps, making a difference of about 3 db in the region from 50 to 1000 cps between the two brands.

Due to the varying impedances presented to the amplifier by the cutter head, most manufacturers provide a

series resistor approximating the nominal impedance value of the head. In a 15-ohm cutter, the actual impedance varies from 2 ohms at 50 cps to 30 ohms at 10,000 cps. The constant-amplitude response of the head is determined partly by the value of the series resistance, and partly by the internal mechanical damping. The RCA heads were provided with a resistor tapped from 5 to 15 ohms, in steps of 0.5 ohms. A capacitor is used in shunt with this resistance to improve the high-frequency response of the cutter. Experiment will be necessary to determine the settings which will provide the maximum response at 10,000 cps without appreciably altering the spectrum from 2000 to 5000 cps. Values from 2 to 4  $\mu$ f will usually be necessary in a 15-ohm circuit. As the compensator supplied with the Fairchild recorder has no easy adjustment, it is difficult to use this method of altering frequency response.

#### Playback Standard

Unless the designer has an instrument such as the FM Calibrator<sup>2</sup> or a reliable method of optically measuring the stylus tip, it will be necessary to set up a playback device capable of acting as an accurate standard for frequency measurements. The light-pattern method<sup>3</sup> of measuring a severely pre-emphasized cutter response is far too tedious and inaccurate, although valuable for constant-velocity measurements. By means of careful light-calibration of the Columbia test record YTPNY-170 it was determined that a Pickering pickup was reliable within 1 db at all frequencies covered on the test record. Thereafter, the Columbia record was used as a control to ascertain that the characteristics of the pickup were not changing. It is also advisable to record your own light pattern test-record as a double check. The next step in setting up the standard was careful plotting of the NAB playback equalizer. This was accomplished by use of a variable frequency oscillator and a gain-set capable of inserting sufficient loss to equal the voltage from the pickup. By adding this source in series with the inductance of the pickup and measuring the equalizer through the playback amplifier, an accurate reading of the network may be made<sup>4</sup>. The response of this circuit was found to be within 0.5 db of the complement of the NAB

pre-emphasis curve. While set up for this measurement, it will be wise also to check the flat-response position of the equalizer, because some networks will be found to start the bass boost above 1000 cps, thus throwing off all readings above this frequency by 1 or 2 db. Additional standard equipment should consist of a good variable-frequency oscillator and a gain-set capable of presenting proper transmission characteristics to the amplifying system. The gain-set output meter should be accurate over a range of 30 db.

Before beginning the design procedure, it will save much confusion if several styli are tested and set aside for measuring purposes. Even a newly sharpened stylus, with slightly dull burnishing facets, may give a reduced response from 8 to 10 db at 10,000 cps. A recommended procedure is to cut bands of 8 kc, 9 kc, and 10 kc of exactly the same light pattern width as 1000 cps. With a calibrated pickup, these frequencies should not show any deviation when the playback filter is set for flat response. Obviously, these styli must also be acceptable for quietness of cut, but almost invariably the satis-

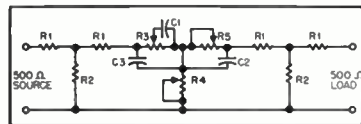

Fig. 3. Basic circuit of combined NAB and radius-equalizing networks. (Values explained in text.)

factory points will possess both attributes. A short-shank stylus is desirable, as the long-shank type possesses an undesirable mass resonance at 8000 cps. We do not wish to enter into the discussion of 70° versus 87° styli, but it should be pointed out that there is a difference in the ability of a playback stylus to reproduce high frequencies from the different cutting angles. We have found the 70° angle to have about 2.5 db higher response at 10,000 cps when played with a .0025" radius reproducing point, with a slight increase in distortion between 1000 and 5000 cps. Of course, when recording phonograph record masters, the wide angle stylus is mandatory.

#### Heating Effect

When the recording heads are subject to signal, there will be some increase in efficiency due to the heating of the damping material. The resultant increased output is therefore considerably more evident in the damped, or constant-amplitude, portion of the curve. Because of this, the reference tone may be found to be as much as 2 db higher when repeated somewhere in the middle of a frequency run. The

RCA MI-11850-C head is equipped with a built-in heater unit and thermostatic control to minimize this heating effect on program material; however, this is not sufficient protection to warrant disregarding the effects of steady tone during measurement. For this reason it was found necessary to resort to alternating two-second tone bursts with fifteen seconds of program at normal level when working within the 4000 to 10,000 cps region of the equalized curve. In this spectrum the amplifiers will be delivering 8 to 16 db higher power levels than the unequalized portion of the curve. For additional protection, the tone input to the equalizer system should be at least 6 db below the meter peaks of the program material. When working in the 50 to 2000-cps region, such a technique of alternation is not essential if the tone is kept considerably lower than normal program peaks. Incidentally, comparable troubles may be encountered on non-temperature-controlled heads due to ambient temperature changes. The author had a disagreeable experience when trying to duplicate a previous day's work on the following morning with an ambient temperature change of only 10 degrees. To avoid this trouble, it is good practice to introduce program at normal level for at least thirty minutes before attempting any measurement.

As a last word of caution before proceeding to the actual equalizer design, it should be impressed upon the reader that *all* measurements from 4000 to 10,000 cps at 33 1/3 rpm, *must* be made at the outer edge of a 16" disc, unless actually working upon the problem of radius losses. The 10,000-cps playback response will drop 1.5 db within one inch of the edge, and will drop 9 db at three inches with .0025" radius styli.

RADIUS (inches)	7.5	6.75	6	5.25	4.5	4	3.5
1000~	0	-2	-3	-6	-7	-13	-15
5000~	0	-7	-19	-3	-4.6	-7.2	-10.2
7500~	0	-2.2	-4.5	-7.7	-11.7	-17.7	-22
10000~	0	-2	-6	-12	-20	-21	-25.2

Fig. 4. Typical radius losses encountered on playback with RCA Vertical-lateral Pickup .0025" radius stylus.

Also, because of these radius losses, checks involving comparative portions of the high-frequency spectrum should be made at as nearly the same radius as possible. In the further interests of uniformity, the experimenter should use the best brand of discs, and preferably from the same package, in order to minimize the chance of error due to non-uniform coating consistency. The "softer" types of coatings will usually produce a slightly reduced

<sup>2</sup> R. A. Schlegel, FM Calibrator for Disc Recording Heads. *AUDIO ENGINEERING*, June 1947.

<sup>3</sup> C. J. Lebel, Light Pattern Calibration Chart. *Communications*, April 1940. Extended Experimental Study of Optical Pattern *Communications*, December, 1940.

<sup>4</sup> C. G. McProud, Elements of Residence Radio Systems. *AUDIO ENGINEERING*, November, 1948.

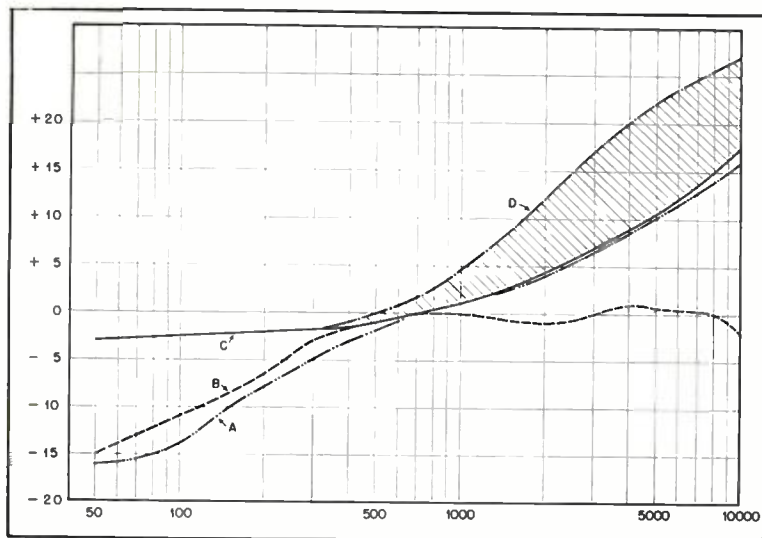

Fig. 5. A—NAB standard recording characteristic. B—Typical response of cutter with 500 cycle crossover. C—Response of NAB position on equalizer shown in Fig. 7 with radius-equalizer at minimum or off. Shaded area—Action of automatic-equalizer, continuously variable to the maximum shown by line D.

high-frequency playback response, approximately 1.5 db at 10,000 cps, probably due to the elasticity of the coating under the tremendous accelerations of the pickup stylus.

#### Network Design

In proceeding with the network design, the author desired to insert the experimental equalizer in the physical portion of the circuit where it would finally be used. In this way it is possible to compensate directly for all high-frequency losses due to long cable runs, amplifier deficiencies, and so on. The test signal was introduced into the front of the entire recording circuit at the program selector switch, and readings were taken from the output of the recording amplifier. Inasmuch as the selector input switch feeds a bridging coil, the oscillator or gain-set must work into a 500- or 600-ohm resistive load. For accurate measurement purposes the recording amplifier must feed a resistive load instead of the inductive load of the cutter.

The experimental form of the equalizer, with the exception of the fixed isolation pads at the input and output of the equalizer, consisted of variable carbon potentiometers and an assortment of small tubular paper capacitors ranging from .001 to .01  $\mu$ f. All values of capacitance within this range should be covered in steps of .001  $\mu$ f. Also, several capacitors from .01 to 0.5  $\mu$ f will be necessary. Three or four of each value should be available, with actual measured values marked on the outside. Considerable later confusion will be avoided by this precaution.

To isolate the inductive and capaci-

tive effects of the transformer windings adjacent to the equalizer, T-pads should be used at both ends of the network. An attenuation of 9 db is sufficient to provide complete isolation, but it is possible to use only 6 db attenuation if the over-all network losses become too great.

Two methods may be used to provide the proper working load for the equalizer and T-pads. If the input transformer to the recording amplifier must be operated without secondary loading, due to inclusion within feedback loops, for example, then the primary winding must be loaded with the proper value of resistance (in this case, 500 ohms). However, if the secondary can be loaded, then the step-up ratio of the transformer should be figured and the proper resistance shunted across it to reflect 500 ohms to the primary.

It may be convenient to utilize the secondary loading resistance as a potentiometer to control the gain of the amplifier. Loading the secondary aids in reducing distortion, and is preferred whenever it can be done conveniently.

The layout of the equalizer is shown in Fig. 3. In its experimental form  $R_3$ ,  $R_4$ , and  $R_5$  are potentiometers;  $R_1$  and  $R_2$  are the series and shunt arms of the isolation pads. Values of 2000 ohms for  $R_1$  and 20,000 ohms for  $R_5$  will allow sufficient range for test purposes.  $R_3$ , substituting for the radius equalizer, should be 5000 ohms.

The radius losses should now be charted. Without any pre-emphasis equalization, record bands of 1000, 5000,

7000 and 10,000 cps at radii of 7, 5,  $3\frac{1}{4}$ , 6,  $5\frac{1}{4}$ ,  $4\frac{1}{2}$ , 4 and  $3\frac{1}{2}$  inches. Tabulate the playback readings of these test cuts, as in Fig. 4. The desired response of the radius equalizer will now become apparent. Usually the losses at the smaller radii will be too great for any practical amount of compensation to overcome entirely, especially when added to an already pre-emphasized response. It is satisfactory to employ sufficient equalization to maintain flat playback to about 5000 cps at these inner radii.

#### Computation of NAB Equalizer

It is now possible to compute the equalization necessary to provide the equivalent of the NAB recording curve. The responses of the cutter itself should be taken by plotting the playback readings from the calibrated pickup. Test frequencies should be 50, 100, 200, 500, 800, 1000, 2000, 4000, 8000, 10,000 cps with the highest frequency at the outer edge of the disc. By adding the irregularities of the cutter algebraically to the NAB standard curve, the desired response of the equalizer will be shown. For example, if the cutter is -3 db at 10,000 cps where the NAB standard calls for +16 db, the desired response of the equalizer should be +19 db. Thus the reproducing complement of the NAB pre-emphasis curve will be met, and the system will produce a flat playback response from any standard reproducing system. In these computations the designer should be careful to use 800 cps as the reference point. Of course, a cutter that departs from flat response at the high end of the spectrum by more than 4 or 5 db cannot be fully compensated, and it is also impractical to attempt to neutralize large peaks or valleys within the spectrum by this method.

The most crucial problem will be the treatment of the region from 100 to 1,000 cps. Any departure from flat playback in this spectrum, which includes most music and speech fundamentals, will be serious when the system is called upon for complex dubbing work. If the ideal curve of a recording head with standard 500-cps crossover is plotted against the NAB curve, Fig. 5, it will be seen that the spectrum from 50 to 500 cps will be higher than the NAB curve by about 2 db. To correct this, the equalizer must start to rise as low as 300 cps and reach +3 db at 1000 cps.

However, with any combination of  $R_4$  and  $R_5$  that did not provide too much loss for the system to handle, such a curve became asymptotic at about 5000 cps when the proper capacitance  $C_2$  was employed to provide the correct slope from 3000 to 4000 cps. In order to keep the response rising from 5000 to 10,000 cps, it proved necessary to add



an auxiliary capacitance,  $C_3$ , across the entire radius-equalizer resistance. Obviously, any capacitance added here detracts from the effectiveness of the automatic radius-equalizer unless the shunt resistance  $R_4$  is lowered. This, in turn increases the loss of the network, and a constant check of the output level from the recording amplifier must be made while working with trial values to ascertain that sufficient power is still available to drive the cutter. The radius-equalizer also must be observed periodically to determine that the curve is capable of being increased by the amount necessary to add full equalization up to 5000 cps at the inner radius.

The final values of the components in the equalizing system, as set up on breadboard, should be capable of providing a curve to fulfill the requirements of both NAB pre-emphasis and radius losses. After these values have been ascertained, the size of the series resistors between the segments of the automatic radius-equalizer may be determined. In order that the over-all gain of the system should not change by more than 1 db when the sliding contactor momentarily shorts two segments, the value of each resistor should be kept small. The device built at WSAI was divided into nine segments, providing a change of response every  $1\frac{1}{2}$  minutes. The values of resistance necessary were found by measuring the settings of potentiometer  $R_3$  when adjusted to give the desired response at the various radii. In regards to radius losses, it was found that the combination vertical-lateral pickups used in the regular studio turntables were less efficient than the Pickering Pickups used in the re-recording setup. Therefore, use was made of the switch sup-

plied with the automatic radius-equalizer to change capacitance values, in order to provide a less steep curve for transcriptions made expressly for copying. Additional positions were provided on switch to make the maximum radius-equalizer responses available as fixed curves.

#### Network For RCA Cutters

The network designed for use on RCA recording heads will differ from the above only in the detail of treatment to the spectrum from 100 to 2,000 cps. With the high crossover frequency, 1000 cps, it will be noted that the constant-amplitude portion of the curve already fits the NAB Standard before any pre-emphasis is added. Inasmuch as it is impossible to make a rising curve of 4 db per octave with a total of 15 db from 1000 to 10,000 cps and which has no effect on the region from 1000 cps down, the real problem is to minimize any change in the lower spectrum. Fortunately, most RCA cutters have a 2 db rise at 2000 cps. By taking advantage of this existing hump, it is only necessary to design the network with a slow beginning rise and a rapid increase at the high frequencies. This can easily be done by adding auxiliary capacitance across the radius equalizer resistance  $R_3$ .

Listening tests indicated that a slightly less steep pre-emphasis curve seems to be in general use today for phonograph records. A 75- $\mu$ sec network, with a total rise of 10 db at 10,000 cps sounds quite acceptable. A value of  $C_2/R_3$  was chosen which provided such a curve. The value of  $R_1$  was so adjusted as to hold the signal level of the unequalized portion of the frequency spectrum at the same level as the NAB position. Inasmuch as it is impractical to use radius equalization with phonograph

records, the automatic equalizer is turned off in this service. However, it is still available if desired.

A flat position of the equalizer network was also provided for test and other purposes. Without pre-emphasis, it is practical to include a greater degree of radius equalization at the inner diameters. The section  $C_2-R_3$  is removed and the loss increased in the rear pad, so that there is again no increase in over-all level when this position is used. It is practical to find the necessary pad value by substituting a standard variable attenuator and reading the loss directly from the dial.

Due to the necessity of keeping the automatic equalizer common to all positions of the selector switch, the auxiliary capacitor  $C_3$ , used on the NAB position, became shunt to ground through 800 ohms when the switch was moved to another position. The resultant high-frequency attenuation could be counteracted on the PHONOGRAPH position by increasing the value of  $C_2$ . However, on the FLAT position the presence of  $C_3$  caused 4 db attenuation at 10,000 cps. To correct this, it became necessary to shunt the series arms of the output pad with a .04- $\mu$ f capacitor. Figure 6 is a schematic of the entire equalizer and Fig. 7 shows the control panel.

#### Operating Techniques

The operating staff was introduced to several techniques which enable the studio to produce competent work. For instance, in handling quantities of direct-copy material, the original record is made with the cutter carriage in a direction of travel opposite to that of the finished copy. This, in conjunction with the action of the automatic equalizer, produces an amazingly faith-

(Continued on page 45)

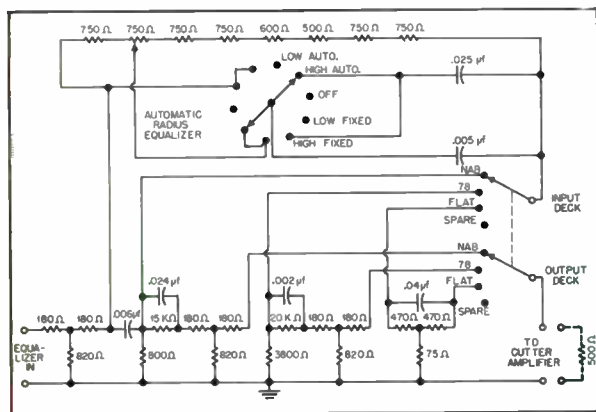
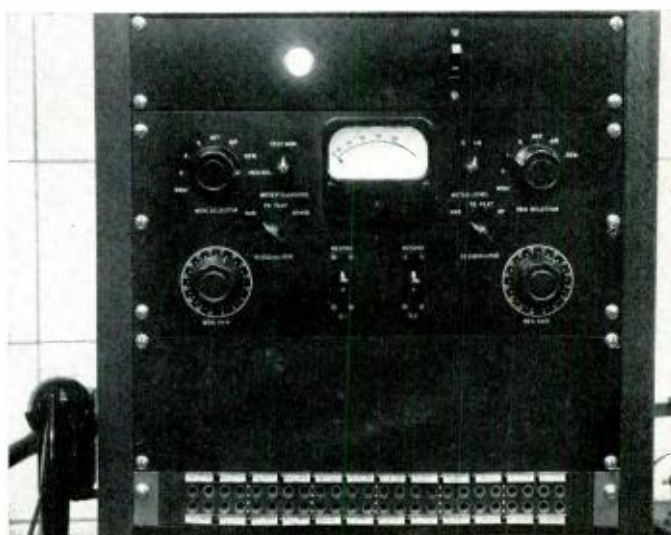

Fig. 6. Complete equalization system for 500 cps crossover cutter, showing NAB phonograph and flat equalizers, and the two-position radius equalizer available for each curve.

Fig. 7. Control panel and patch field of recording bay. All bays are identical.







The pre-amplifier schematic is shown in *Fig. 1*. In this particular embodiment, as used in the author's home, the input is a double triode, to accept signals from two variable reluctance phonograph pick-ups simultaneously. After amplification in this tube, the signals are fed to a potentiometer for gain control, and then split into two channels. One of these, the basic channel, goes directly to the summing amplifier. The other, which is further amplified by a triode stage, is subdivided into the two auxiliary channels by low-pass and high-pass *RC* networks. These networks produce frequency functions suitable for additive equalization.

The feedback amplifier in which the three channels are added has a capacitor,  $C_2$ , across its feedback resistor,  $R_4$ . This, and the capacitor  $C_1$  shunting the plate circuit of the input tube, cause the 12 db per octave high-frequency cut-off of the basic channel. The input resistor,  $R_3$ , for the high-frequency auxiliary channel has a capacitor,  $C_3$ , in shunt for partial compensation of the effect of these elements on the high-frequency auxiliary voltage.

The summing amplifier output is direct-coupled to the grid of a cathode follower, which permits the use of the pre-amplifier at a moderately remote location. The maximum output of the pre-amplifier is not limited by the output stage, which is capable of swinging almost 200 volts peak-to-peak. Overload occurs first at the grid of the auxiliary channel amplifier, which can swing only about one volt peak-to-peak. Since the mid-frequency gain from this grid is unity, the maximum output is also one volt peak-to-peak. This is comparable to the output from a crystal pick-up, insofar as voltage is concerned. Because of the low output impedance of the cathode follower, the output power level of the pre-amplifier is considerably above that of a crystal.

The measured performance of the pre-amplifier is shown in *Figs. 2, 3* and *4*. *Fig. 2* shows the effect of varying the attenuation in the low-frequency channel, with large attenuation in the high-frequency channel. In *Fig. 3* these conditions are reversed. It is seen that the two auxiliary channels overlap in the region of 500 to 1000 cps. The effect of this overlap is seen in the composite characteristics of *Fig. 4*; it is less than 2 db for attenuation greater than 15 db in the auxiliary channels. Smaller attenuation will be used only to compensate unusually poor recordings, or to create special sound effects.

**Fig. 4. Limits of available response curves.**

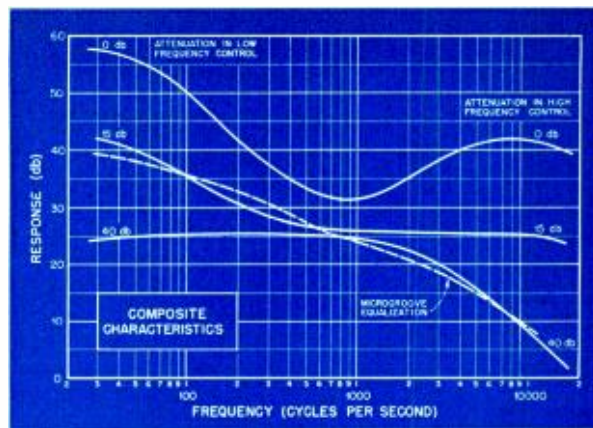

Only three characteristics are shown in *Fig. 4*. Two of these represent extremes, with either no attenuation, or large attenuation, in both auxiliary channels. Between these extremes is a large number of possible characteristics, of which only one is illustrated.

The required equalization for microgroove recordings is also shown in *Fig. 4*. This characteristic may be achieved within a variation of  $\pm 2.5$  db with attenuation settings of 15 db in the low-frequency channel and 40

db in the high-frequency channel.

The method of equalization presented here is not new. Circuits utilizing the addition of several channels have been described before, but meagre performance data were given. The data shown here are the results of measurements made after the circuit was tailored to produce what were considered to be desirable characteristics. Experience with the pre-amplifier has given convincing evidence that this degree of flexibility is profitable.

## N.A.B. Convention

**T**HE 27TH ANNUAL CONVENTION of the National Association of Broadcasters will be held in Chicago from April 6 to 13, with the Stevens Hotel serving as headquarters. Of particular interest is the Broadcast Engineering Conference which occupies the first four days of the convention.

On April 6, the opening day, the afternoon will be given over to a tour of the Hallcrafters plant, to which ladies will be welcome. The papers to be given on Thursday morning cover television problems, from the selection of a transmitter site up to operation of the image Orthicon camera, and including the description of a 2,000-mc relay link.

The principal audio papers are scheduled for Thursday afternoon, and are:

**AM, FM, and TV Audio Measurements**, Frank H. McIntosh, Consulting Radio Engineer, Washington, D. C.

**The NAB Recording & Reproducing Standards for Disc, and Magnetic Recording**, Robert M. Morris, Radio Facilities Engineer, American Broadcasting Co., New York.

**Magnetic Tape Recording and Reproducing**, Dr. S. J. Begun, Vice-President

in charge of Engineering, Brush Development Co., Cleveland, Ohio.

**Properties of Magnetic Tape and Their Relation to Magnetic Recording**, Reynolds Marchant, Development Engineer, Magnetic Tape Equipment, Minnesota Mining & Manufacturing Co., St. Paul, Minn.

**A New Portable Audio Amplifier for AM-FM-TV**, William W. Dean, Audio Engineer, Broadcast Engineering Section, General Electric Company, Syracuse, N. Y.

The official opening of the exhibits is at 5:00 p.m. in the Exposition Hall of the Stevens Hotel, with ladies again being invited. Smaller equipment will also be on exhibition on the fifth and sixth floors of the hotel during the entire convention week.

The Friday morning session involves transmitters and problems associated with them, except for one paper to be given at 11:15 a.m. on Automatic Selection of Broadcast Program Circuits by John A. Green of Collins Radio Co., Cedar Rapids, Iowa, to be followed by a demonstration to be given by Mr. Robert D. Esig of the same company. The afternoon session again deals with television, while the Saturday morning

*(Continued on page 37)*



# Compact 6AS7G Amplifier For Residence Audio Systems

C. G. McPROUD\*

## Part II—Further constructional details on two-unit amplifier of unique design.

IN THE FIRST section of this series, a new type of amplifier was described. This amplifier employs a novel arrangement for furnishing plate power for the output stage as well as the d-c filament power for all the other stages. While the design was discussed thoroughly, exact component values were omitted pending the results of the measurements of distortion and overall performance. These measurements have justified preliminary tests, and the components are listed herein.

The results of the performance tests are gratifying. Power output at one per cent harmonic distortion is 6.5 watts at 400 cps, 6.2 watts at 20 cps, and 6.35 watts at 20,000 cps. Eight db of feedback is employed, extending from the secondary of the output transformer to the cathode of  $V_{2b}$ . The output impedance on the 16-ohm tap is 1.85 ohms, which gives excellent damping. The frequency response curves were shown in Part I, with the tapped tone switches in various positions. Hum and noise measures

—42 dbm, which is not exceptionally low, but which is within the range of good quality amplifiers.

With the volume control at maximum—which is the operating point for the greatest room volume normally desired—a two-volt input signal is required at the two radio input jacks for a two-watt output. This does not leave much leeway, but will suffice for most tuners. The phonograph pre-amplifier supplies the additional gain to bring the output of magnetic pickups to the equal of the radio inputs.

The original design provided for a roll-off in the LP phonograph position so that these records would reproduce normally with the tone controls in the positions for flat response. However, this does not provide sufficient gain, so it is considered more desirable to eliminate  $R_{12}$  and  $C_5$ . Values for these components are given in the list of parts, but it is recommended that the arm of  $SW_{1b}$  be connected directly to the LP position contact of  $SW_1$ , as shown in the schematic, Fig. 4. It should be mentioned at this point that the elimina-

tion of this equalization arrangement does not prevent the user from reproducing LP records at the correct tone control settings, because position 4 of the high-frequency tone control gives the correct roll-off for these records.

### List of Materials

$C_1, C_2, C_{14}$	0.05 $\mu$ f, 400 v, paper
$C_3$	.003 $\mu$ f, mica
$C_4, C_8$	.002 $\mu$ f, mica
$C_5^*, C_6$	250 $\mu$ f, Centralab Hi-Kaps
$C_7, C_9, C_{10}, C_{11}$	750 $\mu$ f, Centralab Hi-Kaps
$C_{12}$	.006 $\mu$ f, mica
$C_{13}$	0.1 $\mu$ f, 400 v, paper
$C_{15a, b, c}$	15-15-10/450 electrolytic
$R_1$	10,000 (all values $\frac{1}{2}$ -watt unless otherwise specified)
$R_2, R_5, R_{29}$	2200
$R_3, R_6$	0.12 meg, 1-watt
$R_4$	1.0 meg
$R_7$	0.1 meg
$R_8$	47,000, 1-watt
$R_9, R_{10}, R_{11}$	0.5-meg potentiometer
$R_{12}^*, R_{17}$	0.12 meg
$R_{13}, R_{14}, R_{15}$	
$R_{16}, R_{22}$	0.27 meg
$R_{18}$	82,000
$R_{19}$	68,000
$R_{20}$	33,000
$R_{21}$	0.39 meg
$R_{23}, R_{24}$	0.18 meg
$R_{25}$	56,000
$R_{26}$	1000
$R_{27}, R_{32}$	0.1 meg, 1-watt
$R_{28}$	special volume control (see text)
$R_{30}$	0.56 meg
$R_{31}$	2700
$R_{33}$	82,000, 1-watt
$R_{34}$	22,000, 1-watt
$SW_1$	Mallory 3136J
$SW_2$	Mallory 3115J, modified (see text)
$SW_3$	Mallory 3115J
$V_1, V_2$	12S17
$V_3$	12SJ7

\*These components should be omitted—see text.

The parts not specifically described for the power section are as follows:

$C_1$	0.5 $\mu$ f, 600 v, oil filled, bathtub type
$C_2$	40-40-10/150, electrolytic, with insulating tube
$C_3, C_4$	125 $\mu$ f, 350 v, electrolytic, with insulating tube
$C_5$	40-30-20-10/450, electrolytic
$C_6$	0.1-0.1, 600 v, oil filled, bathtub type
$R_1, R_2$	600, 5-watt
$R_3$	500-ohm wire-wound potentiometer
$R_4^*$	15,000, 10-watt
$R_5, R_6$	6800, 2-watt
$R_7$	5, 5-watt
$SW_1$	SPST toggle switch

Fig. 1. Partial wiring diagram of power section to show component mounting.

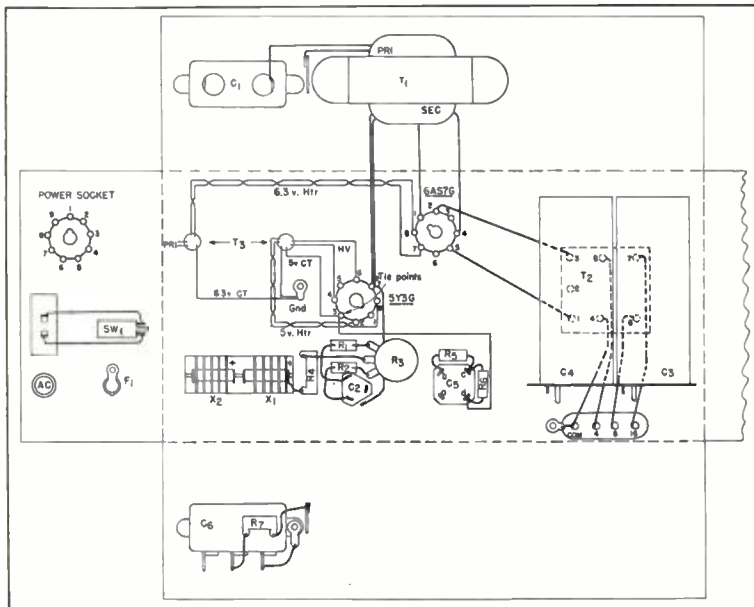

- $T_1$  push-pull input, special channel mounting, no d.c. in primary; Freed 17290
- $T_2$  4000 ohms plate to plate, 4-8-16-ohm secondary; Freed 15929
- $T_3$  325-0-325 v at 50 ma; 5v at 2a; 6.3v at 2.5 a. Freed F-413
- $X_1, X_2$  200 ma selenium rectifier

\*Shown on diagram as 7500 ohms. This value should be adjusted to provide 36 volts across filament string.

The performance of any amplifier depends to a large degree upon the quality of the components used. At the time this amplifier was designed, it was desired to use high-quality transformers throughout, and to make the power section as compact as possible the input transformer had to be mounted underneath the chassis. This ruled against a cased type, and few manufacturers list high-quality transformers in open-frame mounting. The unit employed was designed to work between a single 12SJ7, triode connected, with no d.c. in the primary, and to obtain adequate driving voltage for the grids of the 6AS7G it was required that the step-up ratio should be fairly high. To get this performance and retain a wide frequency range, the transformer is wound in two sections, both placed on the center leg of a conventional E-I core. Measured frequency response of the transformer itself indicates a droop of 1 db at 30 cps and at 30,000 cps. The output transformer, also special, shows a droop of 1 db at 17 cps and at 120,000 cps when operated without feedback, and drooping 1 db at 15 cps and 62,000 cps when operated with feedback. Similar output transformers are available in the standard Freed line under number F-1951 with output impedances of 1.2 to 30 ohms, and under number F-1950 for impedances from 50 to 500 ohms.

The following table indicates transformers of high quality which are generally obtainable from jobber stocks and which should perform satisfactorily, since their characteristics are similar to those used in the original amplifier.

#### Construction Hints

There are a number of suggestions which may be of interest in the construction of these two units. Refer-

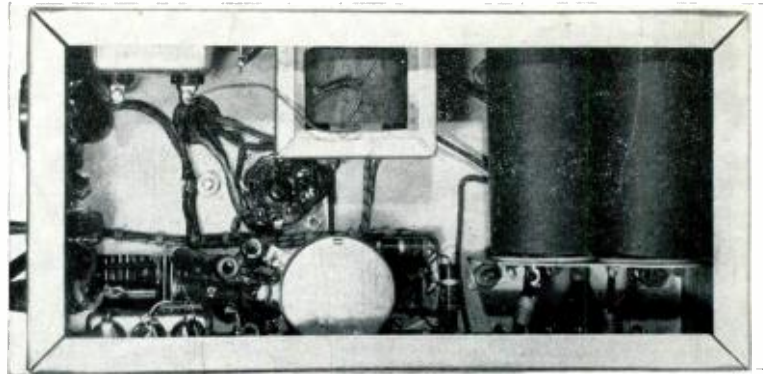

Fig. 2. Underside of power section chassis.

ring first to the power section, it will be noted that the two filter capacitors,  $C_3$  and  $C_4$ , are mounted on a bracket under the output transformer. Therefore, they are necessarily installed after the wiring to the output transformer is completed. The balancing potentiometer,  $R_3$ , is also mounted on a bracket so that its shaft may be adjusted through a hole on the chassis between the two capacitors mounted on top. The selenium rectifiers are mounted on a 6-32 threaded rod which

The value for the resistor  $R_4$  shown as 7500 ohms. This gives somewhat too much current through the filament string, and it is found that 15,000 ohms is more suitable, since the voltage across the filaments should be 36 volts.  $R_7$  has been added to reduce the peak current through the selenium rectifiers, and 5 ohms is a suitable value. This resistor is connected between  $SW_1$  and  $C_3$ .

The push-pull input transformer is mounted directly below the 6AS7G

Fig. 3. Wiring diagram of two tone-control switches. Switch plate on H-F control is changed to furnish tie points on five-step frame. Only one contact arm is used.

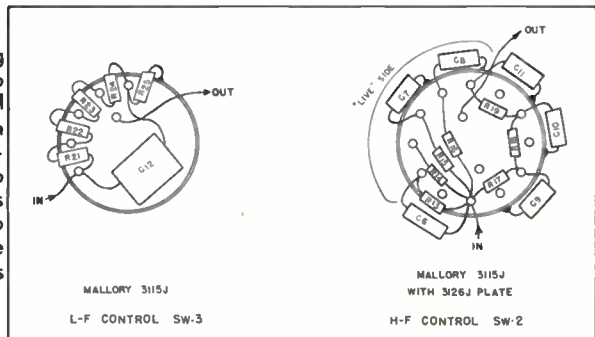

passes through two strips of Bakelite attached to bent-up angles on the chassis. Two saw-cuts are made  $\frac{3}{4}$  in. apart and extending for two inches along the chassis. At the center of these two cuts, another cut is made between them. This frees two "flaps" which may be bent up to mount the Bakelite strips. The cover is bent up from perforated metal to prevent accidental contact with hands or tools.

socket, using leads as short as possible. This will normally require that the leads be connected before the transformer is bolted in place, and since the leads are likely to be of relatively light wire, care should be exercised in this operation. The two bathtub capacitors are mounted on opposite sides of the chassis, with tie-points installed adjacent to them. One is needed to make the connection to the plate end of the primary, and the other serves to hold  $R_7$ .

With some transformers it is probable that there will be a tendency to oscillate at some super-audible frequency. This may require some experimentation, but it is suggested that a small capacitor across each half of the primary of the output transformer, or possibly across the secondary of the input transformer, will suffice to eliminate this trouble. Probable values

TABLE I

	$T_1$	$T_2$	$T_3$
Audio Development Co.	214H*	314C	515C
	215C*	315F	(large)
Chicago Transformer Div.	—	BO-6	PCC-70
Stancor	A-4750	A-3800	P-4078
Thordarson	T20A22	T22S70	T22R02
UTC	LS-21*	LS-57 <sup>1</sup>	R-54
	CG-132*	LS-55 <sup>2</sup>	
		CG-16	

\*Insufficient space under chassis to mount these models.

<sup>1</sup>Voice coil secondary only. <sup>2</sup>Voice coil and line secondary.

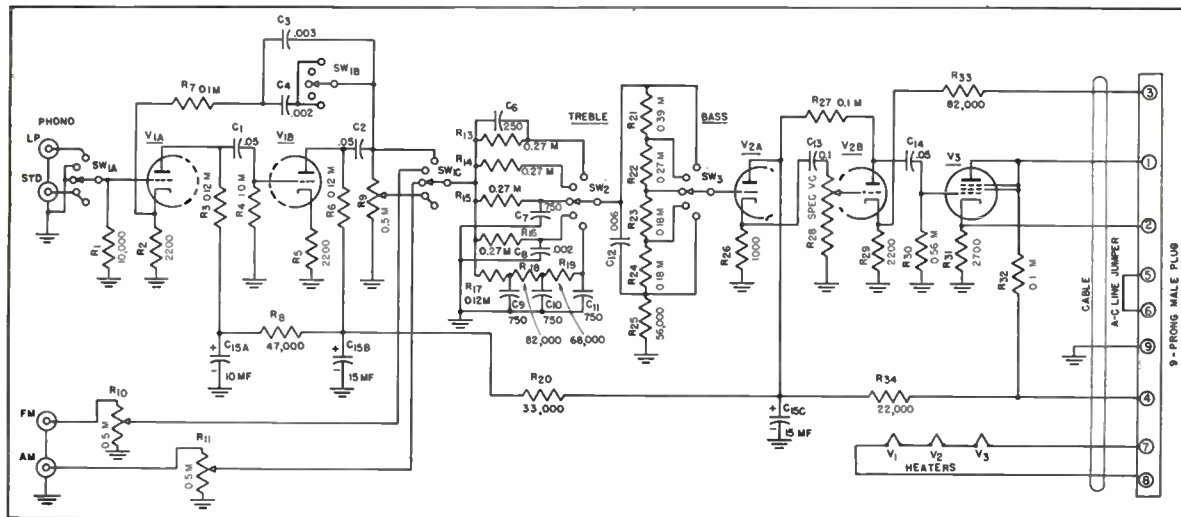

Fig. 4. Schematic of input section, with component values.

will be in the vicinity of .002  $\mu$ f. Figure 1 is a partial wiring diagram of parts employed in the power section, while Fig. 2 is a photograph of the underside of the completed amplifier chassis.

The preamplifier section shown in the photograph of Part 1 is somewhat smaller than the average constructor may wish to employ, but it was built in this manner to keep the space required to a minimum. The chassis was fabricated from a 2 x 7 x 11 aluminum chassis base, cutting it apart at the center. The sides of the chassis are then cut  $1\frac{1}{4}$  in. from the open end, and folded in to provide a  $\frac{3}{8}$ -in. angle. The top is folded down, resulting in a chassis approximately  $3\frac{1}{2}$  x 7 x 2. The tube sockets and the electro-

lytic capacitor are mounted on this section, with the controls on the opposite side of the chassis. The input selector switch is mounted on one end, with a lever extending through the panel for its operation. If the chassis length were extended to eight or nine inches, the selector switch could then be mounted on the front in line with the other controls, and it is quite probable that it would be easier to install in a cabinet because of the difficulty in cutting a neat slot to pass the lever-type arm used to actuate the selector switch.

In the parts list several references were made to the text for further explanation. The volume control, R28, is the loudness control described in the February issue,<sup>1</sup> and consists of a

Centralab 1443 switch on which are mounted the resistors and capacitors necessary to obtain the desired compensation.

The high-frequency tone control switch, SW2, needs a little further description. The series of switches selected for the tone controls consists of small units which are desirable in such a compact amplifier. However, the exact assembly of contacts is not obtainable, so the switch used was made by using the frame and mechanism from a 3115J switch with the contact plate from a 3126J switch. This gives a number of tie points for the resistors used for the cut-off circuit, as well as for the input connection. The capacitors in this circuit are all mounted directly on the switch, being soldered to the frame for ground connection. This is not usually considered the best practice, but it must be remembered that this section of the amplifier does not have any a-c circuits in it, and there is little chance of ground loops causing hum trouble. Suffice that the unit as constructed exhibits no troubles from this source. The exact arrangement of the tone controls is shown in Fig. 3. Similar methods were used for both, in that all parts are wired directly to the switch, but the low-frequency control is a standard 3115J switch without modification.

The overall schematic, Fig. 4, is essentially a repetition of the schematic published last month, with the removal of R12 and C5 as previously discussed. The wiring diagram, Fig. 5, indicates the arrangement of parts and the wiring between them, while

Fig. 5. Input section wiring diagram.

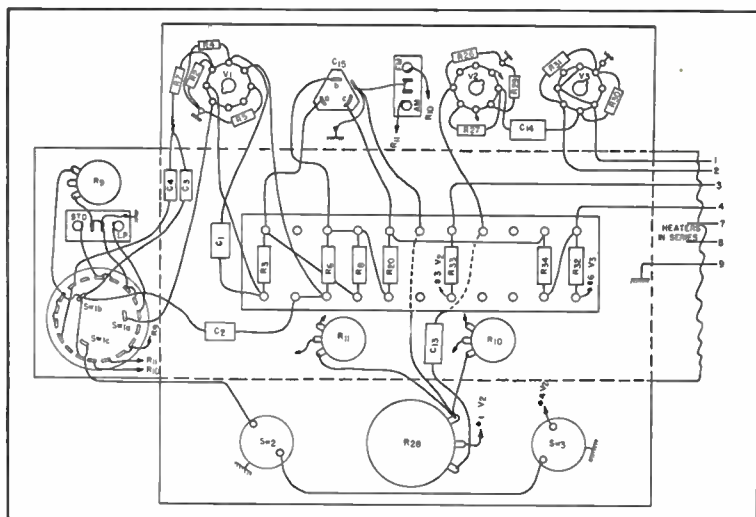

<sup>1</sup>"Full Range Loudness Control," Winslow, AUDIO ENGINEERING, Feb. 1949.



the photograph of *Fig. 6* shows the method of mounting the resistor strip on the back of the volume control switch.

Unless the builder is reasonably well experienced in construction of small amplifier equipment, it might be desirable to increase the overall size of the input section. It is definitely possible to construct the unit in the size shown, but it must be admitted that it is extremely compact, and as the size is reduced the complexity of construction is increased. Of course, once the amplifier is completed there should be no need to get at it again, assuming that the constructor takes reasonable care in the selection of resistor and capacitor ratings to prevent the possibility of failure in use.

A more conventional construction of this entire amplifier would undoubtedly reduce the hum level still further, and if a larger power transformer were used—one which could supply the 0.9 amps of filament current required by three 6-volt tubes in the input section—the electrostatic field existing between heater and cathode of the present first 12SL7 would be reduced. If made in two units, however, it would be preferable to use a separate cable from the power section to the preamplifier to carry the heater current, although the signal from the preamplifier to the power section is of a relatively high level and it is possible that no trouble would be encountered from this source.

If additional gain is required, the cathode follower section of  $V_2$  can be changed to a conventional amplifier, thus giving approximately 32 db more

**Fig. 6.** Interior of input section, showing the mounting of resistor strip on rear of compensating volume control.

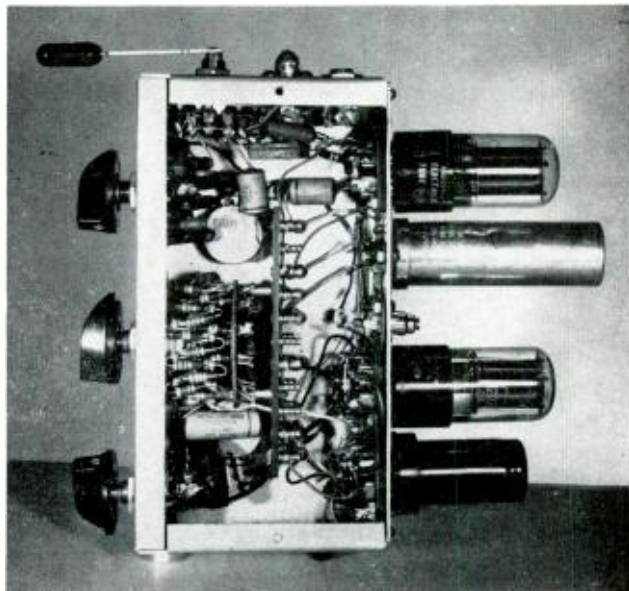

gain than with the present arrangement. For the uses for which this amplifier was designed, however, this should not be necessary. Another possibility is that a 6SN7 could be substituted for the 6SL7 used as  $V_2$ , (if a filament transformer were being used, together with 6-volt tubes) again using the amplifier connection rather than the cathode follower, and the increased gain would be of the order of 10 db. This suggestion would only apply if the filaments were arranged to be supplied from a transformer winding, since the 12SN7 will not operate in a series string with the 12SL7 and the 12SJ7, inasmuch as

the 12SN7 draws a filament current of 0.3 amps. These are design modifications, and some ingenuity on the part of the constructor will be necessary to arrive at the exact desired result. It is felt, however, that the amplifier as described performs satisfactorily, and that no changes are necessary for the purpose for which it was designed. The amplifier was designed for one application—that of modernizing an existing installation, or for providing a control arrangement which could be adapted to cramped quarters with the greatest of ease. This requirement is fulfilled adequately by the arrangement shown.

## Measuring Procedures for Magnetic Recording

**A**BOUT three years ago the Radio Manufacturers Association organized a subcommittee of the Committee on Phonograph Combinations and Home Recording to suggest standards for magnetic recording equipment. A series of sub-subcommittees were formed shortly thereafter, one of which was commissioned to work on "magnetic recording terminology" and to propose measuring procedures for magnetic recording. This sub-subcommittee has now released recommendations for measuring procedures for magnetic recording.

While it fully recognized that this material will be subject to modification with additional knowledge becoming available, it is felt that it presents a valuable basis for comparing the performance of various types of magnetic home recording equipment. To give this tentative proposal as wide a circulation as possible, the RMA Subcommittee on Magnetic Recording has approved its publication at this time.

Particular attention is called to the section on Noise which is subdivided into System Noise and Medium Noise. This subdivision has been suggested since in most cases the inherent noise generated by a completely neutralized medium is lower than the noise which might be expected in a typical magnetic recorder. It should be kept in mind, however, that noise measurements made, even on a properly neutralized medium, can produce indefinite results. To illustrate this point, a slightly magnetized reproducing head can greatly affect the noise generated by the magnetic recording medium and ambiguous results might be obtained.

For the proper evaluation of a medium, not only the ground noise of the medium as such is important but also the modulation noise (noise-behind-the-signal). No recommendations are presently available for an acceptable procedure for determining the noise-behind-the-signal. There can, however, be no question that there is a gap in the measuring procedures which eventually has to be bridged.

Another problem with which the investigator of magnetic recording equipment is confronted is the determination of amplitude variations which are experienced in reproduction when steady tone signals have previously been recorded. The performance of a magnetic recorder depends greatly upon the magnitude of such amplitude variations. Measuring procedures should eventually be provided to evaluate this deficiency of mediums and of complete magnetic recording systems.

### Measuring Procedures for Magnetic Recording

*RMA Sub-committee on Nomenclature and Measurements*  
*RMA Subcommittee on Magnetic Recorders R7.4*

#### 1. FREQUENCY RESPONSE OF UNEQUALIZED SYSTEM

The frequency response of a magnetic recording system depends upon the medi-

*(Continued on page 41)*



Lyle Van, WOR-Mutual's ace news commentator (right) hears principles of Altec miniature microphone explained by Paul S. Veneklasen (left), Altec Lansing physicist, who with W. J. Moreland worked on 3-year development project of the tiny microphone. Lyle Van's six-o'clock news broadcast Tuesday, March 8, was first time the new microphone was used on the air.

JOHN K. HILLIARD\*

Chief Engineer, Altec-Lansing Corp.  
1161 N. Vine St., Los Angeles, Calif.

## An Omnidirectional Microphone

The entire communication field advances to higher standards when previously unconquerable obstacles are surmounted. An indication that such a turn of events has occurred in the audio field comes with the introduction of a miniature condenser microphone, described in this article, with a diaphragm having the area of a human ear drum.

A large number of microphones have been developed since the original work of Alexander Graham Bell. In the broadcasting, recording, and sound reinforcement fields, the double-button carbon microphone was the earliest to come into widespread use. This was later replaced by the Wente type condenser microphone in 1927. A few years later, dynamic and ribbon microphones replaced the large diameter condenser type so as to obtain more uniform response and simplified equipment. Later, directional microphones incorporating features of both dynamic and ribbon types became available and were designed to provide various response patterns such as a figure eight (bi-directional), cardioid and modified cardioid patterns. Theoretical patterns indicate that ideal conditions can be achieved only under "dead room" conditions. These patterns are then considerably modified when used indoors, due to reflection from the wall surfaces. In the extreme case of very reverberant rooms, little directional gain can be obtained over that of non-directional microphones. Also, directional microphones are larger than non-directional units and the sound field is accordingly distorted by their obstacle effect. This results in a directional pattern that varies over

wide limits in frequency. The response angle becomes smaller at the higher frequencies.

Obstacle interference is a direct function of size and frequency. This varies the directivity and absolute output of a microphone. The solution to the problem lies in making the size extremely small.

A high degree of cancellation in cardioid microphones is usually obtained only at the middle frequencies. Compromises must be taken in phase shift by the use of mechanical and electrical networks to obtain approximately 180-degree cancellation. Earlier experiments and data on phase shift indicated that the human ear has difficulty in distinguishing between a system with considerable phase distortion and one without. However, later experiments indicate that a minimum phase shift is highly desirable in high-quality systems. In a comparison of high-quality systems having small and large amounts of phase distortion, the difference can be detected by a critical listening test.

All the microphones mentioned which have been available for high quality work have many undesirable characteristics, the most important of which are listed below:

1. Their large bulk causes shadows in

Motion Picture and Television work requiring that they be moved farther away from cast than otherwise desirable. In direct broadcasting or stage presentations they hide the face of the performer, since usual technique requires that the artist work very close to them.

2. Bass tones are unduly emphasized as the artists work closer to the microphones. This results in boomy reproduction with poor intelligibility.
3. Microphones having freely suspended ribbons are susceptible to puffs of air caused by breathing of the artist. This causes an objectionable rumble and in the extreme can produce damage. They are not shock-proof—a loud hand clap, or gun shot can render them inoperative. It is difficult to use them for exterior work in the presence of wind.
4. Because of their directional characteristics at close range, many microphones are used to give a required musical balance in orchestra or band pickup.
5. They have powerful magnets which attract iron filings and often block the microphone during operation.
6. The directional microphones limit the reproduction of the natural room tones which have been carefully designed by the architect for pleasing listening.

In order to overcome many of these undesirable features and limitations, a miniature condenser type microphone has been designed. Its overall dimension is 6/10" in diameter and 4/10" thick (approximately the size of a stack of six dimes). It weighs less than 1/4 ounce (6 grams). A small circumferential sound entrance channel

20 mils thick provides protection for the diaphragm and aids in obtaining an omnidirectional pickup characteristic. The diaphragm is one centimeter in diameter and is of a special laminated construction. The resonance of the diaphragm is at a high frequency and its peak is controlled by the damping so that it is negligible, varying  $\pm 1$  db from its low-frequency sensitivity.

The microphone is mounted on a base which has a maximum diameter of one inch. This base contains a 6AU6 miniature vacuum tube which is easily replaced and the bottom of the base contains a Cannon 6-pin plug.

The stand mount and output cable contains a Cannon receptacle and the necessary fitting with a  $\frac{3}{8}$ " -27 thread for stand mounts. This cable is in effect a single-conductor shielded cable designed to perform the necessary functions of the impedance-transforming tube by dividing between the central conductor group and an outer group which also functions to shield the inner signal carrying group. This outer shield provides the leads for heater current, high voltage supply and ground from the power supply. This cable may be as long as 400 feet and is attached by a 6-pin Cannon plug to the power supply and matching transformer unit.

The output level of the microphone system is -50 dbm in a sound field of 10 dynes/cm.<sup>2</sup> The matching transformer provides output impedances to work into equipment having assigned input impedances of 30-50, 150-250, 500-600 ohms. The output noise level is less than 30 phons.

The cable which supplies the impedance-transforming tube is in ef-

fect a single conductor cable in which the central signal-carrying conductors are surrounded and shielded by those which supply the tube operating power.

The blast-proof characteristics of the microphone make it unnecessary to protect it from extreme sound pres-



The miniature condenser type microphone, photographed inside a walnut shell, is shown here actual size.

sure levels and shocks which might cause distortion or damage to other type microphones. Tests made on this condenser microphone by firing a 22-calibre cartridge at a distance of eight inches indicate that its calibration is unchanged by such a blast. Based upon electrostatic rather than electromagnetic principles, it is not susceptible to iron filing damage or magnetic induction. The size of the housing and the diaphragm construction allow the microphone to be used under wind conditions in external pickup work that otherwise would be impractical. In public address and sound reinforcement applications, it is possible with this microphone to achieve at least 4 db higher amplification be-

fore feedback or howl is encountered than can be obtained with other non-directional microphones equal to the best directional microphones. Flat response (lack of peaks) explains why this is possible—plus the fact that the sound is practically all reflected energy when more than 20 feet away from the source (in rooms).

The microphone base is separated from the microphone by an extension which serves to reduce the obstacle interference in the immediate field of the microphone and also permits the microphone to be used directly in front of the artist with little shadow.

The weight of the combined microphone, base and extension is approximately four ounces. It is anticipated that because of its extremely small size, weight and shadow as well as other outstanding characteristics mentioned above, this microphone will facilitate heretofore unachieved pickup in the radio, television, recording and sound reinforcement fields.

The microphone system is the first of a series of apparatus resulting from a new basic investigation of sound pickup limitations. Major changes in technique, the development of new uses, and correlative advances in other fields are expected to result from this development.

So many Altec engineers have contributed to the development of this new microphone that no one person can be singled out for special mention. This project was initiated and supervised by G. L. Carrington. P. S. Veneklasen and W. J. Moreland were responsible for important electronic and mechanical developments. Capacitance of the microphone unit is less than 20 micromicrofarads.

## Mass Production Tape Recording

The final technical obstacle in the way of mass production of recorded music on tape now has been overcome. A machine has been perfected by Minnesota Mining and Manufacturing Company, St. Paul, that can simultaneously reproduce 48, hour-long tape recordings indistinguishable from the master transcription in one hour, according to an announcement by W. L. McKnight, president of the firm.

These pre-recorded reels of tape will be designed to compete with disc records for use in the home, in broadcasting, in schools and theatres. Since many sound engineers contend that magnetic sound tape has better fidelity than any other known sound recording medium, it is to be expected that

recorded music on tape may enjoy a competitive advantage over disc recordings, whether of the 78, 45, or 33-1/3 rpm variety. Tape recording machines for home use have been available for some time.

Minnesota Mining and Manufacturing Company describe the new machine as "a high fidelity multiple recorder capable of making tape recordings which are indistinguishable from the master transcription." Reproduction is accomplished by an electrical duplicating process in which the signals from a master copy are picked up by a playback head, amplified and fed electrically into a number of re-recording heads. The master tape and the tapes to be copied are all run side by side on a common capstan.

Thus exact speed relation is maintained at all times.

Recording tape is currently available only in the unrecorded form, which is used by the major broadcasting networks as well as in homes, offices and schools for making private transcriptions. Announcement of the multiple recorder, however, opens the way for mass production of pre-recorded music and promises to affect the whole field of sound recording. Perfection of the multiple tape recorder follows hard upon the introduction of 45 and 33-1/3 r.p.m. disc records and machines by Victor and Columbia respectively.

The single mass production recorder built to date has been offered for lease by Minnesota Mining and Manufacturing Company, its producer.

(Continued on page 47)



# RECORD REVUE

EDWARD TATNALL CANBY\*

**O**UR EDITOR has brought up a point concerning electronic musical instruments where I was technically in error, though the point I had to make was unaffected. In the February article I spoke of "pure" tones to be heard on an electric organ; it seems that according to engineering standards of measurement the fundamental tones produced by such devices are not pure, that indeed a pure tone is very difficult to achieve. What a pure tone is, then, is a matter of engineering vs. musical terminology. From a musical viewpoint, any tone that comes even fairly close to a continuous sine wave form is for all intents and purposes "pure"—by which we musicians mean, of course, something highly uncomplimentary. A continuous "pure" tone in music is a dead duck.<sup>1</sup> It's lifeless, featureless, without character, unfit for musical purposes altogether—just a noise. I'd say the principal musical difficulty with the electronic musical instrument is still that of oversimplification of the wave forms. You will find that the continuing distrust of such instruments (often a highly unreasonable blanket distrust that includes various instruments that work on utterly different principles) is, nevertheless, basically a feeling that the gadgets just aren't musically "natural," and this feeling must be reckoned with.

And by "natural," I hastily add, we do not mean that your electronic sound must be a good imitation of some specific natural sound. The advantage of the electronic sound is that it can introduce all sorts of new qualities. Few musicians would quibble about this—unless provoked by manufacturers who insist upon using such terms as "electronic clarinet." We are entirely ready to recognize the musical value of new tone color combinations whatever names may be assigned to them; silly, fanciful, inspirational, or what.

But whether your newly created electronic sound comes forth like a cello or an oboe, a new-born babe with asthma or a honking goose (a goose is straight-bore, producing only the odd overtones) the musician will give ear and instantly make up his mind on one vital point—whether the tone is *alive* or *dead*; musically natural or unnatural. Being no engineer, your musician will seldom be able to explain what

\*279 W. 4th St., New York 14, N. Y.

<sup>1</sup> The flute, as engineers know, can give an almost pure sine wave tone. But note well that such a tone is hardly what one hears in flute music. A flute player making actual music produces the same multiple varieties of irregularity that are described later in this article. There must be the ictus of the initial accent, a brilliance in loud passages (harmonic tone color) contrasting with less brilliance in soft passages, a vibrato that is among the most noticeable (and most irregular) in any musical instrument, a breath-sound that is normal part of the music (and is not a sine wave)—all this and more, in addition to rhythm, phrasing, etc. A mechanically played flute, actuated by a constant stream of compressed air, may produce a sine-wave—but the sound will be noise, not music. No electronic sine wave "beep" has yet been compared to flute music, that I know of!

he means. Being only human, he will give you lots of reasons for his energetic (and probably correct) opinions that will make no engineering sense, for the most part. (Note the singing teacher who insists that her pupils generate their tone somewhere in space a few feet in front of the forehead! Cockeyed, but pragmatic; it works, because with such conceptions singers actually do learn to produce good sounds.) Explanations in physical terms of these things are up to the engineers to make. And in every case the musician, however false his physics may be, has a basically sound idea, needing only the delicate physical interpretation that will reproduce it in electrical terms. What an astonishingly difficult and challenging area this fringe-area is, between the arts and the sciences, between objective scientific analysis and the far quicker, more penetrating human intuition! In the end, as we all have to admit, it's usually "hunch," that solves the most baffling problems, when the "hunch" is well backed by competent engineering training.

What then, is an "alive" musical tone? How can it be synthesized? This column has touched on the matter before, but look at it this way. To be musical a tone must be complex, irregular, and that in many different ways. It must avoid all sorts of too-regular mathematical patterns that will kill its musical effect. A paradox, since most of us have supposed that pitch and rhythm in music were at least reasonably fixed quantities, not to mention tone color. But no. Life, in tone, is highly delicate; it succumbs instantly to an overdose of regularity. Yes, there must be a sense of pitch, a fundamental tone that is interpretable to the ear in a very exact sense. But even this is seldom mathematically exact. A tone that is interpretable to the ear as an excellent musical "A" may be far removed from a pure 440 tone. Almost all musical tone, for example, includes the baffling feature of the vibrato. It is frequency modulated. Take a lady opera singer producing a walloping A and play her 78 rpm record at 33. You will be astonished at what the ear has managed in its own strange way to interpret as a pitch of 440! The vibrato may waver up and down so enormously that, at 33, the ear recognizes no fixed pitch whatever but only a sort of rapid-action fire siren. A graph of the sound would be even more baffling. Yet this isn't all—for even the vibrato's own frequency must not be fixed, if the tone is to be musical—as electric organ builders know to their own distress. The vibrato is *almost* regular, but never exactly so—make it mathematically regular, and instantly the tone is dead.

Moreover, the amplitude of your vibrato must not be exactly regular. Amplitude

too must vary minutely from instant to instant as the musical tone continues. Fix the amplitude mathematically and your tone is dead. Listen again to your lady singer and note how much the varying amplitude has to do with the musical sense of what she is singing—some passages being almost "flat," others being highly modulated with vibrato. So too with an oboe, a violin, even a trumpet. Only a few instruments dispense with the vibrato: the piano of course and its relatives; to a considerable extent, the clarinet.

But vibrato is merely one factor that must avoid the mathematically regular. Even more vital is the tone-color problem. Engineers tend to take an *average* tone color for, say, a clarinet, and assume that this is that instrument's official tone color. There is scarcely any instrument which produces a constant overtone pattern for more than a fraction of a second at a time; one of the main sources of musical "life" is the dynamically changing tone color of nearly all instruments as they (a) change pitch and (b) change intensity and (c) change methods of tone production. Perhaps the natural pipe-organ is the only instrument with a fixed overtone pattern that actually persists measurably.

All of which no doubt leaves most engineers exasperated—if music is as touchy as all this, what in Heaven's name is the use of trying to please a musician! And yet this *is* music and always will be. Exasperated or no, these are the actual problems that a sound engineer faces in any electronic musical instrument design and they cannot be dodged, only compromised with. When you come down to it (and this a fine reason for this column's discussion of the problem) the same sort of thing is true for the recorded art. If you are going to reproduce *musical* sound in a natural-sounding way you must meet the challenge of the musical ear. Your success as a sound man, given sound training, will depend on it, too.

Any electric organ designer knows that problems of naturalness go far beyond what I have suggested here. One must get the tone under way with the proper "ping" (the musical ear will take nothing else) and one must get it properly stopped, too. Can't just turn it on and off. One must see that the tone "speaks" a bit late in the keyboard-type instrument; the musician won't like an instantaneous action. Unnatural. Theoretically, as volume increases tone color should become more brilliant. Natural music works that way. And so on. These problems bedevil sound engineers and in practice they are bound to involve very great compromises all along the line, depending, of course, on the cash available to put into refinements. Theoretically anything is possible. Practically, the most ingenious compromise wins out musically. Far too often in today's electronic musical instrument some regularity gets in that "kills" the tone as far as

[Continued on page 33]



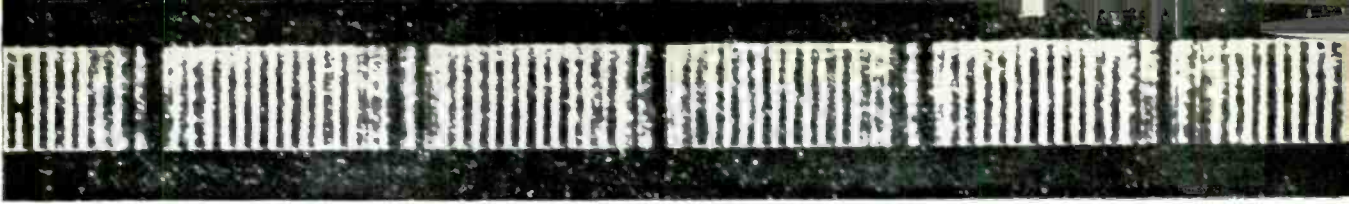

The beat note resulting from a high level recording of the two frequencies, 200 and 230 cps, is seen in this five times enlargement.

# Making Magnetic Recordings Visible

The technique used in making visible the sound tracks shown on this page was described in an article entitled, "Alignment of Magnetic Recording Heads" by B. F. Murphey and H. K. Smith in the January 1949 issue of *AUDIO ENGINEERING*. For some purposes, where several inches or feet of tape are to be visibly examined (as for editing), Mr. Robert Herr of Minnesota Mining & Mfg. Co., who has supplied these pictures, reports a more convenient and less messy method. The carbonyl iron is suspended by shaking

in a volatile liquid, such as heptane (which will not dissolve the tape) and the tape is dipped in this suspension for a few seconds. Upon removal, the liquid will dry quickly and the track becomes visible. The carbonyl iron may be removed by wiping it off. This method allows some flocculation of the particles and does not yield quite so good resolution as the suspension in a more viscous medium, but it is simpler and adequate for examination by the naked eye.

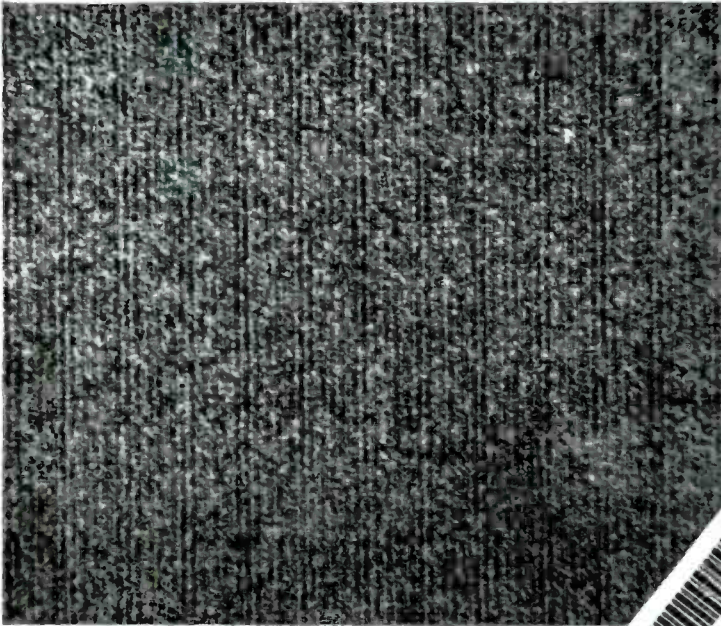

Above: A constant tone modulated by a vibrating head is shown here. Magnification X 60.

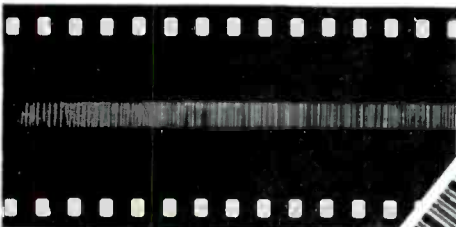

Above: Music recorded on oxide-coated 35 mm film is illustrated by this photo. Ready means for editing and track location is provided by making the track visible. No enlargement.

Below: The word "tape" was recorded with a full width 1/4" track, using an Ampex machine at 30 inches per second. Enlargement, X 1 1/4.

Below: 26-times enlargement of a 0.1-inch wavelength signal recorded on black oxide tape illustrates the fringing effect. In contrast to the other photo of a 100-mil track, no modulation noise is evident.

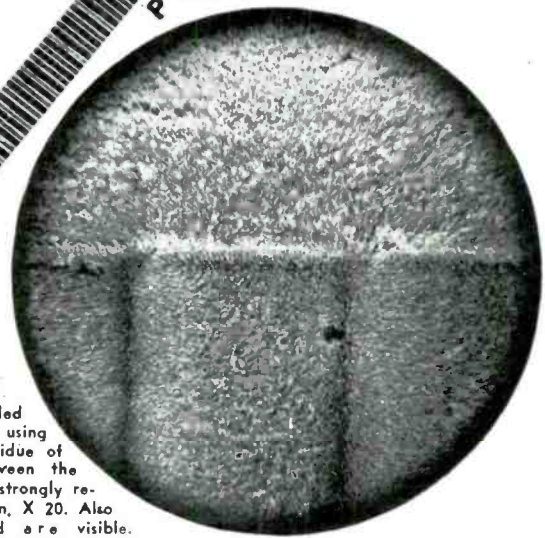

Below: A 0.1-inch wavelength recorded on a 0.1 inch track using noisy tape shows residue of modulation noise between the prominent poles of this strongly recorded signal. Magnification, X 20. Also lamination faults in head are visible.



# Experimental Ultrasonics

S. YOUNG WHITE\*

Part II—A description of some of the problems of instrumentation for experimental work in the realm of ultrasonic frequencies.

**A**BOUT THE MINIMUM AMOUNT of equipment required in the investigation of ultrasonics is a source of ultrasonic power, such as the Hartmann generator, a microphone or pick-up, and an indicating device such as a receiver or oscilloscope. Of course, other indicators can be used, such as pigeons or insects, which have positive reactions of various kinds to certain frequencies and amplitudes, but the lack of some measurement devices is rather a handicap.

One great difficulty in attempting to turn out a standard line of ultrasonic apparatus is the very complexity of the requirements. A biologist might wish to investigate the effect of ultrasonic stimulation on cancer, and a cathode-ray tube production man may wish to use the well-known dust precipitation effect to more rapidly coat his screen with phosphorus. In these cases both the generators and observation instrumentation would be quite different. Also, the biologist would be rather unskilled in using apparatus of this nature.

In this article we shall discuss some design features of rather small pick-up devices, such as would be used in a probe. It is almost universally true that all these receiving probes can just as well be used as low-power transmitters, so it would be a great advantage always to design them for both functions. It is also desirable to make them immersion-proof, if possible, so they can be used in liquids as well as air or other gases. Most of them have a natural temperature limitation of some kind, also, and we wish to extend this to its highest limit possible.

Another requirement is small size. These are to be used in sonic fields of small wave-length, and in general we wish them to disturb the field as little as possible. Of course, if we work up around the megacycle region, the physical size must be many wavelengths in dimension for practical apparatus for general use, although special microscopic devices

\*% Radio Magazines, Inc., 342 Madison Avenue, New York 17, N. Y.

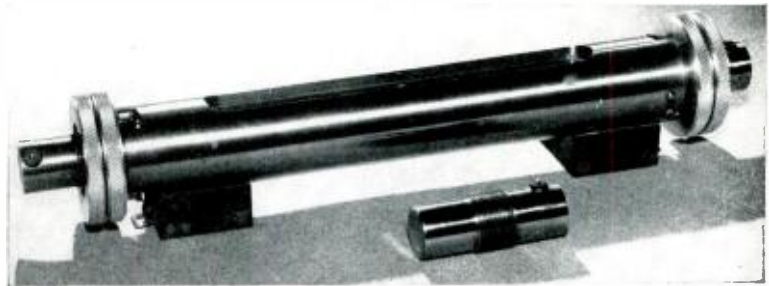

Test chamber used with two transducers for experiments with transmission through various media. One of the transducers of Fig. 1 is shown separately.

can be made if the requirement justifies the expenditure.

Shielding against powerful electromagnetic or electrostatic fields is often necessary. As a rule, 60-cycle hum pickup is small, but can be troublesome if not kept in mind. A particularly difficult case is when two magnetostrictive probes are used close together as transmitter and receiver. Very often the flux leakage from the transmitter will directly excite the receiving unit and the supersonic coupling through the medium will be masked.

It is a great advantage to design a series of units interconnected with modern, 52-ohm concentric cable. It has a nice line of fittings available for all purposes, provides good shielding, is low-loss at all frequencies we may wish to use, and is very neat and durable. Unfortunately, about the only type unit that can readily be made to match this low impedance is a magnetostrictive one. All the piezoelectrics suffer severely from the high capacitance, and sometimes it is necessary to go to troublesome or expensive steps to overcome this.

A real hardship in designing a line of units is the wide frequency range we generally wish to cover in general experimentation. A final commercial installation can often be designed to operate at one frequency only. Before we can determine this optimum frequency it may be necessary to investigate an enormous range of many octaves. In working with small particles in water it is usually interesting to investigate the entire spectrum from 10 kc to nearly 10 mc. This is a real test of the designer.

It is the purpose of this table to give a rather rough idea of the frequency limits of various transducers we may wish to use. The range designated as "natural" shows the frequency limits within which no unusual difficulty is had in normal design. The "extreme" range shows maximum performance ever observed by several experimenters. It may be only a single sharp peak shown in some unusual mode of oscillation.

#### Significance of the Resonant Peak

In general terms, we can operate our devices at resonance or off resonance by any desired amount. Since

TABLE 1

Device	Natural Range	Unloaded Q	Extreme Range	Max. Temp. (F)
Rochelle Bimorph	0 to 30 kc		0-2 mc	120
Rochelle single	0 to 300 kc	20,000	0-3 mc	120
PN	0- 200 (piston)		0-3 mc	250
Magnetostriction	10- 100 kc	30,000	200 kc	250
Rubber electrostatic	10- 500 kc		3 mc	150
Quartz	50- 7,000 kc	10,000	Very high	1,000



many show unloaded Q values that are very high, we can mount them so that high Q is maintained, or load them down to almost any extent.

The chief argument for high Q is the great output obtained at that resonant peak, a very strong argument indeed. The price one pays for it is high, however.

If the units are operated in pairs, one being the loudspeaker and the other the microphone, this resonance rise is squared, and the output is very favorable. The frequency stability on the transmitting signal source must be very great indeed, and in general is hardly practical. If we use a precision frequency standard for the signal to drive the transmitting transducer, it will not follow the transducer peak in many cases, as the transducer is out on the firing line, subjected to variations in temperature, vibration, pressure changes and the like while the standard crystal is locked up in a temperature oven. Also, in the field standing waves with ratios of ten to a hundred are rather common, and these change due to local conditions.

This severely limits the use of the high-Q transducer. So in practice a load sufficient to bring the Q down to as low as ten or thereabouts is often employed. Even at this low Q standing waves are severe, and frequency modulation must be employed to break them up.

This loading does not seriously affect the off-frequency operation of the devices, but of course operation off frequency severely cuts down the signal. A typical example is a pair of one-quarter inch cubes of PN crystal suitable for stable operation in a water supply which might have particles in it. At 200 kc operation, resonance for both units, an input of 200 volts of signal on one will give perhaps 2 volts on the receiving crystal, while off resonance at say 150 kc the combination might give an output of 5 millivolts or so.

#### Diaphragm Design

The only transducer diaphragm easy to design is the magnetostriction type. It is inherently rugged and needs little protection from gas or liquids. A simple metal disk silver-soldered on the end of the nickel rod, gives almost any desired acoustic impedance match.

PN and Rochelle crystals are very fragile and must be protected from shock and damage if used as contact microphones. PN instantly melts if one drop of water comes in contact with it, but Rochelle salt often can be given a protective coating to pre-

vent this. Quartz has high resistance and moisture must be kept out to preserve the insulation of the assembly. A 7-mc quartz crystal, of the X-cut type is about 20 mils thick, and is quite fragile.

So we have our choice of rubber (plastic) diaphragms, or solid metal. The rubber must be quite thin and offers little protection from sharp points. However, diaphragms made from thin rubber, nylon, or Teflon of a thickness of only two mils or so are very easy to handle, as below 200 kc or so they have little effect on the transmission of ultrasonics through them. To provide clean-cut effects, they must be placed under tension in some way, and the mounting made waterproof by some means.

#### Standardized Shell For All Frequencies

Figure 1 and the photograph show an earnest attempt to design a uni-

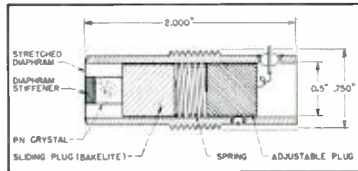

Fig. 1. Universal shell design for transducer suitable for wide range of ultrasonic frequencies.

versal shell of wide application in ultrasonic commercial and experimental work. In most cases it has a metal diaphragm. This was designed to operate through the spectrum from 10 kc to 7 mc, using practically any type of transducer from magnetostriction to X-cut quartz.

An accurate half-inch bore dimension was used with a thick wall so that set-screws and glass-bead lead-throughs could be used. A three-quarter inch thread was formed on the center section and this made the tube outside diameter 0.690 inch, as this cleared the root diameter of the thread. This thread was made rather fine, 24 threads/inch, as very often we want fine adjustment of the position of the diaphragm in our tests. The shell was usually made of monel, because it is an attractive material unaffected by many liquids. Sometimes

Transducer probe for use in air. Details of the interior of the crystal mounting are shown in Fig. 3.



it was hard chrome-plated, or gold plating was called for. A length of 2 inches worked out well.

The series of diaphragms gave us the most trouble to design. If we use quartz or PN crystals, they are mechanically dead flat, and the diaphragm is often used under at least city water pressure, which might reach 60 pounds/square inch at times.

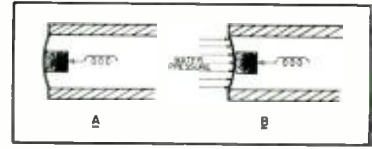

Fig. 2.(B) When used under pressure, diaphragm is pushed inward, providing contact on only a portion of the crystal surface. (A) Pressure behind the crystal bulges diaphragm outward, provides contact only on corners.

This bulges the diaphragm inwards, as shown in Fig. 2B, and the crystal would only touch in the center of its working face. In general, we need some pressure driving the crystal against the diaphragm, to obtain intimate contact, and with no pressure on the outside of the diaphragm a reverse bulge takes place, as in Fig. 2A, and the crystal touches on the corners only.

By soldering a one-quarter inch button to the center of the diaphragm, we accomplish two objectives: At some high frequency any diaphragm breaks up into complicated modes of oscillation, which produce lobes in the radiated or received pattern. A piston action is much easier to analyze and use. This local thickening in the center turns the quarter-inch center into a piston very well, as experience has shown, and gives a pattern very easy to use.

In practice, some care must be used in making and mounting this center button. Since it will often be used with a precision finished transducer element, it must be dead flat and squarely mounted. If slightly cocked, the pattern put out is hard to analyze, and results are undisciplined.

[Continued on page 38]

# The Cutting Stylus Problem In Microgroove Recording

"Stylus"

A discussion of the effect of burnishing-facet dimensions on frequency response.

THE CURRENT INTEREST in new methods of sound recording has made many an engineer re-examine more critically the faults of older systems. Modern disc recordists have become increasingly conscious of diameter effects, and particularly of loss of high-frequency response at smaller diameters. This loss occurs in two parts: First, a loss in recording due to the cutting stylus shape; and secondly, a loss in reproduction due to the reproducing stylus failing to follow the finer groove convolutions faithfully (tracing loss). Reproducing loss can be reduced by using a smaller stylus tip, within reason. In the case of lacquer, it can be reduced by using a harder lacquer, again within reason.

Only recently has there been much interest in minimizing recording loss. It is not generally realized that com-

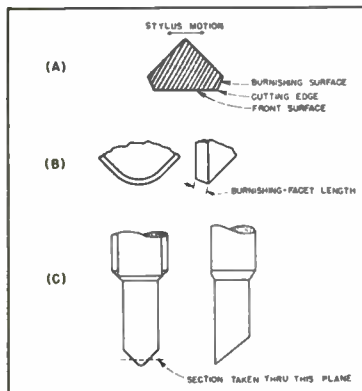

Fig. 1. (A) General view of lacquer cutting stylus. (B) Magnified view of cutting stylus tip. (C) Magnified cross section of tip.

monly used lacquer-cutting styli polish the groove walls by a burnishing action after cutting. This effect is comparable to the use of a dulled cutting tool in making a polished cut in brass.

As the polishing action is made more effective by increased burnishing-surface length, the high frequency response deteriorates. A glance at

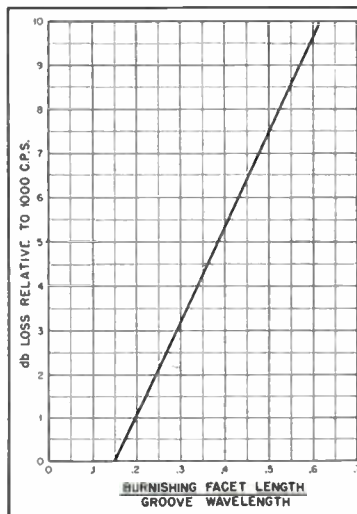
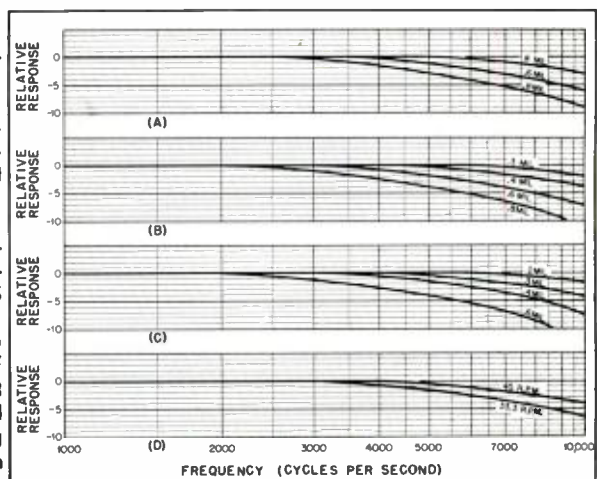

Fig. 2. Generalized effect of burnishing-facet length.

Fig. 1 will illustrate why. Effectively, there are flats on the sides of the stylus, which impede lateral motion.

The shape of the stylus and the nature of recording lacquer are such that it is not feasible to derive a solution by theoretical means, and so laboratory methods must be used. The

Fig. 3. (A) Frequency response of recording stylus at 8 inch diameter, 33.3 rpm. (B) Frequency response of recording stylus at 7 inch diameter, 33.3 rpm. (C) Frequency response of recording stylus at 5 inch diameter, 33.3 rpm. (D) Comparison of response at 33.3 and 45 rpm, .4 mil burnishing facet, 5 inch diameter.



only quantitative study of this phenomenon, which has been published, is that of LeBel<sup>1</sup> in 1942. While the original study was made with a standard-size groove, we believe that its conclusions may be applied to the microgroove without too much error. Every cutting stylus has a certain amount of personality of its own anyhow, and the variability so produced is superimposed on the general trend.

We have used the generalized solution given by the above reference—a graph showing the relation between the fraction: burnish length/wavelength, and the attenuation in recording. We have taken the liberty of continuing the main trend for a db further than the reference has, for reasons that will be evident on inspection of his data. This slightly modified graph appears as Fig. 2.

The tests on which this curve is based were run at a stylus velocity of 1½ inches, and checked at 2¾ inches per second. Visual inspection of Fig. 1(A) will suggest that the loss might increase at very high peak velocities, but the velocities indicated include the range of velocities normally expected.

The LeBel study was made in terms of tip burnish length, which is the easiest to measure accurately. The

*you get*

# ALL THIS!

*in the* **IMPROVED**

# Cardyne

CARDIOID DYNAMIC  
MICROPHONE

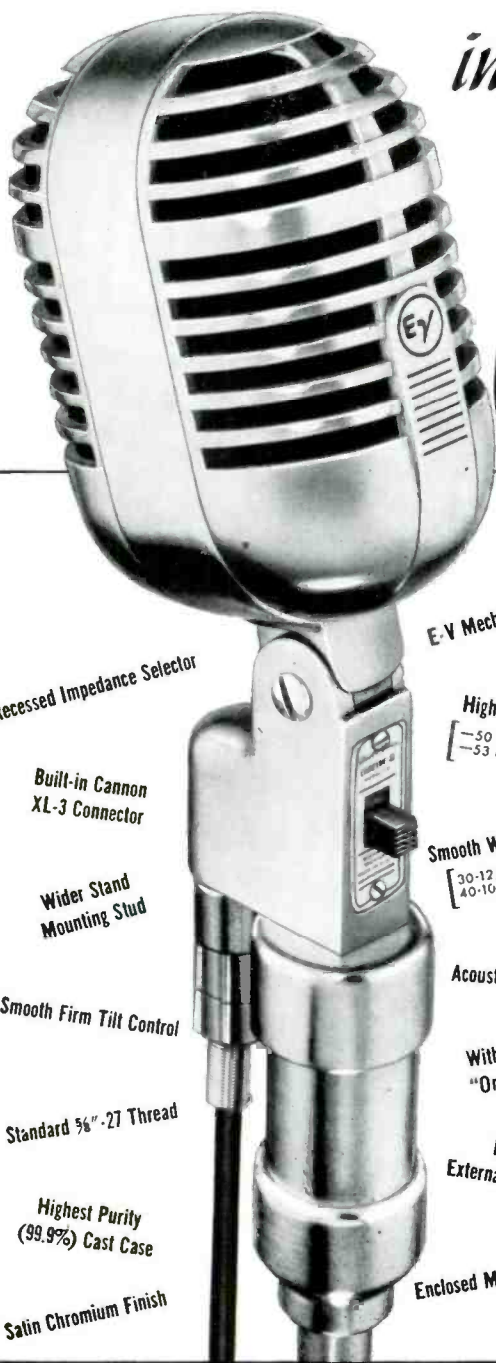

Recessed Impedance Selector

Built-in Cannon  
XL-3 Connector

Wider Stand  
Mounting Stud

Smooth Firm Tilt Control

Standard 3/8" -27 Thread

Highest Purity  
(99.9%) Cast Case

Satin Chromium Finish

E-V Mechanophase\* Cardioid

High Output Level  
[-50 db, Model 731]  
[-53 db, Model 726]

Smooth Wide Range Response  
[30-12,000 cps, Model 731]  
[40-10,000 cps, Model 726]

Exclusive  
Acoustalloy Diaphragm

With or Without  
"On-Off" Switch

Dual-Type  
External Shock Mount

Enclosed Magnetic Assembly

## It Means: Better Performance! Finer Quality! Greater Value!

● Here you have reason after reason for the growing popularity of the CARDYNE. *More features have been added . . . response improved . . . output level increased . . . to provide a higher standard of excellence! It all adds up to greater satisfaction on the job!*

The E-V Mechanophase\* principle provides a high degree of unidirectionality at all frequencies . . . cuts reverberation and random noise pick-up . . . stops feedback . . . nearly doubles conventional pick-up range . . . provides clear, natural close-up response. The *Acoustalloy* diaphragm withstands severest service. *Just try the CARDYNE now!*

E-V Model 731. Broadcast Cardyne II.  
List Price . . . . . \$80.00

E-V Model 726. Cardyne I. With MC-3 connector and without external shock mount. List Price . . . . . \$59.50

SEND FOR CARDYNE BULLETIN NO. 139

ELECTRO-VOICE, INC., BUCHANAN, MICH.  
Export: 13 E. 40th St. • New York 16, U.S.A., Cables: Arlab

NO FINER CHOICE THAN

# Electro-Voice

\*Patent Pend.



length at the sides may be slightly less, with the decrease somewhat under the control of the lapidary.

The following formula is too obvious to require derivation:

$$\text{Burnish length} = \frac{f l}{\pi D n}$$

Groove wavelength  
 where  $f$  = frequency in cps  
 $l$  = burnish length, inches  
 $D$  = recording diameter, inches  
 $n$  = speed in rps

A glance will show that the fraction increases with frequency and burnish length, and decreases with an increase of speed or diameter. From this formula the graphs of Fig. 3 were computed.

A condition typical of standard high-quality 16-inch transcription recording is shown in Fig. 3(A). By the use of 136 or 144 pitch, the inner diameter is limited to 8 inches.

At (B) we have a condition occurring in many broadcast stations which have continued to record transcriptions with the pitch of ten years ago. This results in an inner diameter of 7 inches. The injurious effect of a given burnish is measurably greater, as can be seen by looking at the 10 kc response. Incidentally, this is fairly close to the outer recording diameter of a 7-inch microgroove disc.

#### Conclusions

Finally, we go in to the innermost diameter of a microgroove record—about 5 inches—at (C). A very small

burnish is necessary, else the high frequency loss rises rapidly.

Just for comparison, at (D) we have plotted the response of a .4 mil burnish at 5 inches diameter at 33.3 and 45 rpm. The higher speed eases response problems, by 3 db at 10 kc in this case. This saving taken alone

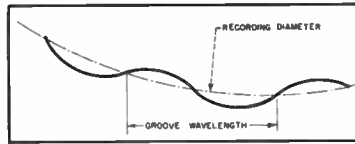

Fig. 4. Groove wavelength and recording diameter.

would not be significant, but similar savings accrue at other stages in the recording process, making a significant total.

With current interest in higher fidelity, it is evident that burnish length will have to be limited. The high quality transcription recordist and the microgroove specialist will both have to use care.

Transcription work will have to use a burnish of not over a half mil, approximately. It is not difficult to make such a stylus satisfactorily quiet. A great many 10- and 12-inch microgroove discs are recorded in to only a 7-inch diameter, and a similar stylus will often suffice. On the other hand, the recordist working with 7-inch microgroove discs will be faced

with a real problem. Compelled to use a burnish of about a quarter mil, he may have difficulty in getting a quiet groove unless he uses a higher cost stylus. It is a good deal harder to get a quiet groove when using a small burnish, and the lapidary may have to be much more careful than he is with a half-mil burnish.

In spite of all these precautions, not every stylus will have equally good frequency response, and it may be desirable for the recordist working at less than 6-inch diameter to check each stylus individually, using the poorer points for less critical work.

It should also be recognized that small-burnish styli of the best quality are not all equally quiet. Some are satisfactory all the way in to 5 inches, while others start to become noisy at the 6-inch diameter. It is highly desirable to segregate the latter for use at the larger diameters only. Again we may say that each stylus has a personality of its own.

One may object that this is a lot of work. True, unfortunately, for the secret of good recording quality has always been meticulous care, and we see no chance of the future remedying the situation.

#### Reference

1. C. J. LeBel, Properties of the Dulled Lacquer Cutting Stylus, *J. Acous. Soc. Am.*, Vol. 13, No. 3, pp 265—273, January 1942.

## Report on 1948 Convention of Speech Assn. of America

**T**HE problems and limitations of bone conduction audiometry were discussed at the 1948 convention of the American Speech and Hearing Association by the well-known authority on hearing measurement, Dr. Scott Reger of the State University of Iowa. His paper, "Factors Influencing the Accuracy and Interpretation of Bone Conduction Hearing Tests," was presented in Washington, D. C., on Dec. 28th.

He first touched on the inherent inaccuracy of measurement of bone conduction and air conduction hearing thresholds by the use of tuning forks as described by Weber, Rinne, and Schwabach. These methods would be valid only if controlled by elaborate instrumentation. While the modern audiometer is superior to the tuning fork, he criticized the naive assumption that the audiometer is a precision instrument. Measurements made with a perfect audiometer under ideal test conditions are only as accurate as the audiologist's testing skill and knowledge about the limi-

tations of his instrument and testing technique.

It is necessary to hold the audiometer's bone conduction vibrator against the skull with constant pressure, because the pressure governs the mechanical coupling between vibrator and head. Also, with some types of magnetic vibrators, the distance between armature and pole pieces (and hence the output) is affected by pressure. He used a pressure of 1000 grams, controlled by a special headband structure.

To measure the resulting vibrations of the skull, he used a crystal-type contact microphone held against the frontal eminence of the forehead by a heavy rubber band. This made possible a study of the vibration waveform, and of the vibrator linearity.

In testing a vibrator it is necessary to determine the difference between the bone conduction threshold of a given unit, and the air conduction threshold produced by the same vi-

brator due to leakage. The differential should be at least 15 db.

He then discussed the application of bone and air conduction measurements to the localization of ear pathology. This was then used to explain why some untrained individuals have acceptable speech even though hard-of-hearing from childhood, while others do not. Children with middle-ear impairment may hear their own voices very well by bone conduction, even though their air conduction hearing of other people is inadequate. They will tend to have normal speech development, while those with an inner ear lesion, and hence impaired bone conduction, from childhood may be in serious need of speech training. Except in extreme cases, this will be of help.

#### Recording Equipment

A symposium of interest to recording equipment designers was held on the morning of December 30, presenting the following subjects and speakers.

[Continued on page 36]

**NOW!**

**SIMPLIFIED**

# A PRECISION HIGH QUALITY **TAPE RECORDER!**

FOR EASY FOOLPROOF OPERATION

EQUIPPED WITH THE **NEW - MAGIC - SWITCH**

**ONE CONTROL!**

- NO SOLENOIDS
- NO RELAYS
- NO BUTTONS TO PUSH

INSTANTANEOUS READING OF INPUT AND OUTPUT LEVELS

**OVERALL DISTORTION LESS THAN 1%**

LOWER FLUTTER • LOWER NOISE LEVEL

**MODEL E-3-T. R.**

See this and many other products  
manufactured by Arcturus at the N. A. B.  
Convention, Hotel Stevens, Chicago.

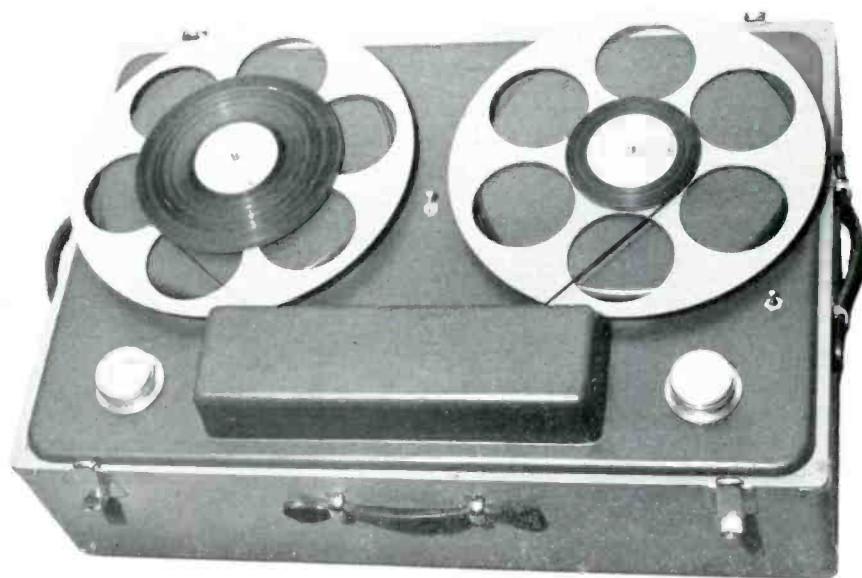

**SEE OUR PRODUCTS at the N. A. B. CONVENTION**

**ALSO AVAILABLE! THE FIRST TAPE PHONOGRAPH!**

Editing Facilities, Timing Meters and Variable Equalizers for Matching Any Tape Response Curve.

contact us at N. A. B. CONVENTION, CHICAGO

Agents and Distributors — Wire — Phone — Write — or contact us at the N. A. B. Convention

**CLIFF McDONALD**

**ARCTURUS ENGINEERING CORPORATION**

1755 Glendale Boulevard • Phone NO 3-1239 • Los Angeles 26, California

# NEW PRODUCTS

## NEW JACK

A new, improved ADC jack for jack panels and numerous similar uses is being produced and distributed by Audio Development Co., 2833 Thirteenth Ave. So., Minneapolis 7, Minn.

The frame of the new ADC jack is made of nickel plated, heavy gauge steel,



and is die-formed and press-welded for utmost rigidity and dimensional accuracy. The brass sleeve is nickel plated. To meet the high corrosion resistance requirements called for, silver alloy contacts and nickel silver springs were specified in the new design.

Dimensions of the new jack are standard, and like earlier types of ADC jacks it is interchangeable with any standard telephone type jack using a 3/4" plug.

## ALL-TRIODE AMPLIFIER

A high-fidelity, medium power, all-triode amplifier is announced by the Browning Laboratories, Inc., of Winchester, Mass. as a companion unit to their recently released RJ-20 high-fidelity FM-AM Tuner. Designated as Model AA-20, the new amplifier features all triode voltage gain and power stages for response within 1 db. from 10 to 17,000 cycles with less than 1 1/2% harmonic distortion at 14 of the rated 15 watts output. Hum level is 65 db below maximum rated output. Extremely high quality pushpull input and output transformers are used and voice coils from 1.2 to 30 ohms can be matched by tap selection. The output stage is pushpull 6B4G's driven by two triode sections of a 6SN7 in cascade with

separate bias rectifier. Convenience receptacle provides voltages for operating noise suppressors or preamplifiers for reluctance pickups. Use of the AA-20 is recommended with the Model RJ-20 Tuner for high fidelity installations.

## NEW RESISTOR

• A positive advance in the field of electrical resistance has been established by the Engineering and Research Departments of International Resistance Co. After years of wartime and postwar exploration and development, a new insulated fixed composition resistor has been produced that challenges performance standards for that type resistance unit.

This new resistor, designated by IRC as the Advanced Type BT, is being produced in 1/3, 1/2, 1 and 2 watt ratings—equivalent to JAN Types RC10, RC20, RC30 and RC41. It meets joint Army-Navy requirements under JAN-R-11 specifications.

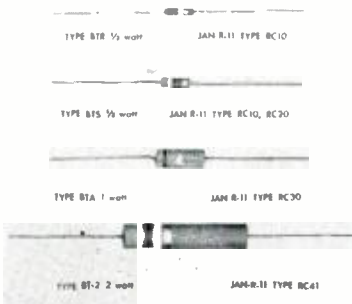

Production experience by IRC on this advanced resistor currently totals over 70 million units.

This family of tiny resistors (type BTR resistor body measures 3/32" x 13/32") is furnished in ± 5%, 10% 20% tolerances in RMA resistance ranges. Temperature coefficient varies from 0.02% per °C. for low ranges to 0.14% per °C. for high ranges. Depending on the size of the resistor, voltage coefficient varies between 0.0% and 0.27% per volt. Noise level is inherently uniform and low. The element, constructed to IRC's filament principle, is housed in phenolic resin; High pressure molding of the housing provides maximum security against humidity damage and moisture penetration, and enables this new resistor to withstand the most severe salt water immersion tests.

For short periods, overloads of 50% to 100% may be applied without damage to the Advanced BT, and 5 second overloads of 2.5 times rated load result in only negligible resistance changes. Frequency characteristics and other performance data are given in Technical Bulletin B-1. Copies may be obtained from International Resistance Co., 401 N. Broad St., Phila. 8, Pa.

## EQUALIZER-AMPLIFIER

A new Equalizer-Amplifier, the Model EA-3, for use in conjunction with Astatic Corporation's highly touted Magneto-Induction Pickup Cartridge, brings to a total of three such accessory units produced by this pioneer Conneaut, Ohio, sound equipment manufacturer.

Astatic invaded less than a year ago the magnetic type cartridge field, with announcement of its revolutionary Magneto-Induction Pickup, after years of adhering solely to the development and production of crystal devices. Radical reversal of engineering precedent and drastic simplification, embodied in the Magneto-Induction unit, eliminate need for delicate handling and common sources of trouble with magnetic type cartridges, the firm

## PROFESSIONAL DIRECTORY

### C. J. LEBEL AUDIO CONSULTANT

370 RIVERSIDE DRIVE  
NEW YORK 25, N. Y.



Consultation • Design • Fabrication

### Audio Research Associates

608 Fifth Avenue  
New York 20, N. Y.

### Custom-Built Equipment

### U. S. Recording Co.

1121 Vermont Ave., Washington 5, D. C.

STerling 3626

### Winston Wells

Designer and Consultant

Acoustical, Electronic and Nuclear  
Research

307 East 44th St. MU 4-3487

New York 17, N. Y.

### RATES FOR PROFESSIONAL CARDS IN THIS DIRECTORY

•  
\$10 Per Month for This Standard  
Space. Orders Are Accepted  
for 12 Insertions Only

### S. Young White

Ultrasonics and Transistors

Box 1386

Audio Engineering



claims. The result is peak fidelity of reproduction that is not diminished by consistent service or adverse climatic conditions.

With the advent of the new long-playing records, the Magneto-Induction Cartridge was one of the first adapted by Astatic to the new requirements. It is

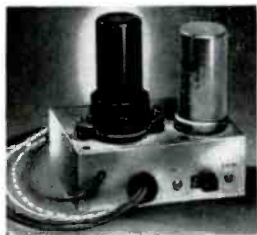

thus available in models for both standard 78 RPM and long-playing microgroove platters.

The Magneto-Induction Pickup has enjoyed steadily mounting acceptance since its introduction. It is felt that availability of a third type of Equalizer-Amplifier, which lends itself most advantageously to many applications, will stimulate still further the rate with which the cartridge itself is being adopted by the trade.

#### WIDE-RANGE CAPACITANCE TEST BRIDGE

The General Radio Type 1611-A Capacitance Test Bridge measures capacitance over the extremely wide range of 1  $\mu\text{f}$  to 10,000  $\mu\text{f}$ , a total spread of 10 billion to one. Over this entire range an accuracy of  $\pm(1\% + 1 \mu\text{f})$  is maintained. The dissipation factor range is 0 to 60%. The frequency of the test voltage is 60 cycles.

The bridge is useful for measuring all types of capacitors, and the dielectric constant and dissipation factor of both solid and liquid insulating materials. It is also suitable for the shop testing of bushings and insulators in the electric power industry. Facilities are provided for introducing a polarizing voltage for the measurement of electrolytic capacitors.

A feature of the bridge is a unique zero-compensating circuit that balances out the initial capacitance and dissipation factor at zero setting of the dials.

The bridge is completely self-contained, including visual null detector, and operates from the 60-cycle power line. The case is of the airplane-luggage type, with handle for carrying. Over-all dimensions are 14½ x 16 x 10 inches, and net weight is 30½ pounds.

#### BROADCAST EQUIPMENT BROCHURE

Three new brochures describing RCA's finest AM broadcast transmitter and new AM-FM and television studio audio equipment are now available to those requesting them on broadcast station letterhead addressed to RCA field offices or to the Broadcast Equipment Section of RCA Victor, Camden, N. J., it has been announced by the RCA Engineering Products Department.

AM BROADCAST TRANSMITTER (Form 2J-4367) fully describes the BTA-50F1, latest model in RCA's series of 50,000-watt AM broadcast transmitters. The new power-saving triodes and other design features which can cut broadcasting costs up to \$12,000 a year are presented in detail in the 24-page booklet.

BROADCAST TWO-STUDIO CONSOLLETTE (Form 2J-4604) provides detailed information on the broadcast two-studio

# Diamonds cost less . . .



**P**ICK-UP cartridges equipped with diamond styli may cost more than sapphire or metal stylus cartridges, initially, but the useful life of a diamond stylus cartridge is so much greater than the difference in cost that, from the viewpoint of length of service, listening pleasure and record life, diamond styli cartridges are cheapest by any comparison.

For those who want and demand the highest quality record reproduction and who don't want their records chewed up by being played with worn styli, the values of a Pickering Diamond Cartridge will prove most significant.

Pickering Diamond Cartridges are unique—their supremacy is unchallenged. They meet the exacting requirements of the most critical listener who wants to hear the realism and brilliance originally recorded and which makes record playing such a pleasure. The design and manufacture of Pickering Diamond Cartridges include all known factors which minimize record wear and eliminate unpleasant, annoying sounds while recreating the quality, brilliance and realism of the original recording.

The diamonds used for the stylus of Pickering cartridges are whole diamonds and not splints. They are more resistant to damage than any other stylus gem material (sapphire, ruby or diamond splints). They are well cut, gem-polished to high accuracy and precisely mounted to ride smoothly in the groove walls, reproducing all the fine modulations which can be pressed into modern recordings.

Pickering Diamond Cartridges are good for thousands of playings . . . compared with hundreds for sapphire and less for metal styli. An authority writing on wear resistance of stylus materials, states— ". . . the ratio of wear resistance between diamonds and sapphires is 90 to 1 in favor of diamonds."

Pickering Diamond Pick-up Cartridges are true gems for record playing . . . and cost less.

**Model D-120** for transcriptions and lacquer discs

**Model R-150** for phonograph records

**Model D-140** for microgroove records

Order your Pickering Pick-up Cartridges from your favorite jobber.



## PICKERING

& COMPANY, INCORPORATED  
OCEANSIDE, NEW YORK

# The New Somerset NOISE SUPPRESSOR\* PREAMPLIFIER

Successfully exhibited and demonstrated at the  
1949 I. R. E. Show in New York City



- Accomplishes a high degree of noise reduction — maintains natural brilliance and realism — essential overtones are reproduced at all volume levels.
- Introduces no unnatural tonal qualities in the reproduction.
- Can be used with most existing record players and FM or AM tuners.
- Installation and operation require no technical skill.

List Price **\$79.50**

## SPECIFICATIONS:

- Power supply** — 115 volts, 50-60 cycles, a. c.  
**Frequency range** — 40 to 15,000 c.p.s.  
**Gain** — .01 volts input produces .8 volts output to volume control of .25 to 1 megohm.  
**Input sources** — magnetic or crystal pickups, and FM or AM detector output.  
**Tube complement** — 2-6SL7GT, 1-6SK7GT, 1-6SJ7GT, 1-5Y3GT.  
**Size of chassis** — 7" x 9" x 2".

Also supplied in combination with a high quality power amplifier for custom and commercial installations.

**Professional Model with additional features for broadcast, recording and other exacting requirements available. Price on request.**

\*Patents Pending

**SOMERSET LABORATORIES, INC.**  
1701 Palisade Avenue,  
Union City, New Jersey

consolette (Type 76C). This 20-page brochure furnishes complete operating data and specifications, as well as simplified line drawings.

CONSOLETTTE SWITCHING SYSTEMS (Form 2J-4622) presents 16 pages of complete information on the latest consolette-type switching systems, Models BCS-1A, -2A, and -3A, for AM-FM and TV networks. Elaborate or simple switching problems for controlling up to 15 studios are outlined in detail in this brochure.

## SOS CINEMA CATALOG

A new 64 page catalog covering every phase of motion picture theatre operation has been issued by the S. O. S. Cinema Supply Corp. Over 100 illustrations distributed throughout the book alongside the text make it simple to order the wanted part.

Sections are devoted to equipment for auditorium, booth, drive-in theatres, electrical installations, lobby, boxoffice, photography, portable and home movies, projection lighting, 16 and 35 mm projection, public address systems, theatre sound, stage, studio, recording and laboratory.

This 1949 edition is claimed to be the most complete listing ever issued in the trade and bears out the S. O. S. tradition as the "Department Store for the Motion Picture Industry."

## — News —

### NEW AUDIO CONSULTING FIRM

Audio Research Associates, 608 Fifth Avenue, New York, has recently been organized with J. H. Beaumont as general manager and L. S. Goodfriend as chief engineer. The services furnished by the new firm include anything from changing a tube in an amplifier to the complete design of a theatrically equipped auditorium, including the lighting, sound control, acoustical treatment, and general overall problems.

The staff includes a number of leading specialists in the fields of audio facilities, the theatre, architectural acoustics, recording and reproducing systems, hearing aids, residence radio systems, psycho-acoustics, patents, technical manuals, and psychological problems. Their work includes consulting, design, preparation of specifications, fabrication, installation, and operation.

\* \* \*

### ERRATA

George W. Curran, whose excellent article on the "Use of the Transmission Measuring Set" appeared in the February issue, has mentioned a few errors in typography, all on page 28. The first word on the page should be "Choose" instead of "constant." Paragraph *f* in the second column should read "The gain of the X-amplifier at the reference frequency will then be equal to the amount it was necessary to change the GS loss in (e)." The second paragraph in the third column should read, "The auxiliary amplifier will not be needed if the AF oscillator can deliver a level at the output of the branch pad equal to the rated output of the X-amplifier."

## RECORD REVUE

[from page 22]

music is concerned. And I repeat, your musician is on absolutely solid ground when he objects. After all, are you designing an electronic instrument or a musical one? Some too-pure wave form is generated that, though perhaps highly impure technically, measured for distortion, is nevertheless too simple, too fixed in its pattern for the musical ear to take as the basis for musical performance.

The type of electric organ in which sliders are pulled out to add each of the overtones of a "pure" fundamental is to some extent a victim of this too-simple pattern. The fundamentals generated by this machine are incredibly dead to any musical ear, even if something less than pure by distortion measurement. Even with a maximum of tone coloration added, via the sliders, the compound tone generated is still, to most musicians, relatively dead and unmusical. That is a widespread opinion. Hence, for the purposes of my February argument on tone color vs. harmony and counterpoint, we may consider the basic tone of this type of instrument as pure—far too pure.

All of which leads to brief mention of an electronic keyboard instrument now under development by a well-known sound engineer who shall be nameless, which I played at length last week. Good. Remarkably alive, though it is designed for the simplest uses at a low (home instrument) price. The answer to this good musical quality would seem to be (a) specifically, tone color directly generated along with the fundamental, as harmonic "distortion" (or so I understand it); (b) more generally, a rather nice appreciation of the importance of all these semi-psychological laws for musical-sounding tone, plus a common-sense, ingenious application of them within the limited means available.

Vital items were, for instance, to my ear, the excellently contrived initial *ictus*, the "speaking" of the sound; similarly, the well-calculated decay rate when the key is lifted. Neither is consciously noticeable, nor should be; the net effect, though, is a sense of rightness, of appropriately musical sound. A fairly simple matter of electronic principle—except for the decision as to values; and that is where it takes what this designing outfit seems to have, a sense for music and the ability to interpret that sense directly into *mfds*. Another item I found pleasing musically was the longer time required for the keys to "speak" in the low registers, as compared to the upper, an excellent and thoroughly musical idea. The lowest tones were so realistically delayed and came in with such a fine "blat" that one would swear a heavy reed was speaking. That's the kind of thing a musician can understand.

### Musical Tone — Dead or Alive

Between the misprint and the correction in a monthly magazine there's a long wait—here's a bit of verbal unangling that goes back to the February issue. What came out takes the prize for insanity among our supposedly sane contributors. Naturally all our readers keep back issues of AUDIO ENGINEERING. Kindly turn to p. 30 of the February issue and look at paragraph two. Note that the second line ("that changes inde cribably. . .") also appears farther on, 21 lines up from the

# ONE EQUALIZER FOR ALL PICKUPS

**VERTICAL, LATERAL, MICROGROOVE!** The Fairchild 6-position Preamp-Equalizer, Unit 622, can be used with any and all modern pickups. It mounts on your transcription table in place of your present equalizer. The Fairchild 622 makes it possible for you to use various pickup cartridges . . . and be sure you are getting the best possible performance from each. Both lateral and vertical transcription arms can be connected, and selected without switching—by simply using the proper setting of the 6-position control knob.

**EXTRA ADVANTAGES . . .** Will not become obsolete. Frees one preamplifier. Provides for cuing and monitoring. Eliminates low level hum problems. Is economical. Write for complete details.



## SYNCHRONOUS FAIRCHILD TRANSCRIPTION TABLE

- HIGHEST SIGNAL-TO-NOISE
- LOWEST RUMBLE AND FLUTTER
- INSTANT SPEED CHANGE WHILE IN OPERATION

Together with the 542 Transcription Arm and the 622 Preamp-Equalizer, you get these benefits:

- Perfectly balanced channel from pickup to high level input.
- Signal from turntable at line level.
- Equalization for any pickup.
- Use of two or more pickups with single equalizer.
- No low level hum problems.
- Synchronous direct drive operation.
- Ease of cuing.
- Provision for monitoring.
- New rugged trouble-free pickup reproducer.
- High compliance—true linearity.
- Economy—the elimination of one preamplifier and extra equalizers . . . the prevention of equalizer obsolescence.

Full details are available on request.



UNIT 524

Transcription Table

\$485 less Pickup Equipment

FR-101



154TH STREET AND 7TH AVENUE, WHITESTONE, NEW YORK

We're  
at the  
N.A.B.  
Show



bottom, where it belongs. The proper line was omitted, this one installed in its place, making for a fine Department of Utter Confusion!<sup>2</sup> Correct reading:

"This peculiar relationship between tone-color and harmony-melody is one of the fascinations of sound as we hear it. . . ." etc. It was a humorous accident that this very sentence concluded with the remark that it was this kind of thing that left engineers gasping like fish out of water. Some of you must have gasped several times.

#### RECORD REVUE

Beethoven, Trio in D, opus 70 ("Ghost" Trio).

<sup>2</sup> (Ed. note: This is what sometimes happens when a compositor reassembles type after making a correction. The editors don't get a chance to check it again.)

Busch-Serkin Trio.

Columbia MM 804 (3)  
Beethoven, Violin Sonata #5 ("Spring" Sonata) opus 24.

Jascha Heifetz, Emanuel Bay.

RCA Victor DM 1283 (2)

An interesting technical example of the difference between good recording and good microphoning—this has the former but is lacking in the latter. The usual excellent tonal range applies here, with what at first might seem to be an unusually strong pre-emphasis of the high end, that is more likely (as one begins to discover in this field) a purely acoustical difference that brings the highs more strongly than usual to the mike. (But note well that whether it is actually pre-emphasis or merely a matter of acoustics, the net result is the same in the listening; with this record you will find it desirable to roll

off the highs and you can ascribe your own best guess as to the reason, if you don't subscribe to mine!) On the other hand the microphone-acoustic factor is not up to par here, in common with a number of Columbia chamber recordings, probably all made at about the same period and being issued irregularly. The general effect is too dead, even for a group of only three instruments. But more unpleasant is the seeming closeness of the two stringed instruments, violin and cello, which have an overly sharp and dry sound; the piano, on the other hand, is relatively off-mike, with a good sound on its own but one that doesn't mix well with the close sharpness of the strings. In some situations this perspective effect might be very useful; unfortunately the piano is notoriously hard to blend with strings at best and this only makes the musical split here a bit wider. . . . However, this is still a good enough job for any listening—I'm splitting hairs for the technical-minded. Musically, Rudolph Serkin does some extraordinarily powerful piano playing, as always, and carries this performance along towards being one of the best Beethoven items for a good while.

The "Spring" Sonata, a similar musical combination, is somewhat the reverse. Though it has good tonal range, I suspect that the above Columbias have a bit more. On the other hand, RCA's acoustics and mike pickup are brilliant, both technically and with a brilliant sound. There is a trace too much violin here and there (Heifetz being the big name) but mostly the volume balance is excellent. The perspective balance is even better and considerably superior to that of the Columbia recording—here the violin and piano blend, in the general acoustical brilliance, as well as they ever can in real life. This album is a continuation of an earlier Heifetz-Bay sonata album, DM 1254.

Mozart, Piano Sonata in F, K. 332.

Vladimir Horowitz

RCA Victor DM 1284 (2)

Kabalevsky, Piano Sonata #3.

Vladimir Horowitz

RCA Victor DM 1283 (2)

Debussy, Serenade for the Doll; Poulenc, Presto; Prokofieff, Toccata, op. 10.

Vladimir Horowitz

RCA Victor 12-0428 (1)

Highly diverse samples—they couldn't be more different—of Horowitz' astonishing facility at the piano. These are, together with numerous other Horowitz recordings, the finest piano offerings Victor has made to date, and you couldn't do better than to sample this wide range of music, all canned under similar conditions, to see what Victor has to offer in the way of piano recording technique. Always a big, concert hall sound, very live, with plenty of brilliance in the piano tone. But these are the records we will most look forward to hearing on the new 45 plastic, since hiss and scratch interfere prominently in all of the softer passages. (Victor allows them to fall to very low levels.)

The Mozart sonata is a model of good playing, making what is usually played as a finger exercise into the real music that it ought to be. Kabalevsky's sonata is a harsh and, I find, rather crude bit of semi-modernism; Horowitz plays it just as harshly as he plays the Mozart with delicacy. The Prokofieff Toccata is harsh but less so and with more good sense to it, a very strong rhythm, fiery, breathtaking performance. The Debussy is lightly humorous, misty, scratchy (i.e., the shellac is

# HARVEY

## PROUDLY PRESENTS THIS FINE RECORDING COMBINATION

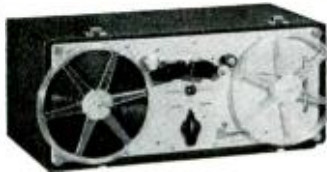

### MAGNECORD PT6-A

Basic tape recorder, excellent quality for music, in use now in hundreds of broadcast stations and recording studios. Low distortion and wide band reproduction, two speeds, 7½" and 15", high speed rewind. Frequency response  $\pm 2$  db 40 cy to 15 kc. Synchronous motor drive. Combines with amplifier PT6-P, combination record-playback-remote with 3 mike inputs. Built-in monitor speaker plus headphone jack. Pre- and post-emphasis cuts in according to use. Line output 600 ohms, 1 ma. into Magnecorder head. Many other features, too many to list. Write for literature, or better still, come in for a demonstration. With 15" plug-in recording equalizer.

Magnecord PT6-A Recorder.....\$278.00  
7½" plug-in recording  
equalizer ..... 20.00

Magnecord PT6-P Portable Amplifier, with case, interconnecting cords and plugs..... \$462.00

### BROOK HI-QUALITY AMPLIFIER

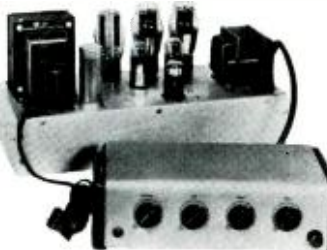

Model 12A3, 10-watt amplifier, remote control cabinet with pre-amplifier, channel selector, tone and volume controls. Frequency virtually flat from 20 to 20,000 cycles, 3 inputs, two equalized for GE, Pickering, and similar pickups ..... \$169.50

Telephone: **7-1000** LUXemburg 2-1500

**HARVEY**  
RADIO COMPANY INC.  
103 West 43rd St., New York 18, N. Y.

### ALTEC 604B DUPLIX SPEAKER

New 604B Duplex Speaker and N-1000B Network incorporate many improvements including lower crossover frequency, improved low frequency cone and redesigned high frequency chamber. 604-B has extended frequency range and provides smoothest frequency characteristic of any speaker. 60° horizontal, 40° vertical coverage, crossover 1000 cycles, impedances 16 ohms, power rating 30 watts, 15" diameter, 11½" deep. Net price less net work ..... \$157.50  
N-1000B network, net ..... 18.00



All in stock  
for immediate  
delivery.

All prices Net, F.O.B. New York and  
subject to change without notice.

scratchy); Poulenc's *Presto* is fast, light-weight, over almost before it gets underway.

**Britten, The Rape of Lucretia.** (Slightly abridged)

Peter Pears, Joan Cross, N. Lumsen, etc., Chamber Orch.

RCA Victor DM 1288 (8)

This is the newest opera sensation from this leading British composer, in a performance supervised by Britten himself, an English cast that is ideally suited to this music, so utterly different from "modern" American music. This is a Roman tragedy set in a classic style, severe, simple, with small orchestra, no big noises, beautifully restrained singing; the whole thing builds by understatement and atmosphere that gets over even on non-long-playing records and is, I find, very moving and mightily impressive. Most of the words are intelligible as sung; the notes in the album give the story. The music is not at all dissonant; rather it is modal, the nearest equivalent being perhaps Vaughan-Williams.

A moot point technically: was this originally one of the famous E.M.I. wide range recordings? If so, then once more, as has been noticeable before, the Victor pressings do not show it. The recording is very fine, but the highs are certainly far from exceptional and I'd say they are definitely weak. Again, it may be a matter of acoustics, but I doubt it, in view of similar effects on other Victor-pressed E.M.I. imports. Has anyone directly compared a British pressing with a Victor pressing of a recent, postwar recording? Does Victor perhaps treat the masters to a bit of polishing? If not, then what?

**Mozart, Symphony #39 in E flat, K. 543.**  
Cleveland Orchestra, George Szell.

**Haydn, Symphony #88 in G.**  
Philadelphia Orchestra, Ormandy

Columbia LP: 4109 (1)

Two first rate symphonies in this style, here recorded with excellent acoustics, performance and engineering; both are on the single LP record and (for my taste at least) a good combination. The two are also available in separate standard albums, 3 records to each. There is considerable difference in liveness between the two recordings; the Philadelphia job is big, brilliant, the Cleveland one somewhat less live, with a closer feeling. Impossible to know whether this is purely an engineering difference or whether it is actually a matter of musical interpretation. My guess might be that Szell, in the Mozart, purposely used a somewhat smaller orchestra as is proper, and perhaps even preferred the less live, more intimate pickup, which also is proper for the music.

**Chopin, Andante Spianato and Grande Polonaise Brillante, Op. 22**

Claudio Arrau, piano; Little Orch. Society, Scherman.

Columbia MX 307 (2)

This early work of Chopin's is somewhat of a freak—the first part, the *Andante Spianato*, is for piano alone, but the second part suddenly sprouts an orchestral accompaniment. Since the two parts are more or less continuous, this poses a nice recording problem, and the results here are unexpectedly happy. Most of Columbia's piano solo recording has been of the close-up, rather dead variety. Here we have a whole piece where the piano is necessarily set up in the midst of an orchestra in a largish hall or studio. I like it, and recommend that Columbia try more of the same. A nice, liquid, unpercussive tone, perfectly suited to Chopin and ac-



# Here

are the superlative new Series of Shure "Vertical Drive" Crystal Cartridges. They reproduce *all* the recorded music on the *new* wide-range high-fidelity pressings. Unusually highly compliant, these "Vertical Drive" Cartridges will faithfully track standard records with a force of only 8 grams—micro-groove records with a force of only 5 grams (an added protection for treasured recordings). Will fit standard or special mountings. Have more than adequate output for the average audio stage. They are requisites for the critical listener . . . the lover of fine music. They are especially recommended for those applications where *true fidelity* is essential. Available in single needle and dual needle turnover models—as illustrated above.

For full details, write on company letterhead to Dept. "A."

Licensed under patents of Brush Development Company. Shure patents pending.



## SHURE BROTHERS, INC.

*Microphones and Acoustic Devices*

225 WEST HURON STREET, CHICAGO 10, ILL. • CABLE ADDRESS: SHUREMICRO

MODEL  
12

# SUBMINIATURE PREAMPLIFIER

for the  
640AA CONDENSER MICROPHONE

◆ ◆ ◆  
**SENSITIVITY:** —43 dbm output for sound pressure of 1 dyne/cm<sup>2</sup> applied to microphone

**RESPONSE:** Down 1 db at 40 cps; down 0.5 db at 20 kc

**OUTPUT Z:** 250 ohms

**SMALL SIZE:** 1 1/8" dia. x 10" long

**LIGHT WEIGHT:** Only 12 ounces

**POWER REQUIREMENTS:** 70 ma at 1 1/4 v; 2 1/2 ma at 135 v.

**LONG BATTERY LIFE:** Virtually immune to changes in battery voltage; change of A voltage from 1.4 to 1.0 reduces gain 1 db; B voltage from 135 to 105, 0.6 db.

The greatly improved performance inherent in this new instrument is made possible by our extensive experience in subminiature techniques

◆ ◆ ◆  
**Audio Instrument Company**

1947 Broadway, New York 23, N. Y.

tually much better than the hard, brassy, triumphant Chopin that Victor's artists often give us. The Orchestra—when it enters—is not of much importance, as always with Chopin, but its background efforts set the piano off well. The *Polonaise* is mostly icing of the most glittering sort, played perfectly and just a bit icily by Arrau.

**Auber, Overtures.**  
Boston "Pop" Orch. Fiedler.

RCA Victor DM 1274 (4)  
A fine batch of rip-roaring, sentimental, dignified orchestral overtures in a real old fashioned style. A good album to have around for general test purposes, as well as casual listening. Big, pompous orchestra, nice melodies, climaxes, etc. None of it vitally important as music—but so what!

## SPEECH ASSOCIATION

[from page 28]

Recording in the Speech Laboratory, by *Giles Wilkeson Gray*  
Recording in the Speech Clinic, by *B. A. Anderson*  
Recording in the Speech Classroom, by *Wayne C. Eubank*  
An Engineer Looks at the Problems of Speech Recording, by *C. J. LeBel*  
Professors Gray, Anderson, and Eubank emphasized the wide use of recording in speech work, and the need for high audio quality. As a teaching device, a recorder is useless unless it can exhibit a speech defect clearly to the student. A machine whose frequency range is inadequate

or whose distortion is excessive cannot be used to illustrate poor diction, for example. The problem is accentuated by the fact that the speech sounds are presented alone, not in context. It is therefore highly desirable to have a frequency range of 50 to 10,000 cycles reproduced uniformly. A large proportion of the recording machines presently offered to schools for speech work are unsatisfactory. Professor Eubank noted that while tape reusability made it preferable for much routine work, it was easier, cheaper, and more compact to store material on lacquer discs.

Mr. LeBel pointed out that their complaints pertained to inexpensive home-type machines. The engineer working on inexpensive equipment has never had to achieve faithful reproduction, a moderately pleasing result being his normal goal. It is out of the question to get a 10-ke range for \$135 as one of the speakers requested, for whereas a home recorder manufacturer may sell several hundred thousand units per year, a professional design will be fortunate if it sells at the rate of one thousand in the same period. Mr. LeBel showed that while magnetic recording media

## It's Tops!

Surveys show that **AUDIO ENGINEERING** is preferred over all other technical magazines read by the best informed in the sound field—the broadcast engineers. Each issue brings you outstanding articles on five or more of the following subjects:

- Broadcasting
- Sound on Film
- Recording
- Phono Reproduction
- Public Address
- Industrial Sound equipment and applications.
- Acoustic treatment of studios, rooms, auditoriums etc.

In addition, each month **Audio Engineering** presents latest improvements in sound reproducing equipment design, test methods, and technical news from here and abroad. The editorial staff includes top authorities in the sound field.

**Subscribe NOW! Don't miss an issue!**

Please write for details of our special group rate covering 6 or more Subscriptions.



**AUDIO ENGINEERING**  
RADIO MAGAZINES, INC.  
342 Madison Avenue, New York 17, N. Y.

Sirs: Here is my  check (or  money order) for \$..... Enter my subscription order to **AUDIO ENGINEERING** for the next.....issues. Subscription Price: In U.S.A., Canada and Pan America—12 issues \$3—24 issues \$5. All others \$1.00 more per year. Please check one:  New Subscription  Renewal

Name (please print).....

Address..... City..... State.....

Occupation (give title and department).....

Firm Name.....



had the advantage of reusability, magnetic recording equipment had maintenance problems not needed by disc equipment. These problems are head wear, head alignment, and bias variation with time.

In the resulting discussion it developed that while the schools had paid several hundred to several thousand dollars for each disc recording unit, and had no complaint about their performance, they were very unhappy about the sound quality and/or durability of home wire and tape machines. It was pointed out that they were calling for professional quality, and could expect to get it only at professional prices.

Educators may not be able to toss around electroacoustical terms as glibly as the average engineer, but they appear to have better trained ears than the average home recorder designer. It would be profitable for sales departments to drop the idea that any old piece of junk is just the thing to sell to schools. This idea was the vogue in the disc recorder field until the educators learned their lesson. Apparently we are now about midway in a similar cycle in magnetic recorders, and the disillusionment stage has already begun.

## N. A. B. CONVENTION

[from page 15]

meetings cover training of personnel, advances in facsimile, and a report on UHF television. An FCC-Industry Roundtable is scheduled for 10:45 a.m., with Royal V. Howard of NAB as moderator.

Two interesting affairs are scheduled simultaneously for Saturday afternoon—a tour of ABC and NBC television stations, and an open meeting of the NAB Recording and Reproducing Standards Committee in which all members and interested parties are invited to participate.

### RMA-IRE SPRING MEETING

● Two audio papers are scheduled for the RMA-IRE Spring Meeting, to be held at the Benjamin Franklin Hotel in Philadelphia on April 25, 26, and 27. Both are spotted for the 9:30 a.m. session Wednesday, and are:

Audio Power Amplifier with Positive and Negative Feedback, John M. Miller, Jr., Bendix Radio.

Longitudinal Interference in Audio Circuits, H. W. Augustadi, Bell Telephone Laboratories.

These papers should be of especial interest to the broadcast engineer, particularly those who are involved in system design.

# See and Hear THESE 3 NEW PRODUCTS ... AT TERMINAL

## REK-O-KUT "CHALLENGER" PROFESSIONAL RECORDER



12" 2-speed recorder with precision overhead lathe mechanism. Automatic speed change from 78 to 33-1/3 rpm. Machined and balanced aluminum turntable, cast aluminum frame. Heavy duty precision-balanced motor. High fidelity 8" speaker. Overhead feed mechanism incorporates a safety cutting head feature, which lifts cutter from record as center of record is approached, thus preventing double cutting and damage to stylii. Wide range, distortion-free amplifier. Inputs for high impedance microphone, phono and radio. For 115 volts 60 cycles AC. Size 25 x 22 x 12 inches, weighs 67 lbs. Shipping weight—80 lbs.

Price **329.95**

## M-12-192

interchangeable feed-screw for micro-groove 192 lines per inch. Specify outside-in or inside-out. Also for use with M-12 overhead assembly.

Net **17.95**

45 RPM idler wheel, interchangeable with 33-1/3 rpm wheel.

Net **6.00**

## Advanced Model 180

WEBSTER-CHICAGO

Portable Wire Recorder

with Exclusive

Record-O-Magic Controls

## BROOK Model 12A3 HIGH QUALITY AUDIO AMPLIFIER

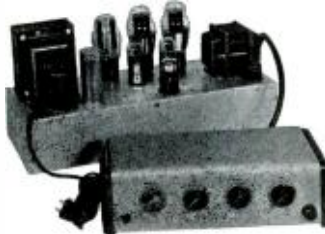

Within the range of its 10 watt power rating, Model 12A3 is equal in all respects to the famous Brook 30-watt amplifiers.

Along with virtually distortionless reproduction, Model 12A3 features a measure of operating flexibility and convenience which is unique in the field of high-precision amplifiers. Although designed primarily for home use as the heart of custom-built radio-phonographs, its incomparable audio characteristics make it equally suitable for laboratory or commercial application where exacting engineering standards prevail.

Complete with separate pre-amplifier and control cabinet

**166.11**

net

The new Webster-Chicago "Electronic Memory" is easy to use! Automatic Stops shut off motor before wire can run off either spool in either direction. Resets automatically when Lock-fast Operating Lever is returned to center position. Push-pull output Expanded Range amplifier allows recording of voice and music with excellent fidelity. Built-in Elapsed Time Indicator permits accurate timing, cueing and editing. New, powerful erase circuit. Removable Take-up Drum permits fast reload of recordings longer than one hour. Has radio input and external speaker or amplifier outlets. Compact luggage case measures 17 3/8" x 11 3/8" x 7 1/2". Carrying weight is 27 lbs. Operates on 105-120 volts, 50 or 60 cycles AC. Complete with microphone, 3 spools of recording wire and instructions.

Price **149.50**

Many useful accessories available to enhance versatility—write for complete catalog!

**FREE!**

WRITE FOR YOUR COPY OF OUR NEW 1949 CATALOG OF HIGH QUALITY SOUND EQUIPMENT

# TERMINAL

RADIO CORPORATION

Distributors of Radio & Electronic Equipment

85 Cortlandt St.

New York 7, N. Y.

Phone WOrth 4-3311

## EXPERIMENTAL ULTRASONICS

[from page 25]

### Stretching The Diaphragm

The diaphragm material can be nickel, monel, German silver and so on. For any reasonable predictability of results, it must be stretched. This proved rather difficult. Welding around the rim did not work out too well, as the joint was required to be waterproof under 100 lb of pressure, and welding often left small gaps. It was finally soldered in a jig that kept the diaphragm under tension during the soldering operation. A jig was

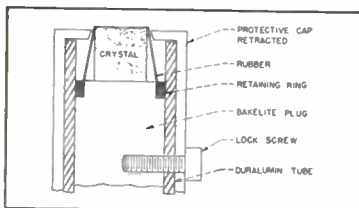

Fig. 3. Details of end of transducer probe suitable for use in air or gases.

constructed that could be placed in a furnace and brought to 400°. After precision tinning both the diaphragm and the shell, as well as the button,

the assembly was slowly brought up to heat and a ring of solder flowed around the joint. Slow cooling gave us a stable assembly, and the diaphragm was turned off flush.

A diaphragm thickness between 4 and 6 mils proved practicable. The button thickness did not prove critical in the sense that a thickness of a quarter or half wave showed up in greatly increased output. The thicker the button, the less the output, in general. For stiffening, a thickness of 6 mils proved adequate.

### Crystal Mounting

In general, a sliding reaction type mounting was used. If we assume the diaphragm will be bulged inward by external pressure, then we attempt to spring mount the crystal so it can move longitudinally with the slow displacement of the diaphragm. This works out well if good sliding fits are made.

Loading the crystal with a lead block did little good above 50 kc or so, a small mass sliding bakelite plug being sufficient to back the crystal.

### Characteristics of Various Crystals as Mounted

In general, the Rochelle bimorph of either bender or twister type, such as are used in phonograph pickups, gives

great output in isolated peaked responses, with no uniformity of output at all. Its modes of oscillation above 10 kc are so complicated as to defy analysis. If you just wish to know that some supersonic energy is in the medium, the bimorph will often be a guide with occasional flashes of output up to several megacycles, but for quantitative work it is useless.

Quartz has little response off resonance, especially when we attempt to drive one quartz with another through some medium. So in general, they are useful well above a megacycle, where other devices are unusable, and then we must frequency modulate the transmitter quartz crystal for practical applications. The combination then works rather well. With a swept band of 100 kc or so at 5 mc, and 200 volts input, the receiving unit will pick up about a millivolt of signal. Quartz must also be used when the temperature is much above 250° F.

A word of warning—practically all wartime quartz was shear cut, so do not attempt to use it under penalty of extremely complicated radiation patterns, useless for any practical purpose.

Primary ammonium tartrate crystals (PN) are about the most promising. They can be used at boiling

# AUDIO ENGINEERING

# BINDERS \$2.50

- Backbone gold stamped with Audio Engineering and year.
- Center channel to keep magazines fastened in position.
- Round corners, hinges and backbone fully reinforced.
- Rich blue Dupont Fabricord—stainproof and washable.
- \$2.50 postpaid. Foreign orders add 50c.

★ ★ ★ Here at last is a binder using modern postwar materials at prewar prices. Designed to provide instantaneous reference to your monthly copies of Audio Engineering. An unusually fine library finish that will stand up under constant use.

- Rigid backbone with bound-in metal support.
- Light weight tarnishproof aluminum ends.
- Coil springs built in at each end to securely position spring steel wire holders.

RADIO MAGAZINES, INC.

342 MADISON AVE.  
NEW YORK 17, N. Y.

AUDIO ENGINEERING  
BINDERS

1947       1948       1949

Enclosed find \$.....for.....Binders

Name.....

Address.....

City..... State.....

water temperature. They readily come up to an inch in length in pure piston action, cut with a natural period of about 50 kc, are fairly sensitive and have low noise level. They have too low a capacitance to be ideal. A half-inch cube has about 0.8  $\mu\text{mf}$  capacitance, so they suffer from the shunt capacitance of a long lead or a vacuum tube voltmeter or oscilloscope.

Since they very readily dissolve in water, any mounting must be waterproof. Any handling with the fingers should be avoided, as they are gradually eroded by finger sweat. They are quite soft, about like a cube of sugar in hardness, so they are easily damaged by a blow, or a sharp-pointed instrument.

Another controlling difficulty in making a stable permanent mounting of the PN is the fact that no pressure can be used except on the working faces. These come marked with a little black dot, and the crystal must be wholly supported by simple direct pressure on these faces only. Otherwise its sensitivity and resonant period will be seriously and erratically affected.

The writer has used these mostly in the form of cubes. Samples are furnished to very exact dimensions, and dead square.

When mounted in the shell of Fig. 1, they are very stable and uniform. Care must be taken that no sharp blow on the diaphragm crushes the crystal but a reasonable amount of care will prevent this. However, the metallic diaphragm lowers the sensitivity very much when used in air or a gas, so the mounting shown in Fig. 3 was developed.

This mounting as a probe has several advantages. The stretched rubber of a thickness of about 0.3 thousandths damps the crystal somewhat, but an absolute minimum. It has no characteristics of its own to speak of as a diaphragm. However, it does not do a very good job of protecting the crystal, and when used as a contact microphone considerable care is required not to damage the crystal. When used on the body there is little danger, but when working around metal parts that have sharp edges, great care must be used. The sliding protective metal sleeve should be only retracted when the crystal is actually in use.

When used with a high-intensity source, such as the Hartmann generator, this unit gives out a volt or two to drive an oscilloscope, if within two inches of the generator, and in the maximum field. It will give the same with the parabolic reflector ten feet away, sharply focused on the face of

# Choice of 626 Tubular Resistor Values IN STOCK

**Hundreds of other Stock Types, sizes and values!**



**the Variety! . . the Range! . . the Quantity!  
Ready to Meet Your Needs Quickly!**

More Ward Leonard wire-wound resistors have been produced and used over more years than any other make. And records show that quite often a stock unit as the perfect answer to many an industrial need . . . for application, for performance, for economy, for quick delivery. For example: there are 626 Vitrohm tubular stock values in fixed and adjustable types . . . and many others . . . promptly available! It pays to check into them . . . for your requirements.

Contact your local Ward Leonard  
Authorized Industrial Distributor.  
Send now for handy  
Stock-Unit Catalog D-130

Radio and Electronic Distributor Division  
**WARD LEONARD ELECTRIC CO.**  
53-R West Jackson Blvd., Chicago 4, U. S. A.



The sign of a  
Ward Leonard  
Authorized  
Industrial  
Distributor

## WARD LEONARD

RESISTORS • RHEOSTATS • RELAYS • CONTROL DEVICES

WHERE BASIC DESIGNS ARE RESULT-ENGINEERED FOR YOU



IN THE PROFESSION, AN HONORED NAME

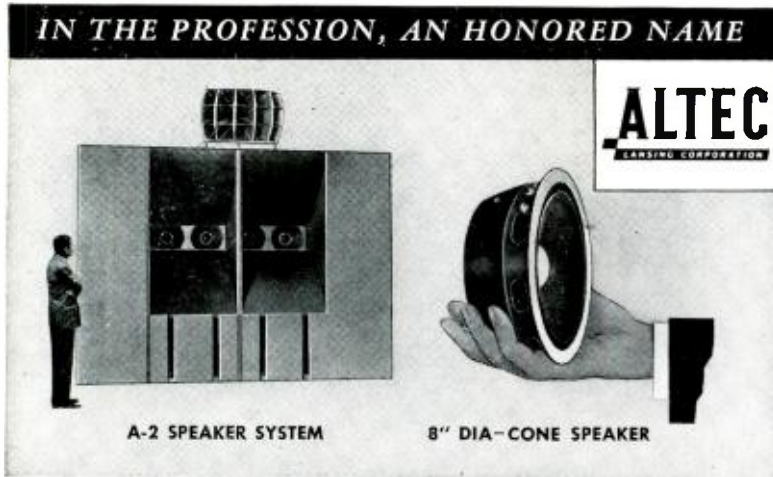

A-2 SPEAKER SYSTEM

8" DIA.-CONE SPEAKER

**ALTEC**  
LANSING CORPORATION

## FROM THE LARGEST TO THE SMALLEST ALTEC LANSING IS FIRST IN QUALITY

To those familiar with the history of Altec Lansing, its reputation in the top-level quality field is easily understood. Altec Lansing is best known as the designer and manufacturer of massive motion picture theatre speaker systems where highest obtainable quality out-

weighs every other consideration. In the design and manufacture of a balanced line of speakers fulfilling every need for highest quality reproduction of sound—yet adaptable to more confined space, no compromise was made with quality. For the professional audio

world and for the electronics industry generally, the history of Altec Lansing is the clue to its reputation.

Write for Descriptive Brochure  
— Altec Lansing Corporation,  
1161 North Vine St., Hollywood  
38, Calif., 161 Sixth Ave., New  
York 13, N. Y.

## Choice of the Professionals The MAGNECORDER

Announcing the new addition to the PT6 series of tape recording equipment.

### MAGNECORDER PT6-JA

Especially designed for schools, industry, laboratories, smaller radio stations, and music lovers who demand the same quality inherent in all Magnecord equipment.

Here Is Quality  
At A Price  
You Can Afford

For detailed specifications and the name of your nearest distributor write:

**MAGNECORD, Inc.**

360 N. MICHIGAN AVE.

CHICAGO 1, ILLINOIS

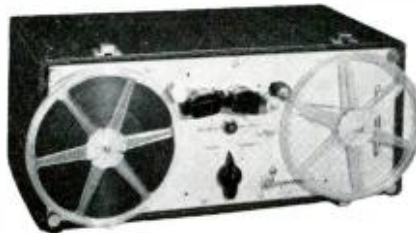

PT6A

### Tape Recording At Its Best

Frequency Response 50 to 15,000 cps.  $\pm$  2 db.  
Distortion 2% at full modulation

Magnecord tape recording equipment has been proven by months of constant use by the most critical users in radio broadcast stations and recording studios.

the crystal. However, this is only true with about two leads about two feet long and separated. If a six-foot concentric cable is used the signal drops rapidly for each foot of cable. For serious work a cathode follower stage right at the crystal and impedance matching into the 52-ohm line is required.

#### Unit Used as Transmitter

Any PN crystal will take 200 volts of drive. If you wish to operate over a wide band of frequencies this offers some problems.

Suitable oscillators should cover the spectrum from ten to a few hundred kc or higher. The output must, of course, be stepped up in voltage by some means.

One means is a tuned circuit right at the crystal. Due to its very small capacitance, this is rather easy to do. Somewhat more difficult is designing a wide-band transformer to step up the 52-ohm line to match the crystal. Another answer is a driver tube at the crystal, choke-coupled to it.

A warning on using the crystal as a self-frequency determining oscillator. By the time the crystal is loaded with a diaphragm and damped by the mounting, it is seldom possible to have it develop sufficient reactance to act as a normal oscillating crystal. This is especially true if it is immersed in water, where the Q often falls to ten or less. The writer made a determined but unsuccessful effort to lock such a crystal to an unstable oscillator.

#### Working Units in Pairs

Two similar units work well in either air or water. For a first experiment, have them face to face and join them with a drop of water. The signal transmission will be very good.

If they are used with only air in between, very high values of standing-wave ratios will be noted as they are moved apart. These may be 40 db or so. These are obtained only when they are dead parallel and dead concentric on the same axis.

If used in a test chamber, as shown in photograph, some interesting effects can be observed. If we gradually fill the chamber with water, reflection from the underside of the water will be almost 100% and wave cancellation will occur, and by careful filling drop by drop a range of signals of 60 db or more will be had. This means that a test cell such as this must be a complete housing with no water surface on top. So the filling orifice must be closed by a plug whose inner wall is flush with the inner wall of the tube. With a suitable selective receiver, almost any of these units

will pick up the ticking of a watch up to 200 kc or so, even through several hundred feet of wire. Some interesting work might be done on machinery noise, especially high-speed machinery. Most of the analyzing now done acoustically cuts off at rather low frequencies.

It is somewhat of a shock to find that the ordinary telephone receiver, when overloaded by loud speech, gives out detectable energy up to 100 kc at least. We might investigate direct pickup of noise above 20 kc from a phonograph needle tip. The noise spectrum direct from a grinding wheel may tell us how many of the cutting particles are engaging the work, and might be used as a feed control. We know it will be difficult for a reader of *AUDIO ENGINEERING* to locate a cockroach to chivy with ultrasonics, but if he is given his dinner on the diaphragm of one of these units the noises are very unusual.

In the next article of this series we will discuss the design of suitable receivers, tuned voltmeters, and the like. It is obvious to select a communications type receiver for frequencies above 550 kc or so, but many of them are too sharply selective for some uses. The range from 10 kc to 550 kc requires very special design indeed.

## MEASURING PROCEDURES FOR MAGNETIC RECORDING

[from page 19]

um, the magnetic heads, the bias level, the signal level, the amplifiers, and the speed of the medium. The last four items can be specified within reasonable limits. However, it seems to be impossible at the present time to specify a standard medium, or standard recording and reproducing heads. This being the case, the frequency responses of different media may only be compared directly when these responses are made using the same or exactly equivalent magnetic heads. Needless to say, the testing procedure must follow certain standard specifications. It is the purpose of this section to state and explain these standard specifications.

### I. Speed of the Medium

- a. *Magnetic Wire.* For magnetic recording wire, the speed of the medium for frequency-response measurements shall be two feet per second  $\pm 2\%$ .
- b. *Magnetic Tape.* For magnetic coated recording tape, the speed of the medium for frequency-response measurements shall be 7.5 inches per second  $\pm 2\%$ .

### II. Signal Level

The recording signal level shall be set at the *Standard Recording Level*. In a given magnetic recording system, the standard recording level is the value of audio current in the recording head such that the resulting remanent induction in the recording medium produces an open-circuit voltage at the terminals of the reproducing head which is approximately 12 db. lower



RESPONSE WITHIN

**.2db**

New

30 TO 20,000 CYCLES

## Chicago FULL FREQUENCY Output Transformers

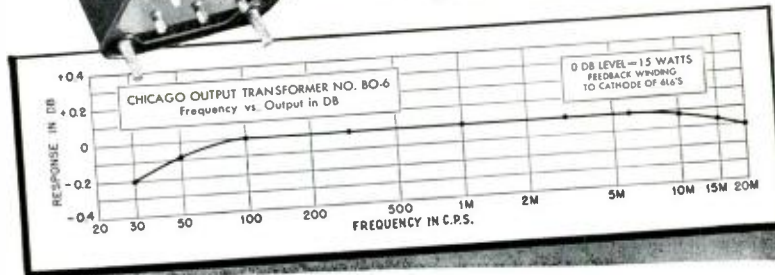

**No. BO-6.** For use in high fidelity amplifiers. Couples push-pull 6L6's (7500 ohms, C-T) to 6/8 or 16/20-ohm voice coil. Center-tapped tertiary winding provides 15% inverse feed-back to reduce harmonic distortion to a minimum. In drawn steel case, 4 $\frac{1}{16}$ " x 3 $\frac{3}{8}$ " x 3 $\frac{1}{16}$ ", with mounting studs and convenient pin-type terminals... List Price, \$23.00

**No. BO-7.** For matching 600 or 150-ohm line to a 6/8 or 16/20-ohm voice coil. Frequency response within plus or minus 1db. at full rated output—maximum power level, 30 watts. Mounted in compound-filled drawn steel case, 4 $\frac{1}{16}$ " x 3 $\frac{3}{8}$ " x 3 $\frac{1}{16}$ ". Mounting studs and pin-type terminals same as No. BO-6 illustrated above... List Price, \$22.00

There's a CHICAGO Output Transformer for Every Full Frequency Use

Cat. No.	Application	Impedance	Max. Power	List
BO-1	Single Plate to Line...	Pri.—15,000 ohms at 0 to 10 ma d-c *Sec.—600/150 ohms CT	+20 dbm	\$13.00
BO-2	P.P. Plates to Line...	*Pri.—20,000 ohms CT *Sec.—600/150 ohms CT	+30 dbm	19.00
BO-3	P.P. Plates to Line...	Pri.—5,000 ohms CT *Sec.—600/150 ohms CT	+40 dbm	17.00
†BO-4	P.P. Plates to Line...	Pri.—7,500 ohms CT *Sec.—600/150 ohms CT	+43 dbm	18.00
BO-5	P.P. Plates to Line...	Pri.—10,000 ohms CT *Sec.—600/150 ohms CT; 16/8/4 ohms	+37 dbm	24.00

†Tertiary winding provides 15% inverse feedback. \*Split and balanced windings.

## HIGH Q CHOKES

for Dynamic Noise Suppression Circuits

Two precision-built chokes with inductance values of .8 and 2.4 henrys respectively—accurate to within  $\pm 5\%$  with up to 15 ma d-c. Units have a minimum Q of 20. Remarkably compact, 1 $\frac{1}{4}$ " x 2 $\frac{3}{8}$ " x 1 $\frac{1}{4}$ ".

No.	Inductance	List
NSI-1	.8 h	\$10.00
NSI-2	2.4 h	10.00



## Famous "Sealed in Steel" New Equipment Line

The units described above are typical of CT's New Equipment Line featuring transformer engineering that's ahead of the trends in circuit design. Get the full facts on the complete line now. Check the features, and you'll see why CT is called the "Engineer's Transformer." Check the prices: see how little more these advanced units cost over ordinary transformers.

Write for Complete "New Equipment" Catalog Today



**CHICAGO TRANSFORMER**

DIVISION OF ESSEX WIRE CORPORATION

3501 ADDISON STREET • CHICAGO 18, ILLINOIS



# A DOUBLE NEEDLE PICKUP CARTRIDGE

WITH TOP QUALITY PERFORMANCE CHARACTERISTICS

**Plus** THE MOST CONVENIENT NEEDLE REPLACEMENT ARRANGEMENT THAT HAS BEEN DEvised

## THE ASTATIC LQD TURNOVER TYPE CRYSTAL CARTRIDGE

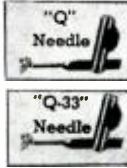

A gentle pry with penknife or screw-driver, and ONE needle comes out of the Astatic LQD Double-Needle Cartridge when replacement is necessary . . . without disturbing the other needle, without removing cartridge from tone arm, without so much as the turn of a screw or use of other tools. Gentle pressure with the tip of a knife blade snaps the new needle into place. Astatic type "Q" Needle, with three mil tip-radius, and "Q-33," with one mil tip-radius, are employed . . . established types which have been on the market for some time and are readily available. The relatively high vertical and lateral compliance of this needle design affords appreciable reduction in needle talk, contributing greatly to the new cartridge's high standard of reproduction.

Listening tests by prospective users have prompted such comments as: "Unquestionably the best we've heard." You are urged to make your own comparisons, note the excellent frequency response particularly at low frequencies, judge for yourself the performance qualities and convenient utility of the Astatic LQD Double-Needle Cartridge. Available with or without needle guards. Write for additional details.

### THE ASTATIC CORPORATION, Conneaut, Ohio

In Canada: Canadian Astatic, Ltd., Toronto, Ont.

⎵ Astatic Crystal Devices manufactured under Brush Development Co. patents ⎴

than the Saturated Signal Output, provided that the frequency is the Frequency of Maximum Response and that the bias is set at the value of Operating Bias Current.

#### Saturated Signal Output

The saturated signal output is the maximum voltage which appears at the terminal of the reproducing head when the field intensity in the gap of the recording head is of such magnitude that a further increase does not result in an increased reproduced signal measured at the frequency of maximum response and at the operating bias current.

#### Peak Recording Level

The peak recording level shall be that value of input which results in 10% total harmonic distortion at 400 cycles, as determined in accordance with distortion measurement procedure.

#### Operating Recording Level

The operating recording level shall be such that modulation peaks do not exceed the peak recording level.

#### Frequency of Maximum Response

The frequency of maximum response is that frequency of recorded magnetic signal which produces a maximum open-circuit output voltage at the terminals of the reproducing head when a constant-current recording signal at the standard recording level is used in the recording head.

#### III. Operating Bias Current

The operating bias current shall be that value which results in maximum output at a frequency of 200 cycles at the standard recording level. The exact value shall be the algebraic mean of a higher and lower biasing current which results in a 1 db. decrease from the output of maximum response.

#### IV. Amplifiers

a. **Recording Amplifier.** The recording amplifier shall be designed and connected to the recording head in such a manner that the signal current in the head for constant voltage supplied to the amplifier input does not vary more than  $\pm 1$  db. over any specified useful bandwidth of the recording system.

b. **Playback or Reproducing Amplifier.** The frequency response of the playback amplifier shall be flat in terms of voltage output within  $\pm 1$  db. over any specified useful bandwidth of the recording system.

It should be pointed out that when high-impedance magnetic heads are used, resonant effects may give an erroneous impression as to the unequalized frequency response of a magnetic recording system. In the recording head, the resonant effect may result in a gap field strength which is considerably higher at the resonant frequency than at other frequencies. In the playback head, the resonant effect may account for as much as 6 or 8 db. higher response at the resonant frequency. This may be a desirable method of obtaining post-emphasis characteristics of a magnetic recording system but does not tend to improve the signal-to-noise ratio of the system.

In making frequency-response measurements of the medium, it is therefore recommended that

- Signal level be that specified as Standard Recording Level;
- Bias be that specified as Operating Bias Current;
- Amplifiers meet the requirements as specified in Section IV;
- Measurements should extend either side of the frequency of maximum response until noise becomes the

## FREE

# "PRODUCTS of EXTENSIVE RESEARCH"

### A NEW LINE OF HIGH FIDELITY OUTPUT TRANSFORMERS

Type No.	Primary matches following typical tubes	Primary Impedance	Secondary Impedance	+ Sub from	Maximum level
F1950	Push pull 2A3's, 6AS6's, 300A's, 275A's, 6A3's, 6L6's	5000 ohms	500, 333, 250, 200, 125, 50	20-30000 cycles	15 watts
F1951	Push pull 2A3's, 6AS6's, 300A's, 275A's, 6A3's, 6L6's	5000 ohms	30, 20, 15, 10, 7.5, 5, 2.5, 1.2	20-30000 cycles	15 watts
F1952	Push pull 2A5, 250, 6V6, 42 or 2A5 A prime	8000 ohms	500, 333, 250, 200, 125, 50	20-30000 cycles	15 watts
F1953	Push pull 6BE, 6AA, 53, 6F6, 5Y, 7Y, 6Y 6V6 Class B 46 59	10,000 ohms	500, 333, 250, 200, 125, 50	20-30000 cycles	15 watts
F1954	Push pull 6BE, 6AA, 53, 6F6, 5Y, 7Y, 6Y 6V6 Class B 46 59	10,000 ohms	30, 20, 15, 10, 7.5, 5, 2.5, 1.2	20-30000 cycles	15 watts
F1962	Push pull parallel 2A3's, 6AS6's, 300A's, 6A3's, 6L6	2500 ohms	500, 333, 250, 200, 125, 50	20-30000 cycles	30 watts
F1963	Push pull parallel 2A3's, 6AS6's, 300A's, 6A3's, 6L6	2500 ohms	30, 20, 15, 10, 7.5, 5, 2.5, 1.2	20-30000 cycles	30 watts
F1964	Push pull 6L6 or Push pull parallel 6L6	3000 ohms	500, 333, 250, 200, 125, 50	20-30000 cycles	50 watts
F1967	Push pull 6L6 or Push pull parallel 6L6	3000 ohms	30, 20, 15, 10, 7.5, 5, 2.5, 1.2	20-30000 cycles	50 watts

### NOISE SUPPRESSOR CHOKES

Coils for Dynamic Noise Suppressors

No. 1950	0.6 H.	\$4.90 list
No. 1951	2.0 H.	\$4.90 list

### TOROIDAL INDUCTORS

From 15,000-15,000 cycles	Type g	Inductance Value	Type g	Inductance Value	Type g	Inductance Value
5 MHY F.0007	1 MHY	F.1000	5 MHY	F.1000	10 MHY	F.1000
10 MHY F.0007	2 MHY	F.1001	10 MHY	F.1001	20 MHY	F.1001
15 MHY F.0007	3 MHY	F.1002	15 MHY	F.1002	30 MHY	F.1002
20 MHY F.0007	5 MHY	F.1003	20 MHY	F.1003	50 MHY	F.1003
30 MHY F.0007	10 MHY	F.1004	30 MHY	F.1004	75 MHY	F.1004
40 MHY F.0007	15 MHY	F.1005	40 MHY	F.1005	100 MHY	F.1005
50 MHY F.0007	20 MHY	F.1006	50 MHY	F.1006	150 MHY	F.1006
60 MHY F.0007	30 MHY	F.1007	60 MHY	F.1007	200 MHY	F.1007
75 MHY F.0007	50 MHY	F.1008	75 MHY	F.1008	300 MHY	F.1008
100 MHY F.0007	75 MHY	F.1009	100 MHY	F.1009	400 MHY	F.1009
150 MHY F.0007	100 MHY	F.1010	150 MHY	F.1010	500 MHY	F.1010
200 MHY F.0007	150 MHY	F.1011	200 MHY	F.1011	600 MHY	F.1011
300 MHY F.0007	200 MHY	F.1012	300 MHY	F.1012	750 MHY	F.1012
400 MHY F.0007	300 MHY	F.1013	400 MHY	F.1013	1000 MHY	F.1013
500 MHY F.0007	400 MHY	F.1014	500 MHY	F.1014	1500 MHY	F.1014
600 MHY F.0007	500 MHY	F.1015	600 MHY	F.1015	2000 MHY	F.1015
750 MHY F.0007	600 MHY	F.1016	750 MHY	F.1016	3000 MHY	F.1016
1 MHY F.0117	100 MHY	F.1017	10 MHY	F.1017	100 MHY	F.1017
1.5 MHY F.0127	150 MHY	F.1018	15 MHY	F.1018	150 MHY	F.1018
2 MHY F.0137	200 MHY	F.1019	20 MHY	F.1019	200 MHY	F.1019
3 MHY F.0147	300 MHY	F.1020	30 MHY	F.1020	300 MHY	F.1020
4 MHY F.0217	400 MHY	F.1021	40 MHY	F.1021	400 MHY	F.1021
5 MHY F.0227	500 MHY	F.1022	50 MHY	F.1022	500 MHY	F.1022

## FREE TRANSFORMER CO., Inc.

DEPT. A.G.      1718-36 WEIRFIELD ST.,      BROOKLYN 27, NEW YORK



limiting factor or the output is 20 db below that obtained at the frequency of maximum response.

In making overall frequency-response measurements of a magnetic recording system, the same conditions as above shall apply, except the amplifiers shall be those used in the system.

## 2. DISTORTION

In measuring the distortion of a magnetic system, or any system where a moving medium is involved, certain precautions must be observed in order to obtain a true distortion evaluation. Variations in speed of the medium may cause frequency and phase shifts which exceed the limitations of the measuring equipment. This is especially true if the equipment is of the type where the fundamental is filtered out by means of a sharply tuned filter and the residue measured, or where the individual harmonics are selected and transmitted through a band-pass filter of only a few cycles in width. It is believed that the band pass of the filter should be broad enough to permit frequency changes of the order of at least plus and minus 5 percent. If harmonic distortion measurements at only one frequency are contemplated, it is suggested that 400 cycles be chosen as the frequency, since distortion measuring equipment which fulfills the requirements stated above exists.

Harmonics above the fifth may not be too significant, and if such is the case, the playback system need only be compensated so that the overall response is flat within one db from at least 400 to 2000 cycles. When making distortion measurements, the recording current should be held constant as recommended for frequency-response measurements. In order to minimize the high-frequency noise, so that it is not an appreciable part of the distortion reading, it may be desirable to permit the high-frequency end to roll off above 2000 cycles.

Obviously distortion measurements may be made at any recording level, and many measurements should be made at different recording levels and with various amounts of biasing current in studying the characteristics of the system. Such a study permits a more accurate determination of the normal recording level and operating bias.

The recording level is usually not too important from the viewpoint of the audio power, as the actual power required is very low and more power, if needed, can easily be obtained. Output voltage from the magnetic head, on the other hand, is low and requires considerable amplification, so that it may be of greater significance when comparing media. It is, therefore, suggested that when making distortion measurements both input and output levels be given.

It is therefore recommended that total harmonic distortion measurements be made

- (a) At 400 cycles (measurements at other frequencies may be made and so indicated, but figures of the 400-cycle distortion values should always be included);
- (b) With a system which is flat within one db from 400 to at least 2000 cycles;
- (c) Using the value of biasing current as defined by Operating Bias Current;
- (d) With inputs 6 and 12 db below the peak recording level.

## 3. NOISE

### a. System

In order to specify noise in a manner that shows the capability of the equipment, two measurements are recommended: First, a "high-frequency" measure-



**INSTRUMENTS**  
**that STAY ACCURATE**

Soft iron pole pieces and full bridge construction are only two of the design and production superiorities which have made the SIMPSON name synonymous with perfection in panel meters.

Whatever your technical problems are the SIMPSON Laboratories will help you work them out.

Meters available in sample quantities at your nearest Radio Parts Jobber.

**SIMPSON ELECTRIC COMPANY**  
5200-5218 W. KINZIE ST.  
CHICAGO 44, ILLINOIS

In Canada: Bach-Simpson, Ltd.,  
London, Ont.

## MODEL 4031-B PROGRAM EQUALIZER



### INSERTION LOSS ONLY 14 DB.!

Capable of providing variable regulation over a range of 16 DB. attenuation and 12 DB. equalization in calibrated and detented 2 DB. steps at both ends of the audio spectrum, the 4031-B Program equalizer is one of the most advanced units on the market today.

Designed to fit the needs of motion picture, recording and broadcast industries, this distortion-free equalizer can be cut in or out without changing the signal level at the center of the range. Variable high-frequency positions are selected at 3, 5 and 10 KC. by a panel key. A separate control permits independent equalization and attenuation over the low-frequency spectrum. Designed with a constant "K" circuit, the impedance remains constant over the entire range of control.

Toroidally wound coils are used to eliminate hum pickup. Controls may be operated while the program is in progress without causing clicks or apparent change of average level.

*Send for literature and complete set of curves.*



**CINEMA**  
ENGINEERING COMPANY  
1510 W. Verdugo Ave. Burbank, Calif.  
Cable Address: CINENG BURBANK



## Announcing— TELEVISION INTERFERENCE Its Causes and Cures

A new Handbook by Radio Magazines, Inc., covering in detail the important facts of TVI. The TVI Handbook is edited to fill the pressing requirements of amateurs and other technicians confronted with the problems of TV interference, or otherwise unsatisfactory television reception. Included in its thorough treatment of causes and cures are a comprehensive set of TV screen photos depicting all types of reception, many case histories, preventative design data, and other equally pertinent facts. It is a vital publication for radiomen wherever TV is on, or about to go on the air.

Price 50c plus 10c postage, or order from your local dealer.

CQ—Radio Magazines, Inc.  
342 MADISON AVE., New York 17, N. Y.

Enclosed find \$ ..... for ..... copies TVI Handbook  
Name .....  
Address .....  
City ..... Zone ..... State .....

ment which excludes hum and other low-frequency noises and evaluates the effectiveness of the Erase, the result of the addition of Bias (used during recording), and the high-frequency noise present in the system; the second method includes the entire frequency spectrum covered by the system and is therefore an "over-all" measurement.

For the high-frequency measurement, a 250-cycle high-pass filter should be used to minimize hum and other low-frequency noises. The equipment noise, with the medium not running, should be at least 10 db below the value measured with the medium moving, in order to obtain reasonable accuracy of system noise measurements. If this is not the case, both measurements, "equipment" and "system high frequency," should be stated.

Since the measurement is usually one of comparison, it is recommended that the comparison be with the reproduced output obtained with the peak recording level as defined previously, and the noise be stated as so many db below this value. The frequency range covered by the system is significant in noise measurements, and it is recommended that the playback system be at least equalized flat within one db between 200 and 2000 cycles. The specified range should be expressed as extending to the frequency at which the output drops 15 db below the flat response portion. For high-frequency noise measurements, the 250-cycle high-pass filter will, of course, determine the low-frequency cutoff, and the range would be specified as being from 250 cycles to some frequency where the output is 15 db below the flat response portion.

For an over-all noise measurement of the system which includes low-frequency noise, such as hum, the 250-cycle high-pass filter should be removed and the noise measured as before. The frequency range should be stated as extending from some low frequency, which is 15 db below the flat response level, to a high frequency, which is also 15 db down.

It should be noted that noise measurements require about the same equalization as distortion measurements, and it may, therefore, be possible to use the same equipment by including a 250-cycle high-pass filter, since the distortion meter of the type available is also designed for noise measurements.

In making both the overall and high-frequency noise measurements, the medium should be erased and bias applied as normally done in recording, but without signal.

It is therefore recommended that when making noise measurements pertaining to the system

- (a) The medium should be erased and bias applied as is normally done in recording.
- (b) The playback system be compensated flat within one db from 200 to at least 2000 cycles.
- (c) The reference signal be 400 cycles recorded at the peak recording level and the noise expressed in db below this level.
- (d) A high-pass filter cutting off frequencies below 250 cycles be used.
- (e) The frequency range be stated as from 250 cycles to the frequency at which the response is down 15 db from the flat response portion.

Note: If the equipment noise (medium not moving) is not 10 db or more below the system noise, both values should be stated. When making noise measurements of the overall system, which would include "hum," the procedure outlined for system



noise should be followed, except that

- (a) The 250-cycle high-pass filter not be used.
- (b) The frequency range be stated as extending from the low frequency which is 15 db below the flat response level to the high frequency which is also 15 db below.

b. *Medium*

Where a noise measurement which properly evaluates the capabilities of a medium is wanted, great care must be taken in erasing the medium prior to the noise measurements. It has been found that asymmetry of wave shape of erase and bias of the high-frequency supplier affects the resulting noise. Therefore, to avoid possible errors due to such an effect, it is recommended complete erasure be obtained by the use of a strong low-frequency (60-cycle) magnetic field (solenoid coil structure), having gradual decreasing strength where the medium leaves the field. Neither high-frequency erase or biasing fields should be applied after the low-frequency erase, and every effort should be made to completely demagnetize the reproducing head or any other magnetic material which may be in contact (or sufficiently close to cause magnetization of the medium), before measurement. The reference signal of 400 cycles should be recorded on a separate section of the medium or the reference level established immediately prior to the low-frequency erase. Since equipment hum should not be chargeable to medium noise, a 250-cycle high-pass filter should be used during measurements.

It is therefore recommended that when making noise measurements pertaining to the medium

- (a) The playback system be compensated flat within one db from 200 to at least 2000 cycles.
- (b) The reference signal of 400 cycles be recorded at the peak recording level and the noise expressed in db below this value.
- (c) A high-pass filter cutting off frequencies below 250 cycles be used.
- (d) The medium be erased completely, using a strong low-frequency field if necessary.
- (e) The frequency range be stated as from the cutoff of the filter, 250 cycles, to the frequency at which the response is down 15 db from the flat response portion.

Note: If the equipment noise (medium not moving) is not 10 db or more below the system noise (medium moving), high values of noise should be given.

Submitted by:

Dr. S. J. Begun, Chairman  
Mr. L. C. Holmes  
Mr. H. E. Roys

## DISC RECORDING

[from page 13]

ful copy. Also, when making recordings purposely for dubbing, lower levels are used in order to take advantage of the reduced cutter distortion, and care is taken to work at the outside radii as much as possible. By careful attention to response and distortion, it has proven possible to re-record speech program as many as five times with very little deterioration of quality. The accuracy of the complementary NAB pre-emphasis and de-emphasis networks allows the faithful

# An EASY and ACCURATE Way to Measure Audio Frequency Voltages

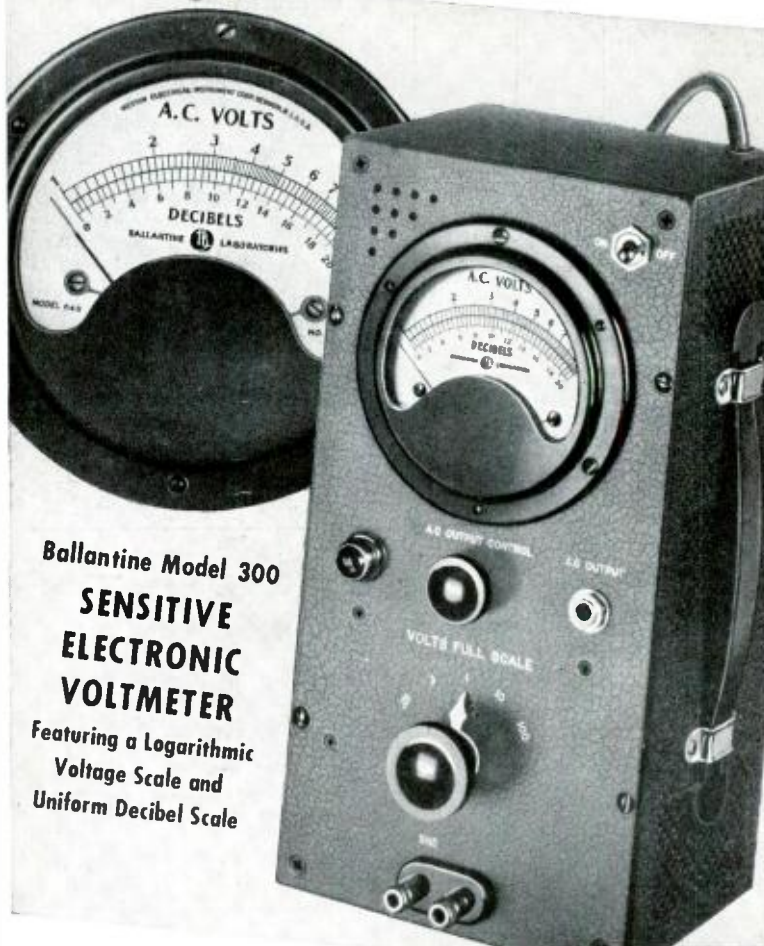

**Ballantine Model 300**

**SENSITIVE  
ELECTRONIC  
VOLTMETER**

**Featuring a Logarithmic  
Voltage Scale and  
Uniform Decibel Scale**

- Designed for the measurement of AC Voltages from .001 Volt to 100 Volts over a frequency range of 10 to 150,000 cycles.
- Accuracy of readings is  $\pm 2\%$  at any point on the scale.
- Very stable calibration—unaffected by changes in line voltage, tubes or circuit constants.
- Range switching in decade steps—easy to use—only ONE scale to read.
- Output jack and output control provided so that Voltmeter can be used as a high-gain (70 DB) high-fidelity amplifier.
- Accessories available to extend readings up to 10,000 Volts and down to 10 microvolts.
- Precision Shunt Resistors convert Model 300 Voltmeter to very sensitive direct-reading milliammeter.
- Write for complete data.

**PRICE . . . . . \$200.00**



In addition to the Model 300 Voltmeter, Ballantine Laboratories also manufacture Battery Operated Electronic Voltmeters, R. F. Electronic Voltmeters, Peak to Peak Electronic Voltmeters, and the following accessories—Decade Amplifiers, Multipliers, Precision Shunt Resistors, etc.



**America's  
leading  
engineers  
of important  
industrial  
organizations**

**SWITCH**  
to  
**NEWARK**  
for

**TV, Radio, Sound and  
Recording Equipment,  
Replacement Parts and  
Electronic Tubes**

**because...**

**NEWARK** has the most complete on-the-spot stock of all standard equipment... from the tiniest replacement part to the most complete installation... on hand in 3 giant centrally located stores, and tremendous warehouses!

**NEWARK** equipment is tops in quality, dependability, and performance. Everything is Newark-tested and Newark-backed, so you know it's the best!

**NEWARK** delivers the goods...but fast! 24-Hour mail-order service...faster on phone or telegraph orders.

**NEWARK** offers the most complete essential reference book...148 illustrated pages full of data on over 20,000 standard brand items, including

Standard and L-P pickups and changers • Wire, tape and disc recorders • Hi-Fi sound and P.A. equipment • Speakers • Mikes • Accessories etc.



Send  
**TODAY**  
for **FREE**  
new 1949  
**NEWARK**  
**CATALOG**

Also featuring a complete line of **RADIO AND TELEVISION KITS, SETS, PARTS and ACCESSORIES** for homes, hams and hobbyists!

**24-HOUR MAIL-ORDER SERVICE**

**3 GREAT STORES!** Uptown at 115 W. 45th St.  
Downtown at 212 Fulton St. in **NEW YORK**  
323 W. Madison St. in the heart of **CHICAGO**

**NEWARK** **RADIO & TELEVISION** **MAIL NOW!**  
Dept. D21

NEWARK ELEC. CO., 242 W. 55th St., N. Y. C.  
Please send FREE 1949 Newark Catalog to:

Name \_\_\_\_\_  
Address \_\_\_\_\_  
City \_\_\_\_\_ State \_\_\_\_\_

preservation of the original response of any phonograph record or transcription recorded at outside sources. Good advantage is taken of this factor when dubbing flip sides of phonograph albums used in daily symphony programs. To keep the radius losses at 78 rpm from doubling during this procedure, additional equalization is available during the last minute of travel by moving the radius-equalizer control switch from "off" to "low-fixed." By addition of the "off," "low-fixed" and "high-fixed" positions to the three basic curves, nine curves are available.

Although such a system of equalization is not applicable to all conditions of recording, it has proven remarkably practical for speech, for all network recording, and for most music. The tracing distortion generated by this system does not become severe until the last equalization step is reached, and even that is tolerable when played with a good magnetic pickup capable of rejection of all vertical components. The segues and overlaps of the sections of a half-hour show are unnoticeable even on better-than-average home radios.

Photographs by Rubeen Lawson, Jr.

**— Letters —**

[from page 6]

as a reader of at least 13 radio magazines every month, I can testify that he is the first to do it.

The Columbia-Victor controversy is so confused and befuddled by corporate names, reputations, advertising, and quasi-engineering considerations that just about everyone in the technical world has got to the point of holding his head in his hands trying to stave off apoplexy. Magazines and newspapers have skirted the subject, adding to the confusion by playing up the befuddlement of all concerned. Canby's comments are the first honest, objective, intelligent ones to appear.

The comments are objective because—paradoxically—they are subjective. Everyone has so far forgotten that the only purpose of any record is to enable someone to listen to music! And music is designed for and produces purely subjective reactions. The only objective view that can be valid must be based on a subjective reaction.

The tremendous, unbelievable, vital fact about LP's is that you can actually forget you are listening to a record! For someone who has been a record addict for years, elimination of the high-pitched surface hiss, the mental picture of the needle travers-

**BETTER COMPONENTS BUILD  
BETTER REPUTATIONS**



**SPECIFY El-Menco**

No product is better than its weakest component. That's why more and more manufacturers specify El-Menco — the mica capacitor that always gives customer satisfaction and builds better reputations.

**CM 15** (9/16" x 1/4" x 3/16")  
For Radio, Television, Other Electronic Applications  
2 to 420 mmf. capacity at 500v DCA  
2 to 525 mmf. capacity at 300v DCA  
Temp. Co-efficient ±50 parts per million per degree C for most capacity values.  
6-dot standard color coded.

**CM 20** Available in "A", "B", "C" and "D" characteristics  
2 to 1500 mmf. intolerances down to ±1%\* or .5 mmf. at 500 D.C. working voltage  
6-dot color coded \*Whichever is greater

**CM 35** Available in "A", "B", "C", "D" and "E" characteristics  
Minimum tolerance 1%  
500 D.C. working voltage  
6-dot color coded

**ARCO ELECTRONICS**  
Sole agent for jobbers and distributors in U. S. and Canada.  
135 Liberty St., New York, N. Y.  
Write, on firm letterhead, for samples and catalog.

**THE ELECTRO MOTIVE MFG. CO., INC.**  
Willimantic Connecticut

**AUDIO ENGINEERING SCHOOL**  
A practical Audio Engineering course in Sound Fundamentals; FILM and MAGNETIC Recording; Transmission Measurements; Monitoring and Mixing. Laboratories contain: Transmission Sets, Oscillators, Distortion Sets; Harmonic Analyzer; Intermodulation Analyzer and other eqpt. Recording Studio assimilating Broadcast, Motion Picture and Commercial Sound Recording. H. M. TREMAINE, Pres-Dir.  
Approved for Veterans and Foreign Visas.  
**HOLLYWOOD SOUND INSTITUTE Inc**  
1040-A No. Kenmore Hollywood 27, Calif.

**8 WIRE SHIELDED CABLE**  
Two No. 16, Six No. 20 tinned, stranded, copper, rubber insulated, coded leads. Waterproof rubber jacket. Tinned copper armor shield overall. New material—No. AEB. Lengths to 400 ft. Price 10c/ft., \$90/Mft., \$700/10Mft., FOB Chicago warehouse.  
**Trans-World Radio-Television Corp.**  
6629 Aberdeen St. Chicago 21, Ill.  
Phones: AUstin 7-4534 ENglewood 4-4454

**VERTICAL LATERAL REPRODUCERS RECONDITIONED**  
Types 9-A, 9-B, D-93306, M1-4856, M1-4875-G  
Complete Stock of New Replacement Parts for All Types  
This service is being used by leading radio stations and wired music companies from coast to coast. Factory prices prevail.  
**VIBRATION SYSTEMS, INC.**  
1040 W. Fort St. Detroit 26, Michigan

**BUY U.S. SECURITY BONDS NOW!**

ing a fast-moving disc, and all the other nerve-shattering disadvantages Mr. Canby mentions is like finding a diamond on the street. You can listen to the music—and not worry. I have bought about 15 LP's since September and will never buy another 78. I have even duplicated some of the music I already had on 78's and the difference makes the LP music sound and feel like a new, unfamiliar composition.

No matter how good Victor's disc sounds (and they do sound good—I've tried them) no one can convince me that Beethoven scored a pause in the orchestration every 4½ minutes. As long as the pause is there, it isn't Beethoven—it's a "canned" imitation.

I regret to say that I don't like the new cover design as well as the old. The magazine, however, is definitely keeping up its standard.

Richard H. Dorf  
755 W. 48th St.,  
New York City

## PRODUCTION TAPE RECORDING

[from page 21]

Details concerning the manufacture of additional such machines have not been completed.

With the new machine, tape can be recorded with a single magnetic pattern in the center, or with a double pattern of two magnetic paths side-by-side on the tape.

One path plays as the reel unwinds forward, the other path functioning when the tape reverses, which is accomplished automatically in a fraction of a second. The double pattern affords twice the playing time with the same amount of tape.

The new multiple recording machine is designed so that it can record either the single or double pattern type of tape. It can record both paths on the double pattern tape simultaneously. In addition, it can be adjusted by switch control for recording different length reels, and for different speeds.

Reels having 600 feet of tape, double pattern, and a playing speed of 3¾ inches per second can be turned out at the rate of 48 per hour, each reel having a full hour's playing time.

Reels with 1,200 feet of tape, double pattern, and a playing speed of 7½ inches per second can be turned out at the rate of 32 per hour, each reel having one hour of transcribed material.

In addition, 1,200-foot tape reels designed for playing speeds of 15 and 30 inches per second can be produced, it was announced. Master transcriptions from which the tape records are made, can be played at varying speeds, to fit the requirements of the job.

# Floating Action!

## for all TV Cameras

### "BALANCED" TV TRIPOD

Pat. Pending

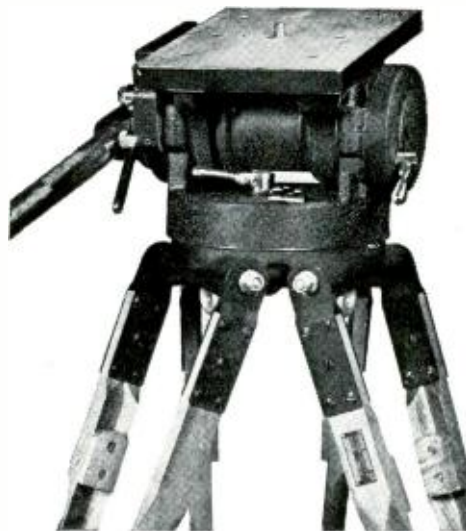

This tripod was engineered and designed expressly to meet all video camera requirements.

Previous concepts of gyro and friction type design have been discarded to achieve absolute balance, effortless operation, super-smooth tilt and pan action, dependability, ruggedness & efficiency.

Below:

3 wheel portable dolly with balanced TV Tripod mounted.

Complete 360° pan without ragged or jerky movement is accomplished with effortless control. It is impossible to get anything but perfectly smooth pan and tilt action with the "BALANCED" TV Tripod.

Quick-release pan handle adjustment locks into position desired by operator with no "play" between pan handle and tripod head. Tripod head mechanism is rustproof, completely enclosed, never requires adjustments, cleaning or lubrication. Built-in spirit level. Telescoping extension pan handle.

Write for further particulars



FRANK E. ZUGER  
**CAMERA EQUIPMENT CO.**  
1600 BROADWAY NEW YORK CITY

#### WANTED

Western Electric Vacuum Tubes. Types 101F, 102F, 272A or B, 310A or B, 311A, 313C, 323A, 32RA, 329A, 344A, 349A, 352A, 373A, 374A, 393A, 394A, 121A Ballast Lamps. Box 100. Audio Engineering.

#### WANTED

W. E. Carrier Telephone and Carrier Telegraph Equipment and components. Filters, repeating coils, transformers, equalizers. Type CF1, CF2, H. C. and other carrier equipment, telephone and telegraph repeaters. Box 101. Audio Engineering.

#### Booklets by A. C. Shaney

Written by a foremost Audio design engineer—

**Yours almost as a gift!**

Elements of Magnetic Tape Recording 25¢  
and 999 Applications 25¢  
Direct-Coupled FM-AM Amplifier Manual 3¢ in postage  
20 Steps to Perfect Amplification

**Thousands Sold!**

Famous Twin-Trax Instruction Book!  
Practically a course in tape recording. 30 diagrams, illustrations.

**\$250** (Price may be applied against future purchase of chassis)



**AMPLIFIER CORP. OF AMERICA**

398-4 Broadway • New York 13, N. Y.



# CUT COSTS ON FILM PRODUCTION



for  
**16 mm**  
AND  
**35 mm**  
1000'  
capacity

**TO MAKE ROOM,** we're sacrificing these efficient, automatic film cleaning machines—worth \$400.....only **\$194.50**

### BETTER BUY THESE TOO

Stop Watch Film Timers.....	\$ 24.75
35 mm Cinephone Recorder.....	495.00
Zoomar A 16mm Lens.....	1175.00
8' Tripods for Spots, etc.....	9.95
Auricon 16mm Recorders.....	535.00
Soud Moviola Composite 35 mm.....	395.00
B & H Sound Printer, Model D.....	1995.00
Bardwell 5KW Floodlights.....	111.75
Micro 16 mm Sound Readers.....	147.50
Houston 16mm Processors.....	3485.00
Synchronous Motors 1/12 H.P.....	57.50

• For details and catalog STURELAB write Dept. G

**S.O.S. CINEMA SUPPLY CORP.**  
602 WEST 52nd ST., NEW YORK 19, N.Y.

## HARTLEY-TURNER Highest Fidelity Speaker.

We use the word "service" in its real sense, meaning a desire on our part to give you honest information and advice on the whole subject of high-fidelity. Traditionally the speaker is the weakest link in the chain. The Hartley-Turner 215 Speaker, at the "ridiculous" price of \$39.50 is one of the strongest. We quote "ridiculous" because several correspondents have called it so for a "real high-fidelity speaker." But the 215 Speaker is designed for superlative performance regardless of cost.

By a happy chance (or our skill?) you get superlative performance at the price of a mass-production unit.

The service we offer cannot cost you more than \$1. That is the price we ask for "New Notes in Radio", a non-partisan guide to the whole subject of high-fidelity reproduction, supplemented by data-sheets giving full details of suitable radio units and amplifiers.

In Britain we sell these units complete, or offer them as home-construction kits, for our customers are on our door-step. To be fair to you who are so far away we tell you all about them. You can repeat their performance with American components. What you cannot copy is the 215 Speaker. Nor, for that matter, can any other country, for it embraces the experience of twenty years' specialisation in one precise field of endeavour. But the price we ask puts it within reach of everyone.

Do remember, however, that the price is merely incidental. With us everything is subordinate to performance.

Catalog free on request.

**H. A. HARTLEY Co., Ltd.**  
152, HAMMERSMITH ROAD,  
LONDON, W. 6, ENGLAND

## ADVERTISING INDEX

Altec Lansing Corp. ....	40
Amplifier Corp. of America .....	46
Arcturus Engineering Corp.....	29
Arnold Engineering Co. ....	1
Astatic Corporation, The .....	42
Audio Development Co.....	6
Audio Devices, Inc. ....	Cover 2
Audio Instrument Co.....	36
Audio Research Associates.....	30
Audio & Video Products Corp. 5	

Ballantine Laboratories, Inc..... 45

Camera Equipment Co.....	46
Chicago Transformer Corp.....	41
Cinema Engineering Co.....	44

Electro Motive Mfg. Co., Inc. 46	
Electro-Voice, Inc. ....	27

Fairchild Recording Equip. Corp. ....	33
Freed Transformer Co. ....	42

Hartley, H. A. Co., Ltd. ....	48
Harvey Radio Co., Inc. ....	34
Hewlett-Packard Co. ....	2
Hollywood Sound Institute .....	46

Lansing, James B. Sound, Inc. 48	
LeBel, C. J. ....	30

Magnecord, Inc. .... 40

Newark Electric Co., Inc. .... 45

Pickering & Co., Inc.....	31
Presto Recording Corp.....	Cover 3
Professional Directory .....	30

Reeves Soundcraft Corp. .... 7

Shure Brothers, Inc. ....	35
Simpson Electric Company .....	43
Somerset Laboratories, Inc. ....	32
S. O. S. Cinema Supply Corp. 48	

Terminal Radio Corp. ....	37
Trans-World	

Radio-Television Corp. .... 45

United Transformer Corp. Cover 4	
U. S. Recording Co.....	30

Vibration Systems, Inc. .... 46

Ward Leonard Electric Co. ....	39
Wells, Winston .....	30
Western Electric Company .....	8
White, S. Young .....	30



for

## MAXIMUM PERFORMANCE

Jim Lansing Signature Speakers will provide an almost unbelievable realism. The experience gained through a quarter of a century of leadership in the sound reproduction field has gone into their development and design. For maximum dynamic range and frequency response compare Jim Lansing Signature Speakers before you buy.



### MODEL D-1002 TWO WAY SYSTEM

Designed especially for FM Monitoring and high quality home sound reproduction. Housed in a beautiful console type cabinet.

Write for Descriptive Catalog containing complete specifications.

SEE YOUR JOBBER  
OR SEND DIRECT



## JAMES B. LANSING SOUND INC.

7801 HAYVENHURST AVENUE  
VAN NUYS, CALIFORNIA



# 66-G

## Here's the Recorder You asked for!

The best features of Presto's dual motor gear drive with the overhead mechanism and turntable of the famous Presto 6-N.

YES, engineers have often asked us for a compact, economical yet high-quality recorder. Now you may have it in the Presto 66-G for standard and microgroove recording.

Here is a unit ideally suited and priced for the typical broadcast station or large transcription manufacturer. List price, Standard Model, \$996! (\$70 additional for microgroove.)

Here's perfection in total speed regulation and very low mechanical disturbance, thanks to the standard Presto dual motor gear drive. Here's high-quality recording, too, for the 66-G, of course, includes the Presto 1-D cutting head.

You'll find 66-G equal to the most exacting recording tasks when used with suitable amplifiers such as Presto 92-A recording amplifier and 41-A limiter amplifier.



### FOR HIGHEST FIDELITY... IT'S PRESTO DISCS

Microgroove, even more than standard recording, demands a perfect disc. The answer is Presto. For, sixteen years ago, Presto made the first lacquer-coated discs... and today Presto discs are first in quality.



RECORDING CORPORATION

Paramus, New Jersey



### READY NOW: Magnetic Tape Recorder

You probably saw Presto's new superquality magnetic tape recorder at the I.R.E. Show. If not, be sure to see it in Presto's room at the N.A.B. Convention in Chicago.

Mailing Address: P. O. Box 500, Hackensack, N. J.  
In Canada: WALTER P. DOWNS, LTD., Dominion Sq. Bldg., Montreal

WORLD'S LARGEST MANUFACTURER OF INSTANTANEOUS SOUND RECORDING EQUIPMENT AND DISCS



# COMMERCIAL GRADE COMPONENTS

A wide range of units for every application

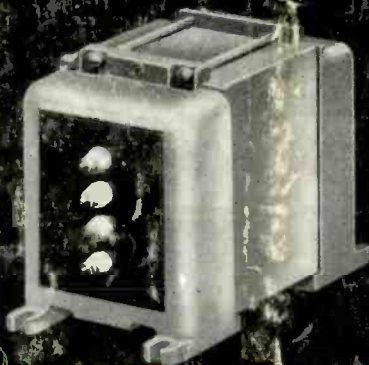

U.T.C. Commercial Grade components employ rugged, drawn steel cases for units from 1" diameter to 300 VA rating . . . vertical mounting, permanent mold, aluminum castings for power components up to 15 KVA. Units are conservatively designed . . . vacuum impregnated . . . sealed with special sealing compound to insure dependability under continuous commercial service.

A few of the large number of standard C.G. units are described below. In addition to catalogued units, special C.G. units are supplied to customer's specifications.

## CG VARIMATCH OUTPUTS FOR P. A.

Universal units designed to match any tubes within the rated output power to line or voice coil. Output impedance 500, 200, 50, 16, 8, 5, 3, 1.5 ohms. Primary impedance 3000, 5000, 6000, 7000, 8000, 10,000, 14,000 ohms.

Type No.	Audio Watts	Typical Tubes	List Price
CVP-1	12	42, 43, 45, 47, 2A3, 6AU, 6P6, 25L6	\$ 9.00
CVP-2	30	42, 45, 2A3, 6L6, 6V6, 6B5	14.00
CVP-3	60	46's, 50's, 300A's, 6L6's, 801, 807	20.00
CVP-4	125	800's, 801's, 807's, 4-6L6's, 845's	29.00
CVP-5	300	211, 242A's, 203A's, 838's, 4-945's, 2B-120's	50.00

## CG VARIMATCH LINE TO VOICE COIL TRANSFORMERS

The UTC VARIMATCH line to voice coil transformers will match any voice coil or group of voice coils to a 500 ohm line. More than 50 voice coil combinations can be obtained, as follows:

2, 4, 5, 6, 1, 1.25, 1.5, 2, 2.5, 3, 3.3, 3.8, 4, 4.5, 5, 5.5, 6, 6.25, 6.6, 7, 7.5, 8, 9, 10, 11, 12, 14, 15, 16, 18, 20, 25, 28, 30, 31, 40, 47, 50, 63, 69, 75.

Type No.	Audio Watts	Primary Impedance	Secondary Impedance	List Price
CVL-1	15	500 ohms	.2 to 75 ohms	\$ 8.00
CVL-2	40	500 ohms	.2 to 75 ohms	11.50
CVL-3	75	500 ohms	.2 to 75 ohms	17.50

## CG VARIMATCH MODULATION UNITS

Will match any modulator tubes to any RF load. Primary impedances from 500 to 20,000 ohms. Secondary impedances from 30,000 to 300 ohms.

Type No.	Max. Audio Watts	Max. Class C Input	Typical Modulator Tubes	List Price
CVM-0	12	25	30, 49, 79, 8A6, 53, 2A3, 6B5	\$ 8.50
CVM-1	30	60	6V6, 6B5, 2A3, 42, 46, 6L6, 210	14.00
CVM-2	60	125	801, 6L6, 809, 4-46, T-20, 1808	20.50
CVM-3	125	250	800, 807, 845, TZ-20, HK-39, 35-T	30.00
CVM-4	300	600	50-T, 203A, 805, 838, T-35, 2B-120	50.00
CVM-5	600	1200	805, HF-300, 204A, HK-351, 250TH	115.00

## INPUT, INTERSTAGE, MIXING AND LOW LEVEL OUTPUT TRANSFORMERS

(200 ohm windings are balanced and can be used for 250 ohms)

CG Type No.	Application	Primary Impedance Ohms	Secondary Impedance Ohms	List Price
131	1 plate to 1 grid	15,000	135,000 3:1 ratio	\$ 9.50
132	1 plate to 2 grids	15,000	135,000 center-tapped 3:1 ratio overall	10.00
133	2 plates to 2 grids	30,000 P to P	80,000 overall 1.6:1 ratio overall	12.50
134	Line to 1 grid hum-bucking	50, 200, 500	80,000	12.50
135	Line to 2 grids hum-bucking	50, 200, 500	120,000 overall	13.50
235	Line to 1 or 2 grids, hum-bucking; multiple alloy shielded for low hum pickup	50, 200, 500 ohms	80,000 overall	17.50
136	Single plate and low impedance mike or line to 1 or 2 grids hum-bucking	15,000, 50, 200	80,000 overall	13.50
233	PP 6CS, 56, similar triodes to AB 45's, 2A3's, 6L6's, etc.	30,000 P to P	25,000 overall 9:1 ratio overall	11.00
333	PP 6CS, 56, similar triodes to fixed bias 6L6's	50,000 P to P	7,500 overall 5:1 ratio overall	11.00
433	PP 45, 2A3, similar tubes to fixed bias 2 or 4 6L6's	5,000 P to P	1,250 overall 5:1 ratio overall	12.00
137	Mixing	50, 200, 500	50, 200, 500	10.00
140	Triode plate to line	15,000	50, 200, 500	12.00
141	1P triode plates to line	15,000	50, 200, 500	13.50

*United Transformer Co.*  
150 VARICK STREET NEW YORK 13, N. Y.

EXPORT DIVISION: 13 EAST 40th STREET, NEW YORK 16, N. Y. CABLES: "ARLAB"

For full details on this line, write for Catalog