

JULY
1948

AUDIO ENGINEERING



THE JOURNAL FOR SOUND ENGINEERS



TEN YEARS OF LEADERSHIP

Ten years ago the first AUDIODISC was manufactured . . . manufactured by a patented precision-machine process, which produced the finest recording disc known.

During this decade AUDIODISCS have been rated first in every field of sound recording . . . radio broadcasting, commercial recording studios, the phonograph record industry, motion picture studios, educational institutions, home recording, research laboratories and governmental agencies. In every country throughout the world, AUDIODISCS are regarded as the true standard of recording quality.

At first the output of AUDIODISCS was measured in tens of thousands, then in hundreds of thousands and later in millions per year. Today this highest rate of production is being maintained and the quality is the finest yet achieved.

AUDIO DEVICES, INC., 444 Madison Avenue, New York 22, N.Y.

Export Department: Rocke International Corp., 13 E. 40th Street, New York 16, N. Y.

Audi discs are manufactured in the U.S.A. under exclusive license from PYRAL, S.A.R.L., Paris



they speak for themselves **audi discs**

Greyhound Bus improves service, saves mileage,
reduces delays with *Motorola* sets

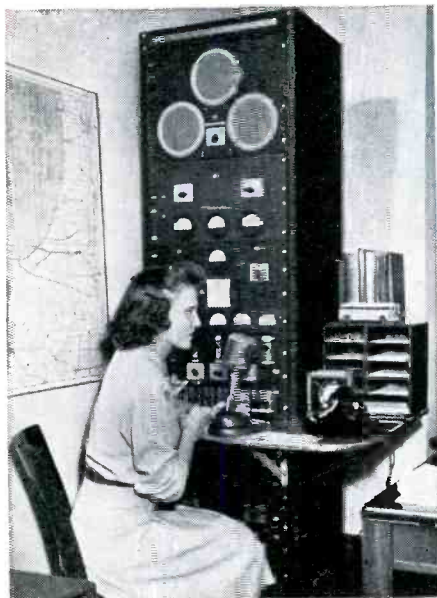
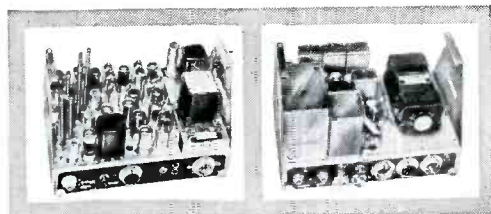

Dispatchers communicate directly with drivers to adjust schedules to changing load conditions.

and Sylvania Lock-In Tubes

BY MAINTAINING 2-WAY RADIO COMMUNICATION between dispatchers and buses on the road in the Chicago area, Greyhound has effected substantial operating economies — and *at the same time* has improved quality of its service to riders! Schedules are quickly readjusted, extra sections added, runs combined — as the dispatcher works with the up-to-the-minute reports coming in from drivers.



The 2-way communication is maintained by FM equipment built by Motorola, Inc., Chicago — using Sylvania Lock-In Tubes in the mobile units. These famous tubes stay put in their sockets, no matter how rough the road. They have no soldered joints, few welded ones. Short, direct connections reduce losses. Getter is located on top; separation of getter material from leads cuts down leakage.

This electrical and mechanical superiority makes the Lock-In the ideal choice for equipment on the road, in the air, on the rails . . . for marine radar, FM, television. See Sylvania Distributors, or write Radio Tube Division, Emporium, Pa.

SYLVANIA ELECTRIC

MAKERS OF RADIO TUBES; CATHODE RAY TUBES; ELECTRONIC DEVICES;
FLUORESCENT LAMPS, FIXTURES, WIRING DEVICES; ELECTRIC LIGHT BULBS



Driver can quickly report overloading or underloading, traffic conditions, weather hazards.

El-Menco PRECISION

POINTS TO

PROGRESS!

El-Menco

laboratory technicians insist on the highest degree of precision at every step in the manufacture of El-Menco Capacitors. They know the important part capacitors play as components in electronic products and how much depends upon their unfailing performance.

This unfailing performance aids immeasurably in the electronic industry's unfaltering progress. The use of El-Menco Capacitors throughout the electronic industry is an indisputable testimony in behalf of their superiority.



Write on firm letterhead for catalog and samples.

MANUFACTURERS

Our silver mica department is now producing silvered mica films for all electronic applications. Send us your specifications.

Send for samples and complete specifications. Foreign Radio and Electronic Manufacturers communicate direct with our Export Department at Willimantic, Conn., for information.

THE ELECTRO MOTIVE MFG. CO., Inc.
Willimantic, Connecticut

JOBBERS AND DISTRIBUTORS
ARCO ELECTRONICS
135 Liberty St., New York, N.Y.
is Sole Agent for El-Menco Products in
United States and Canada



MOLDED MICA

El-Menco

CAPACITORS

MICA TRIMMER

Member of Audit Bureau of Circulation

AUDIO ENGINEERING

Successor to **RADIO**

John H. Potts, Editor
C. G. McProud, Managing Editor
Lawrence LeKashman, Asst. Editor
Louisa B. Dresser, Edit. Prod. Mgr.

Sanford R. Cowan, Publisher
S. L. Cahn, Adv. Director
H. N. Reizes, Adv. Mgr.
Jerome S. Harris, Circ. Mgr.

Editorial Advisory Board

Howard A. Chinn
John D. Colvin
Paul A. de Mars
C. J. LeBel
J. P. Maxfield
George M. Nixon
S. Young White

Representatives

James C. Galloway
816 W. 5th St., Los Angeles 13, Calif.
Dale International Publications, Ltd.
105 Bolsover St.
London W. 1, England
Harris & Floyd
297 Swanston St., Melbourne
C. I, Victoria, Australia

Established 1917

CONTENTS

JULY, 1948

Vol. 32, No. 7

Letters	4
Germanium Crystal Amplifier— <i>Winston Wells</i>	6
The Edispot — A Spotting Device for Magnetic Tape Editing— <i>Richard S. O'Brien</i>	11
Manufacture of Phonograph Record Matrices— <i>Harold Harris</i>	14
Design and Construction of a Wired Music System— <i>Arthur R. O'Neil and Herbert G. Cole</i>	19
30-Watt High-Fidelity Audio Amplifier— <i>Curtiss K. Schafer</i>	21
Getting the Most Out of a Reflex-Type Speaker— <i>Benjamin B. Drisko</i>	24
Telephone Recording—Part II— <i>E. W. Savage and S. Young White</i>	26
Binaural Phenomenon— <i>S. Young White</i>	30
Applications of Magnetic Recording in Network Broadcasting— <i>R. F. Bigwood</i>	31
Record Revue:	
Classical Recordings— <i>Edward Tatnall Canby</i>	34
Popular Recordings— <i>Bertram Stanleigh</i>	34
New Products	36
Professional Directory	36
Advertising Index	48

COVER

Jack Mullen, recording engineer, checking Ampex recording of Crosby show on ABC.

AUDIO ENGINEERING (title registered U. S. Pat. Off.) is published monthly at New York, N.Y., by Radio Magazines, Inc., J. H. Potts, President; S. R. Cowan, Sec'y-Treas. Executive and Editorial Offices at 342 Madison Avenue, New York 17, N.Y. Subscription rates—United States, U. S. Possessions and Canada, \$3.00 for 1 year, \$5.00 for 2 years; elsewhere \$4.00 per year. Single copies 35c. Printed in U. S. A. All rights reserved. Entire contents copyright 1948 by Radio Magazines, Inc. Entered as Second Class Matter at the Post Office, New York, N. Y., under the Act of March 3, 1879.

Shallcross ATTENUATORS

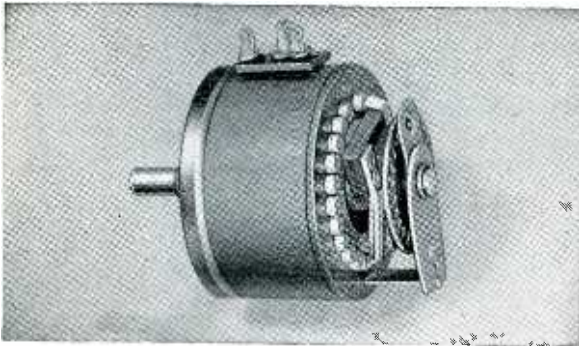

**BRIDGED 'T'
ATTENUATOR
Type 410-4B1**

10 steps, 4 db/step.
Linear attenuation
with detent. 2 1/8" di-
ameter, 2 1/16" depth.

**BRIDGED 'T'
ATTENUATOR
Type 420-2B2**

20 steps, 2 db/step.
Linear attenuation with
off position and detent.
2 1/8" diameter, 2 1/16"
depth.

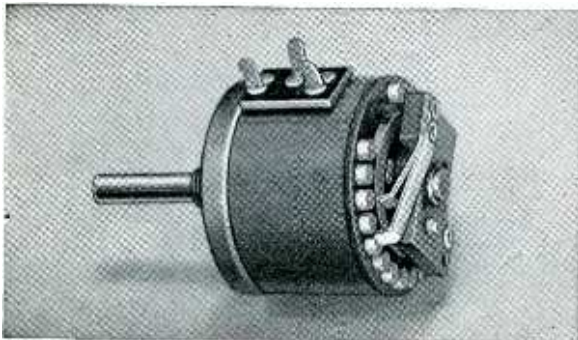
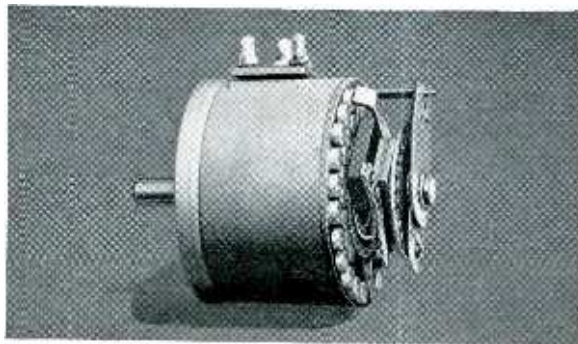

**POTENTIOMETER
Type C720-2A3**

20 steps, 2 db/step,
tapered on last three
steps to off, composi-
tion resistors. 1 3/4" di-
ameter, 1 3/4" depth.

**These Shallcross Features
Mean Better Performance —
Better Value!**

Off position attenuation well in excess
of 100 db.

25% to 50% fewer soldered joints.

Noise level ratings that are factual.
(130 db. or more below zero level.)

Non-inductive Shallcross precision res-
istors used throughout assure flat at-
tenuation to and beyond 30 kc.

Types and sizes engineered for all
needs. Attenuation accuracies of 1%.
Resistor accuracies of 0.1%, on spe-
cial order.

SHALLCROSS ATTENUATORS

Shallcross variable attenuators have proved their remarkable quietness and serviceability in dozens of applications for leading users in all parts of the world. Such important details as the use of spring-temper silver alloy wiper arms, silver alloy collector rings and contacts, non-inductive precision resistors, and sturdy, substantial mounting plates have made possible the high standard of performance attributed to Shallcross.

Standard types include ladder and bridged T mixer controls, bridged T and straight T master gain controls and V.U. meter multipliers, wirewound and composition potentiometers for grid control. Cueing attenuators, and fixed pads, both composition and wirewound, in all circuit configurations are also available.

Write for Catalog and Attenuator Specification Sheet.

SHALLCROSS MANUFACTURING COMPANY

Department A-78, Collingdale, Pa.

— Letters —

MORE ON TV

Sir:

Reference is made to your first editorial on page 6 of the April issue of *AUDIO ENGINEERING* in which you invite comment on the proposal to publish articles on television.

Kindly include me in the group of your readers who have their bellies full of seeing too many articles on television in other technical magazines, and want no part of it in *AUDIO ENGINEERING*, our only retreat at present.

Magazine editors don't seem to realize that there is a lot of America away from New York, and other metropolitan centers, where television is still just something they have "over East," and which, to them, just crowds out other reading matter from their favorite magazines.

There are many of us audio enthusiasts who prefer to see something else on the agenda ahead of television for the masses. I refer to high quality AM programs, FM programs, and commercial phonograph records. None of these is available in most parts of the country. Even wire recorder users are stymied in exploiting their new medium for lack of a satisfactory wide frequency range of program material. So let's work for a better audio world for all before we give space for television articles in *AUDIO ENGINEERING*.

Incidentally, how about more articles on commercial phonograph records? An enlarged section on classical recordings would be especially welcome so that more of the current record releases could be reviewed. Also, please give us an article or so on the making of records,* together with some information on such matters as cross-over frequencies used, amount of pre-emphasis used, highest usable frequencies, etc.

P. C. Lutz,

2006 Grasmere Drive,
Louisville 5, Ky.

*See this issue—and the other points will also be covered in detail soon.—Ed.

WMBI-FM Increases Power

Frequency modulation station WDLM in Chicago is now operating with call letters WMBI-FM, according to new FCC regulations. The change went into effect June 11.

WMBI-FM will be one of the first frequency modulation stations in the Chicago area to increase its power to 50,000 watts, according to A. P. Frye, director of the radio technical department of Moody Bible Institute. This new wattage will become effective early next fall, while amplitude modulation station WMBI will continue to broadcast at 5,000 watts.

*THERE'S PROFIT FOR YOU IN
THE TIME AND MONEY-SAVING QUALITIES OF*

ARNOLD

PERMANENT MAGNETS



Several avenues of profit are open to you in Arnold Permanent Magnets. You can improve the performance and overall efficiency of equipment. You can increase production speed, and in many cases reduce both weight and size. And most important, you can maintain these advantages over any length of production run or period of time, because Arnold Permanent Magnets are completely quality-controlled through *every* step of manufacture—from the design board to final test and assembly. You'll find them unvaryingly uniform and reliable in every magnetic and physical sense.

It's our job to help you discover and then fully attain these benefits. Arnold Products are available in all Alnico grades and other types of magnetic materials—in cast or sintered forms, and in any size or shape required. Our engineers are at your command—check with our Chicago headquarters, or with any Allegheny Ludlum branch office.

W&D 1298



THE ARNOLD ENGINEERING CO.

Subsidiary of **ALLEGHENY LUDLUM STEEL CORPORATION**

147 East Ontario Street, Chicago 11, Illinois

Specialists and Leaders in the Design, Engineering and Manufacture of PERMANENT MAGNETS

Experimental Germanium Crystal

Amplifier

WINSTON WELLS*

Announcement of the Transistor, a germanium valve amplifier/oscillator developed by Drs. John Bardeen and Walter Brattin of Bell Labs, is of such extraordinary importance that we have re-made this issue to include data on an experimental model constructed along Bell Labs design by Winston Wells, from which characteristic curves and the theory of operation were obtained. Such data could not be released by Bell Labs at this time. Further information will appear next month.

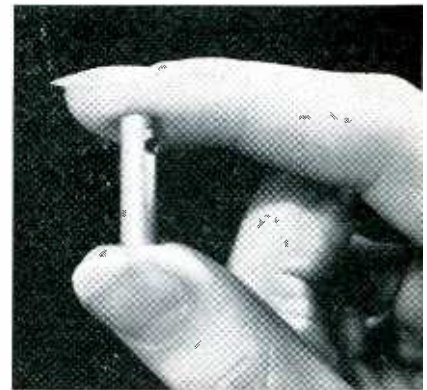

Experimental model of Bell Labs Transistor, a germanium crystal device which can amplify and oscillate at frequencies up to 10 mc. This extraordinary valve requires no vacuum nor heater yet produces power amplification of the order of 100. Power output is approximately 25 milliwatts.

THE behavior of germanium crystals used as amplifying valves may be explained as follows:

The crystals used belong to the class "N" materials, in which the unidirectional conductivity characteristics are derived from imperfections in the crystal lattice, introduced by impurities in the material. In this specific instance, the germanium crystal contains small amounts of tin, interspersed between the germanium atoms in the crystal lattice. The germanium alone would have a normal basic conductivity dependent

upon the capture and release of electrons in the "N" shell of the atom. The binding energy of the electrons in this outer shell is small, and we could expect saturation to occur at relatively low potentials.

Between the inner and outer electron shells of the germanium atom there exists a zone whose force fields do not permit the existence of orbital electrons under normal circumstances. However, the proximity of the tin atom so distorts these force fields, that the four electrons from the "O" shell of the tin atom may circulate in this "forbidden shell" of the germanium atom. Now, these borrowed electrons have a higher binding energy than do the four electrons

in the "N" shell of the germanium atom, and consequently require a greater potential difference between the contact and the crystal for their release. When the contact point is made sufficiently positive in relation to the crystal, the orbits of these borrowed electrons expand, allowing them to come within the outer zone where conductivity may take place.

Conversely, as the potential of the contact is made negative, relative to the crystal, the orbits of the borrowed electrons shrink, placing them in a zone where they are no longer available for participation in

[Continued on page 8]

*307 E. 44th St., New York City.

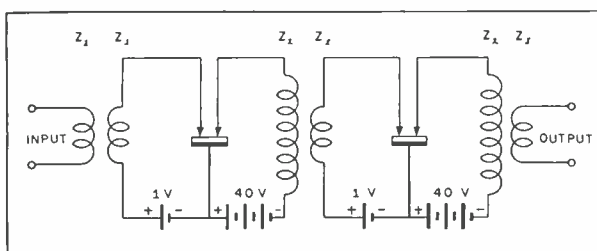

Lower left: Author's germanium crystal amplifier valve (highly magnified). Tungsten contacts spaced .005 inch. Fig. 1 (left). Circuit of two-stage germanium crystal amplifier, based on Bell Labs Transistor design data. Electrodes are separated .002 inch and are each .001 inch diameter. Fig. 2 (below). Average characteristics of author's experimental crystal valve.

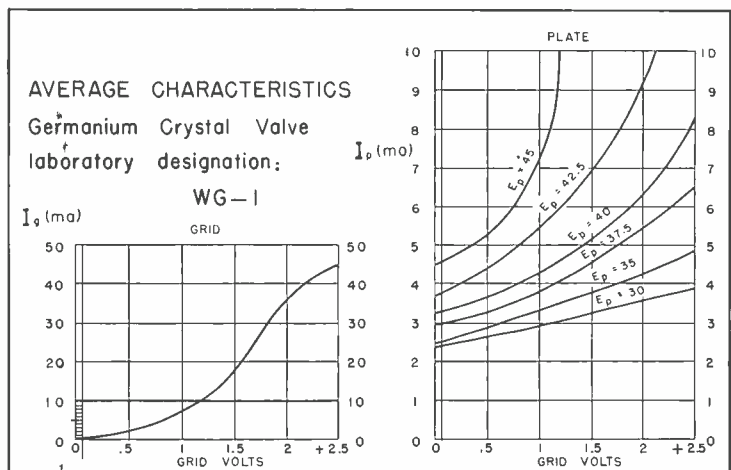
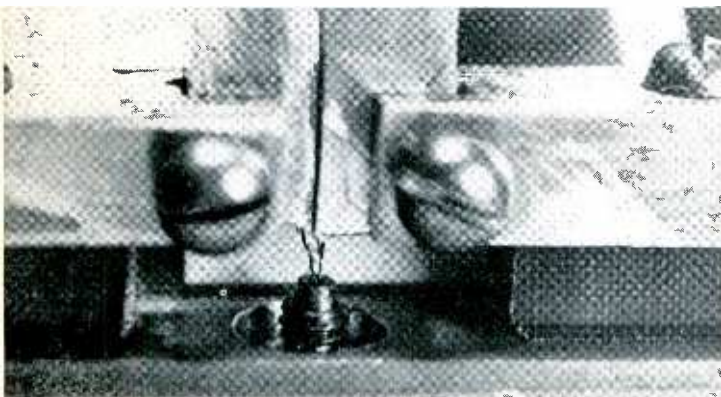

Hyper

guarantees that the
projectors on your
job are the best...
... 6 new designs

Jensen

6601 So. Laramie Ave., Chicago 38

Designers and Manufacturers of Fine Acoustic Equipment

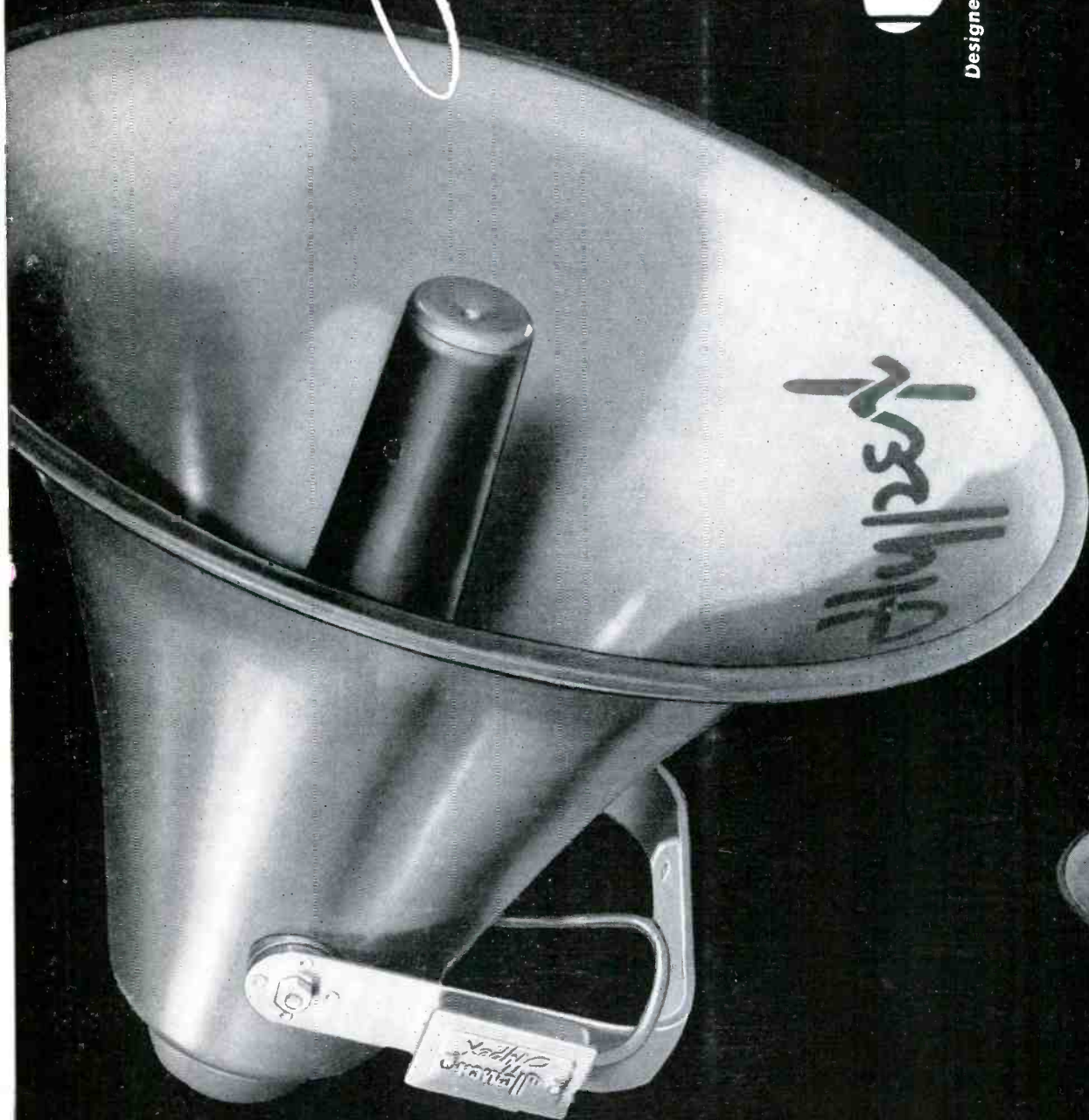

24 inch
Reflex



20 inch
Reflex



15 inch
Reflex



9 inch
Reflex

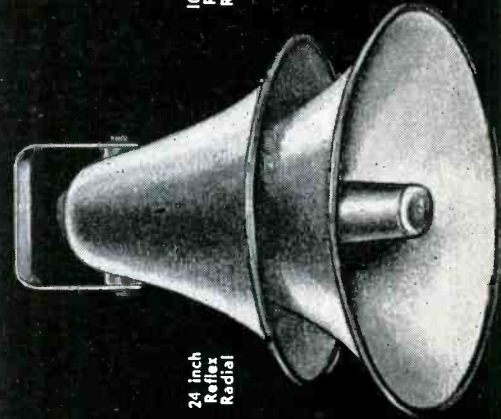

24 inch
Reflex
Radial



10 inch
Reflex
Radial

Still making Audio History

THESE new Racon models mark another step forward in speaker and horn design. A pioneer in "scientifically designed" audio units over twenty years ago, Racon is still making history in this field.

Do not be misled by the fact that speakers and horns of various makes look alike. Under the surface of any Racon unit there are "differences"—small physically but big from the standpoint of Performance!

Whatever the application, you can be sure that these subtle differences—built into Racon units by experienced audio engineers—will give you all-around performance and service of outstanding superiority.

PERMANENT MAGNET HIGH FREQUENCY SPEAKER



An efficient precision built Speaker, to meet the latest requirements for wide range reproduction. Designed to cover the frequency band up to 12,000 cycles. Supplied with horn having a low cut-off at 750 cycles. When used in conjunction with a suitable low frequency speaker and cross-over network will give audio reproduction at a new high quality level. Voice coil impedance 15 ohms.

TWO-CELL HIGH FREQUENCY HORN

Latest type of cellular horn with two cells, specially designed for flush mounting in any cabinet, giving distribution angle of 120° horizontal and 60° vertical. Has a 7/8-18 thread throat connection for a Racon standard high frequency unit.



TWO NEW TYPES OF FILTER CROSS-OVER NETWORKS, COMPLETELY ENCLOSED, EASILY MOUNTED

1. A simple Capacitive filter network with cross-over at 1500 cycles.
2. Resistive capacitive filter network with a cross-over at 1500 cycles and permitting balancing of high response to low.



NEW SMALL RE-ENTRANT HORNS

Extremely efficient for factory inter-com and paging systems; for sound trucks, R.R. yards and all other industrial installations where high noise levels are prevalent. Watertight, corrosion-proof, easily installed. Two new models—type RE-15, complete with Baby Unit, handles 25 watts, covers 300-6000 cps; type RE-12, complete with Dwarf Unit, handles 10 watts, has fre. response of 400-800 cps.

Write for catalog describing complete line of Racon Horns, Speakers, Units, Accessories, etc.

RACON ELECTRIC CO., INC.

52 EAST 19th STREET

NEW YORK 3, N. Y.

RACON



CRYSTAL AMPLIFIER

[from page 6]

conductivity. With sufficient suppression by means of increased negative potential at the point of contact, the current is reduced to a point which may be explained by the intrinsic bulk resistance of the semi-conductor as a whole.

It is to be noted that these changes in mode of conduction occur at discrete levels, dependent upon and proportional to the number of the eight possible electrons involved for each germanium-tin atom in combination. In other words, were we dealing with but one atom of germanium combined with one atom of tin, we would have but eight steps of conductivity, ranging from one to eight. However, the smallest point of contact which is physically possible involves several hundred thousand such atoms and, since their energy states vary according to statistical laws, we may expect these transitions to vary statistically in practice, yielding the continuously changing functions with which we are familiar.

Now it is clear that it will take a fairly high potential to maintain a current flow between a negatively charged contact point and the crystal, since the borrowed electrons will be pushed down below the zone of activity, and only the outer electrons of the germanium atoms will be participating.

If, however, we introduce a second contact point, in close proximity to the first, and charge the second contact positively, the borrowed electrons will again be elevated to the active region, releasing about twice as many for participation in conductivity. *These newly released electrons may take part in the conductivity in the plate circuit as well as the grid circuit . . . hence their effect is that of modulating the current flow of the plate circuit.*

It is apparent that the grid current may have to be equal to, and possibly exceed the plate current in order that this effect take place, *but power amplification takes place by virtue of the fact that the grid voltage is many times smaller than the plate voltage.*

As an example, a typical germanium valve may require a grid current change of 4 ma to effect a plate current change of 1.4 ma. But the impedance ratios would be such that an 0.3v grid voltage change would produce a plate voltage change of 1.5 volts during this transition. *Thus an input signal of 3 mw would yield an output signal of 60 mw.*

Several things are obvious about the design and operation of such an amplifier:

1. That amplification can only take place where

$$EgI_g/EpI_p$$

is less than unity. Therefore, circuit efficiency must be gained in two ways: (1) by making the electronic paths of the plate and grid contacts through the crystal as nearly coincident as possible, consistent with low cross current flow between the contacts themselves, and (2) by using the optimum step-down impedance ratio between the plate circuit of one stage and the grid circuit of the following stage.

It will also be seen that these two factors are interrelated and may be expressed by the formula:

$$ZgZp/1g^2Ip^2$$

[This discussion will be continued in an article to follow, next month. —Ed.]

for DISTORTION and BRIDGE MEASUREMENTS at 2 to 15,000 CYCLES

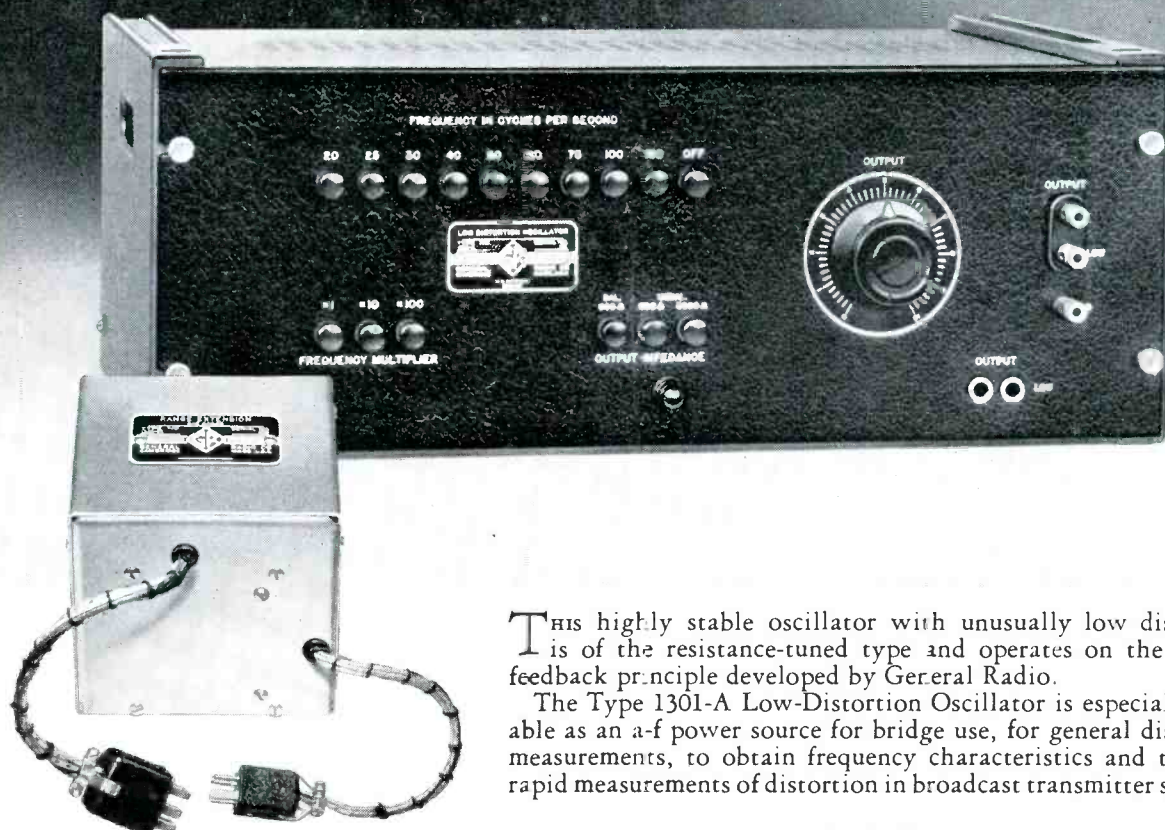

This highly stable oscillator with unusually low distortion is of the resistance-tuned type and operates on the inverse feedback principle developed by General Radio.

The Type 1301-A Low-Distortion Oscillator is especially suitable as an a-f power source for bridge use, for general distortion measurements, to obtain frequency characteristics and to make rapid measurements of distortion in broadcast transmitter systems.

FEATURES

- **WIDE FREQUENCY RANGE** — 20 to 15,000 cycles (with Range Extension Unit, 2 to 15,000 cycles)
- **CONVENIENT TO USE** — 27 fixed frequencies, selected by two push-button switches in logarithmic steps — any desired frequency between steps obtained by plugging in external resistors
- **THREE OUTPUT IMPEDANCES** — 600-ohm balanced to ground; 600-ohm unbalanced; 5,000 ohm unbalanced
- **EXCEPTIONALLY PURE WAVEFORM** — Distortion not more than the following percentages: with 5,000-ohm output 0.1% from 40 to 7,500 cycles; 0.15% at other frequencies. With 600-ohm output 0.1% from 40 to 7,500 cycles; 0.25% from 20 to 40 cycles and 0.15% above 7,500 cycles
- **HIGH STABILITY** — Frequency is not affected by changes in load or plate supply voltage. Drift less than 0.02% per hour after a few minutes operation
- **ACCURATE FREQUENCY CALIBRATION** — Adjusted to within $1\frac{1}{2}\% \pm 0.1$ cycle
- **NO TEMPERATURE OR HUMIDITY EFFECTS** — In ordinary climatic changes, operation is unaffected

TYPE 1301-A LOW-DISTORTION OSCILLATOR \$395.00

● The normal range of this oscillator is 20 to 15,000 cycles. The Range Extension Unit (above) lowers this range by a full decade to 2 to 15 cycles, greatly extending its usefulness to frequencies considerably below those heretofore practicable.

With its very high stability, unusually low distortion and many operating conveniences, the Type 1301-A Low-Distortion Oscillator fills a universal need in distortion and bridge measurements.

TYPE 1301-P1 RANGE EXTENSION UNIT \$70.00

GENERAL RADIO COMPANY

Cambridge 39,
Massachusetts

90 West St., New York 6

920 S. Michigan Ave., Chicago 5

950 N. Highland Ave., Los Angeles 38

**So much of everything you want
packed into this 10-inch speaker!**

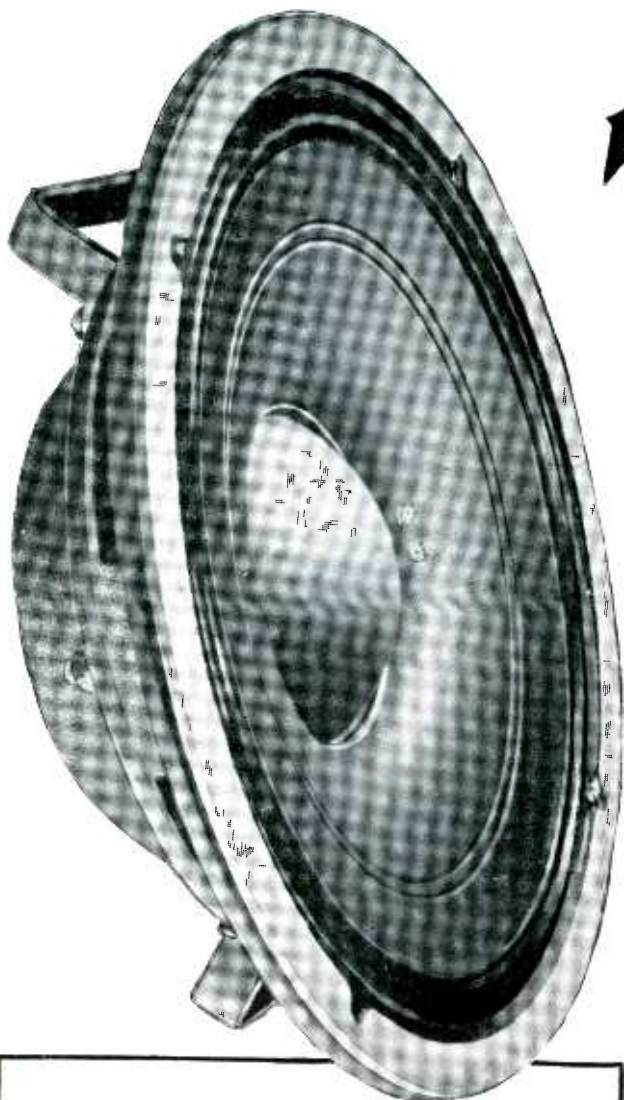

**The new
Western Electric
756A**

*20 watts capacity
Superb quality of reproduction
Compact and simple to install
Available for immediate delivery*

SPECIFICATIONS

FREQUENCY RANGE: 65 to 10,000 cycles.

IMPEDANCE: 4 ohms.

COVERAGE ANGLE: 60°.

POWER CAPACITY: 20 watts continuous.

EFFICIENCY: At distance of 30 feet on the axis, will produce a level of 89.5 db above 10⁻¹⁶ watt per sq. cm. at 20 watts, on basis of warble frequency covering range of 500 to 2500 cps.

DIMENSIONS: Diameter 10¼"; depth 3¼".

BAFFLE HOLE DIAMETER: 8-13/16".

WEIGHT: 10 lbs.

ENCLOSURE REQUIRED: 2½ cubic feet completely enclosed.

Before you select any speaker for broadcast monitoring, wired music, program distribution systems or home radios and record players, look at the 756A and listen to its brilliant tonal quality.

The 756A is just one of a line of new Western Electric speakers with power capacities from 8 watts to 30 watts. Get the full story on all of them from your Graybar representative, or write Graybar Electric Co., 420 Lexington Ave., New York 17, N.Y.

—QUALITY COUNTS—



DISTRIBUTORS: IN THE U. S. A. — Graybar Electric Company. IN CANADA AND NEWFOUNDLAND — Northern Electric Company, Ltd.

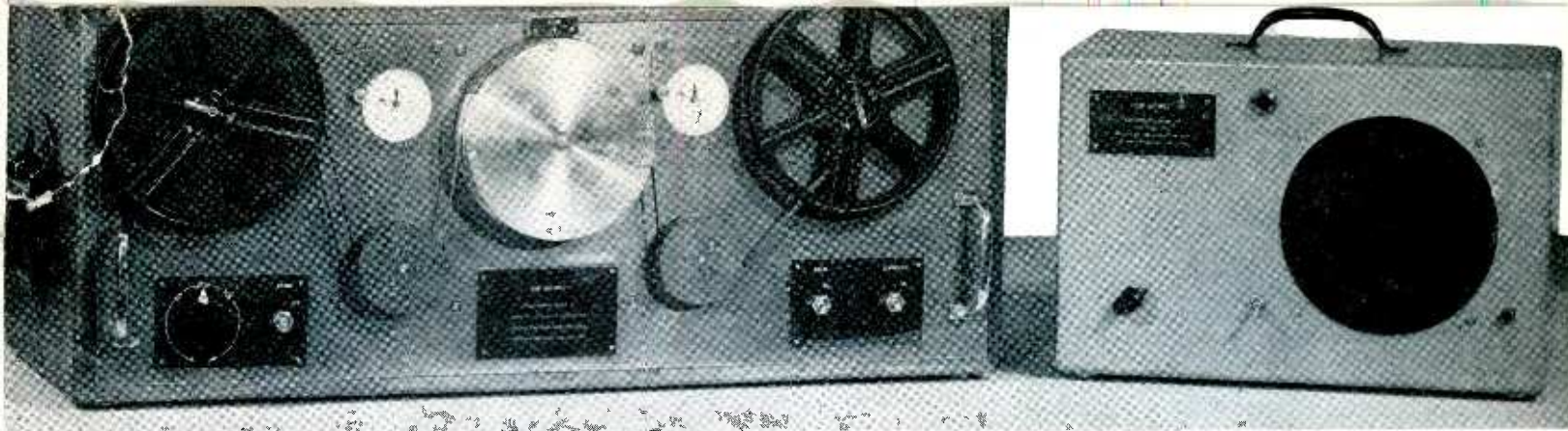

Fig. 1. Front view of C.B.S. Edispot (editing-spotter) and auxiliary amplifier unit. The tape may be reeled forward and backward, the output of a pickup head located on the drum being reproduced through the auxiliary amplifier. With the tape stopped at a desired section, the drum may be rotated, so the head scans a short length of tape, continuously repeating the words in that section. The output may be viewed on a special oscilloscope, together with a marker "pip" keyed exactly as the head passes the "Mark" arrow.

THE "EDISPOT" —

A Spotting Device for Magnetic Tape-Editing

DURING the recent British Royal Wedding, C.B.S. broadcast a full on-the-spot account of the event that began at 6 a.m., E.S.T. To fit a tape-recorded rebroadcast into the broadcasting schedule at a more popular listening hour, the original recording was edited to eliminate pauses and to condense generally the proceedings into a suitably-paced program.

Where it will not obscure the substance of the material, this editing technique is increasingly applied not only to special events coverage but to many day-to-day news shows, discussions, repeat broadcasts, etc. It is used to eliminate unsatisfactory portions of a recording, to shorten and improve coherence of previously recorded material or to obtain excerpts for inclusion with other material. One very common everyday application is the removal of excess ah's, and's, er's and uh's from extemporaneous speech. In some cases a passage will be shortened to half its original length after the annoying and distracting pauses have been edited out.

As has been pointed out,¹ one of the important advantages of the magnetic-tape recording process is its adaptability to the editing technique. The process of editing by direct splicing of the original recording medium enables a considerable saving in time, but to

*General Engineering Dept., Columbia Broadcasting Co., New York, N. Y.

¹H. A. Chinn, "Magnetic-Tape Recorders in Broadcasting," *AUDIO ENGINEERING*, May 1947.

●
RICHARD S. O'BRIEN*
●

fully utilize this advantage of magnetic tape recording, a rapid and accurate method for spotting or locating a desired cutting-point on the tape is required. The C.B.S. "Edispot", to be described, is a spotting device intended to accomplish this function.

The Spotting Problem

In handling recorded magnetic-tape material, a program director decides what editing work is required for the program at hand and makes an appropriate notation of timing and the nature of the operation to be performed. The person who performs the actual editing operation is then faced with the problem of precisely locating the indicated points at which the tape is to be cut and respliced.

If one can afford to tie up a machine for the purpose, a cutting point may be located approximately by playing the tape back on an ordinary recorder/playback machine. The desired section may be located by timing the playback at normal speed or by referring to a special time scale applied directly to the tape reel. A decal transfer which was especially made by CBS to fit an early type of tape reel is shown in *Fig. 2*. When, by one of these means, the desired section of tape is reached, the editor listens to the words on the tape several times and attempts to stop the

tape at the correct point. Of course, after the tape has been stopped, there is no longer any indication of where the words are located on the tape. At best, this procedure leaves considerable chance for error and it has often been necessary to make several cut-and-try splices. That the cutting point must sometimes be very carefully located is demonstrated by one case where an "r" was removed from the word "streamer", which was spoken in error, to make the correct word "steamer". Usually, a less delicate operation is involved but in all cases a means is desired for precisely and quickly spotting the cutting point.

If magnetic recording is compared to motion-picture film sound recording, it is noted that the two techniques are similar in employing a continuous, linear medium. However, it is immediately apparent that film sound track has the advantage, from the editing point of view, of being visible—the word locations may be seen even though the medium has been brought to a stop. One method for making "blind" magnetic-tape competitive on this score would involve a direct inking of the word envelopes on back of the tape. This process, however, would require an extra processing of all tape through a special marking device, would involve ink-drying problems, would not be equally usable on paper and plastic tape and would so mark the tape that the feature of re-use for later recordings would be lost.

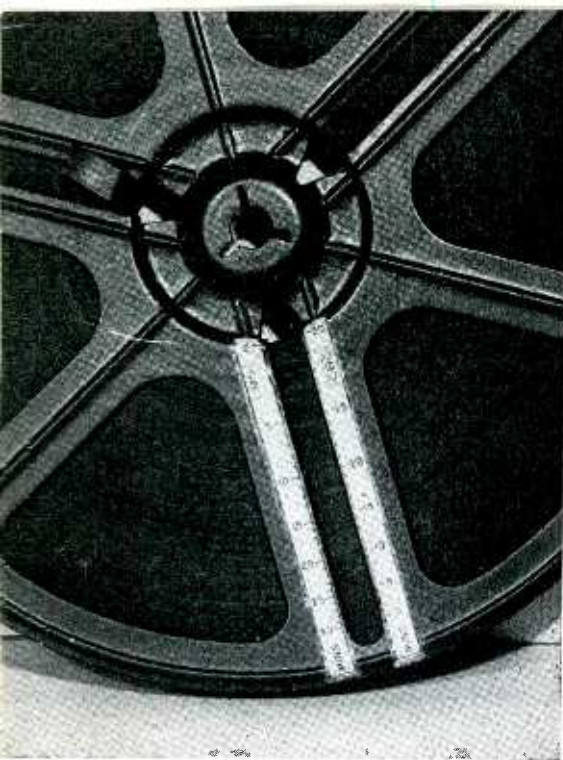
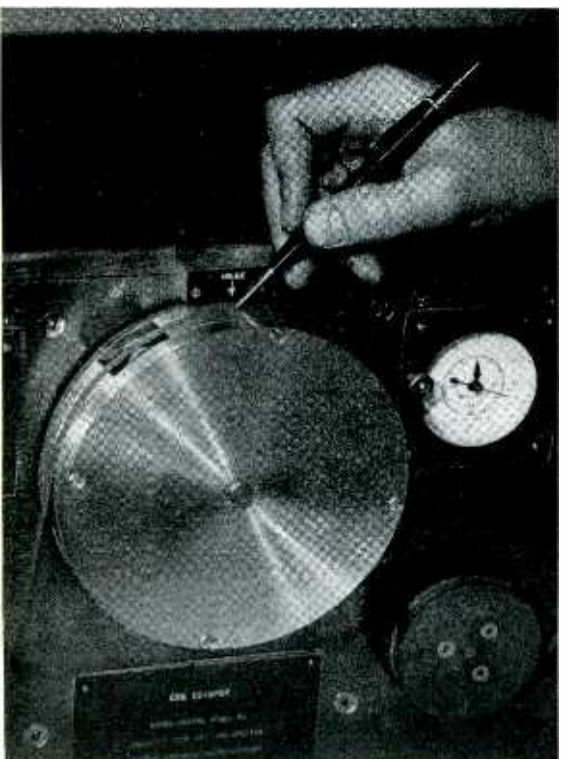

Fig. 2. Reel of magnetic tape with special decal-transfer time scales. The left-hand scale provides a center-out scale useful on recorder take-up reels; the right-hand scale may be used to approximately measure time.

The C.B.S. "Edispot" incorporates a second method for making the recorded material visible and, in fact, makes it possible to both see and hear the recorded material—with the tape stopped! In this system, a short length of tape is scanned repetitiously by a moving playback head. The tape may be moved along so that any group of words throughout the recording may be

Fig. 3. View of rotatable drum on C.B.S. "Edispot" unit showing the magnetic pickup head at about 11 o'clock position and the "Mark" arrow.



scanned. The words being scanned are reproduced on a loudspeaker and are simultaneously presented as a visual image of the "sound-track" on a cathode-ray oscilloscope. As will be described, means are provided for use with both the aural and visual presentations whereby a desired cutting point may be brought into exact alignment with a reference mark on the machine.

In considering the design of a machine to accomplish this scanning process, it was determined that from 2 to 6 words should be reproduced to obtain sensible visual and aural presentation. Much of the material subjected to editing is spoken at 2 to 4 words per second, so that a length of tape corresponding to about 1½ seconds should be scanned. Thus, on tape recorded at 7½ inches per second, 11¼ inches of tape must be scanned. It should be noted that at higher tape speeds, the scanning problem is somewhat different. For example, a recording speed of 30 inches per second would require that almost four feet of tape be scanned! Of course, at the higher speeds, the words are further apart so that a cutting point can often be located by simply scanning and listening to the beginning or end of a key word.² There have been ample indications that adequate fidelity will be achieved at the slower tape speeds where the scanning technique can be utilized to full advantage to facilitate the editing process.

The C.B.S. "Edispot"

An experimental model of the spotting device being described is shown with an auxiliary amplifier unit in Fig. 1. This unit incorporates a flexible single-knob controlled tape drive system, tape-driven, resettable "timers", and a motor-driven rotating drum on which the magnetic pickup head is mounted. In operation, the tape may be reeled in either direction at speeds up to five times normal, a desired section being located by noting the readings on the timers. The tape may be slowed to normal speed in order to monitor the actual word content, the drum being held stationary under these conditions so the pickup head is in contact with the tape. When a desired section is reached, the tape is stopped and the drum set into motion causing the head to scan the length of tape lapped over the drum. The tape may be jockeyed back and forth, either by using the tape drive or by hand, to exactly align the desired cutting point

²R. H. Ranger, "A Magnetic-Tape Recorder for Movies and Radio", *Electronics*, October 1947.

with the "mark" arrow, which is shown more clearly in Fig. 3.

In this experimental model, the tape-drive employs a series motor on each reel spindle. The single knob located in the lower left-hand corner of the panel controls the speed of these motors and actuates associated braking and clutch solenoids in proper sequence depending on which direction the control is turned from its center "stop" position. A toggle-switch to the right of this knob provides a brake release to enable hand manipulation of the reels. The tape drive is characterized by rapid reversal of tape motion, fast braking, controllable speed in either direction, reasonably uniform speed for a given control setting—all with single-knob control of the entire system.

Two timers are provided so that one may be used to measure off prescribed lengths of tape from the supply reel (left) while the other is used to totalize the tape built up on a "program" take-up reel (right). These timers were adapted from clock gear trains to be driven from the tape itself by means of rubber-tired pulleys (located below each timer) adjusted to give the correct length to rotation ratio for the normal tape speed. The timers thus give a reading in minutes and seconds which is correct for the original recording, regardless of the speed at which the tape is driven on the editing machine. The timers may be independently reset to any desired reading by means of a small knob to the left of each dial.

The scanning drum is independently driven by a synchronous motor, controlled by the toggle switch located below and to the left of the take-up reel. Scanning is normally done with the tape stopped but the tape and drum drives may be run simultaneously, if desired. The scanning drum is made of metal, aluminum in this case, rather than of plastic to avoid the generation of a static charge on the tape. The pickup head is surrounded by a double Mu-metal magnetic shield to reduce hum pickup from the motor fields. The pickup head output is taken off on slip-rings and transmitted at low impedance to a special transformer-input preamplifier in the amplifier cabinet. An arrangement for blanking out the audio output by shorting the pickup head over a short interval of the scanning period is included and may be turned on or off by means of the toggle switch located at the right side of the panel.

Several features of the general layout of the editing machine are worth

noting. The tape reels are placed vertically so that the tape will pass over the drum in a flat and easily accessible position. This facilitates marking and makes it extremely easy to remove the tape for splicing and to rethread it on the machine. The reels are held on their horizontal spindles by spring-locked holding clamps as used on movie rewind equipment. Reels may be put in place or removed very easily. Where several reels are being used, the broad top of the editing unit cabinet provides a handy place to put those temporarily set aside. The reel spindles are purposely placed so the reels overhang the cabinet slightly, providing a comfortable grip for hand jockeying of the tape into position. The tape drive (forward if from left to right) and the threading on supply reels (coated side in) and take-up reels (coated side out) correspond to the arrangement of the recording equipment currently used. In general, though bearing the usual laboratory-model characteristics of being overly heavy and larger than necessary, the experimental "Edispot" incorporates a number of features which adapt it to operational use in magnetic-tape editing.

Applications

Use of the "Edispot" and the associated special visual and aural alignment techniques can be described by considering a simple hypothetical editing problem. Suppose, that in a hurried interview, the interviewer had made an introduction as follows: "I should like to introduce Mr. Smith, Democratic, I beg your pardon, Republican candidate for the office of Mayor" The editing problem here is to remove the words, "Democratic, I beg your pardon." The editing man would locate this section of the tape by using the timers and monitoring the actual words. The scanning drum would then be started and the tape jockeyed forward and backward until the gap between the words "Smith" and

Diagrammatic explanation of time and spacing relationship existing with a demonstration sample of recorded tape stopped and being scanned by the rotated pick-up head. The tape has been stopped so that the word "Democratic" starts just after the head passes the "Mark" arrow corresponding to time t_3 .

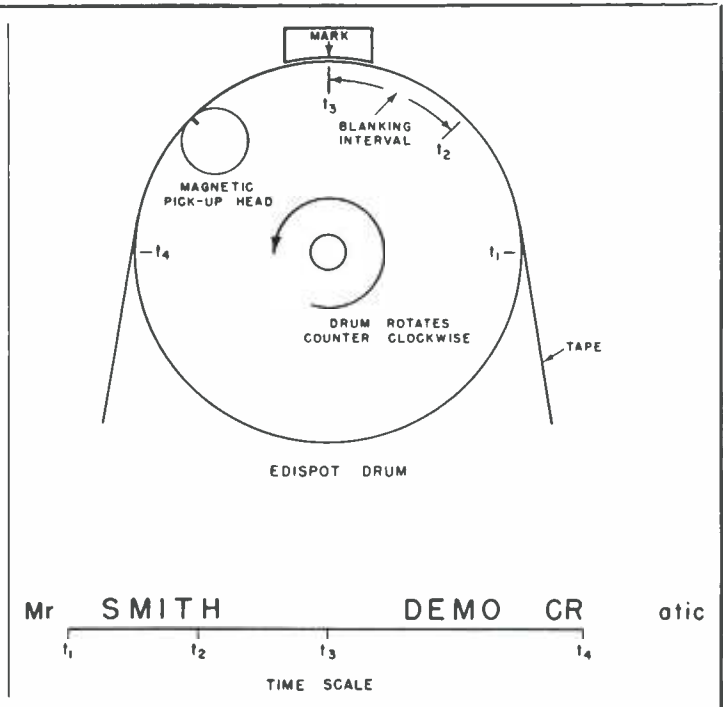

"Democratic" was properly aligned with the "Mark" arrow.

The time and word location relationships applying to the section of tape scanned are shown in Fig. 4. The drum rotates at a constant speed such that the magnetic pickup head travels along the section of tape at the normal linear recording speed. The material on the tape between points t_1 and t_4 is reproduced, and in the present example would be spaced as shown on the accompanying time scale. A visual display of the tape content is obtained by applying the pickup head output to the vertical deflection circuits of a cathode-ray oscilloscope. The oscilloscope sweep is triggered at time t_1 , by means of a cam-switch driven from the rotating drum shaft. At time t_3 , a sharp "pip" is obtained from the action of a second cam switch and is mixed with the audio output signal applied to the oscilloscope. In the resulting display, shown in the photograph of Fig. 5, the position of the "pip" on the oscilloscope pattern corresponds exact-

ly to the position of the "Mark" arrow relative to the actual content of the tape section. The operator can thus see the words he is hearing and in addition can see exactly where they are located. An incorrect alignment may be easily recognized as in the case of Fig. 6, where the same tape has been shifted slightly to place the "pip", and the "Mark" arrow, in the middle of the word "Democratic".

As the scanning rate is quite slow, the period t_1 to t_4 being about $1\frac{1}{2}$ seconds, an oscilloscope having a triggered, slow-speed sweep is required. Also, an extremely long-persistence phosphor screen must be used to retain the image over the scanning interval. The photographs shown here were made with a commercial laboratory-type oscilloscope. For an operational editing machine, a simplified combination listening/viewing unit would be required.

It has been found that an alternate method for accomplishing correct align-

[Continued on page 46]

Fig. 5 (left). Oscilloscope visual display of portion of a demonstration sentence, showing marker "pip" correctly aligned between the words "Smith" and "Democratic." Fig. 6 (right). Oscilloscope visual presentation as in Fig. 5 but with tape shifted slightly to show incorrect alignment with marker "pip" falling in the midst of the word "Democratic."

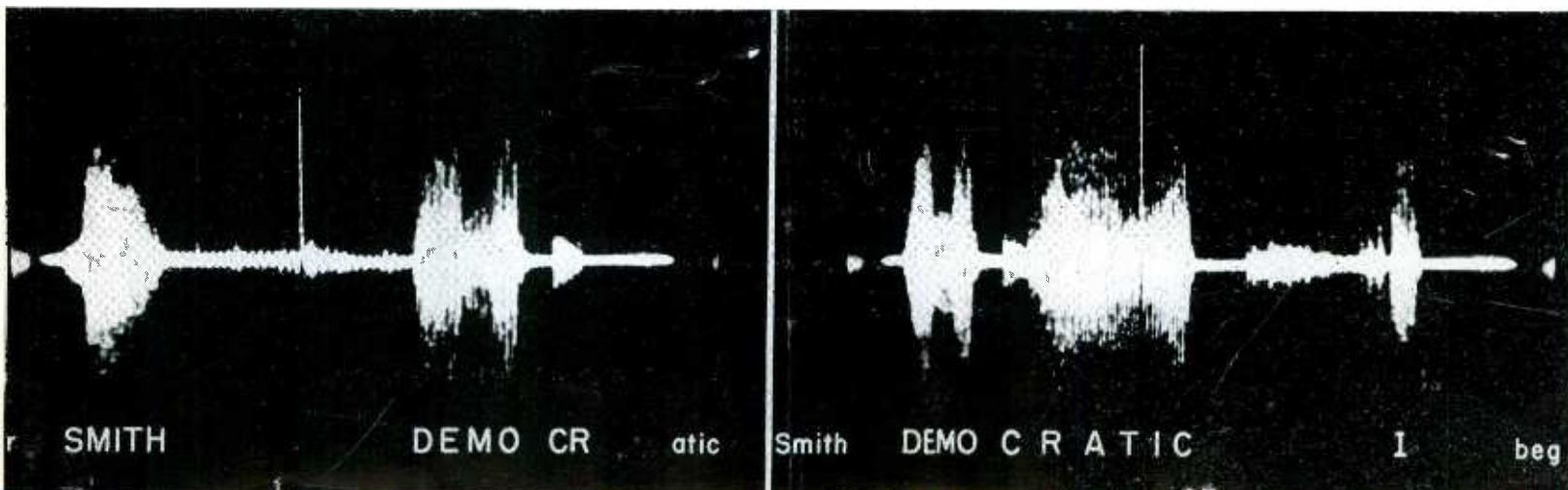

Making Phonograph Record Matrices

HAROLD HARRIS*

Presenting, for the first time in any magazine, complete data on this subject.

THE manufacture of phonograph record matrices is a process of which most sound engineers are uninformed. It is a thankless process, for it can contribute nothing to the fidelity or quality of a record. At best, it can only reproduce what is present on the original acetate master; but if the process is faulty it can add surface noise, distortion, crackling, and grittiness to the finished record. Furthermore, there are as many variations on it as there are processing plants.

Recent advances in recording and sound production make it possible to reproduce on records the entire audible sound spectrum. Yet in many cases the entire upper range is obliterated or distorted by the application of obsolete methods in the processing of acetate masters. It is important, therefore, that the recording engineer understand what becomes of the acetate master recording after it leaves his studio. He must know if the quality of his work is suffering from outmoded methods of processing.

Stampers

The function of the processing or galvano phase of the phonograph industry is to provide from the original acetate master a number of dies or

stampers which contain faithful "negative images" of the recording which in turn are placed on record presses. Two of these stampers, negatives of the two sides of a record, are placed on the platens of record presses facing each other. A heated "biscuit" of compound is placed between them and the platens come together, are quickly heated and cooled by steam and water circulating through them; then separate, leaving a molded record which bears the imprint of the stampers. Since the stampers are negatives, i.e., they contain ridges instead of grooves, the records are positives. A stamper may last for 2000 pressings, and the problem is to produce a large number of identical stampers from one acetate master. The sequence of steps to accomplish this involves the making of a master, mother and stamper.¹ This sequence will be outlined first and then treated in detail. When the master is received, a microscopically thin layer of silver or gold is applied to the surface in order to make the disc electrically conductive. Once this is accomplished, the master is put through a series of electroplating and electroforming tanks which deposit a layer of

metals, chiefly copper, on the gold or silver film. This electro-deposited metal layer is about .050 or .060 inches thick. This metal plate is then separated from the master and it is an exact negative of the disc. It has ridges where the master had grooves and vice versa. This plate is called the metal master, and once it is obtained the acetate master is discarded, for it is frequently damaged when small pieces of acetate adhere to the metal master in separating. Where a small number of records is required, it is common practice to machine this master so that it may be put directly on a record press. It will be readily seen that since the metal master is a negative, it can produce positive records, but once it is worn out another acetate master must be furnished. When the metal master is utilized in this fashion, it is called a "master-stamper" or "strike off."

Generally, however, the master is processed to one or more mothers. This is accomplished by coating the face of the master with a combination of chemicals which allow the surface to be electrically conductive; and which allows the subsequent electro-deposited metal to be separated from the master at the chemical film. When the separating chemicals are applied, the master is then

¹Howard A. Chinn, "Glossary of Disc-Recording Terms," *Proc. I.R.E.*, Vol. 33, No. 11 (Nov. 1945).

* 720 Linden Blvd., Brooklyn, N. Y.

Fig. 1. Nickel tanks in background and copper pre-plate in foreground.

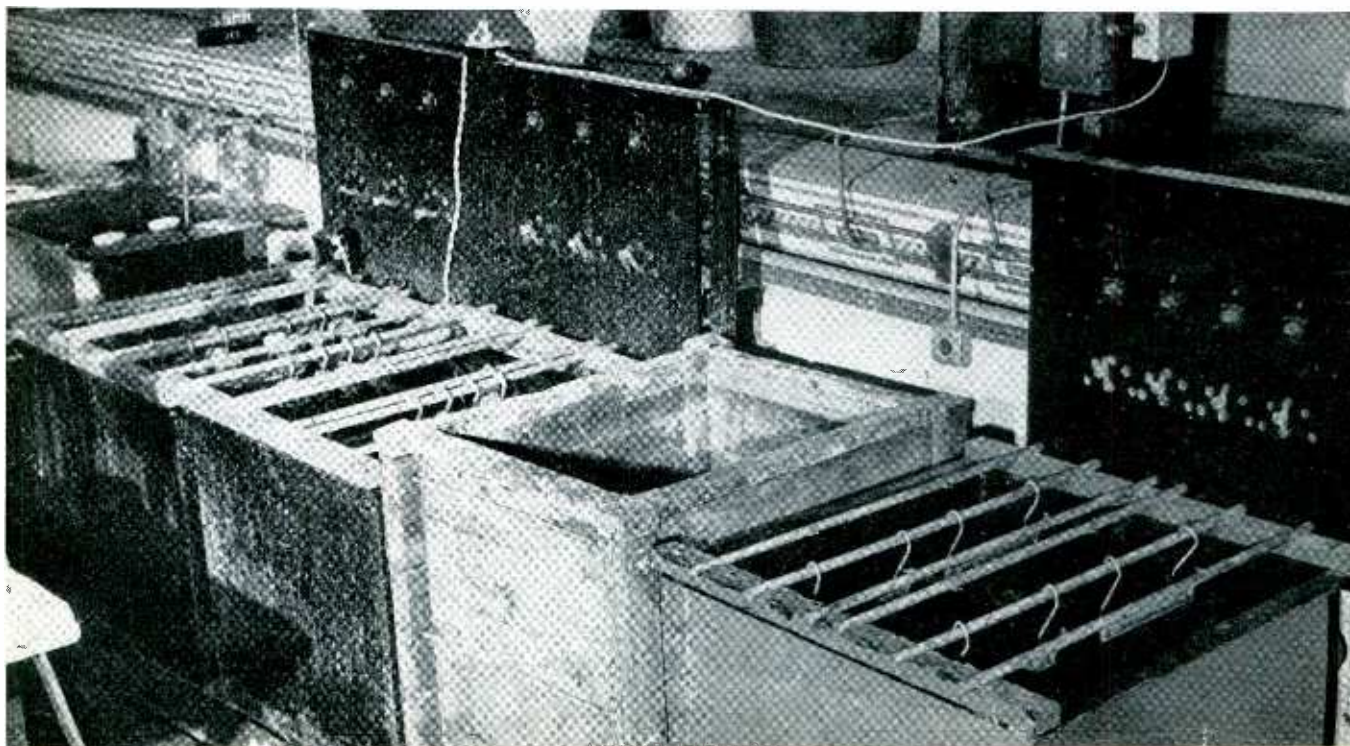

put through the electroforming tanks again until a heavy layer of copper is formed on its face. This layer is then separated from the master. It is a positive, since it again contains the grooves of the original acetate master, and indeed, it may be played as an ordinary record. This positive plate is called a mother and a number of mothers may be made from one master.

The mother then goes through a similar series of operations and the plate separated from the mother is a negative which is called a stamper. A number of stampers can be made from each mother. In general practice, approximately six plates are made from another although it is possible to make many more. The stampers are then given an infinitely thin layer of chrome for hardness and the periphery machined to fit on the record presses.

Thus it is seen that by the process outlined above a pyramid of plates is formed with one master at the apex and a number of stampers at the base. In this manner it is possible to produce many thousands of records from one acetate master.

Metalizing the Master

When the acetate master is received it is given careful inspection and the guide holes are plugged. It is then prepared for its initial microscopically thin coating of metal. If it is to be silvered, it goes through a series of cleansing and sensitizing steps, the most important of which is the application of stannous chloride, which is the last step prior to silvering. If all the stannous chloride is not washed off, tiny black specks will appear in the film of silver where the silver combined with the stannous chloride to form silver chloride. Plating will be poor on these black spots, which are a common cause of loud clicks in records.

The actual silvering solution contains two basic chemicals, silver nitrate and ammonium hydroxide. In some cases, other chemicals are added which control such factors as the speed of reaction and the thickness of the film of silver.

The silver is reduced from the ionic state to the metallic state by dextrose or formaldehyde. The reducing solution and the silver solution are poured on the sensitized acetate. The acetate is agitated in a tray to insure complete and uniform precipitation.

In some plants, a cathode sputtering process is used. The acetate is placed in a vacuum chamber which contains two electrodes, one of which is a gold sheet. A high potential is placed across the electrodes, and under these conditions the system acts similar to a cathode-ray tube. There is a flow of ions of gold from anode to cathode which is deposit-

ed on the acetate, forming a thin layer of gold. This process is used chiefly on transcriptions.

Both these methods are a vast improvement over the old system of providing the initial conducting layer by applying a coating of powdered graphite. This obsolete system contributed considerably to the surface noise which is characteristic of older records.

Research still continues in this phase of the process, and considerable progress has been made in spraying the original metallic film on the acetate.

Pre-plating

In most plants after the plate receives its initial film of silver or gold, it is then put through a copper pre-plate or copper priming bath. (See Figure 1.) The purpose of this bath is to provide a smooth base deposit of copper which will allow plating at a higher current in the next step. After the plate receives its prime layer of copper, it is then put in the copper forming tanks where it plates at a higher current until a copper deposit of sufficient thickness is built up. When it is put into this tank, a rubber ring prevents plating on the back of the acetate, which would be a waste of copper, and plating on the edges, which would make it difficult to separate the metal master from the acetate master. With a ring of proper design, separation can be accomplished by a tap with a file. When the plate is separated, it is given a very thin coat of nickel. If the silver or gold film is unstained and of uniform texture, the nickel is applied directly. If this is not the case, the silver or gold is removed before the nickel plate.

In plants using more advanced methods a better procedure is followed. After the initial film of silver or gold, the acetate master is put in the nickel plating tank where a thin coat of nickel is applied. It then goes into the copper prime and copper forming tanks. Upon separation, the metal master has its layer of nickel directly beneath the film of silver.

The advantages of this second method are apparent. There is no distortion because the nickel is a faithful reproduction of the layer of gold or silver. In the first case this is true only of the master upon separation. When the nickel is applied, it is plated directly on the music lines. It is readily seen that this changes the shape of both the lands and the grooves. The heavier the coating of nickel, the more the distortion. Moreover, the amount of distortion in this method increases with frequency. At low frequencies, the thickness of the plated layer of nickel is small compared to the wavelength on the record. However, at high frequencies where the

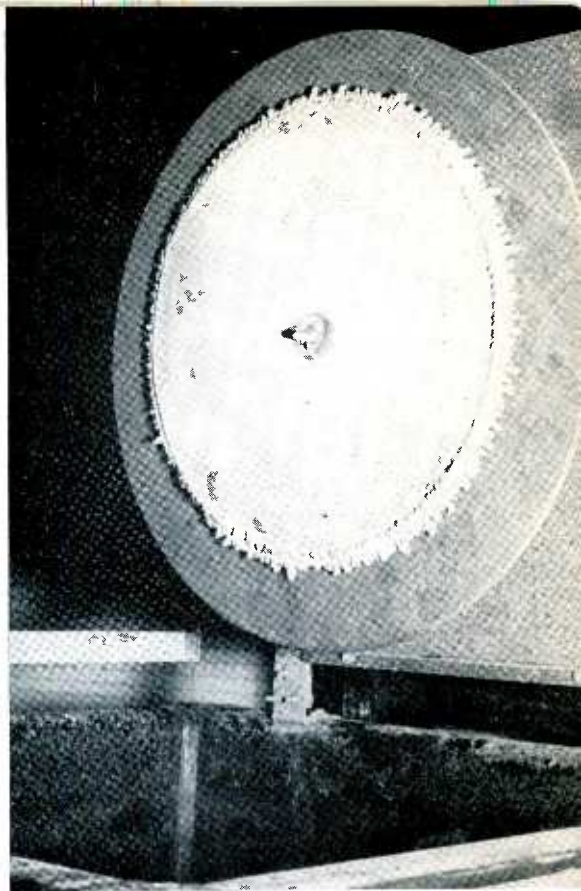

Fig. 2. Effect of plating in high-speed system without rubber ring on edge of plate.

wave-length is very short, the thickness of the nickel layer is appreciable by comparison. This causes serious distortion and is the chief factor preventing the manufacture of high fidelity records from a wide range acetate master. If an acetate is to be processed in a plant using this obsolete method it is pointless to record the entire audible spectrum. It is the recording engineer's responsibility to see that his masters receive adequate processing, because he is generally judged by the quality of the finished record.

Polishing

In some plants the master receives no nickel at all. From the standpoint of fidelity, this omission makes no difference, but it does introduce other considerations. In the first place, records made from copper masters are generally not as bright as those made from nickel. This sheen is transferred from plate to plate and finally to the record. The second consideration is that of corrosion. A copper master oxidizes as time passes and frequently the only way to remove the stains caused by oxidation is to polish them out, the polishing is the cardinal sin of processing.

The types of polishing compounds in use today range from violent abrasives which are used in commercial plating, through jeweler's rouge, to commercial liquid polishes. They all detract from fidelity and impart surface noises in the degree that they are abrasive. This step

Fig. 3. Detail view of high-speed plating head designed by author showing compact arrangement of insulated coupling, collector ring, and thrust bearing under gear head motor.

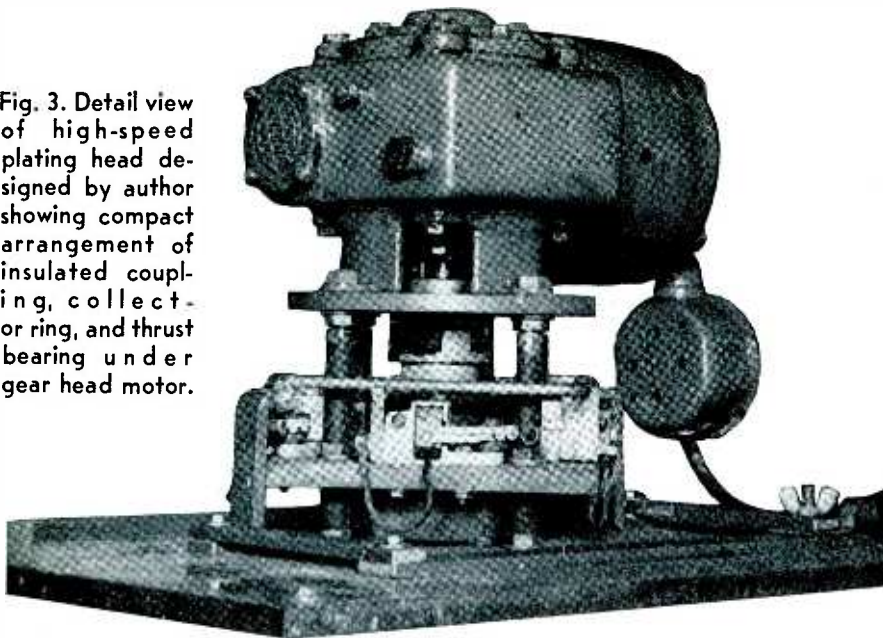

must be eliminated from processing plants if uniform production of quiet and high fidelity records is to be achieved.

Under a microscope, the concentric streaks and scratches caused by polishing compounds and polishing brushes can be seen and appraised. In some cases, polishing not only scores the walls of the grooves, but actually wipes off the crests of the higher frequency sine waves. Where the walls are scored, surface noise and grittiness occur. Where the wave shape is altered, distortion occurs. In some cases, where the very highest audible frequencies are recorded, a range where the acetate master is embossed as well as it is cut, it was possible by excessive polishing, to wipe those frequencies right off the plate. It is the real bogey man of processing.

In those plants which do employ polishing, it is done frequently in the process. The master is polished first before processing it to mother. The mother is polished before being processed to stamper; and the stamper is polished twice, once before chroming, and secondly, before it is put on a press. It is only the surface noise contributed by the inherent grittiness in shellac compound that covers up these processing noises and in many cases it is still audible.

Electro-cleaning

There are two ways of circumventing this difficulty. The first is possible only in very small plants. This is to process each plate individually, immediately upon the completion of the preceding steps. In this way no plate is allowed to dry, stain, or oxidize; but this obviously is impractical. The second method is employed in the more progressive plants. It is called electro-cleaning. Instead of abrading the face of the

record, as is done in mechanical polishing, the plate is immersed in a bath of boiling potash and electrically bombarded by ions. This is a point for recording engineers to insist upon in their processing. It will serve to bring those plants which polish mechanically around to electro-cleaning.

One of the finer points in processing concerns the treatment of the film of silver on the master after it is separated. This film adheres to the metal master and it is the front surface only of this film which is the exact image of the acetate master. The copper or direct nickel is plated on the back surface of the silver. Hence, even the direct nickel master or plain copper master is distorted to the extent of the thickness of the silver film. Since the film is microscopically thin, the distortion resulting from the removal of the film of silver is negligible. However, in cases where a larger number of lines per inch is used as in some transcriptions, the ratio of the thickness of the film of silver to the thickness of the groove becomes a consideration, and the silver must be left on the master. If our master has escaped the pitfalls of processing so far, let us follow it through until a mother is taken from it.

Nickel-plating

The heart of any processing plant is the nickel tank and the processes which treat the plate prior to its immersion in the nickel tank. The actual components of the nickel plating solution vary from plant to plant. Some plants use commercial solutions like "Brite Nickel" or "Watts-Nickel." Some plants modify these to their own needs, and others have developed baths used only in this process. These baths operate under different conditions in regard to temperature and current density; and im-

proper operation results in a multitude of difficulties: pitted nickel, peeling nickel, excessively soft nickel, porous nickel and stained nickel, to mention a few, which cause trouble in the quality and appearance of a record. In addition to the basic ingredients of his nickel bath, the current, and temperature, the plating chemist must carefully watch the *ph* of his bath. The *ph* is an index of the acidity of the bath. If the value of the *ph* is wrong, many of the above-listed difficulties will be encountered even if all other factors are controlled. Finally, if the *ph* and these other factors are proper, unless the bath is filtered frequently, apparently inexplicable troubles will still occur due to the presence of foreign matter in the bath.

Separation Process

The process of preparing a plate for separation is a critical one. Separating technique and chemicals vary as widely as the nickel bath. A good separating phase should be simple and versatile. By versatile, the implication is that a nickel plate can be plated on a nickel one, a copper plate on a nickel one, or a nickel one on a copper one, and have them all separate when the time comes. In some cases, poor separation treatment will cause a plate to separate from another while it is still plating or makes it impossible to separate the plates at all. Both are platers' catastrophies.

In no phase of the process is technique more important. Not only are the mixtures of the chemicals which are applied important, but also the time in the solution is critical—within a second. An inopportune drop of water, or touching the face of the plate at the wrong time, leaves a stain or a spot where the plate won't plate or won't separate.

Those plants which employ modern techniques plate nickel to nickel. In the case of the direct nickel master, in a modern plant, it is electro-cleaned and then given to a plater. The plater gives it a final chemical cleaning by dipping or gentle brushing, and applies his separating chemicals in careful sequence. The plate is then put in the nickel tank where nickel is plated on the molecularly thin separating film. From the nickel tank it goes to the copper prime and copper forming tanks, and when it is taken from the copper forming tank where it is plated with a rubber ring around it (Fig. 2), a mother with a nickel face is separated from the master. This positive mother is complete and requires no further plating.

At this point in many plants, the mother is centered and played with a counter-balanced arm and cactus needle.

If there are any clicks or damages, they are carefully engraved out by a highly skilled engraver.

Copper Mother

However, in many plants the process of direct nickel plating has not been mastered. In these plants, after the separating steps, the master is put through the copper prime and copper forming tanks and a copper mother is separated. The same considerations hold for the copper mother regarding fidelity and corrosion as held by for the master. If the copper mother is put through to a stamper, there is no loss in fidelity but there is a loss in brightness and a danger of corrosion. Therefore, most plants don't use direct nickel which then plate nickel on the face of the mother, further distorting the sound on it. This procedure is then repeated when a copper stamper is taken from the nickel mother.

This indirect nickel process is gradually disappearing in the processing industry and it is being replaced by the direct nickel procedure in all cases but that of the master. Most plants still cannot plate nickel directly in silver, and therefore they make a copper master which they nickel plate. Those who know how to keep the nickel from splitting and peeling off the silver keep the secret to themselves.

The making of a stamper from a mother entails the same procedure and considerations outlined above; but a discussion of the subsequent machining steps, and the quality of the copper, hinges on the type of equipment used in the copper forming phase. The evolution of the equipment may be summarized as follows: agitation is the key

to faster plating. In a still bath it is possible to plate a 12" plate at about 20 amperes. By placing a moving paddle between the copper anode and the plate which is the cathode, it is possible to raise the current to about 30 amperes. If the cathode is swung or rocked in the bath the current can be raised to 35 or 40 amperes; and while this is going on, if a jet of air is allowed to bubble between the cathode and anode, plating currents can be raised as high as 50 amperes.

This seemed to be the limitation until a system was devised for rotating the cathode while plating it. Early equipment designed on this principle had the cathode suspended on an acid-proof pulley by a rubber belt which was slowly rotated by a shaft above the tank. The plate comprised the face of the pulley, and the outer edge of the pulley which fitted around the plate, had a track to accommodate the belt. Electrical contact to the plate was achieved by a flexible wire which rode against a spindle in the middle of the plate as it hung vertically. It was seen that higher currents could be achieved if the plate were rotated faster, but under that physical set up, the plates became mechanically uncontrollable in the bath. The next development saw the plates fastened to a rotating copper spindle which held it face down in the solution. The upper end of the spindle was attached to a gearhead motor by an insulated coupling, and by a slip ring arrangement, the rotating spindle carried current down to the cathode (Fig. 3). To prevent that part of the spindle that was in the solution from plating as a cathode, it was insulated. This method increased the current limit to about 90 amperes, but still the

quest for higher speed plating went on.

Burned copper resulted when any of the previously mentioned limiting currents were exceeded. The high current caused this burning when the copper ions in solution were plated out onto the cathode faster than they could be replaced. Agitation stirred this solution and quickly replenish the area close to the cathode. Finally rotary agitation reached its limits and other means of replenishment had to be found. This problem was solved by injecting fresh solution from a sump tank between the anode and rotating cathode and finally directly at the cathode (Fig. 4). The overflow solution went back to the sump tank.

With this method, the rotary cathode, jetted solution, it is now possible to plate at 200 amperes and above. At this rate a plate can be produced in 3 to 5 hours, depending on the desired thickness.

Plating Quality

The factors which determine the quality of copper are the current density, the temperature of the solution, and the ingredients in the solution. The higher the current the tougher the copper, while the converse is true of temperature. The basic components of the copper bath are copper sulfate and sulphuric acid. A common mixture is about 32 oz/gal of copper sulphate and 6 oz/gal of sulphuric acid. In higher speed plating, the acid content is raised to increase the conductivity of the bath and since this higher acid content allows less copper sulphate to be in solution, its content must be reduced.

In lower speed plating, since the current is so low, it is difficult to get the

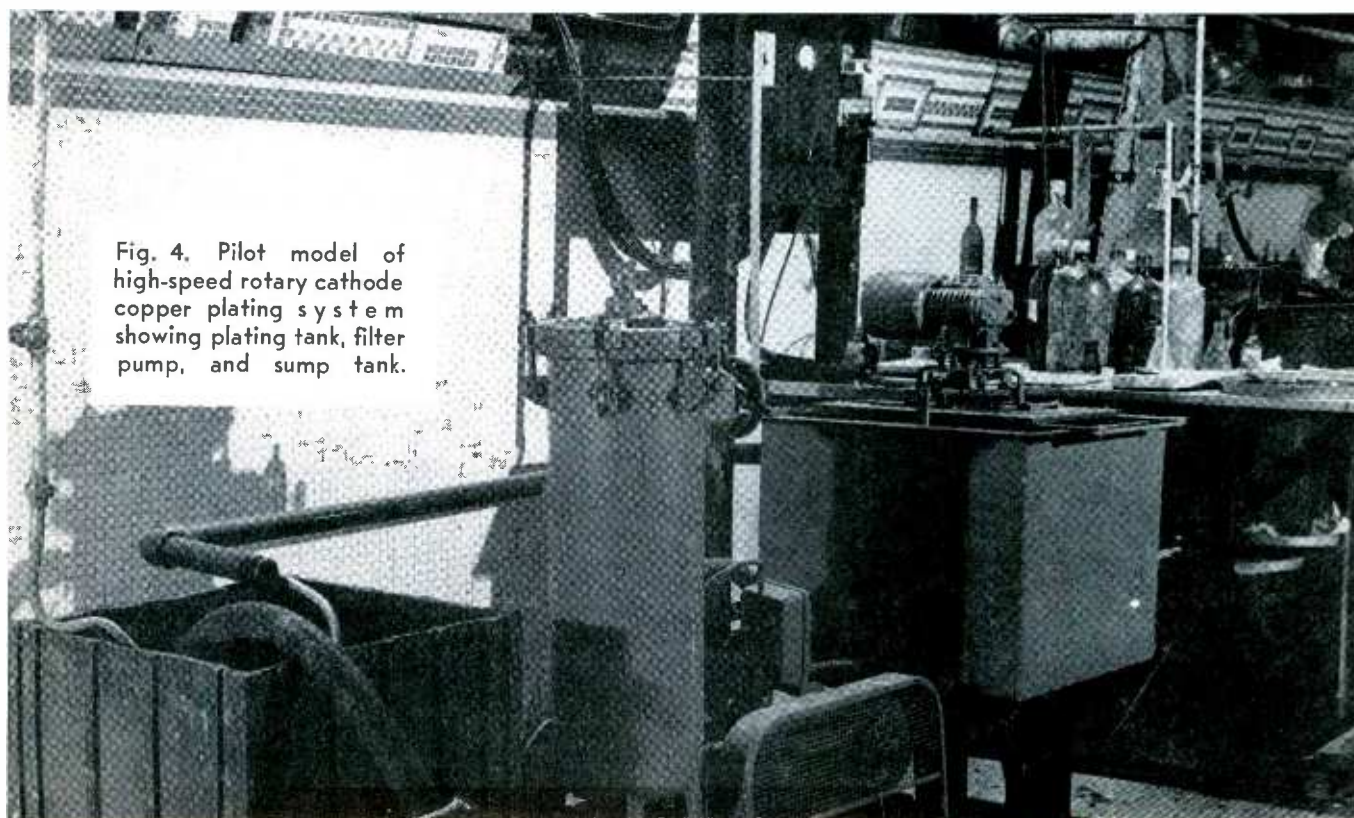

Fig. 4. Pilot model of high-speed rotary cathode copper plating system showing plating tank, filter pump, and sump tank.

tough springy copper of its high speed counterpart. Therefore, many plants which utilize low speed equipment resort to organic addition agents to correct this deficiency. Molasses, Casein, phenol-sulphonic acid, and even commercial preparations are used. Since these addition agents break down in the bath, analysis is difficult; and therefore, control. The bath will behave properly for a long period of time and finally the breakdown products accumulate to the extent that they impair the plating.

The result may be soft copper or it may be brittle copper. Sometimes the bath can be cleared up by filtering, but frequently it must be dumped. Addition agents and their control are among the guarded secrets of the various plants using low speed equipment, while most plants using high speed equipment have dispensed with this problem.

The mechanical properties and the appearance of the copper in the masters and mothers is of little importance. However, the stamper must be machined to fit a press where it will be subjected to pressures varying from 25 tons in toggle presses to 70 tons in hydraulic presses. If the copper is too soft, the stamper will spread and flow under pressure until the music lines are not concentric. If the copper is brittle, the stamper will crack or break in the press.

By the proper control of current, temperature, and ingredients of the bath for any physical copper forming system, copper with good mechanical properties can be deposited.

From the standpoint of machining to fit a press, it is most economical to plate the stampers as nearly to the desired specifications as possible. Most plants prefer flat stampers .038" thick. Some plants prefer them about .025" and others prefer a tapered stamper where the O. D. is .010" thicker than the I. D.

In normal plating, the electrical lines of force concentrate on the edges of the plate. The increase of current there causes more deposition and ultimately a tapered stamper. Those plants which use tapered stampers have the platens on their presses crowned so that a stamper lying on this crown has its taper taken up.

However, most plants do not utilize tapered stampers because they are difficult to produce uniformly. This difficulty is overcome by plating a sufficient time so that even the thinner center of the plate exceeds the maximum thickness desired. This thicker, tapered stamper is then placed on a suction chuck lathe, face forward. The plate, held by a strong vacuum pump to the perforated face of the chuck, is rotated

while a cutting tool traverses its back, cutting off the excess copper and a perfectly flat plate of any desired thickness is produced.

It is apparent that this is a highly uneconomical, although a widespread practice. Not only is all the copper wasted which is cut off by the lathe, but also valuable time is taken while it is being initially plated.

To overcome this waste a method was developed which eliminated the taper caused by a concentration of electrical lines of force on the edges of the plate. A baffle was placed between the anode and cathode. This baffle had a round aperture smaller than the diameter of the cathode. This effectively masked the edges of the plate and produced virtually flat stampers. The backs of these stampers were then sanded to remove any small knobs or growths on the copper.

Chrome Plating

In most plants, prior to machining, the stamper is chrome plated. Chrome plating is a compromise. The purpose of chrome plating a stamper is to give it better wear-resisting properties in the press. Yet chrome plating must be done on the music lines. There is no way known at present to make a direct chrome stamper because no way has been developed to plate on top of chrome. The normal chrome plate on a stamper is about .0003 and again a negligible factor in distortion.

In general, chrome plating is not a problem in the processing plant. The components of the bath are chromic and sulphuric acid and they are usually present in a ratio of 100:1. Unlike the previous plating steps described, chrome plating is the only one which actually takes the metal out of the solution without having the anodes replace it. In a chrome plating installation the anodes are lead and are present only for electrical purposes, while in copper and nickel plating the anodes are of the respective metals and they disintegrate as they plate out into the bath.

The chief trouble poor chrome plating causes is a surface noise brought about by a condition called "crazed" chrome. Under a magnifying lens "crazed" chrome is seen to be a network of tiny cracks which resembles in pattern the skin of an alligator. These cracks cause a surface noise in the record, and also chip further while the record is played. This will cause the rapid disintegration of a record in comparatively few playings.

Centering

When the stamper is chromed and back turned or sanded as described above, it is ready to be cut to the inner

[Continued on page 42]

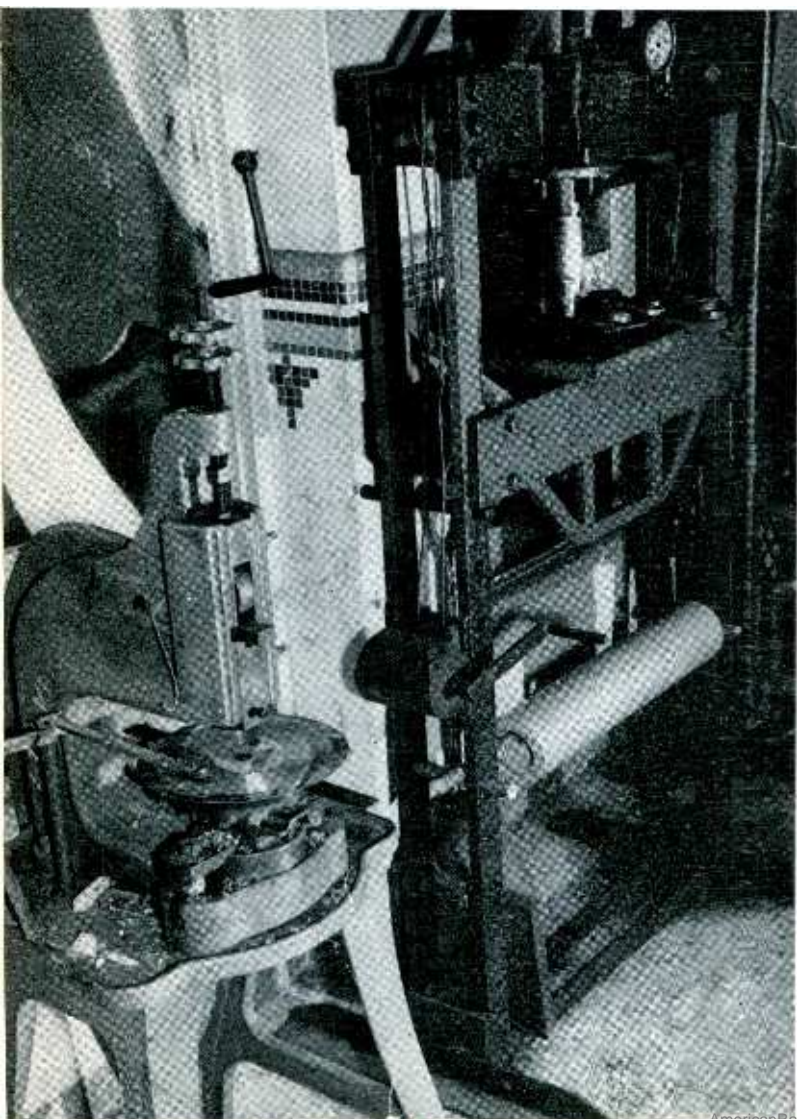

Fig. 5. Footpress with center gauge and turntable in foreground. Hydraulic center punch out press with dies in background.

Design and Construction of A WIRED MUSIC SYSTEM

ARTHUR R. O'NEIL,* and HERBERT G. COLE

WIRED MUSIC, that is, transmission of music from a central source to outlying consumers via telephone or other wired systems, has become increasingly popular in recent years. From an engineering standpoint it presents several interesting problems, principally, anticipating program and customer requirements in order that requirements do not outgrow the equipment, selecting the proper class of telephone service in order to offer high-fidelity service, and feeding these lines with a constant level. If a customer is to be sold a service of this type it must practically sell itself, since its most powerful virtue is its listenability. This listenability, then, must come from a properly designed system plus intelligent programming.

Requirements

Initially, at least three program channels would be required. With three channels it would be possible simultaneously to transmit three types of background music; e.g., dance music, semi-classical, classical, or any other combination which may be desired. A variety of program "breaks" may also be permitted. Three channels would then require a minimum of three turntables and it was decided to purchase four in order that one be on hand for a spare or to work with one of the other tables to provide two tables in use on a single channel. Each channel should have twelve multiplied outputs with rack space reserved for future expansion. All equipment must be terminated in jack strips to facilitate testing. A small console located in the center of the four tables was thought to provide greatest ease in operation. This console must house the monitoring facilities and the gain control for each channel. Limiting amplifiers were included to assure the maximum level would not be exceeded and the customers ears assailed with irritating peaks or blasts.

Let us first consider the number of

lines that must receive the program. A survey of requirements shows that average customer requirements extend from twenty to as high as eighty lines for cities the size of South Bend. Initially then, if jacks are to be used for patching, two jack strips or twenty-four lines would suffice. Jack space must be provided for future expansion to possibly ninety-six lines.

Connection from the amplifier to the lines offers two problems: maintaining an impedance match, and maintaining constant level when lines are inserted or removed. Several possibilities offer themselves but perhaps the most economical in all respects is a system of bridging transformers. Each

line should be totally isolated from others by means of individual transformers in order to avoid possible interaction between lines should trouble develop on one. This isolation and matching of gain and impedance can be accomplished through the use of bridging transformers. We were quite fortunate in securing a miniature bridging transformer providing a 500-ohm secondary and a 40 or 80-thousand ohm primary at very low cost. These transformers are high-quality units, flat within reasonable limits from 30 to 15000 cycles. Twenty-four transformers were mounted on a strip with the 500 ohm side terminating on the telephone terminal and the 80-

Operating
turntables
of wired
music
system



*Engineering Dept., WSBT, South Bend
26, Ind.

thousand ohm side terminating in a jack strip.

Line Amplifier

The line amplifier is terminated in a 500-ohm resistor and also multiplied to a jack strip containing twelve outlets. Each jack has an 80,000-ohm resistor connected across it so that it appears to the amplifier as an 80,000-ohm load. When a patch cord is inserted to make a connection to a line, this resistor is lifted and the transformer substituted therefor. Although this precaution may not be entirely necessary at this stage when more lines are added, these loading resistors will become increasingly important in maintaining the level presented to the lines. Each line is fed at plus 8 VU but, due to the loss through the transformer bridging connections, the output at the amplifier must be approximately 30 VU. A separate transformer is provided and loaded with a 60-ohm resistor for the level indicators located on the operating console. Here the isolation could have been provided through the use of resistors but, inasmuch as the transformers were on hand, it was decided to use these and thus simulate actual line conditions for metering.

Here a word might be said about the required frequency response. It is as convenient to design a system such as this to have a response reasonably flat from 30 to 15000 cycles as to have it cut off at some lower frequency; therefore, a flat response was decided upon with provision for changing the response from flat to a lift at either

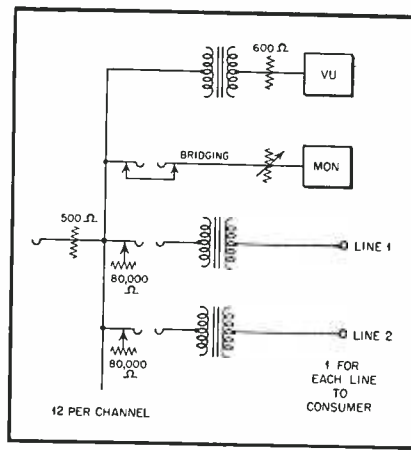
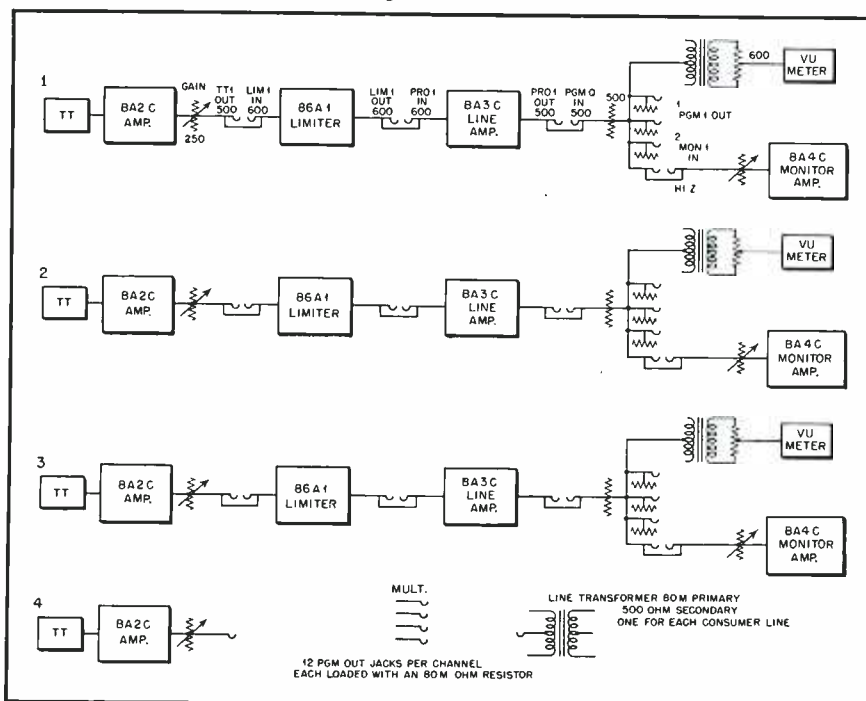

Fig. 2. Expanded diagram of amplifier output to line.

end if the final analysis proved this necessary.

The telephone company informed us the service they furnish to wired music organizations would be good to at least 5000 cycles, depending, of course, upon line length. While broadcast quality lines could be obtained the response they guarantee is not necessary nor the extra rental cost warranted. Some difficulty is experienced in these days of overloaded telephone circuits in getting lines to all locations; however, this situation will probably be corrected as the phone companies complete installation of new facilities. Although response to 5000 cycles is guaranteed, the response has been found to be much better than this on lines of short length. A measured response shows one line to be down only three db at 10,000 cycles.

Fig. 1. Circuit diagram of wired music installation.



The line amplifier¹ used in this installation furnishes sufficient level to supply plus 8 VU to the line. It is driven by a limiting amplifier² which levels off excessive peaks and prevents a sudden loud burst of music should the operator have her gain control opened too far. The operator gain control is connected on the input to the limiting amplifier. The turntable amplifier³ located in the turntable feeds to the input of this gain control.

The operating console houses three VU meters, one across each channel, a gain control on the output of each turntable (4), and a gain control for each monitor input (3).

The gain controls terminate on the jack strips but are normalled through to the inputs to limiter amplifiers one to three inclusive. The fourth turntable output is not normalled through but is available from the jack strip for insertion where required. The monitor gain control normals through the output of each channel but may be patched should the necessity arise.

Customer Service

Installation of equipment in the establishment of a wired music customer has been generally patterned after an ordinary public address installation. Since installations are so varied, no attempt will be made here to suggest a pattern to follow. Basically, an installation is to provide "background music" and no speaker should be so placed as to furnish high level music to a restricted area but must be placed to provide a constant level at all points in an installation. In most cases, ordinary public address amplifiers are used. The level available to the input of the amplifier is generally approximately zero decibels, which means the microphone stage of the amplifier is not required. Some amplifiers can be purchased without this stage and this is the ideal arrangement. However, for existing installations, addition of a pad and a line-to-grid matching transformer have been quite satisfactory.

No matter how much care is put into the point of origination the real success of a wired music enterprise is in getting an installation to please the customer and in getting programming which furnishes pleasant "background music."

High-fidelity response, or a response that furnishes the full range delivered by the transcription used, has not

[Continued on page 47]

¹RCA BA3C

²RCA 86A1

³RCA BA2C

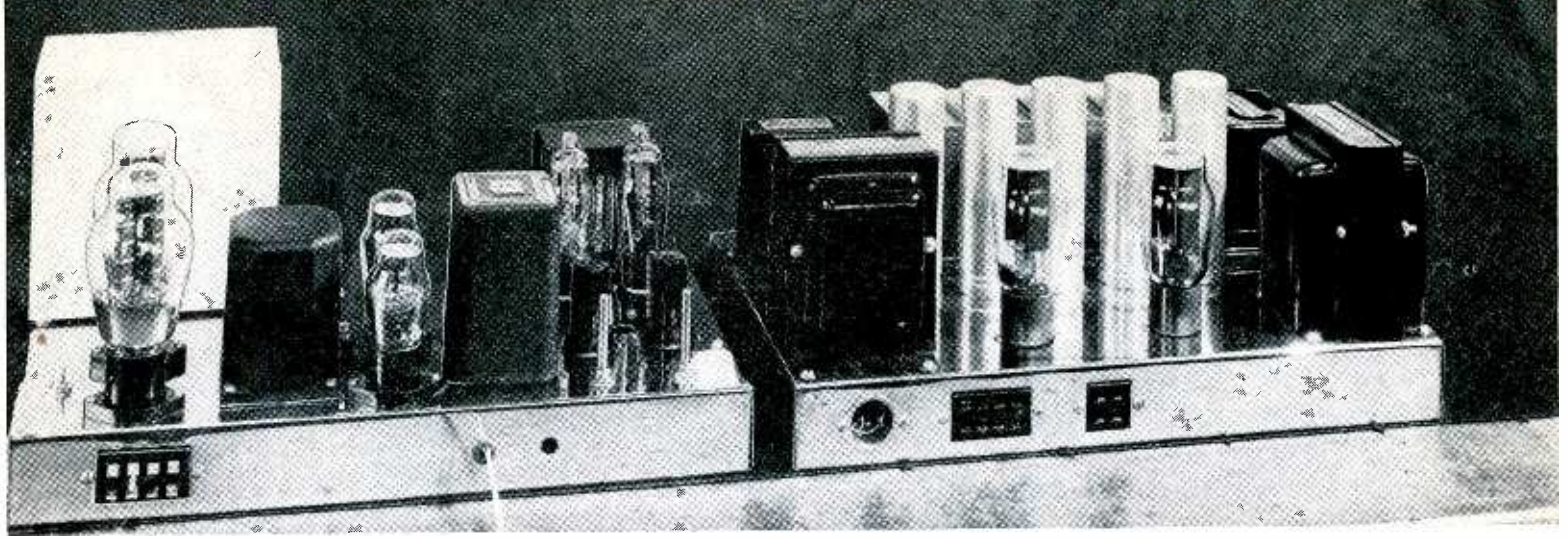

Fig. 1. The high-fidelity, high-quality amplifier and its power supply.

30-Watt High-Fidelity Audio Amplifier

CURTISS R. SCHAFER*

A general-purpose medium-power amplifier of broadcast quality.

THE LOW-MU TRIODE AMPLIFIER enthusiasts are at it again, and in view of the impracticability of some of the designs that have been offered within the past few years, the author would like to point out a few fundamental requirements that must be met by a truly high fidelity amplifier which also can furnish sufficient power to "fill" a small auditorium, for loudspeaker testing, or for driving a wax or acetate cutter. These basic requirements are:

1. *Sufficient power output and gain.*^{1,2}

2. *Low listening fatigue*, which is primarily insured by low intermodulation distortion.^{3,4} The distortion products should result only from second and third harmonics instead of the higher order harmonics usually generated in beam-power tubes. Single-frequency harmonic analysis is useful only in determining some of the operating parameters of the tubes and transformers involved.

3. *Good transient response*, which results in a particularly clean-cut reproduction of speech. Whistling consonants are evidence of parasitic oscillations on peaks. The specific factors responsible for good transient response are (a) good high-frequency response, (b), low phase rotation,⁵⁻⁸ (c), low internal impedance as seen by the loudspeaker or cutting head, and (d),

low hysteresis distortion, especially at the higher frequencies, in any transformers that may be involved.

It should always be remembered that we are not dealing with sine waves in the reproduction of speech and music. This is important in the matter of phase rotation, for instance; two sine waves out of phase still add up to a sine wave, but two waveforms containing harmonics, and out of phase, add up to a new and different waveform which does not resemble either of the originals. Excessive phase shift in an amplifier sounds like high intermodulation distortion, and produces excessive listening fatigue.

4. *Good input vs. output linearity.* This demands that each voltage amplifier stage be capable of supplying several times the actual voltage required to drive the following stage.

5. *Reliability, ruggedness and ease of servicing*, both with regard to locating the faulty part and replacing it easily. This calls for the use of oil-filled or oil impregnated condensers, hermetically sealed transformers and chokes, resistors which do not get noisy with age and/or temperature variations, and tubes which are of simple design structurally, have their elements well braced, and do not have close grid-to-cathode spacing. Close element spacing offers the probabilities of high microphonism, grid emission and wide variations in electronic para-

meters with small variations in tube geometry. Glass envelope tubes usually have a lower gas content than metal envelope tubes. In addition, glass tubes are an aid to rapid servicing, as a bright spot on a cathode, a gassy rectifier, or an open filament are easily noticed.

Design

With these elementary considerations in mind, we began the design of an amplifier. After a year of loudspeaker listening and testing with amplifiers rated at 10, 15, 20, 30, and 40 watts output, it was decided that an output of 30 watts with less than 5% total intermodulation distortion was required. We felt that this output should be obtained with triodes rather than beam power tubes: first, because the absence of a feedback loop would result in a simpler and more easily serviced amplifier; second, because the higher order harmonics generated by beam-power tubes (running up through the tenth) were considered undesirable, even though relatively low in amplitude. The value of distortion selected is so low that we felt we could ignore it when the amplifier is used in listening tests.

The output triodes were selected from a list of the following types: 50, 2A3, 6A3, 6B4G, 6A5G, 6AS7G, 3C33, RJ-563 and DRJ-564, and 300A. The first five of these belong to the same generic type, the 6A5G being a heater-

*Stromberg-Carlson Co., Rochester, N. Y.

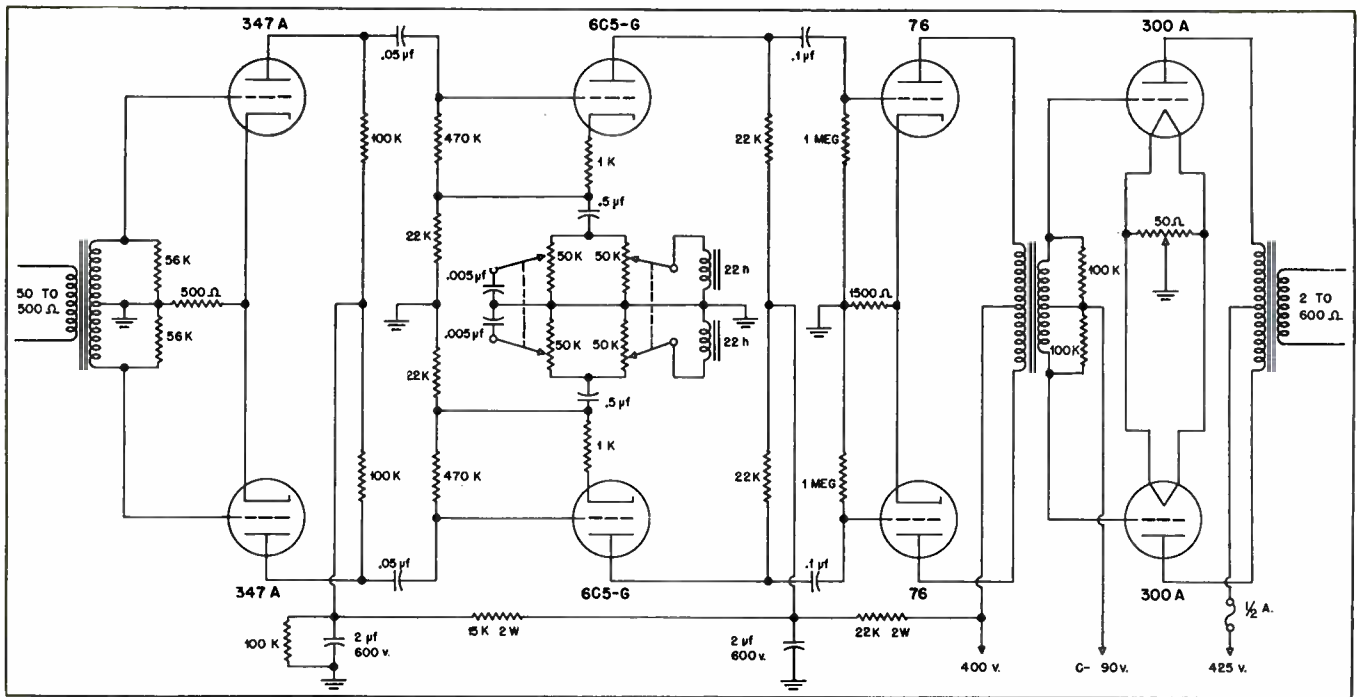

Fig. 2. Complete schematic of the 30-watt high-fidelity audio amplifier.

cathode type which is no longer available. The 2A3 is best of the four remaining in this group from the standpoint of hum. However, a 30-watt output from this type requires either (a), the use of four tubes in a push-pull parallel arrangement, which makes hum balancing difficult, or (b), the use of an automatic bias circuit for two tubes,³ which we felt was undesirable from the point of view of tube aging in the bias circuit and the increased difficulty of servicing the bias circuit. In addition, we wished to operate our output tubes class A all the way, instead of going into AB operation at ten or fifteen watts. The 6AS7G was rejected because its maximum plate dissipation per section is only 13 watts, which is less than that of a 2A3 (15 watts), and also because its construction necessitates the use of self-bias.

The RJ-563 and DRJ-564 are Westinghouse types, and either would be an excellent choice except for their relatively high cost (\$15 and \$25 net, each). The RJ-563 has a mu of 3.8, a plate resistance of 800 ohms, and a maximum plate dissipation of 60 watts. The

DRJ-564 has a mu of 3.8, a plate resistance of 400 ohms, and a maximum plate dissipation of 100 watts (maximum plate current 400 ma).

A single 3C33 compares very favorably with a pair of 2A3s, except that it is easier to drive, having a mu of 11. Its maximum plate dissipation is 15 watts per section, it has a heater-type cathode, and a peak cathode current rating of 500 ma per section. Again the drawback is one of price, which gives a very low watts-per-dollar ratio.

We finally selected the Western Electric 300A (or 300B) as the tube we wanted. It has a mu of 3.8, a plate resistance of 700 ohms, a maximum plate dissipation of 40 watts, and a power output of 17.8 watts as a single-tube class A amplifier, with the second and third harmonics down 21 and 30 db, respectively.⁹ In a push-pull stage the second would be almost completely cancelled out, of course. The single plate assembly, as opposed to the dual plate assembly of the current production of 2A3s, makes hum very easy to balance out, and the very good uni-

formity of characteristics makes it unnecessary to balance the plate currents by means of a bias adjustment for each tube.

The output transformer selected gave excellent wave form at forty watts output, particularly at the ends of the range we wished to cover, 20 cps. and 20 kc.¹⁰ It provides a plate-to-plate load impedance of 4000 ohms

300A and 300B Vacuum Tubes

Filament voltage	5.0 volts
Nominal filament current	1.2 amperes
Amplification factor	3.8
Plate Resistance	700 ohms
Grid-plate transconductance	5500 micromhos
Maximum plate voltage	450 volts
Maximum plate dissipation	40 watts
Typical operation, Class A single tube amplifier:	
Plate voltage	450 volts
Grid bias	-97 volts
Plate current	80 ma.
Load resistance	2000 ohms
Power output	17.8 watts
Second harmonic	21 db. down
Third harmonic	30 db. down

into secondary loads ranging from 2 to 600 ohms. We had early decided on designing an amplifier that would give full power output (not down 1 or 2 db) at thirty cycles, because we wished to use organ transcriptions in some of our listening, and we were surprised at the number of output transformers whose waveform became very bad at 30 cycles, and also above 10 kc.

The grid-to-grid driving voltage required for the 300As is 180 volts peak, which is easily supplied by a pair of 76s in push-pull operating into a

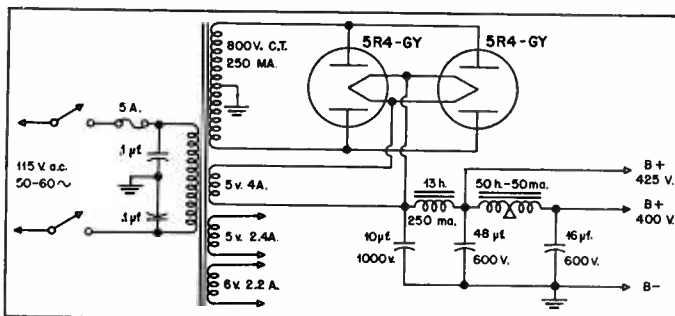

Fig. 3. Schematic of the power supply.

mumetal cored interstage transformer, of the author's own design, with a stepup ratio of 1:2. The UTC LS-22 could just as well be used here. The 76 tube will handle almost 50% more driving voltage than the 6J5 or 6C5.

The amplifier is push-pull all the way; second harmonic distortion is pretty well down, and less plate supply filtering is required than for single-ended stages. The first stage uses Western Electric 347As, which generate very low values of hum, microphonics and fluctuation noise.¹¹ The 1603 triode connected is an acceptable substitute.

A variation of the Thordarson degenerative tone control circuit is used, because it will (a) handle a fairly high value of input signal, (b) give a 1:1 voltage "gain" even in the flat response position, and (c) introduce no measurable harmonic distortion of its own. Here again, 1603s triode connected may be used in place of the 6C5Gs.

Two 45-volt batteries, Burgess 5308 or equivalent, were selected as being the most reliable and economical source of bias voltage. No current is drawn from them, and from previous experience the author has found that they are good for about two years before their voltage begins to drop at all. The power supply circuit is conventional throughout. The 5R4GY was selected for rectifier service because its voltage ratings are high, it is economical of filament power, and electrolysis at its lead-in wires proceeds at a much slower rate than it does in the 5Z3 or 5U4-G. No electrolytics are used.

Figure 1 is a photograph of the amplifier, with its power supply chassis at the right. Eight-prong Jones plugs and sockets are used for inter connecting the two, with a four prong Jones plug for the speaker. A four-prong socket is also provided on the power supply chassis so that heater and plate supply power may be taken for a pre-amplifier or tuner. The 10 μ f 1000 volt input filter is made up of the five 2 μ f 1000-volt cylindrical cans on the power-supply chassis. The output transformer is at the left rear of the amplifier chassis, and the cast case holding the two bass tone control chokes is between the 76s and the 6C5s. Metal 6C5s were used at the time the picture was taken, but 6C5-Gs are used in their places now. The two dual 50,000-ohm tone control potentiometers are manufactured by Trefz. The 347As are shown at the right rear, just this side of the input transformer.

Figure 2 is a schematic of the amplifier, and Fig. 3 of the power supply.

Figure 4 shows the voltage sensitivity and excellent linearity of the amplifier, and Fig. 5 shows the intermodulation distortion as read on an Altec Lansing intermodulation analyzer. The frequencies used were 40 cps and 12 kc. Total hum and noise are 75 db below maximum rated output. With the tone controls in the "flat" position, the frequency response at 30 watts output is uniform within 2 db from 30 cps to 25 kc, with almost all of this variation taking place above 15 kc.

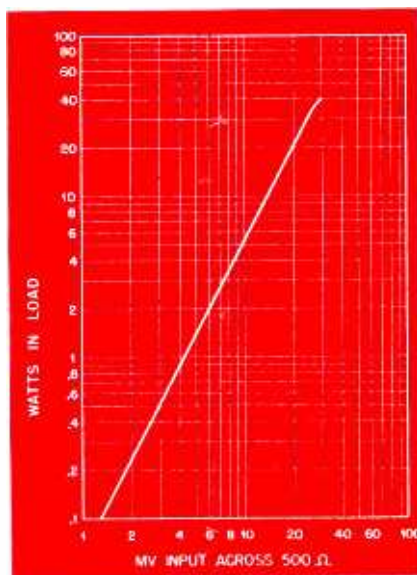

Fig. 4. Voltage sensitivity graph.

The tone controls provide a maximum of 8 db boost at 50 cps and 10 db boost at 8 kc. No bass or treble attenuation is provided, as it has been the author's experience that such attenuation is rarely if ever used.

Listening tests, comparing this amplifier with 15, 30 and 40-watt amplifiers of well-known manufacturers, have confirmed the low distortion and excellent transient response of this design.

BIBLIOGRAPHY

1. L. J. Sivan, H. K. Dunn, and S. D. White, "Absolute Amplitudes and Spectra of Certain Musical Instruments and Orchestras," *Jour. Acous. Amer.*, January 1931.
2. Harvey Fletcher, "Hearing, the Determining Factor For High-fidelity Transmission," *Proc. I. R. E.*, June 1942.
3. J. R. Edinger, "High-quality Audio Amplifier with Automatic Bias Control," *AUDIO ENG.*, June 1947.
4. N. C. Pickering, "Advantages of Space-charge-grid Output Tubes," *AUDIO ENG.*, October 1947.
5. R. L. Hanson, "One Type of Acoustic Distortion in Sound Picture Sets," *Jour. S. M. P. E.*, October 1930.
6. J. C. R. Licklider, "The Influence

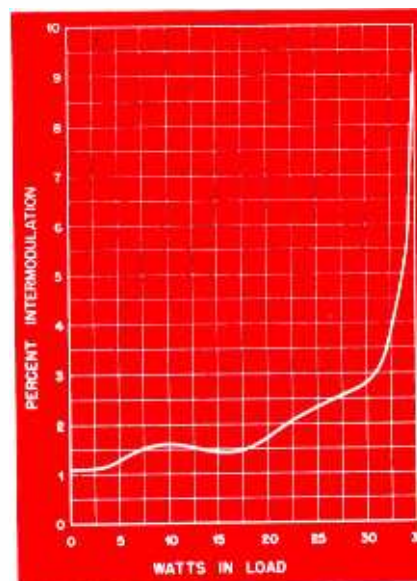

Fig. 5. Intermodulation distortion at various levels.

of Interaural Phase Relations on the Masking of Speech by White Noise," *Jour. Acous. Soc. Amer.*, March 1948.

7. R. C. Mathes and R. L. Miller, "Phase Effects in Monaural Perception," *Jour. Acous. Soc. Amer.*, Sept. 1947.

8. J. C. Steinberg, "Effects of Phase Distortion on Telephone Quality," *Bell Sys. Tech. Jour.*, July 1930. See also Steinberg on "Effects of Distortion on Speech and Music," chapter in Pender-McIlwain, *Electrical Engineers' Handbook, Communication and Electronics*, pp. 9-27 through 9-36.

9. 300A and 300B V. T. Data Sheet, Western Electric Co.

10. W. B. Snow, "Audible Frequency Ranges of Music, Speech and Noise," *Jour. Acous. Soc. Amer.*, July 1931.

11. 262B and 347A V. T. Data Sheet, Western Electric Co.

This Month

PRESTO MOVES

On May 15 the Presto Recording Corporation completed the moving of factory laboratories and general offices from New York City to their recently completed plant at Paramus, N.J., located seven miles from New York City on Route # 4, via the George Washington Bridge. Mail must be addressed P. O. Box 500, Hackensack, N. J.

The new plant, employing approximately 250 people, is adjacent to Presto's other factory that is used exclusively for the production of Presto Recording Discs.

SUMMERFORD JOINS MID-AMERICA

D. C. Summerford has resigned from the position of Assistant Technical Director of radio station WHAS to accept a position as Technical Director for Mid-America Broadcasting Corporation of Louisville, Ky. now installing a new 5000 watt station.

Getting the Most Out of A Reflex-Type Speaker

BENJAMIN B. DRISKO*

Design data, constructional ideas, and simple tests for this type of loudspeaker.

THE so-called "bass reflex" or acoustical phase inverter provides one solution to the loudspeaker mounting problem. To those whose available space or funds do not permit the more cumbersome exponential horn it may be made to provide considerably more uniform response than any simple open-backed cabinet and, with a little care in the adjusting procedure, will give less hangover than almost any other type of mounting.

The minimum requirements for utilizing the following procedure are: 1. A suitable loudspeaker of the direct radiator type and an accurate knowledge of its resonant frequency. 2. Some lumber, preferably plywood and a medium amount of carpentry skill. 3. Some acoustical absorbing material; ordinary carpet lining is very satisfactory. 4. A small step function signal generator; a number 6 dry cell is eminently satisfactory and a flashlight cell will do.

Hangover

If one excites the voice coil of the unmounted speaker with constant current at variable frequency and measures the voltage at the voice coil terminals, one finds usually a pronounced rise at some point, generally between 40 and 100 cycles for ordinary speakers. Also it will be noted that the amplitude of the diaphragm motion is a maximum at this frequency. We are observing the primary resonance between the mass of the diaphragm or cone, the voice coil and other moving parts and the stiffness or restoring force provided by the spider, surround, etc. If the impedance curve is carefully plotted, the frequencies of the half-power points may be noted and the Q of the vibrating system computed from the quotient of the resonant frequency by the half-power b and width. It will usually be found that this Q is between 4 and 8, and in an infinite baffle will usually drop to about half its free air value. Since critical damping corre-

sponds to a $Q=0.5$ it is easy to see why this type of speaker is prone to hangover.

By analogy we may compare the above state of affairs to a series LC circuit which is said to be resonant. By this same analogy the reflex enclosure, which is really a Helmholtz resonator driven by the back of the cone, is an anti-resonant circuit similar to a parallel LC combination. This is a step in the right direction toward reducing the effective Q of the system, both by detuning it and by the added radiation resistance of the port of the bass reflex enclosure. If one now repeats the above impedance plot with the speaker in such an enclosure he finds two frequencies where the impedance has a peak on either side of the original resonance peak. If the resonator has been tuned to the same frequency as the diaphragm, the two peaks will be about equal in magnitude and both will have much lower Q s than the infinite baffle. If the tuning is slightly in error, one of the peaks will be higher than the other and will have a higher Q , which, for purposes of this paper is undesirable. With no sound-absorbing lining in the box, the damping will still be much less than critical and one is apt to find little sharp peaks in the impedance curve at frequencies for which some inside dimension is a multiple of a half wavelength.

The anti-resonant frequency of the Helmholtz resonator may be computed from the formula $f=2070 (A^{\frac{1}{4}}/V^{\frac{1}{2}})$ where A is the area of the port in square inches and V is the volume of the box in cubic inches. The design is still indeterminate inasmuch as there are an infinite number of boxes of different volumes, each with a suitably sized hole and all resonant at the correct frequency. One limitation may be placed by the following. The resonator frequency formula is only good where the maximum dimension is small in comparison with the wavelength. If we interpret small to mean between $1/3$ and $1/10$ we come

out about right. Another rule, this time empirical, is that the area of the port should be between $1/2$ and 1 times the area of the diaphragm. This results in a 4 to 1 latitude for size and it is doubtful if you could tell the difference between any two within those limits. It is considered good practice to keep the shape of the box somewhere near a cube. If the depth, width and height are in 2-3-4 proportion a fairly satisfactory product results, both acoustically and as a piece of furniture of convenient size.

A sample computation follows: Let's say that we are starting with a 12" speaker whose active diaphragm area is 82.6 in.² and whose resonant frequency is 70 cycles. We decide to make the port about $3/4$ of the diaphragm or 60 in.² This gives a 6 x 10 opening which will look well below a 10 $1/4$ " speaker mounting hole. Rearranging the resonator formula

$$v = \left(\frac{2070}{f} \right)^2 \sqrt{A}$$

or, for our hypothetical case,

$$v = \left(\frac{2070}{70} \right)^2 \sqrt{60} = 6770 \text{ cubic inches}$$

If $2x$, $3x$ and $4x$ are the depth, width and height respectively of our box, then the volume $=24x^3=6770$ and $x=6.56$ and our box comes out to have inside dimensions of $13\frac{1}{8}$ " x $19\frac{3}{4}$ " x $26\frac{1}{4}$ ". This is not an inconvenient size, so let's go on from there.

Building the Baffle

The next step depends upon your skill as a carpenter. It is probably in order to make some sketches to see how much larger than the above inside dimensions you have to cut the various pieces to get the proper overlap at the corners and also to most economically utilize the available lumber. As to thickness, there is a fair amount of latitude. $5/8$ " to $3/4$ " plywood is considered good practice and yet one made out of $1/2$ " plywood for a dancing teacher who wanted it very portable showed no serious mis-

*160 Central St., Hingham, Mass.

behavior. It, of course, had to have corner blocks for structural reasons. While you're in the sketching department, lay out some furring strips, anything from $\frac{1}{2}$ " x $\frac{1}{2}$ " to 1" x 1" will do, and sufficient in quantity and sizes so that all six inside faces of the box can be covered with the carpet lining, hair felt, rockwool or whatever you choose, but attached by means of the furring strips so that there is a dead air space behind each piece of felt, between the felt and the inside of the box and as thick as the furring strip. This takes a bit of doing and may be done in a variety of ways. Be guided by how much the thing will have to be handled and bumped around, inclining toward a minimum volume of furring strips and labor but being sure to get the inside of the box pretty well covered and to have the dead air space between the lining and the box. The purpose of all this is to further reduce the Q and hopefully to achieve critical damping.

It is also considered good practice to have the port as close to the speaker hole as possible. The reasons are a bit obscure, the principal one being to have as near a point source as possible. At this point it might be well to digress for a moment and discuss the final location of the whole outfit. The details are much too long to go into here, but it has been shown with the very best scientific rigor that a corner of the room is by far the best place, and by corner we mean really in the corner with no air spaces between the sides of the box and the walls and floor. This necessitates

some elaborations in case there is a projecting base board. But it pays.

There is, however, another alternative. The whole box may be elevated to the upper corner of the room, between the two walls and the ceiling. Furthermore, since the speaker is fairly directional in the upper register it would be desirable to have it pointing in the general direction of the listeners. This calls for a five-sided platform with the cater-cornered side pointing down the long diagonal of the room. For reasons that are not too clear, by far the best-sounding reflex type speaker which has come to my attention was of this construction and, furthermore, it was noticeably better up against the ceiling than down on the floor. The port was in top end of the box top when it was on the floor (the bottom when it was up against the ceiling) which brings us to the reason for the digression. If you can talk yourself into a corner location for the cabinet as a whole, then there is some precedent for locating the port anywhere you choose, but if the speaker must sit in the middle of a flat wall, then it may be wise to keep the port on the same side as the speaker and closely adjacent thereto.

Tests

Let us now suppose that you have the reflex cabinet completed, the speaker mounted and leads coming out at some appropriate spot. Procure the d-c signal generator, namely one $1\frac{1}{2}$ volt dry cell and attach one voice coil lead to one terminal. Touch the other lead to the other terminal and alternately make and

break the circuit a few times. A moment's experimenting will indicate whether the lead and the battery terminal are clean enough to give a sharp, instantaneous make and break. This is important. If either make or break sounds scratchy, try scraping the contacts or better still, if you have a telegraph key handy, use it instead. A plain knife switch might do, but a switch that makes an audible click will not do unless you can have an assistant do the clicking for you at some remote point so you do not hear the switch click.

What you should hear on both make and break may best be described as a "bong." It is more than an instantaneous click, inasmuch as it has a recognizable pitch. If there is a piano near-by you could, in a few tries, find the note that matches it. The motion of the diaphragm and/or air is not yet critically damped. In pulse circles, this is called "ringing," a most satisfactory word. This ringing can be cured by application of the proper acoustic resistance to the port. So far as I know, the rules have not yet been worked out—from here on in you're on your own and its strictly cut-and-try.

It may well be argued that you should hear ringing anyhow unless you are in an anechoic chamber, because even if the speaker is perfect, the acoustic click produced by the speaker will excite the room in one or more modes and you will hear the room ring. To these scoffers I hasten to point out that the evidence

[Continued on page 41]

Control console for an auditorium studio at C. B. S. KNX, Hollywood. Although some of the network's largest and most complicated programs originate from this point, it has been possible by careful design to keep the number of controls to a minimum.



Telephone Recording

E. W. SAVAGE† and S. YOUNG WHITE††

PART II — Methods of overcoming difficulties encountered in this new form of recording.

THE recording of all types of two-way telephone conversations, so they may be reproduced at maximum intelligibility, presents extremely complex problems in the correction of signal intensity variations.

To begin with, the over-all range of intensities which must be anticipated is quite wide—of the order of at least 60 db. The shifts in signal from one intensity level to another may be frequent, very fast, and unpredictable. Under such conditions, it is obviously impractical to rely solely on manual means to effect the necessary gain control adjustment. Consequently, some form of automatic gain control is essential in any telephone recorder amplifier. Provision, in such automatic means, for wide-range correction within split-seconds of time—particularly where the principal energy components of the speech signals handled are in the 200-500 c.p.s. frequency range—is no mean task.

Further complications arise because the intensity variations, which must be corrected during a two-way telephone conversation, occur at unpredictable times, and vary in degree and duration. Unlike the human monitor at a broadcast studio, the automatic monitor in present-day telephone recorders is not supplied with an advance "cue sheet" indicating exactly when adjustments must be made. Therefore, the automatic control cannot properly go into action until *after* the signal which it must correct, has actually originated. This limitation poses the difficult question: How long should the time delay be? Regardless of the time constant chosen, whether it is slow or fast, some form of undesired distortion is bound to result. This is axiomatic where the control is applied "after the fact" instead of "before the fact". Therefore, any time constant used is a compromise, rather than an ideal. Two popular a-v-c systems for telephone recording are described later in this article. They operate at a time constant of approximately .04 second.

†Box 408, New Canaan, Conn.

††Consulting Engineer, 52-12 Van Horn St., Elmhurst, L. I., N. Y.

The third problem with telephone recording stems from the relatively limited over-all signal intensity range which the sound track, itself, will accept without over-modulation and without submersing the speech signal in surface noise. This range is of the order of 25 db; not 25 db just any-

where on the intensity scale, but a 25 db range having *fixed* values for its upper and lower limits. As a result of this limitation, the speech signals which originally may occupy a 60 db range must be compressed into a 25 db range and then shot with William Tell accuracy through a "keyhole" which is at a fixed height from the "floor" of the intensity scale.

TABLE I

Relative Phonetic Powers and Relative Frequency of Occurrence of the Fundamental Speech Sounds as Produced by an Average Speaker

Sound	Key	Rela. Freq. Occurrence	Relative Phon. Power*
i	tip	7.94	260
n		7.24	36
t		7.13	15
r		6.88	210
o	ton	5.02	510
s		4.55	16
d		4.31	7
á	tap	4.17	490
ē	eat	3.89	220
l		3.74	100
e	ten	3.44	350
th	then	3.43	11
a	top	3.33	600
z		2.97	16
m		2.78	52
k		2.71	13
ā	tape	2.35	370
v		2.28	12
w		2.08	**
p		2.04	6
f		1.84	5
b		1.81	7
h		1.81 (No Fig. Available)	
ō	tone	1.63	470
ū	tool	1.60	310
ī	dike	1.59	**
ó	talk	1.26	680
ng	hang	.96	73
sh	shell	.82	80
g		.74	15
u	took	.69	460
y		.60	**
ou	our	.59	**
ch	chaK	.52	42
j		.44	23
th	thin	.37	1
ew	few	.31	**
oi	oil	.09	**
zh	azure	.05	20

*The value of 1 is .05 microwatt-power of the weakest sound *th*, as in *thin*.

**Values for diphthongs not given, but they have the same power as the vowels which compose them.

Material in this table is based on Tables 10 and 13, pages 74 and 84 of the book "Speech and Hearing," by Dr. Harvey Fletcher, of Bell Telephone Laboratories, published by D. Van Nostrand Co., Inc.

Toll Circuits

Still another problem is created by the transmission characteristics of message toll telephone circuits, which attenuate the higher speech frequency components that are so essential to the full articulation of consonant sounds. To counteract this condition, some recorders—not all—provide amplification with rising response at the upper region of those frequencies which a telephone transmits. Although such systems yield higher intelligibility in telephone recording than flat response systems, they are still far from being entirely satisfactory. They make no discrimination between the vowel sounds, which inherently have high energy components in the frequency regions which are "boosted," and the consonants, whose components in those same regions are inherently of low energy value. Often, therefore, the net result is that the vowels are "banged" out in such fashion as to impair recognition of adjacent consonants. Also, such selective frequency "boosting," when indiscriminately applied to both voiced and unvoiced sounds alike, necessarily imparts an unnatural quality to the voiced portions of the reproduced speech. This may account, in part, for the reluctance of telephone companies to employ such means for improving intelligibility at the sacrifice of "naturalness" of the voice, which, understandably, they seek to preserve in transmission.

Thus, with telephone recording, we have two main categories of signal intensity correction which must be made:

- 1—Correction as between *general levels* of signal intensity.
- 2—Correction as between the *intensities of the individual sounds*, themselves, which go to make up the general levels.

The first type of gain adjustment makes it possible to *hear* the speech. The second, properly accomplished, will make it possible *accurately to recognize* what is being said.

Mr. White, later in this article, describes two automatic gain control systems currently being used in telephone recorders to effect Category 1 corrections. In the intervening space, which is indeed limited for the discussion of so complex a subject, I should like to touch briefly on certain aspects of Category 2 corrections, with the suggestion that present methods of making such corrections might be improved upon.

Sound Intensity Corrections

Sixty per cent of the energy in speech is in those frequency components which are below 500 c.p.s. The fundamental frequency range of the vocal cords is of the order of from 90-310 c.p.s. Therefore, the bulk of the energy in speech comes from those sounds which require use of the vocal cords—namely, the voiced sounds.

As will be seen in *Table I*, the energy present in the *unvoiced* sounds is but a small fraction of that found in the majority of the voiced sounds. Therefore, the voiced sounds contribute the greatest weight to the establishment of a *general level* of speech signal intensity; not alone because of their predominance in numbers and in individual strength, but also—in the case of vowels—because of the relatively longer time period which their sounding occupies.

In the light of these facts, it is obvious that merely lifting the *general level* of speech intensity will not, in itself, insure that the important, but inherently much weaker, *unvoiced* sounds will in every case be boosted to the point where they, too, are perfectly intelligible.

It is not proposed that the unvoiced sounds be amplified to a degree where their reproduced strength would approximate that of the louder vowels. In such a procedure the cure would probably be more distasteful than the disease. Rather, what is recommended is that means be explored which will enable selective amplification of the unvoiced sounds, independently of the voiced sounds. The objective of such a system is to provide a wider correction for three forms of attenuation to which the unvoiced sounds often fall heir in passing from the lips of a speaker, into the telephone transmitter, and thence over transmission lines to the recorder amplifier.

The first two forms of attenuation are imposed by the speaker, himself, who

TABLE II
Relative Phonetic Powers and Relative Frequency of Occurrence of the Unvoiced Consonants

Sound	Rela. Freq. Occurrence	Relative Phon. Power*
t	7.13	15
s	4.55	16
k	2.71	13
p	2.04	6
f	1.84	5
h	1.81 (No Fig. Available)	
sh	.82	80
ch	.52	42
th	.37	1

21.79

*The value of 1 is .05 microwatt-power of the weakest sound *th*, as in *thin*.

Material in this table is based on Tables 10 and 13, pages 74 and 84 of the book "Speech and Hearing," by Dr. Harvey Fletcher, of Bell Telephone Laboratories, published by D. Van Nostrand Co., Inc.

may, (1), deliver his sounds carelessly and with lower than average phonetic power and (2), may not speak closely enough to the telephone transmitter.

The third form is imposed by the selective frequency attenuation characteristic of the telephone system itself.

The first two forms of attenuation are easily correctible where telephone recording is regularly used to communicate prepared written matter. In such operations, the person assigned to read the text at the sending station can be taught to stress his consonants, and to speak directly into the telephone transmitter with sufficient loudness to rouse and rattle even the most senile and sluggish carbon microphone. But such discipline over the opposite end of the line is not always possible—or polite—in the recording of random conversations. Modern business has a way, now and then, of connecting a Bull of Bashan, sitting next to his recorder, with a Caspar Milquetoast on the other end of a telepathic level circuit. And what Caspar has to say may be important.

To appreciate the relatively feeble state in which the unvoiced sounds are often called upon to start their telephone journey, reference is made to *Table I*. Here are listed the relative phonetic powers of the fundamental speech sounds as produced by an average speaker in normal conversation. To indicate the importance of these sounds in the carrying on of a conversation, they are tabulated in accordance with the relative frequency of their occurrence. This table was compiled from information appearing in Dr. Harvey Fletcher's well-known book.¹

In *Table I*, a reference value of 1 is assigned to the weakest sound *th*, as in *thin*. The power radiating from the mouth of the average speaker when producing this sound in normal conversation is estimated at .05 microwatt. The loudest sound *ó*, as in *talk*, is produced with a power 680 times that given to the sound *th*. Obviously, during conversation, certain sounds will be stressed for emphasis. But, even so, such stressing does not gain for them a predominance over other sounds which are always their masters in point of inherent power.

Departures from these averages in the most extreme cases would probably reduce the sound *th* to a minimum value of but .01 microwatt, and would raise the loudest sound *ó* to a peak value of 5000 microwatts.

Table II lifts out the unvoiced consonants from *Table I* for closer examination. With the exception of the sounds *sh* and *ch*, the relative phonetic power in these consonants is of a very low order. Yet the group as a whole, in point of frequency of occurrence, represents 21.79% of all sounds used. One out of every five sounds occurring dur-

¹Fletcher, Harvey, "Speech and Hearing," 1929, D. Van Nostrand Co.—Braunworth & Co. Press—Brooklyn, N. Y.

Fig. 1. Partial schematic diagram of Edison Voicewriter.

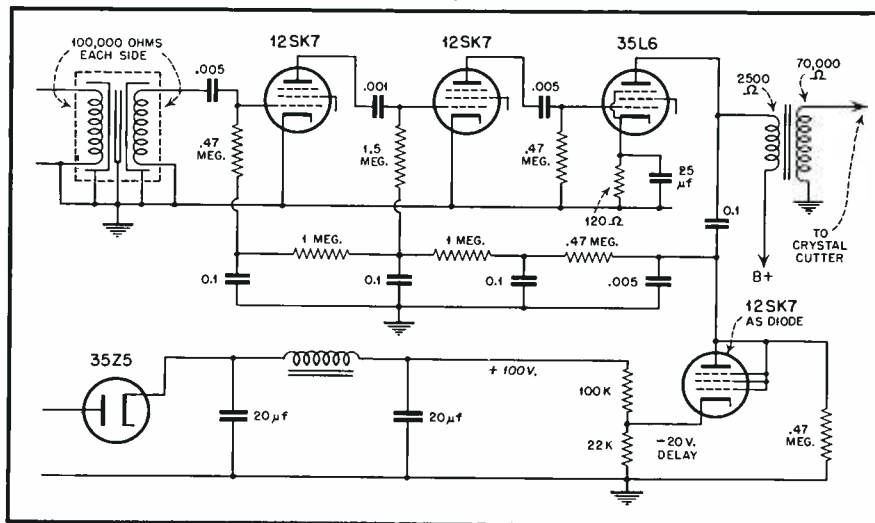

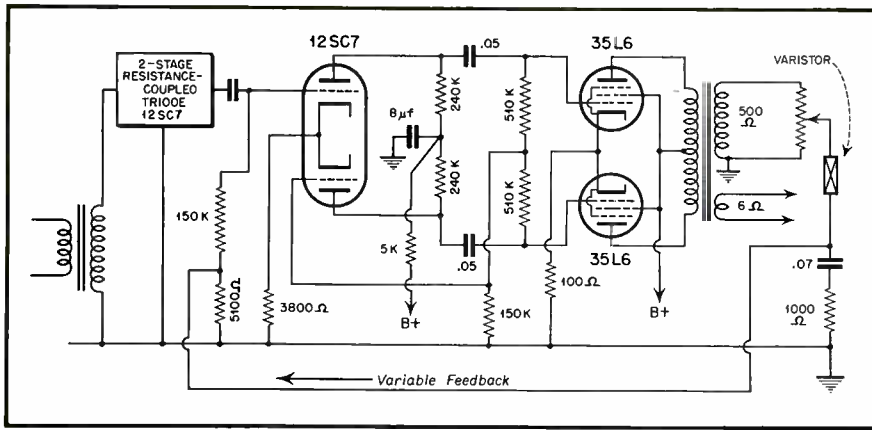

Fig. 2. Circuit used in Soundscriber amplifier.

ing conversation will be one of those shown.

Now let us turn our attention to the effect on these unvoiced sounds which is exerted by the selective frequency attenuation of a telephone system.

In the preceding article of this series,² the articulation loss imposed on the fundamental speech sounds by transmission over systems of restricted frequency bandwidth was shown. Figures were given for circuits having top frequency cut-offs at 2000-2500-3000 c.p.s., respectively. It should be emphasized, that the losses shown apply only when transmission is over flat response systems. Message toll telephone circuits, in many instances, are not flat within the frequency bandwidths which were treated. Even with a 2000 c.p.s. top cut-off, a large percentage of the unvoiced consonants possess substantial recognition information. The important thing to determine, then, is whether such components of those sounds as are in the 200-2000 c.p.s. range—or the 200-2500 c.p.s. range—would yield full identifying information if they were to receive selective amplification by frequency, in excess of, and independently of the gain which is given to adjacent vowel sounds in speech.

Would more gain, alone, turn the trick, or would the amplified components still have to lean on the missing components (of higher frequency) to yield full recognition?

This question is posed because the fundamental speech sounds, themselves, possess certain natural characteristics which are conducive to the design of a system that would automatically and selectively control the gain applied to one group of sounds, independently of that applied to another group. Thus, a consonant could be given an increased high-frequency gain while an adjacent vowel received uniform frequency amplification. And,

the consonant could be given a greater measure of gain than it customarily receives with present systems. Furthermore, the naturalness of the voice in the utterance of vowels would not be disturbed as is the case when all sounds receive rising response gain.

Vital to the perfection of such a system is the acquisition of *reliable and specific* data indicating how the total energy in each of the unvoiced sounds is distributed according to the respective frequency components. Such information of this sort as the writer has come upon is often incomplete or at variance with known and generally accepted fundamentals of speech and hearing. Any fresh sources of information along these lines are therefore eagerly solicited.

As a preface to Mr. White's discussion of two popular a-v-c systems now available in telephone recorders, I should like to insert one or two notes.

The recorder-to-line connector, which will be a part of future telephone recording installations, is expected to reduce the normal disparity between the received intensity levels of the local and the distant voice by 10-15 db. This should be of advantage on landline calls, but may not assist materially in the handling of overseas calls. On landline connections, while the disparity in levels between the two voices will vary from one circuit to another, the disparity on a single call will usually remain fairly steady. But this does not hold true when a shortwave link

is used to bring in a voice from overseas during severe magnetic storms. On such occasions, the incoming signal itself may vary widely during the progress of a single call. All the gain control possible is needed.

Another point. Where the call to be recorded involves transmission which is primarily uni-directional—as with the telephoning of prepared written matter—it is preferable with the present types of a.v.c. to employ automatic gain control of narrower range, in conjunction with manual control. Such a combination avoids much of the "bounce" effect one experiences with wide range automatic control, and in general yields adequate and satisfactory results.

Amplifier Design

The amplifier design for telephone recorders is fairly standard, except for the a-v-c systems.

The principal difficulty is the necessarily compact construction, with the need for elaborate switching. Most of the designs on the market started off functionally as dictating machines, so the input may come from a dictating microphone, a conference microphone, as well as from a telephone line, and, in playback, from the pickup. The output may go to a crystal or magnetic cutter, a loudspeaker or transcribing headset. In past practice, the telephone pickup was by induction, with the necessity for about 110 db gain, but with the new systems it is expected that direct connection to the line can be used, so less gain is required. In some equipment, a flashing neon light is furnished as a level indicator.

The low frequency response starts no lower than 250 cycles, and is usually obtained by limiting the size of the condensers so a rather indefinite droop appears in the curve. Some systems do not reach full gain until 400 cycles, and this is a great help in limiting hum problems.

The high frequency response generally holds up to 3 ke, with some systems having a peak at this frequency. The cut-off above that is usually furnished by the transmission character-

Fig. 3. Monitoring and a-v-c circuit used in Soundscriber.

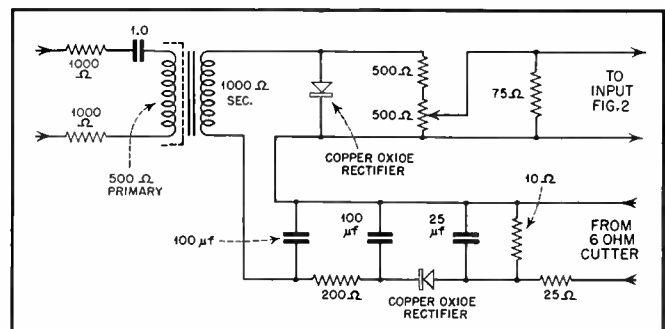

²AUDIO ENGINEERING, April 1948.

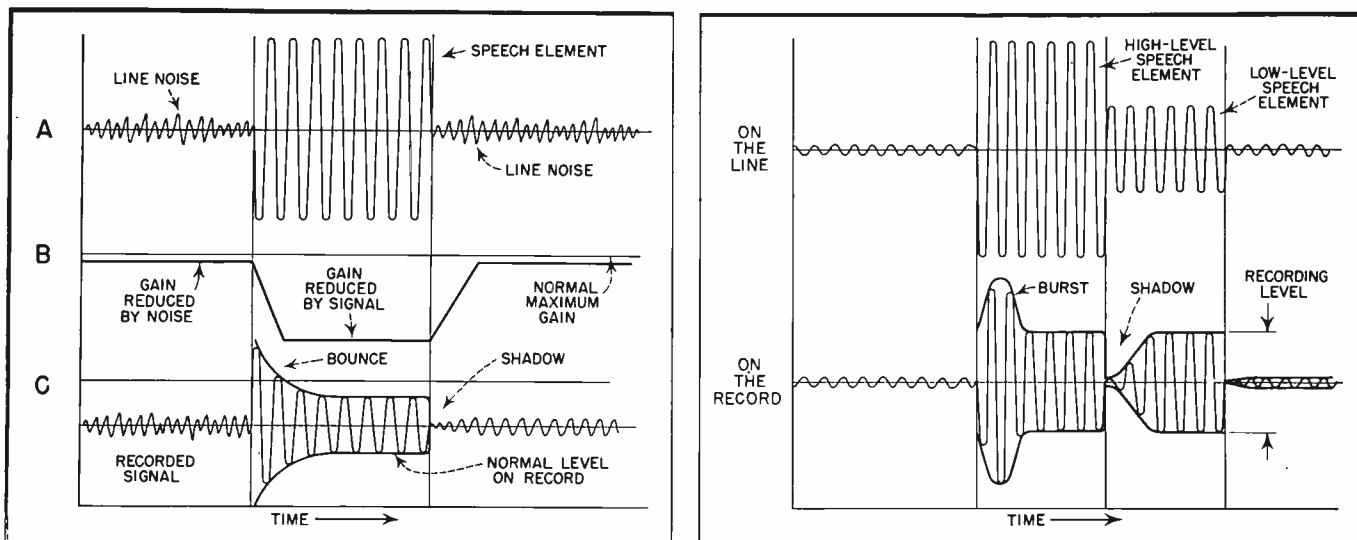

Fig. 4 (left). In (A) line noise and signal. (B) effect of a.v.c., and (C), recorded resultant. Fig. 5 (right). Shadow caused by sudden transition from high to low level.

istics of the telephone line used, few amplifiers being designed for sharper cut-off in themselves.

The two systems shown in *Figs. 1* and *2* are typical. An a-c/d-c power supply is used, eliminating a transformer. The two differ in power output, one working into 70,000 ohms for a crystal cutter, the other giving about 4 watts into a 6-ohm magnetic cutter. In both, great care is expended in the input transformer, which has external shields in addition to internal shielding between windings. The switching is too complicated to show, and undoubtedly represents most of the design in the amplifiers. We all know how the engineers must have sweated to minimize the hum and undesired feedback in these compact assemblies, which also include a motor.

The A-V-C Systems

The most considerable point of actual difference between these two units shown is in their attack on the problem of a.v.c.

Figure 1 shows the Edison Voice-writer. Two stages of unbiased 12SK7s give high gain (110 db). The 35L6 output tube feeds a backed-off diode through a condenser from its plate, with about 20 volts delay derived from the B supply through a bleeder. This rectified and smoothed resultant is applied as bias to the K7 tubes, through two different time constant networks as shown. Of course, the distortion in these K7 tubes is rather large operated this way, but it eliminates a source of motor-boating which can be serious in high-gain systems. Note the differing values of grid condensers and leaks each stage, another insurance against low-frequency oscillations.

Figure 2 shows the Soundsciber system. The a.v.c. is applied to an

intermediate point in gain; at the grid of the phase inverter tube. Since the main output is to the 6-ohm cutter, a special 500-ohm winding on the output transformer gives a feedback source of much higher voltage. This is applied through a Varistor to an .07 μf condenser in series with 1,000 ohms. The Varistor makes the amount of feedback a function of signal level, and the network puts in some frequency and phase angle, so the system is selective to both amplitude and frequency. This system (*Fig. 3*) was mainly designed for the much less difficult job of automatically monitoring the device when used for dictation and serves as an auxiliary to the automatic volume control system for telephone usage.

The principle of operation is to have the audio output of the system act as a.v.c. on the input by shorting an input transformer. The voltage across the nominal 6-ohm cutter is attenuated about two-thirds by the input resistive network. The 10-ohm resistor is shunted by a 25 μf condenser. The impedance of a magnetic cutter, as we all know, rises rapidly with frequency, so this condenser prevents too much a.v.c. on the high frequencies which would otherwise occur.

The resultant voltage is applied to a copper-oxide rectifier, filtered by two 100- μf condensers on either side of 200 ohms, and appears as a variable bias on the other copper oxide rectifier acting as a shunt load on the input transformer. The variable impedance reflected into the telephone line is swamped out by the 1,000 ohm series resistors shown. The 1 μf in series with the line is to block off d.c. from the telephone line. The time constant of this system adds up to about 40 milliseconds.

The a-v-c system shown in *Fig. 2*—variable inverse feedback—creates least distortion, but is rather difficult to apply over a great range of control. The standard system of *Fig. 1*, with variable bias on a tube of curved characteristic, is capable of any amount of a-v-c action, with considerable distortion. The system shown in *Fig. 3* (shorting the transformer) also distorts pretty badly and is capable in practice of but a limited range of control.

The writers have had very considerable experience with telephone recording, and in one particular it is quite surprising. The broadcast or recording engineer usually has little respect for "telephonic quality" with its high harmonic distortion, high noise level, and limited frequency response. When we start to work with it seriously we are apt to think that since it has been so severely distorted before we can record it that a moderate amount of distortion added in routine handling can do no further damage to intelligibility. This is definitely not so.

Requirements

The main requirement in the recording system is very good transient response, and to a lesser but very important extent, low intermodulation distortion. It seems that the run-of-the-mine signals on the telephone line have had so many transients added from one source or another that one simply cannot add any more without a serious loss of intelligibility. The same applies to intermodulation distortion.

Now, as all sound engineers know, a system good on both these counts is almost automatically a high-fidelity system, as the third main characteristic of frequency response can easily be supplied. In this work, nothing below

200 cycles seems to be required, and certainly the high end can be easily extended to 6 kc or so, above which little improvement seems to be noted.

The two examples shown in *Figs. 1* and *2* leave out the most important characteristics, of course, which are the over-all system responses as heard from the recording, transient response, and intermodulation distortion. These data were unobtainable. The difficult points of design are the cutter and pickup.

The systems shown in these examples indicate considerable effort on the a-v-c problem. The difficulties are such as to make an analysis worthwhile.

Two attacks are possible. One is to work by continuous compression, where the system as a whole has a curved response so that 60 db in comes out as 25 db. This has distortions of its own, the 25 db dynamic range of each voice being limited to say 5 db, but it has no time constant. The other attack is a-v-c action.

The a.v.c. inherently can control almost to any degree. Some radio sets have been designed with flat a.v.c. so that a variation in carrier level of 80 db gives an output constant within 3 db, so this problem has been solved. It is well to note that since the control is of the carrier, no distortion of the detected signal occurs.

Audio a.v.c. has no such feature, and the means of gain variation can well distort the signal somewhat, and some systems can cause great distortion. Of course, peak clipping can be used to limit the signal, but this gives a flat top wave that we absolutely cannot stand if any intelligibility is to be retained. Many audio a-v-c systems tend to clip, and we must avoid this.

We have only one advantage in telephone a.v.c.; we have no truly low frequencies to contend with. It is always a limitation in any system when the a-v-c action is so rapid that the lows are suppressed.

So our time constant thinking must

be done in terms of the speech element—the vowel, sibilant or syllable. These vary widely, and each speaker has a different rate of attack and decay of his voice on these elements. Some have the property of approximating a square-topped pulse of energy.

Noise

For a complete solution, we should also set the maximum sensitivity as a function of the noise on the line. As we all appreciate, any a-v-c system can merely suppress surplus gain; it cannot supply gain as demanded. If a signal is "down in the mud," we still want to record something, as there might be some intelligible speech left that would be valuable.

For simplicity of discussion, *Fig. 4A* represents a line slightly noisy, and a single, isolated high-level speech element is shown as a square-topped pulse of say 500-cycle energy. *Fig. 4B* shows the maximum gain of the amplifier, but the actual amplifier gain is slight-

[Continued on page 40]

Binaural Phenomenon

S. YOUNG WHITE*

THERE is a revival of interest in three-dimensional sound, due mainly to the development of magnetic tape recording, which lends itself readily to handling two or three sound tracks suitably phased. It becomes possible to visualize commercial possibilities, since the amount of equipment required is limited.

Anyone who works with high-fidelity equipment for some time begins to realize there are many characteristics of hearing that do not lend themselves to measurement. While the air itself is complex enough, it can be fairly well analyzed as a microphone. In combination with the brain, however, we have a psycho-acoustic complexity that defies all our reasoning at times. This is especially marked in the binaural effect.

Some time ago the writer acquired a piece of test equipment developed by the Germans for "Untersee hören"—underwater listening. The object was to rate potential candidates for the job by testing their directive sense when listening to such sounds derived from two underwater microphonic devices.

In attempting to set up the simplest possible case, they designed the gear shown in *Fig. 1*. It was a rotating disc of brass with two small inserts of magnetic material 180° apart around the

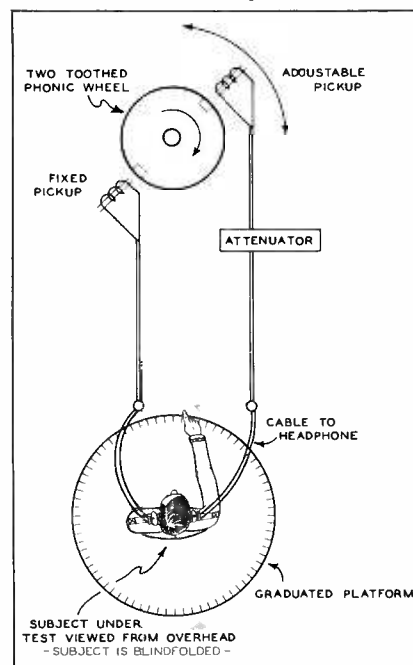

Fig. 1. Testing directive sense when listening to sounds derived from two underwater microphonic devices.

rim. Two pickups each fed a receiver, and when the pickups were 180° apart, they generated simultaneous clicks—in other words, the signals were in phase. By adjusting the position of one pickup around the rim of the disc, it was phased to click a little ahead or behind the fixed pickup.

By adjusting the rpm of the disc, the duration of the pulses could be changed over wide limits. About 500 cycles seemed best—that is, each click was about half a 500-cycle wave. An attenuator in one phone enabled adjustment to any ratio of intensity between the two ears.

The person under test is blindfolded and seated in the center of a graduated circle and is told to point with his arm toward the apparent source of the sound. To prevent confusion, we start off with the clicks in phase.

When the test is started with in-phase clicks, the brain always says the sound is dead ahead. It will be understood we did not test thousands of people—just ourselves and anyone who dropped in the laboratory. In every case, once the test was clearly understood, everybody pointed quite accurately directly in front of him.

[Continued on page 40]

*Consulting Engineer, 52-12 Van Horn St., Elmhurst, L. I., N. Y.

Applications of Magnetic Recording In Network Broadcasting

R. F. BIGWOOD*

THROUGH THE USE of magnetic tape, the American Broadcasting Company has, since April 25, 1948, been recording and playing back on a one-hour delay basis, the 18 hours of daily program material routed through its Chicago studios. In general, this involves continuous recording from one incoming source of network programs and the continuous playback of programs to one out-going line during the entire broadcasting day. It is done to overcome the time differential on the various circuit legs of the network caused by summer Daylight Saving Time and permits placing programs on the air at the same local hour as existed under Standard Time conditions.

ABC has made a further and somewhat more spectacular use of this medium by recording each original performance of the Bing Crosby show on tape. These original shows last as long as 40 minutes; thereafter, the programs are edited and reduced to the regular timing of 29 minutes and 30 seconds. The earlier Crosby recordings began in August, 1947, and were performed on modified German Magnetophones.

During late 1945, ABC circulated among various manufacturers the basic specifications for a proposed professional type tape recording system. It appears that machines of the Ampex Company were the first production units to meet these basic requirements, revised to cover higher fidelity performance. Therefore, in March, 1948, Ampex machines replaced the Magnetophones, and as in the ABC Chicago recording room, this make of machine has subsequently been used exclusively. As of May 12, 1948, the Crosby show was reproduced on the air directly from the edited tape. Prior to this date, the programs were dubbed to discs for distribution and playing.

These two examples of the use of tape in broadcasting are cited because they signify direct experience with, and sat-

isfactory usage of full fledged, high fidelity, professional type tape-recording machines. These applications are the first of their kind in America.

General Features

At network centers and independent stations, the general features of magnetic recording methods have resulted in a startling increase in field recording with transportable gear, several makes of which have been available for some time. Both wire and tape equipment is relatively light, compact, and recording can be carried on in moving vehicles or during transportation by hand. The latter use is limited in a practical sense by the length of the a-c extension cord available. The 150 watts of power needed to supply the a-c synchronous motor drive and associated induction take-up motors in some equipments can not be obtained from truly hand-portable battery and converter supplies. The magnetic recording process requires only a few watts of audio and bias power, so battery supply problems for this are only slightly more severe than in standard remote broadcast equipment. To overcome the electric motor power problem, the spring motor techniques of by-gone phonograph days may be due for rebirth

and use in certain applications requiring extreme portability and lowest possible power drain.

Insofar as magnetically recorded interviews and man-in-the-street types of programs are concerned, there is the inherent advantage of ease of editing, especially when using tape. It is probable that this ease of editing and splicing has caused a trend away from wire for broadcast use. While recordings of long continuous duration can be made on relatively small spools of wire, this feature does not now appear to be of decisive importance to radio users.

Program editing has had limited use in radio disc recording due to dubbing difficulties. With tapes of sufficient speed this process becomes simple. Usually it includes playing back the original recording several times in the presence of producers and engineers who may decide to delete or rearrange portions of the program material. Thereafter, the tape is cued up to the point to be cut and a wax pencil is used to mark the back of the tape immediately over the play-back head. The tape is then removed from the head assembly and snipped with scissors. (Fig. 1.) Several such cuts may be made and syllables of words, sen-

Fig. 1. Editing procedure. After cutting, scotch tape is used to join ends.



*Engineering Dept., American Broadcasting Co., New York, N. Y.

PST	PDT	PROGRAM NO	COL. 1	COL. 2	COL. 3	COL. 4	COL. 5
			PROGRAMS RECORDED FROM EASTERN SOURCES	PLAYBACK TO PST STATIONS	PLAYBACK TO MST STATIONS	PLAYBACK TO PDT STATIONS	PLAYBACK TO KECA ONLY
4:00	5:00						
4:15	5:15						
4:30	5:30						
4:45	5:45						
5:00	6:00						
5:15	6:15						
5:30	6:30	2					I I
5:45	6:45						
6:00	7:00						
6:15	7:15	3			I	I	
6:30	7:30				21	21	
6:45	7:45	4					
7:00	8:00	5					
7:15	8:15	6		I			
7:30	8:30	7			2	2	
7:45	8:45	8					
8:00	9:00	9					
8:15	9:15			2	6	9	
8:30	9:30				7	6	
8:45	9:45				8		
9:00	10:00				9	7	
9:15	10:15	10		9		8	
9:30	10:30	11			5	3	
9:45	10:45			6			
10:00	11:00			7	10	4	
10:15	11:15	12		8	11	5	
10:30	11:30	13		3	3	10	
10:45	11:45	14				13	
11:00	12:00N			4	4	12	
11:15	12:15	15		5			I 12
11:30	12:30			10	12	11	
11:45	12:45	16		13	13		
12:00N	1:00			12			
12:15	1:15			11			
12:30	1:30			16	16		
12:45	1:45	17					I 13
1:00	2:00						23
1:15	2:15					23	23
1:30	2:30	18		17	17	14	
1:45	2:45						
2:00	3:00						
2:15	3:15			22	22	15	
2:30	3:30						
2:45	3:45			14	14	9	
3:00	4:00						
3:15	4:15	19					
3:30	4:30	20		15	15		
3:45	4:45						
4:00	5:00			9			

PST = PACIFIC STANDARD TIME MST = MOUNTAIN STANDARD TIME PDT = PACIFIC DAYLIGHT TIME

Fig. 2. Chart showing recording and repeat schedule at Hollywood terminal of ABC network.

tences or whole sections of programs may be cut out or saved for rearrangement. The desired sections of tape may be spliced together with small strips of adhesive material similar in most respects to "Scotch Tape" except for the extra thin adhesive coating. When complete the spliced material may be played through a machine with no impairment of the original recorded quality and the splices introduce negligible, if any, noise.

Advantages

On a purely technical basis, some advantages are inherent in the use of tape, which recommend it in place of discs:

- (1) Most machines feed the tape past the heads at a constant velocity under control of a driving spindle directly coupled to a synchronous motor. Because of this constant velocity, a uniform program fidelity exists through the entire length of a tape recording. Disc systems incur varying translation losses through cutting and play back as the disc diameter changes. These disc losses can in some measure be overcome by radius equalization, but it introduces technical complications.
- (2) Using suitably high tape speeds and a well designed machine, a program frequency range of 50-15000 cps = 1 db/1000 cps can be achieved and maintained without critical routine maintenance. The noise level is better than 50 db below program level and dis-

ortion at the program level can be held to 2% harmonic distortion or about 4% IMD (intermodulation distortion). It is doubtful whether any commercial disc system, through recording and play back and for the duration of a half-hour program, could meet these specifications.

- (3) A single tape can be recorded, played back, and erased many times without undue degradation of quality. This is an enormous advantage for delayed broadcast work. Obviously, discs must be discarded after one cutting.
- (4) Considerably less audio power is required for tape than for disc recording and, of course, a chip-suction system is not required.
- (5) Continuous monitoring of the recording on the tape can be maintained on professional machines since they are equipped with separate record and play back heads. If close spaced, the monitoring delay is about 1/30 second at higher tape speeds.

It is beyond the scope of this paper to attempt an evaluation of tone tests on tape performed at levels corresponding to peak program conditions. It is recommended that, before making any such tone tests a so-called "AB" listening test be performed to determine the maximum recording level. Live program feed to the recorder over 15 kc lines is preferred for these adjustments. This AB test consists of installing a two position switch in the input of a high-fidelity monitoring system. Position "A" may be connected to the incom-

ing recording line, while position "B" may be connected to the play back output of the tape machine. This assumes, of course, that the machine is equipped with separate record and play back heads. It will be found on high-quality machines that when levels are kept in proper balance, a certain maximum recording level can be reached where the difference between the line program and the play-back program remains undetectable via the monitoring speaker. At higher recording levels distortion will begin to show up. Assume now that tone tests are made at the highest meter-indicated program level previously found to be satisfactory, distortion will be low. If, however, tone tests are made at the estimated level of instantaneous peaks some surprising figures on distortion may be obtained. Until more data is available on tape recording characteristics, it will be difficult to assign limitations to these peak distortion figures or evaluate their meaning.

While hardly a disadvantage of tape, it can not be assumed that tape can or will completely replace disc recording in the near or distant future. For example, it would certainly not be convenient to have a library of short individual numbers recorded on sep-

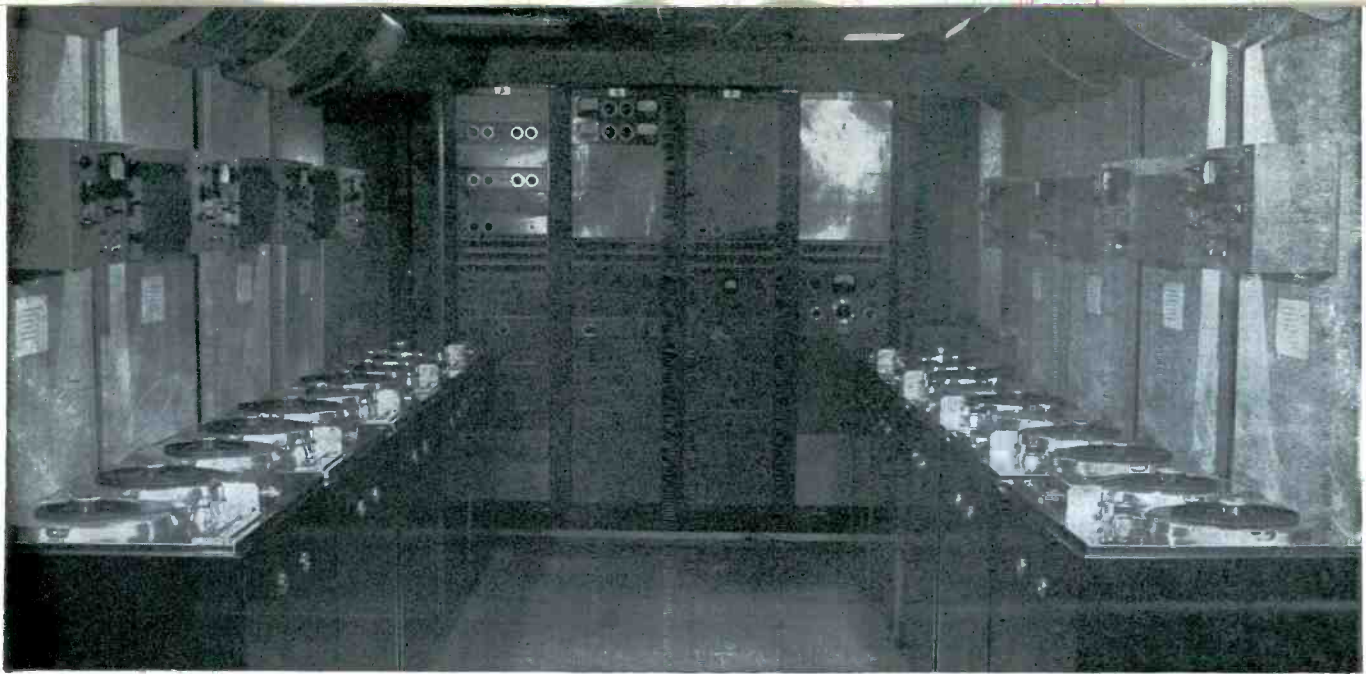

Fig. 3. Chicago installation (WENR). Program repeating and recording room.

arate tapes corresponding to present record libraries. Also, due to the current cost and size of a reel of tape, it is not now feasible to store programs for reference and protection, as is done by many broadcasters. Neither is it now feasible to exchange tape programs with other stations or users, because relatively few machines are in the field and no industry-wide standards have been formulated.

Standardization

At this time manufacturers, broadcasters, and other prospective users are giving serious consideration to magnetic recording standards and it is hoped that recommendations coming out of committees now formed, will be available for general inspection and criticism or approval at an early date. Meanwhile, interested parties are being urged to review their long-range plans for the utilization of tape. The following critical points deserve careful thought and consideration.

- (1) *Tape Speed*—Shall a single standard speed be set up for all types of equipment or should one relatively high speed be set for fixed installation transcription type equipment with a lower speed or speeds for portable gear? With studio type gear for use in repeat broadcasting, the recording of studio shows and interchange of tapes among users, it is believed that full advantage should be taken of a reasonably high speed to insure a full frequency response range up to 15,000 cps. Of equal importance as a practical operating condition, high tape speeds provide greater spacing in program material, hence easier editing.
- (2) *Standard recording characteristics*—This involves standardization on the tape itself, machine design tolerances and circuit equalization. There will undoubtedly be a wide difference of opinion on recording characteristics, but it is urgent for purposes of interchangeability, that some fixed specifications apply.
- (3) *Mechanical standards*—At the very least hubs and driving pin assemblies of the tape reels should have standard dimensions.

ABC Operating Departments have indicated satisfaction with the high-quality professional-type equipment now in use. It has definitely proven of value in delayed broadcast work on a continuous 18-hour-per-day schedule and in the recording, editing and delayed broadcasting of studio-type programs wherein the highest fidelity plus editing features were judged important. When considering the installation of tape equipment, a number of features deserve attention. Assume for example, that a considerable amount of delayed broadcast and audition work is produced on discs and that an appreciable number of these are played but once, or retained for short periods then discarded. This represents many dollars spent for blanks which obviously can not be reclaimed. Good double sided blanks average about \$1.60 each in large quantities. In a similar appli-

cation, tape would not have to be discarded since it can be erased and reused. Of course, the cost per half hour reel of tape is higher. Present prices subject to variation due to changing manufacturing problems are approximately \$3 per thousand feet in large quantities. As an example, at the 30-inch-per-second speed now used by ABC there are nearly 5000 feet of tape per 33-minute reel. Whatever the contemplated daily recording schedule, it is urged that a sufficient footage of tape be contracted for at the time machines are installed. A hundred thousand feet will make about twenty 33 minute reels depending, of course, upon the tape speed. Twenty rolls of tape can quickly be tied up, even in a relatively small recording installation. Furthermore, the ease and convenience of tape recording with a fixed installation, always

[Continued on page 38]

Fig. 4. Author checking power supply system of Ampex recorder.





Classical Records EDWARD TATNALL CANBY*

MR. S. J. White's interesting article on horn-type loudspeakers (AUDIO ENGINEERING, May, '48) puts an analogy into my head that may leave him a bit startled, but which serves to illustrate a fundamental principle of music not too easily appreciated by the trained engineer. The idea is that of impedance—Mr. White, in speaking of the driver unit noted that without a horn there was no match between the moving diaphragm (at low frequencies) and the air, that the horn serves to match the force of the diaphragm to the air, and thus transfer a maximum of energy, at low as well as high frequencies.

There is such a thing as "musical impedance," though possibly it has never been called by that name. Music is a form of expression which is analogous to the propagation of energy in the physical sense. Intense human expression is very closely linked up in our minds with intense energy, with striving, with pressure—voltage, if you will. The use of human energy is specifically to be sensed in such bodily functions as the tensing of muscles against resistance. The function of the human voice itself is one of the fundamental tensions—force against resistance—on which all music is based, either directly, as in singing, or in the production of some other musical sound, instrumentally, that simulates the emotion, the pressure, the expression (with that sense of working against resistance) of the voice. So important is this sense of strain that even those instruments which actually require very little physical work still

*279 W. 4th St., New York 14, N. Y.

To Mr. Canby's widely read column, we add Bertram Stanleigh's interesting evaluation of recent popular music records.

Popular Records BERTRAM STANLEIGH**

depend for their expressiveness on an imitation of the "work" effect. The swell box of an organ, for instance, allows for an increase of tone actually through a lowering of pressure, an opening of doors—but the effect is the opposite.

We can measure the importance of this vocal, muscular tension in music simply by looking at the matter of musical pitch. "Up," to us, means more intense, more tension, higher pressure, ("Up," of course, is a pure figure of speech that often baffles musical beginners who find "up" on the piano horizontally to the right.) "down" means a lessening of tension. The sense of melody is found in this tension. Now, many instruments, such as wind instruments, do in fact require a higher tension in the playing for a tone of higher pitch. But many do not, including the organ and the piano. Yet note well, that a melody which climbs upward on the piano *appears to increase in emotional tension*, and indeed is played that way by a good pianist, who "feels" the music tensing, even though from a mechanical point of view, the increase in playing tension is entirely arbitrary. We may note, too, that the fundamental rhythms of music (we've accounted for pitch) come from twin functions of the body, the staccato beat of the heart and the smooth, flowing pulse of the lungs. Quick proof of the connection: faster music generally is more exciting, clearly because of the emotional association with faster, tenser breathing, quicker heartbeats.

But there is a further, engineering

[Continued on page 42]

WHETHER to record at 78 or 33 1/3 rpm has been a matter for debate among recording enthusiasts. Most advocates for the slower speed have always felt that that method has not received a fair trial on the home phonograph. During the early thirties, Victor did release some slow-playing recordings, but the matter was given little publicity, and after a couple of years, the scheme was discontinued.

Now Columbia is busy preparing a new series of 33 1/3 discs for home listening. News of this venture is still being withheld, so technical details are unavailable. However, it is known that these new discs will use a much narrower needle channel referred to as a *micro-groove*. The recordings will be available in ten and twelve inch sizes, and their playing time will be thirty-five and forty-five minutes, respectively. All pressings will be on vinylite. The price of a twelve inch platter will be five dollars.

Naturally, special equipment will be required to play these *micro-groove* recordings. An adapter unit, consisting of a turntable and special pickup, is being prepared by Philco to sell at \$29.95. This unit will reach the market at the same time as the records, probably early this fall.

High-fidelity is the word being whispered about concerning these new platters, but there is considerable skepticism in some circles. No one doubts that the original masters will be up to Columbia's already excellent standard. The problem is whether the more

[Continued on page 45]

**41 East 59th St., New York 22, N. Y.

IMPROVED!

...to Provide a New Standard of Performance!



CARDYNE

Cardioid Dynamic Microphone

● It's better than ever . . . with new impedance selector . . . new external shock-mount . . . improved response . . . increased output! All this, plus Mechanophase* principle, Acoustalloy diaphragm and other great features, combines to make E-V Broadcast Cardyne today's leader!

True cardioid performance cuts reverberation and random noise pick-up . . . stops feedback . . . nearly doubles conventional pick-up range . . . provides clear, natural close-up response. Excellent for broadcasting, recording or high quality public address. Try the improved Cardyne now! *It's your best buy!*

E-V Model 731. Broadcast Cardyne II. Frequency response substantially flat 30-12,000 c.p.s. Output -50 db. Includes external shock mount. Cannon XL-3 connector. List Price **\$80.00**
(Also available without "On-Off" switch or with 50-250 low impedance selector.)

E-V Model 726. Cardyne I. Frequency response substantially flat 40-10,000 c.p.s. Output -53 db. Without external shock mount. MC-3 connector. List Price **\$59.50**

Send for Bulletin No. 139

NEW EXTERNAL SHOCK MOUNT

Model 345. Newly developed vibration isolation unit with double shock absorber action. Utilizes dual Lord shear-type mountings—eliminates undesirable vibrations transmitted from stand—reduces side sway of microphone without reducing efficiency of isolation unit. Furnished with Model 731 Cardyne. Also available separately for Model 726.

NEW IMPEDANCE SELECTOR

Recessed switch at rear of microphone case gives instant selection of high impedance (25,000 ohms) or low impedance (150 ohms). Switch easily actuated by pencil point or small screw driver. Included in both Models 731 and 726.

NO FINER CHOICE THAN

Electro-Voice

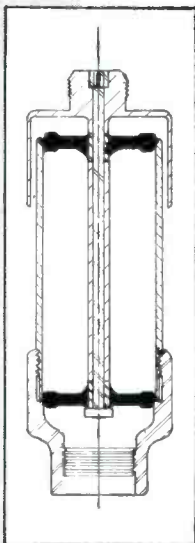
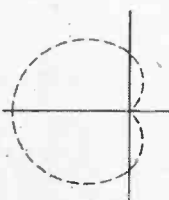
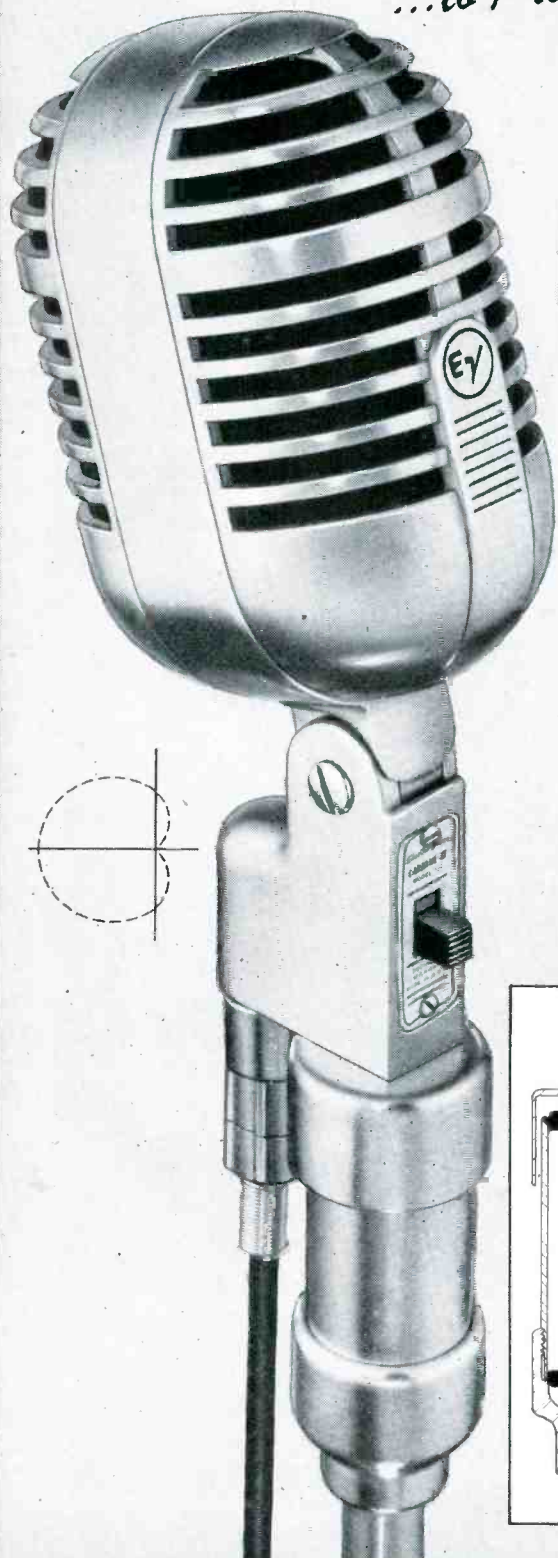

ELECTRO-VOICE, INC., BUCHANAN, MICHIGAN—Export Division: 13 East 40th St., New York 16, U.S.A., Cables: Arlab

NEW PRODUCTS

SUPERHET TUNER

• A new tuner designed to convert the Soundmirror into a combination radio-recorder instrument is presented by the Magnetic Recorders Company. It is specifically designed to fit into the existing cabinet, and tunes from 1700 kc to 530 kc.

Further information can be had by writing directly to the Magnetic Recorders Company, 7120 Melrose Avenue, Los Angeles 46, Calif.

TORQUE DRIVE PICKUP

• The Torque Drive is a new idea in crystal pickup cartridges developed by Electro-Voice engineers, for use in home phonographs, record players, record demonstrators, coin operated machines, etc. It makes possible new light weight and new efficiency in coupling the crystal to the record groove. It acts as a mechanical transformer and provides the proper "Gear Ratio" between record groove and the crystal. It allows a compliant (free-moving) needle point to deliver multiplied force to the crystal—gives optimum transfer of energy at all useful audio frequencies—produces ample voltage output with high needle compliance.

Because of its unique design, it reduces surface noise, scratch and needle "talk"—avoids sound distortion—lessens record wear—lengthens record life—increases needle plays—gives new life to old, worn records.

Among the many features of the new Electro-Voice Series 12 Torque Drive cartridge are:

- Light Weight (weighs only 1/5 ounce)
- Low Mass Drive System
- Multiplied Needle-Force-to-Crystal
- No Bearings or Bushings
- High Lateral Compliance (flexibility)
- High Vertical Compliance
- Matched Frequency Response
- Low Distortion
- Zero Output for Vertical Movement
- Moisture-Proofed Crystal
- Ample Voltage Output
- Replaceable Whisker Needle
(Osmium-Tip or Sapphire-Tip)
- Small Size (1-3/32" x 11/16" x 5/16")

EQUALIZING PREAMPLIFIER

• A new equalizing preamplifier for variable reluctance and magnetic phonograph pick-ups, which requires no soldering iron or

technical training, and which can be installed by the average set-owner or high-fidelity enthusiast in less than a minute, has been announced by Roger Television, Inc., 366 Madison Ave., New York 17, N.Y.

NEW H-P INSTRUMENTS

• Two new battery-operated instruments—a vacuum tube voltmeter and audio oscillator—were announced this month by Hewlett-Packard Company of Palo Alto, California. Both instruments are portable, light-weight, completely hum-free, mounted in weather-proofed dural carrying cases, and designed for general use where power sources



are not available. Both are completely operated from "drugstore" flashlight and standard 45 volt "B" batteries.

For further data, please write manufacturer.



SOUND-ON-FILM RECORDER

• Frederick Hart & Co., Inc., an ATF Associate, Poughkeepsie, N.Y., announce the new Hartron Model 60 Sound-on-Film Recorder-Reproducer, the Hartron Model 60,

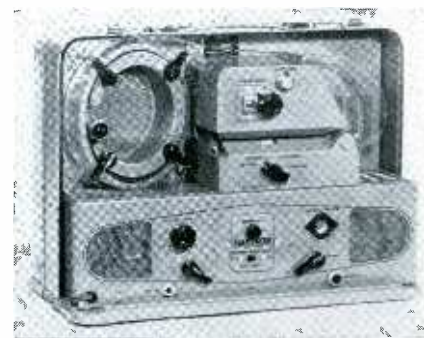

an all-purpose, light-weight unit, which utilizes 35 mm film to produce a permanent, 2 hour, non-erasable sound record. Longer recordings may be obtained to suit particular requirements. The recording may be played back immediately or filed away for ready reference at any future time. No processing of film required.

Auto Start-Stop, a voice-actuated mechanism, automatically starts and stops the machine at any voice level to make the Hartron Model 60 fully automatic in operation. An indispensable feature in direct line recording, the Auto Start-Stop permits unattended operation and gives economy of film use.

Monitoring facilities assure positive control of recording or enable one to listen to material previously recorded without interrupting current recording.

Foot Switch and Earphones available for transcribing purposes. Other accessories available for every recording application.

For further data, please write the manufacturer.

NEW STEPHENS MIKE

• Described as incorporating revolutionary developments in microphone performance and design, is the Stephens Tru-Sonic Phase Modulated Model C-1 Microphone, just introduced by Stephens Manufacturing Corporation, Los Angeles, Calif.

[Continued on page 47]

PROFESSIONAL DIRECTORY

C. J. LeBEL
AUDIO CONSULTANT

370 RIVERSIDE DRIVE
NEW YORK 25, N. Y.

PRODUCT DESIGN • INSTRUMENTATION
PSYCHO ACOUSTICS • SOUND RECORDING
ELECTROMEDICAL • SUBMINIATURE AUDIO

Custom-Built Equipment

U. S. Recording Co.

1121 Vermont Ave., Washington 5, D. C.

District 1640

Winston Wells

Designer and Consultant

Acoustical and Electronic Research

307 East 44th St. MU 4-3487
New York 17, N. Y.

WHAT
 MAKES A GOOD
 RECORDING BLANK
 GOOD?
 ?



INSPECTION

It has been said that "pigs is pigs." Lacquer-coated discs, however, regardless of science in the manufacturing process, do not always turn out to be recording blanks. The suitability of each Soundcraft blank for broadcast-quality recording is judged by the highly-trained personnel of the inspection department.

Aside from routine checking of center-hole size and disc concentricity, the prime task of inspection is visual search for minute physical imperfections in the recording surface. One of the few Soundcraft operations that depends on the human element, inspection is carried on in controlled surroundings. Scientific lighting, room-coloring, temperature, humidity, and dust-conditioning all contribute to consistent inspection, grading, and discarding of rejects.

The common dilemma of disc inspectors has long been the tendency toward sliding standards. When the runs are good, it is human to tend to grade down and vice versa. To assure absolute standards, Soundcraft maintains inspectors to check the inspectors. These final inspectors not only double check the original grading but also eliminate any recording blank accidentally damaged subsequent to initial inspection.

As additional protection to the Soundcraft user, all operators of punch presses, embossing equipment, and labelling machines scrutinize each disc they handle. Thus, with everyone an inspector, many watchful eyes guarantee rigid standards of surface perfection, to establish your discs recording anew on a standardized, predictable basis.

*No. 7 of a series. Watch this space for succeeding ads on how Soundcraft discs are made.



REEVES **Soundcraft** CORP.
 10 EAST 52nd STREET • NEW YORK 22, N. Y.

Export Address
 REEVINTER, N. Y.

The 'Broadcaster' The 'Playback' The 'Audition' The 'Maestro'

Network Broadcasting

[from page 33]

ready for use, will undoubtedly promote a surprising increase in recording activities over and above expectations.

In attempting to determine the number of machines for a given job a word of caution is in order. Remember that a tape machine can not be loaded and threaded or unloaded as quickly as discs can be handled on a cutting lathe or turntable. It is not possible to unload and reload most machines during a 30-second station break. Also the problem of rewinding the reel of tape after recording or play back, in readiness for the succeeding operation, must be considered.

Editing

Direct operating experience in recording studio shows and interview type programs has shown that editing is of great value in program production. Consistently, several hours editing time has been consumed in the rearrangement of 15 minute and half hour shows. Aside from purely technical considerations, the operational convenience of editing tapes recorded at the higher speeds can not be over-emphasized. Also high rewind and fast forward

cueing speeds are essential. Desirable values are 10 to 20 times normal playing speeds. True, a higher tape speed increases the tape stock cost, but this appears to be a relatively small item when considering the over-all cost of the programming, and the total associated time and labor.

The ABC Chicago installation includes the typical switching and monitoring gear usually found in a broadcast plant. Two recording and two play-back lines are available at each of ten machines. Also keys and individual monitoring amplifiers and speakers make "AB" tests on the individual recording channels possible during operation. A simple pre-set system for the program lines and a master starting circuit for motor controls permits pre-setting various combinations of machines, so that from any one of eight control panels the operation of master switches will simultaneously start all machines assigned by pre-set.

While circuit and control characteristics of other machines are not known in detail, it was found that the basic relay system incorporated in the Ampex equipment was well suited to remote starting and control operation.

Operating personnel who have hau-

dled machines with horizontally mounted reels have commented favorably on their ease of loading and threading. Editing with this particular mechanical structure appears convenient. Surprisingly little use has yet been found for precision footage counters, although it is foreseen that they may be of advantage when interchange of tapes becomes feasible. As is usual with other types of equipment used in broadcasting, quality electronic components and heavy duty mechanical fabrication are necessary.

Illustrations associated with this article indicate the individual machines, and Fig. 3 illustrates the ABC Chicago tape recording room. Figure 2 is a chart representing the daily recording and repeat schedule at the Hollywood terminal of the ABC network. This chart was made up from a 1948 summer day schedule. Disc recorders and turntables now carry this load but tape will be used in the near future. In the column labeled "Program Number," word titles have been omitted and arbitrary numbers, 1-20 have been assigned. The solid vertical line in column I indicates recording time. The solid vertical lines in columns 2-3-4-5, represent play back time, and the associated numbers correspond to the program numbers assigned at the left of the chart. Numbers above twenty appearing in the play-back schedule are other recordings. This chart does not indicate certain added complications; cut-in announcements, both recorded and live, must be made during the repeat broadcasts of some of these shows. These cut-ins may be in addition to or in replacement of the commercial or promotional announcements contained in the original program. Several programs are repeated simultaneously over two routes and may require separate simultaneous announcements in place of the originals. Excitement over and above the normal routine is provided when emergency network announcements or occasional line troubles disrupt the continuity of incoming programs. The problem then, is how to fill the program gaps in a sensible manner before the repeat deadline falls due. In Hollywood, this recording schedule or its approximate equivalent is carried on winter and summer; delayed broadcasting is used the year 'round to overcome the zonal time differences existing between the west and east coasts.

It appears desirable to credit and compliment the following: The Ampex Company for design and manufacture of the tape machines; on the Chicago job, The Commercial Radio Sound Corporation of New York for wiring and fabrication of the racks and control

The MOST PERFECT AMPLIFIER

for
Reproducing
Fine Music

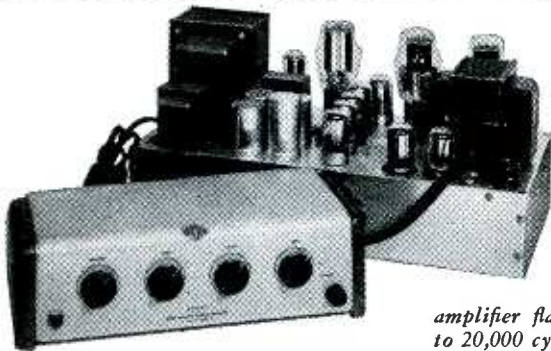

New! Model 10C3—Remote control unit with both high and low-gain inputs for all types of tuners and pickups.

amplifier flat within 0.2 DB from 20 to 20,000 cycles—with intermodulation and harmonic distortion reduced to negligibility.

The Brook All-Triode Amplifier is built with only one objective . . . to provide the cleanest possible reproduction of fine music.

It makes use of low- μ triodes throughout — specially-designed transformers—and the Brook-patented Automatic-Bias-Control circuit which more than doubles efficiency of the output system and at the same time reduces harmonic distortion. *The result is an*

Although its "paper performance" surpasses that of any other amplifier, the Brook must really be heard to be fully appreciated. When you hear the Brook alongside other amplifiers—any amplifiers—you are in for an experience that is both surprising and enlightening.

Write today for copy of distortion analysis and Descriptive Bulletin AG-8!

The BROOK High Quality Amplifier

BROOK

— Designed by LINCOLN WALSH

BROOK ELECTRONICS, Inc.,
34 DeHart Place, Elizabeth 2, N. J.

NOW AVAILABLE

→ **THE NEW**
→ **AMPEX**
→ **MAGNETIC**
→ **TAPE**
→ **RECORDER**

Endorsed by the Bing Crosby
Program . . .

Tested over months of con-
tinuous commercial network
operation by ABC . . . 18 hours
daily

The Ampex Magnetic Tape Recorder has proven fidelity of reproduction unsurpassed by any other known recording instrument. This is the great new unit which put the Crosby show on tape, and has provided the answer to the American Broadcasting Company's continuous rebroadcast schedule originating from Chicago.

The engineering and functional design of this machine makes it the most efficient and economical professional recorder. A demonstration will convince you.

Send for descriptive booklet:

AUDIO & VIDEO PRODUCTS CORP.

Authorized Ampex Representatives East of the Rockies

681 Fifth Avenue, New York City

PLaza 9-6031

units, and The Minnesota Mining and Manufacturing Company for the delivery of two million feet of tape. Engineering design was done by ABC, with Ed Horstman of Chicago supervising the installation.

Binaural Phenomenon

[from page 30]

From the pure physics point of view, this does not follow, as an in-phase signal can equally well come from astern. However, if it is a mental bias, evidently we all share it.

By adjusting the position of the variable pickup, we have a selsyn motor effect with the victim as the controlled motor. His arm will swing accurately to within plus and minus two degrees, in some cases, and we can swing it right or left as we will, with perfect tracking.

Phase Reversal

Now comes the unusual effect, which seems to occur to between 30 and 40 per cent of people with this type of equipment, at least. As we swing the signal out around 50 to 60 degrees off center, there will suddenly occur a phase reversal in your head, and you will instantly point over your shoulder

to a point 180° removed. Sometimes this will occur only toward the right, sometimes on both sides.

If we do not encounter this effect, we come around to 180° following the signal perfectly, and at that point we may or may not reverse.

At a reverse point, we become mentally confused and annoyed. There seems to be about a 20-degree range of confusion—that is, we must backtrack 20 degrees before you are sure it is back where it belongs. For some reason, we become angry if this is tried too many times, and evidently we set up a mental strain which makes us ashamed of our inability to distinguish these clear-cut signals and their arrival phase.

Of course, a great deal of work has been done with binaural effects. This article seems to have the moral that many unexpected phenomena probably are to be found in practical cases that will require some working out. Almost any binaural or stereophonic set-up we can visualize has highly artificial departures from ideal conditions, and certainly if a state of confusion can be set up in the brain, the system will have a great and possibly unrecognized handicap.

Telephone Recording

[from page 30]

ly less, due to a-v-c action caused by the noise. After the signal appears we must rectify and filter it, giving us a time delay. This filtered d.c. is then applied to some control means, which usually has no further delay itself, and the gain is slowly lowered, and establishes itself at a new level. This level is maintained for the remainder of the signal duration until the signal disappears, when the gain is slowly restored to its previous value.

Figure 4C shows the resultant on the record. While the amplifier is lowering its gain, the signal appears at full overload amplitude, giving us a burst or bounce of energy which sadly overloads the record, unless we clip it, which gives us a flat top wave that is intolerable. Then, while the amplifier is restoring gain, the noise is suppressed temporarily, until the former gain is fully established.

Figure 5 shows a similar condition, only the loud local speech element is immediately followed by a weak element from the distant source. The initial part of this element is lost in the recovery time of the amplifier.

AUDIO ENGINEERING

BINDERS \$2⁵⁰

- Backbone gold stamped with Audio Engineering and year.
- Center channel to keep magazines fastened in position.
- Round corners, hinges and backbone fully reinforced.
- Rich blue Dupont Fabricord—stainproof and washable.
- \$2.50 postpaid. Foreign orders add 50c.

★ ★ ★ Here at last is a binder using modern postwar materials at prewar prices. Designed to provide instantaneous reference to your monthly copies of Audio Engineering. An unusually fine library finish that will stand up under constant use.

- Rigid backbone with bound-in metal support.
- Light weight tarnishproof aluminum ends.
- Coil springs built in at each end to securely position spring steel wire holders.

RADIO MAGAZINES, INC.

342 MADISON AVE.
NEW YORK 17, N. Y.

AUDIO ENGINEERING
BINDERS

1947 1948

Enclosed find \$.....for.....Binders

Name.....

Address.....

City..... State.....

This recovery we can call the "shadow" cast by the loud signal.

On any straight a-v-c system this effect is inherent. We have perfect freedom of choice in making the time constant as long as we wish, without difficulty or expense, but the longer we make it the longer the duration of the burst, and the longer the suppression of the leading edge of a weak element immediately following.

The minimum time requirement is that determined by our lowest frequency, say 300 cycles, which must be rectified and then used to charge up a condenser to a new value, plus the extra time required to filter out the 300-cycle component. Since we always use half-wave rectification, and each cycle is about 3 milliseconds long, we need about ten such cycles to reach the new value, which is a time constant of 30 milliseconds. In practice, 40 milliseconds is generally used.

If the range of a-v-c control is small, say 10 db, a nice smooth system results, but 10 db does us little good, and when we extend it to about 60 db we run into a whole series of troubles. The initial surges or bursts contain much transient energy which excites our cutter and any characteristic of the amplifier to forced oscillations of their own. The shadows become quite noticeable, and the rapid alternations between bursts and shadows are very annoying. The burst must also be clipped by some element of the system, or we would have cross-overs, which we cannot tolerate at all, so we find the clipping usually gives us a flat-topped wave, which again is intolerable.

This is really a first-class problem. The writer went through it many years ago, and finally decided to go to the asymptotic system with much of the action built in the cutting head as has been previously described.²

²"Self-Monitoring Recorder Head", S. Young White, *AUDIO ENGINEERING*, Aug. 1947.

Reflex Type Speaker

[from page 25]

that it can be done is that it has been done, twice to my knowledge, once with benefit of audio oscillator and v.t.v.m. for plotting impedance curves as above and once without. The oscillator helps, but is not a necessity. If you listen in the opposite end of the room, and if it is a very live room, then you do undoubtedly hear mostly room ringing, but conversely if your ear is a foot or two from the diaphragm and the room is reasonably dead, then you are to all intents and purposes listening to the speaker ringing. One way of evaluating

the deadness of the room in a rough way is to get some people into it and in conversation. Get as far away as possible still within the room however, and alternately plug and unplug one ear. The difference between binaural and monaural listening is much greater in a live room. In other words if you can still understand the conversation perfectly when listening with one ear the room is plenty dead enough for this experiment. It is, however, wise to keep fairly close to the speaker.

So now we're ready to go to work on the port. What we want is something with many small interstices that will

cause acoustic losses. If the holes get smaller and smaller and the intervening material gets heavier we finally wind up with a solid rigid member. If you place a piece of board over the port you will still hear ringing, and probably indistinguishable in pitch from that heard with the port open, but somewhere between completely open and completely closed there is a material that has just the right resistance. It might be an old sweater, a turkish towel, a burlap bag or a few layers of window screening. Here's where the oscillator helps. If you have plotted two curves, one with the port open (double hump) and one



"Professional Junior"
**COLLAPSIBLE
DOLLY for**
TV Camera Work

**Now being used by RCA--NBC
CBS & DuMont Video Stations**

Sturdily supports TV camera on tripod, also cameraman. Assembles quickly without tools. Collapses into carrying case 1' sq. by 6' long. Ideal for Studio & Location TV work.

This Dolly made by specialists in custom-built TV and motion picture equipment.

Representatives for Houston Developing Machines; Auricon SS camera & recording equipment; Bardwell & McAlister lighting equipment; Moviola and Micro Engineering editing equipment.

Rentals, Sales & Repairs of all types 16mm and 35mm cameras, and editing equipment.

FRANK C. ZUCKER
CAMERA EQUIPMENT CO.
1600 BROADWAY NEW YORK CITY

Complete staff of trained technicians
available for consultation.

with the port closed (single hump) then as you try each new material you can tell at a glance whether it is too heavy or too light and what to try next is somewhat simplified. However, it's still cut-and-try anyway you look at it.

The amount of audible ringing depends upon the total amount of damping in the system and a not inconsiderable portion may be supplied by the generator feeding the voice coil. When the battery circuit is closed the voice coil is practically short circuited, i.e., the electrical damping is very high. When the battery circuit is broken the voice coil is open-circuited and the electrical damping is zero. We may therefore in the course of our experimenting find a material such that the sum of the dampings produced by it and the battery together will be critical. In this circumstance we will hear a "tick" when the circuit is made and a "bong" when it is broken. Make no mistake about the difference between the tick and the bong. You have to listen sharp but it is a very real difference, the tick being cleaner and sharper and without the slightest taint of any pitch whatsoever. So if we hear tick-bong-tick-bong as we close and open the switch we know that we are very close and on the low side and in one to two more moves we should hear tick-tick-tick-tick. In one case we started out with a loosely knitted, light, woolen sweater. One layer did practically nothing. Four layers got us to the tick-bong stage. The only thing we could find at the moment that was heavier than 4 layers of sweater was a piece of the ozite we

had used for lining. It was too heavy, giving almost the same curve as a plain board. We then found that the ozite could be split and one half thickness of ozite turned out to be just the right combination. In another instance two layers of coarse burlap did a very good job. In both cases the final results were such that with an assistant to handle the switch it was impossible for the listener to distinguish the difference between the make and the break and both said tick. It helps to have the material stretched or so secured that it doesn't vibrate, otherwise it may contribute reactance as well as resistance.

Unsolicited and uncoached comments regarding the comparison between the reflex type cabinet with and without critical damping as per above might be summed up as follows: On organ music (steady tones), no difference, on percussion or lows with transients, pizzicato, etc., the damped speaker puts out somewhat less total volume of lows but the various low-frequency instruments stand out much more clearly. Several records with what formerly sounded like kettle drums turned out to be plucked strings. Male speaking voices reproduced 20db too loud lose most of the rain-barrel effect.

Manufacture of Records

[from page 18]

and outer diameters required by the press for which it is intended. The same lack of uniformity which throttles the industry prevails in this phase. There are virtually as many specifications, each

varying by a few thousandths, as there are pressing plants. Prior to cutting the inner and outer diameters, the stamper must be centered accurately in reference to the music lines. In common practice, the stamper comes off the mother with a perfectly flat center or it has a washer in the area of the center. If the latter is the case, the washer is removed and a blank piece of copper is soldered in its place. The stamper is then placed on a turntable which is mounted on a hand arbor or foot press (Fig. 5). The center of the turntable contains a die with a small hole into which a punch slides when the ram is brought down. The turntable is rotated slowly with the stamper on it. A fixed optical instrument, or a fixed feeler gauge attached to a needle which rides the stamper, indicates how far off center the stamper is. The stamper is adjusted on the turntable until its center coincides with the center of the turntable, which is the die. At that time the ram is brought down and a hole is punched, which should be exactly concentric to the music lines. Failure to do this accurately causes the prevalent off-center record which makes all the previous efforts of the recording and processing engineers fruitless.

Using this hole as a reference, the outer diameter is then cut by a circular shear or punched by a punch die; and finally the inner diameter is punched out by another punch and die. In those processing plants which produce stampers for one set of press specifications, it is common to use a compound die which punches both I. D. and O. D.

Classical Recordings

[from page 34]

application of this idea of tension—of work against resistance—which I have in mind. We hear much of the perfection of modern musical instruments as compared with the "crude" instruments of earlier times. In this day of progress, it is an easy thing to assume that for better music all one needs is a better instrument, one that can do more, *offer less resistance* to the player. Tomorrow's oboe can play faster and higher and sweeter than yesterday's. The valve trumpet is an "improvement" over the old valveless instrument because, instead of being "confined" to the overtone series it can now play "any" note, and similarly with the French horn. (Strange that Brahms refused to write for the valve horn, preferring the limitations of the older unvalved horn!) The old recorder was superseded by the flute, which plays louder, softer, higher, lower

ANOTHER ACA-100 AMPLIFIER EXCLUSIVE FEATURE UNCONDITIONAL FIVE-YEAR GUARANTEE



- Normal Response 20 to 20,000 cycles ± 1 db
- Rated Power Output 23 Watts at less than 1% Total Distortion
- Independent Push-Pull High and Low Frequency Controls
- Non-Frequency Discriminating Noise Suppressor
- Push-Pull Dynamic Volume Expander with Variable Timing

Models available to accommodate GE and Pickering Phono-Cartridges

Send today for our literature, which lists complete specifications of the ACA-100 Amplifier.

AMPLIFIER CORP. of AMERICA

398-4 Broadway

New York 13, N. Y.

(though not faster) . . . Progress everywhere—and what could be more natural than that numerous engineers with a musical bent should discover that through electronics all musical instruments can be at last rid of all imperfections, of their remaining clumsinesses! The electronic trombone, no longer the slow-speaking grand-daddy of the orchestra, can play (via electric keyboard) as skittishly as a piccolo, as lightly as a fiddle. The electronic French Horn, or a reasonable equivalent, with a mathematically even tone throughout its unlimited range, can dash about the scale like a xylophone, and as effortlessly. But to what musical end, I ask you?

My point, to bring this to a close, is that even musical instruments, and the players of those instruments *must do work*, must strive against difficulties. And that means imperfections, limitations. An electronic "tenor" might sing a high C with no more effort than a low B-flat. Where, then, is the impetus, the striving-against-odds, the musical impedance, that makes the flesh-and-blood tenor's high C a thing to thrill at, a musical expression? The player piano could never satisfy the musician because no one really wants to hear a purely mechanical rendition, no matter how "virtuoso". (One could produce some remarkable pianism by punching the right holes in the player roll!) To sell player-piano rolls, their human element had to be emphasized, not their easy mechanical perfection. As a reproduction of human effort, against musical impedance, against the resistance of human muscles and of an imperfect instrument, the player roll was fine (and so is the phonograph record). But as a purely mechanical exhibit of virtuosity—be it twice as fast and six times as complex as any human pianist could manage—it was just so much noise.

The danger, then, in the development of electronic musical instruments is simply their perfection, their lack of impedance. Whereas throughout the long history of musical instruments the striving has been to improve, against odds that no one even imagined could be entirely removed—now the electronic instrument builders must strive to get away from the perfect, to build imperfections, or simulated imperfections, into their machines.

A simple change of analogy will finish this essay. Take the foot race. It still exists, after centuries, though man can move himself a lot faster a lot easier; because there still exists that infinitely stretchable, but always-present physical resistance against

which the racer must throw himself, and which furnishes us with all the excitement of a "fast" sprint, a record broken, if by ever so little. If man

RECORD LIBRARY

In this spot a continuing list of records of interest will be presented. This list specifically does not suggest "the" best recordings or versions. It will draw predominantly but not entirely from postwar releases. All records are theoretically available, directly or on order; if trouble is experienced in finding them AUDIO ENGINEERING will be glad to cooperate. Records are recommended on a composite of musical values, performance, engineering; sometimes one, sometimes another predominates but records unusually lacking in any of the three will not be considered. Number of records in album is in parenthesis.

Easy introduction to good contemporary music—postwar records.

Bartok, Piano Concerto No. 3 (1945).
Gyorgy Sandor; Phila. Orch. Ormandy
Columbia MM 674 (3)
Berg, "Wozzeck" excerpts (opera, 1920).
Janssen Symph. of L.A. Charlotte Boerner, sopr.

Artist JS-12 (2 pl.)
Bernstein, "Facsimile" (ballet suite, 1946).
Bernstein, RCA Victor Orch.
RCA Victor DM 1142 (2)
Britten, "Peter Grimes"—Four Sea Interludes.
Amsterdam Concertgebouw, von Beinem.
Decca London EDA 50 (3)

Britten, Serenade for Tenor, Horn and Strings.
Peter Pears, ten. Dennis Brain, horn.
Boyd Neel String Orch. Britten.
Decca London EDA 7 (3)

Copland, Appalachian Spring (ballet suite).
Boston Symphony Orch. Koussevitsky.
RCA Victor DM 1046 (4)

Hindemith, Sonata for Viola d'Amore and Piano (1929).
Milton Thomas, Sara Compinsky.
Alco AC 204 (2)

Menotti, "The Medium", "The Telephone" (operas).
Ballet Society Broadway production.
Columbia MM 726A (7)
MM 726B (3)

Prokofieff, Overture on Hebrew Themes.
Nowinsky, Rivkin, string group.
Disc 4020 (1 pl.)

Prokofieff, Romeo and Juliet Suite No. 2, excerpts.
Boston Symphony Orch. Koussevitsky.
RCA Victor DM 1129 (2)

Stravinsky, Pastorale for Violin, Wind Quartet.
Szigeti, wind quartet cond. Stravinsky.
Columbia 72495-D (1)

Stravinsky, Dumbarton Oaks Concerto (1938).
Dumbarton Oaks Festival Orch. Stravinsky.
Keynote DM 1 (2 pl.)

Virgil Thomson, Five Portraits.
Philadelphia Orch. Thomson.
Columbia MX 255 (2)

Toch, The Chinese Flute (1923).
Alice Mock, sopr. Pacific Symphonetta,
M. Compinsky.

Alco AC 203 (2)
also T-102 (1 16")

New ATLAS SOUND ALNICO-V-PLUS

A great step forward . . . Atlas Alnico-V-Plus Super-efficient magnetic assembly. Energy per unit volume over three times as great as any used before. Traditional Atlas Quality and Fidelity to Precision are incorporated in all these new developments. Keep step with Sound Advancement with Atlas Sound.



PD-8V New Atlas stream-lined Hi-Fidelity Alnico-V-Plus Driver Units.



TP15V New Atlas Alnico-V-Plus Dual Projector. Also in larger model TP24V.



HU-24V All Atlas Speakers have new unbreakable Alnico-V-Plus Driver Units.

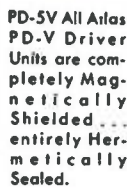

PD-5V All Atlas PD-V Driver Units are completely Magnetically Shielded. . . . entirely Hermetically Sealed.



HU-15V Maximum efficiency as reproducer, utmost performance in talk-micro.



PD-3V All Atlas PD-V Driver Units have full phenolic unbreakable diaphragms.



Write for New Illustrated Catalog.

MICROPHONE STANDS—Atlas is outstanding in Quality, completeness and variety of models produced.

MULTIPLE SPEAKER SUPPORT STAND



Atlas Sound's dual purpose value. Perfect for powerful outdoor (collapsible tripod model) or indoor (illustrated) array. Portable. Quick, convenient, practical.

ATLAS SOUND
CORP.

1445-39th STREET
BROOKLYN 18, N. Y.

could suddenly be "perfected" electronically so that to run 100 miles an hour were no more difficult than to run 15—the foot race would be no more. And so in a thousand other forms of human expression. As far as music is concerned there must be resistance, there must be impedance in every aspect; there must be difficulties, imperfections to work upon—or there is no expression. And nowhere is it more true than in the musical instrument itself.

No wonder, then, that many musicians look askance at electronic instruments advertised as "improvements" over the clumsy mechanical ones. No wonder that some of us are discovering unexpected beauties in the "crude" instruments of earlier centuries, so long obsolete, where the musical impedance was so overwhelming that even a little piece of music could give men a huge and satisfying lift!

Recent Recordings

Ravel, Piano Concerto (1932). Leonard Bernstein, pianist and conductor, Philharmonic Orch. of London.

RCA Victor DV 15 (3 plastic)

Whether this is one of the famed H.M.V. recordings or not I do not know at the moment—it speaks well enough for itself. This is a brilliant, highly colored recording,

with excellent piano, in the solid European manner, and with a tonal range that for once does justice to the excellent plastic the records are pressed on. Musically, the concerto is most attractive—some interesting jazz effects in the outer movements, 1925 style, and a moving slow piano theme, later repeated by English horn, in the middle movement. An excellent antidote to the heavyweight stuff.

Ravel, Concerto for the Left Hand (1932). Robert Casadesus; Philadelphia Orch. Ormandy.

Columbia MX 288 (2)

Composed at the same time as the two-handed concerto above, but showing a very different side of Ravel. A fierce tremendously complex and emotional work, with some of *La Valse* and the *Bolero* in it. One movement only. The thick texture of the score and the elaborate piano part are "cleaned up" by excellent wide-range highlights in the recording. But recording of the piano is not as good as in the two-handed concerto above.

Ravel, Rhapsodie Espagnole (1908). Koussevitsky, Boston Symphony Orchestra.

RCA Victor DM 1200 (2)

A strikingly beautiful recording job. To my ears it seems to have a wider range than most recent Victors, but—knowing the tricks the ear can play, I wonder whether fine musical color, good mike placing and fine acoustics do it? Doesn't much matter, for you will not find a better recording of this for a long while. This is the earlier, more sensuous Ravel, more Spanish than any pure-blooded Spanish music.

Grieg, Piano Concerto in A Minor. Oscar Levant, New York Philharmonic, Kurtz. Columbia MMV 741 (4 plastic)

Schumann, Piano Concerto in A Minor. Rudolph Serkin, Philadelphia Orchestra, Ormandy.

Columbia MMV 734 (4 plastic)

Two fine concerto recordings, both crisp, wide range, good plastic surfaces. This is the modern-style recording, as contrasted with the golden, mellow blur, rich and reverberant, that characterized the best older European concerto jobs. Here, all is sharp and clear (and some will object—but not I; the more of the music one can hear the better I like it). Acoustics on the dead side, with a touch of studio sound. Piano is not first rate in either recording, though the Schumann is better. Both pianos have percussive, tinny qualities. Levant's Grieg is a brilliant one, but superficial—not a bad idea for this overplayed music. Serkin's Schumann is energetic, contemporary, not mellow, a good alternative to more romantic interpretations available.

Tchaikowsky, Symphony No. 4. Ormandy, Philadelphia Orchestra.

Columbia MM 736 (5)

Another new-fashioned version of an old repertory war-horse. Tremendously loud and clangorous, bringing out only too clearly the over-noisy orchestration of this work! But fine as a show piece, and a good solid interpretation.

Bach Arias (excerpts from the Bach Cantatas). The Bach Aria Group, William Scheide, dir.

Vox 637 (4)

This is to my taste the best Bach album of the year, done with small group of instruments, solo voices trained and balanced to blend with them. The instrumental playing (with an obligato solo part in each aria) is superb, the singing good enough.

For thought-provoking theory . . . For practical applications in sound . . . it's **AUDIO ENGINEERING**

For just the right combination of meaty articles on sound theory and practice your book is **AUDIO ENGINEERING**. Sound men consider it "must" reading because it's prepared and edited by sound experts. Every issue contains articles on:

- Acoustics
- Broadcasting
 - Public Address
 - Sound on Film
 - Industrial Sound Equipment
 - Recording and Phono Reproduction

It's the magazine sound men have long awaited and today its editors and contributors are making it better than ever.

Subscribe now! Just fill in the blank below.

AUDIO ENGINEERING
RADIO MAGAZINES, INC.
342 Madison Avenue, New York 17, N. Y.

Sirs: Here is my check (or money order) for \$..... Enter my subscription order to **AUDIO ENGINEERING** for the next.....issues. Subscription Price: In U. S. A. and Canada—12 issues \$3—24 issues \$5. Foreign subscription are \$4 annually. Please check one: New Subscription Renewal

Name (please print).....

Address.....City.....State.....

Occupation (give title and department).....

Firm Name.....



Recording, except for an uncomfortable number of peaks, is excellent, with good wide range, exceptionally good acoustics. But level is dangerously high much of the time, surfaces, though quiet, seem soft. Handel, *Water Music* (arr. Harty); *Concerto Grosso No. 21* (No. 10).
Defauw, *Chicago Symphony*.

RCA Victor DM 1208 (4)

A tasteless, heavy performance of the *Water Music*, far surpassed by the ancient recording of the same conducted by Harty himself (C X 13); the concerto grosso is grossly inflated by an orchestra much too big for the music, played with a decided overdose of Schmalz. Even the recording is nothing to boast of. Try the Busch version of this concerto (complete recording of all 12 concerti grossi) for a much better performance. It's number 10 there. Poulenc, *Petites Voix* (Little Voices).

RCA Victor Chorale, Robert Shaw

RCA Victor 10-1409 (1 10-inch).

On this tiny record is some of the best, most musical singing Shaw has so far recorded. These are little French children's songs (with an adult waggishness to them) for women's voices only.

Popular Recordings

[from page 34]

delicate engraving on the stampers will be able to stand the strain of long commercial runs. Stampers for regular vinylite discs with .003 inch wide grooves have only half the life of shellac matrices. It seems probable that *micro-groove* stampers would stand up only a fraction of that time.

Another fidelity problem concerns wide-range recording at the smaller diameters near the center of the platter. Most 33 1/3 rpm platters have a sixteen-inch diameter not merely for longer playing time, but also because the greater the circumference of the groove, the smaller the tracking error. For this reason a six to eight-inch diameter center is always left on slow playing discs. Could so large an area be wasted on a ten-inch surface? It will be interesting to see what the Columbia solution to this problem is.

Here are some of the more interesting new 78 rpm discs:

Stan Kenton Album Capitol CD 79

Labeled, *Progressive Jazz*, the music of the Kenton band is the loudest, brassiest and fastest of all the popular orchestras. Capturing so much noise with such clarity must have been a difficult problem for the Capitol engineers. Their task would have been more rewarding if they had introduced a little greater resonance. The recording has brilliance and wide frequency range.

On Parade London LA 16

H. M. Irish Guards Band

A good set of high-fidelity band records has been needed for a long time, and this set more than fills the bill. frr recording technique suits this music perfectly. Ample resonance prevents these discs from having the brash sound in loud passages which mars most domestic band platters. Engin-

Studio Quality AMPLIFIERS

WITH CUSTOM-BUILT FEATURES

Design of Bardwell & McAlister's New Commercial Amplifiers embodies the principles which have been proven in custom-built units developed in the Motion Picture Industry, where quality is requisite. Fully licensed.

12w. models operate up to 8 indoor speakers, effectively cover outdoor audience of 2500.

25w. models operate up to 16 indoor speakers, effectively cover outdoor audience of 8000.

Designed & fabricated by manufacturers of high quality Sound & Recording Equipment for the Motion Picture Industry. Union made.

2 to 4 high gain input channels and 2 to 4 high or low gain radio or phonograph input channels.

High fidelity reproduction at any setting of volume controls up to full rated output with less than 4% distortion.

Frequency response flat within 1/2 db from 50 to 10,000 cycles.

Output impedances 500, 250, 16 & 8 ohms. Overall gain 105 db. Hum level 85 db below full output.

With or without professional "T" type bass and treble equalizers.

Write today for informative catalog & Technical data.

Dealer inquiries invited.

12



ELECTRONIC DIVISION
BARDWELL & McALISTER, INC.

BOX 1310, HOLLYWOOD 28, CALIFORNIA

STATION WHKC ...Selects TECH LABS VERTICAL ATTENUATORS

for new CONSOLE INSTALLATION



The flick of a finger operates the patented "Gove" Vertical Attenuator. Representing the very latest in broadcast components, these units are suitable for every type of sound equipment from elaborate broadcast stations to the simplest P.A. system. Unit gives smooth easy operation and can be cleaned from front of panel by removing escutcheon. Completely shielded and dust proof.



Write for Descriptive Bulletin

Courtesy of WHKC, United Broadcasting Co.



Manufacturers of Precision Electrical Resistance Instruments

337 CENTRAL AVE. • JERSEY CITY 7, N. J.

eers and radio dealers will find this set useful in demonstrating sound equipment. Nature Boy, Ritual Fire Dance London 10013 Mantovani and his Orch.

When the record makers decide that a popular tune has that unique quality which places it among the all time hits, they generally wax a lush version replete with strings and piano obligato. London's *Nature Boy* is just such a waxing. The simple melody bears up well in this arrangement, and the recording is fine. De Falla's *Ritual Fire Dance* hardly sounds its best in popular

trappings, but the performance and recording plead mightily in its favor. The Sample Song, Two-Gun Harry From Tucumcari Columbia 38140 Dorothy Shay with orch. under Mitchell Ayres

The Park Avenue Hillbilly, has won considerable popularity for her sophisticated singing of mountain style ballads. Her newest is just as amusing as the earlier ones, and the recording is clean and pleasing. Almost all attention is centered on the voice, but the small orchestra in the background is cleanly recorded. Caramba! It's The Samba, Baby, Don't Be Mad At Me Capitol 15098 Peggy Lee with Dave Barbour and the Brazilians

Caramba! is a trifle fast for the typical Peggy Lee delivery, but she does an efficient job of singing this clever and amusing ditty. The Latin background is well balanced with a purposeful edge in favor of the guitar solos by Peggy's husband, Dave Barbour. The flipover is nothing to get excited about, but it demonstrates the superior recording technique and pressing which Capitol devotes to its releases.

Introducing Cellular Grand by RACON

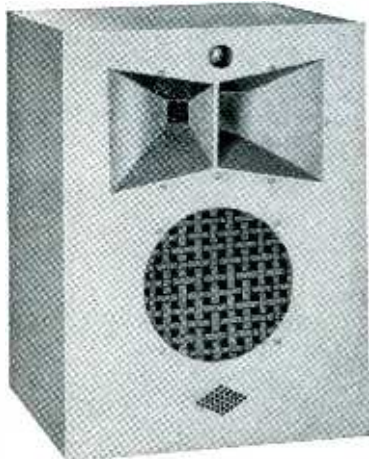

A HIGH FIDELITY reproducer that sets a new standard of efficiency in electro-acoustical conversion. Size 11"x11"x15" small enough to fit into the home console. Sound output ample for studio and industrial requirements. Has 120° horizontal sound angle. Special type cone speaker for low reproduction, and cellular speaker for wide angle coverage and high frequency response, and many other exclusive features. Frequency range 50 to 12,000 cps.

Write for free catalog

RACON ELECTRIC CO., INC.
52 E. 19th St. N. Y. 3, N. Y.

The Edispot

[from page 13]

ment is almost as effective as the above visual technique. In this method, only an aural monitoring output is used. Referring again to *Fig. 4*, the audio output is blanked out from time t^2 to t^3 . This blanking effect is obtained by switching a cam operated shorting switch across the pick-up head. The blanking interval is adjusted to end precisely at the instant the pick-up head passes the "Mark" arrow. The tape is then simply jockeyed into a position where the start of a desired word, "*Democratic*" in this case, is cleanly isolated from preceding sounds. However, the interval is sufficiently short so that some sound is heard ahead of the blanking interval serving to alert the operator's ear and to maintain continuity.

To return to the editing example, with the tape aligned by either of these methods, the drum is stopped and a mark made on the tape at a point opposite the "Mark" arrow. The tape is moved on to locate the other end of the portion being edited out, the gap between "*pardon*" and "*Republican*" is similarly marked and the tape lifted off the drum, cut at the two marks, 19¼ inches apart in this case, and spliced together to produce a smooth and continuous phrase—" . . . Mr. Smith, *Republican* candidate for the office of Mayor." Some editing problems involve the removal of much smaller bits than in this example, some involve a complex synthesizing of sentences from individual words. In all cases, the important problem of spotting a cutting point may be handled with the "Edispot."

Summary

The tape-editing spotting device described, although a laboratory model, has been found to be a valuable tool for use in the process of magnetic-tape editing. The visual display makes it possible to handle normally "blind" tape recordings as easily as film soundtrack recordings are handled in editing. However, although this display is certainly useful and of considerable technical interest, the alternate and simpler technique of aural blanking appears to serve adequately the present requirements of the job.

Although the particular equipment described was designed for use with slow-speed tape, it is felt that many of the principles will be applicable to the editing of other tape material. At the same time, the fact that slower-speed tape is more easily handled in editing work is an important argument for improvement of slow-speed tape fidelity.

The C.B.S. "Edispot" may be summarized briefly as a device which provides convenient means for reeling and timing recorded magnetic tape at various speeds forward and backward, for playing-back recorded material, and for closely examining sections of tape several words in length to enable accurate location of a cutting point for editing work. It enables a direct and precise procedure in place of time-consuming cut-and-try methods.

Acknowledgment

The author wishes to thank H. A. Chinn, C.B.S. Chief Audio-Video Engineer, for his many helpful suggestions made in the course of generally supervising this project. Also, the effective workmanship and mechanical ideas contributed by Morris H. Tucker of the C.B.S. staff are very much appreciated.

S.O.S. SPECIALS of the Month



Neumade Automatic Film Cleaning Machine —Does full 1000' reel in 8 minutes, rewind perfectly dry, cleaned & polished. Totally enclosed steel housing, sealed motor. Quantity limited. Worth \$330. **\$159.50**

Brand New

Added Specials from our \$250,000 Stock

W. E. & Simplex Preview Mags.	
Worth \$750	\$ 395
Auricon Single System Compl outfit worth \$2500	1695
Bardwell McAlister 5000W Spots on stands, new	199.50
heavy Duty Mike Boom 17'6" extension, new	375
Laco Hollywood 200 watt fresnel spots	
Art Reeves Type 35mm Studio Film Recorder	1995.00

Everything for Studio, Cutting Room and Laboratory

—Lights, Mikes, Booms, Dollies, Lenses, Background Process, Moviolas, etc. Send for Catalog Sturelab-7. Thousands of good buys!

S.O.S CINEMA SUPPLY CORP.

Occupying entire building: 602 WEST 52nd ST., NEW YORK 19

Wired Music System

[from page 20]

proved to be as popular in wired music as in other systems. Customers do not appear to desire an extended frequency response but rather prefer considerable bass with a high-frequency cut-off at about three or four thousand cycles. Perhaps one reason for this is the basic requirement of the music remaining in the background. Extending the highs would tend to make the music pierce the ambient background noise in most installations and would perhaps prove objectionable. A bit of bass boost and a roll-off of the highs beyond 5000 cycles at the point of origination has been the most satisfactory arrangement to date. Additional high-frequency attenuation is obtained on some installations through the telephone circuit and still further adjustment may be made through the use of the tone control on the amplifier furnishing sound to the installation.

Conclusion

The construction of the wired music system described here is but one approach to the problem and in some respect could be modified. It has an advantage of using standard broadcast units which are interchangeable with those in use at WSBT. This obviously simplifies the maintenance problem and lowers the stock items for spares. Some form of switching might have been used for connection to consumer lines, however, the jack system is simple and quite foolproof and gain standard procedure in a broadcast station.

New Products

[from page 36]

Employing the principle of Carrier Frequency Phase Modulation, this new microphone is said to eliminate every operating and performance difficulty heretofore encountered in conventional microphones.

The pick-up assembly is ovoid in shape and only 1" x 1 1/4" in size. Other features of the microphone are (1) True and absolute linearity of response by any measurement. Low response is linear to *one-half cycle in 24 hours*. (2) No distortion can be read or detected. (3) No arc-over or breakdown. (4) Pressure-operated at all frequencies. (5) Polar pattern at all frequencies. Almost completely one-half sphere—down 5 db at 90° off the axis. (6) Signal-to-noise ratio at least 11 db higher than the best prior microphones. (7) Rugged construction. Pick-up unit contains only the *acoustic valve* and carrier-matching coil. Valve assembly can be *thrown* on floor without damage. Descriptive literature and prices may be had by writing Stephens Manufacturing Corporation, 10416 National Blvd., Los Angeles 34, Calif.

CINEMA'S NEW SWITCHBOARD KEYS

This series of keys is designed especially for audio switching and control circuits where the requirements call for long, dependable service with no maintenance. The type 1041 is ideally suited for microphone input circuits.

The springs are constructed of heavy nickel silver and exceptionally large, pure silver contacts are used to provide low and constant contact resistance for noise-free operation.

The keys mount on the panel through a half inch hole. The panel may be of any thickness up to one half inch. The following spring combinations are available on the keys:—two makes, two breaks, two make-breaks or two make-before-break.

Prices upon request.



Type 1041
Rotary Cam-Operated



Type 1042
Rotary Cam-Operated



Type 1043
Push-Button (Non-Locking)



CINEMA
ENGINEERING COMPANY
1510 W. Verdugo Ave. Burbank, Calif.
Cable Address: CINENG BURBANK



ALTEC LANSING

adopts new policy of publishing

FREQUENCY RESPONSE CURVES

To be an honest yardstick of the performance of a speaker, frequency response curves must be scientifically accurate: they must be made on measurement equipment that has earned the approval of conservative unbiased audio scientists. The frequency response curves published by Altec Lansing to confirm the radically superior performance of its new 1948 line of speakers were made in its outdoor measurement laboratory at Encino, Cal., with equipment and methods approved and used by nationally known engineers as well as by the Motion Picture Research Council for establishing speaker standards in the motion picture industry. *The dependability of curves is a measure of the professional integrity of the manufacturer who releases them.*



Methods and equipment for outdoor-automatic high speed measurements are those recommended by the American Standards Association in their Loudspeaker Testing Bulletin (C16.4-1942) and refined by Altec Lansing Research Staff.

ALTEC
LANSING CORPORATION



Send for brochure describing 1948 line of Altec Lansing speakers, containing frequency response curves. Altec Lansing Corporation, 161 Sixth Ave., New York 13, or 1161 North Vine St., Hollywood 38, Calif.

SPECIAL PROBLEMS
demand
SPECIAL TREATMENT

Engineering judgment is often the most important ingredient in the design and construction of apparatus for your specific needs. We specialize in —

— **one-of-a-kind instruments for electronic or electro-acoustic measurements**

— **recording or reproducing systems with special characteristics**

— **subminiature audio**
for

Laboratory, Production Testing, Broadcast Station, Recording Studio, or Discriminating Home

Audio Instrument Company

1947 Broadway, New York 23, N. Y.

BUILD BETTER ELECTRONIC EQUIPMENT
with **STANDARDIZED**

PAR-METAL
ELECTRONIC HOUSINGS

READY-TO-USE CABINETS
•
CHASSIS
•
PANELS
•
RACKS

for **ALL P. A. NEEDS**

Par-Metal Equipment is preferred by Service Men, Amateurs, and Manufacturers because they're adaptable, easy-to-assemble, economical. Beautifully designed, ruggedly constructed by specialists. Famous for quality and economy.

Write for Catalog.



PAR-METAL PRODUCTS CORPORATION
12-62-49th ST., LONG ISLAND CITY 3, N. Y.
Export Dept.: Rocke International Corp.
13 East 40 Street, New York 16

ADVERTISING INDEX

Altec Lansing Corp.47
Amplifier Corp. of America....42
Arnold Engineering Co.5
Atlas Sound Corp.43
Audio Devices, Inc.Cover 2
Audio Instrument Co.48
Audio & Video Prods. Corp...39
Bardwell & McAlister, Inc....45
Brook Electronics, Inc.38
Camera Equipment Co.41
Cinema Engineering Co.47
Cook Laboratories48
Electro Motive Mfg. Co., Inc....2
Electro-Voice, Inc.35
General Radio Company..... 9
Jensen Manufacturing Co.....7
Lebel, C. J.36
Par-Metal Products Corp.48
Pickering & Co., Inc.48
Professional Directory36
Racon Electric Co., Inc.8, 46
Radio Corp. of America
(Broadcast Equip. Div.)
Cover 4
Reeves Soundcraft Corp.....37
Shallcross Mfg. Co.4
S.O.S. Cinema Supply Corp...46
Sylvania Electric Products
Inc.1
Tech Laboratories45
United Transformer
Corp.Cover 3
U. S. Recording Co.36
Vibration Systems, Inc.48
Wells, Winston36
Western Electric Co.10

COOK

Q-C RECORDING

Gives You **INCREASED VOLUME
LOW SURFACE NOISE
MORE PLAYING TIME**

YOUR recordings, with Cook Feedback Cutters under the exclusive Cook Q-C System, will stand out conspicuously from recordings made by conventional equipment. The Cook System is unmatched for clear reproduction, useful frequency range and volume level.

The only lateral feedback recording system for sale on the market, developed to meet the requirements of modern recording and sound transmission. Cook Cutters offer you highest stability of performance at low cost of production and maintenance.

Phonograph record makers are shifting to Q-C — and the only cutters capable of this higher performance standard are Cook Cutters. Act now — equip yourself to meet competition in a highly competitive field.

Feedback cutters available for use in your own studios or we will do your Q-C master re-recording in our laboratory.

Write today for literature.

COOK LABORATORIES

139 Gordon Blvd. Floral Park, N. Y.
Telephone: Floral Park 4-7218

PRECISE AUDIO MEASUREMENTS

Pickering and Company, Inc., leaders in the audio field, make available to the industry their specialized facilities for audio measurements.

We are prepared to make guaranteed measurements on any type of audio equipment for manufacturers, dealers, or consumers.

PICKERING & CO. Inc.
Oceanside, N. Y.

VERTICAL LATERAL REPRODUCERS RECONDITIONED

Types 9-A, 9-B, D-93306, MI-4856, MI-4875-G
Complete Stock of New Replacement Parts for All Types

This service is being used by leading radio stations and wired music companies from coast to coast. Factory prices prevail.

VIBRATION SYSTEMS, INC.
1040 W. Fort St. Detroit 26, Michigan

ELECTRICAL ENGINEER

Graduate engr with several years' exp in audio development work, preferably magnetic recording, wanted for design work. Unusual oppty & permanent position for right person, with long-established company, vicinity N. Y. C. Reply giving resume of personal data, educational background, exp & salary expected.

Write Box AE 1699, 113 W. 42 St. N.Y. 18