

G. A.  
BRIGGS

STEREO HANDBOOK

STEREO  
HANDBOOK

G. A. BRIGGS

# STEREO HANDBOOK

*by*

G. A. BRIGGS

*with*

R. E. COOKE, B.Sc. (Eng.)

*as Technical Editor*

## FIRST EDITION

146 Pages 88 illustrations

Written by G. A. Briggs in his usual free and easy style — salted with the occasional touch of good humour, and augmented by contributions from experts such as Cooke, Crowhurst, Kelly, Watts and West—this book is intended to help the amateur to understand stereo and its implications.

The fifteen chapters contain no less than eighty-eight illustrations, most of which are original, and maximum space has been allocated to Pickups, Loudspeakers, and Recording Techniques in that order of importance.

The book is non-technical throughout and should be easily understood by any reader who, like the author, can count up to twenty.

PRICE

10s. 6d.

**“STEREO HANDBOOK”**

**First Edition**

*Two truths are told,  
As happy prologues to the swelling act  
Of the imperial theme.*

*If you can look into the seeds of time,  
And say which grain will grow, and which will not.*

*Macbeth.*

# STEREO HANDBOOK

*by*

**G. A. BRIGGS**

*Author of*

“LOUDSPEAKERS”

“SOUND REPRODUCTION”

“PIANOS, PIANISTS AND SONICS”

*and*

*(with H. H. Garner)*

“AMPLIFIERS: THE WHY AND HOW OF GOOD AMPLIFICATION”

*and*

*(with R. E. Cooke)*

“HIGH FIDELITY: THE WHY AND HOW FOR AMATEURS”

*Assisted by*

**R. E. COOKE, B. Sc. (Eng.)**

*as Technical Editor*

*Published by* WHARFEDALE WIRELESS WORKS LIMITED  
IDLE            : :            BRADFORD            : :            YORKSHIRE

FIRST EDITION  
December, 1959

Copyright  
Registered at Stationer's Hall

Made and Printed in England by Clifford Briggs Limited, Keighley, Yorkshire.

## CONTENTS

									Page
		Introduction	..	..	..	..	..	..	7
Chapter	1	The General Position	..	..	..	..	..	..	9
..	2	Other Views	..	..	..	..	..	..	13
..	3	Sound Source Effects	..	..	..	..	..	..	26
..	4	Tonal Discrimination	..	..	..	..	..	..	29
..	5	Recording Techniques	..	..	..	..	..	..	32
..	6	Hum, Rumble and Noise	..	..	..	..	..	..	45
..	7	Pickups, Tone Arms and Turntables	..	..	..	..	..	..	53
..	8	Record and Stylus Wear	..	..	..	..	..	..	76
..	9	Amplifiers	..	..	..	..	..	..	94
..	10	Loudspeakers	..	..	..	..	..	..	101
..	11	Stereo Tapes	..	..	..	..	..	..	116
..	12	Room Acoustics	..	..	..	..	..	..	123
..	13	Concert Halls	..	..	..	..	..	..	128
..	14	Broadcasting	..	..	..	..	..	..	134
..	15	Questions and Answers	..	..	..	..	..	..	139
		Conclusion	..	..	..	..	..	..	144
		Index	..	..	..	..	..	..	145





## INTRODUCTION

The purpose of this book is to examine the pros and cons of stereo and to consider some of the problems involved in choosing, setting up and using equipment, without going into technicalities. In short, we are producing a handbook rather than a textbook.

As regards nomenclature, the word "stereophonic" is now usually abbreviated to stereo, so it seems only logical to do the same with "monophonic" and simply say mono. This we have done, although a more accurate description of the two systems would be two channel and single channel working, but this is rather a mouthful.

I am pleased to have had the support once again of Mr. R. E. Cooke, B.Sc. (Eng.) as Technical Editor, with valuable contributions by Norman H. Crowhurst, Stanley Kelly, Cecil E. Watts and Ralph L. West (all of whom helped me to keep my head above water in a previous book on Sound Reproduction), plus other contributors who receive due acknowledgment in various chapters.

Mr. F. Keir Dawson has again attended to sub-editing and printing; Miss Isles has coped with spelling and grammatical errors and masses of M.S.S. with her usual competence, and Mr. Eric Barker has done most of the drawings. I appear to have done very little, beyond enjoying myself immensely in compiling this, the ninth work to emerge from the small publishing department of the Wharfedale Wireless Works. By the way, the passport photograph opposite this page has been put in merely to fill up a blank space.

G.A.B.



## CHAPTER 1

### THE GENERAL POSITION

I am still of the opinion that the best stereo reproduction I have heard was the first major demonstration given by E.M.I. in a large recording studio at Abbey Road, North London, more than three years ago. The early demonstrations given in London by James Moir of B.T.H., and F. H. Brittain of G.E.C., and by Ampex in New York, also stand out in my memory as impressive introductions to a new technique.

It is true that high quality tape recordings were used—in some cases with a tape speed of 30"/sec.—but it seems to me that the main reason for success was that reproducing conditions were closely related to recording conditions, with the same engineers in charge of both operations.

The stereo disc demonstrations given by Arnold Sugden of Brighthouse during the period 1956/58, with omni-directional column speakers, also deserve honourable mention as pioneer work of the first order.

#### TAPE

Unfortunately, excellent as many of the commercial  $7\frac{1}{2}$ " /sec. stereo tapes were, users could not duplicate various recording conditions at home, and one had to conclude that stereo *per se* was not an end in itself, and the high cost and inconvenience in use resulted in such a poor demand that stereo tapes almost went out of production.

#### DISC

But when the stereo disc hit the market early in 1958, many people thought that now, at last, the millenium had arrived, and stereo *per se* was an accomplished fact and a big seller. Its launching was, in fact, accompanied by more hoo-ha-ha and wiff-waff than anything heard in the audio field during 30 years.

It must be admitted that the records of trains, ping-pong matches etc. were most impressive, and produced amazing results from quite cheap equipment. It almost looked as though the days of the high fidelity industry were numbered, and we heard sad stories of enthusiasts in America and Canada eagerly changing one large

## THE GENERAL POSITION

speaker system for two small ones so that they could get a front seat on the stereo band-wagon without parting with a lot of money.

But truth, like murder, will out, and it was soon realised that the transients and random frequencies of noises—which suited stereo so beautifully—were not the basis of music, and a staunch body of listeners refused to sacrifice quality merely for a stereo effect.

The main difference between poor pickups and/or loudspeakers and good ones can be explained simply in a couple of sentences. In the poor specimens the frequency range is restricted to about 6/7 octaves and the main bass and/or treble resonances occur within those limits. In high class instruments the frequency range is extended by two octaves and the bass and treble resonances are lower and higher in pitch and are therefore less harmful. From the user's point of view it is unfortunate that the best performance costs the most money; but speaking as a manufacturer I find this one of the laws of nature of which I heartily approve.

These laws apply to stereo reproduction with the same force as they apply to mono, but listeners are entitled to accept some limitations for stereo if they are so minded.

The trouble with disc stereo was that it started off on cheap equipment as though it was easier to work than mono, whereas it is much more difficult. I had a letter from our old friend Stanley Kelly a few months ago in which he wrote, apropos of stereo pickups, as follows:

“When you consider the simplicity of tape, this mechanical monstrosity of a stylus trying to wiggle its hips in four dimensions simultaneously does appear a bit primitive, don't you think? Or am I getting rather long in the tooth?”

I would never accuse S.K. of getting long in the tooth, but I have on occasion found his teeth rather sharp.

The position today is that disc stereo, instead of starting at the top and spreading downwards and outwards, started at the bottom and is fighting its way upwards. The progress made in cutters and pickups in Europe and America during the last twelve months is quite phenomenal, and it is now a reasonable assumption that good stereo will win through.

To prove that I have not got a bee in my bonnet or that I have not just been stung by a horde of bees from a British hive, I will quote from an excellent article by Bert Whyte which appeared in the July 1959 issue of the American Journal *Electronics World* (formerly *Radio and T.V. News*). This is what Mr. Whyte has to say:

“A cry has been raised in the land that the widespread acceptance of the stereo disc is degrading sound quality standards. No doubt there is a certain validity to these arguments. I have seen

various types of distortion tolerated which, in the heyday of mono sound, would have caused loud anguish.

The rugged individualism of the component's manufacturer has always been something to admire and, in a conformist society, he has been a bulwark against mediocrity. Today he is faced with the desire to maintain his product's integrity in spite of the myriad pressures to relax his standards and embrace the hurdy-gurdy world of cheap stereo. It is sad to relate that some are heeding this siren call. This fall from grace has been defended as 'a realistic attitude', that the 'times call for a change,' etc. It would be far better if these people realised how great the danger to their existence is and did some hard thinking."

I noticed that this article was headed CERTIFIED, but if Mr. Whyte continues to write with such sound common sense I would say that he will not himself be in much danger of being certified.

#### DEFINITION

What is stereo? I recall that Lionel Hale asked me this question when he was the guest speaker at the 1958 Annual Dinner of the B.S.R.A. As I was unable to give an answer I asked a Past President of the Association, Mr. H. Davies, who promptly refused to commit himself. I then asked Mr. P. J. Walker, who replied: "I cannot say what stereo is, but we know all about 3D, as we are giving demonstrations of it at the Audio Fair. We play stereo and the man in the next room makes more noise than we do, so we get 3D."

It was at the same Audio Fair that we gave what was, I hope, the only demonstration of single channel stereo. We were playing the famous train record and it sounded all right, but the train did not seem to move with its usual speed. Then a gentleman standing near to the right hand speaker said it was not working. Fortunately this occurred at the start of a 15 min. demonstration and not at the end!

Seriously, I suppose the simplest explanation is that stereo is two channel recording and two channels, like two ears, are better than one, and three channels are better than two. I appreciate that once you cut out scientific explanations of acoustic phenomena you are in danger of over-simplification, but a study of spatial effects, intensity differences and aural or binaural brain messages does not get us very far, as we end up with a couple of speakers in a furnished room and an assortment of records which may have been produced with two, three or even four microphones. Under these conditions, true stereo is a will-o'-the-wisp and the objective should be merely greater realism. As Shakespeare said: *The play's the thing.*

## THE GENERAL POSITION

The remainder of the book is devoted mainly to a study of the problems involved and how to try to overcome them, without pretending that everything in the garden is lovely. As any gardener will tell you, the best soil always produces the most weeds, and prize-winning blooms can only be produced by selection as opposed to mass production, so good results cannot be cheap.

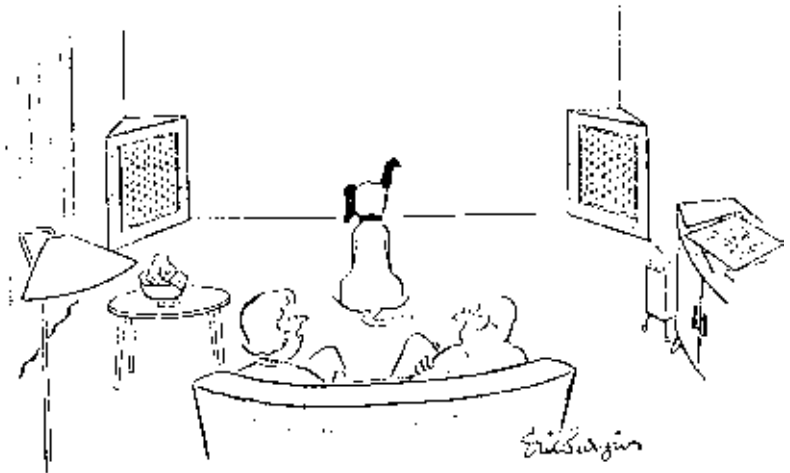

*"I think one of the speakers must be broken."*

*Reproduced by permission of P. N. H.*

## CHAPTER 2

### OTHER VIEWS

Most people are agreed that stereo has caused more confusion and doubt in the minds (and ears) of listeners than anything that has struck the framework of sound reproduction during its 80 years of development. Many listeners—and writers—thought that it struck at the roots of the system, but they have fortunately been proved wrong.

The last thing I should want to do under these circumstances would be to push my own opinions dogmatically down the reader's throat. I have therefore submitted a questionnaire to half a dozen experts whose opinions should be worth having, and here are the results.

To facilitate reference, the experts are listed in alphabetical order as follows:—

D.A.	Donald Aldous.
N.H.C.	Norman H. Crowhurst (U.S.A.)
S.K.	Stanley Kelly.
H.J.L.	Harold J. Leak.
R.W.	Ralph West.
P.W.	Percy Wilson.

*Q. 1. Do you agree that the best possible mono pickup gives better reproduction of mono records than the best stereo pickup, provided the same amplifiers and speakers are used?*

D.A. Not necessarily.

N.H.C. With earlier stereo pickups, Yes; but today, No. I would say, however, that a poor stereo pickup can produce more kinds of distortion than a poor mono pickup can.

S.K. No, provided the stereo pickup is connected to cancel vertical modulation.

H.J.L. Yes, at the present date, but there is very little in it.

R.W. Last year, Yes. This year, Doubtful. Next year, No. Even now I definitely prefer mono records played via a stereo set-up.

P.W. Most definitely not. The word "best" is the key. I can track at  $\frac{1}{2}$  grm. (on my own arm) with the best stereo cartridges I know, and without audible intermodulation distortion. 1 grm. is the limit with the best mono so far.

OTHER VIEWS

*Q. 2. In view of the fact that a stereo cartridge has to perform in two directions instead of one, it must—type for type—be:*

- (a) *bulkier and therefore more limited in HF response than a mono version;*
- (b) *more easily disturbed or damaged and more difficult to make and/or repair.*

*Do you agree?*

- D.A. (a) Yes, but only true if it has to have the same output; otherwise not necessarily.
- (b) Yes, at the moment.
- N.H.C. (a) No. This depends on type: some are, some aren't.
- (b) This too depends on type. More noticeably, however, on whether the design is a revision of an older mono, or a completely new arrangement for stereo. Most of the adapted versions are critical; many of the true stereo types are quite reliable, simple in construction, and therefore easy to make and repair. They do of course require high precision.
- S.K. (a) No. There is no technical reason why magnetic units should be. In the case of crystal devices they usually are, because two crystals are used.
- (b) Yes. Very!
- H.J.L. (a) Yes, to date. (Aug. 1959).
- (b) Yes, to date.
- R.W. (a) Probably, but not necessarily.
- (b) Not necessarily.
- P.W. (a) Not necessarily more limited in effective range; certainly not more liable to distortion.
- (b) Probably.

*Q. 3 As mono discs are cut with a view to replay with a 1 mil stylus, what is the effect of using .7 or .5 mil points on such records in terms of quality of reproduction?*

- D.A. The fine tips greatly reduce tracing distortion and improve HF response, provided the pickup has low enough mass.
- N.H.C. Before stereo came along, some had been recommending the playing of mono discs with .7 or .5 mil styli; they found this would often allow the stylus to penetrate better into the groove, allowing a worn record to sound new again. This will still be true.
- S.K. Less tracing distortion but, mass for mass, reduced HF response.
- H.J.L. It varies according to the contour of a particular record's groove. Many mono discs play well with .7 thou.; relatively few with .5 thou.



- R.W. Perfectly satisfactory in my experience. Worn LP discs are sometimes a bit rough on the first playing with the smaller radius stylus.
- P.W. Depends on cartridge. Reduction of stylus radius lowers the HF resonance, but if this is maintained beyond the audible limit then  $\frac{1}{2}$  mil should give less distortion. With older LP records a  $\frac{1}{2}$  mil stylus may "bottom" the groove with devastating results.  $\frac{3}{4}$  mil gives better tolerance.

*Q. 4 As a result of No. 2 would you expect more wear with the finer points or would this be avoided by the greater vertical compliance in the stereo cartridge?*

- D.A. More wear only if pickup not designed for finer tips. Increased vertical compliance helps somewhat, but extended wear tests with domestic type equipment and use needed to give final answer.
- N.H.C. Wear is a function of three things: point size, stylus pressure and mechanical impedance to stylus motion. The last is not just as simple as a measure of compliance, vertical, lateral or both, but is dependent on a variety of resonance effects as well. What is important is dynamic mass of the stylus, because this controls the needed tracking pressure. If the pressure can be reduced in proportion with point size, wear is not increased. So far this objective has barely been achieved, but it is expected it will be in the future.
- S.K. More wear on both stylus and record. The primary cause is playing weight which, however, for adequate tracking is controlled by compliance and dynamic mass of the cartridge. In practice, using domestic type stereo cartridges, wear on stereo disc is apparently greater than mono disc at the same playing weight (3 to 8 grams) and pickup characteristics; but stylus wear, especially on 0.5 thou, is considerably greater and will remain so until pickup playing weights can be reduced proportionately.
- H.J.L. In practice, wear on a stereo disc is only slightly more rapid (assuming a first-class pickup). At present, stylus wear is more rapid and will remain so until playing weights can be reduced.
- R.W. Less wear is expected as good stereo pickups are working with lower inertias and stylus pressures and are at least one year more recent in design.
- P.W. With  $\frac{1}{2}$  grm. playing weight. (the achievement of which depends on (i) low stylus mass, (ii) high lateral & vertical compliances, (iii) suitable carrying arm) wear should disappear.

OTHER VIEWS

*Q. 5. The first stereo discs of sound effects gave impressive results with cheap equipment and led many people to believe that stereo replaced quality. This is a fallacy. High-class mono is always better than second-class stereo, and high-class stereo still requires the best equipment. Do you agree?*

D.A. Yes. If stereo is regarded as a logical development of high fidelity in the search for "perfect" sound reproduction, then high class stereo certainly requires high class equipment.

N.H.C. Yes.

S.K. Yes.

H.J.L. Absolutely. A first-class stereo chain costs 70% more than a first-class mono chain—an inescapable fact.

R.W. Yes and No. Cheap stereo at least gave many people their first experience of hearing reproduced sound coming from more than one direction through more than one small hole!

P.W. I agree.

*Q. 6. In terms of quality how does a crystal stereo pickup compare with a mono type costing about the same price?*

D.A. It depends on the price!

N.H.C. The piezo-electric types, which are now ceramic rather than crystal (although some people still use the word crystal from habit) have benefited from changes in design made possible by 45/45 stereo. Quality is improved.

S.K. About half as good.

H.J.L. Very badly indeed, to date.

R.W. This year, comparable to slightly inferior. Next year, I would expect comparable to better—providing pickup arm design also improves.

P.W. At present the best mono crystal cartridges are considerably better than any stereo versions, but this may well be changed within a few months.

*Q. 7. Do you think stereo will eventually replace mono records completely? If so, how soon?*

D.A. An "it all depends . . ." answer could be given here, but remembering that primitive peoples may always demand mono discs to drive their portable and/or "acoustic" gramophones, my answer is "probably not." This reply also gets me out of having to hazard a guess how soon such a replacement might happen!

N.H.C. Yes, I do. Probably between five and ten years.

S.K. "Pops," No. "Classics" Yes, but probably 5-10 years.

H.J.L. Yes, for people who want high fidelity—as soon as it can be afforded! This is already proved by the high proportion of music lovers who have to date bought stereo.

R.W. I hope so, but my crystal is clouded.

P.W. Not for 15-20 years. My crystal ball does not extend further in time.

*Q. 8. Practically all loudspeakers have their own characteristics and resonances. Therefore the use of different speakers on stereo sometimes improves the general tone quality. Do you agree?*

D.A. Yes, with reservations. In my opinion identical loudspeakers are desirable when both units are of the best class. However, one very good unit will work well with a second not quite so good.

N.H.C. Yes, sometimes. But this depends very much on the type of stereo system. It's a big question, too big to try and be specific to in answer to a simple question.

S.K. No. Tommy rot!

H.J.L. No. The supposition is nonsense.

R.W. Yes, certain combinations of speakers and room may well be, and in fact have been, quite successful.

P.W. This is a very dangerous question! At present, the safe answer is that the best stereo demands balanced speakers. But I would not rule out the possibility that somewhat different response in the two channels may be found ultimately to improve the stereo effect.

*Q. 9. All in all, would you say that stereo tapes are a better proposition than stereo discs?*

D.A. Yes, theoretically from the quality point of view, but I do not think there can be an "all in all" answer.

N.H.C. No, that is too much of a generalization. It depends what you want them for. I believe stereo discs will produce quite adequate quality—equal to the best mono discs—before long, and consistently. Tape has certain advantages. For the fastidious, its quality may be a little better—at least it is independent of mechanical pickups. But the margin will be small and most of the popular recorders will more than throw it away. Where tape may be more fun is to the man who wants to do his own home recording in stereo.

S.K. Yes, providing that the printing quality of pre-recorded tapes is improved beyond the 1949 standard generally offered to the public at present. There is no argument that theoretically (and practically) with first-class tapes and equipment the results are incomparably superior to the best stereo disc.

H.J.L. At present tapes are slightly better on quality (and more consistently so) than disc, but tape is a poorer proposition in cost-per-minute programme time.

## OTHER VIEWS

- R.W. Not in 1959, but I think they will be eventually because tape completely by-passes many awkward mechanical problems besetting reproduction via disc.
- P.W. In what way better? For quality of reproduction (including signal/noise) Yes, but only in the best conditions. For handling No. Pending developments under both heads may alter the balance.

*Q. 10. Finally, the 64,000 dollar question. In spite of trials and tribulations, do you consider stereo worth while?*

- D.A. From a musical viewpoint emphatically, "Yes, of course."
- N.H.C. Right now, I would say the answer to this is in the balance. But I am confident that the stereo of the future will make it an affirmative Yes.
- S.K. Yes, if only to raise new points for discussion (or argument?)
- H.J.L. Of course, and I have been so convinced since 1931, when I carried out my first stereo experiment (with microphones, of course.) Finally, I will not now listen to single channel reproduction for my own pleasure.
- R.W. Yes.
- P.W. Most decidedly and definitely worth while. But *inferior* stereo is a snare and a delusion. And all *portable* stereo players are in that category.

I should like to thank very sincerely our six consultants for their thoughtful and informative replies, which should be useful to readers even if they find them only half as interesting as I did (having framed the questions). The fact that opinions vary so much seems to me to justify the exercise.

My own comments now follow:

- Q.1.* We have to admit that the design of stereo pickups has advanced enormously during the last 12 months, whereas mono types have lain dormant.
- Q.2.* I still maintain that for a given performance the mono type is simpler and more robust and always will be. To deny this is tantamount to saying that it is as easy to walk upstairs as it is to walk along the corridor. (Using tape is almost like taking the lift, in the mechanical sense.)
- Q.3.* If you will pardon the pun, I would say that it is a mistake to put too fine a point on this question, because nobody can work to 0.1 thou. limits in styli and stay in business. I am told on

excellent authority that, once you go below the old 1 mil radius, tolerances have to go up 20%, so your beloved half thou. stylus might in fact be 0.7 thou. and you can't do much about it. (I still think it is a good idea to use a good mono pickup on single channel records.)

Q.4. These answers prove that playing weight is the main controller of wear, but I always find it necessary to use full weight to maintain good contact with groove. S.K. told me that he was working at 1 gm. quite well until he moved into a bigger house, where the pickup tripped lightly across the record every time a child tripped lightly across the room. So he went up to 2 or 3 grms. P.W. can work at  $\frac{1}{2}$  gm. under carefully controlled conditions, and I agree wear must disappear. But, for me, it would be easier to avoid wear by not playing the records at all.

Q.5. I heartily approve of the H.J.L. answer about the cost of good stereo.

Q.6. Crystal pickups. Two elements always cost more than one.

Q.7. The future and the Crystal Ball. This seemed to work with R.W. and P.W. in answering Q.6, but not here.

Q.8. When I framed the question about the use of different speakers I little thought that Mr. Leak would reply "Nonsense" and Mr. Kelly would say "Tommy rot". (As a matter of fact, Mr. Kelly handed me his replies over coffee in my hotel in London after having had dinner with me. When I read No. 8 I was pleased I had not asked him to have a liqueur!)

The question should have referred more specifically to the bottom 3 or 4 octaves where cabinet and room resonances often colour speech and music, and, *when this occurs*, the use of different speakers on mono and stereo can improve results. This is beyond question. I agree with H.J.L. that for stereo the treble performance should be reasonably matched, and for this reason volume controls fitted to middle and treble speakers are a useful feature in adapting different speaker systems to stereo.

Q.9. The remarks about tape by N.H.C. are revealing. It is difficult to increase the playing time per reel without degrading the performance and signal/noise ratio to some extent.

Q.10. I fully endorse P.W.'s criticism of portable stereo players.

## OVERSEAS

### FRANCE

Mr. R. Lafaurie, Editor of *Revue du Son*, writes that stereophonic sound has aroused much interest in France, but such interest is chiefly documentary and has not yet made itself felt commercially to any great extent.

Newspaper articles expressing extreme views have appeared, such as: "Stereophonic sound is what you may have been waiting for to give you a reason for living", or a comment attributed to band-leader Markevitch, hardly an enthusiast, to the effect that he could not understand why the sources of sound should be disassociated as he—and the majority of band-leaders—take so much trouble to blend them together! (He has a point there, or has he?)

Great interest was shown in demonstrations during 1959, certain of which were successful while many failed; but the French public by and large is not converted to risking its precious, devalued banknotes. It must be remembered that France has been one of the largest buyers of records per head of population in the whole world, in spite of her financial difficulties—music lovers with a million francs' worth of records being not uncommon. They, as well as record dealers, look askance at any move which may reduce the value of their stock to zero.

Then again, prices are very high. A really tip-top stereo system, costing say £200 in England, would run to some 600,000 or 800,000 francs—more than £500. This interests only millionaires, and owners of bars and night-clubs who find it has great prestige value, and no doubt think that by the time visitors see double they might as well hear double. Stereo has also invaded the French Juke Box.

Serious listeners expect stereo to come into general use gradually.

### AMERICA

I am indebted to our old friend Norman H. Crowhurst—who removed from England to America about 6 years ago—for the following graphic account of the advent of disc stereo during 1958 in a country where "off with the old, on with the new" takes place at a speed which leaves old men in Europe rather breathless. I am, of course, speaking for myself here, but I will pass the ball to N.H.C., who must by now be half American in outlook. The contrast with France is quite startling.

The year 1958 will be remembered in America as the year when Stereo "arrived". With the advent of Stereodisc, Westrex

45/45 variety, everybody, big and small, proceeded to announce the “latest scientific marvel, brought to you exclusively by (whoever’s making this announcement) . . . fanfare . . . STEREO-PHONIC SOUND!” At first one wondered how so many companies could claim to be “first” or “exclusive”.

Everyone has jumped on the stereo bandwagon. For example, one small firm in Brooklyn advertised, “There is one thing better than stereo — stereo with *orbit*”. Apparently they put out a miniature, inexpensive (not cheap!) speaker in a cylindrical enclosure (just a little tube), which they call the orbit.

But how did all this get into “high gear” so fast? Undoubtedly the recession during the first part of 1958 played its part; and stereo did give some sections of the “hi-fi” business a tremendous “shot in the arm”. Like the analogy too, the shot made many sick before they felt better!

In 1957 it became apparent that stereo on disc was imminent. The question then was, “Would it be vertical-lateral, or 45/45?” Good demonstrations of both had been given, but nobody wanted to see both in the market at once, so the R.I.A.A. (Recording Industry Association of America) was delegated to make the decision. While they were deliberating, some were feeling impatient to get started making, or at least developing, something.

What tipped the balance seemed to be the inherent symmetry of the 45/45 system. Then before the decision was finalised, two anxious people released samples, early in 1958, one of a disc made 45/45 fashion and the other a pickup to play it, ceramic, low cost.

At this time most of the industry was still at work trying to find the best way to proceed, making sure they did not “build themselves into a corner”: the system chosen must make room for improvement. They were aware that, although quite passable demonstrations had been presented (and some impassable—or should it be spelt impossible—ones), considerable improvement could be expected over, say, a decade, just as had happened with LPs.

Although most of the industry muttered something that sounded like “unethical” about the two brave souls who were first to venture, they could not be left far behind. Crash programs were the order of the day, and stereo got started in high gear.

The shot in the arm began to take effect. Ordinary “monophonic” stock suddenly became a liability, both equipment and discs—also tape. Many manufacturers of pickups had enormous stocks of their single channel cartridges. So they instituted high priority crash programs to convert them to

## OTHER VIEWS

stereo. Certainly not the best way to get good stereo, but in some instances it looked like the only way to stay in business. One has to be practical.

To add to the tape hiatus, the advent of the RCA cartridge which squeezes four tracks on to  $\frac{1}{4}$ " and gives two-way stereo playing of almost an hour on 600 feet of tape in a neat plastic case, stopped output of tape recordings almost completely. Developed with the intention of making a tape player as easy to handle as disc, and providing recorded program at a competitive price, the cartridge, many feel, attempted too much "in one go."

It raised too many possible alternatives for the future of tape: the current favorite, two-track (one-way stereo) at  $7\frac{1}{2}$ "; four-track (two-way stereo) at  $7\frac{1}{2}$ ", to maintain quality but halve the cost; or the RCA cartridge with its four-track at  $3\frac{3}{4}$ ". This question is still not quite resolved.

Radio has not been standing still in the stereo field either. In a sense radio gave stereo its start, with one channel on AM and one on FM, several transmissions of which are still operating at this writing.

The question most often asked concerns the *quality* of stereo, from one angle or another. Right now one has to be careful answering it. In each area of discussion there is a big difference between average and possible performances.

In the original transcription, a few use a suitable microphone technique that achieves really effective perspective; while some go after a real "ping-pong" effect, and others stick to "principles" they gleaned somewhere and make a well-intentioned flop. The really good recordings, particularly in the early days, were a rarity, but are now more numerous and of excellent quality.

The early stereo discs were seriously limited by cutter quality. They either rolled off the high frequencies at a point no high fidelity enthusiast would countenance, or went to pieces up there; but the cutter situation is rapidly improving as it did with LPs in the previous decade.

Stereo pickups have also been improved enormously and are today available in every conceivable type. Now a ceramic pickup offers extremely good quality for the price. But for best quality, and definitely for lowest record wear, the moving magnet "has it".

N.H.C.



## AUSTRALIA

It is always interesting to hear from the far-flung reaches of the Empire (if we may still use the word) and the following contribution by Mr. W. Gray, of Simon Gray Pty Ltd., Melbourne, gives a concise account of the stereo situation over there.

The introduction of stereo came to Australia at a time when television was expanding at its fastest rate. Despite this competition there has been a keen interest in stereo, and sales of equipment have been in reasonable proportion to the total sales of audio equipment.

Generally the class of person using a radiogram or record player for listening to discs has shown interest in the cheaper packaged units, but audio enthusiasts have taken a keen interest in the high quality equipment. Proportionally there is a much greater interest in the high quality equipment than in the packaged outfits. It appears, now that the first novelty value of stereo has worn off, sales seem to channel more towards the higher quality tailor-made installations, whilst sales of cheaper packaged units seem to be dropping off.

Unfortunately tape has not yet become very popular in Australia, possibly because of the relatively high cost and small range available compared with rather plentiful supplies of discs. However, the availability of 4-track stereo tapes will no doubt prove to be greater competition to stereo discs, and may well be the connoisseur's choice in the near future because of the distortion still evident in many discs.

The interest in stereo is growing rapidly, as mentioned, particularly in high quality units, but in our opinion it seems most unlikely that stereo will replace monaural recordings entirely, at least not in the foreseeable future, say the next 7-9 years. There will always be a small section of the populace, such as the teen-age group, who are interested only in material at the lowest possible cost irrespective of performance. Some of the current sales campaigns conducted on packaged outfits with "giant" 6" speakers are unfortunately damaging the reputation of stereo to the uninitiated with the result that many people remain dissatisfied. We believe that this is similar in some respects to the situation in the United States, and to a lesser extent the United Kingdom.

Another point is that stereo has definite limitations due to space requirements, particularly with regard to the "perfect listening area", a point which is not important with monaural equipment, where really excellent results can be achieved in any part of any reasonable listening room.

## OTHER VIEWS

### CANADA

We have received the following report from Mr. J. B. Smyth of Montreal:—

Stereo suffered initially from the same confused mass of misinformation here as in other countries. The principal problems arose from the poor quality of the first stereo records and pickup cartridges. Neither of these problems can be considered to be completely solved as yet, although the public is gradually becoming aware of the extreme importance to be attached to a good cartridge, and also of the wide variations in record quality which still exist. There are, however, now two or three good makes of stereo cartridges and quite a number of good stereo records available. Unfortunately many stereo recordings—probably the majority—are still being made with faked separation by means of widely spaced microphones, so that the famous “hole in the middle” is being deliberately kept open, in the belief that it sells records.

Many enthusiasts believed that identical speakers ought to be used for both channels. It is now realised that a similar polar distribution of high frequencies is the actual requirement, and that two dissimilar systems can be used so long as both are non-directional at high frequencies or have similar high frequency distribution patterns.

Many people found to their surprise that their old mono records sounded far better through the two speakers of their new stereo system than did many new stereo records, and also sounded better than they had done when played with a single speaker.

The major virtue of stereo seems to be that it has introduced two loud speakers into the room and has thus broken up many of the low frequency room reverberations which were a serious problem.

### MATCHED SPEAKERS

I have just noticed (October 1959) that the B.B.C. are resuming their experimental transmissions of stereo, using medium wave and VHF for one channel, and TV sound transmitters for the other. Many listeners have reported favourably on the results obtained from such B.B.C. tests, and yet it would be difficult to imagine a more unbalanced speaker set-up than say a good VHF set with a decent 8" speaker on the one hand, paired with a midget 5" x 3" elliptical unit squirting sound out of a popular TV set on the other. I can't help thinking that matched-speaker protagonists ought to write and

tell the B.B.C. engineers that they are wasting their time.

The fact is that the extra channel adds realism and theories about using identical speakers must take second place.

#### PICKUPS

To end this chapter, let us return to the vexed question of which pickup—mono or stereo—should be used on the millions of excellent mono records still in production and use. I received a very interesting letter from Mr. G. W. Tillett, an authority on high fidelity and well known for his reviews of amplifiers in *Hi-Fi News*, whose views in September 1959 were as follows:—

As I see it, the Decca and one or two of the more recent American stereo pickups are superior to all but the very best mono types. I have spent a lot of time comparing the Decca with the Ortofon C, using a change-over switch with several hundred mono records.

Well, the conclusions were that some records sounded better played with the Ortofon and some sounded better with the Decca—which is why I still use both at home. We did notice that on some records the stereo pickup tended to “bottom” but very often replacing these well-played discs with brand-new records effected a cure.

In this connection, I consider Mr. Tillett’s example to be worth following for the time being, although, in the absence of any new, up-to-date, mono designs from manufacturers, the stereo models will in due course have to be universally used. Our trusted old maids and bachelors will die out and the young married couples will reign supreme.

## CHAPTER 3

# SOUND SOURCE EFFECTS

We have already agreed (I hope) in Chapter 1 that realistic reproduction of noises is not quite the same thing as reproducing music.

### STEREO INFORMATION

It is well known that transients and high frequencies transmit much more directional and stereophonic information to the ear and brain than do sustained musical notes and low frequencies, the vital crossover being not higher than 400 c/s (where the wavelength of sound is less than 3 ft.) It follows that noises, bangs and clicks, which are full of random high frequencies and short, sharp transient effects, are a piece of cake for the recording engineer anxious to put over some impressive stereo.

### DISTORTION

A main objection to such noise tests is that they give no indication of the true quality of either recording or reproduction. In fact, the harmonic distortion caused by overloading an amplifier might well improve the realism of some noises, where it would mar the reproduction of music.

### DIRECTIONAL EFFECTS

But how important are sound source effects in the enjoyment of music? Apart from opera, I should say "not very".

Quite recently, I made a test at a concert in St. George's Hall, Bradford, when I was seated with two friends in the dress circle in the position shown in Fig. 3/1.

This dress circle still has, I believe, some social significance, (the Lord Mayor sits there with a chain round his neck if and when he goes to a concert) but acoustically it is a poor part of the hall. The side seats are the worst because one ear is hit by direct sound waves and the other has to make do mainly with reflected sound; but I found that by closing my eyes and turning my head from side to side I could play a game of trying to place the various instruments

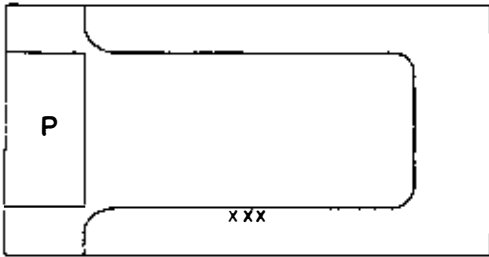

Fig. 3/1. Concert Hall Test.  
xxx = listening positions.  
P = platform.

in the orchestra. It was fairly easy to locate the brass section because it was loud and rather directional; also the tympanist because of the percussive and transient nature of the sound; but on full orchestra the remainder was a nice, homogeneous volume of sound which came from one general direction, with instruments clearly defined acoustically but not geographically.

In the delightful *Serenade for Strings* by Elgar it was possible to locate the violins on the left and the violas on the right, but I don't think this added to the enjoyment of the performance.

My friends made similar tests but they soon agreed that the placing of instruments or sections of the orchestra and the power to locate them seemed to have very little influence on the meaning and appreciation of the music.

So the conclusion is that the main virtue of stereo is in adding colour, depth and definition to the reproduction, as distinct from location of sources of sound.

#### LEFT-RIGHT RECORDING

Many of the early stereo records had a sort of military left-right flavour and gave two distinct channels of sound. They were hailed by some people as a great achievement which showed up the virtues of stereo compared with merely using two speakers on mono input. But today no serious recording company would waste time on such banalities; the importance of "filling in the middle" and presenting a natural, overall sound picture is universally acknowledged.

#### CROSSOVER FREQUENCY AND PHASING

In view of the fact that most of the stereo information is contained in the frequency range above 400 c/s, it is quite a good idea to cross over at 400 cycles instead of 800 c/s in speaker systems using omni-directional middle and treble speakers. Where an 800 c/s network is already in use, dropping by an octave simply involves doubling the C and L values by placing the extra capacitors in parallel, and the inductors in series (orientated at right angles or widely separated).

## SOUND SOURCE EFFECTS

Where directional speakers are in use, the crossover frequency does not affect the issue, but phasing is very important both between bass and treble in each speaker system and between the two separate systems on stereo.

With omni-directional speakers, phasing is much less important, but it is worth while making listening tests to avoid cancellation at low frequencies. It is a good plan to decide all phasing questions by ear, rather than by tracing positive and negative connections in equipment. For instance, the phase shift in a half section crossover network is about  $180^\circ$  so the bass and treble speakers must be connected out of phase electrically to work in phase acoustically!

Another reason for phasing by ear is that records themselves may vary. Mr. Lafaurie of Paris has drawn my attention to a recording of the Berlioz *Damnation of Faust* in which an oboe solo symbolises the soaring of the soul to heaven. But apparently this section was re-recorded in the opposite phase and inserted in the master tape, with the result that the oboe appears to jump about between the loudspeakers (instead of soaring skywards) if they are directional and are not re-phased. Many very good stereo transmissions by radio have been given in France and here again phasing has varied from time to time.

These things are being pointed out, not to suggest that constant reversing of leads to one speaker is necessary, but to warn readers to suspect phasing if peculiar sound source effects are produced. They rarely occur with omni-directional speakers.

Normally, all speaker systems should be acoustically in phase to avoid cancellation of bass—especially on mono input.

### PHASE CHECK

The simplest and most decisive method of checking the phasing of two loudspeakers is to connect them in parallel, place them side by side, and listen to some low notes on single channel input. When out of phase, most of the bass disappears.

If side by side placing is inconvenient, leave the speakers at their normal distance apart, connect them in parallel and feed a single channel of music into them. A solid central image should result for the listener if he is centrally placed, and this image will appear to move to the left or right as the listener moves in either direction. This test is based on the assumption that the two speakers are of similar efficiency. If the sound appears to come from the two speakers separately, they are probably out of phase. With omni-directional speakers, this test is often rather elusive and ephemeral, and it is probably easier just to listen to the bass as in the side-by-side test. If reversing the leads to one speaker makes no audible difference, I should stop worrying and just enjoy the music.

## CHAPTER 4

### TONAL DISCRIMINATION

There is probably more diversity of opinion about tonal qualities than about any other aspect of sound reproduction. By tonal qualities we mean all those variables which, in the final count, can only be judged by the human ear when sound is reproduced in live rooms where measurements and response curves are often more misleading than helpful. You may have heard about the old workman in the country who had spent several days repairing a road when the surveyor came along and criticised adversely everything that had been done. The old man listened patiently to the numerous complaints and finally said: "How is it for length?" I would say that judging tone quality is just about as difficult to the ear as assessing the length of a road would be to the eye.

We have ourselves often been astonished at the variety of opinions expressed about items in concert hall demonstrations. For instance, after our Royal Festival Hall event of May 1956, an Audiophile jazz item was criticised as "Too bass-y" and also as "Not enough bass". Invited comments after our May 1959 concert in the same hall included the following gems, but I ought to add that there was general agreement as to which was the best item in the programme, and that listening position, even in the R.F.H., affects results. The criticisms refer to a couple of stereo and two mono records. (See panel on next page).

These remarks prove once again that ears vary as much as faces, and I personally would never dispute the right of each individual to decide what he likes to listen to just as he decides what to eat or drink.

#### INFORMED CRITICISM

But when we come to published opinions on sound (or stereo) it is important that the critic should have some knowledge of cause and effect, otherwise we find ourselves reading banalities similar to the following, which appeared in March, 1959.

## TONAL DISCRIMINATION

ITEM	COMMENTS
Te Deum Chorus Stereo	Absolutely terrific. Sibilants too prominent. Breath-taking. Woolly cum mushy.
Orchestra—Giselle Stereo	Most impressive. An extraordinarily bad choice.
Concerto Grosso Handel Mono	Best string tone ever heard. Strings lacked sheen. Absolutely first-class. Strings unnatural.
Sea Symphony Mono record with live organ accompaniment	Words cannot express how wonderful this was. Fine climax. Rotten recording. One of the outstanding record- ings of all time. Definitely no marks — terrible. A wonderful noise, but distor- tion in tuttis.

“I have heard stereophonic equipment costing between £25 and £250, and the odd thing is that the most pleasing sounds—and therefore to my musician’s ears, the best stereo—have come from the medium-priced equipment, medium-fi if you like. Hi-fi stereo always has a glassy, ‘tissy’ effect, difficult to get rid of without sacrificing treble. Unfortunately for stereo, all the record companies seem to be following this habit of exaggerating treble.

But it would be quite wrong to blame stereo for all this. The companies, I am confident, will learn very quickly; and already, as I say, the medium-fi machines such as the equipment at 80 guineas, *which I myself am using*, can give excellent results.

One reason why I say it would be wrong to blame stereo is that for the most part stereophony helps one not to hear distortion. I found on comparing stereo discs with their monaural equivalents (i.e. of exactly the same performances) that there was markedly less end-of-side distortion on the stereo discs.

When I told an engineer of this, I was laughed to scorn. He said that there were far more factors to induce distortion on stereo. I repeated what my ears told me.”



We will refer to our critic simply as C.C.—short for Comical Chris. His first mistake is to refer to his musician's ears, because tonal judgment and recording techniques are not related directly to musicianship, and professional musicians are often poor judges of quality of reproduction. For one thing, they spend most of their time close to the instruments. A grand piano sounds quite different away from the keyboard. Another point is that many recording engineers are very musical, but a professional musician who is also technical is an exception.

C.C. is quite right in objecting to exaggerated, glassy treble, but he is wrong in his assumption that cheap outfits should be used to avoid the effect, under the mistaken idea that they succeed by magic instead of by sacrificing treble. The tone controls in high class equipment are more than adequate for the purpose.

He then says it would be wrong to blame stereo for HF distortion, and the companies will learn quickly. But there is a lot of this distortion in records due entirely to stereo, and the companies know all about it and are spending fortunes in improving cutters and pickups.

C.C. admits that he will be using an 80 guinea stereo outfit for reviewing records. This is equivalent to sending an art critic wearing coloured glasses to review an exhibition of paintings.

Finally, our musical friend knocks himself on the head and staggers backwards. After saying that distorted treble is unfortunate for stereo, he says that stereophony helps one not to hear distortion, and refers to end-of-side troubles, which are due simply to the slower surface speed and affect all discs whether mono or stereo. (The finer stylus of a stereo pickup could, however, facilitate tracing, but this is a mechanical—not a stereo—phenomenon.) The engineer to whom C.C. revealed his weighty opinions must be still laughing.

It is high time that all this fiddle faddle about stereo replacing quality was stopped. A discriminating ear can recognise the value of a good pickup or good speaker system on stereo just as on mono, and the idea is to have clean bass and smooth top. To do it properly costs a lot of money. C.C.'s £80 will just about buy the loudspeakers.

I am not suggesting that nobody should buy the £80 equipment. It is excellent value for money and will satisfy many thousands of users. All I say is: Don't make cloth-eared assertions that such equipment is as good as higher quality instruments due to some magical influence of stereo.

## CHAPTER 5

### RECORDING TECHNIQUES

In a non-technical book, it is not possible to do more than skim the surface of recording problems; but to those who wish to delve more deeply into the subject I can strongly recommend the report of the I.E.E. Convention on Stereophonic Sound Recording, Reproduction and Broadcasting held in March 1959 at Savoy Place, London; and the April 1958 issue of the *Journal of the Audio Engineering Society of America*, which is devoted entirely to papers or lectures on the subject of Stereophonic Sound.

This issue of the A.E.S. Journal also contains full and certainly interesting details of the original British Patent Specification No. 394325, dated 1931, by Blumlein, which miraculously covers two-channel recording and reproduction of sound, including the feature "that a light stylus is pulled into two directions at right angles to one another and each preferably at 45° to the wax surface".

For the average listener, the only facts about stereo recording which, so far as I can see, are of direct interest are: (1) a general idea of how recordings are made; (2) how they are monitored; and (3) recording level.

#### MONITORING

Dealing first with number two, I think it is correct to say that practically all stereo monitoring is done with the loudspeakers 8 to 12 ft. apart, and the engineer adjusts his microphones and controls to give the best results under these conditions. The only sensible thing to do at home, therefore, is to use a similar speaker placement, reducing the distance between the two by 2 or 3 ft. in very small rooms. This is bound to give the nearest approach to the original.

For purposes of convenience, other arrangements (such as widely spaced corner positions with a third speaker to "fill in the middle", or two speakers close together and angled outwards) can be used; but it would be illogical to pretend they are better than, or even equal to, an authentic set-up.

## RECORDING SYSTEMS

The main thing to remember here is that mono and stereo techniques must be compatible, meaning that the two types of recording must be made simultaneously. To make them consecutively would almost halve the production from studios, and judging even by the comparatively small experience I have had of the enormous cost of recording, I should say that this would be calculated to put most recording companies out of business.

Another point that strikes me whenever I watch recording engineers at work is how quickly theories are thrown out of the window; it is the practical use of various microphones and controls which enables each engineer—mono and stereo—to obtain the best results possible, the technique obviously varying enormously according to the studio in use, the type of programme, and the engineer in charge.

I have also noticed that the favourite motto of recording engineers appears to be “Mum’s the word”, and I suspect that their service agreements contain a clause reading “Thou shalt not talk or spill any beans”. I had a personal experience of this a few years ago when I called to see Mr. W. S. Barrell (then head of E M I Studios, but now retired) and asked him to give me some dope on recording to be included in a book on Pianos. Mr. Barrell’s reply went something like this: “Listen to me, sonny. (He must have been older than I was at the time.) It has taken us twelve years to get rid of wow in piano tone. If you think we are going to tell you or anybody else how we did it, you must be slightly balmy.”

After all this, I was agreeably surprised to find an informative article on stereo recording by Mr. Seymour Solomon, head of Vanguard Recording Society, N.Y., in the February 1959 issue of *High Fidelity and Audiocraft*, and I am indebted to Mr. Solomon and the publishers for permission to quote and reproduce diagrams. The title of the article was “*The Search for a Third Dimension*.”

First of all, I must not give the impression that Mr. Solomon has been spilling any beans. The following paragraph dispels any such illusion:—

“For anyone who may wonder if trade secrets are being revealed, let me say that the exact, inch by inch, positioning of microphones, their types and patterns, the disposition of the musical forces, and hall acoustics all play their part. The final result is achieved only after long experimentation.”

The important point is not how much information is given away, but that Mr. Solomon speaks with the authenticity derived from practical experience.

RECORDING TECHNIQUES

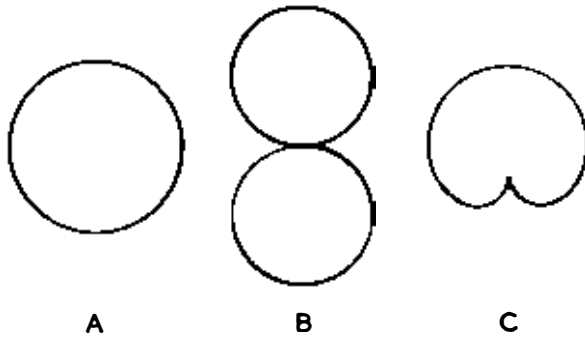

Fig. 5/1. Basic types of microphone.  
A Omni-directional.  
B Figure-of-eight.  
C Cardioid.

There are three main types of microphone: A, omni-directional; B, figure-of-eight, and C, cardioid, illustrated in Fig. 5/1 with their pickup patterns.

Mr. Solomons goes on to explain that there are then three basic systems of use for stereo, illustrated in Figs. 5/2, 3 and 4, but adds that many variations occur in practice.

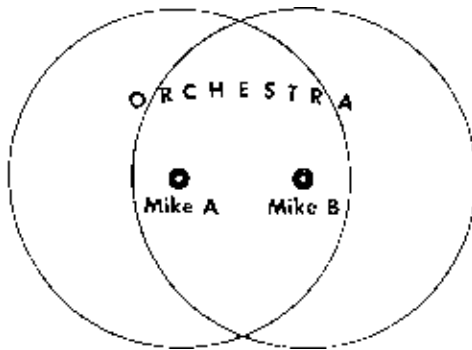

Fig. 5/2. A/B system of stereo pickup with two spaced mics.

The A/B system has been widely used in America, and the M/S method has been more popular in Europe; but Mr. Solomon points out that the technique of mixing auxiliary microphones into the main channels may be extended for various purposes, and he would

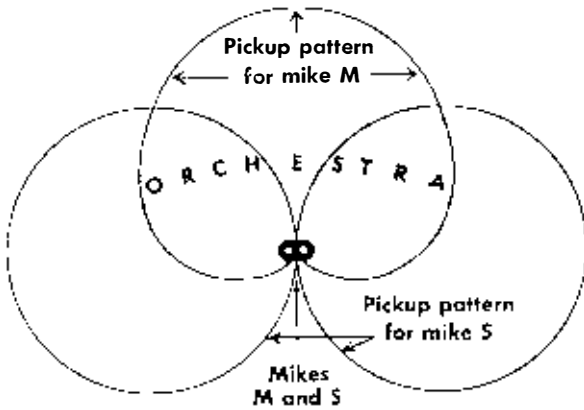

Fig. 5/3. M/S system, mixing outputs of cardioid and figure-8 mics.

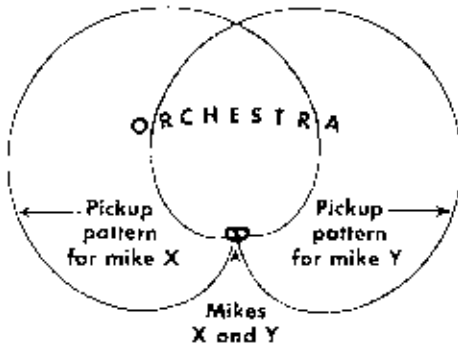

Fig. 5/4. X/Y system using two closely-situated cardioid mics.

Figs. 5/1, 2, 3 and 4 reproduced from *High Fidelity and Audiocraft*, Feb. 1959

like to think that a good recording engineer would use *any* system, depending on the nature of the music to be recorded. (So would I.)

That this in fact is done is neatly illustrated by Mr. Solomon in the following story:—

“Some months ago in London, the chief engineer of a major English firm which has specialised in M/S stereo recording played for me a spectacular recording of Prokofiev’s *Classical Symphony*. After congratulating him, I diffidently remarked

## RECORDING TECHNIQUES

that the tape had certain aspects of definition and separation which I found difficult to reconcile with the M/S system. To this the engineer replied, "Well, it was basically recorded M/S, but of course we have employed additional microphones on left and right channels to heighten the directional illusion and accent certain choirs."

We may properly ask where M/S ceases and A/B begins."

In view of all these variations, the only thing the listener at home can do is to set up his speaker system to suit the room and hope for the best.

One point emerges as the multi-microphone technique is applied to both mono and stereo recordings, and it is that the difference between the two becomes less pronounced, but two-channel still scores in providing depth and definition, or as *The Times* critic so neatly put it after our fourth demonstration in the Royal Festival Hall, the avoidance of opaque *tuttis*.

Mr. Solomon concludes his excellent article by attributing to recorded music a virtue which I, for one, do not think it possesses. I quote:

"Whatever their limitations, recordings stand on their own as a valid means of reproducing the printed music page. They have created what can now be perceived as a revolutionary change in the sound of music in performance. Further, an entire new generation of music lovers is being conditioned to hear Mozart and Beethoven with musical balances unlike those which their fathers heard before them. And since for every person who attends a live concert there are hundreds who gain their musical experience from records, the revolution is the more significant."

To my ear, the best recorded music is still only a pale imitation of a live performance, and those who never taste the real thing by going to a concert just do not know what they are missing.

Perhaps I ought to add that I am one of those who think that the multi-microphone technique can be overdone. I agree that a soloist should be clearly heard, but it is a retrograde step to make each one sound as though he has taken a sudden step forward towards a microphone, like some third-rate crooner who can't really sing at all.

The B.B.C. transmissions of light music with Eric Jupp and Peter Yorke are often superb, with what sounds like a distant microphone technique; but commercial records of similar performances often sound ragged and jerky due to the *undue* prominence given to each soloist. I like to hear Eric Jupp play the piano but I do not want the instrument to leap suddenly into my lap. To suggest

that all these faked recordings are superior to hearing a normal performance is equivalent to pretending that frozen food is better than fresh food. Actually, it should be easier with stereo to give the right amount of prominence and perspective to soloists than it is on single channel working.

#### RECORDING LEVEL

In stereo discs this has usually been considerably lower than the normal levels adopted with mono records, which means that the volume control has to be turned up and this brings up all the background noises such as hum, rumble, surface noise and plops. Efforts are now being made to improve the signal to noise ratio by recording at mono levels, and in view of the more prevalent hum and rumble with stereo discs, this is a worthy objective.

Unfortunately, the higher recording level increases the risk of distortion on loud passages during the cutting process, and such passages are also more difficult for the pickup to trace, so at the moment we appear to be between the devil and the deep sea. But these are problems which will certainly be overcome in course of time.

The trouble, again unfortunately, affects high class pickups more than cheap ones because they are usually magnetic types with lower voltage output than crystals, and with a wide frequency response which exposes distortion.

### DISC QUALITY

Record making is such a highly skilled and tricky business—from microphone to final pressing—that I often marvel at the degree of perfection so often attained.

In the following brief examination of stereo standards, I am delighted to have had the co-operation of Cecil Watts, with illustrations of some of his investigations via photomicrographs, plus his guidance in the interpretation of their significance and meaning.

Up to a few years ago, the groove of a record was cut to a constant number of turns to the inch and the amplitude of the lower frequencies controlled so that the recorded waveforms did not cut into one another to produce a row of knitting.

Modern techniques and the use of tape now make it possible not only to open the pitch automatically whenever large amplitudes approach the cutting head, but with stereo recording, where the waveforms also vary in depth, there are indications that the mean

## RECORDING TECHNIQUES

depth of cut is also variable to allow a shallow (and quiet) normal depth of cut but with the mean depth automatically increased so that an adequate groove width is maintained at the crests of rising waveforms. Records so made usually have a very silent background during quiet passages and a greater overall dynamic range.

Rough textures of groove surface are still observed in some of the more violent excursions, and remain a problem for the engineers. Just take a look at Fig. 5/5, which is a photomicrograph of a section of a fine stereo disc, magnification 250X.

The groove has been beautifully cut and the subsequent pressing has retained all the essential polish and fine detail of the original recorded waveforms. Such a pressing could in good conditions reproduce the original music perfectly without a trace of distortion, and the stereo qualities would be represented in the truest sense of the word.

Unfortunately many records fail to reach this high standard. Fig. 5/6 shows a typical example from a so-called unplayed copy of a factory sealed record. Even though the recording engineers probably cut a perfect master, the groove has obviously been traced by a stylus before or during processing, as every pressing of this particular record examined to date is similar before use.

The groove surface is abraided, rough and discontinuous. When reproduced, the stereo qualities may be confused and degraded. Any self-respecting stylus could only jitter over the rough surfaces with little or no chance of maintaining intimate contact with both walls of the groove, which is the first essential for accurate reproduction.

If I were asked to name the two major faults which still afflict many stereo discs I would say a "comb and papery" top and a lack of solid, well defined bass; and both of these faults, even if the recording were perfect, could be caused by the stylus losing contact with either or both of the groove walls when attempting to trace rough groove surfaces.

At present we have to get rid of the slight tizziness by using the treble control rather more drastically than is normally required on mono records, and hope that the "stereo" effect may more than make up for the slight vagueness at the other end of the scale.

It must be remembered that when tracing the groove of a stereo record, any roughness of surface that is encountered by the stylus will not only be reproduced as background noise but will distort the proper stereo balance between the two sides of the groove. Also, when playing rising and falling waveforms, with some pickups the stylus may bounce and lose contact with the groove altogether when overcoming rough surfaces or other obstructions. Even a record which is incorrectly centred (i.e. a swinger) can apparently move a sustained note from one speaker to the other.





*C. E. Watts.*

Fig. 5/5. Photomicrograph of fine stereo disc. Mag. 250X.



*C. E. Watts.*

Fig. 5/6. BRAND new stereo disc showing many rough places. Mag. 250X.



*C. E. Watts.*

Fig. 5/7. New stereo disc showing rough patches in groove. Mag. 250X.



*C. E. Watts.*

Fig. 5/8. Loud bass note causing cutter to jump and fail to cut a continuous groove.

Fig. 5/7 is another example which is typical of many unplayed records as received, sealed up in their beautiful jackets, and shows rough patches and indentations in the groove walls as though the original lacquer master had been traced with a stiff and heavy stylus prior to processing—which is hard to believe.

In the illustration Fig. 5/8, another not uncommon abnormality is observed. A loud bass note is causing the cutter to rise so high that it almost fails to make a groove for the stylus to trace! It seems logical to assume that this can only cause more harm than good when reproduced on a normal gramophone, and in any case could have easily been slightly moderated for those of us who still have ears.

These pictures are not included as a scathing criticism, but rather to show some of the difficulties which have to be—and are being—overcome in recording, and to resolve some of the puzzling phenomena experienced with even the best reproducing systems; but—caution!—It is not always the record that is wrong.

We ought to point out that we are putting our own interpretation on these things because the big recording groups still adopt a hush-hush policy where technique is involved.

We are told by experts that the truly lateral excursions of the groove occur when the position of the original sound is exactly central to the two recording microphones, and that the more a sound affects one microphone or the other, the more the respective side of the groove is modulated at  $45^\circ$ . Only when the position of the original sound produces an out of phase wavefront of similar intensity to both microphones does the modulation of the groove approach the vertical.

But the absolute vertical is by nature impossible—unless of course the musicians are also acrobats.

#### WIDE TAPE

The use of three or four track recording machines is becoming increasingly popular with commercial recording companies, particularly in America. Special, very high quality machines are employed to produce the master recordings on half inch wide tape. The three or four channel master tape is then transferred to a two channel dubbing by mixing the middle channel(s) with left and right outer tracks.

This arrangement is more versatile than direct two channel recording as it allows changes to be made in stereo balance far away from the stress and strain of the recording session. Improved mono recordings can also be made by combining three or four tracks in a single channel version.

## RECORDING TECHNIQUES

TYPE	ERASE	RECORD	PLAYBACK
300 FULL TRACK		SAME	SAME
300-2 STEREO		SAME	
300-2M SPL MASTER STEREO		SAME	
300-3 3 TRACK		SAME	
300 4 4 TRACK		SAME	
300-8 8 TRACK		SAME	

Fig. 5/9. Head arrangements with Ampex 300.

*Courtesy Rank Cintel*

Fig. 5/9 shows the wide variety of track arrangements comprised in the Ampex 300 series of professional machines.

Up to 8 tracks are available and can be used for special superimposed recordings similar to those by Mary Ford and Les Paul.

## CHAPTER 6

### HUM, RUMBLE AND NOISE

We are devoting a complete chapter to this topic because there exist a number of reasons why a stereo pickup system is more prone to give audible trouble than its mono equivalent. When I totted up the number and the answer was 6 and the chapter was also No. 6, I decided that it was a good omen and that this would be one of those rare and lucky chapters which virtually write themselves. (Knowing that Mr. Cooke had already written most of it, this was a fair assumption.)\*

#### CONCERT HALL TROUBLE

We have actually another reason—a sad one—for taking a vital interest in the problem, because we ran into trouble with our fourth Festival Hall concert when we played stereo discs for the first time in a large hall and many loud passages of music were accompanied by 50 cycle hum which was heard prominently in many parts of the hall and made the bass speakers sound woolly and resonant. As a result, our technical editor made a thorough investigation into the problem, prior to our next rehearsal booked for Colston Hall, Bristol. I threatened to retire if we had any more rude letters about hum, and Mr. Cooke promised to eat the concrete slab on which we proposed to mount the turntable equipment if he did not clean things up completely. (He has not had to change his diet.)

It is of course obvious that the standards required when playing to an audience of 3,000—with the volume control set at 9 as against 3 or 4 at home—are very stringent, and our R.F.I. set-up was satisfactory under domestic conditions, but the remedies can be applied where necessary.

#### THE DISEASE

Here are the six reasons why disc stereo adds to the problem:—

1. Two channel working involves more wiring and connections, with increased liability to hum pickup and earth loops.

---

\* Most of the contents of this chapter appeared in an article by Mr. Cooke in the October 1959 issue of *Wireless World* and are reproduced here by arrangement with the Editor of that journal.

## HUM, RUMBLE AND NOISE

2. The voltage output of stereo pickups is usually less than mono equivalents and this affects adversely the signal/noise ratio.
3. Lower recording levels had a similar effect, but these are now being stepped up to mono standards.
4. Stereo pickups respond to vertical as well as to lateral vibrations, and are therefore more sensitive to rumble.
5. Magnetic types contain two or three separate windings, each looking round for sources of hum.
6. Two amplifiers are in use, thus enlarging the hum potential of mains transformers and chokes.

## THE TREATMENT

### NOISE

Before tackling the specified diseases, we will deal with the general complaint of noise, which covers grunts and groans, mechanical (acoustic) feedback, plops and hiss.

### MECHANICAL FEEDBACK

Groaning on loud passages of music may be caused by mechanical transmission of vibration between loudspeaker and pickup. The cure is to reduce this coupling as much as possible. The turntable should be placed well away from the speaker and isolated from vibration, and the loudspeaker may be stood on a thick pad of foam rubber or rubberised hair to isolate it from the floor. Moving the loudspeaker or turntable to a more solid part of the floor might also make a big difference.

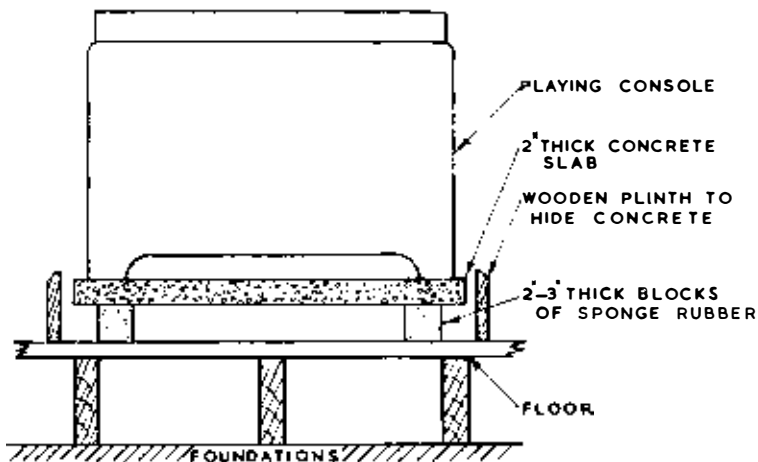
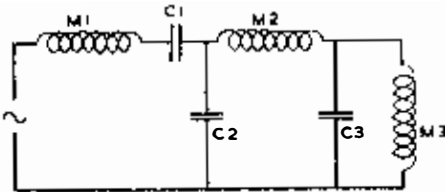
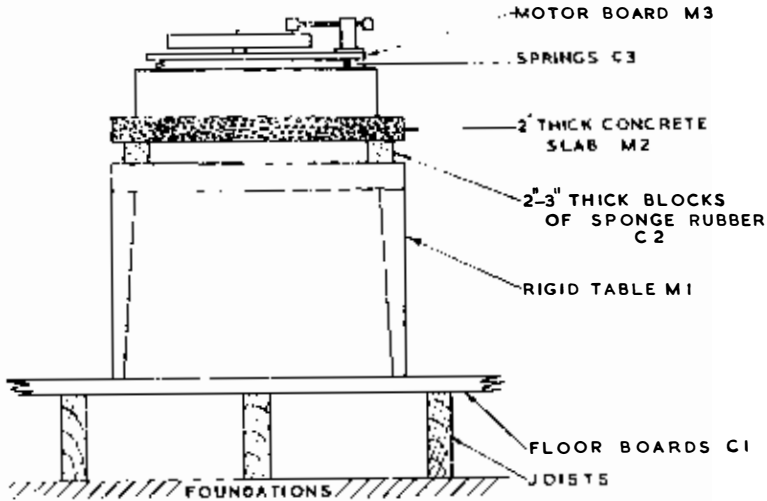

Fig. 6/1. Mounting system for turntable console to avoid mechanical feedback.



In chronic cases, Mr. Cooke suggests mounting the turntable console on the lines indicated in Fig. 6/1.

For public demonstrations, we have adopted with considerable success the set-up illustrated in Fig. 6/2, which also includes the equivalent electrical circuit.



EQUIVALENT ELECTRICAL CIRCUIT

Fig. 6/2. Transportable system for isolating turntable from floor vibration. Concrete slab M2 acts as virtual earth.

CENTRE OF GRAVITY

Another cause of trouble from vibration may be due to the centre of gravity of the turntable assembly being to one side instead of at the geometric centre of the motor board. This condition can produce spurious noises and may even cause groove jumping.

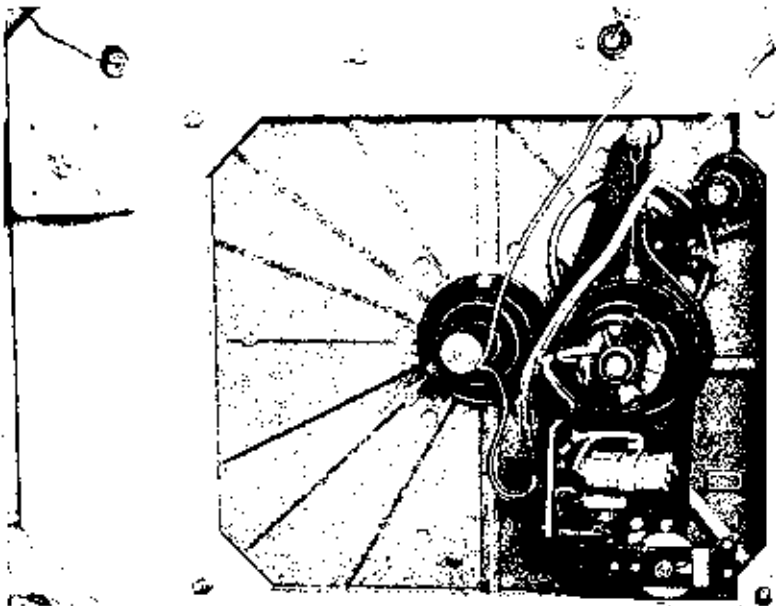

Fig. 6/3. Steel plates added to underside of motor board to counterbalance weight of motor and avoid side wobble. (After R. L. West).

A remedy suggested by Ralph West is to add weights to the motor board to counterbalance the weight of the motor, so that the whole thing balances horizontally, with the further benefit of adding mass to the assembly, which always helps to reduce vibration. A photograph of a playing desk so treated is reproduced in Fig. 6/3.

#### PICKUP RESONANCE

Pickups having a pronounced low frequency vertical resonance may be shock-excited when the stylus is lowered abruptly on to the record. The use of a pickup lowering device is useful to minimise the shock and to preserve a delicate pickup mechanism.

#### PLOPS AND HISS

Plops are usually caused by dust in record groove and are reproduced strongly by the vertical output of a stereo pickup.

As to hiss, it is surprising how often people accuse loudspeakers of producing this when they should really be investigating their amplifiers. There is always a certain amount of valve noise from

any amplifier, but with modern high quality types this should only be apparent as a faint hiss with the ear about one foot from the H.F. loudspeaker and the controls at normal settings. If the hiss becomes obtrusive it is usually a sign of trouble: perhaps a faulty valve or incorrect installation.

When testing for valve noise, the pickup should be left off the record, as some pressings have a high level of background hiss.

\* \* \* \*

Having acquired a satisfactory installation, we can now take a brief glimpse at the trouble which may yet crop up, and suggest a few palliatives—if not cures.

## HUM

Hum may be induced in the pickup head itself or in the wiring to the amplifier input. Efforts to reduce hum therefore take two general courses. One is to reduce as much as possible the stray alternating magnetic fields which surround the pickup and associated leads. The other is to arrange the wiring to minimise hum induction by residual stray fields.

The turntable motor itself is often a major source of trouble because it is situated very close to the pickup and input leads. For quiet background, the motor should have a very low stray field, but few manufacturers quote measurements which would enable an intending purchaser to assess the position.

In a typical case, using a high quality variable reluctance pickup which is particularly prone to hum pickup, the hum level fell by 12 dB when used with one high grade transcription turntable compared with another turntable of similar mechanical quality. This striking difference was due simply to a much lower stray field at the pickup.

Very small motors may be shielded by wrapping with mumetal tape, suitably ventilated, but the high cost of this material precludes its general use with larger types.

### HUM TEST

When testing for hum, the pickup should be swung back and forth through its playing arc, close to the turntable, because the hum level varies with position. Fig. 6/4 shows hum induced in a magnetic pickup when used with a high quality turntable. A 50 c/s sine wave is included at A to show that the fundamental hum frequency is 50 c/s, with a small proportion of higher harmonics in some positions of the pickup. With the volume control of the preamp set at 7 (full domestic volume) the hum at positions B, C

## HUM, RUMBLE AND NOISE

and D was inaudible, but at E was very loud, which means obviously that the pickup head must not be allowed to pass directly over the motor in use.

The results of Fig. 6/4 should be compared with those shown in Fig. 6/5, taken in a similar manner with the same pickup but with another instrument fitted with a heavier turntable. The hum, especially in position C, was quite audible under domestic conditions.

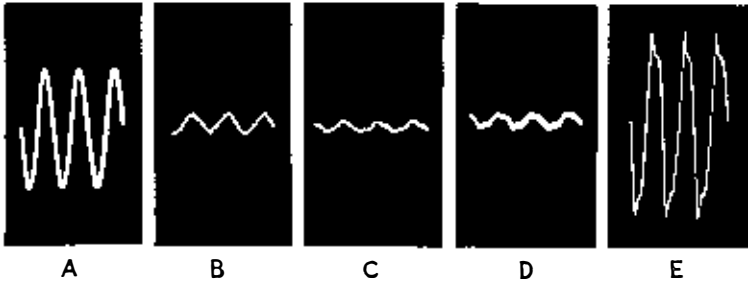

Fig. 6/4. Hum induced in magnetic pickup using turntable of medium weight.

- A — 50 c/s sine wave for comparison.
- B — Pickup head at start of 12" record.
- C — " " " " " 10" record.
- D — " " " " " end of record.
- E — " " " " " directly over motor.

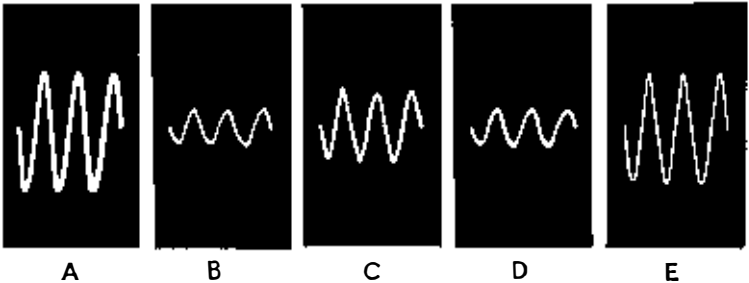

Fig. 6/5. Same as 6/4, but with very heavy turntable.

It should be pointed out that crystal and ceramic pickups, and certain magnetic types, are much less sensitive to hum than the type under review.

It was observed that a heavy aluminium turntable increased the hum due to eddy currents induced by the motor. In other words, the turntable effectively carries the hum round to the pickup head;

but it is not suggested that heavy turntables should be discarded! Models with the motor placed outside the rim of the turntable give less trouble from this cause.

Hum pickup is halved by raising the cartridge and tone arm  $\frac{1}{4}$ " and placing a mat  $\frac{1}{4}$ " thick between turntable and record.

In a stereo installation, each channel should be tested separately to avoid acoustical phase cancellation at the listening position. The hum will often be found unequal in the two channels.

#### WIRING

To minimise hum induction, the leads between pickup and amplifier should be as short as possible and kept clear of motors and mains transformers. Screened cable is essential for all except moving coil pickups of very low impedance, and the leads for the two channels should be strapped together to avoid hum loops. If it is necessary to extend the leads provided by the pickup manufacturer, the joints should be soldered and insulated with good quality plastic tape. (Bituminous insulating tape is not reliable for this work.) The insulated joint should then be wrapped with tinned copper fuse wire to act as a screen, and this should be soldered to the earthy braid on both sides of the joint. If intermediate plugs and sockets are required, as for example in demonstration equipment, these should be good quality shielded types, and must be placed as close together as possible.

The relative amounts of hum induced in the pickup itself and the input leads can be assessed by removing the pickup head and shorting together all the connections in the arm, using a *very short* length of thick wire. The residual hum is that due to the wiring alone.

#### AMPLIFIERS

The mains transformer of the power amplifier is also a prolific source of hum, with a surprisingly large field of radiation. When assembling equipment in a cabinet, the power amplifiers and any other mains transformers should be located as far away as possible from the pickup and input wiring. It should also be remembered that magnetic fields are "directional" and some reduction in hum is often possible by arranging the amplifiers at different angles, or reversing one completely. The best positions can only be found by trial and error.

#### EARTHING

Whereas with mono equipment it is frequently possible to dispense with an earth connection and still retain a satisfactory hum

## HUM, RUMBLE AND NOISE

level, it is usually essential to earth stereo equipment. Earthing should be carried out at one point only, usually at the amplifier. All the other equipment, such as turntable and tuner unit, should be earthed via the screened leads which run to the amplifier input sockets.

Although the laws of nature never change, they do sometimes appear to be perverse: it is unfortunate that some of the best stereo pickups have high impedance windings with low output and therefore the risk of hum is much greater than with cheaper crystal types. Even so, with reasonable precautions, satisfactory results at domestic volume levels should be achieved without much difficulty.

### AFTERTHOUGHT

Reverting to Figs. 6/4 and 5, it is interesting to note that as the hum is carried round to the turntable, it is reduced immediately above the motor. (Inevitably so). Conversely, dispense with the turntable altogether and hum troubles at pickup disappear! Presumably a plastic or concrete model would have a similar beneficent effect.

## RUMBLE

The vertical sensitivity of a stereo pickup increases its tendency to expose turntable rumble, and the coincidence of pickup resonances with certain rumble frequencies can also intensify the effect. It is therefore difficult to estimate precisely how much rumble will be obtained from any combination of turntable and pickup, especially as wide variations can occur between examples of the same models.

The method of mounting the turntable can affect the rumble content. It is usual to "float" the turntable mounting board on four corner springs in order to reduce mechanical feedback and to isolate the pickup from external vibration. Unfortunately this sometimes allows resonances to build up in the mounting board, and rumble may often be reduced as much as 8 dB by clamping down the motor board firmly.

It is a pity that a spring-loaded turntable which is useful in avoiding mechanical (acoustic) feedback may be bad for rumble. (What you gain on the springs you lose on the roundabout.)

It must be admitted that rumble is not produced exclusively by turntables. Records themselves sometimes contain a little as well as other low frequency background noises, but the best discs are still superior to the average transcription turntable in this respect. Also, some of the cheaper turntables have bearings which are more rumble-free than some more elaborate transcription types.

## CHAPTER 7

### PICKUPS, TONE ARMS AND TURNTABLES

In writing about pickups, it is not our intention to report on or to compare different makes; that is a task better left to the monthly journals, year books (and consumer reports?) because of the rapid developments which take place.

A more useful approach—and one less liable to personal or national bias—is to consider the basic requirements of good performance, followed by a description of the main types; crystal or ceramic and the many variations of the magnetic system. The reader will then be free to decide for himself how to spend his hard-earned money.

A good stereo pickup is a beautifully made instrument which cannot be cheap, and, before appearing to criticise, we should like to raise our hats to all designers and manufacturers who have attempted and very nearly achieved the impossible. For instance, in the Decca pickup, coils are wound with 52 s.w.g. copper wire which is only 0.5 thou. diameter, and we have heard of coils being used in America wound in silver wire only 0.3 thou. thick. To give the reader some idea of the physical dimensions involved, a reel 3" long will accommodate 1½ lb. of 50 gauge wire 1 thou. thick, with a length of 90 miles.

#### PERFECTION

According to our Technical Editor, a nearly-perfect stereo pickup would have the following attributes—some of which are in direct opposition to each other so far as practicable considerations are concerned.

- \*1. Wide frequency response.
- \*2. No undamped resonances.
3. Low harmonic distortion.
- \*4. Low record wear.
- \*5. Good separation between channels.
- \*6. Well balanced output from each side.
- \*7. Reasonably high output.
8. Mechanical robustness.
9. Long term stability of performance.
10. Immunity to variations of climatic conditions.

## PICKUPS, TONE ARMS AND TURNTABLES

For example, No. 8 is difficult to achieve without affecting Nos. 1 and 4. High output No. 7 must give way to requirements 1, 2 and 3. As regards qualities 9 and 10, we can only say *experientia docet* and time will tell.

Such troubles as hum pickup, variation in performance with change in playing weight, and the collection of lint and dust around the stylus, can be countered by due care and attention to conditions of use and cannot fairly be blamed on the pickup.

Manufacturers naturally differ in the importance they attach to various requirements, and so each one produces a slightly different set of compromises, which to say the least gives us a wide variety of pickups.

### TESTS

Pickup testing is a slow and laborious business, second only to loudspeaker testing in its complications. It can easily take one man a whole week to evaluate thoroughly a single cartridge and tone arm, or a whole book to evaluate the general position.

The tests described here must therefore be brief, and they relate only to points 1, 2, 4, 5, 6 and 7, which are starred in the list of requirements. Harmonic distortion is difficult enough to assess on mono pickups, but the position is much worse on stereo because suitable test discs are not yet available.

It is now my pleasure to hand this chapter over to our old friend Stanley Kelly, who has a vast experience in the design and production of pickups of various types.

### S. KELLY ON PICKUPS

Mono pickups have been on the market for approximately 35 years and during this time a wealth of experience and know-how, in the laboratory, the factory and in the field, has been accumulated. The advent of stereo discs threw an extremely large, heavy and sharp-cornered spanner into the somnolent calm of most pickup laboratories—the bruises are still being felt in many places.

At first sight, the 45°/45° system of recording bears much more than a superficial resemblance to the normal lateral mono system. Further investigation shows, however, that it is essentially two separate hill and dale modulations using opposite walls of the same record groove. This means that the inherent distortion in the record is of a different order of magnitude and kind to that in mono records; in an electronic sense the mono is a push-pull pentode output system, whereas the stereo has two single-ended pentode outputs each driving their respective channels.



The magnitude of harmonic distortion (other things being equal) is controlled by the radius of the stylus tip. The smaller the radius, the less the distortion, and it has been shown mathematically that assuming the same recording characteristics and the same maximum modulation level, the stereo stylus radius should be reduced to approximately one-third that of the monaural for the same effective distortion. From manufacturing considerations alone, it has been found to be impracticable to reduce the stylus radius to 0.3 mil. (In order to measure the stylus radius at 0.3 mil. to an accuracy of  $\pm 10\%$  a magnification of x1500 and monochromatic light must be used.) Initially, therefore, a tentative compromise was offered with a stylus radius of 0.5 mil. and, lately, when "compatible pickups" were offered, a further variation using 0.7 mil. radius was also issued.

WEAR

Reducing the size of the stylus point increases wear at a given playing weight, and the graph, Fig. 7/1, shows the relation of stylus wear against stylus radius using diamond styli. Record wear is also related to stylus wear, but unlike the "flat" on a stylus, which can be measured, record wear is a euphemistic term and must be judged subjectively, which in turn is determined by the frequency response, etc. of the rest of the equipment, to say nothing of the room acoustics and the hearing acuity of the listener's wife!

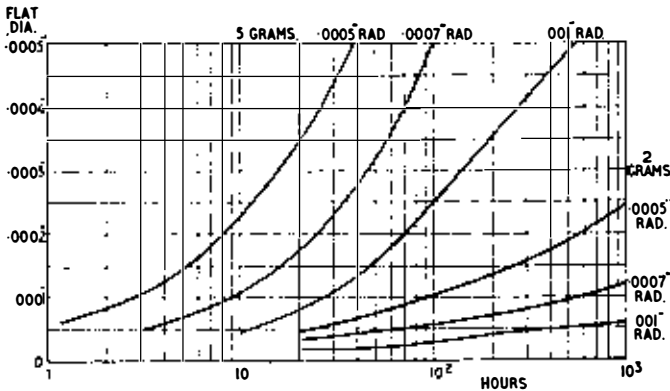

Fig. 7/1. Stylus wear related to point size and playing weights of 2 and 5 grms.

## PICKUPS, TONE ARMS AND TURNTABLES

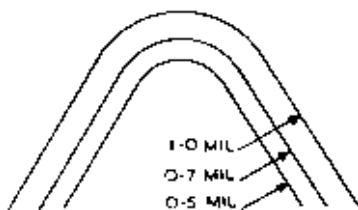

Fig. 7/2. Comparison of stylus radii.

### PLAYING WEIGHT

Fig. 7/2 shows the ratio between the three standard sizes of points now offered. To avoid undue wear and tear, half mil. points should be used with a maximum playing weight of about  $3\frac{1}{2}$  grms.; 0.7 mil. styli at  $4\frac{1}{2}$  to 5 grms., and 1 mil. points at an absolute maximum of 6 grms. Unfortunately, the majority of pickups, especially those used in automatic record changers, do not even commence to approach these design centres.

If and when a cartridge is produced in which the dynamic constants (compliance, effective mass, etc.) are such that it will satisfactorily play the normal stereo record at less than 2 grms., the life of the stylus and record under optimum conditions should be in excess of 2,000 playings. With present day cartridges playing at 6 to 8 grms., the stylus life is nearer 20 playings for sapphire and a few hundred for diamond.

(Surely nobody wants to play any record 2,000 times? Once is enough for some of them.—G.A.B.)

### DESIGN DETAILS

Here we must leave the stylus, although it is probably the most important point in pickup design. (A Kelly pun, this.) The record and its relation to the stylus are our next consideration. Because the two channels are cut at  $45^\circ$  there is vertical as well as lateral modulation and one would expect the vertical velocities in extreme cases to be the same as lateral velocities, but the phasing system adopted in commercial recording, limits the low frequency vertical modulation to about 30 or 40% of the maximum lateral modulation on music recordings. It is therefore possible to reduce design requirements for a vertical compliance by a factor of approximately two; this is often done in domestic cartridges used on record players, and can possibly lead the way to "compatible" stereo discs—i.e., discs which can be played with a lightweight monaural cartridge without damage.

## CHANNEL SEPARATION

We have not yet discussed the question of channel separation, which, on the record, can theoretically be infinity. Up to the present, however, because of major difficulties associated with cutter design and the mechanical resonances of linkages, etc., which have not yet been eliminated, the channel separation is a maximum of about 25 dB, though this is still in advance of pickup design. It is fortunate that the channel separation, or, should we say, "cross talk" inside the human skull is only of the order of 15 dB. That is, if a telephone receiver is placed in, say, the left ear and is completely sealed so that no acoustic energy can be transferred externally to the right ear, the auditory sensation at the right ear is only about 15 dB lower than that of the left ear. This is in a large measure due to the conduction of sound through the bone structure of the cranium, and in my own experiments (incidentally using tape, because the cross talk is lower than disc) I have found that, providing the cross talk limit can be maintained greater than approximately  $-16$  dB to  $-18$  dB over a frequency range of 300 to 3,000 c.p.s., the cross talk can actually approach unity at frequencies above 8 Kc/s and below 100 c/s without substantially affecting the positional information. This is a great boon to both pickup and cutter designers because were a minimum 20 dB separation to be required over the whole of the frequency range, they would be in very serious trouble indeed.

## CRYSTAL PICKUPS

In this country, crystal pickups have formed the majority of the transducers offered to the public, the reason being that because two completely separate generating systems are used, the cross talk problems are considerably easier than in magnetic devices where, with one exception (namely, the Ortofon) the magnetic generating structures are very closely linked both magnetically and mechanically. We will therefore discuss the average type of crystal transducer that is being offered.

A standard cantilever stylus is used (except that it is made approximately equally compliant in all directions) and it then drives two crystal elements through a modified bridge system, see Fig. 7/3. The mechanical cross talk between the two units is a function only of the ratio of the compressional compliance to the flexing compliance.

N.B. All the curves in this chapter are related to 1 volt and therefore show the general level of pickup output as well as the output from each channel.

Fig. 7/4 shows the response of a typical Rochelle Salt crystal pickup.

## PICKUPS, TONE ARMS AND TURNTABLES

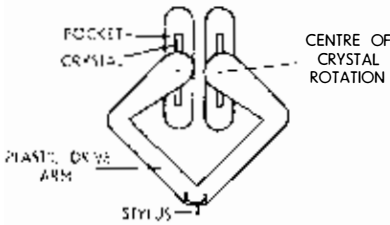

Fig. 7/3.  
Crystal drive system in stereo pickup.

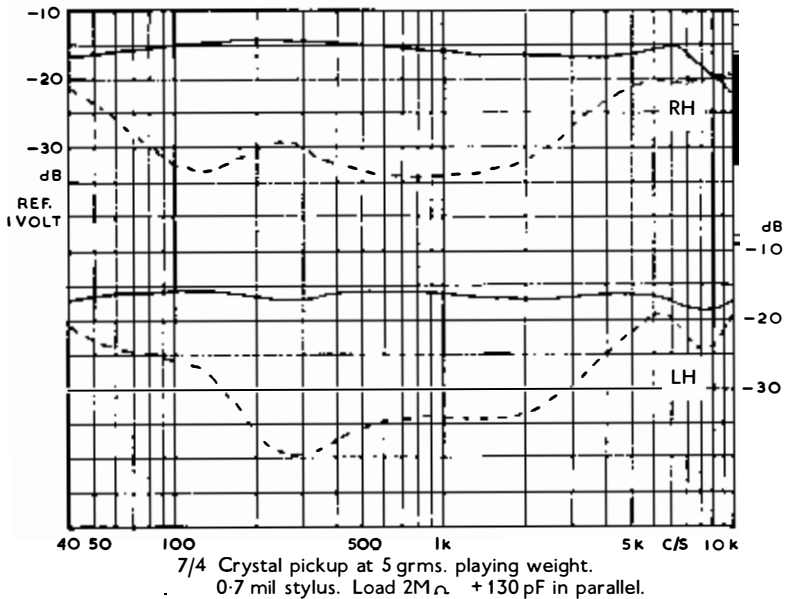

Fig. 7/4. Typical response curves and separation between channels of crystal pickup.

## CERAMICS

The construction of ceramic pickups is generally the same as listed above for Rochelle Salt units, except that bender crystals instead of torsional crystals are used. Until recently this was a considerable disadvantage in that the sensitivity and effective mass of the ceramic element were inferior to torsional Rochelle Salt crystals. With the advent of the new Lead Zirconate elements, these disadvantages have been largely negated and modern ceramic units

compare very favourably with Rochelle Salt units on the score of frequency response, voltage sensitivity and required playing weight, plus the merit of not being so easily affected by heat and humidity which can throw a stereo crystal type completely out of balance.

Fig. 7/5 shows the response of a typical ceramic pickup.

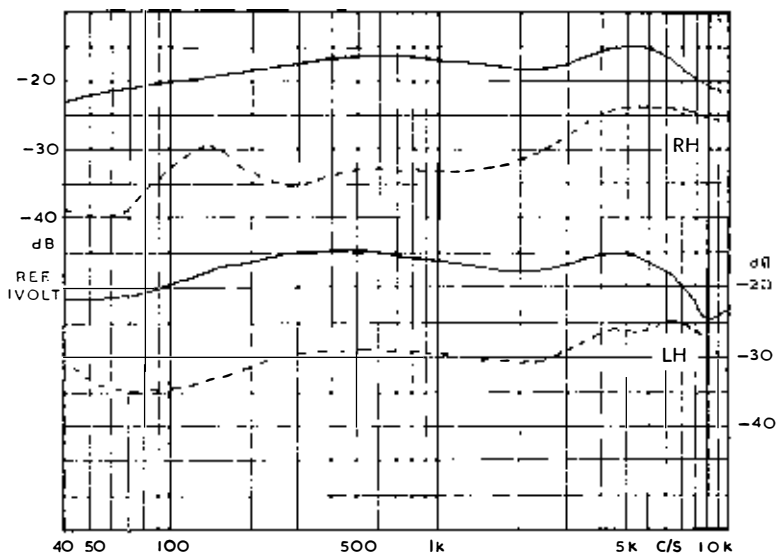

7/5 Ceramic pickup at 5 grms. playing weight.  
0.7 mil stylus. Load  $2M\Omega$  +  $130\mu F$  in parallel.

Fig. 7/5. Same as Fig. 7/4 but ceramic.

#### MAGNETIC TYPES

The magnetic cartridges can be divided into two main types: those in which the sensing elements work at  $45^\circ/45^\circ$  and those in which the sensing elements work laterally and vertically and by what is known as "sum and differencing" give a resultant output which is sensitive in the  $45^\circ/45^\circ$  direction, e.g. the Decca. The first type is shown in Fig. 7/6. This is a modification of the variable reluctance cartridge, in which the magnetic stylus member has to activate two sets of mutually perpendicular pickup coils and at  $45^\circ$  to the horizontal plane. This is theoretically a very simple mechanical structure but the attendant difficulties of reducing magnetic coupling (and hence cross talk due to this coupling) have exercised the ingenuity of designers both in Europe and in America.

PICKUPS, TONE ARMS AND TURNTABLES

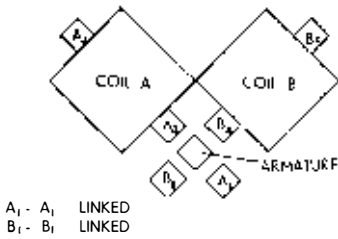

Fig. 7/6.  
Schematic of variable reluctance, balanced armature cartridge.

The response curve of a typical "variable reluctance" cartridge is shown in Fig. 7/6A. The major design difficulty with this cartridge is the coupling between the two channels due to a common magnetic element.

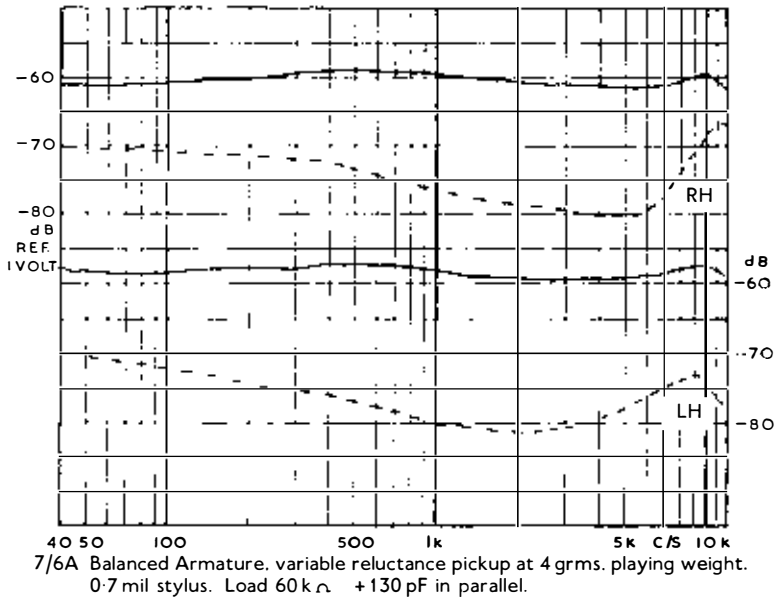

Fig. 7/6A. Typical response and separation curves of variable reluctance, balanced armature, cartridge.

MOVING MAGNET

A neat solution to this is to make the armature in the form of a magnet. The magnet, usually one of the high coercivity materials, has a very low reluctance, and in part acts as a shield between both sections of the unit. The cross talk is then reduced to 18 to 20 dB over the middle of the range, but because of the added mass of the magnet, the resonance of the system is usually about 9 Kc/s or, at the utmost, 12 Kc/s.

The magnet is about 1/8" long and about 1/16" square section and is magnetised along the length, the stylus cantilever protruding from one end. The bearing (or gimble) is usually in the form of a narrow rubber band surrounding the magnet about its centre of gravity. The magnet assembly is then placed in a tunnel formed by two pairs of pole pieces from the pickup coils, opposite faces being part of the same magnetic circuit. See Fig. 7/7. When the stylus is deflected in a 45° direction (say, left-hand channel) it will move the north pole nearer one pole piece ( $A_1$ ) and further away from  $A_2$ , the south pole moving in the opposite direction. At the same time it will be moving parallel to pole pieces  $B_1$  and  $B_2$  and thus, in theory at least, no voltage will be induced in the latter coil. Should the motion be 45° in the right-hand channel, maximum voltage will be induced in coil B and zero in coil A.

Response curves are given in Fig. 7/7A.

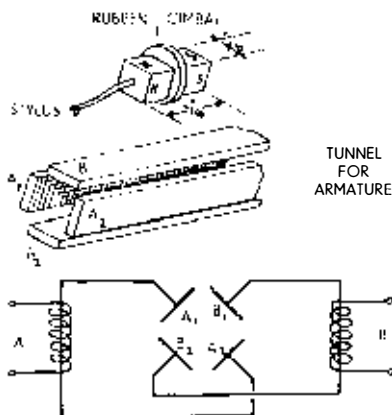

Fig. 7/7. Moving magnet layout and circuit

## PICKUPS, TONE ARMS AND TURNTABLES

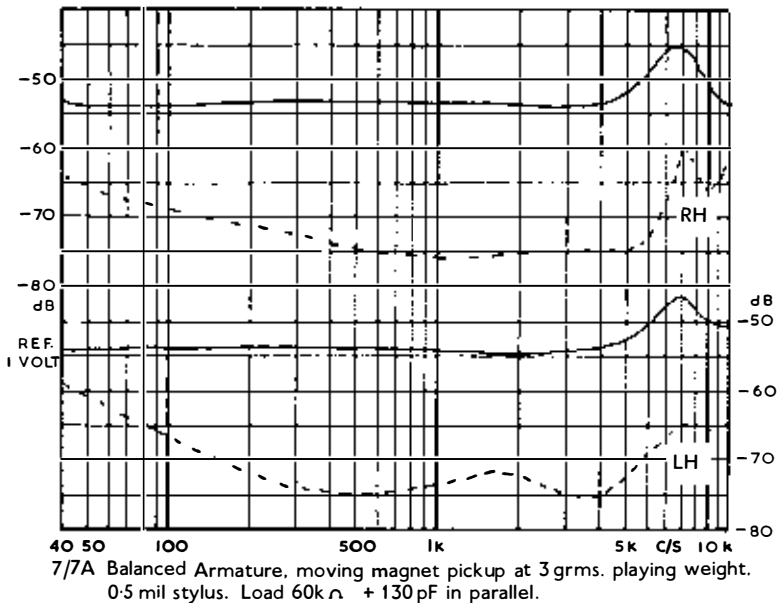

Fig. 7/7A. Response Curve of Pickup Type 7/7.

## PRODUCTION PROBLEMS

There are now a number of variations of magnetic pickups appearing on the market, and production wise the biggest difficulty is to produce units in which the channel sensitivities are within the necessary 1 to 1.5 dB, at 1,000 c/s. It is usual for the system to go out of balance by up to 3 dB or 4 dB at 12 Kc/s and up to 3 dB at 50 c/s. Without very strict control over production processes, and almost impossibly fine limits, it is impracticable to make cartridges with a better consistency than these figures. If, however, we decide in the magnetic case to go from the  $45^\circ/45^\circ$  to a hill and dale summation pickup, a lot of the difficulties can be resolved fairly easily.

## SUM AND DIFFERENCE TYPE

The  $45^\circ$  motion can be shown as two motions at  $90^\circ$  to each other, one vertical and the other lateral. We can therefore produce a pickup which instead of the sensing elements responding to  $45^\circ/45^\circ$  motions only, is designed to be sensitive to lateral and vertical



modulation, and by suitable circuitry to combine the output so that we get two outputs which are sensibly equivalent to the 45° motions. The term given to this is "sum and differencing". Fig. 7/8 shows the philosophy behind this idea. The three coils A, B and C are the lateral sensing coil and two vertical sensing coils respectively. The lateral coil (in theory, at least) responds only to lateral vibrations.

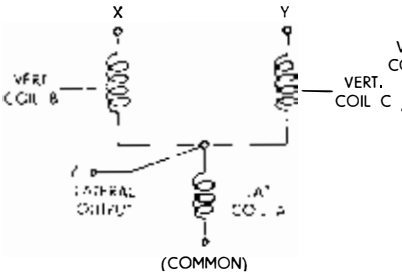

Fig. 7/8. Circuit of sum and difference cartridge.

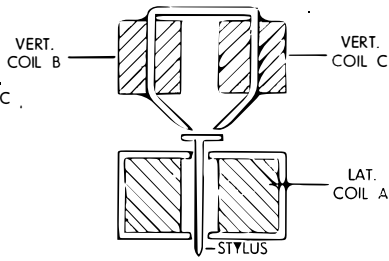
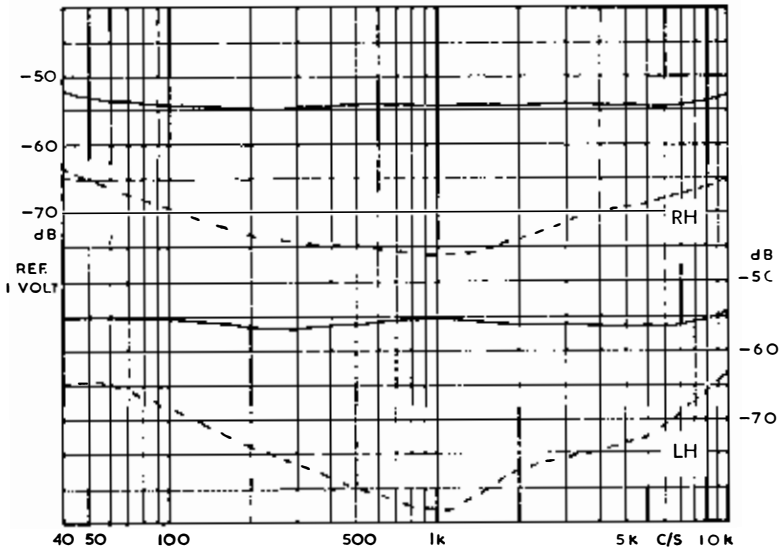

Fig. 7/9. Layout of "sum and difference" pickup. (Decca).



7/10 Decca pickup at 3½ grms. playing weight.  
0.5 mil stylus. Load 60 kΩ + 130 pF in parallel.

Fig. 7/10. Excellent performance of "sum and difference" cartridge.

## PICKUPS, TONE ARMS AND TURNTABLES

The two vertical coils will be sensitive to vertical impulses only, and for the same stylus velocity as the lateral (in their own sense, of course) will give equal voltages to the lateral, but will be reversed in polarity. Thus, if we have the stylus moving upwards and outwards, we will induce a voltage say, positive at Z and positive at X, but negative at Y. We shall thus get an output of two units from coils A and B and zero from A and C. Conversely, if the stylus is moving upwards and inwards, the sign of the voltage from the vertical coils will remain unchanged, but the sense of voltage from the lateral coil will be reversed; we shall therefore get zero voltage from coils A and B, and two units from coils A and C.

Fig. 7/9 shows the general configuration of this type of pickup. The coil at the bottom consists of about 5,000 turns of fine gauge wire and because a balanced armature is employed, the output voltage is sensibly free from vertical modulation. The two vertical sensing coils are placed above the cantilever and provision is made in assembly to vary the gap spacing between the armature and the pole piece assemblies. When this is done, it is possible to equalise the output between the two vertical coils and the lateral coil to better than 1 dB, then the cross talk is never more than 2 dB to 3 dB worse than that inherent in the record. The vertical output of the pickup will be sensitive to playing weight and this will affect the cross talk, but when correctly designed the cross talk should not deteriorate by more than 2 dB for a change in playing weight of 1 gm. Fig. 7/10 shows the excellent performance of a pickup of this type.

## MOVING COILS

Of the moving coil types, there are two main trends of thought. The first is one in which the two coils are wound 90° to each other in the form of a small ball, suspended at 45° to the horizontal and driven by a cantilever, as shown in Fig. 7/11, with typical response in Fig. 7/11A.

In order to bring the dynamic mass as small as possible, the coils are wound with wire only half-thou. thick and the assembly calls for extreme delicacy of manipulation. The alternative is to take two completely separate moving coil systems, mounted at 45° to the horizontal and drive them through a special form of cantilever, as shown in Fig. 7/12, with typical response curves in Fig. 7/13.

Incidentally, many listeners still like the "sound" of moving coil pickups.

PICKUPS, TONE ARMS AND TURNTABLES

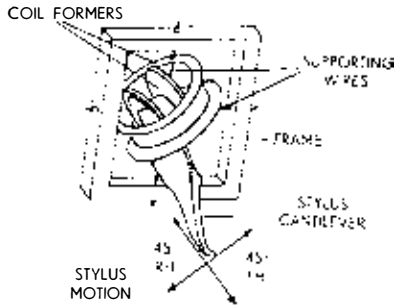
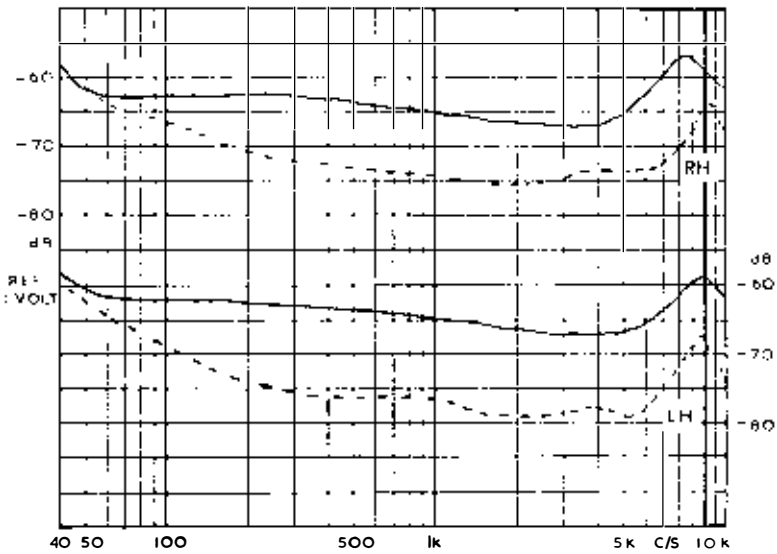

Fig. 7/11. Schematic of 45°/45° moving coil system.



7/11A Moving coil pickup at 4 grms. playing weight.  
0.7 mil stylus. Load  $2 M\Omega$  +130 pF in parallel.

Fig. 7/11A. Typical response curve of type 7/11.

PICKUPS, TONE ARMS AND TURNTABLES

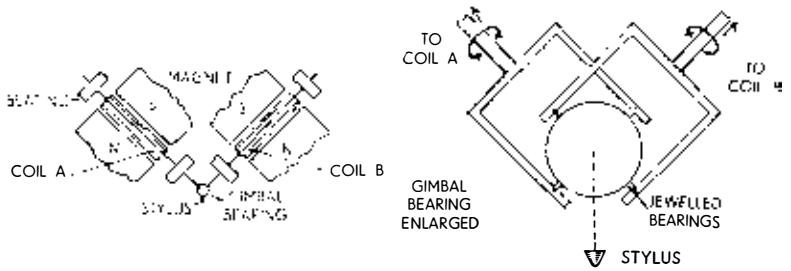
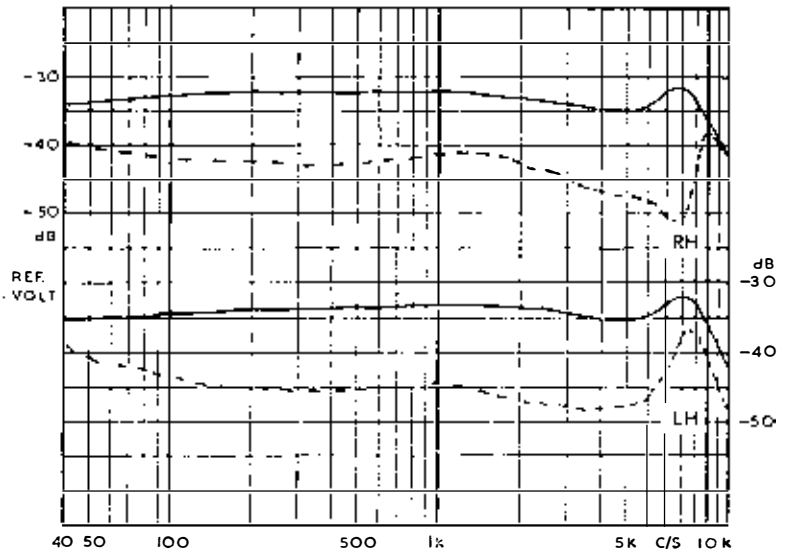

Fig. 7/12. Cantilever moving coil system.



7/13 Moving coil pickup at 3 grms. playing weight.  
0.5 mil stylus. Load  $2M\Omega + 130\text{ pF}$  in parallel.

Fig. 7/13. Response of moving coil cantilever system.

SUMMARY

CRYSTAL

To summarise: Crystal cartridges, both Rochelle Salt and ceramic, are characterised by an extremely high output, moderate

compliance and dynamic mass, and usually require playing weights of the order of 4 to 7 grms. The output is internally "compensated"—that is, correction circuits are not usually required in the amplifier proper and amplifiers with a sensitivity of the order of 0.25 volts for full output are adequate. It should be noted, however, that the input impedance of these amplifiers should be a minimum of 0.5 megohm and preferably in excess of 2 megohms. Reducing the input resistance of the amplifier reduces the bass response of a cartridge, and this fact is sometimes made use of where it is required to feed a crystal cartridge into an amplifier which has been specifically designed for a magnetic (or velocity type) pickup. Generally, the cartridge has to be shunted with a resistance of about 25,000 ohms to convert it from an "amplitude operated device" to a "velocity" one.

#### MAGNETIC

Magnetic pickups usually have an output of the order of 30 to 120 m.V. at full modulation and require a fair amount of amplification. Because they are strictly velocity operated devices, the necessary correcting circuits must be built in to the amplifier and precautions must be taken against the introduction of hum, either due to magnetic pickup from the gramophone motor or to "earth loops". A notable case occurred when the author fitted two high quality power amplifiers in the base of the equipment cabinet, situated about 18 inches below the pickup. A strong 100 c/s hum was noticed, which could not be eradicated until it was found to be due to the magnetic field of the smoothing chokes. Turning one of the amplifiers through 180° resulted in almost complete cancellation of this hum, which, incidentally, says something for the consistency of the chokes (and their attendant fields) of this particular make of amplifier.

Moving coil pickups, which have a source impedance of only a few ohms, require a matching transformer of between 250:1 and 400:1 in order to bring their output voltage to the same order as that of the magnetic cartridges. These transformers, which must be specially shielded against hum, are expensive, but moving coil enthusiasts are adamant that the allegedly superior results obtained from this type of instrument justifies the very special precautions which must be taken to secure hum-free reproduction.

Unlike the crystal cartridge, the magnetic unit does not require a very high input resistance from the pre-amplifier, a value of about 50,000 ohms usually being adequate. Reducing the input resistance of the amplifier reduces the high frequency response of the pickup and this is sometimes used to reduce the effects of the 12 Kc/s resonance often found in present day stereo cartridges. S.K.

Thank you, Mr. Kelly, for a very erudite contribution.

## PICKUPS, TONE ARMS AND TURNTABLES

The following curves, prepared by Mr. Kelly but not referred to in his text, will help to illustrate some of the points made. Fig. 7/14 shows a pickup with a severe resonance in the 7 Kc/s region, resulting in a total loss of separation, followed by an illegal crossing of the white line.

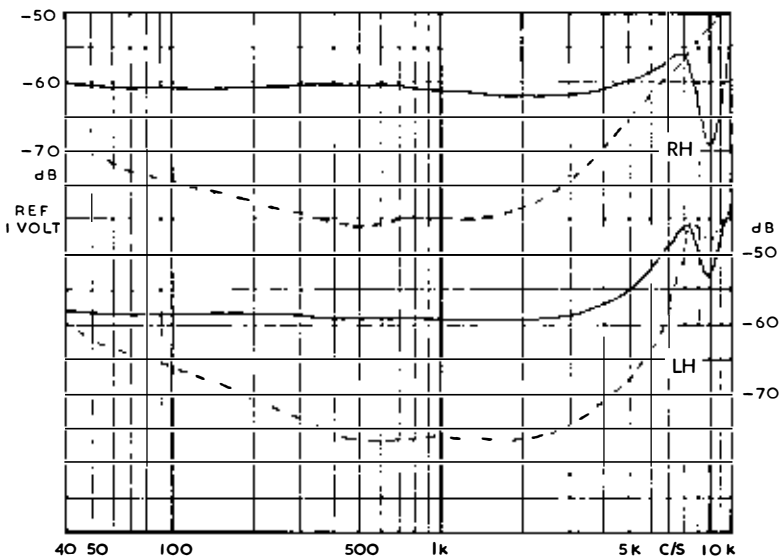

7/14 Variable reluctance pickup at 4 grms. playing weight.  
0.5 mil stylus. Load 60 k  $\Omega$  + 130 pF in parallel.

Fig. 7/14. Devastating effect of severe resonance.

In Fig. 7/15 we have a moving coil type with a more gradual rise at about 7 Kc/s, showing that separation tends to diminish as resonance is approached.

The graphs of Fig. 7/16 show nice clean results from an American moving magnet design of which Mr. Crowhurst speaks favourably in Chapter 2.

It will be observed that pickups with the lowest output usually give the best results.

### PLAYING WEIGHT

To refer once again to this question, I still find that theory and practice are often 1 or 2 grms. apart, and if records wear out after

## PICKUPS, TONE ARMS AND TURNTABLES

much use they are no worse than men's suits or motor car tyres. So far as listening goes, it usually sounds better to play at 1 gm. too much than 1 gm. too little weight.

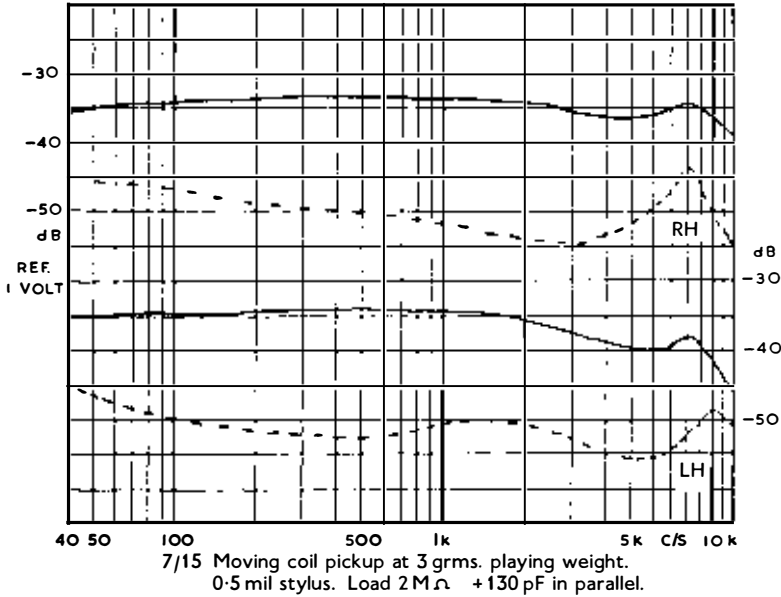
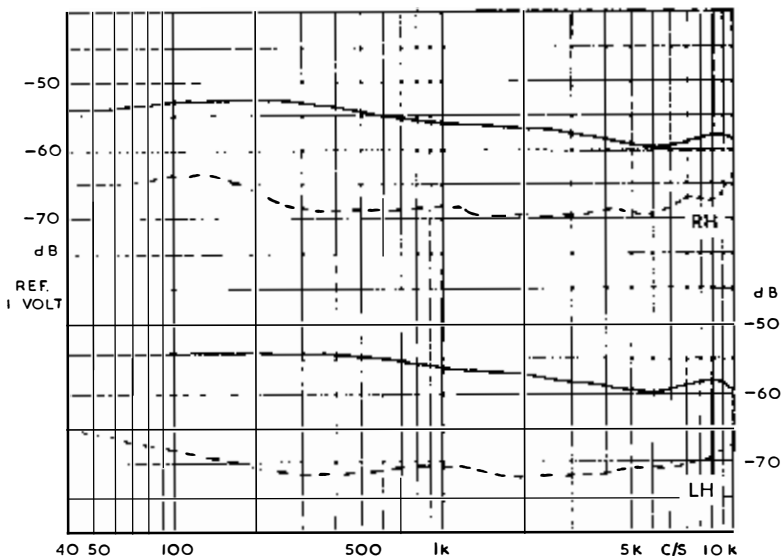

Fig. 7/15. Resonance less severe.

## SEPARATION

A study of the various response curves reveals that some pickups have a 20 dB separation between channels in the middle registers, falling to say 5/8 dB or less at about 8 Kc/s, whereas another model may have fairly even separation at 10/15 dB over the full range. I asked Mr. Kelly which he prefers and he replied: "Definitely the latter, because harmonic distortion is not transferred from one channel to the other. Assuming distortion at 4,000 c/s in the lateral sense, the harmonics at 8,000 and 12,000 c/s would be produced also in the vertical channel if the separation has disappeared, thus increasing any 'tizzy' effect."

## PICKUPS, TONE ARMS AND TURNTABLES



7/16 Moving magnet pickup at 4 grms. playing weight.  
0.7 mil stylus. Load  $60\text{ k}\Omega$  +130 pF in parallel.

Fig. 7/16. Clean performance with moving magnet type.

## COMPATIBLE RECORD

I was interested to note S.K.'s reference to a compatible record—an idea which must have been engaging the attention of recording engineers from the start. There can be little doubt that, if practicable, it would solve many problems, especially for dealers who have to double their stock items in buying mono and stereo versions of the same recording.

The LP record was saved by the fact that 2-speed turntables were available. Then 3-speed versions saved the 45 rpm type.

The tape situation has developed into a schmozzle for the simple reason that there are too many types and speeds and dealers just don't know which it would be safe to put into stock.

It is made abundantly clear in Chapter 14 that the success of broadcast stereo will depend on the world-wide adoption of a compatible system.

If a compatible record came along, we could have improved mono pickups with reasonable vertical compliance. The user would



go right ahead buying records, adding an extra speaker, then a stereo amplifier and finally a stereo pickup for optimum results. There would be little obsolescence and the business would be on a much sounder basis, although I am quite sure it is all more easily said than done.

## TONE ARMS

As the majority of high quality pickups are now supplied complete with tone arms—which must to some extent suit the particular pickup—we cannot do better than outline the main requirements for satisfactory results.

The stereo cartridge is sensitive to vibrations in the vertical plane, therefore the arm should be balanced vertically as well as laterally. Additionally, because of the low playing weight required, the bearings must be as free as possible; whilst, finally, it is essential that the vertical pillar supporting the arm be truly vertical. Although great care is often taken to ensure that the gramophone turntable is exactly level, it is usually taken for granted that the main bearing of the pickup will be at  $90^\circ$  to the turntable. This is rarely so, and often the centre line of the main bearing may be anything up to  $2^\circ$  off vertical. This can result in a side thrust equivalent to 30 or 40% of the playing weight. Where possible, the tone arm should be balanced so that it does not tend to swing either inward or outward from the centre of the record (even though the turntable itself may then be not quite horizontal).

### TONE ARM RESONANCE

Many tone arms introduce irregularities into the frequency response in the 200-800 c/s region due to torsional resonances.

Fortunately, the trouble tends to diminish with playing weight, and quite a light tubular arm is usually satisfactory with pickups tracing at  $3\frac{1}{2}$  grms. or less.

### BEARING FRICTION AND SIDE THRUST

The importance of low bearing friction in reducing side thrust is obvious, and as playing weight is reduced bearing friction becomes more of a problem. Systems depending on lubricants may be satisfactory in temperate climates, but in hot countries the lubricant dries up with alarming results, unless facilities for cleaning and re-oiling are available.

Some of the best tone arm designs employ a single pivot giving both lateral and vertical freedom. Such an arrangement is virtually foolproof and is easily dismantled for cleaning and re-lubrication.

## PICKUPS, TONE ARMS AND TURNTABLES

In fact, the unipivot for stereo disc use is usually considered to be in a class by itself.

In any case, lubrication of moving parts is always essential, and a virtue may be made of necessity by introducing a viscous fluid or grease into the tone arm bearings to reduce both lateral and vertical low frequency resonances. As the viscous damping medium may ultimately thicken and increase friction or migrate from the moving parts, methods of renewing the grease are desirable.

## OFFSET ANGLE

A certain amount of side thrust is developed by the pickup head offset angle and the stylus/groove friction. This is a variable quantity depending upon playing weight and groove modulation. Any attempt to compensate for this particular brand of side thrust by deliberately introducing friction into the lateral bearings or by tilting the motor board must represent at least 50% compromise and will probably do as much harm as good. The best plan is to select an arm with low bearing friction, instal it carefully, and let the offset side thrust take care of itself.

## TRACKING ERROR

Like the Doppler effect in loudspeakers, tracking error is a minor fault which has received major emphasis. As was shown in *Sound Reproduction* about seven years ago, a 12" tone arm with properly adjusted pickup head will pass through zero tracking error twice during the playing of a 12" record, with less than 2° error at the worst position. We have yet to meet a pair of ears that can identify this position on a music listening test. Mr. Kelly says the distortion could be as high as 6% on certain types of input and the reason we cannot detect it is that loudspeakers are producing still more distortion. (I don't believe this but I can't disprove it.)

## CONSTANT PLAYING WEIGHT

The majority of records are slightly warped, and unless the tone arm is correctly designed and installed the resultant rise and fall of the pickup head will cause variations in playing weight. Such variations can be serious with stereo pickups because the vertical output is affected in some types.

Tone arms which employ springs are theoretically superior to those fitted with counterweights, but in practice their advantage is often lost due to friction and other defects which influence downward pressure.

## PICKUPS, TONE ARMS AND TURNTABLES

Variations in playing weight can be minimised by keeping the centre of gravity of the arm level with the vertical pivots. This ensures the least vertical inertia for a given arm construction as depicted in Fig. 7/17.

Steel turntables should not be used with magnetic pickups as they attract the magnets, producing variations in downward force according to separation.

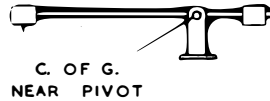

Fig. 7/17. A counterbalanced pickup with cartridge and weight located coaxially.

### ARM ADJUSTMENT

With stereo pickups it is absolutely essential to keep the cartridge parallel with the record surface in both directions (latitude and longitude). If this is not done, stylus movement will not be at the correct angle relative to the record groove and distortion will occur. Worse still, left hand information will appear in the right hand channel and vice versa, causing an increase in cross talk. When installing a pickup the tone arm must therefore be level with the motor board or otherwise, as directed by the manufacturer. With offset pickup, incorrectly aligned arm causes cartridge to tilt in two directions.

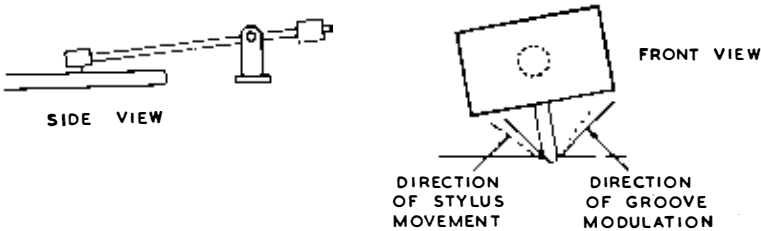

Fig. 7/18. Effect of misalignment.

## TURNTABLES

The advent of long playing records some seven years ago revealed deficiencies in gramophone turntables—mainly in respect of rumble and wow—which did not show up at 78 rpm. A revision of design and construction with finer production tolerances overcame the trouble and so-called transcription models have proved to be satisfactory for mono reproduction.

## PICKUPS, TONE ARMS AND TURNTABLES

### RUMBLE

Stereo has produced further difficulties because of the pickup's response to vertical vibrations, and rumble, not previously suspected, is often heard through the loudspeaker. The eradication of vertical rumble demands another step forward in design and construction, and we need to look with suspicion on the excessive use of spring mounting, which often aggravates the trouble.

A good method of absorbing vibration is to increase the mass, as in loudspeaker enclosures, and we might learn a lesson here from the old cotton and woollen mills of Lancashire and Yorkshire, in which the vibration of huge engines was absorbed by mounting them on massive beds of concrete. With spring mounting, the engine would soon have crept out of its shed, through the mill and into the next village. (At least, this is what Mr. Arnold Sugden of Brighouse tells me!)

### SPEED VARIATION

Some turntables depend upon accurate mains input voltage for a correct running speed during use. In most civilised countries today, the mains voltage is sufficiently well maintained for the playing of records with such turntables, as not one listener in 50,000 can detect a minute change of pitch. I notice that *Consumer Reports* (U.S.A.) for October 1959 condemn certain turntables for this possible variation in speed, which strikes me as rather unfair. They ought to blame the purveyors of electricity who fail to deliver the goods properly. (We might as well condemn fireplaces in England which will not burn slate.)

Variations in line voltage affect the performance of other electrical devices, including valves and amplifiers, and in countries where the voltage varies noticeably there is a healthy local industry in the manufacture of regulating transformers. When the C.U. back room boys tested amplifiers did they complain that they were affected by line voltage and should be supplied with regulating devices? No, they didn't.

A control unit which we have found useful for maintaining accurate pitch with tape or disc, is illustrated in Chapter 13, Fig. 4.

### STYLUS DRAG

Another subtle form of speed variation may be produced by a heavily modulated groove in a stereo record. This imposes an appreciable dragging force on the stylus, and may even cause a noticeable drop in pitch on loud passages with some turntables, due to slipping in the drive mechanism or a motor which is not

strong enough to handle the load. A heavy turntable helps to smooth out the effects of sudden stylus drag, and playing weight *must* affect the issue. (I don't suppose our friend and counsellor Percy Wilson ever stops the traffic in Oxford when he plays at 1 grm.)

#### HUM

Some of the best stereo pickups have fairly high impedance coils which are sensitive to hum so often produced by the turntable motor. This shows up worst when high volume levels in large rooms or concert halls have to be used. Our tests reveal differences of as much as 12 dB between one motor and another, as outlined in Chapter 6, and this *is* a problem which should be watched by turntable makers.

Strange to relate, the *Consumer Report*, to which reference has already been made, did not mention hum as a possible fault in turntables and such an omission makes one wonder whether the tests are made by practical men, or by starry-eyed theorists who often fail to assess performance in the qualities that really matter to the user. To get down to cases, we are using for concert hall demonstrations a model condemned by them on all counts but hum—which they ignored. We must have hum-free conditions for stereo discs.

#### CONCLUSION

Stereo cartridges, tone arms and turntables today are by no means perfect, but the strides taken over the past two years have been enormous and the steady improvement in quality is apparent in new products as they come from the factories.

It is obvious that, after their experience in designing stereo models, pickup makers could now produce a superb mono cartridge which would be superior to any existing pickup for use on mono records. As it is easier to drink out of one cup than simultaneously out of two, such a pickup would be simpler, more robust and less costly than a stereo version, and would I feel sure, meet with a good demand.

After all, there are millions of mono records in existence, and the production rate of stereo discs - at least in Great Britain - is still not more than 10% of the total output. To pretend that mono is dead, or to buy a stereo pickup to play mono records, is rather like trying to use both eyes with a microscope and pretending it is a pair of opera glasses.

## CHAPTER 8

### RECORD AND STYLUS WEAR

The contents of this chapter have been contributed by Mr. Cecil E. Watts, than whom I know no greater authority on the questions involved. So here goes C.E.W.

Record wear as we used to know it caused by dust and other abrasive particles in the groove grinding away the stylus until it first loses its polish and gradually its shape. To wear away the surface of the groove walls, has ceased to be much of a nuisance for any but the careless user.

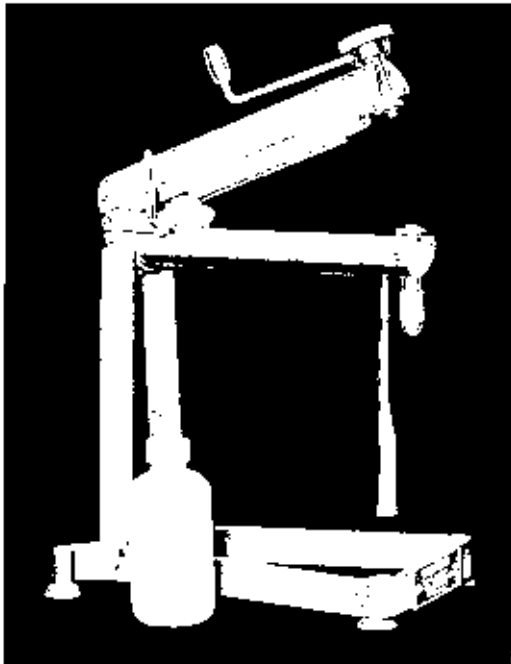

**Fig. 8/1.** Parastat machine for cleaning records and making them anti-static.  
*(C. E. Watts, Sunbury-on-Thames).*



Fig. 8/2. Silk threads attracted by static on record.

Treatment for the prevention of static charges and the use of modern accessories make it no longer necessary to endure the pernicious effects of dust causing noisy backgrounds and blocking the delicate movements of stereo pickups, but even though the record is perfectly clean to start with the careful user must still continue to remove a certain amount of loose matter which collects in the record groove during playing.

This is mostly airborne lint and small fibres but a proportion is observed to be produced from the groove itself. Minute particles are constantly being scraped from the groove whenever the recorded velocity produces a lateral or vertical pressure on the stylus exceeding the strength of the record material.

Cleaning the record with a cloth or tissue may seem satisfactory for average purposes. Some impregnated cloths do also in fact remove static for quite a long time, but there is always a considerable amount of extraneous matter left in the groove.

## RECORD AND STYLUS WEAR

### CLEANING DISCS

To do the job properly, all records should be cleaned and rendered anti-static by PARASTAT treatment in the machine illustrated in Fig. 8/1.

Many record dealers are now equipped with this machine and give valuable service, but the pads must themselves be thoroughly cleaned after each half dozen records have been treated.

Fig. 8/2 shows a record attracting the silk threads on the machine, prior to anti-static treatment.

During the playing of a record, the Dust Bug, freshly dabbed, should be used. This is illustrated in Fig. 8/3.

(Mr. Watts estimates that 250,000 people use Dust Bugs. If I could only get into the habit of using mine, the number would be 250,001.—G.A.B.)

The amount of dust etc. collected during one playing of a 12" record is shown in Fig. 8/4.



Fig. 8/3. (Above)  
The Watts Dust Bug.



Fig. 8/4.  
Under-side view of Dust Bug, after one playing of "clean" 12" record.



## DUST ON STYLUS

The heavier pickups rake a lot of dust out of the grooves and the amount collected on the stylus is a good guide to the state of affairs, but any such accumulation can result in an appreciable amount of distortion with lighter types of pickup.

Fig. 8/5 shows the accumulation of foreign matter collected around the stylus movement of the Decca stereo pickup after playing one side of a record "cleaned" with an impregnated cloth. Fig. 8/6 shows the amount collected during the first playing of a record after Parastat treatment. Normally this collection diminishes with each playing but should it persist it is a sure sign that something is very wrong and it would be wise to send a specimen record to a consultant for an opinion. (Not to me, please, because I am a patient—not a consultant.—G.A.B.)

Fluids of all kinds have been shown to be harmful in that the non volatile varieties bind and hold any dust in the groove to form a sticky mess through which the stylus must be dragged, while the volatile types dissolve anything soluble, which is then precipitated on the groove wall on drying.



Fig. 8/5. Stylus of Decca pickup after one playing of 12" record "cleaned" with an impregnated cloth. "You can't see me for dust" says the stylus. Magnification 50X.



Fig. 8/6. Same as Fig. 8/5 but record cleaned with Parastat. Magnification 50X.

## RECORD AND STYLUS WEAR

### PLASTIC RECORDS

The material from which LP and stereo records are made is necessarily soft and resilient. It behaves as a cushion to the hard stylus in much the same way as a motor tyre cushions the car from the shocks of the road surface, providing a quiet contact. If both the stylus and record were equally hard they would very quickly destroy each other, producing quite a lot of noise from the speakers in the process.

If the groove is well formed to begin with and the best type of pickup available is used and is behaving as the makers intended, there is for all practical purposes no *audible* change likely to occur even after many playings of records having average recorded velocities.

During fortissimo passages, or wherever the stylus requires to be accelerated violently, even using the best pickups, the elastic limit of the record material can be exceeded and a slight physical distortion of the groove takes place, at first as an indentation. With increased velocity the groove wall is ploughed through or shaved away until the acute contours of the waveform are reduced to something around which the stylus can be forced without further damage to the groove wall.

### PLAYING WEIGHT

It is sometimes thought possible to adjust the downward pressure on the stylus to less than that recommended by the manufacturer in order to reduce any likely damage to the record. It may be that, when tested with a frequency disc, the output from the pickup will be accurate enough, but it should be remembered that the recorded velocity of these test records is only a fraction of that encountered in general use. It is more than likely that if the pressure is insufficient to maintain contact between the groove and stylus, the latter will climb up the walls and bounce from crest to crest in the groove whenever it exerts a force exceeding the vertical pressure.

### GROOVE DAMAGE

With the more robust types of domestic pickups, even with moderate modulations, quite a lot of change in groove shape occurs in the first few playings of the record without anyone being much the wiser. The effect is unlikely to be noticed in the loudspeakers usually associated with these pickups. The record is, however, permanently degraded for any better type of reproduction.

Unless the minute particles of extraneous matter produced in this way are removed they are likely to collect in the bottom of the groove and cause the stylus to pass over or around them with a loss of accuracy in tracing and quality of reproduction.

With continued playing, and if kept clean, the record groove settles down to the requirements of any particular pickup and little further production of this form of dust occurs unless a change in the type of pickup used causes the process to commence all over again.

#### ACTUAL TESTS

The next two photomicrographs show the result of tests made with a mono and stereo record of the same piece of dance music.

Fig. 8/7 shows the effect of the stylus tracing a mono recording of a side drum beat. The four sections A B C D are from separate records which have been played as indicated. The increasing amount of debris can be observed, although D would be considered somewhat abnormal for this type of pickup.

Fig. 8/8 is the result of the same kind of test on the stereo version of the same sound. Section D is included to show the damage which can be caused to stereo records when the wrong type of pickup is used. No audible change was observed during the tests of sections A, B and C.

Note damage caused by mono cartridge due to lack of vertical compliance.

Moving coil pickups were used for both tests.

#### FINE POINTS

The use of a half mil stylus is sometimes a mixed blessing if many of the records to be played have been produced more than a year or so ago, or have previously been played with a larger radius stylus. Better reproduction would probably be obtained by using a 1 mil stylus.

#### FINE GROOVE FORMATION

During the past year the groove form of both mono and stereo records shows a very marked improvement. Fig. 8/9 shows at A one of the best examples of groove formation from a mono recording of a year or so ago, and for comparison at B a similar waveform from a record of recent issue. The improvement in form is unmistakable.

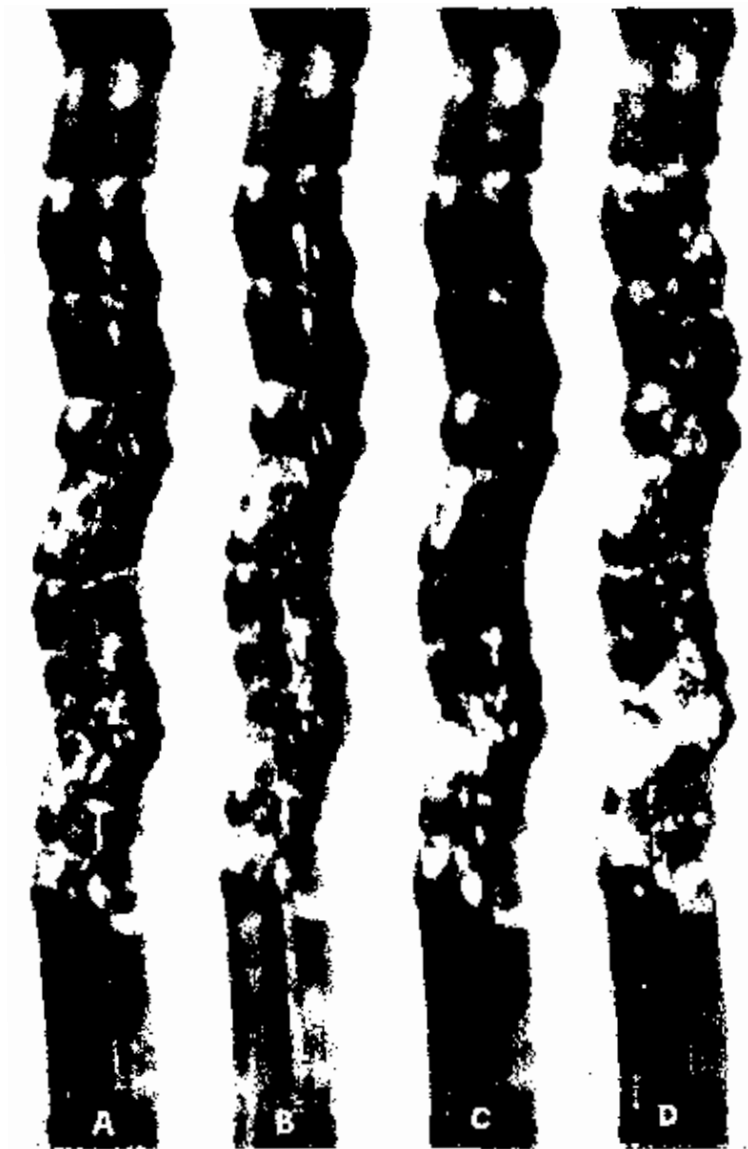

Fig. 8/7. Mono record, Drum Beat.

A — New copy.

B — Played 12 times with stereo pickup at  $3\frac{1}{2}$  grms.

C — " " " " mono pickup at 4 grms.

D — " 50 " " stereo pickup at  $3\frac{1}{2}$  grms.



Fig. 8/8. Stereo version of 8/7.

A — New copy.

B — Played 12 times with stereo pickup at  $3\frac{1}{2}$  grms.

C — " 12 " " stereo pickup at 6 grms.

D — " 6 " " mono pickup at 4 grms.

RECORD AND STYLUS WEAR



Fig. 8/9. Excellent mono grooves.  
A — One year ago.  
B — To-day's high standard.



Fig. 8/10. Groove of Fig. 8/9B.  
A — After 10 playings with stereo pickup, .5 mil stylus at  $3\frac{1}{2}$  grms.  
B — After 10 playings with mono pickup, 1 mil stylus at  $3\frac{1}{2}$  grms.

## RECORD AND STYLUS WEAR

## RECORD AND STYLUS WEAR

Fig. 8/10A is the same section as 8/9B after having had Parastat treatment and 10 playings with a .5 mil stylus at  $3\frac{1}{2}$  grams. It well illustrates the ability of the best stereo pickups to trace accurately at very high velocities.

Fig. 8/10B is again of the same section (from another copy of the same record) after playing 10 times with one of the best types of lateral pickup. It shows where the one mil stylus at the same pressure was unable to adequately trace the waveform and at the point of highest velocity, i.e. where the stylus was forced to change direction most rapidly the waveform had already been slightly ploughed through.

(After the damage we did in Fig. 8/8D, I must say that 8/10B still looks pretty good to me.—G.A.B.)

## FAULTY GROOVES

False signals are often very confusing from stereo records and an example of what sometimes occurs is illustrated in Fig. 8/11 where the stamper from which the record was pressed has broken away, producing a hillock in the bottom of the groove. The stylus passes sometimes one way and sometimes the other with a consequent confusion of sound from the speakers. Dust does of course cause the same effect.

## FAULTY PICKUP

Due to the plastic nature of the record a badly adjusted pickup can cause enormous damage to the record groove without much apparent distortion of the reproduced sound. Fig. 8/12 shows where, for some reason best known to itself, the half mil stylus has embossed its own new track along the right hand wall of the groove. It is amazing that many listeners still judged the reproduction from this record to be excellent stereo.

One is inclined to think however, that the reproduction could have been much improved if the pickup had accurately traced the original groove.





Fig. 8/11. Faulty groove causing confusion on stereo.



Fig. 8/12. Double track formed in stereo groove by faulty pickup action.

## LONG LIFE

Examples of faults and damage, while contributing to an understanding of the possibilities, can perhaps be misleading unless counter-balanced by an illustration of the normal behaviour of most records. Fig. 8/13 shows a section of a new stereo record and 8/14 the same section after more than 150 playings.

Obviously the conditions here were excellent as there is very little visible difference between the two and it is certain that no audible change is yet discernible.

## CONCLUSION

The examples illustrated have been subscribed from many authoritative sources and have been selected to provide the widest information on the general performance of stereo records over the past year. The degree of perfection already attained in the manufacture of records can be assessed when it is remembered that the actual physical size of the grooves illustrated is often less than the thickness of a human hair and that the tip of the stylus is much smaller still, also that the highest frequencies shown are well beyond the perception of the average ear.

Further improvements will no doubt be made, but if the foregoing assists in a better understanding of the progress towards perfection and shows the need for more careful treatment than ever before, then it will have served its purpose.

The gramophone record is still the finest vehicle for the reproduction of sound. The losses introduced during the transfer of the original tape to the final pressing are less than half those introduced when copying the original tape to another, even at the same speed.

The best reproduction from the record, when compared to the original tape reproduction is indistinguishable and can be accomplished at less than a tenth of the cost.

It is certain that all other forms of reproduction take second place once the thrill of well reproduced stereo from records is experienced.

CECIL E. WATTS.

\* \* \*

There we have the gospel of clean disc stereo according to C.E. Watts. Although I would not agree that the best disc is equal to a 15"/sec. tape duplicate, it is much cheaper and handier to use, and all the advice from Mr. Watts is worthy of our attention.



Fig. 8/13. New stereo record.



Fig. 8/14. Same as 8/13 but after more than 150 playings with Decca pickup.

## RECORD AND STYLUS WEAR

### PRECAUTIONS

In order to enjoy the wonderful results pictured in Fig. 8/14 it is necessary to ensure that everything is in perfect order. The records must obviously be kept clean and the pickup must be a high class instrument played at the weight recommended by the makers. (They ought to know). The tone arm must be carefully mounted and free to swing laterally at the correct height, with the pickup head absolutely level. Any tilting is fatal to results. A pickup lowering device is a useful aid in the careful handling which such fine and delicate instruments require and deserve. Never flick the stylus with the finger to see if it is working; just tap the case. Remove dust with a fine camel hair brush.

### PHOTOMICROGRAPHS

All the groove pictures are at 250X magnification and the direction of rotation of the record is downwards.

A human hair photographed with the same magnification is shown in Fig. 8/15.



Fig. 8/15. Human hair, magnified 250X, for comparison with previous photographs.

ACTUAL EXPERIENCE

Towards the end of the Northern Audio Fair at Harrogate in October, 1959, Mr. John Collinson of Acoustical Mfg Co. Ltd., informed me that they had played one excerpt from a stereo record (Decca, Pirates of Penzance) more than 100 times during the Fair, using a pickup at  $3\frac{1}{2}$  grms. playing weight, and that they had never previously been able to use any record - mono or stereo - to such an extent. I then listened to the record myself and could detect no trace of distortion.

This confirms that, given the best condition of use, record and stylus wear will no longer bring rapid repeat orders to the makers of these commodities.

PLASTICS

Records are now being produced by R.C.A. in America in a new anti-static material which should greatly reduce the dust problem on LP and stereo discs, as this plastic becomes more generally used.

**STYLUS WEAR**

As it is presumed that readers will use diamond points at a reasonable playing weight, and as Mr. Watts reports that he has not yet come across a worn specimen in the half thou. class, there would seem to be no point in enlarging on the subject.

## CHAPTER 9

# AMPLIFIERS

As very few people who go in for stereo today build their own amplifiers from circuit diagrams, this chapter is limited to a general outline of requirements. I asked Ralph West to give us his views, as he devotes quite a lot of time to testing stereo equipment of one sort and another, and his ideas have been pooled with our own to produce the following guide to stereo starters.

### GENERAL REQUIREMENTS

The amplifier is probably the one link in the chain which is approaching finality in design, and there are many really good ones available today, with little likelihood of becoming obsolete in a few years. Even if transistors come into fashion, they can't sound any better than existing high grade valve amplifiers, and as to printed circuits, any application of this modern touch to hi-fi equipment would drive service engineers round the bend and leave listeners very often in the lurch.

#### POWER

The first question is how much power do we need?

Before answering, we ought to explain that we refer here to watts in terms of RMS or British rating, whereas in the U.S.A. it is customary to refer to peak values which give a figure twice as big. Thus a 5 watt amplifier here would be rated as 10 watts over there. Also, in high fidelity equipment, we mean 5 watts undistorted output over a wide frequency range, say 30 to 20,000 c/s.

Most domestic radio sets produce 3 or 4 watts output (over a limited frequency range of perhaps 60 to 12,000 c/s). Even with the small and cheap loudspeakers normally fitted, 4 watts can deafen the household and annoy the neighbours, especially if there is some distortion.

Practically all the loudspeakers we would admit into the high fidelity category will produce more sound from the 4 watts, so a stereo amplifier giving 5 watts per channel is adequate for the average sized room. Most of the time the output is under 1 watt; only



occasional peaks of sound are likely to evoke anything approaching the full output. Even if these peaks slightly exceed the maximum, the distortion produced is of such a temporary nature that it often passes unnoticed. Eight to ten watts maximum output per channel is better as there will be no distortion on peaks at full domestic volume with speakers of reasonable efficiency.

In the U.S.A. the average amplifier—like the average car—is rather larger than ours, “rather” meaning in many cases about 100%. This is due perhaps to a different fashion in loudspeaker design. While we have tended to aim at producing very efficient loudspeakers fitted with big and relatively costly high-flux magnets, our American hi-fi cousins have tended to use less efficient speakers driven by bigger amplifiers. Looking at the question the other way round, if you have a 50 watt amplifier, or a pair of 25’s for stereo, you don’t need very efficient loudspeakers in order to blow the roof off.

#### CHANGING TO STEREO

Many readers who already have one good amplifier may wish to proceed gradually in the direction of stereo. Probably the best plan is to start with the addition of a second loudspeaker and run them both from the one amplifier, and enjoy at least “demi-semi stereo”. If the amplifier has 15 ohm and 7 ohm outputs, use the latter for ideal matching, but this is not critical. If you still use the 15 ohm output, distortion at full output will only increase say from 0.1% to 0.2%, but the effective power will be reduced by mismatching.

The next move would be the amplifier change. There is no need to sell the main amplifier and start afresh, as a second amplifier can be obtained; not necessarily an identical one, though that is probably more convenient. Any two good amplifiers can produce results that are indistinguishable from each other. They do not even need to have the same output power rating. The balance control on the preamplifier will balance up the two signals.

The preamplifier with its various controls may have to be pensioned off, although it is possible to use two separate preamplifiers. (We often do, as we like two full sets of controls in spite of considerable inconvenience in use.) Most amplifiers will give full output for an input signal between about  $\frac{1}{4}$  and 2 volts. Most preamplifiers, stereo and otherwise, will produce an output signal of at least 2 volts from the various inputs. It would be better to choose the preamp and new main amplifier from the same maker, as half the inter-connecting plugs and sockets at least will be right and link up properly.

## AMPLIFIERS

### PREAMPLIFIERS

This is really the most important section of the amplifying equipment. It is the part we see and handle, and like the shutter/lens assembly on a camera, its facilities determine the operational efficiency and the sound picture produced by the complete installation.

#### SENSITIVITY

The first requirement is adequate sensitivity for use with a selected pickup. Crystal pickups do not require a great deal of amplification but it is essential to terminate the pickup leads with the correct load suggested by the pickup manufacturer.

Magnetic pickups require substantial amplification and with this type the preamp should be capable of delivering full output for an input of about 5 mV.

#### PICKUP MATCHING

Suitable loads are indicated in the various response curves which appear in Chapter 7.

Pickups now vary considerably in impedance and output voltage and it is difficult to design a preamplifier capable of providing optimum load conditions for each type.

The simplest input arrangement uses a variable preset potentiometer as shown in Fig. 9/1.

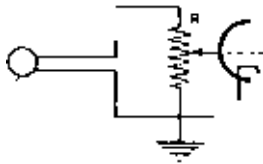

Fig. 9/1.  
Pickup input circuit of medium-price amplifier.

The potentiometer  $R$  is usually about  $100\text{ K}\Omega$ , which may be too high for some magnetic pickups. In such cases it is advisable to connect an extra resistor in parallel with the input leads to give the correct load resistance specified by the pickup manufacturer. Failure to do this may cause a peak in response at high frequencies.

On the other hand an input resistance of  $100\text{ K}\Omega$  will be too low for use with most crystal and ceramic pickups. Direct connection of a crystal pickup would then result in serious loss of bass, but there is usually a separate input circuit for crystal types.

When installing a new pickup, the *preset* input control should first be turned fully anti-clockwise. Then, with the main volume control at about three quarters full travel, the preset control should be advanced to give loud reproduction on full orchestra. This will then give a good range of adjustment with the main control knob.

More expensive amplifiers provide means of tailoring the input circuits to suit particular pickups. This may be done by omitting some of the components from the first stages and building them into a small screened case which plugs into the rear of the preamplifier. With such arrangements a pickup can be matched for optimum input impedance, sensitivity and performance. A range of about fifteen compensator units should cover all the pickups in existence, (or likely to appear!)

#### FILTER CONTROLS

There are three methods of treble control, illustrated in Fig. 9/2, and there can be no doubt that the best is a combination of choice of cut-off frequency with continuously variable control of filter slope at each point of cut-off, as at C. A somewhat cheaper version employs a fixed rate of cut-off at various frequencies, as at B.

Adequate controls are essential for suppressing hiss and subduing HF distortion, or producing the "mellow" tone of cheap outfits if it is to the taste of the listener.

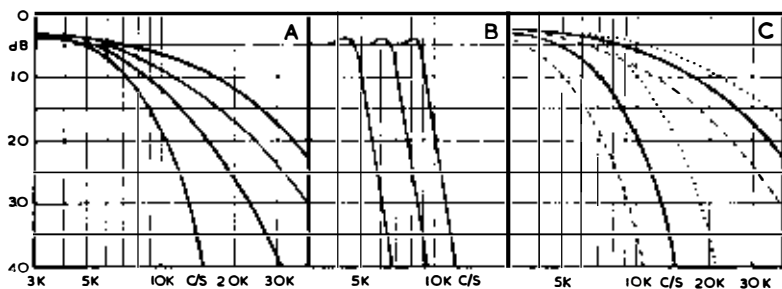

Fig. 9/2. Low-pass filters.

- A — Fixed cut-off frequency with variable slope control.
- B — Variable cut-off frequency with constant slope.
- C — Combination of A and B.

#### RUMBLE FILTERS

In view of the increased vertical rumble revealed by stereo pickups, a well designed rumble filter can obviously be a boon and

## AMPLIFIERS

a blessing. The filter should not affect response above about 40 c/s and should cut off sharply below this point, as at A in Fig. 9/3. In cheap equipment a simple capacitor roll off is usually provided but this attenuates slowly and reduces output in the 40 to 100 c/s bass region.

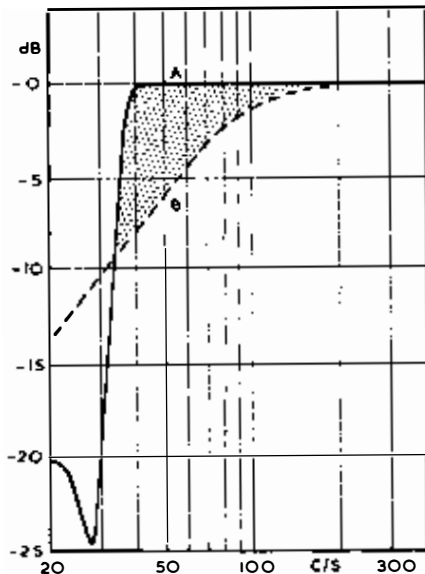

Fig. 9/3.  
*Rumble filter.*  
A — sharp cut-off at 40 c/s.  
Ideal arrangement.  
B — slow cut-off below 100 c/s.  
Shaded area represents loss of bass when using type B.

When all is said and done the proper way to avoid rumble is in the turntable itself.

## VARIOUS CONTROLS

Separate treble controls in each amplifier channel are a refinement in balancing speaker differences, lopsided room effects, and possible unbalance in pickup output, but as many of the loudspeakers now being produced for stereo are fitted with treble controls, the preamp can be excused.

A phase reversal switch is often a useful control, but is not absolutely essential. If you wish to use a mono pickup as well as a stereo model, facilities for switching from one to the other without disturbing the twin amplifier/speaker set-up are a necessity.

## PLAYBACK EQUALISATION

Prior to 1955 a wide variety of recording equalisation circuits were required to secure optimum results from a varied collection of records. The situation was almost chaotic, but since that time the major recording companies throughout the world have produced records which conform to an agreed standard and the need for multifarious characteristics has disappeared when playing modern discs.

Many amplifiers are therefore provided with only one recording equalisation setting which is variously referred to as R I A A (Recording Industry Association of America); N A R T B (National Association of Radio and Television Broadcasters); or the rather less colourful B.S.S. 1928/1955. More ambitious models still incorporate other curves such as British 78 rpm, which are useful to those with large collections of older records; but for most practical purposes satisfactory reproduction of these discs can be achieved by adjustment of bass and treble tone controls. It is actually possible to produce better results by this means in many cases, especially with very old records in which surface noise is often louder than the music.

## VOLUME AND BALANCE CONTROLS

Both these are of course essential, but opinions vary about the form they should take. Probably the most convenient arrangement is a common ganged master volume control giving simultaneous adjustment of both channels with a separate balance control giving a limited range of variation in relative gain. This is usually contrived so that the overall loudness remains the same; one channel is boosted whilst the other is reduced by an equal amount.

Some amplifiers employ separate volume controls for each channel mounted concentrically on a common shaft. When balance is achieved, the controls can be locked together mechanically.

## V.C. TRACKING ERROR

Dual controls employing concentrically mounted potentiometers tend to go out of step over a wide range of rotation. This is referred to as tracking error.

It is obviously desirable to limit any out of balance as much as possible, particularly with volume controls, although the same applies to ganged tone controls. Manufacturers are continually improving potentiometers, but at present some amplifier designers prefer the more expensive switched types. These can certainly be made more accurate but they are not so convenient in use as the

## AMPLIFIERS

continuously variable type, and the maximum attenuation is limited to about 45 dB.

### MAIN AMPLIFIERS

The general standard is now so high that it is not necessary to go into details.

Thanks to negative feedback—the shrine at which all amplifier makers worship in grateful homage—there is no difficulty in achieving frequency response within 0.5 dB from 30 to 20,000 c/s, with a total harmonic distortion under 0.25% at full power output.

We have already agreed that 5 watts per channel are adequate for small rooms, with 8-15 watts for larger installations. At the Royal Festival Hall demonstration referred to in Chapter 13, we used only 30 watts per channel on stereo with an audience of 2,900. The important thing is to have the required power output over the full frequency range mentioned above, without distortion at either end.

## CHAPTER 10

# LOUDSPEAKERS

The most significant result of stereo as affecting the loud-speaker, especially in America, has been the widespread use of small enclosures, around 2 cu. ft., in which it is now possible to produce clean bass down to 30 c/s, either by using a total enclosure with a speaker of 15/20 c/s resonance, or a tuned enclosure with a unit of 20/25 c/s resonance. (How you do it does not matter; it's the result that counts.) The importance of saving space when two speakers are required is self-evident.

In considering the achievement of getting a quart of bass out of a pint pot we must hand a bouquet to Mr. Edgar Villchur, who pioneered this work in the U.S.A.

I have no quarrel with people who like and use these small speakers, but I do definitely cross swords with those who pretend they are equal to larger and/or more open assemblies, including baffles and full range electrostatics. There is a breadth and freedom of tone with these larger models which the small box can never even approach in character.

Given a big enough listening room, it is quite feasible to instal a couple of fairly large speakers for stereo without offending the good taste of the lady of the house, as the colour pictures on pages 113 and 114 so nicely show.

The first photograph was taken in the home of Mr. Leonard Carduner on Long Island and includes a couple of baffle speakers separated by the playing equipment, which comprises:

- Garrard RC98 changer with Pickering Stereo Cartridge.
- Garrard 4 HF player with Shure Stereo Cartridge.
- Leak Point One and Stereo 50 Amplifier.
- Harman Kardon AM/FM Tuner.
- Reflectograph Tape Recorder.

The second colour photo was sent to me by Mr. G. Hollis-Dennis of Southwick, Sussex, and includes a couple of 9 cu. ft. concrete enclosures, with 8" and 3" speakers mounted in free air immediately above them. The amplifiers are Goodsell/Williamson, with Ortofon mono pickup and Decca stereo model. The room is 26' × 13' × 9' 6". Mr. Hollis-Dennis wrote:

## LOUDSPEAKERS

“Beautiful sound deserves appropriate surroundings.”

If we could bring about a general acceptance of the slogan “Beautiful surroundings deserve appropriate sound” we should be approaching the hi-fi millenium.

Unfortunately, even if we could afford a Rolls-Royce, most of us do not own a garage big enough to accommodate one, so the rest of this chapter is devoted to listening tests as affecting rooms of average size, in which the fine set-ups of Figs. 10/1 and 2 would be difficult to accommodate. It should hardly be necessary to say that the best speakers always give the best results on both mono and stereo, provided the rest of the equipment is first-class. (Stereo as an end in itself means nothing.)

There are dozens of ways of reproducing stereo, from a pair of, say, £75 speaker systems, down to a radio transmission using a 5" × 3" elliptical TV speaker on one channel with an 8" set-speaker on the other.

Without expecting miracles from perfect matching, the main requirements for good results can be summarised as follows :-

- 1 Similar HF response and dispersal.
- 2 Similar efficiency and flux density in magnets, which includes transient response.
- 3 Reasonable spacing between the two speakers.
- 4 Correct phasing especially if speakers are rather directional.
- 5 Careful balance of volume levels.
- 6 Treble distribution at not less than 2' 6" above floor level—especially if directional.

Listening tests have been carefully carried out in the lounge of our Technical Editor, Mr. Cooke, size 12' × 10' (lounge is referred to here) with large folding doors to dining room of similar dimensions; also in our laboratory, measuring 18' × 13'. See Figs. 10/3, 7 and 11.

### SPEAKERS IN PAIRS

If you are going in for stereo from scratch and you have a room of only average size, your best plan would probably be to instal a pair of speakers along the lines indicated in Fig. 10/3, which illustrates three pairs comprising 2, 3 and 4-way systems.

The bass enclosures here are about 2 cu. ft. (as referred to earlier in the chapter) and give clean response down to 30 c/s at reasonable input levels, as illustrated in Figs. 10/4 and 5.

There are today several makes of speaker—especially in America—which are capable of giving excellent LF output with these small enclosures—some designed as infinite baffles, others as



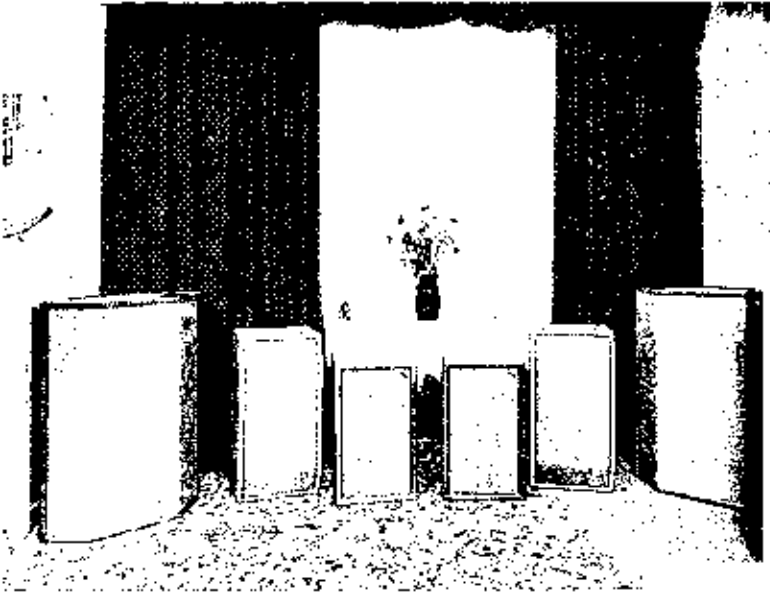

Fig. 10/3. Stereo speaker systems.

- |              |    |   |
|--------------|----|---|
| Centre pair  | W2 | 12" and 5" units (facing forward).  |
|              | W3 | 12", 5" and 3" units<br>(5" and 3" facing outwards and upwards<br>at different angles). |
| Outside pair | W4 | 12", 5", 5" and 3" units.<br>(5" facing outwards, 3" upwards).                          |

tuned reflex systems. The main requirement is large cone excursion without non-linearity.

But what about a listening test? The W2 speakers are more directional than the others but give excellent stereo. Raising them two or three feet from the floor improves the treble radiation but loses a little bass. On the other hand, the W3 speakers can be stood on the floor and still give well diffused middle and top.

The W4's stand on the floor and give maximum bass, with the upper registers diffused at the ideal height to clear chairs and other obstructions, the crossover being at 400 c/s.

Leaving one W2 working and changing to a W3 or W4 on the other side detracts from stereo but improves over-all results, especially on single channel input. As usual, there are swings and roundabouts.

## LOUDSPEAKERS

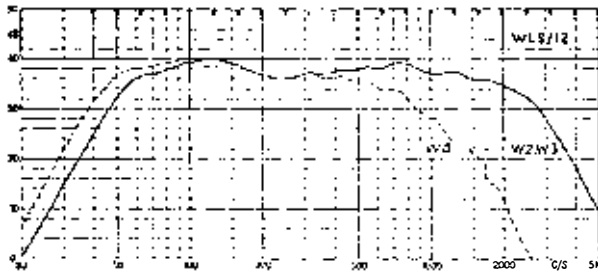

Fig. 10/4. LF Response curve of speakers shown in previous illustration.

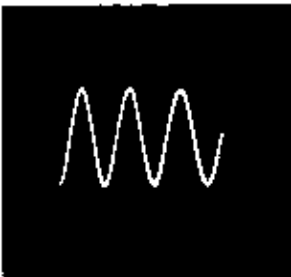

Fig. 10/5. Waveform of output from W2 and W3 with 4 watts input at 30 c/s.

### ONE BASS, TWO TREBLE

Next to a couple of full range speakers suitably spaced—unquestionably the ideal arrangement—the best compromise is to have one bass system and two treble speakers, with a crossover not higher than 400 c/s. Quite astonishingly good results are possible with a well designed system.

If two bass units are mounted in one enclosure no special circuit is required as the speakers are merely treated as though they were in separate cabinets—they don't know they are not—but if a common bass unit is used, a transformer circuit as given in Fig. 10/6 is necessary. Details of the isolating transformer are given in Fig. 10/8.

This arrangement may be useful where floor space is at a premium, because the treble units will stand on shelf or table or may be hung on the wall.

If the centre or main speaker is a full range model it may require attenuating with a constant impedance volume control, adjusted for optimum results, as it spoils the stereo spread if too loud.

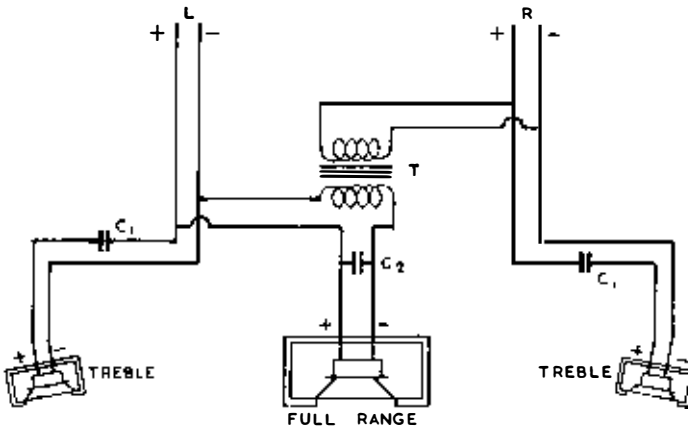

Fig. 10/6. Two treble speakers with common bass unit and isolating transformer T. The two capacitors C<sub>1</sub> are 30 Mfd with 15 ohm speakers, or 60 Mfd for 7/8 ohm circuits. The shunt capacitor C<sub>2</sub> has the same value but may be omitted if the centre speaker is a full range model.

We had a long session of listening tests in Mr. Cooke's lounge, using various types of treble speakers as shown in Fig. 10/7. The general conclusion was that the treble units must be reasonably well matched in transient response and directional effects. If identical speakers are not used, volume controls are essential.

The best arrangement was to have the bass speaker in the middle and two identical treble speakers 6/7 ft. apart and not less than 3 ft. above floor level.

The bass speaker can be moved into a corner without much loss of balance.

#### LISTENING TESTS

The type of record makes a big difference to results in all these listening tests. We avoid the old left/right two-channel type which must now be on the way out; but we include choral, orchestral, solo and dance items in any serious attempt to assess results.

When listening to treble speakers, it is as well to remember that many specimens have built up a reputation for smoothness because they tail off at about 10 kc/s, and produce very little real HF. A good tweeter must operate up to 16 kc/s. If the input is harsh or strident, the pre-amp tone control will usually cope with

## LOUDSPEAKERS

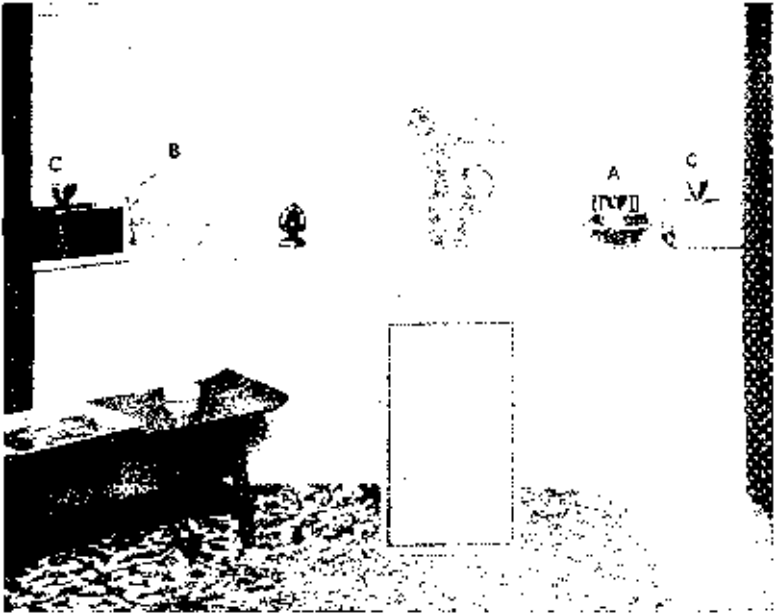

Fig. 10/7. One bass speaker and various treble units.

- A Goodman's Bowl.
- B Multi-speaker array for wall mounting.
- C 5" unit with diffuser.

the trouble, but a tweeter volume control is often a boon and a blessing. (See end of chapter for simple VC circuit.)

### ISOLATING TRANSFORMER

This is an indispensable unit for many stereo arrangements, including the following:

- A. 1 Bass and 2 Treble speakers.  
(Already described.)
- B. Full range system on one channel with treble speaker on the other.
- C. Two full range speakers rather widely spaced, with third speaker in the middle.

The ratio of the transformer is 1 to 1, and the two low-resistance windings are preferably placed side by side, with a core of fairly generous dimensions. See Fig. 10/8.

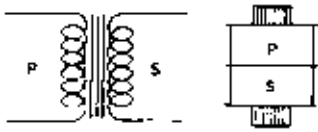

EACH WINDING, 200 TURNS  
18 SWG EN. COPPER; ON 1" SQ.  
SUPER SILICON CORE.

Fig. 10/8.  
Isolating transformer, ratio 1 to 1,  
with side by side windings.

ARRANGEMENT B

Owners of a large full range speaker who wish to try stereo may do so without (foolishly) discarding their well tried and trusted systems in favour of two little boxes. A small speaker handling the range above 400 c/s is used for the left hand channel, and the left hand low frequencies are mixed with those from the right and fed to the full range system. See Fig. 10/9.

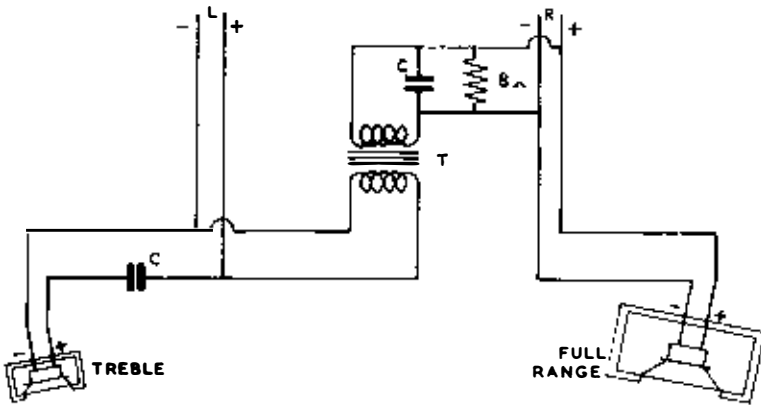

Fig. 10/9. Full range speaker on one channel with treble speaker on the other.  
T = Isolating transformer.  
C = Each 30 Mfd with 15 ohm speakers.

The arrangement shown has the merit of minimum cost and is easy to instal. However, the stereo results are not so good as those obtained from a symmetrical installation, unless the acoustic set-up of the treble unit is the same as the treble section of the full range speaker, which would obviously give a good balance.

## LOUDSPEAKERS

### ARRANGEMENT C

Where two full range systems are of necessity spaced too far apart, there may be a noticeable "hole in the middle" effect, especially when listening at close range. By using a centre speaker as shown in Fig. 10/10, the middle may be filled in satisfactorily.

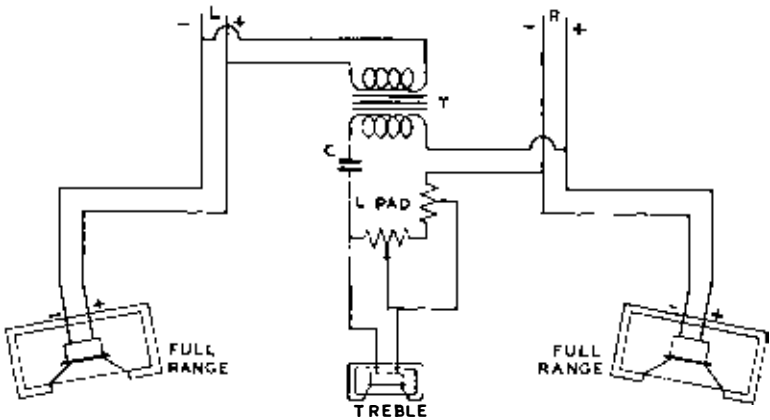

Fig. 10/10. Widely spaced main speakers, with third unit to "fill in the middle".

T = Isolating transformer.

L Pad + C—See text.

The value of capacitor C should be chosen to cut off the input to the centre speaker at frequencies below its lower working limit. Assuming a 15 ohm system, a value of 30 Mfd will roll off the input below about 400 c/s. The capacitor should be increased to 60 Mfd with 8 ohm units or 120 Mfd with 3-5 ohm systems. If a full range system is available in the centre position, the filter capacitor may of course be omitted.

A constance impedance type volume control is shown, but if the centre speaker is limited to treble input a potentiometer control would suffice.

### LARGE AND VARIED TYPES

We now come to a picture of an array of speakers in our laboratory, with a brief account of the sort of noise they make. I am sure that what we are about to say will give true stereo addicts a bilious attack and will cause friends Kelly and Leak to say

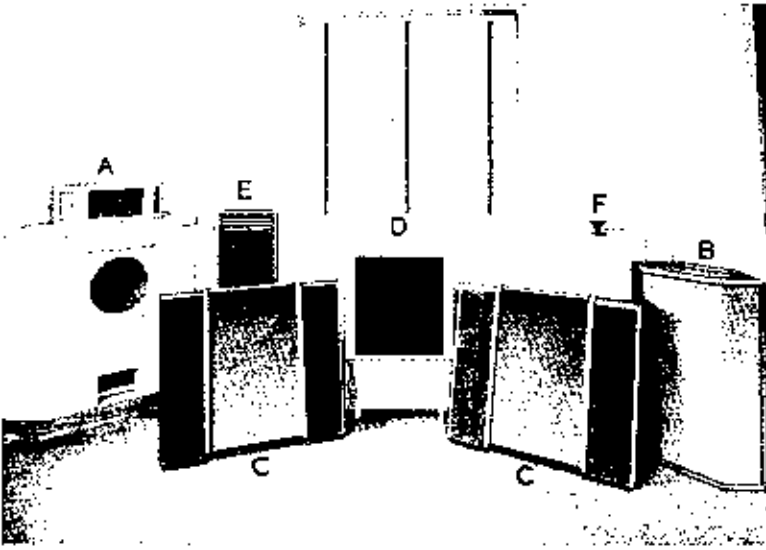

Fig. 10/11. Speaker Tests in Lab.  
measuring 18'  $\times$  13'.

- A 3 speaker brick assembly.
- B 4 speaker mobile model.
- C 3 speaker baffles.
- D Coaxial 12" in 5 cu. ft. reflex cabinet.
- E 8" Column speaker.
- F As E, but concrete.

“tommy-rot” and “nonsense” once again; but even so we are not dismayed. The reason is that good sound is still more important than good stereo.

This lab. is livelier than the average living room as it contains test equipment instead of soft furnishings. (All applications from the technical staff for easy chairs have been turned down.).

Practically any combination of speakers works well on single channel input, provided they are of similar sensitivity.

On stereo, the first conclusion was that the idea that pairs of identical speakers are essential for good results is a fallacy which should now be carefully wrapped up and buried. This does not in any way disqualify the use of two identical speakers, but the basic fact is that a better speaker always sounds better, provided results are not hampered by obvious incompatibility.

## LOUDSPEAKERS

The listening panel consisted of Mr. Cooke, our Technical Director; Mr. Broadley our Works Manager; Mr. Jamieson, formerly with E.M.I. and now on our staff; a visitor from Utete, Tanganyika (Mr. Young); and your humble servant. (Quite a mixed bag.)

There was naturally some difference of opinion and results varied according to type of record being played, but the general conclusions were as follows:-

The best results came from speakers A and B, then A and F, followed by A and E or A and C. In short, the use of the three speaker corner system always improved the reproduction.

Speaker B could be used with any of the other models.

Two baffles were very good; a baffle and a column worked together with surprisingly good results.

Two columns, if near two corners, tend to emphasise room resonance and cause a honk. As a versatile speaker to work with almost any other type—including baffles—the column is hard to beat, when suitably placed.

An interesting example of the use of a column speaker with a full range electrostatic appeared in a recent issue of *Gramophone Record Review*, and is reproduced in Fig. 10/12.

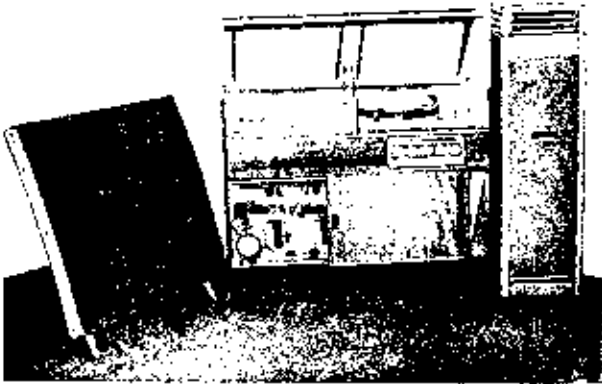

Fig. 10/12. Use of different types of speaker.  
Mr. C. J. C. Siggers, of Devizes, Wilts.  
*Courtesy Gramophone Record Review.*



The coaxial speaker D gives excellent results in pairs but is unsuitable for use on stereo with any of the other models illustrated.

A pair of A's or a pair of B's are highly satisfactory.

This report is intended only to give general guidance and should not be taken too literally, as a different listening room would produce different results.

#### COLUMN SPEAKER

Having shown a concrete column in Fig. 10/11, and as results from a suitable 8" unit are quite fantastic with such a structure—judged on a purely cost v. performance basis—it is worth while repeating the constructional details already given in the 5th Edition of *Loudspeakers*.

The column illustrated was built with concrete blocks 12"×6"×2" so the outside dimensions are 17"×15", with a total weight of some 2½ cwt. Concrete 1" thick would be satisfactory, but the slabs are liable to break in transit or if dropped on the big toe during building operations.

The acoustic filter is placed across the column with an airtight fit on all four sides, and consists of a piece of  $\frac{3}{8}$ " or  $\frac{1}{2}$ " plywood with 7 slits or saw-cuts 9" long, 1½" apart, and about  $\frac{1}{16}$ " wide.

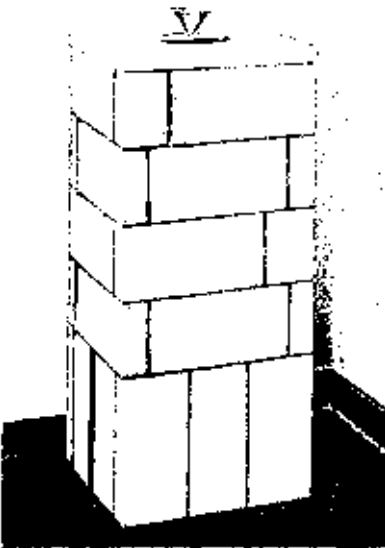

Fig. 10/13.  
Concrete column for 8" units.  
Volume 3 cu. ft.  
Twin ports 12" × 1".  
Inside dimensions 13" × 11".  
Height 36".  
Diffuser 4" diameter.  
Acoustic filter 12" from base.

## LOUDSPEAKERS

The baffle on which the speaker is mounted must make an airtight fit to the top of the column, which is lined with 1" absorbent material above the filter.

The finished column is easily painted or papered to match the walls of the room, or may be covered by thin plywood panels.

Bigger columns fitted with 10" or 12" units have been tried, but in our opinion the general balance of tone is not quite so satisfactory as that obtained with an 8" unit. In other words, more conventional methods of mounting larger units are preferred.

## VOLUME CONTROLS

Speaker controls are now almost a necessity for setting up various stereo systems and overcoming differences in loudspeakers and room reflections.

Potentiometers are quite satisfactory for middle and upper registers where control is usually required. The circuit to operate at about 2 kc/s upwards is given in Fig. 10/14.

If it is found necessary to reduce the volume level of a full range speaker or of a woofer, then a constant impedance type of control should be used to avoid build-up of bass resonance and possible ill effects from undue interference with the damping factor of the amplifier.

A few purists still object to the use of volume controls on speakers, but there are far worse things in any amplifier, recording system or listening room.

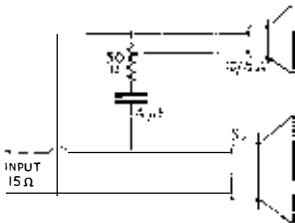

Fig. 10/14.  
Tweeter with volume control. If the impedance of the main loudspeaker is  $2/3$  ohms, the filter capacitor and V.C. should then be 12 Mfd and 20 ohms respectively.

## STEREOPHONER

Although we have often advocated the use of two or more loudspeakers on single channel input, we have not—I hope—implied that this gives the same effect as that obtained by two channel working. As Mr. James Moir has often pointed out, if two speakers are of equal efficiency, most of the sound on mono input will appear to come from the one nearest to the listener, or from a point between



Fig. 10/1. Stereo system in the home of Mr. Leonard Carduner, Long Island.



Fig. 10/2. Nicely decorated 9 cu. ft. concrete enclosures in the home of Mr. Hollis-Dennis, Southwick, Sussex. Mid-range and treble speakers hidden behind furnishing fabric and open mesh screen.

the speakers if the listener stands at or near the apex of a triangle formed by himself and the speakers.

There is nothing wrong with this at all. The reason why two speakers are better than one is quite simple: we live in an imperfect world. Loudspeakers and listening rooms are far from perfect, and two speakers therefore help to spread the resonances and subdue room and speaker coloration. Although two blacks don't make a white, they can produce a peaceful shade of grey in the world of listening to "canned" music.

On the other hand, the advantage of stereo is that two channels are used and a different sound picture emerges from each of the two loudspeakers, thus reducing or removing the monotony of a single picture. (I am personally convinced that "stereo" means very little, but two channel working is really important.)

In order to increase the apparent "spread" when using two loudspeakers on single channel input, Dr. Hermann Scherchen has produced his STEREOPHONER, to be used between amplifier and loudspeakers, and illustrated in Fig. 10/15.

The device is a network of passive components which divides the sound spectrum between the two loudspeakers. Listening tests reveal that the Stereophoner improves the "spread" on choral and orchestral works at the cost of some loss in output power and HF response, which is easily made up by a readjustment of pre-amp controls.

Although the Stereophoner serves a useful purpose by giving a new lease of life to the enormous existing repertoire of irreplaceable mono records, the results cannot be quite the same as those obtained from two-channel recording.

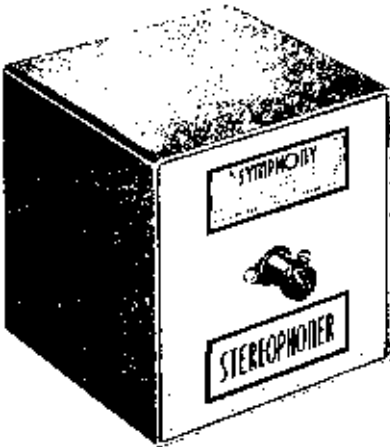

Fig. 10/15. Dr. Scherchen's Stereophoner.

## CHAPTER 11

# STEREO TAPES

Just about the time we were ready to compose this chapter, our Technical Editor paid a flying visit to New York and was thus able to see and hear the latest developments in stereo tape as at August 1959. I am therefore pleased to leave a controversial subject largely in his hands.

Most enthusiasts have always had a sneaking regard for tape. They argue that because all professional recording is nowadays initiated on tape the transfer to yet another tape for commercial distribution is a logical step, which avoids the mechanical problems associated with cutter heads and pickups.

Although these arguments are valid for tape transfers carefully engineered in laboratory conditions, commercial tape copies do not always achieve the same high standards.

In 1955 two-channel stereo was first offered to the British public on twin track tape running at  $7\frac{1}{2}$ " /sec. In this country, only the E.M.I. Group of Companies entered the pre-recorded tape field and from the beginning they used the in-line head system.

The Americans started issuing stereo tapes somewhat earlier, but unfortunately with the staggered head system. When eventually they decided to switch to in-line head working the public became confused and a nail went into the tape coffin.

During the following three years, manufacturers tried hard to "push" tape, but the public remained unconvinced on both sides of the Atlantic. The principal reasons were undoubtedly the high cost of tape records and replay equipment compared with disc, inconvenience in use, and small repertoire. It must be remembered that the sale of millions of "pop" records each year helps to bring down the production cost of classical discs, and it will be difficult for tape to compete without a similar mass market.

Stereo disc knocked another nail into the tape coffin, although many users in America were enjoying  $7\frac{1}{2}$ " /sec. 2-track stereo. There are now signs that tape is about to raise its head once more, but this time like a Hydra with four heads instead of two.

FOUR TRACK TAPES

A large part of the cost is in the actual tape and its reel; the easiest way to reduce prices is to increase the playing time from a given length of tape. It seems logical, therefore, to increase the number of tracks on a  $\frac{1}{4}$ " wide tape from two to four, thus giving double the playing time at  $7\frac{1}{2}$ "/sec. or four times at  $3\frac{3}{4}$ "/sec.

A 4-track system has been developed by R.C.A. in America, and Fig. 11/1 shows the arrangement in comparison with 2-track tape.

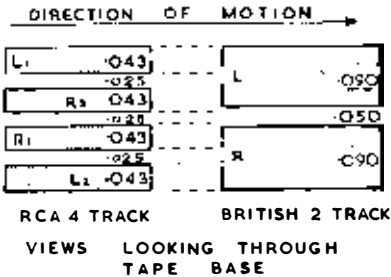

Fig. 11/1.  
R.C.A. 4-track tape compared with standard 2-track.

The 4-track tape is intended for replay in both directions. When travelling one way, tracks L<sub>1</sub> and R<sub>1</sub> are used, whereas L<sub>2</sub> and R<sub>2</sub> are operative when the tape runs back.

REPLAY HEADS

Fig. 11/1 makes it quite clear that 4-track tapes cannot be played with the standard type of 2-track head. A new head is necessary in which the gap length is 0.043" as shown in Fig. 11/2.

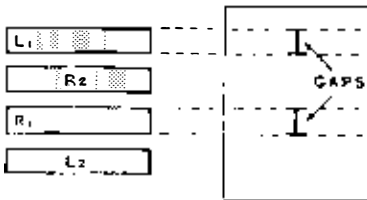

Fig. 11/2.  
Replay head arrangement for 4-track tapes.

The 4-track head will play standard 2-track tapes, but the shorter gaps scan less than half the 0.090" track width and in consequence give a lower output compared with conventional heads.

In order to offset some of the difficulties encountered by reducing tape speed to  $3\frac{3}{4}$ "/sec., improved replay heads have been

## STEREO TAPES

designed. With the awe-inspiring title of quarter-track ultra-narrow-gap playback heads, these new designs make it possible to extend the frequency response to 12,000 c/s at  $3\frac{3}{4}$ " /sec. compared with 7,500 c/s using normal heads at the same speed. To achieve this the head gap width is reduced to about 0.0001" compared with 0.00025" in normal heads. However, a price has to be paid in loss of output due to the narrower gap. This of course leads to a reduction of signal to noise ratio.

## TAPE CASSETTES

To simplify loading, several designs of cassette have been suggested, and the ingenious device produced by R.C.A. is worthy of attention. See Figs. 11/3 and 11/4.



Fig. 11/3. Tape Cassette.

*Courtesy RCA.*

The cassette (or cartridge in U.S.A.) consists of a flat plastic container  $7'' \times 5'' \times \frac{1}{2}''$ . The reels inside are secured by a spring-loaded brake which is automatically released when the cassette is loaded on to the replay machine. The tape engages the replay heads and the driving capstan and begins to play at the touch of a button.

Holes in the cassette disengage the erase and record circuits of the machine to prevent accidental damage to the tape.

The cassette holds nearly 600 ft. of 1 mil tape and can provide about an hour's programme at  $3\frac{3}{4}$ " /sec.

Another type of magazine loading tape deck has been developed in England by Garrard, and is illustrated in Fig. 11/5. The magazine is made of transparent plastic giving a full view of the tape on both



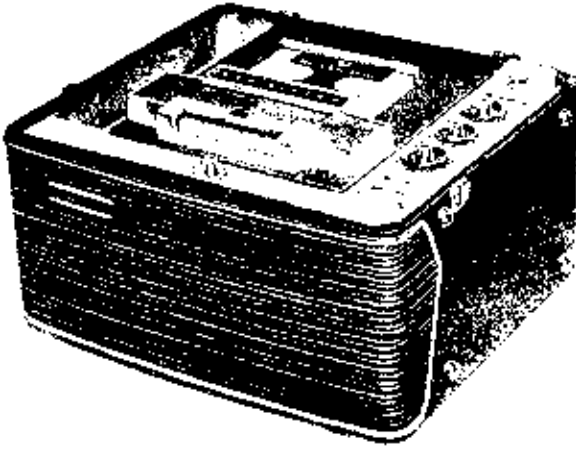

Fig. 11/4. Cassette in position on replay machine. *Courtesy RCA.*

reels for easy identification of sections. In its present form the Garrard deck is designed for half track tapes only at  $3\frac{3}{4}$ "/sec., but later models will be equipped to handle 4-track stereo tape.

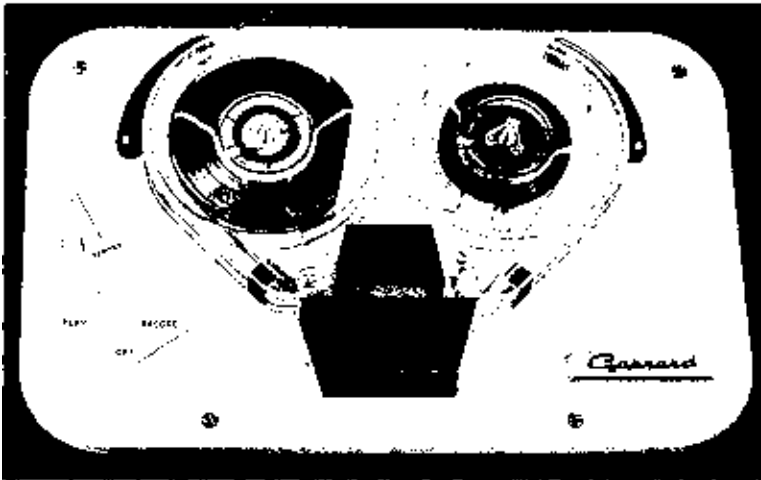

Fig. 11/5. Garrard-tape deck with magazine loading.

## STEREO TAPES

### FREQUENCY RESPONSE

Tape at  $7\frac{1}{2}''$ /sec. easily competes in HF response with stereo discs, but at  $3\frac{3}{4}''$ /sec. the position is not so easy. Good response up to 12 Kc/s is possible when everything is just right, but substantial amounts of pre- and post-emphasis or treble boost are applied.

The use of shorter head gaps reduces the risk of ill effects of azimuth on HF response, but the very narrow gaps may be affected by wear from the abrasive effect of the tape—although the lower speed must mean less wear—and small amounts of dirt adhering to the heads affect output and response sooner than with  $7\frac{1}{2}''$ /sec. half track. The regular use of a head cleaning fluid is recommended.

### SIGNAL TO NOISE RATIO

At the present time we can grade the various systems in the following order from the point of view of background noise:—

1. Disc.
2.  $7\frac{1}{2}''$ /sec. tape 2-track.
3.  $7\frac{1}{2}''$ /sec. tape 4-track.
4.  $3\frac{3}{4}''$ /sec. tape 4-track.

A well cut disc is the best; 4-track tape is not so good here as 2-track because the signal is lower; but at  $3\frac{3}{4}''$ /sec. in addition to the narrower gap, there is a further loss of output due to halving the speed, and an increase in high frequency noise caused by the greater treble boost necessary to maintain upper frequency response.

Tape drop-outs and other spurious noises become more serious with narrower tracks and reduced speed, but such difficulties are gradually being overcome by improvements in the tape itself.

### CROSS TALK

With tape the cross talk between channels is greatly superior to disc systems. The average stereo pickup gives less than 20 dB separation between channels and then only at middle frequencies. At the present time the absolute maximum is probably about 25 dB.

On the other hand a twin half track stereo head will give 40 dB separation without much difficulty. The position is even better with twin quarter track heads because of the greater separation between the gaps.

## DISTORTION

Although harmonic distortion is not an inherent problem with tape it may become one by virtue of signal/noise requirements. In order to rise as far as possible above the background noise, tape record manufacturers go as high as they reasonably can with volume level. If carried to excess, the result is distortion on loud passages, the risk being greater with 4-track than with 2-track systems.

## WOW AND FLUTTER

Wow and flutter have always been serious problems with domestic tape machines running at  $7\frac{1}{2}$ " /sec. and even today machines at a moderate price are not equal to a good transcription turntable.

When the speed is halved to  $3\frac{3}{4}$ " /sec. the inertia of the capstan flywheel is reduced by four times. The position can only be restored by precision engineering, which is very expensive.

## LISTENING TEST

As always, the proof of the pudding is in the eating, and our Technical Editor was treated to a portion of tape pudding during his recent visit to the U.S.A. His host was David Hall, Music Editor of *Hi-Fi Review*, who arranged a grand comparison-demonstration of disc versus all forms of tape at his home in Connecticut.

The comparisons were interesting and sometimes odious. A brief summary now follows:—

1. **Stereo disc.** Very quiet background. Some comb and paper effect on loud passages.
2.  **$7\frac{1}{2}$ " /sec. 2-tracks.** Background noise slightly higher than disc. Almost total absence of comb and paper effect. Very good frequency response.
3.  **$7\frac{1}{2}$ " /sec. tape, 4-tracks.** Background noise slightly greater than 2. General performance similar to 2-track tape.
4.  **$3\frac{3}{4}$ " /sec. tape, 4-tracks.** High background noise interfered with our listening pleasure on classical music, but was acceptable on loud "pop" items with sustained high volume levels. High frequency response inferior to 1, 2 and 3. Distortion more noticeable than with  $7\frac{1}{2}$ " /sec. tape.

## PRICE

Even with twice the number of tracks and half the speed, tape is still more expensive than disc.

One of the basic reasons why tape records cost more than discs is that the raw materials are much more expensive. A reel is quite

## STEREO TAPES

costly and merely holds the tape, which in itself is much dearer than the plastic material used for pressings. In fact, we have been told (on doubtful authority) that discs can be produced at a very low price by adding sweepings-up to the mixture. No self-respecting record maker will openly admit doing this, although some of the cheap "pops" sound like it!

As usual, the Editor of *Audio* hits the nail on the head.

He points out in the October 1959 issue that in America the average cost of a 2-track 1200 foot reel of mono tape was \$7.95 with a playing time of one hour. The same length of tape in 2-track stereo provided only half the playing time and yet was priced at about \$14.95.

As against this the price of stereo discs was brought down - at least in Great Britain - to about the same level as mono discs and there was no loss of playing time. So far as commercial success went, this was a walk-over for discs.

It remains to be seen whether longer playing time per reel, lower cost, easier handling and fewer alternatives will enable stereo tape to stage a come-back.

## CHAPTER 12

# ROOM ACOUSTICS

It is well known that room acoustics affect all musical sounds whether live or reproduced, mono or stereo. The walls, ceiling and floor absorb part of the sound energy and reflect the remainder back into the listening area. Large pieces of furniture and even the listeners themselves have a similar effect. Moreover, the results vary considerably with frequency and depend on the nature of the surfaces and on the size and shape of the room. In the reproduction of sound the location of the loudspeakers also affects the general results.

As we devoted 11 pages to the subject in the 5th edition of *Loudspeakers*, we will direct our observations here to the special requirements of stereo. (To those who wish to delve more deeply into the general subject we can recommend the book *Sound Insulation and Room Acoustics* by Per. V. Bruel, Chapman & Hall, London.)

At the outset, it must be emphasised that room acoustics have a considerable effect on stereophonic reproduction and those who expect perfect results by using carefully matched loudspeakers will often be thwarted by unbalanced room effects, (not to mention stereo pickups!) Mr. Cooke has in fact made a number of tests in various listening rooms and has come to the conclusion that the acoustics have a greater effect than one would have expected, although a thoroughly “bad” room may not show up so much on stereo as on single channel because of the improved clarity of two channel working.

### REVERBERATION

Experience indicates that stereo effects are more easily reproduced in rooms with plenty of absorption than in more “live” surroundings. This may be explained as follows:

In Fig. 12/1 we have a single speaker system, with a listener at L who hears direct sound, plus reflected sound from many directions, one of which is indicated.

ROOM ACOUSTICS

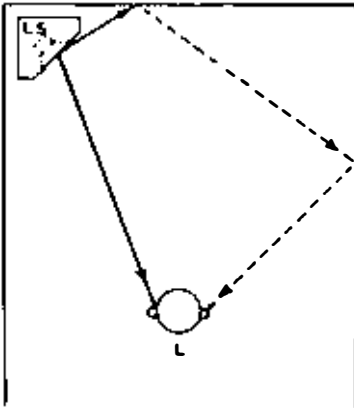

Fig. 12/1.  
LS—Loudspeaker.  
L —Listener.  
Solid line —direct sound.  
Dotted line —reflected sound.

A fair amount of reverberation adds warmth to the reproduction and results are usually lifelike and pleasing, with an apparent increase in the distance of the sound source from the listener. Room effects do actually help to mask the loudspeaker's own characteristics.

With stereo, these random effects—if rather strong—may become confusing and may interfere with the listener's appreciation of the two channels, as indicated in Fig. 12/2.

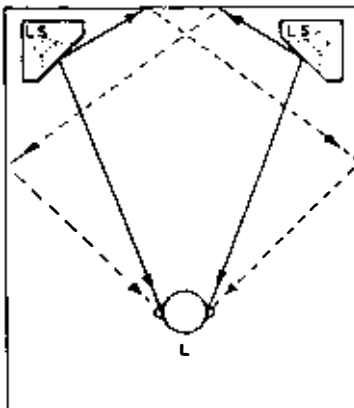

Fig. 12/2. Same as previous figure but with two lots of direct and reflected sound images

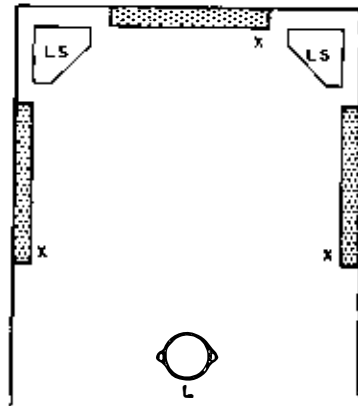

Fig. 12/3. Wall treatment at X to avoid undue reflection effects on stereo.

The confusion arises because images of the left hand speaker occur on the right of the listener and vice versa. If excessive, the remedy is to place sound absorbent surfaces on the walls as shown in Fig. 12/3.

Acoustic perforated tiles may be fixed to the walls, or simply draping with heavy curtains would be effective. (It is assumed here that both the reader and his wife are dead keen on stereo.)

#### ACOUSTIC UNBALANCE

Because of different walls and windows, the arrangement of furniture, and structural features such as recesses and chimney breasts, it is rare for acoustical conditions to be identical in the vicinity of two speakers suitably spaced for stereo.

This form of acoustical unbalance or asymmetry could be very good for results with mono input to the two speakers, but on stereo it may cause the image to go off-centre and certain instruments may appear to hop about, although, as the multi-mic. technique is developed in recording, this phenomenon seems to be less likely to appear.

The bass end always spreads itself all over the room and need not concern us in this investigation, but differences in absorption and reflection effects above say 500 c/s can upset the most carefully matched or balanced speakers. Failing room treatment on the lines already indicated, and in the (usual) absence of separate tone controls in each channel in the pre-amp, the easiest way to cope with the problem is by volume controls fitted to middle and treble speakers.

## ROOM ACOUSTICS

The more directional types of speaker reduce the trouble because they cut down the sound reflected from adjacent surfaces, but as usual the listening area for good stereo is also reduced.

A very striking example of the effect of unbalance was heard recently in a room equipped with a pair of omni-directional column speakers, as outlined in Fig. 12/4.

The recess behind speaker A is much larger than that behind speaker B; also the curtains on the left absorb more HF than does the partition on the right. When a mono record is played, the instruments spread themselves out between the speakers, and the general break up of room resonances gives a sense of depth and good dispersion. On the other hand, these spectacular effects make it more difficult to obtain a firm location of the sound image on stereo. (As there are still about 9 good mono records to 1 in stereo, and there is no regular two channel broadcasting, I should personally plump for optimum results on mono.)

The general rule is that for best results on stereo the loudspeakers and listeners should be arranged for maximum left/right acoustic symmetry or balance.

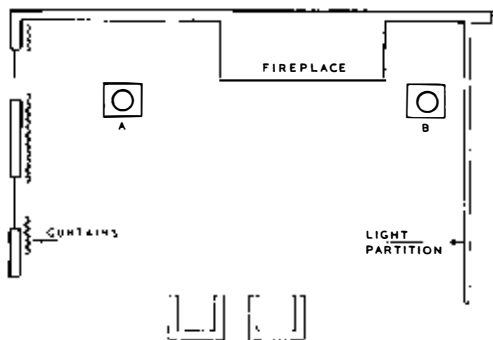

Fig. 12/4. Asymmetrical listening room giving well-dispersed effects on mono input.

## LARGE ROOMS

Although the majority of living rooms are small, it is not without interest to take a look at a bigger one. Normally I would say that the larger the room or hall, the more omni-directional must the speakers be made. But we recently had an interesting problem sent to us by G.K. of Winchester, who occupies a large bed-sitting room, a plan of which is given in Fig. 12/5, and for which a compromise was adopted.



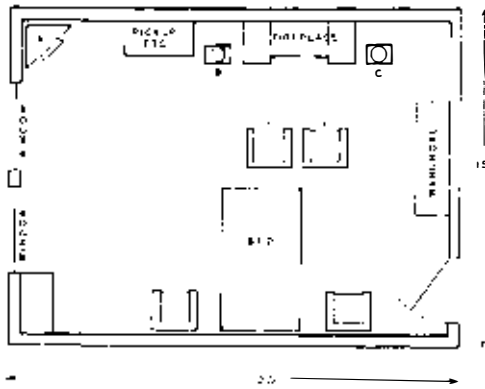

Fig. 12/5. Large room with listeners at L.

- A—Coaxial speaker already in use.  
 B & C—Suggested column speakers for stereo, with all three in use on mono.

A good coaxial speaker was already in use in the corner at A and the question was how to convert to stereo without undue cost.

It is always difficult to diagnose at a distance, but we suggested that omni-directional columns at B & C would be ideal for stereo, with listeners in front of fire, using all three speakers on mono. This was too costly, and a cheaper but far better plan to build a concrete column at each side of the fireplace could not be adopted because the room was occupied on a rental basis.

A fair working compromise was to instal another directional speaker at B and move over for listening to stereo; a better position on the left hand side of the room could not be used because of very large windows.

Compromise is often inevitable, and no doubt in mid-winter our friends in Winchester will move back to a comfortable position in front of the fire and let stereo go to the wall.

#### SMALL ROOMS

As rooms become smaller, the choice of speaker position is more and more restricted and the general results are more uniform, so there would be no point in enlarging on the subject.

## CHAPTER 13

### CONCERT HALLS

I still hold the lone view (shared by my Technical Editor) that the most reliable way to assess the quality of a record, turntable, pickup or loudspeaker is to listen to results in a good concert hall which adds little or no colour of its own. It is similar in effect to examining a small object through a magnifying glass or a stylus point through a microscope to find out what is there.

The fact that you may use, in a concert hall, equipment which you would not use at home does not nullify the test. You determine what is really the best and decide to get as near as you can in your domestic set-up; rather like listening to Denis Matthews at the piano (or any of the top-liners) and going home and trying to do likewise, but not quite so disheartening.

The reason is quite simple. When listening for faults in such a hall, working on a large scale with no small room effects, a sprat becomes a mackerel and a slight fault stands out like a sore thumb. This was brought home to us recently when we were testing small enclosures (about 2 cu. ft.) which have been developed to give good bass in a small size for stereo, and represent a marked improvement on anything available a few years ago. (So much so, in fact, that an American Consumer's Union report placed them in the top class for domestic use.) But the Royal Festival Hall test exposed the inherent boxiness and constrained tone quality inevitable with small cabinets, and we had to continue to use open baffles and large enclosures for realistic results in the hall.

I am not suggesting that small models should not be used at home—of course they must be in many rooms—but to pretend that they are equal to large baffles and/or cabinets or horns is just as foolish as pretending that a 4' 6" grand piano is equal to an instrument 6' or more in length, made by the same firm.

In turntables, rumble and hum are shown up, whilst surface noise in records and the true quality of recordings are quickly exposed.

But what of stereo? We played items from a couple of H.M.V. Stereosonic tapes in the Royal Festival Hall in 1956. Results were excellent over a very limited listening area. Then for 1959 our Technical Editor cooked up a pair of multi-speaker systems to

spread the sound in all directions at frequencies above 400 c/s. One of these is outlined in Fig. 13/1, with a view of the platform arrangement in Fig. 13/2, the special speakers being placed one at each end of the platform.

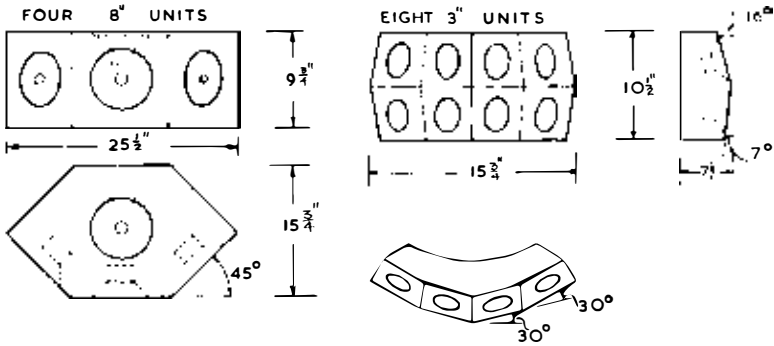

Fig. 13/1. Omni-directional assembly for concert hall stereo, with four 8" and eight 3" units. Frequency range 400 c/s upwards.



Fig. 13/2. Platform layout for demonstration in R.F.H. May, 1959.

There can be little doubt that this extra array of speakers helped in the dissemination of good sound on stereo over a wide area, and the records (H.M.V., Decca, Pye and D.G.G.) offered a much better "spread" of sound than was achieved in earlier stereo tests. Although

## CONCERT HALLS

I would not recommend these 12-speaker assemblies for domestic use, the benefits of omni-directional working still apply at home.

As ever, the reactions of the audience were varied and unpredictable. Out of 50 letters, 12 favoured stereo, 17 said stereo was not for them, and 21 left the question open. Further, the preference for stereo was not confined to those sitting in the best seats (acoustical, not box office.) Five of the pro-stereo voters had side seats and one was behind the platform.

There is probably no more searching test of the quality of reproduced sound than to record it and listen to a re-play. We have a tape recording of the Royal Festival Hall event and, by this test, the stereo discs sound more like the real thing than do the single channel records. This forces one to the conclusion that stereo has something tangible in its make-up.

## MONO/STEREO DEMONSTRATIONS

On Tuesday, 15th September 1959, our Technical Editor Mr. R. E. Cooke gave a lecture-demonstration in Powolny's Restaurant, Leeds, using both mono and stereo records. In the case of two items, the audience, numbering over 250, were able to hear the same performance, recorded both mono and stereo.

Two omni-directional three-speaker systems with 15" bass units in 9 cu. ft. reflex enclosures were used both on mono and stereo, and members of the audience were asked which reproduction they preferred. With both items the choice was overwhelmingly in favour of stereo. The only dissenters were a few people scattered on the extreme flanks of the audience where it was impossible to hear the stereo effect properly.

As a point of interest, the records used for this comparison were the following:—

Utrecht Te Deum	— <i>Handel</i>	Archive	mono APM 14124
			stereo SAPM 198008
España	— <i>Chabrier</i>	Decca	mono LXT 5333
			stereo SXL 2020

## COLSTON HALL

Another experiment, this time in the Colston Hall, Bristol, on October 9th, 1959, before an audience of about 1,500 people is worth placing on record—printed variety. Mr. Devereux, Editor of *Wireless World*, had suggested that a real test of the merits of stereo would be to compare mono *and* stereo recordings with live performances. We therefore betook ourselves to E.M.I. Studios with a piano trio (Messrs. Gover, Popplewell and Weil) and a fine bass

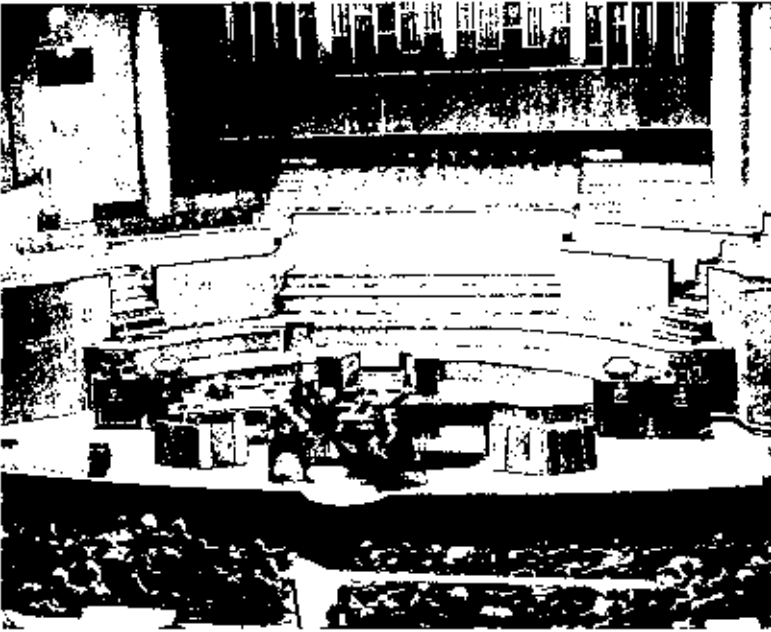

Fig. 13/3. Colston Hall, Bristol, October 9th, 1959.

(Harold Blackburn). The recording engineers did their utmost to produce optimum results with each system.

At the concert, the audience voted overwhelmingly in favour of the stereo versions, which had a depth and warmth not felt with mono reproduction, using the same loudspeakers.

A photograph taken during the concert is shown in Fig. 13/3. The four open baffles were used for the bass voice, and the four large corner speaker systems for reproducing the piano trio.

Incidentally, we had no hum or rumble troubles with stereo discs, thus proving that the precautions outlined in Chapter 6 really are effective.

#### SWEDISH REPORT

In writing about concert hall activities we have resisted the temptation to report on events which would be of only passing interest, but we have referred in Chapter 6 to some trouble we ran into at our May 1959 demonstration in the Royal Festival Hall, London.

## CONCERT HALLS

A translation of an article of mine on this topic was published in the August 1959 issue of the Swedish journal *Radio och Television*, and as we could not understand a word of it we sent it to the Swedish Consul to be translated back into English. The work was done by somebody no doubt experienced in the diplomatic field, but not well versed in technical terms normally used in gramophone circles, with the following rather amusing result. (I particularly like the references to engine noise and herrings, not to mention brum.)

For the first time in the fourteen Hi-Fi Concerts which we have had the opportunity to give, we had some trouble with brum and rumble. The reason for this was that we were now for the first time trying out disc stereo reproduction. The main problem was to eliminate the 50 Hz brum tension, which was practically inaudible in some parts of the hall but which built up to maxima in other parts on account of interference phenomena between the brum effects emanating from the two loudspeakers.

Even the best magnetic stereo needle microphones are very sensitive to brum and engine noise. This means that when working with stereo reproduction in concert halls extra care must be given to shielding motors and power lines. The rumble and brum level appears to lie 10-15 dB higher with stereo needle microphones than with corresponding needle microphones of mono type. Further, the reproduction equipment must be placed on a foundation of concrete as resonance phenomena seem to be even more troublesome in the case of needle microphones than in that of loudspeakers.

We played at the concert mono records with stereo needle microphones. Personally, I prefer playing with a dynamic mono needle microphone. The difference is nevertheless small—let us say that the difference is as tea served out at sea compared with tea served at home. But in concert halls the smallest difference is of essential importance: a herring becomes a mackerel, if not a whale. We used a Decca needle microphone, a needle microphone that I really like for stereo.

Thank you, Sweden!

## PITCH CONTROL

When playing records in the ordinary way, either tape or disc, absolute accuracy of speed is not necessary, because only those rare birds gifted (or afflicted) with the faculty of absolute pitch can tell if the music is being reproduced a semitone too high or too low.

Concert pitch is now A440 throughout the civilised world, but Handel's tuning fork was A422.5 c/s, so to play his music today

exactly as heard by the composer you would have to lower the pitch by a semitone.

But if you are accompanying a record at the piano, or comparing live with recorded music on the spot, then absolute equality of pitch is essential, and a variable control is often required.

In concert hall activities we have found the speed adjustment fitted to transcription motors such as the Connoisseur and the Garrard 301 to be adequate, but with portable tape recorders we found we had to have some form of external frequency control. Even the pitch of an organ varies slightly as hall temperature goes up, and the AC mains voltage and frequency can change slightly between an afternoon rehearsal and an evening performance due to variation in industrial load, etc.

Mr. P. J. Walker therefore designed the frequency control unit illustrated in Fig. 13/4, and this has become a *sine qua non* of the equipment used in all our live v. recorded music demonstrations; it has literally saved our bacon on numerous occasions.

The device consists of a stable low frequency RC oscillator driving a large power amplifier. The illustration shows the arrangement using two Quad Amplifiers fitted with special output transformers to feed a 240 v. line. The oscillator is built on the small chassis immediately behind the front panel. The two power amplifiers are connected in parallel to give over 30 watts output, which is ample for most turntables and capstan motors.

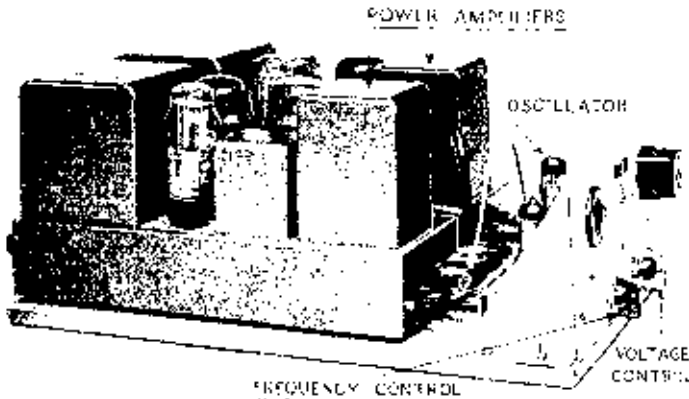

Fig. 13/4. Speed control unit made by Acoustical Manufacturing Co. Ltd. for insertion in mains lead to driving motor in tape machine or turntable equipment.

## CHAPTER 14

# BROADCASTING

Many people in this country, and many more in America, have listened to and enjoyed the stereo programmes—using two transmitters—which have been broadcast on an experimental basis. There can be little doubt that the adoption of regular stereo transmissions would establish two channel working on a firm footing and would induce many listeners—who now hesitate—to instal high grade reproducing equipment.

The first snag is compatibility, as pointed out by Mr. H. T. Greator, Assistant Head of the B.B.C. Engineering Information Department, in an article in *The Listener* October 16th, 1958 from which I quote as follows:

“The system which is being used for the forthcoming series of stereophonic sound broadcasts, involving separate chains of transmitting stations, has the serious disadvantage of not being compatible; i.e. properly balanced reproduction will not be obtained when listening to either one channel alone. This means that listeners not equipped for stereo will not obtain satisfactory reproduction of the stereo programmes. It is for this reason that the experiments are being made outside normal programme hours. The B.B.C. is, however, studying methods of transmitting stereophonic programmes from a single V.H.F. transmitter. If it is found possible to introduce such a system in the future, the necessary receiving apparatus will include twin amplifiers and loudspeakers such as are already available for the reproduction of stereophonic tapes and gramophone records.”

Mr. Greator draws attention here to a very important point, which is that it is not possible to compare mono with stereo—fairly—merely by switching off one channel; a trick adopted in one or two early test records.

Compatibility is of course much easier to achieve in recording, because separate recording systems are used for mono and stereo with as many microphones in each as the engineer may require.



The second snag is the universal adoption of an agreed multiplex stereo system, which enables two channels to be broadcast by one transmitter and received in one radio set. The problem is not that this can't be done, but that there are too many ways of doing it! It is interesting to note that a multiplex system—not for stereo—is in fact now being used in America as outlined by Norman H. Crowhurst in the following account:

“The technical problem here is relatively simple. For years telephone systems have employed multiplex, or carrier telephony, to get many more than two channels over a pair of wires, or over a single radio transmission. It has already been done quite successfully for stereo, in the present FM band, experimentally. The real problem here is an economic or ‘political’ one, that few people outside of America (and not too many inside, apparently!) will understand.

It springs from the nature of private enterprise broadcasting. When FM started, some years ago, to provide high quality (‘High Fidelity’ had not yet become the magic words), it was seen as the new medium for public entertainment, and did not lack sponsors to buy program time and pay the radio station's way for him.

Then came TV. Ordinary AM radio managed to hold on, because there are kitchen and automobile radios that TV doesn't reach. But sponsors could not see the need to use FM. So the FM stations found themselves short of bread and butter. Then a benefactor appeared on the scene.

This was private service multiplex. People whose business is to provide background music for shops and restaurants found they could do it much cheaper by radio than by direct wire. So, with the consent of the FCC, they rented a multiplex subcarrier from a local FM station. With this arrangement, the rent for the subcarrier enabled the station to continue broadcasting high quality program for public use, without being dependent on sponsors for his bread and butter.

The subcarrier was narrow band, to give just sufficient quality for the purpose, and it allowed practically unimpaired transmission on the main carrier for public use.

Now, regardless of how a subcarrier channel is used to transmit stereo, the problem arises about what to do with the background music. He's paid the FM station's rent, and may well continue to do so. So they cannot very well throw him out on his ear. Before stereo appeared, everything was easy. The shop or restaurant had to rent a special receiver to pick up the subcarrier. But now, if multiplex stereo is made available, any home tuner can also be used to pick up the background music channel.

## BROADCASTING

Of course this won't interest the average home listener, who wants it for stereo. But it means shops and restaurants can very easily 'steal' the background music, without paying the rental." N.H.C.

I can see the problem here, but if stereo transmissions became popular no doubt sponsors would come in again with their dollars and the shops and restaurants would fall back on continuous music from slow running tape.

The reader, after getting beautifully tied up in the knot of vested interest, would naturally imagine that the B.B.C.—free from all commercial entanglements—should have no difficulty in broadcasting FM multiplex stereo. But the following report dated 12th August 1959, and kindly sent to us by Mr. M. G. Foster on behalf of Head of Engineering Information Department, B.B.C., proves that the difficulties are many and varied. I am reproducing this report in full because it throws light on many aspects of an important problem.

### B.B.C. REPORT

F.C.C. = Federal Communications Commission  
C.C.I.R. = Comité Consultatif International Radio  
N.S.R.C. = National Stereophonic Radio Committee  
E.B.U. = European Broadcasting Union.

As you know we have suspended the stereophonic transmissions on alternate Saturday mornings, partly due to the fact that public interest in them had diminished during the summer months, also to make a break to allow us to build up a stock of suitable material and to allow the small team engaged in the project to have some leave. The question of the supply of material is a major factor because the choice of material and the number of times it can be repeated is severely restricted by copyright. We hope to resume the experimental transmissions on 3rd October 1959.

We believe that it would be most unwise to build up too much public enthusiasm for the transmissions in their present form and thereby encourage listeners to instal expensive equipment solely for the purpose of receiving them, since it is almost certain that any regular service of stereophonic broadcasting that might be introduced later will be different from the make-shift arrangements used in the experiments. For this reason we have always stressed the experimental nature of the transmissions, and we have not given any undertaking that they will be continued indefinitely.

I feel sure you will agree that any permanent stereophonic service should be compatible and should, as far as possible, enable listeners to make use of any equipment they have already acquired for the reproduction of stereophonic discs or tapes.

Most broadcasting organisations are interested in stereophony on a single channel and this makes it necessary that any system adopted should give acceptable results on ordinary receivers. In nearly all the proposed systems of transmission the so-called "compatible" monophonic programme is derived by the addition of the left- and right-hand channels. There is some doubt as to whether such a monophonic signal will give acceptable results in cases where the programme material and studio technique have been planned for the best stereophony.

However, broadcasting authorities in Europe and the United States are now giving further consideration to the economic and engineering problems which would be involved in providing a stereophonic service. A great volume of work is being done on the subject and experiments have been carried out on a number of systems. In America, the National Stereophonic Radio Committee has been set up to make recommendations to the F.C.C. on transmission standards. The B.B.C. is represented by an observer on one of the technical panels. The C.C.I.R. has accepted a study programme on stereophonic broadcasting. The E.B.U. has also set up a working party to consider broadcasting aspects of stereophony, and at a recent meeting of the E.B.U. it was agreed that the question of compatibility should be investigated experimentally by all member countries of the Union.

To attempt a summary of various methods for transmitting stereophonic programmes on available radio channels is well nigh impossible because of rapid development. In the United States the National Stereophonic Radio Committee had, by March 1959 received for consideration proposals for *seventeen systems* covering applications to television, AM and FM broadcasting, but the information available on most of these and on other systems being developed in Europe, is rather sketchy.

To decide what compromises are necessary, a series of subjective tests, covering a wide range of programme material, must be carried out and for this purpose, as I suggested earlier, it is urgently required that suitable material be prepared. This having been acquired the experiment for each type of programme material will need to be in three parts: (a) to find the conditions for the best stereophony, (b) to find the conditions for the best monophony, and (c) if the best stereophony is not compatible

## BROADCASTING

with the best monophony, to find the most acceptable compromise.

When one considers that the experiments mentioned in the preceding paragraph must be carried out for such types of programmes as Drama, Light music, Dance music, Symphonic music, Piano music, Chamber music and Opera, and also that before International agreement, in Europe at least, can be reached, similar experiments will require to be made by all E.B.U. members and fully discussed, it seems likely that any permanent single transmitter stereophonic service is quite a long way off.

M.G.F.

My thanks are due to Mr. Foster and the B.B.C. for this up-to-date information. The mere fact that all these engineers and authorities are taking stereo seriously proves it has intrinsic merit, and we cannot but applaud their efforts to agree on a uniform world-wide system of working.

## CHAPTER 15

### QUESTIONS and ANSWERS

I believe most manufacturers of high class sound reproducing equipment would agree that, so far, disc stereo has had more effect in swelling their post bags than in adding to their profits. As the Editor of the American Journal *Audio* wisely observed in the issue of June 1959:-

We will agree that a stereo system is more critical to set up and get working to the listener's complete satisfaction than any single-channel outfit. But in all fairness, remember how long and hard you worked to get your first monophonic system performing the way you wanted it to. And by the same token, remember that early LP's weren't all perfect either.

It is therefore hoped that the following Questions and Answers will prove to be of interest and will help to clear the air and cut down confusion in the minds of amateurs.

STEP BY STEP

H. W., London, W.1

*Q. 1. Although I am more than pleased with the results from my large, 3-speaker corner system, and they seem to be omni-directional, there is I think a psychological factor arising from the fact that I know the speaker is in one particular corner of the room, of which I attach a plan. (Fig. 15/1).*

*I have not yet been bitten by the stereo bug, but I may want to add stereo in a year or two. Could I instal a second corner speaker at B to match my present system and improve results on mono and thus be ready for stereo in due course?*

*Would my existing 15 watt amplifier drive two speaker systems, and could I keep the volume of sound down to present levels without losing quality?*

Answer :

With a second 3-speaker system at B you would undoubtedly have better results on mono, but the distance of 14-15 feet would be too great for stereo. We therefore suggest a movable second speaker which you can use in the corner until you change to stereo. The enclosure will be smaller and you will have maximum bass from the big corner system, but this is quite satisfactory on both mono and stereo. As the speakers are fitted with mid-range and tweeter controls you will have no difficulty in balancing on stereo.

## QUESTIONS AND ANSWERS

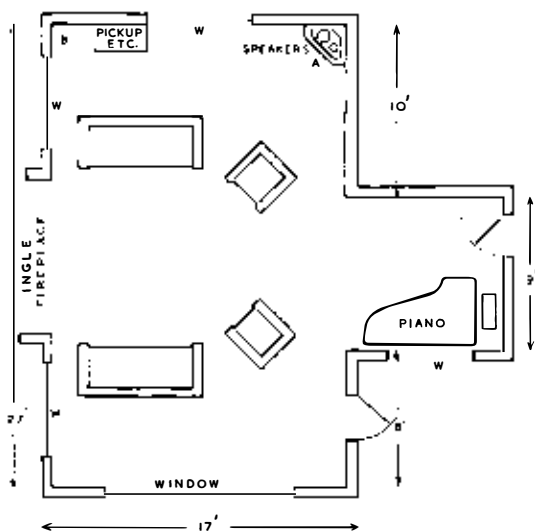

Fig. 15/1. Large room with omni-directional speaker at A. Second speaker B ideal for single channel but should be movable for stereo, unless a third speaker is placed in the centre.

If you prefer a large corner speaker at B, a centre speaker with isolating transformer could be added for stereo, as described in Chapter 10.

You do not need a bigger amplifier to drive two speakers, nor do two speakers sound louder than one—unless you double the output from the amplifier!

When connected in parallel the impedance is halved, so you might change to the  $7/8$  ohms output on amplifier; the volume settings and levels will then be exactly as they were before.

If later you instal a second amplifier for stereo, you return to 15 ohms output, but today the matching is not critical, thanks to our old friend N.F.B.

As to quality, two good speakers are *always* better than one, and their task is obviously 50% lighter.

LOAD MATCHING

T. E. P., Princeton, New Jersey

*Q. 2. I am installing two multi-speaker systems with a view to having stereo later, but I am worried about impedances. One system has  $8/10$  ohms middle and top speakers and I have two of each in parallel. I have inserted series resistances to bring them up*

*to 15 ohms to match the crossover network. Is this a good idea? I am actually driving two speaker systems comprising 9 units in all, from a 15 watt amplifier.*

**Answer :**

We do not like the idea of series resistors for middle and top speakers, as it is almost equivalent to throwing one of each of the pairs of speakers away. A better solution would be the insertion of small matching transformers, ratio about 2 to 1, between the speakers and the crossover network.

With multi-speaker systems, the only reliable way to ascertain the total impedance is to measure it throughout the frequency range. If one system looks like 8 ohms and the other 16 ohms, the first one will take more power on mono input working in parallel; but when changing to stereo they could be connected to the 8 ohms and 16 ohms output of their respective amplifiers and matching would be in order.

BASS AND STEREO

General

*Q. 3. I have a large corner enclosure, about 12 cu. ft., and also a 15" and a 12" woofer. Could I place them both in the one enclosure and use them for stereo?*

**Answer :**

Yes. You simply connect each one to its crossover network as though the speakers were in separate cabinets, but they *must be* correctly phased. The mere fact of having two cones mounted side by side improves the radiation at low frequencies and in itself practically doubles the output. The crossover frequency should not be higher than 400 c/s.

Owing to the devastating out-of-phase effects with such a bass system, it might be a good idea to fit a reversal switch to one of the speakers, as described in the next answer.

PHASE SWITCH

General

*Q. 4. My amplifier is not fitted with a phase reversal switch, and I find it inconvenient to change the speaker connections. How can I fit my own switch?*

**Answer :**

The best way is to use a 3 position Yaxley switch in one pair of speaker leads, connected as in diagram Fig. 15/2. The third position is "off" and could be used when testing hum and rumble levels, or for fault-finding and assessing speaker performance in general.

QUESTIONS AND ANSWERS

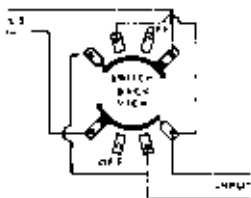

Fig. 15/2. Phase reversal switch with "off" position.

AMPLIFIERS

General

*Q. 5. I have a 15/20 watt amplifier. Do I require another of the same power for stereo ?*

Answer :

Not really. Although the volume level varies between the two channels according to programme material, the requirements are about half, so a good 10 watt amplifier would be adequate for your second channel (meaning 10 watts rms British rating). The large reserve of power on channel one cannot do any harm.

STEREO PICKUP FOR MONO USE

General

*Q. 6. I have been told that I should cancel the vertical output from my stereo pickup when I use it on mono records. How can I do this ? My pre-amp makes no provision for it.*

Answer :

To cancel the vertical output from a stereo pickup it is necessary to short together the live leads from left and right hand channels. This can be done with a small switch but you should keep the wiring as short as possible to avoid picking up hum. See Fig. 15/3.

Sum and difference pickups such as the Decca (London—Scott) are provided with special connections to the lateral coils for use when playing mono records.

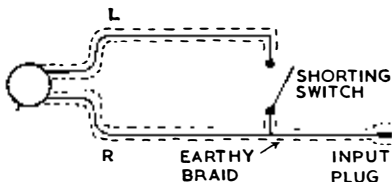

Fig. 15/3. Stereo pickup connected for mono use.



BUILDING OPERATION

D. A. J., Johannesburg, S.A.

*Q. 7. I wish to instal a stereo system in a house now being built for me. Cost should be low, using preferably only a couple of 8" units. Could I use horizontal built-in enclosures, say 7 ft. long, 18" high and 12" deep, with a speaker at one end and a vent at the other? If brick-built columns, one at each side of the fireplace and some 8 ft. apart, would be better, can I cover in the top without upsetting the performance, and simply treat the speakers as reflex enclosures?*

Answer :

You certainly cannot do better than use bricks and mortar. The first proposition is not really very good, because with stereo the middle and upper registers should preferably be radiated at 3 or 4 ft. above floor level.

Your second idea of columns adjoining the fireplace is excellent, but you must face the units upwards and fit diffusers for omnidirectional effects. You can easily add open mesh to hide the trimmings. Any boxing-in here is out of the question.

VOLUME LEVEL

J. A., Ilkley

*Q. 8. I have been informed that stereo is not suitable for domestic listening because it must be played very loudly in order to obtain the stereophonic effect. Is this so?*

Answer :

There is no truth in the assertion. The only life-like level for reproduction of music on mono or stereo is the level normally heard at the listener's ear.

HEAVY WORK IN LIGHTER VEIN

M. C., Hornchurch

*Q. 9. I am building a concrete column. (Heaven help us!) My wife was delighted when she caught me furtively unloading concrete slabs from my van. She thought—poor woman—that my long-forgotten promise to build a coal bunker was actually materialising. But there has been an ominous drop in temperature since my wife discovered the truth: She says: "If you think I'm having that thing in the front room, then you have a double think coming."*

*Having studied your construction manual, my wife is surprised at Mr. Briggs' limited imagination, and asks why he could not have included the plan of a concrete block-house to accommodate a real enthusiast in the back garden?*

Answer :

My sympathies are all with Mrs. C.

## CONCLUSION

Writing about stereo is rather like shaking hands with a jelly fish; you never know quite where you are and it is difficult to control the situation.

It must have been about November 1958 when we decided that producing a book on stereo would be an interesting hobby; but six months later I found that I had written four Chapter One's and they all appeared to be unsatisfactory. Then about the middle of 1959 the air seemed to clear; Cecil Watts agreed to help us with the fruits of his investigations, and we were able to adopt a set line of approach.

Looking back at the book, I would say that it is much less factual than our previous publications, but that is inherent in the topic. With stereo, it is difficult to separate fact from fiction, and technicalities are much too involved for the average listener.

If the book has solved a few problems without boring the reader to tears, it has, I submit, served its purpose.

# INDEX

<b>A</b>		<b>F</b>	
Acoustic unbalance .. .. .	125-6	Feedback (mechanical) .. .. .	46
Aldous, D .. .. .	13	Filters .. .. .	97
America .. .. .	20	Foster, M. G. .. .. .	136-8
Ampex .. .. .	44	France .. .. .	20
Amplifiers .. .. .	94	<b>G</b>	
"    Power .. .. .	94	Garrard .. .. .	119
"    Watts .. .. .	142	Gray, W. .. .. .	23
Arm adjustment .. .. .	73	Greatorex, H. T. .. .. .	134
<i>Audio Journal</i> .. .. .	122, 139	Groove damage .. .. .	80
Australia .. .. .	23	"    faulty .. .. .	86-87
<b>B</b>		"    shape .. .. .	84
Barrell, W. S. .. .. .	33	<b>H</b>	
Bass Enclosure .. .. .	141	<i>High Fidelity Journal</i> .. .. .	33
Blumlein .. .. .	32	Hollis, Dennis G. .. .. .	101, 114
B.B.C. .. .. .	24, 36, 136	H.M.V. .. .. .	128
Broadcasting .. .. .	134	Hum .. .. .	75
<b>C</b>		Hum and Rumble .. .. .	45
Canada .. .. .	24	Hum Test .. .. .	49
Carduner, L. .. .. .	101, 113	Human Hair .. .. .	92
Ceramic pickup .. .. .	58	<b>I</b>	
Channel separation .. .. .	57, 69	Impedance .. .. .	140-1
Cheap equipment .. .. .	30-1	<b>J</b>	
Collinson, John .. .. .	93	<i>Journal A.E.S.</i> .. .. .	32
Colour photos .. .. .	113-114	<b>K</b>	
Colston Hall .. .. .	131	Kelly, S. .. .. .	10, 13, 19, 54
Comical Chris .. .. .	31	<b>L</b>	
Compatible record .. .. .	70	Lafaurie, R. .. .. .	20, 28
Concert Hall test .. .. .	27, 45, 128	Leak, H. J. .. .. .	13
Concrete column .. .. .	111, 143	Listening Test .. .. .	105, 109, 121
Concrete slabs .. .. .	46-47	Loudspeakers .. .. .	17, 24, 101, 129
Consumer reports .. .. .	74-75, 128	"    Response .. .. .	104
Critics .. .. .	29	<b>M</b>	
Crossover frequency .. .. .	27	Magnetic pickups .. .. .	59
Crowhurst, N. H. .. .. .	13, 20, 135	Matched speakers .. .. .	17, 24
Crystal pickups .. .. .	16, 57	Microphones .. .. .	34-5
<b>D</b>		Monitoring .. .. .	32
Decca pickup .. .. .	24, 63	Mono v. Stereo .. .. .	130
Definition (stereo) .. .. .	11	Motorboard .. .. .	48
Devereux, F. L. ... .. .	130	Moving coil pickups .. .. .	64, 66, 69
Directional effects .. .. .	26	Moving magnet pickups .. .. .	61, 70
Disc quality .. .. .	37	Multi-speakers .. .. .	129
Dust .. .. .	79	<b>E</b>	
Dust Bug .. .. .	78	Earthing .. .. .	51
<b>E</b>		<i>Electronics World</i> .. .. .	10
Earthing .. .. .	51	ELS and Column .. .. .	110
<i>Electronics World</i> .. .. .	10	E.M.I. Studios .. .. .	130
ELS and Column .. .. .	110		
E.M.I. Studios .. .. .	130		

INDEX

	<b>N</b>	
Noise .. .. .		46
	<b>O</b>	
Offset angle .. .. .		72
Omni-directional Speakers .. .. .		129
Opinions .. .. .		30
Oscillograms .. .. .		50, 104
	<b>P</b>	
Parastat .. .. .		76
Phase check .. .. .		28
Phase reversal .. .. .		142
Phasing .. .. .		27
Photomicrographs .. .. .	39-42, 82-91	
Pickups .. .. .	13, 25, 53	
Pickup coils .. .. .		53
" crystal .. .. .		16
" design .. .. .		56
" faulty .. .. .		88
" matching .. .. .		96
" stereo/mono .. .. .		142
" summary .. .. .	66-67	
" tests .. .. .		54
Pitch .. .. .		74
Pitch control .. .. .	132-133	
Plastics .. .. .		93
Playing weight .. .. .	68, 80	
Preamps .. .. .		96
<i>Punch</i> .. .. .		12
	<b>Q</b>	
Quality M/S .. .. .		16
	<b>R</b>	
<i>Radio &amp; TV News</i> .. .. .		10
R.C.A. .. .. .		118
Record, new .. .. .		90
" played 150 times .. .. .		91
" wear .. .. .	81-83, 85	
Records, mono .. .. .		16
Recording level .. .. .		37
" systems .. .. .		33
Response curves .. .. .	58-70	
Reverberation .. .. .		123
Room acoustics .. .. .		123
Rooms, large .. .. .	126-140	
" small .. .. .		127
R.F.H. .. .. .	29, 129	
Rumble .. .. .	52, 74	
	<b>S</b>	
Small Enclosures .. .. .		128
Smyth, J. B. .. .. .		24
Solomon, Seymour .. .. .		33
Sound reflection .. .. .	124-125	
Speaker tests .. .. .		109
Speed variation .. .. .		74
Static .. .. .		77
Stereo effects .. .. .		26
Stereo speakers .. .. .	103-110	
Stereophoner .. .. .	112, 115	
Stylus, diameter .. .. .	14, 56	
" drag .. .. .		75
" wear .. .. .	15, 55	
Sugden, A. .. .. .	9, 74	
Sum and difference pickups .. .. .		62
Swedish report .. .. .	131-132	
	<b>T</b>	
Tape, price .. .. .		122
" wide .. .. .		43
Tapes .. .. .	17, 116	
" cassettes .. .. .	118-119	
" cross talk .. .. .		120
" four track .. .. .		117
" response .. .. .		120
" signal/noise ratio .. .. .		120
Three speakers .. .. .	105, 108	
Tillett, G. W. .. .. .		25
Tone arms .. .. .		71
" friction .. .. .		71
" resonance .. .. .		71
Tone controls .. .. .		97
Tracking error .. .. .		72
Transformer .. .. .	106-7	
Treble units .. .. .	106-7	
Turntables .. .. .		74
	<b>V</b>	
Vanguard records .. .. .		33
Variable reluctance pickup .. .. .		68
Volume controls .. .. .	99, 112	
" levels .. .. .		143
	<b>W</b>	
Walker, P. J. .. .. .	11, 133	
Watts, C. E. .. .. .	37-43, 76, etc.	
Wear .. .. .		15
" Stylus .. .. .		55
West, R. L. .. .. .	13, 48, 94	
Whyte, Bert .. .. .		10
Wilson, P. .. .. .	13, 75	
<i>Wireless World</i> .. .. .	45, 130	

# OVERSEAS AGENTS

## U.S.A.

British Industries Corporation  
80 Shore Road, Port Washington, N.Y.

## CANADA

J. B. Smyth  
380 Craig Street West, Montreal 1, Prov. Que.

## AUSTRALIA

McGill's Authorised Newsagency  
183-185 Elizabeth Street, Melbourne C 1, Vic.

## BELGIUM

Modelbouw  
Borgerhout, Turnhoutsebaan, Antwerp.

## CUBA

California Alta Fidelidad  
Calle 23, No. 72-74, Habana.

## FRANCE

Young Electronics  
11 bis Rue Roquépine, Paris 8e.

## HOLLAND

U.M. De Muiderkring  
Nijverheidswerf 19-21, Bussum.

## HONG KONG

The Radio People Ltd.  
31 Nathan Road, Hong Kong.

## JAMAICA

Stanley Motta Ltd.  
109 Harbour Road, Kingston.

## MALAYA

Eastland Trading Co.  
1 Prince Street, Singapore.

## PERU

Sruli Roif  
San Ramon 236-240, Miraflores, Lima.

## PORTUGAL

Est. Valentim de Carvalho Lda  
Rua Nova do Almada 95-97, Lisbon.

## SOUTH AFRICA

Procter International (Pty) Ltd.  
P.O. Box 10013, Johannesburg.

## SWITZERLAND

W. Eggenberger  
Socinstrasse 27, Basle 3.

## TRINIDAD, B.W.I.

Investments & Agencies Ltd.  
94/96 Henry Street, Port of Spain.

## VENEZUELA

Maracaibo Import  
Plaza Baralt, Aptdo 658, Maracaibo.

## Other Wharfedale Publications

### LOUDSPEAKERS

(57,000 copies sold)

FIFTH EDITION

by G. A. BRIGGS

Assisted by

R. E. COOKE B.Sc. (Eng.)

as Technical Editor

336 pages

230 illustrations

Originally published in 1948 as a booklet of about 90 pages, and reprinted 15 times with minor revisions, the book has now been brought up to date and completely re-written, and enlarged to 336 pages.

Problems of design and performance of loudspeakers and enclosures are dealt with in non-technical terms, with the inclusion of two chapters of reminiscences briefly covering the writer's 25 year's experience in the loudspeaker field. Separate chapters are devoted to Electrostatic Speakers and Stereo.

19/6 20/9 post free

### SOUND REPRODUCTION

by G. A. BRIGGS

THIRD EDITION (Revised and Enlarged)

368 pages. 315 illustrations. Fine art paper. Full Rexine.

First Edition -10,000 copies, July 1949—Sold Out

Second Edition -12,000 copies, May 1950—Sold Out.

Third Edition -10,000 copies, March 1953

Reprinted - 7,500 copies, May 1954

Reprinted - 4,000 copies, March 1958

All aspects of recording and reproducing sound are covered in non-technical language enlivened with touches of humour. French Edition published by Société des Editions Radio, Paris.

17/6 18/6 post free

### PIANOS, PIANISTS & SONICS

by G. A. BRIGGS

190 Pages. 102 Figures, including 62 plates, 25 of which contain no less than 75 original oscillograms of sounds and piano tones. Fine art paper. Bound Full Rexine.

Published June 1951. Over 7,500 copies sold.

10/6 11/6 post free

The books  
AMPLIFIERS and HIGH FIDELITY  
are out of print

*The total publication figure of Wharfedale books now exceeds 150,000 copies*

Published by Wharfedale Wireless Works Ltd., Idle . Bradford . Yorks.