



Catalogue of High Fidelity Equipment and Accessories

ACOUSTICAL
ACOS
B.J.
B.S.R.
COLLARO
CONNOISSEUR
DECCA
DULCI
ELAC
FANE
GARRARD
GOLDRING
GOODMANS
GRAMPIAN
LEAK
LENCO
LOWTHER
PHILIPS
QUAD
ROGERS
RONETTE
SHURE
VITAVOX
W.B.
WHARFEDALE

A. C. FARNELL LTD

HEREFORD HOUSE, NORTH COURT
VICAR LANE, LEEDS 2

Telephone Leeds 35111

(WHOLESALE ONLY)

and also at

27 BROOMHALL STREET, WEST STREET
SHEFFIELD 3

Telephone Sheffield 27466

In line with our usual policy

ALL ITEMS IN THIS CATALOGUE ARE CARRIED IN STOCK

Subject only to normal availability of supplies

JULY 1961

TAPE RECORDERS & ACCESSORIES



We also have a specialized tape recorder department and large stocks are carried covering the products of the following manufacturers.

RECORDERS

CLARION	ELIZABETHAN	FIDELITY	STUZZI
TRUVOX	TELEFUNKEN		TANDBERG

TAPES AND ACCESSORIES

B.A.S.F.	BIB	CLARION	E.M.I.
GARRARD	GRUNDIG	GELOSO	METROSOUND
M.S.S.	PHILIPS	SCOTCHBOY	TELEFUNKEN
WEARITE			

INDEX

A			
Acos Pick-ups	...	30	
Acoustical Resistance Units	...	19	
Amplifiers	4, 5, 6, 7, 8, 9, 10, 11, 12		
Audio Amplifiers	4, 5, 6, 7, 8, 9, 10, 11, 12		
Auto Changers	...	3, 4	
Audio Fidelity Records	...	43	
B			
B.J. Pick-ups	...	32	
B.S.R. Changers	...	3	
" Gram Units	...	3	
" Matching Transformer	...	35	
C			
Connoisseur Pick-up	...	29	
" Transcription Motor	...	2	
Crossover Units	...	16, 19, 20	
D			
Decca Pick-up	...	28	
" Microlift	...	33	
Dust Bugs	...	33	
Dulci Amplifiers	...	11, 12	
" A.M.F.M. Chassis	...	13, 14	
" F.M. Tuner Unit	...	14	
E			
Elac Cartridge	...	30	
" Tweeter	...	21	
Elizabethan Tape Recorder	...	39	
F			
Fane Tweeter	...	21	
" Speaker	...	25	
F.M. Tuner Units	...	12, 13, 14	
G			
Garrard Autochangers	...	3, 4	
" Gram Units	...	3	
" Pick-ups	...	29	
" Record Spindle	...	35	
" Stylus Pressure Gauge	...	33	
" Transcription Units	...	1, 2, 4	
Goldring Pressure Gauge	...	33	
" Pick-ups	...	28, 29	
Goodmans Acoustical Resistance Units	...	19	
" Crossover Units	...	19	
" Speaker Units	...	17, 18, 19, 25	
Gramophone Pick-ups	...	28, 29, 30, 31, 32	
" Units	...	1, 2, 3, 4	
L			
Leak Amplifiers	...	4, 5, 6	
" F.M. Tuner Unit	...	12	
" Pick-up	...	29	
" Pre-Amplifiers	...	6, 7	
" Speaker...	...	22	
Lenco Transcription Units	...	1	
Loudspeaker Cabinets	...	22, 23, 24, 25, 26, 27	
Loudspeaker Units	...	15, 16, 17, 18, 19, 20, 21	
Lowther Pressure Unit	...	21	
" Acousta Cabinet	...	22	
M			
Microphones Telefunken	...	38	
Miscellaneous...	...	35	
P			
Pick-ups	...	28, 29, 30, 31, 32	
Pre-Amplifiers	...	6, 7, 8, 9, 10, 11	
Pressure Gauges	...	33	
" Units	...	17, 19, 20, 21	
Q			
Quad Amplifiers	...	10	
" Tuners	...	12	
" Electrostatic Speaker	...	22	
R			
Rogers Amplifiers	...	7, 8, 9	
" Tuners	...	13	
Ronette Pick-ups	...	30	
S			
Separator Units	...	16, 19, 20	
Southdown Cabinet	...	27	
Stentorian Speakers...	...	20	
S.M.E. Pick-up Arm	...	31	
Stylus Pressure Gauge	...	33	
Speaker Cabinets	...	22, 23, 24, 25, 26, 27	
Speaker Units	...	15, 16, 17, 18, 19, 20, 21	
Sonotone Cartridge	...	30	
Shure Pick-ups	...	32	
" Cartridges	...	31	
Switch, Wharfedale Speaker	...	21	
T			
Telefunken Tape Recorders, Mikes	...	36, 37, 38, 39	
Transcription Units	...	1, 2, 4	
Tweeter Units	...	21	
Tape Recorders	...	36, 37, 38, 39, 40, 41	
Tandberg	...	41, 42	
Truvox Recorder	...	38	
V			
VHF/AM Tuner Units	...	12, 13, 14	
Vitavox Speaker	...	21	
W			
W.B. Cabinets	...	26, 27	
" Speaker Units	...	20	
Wharfedale Speaker Units	...	15, 16, 23, 24	
" Separators	...	16	
" Speaker Matching Transformer	...	15	
" Speaker Switch	...	21	
Wal Gain Pre-Amplifiers and Tape Accessories	...	40	

GRAMOPHONE UNITS

TRANSCRIPTION UNITS



Garrard 301

GARRARD MODEL 301 THREE-SPEED TRANSCRIPTION UNITS

Refinements include suppression of switch clicks, carefully designed turntable mat, perfectly balanced, cast aluminium 12" turntable. "Wow" and "flutter" have been reduced to the minimum and all three speeds are adjustable by approx. plus and minus 2½%.

Supplied complete with plastic stroboscope, special grease, fixing screws, springs, washers, template and instruction manual. Minimum cabinet space, excluding provision for pick-up, 13¾" long x 16" wide with 2½" clearance above and 3½" below top of motor board. For 100/130, and 200/250 volts, A.C. 50 c/s. Finished in broken white enamel with black relief. Price ... £17 14 6 plus £5 15 3 P. Tax. Total £23 9 9 (A) As above but with turntable stroboscopically marked on its rim for 33½, 45 and 78 r.p.m.

Price ... £18 19 3 plus £6 3 3 P. Tax. Total £25 2 6 (A)

GOLDRING LENCO STANDARD TRANSCRIPTION UNITS

Four-speed model for monaural and stereo reproduction. Speed continuously variable from above 78 r.p.m. to below 33½ r.p.m. "Wow" and "flutter" less than 0.5%. 11¾" turntable. Unit plate size 15" x 13"; clearance above board 3", below board 2¾".

GL55/X (GL58 Unit without pick-up Arm)
Price ... £11 5 0 plus £3 13 2 P. Tax. Total £14 18 2

GL58 fitted with G60 arm, less cartridge
Price ... £13 15 0 plus £4 9 5 P. Tax. Total £18 4 5

GL58 complete with pick-up arm and cartridge—

GL58/MX1/D
Price ... £15 12 6 plus £5 1 7 P. Tax. Total £20 14 1

GL58/580
Price ... £17 19 0 plus £5 16 8 P. Tax. Total £23 15 8

GL58/600
Price ... £22 3 0 plus £7 4 0 P. Tax. Total £29 7 0

GL58/SX10/D
Price ... £16 0 0 plus £5 4 0 P. Tax. Total £21 4 0

GL58/700
Price ... £21 2 0 plus £6 17 2 P. Tax. Total £27 19 2



GL58

GOLDRING LENCO HIGH FIDELITY TRANSCRIPTION UNITS

Four-speed model with heavy turntable for monaural and stereo reproduction. Speed continuously variable from below 30 r.p.m. to above 80 r.p.m. and from 15 to 18 r.p.m. "Wow" and "flutter" approx. 0.2%. Clearance size 15¾" x 13¼" x 5½" high.

GL59 (GL60 Unit without pick-up arm).
Price ... £16 0 0 plus £5 4 0 P. Tax. Total £21 4 0

GL60 fitted with G60 arm less cartridge
Price ... £18 10 0 plus £6 0 3 P. Tax. Total £24 10 3

GL60 complete with pick-up arm and cartridge—

GL60/MX1/D
Price ... £20 7 6 plus £6 12 5 P. Tax. Total £26 19 11

GL60/580
Price ... £22 14 0 plus £7 7 7 P. Tax. Total £30 1 7

GL60/600
Price ... £26 18 0 plus £8 14 10 P. Tax. Total £35 12 10

GL60/SX10/D
Price ... £20 15 0 plus £6 14 11 P. Tax. Total £27 9 11

GL60/700
Price ... £25 17 0 plus £8 8 0 P. Tax. Total £34 5 0



GL60

GRAMOPHONE UNITS

TRANSCRIPTION UNITS

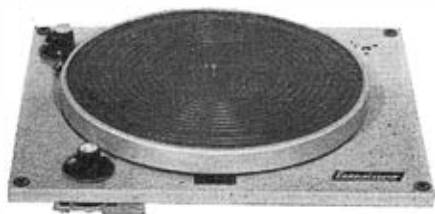

Connoisseur Type B

CONNOISSEUR VARIABLE THREE-SPEED TYPE B

Lathe-turned 12" turntable. Revolving shafts are precision ground, and run in a nylon graphite type bearing. For A.C. voltages 210/250 v. 50 c/s. The motor platform is 15 $\frac{1}{4}$ " x 13 $\frac{1}{2}$ " with 3 $\frac{3}{8}$ " clearance distance below the motor-board.

Price ... £20 10 0 plus £7 6 1 P. Tax. Total £27 16 1 (C)



Connoisseur Fixed 2-speed Transcription Motor

CONNOISSEUR "CRAFTSMAN" FIXED 2 SPEED TRANSCRIPTION MOTOR

For 33 $\frac{1}{2}$ and 45 r.p.m., full 12" heavy lathe turned turntable. 210/250V A.C. 50 c/s. Minimum motor board size 15 $\frac{3}{8}$ " x 13 $\frac{1}{2}$ "—3 $\frac{3}{8}$ " clearance below.

Price ... £14 0 0 plus £4 13 1 P. Tax. Total £18 13 1 (B)

GARRARD MODEL 4HF FOUR-SPEED SEMI-TRANSCRIPTION UNIT

Fitted with the latest TPA12 pick-up arm using the M.P.M.4 moulding which will take almost all present day pick-up cartridges.

Size: 17 $\frac{1}{4}$ " x 13 $\frac{1}{4}$ " x 3 $\frac{1}{2}$ " above top of motor board, 3 $\frac{1}{2}$ " below top of motor board.

For 100/130 or 200/250V A.C. only

4HF/GC8 Fitted with GC8 cartridge.

Price ... £14 13 3 plus £4 15 4 P. Tax. Total £19 8 7 (A)

4HF/EV26 Fitted with EV26 Stereo cartridge.

Price ... £15 7 3 plus £4 19 9 P. Tax. Total £20 7 0 (A)

4HF Unit mounted on B3 Base (Less plug in pick-up head)

Price ... £15 19 0 plus £5 3 9 P. Tax. Total £21 2 9



4HF

GRAMOPHONE UNITS (NON AUTO-CHANGE)



B.S.R. TU9

B.S.R. TU9

4 speed motor. Independent on/off switch. 8" dia. turntable. Suitable for 100/125 volts and 200/250 volts. 50 c/s. A.C. mains. Pick-up arm is completely separate—but is particularly suitable for use with the TU9 unit.

TU9 Unit ...	£2 7 0 plus	15 0 P. Tax.	Total £3 2 0 (A)
TU9 Pick-up ...	£2 0 0 plus	12 9 P. Tax.	Total £2 12 9 (A)
Complete ...	£4 3 0 plus	£1 6 7 P. Tax.	Total £5 9 7 (A)

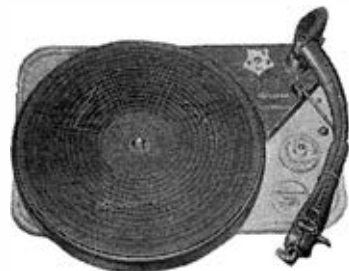

Garrard Model TA/Mk. II Unit

GARRARD MODEL TA/Mk. II UNIT

Mounted on a rectangular unit plate. Most suitable for the home constructor. Voltage range 100/130 and 200/250 volts A.C. only.

Minimum cabinet space $14\frac{1}{4}'' \times 12\frac{1}{4}'' \times 3''$ clearance above and $2\frac{1}{8}''$ below the top of the motor board.

Price ...	£6 15 3 plus	£2 4 0 P. Tax.	Total £8 19 3 (A)
Price, D.C. 6 volts	£7 7 6 plus	£2 8 0 P. Tax.	Total £9 15 6 (A)

GRAMOPHONE UNITS (AUTO-CHANGE)



B.S.R. Monarch UA14

B.S.R. MONARCH UA14

4-speed motor. Magidisc selector enabling 7", 10" and 12" records to be selected automatically. Ful-Fi turnover crystal cartridge. Attractively styled in two colours of grey and fawn. Suitable for A.C. mains 100/125 volts and 200/250 volts 50 c/s. Unit plate $13\frac{1}{4}'' \times 11\frac{1}{4}''$.

Price ...	£6 15 0 plus	£2 3 4 P. Tax.	Total £8 18 4 (A)
-----------	--------------	----------------	-------------------



Garrard Model 210

GARRARD MODEL 210

4 speed motor. 100/250V. Will play up to eight records. 10" and 12" records at same speed may be mixed in any order. Pick-up takes MPM5 head moulding and is supplied with GC8 monaural cartridge, though other cartridges may be fitted. Arm wired for stereo reproduction. Cabinet space required $14\frac{1}{4}'' \times 12\frac{1}{2}'' \times 5\frac{1}{8}''$ clearance above.

Price ...	£10 1 0 plus	£3 5 5 P. Tax.	Total £13 6 5 (A)
-----------	--------------	----------------	-------------------

GARRARD MODEL 210

Mounted on B5 base complete with monaural GC8 head.

Price ...	£11 19 9 plus	£3 18 1 P. Tax.	Total £15 17 10 (A)
-----------	---------------	-----------------	---------------------

GRAMOPHONE UNITS (AUTO-CHANGE)



Garrard Type A

GARRARD LABORATORY SERIES AUTO TURNTABLE Type A

A Transcription Record Player with provision for playing records automatically. It incorporates a sandwich construction heavy turntable which comprises an inner steel shell, a foam polyurethane disc, a die cast non-magnetic outer turntable and a rubber mat.

A scientifically designed precision weight counter-balance pick-up arm is fitted with a built-in stylus pressure adjustment.

Voltage range 100/130 and 200/250 A.C. only. Minimum cabinet space—16 $\frac{3}{8}$ " long by 14 $\frac{1}{8}$ " back to front and 6" clearance above and 2 $\frac{7}{8}$ " below top of motorboard.

CAN BE SUPPLIED WITH OR WITHOUT BASE

Laboratory Series Auto Turntable Type 'A' (less plug-in pick-up head)

Price ... £15 18 0 plus £5 3 5 P. Tax. Total £21 1 5

Laboratory Series Auto Turntable Type 'A' (less plug-in pick-up head) on B6 base.

Price ... £17 19 9 plus £5 17 0 P. Tax. Total £23 16 9

PLUG-IN PICK-UP HEADS

GC8 Turnover—Monophonic L/P and 78 r.p.m.

Price ... £1 1 6 plus 7 0 P. Tax. Total £1 8 6

GCS10 Stereophonic and Monophonic L/P

Price ... £1 13 3 plus 10 10 P. Tax. Total £2 4 1

EV26 Ceramic Turnover—Stereophonic and Monophonic (inc. 78 r.p.m.)

Price ... £1 15 6 plus 11 7 P. Tax. Total £2 7 1

AUDIO AMPLIFIERS

LEAK

"TL/12 PLUS" POWER AMPLIFIER

Circuitry: 3-stage triple loop feedback circuit, the main loop applying 26 db. of negative voltage feedback over the complete amplifier from input to output terminals. Low-noise, high-gain pentode feeds into a second-stage double-triode phase-splitter which, in turn, feeds two- push-pull output valves.

Valves: 1 x EF86, 1 x ECC81, 2 x EL84, 1 x GZ34. Power output 14 watts r.m.s. maximum. Harmonic distortion 0.1% at 12 watts output (± 1 db.) at 1,000 c/s. Hum and noise 85 db. ± 3 db., below 12 watts with source impedance of 25,000 ohms. Sensitivity: Input of 125 mv. at 1,000 c/s. gives 12 watts output. Frequency response ± 0.5 db., 20 c/s. to 20 kc/s. Input impedance 1 megohm, plus approximately 5 mmfd. Consumption 75 watts. Speakers of any impedance between 3 and 20 ohms. may be used. Adjustable plug on output transformer selects three tapings, nominally 16, 8 and 4 ohms. Mains voltage 200/250 v. 50/100 c/s., or 100/125 v. 50/100 c/s.

Size: 10" x 7 $\frac{3}{8}$ " x 5 $\frac{1}{8}$ " high. Weight 14 $\frac{1}{2}$ lb.

Finished in beige gold paint with visible accessories black.

Price £18 18 0 (Free of P. Tax) (C)



"TL/12 Plus"

"TL/25 PLUS" POWER AMPLIFIER

The circuitry on this amplifier is similar to the "TL/12 Plus". Valves: 1 x EF86, 1 x ECC81, 2 x EL34, 1 x GZ34. Power output 32 watts r.m.s. maximum. Harmonic distortion 0.1% for 25 watts output (± 1 db.) at 1,000 c/s. Hum and noise 86 db., ± 3 db., below 25 watts with a source impedance of 25,000 ohms. Sensitivity: An output of 125 mv. at 1,000 c/s. gives 25 watts output. Frequency response ± 0.5 db., 20 c/s. to 20 kc/s. Input impedance 1 megohm, plus approximately 5 mmfd. Consumption 130 watts. Speakers of any impedance between 3 and 20 ohms. may be used. Adjustable plug on top of the output transformer selects three tapings, nominally 16 ohms. 8 ohms. and 4 ohms. Mains voltages 200/250 v. 50/100 c/s. or 100/125 v. 50/100 c/s.

Size: 10" x 7 $\frac{3}{8}$ " x 6 $\frac{1}{8}$ " high. Weight 17 lb. 6 oz.

Finished in beige gold paint with visible accessories black.

Price £25 4 0 (Free of P. Tax) (C)



"TL/25 Plus"

AUDIO AMPLIFIERS

LEAK

"TL/50 PLUS" POWER AMPLIFIER

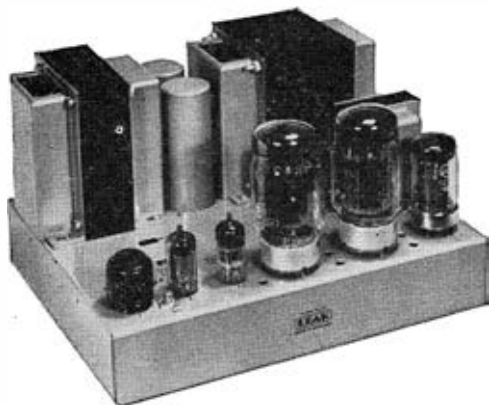

"TL/50 Plus"

The circuitry is identical with the "TL/12 Plus" and TL/25 Plus" amplifiers. The massive output transformer has a core of high grade orientated steel. Valves: 1 x EF86, 1 x ECC81, 2 x KT88, 1 x GZ34. Power output 50 watts r.m.s. maximum (British rating) or 100 watts peak (American rating). Harmonic distortion 0.1% for 50 watts output (± 1 db.) at 1,000 c/s. Hum and noise 83 db., ± 3 db., below 50 watts with a source impedance of 25,000 ohms. Sensitivity: An input of 125 mv. at 1,000 c/s. gives 50 watts output. Frequency response ± 0.5 db., 20 c/s. to 20 kc/s. Input impedance 250 k ohms., plus approximately 5 mmfd., feedback magnitude minus 23 db. at 1 kc/s. Consumption 145 watts. Loudspeakers of any impedance between 3 ohms and 20 ohms. may be used. Adjustable plug on top of the output transformer selects three tapings, nominally 16 ohms., 8 ohms and 4 ohms.

Mains voltages 200/250 v. 50/100 c/s., or 100/125 v. 50/100 c/s.

Size: $11\frac{1}{4}'' \times 9'' \times 6\frac{3}{8}''$. Weight 28 lb. 10 oz.

Finished in beige gold paint with visible accessories black.

Price £33 12 0 (Free of P. Tax) (C)

"STEREO 20" POWER AMPLIFIER



"Stereo 20"

The "Stereo 20" has a total power output of 20 watts, which is adequate not only for the largest room in a dwelling but for small halls seating up to 400 people.

It has two identical circuits, each comprising a 3-stage triple loop feedback amplifier, the main loop applying 26 db. of negative feedback over the complete amplifier from input to output terminals. A low-noise, high gain triode feeds into a second-stage double-triode phase-splitter, which in turn feeds two push-pull output valves arranged in the distributed-load condition. Grain-orientated steel is used for the cores of the two output transformers and the mains transformer. Valves: 3 x ECC83, 4 x EL84 1 x GZ34. Power output 22 watts r.m.s. maximum (11 watts per channel) or 44 watts peak (22 watts per channel). Harmonic distortion 0.1% for 10 watts r.m.s. output per channel (± 1 db) at 1,000 c/s. Hum and noise 80 db. (± 3 db.), below maximum output with a source impedance of 25,000 ohms. Sensitivity: An output of 120 mv. gives maximum output. Frequency response ± 0.5 db., 20 c/s. to 20 Kc/s. Input impedance 1 megohm. plus approximately 5 mmfd. Stability margins: Gain 10 db. ± 3 db., phase $20^\circ \pm 10^\circ$. Loudspeakers of any impedance between 3 ohms. and 20 ohms. may be used. Adjustable plugs on top of each output transformer select three tapings, nominally 16 ohms., 8 ohms. and 4 ohms.

Mains voltages 200/250 v. 50/100 c/s. or 100/125 v. 50/100 c/s. A voltage selector plug is fitted on top of the mains transformer. Consumption 105 watts.

Size: $10\frac{1}{2}'' \times 12\frac{1}{4}'' \times 6\frac{7}{8}''$ high. Weight 22 lb. 6 oz.

Price 29 gns. (Free of P. Tax) (C)

"STEREO 50" POWER AMPLIFIER



"Stereo 50" Power Amplifier

Larger and more powerful version of the "Stereo 20". Valves: 3 x ECC83, 4 x EL34, 1 x GZ34. Power output 50 watts r.m.s. maximum (25 watts per channel) or 100 watts peak (50 watts per channel). Harmonic distortion 0.1% for 20 watts r.m.s. output per channel (± 1 db.) at 1,000 c/s. Hum and noise 80 db. (± 3 db.), below maximum output with a source impedance of 25,000 ohms. Sensitivity: Input of 120 mv. gives maximum output. Frequency response ± 0.5 db., 20 c/s. to 20 Kc/s. Input impedance 1 megohm, plus approximately 5 mmfd. Stability margins: Gain 10 db. ± 3 db., phase $20^\circ \pm 10^\circ$. Loudspeakers of any impedance between 3 ohms and 20 ohms may be used. Adjustable plugs on top of each output transformer select three tapings, nominally 16 ohms., 8 ohms. and 4 ohms. Consumption 180 watts. Mains voltages 200/250 v. 50/100 c/s. or 100/125v, 50/100 c/s. A voltage selector plug is fitted on top of the mains transformer.

Size: $10\frac{5}{8}'' \times 13\frac{1}{8}'' \times 6\frac{7}{8}''$ high. Weight 27 lb. 6 oz.

Price 40 gns. (Free of P. Tax) (C)

AUDIO AMPLIFIERS

LEAK

LEAK "POINT-ONE-PLUS" PRE-AMPLIFIER



"Point-One-Plus"

Circuitry: A low-noise, low-distortion 2-stage feedback control pre-amplifier. The first stage is used to give record compensation by the use of frequency selective negative feedback. The second stage embodies feedback tone control circuits which give continuously variable control of both bass and treble frequencies, and additionally, a twin-T low-pass filter. The case-work is finished in beige-gold.

Valves: 2× EF86. A six-position switch allows the choice of inputs. Pick-up sensitivity 9.5 mv. Input resistance varies from 70,000 — 100,000 ohms., depending on the position of the pre-set level control. Tuner sensitivity 50 mv. r.m.s. Input resistance varies from 125,000-200,000 ohms., depending on the position of the pre-set level control. Bass control continuously variable ± 16 db. at 30 c/s. Treble control continuously variable ± 18 db. at 20 Kc/s. Harmonic distortion less than 0.01% for 125 mv. output. Hum and noise approximately 66 db. below full power output on radio and tape positions and approximately 60 db. below on other outputs. Size, chassis 10½" × 3¾" × 5" deep. Weight 4 lb. 12 oz.

Price **12 gns.** (Free of P. Tax) (C)

LEAK "VARISLOPE III" PRE-AMPLIFIER



"Varislope III"

A low-noise, low-distortion 2-stage feedback control pre-amplifier. The first stage is used to give record compensation by the use of frequency selective negative feedback. The second stage embodies feedback tone control circuits which give continuously variable control of both bass and treble frequencies.

Valves: 2× EF86. A 2-way switch on the front panel allows the choice of any two pick-ups available in the world. Six-position input selector switch. Bass control continuously variable, plus or minus 16 db. at 30 c/s. Treble control continuously variable, ± 18 db. at 20 Kc/s. Harmonic distortion less than 0.01% for 125 mv. output. Hum and noise approximately 66 db. below full power output on radio and tape positions, and 60 db. below on the other inputs.

Size, chassis: 10¼" × 3¾" × 5" deep. Weight 5 lb.

Price **15 gns.** (Free of P. Tax) (C)

"POINT ONE STEREO" PRE-AMPLIFIER



"Point One Stereo"

Two identical monaural pre-amplifiers, forming a complete stereo amplifying system when connected to a Leak power amplifier type "Stereo 20" or "Stereo 50". The case is finished in light bronze, the front panel is engraved on the rear face in deep maroon, cream and gold. Each of the two identical circuits consists of a low-noise, low-distortion 2-stage feedback tone control pre-amplifier. The first stage is used to give record and tape compensation by the use of frequency selective negative feedback. The second stage embodies feedback tone control circuits which give continuously variable control of both bass and treble frequencies. All controls are of the single knob, dual-ganged, close-tolerance type.

Valves: 4× EF86. Five-position input selector switch. Bass control continuously variable, plus or minus 16 db at 30c/s. Treble control continuously variable ± 14 db. at 20,000 c/s. Harmonic distortion less than 0.01% for 125 mv. output.

Size, chassis: 10½" × 3¾" × 5" deep. Weight 5½ lb.

Price **20 gns.** (Free of P. Tax) (C)

AUDIO AMPLIFIERS

LEAK



Leak "Varislope Stereo"

LEAK "VARISLOPE STEREO"

CIRCUITRY. The two identical circuits are designated "L" (for the left-hand input signal) and "R" (for the right-hand input signal). Each circuit consists of a low-noise, low-distortion 2-stage feedback tone control pre-amplifier. The first stage is used to give record and tape compensation by the use of frequency selective negative feedback. The second stage embodies feedback tone control circuits which give continuously variable control of both bass and treble frequencies, and additionally, the famous LEAK "Varislope" filter circuitry. Valves 4XEF86. An eight position switch allows the choice of inputs. Pick-up sensitivity 3.5 mV. at 50 K. ohm.

FUNCTION. When used with any combination of two Leak monaural power amplifiers or with a 'Stereo 20' or 'Stereo 50' power amplifier this pre-amplifier reproduces stereophonically and monaurally from records, tape, radio and microphone, using any pick-up, any tape head, any tuner and any microphone available in the world. This comprehensiveness gives two important advantages. First, you can use the finest pick-ups and microphones available in the world: this is not the case with cheaper low-gain pre-amplifiers. Second, when reproducing from tape you can do so directly from the tape head, thus saving the cost of amplifiers built into the tape mechanism. Note that the high sensitivity allows for the playback of the new quarter track tapes.

Price £25 0 0 (Free of P. Tax) (C)

ROGERS

R.D. JUNIOR STEREO AMPLIFIER

Developed from the extremely successful RD Junior Mono Amplifier, the Stereo version retains all the features of the original design, plus a number of valuable detail improvements. Suitable for use with either the Junior III or Master Stereo Control Units.

BRIEF SPECIFICATION

Features. High-grade Multi-section Output Transformers with grain orientated laminations. Ample Spare Power for auxiliary equipment. Three alternative output impedances instantly available. Unconditionally stable—suitable for Electrostatic Loudspeakers. Generous Inductance Smoothing featuring Dual Choke Filter. Dual A.C. Outlets. Speaker Phasing Switch. Excellent Power/Frequency Characteristics. Power Output 12+12 watts (nominal) — 15+15 watts (peak). Sensitivity 750 m/v for 12 watts. Harmonic Distortion 12 watts .2% at 1,000 cps. Frequency Response ± 25 DB 20-20,000 cps. NFB 20 DB ± 1 DB 30-20,000 cps. Damping Factor 20. Hum and Noise —85 DB below 12 watts. Cross Talk 1 kc/s. 70 DB. Output Impedance 4 ohms., 8 ohms, 16 ohms. Spare Power 300v. 40 m/a. 6.3v. 2.5a. Consumption 125 watts. Operating Voltage 200-230-250v. 50 cps. or 110-115-125v. 50/60 cps. Valves 4 x EL84. 2 x ECC 83. GZ34. Overall dimensions 14" long x 8" wide x 5 $\frac{3}{8}$ " high. Weight 22 lbs. Finish Chassis—stove enamelled dark maroon; transformers—hammer silver grey.

Price £28 10 0 (Free of P. Tax) (C)

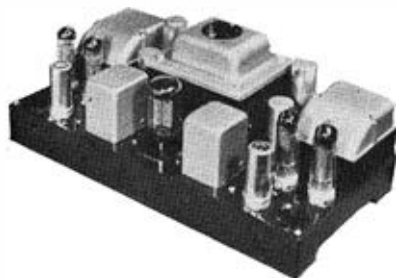

R.D. Junior Stereo Amplifier

R.D. CADET Mk.II MONO AMPLIFIER

Features High-grade multi-section output transformer. Ample spare power. Three alternative output impedances instantly available. Inductance smoothing—valve rectifier. A.C. Outlet. Excellent Power/Frequency characteristics. Power Output 7 watts. Input Sensitivity 600 m/v. for 7 watts. Harmonic Distortion .25% for 7 watts. NFB 20 DB. Hum and Noise —75DB below 7 watts. Output Impedance 4, 8 and 16 ohms. Spare Power 250v. 40 m/a. 6.3v. 2.2a. (humdinger fitted). Consumption 50 watts. Operating Voltage 200-230-250v. 50 cps. Valves 2 x ECL86. EZ81. Overall Dimensions 12 $\frac{3}{4}$ " x 4 $\frac{1}{2}$ " x 4 $\frac{1}{2}$ ". Weight 10 lbs. Finish Chassis—Stove enamelled dark maroon; Transformers—Hammer silver grey.

Price £12 0 0 (Free of P. Tax) (C)

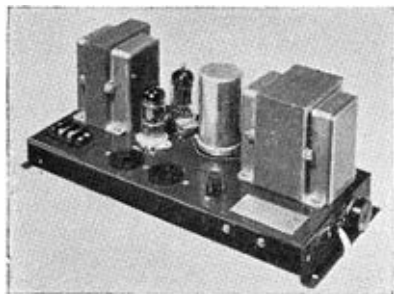

R.D. Cadet Mk.II Mono Amplifier

AUDIO AMPLIFIERS

ROGERS

R.D. JUNIOR Mk.III STEREO CONTROL UNIT

Essentially a simplified version of the Master Stereo Control Unit this entirely new design has similar styling and boasts a comprehensive specification catering for every requirement of the average Home Stereo System.



R.D. Junior Mk.III Stereo Control Unit

BRIEF SPECIFICATION

Input facilities Magnetic or Crystal pick-ups. (4 or 80 m/v) (RIAA or Flat). Second Mono Pick-up—facilities duplicated. Tape heads. (4 m/v) (CCIR). Tape pre-amplifiers. (25 m/v.) (Flat). Radio. (100 m/v). Aux. (2.5 or 30 m/v). Pre-set level controls on Disc Inputs. Mixing may be achieved by using Radio and Aux Inputs with both buttons depressed. Tape Record Outputs Two pairs of outputs—high and low level. Control Facilities 4-position push-button Input selector—Disc, Tape, Radio and Aux. (Additional facilities provided by operation of Tape/Radio and Aux/Radio buttons together.) 3-position Function Selector. Stereo. Mono A and B. (Both outputs in parallel from either Input Channel.) Ganged variable Bass and Treble Controls. Ganged Variable Low Pass Filter. (5—20 kc/s. 12 DB per octave.) Mono/Stereo Disc Button. Hi-Pass Filter. (—3 DB 60 cps. —20 DB 20 cps.) RIAA/Flat Slide Switch—pre-set. Ganged Balance Control. On/Off Toggle Switch, fitted click suppressors. Close tolerance ganged Volume Control. Valves 2×EF86. 2×ECC83. Overall Dimensions 11 $\frac{3}{4}$ " wide × 7 $\frac{1}{4}$ " deep × 5 $\frac{1}{2}$ " high. Weight 8 lbs. Styling Front Panel, Brushed brass. Sub-Panel, Matt Black. Control Knobs, Ivory with ground brass inserts.

Price £22 10 0 (Free of P. Tax) (C)

HG88 Mk.II INTEGRATED STEREO AMPLIFIER

This latest version of an extremely popular design provides in a single, compact, superbly styled unit every facility necessary for the average Home Stereo System. Compared with the original model the new design marks a considerable step forward, with a 50% increase in power output and a host of detail improvements, many incorporated as a result of suggestions from HG88 users.

BRIEF SPECIFICATION

Control Unit Section. Inputs Magnetic pick-ups (4 or 80 m/v). (RIAA). Crystal pick-ups (6 or 120 m/v) (Flat). Radio (120 m/v). Tape Heads (4 or 20 m/v.) (CCIR). Tape pre-amplifiers (20 or 120 m/v) (Flat). All inputs dual. All sensitivity figures for 12 watts. Overload capacity —40 DB. Tape Record Outputs 100—250 m/v. Control Facilities 5-position Input Selector. Pick-up, magnetic or crystal. Tape, flat or compensated. Radio. 4-position Functional Selector. Stereo. Mono A and B. (Both amplifier sections in parallel from either Input Channel. Mono Disc (For compatible stereo pick-ups). Ganged variable Bass and Treble Controls. Ganged variable Low Pass Filter. (5—20 kc/s.) Built-in High Pass Filter.) Ganged close-tolerance Volume Control. Ganged Balance Control. on/Off Toggle switch, fitted click suppressors. Main Amplifier Section. Power Output 12+12 watts (normal) 14+14 watts (peak). Harmonic Distortion .25% for 12 watts. Intermodulation Distortion 1.5%. 50 cps. and 6,000 cps. 4:1. Frequency Response ±1 DB 30—20,000 cps. NFB 16 DB 1 k/s. Hum and Noise 80 DB below 12 watts. Output Impedance 4 ohms, 8 ohms, 16 ohms. Operating Voltage 200—230—250v. and 50 cps. and 110—115—125v. 50/60 cps. Consumption 95 watts. Valves 2×EF86. 2×ECC83. 4×ECL86. GZ34. Overall Dimensions (Case) 15 $\frac{3}{8}$ " × 10 $\frac{3}{4}$ " × 7". (Chassis) 14" × 10 $\frac{3}{4}$ " × 5 $\frac{1}{2}$ " Weight (Case) 27 $\frac{1}{2}$ lbs. (Chassis) 23 $\frac{1}{2}$ lbs. Styling Case (optional) Figured Teak. Front Panel, Bruhed brass. Control knobs, Ivory with ground brass inserts.

Price Chassis only £38 10 0 (Free of P. Tax) (C)

Price Complete in case £42 0 0 (Free of P. Tax) (C)



HG88 Mk.II Integrated Stereo Amplifier

AUDIO AMPLIFIERS

ROGERS

R.D. CADET MONO CONTROL UNIT



R.D. Cadet Mono Control Unit

An inexpensive Mono Control Unit suitable for operation from Tape, Records and Radio. Designed primarily to work in conjunction with the Cadet II Mono Amplifier.

BRIEF SPECIFICATION

Inputs Crystal and Ceramic pick-ups (18 or 220 m/v) (Flat). High Output Magnetic pick-ups (60 or 360 m/v). (Three alternative compensations—early LP. RIAA and 78). Tape Replay (200 m/v.) (Flat). Radio (200 m/v). Pre-set level control on pick-up input. Tape Record Output 200 m/v. Control Facilities 6-position Input Selector. Pick-up—LP. RIAA. 78. Flat Tape Replay, Radio, Variable Bass and Treble Controls. Volume on/off Control. Valve ECC83. Overall Dimensions $8\frac{1}{2}'' \times 5\frac{1}{8}'' \times 2\frac{1}{2}''$. Weight 3 lbs. Styling Front Panel—Bronze. Control Knobs—Ivory with gold pointer.

Price £7 0 0 (Free of P. Tax) (C)

MASTER STEREO CONTROL UNIT

The new Master Stereo Control Unit represents the ultimate in Stereo Control Units. Designed without compromise in any respect, this new unit has a quite exceptional specification, setting standards of performance, flexibility, workmanship and styling far in advance of anything so far offered on the British high fidelity market.

BRIEF SPECIFICATION

Input facilities Magnetic pick-ups. (3 or 30 m/v.) Crystal pick-ups. (4 or 40 m/v.) Second Mono Pick-up—High or medium output crystal or magnetic. Auxiliary. (30 m/v.) Radio. (30 m/v.) Tape heads. (1.5 or 5 m/v.) Tape pre-amplifiers. (8 or 30 m/v.) Tape Recorders via panel sockets. (250 m/v.) Microphone via panel sockets. (3—30 m/v. according to matching transformer fitted.) All sensitivity figures for 750 m/v. output. Pre-set level controls on Disc, Aux, Radio and Tape inputs. Pre-set output level controls. Tape Record Outputs 250 m/v. (via Panel or Chassis Sockets). Control Facilities 6-position push-button Input Selector—Mic., Radio, Disc., Aux., Tape, and Monitor. (Monitor position provides instantaneous Mono Tape Monitoring.) 3-position Function Selector. Stereo. Mono A and B. (Both outputs in parallel from either Input Channel). Ganged variable Bass and Treble Controls. 3-position Low Pass Filter (5, 7 and 9 kc/s.). Variable Slope Control. (0—24 DB per octave). 3-position High Pass Filter. (20, 60 and 120 cps.). 3-position Equalisation Switch. (Disc—LP. RIAA. Flat. SP RIAA). Tape—CCIR. Flat. NARTB). Mono/Stereo Disc Button. Ganged Balance Control. On/Off toggle switch, fitted click suppressors. High precision ganged Volume Control. Valves $2 \times$ EF86. $4 \times$ ECC83. Overall Dimensions $14''$ wide \times $6\frac{1}{2}''$ deep \times $5\frac{1}{8}''$ high. Weight 10 lbs. Styling Front Panel, Brushed brass. Sub-Panel, Matt Black, Control knobs, Ivory with ground brass inserts.

Price £35 0 0 (Free of P. Tax) (C)



Master Stereo Control Unit

AUDIO AMPLIFIERS

QUAD

ACOUSTICAL "QUAD II" CONTROL UNIT



Quad II Control Unit

The monaural counterpart of the Quad 22 and is similar in all the main features except those associated exclusively with stereo.

Frequency response, cancel position: Radio and tape inputs 20-20,000 c/s. to within 0.3 db., microphone input 20-18,000 c/s. within 1 db.; Bass and treble controls within 1 db of curves. Filter frequencies 5 Kc/s., 7 Kc/s. 10 Kc/s. \pm 250 c/s. Input sensitivities for 1.4 v. output: Radio and tape 100 mv. at 100 K. ohms., microphone 1.5 mV. at 100 K. ohms.

Price **£19 10 0** (Free of P. Tax) (C)

Pick-up Matching Plugs (Mono) **12 0** (Free of P. Tax) (C)

Pick-up Matching Plugs (Stereo) **15 0** (Free of P. Tax) (C)

ACOUSTICAL "QUAD II" AMPLIFIER

Remains completely stable under all signal and load conditions and full performance may be obtained with random valve replacements.

The output circuit utilises a cathode coupled arrangement, with resultant low distortion combined with a high efficiency which is reflected in the overall size of the equipment.

Power output 15 watts throughout the range 20-20,000 c/s. Input: Sensitivity 1.4 v. r.m.s. for 15 watt output. Load imposed on input of 1.5 Megohm in parallel with 10pF. Frequency response: within 0.2 db 20-20,000 c/s. Within 0.5 db 10-50,000 c/s. Valves: 2 x EF86, 2 x KT66, 1 x GZ32. Consumption 90 watts. Mains voltages 200/250 v. A.C. single phase (or 95/125 v. A.C.) 40/80 c/s.

Size: 13" x 4 1/4" x 6 1/2". Weight 18 1/4 lb.

Price **£22 10 0** (Free of P. Tax) (C)



Quad II Amplifier

ACOUSTICAL "QUAD 22" STEREO CONTROL UNIT

Designed to operate with the Quad II power amplifiers but it may be used with one only for monaural operation if required. Selection of stereo or monaural is by push-buttons, as also are the choice of programme and record equalisation characteristics. The gramophone input may be accurately matched to any pick-up by choice of the correct plug-in adaptor unit, indicated on a chart supplied with the amplifier, while another chart shows the push-button combinations required to provide correct equalisation for different makes of record.

Frequency response cancel position: Radio and tape inputs 20-20,000 c/s. \pm 0.5 db., microphone 20-20,000 c/s. \pm 2 db. Filter frequencies 5 Kc/s., 7 Kc/s. and 10 Kc/s. Input sensitivity (at 1 Kc/s. for 1.4 v r.m.s. output): Radio and tape 70 mv r.m.s. Load impedance 100,000 ohms.

Microphone: 1.5 mv r.m.s. Load impedance 100,000 ohms. Distortion: All controls level; Any input: 0.02%.

Output, control unit to amplifier: 1.4v r.m.s.

The unit takes its power from the main amplifier as follows:

330 v. 4 mA.

6.3 v. 1.1 amp.

} Plus current taken by tuner units.

Maximum power available from tuner sockets 330 v., 35 mA. each tuner.

Rad. 1 and Rad. 2: 6.3 v., 3 amp. total.

Rad. 1 (2nd channel): 6.3 v., 3 amp.

The heater supply is C.T. to chassis.

Valves: 2 x EF86, 2 x ECC83.

Price **£25 0 0** (Free of P. Tax) (C)



Quad 22 Stereo Control Unit

AUDIO AMPLIFIERS

DULCI

DULCI MODEL DPA10 ULTRA LINEAR PRE-AMPLIFIER INCORPORATING TONE CONTROL



DPA10 Pre-Amplifier

For operation on A.C. mains 200/250 v. 40/60 c/s. Controls: 6-position input selector, continuously variable bass and treble controls, volume combined with on/off switch. Input impedance and sensitivity: Microphone 1.5 mv. 2 M ohms.; tape replay 100 mv. 100,000 ohms.; radio 1 100 mv. 100,000 ohms.; radio 2 300 mv. 560,000 ohms.; pick-up 6 mv. 56,000 ohms. Frequency response (radio and tape) well within 1 db., 30 c/s. to 20 k/cs. Valves: 2 x EF86.

Finished in copper bronze front plate, ivory engraving. Size (front panel): 11 1/4" x 3". Cabinet cut-out 10 3/8" x 2 3/8". Depth behind front panel 4 1/2". Overall depth 5 1/4". Weight 2 lb. 7 oz.

Price 8 Gns. (Free of P. Tax) (B)

DULCI MODEL DPA10/2 STEREO POWER AMPLIFIER

Matched pair of DPA10 Ultra-linear amplifiers.

Price (two units at £14 14 0 each) £29 8 0 (Free of P. Tax) (B)

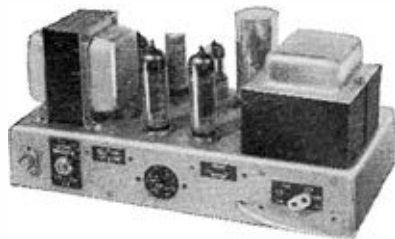

DPA10 Amplifier

DULCI MODEL DPA10 ULTRA LINEAR AMPLIFIER

For operation on A.C. mains 200/250 v., 40/60 c/s. Rated output 10 watts. 15 watts peak. Output impedance switchable 3-5, 6-8, 12-16 ohms. Hum and noise 75 db. below 10 watt. Sensitivity 40 mv. for 10 watt. Frequency response at 1 watt within 1 db. 5 c/s. to 20 kc/s. Within 5 db. 3 c/s to 50 c/s. At 10 watt within 1 db. 30 c/s to 15 kc/s.

Valves: EF86, ECC83, 2 x EL84, EZ81. Consumption 70 watts. Size: 11 1/8" x 6" x 5 5/8" high overall. Weight 12 lb. 8 oz.

Price £14 14 0 (Free of P. Tax) (B)

DULCI "STEREO EIGHT" TWIN-CHANNEL PRE-AMPLIFIER

Two identical pre-amplifiers on printed circuit panels, entirely screened from each other, but with mechanically linked controls. Controls: 6-position selector switch, continuously variable bass and treble controls, filter control, balance and volume controls and 5-position function switch. Input impedance and sensitivity: Microphones 3 mv. 1 megohm; tape 3 mv. 1 megohm; radio 100 mv. 1 megohm; pick-up 8 mv.-100 mv. (adjustable) 100 K ohms. auxiliary 50 mv.-2 v. (adjustable) 1 megohm; tape recorder 100 mv. 2 v (adjustable) 1 megohm. Valves 8 x EF86. Power supply (L.T.) 6.3 v. A.C. 1.8 amp. (H.T.) 250 v. D.C. 12 mA.

Front panel finished in copper bronze, ivory engraved. Size, front panel: 14" x 4". Overall depth 9 3/8". Weight 9 lb.

Price £23 2 0 (Free of P. Tax) (B)



Stereo Eight

DULCI "STEREO TWO" TWIN-CHANNEL PRE-AMPLIFIER

Printed circuit. Controls: 6-position function and input selector, continuously variable bass, treble and balance controls; volume control; on/off switch. Input impedance and sensitivity: Radio 100 mv. 250 K ohms.; pick-up 50 mv.-2 v. (adjustable) 1 megohm; tape 100 mv. 250 K ohms. Valves: 2 x ECC83. Power supply (L.T.) 6.3 v. A.C., .8 amp. (H.T.) 250 v. D.C., 2.5 mA. Front panel finished in copper bronze, ivory engraved.

Size, front panel: 12 1/2" x 3 1/4". Overall 12 1/2" x 3 1/4" x 5". Weight 3 1/2 lb.

Price £10 10 0 (Free of P. Tax) (B)



Stereo Two

AUDIO AMPLIFIERS

DULCI



SP 44

DULCI MODEL SP44 STEREO TWIN POWER AMPLIFIER

Two identical power amplifiers with a common power supply, all mounted on one chassis. Designed for stereo application to operate in conjunction with a "Stereo Two" or "Stereo Eight" pre-amplifier control unit. Output power 8 watts peak (4 watts per channel.) Frequency response ± 1 db. from 40-25,000 c/s. Input sensitivity 65 mv. for 3 watt output per channel. Valves: 2 \times EF86, 2 \times EL84, EZ81. Mains voltages 200/250 v. A.C. 40/60 c/s. Consumption 60 watts. Finish: Cadmium plated, passivated and silver grey hammer stove enamelled. Size: $11\frac{1}{2}'' \times 6'' \times 5\frac{3}{8}''$ high overall. Weight 13 lb.

Price **£14 14 0** (Free of P. Tax) (B)

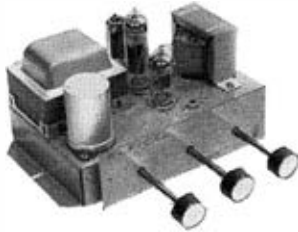

Dulci A.C.15

DULCI AC15

The AC15 amplifier is a general purpose and music amplifier designed and built to high fidelity standards. Extremely good reproduction can be obtained both from gramophone and radio inputs, and the quality of reproduction compares favourably with much higher priced equipment. Only the very best components have been used, and the finished product will give superior reproduction at a most competitive price. Rated 4 watts. Speaker output adjustable 3/15 ohms.

Price **£6 19 6** (C)

TUNER UNITS

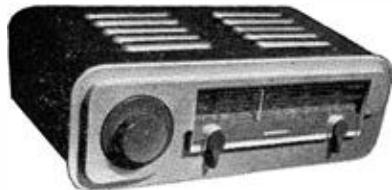

"Quad" A.M. Tuner

ACOUSTICAL "QUAD" A.M.II TUNER

Designed for the Quad II or Quad 22 control units. Output 100 mv. at 5,000 ohms. impedance via screened cable. Selectivity 2 position switched to give audio bandwidths of 5 and 12 kc/s. Consumption 6.3 v. 1.2 amp. Valves: EF89, ECH81, EBF89, EM84. Size: $10\frac{1}{2}'' \times 3\frac{1}{2}'' \times 6''$. Weight 6 lb.

Price ... **£24 0 0** plus **£9 0 0** P. Tax. Total **£33 0 0** (C)



"Quad" F.M. Tuner

ACOUSTICAL "QUAD" F.M. TUNER

To be used with the Quad II amplifier. Tuning range: 87.5-108 mc/s. Output 100 mv. at 100 K ohms. impedance (to be terminated by 100 K ohms. across amplifier input). Consumption: 6.3 v. 1.85 A., 330 v. 27 mA. Valves: 6BJ6, 12AT7/ECC81, 6BH6, 6AU6, 6AL5/EB91, 12AX7/ECC83, neons Hivac CC11L, Lamp 6.5 v. 0.3 A. Front panel: Die-cast, stove finished silvered fawn, aluminium knob. Dial $\frac{3}{8}''$ perspex. Size: $10\frac{1}{2}'' \times 3\frac{1}{2}'' \times 6''$. Weight 6 lb.

Price ... **£21 0 0** plus **£7 17 6** P. Tax. Total **£28 17 6** (C)

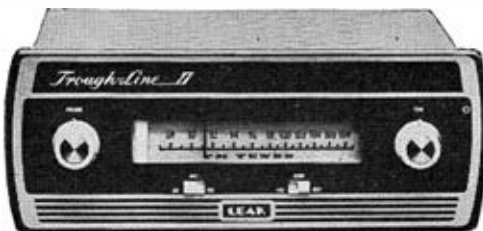

Leak Trough-Line F.M. Tuner

LEAK TROUGH-LINE F.M. TUNER Mk. II (Self Powered)

The oscillator of this tuner employs a trough-line as a tuning inductor. Foster-Seeley discriminator employing thermionic diodes is used, and the preceding stage has a limiter which eliminates amplitude-modulated signals, rendering the receiver insensitive to ignition and other forms of impulse interference. Frequency range: 88-108 mc/s. Sensitivity: 2 mv. at aerial terminals for full limiting. Valves: 2 \times ECF80, ECC84, ECC85, EF80, EM34, EZ80, 2 \times OA79. Front panel: $11\frac{1}{2}'' \times 4\frac{7}{8}''$

Price ... **£25 0 0** plus **£8 15 0** P. Tax. Total **£33 15 0** (B)

TUNER UNITS AND RECEIVERS



R.D. Junior Variable FM Receiver



Model "C" Power Pack



R.D. Junior Switched FM Receiver

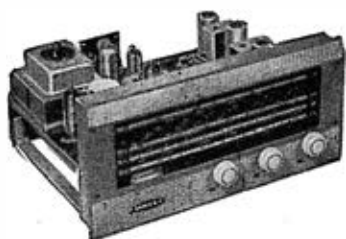

Dulci H4T/2 A.M./F.M. Tuner Chassis

R.D. JUNIOR VARIABLE FM RECEIVER

A seven-valve receiver of advanced design, with a comprehensive specification, ensuring optimum results from the B.B.C. VHF transmissions. Matching is greatly facilitated by the inclusion of a built-in power supply and low impedance cathode follower output, extending the units application as a high quality programme source.

BRIEF SPECIFICATION

Features Automatic Frequency Control. Grounded-grid twin-triode RF stage. Foster-Seeley Discriminator. Low Impedance Cathode Follower Output. Built-in Power supply. High quality tuning mechanisms entirely free from back-lash. Frequency Coverage 87—107.5 mcs. Valves 2× ECC85, ECF80. 2× EF80. EB91. EC90. Overall Dimensions 8 $\frac{3}{8}$ " × wide 5 $\frac{3}{8}$ " high × 9" deep. Weight 5 $\frac{1}{2}$ lbs. Styling Front Panel—brushed brass; Control Knobs—ivory with ground brass inserts. Available in Figured Teak Case to match HG88 II Stereo Amplifier.

Price ... £19 5 0 plus £6 11 6 P. Tax. Total £25 16 6 (B)

Complete in Teak case

Price ... £22 7 4 plus £7 12 8 P. Tax. Total £30 0 0

MODEL "C" POWER PACK

BRIEF SPECIFICATION

Designed to provide H.T. and L.T. current for the Switched FM Receiver in cases where it is not possible to draw these supplies from the main amplifier. Output 250v. 40 m/a. 6.3v. 2.5a. Operating Voltage 200—230—250v. 50 cps. or 110—115—125v. 50/60 cps. Consumption 40 watts. Contact-Cooled Rectifier. Overall Dimensions 7 $\frac{3}{8}$ " × 3 $\frac{1}{4}$ " × 4 $\frac{3}{8}$ ". Weight 3 $\frac{1}{2}$ lbs.

Price £4 0 0 (No Tax) (C)

R.D. JUNIOR SWITCHED FM RECEIVER

Provides FM reception in its simplest and most economical form. A single control affords selection of the three B.B.C. FM transmissions, a fourth position muting the receiver, but at the same time leaving it available for immediate use. Designed to draw HT and LT current from the main amplifier.

BRIEF SPECIFICATION

Features Automatic Frequency Control. Cascode RF Stage. Variable Inductance Incremental Tuning. Foster-Seeley Discriminator. Low Impedance Cathode Follower Output. Pre-set output level control. Muting position on Selector Switch. Pre-set Tuning Control. Frequency Coverage 87-96 mcs. Sensibility 10 uv. for 20 DB quietening (25 kcs. deviation). Audio Output .25 v. R.M.S. (average). Aerial Impedance 70-90 ohms. Consumption 35 m/a. 250v. 1.7 a. 6.3 v. Control 4-position Rotary Switch. 3 Stations. 1 Muting. Valves ECC84. 3× ECF80. 2× OA79. Overall Dimensions 9" deep × 5 $\frac{5}{8}$ " wide × 5 $\frac{5}{8}$ " high. Weight 2 $\frac{3}{4}$ lbs. Styling Front Panel—brushed brass; Control Knob—ivory with ground brass insert.

Price ... £11 18 0 plus £4 1 3 P. Tax. Total £15 19 3

DULCI H4T/2 A.M./F.M. TUNER CHASSIS

A first class tuner for both A.M./F.M. transmissions and being self-powered will operate satisfactorily with any good quality amplifier. A.M. bands Short, Medium and Long. Manual tuned and with magic eye tuning indicator. An ideal partner to DPA10 equipment with front panel of matching finish to DPA10 pre-amplifier. Dial 10" × 3".

Price ... £19 10 0 plus £6 5 2 P. Tax. Total £25 15 2 (A)

TUNER UNITS AND RADIOGRAM CHASSIS



Dulci FMT/2 VHF Tuner Unit

DULCI FMT/2 VHF TUNER UNIT (Self-powered)

High sensitivity for fringe area reception. Limiting on two stages provides a constant output free from interference and is therefore ideally suited for tape recording. Automatic Frequency Correction ensures stable reception and eliminates the need for a tuning indicator. Continuous tuning covers all stations. Cathode follower output stage permits the use of long output leads and maintains full audio frequency range coverage with any amplifier. High audio output (adjustable) makes this tuner suitable for direct connection to any amplifier. Foster-Seeley discriminator for highest audio quality. Integral power supply simplifies installation. Engraved copper bronze facia panel harmonises with domestic surroundings. Slim modern styling and construction. Requires cut out $2\frac{7}{8}'' \times 1\frac{1}{8}''$. Dimensions $12\frac{1}{2}''$ wide, $3\frac{1}{4}''$ high, $9\frac{3}{4}''$ deep.

Price ... **£18 13 6** plus **£5 19 10** P. Tax. Total **£24 13 4** (A)

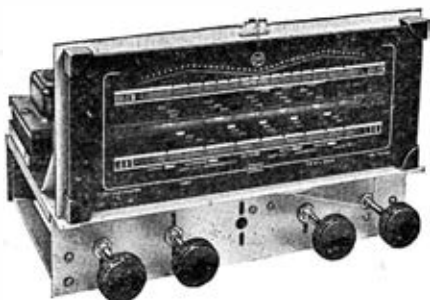

Dulci H3 Radiogram A.M./F.M. Chassis

DULCI H3 RADIOGRAM A.M./F.M. CHASSIS

A self-contained radiogram chassis. 3 waveband: V.H.F., Medium and Long. For use with high output crystal and magnetic pick-ups and facility for connection to tape recorder. Speaker output impedance 3 ohms. Dial $1\frac{1}{2}'' \times 4\frac{1}{2}''$. Output 4 watts approx.

Price ... **£17 5 0** plus **£5 10 8** P. Tax. Total **£22 15 8** (A)

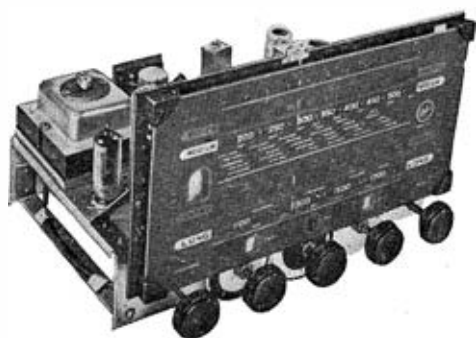

Dulci H3S Stereo Radiogram Chassis

DULCI H3S STEREO RADIOGRAM CHASSIS

Designed by Dulci to give incomparable reproduction of broadcasts, long playing and stereo records, the H3S assures that full and proper advantages will be taken of modern recording and BBC/VHF transmissions—without distortion or interference. Medium and long wave bands provide impeccable reception from choice of local and continental programmes and ample power plus full frequency response act as guarantors of first class performance.

Naturally, typical Dulci technique has made the unit simple and convenient for installation into almost any cabinet and great care has been taken so that design and every component make trouble-free operation.

Dial $1\frac{1}{2}'' \times 4\frac{5}{8}''$. Cut out $9\frac{3}{4}'' \times 3\frac{7}{8}''$.

Price ... **£21 0 0** plus **£6 16 6** P. Tax. Total **£27 16 6** (A)

LOUDSPEAKER DRIVE UNITS

WHARFEDALE



Super 3

WHARFEDALE MATCHING TRANSFORMERS WMTI

Auto Transformers for matching 10-16 ohm. or 7-9 ohm. speakers to sets with 2-5 ohms. output or vice-versa. Frequency response within 1 db. from 20 c/s. to 15Kc/s. Power handling capacity 15 watts. Can be used to match loudspeakers of different impedances to crossover unit in high quality two or three speaker system, 2 7/8" high x 2 3/4" wide, weight 1 1/2 ozs.

Price **13/6 (B)**

SUPER 3

Highly efficient treble unit for frequencies above 3kc/s. The small cone and absence of conventional centring device result in a smooth H.F. response extending to 20 kc/s. Because of its high sensitivity, the Super 3 may be added to existing loudspeaker systems, even to a Super 12, to improve the extreme top. It can safely be used as the treble unit in a 15/20 watt 3-speaker system. This unit must not be used with L.F. input, even for a few seconds, as it is liable to be damaged. 2/3 ohms. or 10/15 ohms. Flux density 14,500 gauss. 1" dia. centre pole. Aluminium speech coil. Max. peak input 6 watts above 1,000 c/s.

Price **£5 0 0 plus £1 13 3 P. Tax. Total £6 13 3 (B)**

8" BRONZE/FS/AL

With foam surround and aluminium voice coil, giving improved H.F. response. Suitable for use in PST/8 Cabinet. 2/3 or 10/15 ohms. Max. peak input 4 watts.

Price **£3 5 0 plus £1 1 7 P. Tax Total £4 6 7 (B)**



8" Bronze

SUPER 8/FS

For refined quality up to 5 watts or for use as a middle or treble speaker with crossover network. 2/3 or 12/15 ohms. Flux density 13,000 gauss. 1" dia. centre pole.

Price **£5 0 0 plus £1 13 3 P. Tax. Total £6 13 3 (B)**

SUPER 8/FS/AL

An outstanding treble unit with aluminium speech coil giving response up to 20,000 c/s. Max. peak input 4 watts. Recommended for use in a 2-speaker system with a crossover in the region of 1,000 c/s. or as a single speaker in the PST/8 Cabinet. 2/3 or 10/15 ohms. Flux density 13,000 gauss. 1" dia. centre pole.

Price **£5 5 0 plus £1 14 11 P. Tax. Total £6 19 11 (B)**

COLUMN 8/145

With foam surround and aluminium voice coil, which has been specially developed for optimum results with column loading. Max. peak input 4 watts. 2/3 or 10/15 ohms. 1" dia. centre pole. Flux density 14,500 gauss.

Price **£5 5 0 plus £1 14 11 P. Tax. Total £6 19 11 (B)**

10" BRONZE/FSB

A medium-priced unit with foam suspension and bakelised cone apex for wide range and smooth response with fundamental resonance between 30 and 38 c/s. Recommended for use with the AF10 Reflex Cabinet with acoustic filter. 2/3 or 12/15 ohms. Flux density 10,000 gauss. 1" dia. centre pole. Max. peak input 6 watts.

Price **£3 19 6 plus £1 6 5 P. Tax. Total £5 5 11 (B)**

GOLDEN/FSB

New foam surround, special voice coil and high flux density combine to give an outstanding smooth performance with high sensitivity and excellent damping. When used in the AF10 Reflex Cabinet results are extremely good. 2/3 or 12/15 ohms. Flux density 14,500 gauss. 1" dia. centre pole. Max. peak input 8 watts.

Price **£6 5 0 plus £2 1 7 P. Tax. Total £8 6 7 (B)**

W10/FSB

Incorporates all features of Golden/FSB plus even higher flux density. Aluminium centre dome for improved H.F. response. One of the finest wide-range speakers available today. Recommended for baffle or reflex loading as well as for use as a treble unit in two speaker systems. 2/3 ohms. or 12/15 ohms. Flux density 16,000 gauss. Max. peak input 10 watts. 1" dia. centre pole.

Price **£9 7 6 plus £3 2 4 P. Tax. Total £12 9 10 (B)**

COMPONENTS FOR WHARFEDALE COLUMN ENCLOSURES

We do not supply the pipe, but the other components are available as follows:—

	8" Type	10" Type
Wooden base, acoustic filter, circular baffle and strut for diffuser	£2 15 0	£3 5 0
Two rolls of B.A.F. wadding	12 6	£1 2 6
Aluminium Diffuser	7 6	10 6
Total	£3 15 0	£4 18 0

(Free of P. Tax) (B)

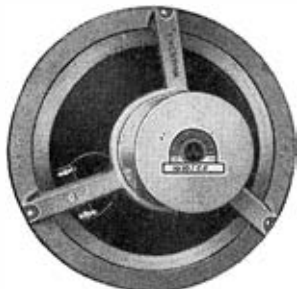

W10/FSB

LOUDSPEAKER DRIVE UNITS

WHARFEDALE UNITS

RS12/DD

This loudspeaker gives a superb performance in the recommended cabinets. Constructional details of several enclosures are supplied with each unit.

Fundamental Resonance 25—30 c/s. Frequency Range 30 c/s.—15 Kc/s. Flux Density 14,000 gauss. Total Flux 156,000 maxwells $1\frac{3}{8}$ " dia. Centre Pole. Aluminium Voice Coil 12-15 ohms. only. Impedance 15 watts r.m.s. Max. Input 30 watts peak.

Price £11 10 0 (Free of P. Tax)

W12/RS

A 12" bass unit specially developed for use in small enclosures. Very good results are obtainable with cabinet volume down to $1\frac{1}{2}$ cubic feet. Constructional details supplied with speaker

The W12/RS is fitted with a heavy soft fibre cone, which produces exceptionally smooth response, and latest type ceramic magnet. Excellent linearity is ensured by the use of roll surround and special corrugated centring device.

Fundamental Resonance 25-30 c/s. Frequency Range 30-4,000 c/s. Flux Density 14,000 gauss. Total Flux 156,000 maxwells. $1\frac{3}{8}$ " dia. Centre Pole. Copper Voice Coil 12-15 ohms only. Impedance 15 watts r.m.s. Max. Input 30 watts peak.

Price £10 10 0 (Free of P. Tax)

SUPER 12/RS/DD

Employing the double diaphragm assembly. This new construction brings the well-known Super 12 unit to a new peak of performance, and makes it suitable for use in enclosures down to 2 cubic feet in volume.

The powerful Alcomax III gives maximum sensitivity and excellent transient response. Fundamental Resonance 25-30 c/s. Frequency Range 20 c/s.-15 Kc/s. Flux Density 17,000 gauss. Total Flux 190,000 maxwells. $1\frac{3}{8}$ " dia. Centre Pole. Aluminium Voice Coil 12-15 ohms. only. Impedance 20 watts r.m.s. Max. Input 40 watts peak.

Price £17 10 0 (Free of P. Tax)

W15/FS

Designed for smooth response between 25 and 2,000 c/s. and is provided with a heavy rigid cone and long voice coil. It is an ideal bass unit and, when provided with 9 cu. ft. (or more) of reflex loading, it will radiate quite large output down to 30 c/s. without distortion. It is, therefore, possible to reproduce "beats" or difference tones which are so rarely heard with conventional equipment.

12/15 ohms. only. Flux density 13,500 gauss. 2" dia. centre pole. Max. peak input 15 watts.

Price £17 10 0 (Free of P. Tax) (B)

COAXIAL 12

The main cone is of special design and is three to four times heavier than normal 12" types. In conjunction with foam suspension this gives a very low resonance frequency in the range of 25/30 c/s. Copper voice coil.

12/15 ohms. only Flux density 14,000 gauss. $2\frac{3}{8}$ " dia. centre pole.

The tweeter section employs a 2" dia. steep-sided paper cone, with foam surround, aluminium centre dome and aluminium voice coil. Flux density 13,200 gauss.

Price, complete with tweeter volume control ... £25 0 0 (Free of P. Tax) (B)

WHARFEDALE SEPARATORS— $\frac{1}{4}$ SECTION TYPE

Size $7" \times 4" \times 3\frac{3}{4}"$. Weight 2 to $2\frac{1}{2}$ lb. Max. input, 30 watts at 3 to 15 ohms. impedance. To divide the bass and treble between two speakers at low impedance thus eliminating distortion of the treble by modulating from the base. Recommended for use with two speakers of similar sensitivity.

Separator Type	c/s.	Ohms.	Connections	Price
				£ s. d.
A	1,000	7/16	Terminals	3 17 6
B	1,000	7/16	Tags	3 5 0
C	1,000	2/6	Terminals	4 17 6
D	1,000	2/6	Tags	4 5 0
E	3,000	7/16	Terminals	3 3 6
F	3,000	7/16	Tags	2 11 0
G	3,000	2/6	Terminals	3 18 6
H	3,000	2/6	Tags	3 6 0

WHARFEDALE 3-WAY SEPARATORS— $\frac{1}{2}$ SECTION TYPE

With volume controls for middle and treble units and switch for 2-way use. $\frac{1}{2}$ -section, 3-way crossover units. 7/16 ohms. or 2/6 ohms. Crossover frequencies 800 and 5,000 c/s. Max. input 30 watts. Weight $6\frac{1}{2}$ lb. Size $9" \times 6" \times 5"$. Fitted 2-way/3-way switch.

Separator Type	Description	Ohms.	Connections	Price
				£ s. d.
HS/CR3/2	With two v.c.'s	7/16	Terminals	8 10 0
HS/CR3/2	With two v.c.'s	2/6	Terminals	11 0 0
400/CR3/2	With two v.c.'s	7/16	Terminals	10 0 0

(All prices Free of P. Tax) (B)



RS12/DD



W12/RS



Super 12/RS/DD



Wharfedale Separator

LOUDSPEAKER DRIVE UNITS

GOODMANS



Axiom 110



Triaxiette 8"



Trebax 5K/20XL

AXIOM 110 10"

Frequency Range	40—15,000 c/s.
Power Handling Capacity	10 watts
Fundamental Resonance	45 c/s.
Flux Density	12,000 Gauss
Voice Coil	1" diameter—aluminium
Impedance	15 ohms at 400 c/s.
Diaphragm	Hyperbolic; plastic terminated
Chassis	Diecast
Price ...	£3 15 9	plus	£1 4 3 P. Tax.	Total	£5 0 0 (A)

AXIOM 112 10"

A higher powered (12 watt) version of the AXIOM 110. 16,000 gauss magnet system.

Frequency Range	40—15,000 c/s.
Power Handling Capacity	12 watts
Fundamental Resonance	45 c/s.
Flux Density	16,000 Gauss
Voice Coil	1" diameter—aluminium
Impedance	15 ohms at 400 c/s.
Diaphragm	Hyperbolic; plastic terminated
Chassis	Diecast
Price ...	£6 8 8	plus	£2 1 4 P. Tax.	Total	£8 10 0 (A)

TRIAXIETTE 8"

Frequency Range	40—20,000 c/s.
Power Handling Capacity	10 watts
Fundamental Resonance	45 c/s.
Total Flux (main gap)	178,000 Maxwells
Voice coil diameters...	Bass and mid-range, 3" High Frequency, 1"
Impedance	15 ohms at 400 c/s.
Chassis	Diecast
Fitted L-pad H.F. control and crossover network.					
Price ...	£10 4 3	plus	£3 5 9 P. Tax.	Total	£13 10 0 (A)

TREBAX 5K/20XL

Frequency Range	2,500—20,000 c/s.
Crossover Frequency	5,000 c/s.
Power Handling Capacity	20 watts in Systems
Fitted L-pad attenuator and L.C. Crossover network.					
Price	£7 0 0 (Free of P. Tax) (A)

AUDIOM 80 BASS. 15" 25 WATT SINGLE CONE LOUDSPEAKER

A heavy-duty unit of massive construction. High reliability under full load conditions. Plastic treated cone-edge for correct termination.

Bass resonance	35 c/s.
V. Coil imp.	15Ω
Flux Density	14,500 gauss.
Weight	25½ lbs.
Baffle Hole dia.	13"
Rating	25 Watts
Depth	8⅝"
Public Address version also available—bass resonance 60 c/s.					
Price	£22 10 0 (Free of P. Tax)

AUDIOM 90 BASS. 18" 50 WATT SINGLE CONE LOUDSPEAKER

This heavy-duty Loudspeaker is eminently suitable for very high power public address systems. Massively built so as to be able to withstand continuous handling of heavy inputs.

Bass Resonance	35 c/s.
V. Coil imp.	15Ω or 6Ω
Flux Density	14,500 gauss
Weight	29½ lbs.
Baffle Hole dia.	16½"
Rating	50 Watts
Depth	10⅜"
Public Address version also available—bass resonance 50 c/s.					
Price	£28 0 0 (Free of P. Tax)

LOUDSPEAKER DRIVE UNITS

GOODMANS

TRIAXIOM 12/20

Flux density	16,500 gauss
Frequency range	30-20,000 c/s.
Fundamental resonance	35 c/s.
Maximum power handling	20 watts
Pole diameter	1 $\frac{3}{4}$ "
Price	...	£25 0 0	(Free of P. Tax) (A)



Triaxiom 12/20

AXIETTE 8"

Flux density	15,000 gauss
Frequency range	40-15,000 c/s.
Fundamental resonance	65 c/s. (nominal)
Maximum power handling	6 watts peak A.C.
Overall dia.	8 $\frac{1}{2}$ "
Overall depth	4 $\frac{7}{16}$ "
Baffle hole dia.	7 $\frac{3}{8}$ "
Net weight	3 lb. 9 oz.
Impedance	3 or 15 ohms.
Price	...	£5 0 0	plus £1 12 1 P. Tax
			Total £6 12 1 (A)

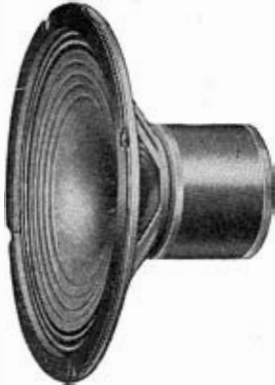

Axiette 8"

AXIOM 80 9 $\frac{1}{2}$ " (6 watts)

The extended frequency coverage from 20/20,000 c/s. in free air has been achieved by the duplex cantilever (free suspension) cone assembly.

Frequency coverage	20/20,000 c/s.
Fundamental resonance	20 c/s.
Flux density	17,000 gauss
Net weight	9 lb. 6 oz.
Impedance	15 ohms.
Price	...	£17 10 0	plus £5 12 4 P. Tax
			Total £23 2 4 (A)

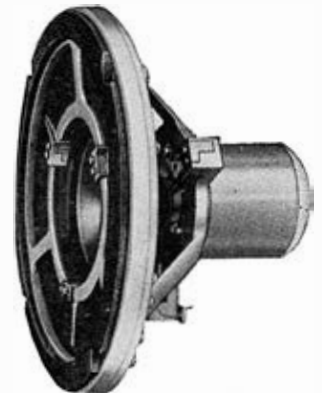

Axiom 80 9 $\frac{1}{2}$ "

AXIOM 300 12"

Frequency coverage	30/16,000 c/s.
Fundamental resonance	35 c/s.
Power handling capacity	15 watts
Flux density	14,000 gauss
Impedance	15 ohms.
Price	...	£11 5 9	(Free of P. Tax) (A)



Axiom 300 12"

AXIOM 400 12"

Frequency range	30/16,000 c/s.
Fundamental resonance	35 c/s.
Power handling capacity	20 watts
Flux density	17,500 gauss
Impedance	15 ohms.
Price	...	£16 1 0	(Free of P. Tax) (A)



Axiom 400 12"

AUDIOM 60 12"

A versatile single-cone 15 watts loudspeaker available with bass resonance of 35, 55 or 75 c/s. The two former are particularly suited for high fidelity crossover systems with AXIETTE as treble unit.

Flux density	14,000 gauss
Total flux	158,000 maxwells
Net weight	12 lb. 13 oz.
Impedance	15 ohms.
Price	...	£9 12 9	(Free of P. Tax) (A)

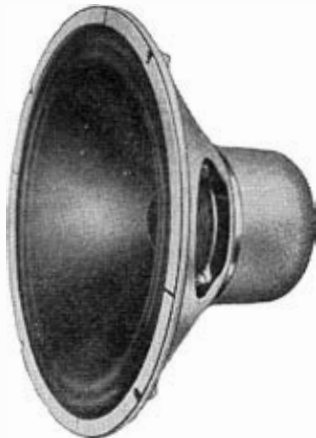

Audiom 60 12"

LOUDSPEAKER DRIVE UNITS



Audiom 70 12"

AUDIOM 70 12"

A 20 watt heavy-duty P.M. loudspeaker recommended for use where high power and high quality sound reproduction are required. Available with 35, 55 or 75 c/s. bass resonances.

Flux density	17,500 gauss
Total flux	195,000 maxwells
Net weight	18 lb. 4 oz.
Impedance	15 ohms.
Price	...	£15	2 0	(Free of P. Tax) (A)



TREBAX PRESSURE UNIT 100

A pressure driven horn unit covering from 2,500 to 16,000 c/s. Intended to be used only as a treble unit. Very low distortion at high frequencies. 15 ohms.

Price ... £6 4 0 (Free of P. Tax) (A)

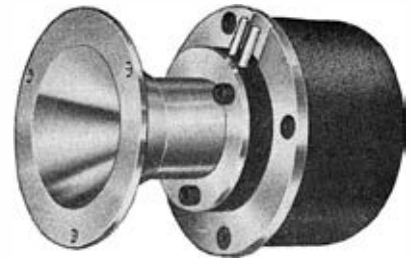

Trebax

MIDAX PRESSURE UNIT 650

Frequency range 650 c/s. to 8,000 c/s. 15 ohms impedance. Power handling capacity 25 watts. Baffle cutout $5\frac{3}{8}'' \times 2\frac{7}{8}''$ with $\frac{5}{16}''$ radii corners. Overall length $9\frac{1}{16}''$.

Price ... £9 10 0 (Free of P. Tax). (A)



Midax 650

ATTENUATOR AND CROSSOVERS

	Price
	(Free of P. Tax)
Attenuator (12 db.) 8-step variable	... 2 8 9
Chokes 1005 (4.5 mH), per pair	... 1 17 0
Crossover Type XO/5,000 c/s.	... 1 19 0
Type XO/950	... 5 5 8
Type XO/950/5000	... 7 0 6
	(A)

GOODMANS' ACOUSTICAL RESISTANCE UNITS

The acoustical resistance unit is a rectangular panel having specific acoustic properties, and it is fitted into an aperture cut in one wall of the enclosure. This system reduces the cone resonance both in amplitude and frequency and eliminates all serious resonances above this frequency. As a consequence, transient characteristics are improved and harmonic and inter-modulation distortion levels are reduced.



180ARU

Cat No.	Loudspeaker Type:	Price
		£ s. d.
180ARU	One Axiom 80 ...	3 5 6
280ARU	Two Axiom 80's ...	2 19 6
480ARU	Four Axiom 80's ...	4 4 0
172ARU	{ Axiom 300 ...	3 5 6
	{ Axiom 400 ...	3 5 6
	{ Audiom 60 ...	3 5 6
	{ Audiom 70 ...	3 5 6

(All prices free of P. Tax) (A)

LOUDSPEAKER DRIVE UNITS

W.B.



T359

S510 TWEETER UNIT

Recommended for use with Stentoreo loudspeaker system.

Price £1 11 7 plus 10/7 P. Tax. Total £2 2 0 (B)

MODEL T359 CONE TWEETER UNIT

High standard of reproduction when used with Stentorian 10" or 12" units. 9,000 gauss magnet. Frequency response 3,000-15,000 c/s. Voice coil impedance 15 ohms. or 5 ohms. Power handling capacity 15 watts when used with a 3,000 c/s. crossover.

Price £1 6 2 plus 8/10 P. Tax. Total £1 15 0 (B)

MODEL T.10 TWEETER UNIT

Moving coil pressure type. Gives a very high standard of reproduction when used with the HF1012, 1016 or 1214 speakers. Speech coil impedance 15 ohms. Flux density 14,000 gauss. Power handling capacity 5 watts. Dispersion angle 90°. Response 2000/15,000 c/s.

Price £4 8 3 (Free of P. Tax) (B)

HF610 6" DIE CAST UNIT

10,000 gauss magnet. Handling capacity 3 watts. Frequency response 60-10,000 c/s. Bass resonance 70 c/s.

Price £2 0 2 plus 13/7 P. Tax. Total £2 13 9 (B)

HF810 8" STEEL UNIT

Handling capacity 5 watts. Frequency response 50-12,000 c/s. Bass resonance 65 c/s. 10,000 gauss magnet.

Price £2 6 5 plus 15/7 P. Tax. Total £3 2 0 (B)

HF812 8" DIE CAST UNIT

12,000 gauss magnet. Handling capacity 5 watts. Frequency response 50-12,000 c/s. Bass resonance 65 c/s.

Price £3 2 6 plus £1 1 0 P. Tax. Total £4 3 6 (B)

HF816 8" PERMANENT MAGNET UNIT

16,000 gauss magnet. Fitted with cambric cone, die-cast chassis and universal speech coil providing instantaneous matching at 3, 7.5 and 15 ohms. Handling capacity 6 watts. Frequency response 50-15,000 c/s. Bass resonance 63 c/s.

Price £5 2 7 plus £1 14 8 P. Tax. Total £6 17 3 (B)

HF1012 10" DIE CAST UNIT

12,000 gauss magnet. Handling capacity 10 watts. Frequency response 30-14,000 c/s. Bass resonance 35 c/s. Universal impedance coil for 3, 7.5, 15 ohms.

Price £3 14 9 plus £1 5 3 P. Tax. Total £5 0 0 (B)

HF1016 10" PERMANENT MAGNET UNIT

16,000 gauss magnet. Fitted with cambric cone, die-cast chassis and universal speech coil providing instantaneous matching at 3, 7.5 and 15 ohms. Handling capacity 10 watts. Frequency response 30-15,000 c/s. Bass resonance 35 c/s.

Price £5 19 8 plus £2 0 4 P. Tax. Total £8 0 0 (B)

HF1216 12" PERMANENT MAGNET UNIT

16,000 gauss magnet. Fitted with cambric cone, die-cast chassis and aluminium voice coil. Handling capacity 15 watts. Frequency response 20-16,000 c/s. Bass resonance 37 c/s.

Price £15 15 0 (B)

HF1214 12" UNIT

Incorporating 14,000 gauss magnet. Handling capacity, 15 watts. Frequency response 25 c/s.—14,000 c/s. Bass resonance, 39 c/s. Die cast chassis.

Price £10 5 6 (Free of P. Tax) (B)

CROSSOVER NETWORKS

Type CX3000 For use with Models T10 and T12, 3,000 c/s. £1 11 6 (Free of P. Tax) (B)

Type CX1500 For use with No. T816, 1,500 c/s. £2 0 0 (Free of P. Tax) (B)

Type CX500 For use with 3-speaker systems, 500 c/s. £1 7 3 (Free of P. Tax) (B)

CONSTANT IMPEDANCE VOLUME CONTROL

For installations where the impedance presented by the load must be constant whilst the volume level fed into it is varied. T-pad type attenuator having 10 steps of attenuation. 3, 8 or 15 ohms.

Price £1 2 0 (Free of P. Tax) (B)

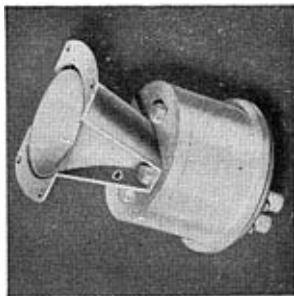

T10



HF816

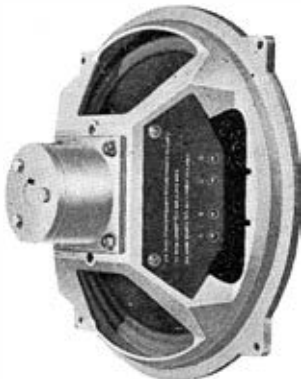

HF1012

LOUDSPEAKER DRIVE UNITS

LOWTHER

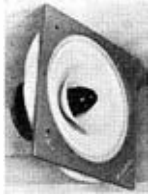

Lowther PM6

LOWTHER PM6 UNIT

6". Selected paper cone. Plastic surround. Speech coil 39 mm. Gap flux 17,500. Handling capacity 6 watts. Impedance 15 ohms. Frequency range 20-18,000 c/s. Total flux 196,000 maxwells. Weight: 7 lb. See page 24 for suitable cabinet enclosure.

Price £18 18 0 (Free of P. Tax) (B)

LORENZ

TSL LORENZ LHP65

Treble reproducer. 5.5 ohms. impedance at 800 c/s. Frequency range 2,000—above 17,000 c/s. Power rating 2 watts. Outside diameter 2½".

Price £1 8 6 plus 9/2 P. Tax. Total £1 17 8 (A)

ELAC

ELAC 4" TWEETER

4" cone type tweeter. Should be used with a suitable crossover filter in conjunction with one or two larger units. Frequency response within ± 5 db. from 5,000-17,000 c/s. Power handling 2 watts peak A.C. output. Speech coil impedance 6 ohms. 7,500 gauss magnet.

Price £1 4 0 plus 7/8 P. Tax. Total £1 11 8

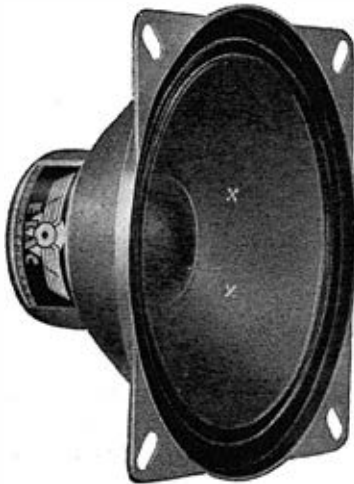

Elac 4" Tweeter

FANE

FANE HIGH FREQUENCY UNIT

Pressure type high note unit. Power handling 15 watts peak. Flux density 17,000 gauss. Frequency range 1,500-18,000 c/s. Matching impedance 15 ohm.

Cat. No. 301. Price £3 15 0 (Free of P. Tax)(A)

2X1 Crossover Unit

Price £3 0 0 (Free of P. Tax) (A)



Fane H.F. Unit

VITAVOX

VITAVOX DUI20 LOUDSPEAKER UNIT

A full range unit which is to be highly recommended. Power rating: 15 watts. Impedance (at 400 c/s.): 15 ohms. Bass Resonance: 40/45 c/s.

	L. F. unit	H.F. unit
Voice Coil Diameter	1.780"	0.650"
Magnet (Ticonal G or similar material)	3¼ lb.	2½ ozs.
Total Effective Flux	160,000 maxwells	15,000 maxwells
Flux Density	14,000 gauss	12,000 gauss
Cone Diameter	12"	3"
Piston Diameter	9½"	2¾"

Nominal Response: 30-15,000 c/s. Crossover Frequency: 2,000 c/s. Recommended Enclosure: 6 cu. ft. minimum. Finish: Satin chrome and grey hammertone enamel. Nett Weight: 14½ lb.

Price £19 10 0 (B)



Vitavox DUI20

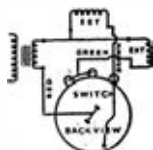

Wharfedale Speaker Switch

WHARFEDALE SPEAKER SWITCH

A very useful fitting for any set operating a low impedance extension speaker. The switch may be mounted on the side or the back of the receiver, and gives the following connections by turning the knob.

(1) Set speaker only. (2) Extension speaker only. (3) Both speakers.

Price 17/6 (B)

LOUDSPEAKER SYSTEMS AND ENCLOSURES

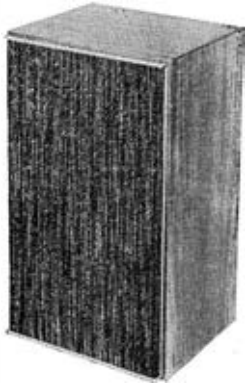

Leak "Sandwich"

LEAK "SANDWICH" FULL RANGE LOUDSPEAKER

The cabinet, which measures only 26" x 15" x 12", is of unique construction which damps panel resonances and permits the loud speaker motor to reproduce full clean bass without the "boxy" colouration of conventional cabinets. A 3" and a 13" loudspeaker motor of novel design and a half-section cross-over network complete the system which gives the highest quality of reproduction over the whole frequency range of the input signal from records, radio, tape or microphone. The 13" unit employs a new cone whose stiffness to weight ratio is two hundred times better than the best cones which are currently available. This invention is the greatest advance in moving-coil loudspeaker design since Rice-Kellogg invented the moving coil loudspeaker in 1925. The low stiffness of conventional cones results in the flexing of the cone at large amplitudes and break-up resonances. The new LEAK cone which has immense stiffness for no greater weight than a conventional cone has given us, for the first time, a loudspeaker which behaves as the theoretical idea of a rigid piston, thus there is no flexing of the cone at large amplitudes and there is no break-up distortion within the frequency range handled by the loudspeaker. It is this freedom from colouration, produced in conventional systems by break-up distortion of the cone and cabinet resonances, which distinguishes the superior quality of reproduction of the LEAK "SANDWICH" LOUDSPEAKER SYSTEM from that of the best currently available moving-coil loudspeaker systems.

Price £39 18 0 (C)

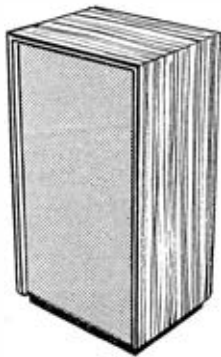

LOWTHER ACOUSTA CABINET

Affords the maximum performance in direct radiation (mid and high frequencies) and strict exponential bass horn loading for low frequencies. Two such assemblies for stereo reproduction afford great freedom in positioning the units where difficulty in placement arises. Finished in oak, walnut and mahogany. Recommended drive unit Lowther PM6 detailed on page 21.

Price, Cabinet only ... **£18 18 0** (Free of P.Tax) (C)

Price, PM6 Unit ... **£18 18 0** (Free of P. Tax) (B)

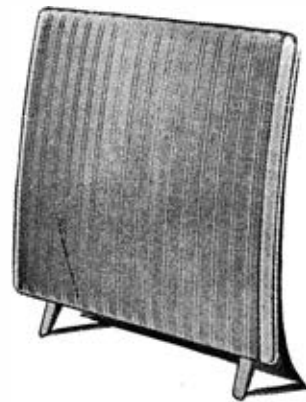

QUAD ELECTROSTATIC LOUDSPEAKER

Supplied complete with built-in networks for operation direct from a low impedance amplifier source. Intended to be used with a Standard Quad II amplifier. Should be capable of delivering at least 15 watts at low distortion when a resistive load is varied between 30 ohms. and 7 ohms. The source impedance should be not more than 2 ohms. in the frequency range 100-5,000 c/s. and not more than 6 ohms. in the range 40-20,000 c/s. Dimensions: 13" high x 34½" long x 10½" deep.

Price **£52 0 0** (C)

LOUDSPEAKER SYSTEMS & ENCLOSURES

WHARFEDALE SPEAKER SYSTEMS

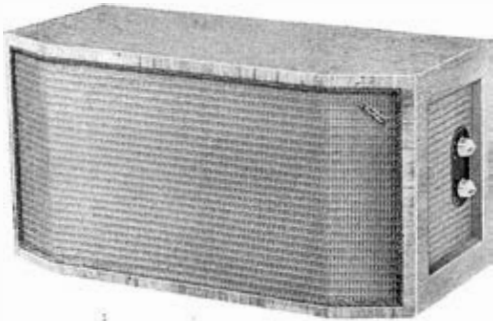

WHARFEDALE MODEL W3 LOUDSPEAKER SYSTEM

Suitable for floor standing in upright position or horizontal placing on shelf or table. A special feature is the open mounting of the treble units which are isolated from the main enclosure. This arrangement gives a free, open quality to the reproduction, with good diffusion of the high frequencies. Units: WLS/12, 5" Bronze and Super 3.

Crossover frequencies 1,000 c/s. and 5,000 c/s. Two controls for middle and treble placed at one end of cabinet.

Finished in walnut, oak or mahogany veneers, or whitewood.

Size 28" x 14" x 12". For stereo reproduction the W3 system makes an ideal partner for the SFB/3, see page 22.

Price, whitewood £36 10 0 (Free of P. Tax) (B)

Price, polished £39 10 0 (Free of P. Tax) (B)

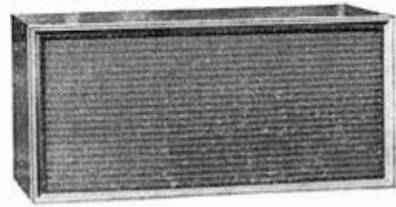

WHARFEDALE PST/8 CABINET

Designed to give optimum results at minimum cost in money and room space. Placed on a shelf or table, it is an ideal second speaker for stereo with the SFB/3 or Column Eight on the other channel, and may be laid on its back with the cone facing upwards to avoid directional effects if preferred.

The cabinet can also be placed in an upright position on the floor, where more bass and less "top" will be heard.

The PST/8 also functions well as a second speaker to reduce room resonance on single channel input.

Fitted with expanded polystyrene panels.

Size 24" x 12" x 12".

Finished in polished and veneered walnut, oak or mahogany, or whitewood.

Price, cabinet only, whitewood £7 10 0 (Free of P. Tax) (B)

Price, cabinet only, polished £10 10 0 (Free of P. Tax) (B)

WHARFEDALE SFB/3 THREE-SPEAKER SYSTEM

A wide-range, high-quality, free-standing speaker, which can easily be accommodated in the average room, can be placed in the best position for listening and easily moved against a wall when not in use, with choice of walnut, oak, mahogany and maple veneers.

Frequency range: 30 c/s. to 20,000 c/s. Impedance: 8-15 ohms. Bass resonance: 30-35 c/s. Max. input: 15 watts.

Size 34" x 31" x 12". Weight 64 lb.

Units employed W12/FS, 10" Bronze/SFB, Super 3. The 12" and 10" units are in parallel. This arrangement gives very smooth results over the full range with a 3 db. gain at low frequencies.

The Super 3 is again in parallel via 4 mfd. capacitor and is mounted on a small baffle facing upwards.

The efficiency of the system is high and will give full domestic volume from any good 5 watt amplifier. The baffle is sandfilled; there is no cabinet resonance because there is no cabinet. The system is omni-directional.

The 12" and 10" units are specially built and **matched for optimum** results from this system. Baffles cannot be supplied separately.

Price £39 10 0 (Free of P. Tax) (B)

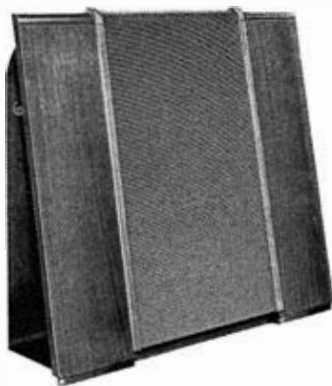

SFB/3

LOUDSPEAKER SYSTEMS & ENCLOSURES

WHARFEDALE SPEAKER SYSTEMS

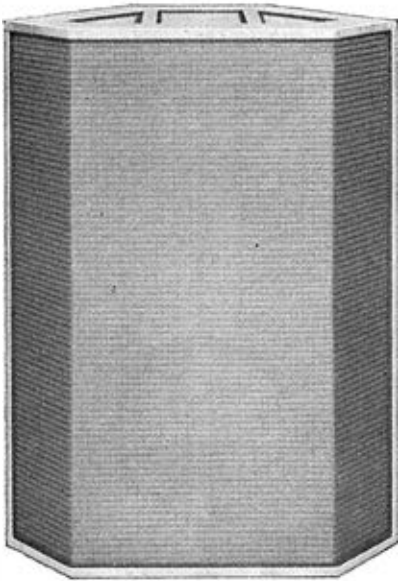

Airedale

AIREDALE

The smooth, clean bass is characteristic of the high flux 15" unit which is now fitted with roll surround.

The 8" mid-range and 3" treble units face upwards for omni-directional treble, and are arranged in a manner which imparts a natural airiness to the reproduction.

Cabinet resonance is avoided by loading the larger panels with ceramic tiles. Some idea of the solid construction is given by the fact that the total weight exceeds $\frac{3}{4}$ cwt.

UNITS:

W15/RS fitted with heavy cone and impregnated cloth roll surround for minimum distortion.

SUPER 8/FS SUPER 3

Half section three-way separator unit with crossover frequencies of 400 c/s. and 5,000 c/s.

Size 39" x 28½" x 14". Weight 91 lb. complete. Impedance 12/15 ohms only

Max. Input 20 watts.

Individual controls for middle and treble response are located in the rear panel.

Available in whitewood or fully finished with a choice of walnut, oak or mahogany veneers. Tropical model also available at extra cost.

Fully descriptive literature free on request.

Price £65 0 0 (Free of P. Tax) (B)

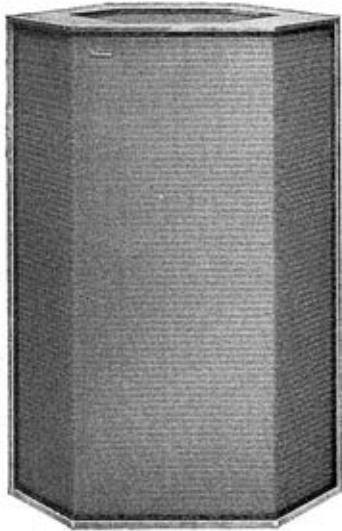

WHARFEDALE MODEL W4 LOUDSPEAKER SYSTEM

A free-standing cabinet of hexagonal shape, suitable for corner or wall position, this is a virtually omni-directional speaker and makes a worthy partner for the larger three-speaker corner system.

Units: WLS/12, two 5" Bronze and Super 3.

Crossover frequencies 400 c/s. and 5,000 c/s. Two controls for middle and treble placed in back panel.

Finished in walnut, mahogany or oak veneers, or whitewood. Size 35" x 24" x 12".

Price, whitewood £47 5 0 (Free of P. Tax) (B)

Price, polished £49 10 0 (Free of P. Tax) (B)

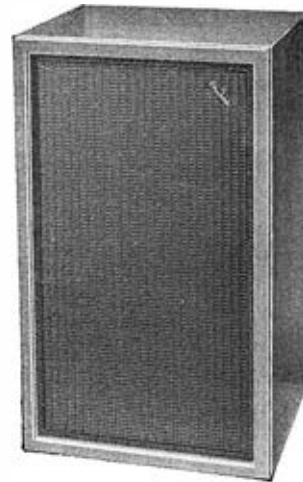

WHARFEDALE MODEL W2 LOUDSPEAKER SYSTEM

A two-unit compact loudspeaker system which can be stood vertically on the floor or used horizontally as a table or shelf-mounting model. Should be used with a forward facing speaker.

Crossover at 1,000 c/s. Treble control fitted to back panel.

Units: WLS/12 and Super 5.

Size 23½" x 14" x 12".

Finished in walnut, oak or mahogany veneers, or whitewood.

Price, whitewood £27 10 0 (Free of P. Tax) (B)

Price, polished £29 10 0 (Free of P. Tax) (B)

LOUDSPEAKER SYSTEMS AND ENCLOSURES

GOODMANS

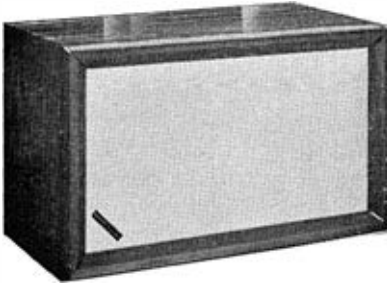

GOODMANS "AL" LOUDSPEAKER SYSTEMS

The AL Series comprises two models—AL/120 and AL/100. Both have been designed to meet the need for High Fidelity installations, stereophonic or monophonic, **without overcrowding the modern home**. They have been made so compact ($24" \times 11\frac{1}{2}" \times 14\frac{1}{4}"$) as to simplify the problem enormously, as the accompanying illustration shows. From the acoustic viewpoint there has to be some compromise when small enclosures are used, but in the AL series this compromise is reduced to a minimum by the use of a **patented feature**, the A.R.U.

SPECIFICATIONS

	AL/120	AL/100
Frequency Range	35-20,000 c/s.	35-15,000 c/s.
Power Handling	15 watts	12 watts
Capacity	American Rating 30w.	American Rating 24w
Impedance	15 ohms.	15 ohms.
Radiating elements	3	2
Crossovers	Mechanical and Electrical	Mechanical
	L-pad HF control	
Size	$24" \times 11\frac{1}{2}" \times 14\frac{1}{4}"$	$24" \times 11\frac{1}{2}" \times 14\frac{1}{4}"$
Price	AL100 £23 10 0	0 (Free of P. Tax) (B)
	AL120 £29 10 0	0 (Free of P. Tax) (B)



"Trio"

FANE "TRIO" REPRODUCER

Three speaker reproducer. Incorporates a 12" bass unit with a 10,000 line magnet and a heavy 4-layer voice coil. The intermediate unit is an 8" deep chassis design with a curved cone.

Matching Impedance: 8-15 ohms. Power handling: 15 watts R.M.S.
 Frequency Range: 70-15,000 c/s. Horizontal dispersion 90° to front.
 Size: $24\frac{1}{2}" \times 24" \times 8\frac{1}{2}"$. Weight 13 lbs.

Finished walnut, sapele mahogany or light oak.

Price **£17 10 0** (Free of P. Tax) (A)

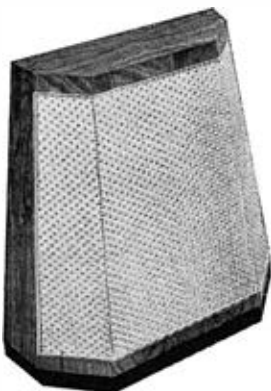

"Quartet"

FANE "QUARTET" REPRODUCER

Consists of four specially developed loudspeaker units and a crossover network mounted in a novel type of cabinet-baffle. Free standing and readily portable.

Matching impedance: 15 ohms. Power handling: 20 watts R.M.S.
 Frequency range: 25-17,000 c/s. Horizontal dispersion 180° to front of speaker.

Size: $25\frac{1}{2}" \times$ max. width $25\frac{1}{2}" \times$ frontal width $14\frac{1}{4}" \times 8\frac{3}{4}"$ deep.

Weight: 22 lbs.

Finished in figured walnut, sapele mahogany or oak.

Price **£35 0 0** (Free of P. Tax) (A)

LOUDSPEAKER ENCLOSURES

W.B. STENTEREO STEREOPHONIC ENCLOSURES C13

With listener position control.

Two corner speaker enclosures. Each enclosure is divided into two sections, the lower section taking the form of an infinite baffle. Into this may be fitted a W.B. Stentorian loudspeaker, type HF810 or HF812 to provide the lower and part of the middle register of sound. For the upper and remainder of the middle register a W.B. Stentorian loudspeaker, type HF510 is used and the two units are coupled by means of a crossover unit type CX1500. A single cabinet with loudspeaker may be used for single channel listening.

Price, enclosure only (each)

Price £8 0 0 (Free of P. Tax) (C)



Senior Column



Junior Column

W.B. STEREO COLUMN ENCLOSURES

The columns, which have 360° diffusion by means of a dome mounted above the loudspeaker, are designed to house the loudspeaker mounted horizontally near the top of the column. If desired, one single unit may be used for monaural sound reproduction and a second unit added later for stereo.

Junior C11

Size 36" × 9" × 9".

Price, cabinet £11 0 0 (Free of P. Tax)

Recommended speaker HF610. (C)

Senior C10

Size 55½" × 13½" × 18½".

Price, cabinet £20 0 0 (Free of P. Tax)

Recommended speaker HF816. (C)



"Prelude" Corner Console

"PRELUDE" BASS REFLEX CORNER CONSOLE C6

A most attractive cabinet has been specially designed to utilise the natural acoustic properties of the walls and is also suitable for use where space-saving is a consideration. For use with Stentorian 8" or 10" units and with provision for Tweeter unit.

Size: 33" × 21" × 17".

Price £11 0 0 (Free of P. Tax) (C)

"PRELUDE" BASS REFLEX CONSOLE CABINET C7

Will provide outstanding reproduction when used in conjunction with Stentorian 8" or 10" units, provision also for Tweeter unit.

Size: 33" × 19" × 19½".

Price £12 12 0 (Free of P. Tax) (C)

"Prelude" Cabinets finished in Sapele.

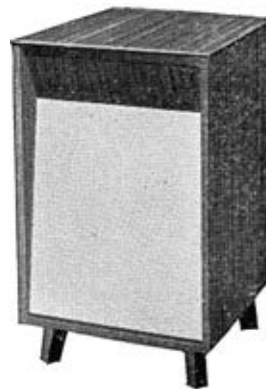

"Prelude" Bass Reflex

LOUDSPEAKER ENCLOSURES & EQUIPMENT CABINETS

READY-TO-ASSEMBLE W.B. SPEAKER CABINETS

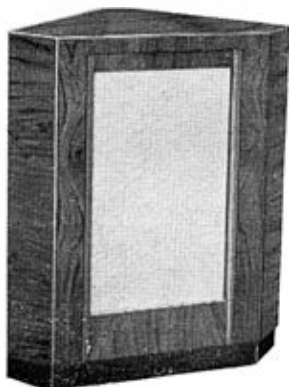

Senior Bass Reflex

SENIOR BASS REFLEX CORNER CONSOLE C2

Designed to ensure high quality reproduction when used in conjunction with Stentorian 10" or 12" units. Provision is also made for Tweeter unit, if required.

Size: 35" x 30" x 19".

Price £12 12 0 (Free of P. Tax) (C)

JUNIOR BASS REFLEX CORNER CONSOLE C3

A contemporary-style cabinet, specially designed to give maximum reproduction quality from Stentorian 8" or 10" units, with provision for Tweeter unit, if required.

Size: 33" x 22½" x 18½".

Price £10 10 0 (Free of P. Tax) (C)

Above finished in Walnut.

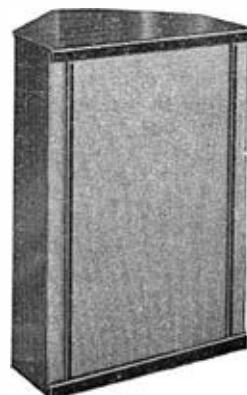

Junior Bass Reflex

EQUIPMENT CABINETS

W.B. "PRELUDE" HI-FI TABLE CABINET C9

Will accommodate any make of tape deck or single record player, amplifier, pre-amplifier control unit, and radio tuner. In carton ready to assemble.

Size 17½" x 19¼" x 18½".

Price £10 10 0 (Free of P. Tax) (C)

With Legs

Price £12 0 0 (Free of P. Tax) (C)

W.B. "PRELUDE" HI-FI CONSOLE CABINET C8

Takes any make of tape deck or record player, amplifier, pre-amplifier, control unit, and radio tuner. In carton ready to assemble.

Size 33" x 19" x 19½".

Price £14 14 0 (Free of P. Tax) (C)



"Prelude" Console



"Prelude" Table Cabinet

"NEW SOUTHDOWN" CABINET

Designed specifically to accommodate Leak high fidelity equipment. Finished in natural walnut or contemporary mahogany.

Size 29" high x 34" long x 23" deep.

Player well 16½" x 16½".

Price £21 0 0 (Free of P. Tax) (C)

Convactor shield for use with Stereo 50 only, price ... 5/- (Free of P. Tax)



"New Southdown"

PICK-UPS & CARTRIDGES

DECCA ffs STEREOPHONIC PICK-UP

The pick-up and arm are manufactured to precision limits by one of the best equipped instrument makers in the country. The head cover has an internal static screen of silver-plating. Setting and adjustment of the diamond stylus and the final assembly of the armature are so precise that the operation is carried out under a microscope. The whole assembly is designed to keep the arm resonance well below the audio spectrum and is specially damped with viscous fluid to prevent shocks exciting the pick-up. Playing weight is accurately adjusted in the factory to 3.5 grams. The tip mass of the pick-up is under one milligram so that wear, both of the record and the diamond stylus, is negligible. The output is sufficient to load the majority of high grade stereo amplifiers now on the market.



Decca ffs Stereophonic Pick-up

Price with Stereo Head	£15 18 0 plus £5 2 0 P. Tax.	Total £21 0 0 (A)
Monaural L.P. Head	£8 5 9 plus £2 13 3 P. Tax.	Total £10 19 0 (A)
Monaural Standard Head	£8 5 9 plus £2 13 3 P. Tax.	Total £10 19 0 (A)
Stereo Head	£11 10 6 plus £3 14 1 P. Tax.	Total £15 4 7 (A)

GOLDRING G60 TRANSCRIPTION ARM

A new pick-up arm of transcription quality specially designed to take all modern monaural and stereophonic cartridges with standard fixing dimensions. **The slide-in platform carrying the pick-up cartridge is the simplest and most positive "head" arrangement yet devised.** Its four-pin contacts mate perfectly with the lead carrying contacts in the arm. The height of the arm and also of the folding rest are adjustable for all modern transcription motors. Playing weight is easily adjusted by a milled wheel under the arm from zero upwards. New type precision bearings ensure smooth free movement laterally and vertically. Offset angle and overhang dimensioned to give minimum distortion on 12" records.



Price £3 0 0 plus 19/6 P. Tax. Total £3 19 6 (A)
Additional Slide-in Platforms.

Price 10/6 plus 3/5 P. Tax. Total 13/11 (A)

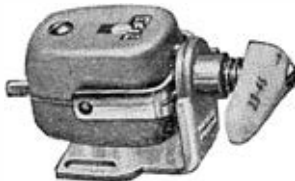

Goldring 580 Cartridge

GOLDRING 580 CARTRIDGE

A high quality variable reluctance cartridge almost approaching 600 type in performance but fitted with two sapphire styli; one 78 r.p.m. one L.P. Complete with mu-metal shield.

Price £4 4 0 plus £1 7 4 P. Tax. Total £5 11 4 (A)

GOLDRING 600 CARTRIDGE

Similar to 580 cartridge but designed specifically around a diamond L.P. stylus. A high fidelity cartridge with flat response from 20 to 20,000 c/s. Sapphire 78 r.p.m. and diamond L.P. fitted as standard.

600 Cartridge 1 sapphire standard, 1 diamond L.P. and mu-metal shield.

Price £8 8 0 plus £2 14 7 P. Tax. Total £11 2 7 (A)

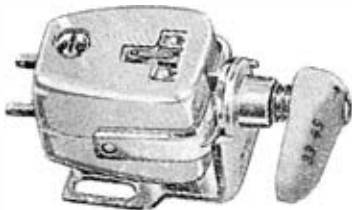

Goldring 600 Cartridge

GOLDRING MODEL MX1D CARTRIDGE

A new monaural turnover crystal cartridge of high quality designed as a universal replacement. Fitted with sapphire styli for standard, diamond stylus for L.P.

The mounting bracket has standard 1/2" mounting centres as well as a single fixing hole.

Price £1 17 6 plus 12/2 P. Tax. Total £2 9 8 (A)



Goldring SX10D Cartridge

GOLDRING MODEL SX10D CARTRIDGE

A wide range turnover stereophonic/monaural crystal cartridge designed for use with all types of records. Sapphire stylus fitted for 78. Diamond for Stereo/L.P. records. The mounting bracket has standard 1/2" mounting centres as well as a single fixing hole.

Price £2 5 0 plus 14/8 P. Tax. Total £2 19 8 (A)

PICK-UPS & CARTRIDGES

GOLDRING 700 MAGNETIC STEREO PHONIC CARTRIDGE

This is a new cartridge designed to a rigid specification with the same devotion to quality as the Goldring Monaural cartridges Nos. 580 and 600. It is a single sided cartridge fitted with a .0005" diamond stylus. Completely screened by a pair of mu-metal shields, it is very insensitive to stray magnetic fields which might induce hum into it from the turntable motor.

Price ... £7 7 0 plus £2 7 9 P. Tax. Total £9 14 9 (A)



Garrard TPA12

GARRARD TPA12 TRANSCRIPTION PICK-UP ARM

Elegantly styled in an attractive combination of Ivory, Chrome and Red. Length 9½" from stem to stylus minimising tracking errors and permits the playing of 16" records. It is wired and technically approved for monaural and stereo reproduction. Arm complete with MPM5 plug in shell allowing for all cartridges being fitted.

Price ... £3 11 0 plus £1 3 2 P. Tax. Total £4 14 2 (A)

MPM4 SHELL with GC8 monaural crystal cartridge.

Price ... £1 1 6 plus 7/- P. Tax. Total £1 8 6 (A)

MPM4 SHELL with GCS10 stereo crystal cartridge.

Price ... £1 13 3 plus 10/10 P. Tax. Total £2 4 1 (A)

MPM4 SHELL with EV26 stereo ceramic cartridge.

Price ... £1 15 6 plus 11/7 P. Tax. Total £2 7 1 (A)

LEAK DYNAMIC PICK-UP

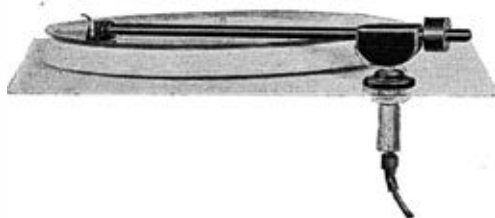

Leak Dynamic Pick-Up

Pick-up arm of advanced design having a very low inertia and supplied with pick-up rest. Heads are of the plug-in type, Dynamic (Moving coil) and are fitted with diamond stylus. The shielded step-up transformer delivers an output of 8mV for each c.m./sec. r.m.s. recorded velocity. This means that an amplifier with a sensitivity of 40 mV at 1,000 c/s. will be easily loaded by the pick-up.

Pick-up arm only.

Price ... £2 15 0 plus £1 3 1 P. Tax. Total £3 18 1 (B)

Pick-up Heads Standard or L.P.

Price ... £5 15 0 plus £2 0 3 P. Tax. Total £7 15 3 (B)

Mu Metal Matching Transformer.

Price ... £1 15 0 (Free of P. Tax) (B)

CONNOISSEUR SUPER LIGHTWEIGHT PICK-UP ARM Mk. III



Connoisseur Super Lightweight

This arm is designed to accept both monaural and stereo heads. The pivot point is a single conical bearing self adjusting and the back support pillar is adjustable for heights of various turntables. The arm is identical with the Mk. II in fixing dimensions and weight, and finished in satin chrome and black.

Pick-up arm only.

Price £3 0 0 plus 19 11 P. Tax. Total £3 19 11 (B)

SUITABLE HEADS

Mk. II Monaural Heads with Sapphire. ... Price ... £3 10 0 plus £1 3 3 P. Tax. Total £4 13 3 (B)

Mk. II Monaural Heads with Diamond. ... Price ... £6 10 0 plus £2 3 3 P. Tax. Total £8 13 3 (B)

Stereo Head with Diamond. ... Price ... £6 0 0 plus £1 19 11 P. Tax. Total £7 19 11 (B)

Mk. II MONAURAL

.001" radius Diamond or Sapphire for L.P. recordings. }

.0028" radius Sapphire for Modern Standard recordings. }

.0035" radius Sapphire for Older Standard recordings. }

STEREO HEAD with .0005" radius Diamond.

Magnetic
400 ohms.
Ceramic

CONNOISSEUR STEREO PHONIC PICK-UP

A ceramic type pick-up suitable for feeding into the modern high gain amplifier and fitted with diamond stylus.

The stereo pick-up arm manufactured to take the stereo head will also take the CONNOISSEUR Mk. II head and is wired appropriately.

A lifting device is fitted on the pick-up arm above the pivot points and with this device the head can be raised or lowered accurately. This arm is finished in a high gloss black and ornamented with anodised strips. The pick-up base column is adjustable for height to accommodate varying models of turntables.

Pick-up complete with Stereo Head.

Price ... £9 15 0 plus £3 4 10 P. Tax. Total £12 19 10 (B)

Pick-up arm only.

Price ... £3 15 0 plus £1 4 11 P. Tax. Total £4 19 11 (B)

Stereo Head only.

Price ... £6 0 0 plus £1 19 11 P. Tax. Total £7 19 11 (B)



PICK-UPS & CARTRIDGES

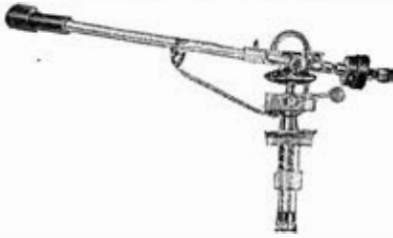

Acos 'Hi-Light' Stereophonic Pick-up

ACOS 'HI-LIGHT' STEREOPHONIC PICK-UP

The 'Hi-Light' Pick-up has been designed to play records at downward pressure within the elastic limit of the disc material. No permanent deformation of the record takes place under these conditions and record wear is not measurable.

The requirements for a cartridge to fulfil such conditions are most stringent. A very low effective tip mass is required, coupled with a high compliance. With one head Stereo or L.P.

Price ... **£13 10 3** plus **£4 6 9 P. Tax.** Total **£17 17 0 (A)**

Additional Head.

Price **15/11** plus **5/1 P. Tax.** Total **£1 11 0 (A)**

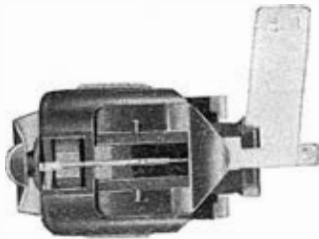

Acos 73-1 Stereo Cartridge

ACOS 73-1 STEREO CARTRIDGE

A dual purpose Cartridge for Monaural and Stereo use. Incorporates a turn under stylus with one point for 78 r.p.m. Monaural Records and the other for Stereo/L.P. Monaural—a compatible tip. A high output Cartridge with good separation on Stereo.

With one sapphire and one diamond L.P./Stereo stylus.

Price **£2 13 6** plus **17/2 P. Tax.** Total **£3 10 8 (A)**

With two sapphire styli.

Price **£1 15 0** plus **11/2 P. Tax.** Total **£2 6 2 (A)**

ACOS 71-5 STEREO CARTRIDGE

A single sided stereo crystal cartridge with diamond stylus. Price ... **£2 0 0** plus **12/10 P. Tax** Total **£2 12 10 (A)**

RONETTE STEREOPHONIC CARTRIDGE BF40

The Binofluid stereo cartridge is acknowledged to be one of the finest yet available. Fitted with 0.5 thou. sapphire stylus.

Price **£2 10 0** Plus **16/3 P. Tax.** Total **£3 6 3 (A)**

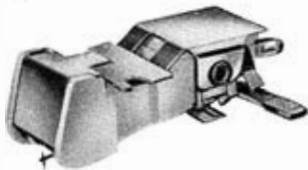

8T Sonotone

8T SONOTONE STEREOPHONIC CARTRIDGE

A ceramic type Cartridge suitable for tropical use designed for Monaural and Stereophonic reproduction. The familiar Twin Stylus Needle, with a point mounted on either side of the shank is used one being 3 mil. for 78 r.p.m. Monaural Records and the other 0.7 mil. for L.P. Monaural Stereo

Price **£2 0 0** plus **13/4 P. Tax.** Total **£2 13 4 (A)**



Elac Stereotwin

ELAC STEREOTWIN STS210D VARIABLE RELUCTANCE CARTRIDGE

The "Elac" Stereotwin 210 is a variable reluctance magnetic Cartridge which, whilst it is superlative in the stereophonic field, it is also suitable for reproduction of Monaural records. The cartridge is designed for absolutely symmetrical reproduction of both channels, thus ensuring highest reproduction fidelity for stereophonic records. A well-designed shield protects the Cartridges against hum picked up from external magnetic fields. The stylus is easily replaceable. The cartridge is fully tropicalised and is not affected by temperature or humidity.

Price**£12 10 6** plus **£4 0 4 P. Tax.** Total **£16 10 10 (A)**

ELAC STEREOPHONIC STS310D VARIABLE RELUCTANCE CARTRIDGE

Identical in appearance to STS210D Stereotwin Cartridge detailed above but engineered to even higher standards. This is designed for reproduction of Stereo Records only and is fitted with diamond stylus. Output is slightly lower but separation between channels somewhat improved.

Price **£19 7 6** plus **£6 4 4 P. Tax.** Total **£25 11 10 (A)**

PICK-UPS AND CARTRIDGES



S.M.E. PRECISION PICK-UP ARMS

Built throughout to instrument standards of quality. All parts precision machined, heat treated and ground where necessary. Finished in satin chrome plate, gun black and polished stainless steel. A unique weight system enables the arm to be balanced longitudinally and laterally. This important feature makes levelling unnecessary. Reproduction is unaffected even if the arm and turntable assembly are tipped through 30° from horizontal, demonstrating the excellent groove contact maintained. Tracking pressure is adjusted from 0.5 grammes by moving a rider weight along a scale

graduated in 1/2 grammes. As this always starts from a balanced position precise pressure is applied to the stylus of any cartridge obviating the use of a pressure gauge.

Models 3009 and 3012 are of similar construction, the essential difference being the length of tone arm. The choice depends on the space available. If the motor board is big enough the 3012 is the better, tracking error is even smaller and for studio use 16" records can be played. If not the 3009 can be used with every confidence and indeed is the one most frequently employed.

Model 3012 Arm only.	Price ...	£19 19 2 plus	£6 10 10 P. Tax.	Total	£26 10 0 (A)
Model 3009 Arm only.	Price ...	£18 1 8 plus	£5 18 4 P. Tax.	Total	£24 0 0 (A)
SME Head Shell (For all standard cartridges)	Price ...	15 0 plus	5 0 P. Tax.	Total	£1 0 0 (A)
SME Bias Adjuster	Price ...	15 0	No. Tax.	Total	15 0 (A)
SME D2 DECCA ADAPTOR. This enables the Decca fss stereo and monaural pick-up heads to be plugged straight into the SME Arm.	Price ...	£2 0 0	No Tax.	Total	£2 0 0 (A)

For Decca heads which are also available please refer to page 28.

SHURE STEREO DYNETIC CARTRIDGES



PROFESSIONAL MODEL M3D SPECIFICATIONS

Channel separation: More than 20 db at 1,000 cps. Frequency Response 20 to 15,000 cps. (± 3db). Output voltages 5 mv per channel at 1,000 cps. Recommended Load Impedance 50,000 ohms. Compliance Vertical, Lateral 4.0×10^{-6} centimeters per dyne. Tracking force 3 to 6 grams. Inductance 400 millihenrys. D.C. Resistance 400 ohms. Terminals 4 terminals. Adaptable to 3 terminal arms. Mounting Standard 1/2" centres. Stylus .0007" diamond stylus.

Model M3D Professional Stereo Dynetic cartridge including .0007 Diamond Stylus.

Price £18 0 0 plus £6 1 4 P. Tax. Total £24 1 4 (B)

Model N3D Stereo Stylus assembly for M3D, including .0007" Diamond.

Price £9 0 0 plus £3 0 8 P. Tax. Total £12 0 8 (B)

M3/N21D

As M3 but fitted with tubular stylus giving higher compliance and increased frequency response 20/20,000 cps. and capable of tracking at 2 1/2 grams maximum.

Price £19 0 0 plus £6 8 1 P. Tax. Total £25 8 1 (B)

N21D replacement diamond stylus assembly.

Price £10 0 0 plus £3 7 5 P. Tax. Total £13 7 5 (B)



CUSTOM MODEL M7D SPECIFICATIONS

Channel separation: More than 20db at 1,000 cps. Frequency Response 20 to 15,000 cps. Output voltage 5mv per channel at 1,000 cps. Recommended Load Impedance 47,000 ohms. Compliance Vertical, Lateral 3.5×10^{-6} centimeters per dyne. Tracking Force 4 to 7 grams. Inductance 400 millihenrys. D.C. Resistance 400 ohms. Terminals 4 terminals. Adaptable to 3 terminal arms. Mounting Standard 1/2" and 7/16" centres. Stylus .0007" diamond stylus.

Model M7D Custom Stereo Dynetic cartridge . . . including .0007" diamond stylus.

Price £9 10 0 plus £3 4 0 P. Tax. Total £12 14 0 (B)

Model N7D Stereo Stylus assembly for M7D, including .0007" diamond.

Price £4 15 0 plus £1 17 0 P. Tax. Total £6 12 0 (B)

M7/N21D

As M7 but fitted with tubular stylus giving higher compliance and increased frequency response 20/20,000 cps. and capable of tracking at 2 1/2 grams maximum.

Price £14 15 0 plus £4 19 5 P. Tax. Total £19 14 5 (B)

N21D Replacement diamond stylus assembly.

Price £10 0 0 plus £3 7 5 P. Tax. Total £13 7 5 (B)

M8D

A high quality, low cost stereo cartridge designed primarily for use in auto change units. Separation more than 20 db at 1,000 cps. Frequency response 30/15,000 cps. Output 5 mv per channel at 1,000 cps. Load imp. 47K ohm. Tracking force 5/8 grams. 1/2" x 7/16" fixing centres. Complete with diamond stylus.

Price £7 2 6 plus £2 8 0 P. Tax. Total £9 10 6 (B)

N8D Replacement diamond stylus assembly.

Price £3 11 3 plus £1 4 0 P. Tax. Total £4 15 3 (B)

PICK-UPS & UNIT ACCESSORIES

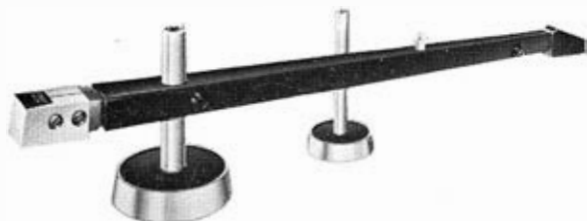

Shure M212 Integrated Tone Arm and Cartridge



Shure M232 Professional Tone Arm

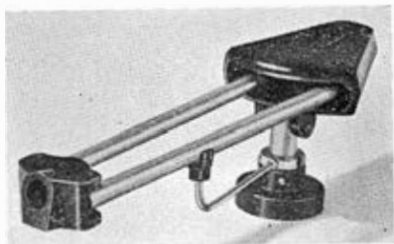

B.J. Tan II Pick-up Arm

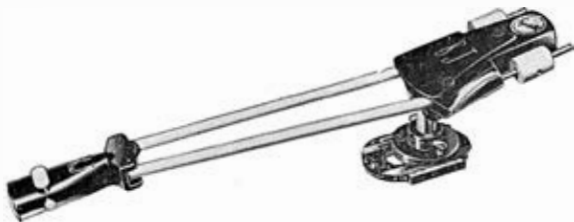

B.J. Super 90 Pick-up Arm



B.J. Stereophonic Pick-up Head

SHURE M212 INTEGRATED TONE ARM AND CARTRIDGE

This pick-up tracks at the incredibly light weight of $1\frac{1}{2}$ - $2\frac{1}{2}$ grams minimizing record wear and virtually eliminating the possibility of scratch. Jewel bearings throughout. Cartridge is pivoted on ruby sleeve and jewelled bearings. Arm pivot is a ruby thrust bearing. Cartridge is of moving magnet type within stationary coils. Frequency response 20/20,000 cps. Separation better than 21db at 1,000 cps. Output 4-5mv per channel. DC resistance 600 ohms. Compliance (Vert-Lateral 9×10^{-6} cms./dyne.

Price complete with Stereo head.

£36 0 0 plus £12 2 7 P. Tax. Total £48 2 7 (B)

Price of mono L.P. head for M212.

£16 16 0 plus £5 13 3 P. Tax. Total £22 9 5 (B)

SHURE M232 PROFESSIONAL TONE ARM (12")

This is an arm of the highest quality which features plug-in head with positive alignment lock which accepts practically all types of cartridges. Precision ball bearings at all pivot points, variable height adjustment. Tracking force 0-8 grams Easy to instal—all connections can be made from top of motor board. Furnished with cable having plug on each end to simplify installation.

Price Pick-up Arm.

£13 0 0 plus £4 7 7 P. Tax. Total £17 7 7 (B)

Price Plug-in shell.

£1 1 0 plus 7/1 P. Tax. Total £1 8 1 (B)

B.J. TAN II PICK-UP ARM

Following the tangent of the groove, it opens an entirely new field in high fidelity reproduction. The arms are arranged geometrically to follow the tangent paths of the groove. It is designed to accommodate Decca XMS and H, B.J., Acos HGP55 and with adaptor HGP39 heads.

Price £3 3 0 plus £1 0 3 P. Tax. Total £4 3 3 (A)

B.J. Head Shells

Price 17/3 plus 5/9 P. Tax. Total £1 3 0 (A)

B.J. Acos Adaptor

Price 10/- plus 3/3 P. Tax. Total 13 3 (A)

B.J. Counterweight Unit

Price 12/- plus 3/11 P. Tax. Total 15 11 (A)

B.J. SUPER 90 PICK-UP ARM

The B.J. Super 90 is the new de-luxe edition of the world famous B.J. Arm which since its introduction as the first pick-up to overcome tracking error, has made the word tangentiality another way of saying High Fidelity. Supplied with two plug-in shells which will suit over 15 popular heads, arm clip, spare weights and mounting template. Suitable for all records up to 16". Height variable by more than 1" to adjust for different turntables.

Price £11 11 0 plus £3 14 2 P. Tax. Total £15 5 2 (A)

B.J. STEREOPHONIC PICK-UP HEAD

This head houses a cartridge capable of faithfully reproducing into two channels the delicate and highly complex grooves of stereo records. Supplied with 0.5 thou. diamond stylus.

Price £3 14 9 plus £1 4 0 P. Tax. Total £4 18 9 (A)

PICK-UPS & UNIT ACCESSORIES

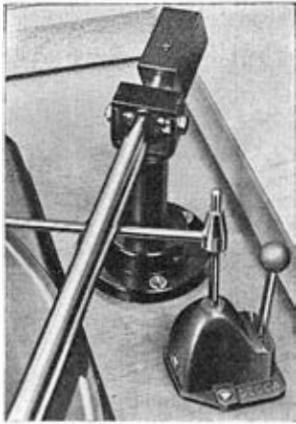

Decca Microlift

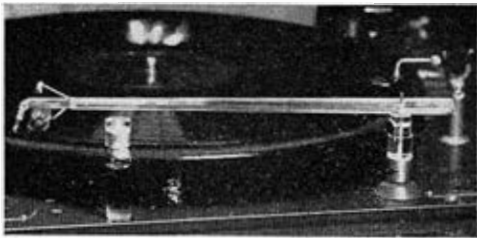

The "Dust Bug"

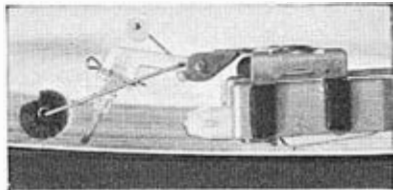

Auto Changer "Dust Bug"



Goldring Stylus Pressure Gauge



Garrard SPG3 Stylus Pressure Gauge

DECCA MICROLIFT

Easy to fit and adjust for any pick-up. Positive positioning at any point on the record. Ensures against damage to styli and the surface of records. Never in contact with the pick-up while playing.

Gently and accurately the Microlift lowers the stylus on to the record at any point you choose. . . and just as gently lifts it clear. A simple operation but one which fingers so often fail to accomplish, with dire results to record life, stylus life and the quality of reproduction.

Fit a Microlift to protect your favourite records . . . **for less than the cost of replacing just one of them.**

Price £1 2 8 plus 7/4 P. Tax. Total £1 10 0 (A)

THE "DUST BUG"

Easily fitted to any turntable and will remove dust and static from the grooves of a record at the moment of playing. A device which has already sold in many thousands and is to be highly recommended.

Price 17/6 plus 5/10 P. Tax. Total £1 3 4 (A)

Spare Plush Pads.

Price 9d. (No P. Tax) (A)

Spare Nylon Bristles.

Price 1/- (No P. Tax) (A)

Spare Bottles Cleaning Fluid.

Price 1/6 (No P. Tax) (A)

AUTO CHANGER "DUST BUG"

As above but specially designed for fitting to pick-up arms on Auto-Change units.

Price 17/6 plus P. Tax 5/10. Total £1 3 4 (A)

GOLDRING STYLUS PRESSURE GAUGE

A small, simple and accurate balance which does not rely on springs. The stylus tip rests in an indention at one end, and a sliding weight, moving along a scale graduated from 4 to 10 grammes indicates stylus pressure. An inexpensive "must" for all gramophone users.

Price 3/6 plus 1/2 P. Tax. Total 4/8 (A)

GARRARD SPG3 STYLUS PRESSURE GAUGE

FEATURES. Elegantly styled—Modern design—Pleasing appearance. Easily readable scale, visible through a clear plastic window, reading 0-12 grammes, with ½ gramme indications. Utmost sensitivity and accuracy. Accurate through the entire scale, 0-12 grammes. Easy to operate. Readily adjustable. Plastic Scale Pan—no damage to delicate stylus. Swivelling Balance Lever to ensure sensitivity with all pick-ups. Will accommodate all current Pick-up Arms and Heads. Measures the exact Stylus Pressure at the actual stylus and at record level. Supplied complete with a 5 gramme checking weight.

Price 14/8 plus 4/10 P. Tax. Total 19/6 (A)

PICK-UPS & UNIT ACCESSORIES



Miragrip Record Holder

MIRAGRIP RECORD HOLDER

A good L.P. record, if treated well, can be an everlasting source of pleasure for its owner. Looked at in this way, it represents wonderful value. But it is an expensive article to buy. It becomes an extravagance if allowed, through sheer negligence, to deteriorate rapidly.

That is why Record Companies, Libraries, Broadcasting Stations and private record-users all over the world employ a **Miragrip** whenever records have to be handled. It does the job simply, effortlessly and **safely**.

Price **18/6** (No P. Tax) (A)

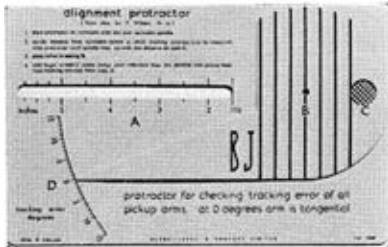

B.J. Pick-up Alignment Protractor

B.J. PICK-UP ALIGNMENT PROTRACTOR

Produced in plastic ivory instantly measures the tracking accuracy of all pick-up assemblies, thus allowing the mounting position to be checked.

Price **7/-** (No P. Tax) (D)



Goldring Stylus Microscop

GOLDRING STYLUS MICROSCOPE

A new Stylus Storage Cabinet with a Microscope designed specially for the examination of styli. The cabinet is fitted with an attractive plastic top, recessed to hold microscope.

Styli are easily positioned under the lens of the microscope by means of the rotating snap clip. Twin illumination is provided to offer maximum contrast and magnification is variable from 50 to 150 times, enough for even the smallest flaw or flat to be detected.

Price **£6 6 0** Net

SUNDRY ITEMS

B.S.R.

45 r.p.m. Adaptor Spindles for Monarch changerPrice ...	17/6 plus 5/8	P. Tax.	Total 23/2 (A)
AF333 Pick-up matching transformerPrice £1 16 0 (C)
Clip-in 45 r.p.m. Adaptor for 7" records	(per doz.) Price ...	3/- plus 1/-	P. Tax.	Total 4/- (A)

REGENTONE

Replacement Jockey Pulley Assemblies for HG5WPrice ...	6/6 plus 2/1	P. Tax.	Total 8/7 (A)
Replacement Pick-up Arm Mouldings for HG5WList ...	6/6 plus 2/1	P. Tax.	Total 8/7 (A)

GARRARD

Plastic Centre-hole Adaptor for 45 r.p.m. recordsPrice ...	9d. plus 3d.	P. Tax.	Total 1/- (A)
Centre Spindles for RC72A, RC75, RC75A, RC75M, RC80, RC80M, RC90	Price ...	7/10 plus 2/8	P. Tax.	Total 10/6 (A)
Centre Spindles for RC110-RC111Price ...	16/6 plus 5/6	P. Tax.	Total 22/- (A)
Centre Spindles for RC120-121Price ...	15/1 plus 5/1	P. Tax.	Total 20/2 (A)
Centre Spindles for RC88-RC98Price ...	9/5 plus 3/2	P. Tax.	Total 12/7 (A)
Drive Bands for RC72-RC75-RC80 and T unit	(per pair) Price ...	1/4 plus 6d.	P. Tax.	Total 1/10 (A)
Inter wheels for RC72, RC75, RC80 and T unitPrice ...	5/9 plus 1/11	P. Tax.	Total 7/8 (A)
Inter wheels for RC90Price ...	6/3 plus 2/1	P. Tax.	Total 8/4 (A)
Inter wheels for RC110-RC111Price ...	6/6 plus 2/2	P. Tax.	Total 8/8 (A)
Inter wheels for RC121-RC120 Mk. II-RC88-RC98-4SPPrice ...	4/11 plus 1/8	P. Tax.	Total 6/7 (A)
LRS1 45 r.p.m. Adaptor Spindle for RC80M and RC90Price ...	20/3 plus 6/7	P. Tax.	Total 26/10 (A)
LRS3 45 r.p.m. Adaptor Spindle for RC88-RC98Price ...	20/3 plus 6/7	P. Tax.	Total 26/10 (A)
LRS2 45 r.p.m. Adaptor Spindle for RC110-RC111-RC120-RC121Price ...	20/3 plus 6/7	P. Tax.	Total 26/10 (A)
LRS4 45 r.p.m. Adaptor Spindle for RC120-RC121 Mk. IIPrice ...	20/3 plus 6/7	P. Tax.	Total 26/10 (A)
StroboscopesPrice ...	9d. plus 3d.	P. Tax.	Total 1/- (A)
LRS4/W 45 r.p.m. Adaptor Spindle for 210Price ...	20/3 plus 6/7	P. Tax.	Total 26/10 (A)
Record Arm Selector CapsPrice ...	6d. plus 2d.	P. Tax.	Total 8d. (A)
Interwheel for 4HFPrice ...	8/5 plus 2/10	P. Tax.	Total 11/3 (A)

E.M.I.

Rubber Drive BandsPrice ...	3/- plus 1/-	P. Tax.	Total 4/- (A)
---------------------------	--------------	--------------	---------	---------------

LENCO

Spare Idler wheelsPrice ...	9/9 plus 3/7	P. Tax.	Total 13/4 (C)
Spare sets, Mounting Springs, Nuts, etc.Price ...	11/3 plus 4/2	P. Tax.	Total 15/5 (C)
Spare Mains Switches...Price ...	7/6 plus 2/4	P. Tax.	Total 9/10 (A)
45 r.p.m. Clip-in adaptors (12 per card)Price ...	per doz. 3/6 plus 1/2	P. Tax.	Total 4/8 (A)
Sets Mounting Springs (Lenco)Price ...	11/3 plus 3/9	P. Tax.	Total 15/- (A)

DULCI

Spare Pick-up Matching Units for DPA10 and H11Price 10/- (A)
---	--------------	--------	--------	--------------

TAPE RECORDERS

TELEFUNKEN

MAGNETOPHON 85T

High Fidelity is not a matter of frequency response but it is equally dependent on the signal to noise ratio, i.e. freedom from background noise, hiss and hum at low modulation levels. In the magnificent 'Magnetophon 85' models this is achieved by using D.C. heaters for pre-amplifier stages, efficient double screening of the motor and incorporation of a Philberth transformer with a specially low stray field. The signal to noise ratio achieved is $>50\text{dB}$, which remains constant throughout its life and is unaffected by ageing valves—a remarkable achievement in a domestic tape recorder!

Two tape speeds: $7\frac{1}{2}$, $3\frac{3}{4}$ i.p.s. Frequency range: $30/20,000$ c/s. $\pm 3\text{dB}$ at $7\frac{1}{2}$ i.p.s. $30/15,000$ c/s. at $3\frac{3}{4}$ i.p.s. Playing time: 4 hrs. 12 mins. at $3\frac{3}{4}$ i.p.s. (7" DP tape at slow speed).

Silent input-selection switch for radio microphone and record player. Press-button controls for recording stop/start, playback, recording interlock, trick button, fast rewind, speed change and quick stop. Telefunken patented tape tension control. Indirect flywheel drive. Automatic tape end switch. Digit counter. Connections for earphones, remote control. Built-in splicing groove. Complete in highly polished wooden case with non-slip rubber feet.

Mains supply: -110/127/150/220/240 volts A.C. at 50 c/s. Power consumption: 40 watts approx. Valves: EF86, ECC83, ECC81, EM71a. Recording inputs: 2mV at $2\text{M}\Omega$ (Microphone); 2mV at $100\text{K}\Omega$ (Radio); 150mV at $1\text{M}\Omega$ (Pick-up) Playback outputs: 1.5V at $18\text{K}\Omega$ (Radio); Earphone Monitoring. Signal to noise ratio: $>50\text{dB}$. Wow and Flutter: $< \pm 0.2\%$ peak to peak unweighted at $7\frac{1}{2}$ i.p.s. $< \pm 0.3\%$ peak to peak unweighted at $3\frac{3}{4}$ i.p.s.

Size (Magnetophon 85T): Height 7-4", Width 15-5", Depth 11-4", Weight 26-4 lbs.

Price **63 Gns. (B)**



MAGNETOPHON 85KL

The technical conception of this portable model is as the table model detailed above. The provision of the 6 watts push/pull power stage, two matched, permanent magnet, oval loud speakers with cut-out switch, volume control and separate bass and treble tone controls make it a compact unit worthy of the most serious consideration by the recording enthusiast.

It is possible to use the loudspeaker and volume control for monitoring while recording, and the set can be used as a straight through amplifier. "Magic-eye" level control. External speaker connection. Continuously variable trick control can be fitted.

The tonal quality of this portable model is equal to the finest Hi-Fi Radio and makes it eminently suitable for use by the artist, the discriminating amateur or in the class-room and lecture hall. Complete with power stage in luxury case.

Technical specification as above except for:— Power consumption: 55 watts approx. Valves: EF86, ECC83, ECC81, EM71a, ECL83 and two EL95's. Power output: 6 watts loaded with 4.5Ω

Size (Magnetophon 85KL): Height 7-9", Width 17-9", Depth 16-3", Weight 33 lbs.

Price **79 Gns. (B)**

NOTE: Prices for TELEFUNKEN Magnetophon Tape Recorders are exclusive of microphone.



TELEFUNKEN MICROPHONES

C14 3 Gns. (B) D9F 6 Gns. (B)
DI1B 8 Gns. (B) DI9B £19 10 0 (B)

TAPE RECORDERS

TELEFUNKEN

MAGNETOPHON 75K-15

The ideal general purpose domestic or business machine that incorporates the well known Telefunken Features that are the secret of its high standard of reproduction and fidelity. Easy in operation, and designed to give long, trouble-free service. The Magnetophon 75K-15 has slim elegant appearance that well reflects its inner quality and efficiency.

Two Tape speeds: $3\frac{3}{4}$, $1\frac{7}{8}$ i.p.s. Frequency range: 60/16,000 c/s. at $3\frac{3}{4}$ i.p.s. and 60/9,000 c/s. at $1\frac{7}{8}$ i.p.s. Playing time: 6 hrs. 20 mins. ($5\frac{3}{4}$ " DP tape at slow speed). Twin track to international standards. Fully automatic press-button controls. The Telefunken extra-sensitive braking and tape tension control system ensures high performance and long life for tapes and recording head. Telefunken ultra-fine gap recording heads make possible the high standard of reproduction at slow speeds. Indirect flywheel drive minimises wow and flutter. Fast rewind, quick stop button. Digit counter. Automatic tape-end stop. Connections for earphones, remote stop/start control and extension speaker. The portable model which comes in an attractive lightweight Styron case, has a tone control.

Main supply: 110/127/150/220/240 volts A.C. at 50 c/s. Power consumption: 40 watts approx. Valves: EF88, ECC83, EL95, EM84. Recording Inputs: 2mV at $2M\Omega$ (Microphone). 2mV at $100K\Omega$ (Radio). Playback Outputs: 1.5V at $18K\Omega$ (Radio). Earphone Monitoring 2.5 watts loaded with 4.5 (Loudspeaker). Signal to noise ratio: >40 dB. Wow and Flutter: $<\pm 0.3\%$ peak to peak unweighted at $3\frac{3}{4}$ i.p.s. $<\pm 0.4\%$ peak to peak unweighted at $1\frac{7}{8}$ i.p.s.

Size ('Magnetophon 75T-15'): Table Model (with output stage only). Height 5.6", Width 12.2", Depth 9.2", Weight 16.3 lbs.

Price 43 Gns. (B)

Size ('Magnetophon 75K-15'): Portable Model. Height 6.3", Width 12.4", Depth 12.6", Weight 21 lbs.

Price 47 Gns. (B)



MAGNETOPHON 76K

The fabulous Four-Track system used in the 'Magnetophon 76K' allows for over 12 hrs. 40 mins. playback using only one $5\frac{3}{4}$ " DP Tape! Two tracks may be played back together giving tremendous scope to cine enthusiasts and effects men. Superimposition effects may be monitored while the other track is being recorded by means of the "Teleset 75-76" Earphone available as an accessory.

Two tape speeds: $3\frac{3}{4}$, $1\frac{7}{8}$ i.p.s. Frequency range: 30/16,000 c/s. at $3\frac{3}{4}$ i.p.s. and 30/9,000 c/s. at $1\frac{7}{8}$ i.p.s. The incorporation of a special transistorised pre-amplifier stage gives an extra octave extension in the bass. Playing time: 12 hrs. 40 mins. ($5\frac{3}{4}$ " DP tape at slow speed). Recordings made on standard twin track recorders may be played back on the Magnetophon 76.

A noiseless switch is incorporated for microphone or radio channels with a zero position for tape erasing. Fast rewind by powerful 2-pole motor with forced draught cooling. Push-buttons control track selection, stop, start, rewind, fast forward and quick stop.

Telefunken extra-sensitive braking and tape tension control system. Fluorescent horizontal bar modulation indicator and combined recording level/playback volume control. Built-in microphone pre-amplifier for dynamic, or condenser microphone. D.C. heating of all valves. Oval loudspeaker with cut-out switch. Complete with tone control in attractive Styron case. Technical specification as for Magnetophon 75K-15 except for: Valves: Transistor OC603, EF86, ECC83, EL95, EM84.

Size ('Magnetophon 76T'): Table Model (with output stage only) Height 5.6", Width 12.2", Depth 9.2", Weight 16.3 lbs.

Price 53 Gns. (B)

Size ('Magnetophon 76K'): Portable Model. Height 6.3", Width 12.4", Depth 12.6", Weight 21 lbs.

Price 57 Gns. (B)

TAPE RECORDERS

TELEFUNKEN

MAGNETOPHON 77K 4-TRACK STEREO MODEL

This stereo tape recorder not only provides full facilities for two-channel stereo recording and playback but also manifold possibilities for monaural superimposition effects.

Two tape speeds: $3\frac{3}{4}$ i.p.s. and $1\frac{7}{8}$ i.p.s. Frequency response: 40-16,000 c/s. at $3\frac{3}{4}$ i.p.s. and 40-9,000 c/s. at $1\frac{7}{8}$ i.p.s. Playing time: 6 hours 15 minutes stereo operation and 12 hours 30 minutes monaural operation ($5\frac{3}{4}$ " DP tape at slow speed). Four tracks to International standards. Twin low noise transistorised input stages Horizontal fluorescent bar modulation indicator and combined recording level/playback volume control. Push-button control for all tape functions and track selection. Additional speaker in lid for stereo playback. Extension speaker sockets for each channel. Facilities for monitoring by earphone of one track whilst recording the other. Inter track transcription possible by means of "Stereo Transcription Lead 77" available as an accessory.

Mains Supply: 110/125/150/220/240v. A.C. at 50 c/s. Power Consumption: 50 watts approx. Valves: 4 Transistors OC603; 2 x ECC83; 2 x EL95; EM84. Recording Inputs: 2 x 2mV. into 50 K Ω (Radio); 2 x 2mV. into 90K Ω (Microphone). Playback outputs: 2 x 1.5v across 30K Ω (Radio); Earphone monitoring; 2 x 2.5 watts loaded 4.5 Ω (Loudspeaker). Signal to Noise Ratio: >40dB. Wow and Flutter: Max. \pm 0.4% at $3\frac{3}{4}$ i.p.s. peak to peak unweighted.

'Magnetophon 77T' Table model. (With output stages only) Height 5-6", Width 12-2", Depth 9-2", Weight 16.3 lbs.

Price: To be announced.

'Magnetophon 77K' Portable Model. Height 8-1", Width 12-4", Depth 12-6" Weight 25 lbs.

Price 85 Gns. (B)



TRUVOX

R6

Contemporary styling in beige/mushroom with gilt trim. $\frac{1}{2}$ track tape deck accepting up to 7" reels. Two speeds ($7\frac{1}{2}$ and $3\frac{3}{4}$ i.p.s.). Frequency response, 30-15,000 c/s. 3 B.T.H. motors giving fast spooling. Interlocked press-button deck control. Pause control. 4 watt amplifier with volume and tone control. "Magic eye" for modulation level. Input sockets for microphone, pick-up and radio tuner. Output sockets to high power amplifier and 15 ohm. ext. speaker.

Price (including mic. and tape) 55 Gns. (B)



R7

$\frac{1}{2}$ track tape deck, accepting up to 7" reels with twin tape lead assemblies. Play/record IN BOTH DIRECTIONS, with almost instantaneous reversal. Two speeds $7\frac{1}{2}$ and $3\frac{3}{4}$ i.p.s. Frequency response at $7\frac{1}{2}$ i.p.s. 30-17,000 c/s. Fast rewind. Simple two knob control plus auto-stops. Digital counter and direction indicators. 10 watt push-pull amplifier with separate bass and treble tonal-balance controls. "Magic eye" modulation level. Input sockets for mic. and pick-up. Output for ext. speaker 15 ohm. and high power amplifier. 2 loudspeakers with crossover network. Cabinet in classical styling in three tone blue/grey with contrasting knobs and silver trim.

Price (including mic. and tape) 75 Gns. (B)



TAPE RECORDERS

ELIZABETHAN



MAJOR

The major is specifically designed for the serious enthusiast who requires professional standards above everything else. Specification: Collaro deck. 7" spool. Four track. Three speeds: $7\frac{1}{2}$, $3\frac{3}{4}$, $1\frac{7}{8}$ i.p.s. Tape position indicator. Output: 6 watt push-pull. Meter for registering recording level. Inputs: Mic. and gram. Outputs: Hi-Fi and ext. L.S. 15 ohms. Independent Mic. and gram controls. Separate bass and treble controls. Safety interlocks. $10" \times 6"$ elliptical and 4" tweeter speakers. Mains supply 200/220/240 or 110 volts A.C. 50 c/s.

Price (including tape) **65 Gns. (B)**

Microphone optional extra.

TELEFUNKEN MICROPHONES

CONDENSER MICROPHONE C14

An ideally simple condenser microphone with omnidirectional characteristics which can be used with all current Telefunken Magnetophon Tape Recorders as the polarising voltage is supplied at the microphone socket.

3 Gns. (B)

Part No. 8267 029



Microphone D11B

REMOTE CONTROL MICROPHONE D9F

All the current Telefunken Magnetophon Recorders are equipped with remote control facilities and the D9F with its Start/Stop control is ideal for dictation purposes. Whilst the D9F is in the horizontal position the tape is stationary, but when the microphone is raised the recorder automatically starts.

6 Gns. (B)

Part No. 8267 028



Microphone C14

DYNAMIC DIRECTIONAL MICROPHONE D11B

A moving coil dynamic microphone with cardioid characteristic. Intended for use in halls with poor acoustics and for recording at some distance away from the source of sound. Speech/music/telephone switch.

8 Gns. (B)

Part No. 8266 533



Microphone D9F

DYNAMIC DIRECTIONAL WIDE RESPONSE MICROPHONE D19B

This moving coil microphone will achieve high quality recording under acoustically difficult condition. Continuously variable bass control.

£19 10 0 (B)

Part No. 8266 708



Microphone D19B

STEREO MICROPHONE D77

This microphone consists of two directional microphones mounted one above the other, the cardioid response pattern of which can be varied in an angle at 60° — 180° for XY stereophony. Simple press studs enable separation of the microphones for AB effect stereophony. Supplied complete with two table stands.

15 Gns. (B)

Part No. 9267 225



Microphone D77

WAL GAIN PRE-AMPLIFIERS & TAPE ACCESSORIES

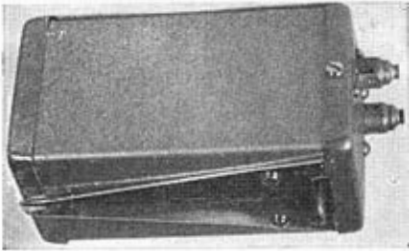

MONO WAL GAIN

An impedance matching transistorised pre-amplifier, battery operated (3,000 hour life). Noise and distortion too low to measure, gain better than 100.
Size $3\frac{3}{8}'' \times 2\frac{1}{8}'' \times 2\frac{1}{8}''$

Price **£5 0 0 (C)**

Due to its compactness, long life and versatility, the Wal Gain can be mounted in any position, and has many applications in the Industrial, Commercial, Medical, Scientific Audio and Cine fields. In fact for any purposes where it is necessary to amplify a minute voltage into a useful output. Suitable for direct connection to tape head, or for use with low output pick-up, etc.

STEREO WAL GAIN

Transistorised, battery operated. Gives you the EXTRA GAIN you need, without hum or distortion. This version too has a number of applications including being used to provide extra amplification for microphones, or tape heads, or as a two channel mixer with resistive network. Each channel is independent of the other for stereo operation, cross talk between channels being better than +60db, and the Wal Gain can be used for operation on two separate mono channels. Also many Audio, Medical, Commercial, Scientific, Industrial and Cine applications.

Size $6\frac{7}{8}'' \times 2\frac{1}{8}'' \times 2\frac{1}{8}''$

Price **£7 10 0 (C)**



THE NEW HI-GAIN Pre-Amplifier

Fully transistorised, battery operated, with tape equalisation. The complete answer to monitoring, for dubbing purposes with a second deck etc. Provides sufficient equalised CCIR voltage to directly couple to a pair of head phones, or to a Hi-Fi amplifier with sensitivity of not less than 100 mV. Also you can add a second 'stereo' channel to existing mono tape equipment. Many applications.
Size $6\frac{7}{8}'' \times 2\frac{1}{8}'' \times 2\frac{1}{8}''$.

Price **£7 16 0 (C)**



THE WAL BULK TAPE ERASER

THE IDEAL ACCESSORY FOR TAPE RECORDING.

Wipes both tracks, perfectly 'clean' in under half a minute. Used in laboratories, colleges, schools, dealers 'demo rooms, studios, offices, tape clubs, etc.—in fact by ANYONE who does a lot of tape recording and wishes to rapidly 'clean' up tapes ready for the next session.

Price **£7 18 6 (C)**



THE NEW D-MAG

A Mains operated, pocket size head de-magnetiser, that provides a complete de-gaussing circuit. Especially designed for ERASING SHORT UNWANTED PASSAGES OF SOUND from tape or striped film. Demagnetising tape Deck heads, etc. A necessity for the professional and the amateur for tape and film editing.

Price **£2 10 0 (C)**

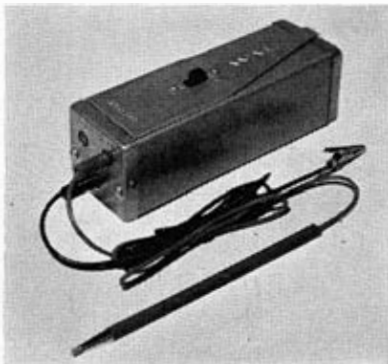

WALTRAK POCKET AUDIO OSCILLATOR

The accessory that Service Engineers, Radio and Laboratory technicians, keen enthusiasts consider a necessity in their kit. Battery operated, transistorised, supplied complete with probe, etc. for fault finding, 'dead' set checking, stereo matching, recording bias check, etc. Output 1,000 cps., sine wave. Over 2v max. Calibrated 1v., 0.1v., and 0.01v. tappings.

Price **£6 10 0 (C)**

Full technical leaflets are available on all WAL GAIN products from A. C. FARNELL LTD. on request.

Tandberg

SERIES 6

STEREO TAPE DECK

PRICE 110 gns.



This World Famous example of Norwegian Electronic and Mechanical engineering is a product of TANDBERGS RADIOFABRIKK AJS, OSLO, pioneers in the development of high class Stereo, two and four track, tape techniques.

This is a "No compromise" instrument capable of delivering consistently fine "Professional" quality. Entirely self-contained and without need of Add-on Unit. The Tandberg Model 6 is complementary to the finest Audio and Speaker Systems and it is not possible to incorporate Amplifiers and Speakers, in portable case, capable of doing justice to this exceptional Deck.

For further details and Reprints of Technical Reviews; apply to the British Distributors, our associated company—

TANDBERG G.B.

ELSTONE ELECTRONICS LIMITED EDWARD STREET TEMPLAR STREET LEEDS 2

Telephone: Leeds 35111 (7 lines)

NOTE: Enquiries and Orders for TANDBERG may be included when writing to A. C. FARNELL LTD.

TANDBERG STEREO TAPE DECK

SERIES 6

SPECIFICATION

The following is a brief specification detailing the manufacturers figures as referred to in aforementioned reviews:—

Heads. Incorporates a THREE-HEAD four-track system permitting design without the sacrifices necessary when a combined Record/Playback Head is used. Erase Head is wired for single and double track erasing.

Tape Speeds. $7\frac{1}{2}$ ", $3\frac{3}{4}$ " and $1\frac{7}{8}$ " sec. Reels 7".

Amplifiers. Four: Two separate recording Amplifiers with ganged concentric controls for mixing or balancing. Two separate Playback Amplifiers with ganged concentric volume controls. Cathode follower outputs of approx. $1\frac{1}{2}$ volts each.

Record Level Indicators. Two magic eyes, one for each channel, mounted side by side in one frame.

Inputs. Each channel has one Microphone input using standard Jack Plug and one high level and one low level input using standard Midget Co-axial Plugs.

Mixing. When recording a single channel (Monaural) you can utilise all Tandberg inputs to mix up to four signals. When recording two channels (Stereo) you can utilise three inputs to mix up to two signals per channel or track.

Monitoring. All recordings Monaural or Stereo, whether using single or mixed inputs, can be monitored with A or B TEST. ("A" Test monitors signal before the recording head and "B" Test, the signal just recorded, from the playback head).

Sound-on-Sound. A unique Tandberg feature completely doing away with the old system of superimposition with its attendant degrading of the master recording.

Language Laboratory Application. Master records one track. Pupil monitors Master's playback and records lesson on other track. Stereo position is then selected for dual playback with master from one speaker and pupil from the other.

Tape Counter. 4-Digit in place of usual 3-Digit counter.

Power requirements: 110—125—145—200—220—245 volts. 50 Cycles, 65 watts. (Can be changed easily to 60 cycles by means of motor pulley and capacitor).

Inputs, Sensitivity and Impedance.

Two Microphones00125 volts RMS.	5 Megohm.
Two High Level05 volts RMS.	1 Megohm.
Two Low Level005 volts RMS.	100K ohm.

Playback Outputs. With the output control-knobs set to max. (6) the RECORDING LEVEL INDICATOR LIGHT BEAMS touch each other in A-Test, and 3% distortion the cathode Follower output is adjusted to $1\frac{1}{2}$ volts.

Frequency Response. $7\frac{1}{2}$ I.P.S. 30 to 20,000 cycles (± 2 db, 30 to 16,000 cycles).
 $3\frac{3}{4}$ I.P.S. 30 to 15,000 cycles (± 2 db, 40 to 11,000 cycles).
 $1\frac{7}{8}$ I.P.S. 30 to 7,000 cycles (± 2 db, 50 to 5,500 cycles).

Distortion. A recording level 10 db. below maximum level results in $2/10$ of 1% distortion of a 400 cycles signal when played back.

Recording Amplifiers Distortion. $\frac{1}{2}$ of 1% at maximum recording level.

Playback Amplifiers Distortion. $2/10$ of 1% at $1\frac{1}{2}$ volts output and with a load impedance of 10,000 ohms. or more.

Bias and Erase Current Distortion. $4/10$ of 1%.

Noise Level. 55db. below maximum recording level. Maximum recording level corresponds to 3% distortion.

Bias and Erase Frequency. 80 to 100 kC, common bias supply to each recording channel.

Wow and Flutter. .1% RMS $7\frac{1}{2}$ I.P.S. .2% RMS. $3\frac{3}{4}$ I.P.S. .25% RMS. $1\frac{7}{8}$ I.P.S.

Speed Accuracy. $\pm .2\%$ or ± 3.6 seconds in 30 minutes.

4-Track Stacked Record Head. Gap width .00052".

4-Track Stacked Playback Head: Designed for ideal playback characteristics of highest frequency response, plus maximum sensitivity, gap width .00012".

Cross-talk Rejection: Better than 60 db.

Motor. Hysteresis synchronous motor, system Papst. Instant start or stop by push-button.

Automatic Stop. When metalized leader tapes are used.

Valve Complement. 6 - ECC83. 3 - ECC82. 2 - Selenium Rectifiers. 2 - EAM86.

Dimensions. Teak Cabinet 16" long, 12" wide, 6" high.

Weight. Instrument alone 25 lbs. With carrying case (priced extra) 30 lbs.

PRICE:— including empty 7" reel and 4 special recording and playback connecting leads—110 gns. (C)

For further information and name of your local TANDBERG DEALER write to:—

TANDBERG G.B.

ELSTONE ELECTRONICS LTD., EDWARD STREET TEMPLAR STREET LEEDS 2.

Telephone Leeds 35111 (7 lines).

**WHEN YOU HAVE STUDIED THE SPECIFICATION—WHEN YOU HAVE READ THE REVIEWS—
HAVE A DEMONSTRATION—YOUR EARS WILL DECIDE YOUR CHOICE.**

AUDIO FIDELITY RECORDS

We are area distributors for Audio Fidelity records which are most highly regarded by High Fidelity enthusiasts in America and becoming increasingly popular here. The Stereo numbers particularly are in great demand for demonstration purposes due to the quality of recording and excellent Stereo separation.

Audio Fidelity literature is available upon request and provides information concerning the releases up to July 1961 as numbered below.

MONO		STEREO	
AFLP	AUDIO FIDELITY	AFSD	AUDIO FIDELITY
1801	The Brave Bulls Vol. I	5801	The Brave Bulls Vol. I
1802	Marimbo Mambo	5815	Accordion de Paris
1810	Cha Cha Cha	5822	Rome with Love
1815	Accordion de Paris	5823	Dukes Vol. I
1816	Fiesta En Mexico	5825	Mallet Magic
1822	Rome with Love	5829	Leon Berry Vol. II
1823	Dukes Vol I	5830	Johnny Puleo Vol. I
1825	Mallet Magic	5836	American Military Marches
1827	Honky Tonk Piano	5840	Dukes Vol. II
1830	Johnny Puleo Vol. I	5843	Railroad
1833	Port Said	5844	Leon Berry Vol. III
1835	Bull Ring Vol. III	5848	La Zambra
1840	Dukes Vol. II	5851	Dukes Marching Along Vol. III
1843	Railroad	5877	Al Hirt
1844	Leon Berry Vol. III	5883	Johnny Puleo—Molto Italiano
1848	La Zambra	5890	Demonstration Disc
1851	Dukes Marching Along Vol. III	5896	Guitarra Flamenca
1865	Armenian Wedding	5912	Happy Sound of Ragtime
1873	Sutton Place South	5913	Hamp's Big Band
1877	Al Hirt	5921	Revival!
1886	Al Melgard	5924	Louie & The Dukes
1896	Guitarra Flamenca	5930	Satchmo Plays King Oliver
1913	Hamp's Big. Band	5949	Irma la Douce
1921	Revival!		
1924	Louie & The Dukes		
1930	Satchmo Plays King Oliver		
1949	Irma La Douce		
DFM	Doctored Mono Series	FCS	First Component Series
3002	Percussive Jazz	50000	Test Record
3003	Percussive Cha Cha Cha	50002	Pathetique
KINOR	KINOR RECORDS	50003	Symphony Fantastique
1231	Chanukah Music Box	50005	Bolero
EKL	ELEKTRA RECORDS	50006	Romeo & Juliet
102	Josh At Midnight	50008	Marches From Operas
108	Blood Booze'n Bones	50009	Russian Composer Masterpieces
116	Susan Reed	50010	Ballet Suites
117	Sabicas Vol. I	50012	Overture
121	Sabicas Vol. II	50013	Strauss Waltzes
150	Songs of a Russian Gypsy	DFS	Doctored Stereo Series
158	Chain Gang Songs	7002	Percussive Jazz
180	The Limelinters	7003	Percussive Cha Cha Cha
184	Presenting Joyce Grenfell	EKS	ELEKTRA RECORDS
186	Hora!	7159	Cuadro Flamenco
188	Sports Car Songs		
EKLSP	Elktra Special		
175	Bravo Bikel!		

PRICES

ELECTRA Series MONO	37/6 inc. P.T. 9/2½	ELECTRA Series STEREO	37/6 inc. P.T. 9/2½
ELECTRA SPECIAL	39/9 inc. P.T. 10/-	AFSD 5800 Series (STEREOPHONIC 12" LPS)	46/- inc. P.T. 11/3½
	FCS 50000 Series (STEREOPHONIC 12" LPS)		46/- inc. P.T. 11/3½ (A)
	DFS 7000 Series (STEREOPHONIC 12" LPS)		44/- inc. P.T. 10/9½
	AFLP 1800 Series (MONAURAL 12" LPS)		44/- inc. P.T. 10/9½
	DFM 3000 Series (MONAURAL 12" LPS)		13/- inc. P.T. 3/2
	KINOR Series (45 r.p.m. EPS)		

HIGH FIDELITY EQUIPMENT DEMONSTRATIONS

Can be arranged BY APPOINTMENT in our special Demonstration Room at Hereford House, Leeds. Dealers may bring, or send their customers to hear a varied selection of high class equipment which is permanently connected.

A Comparator Console selects Speaker Assemblies in combination with various amplifiers, transcription units, pick-ups, tuners and tape units.

(Our premises are immediately adjoining the West Yorkshire Bus Station and cars should turn out of Vicar Lane into Templar Street then first turn to the right).

SHEFFIELD:— Similar Demonstration Facilities are in course of preparation at 27 Broomhall Street.