

an *ALLIED* publication

An illustration on the left side of the cover shows three black-gloved hands, each holding a wooden drumstick. The hands are arranged vertically, with the top hand at the top, the middle hand in the center, and the bottom hand at the bottom. The drumsticks are held in a way that they appear to be reaching towards the center of the page. The background behind the hands is a light grey-blue color, while the rest of the cover is a textured orange-brown color.

All About High Fidelity & Stereo

An easy-to-understand presentation of fundamentals, written for the benefit of anyone interested in obtaining maximum enjoyment from high-fidelity equipment.



ALL ABOUT HIGH FIDELITY & STEREO

Allied's Handbook of High Fidelity and Stereo Fundamentals

Written Under the Direction of
the Publications Division
Allied Radio Corporation

Edited by
C. G. McProud

Publisher and Former Editor, *AUDIO Magazine*



Published By

ALLIED RADIO
CHICAGO, ILLINOIS 60680

SECOND EDITION

SEVENTH PRINTING—FEBRUARY, 1969

ALL ABOUT HIGH FIDELITY & STEREO

Copyright © 1964 by Allied Radio Corporation, Chicago, Illinois 60680. Printed in the United States of America.

Reproduction or use, without express permission, of editorial or pictorial content, in any manner, is prohibited. No patent liability is assumed with respect to the use of the information contained herein.

Library of Congress Catalog Card Number: 62-22390

PREFACE

Since World War II, a revolution has taken place in the world of sound reproduction—a revolution which has resulted in greater listening pleasure for all those interested in the faithful reproduction of recorded sound. Even the casual listener has become aware of the ever increasing quality of sound that issues from his “hi-fi.”

Hi-fi! An advance in science that has added, in conjunction with stereophonic reproduction, a new dimension in sound to the lives of millions of persons. Yet there are many who do not understand the fundamentals of hi-fi and stereo, and who will have to be content with less fidelity than is possible simply because they do not know how to secure this “best” sound.

This book was written to fill these gaps in knowledge—gaps that can cost you money, and gaps that can take away from your listening pleasure. Every effort has been made to use clear, readable language with a minimum of jargon, yet to keep the book completely informative where it counts. These are the fundamentals—what you should know to get the most out of your present sound system, or how to make intelligent choices if you are just starting out in the world of high fidelity.

ALLIED RADIO CORP.

About The Editor

C. G. McProud, Publisher and former editor of Audio Magazine, is a radio old timer and a recognized authority in the audio field.

He is a Charter Fellow and Past President of the Audio Engineering Society, Member of the IEEE, Member of the Acoustical Society of America and Associate Member of Society of Motion Picture and Television Engineers.

Mr. McProud keeps pace with developments in Hi Fi by personally testing new products and doing his own assembly of new kits which have been released on the market.



HIGH FIDELITY CUSTOM INSTALLATIONS



Custom wall installation includes a stereo multiplex FM tuner/amplifier, automatic record changer, tape recorder, 2 speakers, TV set (behind sliding panel) and record compartments. The main seating area is directly across from the built-in wall unit. TV set swivels for viewing from a bar in the opposite corner. All equipment can be placed out of sight by means of the sliding panel, sliding tape unit drawer, and record compartment doors.

Installations by Custom Division, Allied Radio Corp.

**Hi-Fi Components Are Attractive and Versatile
Adaptable For Any Home Decor**



Room divider installation. Behind it is an entrance hall. Installation includes stereo amplifier, stereo tuner, 2 speakers, 2 tape transports and stereo record/playback pre-amplifier. At the flick of a switch, tape recordings can be made from stereo records, stereo FM broadcasts, stereo tapes or stereo microphones. The unique preamplifier (Knight-Kit®) permits sound-on-sound recordings.



Stereo components in custom floor cabinet. This is a conventional music system with stereo amplifier, stereo FM-AM tuner, automatic record changer and 2 speakers.

TABLE OF CONTENTS

CHAPTER 1	
What Is Hi-Fi?	7
CHAPTER 2	
The Basic Hi-Fi System	12
CHAPTER 3	
Amplifiers, Preamplifiers, and Speaker Systems	33
Amplifiers — Preamps — Transistors — Speaker Systems — Enclosures	
CHAPTER 4	
What About Stereo?	50
Hi-Fi Stereo — Stereo Program Sources	
CHAPTER 5	
Planning Your System	64
Components versus Package Systems—Record Play- ers—Tape Recorders	
CHAPTER 6	
What About Kits?	76
CHAPTER 7	
Planning a “Built-In” System	79
GLOSSARY	84
INDEX	94

CHAPTER 1

WHAT IS HI-FI?

High fidelity is many things to many people; to some it is what comes out of any phonograph capable of playing a long-playing monophonic or stereophonic record, any tape recorder that uses AC current and 7-inch reels, or any console-size FM radio. Others insist that hi-fi is nothing short of absolute perfection—sound “more real than the real thing itself.”

If you were around in the 1920's when the old acoustic phonograph gave way to that revolutionary development, the electrically-amplified machine, you undoubtedly would have thought you were listening to high fidelity. Chances are you would have called it “concert-hall realism.”

High fidelity, in short, is a relative term. What does it really mean? More or less what it says—a high degree of faithful reproduction of the original program. (As we shall see later on, stereophonic sound adds to high fidelity tonal and dynamic faithfulness a true reproduction of the spatial element in musical experience.)

Perfect reproduction of sound will probably never be achieved, because there are simply too many variables involved; variables like the sound characteristics, or acoustics, of the recording hall as well as the acoustic characteristics of your own living room.

Normally, you hear sound as vibrations of air. The vibrations are actually rarefaction and compression waves, or cycles. The number of cycles which occur during one second determines the frequency of the sound. The fewer the cycles

All About Hi-Fi & Stereo

generated per second, the lower-pitched is the sound. Likewise, the greater the number of cycles per second (cps), the higher is the pitch.

Generally speaking, the human ear, at its very best, can just barely detect 20 cycles at the low end of the sonic spectrum and 20,000 cycles at the high end—if you can hear sounds at 20,000 cycles, you have a “platinum” ear.

Actually, almost any modern phonograph can reproduce the *fundamental* tones of the human voice or of most musical instruments. For example, a bass singer would probably “blow out” a vocal chord trying to get below 80 cycles. And the top *basic* note with which an operatic soprano electrifies an audience is really no higher than 1,000 cycles. Even the almost

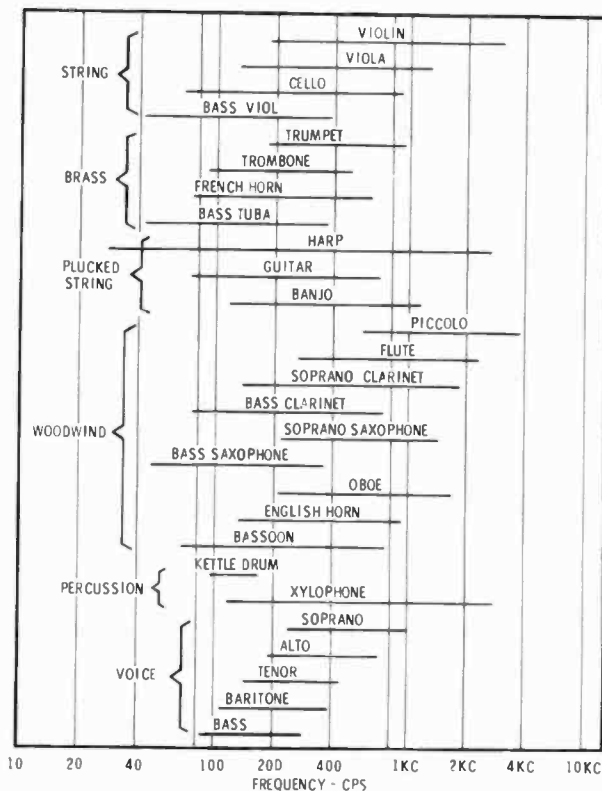

Fig. 1-1. Basic frequencies produced by musical instruments and the human voice.

painfully shrill piccolo doesn't sound a fundamental note higher than 4,000 cycles (Fig. 1-1).

What is all the excitement about then? A phenomenon known as *overtones*, or *harmonics*—sympathetic frequencies, or multiples of the fundamental frequencies. It is these harmonics that give each instrument the distinctive sound that lets you hear the difference, for example, between a piccolo and a flute. Overtones often extend at least two octaves above the fundamental tones. In the case of the piccolo, this means its sound extends into the 16,000-cycle range. So, if you are going to have true high fidelity, you will want a music system capable of reproducing from at least 50 to 15,000 cycles.

Having achieved this, can you now sit back and relax, confident that you are listening to bona fide high fidelity? No, not yet—there are a number of other factors to be considered first. One of these is *tonal balance*, or to put it in true audiophile talk, *flatness of response* from the lowest tones (50 cycles) to the highest (over 15,000 cycles).

You might compare tonal balance to the color balance in a picture. Perhaps you don't enjoy a "washed-out" or gaudily over-emphasized color photograph. Also if you're interested in high fidelity, it isn't likely that you will get much pleasure from a "boom-boom" juke box that parades the drums and bass fiddle to the exclusion of most of the high notes. Nor is it much fun to listen to a screechy radio that pierces your ears with highs and produces weak and indistinct bass notes. For true musical enjoyment, the "tone colors" of a performance must be balanced properly, with the high and low notes maintained in the same relationship as in the original performance.

It is perfectly possible to have a music system that honestly claims to produce the lowest lows and the highest highs—and still be unable to hear either. Why? Because if they are reproduced at sound levels markedly below the middle frequencies, you won't be able to hear them unless the volume is turned up so high that the middle frequencies "blast you into your neighbor's house."

Our ears tell us that some sound levels are softer or louder than others. So that these levels could be defined, a unit of measurement known as the decibel (db) was created. The threshold of sound (the lowest level you can hear) is 0 db, and 130 db is the threshold of pain (the volume at which sound actually hurts your ears).

If you examine literature on high-fidelity equipment, you will see such specifications as ± 2 db. When applied to a given range of frequencies, this means the loudness of any given tone will be no more than 2 db greater or less than an arbitrary base level; to put it another way, there will be no more than a 4-db variation throughout the frequency range. For a true high-fidelity system, this variation should not exceed ± 2 db from 50 to 15,000 cycles.

The next consideration is distortion. If you've ever looked through a "wavy" window pane or at a photograph or motion picture that is out of focus, you know the meaning of distortion. The images you see are falsified; that is, they are blurred, or poorly defined. Distorted sound is fuzzy or harsh to your ears. It is difficult to distinguish the individual sounds of each instrument. This musical despoiler comes basically in two forms, *harmonic* distortion and *intermodulation* distortion. The latter is more commonly referred to as IM.

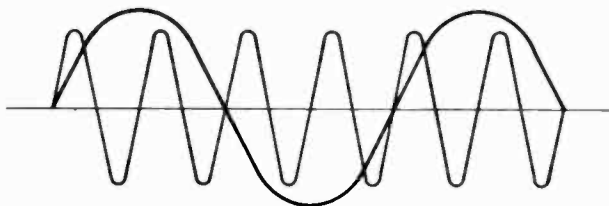

Fig. 1-2. A sinusoidal waveform and fourth harmonic.

Each musical instrument produces a combination of fundamental and harmonic tones (Fig. 1-2). Harmonic distortion results from the generation of new frequencies which are harmonics, or multiples, of those frequencies present in the original sound. It is caused by the presence of a nonlinear element in the amplifier, and acts to change the "color" of the sound. It is present in virtually every high-fidelity component, but it is most critical in the amplifier. In a good high-fidelity system, harmonic distortion should be less than 0.5% at normal listening levels.

Intermodulation distortion, however, is somewhat different. It occurs when two or more frequencies pass through an amplifier simultaneously. It is also caused by the generation of frequencies not present in the original recorded material, due to a nonlinear element in the amplifier, but these frequencies

are not harmonics, but rather are equal to the sums and differences of the various signals passing through the amplifier. The effect of IM, if at all severe, is an extremely unpleasant, mushy kind of sound.

If, when listening to a record, you cannot distinguish between two instruments, you probably have a bad case of IM distortion on your hands. A true high-fidelity system should enable you to identify the various instruments just as easily as you would if you were at a "live" concert. For good reproduction of sound the IM distortion must be kept below 2%.

The next consideration is a matter of *dynamic range*. Think back to the last time you heard a symphonic selection. Remember that some passages were quite soft and others "assaulted" you with sound so formidable that you could feel it? Such variations in intensity help to give music character and create the desired mood. A good high-fidelity system must be able to reproduce the softest, most delicate sounds with all their subtlety, and then bring you instantly all the power and magnificence of the most thunderous percussive passages without a trace of rattle or distortion. This takes power; and it is for this reason that you hear the power ratings of amplifiers—20 watts, 40 watts, 70 watts—discussed so seriously. This will be discussed in more detail later, but for now assume that for minimum acceptable dynamic range, an amplifier should be able to deliver to an average speaker a solid 10 watts of audio power over the entire frequency range.

Another quality is known as *transient response*. What does this mean? When a trap drum is struck with a stick, it produces a sound immediately—it has a fast attack, and the sound disappears, or decays, almost as fast. If piano strings are muted, their sound too decays quickly. In a music-reproduction system, and especially in a speaker, this problem of responding faithfully to sudden attacks and mutes is a difficult one. Yet, it must be met if sounds are going to remain crisp and clean in the reproduced rendition. The sound-reproducing system must be able to overcome the problems of sheer mechanical momentum by responding instantaneously to changes in attack and decay. Otherwise, an echo, or hang-over, is produced; this changes the emphasis of a musical passage completely.

While there are no exact standards for transient response, manufacturers who strive for equipment with the best possible reproduction do use tone-burst signals in checking response.

CHAPTER 2

THE BASIC HI-FI SYSTEM

A high-fidelity music system may be compared to a story; that is, it has a beginning, a middle, and an end. The beginning is a program source. The music has to come from somewhere, a broadcast, a phonograph record, or a magnetic-tape recording (Fig. 2-1). The program source is a specialized device that extracts the music from the medium in which it is carried or stored and converts it to a usable form. Some of the more common program sources include radio tuners, record players, tape players, microphones, and television receivers.

The second basic section of a hi-fi system consists of one or more amplifying devices (Fig. 2-1). When the program material is extracted from its "package," it appears as an audio voltage—the electrical equivalent of sound. This electrical signal, however, is very weak and must therefore be amplified before it can be converted back into sound energy. This logically calls for the services of an amplifier, which simply takes very weak signals and makes them stronger.

Even an amplifier requires an input signal of sufficient power to "drive" it. Because of this and the fact that audio signals delivered by most phonograph cartridges and tape playback heads are very small, the main power amplifier is preceded by a device called a *preamplifier*, or preamp. Its job is something like that of a setup man's in a volleyball game, who puts the ball in just the right position for another player.

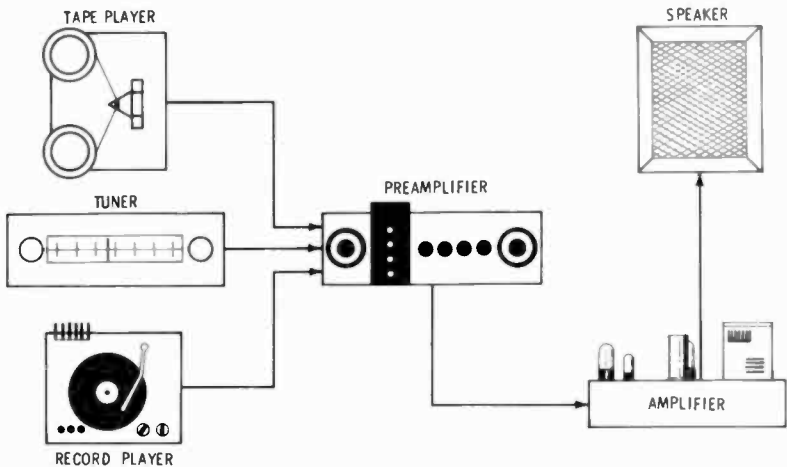

Fig. 2-1. A basic monophonic hi-fi system.

In the end process, the electrical signal must be converted back into sound variations. To do this, electrical energy must be transformed into mechanical energy. This is accomplished through the use of a speaker system, or possibly a set of earphones.

PROGRAM SOURCES

Now, let's take a closer look at some of these components, starting with the "beginning," the program sources.

Tuners

A tuner is nothing more than a radio receiver. But where the conventional radio is actually a self-contained audio system, complete with amplifier and speaker, the tuner's job stops after it picks up the broadcast and extracts the actual program material. Lacking an amplifier or speaker, it cannot reproduce sound by itself. Normally, when one speaks of high-fidelity broadcasting, he thinks almost exclusively of FM radio. Many people, however, prefer to have a tuner that offers reception of AM as well as FM because of the greater number of program sources.

What is the difference between AM and FM, and how do they work? First, consider the basics of radio transmission. A

radio station transmits signal energy within a given portion of the radio-frequency spectrum. The radio signal at the operating frequency (referred to as the carrier signal) is identified by a numeric designation, such as 980 kc (kilocycles), 105 mc (megacycles), etc. Before a station can be "heard," the receiver must be tuned to the carrier frequency. The program material, in the form of an audio signal, is blended with the carrier in such a way that it alters, or *modulates*, it. These alterations of the carrier contain all the intelligence of the broadcast. When a tuner is adjusted to receive a broadcast, the modulation component of the carrier (the original audio signal) is recovered. At the same time the carrier, which has already served its purpose, is filtered out.

The manner in which modulation is accomplished makes the big difference between AM and FM. The standard table model radio, transistorized portable, and car radio are most likely AM, (although today, there are FM radios in each of these categories). With AM the *frequency* of the transmitted carrier is constant, but the *amplitude* of the signal is varied (Fig. 2-2A). With FM, however, the amplitude of the carrier remains constant and the *frequency* is varied (Fig. 2-2B).

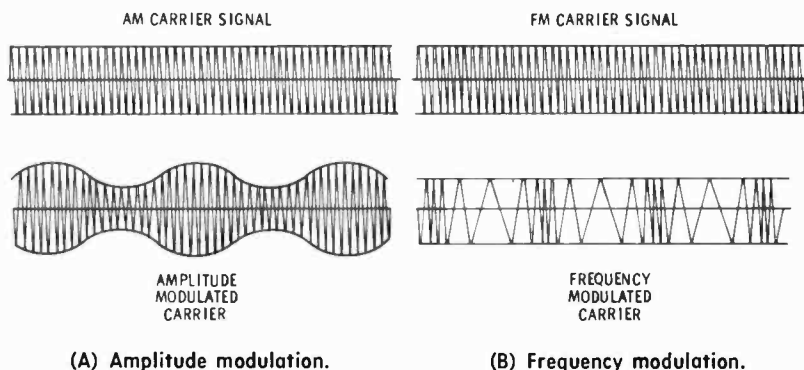

Fig. 2-2. Two methods of modulating an RF carrier signal.

When frequency becomes the plaything, the range of frequencies used is greater than when amplitude modulation is employed. For this reason, FM radio is allocated a band extending from 88 to 108 mc (1 megacycle equals 1,000,000 cycles)—which happens, incidentally, to fall between the low- and high-band VHF television channels.

The width of an FM channel is determined by the percentage of modulation, and not by the modulating frequency. The upper frequency limit is a function of the bandwidth of the IF amplifier and the detector in the tuner. The result is that the frequency response of FM is markedly superior.

The practical audio-frequency range of AM extends only to about 15,000 cps as a maximum, although because stations are separated by only 10,000 cps, there is often some interference between stations on adjacent channels. For this reason, AM tuners are usually limited to a response up to about 5000 cps. Transmitters are not limited by FCC regulation, and most are good up to 10,000 cps. In rare cases of interference, the FCC can cause a station to limit its transmission to 7,500 cps, but this limitation is seldom imposed. To avoid interstation heterodynes (or "beats" resulting from the combination of two frequencies) most AM tuners limit the audio frequency response to about 5000 cps, which is obviously quite far from high-fidelity performance.

FM does have a higher dynamic range than AM, so the softest pianissimo and the loudest crescendos can both be accommodated, with increased realism to the listener. This is something an AM radio just cannot do.

Because of technical problems, there is a limit to how loud sounds can be broadcast on either AM or FM. However, while the very low passages of music in AM are "lost in the noise" inherent to AM, the superior quietness of FM allows the soft passages to be transmitted in true proportion.

There is also the matter of static and other forms of interference which plague AM reception. With FM, however, the type of interference which affects the amplitude of radio signals is nonexistent. Of course, FM can fall prey to its own kinds of noises, but this usually indicates a technical problem to be solved rather than a limitation which must be accepted.

In the metropolitan areas of a few large cities, established AM stations offer a simultaneous FM service. Many audiophiles in these communities content themselves with a less expensive FM-only tuner.

In many localities, FM service is very scarce. If you are an FM fan exclusively, you will probably be missing out on most of the locally-available radio service unless you have a combined FM-AM tuner. Why not simply use an ordinary, self-contained AM radio for such service and restrict yourself to a high-quality FM tuner for your high-fidelity music system?

Of course, you can certainly do this. But if you ever compare the sound quality of an ordinary AM radio to what a high-fidelity system can produce from the AM section of a hi-fi tuner, you'll discover a world of difference.

True, the AM sound leaves much to be desired, compared to true hi-fi reproduction. But the gap here is probably a great deal smaller than the gap between the AM tuner section and the AM radio. A good AM tuner circuit delivers all the sound quality a radio station is capable of transmitting. It adds no substantial shortcomings of its own to the ultimate product. Remember that some AM stations *do* get up to 10,000 cycles, which can produce very respectable sound quality indeed, quality the average AM radio receiver cannot possibly reproduce.

There is one area in which AM is inherently superior to FM—geographic range. Depending on transmitter power, carrier frequency, and other factors, an AM station can radiate signals long distances when compared with FM transmissions. Therefore, if you live very far from an FM station, you may have a reception problem. Sometimes it isn't even distance that causes the trouble; it may simply be some intervening obstacle, such as a mountain, between you and the station transmitter. That is because FM, like TV, is pretty much a line-of-sight proposition.



Fig. 2-3. Knight-Kir® stereo FM-AM tuner. Receives single-channel AM or FM, and multiplex (2 channel) FM broadcasts.

If you have reception problems with a given TV station, you will most likely also have trouble receiving FM broadcasts originating from a station in the same locality. Fortunately, the remedies for improving the reception from one

works just about as well for the other. In fact, you can hook an FM tuner to a TV antenna, provided you use a device known as a two-set coupler to prevent undesirable interaction between the two receivers.

Most FM-AM tuners have been designed to provide either FM or AM reception at any one time, but not both, since some circuits are common to both modes.

With the emergence of FM stereo multiplexing, which will be discussed later, late model tuners include circuits for multiplex reception. These new tuners (Fig. 2-3) permit reception of AM, conventional FM, or FM Stereo.



Fig. 2-4. Multiplex FM-AM stereo receiver (Fisher 250T).
Dual amplifier and FM-AM stereo in one compact case.

Increasing in popularity is the tuner-amplifier, or receiver (Fig. 2-4). This is actually an FM-AM stereo multiplex tuner and a stereo amplifier on one chassis. To complete a stereo music system, you only need to add two speakers. Additional sound sources, such as record players or tape recorders, can be plugged into this unit.

Records

The medium that really got high fidelity off the ground was the LP phonograph record. It is by far the most popular

home-music source today. If a person starts with a minimum high-fidelity system, he will almost surely choose records for his initial music source. A record, whether monophonic or stereo, is simply a physical representation of an electrical audio signal, which itself is a representation of sound. The record is translated back into an audio signal by the phonograph pickup cartridge. This cartridge converts the gyrations of a needle (referred to as a stylus) into a corresponding electrical current. The movement of the stylus is produced as it follows the minute groove of the disc as it spins serenely around on the turntable.

Basically, the mechanics of disc playing are essentially the same as with Thomas A. Edison's original phonograph. Of course, he didn't have an electronic "middleman." Instead of converting the variations of the record groove into electrical impulses, his invention connected the needle to a thin metal diaphragm which converted the physical variations directly into sound waves. Original records were actually cylinders, rotating on their axes, instead of today's flat discs revolving around spindles. There have also been a few changes in the way that the grooves make the stylus move, the latest of which made stereo records possible.



Fig. 2-5. Allied 990A 4-speed hi-fi automatic turntable.

Next to consider is the device used to "spin" the record. This may be a record changer (now usually called "automatic turntable"), a manually operated turntable or a record player. The changer accepts a stack of 10 or 12 records, while the manual turntable (a precision unit) and player (bargain-priced) are one-at-a-time mechanisms. The changer (Fig. 2-5) is a complex device. Through an intricate system of gears, cams, levels, and idlers, its motor not only keeps the turntable spinning but also drops the records down on the turntable between plays, moves the tone arm into precisely the right position for the size of the record, lowers the arm gently to the surface of the disc, and in some changers even selects the appropriate speed; for example, 45- and $33\frac{1}{3}$ -rpm recordings are intermixed.

This means that, if you want it, you can have up to six hours of nonstop music without lifting a finger. But, as with most things, you pay a price. The big job of a record spinner, after all, is to make that disc rotate at exactly the same speed as the master record when it was being cut. With most manual turntables the motor has no function other than to make the record rotate at the correct speed and without any variations, such as high-speed *flutter* or low-speed *wow*, that can distort tonal characteristics. The motor, in most manual turntable designs, is assisted toward that end by a king-size heavy table that acts, in effect, like a flywheel.

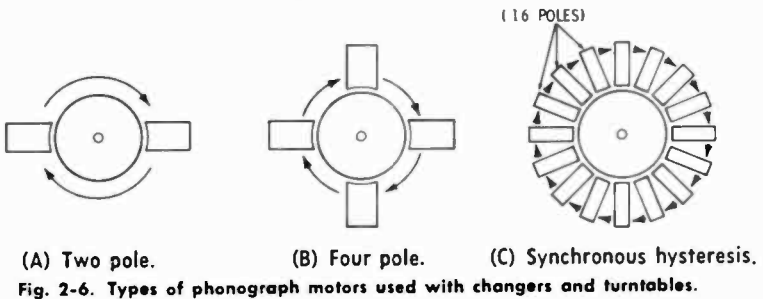

Some of the newer high-quality changers do use relatively large and heavy turntables, and the best approach turntable speed accuracy. This is a real achievement when you consider the work load already imposed on the drive motor by the changer mechanism, plus the constantly increasing load of records piling up during play. Even so, a good changer can deliver good, quiet sound to the preamp.

The more expensive changers and most manual turntables use four-pole motors (Fig. 2-6B). Two-pole motors (Fig. 2-6A) were quite popular in the days of 78-rpm records, and these motors are still used to some extent in some inexpensive phonographs. The primary disadvantage of two-pole motors is that they have a very strong external magnetic field, which is often picked up by the cartridge and reproduced in the speaker as hum. In addition, they often introduce rumble (noise in the low-frequency range caused by motor vibration). Better than the four-pole motor is the hysteresis-synchronous type (Fig. 2-6C). This is the type of motor found in the more expensive manual turntables. It maintains a more constant speed despite variations in line voltage than either of the other types of motors used in changers and turntables. Regardless of whether synchronous or four-pole motors are used, good turntables and changers are adequately rumble-free.

When you buy a changer, you also get a built-in tone arm. The arm usually includes a pickup cartridge. Sometimes you can have your choice of cartridges. With most turntables, however, the tone arm and cartridge are purchased separately.

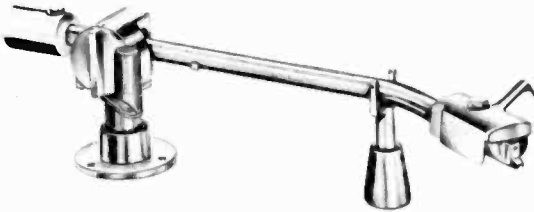

Fig. 2-7. Tone arm with plug-in head (Empire Model 980).

The tone arm (Fig. 2-7) is an important item, and another factor in giving the manual turntable an edge over the changer. To understand one reason for this, you have to go back to the cutting of a master phonograph disc. During the recording process, the original blank disc revolves on an extra-heavy turntable, somewhat like the hi-fi-component type but built even better. There is no tone arm; instead, there is a cutting stylus and its driving cartridge which are screw-fed along a bridge-like structure that runs from the outer edge of a record to its center. Thus, the cutting stylus moves in a path exactly perpendicular to the groove it is carving.

The tone arm of a playback turntable, however, swings in toward the center of a record from a pivotal point on the baseplate of the turntable. Thus, instead of traveling a straight path exactly perpendicular to the grooves, the pickup cartridge in the tone arm actually moves along a shallow arc. This obviously causes a tracking error. Since the cartridge cannot be perfectly tangent to all grooves of the record, the stylus presses against one side of the groove or the other, depending on the tracking error, and causes distortion. The longer the tone arm, the less the amount of distortion.

Some of the newer changers boast longer-than-usual arms, although high-quality tone arms designed for manual turntable use are usually much longer than those supplied with changers. Such an arm also has special features not usually found in all record changers. It has a delicate pivot that offers a minimum of resistance to record tracking, and an adjustment for changing the amount of stylus pressure (the less pressure, the less wear and tear on the record grooves). The better quality changers also have such an adjustment, and can be made to track excellently with only 3 grams of stylus pressure. Stylus pressure is particularly critical with the extremely delicate grooves of stereo records. A good independent tone arm, thanks to its delicate balance, can track properly with less than 2 grams of stylus pressure. A good tone arm, either independent or changer-mounted, is also designed to eliminate or minimize mechanical resonance, which can feed back to the pickup cartridge and degrade the sound. In recent years, many turntable manufacturers have taken pity on the audiophile who doesn't want to shop for a separate pickup arm and then go to the trouble of mounting it. They offer turntables with arms already mounted on the baseplate; some have even gone so far as to provide mechanisms that lift the tone arm off the record at the end of a play.

The manual is a compromise between changer and turntable. Essentially it consists of a changer-type turntable and motor, complete with a better-than-average pickup arm. Note that because of the vast effort in recent years to improve changers, careful shopping can turn up a changer with less rumble, wow, and flutter than even fairly expensive turntables.

Next to consider is the pickup cartridge. Like the speaker, the pickup cartridge is a transducer. However, this type of transducer converts mechanical energy to electrical energy. Early electrical cartridges were of the magnetic type, but

they were heavy, expensive, and low in compliance. They were followed by the piezoelectric types, which produced a much higher output and required no preamplification. With the appearance of the LP record, magnetic types again came to the forefront. Today they are the preferred type in high-quality systems.

The piezoelectric cartridge consisted of a basic element of crystalline material, usually Rochelle salt, to which the stylus was connected. When such a crystal is strained or twisted, it produces a corresponding electrical voltage. However, they are extremely fragile; and, more important in high fidelity, were until very recently sharply limited in frequency response. Also, because of the very nature of the physical operation involved, they left something to be desired in their ability to let a stylus comply precisely with all of the minute variations presented by the record groove.

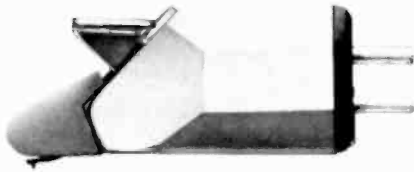

Fig. 2-8. Example of a magnetic phono cartridge.

High-fidelity sound reproduction from discs was really made possible by the *magnetic* cartridge, an example of which is shown in Fig. 2-8. Fundamentally, all magnetic cartridges are miniature electric generators. When a magnet's lines of force are moved across a wire coil, or vice versa, a voltage is induced in the coil. All magnetic cartridges have tiny permanent magnets and coils.

Earlier magnetic cartridges worked on the variable reluctance principle. Reluctance is resistance to magnetic lines of force. In this type of cartridge, an iron armature is moved by the stylus within the field of a magnet to vary the length of the magnetic path, and hence the lines of force which act upon the coil. Most modern pickups use the moving-magnet principle, in which a tiny magnet on the end of the stylus bar is actuated by the stylus so the lines of force acting on the coils vary, thus generating a voltage proportional to the velocity of the stylus.

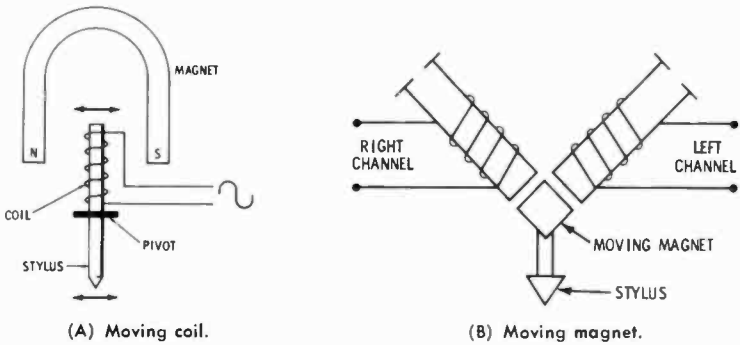

Fig. 2-9. Operating principles of magnetic pickup cartridges.

In the moving-coil, or electrodynamic cartridge, the coil is attached to the stylus (Fig. 2-9). As the motion of the stylus causes the coil to move across the magnetic lines of force, a voltage is induced within the coil. The voltages induced through such techniques are quite small, generally ranging from 0.01 to 0.2 volt. Therefore, these voltages require pre-amplification. But the magnetic cartridge justifies this need by providing full-range frequency reproduction and extremely high compliance to the record grooves. Such cartridges are not generally practical for use with inexpensive changers, however, because their magnetic nature makes them especially susceptible to the hum field from inexpensive motors. In this type of changer or record player, the ceramic cartridge, which employs a synthetic piezoelectric material, is better suited. Good examples of ceramic cartridges offer wide frequency response and are less affected by heat and humidity than the older crystal models. One type of ceramic cartridge is shown in Fig. 2-10.

Ceramic cartridges are popular for use in portable phonographs because they are fairly insensitive to rumble, and they seldom need preamplification; their outputs generally range from 0.5 to 1 volt. However, for high-fidelity reproduction, frequency response, freedom from distortion, and compliance of even the best ceramics is still not quite up to par with a good magnetic cartridge.

Tape

While tape has a long way to go before it approaches the popularity of records, it is fast growing as a high-fidelity mu-

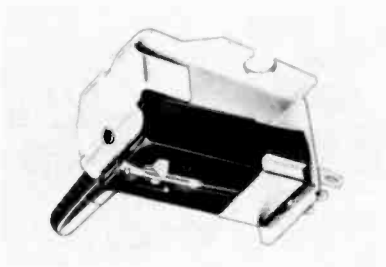

Fig. 2-10. Typical ceramic phono cartridge.

sic medium. Tape actually ushered in stereophonic sound for the home. Whether it is stereo, monaural, or binaural; tape is capable, at its best, of delivering the finest possible music reproduction.

Because tape reproduction is electromagnetic rather than mechanical in nature, a tape can be played for an indefinite period of time without degrading the reproduction. However, with records every playing causes a minute degree of wear on the grooves because of the physical contact of the stylus. This, of course, eventually rubs out the higher frequencies and leaves a residue of noise. Tape is also free from distortion caused by sheer mechanical inertia, since physical movement has no role in the actual recording or playback functions.

When played on top-notch equipment, top-quality tape recordings—masters, or first generation copies can easily outperform records when it comes to frequency response. Furthermore, the volume spread between the loudest and softest sounds is far greater on a tape recording than it is on records. Here again, tape isn't subject to the purely mechanical reproduction restrictions of the disc medium. Even the most thunderous and resounding passages, with all their power and impact, can be captured on tape. Stereo tapes are also unrivaled for their channel separation; there is very little, if any, mixing of left- and right-channel sounds.

Actually, the only thing really holding back tape is the cost factor. Commercially recorded tapes still cost more than their disc counterparts, though the difference is narrowing. Full-fledged tape recorders that meet high-fidelity standards usually cost at least as much as a turntable and amplifier combined. This is not really a fair comparison because a true recorder, as its name implies, permits you to make your own recordings as well as play commercially-prepared tapes. Those who want only to collect recordings that are truest to the ear

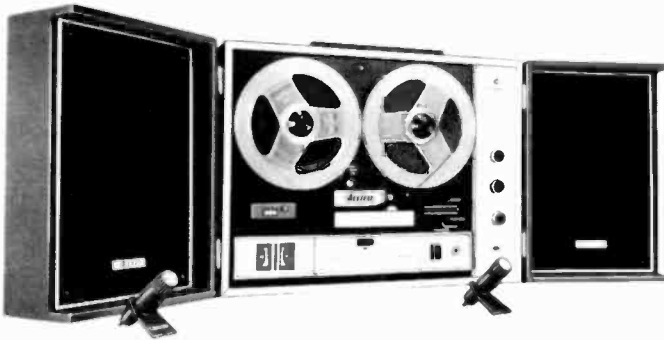

Fig. 2-11. High-fidelity stereo tape recorder.

can buy a playback-only tape transport deck for the price of a fine turntable, tone arm, and cartridge. Furthermore, many people who own a full-fledged recorder (one that is capable of recording tapes as well as playing them back) will tell you its price represents real value when you consider the extra benefits it provides. With such a recorder you can make your own copies of friends' records and broadcast concerts on inexpensive tape. This is perfectly legal so long as you don't try to sell your tape copies. Over a period of time, the savings realized here will repay the extra cost of the recording facilities. A typical hi-fi stereo tape recorder is shown in Fig. 2-11.

With its microphone, a recorder offers many possibilities aside from its hi-fi uses. It can be used to provide a living record of your family. If you enjoy home movies or color slides, a recorder can be utilized as an inexpensive, easy way of making extremely high-quality sound tracks for your showings. If anyone in your family is learning to speak a foreign language, play a musical instrument, or even memorize a speech, a tape recorder is an incomparable study aid. A little recording session before a party makes this machine a highly flexible source of dance music. The possibilities of a recorder are limited only by your imagination.

Tape recording and playback are made possible by electromagnetic principles. The tape itself is a plastic ribbon which is coated with microscopic particles of iron oxide.

Basically, an electromagnet is an iron core with a wire coiled around it. When electricity is passed through the coil, a magnetic field is generated. In the case of a tape recorder, the electromagnets are called recording and playback heads. They have the smallest-possible air gaps between their poles. When

an audio signal is passed through a recording head, a constantly-reversing magnetic field is generated. This is because an audio signal is actually a minute alternating current, in which electricity travels in one direction during the positive half of each cycle and in reverse during the negative half cycle. Now consider what happens when the oxide-covered surface of a tape is drawn past the air gap of the recording head. Fig. 2-12 shows the basic construction of a recording head and the principle by which recordings are produced on the tape.

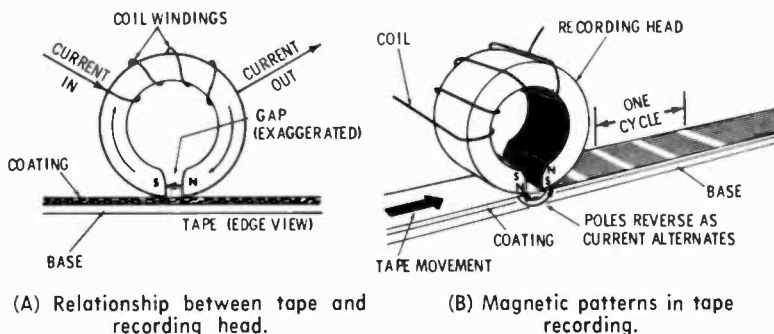

Fig. 2-12. Method by which recordings are made on magnetic tape.

As the audio signal goes through the head (Fig. 2-12A), a magnetic field is generated; the portion of tape that happens to be passing the air gap at that instant becomes magnetized. Since the signal current reverses once each cycle, actually two magnetic patterns are impressed on the tape for each cycle (Fig. 2-12B). The higher the signal frequency, the shorter is the duration of each individual cycle, and the shorter is the taped magnetic pattern representing it.

This gives a clue to the frequency response of a tape recorder. If the frequency is so high that a cycle begins and ends before a stretch of tape has passed the air gap of the head, it cannot be recorded. Obviously, the faster the tape speed, the more tape that will pass the gap in a given time. And the smaller the gap, the shorter is the cycle or higher the frequency that can be recorded for a given tape speed. So the higher the tape speed and the smaller the head gap, the greater the frequency response of the recorder.

The top-quality home recorders of today offer full-frequency-range performance at a tape speed of $7\frac{1}{2}$ inches per second,

which is now the standard speed for commercially recorded tapes. A somewhat limited frequency range is obtained at $3\frac{3}{4}$ inches per second.

Playback is accomplished by the reverse of the recording process. In other words, as each magnetic pattern is drawn past the head, its lines of force create a signal voltage which duplicates (or reproduces) the one used to produce the tape pattern. From here it is fed to an amplifier and subsequently to a speaker where it is converted into sound.

The signal derived from the tape is very small and must therefore be beefed up by a preamplifier before a power amplifier can handle it. If the tape machine is the simplest of decks, preamplification will take place in the hi-fi system to which the signal is fed. If, however, the tape unit is of a higher order, it will contain its own playback preamp.

So a playback-type deck, in addition to the mechanical tape-transport mechanism, needs only a playback head and, possibly, a preamplifier. To record as well, you will need a few other things, including a recording amplifier. This amplifier may either be a separate unit, or the playback preamp may be made to serve both functions. Fig. 2-13 shows a typical stereo tape deck and stereo preamplifier combination.



Fig. 2-13. Knight-Kit KG-415 tape deck and preamplifier.

The majority of lower-priced recorders use one head for both recording and playback, whereas the more deluxe machines use separate heads. This gives the advantage of

specialized design for optimum performance. The latter arrangement also permits the program to be monitored as it is recorded and allows you to indulge in trick echo and reverberation effects through a simple feedback arrangement.

A tape-recording machine also needs an erase head to remove unwanted program material from the tape before it gets to the record head. The erase head is fed by an oscillator that generates a powerful high-frequency (50 to 100 kc) signal.

Originally, tape recorders were designed to record program material on the full width of the tape. But to make tape economically feasible, machines were developed to use only half the width of the tape at one time, thereby permitting twice the amount of recording time with a single tape. Because these half-track machines have to work with magnetic patterns only half the width of those produced by full-track models, the playback signal that is generated is of lower intensity, providing less of a margin between the inevitable background noise on the tape and the recorded program. This problem was virtually eliminated by improved head design.

Today, many home tape players and recorders are quarter-track models, using only one-fourth the width of the tape at a time, and thereby increasing playing time even further. The development of multi-track tape recording made stereo possible, and this is the basis for the popularity of tape in the hi-fi field today.

With these developments in tape machines, the basic tape medium itself has been improved. Not too long ago, all tapes had bases of $1\frac{1}{2}$ -mil cellulose acetate plastic. A standard seven-inch reel will accommodate some 1,200 feet of this tape and provide a half hour of continuous playing time at a tape speed of $7\frac{1}{2}$ inches per second (ips). A 1-mil version made extra play possible, since 1,800 feet of this tape could be placed on a 7-inch reel, playing 45 minutes at $7\frac{1}{2}$ ips.

Acetate tapes break relatively easily. Moreover, acetate tape has a tendency to change dimension with temperature and humidity variations, and also to dry out with age, producing tape "squeal." Manufacturers have offset this last problem to some extent by adding built-in lubricants.

The appearance of polyester bases (DuPont calls them Mylar) made extra-play tapes more practical because of their much greater tensile strength. In fact, they even made possible the creation of tape with a thickness of $\frac{1}{2}$ -mil, permitting 3,600 feet to be wound on a 7-inch reel for $1\frac{1}{2}$ hour of

nonstop play at $7\frac{1}{2}$ ips. Other advantages of polyester are its dimensional stability and durability under all weather conditions.

Unfortunately, it will stretch out of shape under extreme tension, and if it breaks it will do so quite jaggedly. Thin tapes, regardless of the base material used, also have a problem known as print through, whereby the magnetic pattern of one layer tends to produce a similar pattern on the adjacent layers. To help overcome this, the recording level must be kept slightly lower when thin-based tapes are used.

Microphones

Some high-fidelity preamps and amplifiers have inputs for microphones. But unless you plan to use your music system as a public address system as well, you aren't likely to make much use of this particular input.

That does not mean that microphones don't figure in the home hi-fi picture, however. They do if you go in for tape recording, especially if you intend to make high-quality live recordings of home musicales, amateur musical groups, etc.

Tape decks, even those with recording amplifiers and playback preamps, do not usually come complete with microphones. They must be purchased separately. But full-fledged, self-contained recorders generally do include a mike in the package (often two mikes with stereo machines). These microphones, however, are rarely of very high quality. While they are suitable for noncritical voice recordings or just "kidding" around, they can seldom produce a recording of live music that meets even minimum high-fidelity standards. As a matter of fact, to enjoy the full recording capabilities of a top-notch tape unit generally requires the use of a microphone costing at least half as much as the recorder itself. If you can be satisfied with something less than the very best, live recordings below this ultimate can still be satisfying, and an investment of \$50 or less can buy a mike that will meet your needs very well.

The majority of microphones supplied with tape recorders are of the high-impedance type; this design tends to pick up hum, and if it is capable of capturing high frequencies, it requires that a relatively short cable be used if these frequencies are to be delivered with a minimum of loss. Low-impedance microphones have neither of these drawbacks. Their ability

to work with long extension cables can be a blessing. Obviously, the recorder should be designed with a low-impedance mike input. If it is not, there are matching transformers available that permit very satisfactory use of a good, low-impedance microphone with a recorder that has only a high-impedance mike input.

Another choice to make is between a crystal and a dynamic, or moving-coil, microphone. The dynamic mike is the equivalent of a magnetic phono cartridge. As with crystal phono pickups, a crystal mike is a very delicate instrument, easily damaged by shock and extremes in temperature and humidity. Though the best of them offer quite good frequency response, top response is generally more easily obtained with a dynamic or moving coil mike.



Fig. 2-14. Dynamic microphone with cardioid pickup pattern.

The frequency response of a microphone is important in recording. Remember what was said earlier about flatness of response? This is especially true with mikes. There is one microphone on the market that actually goes no higher than 8,000 cycles. Yet it produces results much more realistic than you can get from some models claiming a 10,000- to 14,000-cycle response. That is because it is substantially flat, with little deviation in sensitivity through the frequency range it

covers. So, when you get right down to it, flatness of response is really more important than frequency range.

While this is true of any high-fidelity component, it is always truer of those nearest the beginning of the chain. Flatness of response is critical at the beginning of the line because every link in the chain adds its own deviations; thus, initial failings are magnified along the way.

Another factor to consider in choosing a microphone is its pickup pattern. Most microphones have patterns that are either omnidirectional or cardioid in configuration. A microphone with a cardioid pattern is directional in nature, almost totally insensitive to the rear, but highly sensitive in a pattern of varying narrowness to the front. A mike with an omnidirectional pattern picks up any sound coming from any direction and is generally less expensive. For rejection of spurious background noises and echoes, a cardioid microphone is the better choice. A typical dynamic mike with a cardioid pattern is shown in Fig. 2-14.

Television

The television set is not, properly speaking, a high-fidelity component, although a few years ago it was widely offered in a custom chassis form. Many high-fidelity authorities claim that most television sound is simply not full-range, low-noise high fidelity, even though it is actually an FM transmission. It is usually good, however, in the primary service area.

Yet the same people who frown on a TV linkup with a hi-fi system would never have dreamed of talking down tape recorders some six years ago, even though few home machines at that time could top 10,000 cycles.

Actually, much depends on where you live. If your local TV stations offer nothing but pickups from the coast-to-coast coaxial cable, you may seldom get a telecast with sound that goes above 5,000 cycles. But if you're in range of a station that uses good equipment and originates live musical shows, or if stations near you transmit taped musicals from their own video-tape machines, you will discover that your home music system can greatly enhance your televiewing. The difference is at least that between the most inexpensive tabletop radio and AM reception by a high-grade tuner, and often the difference is even greater.

Admittedly, it is not necessarily an easy proposition to in-

stall an audio tap on your TV set. If your TV receiver is one of those known as transformerless or "hot" chassis in which line current runs through the metal frame, a tap is much more complicated. But on a set with a "cold" chassis, all it takes is a simple connection to the volume control. Some TV receivers even have an output already provided to feed an external amplifier. You should let a qualified TV serviceman do the job in either event. There is little point in guessing, no matter what kind of virtuoso you might be with a soldering gun. A "hot" chassis you didn't think was "hot" is just like the gun you didn't think was loaded.

Once you have gotten your tap, though, all you need do is plug it into either the TV or auxiliary jack of your amplifier or preamp. In addition to the much better sound, you will find that high-grade tape recordings can be made from TV, just as with FM. The number of TV programs that stand up as sheer listening experiences will surprise you.

There is one further problem, though. Obviously, you will want the TV set near the hi-fi speaker system. This means that the preamp or amplifier will have to be near the speakers, too, otherwise, some of the higher frequencies may be lost in the long lead runs.

CHAPTER 3

AMPLIFIERS, PREAMPLIFIERS AND SPEAKER SYSTEMS

Earlier, it was shown that magnetic phonograph pickups and tape heads produce signals so weak that even the amplifier cannot cope with them unless they are first boosted in strength by a preamplifier. The preamp can either be a separate unit or an integral part of the power amplifier.

AMPLIFIERS

Today the integrated amplifier with its built-in preamp is very popular. In the medium power range, which most people find entirely satisfactory, they do a fine job. However, when you get into the truly high-powered amplifiers, this arrangement can cause problems.

Noise that breaks into the system at the preamp stage is particularly bad because of the large total amplification it will receive. It becomes increasingly difficult to effectively isolate real powerhouses from preamps sharing the same chassis, and they can induce noise. In fact, with these juggernauts of sound, the best design is considered that in which the preamp has its own power supply, instead of drawing on power supplied by the power amplifier.

It has become common practice to put all the operating controls of an amplifying system on the preamp when it is a separate component. In this way, the preamp has all the

inputs, and the power amplifier has only the preamp input plus the output terminals for the speakers.

All inputs and outputs are on one chassis when the preamp and power amplifier are combined. Essentially, there are inputs for each of the program sources already considered; but not all amplifiers have each of them. An amplifier with a full complement of inputs will generally provide for magnetic and piezoelectric (crystal or ceramic) phono pickups, radio-tuner, TV, and/or auxiliary and tape.



Fig. 3-1. This dual channel (stereo) amplifier with built-in preamplifier has inputs and controls for all program sources (Knight-Kit KG-870).

Fig. 3-1 illustrates a stereo amplifier chassis of advanced design with inputs for all program sources.

In recent years, a tape-head input has been added. This is for decks that have no built-in amplifier of any kind. The input feeds incoming signals to the preamp section, just as a magnetic phono input does; such an input is sometimes labelled Tape Head. It may be provided in addition to the regular tape input for machines with their own built-in preamps. It may also be labelled simply Tape, in which case a preamp-equipped deck or recorder would have to be plugged into an input marked Auxiliary. As mentioned earlier, some home amplifiers even have microphone inputs, though this is a rarity these days.

Some of the higher-priced amplifiers are equipped with individual impedance or level adjustments for perfect matching of each individual input. This means that all the program sources will have the same system value. In other words, should you shift from one program source to another in the middle of a

passage, the volume control will not necessarily have to be readjusted.

Now look at the output provision of an amplifier. There are two basic types; one is the tape output with separate preamp and amplifier components. The tape output is found on the preamplifier chassis; it taps the program going through the total amplification process directly from the first input stage. Thus, the program can be fed straight to the recorder. On most amplifiers, this tap is totally unaffected by the volume control so that the sound level can be set to suit your ears without interfering with the recording. The average amplifier also leaves the recording unaffected by the tone controls for the same reason, though it usually does get the benefit of any existing variable phonograph compensator.

The other kind of amplifier output is for the all-important speaker. This output is found only on power amplifiers, whether it is combined with or separate from the preamp. While the inputs and the tape output are almost always plug-in jacks, speaker outputs are usually screw terminals provided in pairs to form a closed circuit with the speaker. Most amplifiers are designed to offer a choice of either 4-, 8-, or 16-ohm outputs in order to match just about any type of high-fidelity speaker. Some also provide additional output facilities for extension speakers so that you can have music in different parts of your home.

In some instances, the amplifier is equipped with an ear-phone output. On some of the newer units this output is located right on the face of the control panel for easy use. The advent of stereo headphones, which will be discussed later, has made such outputs especially popular.

A high-fidelity amplifier isn't really one amplifier at all. It actually consists of a series of amplifier stages, one feeding into the next. The earlier stages merely increase the voltage of the signal. This higher voltage is then fed to the power-output stages. Most *power stages* work on the so-called "push-pull" principle whereby the signal is split into two paths, each feeding a separate tube. Basically, each tube provides half the output, first one conducting and then the other. Their outputs are combined to provide the complete signal. While this may sound like both ends pulling against the middle, it really makes sense. The principle is something like that of a gasoline engine whose cylinders fire at different times, each contributing its share to the total power. You get smoother

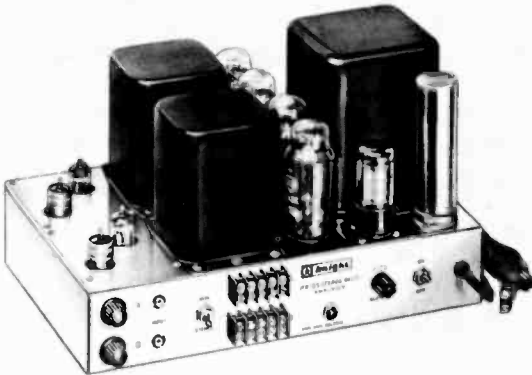

Fig. 3-2. Stereo basic amplifier used in systems with separate preamplifiers.

performance and, in the case of an amplifier, less hum and distortion.

Among other things, push-pull operation permits the use of smaller and less-expensive output transformers; the output transformer is the most expensive single part of the amplifier, and also the heaviest and most cumbersome.

Some amplifiers have what is called a negative-feedback circuit. That is, part of the output is fed back into the input. This tends to lower the signal level, but it also lowers noise and distortion originating within the amplifier. Fig. 3-2 shows one type of amplifier that employs a push-pull output arrangement, as well as negative feedback for minimum distortion.

There was a time when a 10-watt amplifier was popular and 30 watts represented just about the ultimate in audio power. Today, 20 watts is a more common average for the lower-priced amplifier—ratings up to 50 watts (per channel, in the case of stereo) are not at all unusual. While this may sound like power for its own sake, there are two very good reasons for this trend.

First is the matter of distortion. The greater the amount of peak signal power, the greater the distortion factor becomes. A moderately powered amplifier may be right for normal listening volume; but let a crescendo come along, and the result is an increase in the distortion figure as the amplifier strains to handle the increased power.

It's a question of how loud you play your recorded music and what kind of music you listen to. If you like to listen to

a Beethoven symphony at near concert-hall levels, you need plenty of spare watts. Other types of music, where the demands are not as dynamic, require less wattage. Another factor along these lines is acoustics. An "acoustically-live" room calls for moderate volume levels, while a "dead" one needs audio "oomph" to pep it up.

The other major contributing factor to the growing popularity of high-powered amplifiers is the equally growing demand for low-efficiency speaker systems. Such a system, because it emits a relatively small portion of the energy it receives, must be fed a large amount of power to produce appreciable audio quality.

It wasn't so long ago that amplifier ratings had various meanings to many people. One company's 20-watt amplifier delivered its 20 watts only when "all the stops were pulled out." Another firm's amplifier delivered its full rated power before any distortion became evident; actually, it may have had the ability to handle a third more, or even twice the power of the first one.

The Institute of High Fidelity (IHF), an organization of hi-fi component manufacturers, has tried to have its members adopt uniform standards. This effort has been only partially successful and the audiophile's best protection is still the guarantee of a dependable supplier.

PREAMPS

The main job of a preamp is to take the weak signals produced by magnetic phono cartridges or tape heads, and give them the required amplification to drive the main amplifier. The preamp has another function closely allied with this—compensation or equalization. Because of certain mechanical problems inherent in the disc-recording process, the sound transcribed on a record is deliberately made weak on bass and heavy on treble. The job of a compensator circuit is simply to restore proper balance to the music.

Several years ago every record manufacturer had his own pet recording curve, or recipe for the degree of bass reduction and treble pre-emphasis introduced in the recording process. So the better preamplifiers all had variable compensators, permitting you to select the proper curve for the make of record you wanted to play. In 1954, however, the members of the *Record Industry Association of America* agreed to adopt a

common recording characteristic, which they named the RIAA curve. As a result, many of the finest preamplifiers and preamp-amplifiers offered today have fixed compensation. Some manufacturers, however, go one step further and still provide compensation for other curves. The preamplifier shown in Fig. 3-3 is an example.



Fig. 3-3. Stereo preamplifier (Marantz 7T).

Unless you have a substantial library of long-playing records bought before 1955, old 78-rpm records, or foreign-made discs, a preamp with standard RIAA equalization should serve you very well. As a matter of fact, even non-RIAA records, with a little tone-control adjustment, sound just fine played with RIAA compensation.

Ceramic or crystal cartridges, of course, don't require pre-amplification, hence the sound they transmit does not receive this compensation. However, the inherent characteristics of such cartridges provide the same effect as external compensation.

Tapes, too, require equalization on playback for much the same reasons as records; the equalization differs for each speed. A recorder or playback deck with its own preamps automatically takes care of this. No problem is posed here, barring the use of foreign tapes, because American tapes commercially recorded at $7\frac{1}{2}$ ips all follow the NAB curve created by the *National Association of Broadcasters*.

If a simple deck and the tape-head input of your hi-fi preamp are used, you get the NAB equalization designed for the $7\frac{1}{2}$ -ips speed. However, if you have occasion to play a tape recorded at $3\frac{3}{4}$ ips through this arrangement, you will prob-

ably have to adjust the tone controls to get it to sound just right.

Controls

Now, take a look at the controls on a preamplifier, or integrated preamp-amplifier. The most basic is a simple, multi-position switch that is used for program, or source, selection. This connects the amplifying circuitry to inputs from the phonograph, tuner, tape preamp, and/or tape head, and an auxiliary source such as a television receiver. If the preamp has provisions for variable record compensation, this will probably be incorporated in the program selector also.

There have been some low-priced preamps offered in which two program-source components, such as tuner and tape, have shared the same position on the selector switch. This isn't too much of an inconvenience, as long as you remember to keep the unused unit turned off.

Some preamps also have a very special kind of program selector called a Tape-Monitor switch. This is for use with recorders that have separate recording and playback heads. The idea is that you can be playing music from, say, records or radio through your music system while recording it at the same time. By throwing the Tape Monitor switch, you can hear the program from the tape a split second after it is recorded—thus, comparing it to the source material. When this switch is used, the source material obviously continues to be fed to the recorder. This arrangement permits you to make the necessary recording adjustments to ensure good reproduction.

The next control element consists of two knobs, the Bass and Treble tone controls. A less expensive phonograph will usually have only one tone control which generally does nothing more than cut the level of the treble, thereby making the bass sound louder.

A true Treble control will boost as well as cut the treble frequencies; the Bass control performs the same two functions for the low end of the audio frequency spectrum. The middle frequencies, to which the human ear is most sensitive, are not affected by either control.

When the tone controls are in what is called the Flat position, they neither add to nor subtract from the sound; they leave it as it was delivered by the program source or pre-

amplifying circuit. In fact, at least one preamp design guarantees that the program will be left unaffected by cutting the tone controls completely out of the circuit when they are in the Flat position. Under ideal conditions, this is the setting to use for completely natural reproduction.

Why bother with tone controls at all? Because very often conditions are less than ideal. A room's acoustics might tend to accentuate either the highs or the lows; tone controls can compensate for this. They can also correct for speaker deficiencies or deficiencies in the program itself.

Probably the most familiar of all audio controls is the Volume control, which is frequently combined with the On-Off power switch. But there is a related device which is sometimes physically linked with it; this is called the Loudness control. As the volume is reduced, sensitivity to treble and especially to bass tones drops off sharply. Therefore to retain a sense of balance for low-level listening, the Loudness control boosts the treble and bass in the proportion that an individual's ear's sensitivity to them falls off. In the absence of this control, of course, you can get the same results with a bit of effort by adjusting the tone controls.

Rounding out the more common controls are the rumble and scratch filters. These are designed for use primarily with 78-rpm records and old scratched-up long-playing discs. As a natural consequence of their use, they cut off low- and high-frequency program material along with the offensive noises. Modern records that are kept in good condition and played on good turntables make such controls unnecessary.

TRANSISTORS

At this point it is a good idea to stop and take note of a new development; the advent of the transistor as a replacement for the vacuum tube in high-fidelity components. Unlike the tube, the transistor is actually a solid, crystalline device; it doesn't need a heating element to provide electron flow. The transistor is much smaller than its vacuum-tube counterpart and requires much less power for operation. Fig. 3-4 will give you some idea as to the comparison in size between a vacuum-tube and transistorized preamplifier.

What does all this mean for high-fidelity components that normally require tubes? It means greatly reduced size and weight and ultimately, a much more compact unit. It also

means greatly minimized heat generation which eliminates the ventilation problem and permits the use of much smaller cabinets. Design engineer of solid state (all-transistor) hi-fi components say that these units have virtually no hum or noise, and no microphonics. No warm-up time is required. Distinct operating advantages are also gained by the elimination of output transformers.



Fig. 3-4. Size comparison between stereo amplifier using vacuum tubes and comparable transistorized unit.

Until recently, transistors of dependable and uniform quality for use in high fidelity products were hard to make. Today's production techniques, however, make it possible to turn out transistors of predictable performance. The engineers of those manufacturers who pioneered transistorized high fidelity units have, at the same time, solved some complex design problems. Now, an increasing number of solid-state (all-transistor) amplifiers and tuners are becoming available in both kit and assembled form. Many audiophiles enthusiastically proclaim a special clean "transistor sound."

SPEAKER SYSTEMS

Basically, a speaker is a device designed to convert electrical variations into sound waves. The more common types of speakers for high-fidelity use include the dynamic and electrostatic. A dynamic speaker is fundamentally very much like a

dynamic microphone, except it operates in a reverse manner. A speaker contains a permanent magnet and a wire coil, known as a voice coil—this coil is attached to a treated-paper or plastic cone.

When a signal is passed through the coil, a magnetic field, which constantly changes polarity as the signal current reverses itself, is set up. This causes the coil to be alternately attracted and repelled by the permanent magnet; thus, it moves back and forth, taking the cone with it. The cone acts somewhat as a pump, producing air waves which are heard as sound.

Hi-fi speakers must be able to reproduce all audio frequencies without discrimination or "coloring" the sound with its own tonal characteristics. The cone of a bass speaker vibrates relatively slowly, moving large amounts of air to produce the low bass tones. To generate treble tones, however, it has to race back and forth at a very rapid rate.

Design Considerations

Designers of single-cone speakers try to accomplish this complex combination of functions by stiffening the cone near the apex in order to concentrate on the highs, leaving the

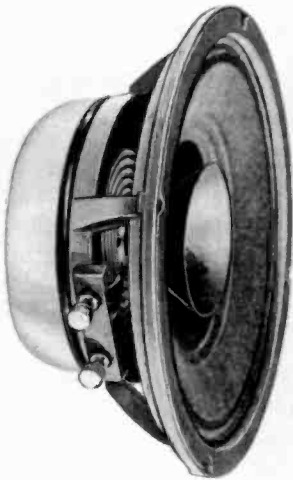

(A) Single-cone 8" midrange.

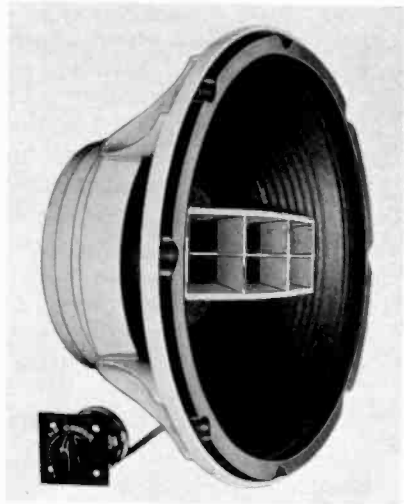

(B) 12" coaxial-type.

Fig. 3-5. Typical hi-fi speakers.

softer, outer portion of the cone to produce the lows. A better approach is to use two entirely-separate cones, both coupled to the voice coil. But the best solution of all is to use separate speakers, each having its own driving element for the upper and lower portions of the frequency range. These speakers may be totally-separate, individual units, or they may be a combination unit in which two speakers are mounted on the same frame—known as a coaxial speaker. Fig. 3-5A shows a single-cone 8-inch speaker, while a 12-inch coaxial speaker is illustrated in Fig. 3-5B. On the theory that the more specialization, the better, there are systems with three or even four individual speaker units collected in one enclosure.

Speakers designed for bass reproduction are known as *woofers*, and high-frequency speakers have acquired the name *tweeters*. When midrange speakers entered the picture, some people dubbed them *squawkers*. A fourth speaker element sometimes encountered is called the *super tweeter*.

Because a specialized unit works best when it isn't cluttered with extraneous signals, there is a special circuit known as a crossover network that is designed to spare the woofer the job of sorting out high frequencies, the tweeter the task of dealing with middle ranges, etc. It is simply a tone filtration system, an audio traffic cop that routes the right frequencies to the right speakers. There is usually an individual level control provided for each speaker in the system so that you can balance the output of each unit to make it blend in proper proportion with the others.

Although all dynamic woofers use cones to generate sound, this is not necessarily true of tweeters or squawkers. High frequencies tend to have an extremely directional characteristic, the higher the frequency the more directional it is. Bass tones, on the other hand, tend to radiate equally in all directions.

A cone speaker tends to intensify the beaming effect of highs so that the listener has to be directly in front of the set to hear them. For this reason, the popular horn-type tweeters, which distribute the sound over a broader area, were developed. Two horn-type speakers are shown in Fig. 3-6. Instead of a cone, the driver of a horn moves a small diaphragm set into a trumpet-like horn. A still newer tweeter design resembles a fried egg; it is a diaphragm in the shape of a half hemisphere. This one provides considerable brilliance over a widely-dispersed area.

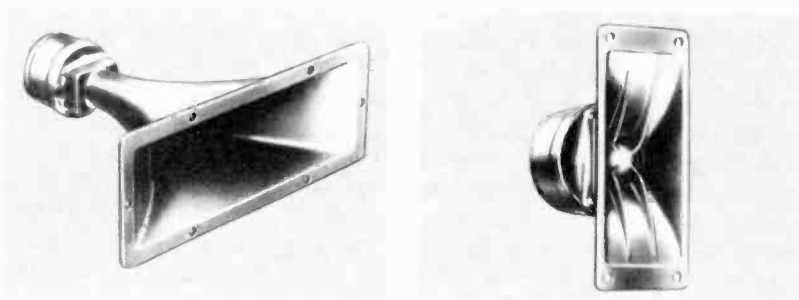

(A) Midrange.

(B) Tweeter.

Fig. 3-6. Typical horn-type speakers.

Between the two-speaker coaxial unit and the collections of three or four separate speakers, there has arisen a development known as the three-way speaker (Fig. 3-7). Actually, on most such speakers one voice coil drives separate bass and midrange cones; there is a self-contained tweeter for the highs.

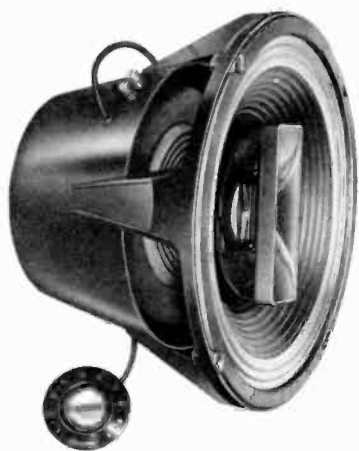

(A) Photo.

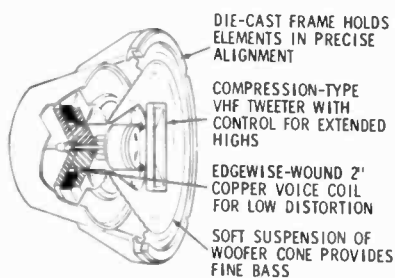

(B) Cutaway view.

Fig. 3-7. The Knight KN-612 3-way speaker.

When it comes to bass reproducers, the larger they are, the better they perform at the very bottom of the audio range. For example, a 12-inch woofer is better than a 10-inch unit of the same quality, and much better than an 8-inch speaker, etc.

This is not to say that good bass cannot be reproduced through a speaker system using speakers smaller than 8-inch speakers. As will be discussed later, under "Enclosures", much

of the quality of the performance obtained from any speaker depends upon the type of enclosure in which it is housed. This is especially true in the reproduction of bass frequencies. Have you ever heard a table model radio's plastic cabinet go into resonance as the speaker tried to reproduce bass tones?

An additional factor to be considered in the design of speakers is the power handling capacity. In the specifications covering speakers, this factor is expressed in watts. A common rating of better-quality high-fidelity speakers is 25 watts. This means that musical program material delivered by an amplifier at this power level will safely be handled by the speaker. When a speaker with a 25-watt rating is used with a 10 or 15-watt amplifier, it has a margin of power handling ability that considerably exceeds the power available from the amplifier. When the same speaker is used with a 25- or 30-watt amplifier, it will adequately provide musical reproduction at the full-power level of the amplifier. Even when a 25-watt speaker is connected to an amplifier rated at 50 or 60 watts, the speaker will be adequate for home music installations where the average power level almost never exceeds a few watts.

In recent years the trend in high-fidelity system design has been to ever-smaller enclosures, designs calculated to appeal as beautiful furniture, rather than massive, utilitarian enclosures.

This has led to the development of "bookshelf" cabinets and thin "decorator" designs that are more or less inconspicuous. More recently, speakers have even been mounted in walls. In fact, speaker designers have managed to design a 15-inch woofer that is less than 6½ inches thick, and smaller diameter speakers that vary in thinness down to less than four inches. Can you imagine—a 12-inch woofer, only 3¾ inches thick.

ENCLOSURES

Speaker enclosures are a great deal more than mere housings. Without them it is impossible to get decent reproduction of bass tones. The speaker cone vibrates in two directions, sending out sound waves in both directions. These front and back waves are naturally out of phase, since the cone is pushing on the air in front at the very moment it is relieving air pressure in back. When these out-of-phase (front and back)

waves pass around the edge of the speaker and meet, they cancel one another out (Fig. 3-8). It is up to a speaker enclosure—also called a baffle—to prevent this cancellation effect.

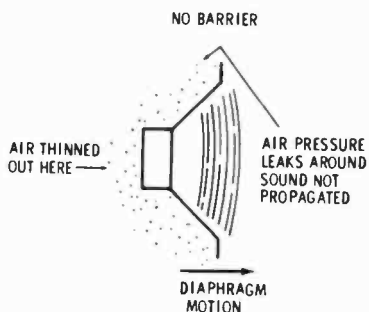

Fig. 3-8. The cancelling effect of sound when no baffle is employed with a speaker.

One approach of overcoming the cancelling effect with cone-type speakers is through the use of the so-called infinite baffle (Fig. 3-9), a mounting board so big that the front and back waves never meet. The closest practical approximation of this is a speaker mount in the wall of a room. It is also possible to use an extremely large enclosure—one with a volume in the neighborhood of 10 cubic feet—to come near this effect.

Speakers that are infinitely baffled are relatively inefficient; that is, the back wave is completely discarded, leaving the whole job of bass reproduction to the waves traveling outward from the front.

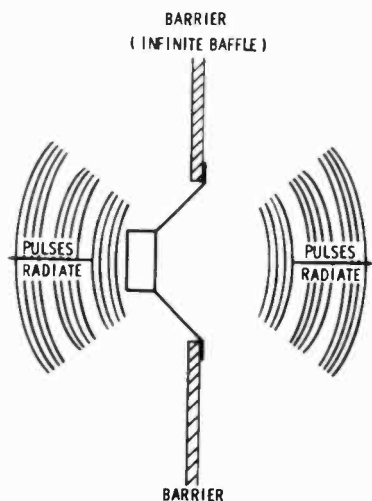

Fig. 3-9. Infinite baffle.

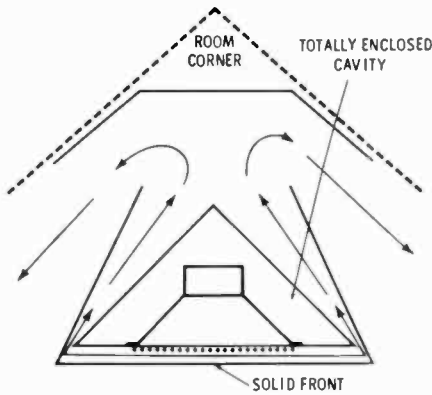

Fig. 3-10. A folded corner horn.

Another highly efficient approach is the horn; this works much like a megaphone, greatly increasing the coupling of air to the speaker in order to create really exciting bass response. A straight horn big enough to do the job, however, would be enormous. Some early hi-fi enthusiasts actually went so far as to fill an entire adjacent room with such a horn, making a gigantic hole in the wall.

Since this is impractical, most hi-fi enthusiasts prefer to buy a folded-horn cabinet (Fig. 3-10). Such an enclosure has many passages for the sound to follow; it is similar in principle to the trumpet coil. Designed to fit into the corner of a room so that the walls are its extension, this set up results in impressive sound reproduction.

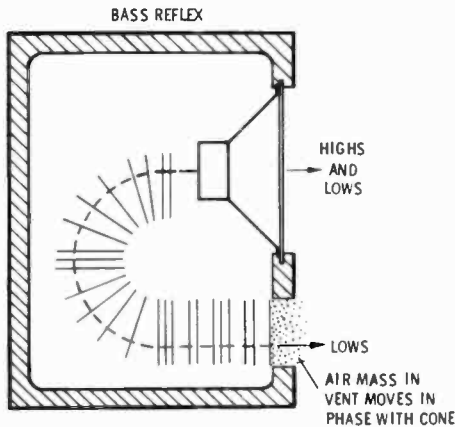

Fig. 3-11. A bass-reflex enclosure.

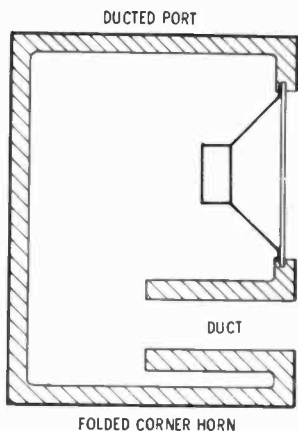

Fig. 3-12. A modified version of the bass-reflex speaker enclosure with a ducted port.

A considerably less-complex approach is called a bass-reflex enclosure. It is nothing more than a box of prescribed size with a cutout for the speaker mounting and a rectangular opening below it (Fig. 3-11). The dimensions of the box and rectangular hole, or reflex port, are such that the speaker's back wave has time to change phase before it comes out of the port. Instead of cancelling the front wave, it reinforces it and provides respectable bass reproduction. The size of the port is crucial and must be tailored to the particular speaker used.

About the only thing wrong with a good bass-reflex enclosure is that it requires a fairly large cabinet—this is fine for a large room where you can blend it into the decor, but it is sometimes difficult to place when space is at a premium. One way this problem can be alleviated is to add a tube behind the port. This turns the speaker into a ducted port (Fig. 3-12), permitting the same bass response with a small cabinet or box.

When the infinite baffle was mentioned earlier, it was said that an enclosure for this purpose would have to contain at least 10 cubic feet of air. The reason for this is that the speaker, on its backward swings, would compress the air in the box. In a smaller enclosure, this compression, in effect, would resist the movement of the cone, which has a mechanical flexibility built into it to aid its recovery movement. The result of this air resistance would be to greatly reduce the ability of the speaker to produce low frequencies.

Designers have tackled this problem by creating a speaker system in which the speaker has a soft suspension, or virtually

no built-in "stiffness" at all. Actually, it uses the compression effect of a small, totally enclosed box (Fig. 3-13) to give the cone its needed restoring force.

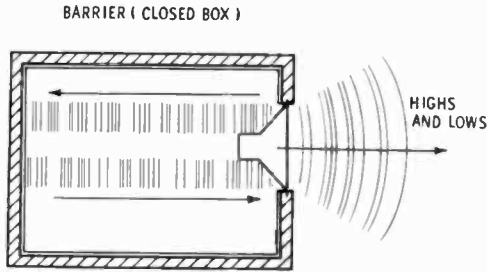

TRAPPED AIR "SPRING" PUSHES BACK ON AND "STIFFENS" CONE

Fig. 3-13. A barrier-type speaker enclosure.

Such speaker systems, when equipped with 12-inch woofers, can reproduce the same full low frequencies heard from the finest large systems available; yet they are small enough to fit on a bookshelf. Because these systems are designed and built as a unit, speaker and enclosure cannot be bought separately but must be purchased fully assembled. Like all infinitely baffled speakers, they are relatively inefficient and must be used with fairly high-powered amplifiers.

Some of the new family of thin-enclosed systems make use of the ducted-port principle to get satisfactory bass out of a box of relatively-small cubic capacity. Many employ a speaker with a long back-and-forth excursion of the cone to enhance bass through sheer brute force. Others, of exceptional thinness, make use of such speakers and also throw away the book of conventional enclosure design by opening up the back. The idea is that, classical theory to the contrary notwithstanding, backwaves that travel straight back into the rear wall of a room will bounce off and work their way around to the front of the baffle in phase with the front wave, thereby reinforcing it. To add to this total effect, some designs call for up to four woofers of small size because four small speakers will actually push more air than a comparable larger speaker.

CHAPTER 4

WHAT ABOUT STEREO?

The high-fidelity field has been working with stereo for many years now, but it took the development of the stereophonic phonograph record to make stereo a practical reality for everyone to enjoy. Fundamentally, stereo is a spatial effect, adding the physical dimension of a live performance to the listening experience.

If the violins are on the left in the recording studio, their tones sound as if they are coming from the left in your home. If a jazz vocalist is standing in front of the band during a recording session, that is where the sound should come from in your speaker system. Stereo sound reproduction adds the sense of depth to a musical performance that is similar to the effect stereo slides add to a color photograph.

Stereo is available in both the highest and the lowest fidelity. There are inexpensive portable phonographs with removable speakers that provide stereo. However, an inexpensive stereo phonograph with poor reproduction qualities can grate on your nerves after a very short listening time. That is, it seems to intensify all the shortcomings of the sound reproducing device. On the other hand, a high-fidelity stereo system can produce the ultimate in sustained, aural pleasure. A quality component system, by putting the instrumentalists in true spatial perspective, makes each individual instrument stand out even more to achieve greater clarity than the normal high-fidelity standards. This type of system has a realism that must be heard to be believed.

Stereophonic sound has also been called binaural sound because it is the electronic equivalent of our two ears. The fact that an individual's ears are on opposite sides of his head means that each one hears something slightly different from the other. This is also the way a stereoscopic camera works. The left-hand lens covers more field to the left, and the right-hand lens covers more to the right. When the two resulting pictures are simultaneously viewed this coverage difference gives you the illusion of viewing a true scene by duplicating the natural mechanism for discerning depth and three dimensionality. The fact that sounds coming from the left are heard more loudly in the left ear than in the right and vice versa helps to locate the origin of a sound.

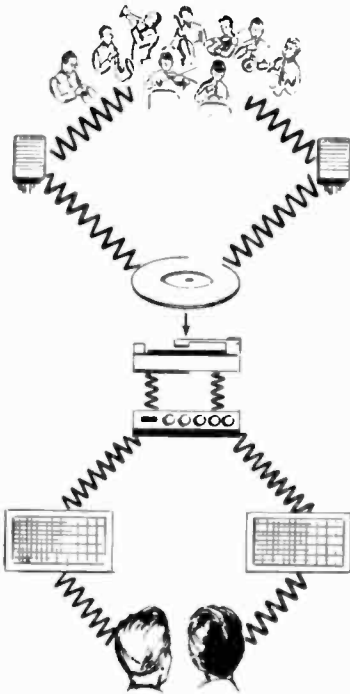

Fig. 4-1. The basic concept of stereophonic sound.

In stereophonic recordings and broadcasting two separate microphones are used, one to the left and one to the right of the subject. These microphones actually produce two entirely-separate recordings or programs. These programs are then combined on the same medium or, in the case of radio, broad-

cast simultaneously. They are then played through a dual music system where the sound comes out of separate left- and right-hand speaker systems (Fig. 4-1). Thus, dimension and direction are restored to the music.

There has to be two separate speaker systems for stereo reproduction; however, the mere fact that you have two speakers does not necessarily mean that you really have stereo. If the very same program is coming out of both speakers, all you're doing is giving it good dispersion. This, itself, can be very pleasant, but it does not produce any directional effect. Likewise, a true stereo system cannot put out stereophonic sound, unless a stereo program is played through it.

When stereo discs first came out, a lot of record companies tried tricking up some of the monophonic recordings they already had on hand. They used stunts like time delay and frequency separation in an attempt to create the illusion of stereo. True stereo begins in the recording or broadcast studio with two mikes; the initial separation of sounds must be maintained throughout the sound reproduction chain.

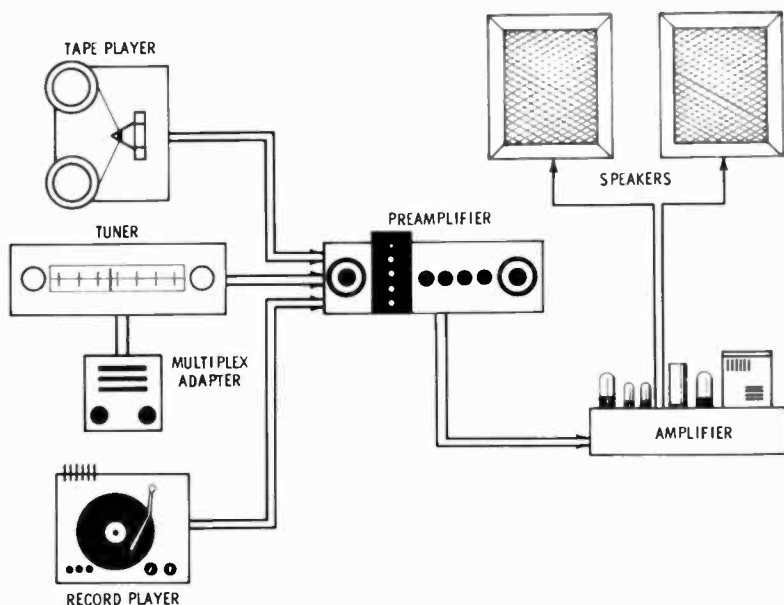

Fig. 4-2. Relationship between the various components of a stereophonic hi-fi system.

HI-FI STEREO

A stereophonic hi-fi system has the same basic components as the fundamental, monophonic high-fidelity systems discussed previously, except for the speakers.

All the basic program sources described earlier are now available in stereo versions. Tape recorders and tape players were the first instruments ever offered that could provide stereo. Next came stereo records, and finally FM stereo (Fig. 4-2). Television, however, is not as yet a part of the stereo scene. Some major musical telecasts have been "simulcast" on FM stereo, which means you could watch the program on TV while enjoying all its beauty in true stereo depth from an FM receiver.

Stereo Preamp-Amplifier Set Up

As in monophonic high fidelity, the preamp can either share the same chassis with the power amplifier or be separate. Actually, a stereo preamp is two separate perfectly matched preamp units on one chassis—the same applies to the integrated preamp-amplifier. In the case of the separate self-contained preamp, it may be used either to feed two matched, basic power amplifiers or a single two-in-one stereo amplifier.

If you already have monophonic high fidelity and want to get into stereo, you can simply duplicate your present amplifying and preamplifying equipment; however, this is often a cumbersome, expensive, and space-consuming arrangement. It also complicates the playing of your monophonic records. If your monophonic hi-fi setup is built around separate preamp and amplifier units, you could logically replace the preamp with a stereo model and add an amplifier to match the one you already own.

Stereo amplifiers are generally rated at their total power output; thus, a 60-watt unit supplies 30 watts to each of the two stereo channels. If, on the other hand, it is used to play a monophonic program, all 60 watts will be used for the one channel reproduction.

Naturally, the stereo amplifier has a separate set of terminals for each of the speakers; some even have a third voltage-type output to feed the combined program to an additional amplifier for a central, or filler, speaker. Inputs to stereo preamps or amplifiers are doubled and so is the tape-recorder output.

The input selector is similar to that used with monophonic equipment, except that there are mode and, possibly, phase-reversal controls. The simplest version of a mode switch is one that permits selection of either stereo and mono operation. A more complex type may also combine the two stereo channels into one and possibly even reverse the channels. The reversal feature came in handy in the early days of stereo, because records didn't always have left and right channel programs on the same side of the groove. Fortunately, the record makers have since agreed on a standard for this.

The principle of a phase-reversal switch is to make sure the two stereo speakers pull together instead of against each other. If one is emitting compression waves while the other is in the process of rarefaction, the resulting sound can often be unpleasant. This condition can be corrected by taking a screwdriver and reversing the leads on one of the speakers.

Some stereo amplifiers have one bass and one treble control for the two channels. The more common practice, however, is to provide separate tone controls for each. This is a good idea because, no matter how well built, a stereo amplifier may have slight tonal variations between its two channels; separate controls allow you to balance them. For convenience, these controls are often mounted concentrically, one over the other.

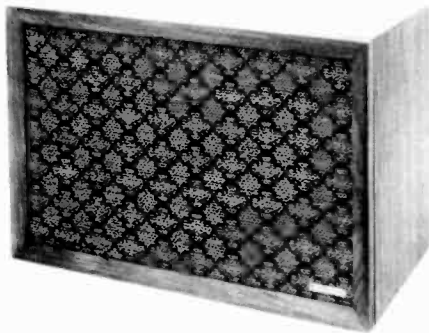

Fig. 4-3. Typical 3-way bookshelf-type speaker.

Usually, one volume control handles both channels; but there is a balance control to alter the volume relationship between them. This can be used to preserve the stereo effect

even if you aren't sitting precisely between the two speakers. All you do is emphasize the speaker further away while de-emphasizing the closer one.

Another special control found on some stereo amplifiers is the channel-separation control, which is, in effect, a mixer. In the Off position, the two channels are completely separated. As the dial is turned, however, there is an increasing amount of blending as parts of one channel are fed into the other, until at the extreme setting you get straight full left-plus-right sound from both speakers. This control was devised to offset the "hole-in-the-middle" effect you sometimes get if the speakers are too far apart. The idea is that by a little blending you can create the effect of a third speaker. But, like that third speaker, it represents a compromise in the stereo effect.

There are no special kinds of speaker systems for stereo—you simply need two of them; however, because two speakers take up more space than one, stereo has made the bookshelf models more popular than ever (Fig. 4-3). Thanks to the development of the soft-suspension type speaker, it is possible to get a stereo speaker system in a compact package with good bass reproduction. The important thing with speakers for stereo is to make sure they match. No two speaker systems have exactly the same tone color or sound output. Unmatched systems will not create as realistic an effect as will twin units.

When stereo first became popular, some speaker manufacturers offered second units that produced only the midrange and treble. The theory was that only one woofer was needed because bass tones have no directional quality. This theory, however, does not mean that you cannot tell where the notes come from. Bell Telephone Laboratories ran experiments to prove that people can tell where bass tones are coming from.

Though balance controls help to offset the effects of off-center seating, ideal seating is midway between the two stereo speakers (Fig. 4-4). With infinitely baffled units, such as the bookshelf systems, or with bass-reflex types, many authorities recommend that the speakers be placed at each end of the room. There should be a minimum of at least 8 feet between the speakers.

A typical all-in-one console or "packaged" system seldom offers this separation, which means that you have to sit relatively near it to get the full stereo effect. Actually, the distance between the speakers governs the right place to sit for the

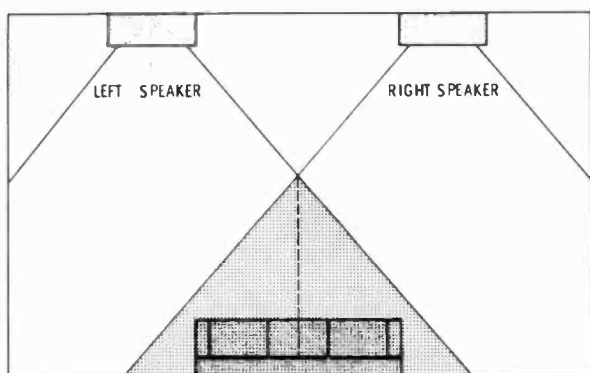

Fig. 4-4. Recommended seating position for best stereo listening.

proper stereo effect; as long as the basic relationship is maintained, the exact distance involved isn't too important. The rule states that the distances between the speakers and the listener should form a triangle which is equal on all sides.

If you arrange your seating according to this rule, you will get a true stereo balance. When an instrumentalist is in the middle of the recording studio, that is where the sound of his instrument will be in your room. It is as if you were hearing him through a ghostly center speaker that you can't see. This is due to an equal volume of the instrument's sound coming to you from each of the speakers, creating the illusion of a central source—the hallmark of well-balanced speakers and seating. In fact, a good test of stereo balance is to play a monophonic program to see whether you get this effect.

Now, if you were to sit too close to the speakers, you'd lose this effect, and there would seem to be a "hole" in the middle with all sounds coming from right and left. If you sit too far back, the stereo effect becomes compromised and indistinct.

Where a room is arranged so that too-close seating can't be avoided, use of the blend control may tend to reduce the "hole" effect. Or a third speaker can be placed in the middle, drawing equal amounts of the program from the left and right channels. As was noted before, some amplifiers have a voltage output to feed a blended audio signal to a second amplifier so that it can drive such a center speaker. A less-expensive arrangement is a rather involved tap of the left and right speaker outputs.

Incidentally, makers of corner-horn systems recommend

that they flank the longer wall of a room and that a center-fill speaker be used with them.

STEREO PROGRAM SOURCES

Records

The development of the stereophonic record is responsible for the popularity of stereo. Before stereo records were introduced, stereo had been enjoyed pretty much exclusively by owners of tape recorders.

Actually, there had been experiments with stereo discs close to a decade ago, but these were cumbersome, impractical affairs. The early stereophiles used the outer half of a record side for one channel and the inner half for the other. The tone arm was a dual affair, with two cartridges that tracked both sets of grooves in parallel. Obviously, playing time was very short, and since the inner grooves formed tighter spirals than those on the outside of the disc, the mechanical distortion problems were enormous. Today there is a much more practical system in which the right and left channels are both recorded on one groove. With monaural records the stylus is forced to move as it follows the constantly-changing groove pattern, and the cartridge converts this motion to an audio signal. But in what way is the stylus made to move?

With conventional monophonic records the stylus moves from side to side (lateral cut). But in Thomas Edison's day, and even more recently on some broadcast transcriptions, the stylus moved up and down in the groove (vertical cut)—this was called the hill-and-dale system. Basically, stereo records combine both of these systems. One of the first practical stereo-disc systems combined them literally, with lateral move-

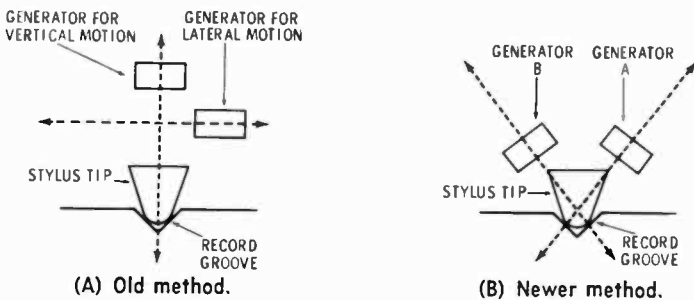

Fig. 4-5. Methods of exciting the stylus in stereophonic recordings.

ment generating one channel and vertical motion reproducing the other (Fig. 4-5A).

The system now in universal use is much the same as this, except that the whole operation has been tipped 45° (Fig. 4-5B). So now stylus movement along a right diagonal recreates one channel, while motion along a left diagonal takes care of the other. This can be seen in Fig. 4-6.

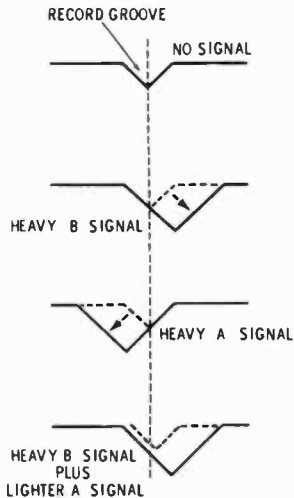

Fig. 4-6. Groove of a stereophonic record under various signal conditions.

This means that a stereo pickup cartridge is actually a double unit; two signal generators are attached to the stylus instead of one. Yet, despite this double attachment, the stylus has to move much more freely and be more compliant than a monophonic cartridge's stylus.

A particularly critical requirement of a stereo cartridge is that it provides good channel separation so that channel A signals do not audibly spill over into channel B. The idea is to make the channel A signal generator as insensitive as possible to channel B stylus movements, and, of course, the channel B generator equally insensitive to channel A movements. For good performance, a cartridge should provide at least 20-db channel separation.

Stereo gives just a bit more of an edge to the magnetic cartridge. By its very nature the magnetic cartridge tends to be more compliant than the purely mechanical ceramic. Improved ceramic cartridge design has offset this disadvantage to some degree.

On the other hand, magnetic stereo cartridges are even more sensitive to turntable rumble than their monophonic counterparts. This means, of course, that a changer or player that had only a slight trace of rumble when used with a mono system may prove unsatisfactory for stereo.

Stereo grooves are narrower than those on a monophonic disc. Therefore, instead of the 1-mil mono stylus—with a tip diameter of one-thousandth of an inch—it is necessary to use a 0.7-mil stylus. In fact, some stereo styli are only 0.5 mil in diameter. The extra delicacy of the stereo disc also calls for a lighter tracking force (the pressure exerted by the tone arm and cartridge on the groove) to minimize distortion and reduce record wear. This calls for a better tone arm.

One of the beneficial characteristics of stereo cartridges is that they can play ordinary monophonic records. In fact, their better compliance sometimes allows them to do an even better job than a mono cartridge.

But *never, never* play a stereo disc with a mono cartridge; its larger stylus and lower compliance can *ruin* the grooves of a stereo record.

Tape

As was explained in Chapter 2, stereo really got its start with tape. It all began with the advent of the dual-track tape machine. With this device, half of the tape width is recorded the first time through, then the reel is "flipped" to record the other half.

This offered a natural opportunity. Why not, the engineers reasoned, use multiple heads with independent elements for each track, and instead of using one at a time, put the left channel on track 1 and the right channel on track 2 simultaneously. They did just that, and the result was superb stereophonic reproduction with excellent, inherent channel separation.

The only drawback was that, at the quality speed of 7½ ips, a 1,200-foot reel provided only a half-hour of stereo playing time. This put tape at a serious disadvantage when the single-groove stereo disc, with playing time equal to a monophonic record, was perfected.

But then a short time later, improvements in tape heads and in the tape itself made the quarter-track system feasible. Each tape-head element now covers only one quarter the

width of the tape. Playing a 1,200-foot reel at $7\frac{1}{2}$ ips, the quarter-track system delivers a solid hour of high-quality stereo music.

Strangely enough, the quarter-track system provides even greater channel separation than the half track. On the first stereo recording pass, only tracks 1 and 3 (numbering from 1 through 4, starting at the top) are used. They are isolated from each other by track 2. Then the reel is turned over, and tracks 2 and 4 are used, separated by track 3. With this setup, there can be virtually no crosstalk between channels.

Because of its inherently-superior stereo music reproduction, tape is becoming more popular than ever. Moreover, the recording companies are now turning out tape albums on extra-play, 1,800-foot reels. This means that two complete symphonies, for example, can often be recorded on one tape.

Simple tape decks that plug into your own hi-fi preamp now make such tape enjoyment possible at reasonable cost. If you later add electronic recording facilities, or start out with a full-fledged stereo recorder, you can make your own copies of stereo records at very low cost. The advent of FM stereo broadcasting gives you an infinite source for making your own stereo tapes right off the air.

FM Stereo

FM radio is the newcomer to the stereo family, and just about the most exciting thing that has happened to broadcasting since color television. As a matter of fact, the development of FM stereo makes it possible to have stereo TV sound, if the broadcasters and set makers find there is a demand for it.

Before FM stereo came along in its present form, broadcasters started experimenting with some rather ingenious systems, but they always involved two transmitters. Sometimes it was two FM stations, one taking the left channel and the other, the right. More often, one channel was broadcast on FM and the other on AM. This allowed you to hear stereo through two sets, an FM receiver and a regular AM radio. Or, you could use an AM-FM stereo tuner.

These approaches, however, left much to be desired. AM cannot reproduce the entire frequency range, so one channel was slighted and the sound wasn't truly balanced. And the FM-FM approach required two FM tuners for reception.

With today's FM stereo, however, the job is done as it should be done. Now the entire program on (both channels) is broadcast as a single transmission for reception on a single receiver.

How do you make a radio transmitter handle two programs at once? It is done by a technique the engineers call *multiplexing*. Earlier, when carrier signals were discussed, it was said that in FM transmissions the frequencies of the carrier are altered to correspond to changes in the program signal. In FM stereo multiplexing there are two carriers. One is the main carrier, the basic station transmission, and the other is a subcarrier.

One of the two stereo programs modulates the main carrier in the usual manner. The other program modulates the subcarrier.

Now here is where the fun comes in. The subcarrier also modulates the main carrier, sharing spectrum space with program one. In other words, you might say that the subcarrier takes a "piggyback ride." At the stereo receiver it is separated from the carrier; then the dual programs are extracted, respectively, from the carrier and subcarrier (Fig. 4-7).

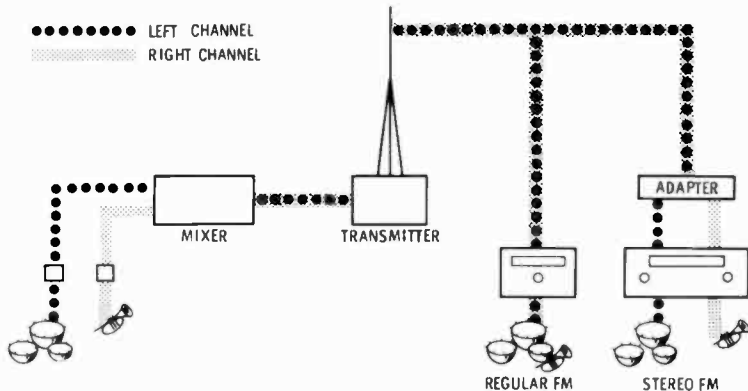

Fig. 4-7. The basic concept of FM multiplexing.

Left and right channels are literally added to one another on the main carrier so that nonstereo listeners can hear them as well. Algebraically, this looks like $L + R$. But on the subcarrier, the two channels are combined with the right channel

180° out of phase, in effect, an algebraic subtraction, or $L - R$.

When a stereo tuner sorts these two complex signals from their carriers, it passes them through a phase-changing network called a *matrix*. For the left channel the two signals are simply added, giving $(L + R) + (L - R)$. Being out of phase, the two R 's cancel out, leaving $2L$. For the right channel the phase of the entire subcarrier program is reversed before it is combined with the main carrier signal; thus, $(L + R) - (L - R)$. This causes the two L signals to cancel each other out, leaving $2R$. This reconstitutes distinct left and right channels that can be routed through their respective amplifier sections in the normal manner, while at the same time leaving the nonstereo listener to his monophonic bliss.

Like every other audio development, FM stereo has its problems. Because of the manner in which each station's total bandwidth is, in effect, shared by two programs (some stations even air a third, unheard-at-home, program for commercial reception), the strength of the total stereo signal tends to be considerably weaker than a monophonic signal. One estimate indicates that a stereocast covers only about $\frac{2}{3}$ the geographic area served effectively by a monophonic broadcast.

This means that for stereo you really need a good, sensitive tuner. It can also mean that an outdoor antenna is indicated where an indoor type was adequate for monophonic reception. Even the directional-type antenna may prove necessary, if you are far from a station transmitter.

Fortunately, however, stereocast reception for monophonic



Fig. 4-8. Stereo multiplex adapter.

listening is normally almost as good as straight mono-broadcast reception.

As might be expected, the complexity of FM stereo also leaves it more susceptible to distortion; a tuner must have extremely low-distortion characteristics built into it.

Many tuners that date back several years are equipped with built-in "multiplex jacks," originally provided so that a stereo adapter, such as that shown in Fig. 4-8, could be plugged into them when FM stereo came into being. Such adapters are now available, and the right models teamed with a number of these older tuners can do a fine job. In general, any good-quality tuner that has a high FM sensitivity rating and the ability to hold the station tuned-in without drifting, can be used with a multiplex adapter.

Current high-fidelity tuners, with built-in multiplex facilities, utilize wide-band tuning design to make use of all the information carried by a stereocast (Fig. 4-9). These units are capable of totally satisfactory stereo reception, as well as receiving full-fidelity monophonic FM broadcasts, and may be purchased with complete confidence. Over one-fourth of the FM stations in the nation, serving the most populated areas, are now broadcasting in stereo. These stations, along with numerous others planning future stereocasts, will provide a wealth of entertaining programs that meet the taste of high-fidelity listeners.



Fig. 4-9. Stereo multiplex FM-AM tuner.

CHAPTER 5

PLANNING YOUR SYSTEM

One of the first questions that comes to mind when buying a hi-fi or stereo setup is whether you should buy a *packaged* unit (an integrated assembly in a cabinet with speakers) or individual components—an amplifier, turntable, and possibly a tuner—that can be interconnected to form the hi-fi stereo system.

COMPONENTS VERSUS PACKAGE UNITS

Much depends on what is most important to you. Unquestionably, some packaged console phonographs and radio-phonos are handsome pieces of furniture, and a particular unit may appeal to you because of this.

Components, on the other hand, offer flexibility. These can be put in existing cabinets; some are so well styled and so compact that they can be used in their decorator castings, simply placed on bookshelves, etc. They can also be built into a wall or integral cabinetry. A number of firms specialize in making cabinets designed specifically to house high-fidelity components, many of these cabinets are an extremely attractive addition to a house's decor. Such a cabinet is shown in Fig. 5-1. This one can be purchased either assembled or as a kit.

When you buy components, you buy performance values attainable only through specialization, and your money usually commands full value. One of the best things about a com-



Fig. 5-1. Inexpensive cabinet designed to house high-fidelity components and records.

ponents system is that you can start with an absolutely minimal setup and then add to it at your leisure.

For example, you can even start with a stereo record player, stereo preamp and amplifier or a combination of the two and one speaker; with this you can enjoy both monaural and stereo records, hearing both of them monophonically until you

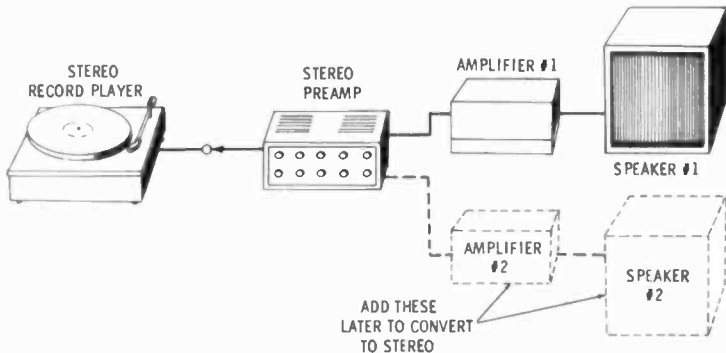

Fig. 5-2. Basic monaural hi-fi system showing additional components (in dotted lines) that can be added to convert to stereo.

purchase a second amplifier and speaker (Fig. 5-2). After that you can add a tuner and finally, if you choose, a tape player or recorder.

It is even possible to start with moderately priced record-playing equipment and get higher-quality replacements, one at a time, thus, upgrading your entire system in stages at a later date. This also means that the major improvements which come with the years won't leave you behind. You can replace any individual component that becomes obsolete without scrapping your entire system.

RECORD PLAYERS

Changers

If you have a number of old 78- or 45-rpm records that you want to play, a changer is the thing for you. Be certain, however, that the changer you select has a four-pole motor.

For tolerable listening, the low-frequency rumble created by motor vibration should be at least 40 db below the average volume of the music played. As mentioned previously, rumble is particularly serious in stereo, because stereo cartridges are extremely sensitive.

You also want to be certain that the turntable speed is accurate. This is easily checked with a stroboscopic disc, a cardboard disc with a circle of radial stripes for each speed. When this disc is viewed on a revolving turntable under a 60-cycle light source, the stripes that represent the selected speed will appear to be standing still when the turntable is running at the correct speed.

Turntables and Tone Arms

If you expect to restrict your music listening to long-playing $33\frac{1}{3}$ -rpm records, you might well consider a turntable. Its full-sized, 12-inch table gives any record full support along its entire surface, and the turntable is usually heavy enough to provide a speed-smoothing, flywheel effect. A turntable equipped with a top-quality four-pole motor will generally do a fine job. However, you cannot go wrong by spending a bit more for a model with a hysteresis-synchronous motor.

Turntables offering only $33\frac{1}{3}$ - and 45-rpm speeds are reasonably priced; and there is real value available if you are

interested in long-playing records exclusively. Some of the newer, single-speed turntables offer performance almost as fine as the most expensive three-speed models, yet they cost little, if any, more than the better changers.

True turntables require high-fidelity tone arms with certain special features. For one thing, these arms are long enough to minimize tracking error. They also move very freely on their suspensions, further minimizing tracking errors. They can even be adjusted to provide exactly the right tracking pressure for a given cartridge; some have built-in, calibrated scales to simplify the adjusting process. In many cases, this means that you can balance them to put less than 2 grams pressure on the record. This, in addition to minimizing record wear, means that if the tone arm is inadvertently dropped, it will tend to float down to the record's surface instead of crashing the stylus into the grooves.

Furthermore, top-quality tone arms are usually damped in one way or another to eliminate the possibility of feeding unwanted vibrations to the stylus. This damping may be inherent in the material of which the tone arm is made, it may be built into the suspension system, or it may actually involve an oil reservoir within the arm to provide viscous damping.

Many tone arms have a provision for plug-in shells, which means that you can use them interchangeably with more than one cartridge. So, if you do play 78's as well as stereo discs, you can interchange the 78-rpm cartridge with ease. Tone arms and turntables can be bought separately, requiring the installation of the arm on the turntable baseplate; or it is possible to buy a turntable complete with the tone arm installed.

Cartridges and Styli (Needles)

The better ceramic cartridges do a fairly creditable job in the true reproduction of sound, but the magnetic types are the best. Certainly, if you are going to invest in a turntable and tone arm, it would be unwise to use anything less than a magnetic cartridge, especially if they are to be used with a stereo system. On the other hand, if you are temporarily using a "rumbling," low-quality changer, a good ceramic cartridge will help you make it tolerable until you're ready to move on to better things.

Even if you plan to start with a monophonic system, a stereo cartridge makes sense. It can't be beat for compliance;

it does a superlative job with monophonic discs, and a tone arm can easily be wired to feed its signal to a monophonic amplifier. A stereo amplifier or preamplifier, of course, can be set to give you monophonic-type program from the output of a stereo cartridge.

Aside from the fact that an initial investment in a stereo cartridge will save you the waste of a mono cartridge when you're ready to go to stereo, there is an immediate advantage—an increasing number of recorded selections are being released only in stereo versions. Equipped with the right cartridge, you can enjoy them monophonically until you are ready to hear them stereophonically.

Obviously you want top frequency response in your cartridge; this is no great problem these days. The next thing you want to watch for is compliance. In addition to reducing record wear, high compliance means better response to transient musical passages and easier handling of loud passages.

As was mentioned earlier, the standard stereo stylus has a 0.7-mil tip. The very finest will actually be as small as 0.5 mil, but this isn't necessary for the average home music system. For years, the diamond stylus has been preferred over the sapphire variety, because its greater hardness reduces wear. The theory is that, though it costs more, the diamond is cheaper in the long run because of this extra playing time. However, because of the very low tracking force required by the better stereo turntables, the useful life of sapphire styli, in some cases, is prolonged so well that they can actually successfully compete with diamonds.

Whichever kind you use, it is a good idea to have your stylus examined periodically for signs of wear. Many record stores provide this service. If you want to check more frequently, and at your leisure, there are inexpensive magnifying devices on the market for this purpose.

Tuners

The exact type of tuner you want depends on your listening tastes and the activity in your locality. If your area is well served by FM stations and if the AM service of interest to you is also carried on FM, an FM-only tuner will be adequate.

If space saving is an important factor, you may be interested in getting a so-called "broadcast" receiver, or tuner-amplifier. As we saw in Chapter II, this is actually a tuner and ampli-

fier put together on one chassis, needing only the addition of a speaker system to make a complete, high-fidelity radio music system. The tuner-amplifier also offers other advantages, of which economy is not the least. The entire set of hi-fi controls is in one central location, making for greater convenience, and many of the tuner-amplifiers have been designed as handsome furniture additions to any room.

Your next big decision will be whether to get FM stereo now or later. As was mentioned previously, the FM tuners of today either have provision for a plug-in stereo multiplex adapter on the chassis or they are equipped with an output jack for connection to a self-powered adaptor. Such an adaptor is, in turn, plugged into the tuner inputs of your preamp or amplifier.

If you do want FM stereo, your most likely purchase would be a tuner with built-in stereo multiplex circuitry (Fig. 5-3).



Fig. 5-3. Solid-state (all-transistor-diode) FM-AM multiplex stereo tuner. Solid state design makes for a compact, lightweight unit that operates virtually free of heat or hum.

All things being equal, such a tuner will usually cost less than the combination of a mono tuner and an adapter. This assures you of the best possible matching, since the circuitry is integrated in the design. A single chassis obviously takes up less space than a separate tuner and adapter.

In any event, unless you are located right in the middle of a broadcasting complex, you want to be sure that you have plenty of sensitivity for stereo reception—at least 4 microvolts

for 30-db quieting. This means that a signal picked up by the antenna with a strength of not more than 0.000004 volt will be enough to separate the program from background noise by 30 db.

You will also want relatively wide-bandwidth reception to do full justice to the stereo signal. Another thing to watch out for is selectivity, the ability of the tuner to discriminate against stations on adjacent frequencies.

Still another very important consideration is freedom from drift, the tendency of a tuner to go "off center" so that it must be retuned. Many FM tuners have a feature known as automatic frequency control (AFC) which literally "locks" onto the center frequency of a station. Some tuners have this frequency stability built into them and do not need AFC.

One of the newer and more valuable features available in tuners is a system called *Dynamic Sideband Regulation* (DSR). This is designed to offset possible overloading of the signal at the broadcast transmitter. Such overloading, or overmodulation, violates Federal Communications Commission (FCC) rules; some stations do it accidentally from time to time. DSR eliminates the distortion that normally results from overmodulation. It also tends to reduce the distortion resulting from weak signals.

A tuner with low sensitivity or one located in a fringe area can be helped greatly by an outdoor antenna. An ordinary TV antenna can frequently do the trick, and a device known as a two-set coupler allows the tuner to share the same antenna employed with your TV set. A word of caution here, however. If you live in an apartment house with a master antenna system, it is possible that the FM portion of the spectrum has been deliberately filtered out; test the antenna with the tuner before you invest in a coupler.

When even an outdoor antenna proves insufficient, a signal booster can be a big help. This is a special amplifier designed for connection between the antenna and the tuner; it boosts the strength of signals going into the tuner. Another approach is the use of a directional antenna. If the FM stations in your area are dispersed around the compass, you will need a power-rotor to swing the antenna into line with the desired station.

A discussion of antenna rotors would obviously be out of place in a hi-fi book; however, for those who are interested we might mention that a wide variety of rotor styles are currently available at a cost that will suit almost any budget.

Amplifiers and Speakers

Whether you decide to use a separate preamplifier and power amplifier unit or to buy a combined preamp-amplifier will depend to some extent on what order of power you feel you need. The stereo preamp/amplifier in Fig. 5-4 is a typical com-



Fig. 5-4. Transistorized combination stereo preamp/amplifier unit.

bination unit designed to deliver 25 watts of audio power from each channel. As with automobile horsepower, there is power competition among amplifier manufacturers. Some combination units are available with rather high power ratings.

Just about any speaker system can be driven quite adequately under normal conditions by preamp/amplifier units now on the market. Your room and personal taste for perfection may, however, dictate the super high-powered approach of using a separate basic amplifier and a preamplifier.

The three interdependent factors to consider here are the room that will house your music system, the speaker system you choose, and the power output of the amplifier. Speaker and amplifier must be matched, at least so far as minimum power requirements are concerned. Another, but less pressing consideration, is not to run an amplifier beyond the power rating of the speaker. But this isn't very likely to happen unless you have "dial-happy" youngsters and fail to take precautions.

There are three basic kinds of rooms from an acoustic standpoint: live rooms, dead rooms, and normal rooms. A live room is one that has many reflective surfaces which promote reverberation and thus intensify sounds; treble often tends to become strident in such a room. Typical of this would be a playroom with a low plaster ceiling, linoleum flooring, wood-

panelled walls, and bare wooden, metal, or plastic furniture. The classic example of a live room is the average bathroom.

A living room that is complete with thick wall-to-wall carpeting, heavy draperies, overstuffed furniture, and possibly a high ceiling can be very dead acoustically because of its multitude of sound-absorbing surfaces. If such a room were very large, it could eat up audio power before the music acquired any hint of sparkle and fullness.

The acoustically-normal room is a cross between these two extremes, the most desirable from the high-fidelity standpoint. If you added sound-absorbent material on that playroom ceiling and draperies and, perhaps, some foam-upholstered furniture, you would come closer to the normal room. That living room would also be more nearly acoustically normal if it had a lower ceiling and the heavy draperies were changed to a lighter fabric. But if your rooms are decorated the way you like them, acoustically extreme or not, the thing to do is to fit the speakers and amplifier to the room's characteristics.

Forgetting power for a moment, consider the tonal characteristics of a speaker. Because high frequencies are particularly susceptible to absorption, you would probably find a relatively sharp, bright-toned speaker more satisfactory in a dead room. On the other hand, in a live room where crisp biting highs ricochet around madly, a gentler mellow-toned speaker will undoubtedly prove more enjoyable. In the normal room, you should seek a speaker with an absolute minimum of any kind of tone coloration.

Now examine how a room affects the power needs. For the purposes of this discussion, single-speaker units will be referred to. This means that, for a pair of stereo speakers, the power amplifier would have to deliver a total wattage double the figures mentioned below.

Take an extremely low efficiency speaker, a high-compliance type housed in a bookshelf-size case with infinite baffle. Such a speaker system in a relatively live room of 4,000 cubic feet would settle for 10 watts. In an acoustically normal room of this size it would need 15 watts, and in a dead room, 20 watts.

Sticking to the 4,000-cubic-foot space, what would a high-efficiency speaker system need? In the live room, 2.5 watts, in the normal room 3.75 watts, and in the dead room it would need 5 watts. A speaker of medium efficiency in the live room would eat up 6.3 watts; in the normal room, 9.45 watts; and in the dead room, 12.6 watts.

Speakers are the hardest components of the hi-fi system to rate, because everything really boils down to what sounds good to the individual listener. One individual's ideal setup can, strangely enough, sound just terrible to somebody else. There is one very important thing to remember about speaker quality. The better it is, the more it will show up the shortcomings of the other components. A good bass reproducer is not likely to please the listener if it is matched to a "rumble-rich" record player; any form of broadcast or amplifier noise will be reproduced with painful clarity. So, if you are going to start out with the best possible speaker system, be prepared for less-than-ultimate sound unless you match it with the best-possible program-source and amplifying components.

Although earphones have always figured into hi-fidelity systems to some extent, the advent of stereo has made them more popular than ever. Part of the reason for this popularity has been the improvement in their ability to reproduce bass, an accomplishment that has always eluded headsets in the past.

Stereo earphones, such as those in Fig. 5-5, treat you to



Fig. 5-5. Stereophonic high-fidelity headphones.

absolute stereo, without any worries about speaker placement or room acoustics. They also permit you to enjoy your music at earsplitting volume, if this sort of thing suits you, without bothering others. The only criterion, aside from sound quality and price, in judging earphones is comfort. Make sure the earphones you select are well padded and do not fit too tightly. Your listening pleasure will not be enhanced by a headache. Many amplifiers and preamps now come equipped with a

front-panel earphone jack to simplify hookup.

Focusing sharply on the amplifier and preamp, it can be said that most of them perform creditably within the limits of their rated power. If your collection includes many long-playing records, old European recordings, and even 78's, you might want the fullest record-compensation facilities available. The number of program sources you ultimately expect to enjoy will influence your desire for input facilities—most units are pretty complete on this score today.

Should you plan to start with a relatively inexpensive record-playing unit, you will probably find a rumble filter handy, and any number of cherished old, but scratchy, discs in your collection will probably suggest the advisability of a scratch filter.

While the primary function of a speaker system is to produce true sound, there is no denying that it occupies space and makes itself felt as any other piece of furniture in a room. The fact that stereo requires two speakers obviously makes this factor doubly important. All speaker enclosures, regardless of size or type, are available in a wide variety of finishes and woods. They can also be purchased unfinished.

Finally, it is entirely possible to take an existing piece of furniture and convert it to a fine speaker enclosure, often without the slightest effect on its outward appearance. If infinite baffling is your goal, totally unobtrusive wall or closet installations can produce excellent results where they are physically feasible.

Components in a modern, high-fidelity music system are now compact, available in handsomely styled cases that can be easily installed.

TAPE RECORDERS

If you want to play commercially recorded stereo tapes but are interested in recording only monophonically, there are units available that make this possible. You can start with the most basic kind of tape transport deck and add electronics—even a portable case—as you choose, giving any kind of final versatility you may desire.

In a basic playback deck the chief interest is in getting the smoothest, most accurate transport system and the finest quality heads. All things being equal, decks with three motors generally outperform those that utilize a single motor to drive

the takeup reel and the supply-reel rewind as well as the tape capstan. But nevertheless, there are excellent units that manage very well with one high-quality motor.

Wow and flutter (low- and high-speed variations) are a particular problem in tape units. With the better recorders this type of distortion will be below 0.2% at 7½ ips. Reasonably acceptable units do not exceed 0.3%.

The basic tape player will have only a stereo playback head. This head should have the smallest-possible air gap to capture every frequency the tapes have to offer. If there are built-in preamps in the tape unit, they should match the frequency response of the heads.

For building up to a recorder later on, you should select a deck that will accept additional heads. Recorders must have at least two, one for erasing and one for recording and playback. Three heads, including one each for recording, erasing, and playing, are better for two reasons; they permit specialized design for best-possible results, and they make it possible for you to monitor your recording even as you make it.

For playing commercially recorded tapes, you can settle for a 7½-ips tape speed. As a practical matter, just about every transport also provides at least 3¾-ips as well, which is very useful for less-critical music recording when longer playing time or a bit of economy is desired. Some units also provide a 17⁄8-ips speed, which is suitable for inexpensive voice recording and, in some units, can reproduce music at least as well as a table-model AM radio.

Remember, the tape-head input of a high-fidelity preamp or preamp-amplifier is not equalized for any speed except 7½ ips. For best results at the lower speeds, you will probably need a specialized tape preamp.

CHAPTER 6

WHAT ABOUT KITS?

"I want to do it myself!"

This could well be the new declaration of independence of the over-indulged average American male.

With automated equipment in the shop, bookkeeping machines, microfilming and card punching operations in the office, power-driven devices and labor-saving gadgets all around the home, the areas for individual self-expression these days are becoming very limited.

This could explain the increasing popularity of the do-it-yourself project. And if the project involves the construction of a sophisticated piece of equipment, like a high fidelity amplifier or tuner, the challenge may be even more welcome.

Thousands of people of all ages are building hi-fi kits. The thrill and pride of accomplishment in completing a complex project is perhaps a major motivation. There are however, other good reasons for building a kit.

The fact is that there is a substantial saving—as much as 50%—in selecting a kit rather than a comparable factory-wired component. The builder contributes his own labor, and this is an important cost element of manufactured electronics devices.

It is also true that advanced design features have often appeared first in hi-fi products placed on the market in kit form. The explanation may lie in the greater flexibility of kit engineering, production and marketing with less need to amortize costs of any one model or design over an extended period.

So, for whatever reasons—perhaps just for sheer enjoyment

—more and more people are building hi-fi kits. You don't have to be an electronics technician to join this group. All that is really required is a degree of patience and the ability to follow instructions. The way today's kits are set up, you don't



Fig. 6-1. Spread of parts for a stereo amplifier kit.

even have to be able to tell a tube from a resistor to succeed with little effort.

Today there are kits for tuners, preamplifiers, basic amplifiers, preamp-amplifiers, pickup arms, turntables, and even tape equipment. Tape kits are usually restricted to the playback preamp-recording amplifier assembly, while the transports are customarily offered in assembled form.

Basic power amplifiers are about the simplest kits to put together because their circuitry is fairly simple and they generally have no controls. Preamplifiers are a bit more involved and therefore more time consuming. The most exacting kits are those for tuners; however, the most critical part of a tuner, the FM front end, is generally preassembled and aligned at the factory. This takes all the real difficulty out of assembling this sensitive instrument.

One of the big boons to the kit assembler is the printed-circuit board; these boards actually reduce the number of wire connections you must make.

To make assembly easy, a good kit includes every material you need, down to the right type of solder. The easy-to-understand instructions, which accompany such a kit, are generously illustrated with simple diagrams and pictures to rule out any possibility of confusion. The entire building process is outlined in a step-by-step procedure. Fig. 6-1 illustrates the various components and instruction data for a typical hi-fi kit. The instructions are virtually foolproof. Such items as resistors are neatly mounted on cards and clearly identified so that there is no hunting around for the right one at any given point in the assembly operation. All other electronic components have their values clearly marked for immediate identification. All wires are precut to the correct sizes, and their ends are stripped of insulation and tinned to make soldering as easy as possible. Color coding eliminates any uncertainty about which length of wire is the one for a particular connection. The chassis is prepunched, of course, so that all sockets, controls, and other parts fit precisely without any need for metal cutting or drilling. It is even possible, for a nominal charge, to have your handiwork checked by the factory and any errors corrected.

Actually, kits are sometimes more difficult to assemble for the individual who has some knowledge of electronics than they are for the complete novice. The expert often tends to rush ahead without paying strict attention to the instructions.

It is good practice, after you complete each section of an assembly, to retrace every step, paying particular attention to the soldered connections to make sure every wire is properly connected and that the solder joints are good. A so-called "cold" soldered joint can turn up as a troublemaker long after the assembly job is completed. To preclude such troubles, the instructions supplied with the kit include a detailed rundown on the proper soldering techniques.

No discussion of kits would be complete without mentioning one of the first hi-fi components available in kit form, the speaker enclosure. Still one of the most popular of kits, it involves little more than the ability to handle a screwdriver, cement a joint, and varnish—possibly also stain—a wood surface. These simple operations can produce a significant saving in cost.

CHAPTER 7

PLANNING A "BUILT-IN" SYSTEM

Today's high fidelity components are extremely compact and very attractively designed. Most owners feel that their hi-fi equipment can stand on its own—in plain view, on shelves, tables or bookcases—with apologies to no one. One of the major advantages of separate high fidelity components is flexibility in installations. You can buy ready-made cabinets that are designed for high fidelity applications, have cabinets made to order, or make them yourself, or you can literally build your music system into the room. Note examples of custom high fidelity installations on pages 4 and 5.

If you prefer speakers that require large enclosures, the built-in idea may prove especially attractive to you. A well-insulated wall can provide excellent infinite baffling. A fine place for an extension speaker system is a closet (Fig. 7-1). It can even continue to be used as a closet, if you don't object to looking at the rear of a speaker on the door when you open it. The clothes in the closet will serve as efficient sound absorbers to soak up high-frequency back waves, thereby eliminating unwanted resonances. Such a closet can usually serve as an exemplary infinite baffle, though it would probably prove awkward for stereo (unless you happened to have two with just the right spacing).

Many existing cabinets can also be converted into good speaker enclosures. The usual practice is to use them either

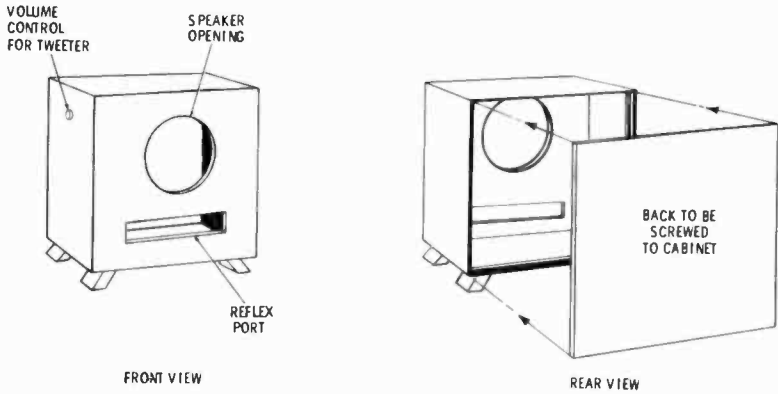

Fig. 7-1. A hi-fi speaker mounted on the inside of a closet door.

as infinite baffles, if they are large enough, or as bass-reflex enclosures. If you prefer a bass reflex, you should consult the speaker manufacturer for the proper size bass-reflex port. To work properly this port must match the speaker bass-propagation characteristics. You will also want to be sure the cabinet has the minimum cubic capacity necessary for your speaker. Should it be too big, you can always install an internal panel to cut it down to the right-size resonance cavity.

Even with the speaker manufacturer's help, it is sometimes hard to hit on just the right size for the reflex port. One approach is to make the port a bit oversize and then cut the opening down with a concealed screwed-on wood block. An easier method is to substitute a series of closely related holes for the single port. The sum of the holes should approach the size of a conventional port. Then all that has to be done is to run listening tests, drilling one additional hole after another until the bass sounds right. When you convert a cabinet this way, you must line about half its inner surfaces with a thick layer of sound-damping material, such as *Fiberglas* or rock wool. A good rule is to cover either the top or bottom, the rear panel, and one side panel with the material. If you intend to build your own bass-reflex enclosure, you will find the construction details in Fig. 7-2 helpful.

The two main things to consider when building such equipment as preamps, amplifiers, and tuners is easy access for servicing and adequate ventilation to preclude heat problems. Since nothing is really indestructible or infallible, the best components made will require servicing from time to time. Be certain that your equipment can be removed without too



NOTE: INSTALL SOUND INSULATION MATERIAL ON INTERIOR SURFACES. COVER BACK COMPLETELY AND APPROXIMATELY 50% OF REMAINING SURFACES.

Fig. 7-2. Construction details for a bass-reflex speaker enclosure.

much difficulty when the time comes for servicing.

Also, conventional vacuum-tube units, particularly those on high-powered amplifiers, create a lot of heat, which can cause the breakdown of components—not to mention wood warpage. Consequently, good ventilation is essential. Ideally, components should be mounted in a manner that guarantees plenty of free-air space around them for heat dissipation.

If you plan to mount your components stack style, be sure to place the tuner on top. Never install it too close to the amplifying components; heat tends to make a tuner drift out of tune.

Cabinetry should be open in the back or at least have large cutouts for ventilation. Small noiseless electric fans, specifically designed to help ventilate hi-fi components, are now on the market.

Of course, if you are using transistorized equipment, your heat problems will be reduced to a negligible factor. Transistors use a minimum amount of power, thereby giving off very little heat.

Wherever feasible, it is a good idea to put speakers and record-playing equipment in separate cabinets. Otherwise, on strong bass passages, there may be mechanical feedback of vibration that may be picked up by the phono cartridge. If you feel you must have the record player and speakers housed in the same cabinet, every effort should be made to isolate them from one another. One way is to literally mount the

speakers in an enclosure that is suspended, "floated," within another heavily-insulated enclosure. Tuners may be separated from amplifiers by distances up to 25 feet without difficulty. But for the sake of convenience, you will probably prefer to keep all your control elements grouped together. Separate pre-amps and amplifiers can also be separated by approximately 25 feet with a negligible loss of audio.

On the other hand, it is a good idea to keep a record player using a magnetic cartridge within 5 to 8 feet of the preamp in order to prevent high-frequency loss. This is even more true of tape decks in which the heads feed directly into the hi-fi preamp. Decks equipped with their own preamp facilities, however, can be placed without difficulty at greater



(A) Kitchen.



(B) Bedroom.



(C) Utility room.



(D) Recreation room.



(E) Patio.

Fig. 7-3. Possible locations for remote hi-fi speakers.

distances from the amplifier—especially if they make use of a low-impedance signal output.

For all practical purposes, there is generally no limit to the amount of separation between the speaker system and the power amplifier. A good amplifier located in the basement can effectively power a speaker on the second floor. The least expensive and most convenient connector for speakers is ordinary lamp-type electric "zip cord." But if your speaker wiring must run under carpeting, it would be better to use the same ribbon-type transmission line that is used to connect your TV set to its antenna.

You may want to use extension speakers in other rooms of your house, possibly even on your patio (Fig. 7-3). This generally calls for a higher-powered amplifier so that several speakers can be driven without undue strain.

Be sure to use speakers with the same impedance ratings. Strange things happen to impedances when you make parallel hookups; for example, two speakers, each with an 8-ohm impedance, present a combined impedance of only 4 ohms to the amplifier when they are linked this way. So they should be connected to the 4-ohm terminals on the amplifier.

It is possible to attach individual volume controls (Fig. 7-4) to extension speakers so that you can adjust the volume



Fig. 7-4. Speaker volume control.

without going to the amplifier. Should you want to use speakers on your patio, your best bet is a special outdoor-type high-fidelity speaker. Several such units offer surprisingly good bass, in addition to clear middle- and high-range tones.

GLOSSARY

A

A-B test—Comparison of sound from two sources, such as comparing original program to tape as it is being recorded by switching rapidly back and forth between them.

acetate backing—A standard plastic base for magnetic recording tape.

AES—Abbreviation for Audio Engineering Society; also refers to disc-recording curve specified by the AES that is no longer in use.

AF—Abbreviation for audio frequency, a range which extends from 20 to 20,000 cycles per second.

AFC—Abbreviation for Automatic Frequency Control, a circuit commonly used in FM tuners to compensate for frequency drift, thus keeping the tuner "locked" onto a station.

AM—Amplitude modulation, method of superimposing intelligence on a radio-carrier signal by varying the amplitude of the carrier.

amplification—Magnification or enlargement.

amplifier—An electronic device that magnifies or enlarges electrical voltage or power.

attenuation—Opposite of amplification, a reduction of electrical voltage or power.

audio—A term relating to sound.

audiophile—One who enjoys experimenting with high-fidelity equipment and is likely to seek the best-possible reproduction.

B

- background noise*—Noise inherent in any electronic system.
- baffle*—A barrier separating sound waves generated by the front and back of a speaker cone.
- bass-reflex enclosure*—A speaker enclosure with a bass port designed to reverse the phase of a speaker's backwave while using it to reinforce the front wave.
- binaural*—A type of sound recording and reproduction. Two microphones, each representing one ear and spaced about 6 inches apart, are used to pick up the material to be recorded on separate tape channels. Playback is accomplished through separate amplifiers (or a two-channel amplifier) or special headphones wired for binaural listening.

C

- capstan*—The spindle or shaft of a tape transport mechanism that actually drives the tape past the heads.
- capture ratio*—The tuner's ability to reject unwanted signals occurring at the same frequency as the desired signal. If an undesired signal, for example, is only 2.2 db less than a desired one, the undesired signal will be rejected. The lower the capture ratio figure the better.
- cardioid pattern*—A heart-shaped (directional) microphone-pickup pattern that tends to reject background noise.
- cartridge*—See pickup cartridge.
- ceramic*—A man-made piezoelectric element that is used as the basis of some phonograph pickups; it emits electric current when mechanically strained.
- changer*—A record-playing device that automatically accepts and plays up to 10 or 12 records in sequence.
- channel*—A complete sound path. A monophonic system has one channel, a stereophonic system has at least two full channels. Monophonic material may be played through a stereo system with both channels carrying the same signal. Stereo material played on a monophonic system mixes and emerges as a monophonic sound. An amplifier may have several input channels, such as microphone, tuner, and phonograph.
- channel balance*—Equal response from left and right channels of a stereo amplifier. A balance control on stereo amplifiers permits adjustment for uniform sound volume from both speakers of a hi-fi system.

- chassis*—The metal frame, or box, that houses the circuitry of an electronic device.
- compensator*—The fixed or variable circuit built into a pre-amplifier that compensates for bass and treble alterations that were made during the recording process.
- compliance*—Physical freedom from rigidity that permits a stylus to track a record groove exactly or a speaker to respond to the audio signal precisely.
- cps*—Abbreviation for cycles per second. See “cycle” and “cycles per second.”
- crossover network*—A filtering circuit that selects and passes certain ranges of audio frequencies to the speakers designed to reproduce them.
- crosstalk*—In stereo high fidelity equipment the amount of left channel signal that leaks into the right channel, and vice versa.
- crystal*—A natural piezoelectric element used in some phonograph pickup cartridges and microphones; it emits electric current when mechanically strained.
- cycle*—One complete reversal of an alternating current, including a rise to a maximum in one direction, a return to zero, a rise to a maximum in the other direction, and another return to zero. The number of cycles occurring in one second is the frequency of an alternating current. The word cycle is commonly interpreted to mean cycles per second, in which case it is a measure of frequency.
- cycles per second (cps)*—The unit for measuring the frequency or “pitch” of sound, various forms of electromagnetic radiation, and alternating electric current.

D

- damping*—The prevention of vibrations, response or resonances which would cause distortion if unchecked. Control is usually by friction or resistance.
- decibel (db)*—The unit for measuring the intensity or volume of sound; 0 db is the threshold of human hearing, and 130 db is the threshold of pain.
- de-emphasis*—The attenuation of certain frequencies; in playback equalization this offsets the pre-emphasis given to the high frequencies during recording.
- diaphragm*—A thin, flexible sheet which vibrates when struck by sound waves, as in a microphone; or which produces sound waves when moved back and forth at an audio rate,

- as in a headphone or loudspeaker.
- distortion*—The deviations from the original sound that crop up in reproduction. Harmonic distortion disturbs the original relationship between a tone and other tones naturally related to it. Intermodulation distortion (IM) introduces new tones caused by mixing two or more original tones.
- ducted port*—A cousin of the bass-reflex speaker enclosure in which a tube is placed behind the reflex port.
- dynamic cartridge (electrodynamic)*—A magnetic phonograph pickup in which a moving coil in a magnetic field generates the varying voltages of an audio signal.
- dynamic microphone*—A microphone that works on basically the same principle as a dynamic cartridge.
- dynamic range*—The range of loudness, or sound intensity, that an audio instrument can reproduce without distortion.

E

- efficiency*—In a loudspeaker, the ratio of power output to the power input, expressed in percentages—the higher, the better.
- enclosure*—A housing which is acoustically designed for a loudspeaker.
- electromagnetic*—Pertaining to radiated energy including radio waves and light waves; a phenomenon involving the inter-action of electricity and magnetism.
- electrostatic speaker*—A type of speaker in which sound is generated by charged plates that are made to vibrate as one is changed from positive to negative polarity, causing them to attract and repel each other.
- erase head*—The leadoff head of a tape recorder that erases previous recordings from the passing tape by generating a powerful random magnetic field.

F

- feed reel*—The reel of a tape recorder that supplies the tape.
- fidelity*—The faithfulness with which sound is reproduced.
- flat response*—The ability of an audio system to reproduce sound without deviation in intensity for any part of the frequency range it covers.
- flutter*—A form of distortion caused when a tape transport or a phonograph turntable exhibits rapid speed variations.
- FM*—See frequency modulation.

FM stereo—Broadcasting over FM frequencies of 2 channels of sound. Transmitting FM stereo is called multiplexing. Stereo FM (Multiplex) tuners are used for FM stereo reception. Many monophonic FM tuners have been designed to permit use of an FM stereo adapter.

folded horn—A type of loudspeaker enclosure using a horn-shaped passageway which improves the bass response.

frequency—The number of complete cycles of vibrations per unit of time, usually per second. Bass tones are expressed in low frequencies, treble tones in high frequencies.

frequency modulation—A method of broadcasting which varies or modulates the frequency of the carrier signal, instead of the amplitude or strength of the signal, as in amplitude modulation (AM). Most of the static and noises in the radio spectrum are in the form of AM signals. Advantages of FM are almost complete freedom from atmospheric and man-made interference as well as little or no interference between stations. FM is the selected high fidelity medium for broadcasting high quality program material.

frequency response—A rating or graph which expresses the manner in which a circuit or device handles the different frequencies falling within its operating range. Thus, the frequency response of a high fidelity amplifier may be specified as being essentially flat or uniform between 20 and 20,000 cycles per second.

G

gain—The degree of amplification a signal receives from an amplifying device.

H

harmonic distortion—See distortion.

head—The electromagnetic device used in magnetic tape recording to convert an audio signal to a magnetic pattern, and vice versa.

headphones—Small sound reproducers resembling miniature loudspeakers used either singly or in pairs, usually attached to a headband to hold the phones snugly against the ears for private listening. Available in monophonic or stereo design.

hill-and-dale—A phonograph reproduction system in which the stylus moves up and down instead of sideways, or laterally.

horn—A type of speaker in which the mechanical vibrations are coupled to the air by a flaring horn-like passageway instead of a cone.

hum—Noise generated in an audio device by the power line or current.

I

IHF (*IHF*)—Refers to the Institute of High Fidelity Manufacturers, now called the Institute of High Fidelity, Inc. A group of manufacturers who devise and publish standards and ratings for high-fidelity equipment.

image rejection—The effect noticed when one station is heard faintly in the background of another. The tuners' ability to eliminate the background station. Expressed in db, the higher, the better.

impedance—Unit of measure, given in ohms, for resistance to an alternating current; it must be matched up between audio units that are connected to each other.

infinite baffle—Speaker mounting arrangement in which the front and back waves of the cone are totally isolated from each other.

input—Connection through which an electrical current, or signal, is brought into an electronic device.

intermodulation distortion (IM)—Two distinct and separate frequencies that are mixed by the amplifier to form the sum and difference of the combined frequencies. Expressed as a percentage, the less the better. Also see distortion.

ips (inches per second)—The unit of speed measure for tape-travel through a transport mechanism.

J

jack—Female receptacle for a plug-type connector.

L

lateral system—System of disc recording in which stylus moves from side to side.

level indicator—A neon bulb, meter, or cathode-ray ("magic-eye") tube, used to indicate recording level.

load—The device to which electrical energy is supplied; e.g., a speaker constitutes the load of an amplifier.

loudness control—Device that boosts treble and particularly bass tones in an amplifier as the volume is reduced; used to compensate for the listener's insensitivity to the extreme ends of the audio range.

M

- magnetic tape*—Plastic tape with an iron-oxide coating for magnetic recording.
- manual player*—A manual record-playing device with a changer-type motor.
- micro*—Prefix meaning one one-millionth.
- milli*—Prefix meaning one one-thousandth.
- mixing*—Blending two or more signals for special effects.
- monophonic*—Recording and reproduction systems in which all program material is on one channel (e.g., as opposed to binaural or stereophonic). Monophonic, sometimes referred to by the older term monaural, is usually, although not necessarily, associated with a one-speaker speaker system.
- multiplexing*—System of broadcasting in which two or more separate channels can be transmitted on one FM carrier. Usually used to denote stereo broadcasting.

N

- NAB curve*—Tape-recording equalization curve set up by National Association of Broadcasters; it is accepted as the standard for commercially recorded tapes.

O

- ohm*—Unit of electrical resistance.
- output*—Connection through which an electrical current, or signal, passes out of an electronic device.

P

- patch cord*—A shielded cable used to connect one audio device to another.
- phase*—The position at any instance which a periodic wave occupies in its cycle. Any part of a sound wave or signal with respect to its passage in time. Two devices are in phase when they provide the same parts of sound or signal simultaneously and out of phase to the extent that one leads or lags behind the other.
- phase distortion*—Disturbance of the natural timing sequence between a tone and its related overtones. The ear can't detect phase distortion but it is of consequence in television and test circuits. Expressed in degrees.
- pickup cartridge*—A device used with phonographs to convert mechanical variations of the record groove into electrical impulses.

- piezoelectric*—A crystal or ceramic substance that emits an electrical voltage when it is mechanically strained or twisted; it is used in phonograph pickups and microphones.
- playback head*—The last head on a tape recorder or the only head on a tape player used to convert the magnetic pattern impressed on a passing tape to an audio signal.
- PM*—A permanent magnet that is a basic component of most high-fidelity speakers.
- polyester backing*—A plastic material used as a base for magnetic recording tape. Developed by DuPont as Mylar, it is extremely strong and resistant to the effects of heat and humidity.
- power amplifier*—Amplifier used to drive a speaker.
- power output*—The maximum power supplied by an amplifier, expressed in watts.
- preamplifier*—Amplifying device used to give an extremely weak signal enough strength to drive a power amplifier.
- pre-emphasis*—Exaggeration deliberately introduced into high frequencies during recording for technical reasons.
- print-through*—Magnetization of a layer of tape by an adjacent layer, usually most troublesome with thin-based tapes.

Q

- quarter-track recorder*—A tape recorder that uses one quarter the width of the tape for each recording; two of the four tracks are used simultaneously for stereo recording.
- quieting*—Standard of separation between background noise and program material produced by a radio tuner.

R

- radio receiver*—Tuner and amplifier unit on one chassis—also called a tuner-amp.
- record head*—The second head of a tape recorder; it is used to convert an audio signal to a magnetic pattern on the passing tape.
- record-playback head*—Head on a tape recorder performing both record and playback functions.
- recording amplifier*—Amplifying circuit of a tape recorder used to prepare an audio signal for input to the record head, and bias current to the erase head.
- RIAA curve*—Standard disc-recording curve specified by the Record Industry Association of America.

reverberation—Persistence of sound after its origin has stopped; deliberately introduced in some audio devices by time-delay and feedback techniques to impart feeling of fullness experienced in concert halls.

rolloff—Another term for de-emphasis, deliberate playback attenuation of high frequencies that had been pre-emphasized during recording.

rumble—Low-frequency vibration created by an electric motor; particularly prevalent in low-quality phonograph turntable motors.

rumble filter—A low-frequency filter circuit designed to eliminate rumble.

S

scratch filter—A high-frequency filter circuit to eliminate scratchy sounds.

selectivity—The measure of the ability of an electronic device to select a desired signal while rejecting those adjacent to it.

sensitivity—The minimum input signal required by an electronic device, such as a tuner, to deliver a specified output signal.

separation—The degree to which one channel is kept from being blended with the other. Expressed in db, the higher the better.

signal-to-noise ratio—The degree expressed in db, by which program material is separated from background noise.

soft-suspension speaker—Speaker designed without inherent springiness to use the spring effect of a trapped backwave for restorative force.

speaker—A device that converts electrical impulses into sound.

stereophonic sound—A system whereby sound picked up by two separated microphones is recorded on separate channels and played back through separate channels driving their own speakers.

stroboscopic disc—A cardboard or plastic disc used to check the accuracy of turntable speed.

stylus—Term for phonograph needle.

super-tweeter—A speaker capable of reproducing the highest frequencies of the audio range.

T

take-up reel—The reel of a tape recorder that winds the tape after it has passed the heads.

- tape deck*—Any tape unit without its own power amplifier and speaker, usually also without a case and designed for custom installation in a high-fidelity system.
- terminal*—A connecting point.
- tone arm*—The pivoted arm on a phonograph that houses the pickup cartridge.
- tone control*—A control, usually part of a resistance-capacitive network, used to alter the frequency response of an amplifier so that the listener can obtain the most pleasing sound.
- tracking*—The path of a phonograph pick-up stylus in following record grooves.
- transducer*—A device that converts electrical energy to mechanical energy or vice versa; e.g., pickup cartridges, speakers, microphones.
- transient response*—The ability of a speaker to follow sudden changes of sound level fed from an amplifier.
- transistor*—A solid-state device made from semiconductor materials—metals such as germanium or silicon which can act as electrical insulators or conductors, depending on the electrical charges placed upon them. Transistors can be substituted for vacuum tubes in almost all applications involving amplification, rectification, detection or oscillation. Among the important features transistors possess are: (1) they require no heater current; (2) their small physical size makes them ideal for space-saving applications; (3) their almost unlimited service life.
- transport*—The mechanism that moves magnetic tape past the heads.
- tuner*—A device that receives radio broadcasts and extracts the audio signal.
- turnover*—Frequency above which constant velocity cutting is employed in phonograph recording, and below which a constant amplitude is maintained. In a phono preamp, frequencies below turnover are boosted at the rate of 6 db per octave to compensate for the cutting process.
- turntable*—The circular part of a record-playing device that carries the disc on its circular journey; also the name given a high-quality device for “spinning” records.
- tweeter*—A speaker designed to reproduce the high frequency range of the audio spectrum.

V

volume—The intensity, or magnitude, of sound.

W

watt—The unit of measurement of electrical or acoustical power. The rate of work represented by a current of one ampere under a pressure of one volt. Electrical wattage is a measure of the power an amplifier can develop to drive a loudspeaker. Acoustical wattage is a measure of the actual sound a loudspeaker produces in a specific environment. In any amplifier-speaker system, the two figures will differ widely because the low efficiency of speakers requires that they receive high amplifier power to produce satisfactory sound levels over a wide range of frequencies.

woofer—A speaker designed to reproduce the bass, or low-frequency, portion of the audio-frequency range.

wow—A form of distortion caused when a tape transport or a phonograph turntable exhibits slow speed variations.

INDEX

A

Acoustic, 71
AFC, 70
AM, 14
Amplifiers, 35-37

B

Baffle, 45
 infinite, 46
Balance, tonal, 9
Bass control, 39
Bass-reflex, 48
Binaural, 51

C

Cardioid pickup pattern, 31
Cartridges 21-23
Chassis, "hot," "cold," 32
Color coding, 78
Compensation, 37-38
Compliance, 22, 23, 58, 67
Components, 64-66
Controls, 39-40
Crossover network, 43

D

Decibel (db), 9
Diamond stylus, 68

Distortion, 36
 harmonic, 10
 intermodulation, 10-11
DSR; *See* Dynamic Sideband
 Regulation
Dynamic range, 11
Dynamic Sideband Regulation,
 70

E

Electromagnetic principles, 26
Electrostatic speaker, 45
Equalization, 38
Erase head, 27

F

Fiberglas, 80
Filters, 40
Flatness of response, 9, 30
Flutter, 19, 75
FM, 14-15
 stereo, 60-63
Frequency response, 22
Fundamental, 8

H

Harmonic, 9
Harmonic distortion, 10

- Headphones, 72
 High fidelity, 7
 High-frequency loss, 82
 Hill-and-dale, 57
 Horn, 47, 56
 Human ear, range, 8
- I**
- Impedance, speaker, 83
 Input, amplifier, 34
 Intermodulation distortion (IM), 10-11
- J**
- Jack, headphone, 35
- K**
- Kits, 76
- L**
- Loss, high-frequency, 82
 Loudness control, 40
- M**
- Magnetic tape, 25-27
 Matrix, 62
 Mechanical resonance, 21
 Megacycle, 14
 Microphones, 30-31
 Modulate, 14
 Motor, changer, 19-20
 Multiplexing, 61
Mylar, 28
- N**
- Needle; *See* Stylus
 Negative feedback, 36
- O**
- Output, amplifier, 35, 37
 Overtones, 9
- P**
- Packaged unit, 64
 Pickup pattern, microphone, 31
 Pitch, 8
 Polyester bases, 28-29
 Port, 48, 80
 ducted, 48
 Preamplifier, 12, 37
 Pressure, stylus, 21
 Push-pull, 35-36
- Q**
- Quieting, 69-70
- R**
- Radio transmission, 13
 Range, dynamic, 11
- Range—*Cont'd.*
 of the human ear, 8
 Recording principle, magnetic tape, 26-27
 Recording tape, 28-29
 Reluctance, 22
 Resonance, mechanical, 21
 Response
 flatness of, 9
 frequency
 crystal cartridge, 22
 tape recorder, 26-27
 transient, 11
 Rumble, 20
 filter, 74
- S**
- Sapphire stylus, 68
 Scratch filter, 74
 "simulcast", 53
 Sound, 7-8
 Speaker, 41-45
 impedance, 83
 Squawker, 43
 Squeal, 27
 Stereo, 50
 FM, 60-63
 multiplexing, 61
 Styli, 68
 Stylus, 57-59
 pressure, 21
 definition, 18
- T**
- Tape, magnetic, 28-29
 Tape recorder frequency response, 26-27
 Tape, recording, 28-29
 Tonal balance, 9
 Tone arm, 20
 Tone controls, 39-40
 Transducer, 21
 Transient response, 11
 Transistor, 40-41, 81
 Transmission, radio, 13
 Treble control, 39
 Tweeter, 43
 Tuner, 68-70
 FM stereo, 60-63
- U**
- Units, packaged, 64
- V**
- Volume control, 40
- W**
- Woofers, 43
 Wow, 19, 75

THE ALLIED ELECTRONICS LIBRARY

ELECTRONICS DATA HANDBOOK



Contains math constants and algebraic formulas; log and trig tables; tables of roots, powers and reciprocals; formulas for Ohm's law, resistance, capacitance, inductance, impedance, vacuum tubes, transistors, etc. color codes; interchangeable tubes; lamp data; wire table; metric relationship; decibel tables; attenuator networks. 112 pages, 6x9".

23 J 7398 EP. Postpaid in U.S.A. \$1.00

USING YOUR TAPE RECORDER



ABC's of modern tape recording. Written in simple language for the hobbyist and nonprofessional user. Chapter headings: Sound—What Is It; Your Recorder; Microphone Recording; Recording "Off the Air"; Dubbing from Record and Tape; Editing Tape; Sound and Special Effects; Sound for Slides and Home Movies; Recorder Maintenance. 96 pages, 5 1/2 x 8 1/2".

23 J 7730 EP. Postpaid in U.S.A. 50c

UNDERSTANDING SCHEMATIC DIAGRAMS



A basic text which is a must for the understanding of the science of electronics. Explains the functions of components, their use in electronics circuits, the symbols and techniques of schematic diagrams. Chapters: Getting Started; Fundamental Components; Tubes and Semiconductors; Other Components; Connecting Devices; Putting It All Together. Illustrations, diagrams, and symbols. 112 pages, 5 1/2 x 8 1/2".

23 J 7931 EP. Postpaid in U.S.A. 75c

GETTING STARTED IN ELECTRONICS



Covers types of transmission—AM, FM, TV, CW, and short wave. Explains uses of basic components, electron theory, resistance, magnetism, capacitance, antennas, and test equipment. Building projects: crystal set, walkie-talkie, 1-tube set, transistor set, intercom, burglar alarm, light detector, code-practice oscillator, and 5-band short wave receiver. 112 pages, 5 1/2 x 8 1/2".

23 J 7705 EP. Postpaid in U.S.A. 50c

HOW TO BUILD ELECTRONIC KITS



Discusses types of kits available; how to select kits, tools required. Chapters: The Values of Kit Building; How To Identify Parts and Components; Connecting Components; Electrical wiring; Soldering. Includes details on building 3 popular kits. 96 pages, 5 1/2 x 8 1/2".

23 J 7066 EP. Postpaid in U.S.A. 50c

ALL ABOUT HI-FI AND STEREO



Helps you understand, select, and enjoy your music system. Covers components used; program sources—records, tape, broadcasts; discuses tape recorders, kits, use of transistors, and includes data on planning a built-in system. Glossary, charts, and illustrations. 96 pages, 6 1/4 x 8 1/2".

23 J 7699 EP. Postpaid in U.S.A. 50c

BEST WAYS TO USE YOUR VOM AND VTVM



Covers construction and use of VOM and VTVM. Tells how to test capacitors, chokes, switches, and other components. Covers functions of shunts and multipliers and explains calculations necessary for obtaining correct shunt and multiplier values. Discusses use in CB, ham radio, and hi-fi. 112 pages, 5 1/2 x 8 1/2".

23 J 7067 EP. Postpaid in U.S.A. 50c

ENCYCLOPEDIA OF ELECTRONICS COMPONENTS



Alphabetical listing of the basic electronics components with a clear description and illustration of each. Prepared for the newcomer, hobbyist, and experimenter, this is really an "instant" course in electronics. Edited by A. C. Todd, Ph. D., Professor of E.E. Illinois Institute of Technology. 112 pages, 5 1/2 x 8 1/2".

23 J 7930 EP. Postpaid in U.S.A. \$1.00

UNDERSTANDING AND USING YOUR OSCILLOSCOPE

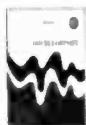

Edited by William A. Stocklin, Editor, Electronics World. Chapters: History of the Cathode-Ray Tube; Basic Oscilloscope Principles; Interesting Applications for an Oscilloscope; Oscilloscope Tests and Measurements; Types of Scopes Needed for Various Applications; Auxiliary Equipment; Oscilloscope and Test Equipment Kits. 128 pages, 5 1/2 x 8 1/2".

23 J 7932 EP. Postpaid in U.S.A. 75c

UNDERSTANDING AND USING CITIZENS BAND RADIO



Chapter headings: Getting Acquainted With CB Radio; Obtaining the License; About the Equipment; Setting Up A Station (Mobile and Base Station Installations); CB Antennas; Operating CB Equipment; The Uses and Abuses of CB Radio. Discusses CB servicing. Covers operating procedure and using the "10" signals. 112 pages, 5 1/2 x 8 1/2".

23 J 7701 EP. Postpaid in U.S.A. 50c

UNDERSTANDING TRANSISTORS AND TRANSISTOR PROJECTS



Covers basic transistor applications, characteristics, and construction. Discusses NPN, PNP, alloy-junction, drift, tetrode, surface barrier, power types, etc. Transistor projects: audio amplifier, 1-transistor radio, capacity-operated relay, code-practice oscillator, wireless broadcaster, timer, electronic flasher, and photoelectric controller. 112 pages, 5 1/2 x 8 1/2".

23 J 7602 EP. Postpaid in U.S.A. 75c

INTEGRATED CIRCUITS FUNDAMENTALS & PROJECTS



By Rufus P. Turner, Ph.D. Development, design, applications and electrical features of IC's are covered in non-technical language. Provides details on use of IC's in easily-built projects including a simple audio preamplifier, high gain preamplifier, quarter-watt audio amplifier, crystal oscillator/frequency standard, AF/RF signal tracer and DC voltmeter. 96 pages, 5 1/2 x 8 1/2".

23 J 7625 EP. Postpaid in U.S.A. 75c

DICTIONARY OF ELECTRONIC TERMS



New eighth edition. Over 4,800 terms. Edited by Robert E. Beam, Ph.D., Professor of Electrical Engineering, Northwestern University. Covers radio, monochrome and color TV, high fidelity recording, Radio Amateur, Citizens Band, Public Address and solid-state and integrated circuit technology. Includes aerospace, math, physics and computer terms. 112 pages, 6x9".

23 J 7756 EP. Postpaid in U.S.A. \$1.00





published by

ALLIED RADIO CORPORATION

CHICAGO 80