

XTAL

JULY
1948

Vol. 10 No. 7

for the

radio amateur

O. A. Sandoz, VE1QZ
76 Quinpool Rd.,
Halifax, N. S.

7/48

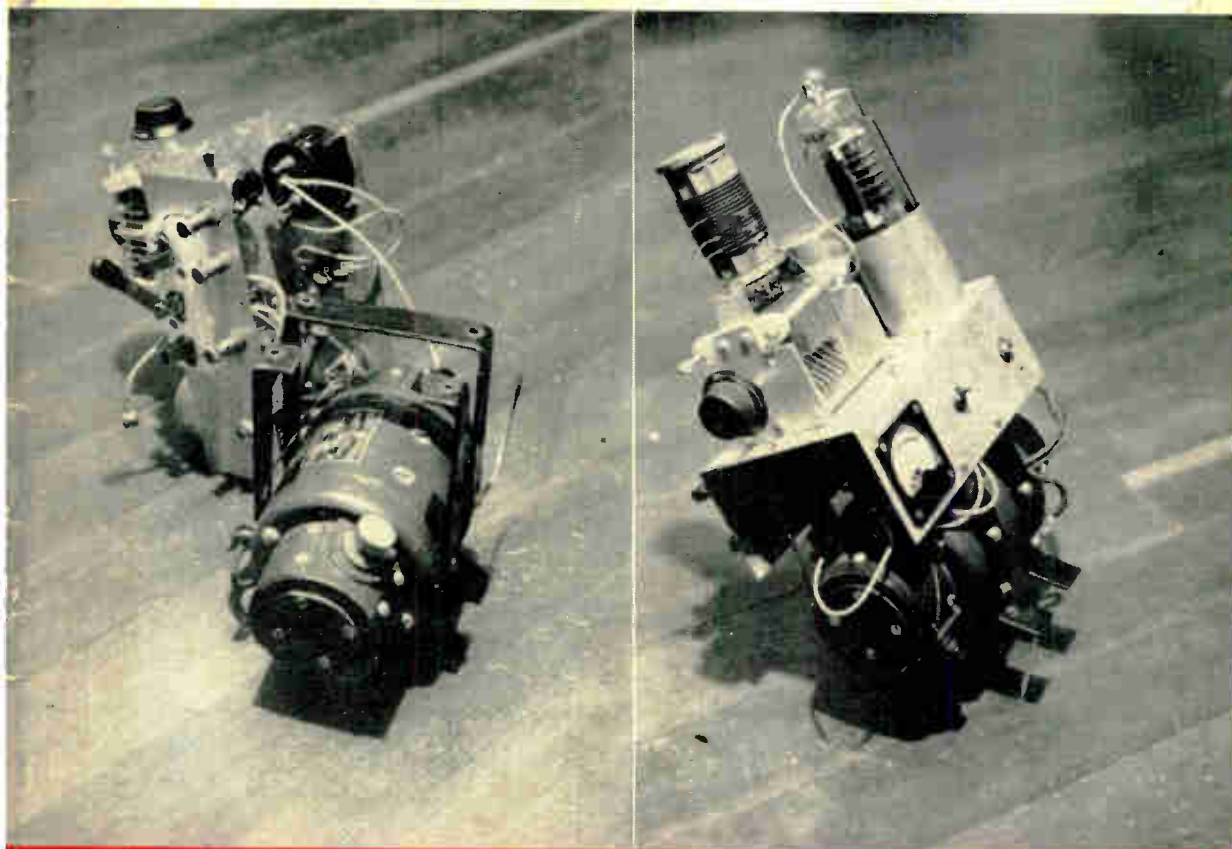

OFFICIAL JOURNAL
THE CANADIAN AMATEUR RADIO OPERATORS' ASSOCIATION
TORONTO, ONTARIO



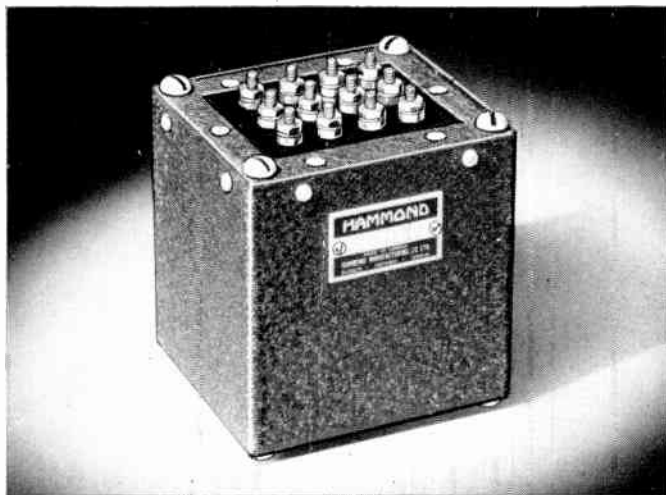

Universal Driver Transformers

Type	Watts	D.C. Per Wndg.	Weight
1703	15	70 MA.	6 lbs.
1705	30	100 MA.	10 lbs.
1707	60	140 MA.	16 lbs.

Ten ratios from 1.25:1 to 6.3:1. Total Pri. to half sec.

PRACTICAL APPLICATION

Driver	Mod.	Ratio Pri. To Half Sec.
PP2A3	PP8G9	2.1:1 for 100W - 1.97:1 for 145W
PP2A3	PP811	3.2:1 for 175W - 2.66:1 for 220W
PP2A3	PPTZ40	1.57:1 for 225W - 1.57:1 for 250W
PP2A3	PP805	1.57:1 for 300W - 1.25:1 for 370W
PPP2A3	PP810	1.57:1 for 590W - 1.25:1 for 725W
PP6L6	PP809	4.1:1 for 100W - 3.2:1 for 145W
PP6L6	PP811	4.1:1 for 175W - 3.2:1 for 220W
PP6L6	PPTZ40	2.04:1 for 225W - 2.04:1 for 250W
PP6L6	PP805	2.55:1 for 300W - 2.04:1 for 370W
PP6L6	PP810	1.57:1 for 590W - 1.25:1 for 725W

500 OHM line to mod. grids—connect line to 7 and 8—join 7 and 11, 8 and 12—connect grids to 2 and 5, join 3 and 4 for "C" bias.

PP2A3 driver class AB1 + 300 V—62 V fixed bias 15 watts output. PP6L6 driver class AB1 with 20% feedback + 360 V, 250 OHM cath. res. output 20 watts. The above ratios are correct only when the driver is operated at the specified voltages.

Write for free driver diagrams using Hammond Transformers

Distributed Through Leading Jobbers From Coast To Coast

HAMMOND MANUFACTURING COMPANY

Limited

GUELPH · ONTARIO · CANADA

PR's pay off!



Whether you're stalking an Asian or probing for a W6 . . . you'll find that PRs pay big dividends. Today's crowded bands emphasize more than ever that it PAYS TO STAY PUT. It's no fun to drift on the sea of QRM . . . unknown, unloved, un-QSOed. It's a lonely life at best. More and more, smart operators are sticking to crystal control for all but special occa-

sions. Pick your favorite frequencies . . . buy inexpensive PR Precision CRYSTALS to cover them. You'll find that life on the bands isn't so bad after all. USE PR and KNOW WHERE YOU ARE! Get the exact frequency (integral kilocycle) at your jobber's. PRs are unconditionally guaranteed.—Petersen Radio Company, Inc., 2800 W. Broadway, Council Bluffs, Iowa. (Telephone: 2760)



<p style="text-align: center;">10 METERS PR Type Z-5.</p>	<p>Harmonic oscillator. Ideal for "straight through" mobile operation. High activity. Heavy drive without damage in our special circuit</p>
<p style="text-align: center;">20 METERS PR Type Z-3.</p>	<p>Harmonic oscillator. Low drift. High activity. Can be keyed in most circuits. High power output. Just as stable as fundamental oscillators</p>
<p style="text-align: center;">40 & 80 METERS PR Type Z-2.</p>	<p>Rugged, low drift fundamental oscillators. High activity and power output with maximum crystal currents. Accurate calibration</p>

NOW YOU CAN GET MORE FOR YOUR MONEY WITH BUD

The surest way to get more for your money, when you buy, is to get two or more items for the price of one. Just look at the money savers listed below and you will see why "You Can Get More For Your Money Now" by buying BUD products.

COMBINATION CODE PRACTICE OSCILLATOR AND MONITOR

The new BUD CPO-128 is a dual purpose unit that operates as a CODE PRACTICE OSCILLATOR until your amateur license is obtained and then as a good C. W. MONITOR after you are on the air. Its function as an audio oscillator enables it to be used in many industrial applications. **CPO-128 now at your distributor for \$17.07 net.**



FOR THE CONSCIENTIOUS 'HAM'

For the "ham" who is conscientious in his compliance with federal regulations the BUD FCC-90 Frequency Calibrator is a must. It is a 100 kc crystal oscillator that is COMPLETELY SELF POWERED!

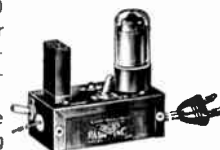

That's where the money saving aspect of this item comes in. No chance that you will damage an expensive receiver accidentally while trying to tap the power supply of your receiver. NOT WITH THE FCC-90. Just plug it into your AC line and it is ready for operation. **At \$19.47 this is a unit that should be in your shock.**

HERE'S A REAL MONEY SAVER



Where else can you get not one, not two, but FIVE for the price of one?

The BUD GIMIX GX-79 can be used as a Wavemeter, a Monitor, a Field Strength Indicator, a Carrier Shift Indicator and a Sensitive Neutralizing Instrument.

Savings like this are not found every day. **Ask your**

distributor to show you the BUD GIMIX. \$11.23 net.

WHEN SPENDING IS SAVING!

For the one who wants to save buying an expensive radio-phonograph combination, the

BUD WO-6 WIRELESS PHONOGRAPH OSCILLATOR is a real money saver. It is a FULLY ENCASED compact unit that enables you to convert your record player to wireless operation. Record reproduction is then possible through your radio receiver without the necessity of interconnecting wires. Comes completely wired and tested. Operates from 115 volts AC or DC. Ask to see the WO-6 at your distributor today. It means real savings

at only\$10.74



Visit Bud booth No. 131 of the National A.R.R.L. Convention, Milwaukee, Wisc., Sept. 4-6, 1948.

Canadian Representative

HEFCO AGENCIES

95 Harding Blvd., Toronto, Canada



The mark of perfection

BUD RADIO INC.

CLEVELAND 3, OHIO

This coupon is the key to the new lower prices in BUD Products.

BUD RADIO, INC.,
2122 East 55th St., Cleveland 3, Ohio.

Send copy of NEW BUD CATALOG.

Name

Address

City State

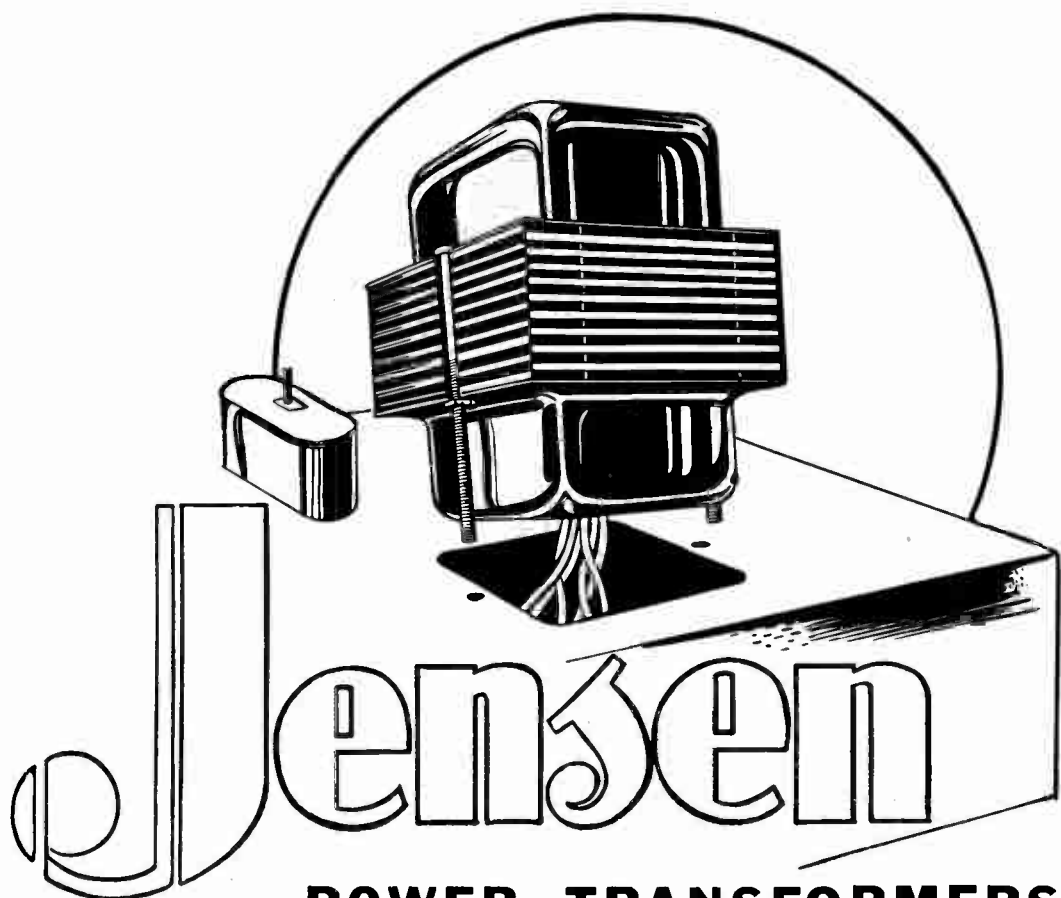

Jensen

POWER TRANSFORMERS

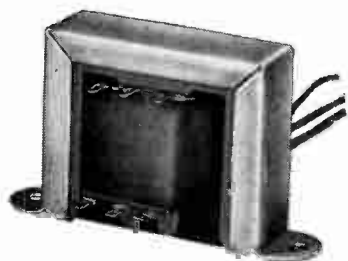

Universal Output Transformer

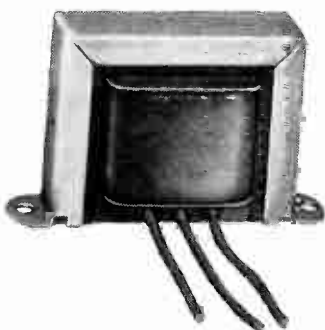

Input Transformer

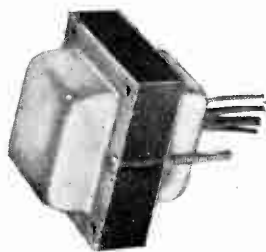

Power Transformer

Copper Wire Products Ltd.

11 KING ST. WEST

TORONTO, ONTARIO



GENERAL ELECTRIC

VARIABLE RELUCTANCE PICKUP

● HERE'S EXTRA BUSINESS for your Service Department.

Easy to install... easier to sell... the G-E Variable Reluctance Pickup and the SPX-001 preamplifier give your customers improved reproduction from their treasured recordings. New sales are assured because listening tests prove the new pickup and pre-amp are the best yet.

The sapphire stylus rides like a feather in the record grooves, responds only to lateral motion. Hundreds of broadcast stations have changed over to the G-E pickup for studio use. Stock is available immediately from your local jobber or nearest C-G-E office.

Take advantage of the widespread public interest in this excellent service item.

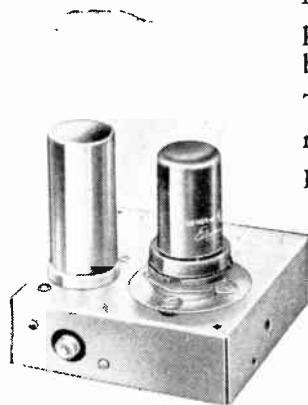

CANADIAN GENERAL ELECTRIC CO LTD

HEAD OFFICE: TORONTO

48-TU-5R



XTAL

[C R Y S T A L]

VOL. X
No. 7



JULY
1948

Published by

THE CANADIAN AMATEUR RADIO OPERATORS' ASSOCIATION

46 ST. GEORGE ST., TORONTO 5, ONTARIO
TEL. Midway 8235

CONTENTS

	Page
Editorial—CAROA Elections.....	6
35 Watts from Battery Power.....	9
Club Activities.....	10
DX News.....	11
VHF in Canada.....	12
National Report.....	14
Introducing Your DR.....	19
Welcome OM's.....	20

STAFF

Editor
F. G. E. Powell, Ve3ZE

DX Editor
R. D. Carter, Ve3QD

VHF Editor
R. G. Coleman, Ve3ANY

Advertising Manager
Don Fairbairn

Authorized as second class mail, Post Office Department, Ottawa.

CAROA

Affiliated with
A.R.R.L. and R.S.G.B.

OFFICERS

President
T. G. E. Powell, Ve3ZE

Vice-President
R. A. R. Macdonald, Ve3APS

Secretary-Treasurer
D. W. Patterson, Ve3BBZ

Executive Secretary
H. A. M. Whyte, Ve3BWY

EXECUTIVE COMMITTEE

The Officers and,
W. H. Anderson, Ve3AAZ
R. D. Carter, Ve3QD
R. G. Coleman, Ve3ANY
D. G. Hall, Ve3TB
A. A. McArthur, Ve3DJ
A. Palmer, Ve3WK
J. V. Perdue, Ve3QK
P. Posnikoff, Ve3BBN
J. Staley, Ve3GR
H. A. M. Whyte, Ve3BWY

DISTRICT REPRESENTATIVES

R. J. Hesler, Ve1KS
F. G. Gribben, Ve2XR
R. C. Hunt, Ve3WX
Les Saul, Ve4FJ
Bill Gordon, Ve5MW
W. R. Savage, Ve6EO
Ernie Savage, Ve7FB
Jack Spall, Ve8AS

CAROA

... CAROA Elections ...

ELSEWHERE in this issue will be found a motion on the subject of association elections. It is a motion of much importance which is worthy of the careful attention and consideration of every member.

Simple though the question appears to be on the surface, its real answer may not be readily apparent, for more is involved than a yes or no reply to an academic query, or the democratic right of members to determine association leadership through the medium of the ballot. Possibly the future of CAROA is involved, therefore practicalities must not be overlooked. The ultimate good of the association must be the motivating factor behind every decision. This demands thought.

It is not the purpose of this editorial to influence the thinking of members, but rather to submit some pertinent facts in such manner as to make of them an aid in the formulation of a decision. A decision, if it is to be objective and constructive, and to be more scientific than a mere guess, must be predicated on a knowledge of the facts. It is the mission of these paragraphs to present those facts for your information, guidance and assistance.

It is axiomatic that the solving of a problem first calls for an understanding of the problem. To paraphrase, it might be said that to decide for or against an immediate election first calls for an understanding of the possible effects of such an election. So, let us review the present position of the association in order that you may judge the possible effects.

The basic organization of CAROA is still in a state of flux. Our fundamentals will be part of the new constitution content, and will be officially determined by the members when they adopt the constitution.

The draft constitution is partially completed, but further time and study will be required before it is ready for submission to the membership for amendment and, finally adoption. Many items to be included in the constitution are of a routine nature and have caused us no trouble. However, the matter of representation on the Executive Committee from each call area, at the same time making it possible to hold frequent meetings of the committee, is a matter that has caused us much concern. It is one of the problems holding up the new constitution. We have asked the members for suggestions, but none have been forthcoming. The constitution committee has submitted a thought on the matter but it has not met with unanimity in the Executive Committee. Upon

further analysis by the Executive, the proposal may be accorded unanimous support or, on the contrary, sufficient inherent weakness may be revealed to justify its elimination from further consideration.

The financial position is not all we would like it to be. We might as well be frank about that. The Executive Committee has been struggling with this major problem at regular and special meetings. The situation is simply that the high cost of living reflects itself in the cost of operating the association and of producing XTAL. Our expenditures have been restricted to operating essentials but we still have our acute financial worries. Some conception of the nature of this problem may be had from an understanding of the fact that after taking in advertising agencies' commission, the commission of our advertising solicitor — which is his sole basis of remuneration — and XTAL printing costs, there is available to the association approximately forty cents of every dollar of advertising space sold. Some may be of the belief that this position can be currently improved, but our efforts and experience tell us this is not so.

Next, it is obvious than an immediate election must be held under the provisions of the existing constitution. Let us briefly scrutinize some of those provisions.

First, we shall quote section 11:

"There shall be an Executive Committee composed of the members elected from each Call District, the Chairman of each Chapter, and the Immediate Past President."

Now, a portion of section 16:

- (1) Each Call District shall be entitled to elect one of its members to the Executive Committee.
- (2) Whenever a Call District includes within its area an association membership of fifty, it shall be entitled to elect a second member to the Executive Committee, and an additional member for each twenty-five members or fraction of twenty-five in excess of fifteen over the first fifty members.

Our Cover Picture . . .

shows two views of the portable transmitter described in the technical article this month. See page 9.

After the foregoing, section 12 comes into play, which says:

"The Executive Committee shall, from its own numbers, elect the officers and a Publications Manager."

The officers of the association are enumerated by section 10, which is as follows:

"The officers of the association shall be a President, a Vice-President, a Secretary and a Treasurer."

Section 5 is one of importance, and is worthy of note. It says:

"The office of the Secretary, the Treasurer and of the Publications Manager shall be at headquarters."

Then, section 4:

"The headquarters of the association shall be in the City of Toronto."

If we analyze these excerpts from the constitution, we will find that it is quite possible to immediately hold an election under the existing constitution which will provide for representation on the Executive Committee from every call district. The extent of such representation will be directly related to association membership in the district. But, with the exceptions noted, it is possible for the committee to be composed of people who, subject to call district distribution, live anywhere within the four corners of the country and none residing with commuting distance of headquarters. That fact is of importance only in so far as it proves a detriment to the holding of frequent meetings of the Executive Committee which are strictly necessary in our present circumstances.

For some time past, the committee has found it necessary to meet every week. Some of our Executive members are serving on sub-committees which meet between meetings of the main committee. There also is work to do between meetings. All this has imposed somewhat of a burden on the members of the Executive, particularly on the officers, and especially on the President, who has proved to be a very capable and willing jack-of-all-trades.

One might reasonably ask the need for so many meetings. The fact is, the Executive Committee has a dual capacity. It is directing the affairs and destiny of CAROA, and those who have had experience in developing a comparatively young association will be quick to realize the work and responsibilities involved. But the Executive has another job of no small magnitude, and that is the publication of a monthly magazine. That in itself, under prevailing conditions, is a mighty big job for volunteer workers.

Many are the factors that demand frequent meetings of your Executive Committee. We

hope it will not always be so, but, until we are more firmly established than we are at present, there seems to be no alternative.

The immediate question is simply one of deciding whether or not it is possible to give direction to the affairs of CAROA and XTAL by a decentralized form of Executive Committee such as might result from an election held under the existing constitution.

We must not lose sight of the fact that under our present set-up, we have District Representatives who are doing a really swell job and who, pending the new constitution, are a very effective liaison between members and the Executive Committee. Your DR will be glad to get your ideas, suggestions or reactions for transmission to headquarters. He is part of our administrative machine and he lives right in your own call district. It is true that he does not attend meetings of the Executive Committee unless he happens to be visiting Toronto when a meeting is held, nevertheless, District Representatives do bring many things to the attention of the Executive Committee. This means that each call district has a direct channel into the Executive Committee.

Now, a word about the present Executive Committee. There are four still serving who were part of the group which founded the association and who were subsequently elected to office by the association membership about a decade ago. They are: President T. G. E. Powell, Ve3ZE; Vice-President R. A. R. Macdonald, Ve3APS; A. G. Palmer, Ve3WK, and J. Staley, Ve3GR. These men have been flanked by others who have been appointed to complete the unexpired term of the members causing the vacancies. The names of these appointees appear in every issue of XTAL.

Vacancies on the committee have been filled by appointing members, who, for one reason or another, were deemed able to make a substantial contribution to CAROA development, and who could regularly attend frequent meetings of the Executive Committee. In making such appointments, we drew on precedent as found to exist in similar organizations, and as provided in the Companies Act. There seemed little point to holding elections to fill vacancies rather than a general election, and we felt that the fortunes of the association were not such as to withstand a decentralized committee. Appointments were made in the belief that such was the only practical course available in the circumstances.

The members of the committee, however, feel that the membership should now decide to hold a general election, or, in the alternative, give the present Executive Committee a mandate to carry on for such further period as the association members may decide.

We all subscribe to the belief that the Executive Committee of a national association should be representative of the territory served by the association. However, in a territory so expansive as Canada, is there a level of development, and a degree of financial security to be achieved before launching into decentralized executive direction? If so, are we on that level? Have we attained that security? The present members of the Executive Committee do not think so.

This question is submitted to you, however, because this is a democratic association. You have a right to an election if you wish one. It is your association to fashion as you think best. It is your right and privilege to choose the leaders of your association. It is also your right to be placed in possession of sufficient information to enable you to make the wisest possible decision, and that is the objective of these paragraphs. In that respect it may be pertinent to point out that this editorial has been written by the same member of the Executive who introduced the election motion. That, we mention in order that there may not be any misunderstanding.

So, CAROA members, the decision is yours to make. Here is your opportunity to say what you like and think with the knowledge that if enough people think as you think, you will have your own way.

Democracy wheels into action—its vitality will be reflected by the extent of your response. In the words of the bill-board: "Vote as you like, but vote."

EXCERPTS FROM EXECUTIVE COMMITTEE MINUTES

At the executive meeting of June 3 the following resolution was moved and seconded and tabled for further discussion:

WHEREAS demands, requests or expressions variously made by many members indicate an extensive conviction that association elections should be held at the earliest possible moment, and

WHEREAS the last election was held in the year 1938 or 1939, which fact gives strength and merit to current election demands, and

WHEREAS elections have been withheld pending the adoption of a new constitution, and

WHEREAS the Constitution Committee has submitted the nucleus of a draft constitution to the Executive Committee which is now receiving the consideration of that body, and

WHEREAS it is apparent from such consideration that a further period of approximately one year will be required to:

(a) give adequate consideration to the many

factors including membership representation on the governing body, which must be included in the proposed constitution;

- (b) submit the draft constitution to the membership with an invitation to suggest changes;
- (c) permit Executive Committee study of all suggested changes;
- (d) submit suggested changes, with Executive Committee comment, to the membership for further expression on the suggested changes;
- (e) obtain constitution adoption vote, and

WHEREAS following the adoption of the new constitution, a further period of approximately three months will be required for the purpose of receiving nominations, holding an election and installing officers, and

WHEREAS the principles of democratic control entitle the members to the right and privilege of an election, and

WHEREAS further deferment of elections, notwithstanding any validity of reasons therefor, will be a potentiality for the destruction of confidence in the association, therefore,

BE IT RESOLVED that the Executive Committee continue its deliberations on the content of the new constitution and, in order that such deliberations may progress without detriment from a time factor, that association elections be held in 1948 pursuant to the provisions of the existing constitution, and that all things necessary as preliminaries to the holding of an election be done forthwith and, further, that information in the form of advance notice be set forth in the next ensuing issue of XTAL following the adoption of this resolution, and that such information include a copy of this resolution.

After discussion following lifting the above from the table of the meeting of June 10, it was moved and carried that the question be referred to the membership, and Mr. R. Macdonald prepare an article on same for publication in XTAL. The editorial in this issue outlines the discussion by the executive committee, and all members are urged to express themselves on this question.

WAVE AWARDS

The following WAVE certificates have been issued in accordance with rules and regulations already published in the October, 1947, issue of XTAL, and repeated in April 1948.

- 17. A. F. Ferguson, V3HP, Toronto, Ont.
- 18. D. Edwards, G3DO, Birmingham Eng.
- 19. Jerome F. Lowenstein, W8RDZ, Cleveland Heights, Ohio.

35 watts from a Battery-Powered Portable

By C. Littlewood, Ve7ABQ

Here's a portable CW rig that really puts out power despite its simplicity and small size. It's built around a type VT104 pentode and a 12 volt to 1200 volt 75 ma. dynamotor. Both items are war surplus and once you've got them you practically have the transmitter.

To get the greatest overall efficiency no exciter stages are used and the VT104 operates as a crystal oscillator. The only unconventional feature of the circuit is the feedback arrangement. It is a variable version of the method developed by C. H. Brereton, Jan. XTAL. Advantages noticed over conventional grid-plate capacity feedback are:

1. Rapid keying is possible (no crystal is lazy in this circuit).
2. Crystal current is less.
3. With weak crystals the output is greater.

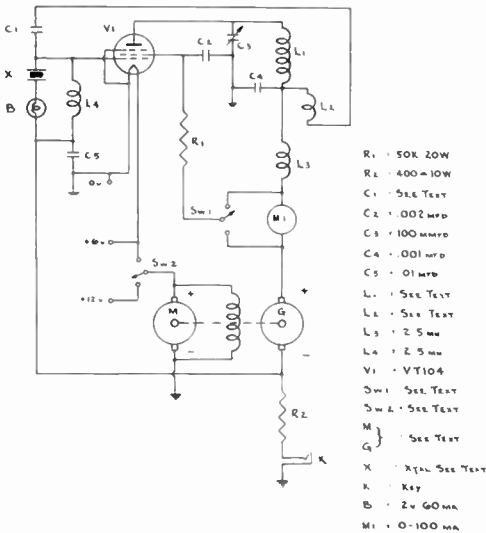

L₁ is the plate tank coil. L₂, the feedback coil, is 14 turns of No. 22 enamelled close wound on a 7/8" form and is located inside the coil form. It is not critical, but must be wound in the same direction as the tank coil, L₁. Feedback is controlled by C, a homemade condenser consisting of a piece of well-insulated stranded No. 16 wire sliding inside a 2 3/4" length of 1/4" copper tubing which is bolted to an insulated part of the tank condenser. Increasing this capacity increases the feedback; only about 1/2" of the No. 16 need be inside the tube. The meter reads plate current

with Sw. 1 in one position and plate and screen current in the other position. The difference of the two readings is the screen current. Both the meter and Sw. 1 should be insulated for 1500 volts. For preliminary tuning, the knife switch, Sw 2 may be set for 6 volts.

The chassis is bolted to a 1" by 1/8" strap iron frame which is screwed on to the dynamotor. Rubber grommets separate the chassis from this frame to reduce chassis vibration. A 2 volt 60 ma. bulb which serves as a current indicator and fuse for the crystal is mounted behind the jewel in photo 1. The crystal is housed in a shield can which may be seen beside the tube in photo 2.

The output is sufficient to light a 40-watt bulb to nearly full brilliancy. If the builder doesn't mind overloading his dynamotor he can leave out the bias resistor and get a full 40 watts out (nothing gets red hot). A six-volt supply may be used; the output, of course, is much less then. On the air the keying is clean and there is no chirp or ripple, even though no power supply filter is used. Despite the high plate voltage there is less than 200 volts across the key. Operation has been attempted only on 40 meters, but it should work as well or better on 80 meters.

The Ottawa Amateur Radio Transmitting Association will operate a station at the Central Canada Exhibition this year under the call Ve3CCE. The station will be operated for six days, August 23 to 28 inclusive. A souvenir QSL will be mailed on request.

LAPEL BUTTONS For CAROA Members

Do you know that any member can obtain one of these handsome buttons by merely writing to HQ CAROA, 46 St. George Street, Toronto and enclosing postal note for 75c. We will send immediately your own CAROA lapel button.

NOW IN STOCK—NO WAITING

Identify yourself at Hamfests, outings, etc., in the coming season.

SEND FOR ONE NOW

C A R O A CLUB ACTIVITIES

Several clubs have written in lately to say that they have written letters to CAROA in the past, but that no mention has been made of their activities in this column. Since this column started, shortly after the reorganization of the CAROA executive, every club that has written in (and some from whom we have not heard directly) has been faithfully entered in the news. We must admit the news has had to be condensed due to limitations of space in XTAL. Several clubs have already applied for affiliation in CAROA, but as yet they have not received their certificates. If your club is one of those who have sent letters to CAROA in the past and have not had your letters answered, we urge you to write us once more and give us a chance to make amends. We are continually digging out "skeletons from the closet." Let us hope that you are not keeping that skeleton buried and have drawn hasty conclusions from what has gone before. Write us—again and again, if necessary until you receive an answer. Those clubs who have liked what they have read in this column can do us a favour by urging other clubs to go behind CAROA and help give us the boost that we need to give us and the amateurs of Canada full and complete representation. The coming election, if the membership votes for it, will no doubt be the topic of many discussions at club meetings. We urge those clubs who will be discussing this important matter to give it full consideration. The years ahead for amateur radio are going to be no easy ones. The next international conference may well ring the death knell for more of our frequencies. Remember we once possessed the frequencies from 1750 to 2050 Kc. Your hope of retaining what we now possess lies in a strong national association. We need your help to make CAROA really strong. Clubs can help greatly by getting behind us and informing us of their activities. Let's fill in the empty spots in the Club Directory for a start!

The Winnipeg Amateur Radio Club held their regular monthly meeting in the club-rooms in the Free Press Building May 8. Visitors to the meeting were Ve3AZA, Toronto, Ont., and Ve4AB. A letter was read from the Acting O.C., R.C.M.P., J. E. Bird, in which he expressed the force's appreciation for the work done by Winnipeg amateurs during the Emerson floods, and especially to Alex Parmley, 4AD, and Don Taylor, 4QV. Guest speaker was Harold Rasmussen of the Research Department, Dominion Government, who gave an illustrated talk on mechanical measurements by electrical means. 4AD and 4QV described flood relief and showed pictures taken during the crisis.

The 1948 executive of the Truro Amateur Radio Club is: President, T. W. Mills, 1NZ,

and secretary-treasurer, G. R. Rector, 1KN. The club has nine members, seven of whom are members of CAROA. The T.A.R.C. was organized in March, 1947, and their address is 222 Robie St., Truro, N.S.

We have heard of another club, the Stratford Amateur Radio Club. Their address is Box 219, St. Marys, Ontario. No further details are available, but we will try to have some news by next issue.

An excellent example of international cooperation is the local club for the twin cities of Sault Ste. Marie, Mich., and Sault Ste. Marie, Ont. The amateurs of both cities, under the direction of W8MEV, instructor at the Michigan Mining and Technology School, got together and formed a club last fall called the Twin Saults Radio Club. Membership consists of 8 Ve3's, 10 W8's and several SWL associate members. Meetings are held at the various members' homes. Secretary is Max Fisher, Ve3AFR, and the president is Herb Sandstrom, W8MEV. This is a unique club and the gang are to be complimented on a fine job of international good-will. What say, Niagara Falls, Fort Francis, Prescott, etc.?

The West Side Radio Club is moving their field-day site from Thistleton to King, Ont. Let us hope that this change does not bring them bad luck, so that they lose the cup this year.

The Nanaimo Amateur Radio Association has recently been formed in Nanaimo, B.C. Present membership is 21 and the meetings usually have 35 in attendance. The club is open to both sexes and several y1's and xyl's are among the members. The secretary-treasurer is H. Prescott, P.O. Box 187, Nanaimo, B.C.

The London Amateur Radio Club held their regular monthly meeting May 13. The picnic, which this club is organizing in conjunction with the Ontario Phone Club, was slated for sometime in July. Speakers of the evening were Dwight Fields and Gordon Godwin of Forest, who discussed and demonstrated high frequency equipment, especially for two meters. Final plans were laid for field day.

The Scarboro Amateur Radio Club is ready for field-day and are raring to go. Code classes under the direction of J. W. Harvey still continue, and two more students are ready for graduation. A separate class is held for the beginners in the club rooms on Tuesday evenings, so that the senior class can progress faster. The club has received some very heart-warming letters from Britain, thanking them for parcels which they have sent recently. Keep up the good work, boys!

While not exactly Canadian club news, mention must be made of a recent letter received
Concluded on next page

DX NEWS OF THE MONTH

R. D. Carter Ve3QD

Well, here we are at the beginning of vacation time and the bands every day seem to get just a little bit worse. It seems strange that last year conditions were so stable and while it did not roll in 24 hours a day nevertheless there was plenty to hear and work. Right now it is spotty, and though there is dx to be heard it is mighty hard to keep at it to dig them out as the noise level remains high and the short skip also makes it difficult to hear and work those signals that are getting through. This past week has shown some improvement and if any of you need any European or Asian stations it will pay you to put up with conditions and dig, as they are coming through and can be worked with nice reports. I had the opportunity to use one of the new Hammond 20-meter beams with the H.A.R.C. on field day and with only 25 watts we got some very pleasant surprises. You don't need much power when it's fed to a decent beam and we got several S8 reports from Europe in the Sunday QRM. We also worked several VK's and ZL's with it, so don't give up those low-power rigs until you give a good antenna a chance. Also it's lots cheaper to put up a good antenna than to triple your power. We also hear that the West Side Radio Club had the same good luck with low power.

Many thanks for the fine replies to the countries lists we sent out, and though a number are at hand there aren't enough so far to start our new listing. We promise that next month we will have the listings in the form suggested and it will be of much interest to watch you all go for the balance of the year. It puts new zip in the operating and makes it worth while working some of the ones we have been passing up. More on this next month and don't forget any of you who haven't re-

by your conductor from Hilversum, Holland. Many of the Signal Corps men who were overseas during the past war will remember Hilversum as a friendly town which became a Mecca for the signals "Joes." The Hilversum gang send greetings to all Canadian hams, and offered to take any QSP to Holland. PAØFE, HS, EH and JM are on 10-meter fone and PA's PT, IDW, RU are on 10 and 20 fone. Most of the group are interested in VHF but are handicapped by lack of equipment and tubes. If anyone has any spare VHF tubes and would like to repay in part for the kindness accorded our boys overseas, kindly contact Rene Veltman, 31 Kapelstreet, Hilversum, Holland. The above address will also do to arrange skeds for QSP.

ceived these lists and want them can get these by dropping me a line.

Now we will dig into the mail bag and give you the dope on what the gang has been doing. Ve1NE sends in his list and from it we note that he has worked some real choice dx such as ZA2F, Albania, CR6AI, MD5KW and ZD1LQ. Ve3BHX worked OK1RW with his antenna only 10' off the ground also a three way with G2HF0 and HH2JD. Ve1AQ is no longer, as Don has now moved to Montreal and will start all over again at Nitro, Que., and will have lots of competition from the Ve2's living near. The Yukon is again heard from, and Ve8AS has been busy. The best is RV2/FO8 in Tahiti and Jack says he has been pounding in there every night. Wish I could get up enough ambition to get up early enough to hear him. This was done with a single 6L6 and 35 watts. Keep it up, OM. Ve3BWY is heard on regularly and in between G's continues to add a few countries. New ones were ZD2RGY, HA4EA and M1A for a choice one. Ve7CE with 40 watts to an 807 worked KH6NE and ZK1AM on 80 meters and ZL1LQ and ZL4FT on 40. Ve5JV has added some nice ones with VK6, PK6, ZS, SM, HL, C1 and J3. Ve4RO has been busy with the garden but still found time to add ZD1, UF and CT3 to his total. Ve1PQ says the Halifax club are running a dx contest among themselves which lasts a month. That HF man Ve1QZ is doing ok in it, we hear. We would like more on this if someone will do the honours. The question has been asked re MM operation. It doesn't count.

Ve3AGC also worked RV2/FO8 and is planning on a rotary. A nice letter in from Ve7AFI, who works his dx with a 6V6 and 15 watts. Worked were C7AT, ZS2F, OA4AP, as well as VK, ZL, KH6, KL7, and needs only Europe for WAC. FB, Harry. Ve3QB is all set to go to town now that he has a VFO and promises to show us all up. Ve2WW added FK1AJ, FT4AN and KM6AH to his totals. He had a visit with W1FH in Boston and says that he's worked 206 countries and has confirmations from 189 of them. 2WW has been going around in circles ever since. Ve3BNL put up a 2-element shortened beam for 20 and has had good luck with it and has worked 41 countries since getting it tuned up. Ve3TB still needs Asia but otherwise gets out ok. Ve7HC worked OY31GO to up his total to 151. Ve3EK has put up a Smith bi-square antenna with the centre pole 60' high and in the short

QSY to page 21

VHF IN CANADA

Conducted by GORDON COLEMAN, VE3ANY

With the reporting in of several more stations competing in the CAROA VHF Marathon, we can resume this contest. The contest can stand many more entries, so check the rules in XTAL for February and enter your score now.

Mother Sol was kind enough to ionize the E layer several times during May and E's provided good 6-meter dx for those fortunate enough to be listening. Reports received about these openings make it possible to resume the CAROA 6-meter dx Derby. This yearly feature was won last year by Ve7AEZ with 159 QSO's and 25 states. The leading score this month is 25. That 1948 has not as yet been as good as 1947 is evident from a look at this column for July, 1947. The leader then had 70 QSO's by the E's route. However, there is some real god dx in store for the station who consistently operates on 6 meters and we can count on the band remaining open until well on in November. Please report the dx you have heard and worked on 6 and be assured of entry in the dx Derby.

Starting where we left off last month on, May 9, the 6-meter band has been open as follows:

- May 13—Good opening to Belleville, Oshawa and Toronto, Ontario stations at 2215-2330 hrs. EDST from W4's.
- 16—Fair opening to Oshawa at 1700-1730 hrs. through heavy thunderstorms, and to Toronto at 2100-2200 hrs. from W4. During this opening Ve1QZ was heard on CW.
- 20—Brief but strong opening to Toronto at 1230 hrs. from W4.
- 23—A few W4 heard in Toronto at 1830 hrs. Band open to Vancouver at 1530-1630 from W6 and at 2045-2230 hrs. PDST from W6 and W7.

24—An excellent opening to Toronto, Belleville, Trenton, Oshawa and Hamilton at 1030-1300 hrs. from W9 and Wø's.

26—Vancouver working W6's at 1730-1830 hrs. PDST.

31—The best opening yet! 6 meters was open all day to Toronto, Belleville and Vancouver stations. Toronto—1030-1100 hrs. W4 and W5, 1200-1300 hrs. W4 and W5's came thru strong, 1430-1500 W9 and Wø. The band was open to Vancouver at 1900-1915 hrs. PDST from W6.

June 4—Extremely good opening with little QSB and consistent S9 signals to Toronto, Hamilton, Oshawa and Belleville all evening from W4 and W5. Twenty-one Ontario stations were in on this opening and the W's numbered in the thirties.

No reports have been received from Ve1QZ and Ve2KH. However, these districts were in on the recent openings, as several Toronto stations heard both Ve1QZ and Ve2LP in St. Lambert, Que., being called by the W's.

There is little news this month about 144 Mc. From the silence presented by the active stations on this band, it would seem that nothing important happened down there, but it has been heard that some good dx has been recently worked on 2. Wish someone would drop us a line about 2 once in a while. Ve7AEZ says there are a few 2-meter stations active in Vancouver, with Ve7BQ xtal-controlled. Ve3RM promises some news of 420 Mc. activity in Ottawa, but as yet we have not heard from him.

Earl Fowler, Ve3AZT, carried out some very fine mobile work on 6 meters recently when he was en route from Oshawa to Bowmanville,

CAROA 6 METER DX DERBY

Call	DX	States	Call	DX	States
Ve3RM	25	-	Ve3AOP	7	6
Ve7AEZ	21	5	Ve7NM	7	2
Ve3AJS	15	7	Ve7DU	4	2
Ve3AZV	12	10	Ve3APV	3	3
Ve3AGB	12	7	Ve3RW	3	3
Ve3APF	8	8	Ve2AET	2	2
Ve3AXT	8	6	Ve3AAJ	2	2
Ve3ALJ	7	4	Ve3ABG	2	3
Ve7BQ	7	4	Ve3ARV	1	1
			Ve3AVF	1	1

Ont. Starting with 3AZV in Oshawa, Earl then worked 3APV in Toronto. As he approached Bowmanville 3APV's sigs were QRMed by a Peterboro station. Earl then worked the Peterboro station until he was at his destination in Bowmanville. This is the first we have heard of 6 meter stations being active in Peterboro. How about some information on your activities, boys!

CAROA VHF Marathon	
Call	Score
Ve3RM	270
Ve3AID	210
Ve3AJS	208
Ve7AEZ	144
Ve3BBW	130
VeADJ	78
Ve3RW	76
Ve3AOP	66
Ve3AAJ	61
Ve3OJ	38
Ve3ABG	26
Ve3BFP	18
Ve3ARJ	16

The computation of some of the scores are as follows:

Ve3RM— 50 Mc.—34 local qso's— $34 \times 1 = 34$
 25 dx qso's— $25 \times 4 = 100$
 420 Mc.—2 local qso's— $2 \times 50 = 100$
 Total qso's— $34 + 25 + 2 = 61$
 Activity bonus— $61 - 25 = 36$
 Total—270

Ve3AID—235 Mc.—19 local qso's— $19 \times 10 = 190$
 Plus past score of 20 = 20
 Total—210

Ve3AJS— 50 Mc.—79 local qso's— $79 \times 1 = 79$
 15 dx qso's— $15 \times 4 = 60$
 Total qso's— $79 + 15 = 94$
 Activity bonus— $94 - 25 = 69$
 Total—208

The above should indicate how easy it is to pile up a sizeable score in several different ways. As you can see, the information can be put on the back of a post card, so what are you waiting for?

BEAT NOTES

Ve2XR on 80 and Ve2WK on 40 were top scorers on each of these bands in the CAROA "4 in 1" contest of Feb. 7 and 8, making them both certificate winners. The odd part of it all is, believe it or not, is that XR did all the operating for both winners! How, Well, XR was on 80 at night only, as naturally the band is NG during the day. Realizing the usual lack of Ve2 in most any contest, XR approached WK, who couldn't go on the air, and asked his permission to add one more Ve2 to the battle. That's how it went. Two wins by one operator!

W.A.R.C. HAMFEST—SEPT. 12

WITH the many compliments concerning last year's hamfest still ringing in their ears, members of the Winnipeg Amateur Radio Club are planning on going all out to make this year's "do" one that will go down in the history of Manitoba and even Canadian amateur radio as "the best ever." Looking after the organization of this year's hamfest is a committee made up of Darcy Langtree, 4DY; Ken Williamson, 4KW, and Jerry Walsh, 4GW.

Sept. 12 is the big day when all the radio-minded people of Winnipeg and vicinity will gather at the St. Vital fair grounds for the day's festivities.

Included on the program will be special features for yl's, xyl's and children, exhibits by various commercial radio firms, sports, judging of equipment on low frequencies, with a special award going to the ham coming from the farthest distance and, of course, the ticket draws for valuable equipment. The program will commence at 11 a.m.

Although final details have not as yet been completed, the committee is confident that it has a program lined up which will appeal to everyone, young and old, radioman or layman. All that's needed now is the support.

QVE

CAROA Official Broadcasts 75 Meters Each Thursday 9 p.m. Local Time

The undersigned stations have been appointed as CAROA Official Broadcast Stations. Be sure to listen for your district OBS for latest messages and bulletins of interest to all Canadian amateurs.

Ve1GD—3835 Kc—H. A. Garland
 Ve2HL—3809 Kc—J. W. Labelle
 Ve2DL—3827 Kc—R. Frenette
 Ve3QB—3835 Kc—W. B. Knowles
 Ve3CP—3775 Kc—T. Hunter
 Ve4KK—3820 Kc—B. Fowler
 Ve5FA—3848 Kc—W. A. G. Simpson
 *Ve5GA—3847 Kc—W. T. Rogers
 Ve6OD—3801 Kc—E. A. Anderson
 Ve7FB—3825 Kc—H. E. Savage
 Ve8AS—3820 Kc—J. Spall

*—10:00 p.m.

C A R O A NATIONAL REPORT

Ve1

Ronald J. Hesler, **Ve1KS, D.R.**, Box 160, Sackville, N.B.—IB, secretary-treasurer of the Truro Club, has been transferred to Halifax, and KN is his successor. DK has been heard on 20 CW. NZ appears to have had considerable trouble pushing his Kaiser the past winter. GK is rumored to be about ready to throw the switch on a new half-gallon. CB claims that he has pre-war WAC but is unable to find that elusive Asian card. QK is building up a six-meter xmt-r receiver AM-FM. EQ, who hasn't been too active of late, will soon be on 20 with an 807. MT is raising lots of G's the past while. KN received his WAS certificate and needs Asia for WAC. Gordon Purdy of Truro has a bet on with Allan Doane that he will get his ticket first. VF, VK are new hams in the Lakeburn area. VF will be on the air by the time you read this, on 20 and 40 CW. VK is already causing QRM on 80 CW using an AT-1. AQ, former secretary of the Lakeburn Club, has been transferred to Montreal. MV is happy now with the newly-acquired BC-348R but discontented with the AT-1 xmt-r which he does not dare use for some reason or another. PA is now running ½ k.w. but unfortunately is having trouble getting his aerial to take it; he is also the proud owner of a 35 w.p.m. certificate from A.A.R.L. DG and xyl Joan run dual operation, and when the om is away at work the old girl takes over and does he get meals on QSL cards. Joan is a former R.C.A.F. radio operator and holds a commercial ticket. TN, or should we say ex-TN, an old-timer in ham radio, has given up the works in favor of gladiola bulbs; he sold his rig complete and is now in the flower business. QT is rated as a NBFM expert of the first order. BF is active on 20 and 80 phone. ON is at the present time in Prestwick, England, visiting the G's. BL, located in Scoudouc, is active on 20. SS is QRX while the builds a new house. QR and QG are on 10 using NBFM. RL is building a new rig. SI is using a 19 set as a sig. OK is knocking off the dx with a pair of 813's. SO is doing well with his 19 set, using it as an exciter. DD is another 19 set laddie using his on 80. AF is having trouble lately with filter condensers. RU is operating 20 CW with a new bug. MS is running a pair of E1148's on 80 CW and sounds fb. PB is now **Ve3OF**. OX is slugging it out on 20 working some nice stuff, it is reported. SW is quite content these days with his ZL contacts on 20 CW—and well might he be! ER is fooling around with **SCRE22's**, so we should see him on 2 one of these days. GQ is converting one of the 522's and is sweating out field day plans. UR is laid up again for a few weeks and is thinking of founding an Anti-Electric Razor Society. HM is knocking off the west coast with his AT7. DR has been having a bit of trouble with his 80-meter rig of late—he has been licensed for over 20 years and boasts three WAC certificates (one for CW, one for 20-meter phone and one for 10-meter phone!). LI is back on the air again but complained of bugs in the re-vamped rig; says he will have to spray it with DDT one of these days in order to get rid of 'em. GE plans to place a preselector and xtal filter on the S-20 in order to make bigger and better contacts. HU is in the converter and preselector making business these days—will custom make these for a small sum. DI recently attended a Detroit hamfest, where, he says, they gave away Hallicrafters like mad as door prizes, as well as tossing around 1 KW xmt-rs. DW is Yarmouth reports three 2-meter rigs rarin' to go over there. RQ is running 500 watts with no BCI. LJ is working over an **SCR522**. FC is off 75 phone due to BCI and is going to rebuild but can be heard in the meantime on 20 phone or CW. IE is the new AFARS net controller down in these parts. QU has a tough time with his Christia name . . . or at least we do—seems as though his name is really Audrey. PC has gone with C.P.R. telegraph since leaving the phone company, we understand. MW is now on phone and doing swell on all bands. TO went into the Quebec woods in May for a vacation and planned to take a ten-meter portable with him. HU is working on plans for a 10-meter rig in his car. FV, who hangs out a bigger and better L.C.A.R.C. bulletin every month, is just like the rest of us columnist—down on his hands and knees, begging for letters from you all for his bulletin.

Attention two-meter fans: GQ and RQ and LJ are now on two meters and would like to make test schedules. Three Yarmouth hams and one in St. Andrews (ER) are interested in skeds, too, so why not get together and see what you can do, and when you do it how about dropping Gord, Coleman a note letting him know how you make out (VHF, editor of XTAL).

DON'T FORGET THE BIG HAM REUNION FOR THE MARITIMES AND OUR NEW ENGLAND NEIGHBORS . . . ST. JOHN, N.B., SATURDAY, SEPT. 4. MORE DETAILS IN LATER ISSUES OF XTAL. MEANTIME TALK IT UP GANG, AND LET'S ALL BE IN ST. JOHN ON THE "GLORIOUS" FOURTH.

KQ in Bathurst sends along a newsy letter and claims that he is the only ham on the North American continent who is using a water-cooled crystal. PD now has the power line to feed his 807 on 80 meters. UD is a new call in Moncton on 80 and, according to reports, is QRM'ing G's locally in G land. GB is active on 40 CW. QU is operating 75 fone. UL, a blind operator in Bathurst, continues to toll them in—his latest dx is a VS4 in the Virgin Islands. DJ wiggles along on 20 and 80 and is a dx hound. DU has given up 75 fone for the present in order to give 20 fone a going over. UU, an engineer at CKNB in Fredericton, has been on 80 all winter and is now planning a QRM "buster" for 1949. HW has rebuilt his 75 fone rig. DT is now in Marathon, Ont., has the new call of **Ve3ID** and expects to be on 10 and 20 shortly. FZ using low power and a three element rotary beam is knocking off the Europeans and uses an S40 for an inhaler. OA is active on 75 fone. KE operates 75 fone once in a while and did spend some time on 10 meters when it was open. ER, a staunch supporter of CW, for many many years, has been heard on 75 fone! GL, the A.R.R.L. traffic manager, is the Maritime member of the Trans-Canada net on 80 CW. NY is operating 80 and 40 CW. KS actually took traffic on CW from KQ! IX has completed his studies at Mount Allison and has pulled out for **Ve3** land. KT hasn't been heard around since 10 folded up for the season—received his engineering certificate from Mount Allison recently.

HV (ex) has again changed his call—is now **Ve2OK** and operates on 75 and 20 fone and CW. VY now has a Hallicrafters SX-18 receiver and operates on 80 CW. VZ acted as an interpreter at the International Trade Fair in Toronto. DC is putting up a 20-meter beam and hopes to be active soon on this band. KS and VZ are planning to operate 75 fone portable from their summer home at Cape Tormentine this summer—will have about 25 watts fone and 75 watts on CW.

I have been asked by the publisher of the Radio Amateur Call Book to act as a clearing station for new calls, changes and errors in QRA, etc. If individuals and club secretaries would advise me of new calls, together with QTH, etc., I shall be pleased to collate these and forward to the publication in order that you will be correctly listed in the new editions of the Call Book. It is highly desirable that we are all listed correctly in the Call Book so that some of those valuable dx (?) cards do not go astray. May I have your co-operation please—simply place the following information on a postcard: Call letters, ex-calls, name (first, middle and last, please), and complete address. 73—Ron.

Ve2

Floyd G. Gribben, **Ve2XR, D.R.**, 5120 Westbury Ave., Montreal, Que., Phone EL 5387—Hello, gang! If you're complaining because it's too hot, then be thankful the temperature isn't so high that you have to resolder the rig! Forget the heat! Sit back and gander here to see what's been doing in **Ve2** land. TM, Leon Baldwin, of Quebec, gave the postman the job of bringing an fb letter to us this month. Here's what Leon had to say. LA, Tony Guimond, turns out the finest commercial looking gear for miles around. Tony is heard on 80 and 10 phone over ZL's rig (built by Tony) which is one of the snappiest layouts in the land. LA is rigging up a 32-

element (VHF bedspring) beam for two meters. Leon goes on to say that 60 per cent of the technical staff at CBV transmitter at Charlesbourg are hams and that oddly enough the transmitter house number is 73! Claude Dostie now has the call ZN. Claude put off renewing his license too long and lost his old call of NW. HB built fb six-meter rig that looks like a factory job and will help in getting a Quebec net going on this band. He's also QRL getting a 20-meter antenna back up. TM answered the prayers of LO in Drummondville who wanted a Quebec traffic outlet on 40. Leon is also working on IUD in Moncton to act as an N.B. outlet. Leon works at the C.B.C. studios in Quebec and says he worked ACI in Chicoutimi who is a yl member of the C.B.C. staff at CBJ studios. Her QSO with TM was her first contact with a fellow C.B.C'er. Hey, ACI, how about looking for other staffers? XR and GM of Keefer for instance! On 80 that is. IW is now heard on 80 and 10 phone as well as 40 CW and has antenna troubles. TN should be on as soon as he gets his antenna up. He's having bleeder trouble. His power supply needs a transfusion. LZ is heard regularly on 80 phone. With the aid of Virginia, his xyl, his QSO's are often more fun than a Jack Benny program! That is the works from TM. Many thanks for writing, Leon. The Montreal Amateur Radio Club held their last meeting on May 26 before closing down for the summer. CO, Lindsey Morris, gave the boys a pep talk on Field Day preparations. EW, Ray Stiles, gave a very interesting talk on microphones and amplifiers. IE, Art Dingman, did an fb job of thanking Mr. Stiles for presenting his timely topic. CC, Guy Le Fort of 12491 Chevalier St. in Cartierville, won a BC-696A VFO rig via a draw. It was the main prize, of many, for the evening. Guy has been rock-bound on 80 CW. Now you'll hear the guy all over the place, including FM phone. BEEF DEPT. . . . Many of you complain that there isn't enough technical dope in XTAL. Have any of you ever considered that the fault may be due to YOU? Any magazine is only as interesting as its contributors make it! Those at HQ are continually hoping you readers will send in more data for publication, be it ham stories, constructive criticisms or your favorite item of equipment. If you have something of interest to others, and you're not quite sure how to go about preparing your material for publication, then by all means, write HQ. YOU can help make XTAL better! Do it now! VL having fun with NBFM on 20 and 80 phone. Bud says he made slight changes to output stage of his Sept. 1946 QST VFO and phase modulates it with his first power audio stage of his old AM modulator unit. The quality delights him! ACF, Arthur E. Strange, of 279 Argyle Ave. in Verdun, bangs the hardware on 10. AAN, George Pendlebury, of 3854 Northcliffe Ave. in Montreal, is a new one of the gang. Welcome, George! HG, Gerry F. Hudson, when shift work permits, modulates his final on 10 phone from 4432 King Edward Ave. in Montreal. ZK, J. Ed Hayes, the famed antenna man who has given several extremely interesting demonstrations on beams at M.A.R.C. meetings, just doesn't seem to get the time to play with the VHF fb would like to. If you ever hear Ed it'll be coming from 5416 Clanranald Ave. in Montreal.

If you happen to hear ACP from 6th St. in Val d'Or, it'll be Julien Trepanier, who operates a 19 set when he's not busy at the controls as projectionist at a Val d'Or movie house. That wallowing signal from SC comes from a pair of 100TH's owned by Charles E. Dunlop, c/o Perron Mines in Perron. If you call Chuck, he'll most likely hear you on an HRO. LO, a most reliable letter writer to this column, sends in his usual welcome contribution. John hails from Drummondville and appears to be the real OT of the district (a Granddad, too!) John says he is quite pleased to have at last raised a Quebec City outlet for his 40-meter traffic. TM is the guy taking John's stuff. John says he handled a message from Japan. TD, also of Drummondville, works 40 but tried 20 only to blow two RF chokes due to excess soup around the rig. The R.I. passed through Drummondville and it is reported that a new ham is in the offing. Let's know who it is, John. JI, also of Drummondville, spends his time on 20 CW and still keeps busy with the Rover Scouts. LO says a recent QSO on 40 ended with 88's being extended to him but he wouldn't say who the sweet thing was on the other end of the QSO. John says for us to keep an ear peeled (for the sweetest QSO this side of heaven!) for her. Quit jamming the band, men! XB sporting new Bendix TA-12C rig. It looks like Tommy will soon be heard with more sock from Verdun. RN of Sherbrooke runs 70 watts to a Marconi 1154 outfit and gets the noise on an HRO. Give Harry a call on 80 CW. PK is now on 20 phone after leaving 10, where he first was introduced to ham radio. It's interesting to note that not all XTAL's are read by us. Ves for this time we hear from W5YGR, Jack Lvon, ex-Ve3GJ, ex-Ve3JL, of 477 South Wheeling St., Toledo, Ohio. Jack says he's trying for a WAVE

Certificate (sponsored by CAROA) and wants Ve2 contacts on 20 CW. How about helping Jack out, gang? Please give him a call, he'd appreciate it. OA of Montreal gives 80 CW a rest and takes to phone on the same band. PT of Verdun is familiar voice on same band. CB, KN, UM, ACU, ADD and ABF hammer away on 40 while AEO, NU, AEG and ACM do the anvil chorus on 80.

CJ does his phoning on 20. NZ, known as Romolo G. J. Pistono, of 11 Jasper Ave., in Mount Royal, plays with a Hallcrafters HT-9 at 75 watts, an SX-42 receiver and a 4L beam, all tuned up on ten phone. Then we have AAW, George W. Richards of 115 Oak St., St. Lambert, who uses a VFO and 40 watts to an 807 on 40 and hauls 'em in on a Marconi R-1155 recvr. Up in Ville St. Laurent we find AEX, who turns out to be Wm. F. Borrie of 65 St. Mathieu St. Then at 5011 Gatteau Ave. in Montreal we see Sidney Allen who signs AEG on 80 and 40 with a 6L6 crystal osc. and hears the boys on his ARC-5 recvr. Swimming over to 14 Clement Ave. in Dorval we run in to R. R. (Peter) Smith, who calls himself AAV with the aid of two 807's in the final on 6 and 10 phone. Coming back to the big city we bump in to a telephone company man known as Brock B. Wilcox who proudly displays his call of AEW from 3365 Barclay Ave. in Montreal. He lets the boys know he's on the air with a pair of 24G's on 40. Then there's ABT, who answers to Raymond Mercier at 7750 Champlain St. in Montreal, and Norman Hagan, NL, of 7420 Querbes Ave., also in Montreal. On 80 we might hear Andre Baribeau of 5462 Third Ave. in Rosemount who signs ABG with a 19 set. Or we could hear YE on 80 phone. The mailman got past Dagwood to deliver a very nice letter from AHS, Herbert A. Shaw, of P.O. Box 142 in Val d'Or. Herb says he's been on the air eight months using 30 watts to an 807 and receiving on an S-40. Herb is a member of CAROA and A.R.R.L. and is anxiously looking for one of you lads to help him get this Rag Chewers' Club Certificate. Herb says he and ACT, who is Guy Lauzon of nearby La Sarre, plan on taking a hitch-hiking tour down into U.S. this summer. Hope you have a good trip, fellows. Thanks for the news, Herb OM. The Eastern Canada A.R.R.L. Convention chairman, Herman Eberts, is now signing Ve2XP (although announced as AEC in June issue hi! He wanted a two-letter call!) Herman is set up at 57 Oaklands Ave. in Westmount in a very fb spot on the mountain. Heuses a VFO to an 807 on 30 and a smaller rig for 40 and hears you on an HRO. UJ trying to sell complete station with hopes of getting car. WH, Marc Cimon, of 2156 Blvd. Laurier in Quebec sends in fb letter. Marc uses PP 807's and an S40 on all bands, both phone and CW. Marc also has this to say. PC got a new bug which he uses on 80. VO is building a new rig with telephone dial channel selector. CW having fun on 20 with HT-9. AC and HB get their share of 20 dx. OF, TJ and HB will soon be on 6. RL is too QRL to be on much. Thanks for the letter, Marc. The postman also delivered a nice letter from GF, Rosaire, Nadeau, 135 Morin St. in Quebec. Rosaire says that PM is rebuilding 150 watt rig but having trouble de-lousing buffer. Why lose time, Phil? Try DDT! ADF rebuilding antenna. ZU, who is brother of AO of Montreal, having antenna trouble. HL is sick in hospital. All his friends wish Henry a prompt recovery. VP, who's been studying in Fort Wayne, Indiana, comes home to spent summer with family. Welcome home, Andre. In closing his letter, Rosaire thanks RM for helping on the news items and adds that we should watch our modulation, or the R.I. will! Rosaire also reminds us to check with the R.I. before moving the rig to our summer locations. Better do that, eh? Thanks for the news, Rosaire. MO, Thomas G. Ling of 105 Upper Edison Ave. in St. Lambert, topped Ve2 in the Ve/V Contest with 25 watts to a Marconi AT-7 and an SX-25 receiver. Nice going, Tommy. IB, Bert A. Laxson, Jr., does a good job on 40 CW with a VFO to PP 807's and an R1155 receiver from his shack at 6232 Casgrain St. in Montreal. QE of Roberval does his phoning on 80 with a Marconi Navy rig type TB-500 which has PP 810's in the final modulated in the cathode circuit with a string of 6L6's. Ed hears your side of the QSO on an NC-173. If you want a contact with St. Johns on 80 CW, why not call J. Marcel Girard who signs WB from 149 St. James St? Marcel cuts loose with a 19 set and drags you in on an S40 receiver. From Chambly Basin you'll hear the 80 CW sigs of QR with 22 watts on a 6L6, hearing with a R1155. JM modulates his final on 80. Another letter brings words from FL, Guy Midwinter of Sixma Mines Ltd. at Bourlamaque (near Val d'Or). Guy uses a 19 set and gabs regularly with 3BCI and 3AOI in Haleybury and uses the 235 Mc section of his 19 set for local contacts. Guy says he also has a new Harvey-Wells TBS-50 rig that he uses on ten phone. He's only been on for about 8 months but he's no squirt! He's seen 63 calendars!

Nice going, Guy! Here's the rest of his news. ACL, Maurice Cousineau, of Val D'Or, uses a 19 set. ABP, Alfred Lauzon, of La Sarre, has a Hallcrafters HT-9 and an S40. His son Guy is ACT and also has a 19 set. Another new ham in La Sarre is ABU known as Jean Langevin who sports a 19 set. Now we know where all those 19 sets went! Thanks for the letter, Guy. LOUIE THE LID SEZ . . . "My sister must have had an all-band job done at the local beauty salon 'cause her dome is covered with coils!" (oh-oh-oh-oh—slug 'im!) If you deal with Bill McKim at Canadian Electrical's Montreal store, take note that he now signs MK and uses a Harvey-Wells TBS-50 on 10 phone. New hams are popping up all over the place. Here's a few who live in the married quarters of the old wartime R.C.A.F. depot in Lachine. One lad is ACZ, Sgt. C. F. Cooke, whom the boys affectionately call "Cookie." He runs 45 watts on 80 and 150 on 20 CW and hears the noise on a BC-348. Then we have David Bell, AEQ, who runs 25 watts to a BC-696A and draws in the stuff on an HRO. Right next door we run into AER, Donald Farmer. All these lads are members of the R.C.A.F. Transport Squadron. They say that they like QSL's sent to them c/o R.C.A.F., 426 Sgd., Dorval. SU takes to 80 phone using 25 watts on an 807 cathode modulated with 2A5's. IE uses the same style of mod. for his 80 phone rig. JJ thumbs his nose at BCL's now that he has a Sonar XE-10 NBFM unit for his ten phone. DL is studying suppressed carrier (the high power boys sure suppress his 10 watt one!). Don't forget that DL is the CAROA Official Broadcaster for Montreal area. Hear the latest in Ve ham news Thursday nights at 9 on 3809 kilocycles. WY trying to get his code speed up to pass his unlimited phone exam. Keep plugging, Ross. JE, "Buck" Ewart, whose apartment overlooks the very noisy Snowdon Junction in Montreal, gets away from all the QRN by operating his 814 phone rig from his summer spot at Weir. Buck gets the 110 for the rig from a gas engine generator. He's been QRL on a new receiver since last Christmas but at last it's completed. GE was in Winnipeg on biz recently. After visiting a bunch of the Ve4's he's decided that the antenna for him is a twin three beam. LF of Vercheres is heard the odd time on 80 phone grid modulating an 807. Anselme hears his sigs on an S40. DY, of Lachine, uses an 807 mod. by 6L6's on 80 and oddly enough the RF section of the rig belongs to his xyl ACA. Apparently Dick feels that a marriage should be a 50-50 deal even when it comes to a ham transmitter! G2CIN has now joined the ranks of Ve2. He's Thomas M. Lott and he has his stuff fixed up at 3877 Harvard Ave. in Montreal. Tommy signs the call AGF. He had all his gear sent out from London, England. The rig has three finals, one with 813's and the other two with 35T's. Of the many receivers, he favors his HRO. You'll most likely hear him sounding off on 20 phone. Lots of luck, Tommy, and welcome to Ve ham radio. HG giving FM a try on 10. FX of Pointe Claire is sporting new Hammond 10-meter beam. CY keeps going, but this time Mac has been giving FM a whirl on ten. Before this report goes to HQ it is learned that the Montreal Amateur Radio Club gets into the Field Day battle under the call CO and on top of the mountain in Westmount. SA and his aides as a separate contest

group on their own make the F. D. their affair from the Brome Lake area. Watch a later issue of XTAL for the results of their hard work. Well, gang, this is where I sign, so now you can read on. Don't forget to read the other fellow's columns too. They write up interesting dope on our fellow Ve's in other districts. See what they have to say. Have nice holidays all. See you here in the August issue.—73.—Floyd.

Ve3

Due to circumstances beyond his control, we are informed, Ve3WX is unable to carry on with his duties as D.R. and regrets that he must resign from this post. On behalf of the Ve3 hams, HQ wishes to thank Bob for his past services. This vacancy in our establishment has already been filled and HQ takes pleasure in announcing the appointment of your new Ve3 D.R.—none other than your old friend and QSL manager, W. Bert Knowles, Ve3QB, D.R., Lanark, Ont. We are sorry to learn that MB has been very ill with a heart attack but last report he is slowly improving. EK has skeds with 8NW, at Clyde River, Baffin Island, for over two years and has handled about 750 messages, also EK has just put up a Smith BI-square beam and reports results good. QB has at long last gone VFO. BCL has moved from upstairs to downstairs and according to EK has a BC layout. KE is building a new house for himself, xyl and junior ops. (the main room is, of course, the radio room). Is it being made sound proof? BWY is going to give some of the boys a run for their money in the dx line. YJ and QC visited QB for a few minutes on May 24. WZ is on 75 phone from cottage on the shores of the Rideau Lakes. There are a few choice dx cards at the Ve3 QSL bureau looking for owners. This is about all the news we have been able to collect since receiving the appointment as your D.R. a couple of days ago. I hope to be able to have a good lineup for next month, and am looking forward to your co-operation in this, for the success of the Ve3 news will be up to you. Please drop us a note about the 25th of the month so that the news can be written up and in Toronto in lots of time. Summer, with the strong attraction of outdoor activities, has not driven the Beaver Net off the air. The ever-faithful Ve3DU and Ve3ATR are there every night, with other members of the net being QNI whenever possible, which augurs well for the future of this 365-days-a-year traffic organization. Amateurs with traffic for CAROA headquarters may route it through the Beaver Net (3535 kc., 7 p.m. E.D.T.) where it will be promptly dispatched to Ve3APS, vice-president of CAROA, who is a member of the net. ATR reports traffic total of 51, BCP7, APS 43. The London club participated in the field day with customary good time by all. 73—Bert.

Ve4

Les Saul, Ve4FJ, DR, St. James, Man.—St. Boniface is becoming a real ham town. Latest additions are MR, BB, RS, and HE. Welcome to the madhouse OM's. Of the ten ops active, five are teen-age. MR works EL two blocks away on 20 using a tritet 6L6 and no antennae. BB sets out on 20 and 40 simultaneously with a 40-meter rig and 20-meter folded dipole. Congrats to HB, latest addition to St. James. DL raves over his bob-tailed beam, good for receiving and transmitting. Reg. sold his rvr to BB and plans building a new one and rebuilding the xmtr all in one rack. How he'll get that 450-watt rig a size smaller is a question. MR is losing sleep trying to design a rig to operate from 80 through 2½. He did get a 10 meter beam from SJ, however. What about the other bands?? AT has that new bug on the air. GW plans on remodeling the shack. He's getting astonishing results from a home-made preselector. Now the S-meter never dips below 10 db over S9. DO is knocking himself out trying to get all that power into his 20 meter three-element beam. NZ works the ON4 boys with 25 watts to a Zepp. EL pared a foot off his doublet and succeeded in working his first dx. VK, ZL and ON's that is. DP has moved his QTH. SS is now with the C.B.C. LC is off till he finds what caused all the blue smoke the other day. SJ is leaving for Ve5, we understand. BM is back on 20 after the winter on 10. CX has changed his QRA to the west end of Winnipeg. DG sets on 20 phone occasionally. DL is playing with phase modulation. DO has gone to Shilo. EL is going on 20 with NBFM. KW is braving 20 with only 35 watts. MC has finally repaired his twin triplex. TB is using NBFM now. FW to sign Ve8 soon. AM moved his xmtr. Now he's trying to get it together again. FK has a new home-made rvr. DY is thinking of six meters. GW wants ideas for the hamfest. Come on, fellows, cough it up while there's time. LL and diathermy machines don't agree. The boys held a party for SJ prior to his departure for Hamlin, Sask. Present were SH, JE, SJ, DP, GI, TB, WB, AF, XO.

LEARN CODE this easy way

• This automatic INSTRUCTOR machine will teach you quickly to send and receive code (Morse or Continental). It comes complete with code tapes and instruction book, gives clear signals as fast or slow as you wish. Low Rental plans, clockwork models, for 1, 3 or 5 months. New machines for sale, Electric Models included. Write for folder giving full details.



Also Day, Night and Home Study Courses in all branches of Radio Communications.

RADIO COLLEGE OF CANADA
54 Bloor St. W. - Toronto

Conodion Rental Hdqtrs. for over 10 Years

NX, LC, DP and GI have combined station at GI's QTH. Plans are to have a rig on 10 and on 20. GI, aided by DP, is busy putting up a dual 10-20 beam with a 40-foot lattice tower also planned. It's WAC or bust. SH finally gave in and slid down to 20 where he runs 300 watts to a doublet. LF, another old reliable on 10, succumbed to the lure of 20 with 100 watts to a doublet. TB beat the silent hour rap by switching to NBFM with 285 watts from an 813 to a three-element beam on 20. EX reports hearing some W's on six but ignition noise wiped them out before they signed and he hasn't heard them since. FU has shifted to 20 with 285 watts, an 813 and an indoor folded dipole. SH reports that most of the boys have left 10 since it has got spotty and there's very little doing. Our sincere thanks to SH, GW and EL. The boys are really indispensable in this department. 73—Les.

Ve5

Bill Gordon, Ve5MW, DR, Oxbow, Sask.—RB has only one hobby, that of amateur radio. Ray committed himself one day by stating that he wants somebody sitting beside him to help him operate in more ways than one. Ray specifies that he wants somebody with the new look. So there you are gals—he can be had!

PS, CO, HB and NC are on six, mostly for local ragchews. JV and OC at Regina ringing up plenty dx. JD in Moose Jaw is new ham on 40. LV is buying tubing for a beam. BF wrote us a very nice letter which we present herewith to show you what a column we could have if each of you sent us one like it—"Trying to think up a good lie to defend my liars trophy at the Regina hamfest. Blew a hole in the glass envelope of one of my 811's you could stick a pencil in. Only had the 811's in place of the T55's for two days. Result—T55's back in service again. Conclusion RF too rough for 811's. Using NBFM on 10-11-20-75. Fair results, but you don't make as many dx contacts. Only interesting dx was VQ3HGE (the Hallcrafters Expedition). Am figuring on six meters for the summer." So there you are, fellows. If each of you sent us a letter like that, we could fill XTAL. Simple, isn't it? RB is using NBFM on 75 now.

In closing let me wish all of you a good time at the Regina hamfest. If we know the Regina gang, you won't have anything else but. 73—Bill.

Ve6

W. R. Savage, Ve6EO, DR, 329 15th St. N., Lethbridge, Alta.—WTEQM is anxious to know how many Canadian hams intend to go to the Glacier Hamfest this year. He said he really enjoyed himself at the Waterton Lakes hamfest last year. ND, ex-7NL, is now located in Calgary and has his rig going on 75 fone. It seems that Norm can't keep away from Calgary. AG is a new ham at Lacombe with the new C.B.C. station. Roy is ex-1QF.

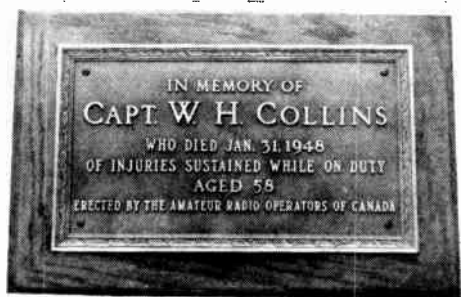

The plaque unveiled at Lethbridge in memory of Ve6WC

ID has a new jr op. and I think he will be handing out cigars at the Hamfest this year, so he sure to be there, fellows. FK is trying out NBFM, which seems to be working out very nice for him. OD has rebuilt a Bendix TA12 transmitter which is doing a fine job. He built a speech amp and modulator in the same cabinet. After paying a visit to the residence of AC we gathered the opinion that Elizabeth must have dug the hole and mixed the cement for him to be able to get his 10 mtr beam up. CY is a busy man with his new shop. He also installed the FM radio system for the Calgary Electric Dept. GD is holding a regular morning sked with a ZS and it is working out nicely. HQ is a busy fellow trying to sort

out War Asset equipment so the boys know what they are buying. JV is now going mobile; yes, he is building a mobile outfit. AB is still trying for new dx stations. KU says she has been isolated so long by snow and rain that she won't know how to act when the time comes to go to the big city. Also without plane service they would have starved to death. EO received a wonderful letter from VP9E, who states that when he calls a CQ he can't work any one, because they all tune on his freq and call him. My xtal was about 3 Kc off and it worked fb. Why not try it, fellows? NW is looking for dx cards. Sure was pleased to meet you when in Calgary. OX is working some dx on ten. MN has taken down his 10 mtr beam and is putting up a 20 mtr beam. 7LB, ex-6JF, who is now living in Vancouver, wrote yours truly a very nice letter. While he likes the rain and fog at the coast, I think he is a little home-sick for the prairies, also the good old Gyp Joint. BU thinks the QSL Bureau is doing a super job. 6JJ has really been a busy boy. He has printed and mailed out nearly 200 fotos to hams who made contributions to the plaque which was erected in memory of Capt. Bill Collins (ex-6WC). Thanks to all the work. Jessop, I am sure everyone appreciates it very much. KO and LD are busy arranging the Lethbridge boys for a field day and for the display at the Exhibition. CE is on his holidays and is visiting several ham stations. MA has a new 1948 jr. op. Well, fellows, how about some information for next issue? 73—Bill.

Ve7

Ernie Savage, Ve7FB, DR, 4553 12th Ave. W., Vancouver, B.C.—Well, there are two new junior operators in B.C. and only one has reported in—that is a new son for ALQ Art and he will have to be getting on the air soon now so that his two sons can have an early start. AFM Wally has most of his stuff here now; 1,800 pounds of gear arrived from England, and with it was records. Not one was broken or chipped and that is a record for freight. PO, Clarence, the fellow who has been spending his time talking to China, is in the bad books of the B.C. Police. They don't like him on their FM transmitter frequency. That shows those harmonics go places even in Victoria. ACW, Cyril, has had his name in the local paper again—this time not in aiding those in distress, but he was distressing a person's programs and they told the paper about the amateur that bothers their radio. So he gets the front-page citation. DB, Bill, and DF, Nelson, were heard, traded eggs for hatchings. Wonder what is hatching now between Oliver and Stevenson. DD, Cecil, was spotted carrying home a tuning unit from a TU9B and someone was heard saying that Cecil is going on the air. DZ, Maxie, is still on the air and still building that new transmitter as well reporting into the net and then diving out to dig the garden. ABO has a new receiver HQ129X and is heard in the small hours working dx (W7's). WI, Wally, is no more in the Navy and just a plain "chilvillian," going to work. BJ, Ed, the able master of the wildest network on this side of the Iron Curtain, is still working on his new rig which is going into one of those steel cabinets with doors and all. The old rack is going to hold this reporter's new (?) rig. So any that read this far don't need to think that you obtain a rack from Ed, thanks. The Vancouver Amateur Radio Club held its first outdoor activity Sunday, Apr. 25, with a tube hunt and hike from the upper Capilano swinging bridge down the trail that follows the canyon looking for radio tubes that were placed on and off the trail. Very fine time was had in the merry search for those little bottles, with ADF Bill's xyl finding the two-dollar valve hanging on a little piece of string after looking and looking and even being told that it was here and none could see that little piece of string. So ADF xyl Eileen, \$2.00. AP, Dave, some twenty tubes the numbers totalled 1,656, \$1.00. AFM, Wally, some ten or more tubes totalled 43 prongs, \$1.00. LO Feirue, MQ Archie, AFM Wally and Bea, Fairmont 6673Y (her calls), each found a seeing eye tube and win small prize. This tally was made over tea, coffee and hot dogs at the lower Canyon Bridge. Those that missed, did miss some fun. The Vancouver Amateur Radio Club's junk transmitter contest closes this month of June for sure and be sure you're in the contest for the prizes. We now have some old members that have made the grade and are now on the air. AOB, Don, is on CW 3555-3560 Kc and is going to town. AOW, Bill, and AOV, Betty, a Mr. and Mrs. setup, so that will be harmony in the house till one outdoes the other in the dx. The last meeting was a talk on noise elimination with lantern slides and the guest speakers from Electronics Laboratories of Canada, Mr. Don Hings and Mr. Jack Baldwin.

Collingwood club members had the privilege of visiting the new FM station in the New Vancouver Hotel. A fine lecture on the FM was given by Mr. A. B. Ellis, the

regional engineer. Then a tour of the CBR studios was conducted by control operator, Bill Howard, GH. The great musical talents of the club members were demonstrated in the main studio by a small and very original concert (not broadcast). We would like to congratulate the V.A.R.C. for the fine time shown to everyone at their dance. AZ, Jack, is having troubles building two-meter receiver. We hope to see AAK and OJ sporting beams on ten soon. Wonder how much more we have to blab to convince them dipoles on ten are like digging with a teaspoon. AIH building new tower and six element beam for ten. He says he is through with speech clipping for life. (Well, why not write a story for CAROA on the reason that you are through with it, so all can see the reason). AME, Doug, is running about 45 watts on two meters now. ABP also on two meters. How can an old pumphandler like you know what to say into a mike, Jim? Thought Gravel Gertie was on ten the other night—but when she signed—it turned out to be MH. He's still getting those choice 20 meter dx cards from Russia, etc. It has been said that he used to eat breakfast with the cans on and key in hand and with the spare hand shovel in the grub; went over big with the wife. ABL has the beam in the middle of the foundation for his new house but no visible developments in either house or beam for long time now. AJR too busy washing dishes, etc., to do any hamming (right, Spud?). AJP gone fishing, we think—or has he left with spring fever? XT has two-element beam on 20, about 27 feet high. LF ironing out the bugs from PP/813 for 20 CW. The neighbors have yet to hear the clicks from that full gallon. ADV running 807 rig mobile on ten—we hear he has six antennas at home. Ex-Ve8AER-Ve8AJY, now Ve7AFI, Harry, is running a real fine all-band rig from Kamloops. The S.O.R.C. annual meeting of the club consisted of a very fine social evening boosted by the xyl's and the election of officers. President, FD, Dud Hatcher; ZF-xyl, secretary-treasurer, Verona is the handle. The hams are fairly active with US making improvements to cut down splatter for the benefit of local amateurs, also trying out bazooka antenna. AMJ has been pounding brass on 40 and yelling CQ on 10 and 75. What with the bottle works being piped in next door, he has been busy, hi. YE has been busy rebuilding his VFO. ZF, Russ, has also been busy rebuilding and using US's transmitter while doing it. The spring air has enticed MB to the outdoors, where fishing is as thick as twenty meters. HL is doing fine business with the Mighty Mite—has worked the coast on skeds.

Remember, July 13, 1947, when the V.A.R.C. got lost with transmitter and was found in hour or so? Also the beach party? Well, it is coming again this year. Are you ready this time??

Albani District Amateur Radio Club meetings held 8 p.m. the first Wednesday of every month in the wireless room of local Reserve Unit Army Camp, Port Albani. Visiting amateurs cordially invited. AAZ, Nobby, of Victoria, paid the twin cities, Albani and Port, a visit Wednesday, Apr. 28, to see his son Tommy, who is sick in hospital here, accompanied by his wife, Verma, and also called in on CX, Stan, and Betty and ACW, Cy and Connie. Cy is still crving, "Go away, Nobby." Nobby left Cy's rig in little pieces. Heard before of those kind of guests!

ADV, Jim, same night dropped into Cy's. Jimmy installs and services transmitter for Spillsbury and Hepburn (Hep, Ve7HP). PO, Clarence, and AEK, Dick, paid a flying visit to Albani and Port. to roll some

movies for the B.C. good-will. ACW, Cy, is still on the five o'clock net and again has the idea to rebuild, to go with the new receiver that is doing the good job of beating the noise. CX, Stan, gets on occasionally, but he's rather busy, with house building, gardening and having to work nights. BB has gremlins or termites in his rig or sumpin', but expects to get busy soon and chase them out. HE, Teddy, "Happy Engineer" is on twenty phone; no word what he is working but do know that his fishing line is bringing in good results. HJ, Charlie, our young fellow, has been on 75 phone. Glad to know you made the grade. Charlie is 75 years young. PY, Dave, is active on 20 phone and he won't speak either on any dx. Have you heard a fone man struggling on CW? Well, that was our DZ, Maxie, and he has done it and made a ham out of his student many miles away. Don't know, but congrats to you Max and super best dx to you, AOG, Buster, at Franklin River. Oliver Radio Club has been at a low ebb in the radio work but plenty busy in their trade and that is in farmer. Most members are fruit growers and the spring rush is on, and what weather to work in. MC, Milton, has the power supply finished for that full gallon, but is busy building a new house. Wonder if it is for the gallon? DB, Bill, and ZL, "Willie's Puddle" Bob made it possible for Tommy to chin wag with folks from home. The president for the West Summerland Radio Club made the grade and is AOG. Congrats to you, Doug. Then when he was caught in the rain down at Oliver he made DB, Bill, a pre-selector for his Sky Buddy so he can't hear McCord Airways in the middle of the 75 meter band. Bill does give credit and says it does work.

White Rock by the Sea reports much activity in amateur movements. DZ, Maxie, who held down this most south-westerly tip of the mainland reports he is losing that honour and have AOP who held Ve1-Ve3-Ve5 calls and CW on 80 and 40 and 20. AIZ on 80-40 CW, YV on 80 and 40. Then there are several ex-hams who soon will feel the change in the air. There are several yf's who are learning the code and all. MX works 80-40-20 fone and CW. Your official bulletins are transmitted on 3850 Kc near 1800 hrs on Thursdays, and we try to find a hole between 3820 Kc and 3825 Kc at 2100 hrs. ANM is another new call from Albani. MQ, Archie, has up that new beam and is heard on 75 fone. Some person or persons have heard OT, Marvin, on CW. YI, Wes, has been blowing hard as to the current he has been pouring into the 807 and getting away with it, till some fellow didn't believe it and proved his mil-meter was not working. Poor Bill, DE, Harry, has been heard with nice signal and powered by gas generator. AAZ, Nobby, has been working hard trying to make the rig sound like a local transmitter instead of a transatlantic station, and the reports you receive give you hopes. CB, Chris, is rebuilding and it seems when finished it will be a small parcel with plenty of punch in it. Please let's hear from you often, gang. 73—Ernie.

Ve8

Jack Spall, Ve8AS, DR, Box 268, Whitehorse, Y.T.—Ve8AK at Teslin walked the aisle during May. We wish Bob and his xyl the very best for the coming years. Ve8BM, also of Teslin, is hoping to be moved shortly to the bright lights. SCE, of Dawson City, operates 40 and 20 with parallel 807's. 8CG, also Dawson City, uses same type rig for strictly 40 meter operation. 8AH, another Dawson Cityite, used a 19 set on 75 but now rebuilding to parallel 807's for 80 and 40. Dawson City is soon to have another well-known Ve8 in the form of Ve8AY, who is moving to the fair city this month. George is well known for his dxing on 20 and 40, using PP 813's in the final. 8AO of Lac LeBarge now is sporting a V beam 800 feet on each leg. His xyl helped him string it. 8BL leaving soon for a month's holidays outside. 8AL busy rebuilding to 807's in parallel with built-in scope for mod. indicator. Fred says he has been too busy and lack of info so had to cancel publication of the Ve8 drift, but hopes to have a copy out soon. 8AN returned to town after extended trips for customs dept. and expects to go places with his new SX43 revr. 8BB still QRT for lack of time to finish his PP813 rig. Several new hams around Whitehorse will soon be on to add to the QRM. 8AW, the ole dxer, claims WAZ and 132 countries post-war. Lyle sez he needs only one more card to complete confirmations of his WAZ. 8AS has been on 20 since April with PP813. Jack very busy now building three-elm rotary for 20. Still waiting for news from the N.W.T. gang, so hw abt dropping us a line next month; also don't forget if you are expecting some rare dx QSL crds, we have them stacked up waiting for you to send in self-addressed envelopes to claim them. Save some money by writing in a report and enclosing an envelope for those QSL cards. 73 and CU next month—Jack.

Correction!

We regret that owing to a printing error in the Lamar Co. ad in last issue an incorrect address was given. It should read:

LAMAR COMPANY
1497 Wellington St.,
MONTREAL

Introducing Your DR . . .

W. R. SAVAGE, Ve6EO

This month we introduce Bill Savage of Lethbridge, Alta. He was born in 1908 in London, Eng., coming to Canada at the ripe age of one year. Although Bill became interested in radio when only 12 years old, it was not till 1932 that he went on the air. His first contact was on 80 meter CW with K6VG, which augured well for his ham career.

At present Ve6EO runs about 200 watts to PPT40's in the final, crystal controlled. For phone work on 20 and 75 meters he modulates with a pair of TZ20's and runs CW on 20, 40 and 80. The receiver is an SX 23.

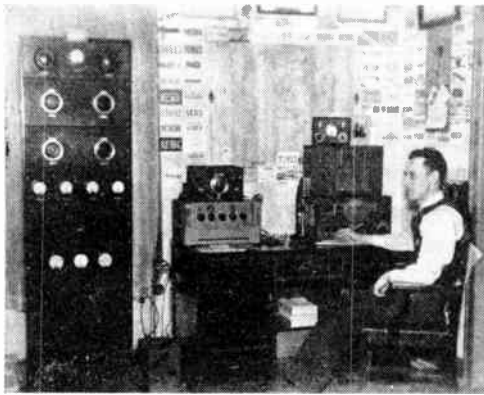

Not satisfied with this nice layout, he is building another rig using an 813 in the final for 10 and 20 meter work.

Bill is WAC on CW and phone — WAS and WBE and DXCC. He has held ORS and OBS appointments with ARRL and at present is the Ve6 QSL manager!

When not working at ham radio his occupation is city electrician in charge of the Lethbridge Electrical Inspection and Meter Depts.

Married to a wonderful xyl (who always has the coffee ready in a contest) he has three children.

We are glad to introduce Ve6EA and extend our best wishes and thanks for his good work.

LATE AGAIN!

We are late with XTAL again. A long weekend over the July 1 holiday, and a week's plant holiday starting July 19, has knocked the schedule of the printer, and us, into a cocked hat. Now we start all over again to get on a mailing schedule of the 15th of the month of issue.

YOU'VE BEEN WAITING FOR IT...



35¢

HERE IT IS!

The NEW RC-15 RCA RECEIVING TUBE MANUAL

The most complete and authoritative reference guide to receiving-type tubes ever published.

Patterned after the famous "RC-14", it has been extensively revised and expanded. Features RCA's complete receiving line. The highly popular introductory section on tube and circuit theory has been increased to 55 pages and includes new reference data on FM applications. The widely used Resistance-Coupled Amplifier Charts provide 27 combinations for each tube type. The circuit section gives diagrams and parts values for up-to-date receiver and amplifier designs.

You'll find the new RC-15 indispensable. Order your copy today. Only 35c.

 **RCA VICTOR**

RCA VICTOR COMPANY LIMITED

Halifax • Montreal • Ottawa • Toronto
Winnipeg • Calgary • Vancouver

RCA VICTOR COMPANY LIMITED
1001 Lenoir St., Montreal, Que.

Enclosed find 35c for which please send me one copy of the RC-15 RCA Receiving Tube Manual.

Name.....

Call Letters.....

Street.....

City..... Prov.....

HAMFEST!

We are pleased to announce for the Fall,
At the Mount Royal Hotel, Montreal,
That we've planned for the best
And biggest hamfest,
That you lads can ever recall.

Start saving five-fifty for you.
Three-fifty to bring ladies too.
Forsake that new gear,
'Til sometime next year,
And blow the nine bucks on our "do".

There'll be prizes and fun for you here.
Guest speakers, good food and good
cheer.

For the time of your lives,
Bring your YLs and wives,
Start planning for October 's near.

It's the 8th and 9th, with a plea
That you'll tell each and every Ve,
Obtain tickets and rooms,
Before October looms,
Write the sponsors, the M.A.R.C.

●
THE

EASTERN CANADA A. R. R. L. NATIONAL CONVENTION

IS SPONSORED BY THE
MONTREAL AMATEUR RADIO CLUB

●

Address all communications to
**Box #1, Postal Station "D",
MONTREAL, Quebec.**

"SEE YOU IN MONTREAL NEXT FALL"

WELCOME OM'S

New Call Signs Assigned at Toronto Since
April 1, 1948

Ve3BVA—R. J. Pinchin, 312 Dominion Ave.,
Midland.

Ve3BVB—G. E. Symons, 79 Fuller Ave.,
Toronto 3.

Ve3BVC—E. H. Whyatt, 79 Helena Ave.,
Toronto 10.

Ve3BVD—H. F. Jones, 2140 5th Ave. W.,
Owen Sound.

Ve3BVE—J. A. Coons, 50 King William St.,
Huntsville.

Ve3BVF—W. F. Fowler, Foleyet

Ve3BVG—E. Bray, Box 785, Huntsville.

Ve3BVH—R. L. Kirby, General Delivery,
Clinton.

Ve3BVI—P. O. Jones, c/o 94 Grant Ave.,
Hamilton.

Ve3BVJ—Margaret J. Calder, 351 Princess
Ave., London.

Ve3BVK—E. G. Rooke, 157 Wellington St.,
St. Thomas.

Ve3BVL—S. S. Whiteford, 199 Victoria St.,
Ingersoll.

Ve3BVM—C. M. Heddington, 12 Major St.,
London.

Ve3BVN—E. K. Long, R.R. No. 2, Freeman.

Ve3BVO—A. E. Holmes, 398 Whaincliffe
Rd. S., London.

Ve3BVP—R. L. Gilbert, 522 Piccadilly St.,
London.

Ve3BVQ—H. C. Moon, 7 Humberview Cres.,
Weston.

Ve3BVR—F. M. Struke, 24 Argyle St.,
Stratford.

Ve3BVS—M. B. E. Racey, Box 173, Lucan.

Ve3BVT—Frances Mary Tamblin, 20 Jean
St., Port Arthur.

Ve3BVU—D. M. Davies, 2455 Clemenceau
Blvd., Sandwich E.

Ve3BVV—A. G. Barker, R.R. 3, Weston.

Ve3BVW—W. M. Bryant, 511 King St.,
London.

Ve3BVX—J. E. Thomas, 167 East St., Delhi.

Ve3BVG—G. E. Panter, 16 Onaway Road,
Port Credit.

QSY to page 22

GODERICH PICNIC

The Goderich picnic will be held on
Sunday, August 8, at Point Farm, two
miles north of Goderich on No. 21 high-
way. All hams, phone and CW, their
xyls, yls and jr. ops. are welcome. No
admission. Just bring your own grub.
Tea, coffee, milk and ice cream served
free.

DX—From Page 11

time he has used it has had some nice reports from it. Vince is another one of the low-power boys and runs 40 watts to a long wire most of the time. VP3ACS and VU2BX are recent contacts with this. Ve3AGC has been busy with KM6AB, MD5KW, TRIP, VR51P and lots of others. He's also waiting cards for DXCC. Ve5JV works VQ3, ZS, ZE, OQ, KM, KG, C7, UA9 and a bunch of Europeans. Ve3AVA adds SV1RX, UA1KED (Franz Joseph Land) and UD6BM. That's the dope for this month, and can use more reports, boys, so what say.

DX PW Totals

VE3QD	163	Ve1AQ	84
Ve4RO	161	Ve7Eil	77
Ve7HC	151	Ve3TB	73
Ve3IJ	123	Ve3BBZ	72
Ve1EA	120	Ve5JV	72
Ve2WW	111	Ve3BBN	70
Ve3AGC	108	Ve1NE	66
Ve1PQ	106	Ve3QB	65
Ve3AVA	103	Ve6AO	64
Ve3AAZ	102	Ve3BWY	61
Ve3ACS	100	Ve4RP	55
VO6EP	100	Ve3BHX	54
Ve6FK	93	Ve8AS	53

**SEND IN YOUR NAME FOR
OUR "NEW" SUMMER
HAM BULLETIN !!**

▶ **LOWEST prices in Canada !!** ◀

#19 - Mark III, new,
complete in case \$ 29.50
TA-12G Bendix 4-Band
Transm. 55.00
Min. Mica-filled Sockets,
10 for 1.25
S-38 Hallicrafters (used) ... 65.00
NC-173 National 25 cy. 298.00
SX-43 Hallicrafters 25 cy. ... 300.00

EARL PHILLIPS — Ve3AGV —
now on our staff.

Unusual Stocks — Regular lines
and Surplus.

LANGFORD'S
246 Dundas Street - London, Ont.

There **IS** a
DIFFERENCE

When you buy radio tubes, you can be sure that the name of Westinghouse on each tube means uniformity . . . dependability and long operating life. That's why it will pay you to specify and use

**Westinghouse
RADIO TUBES**

CANADIAN WESTINGHOUSE COMPANY LIMITED, HAMILTON, ONTARIO



NEW CALLS—From Page 20

Ve3BVZ—E. D. Bradt, 1428 Bruce Ave., Windsor.

Ve3BWA—A. R. Anderson, 211 Roslin Ave., Toronto.

Ve3BWB—W. A. Legott, 50 McMillan Dr., Oshawa.

Ve3BWC—J. L. R. Berube, 5 Taunton Rd., Toronto 12.

Ve3BWD—W. E. Anderson, 11 Bridge St., Goderich.

Ve3BWE—H. G. McKay, 1149 Dufferin St., Toronto.

Ve3BWF—A. Baier, 30 Summerhill Ave., Toronto.

Ve3BWG—L. W. Lodge, 241 Gainsborough Road, Toronto.

Ve3BWH—W. J. Wright, Radio Range Station, Armstrong.

Ve3BWI—C. H. M. McKenzie, 108 Hiawatha Rd., Toronto.

Ve3BWJ—G. T. Lake, 35 Forest Ave., Sault Ste. Marie.

Ve3BWK—J. Sherman, 20 Coolmine Rd., Toronto.

Ve3BWL—R. M. Brown, 25 Borden Ave. N., Kitchener.

Ve3BWM—G. Mitchell, Drawer "A," South Porcupine.

Ve3BWN—N. F. Quinton, 507 Pape Ave., Toronto.

Ve3BWO—K. R. Stockwell, 67 Wroxeter Ave., Toronto.

Ve3BWP—J. M. McIntosh, 16 Ann St., Galt.

Ve3BWQ—H. R. Spencer, 117 Briar Hill Ave., Toronto.

Ve3BWR—E. D. McKellar, Caribou Island, c/o Canal P.O. Sault Ste. Marie.

Ve3BWS—Reginald John Levens, 800 Dundas St. W., Toronto 3. Station at H.M.C.S. York, Fleet St., at Bathurst St., Toronto.

Ve3BWT—Wm. Gordon Walker, Con. 8, Lot No. 21, Tilbury East Twp., County of Kent (Tilbury, Ont.), R.R. No. 3.

Ve3BWU—Hugh Campbell Gill, 175½ Dundas St., Apt. 26, London.

Ve3BWW—Wm. Frederick Furter, 546 Queen's Ave., London.

HERE'S OPERATING *Flexibility* PIONEERED BY B&W

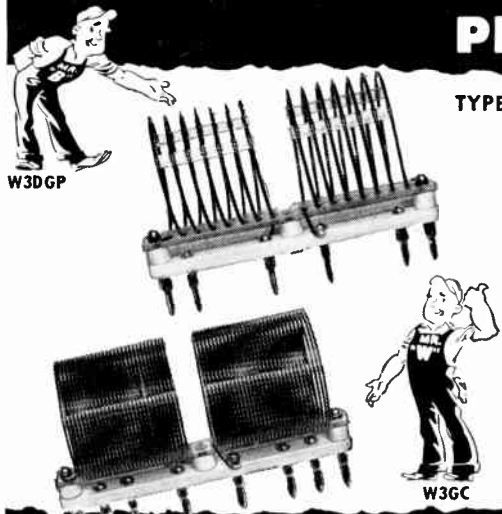

TYPE TVH INDUCTORS—For powers up to 500 watts

Type TVH Inductors are a special group of units designed for a specific purpose . . . to provide maximum operating flexibility with automatic changes in fixed capacitor padding circuits as coils are changed. The use of an eight plug jack bar, together with jumpers which are provided with each Type TVH coil, make this increased operating efficiency possible.

Pioneered by B&W, and available only in B&W coils, this feature is typical of the extra value available in B&W parts and instruments designed and built specifically for the amateur.

**Write Dept. XL-78
for the complete B & W Catalog**

BARKER & WILLIAMSON, Inc.

237 Fairfield Avenue Upper Darby, Pa.

Canadian Representative: WM. F. KELLY CO., 1207 Bay St., Toronto

GET THE C.E.S. HABIT ... FOR HAM GEAR NOW

B & W MINIDUCTORS SPECIFICATIONS

Catalog No.	Diameter	Turns		Your Cost
		per Inch	Length	
3001	1"	4	2"	.43
3002	1 1/2"	8	2"	.43
3003	1 1/2"	16	2"	.43
3004	1 1/2"	32	2"	.43
3005	1 1/2"	4	2"	.48
3006	1 1/2"	8	2"	.48
3007	1 1/2"	16	2"	.48
3008	1 1/2"	32	2"	.48
3009	1 1/2"	4	2"	.57
3010	1 1/2"	8	2"	.57
3011	1 1/2"	16	2"	.57
3012	1 1/2"	32	2"	.57
3013	1"	4	3"	.67
3014	1"	8	3"	.67
3015	1"	16	3"	.67
3016	1"	32	3"	.67

B & W JUNIOR INDUCTORS FOR POWERS UP TO 75 WATTS INPUT SPECIFICATIONS

Band	Type	Capacity to Res.	
		L.F. End of Band	mmfd.
End Linked Models			
5	5JEL		15
10	10JEL		22
15	15JEL		22
20	20JEL		34
40	40JEL		47
80	80JEL		60
Center Linked Models			
5	5JCL		15
10	10JCL		16
15	15JCL		16
20	20JCL		16
40	40JCL		33
80	80JCL		53
Variable Link Models			
5	5JVL		15
10	10JVL		22
15	15JVL		27
20	20JVL		21
40	40JVL		31
80	80JVL		46

Your Cost Any Type \$1.85

OHMITE RF CHOKES

Stock No.	Operating Range Megacycles	Microhenries	Core Dimensions	Price
Z-7	3 to 20 Mc.	85.0	6" x 1 1/2"	\$1.25
Z-14	8 to 35 Mc.	44.0	2" x 1 1/2"	.55
Z-28	20 to 60 Mc.	21.0	1 1/2" x 1 1/2"	.36
Z-50	35 to 110 Mc.	6.5	1 1/2" x 1 1/2"	.27
Z-144	75 to 190 Mc.	1.9	3/4" x 1 1/2"	.27
Z-235	160 to 370 Mc.	0.84	3/4" x 1 1/2"	.27
Z-460	320 to 520 Mc.	0.20	1 1/2" x 1 1/2"	.27

Non-magnetic Brackets Furnished with Z-7.
All chokes 1000 ma. rating except Z-14 and Z-28.
These are rated at 600 ma.

CENTRALAB BC-HI-KAPS CERAMIC CONDENSERS

For by-pass and coupling ckts.

500 Volt			
.00001 Mfd.	.20	.00025	.20
.000025	.20	.0005	.20
.00005	.20	.001	.20
.0001	.20	.002	.20
.00015	.20	.05	.24
.0002	.20	.01	.24

CRYSTALS

BLILEY		
AX2—80 Meter		3.50
AX2—40 Meter		3.50
SMC 100—100-1000 Kc.		11.25
PR		
Z2—8000 to 8222 Kc.		3.33
Z2—8334 to 9000 Kc.		3.33

VALPEY

CM5 or VP3	3500 to	4000 Kc.	3.36
CM5 or VP3	7000 to	7300 Kc.	3.36
CM5	6250 to	6750 Kc.	3.36
CM5	6796.25 to	6836.3 Kc.	3.36
CM5 or VP3	12500 to	13500 Kc.	4.20
CM5 or VP3	13592.5 to	13727.5 Kc.	4.20
CM5 or VP3	14000 to	14400 Kc.	4.20
CM5 or VP3	28000 to	29700 Kc.	5.40

SELENIUM RECTIFIERS

Half Wave for 115 Volt Operation

100 MA	1.30
150 MA	1.51
200 MA	1.92

COAXIAL RELAYS

Designed for use with 52 or 75 ohm RG cables. Maximum rating is 880 watts at 100 megacycles.

Type 7200 AC operation, 110V	10.50
25 or 60 cycle can also be supplied in other voltages and in AC or DC.	
Type 7204, similar to above but has DPDT auxiliary contacts mounted externally	13.02

CANADIAN ELECTRICAL SUPPLY CO. LTD.

TORONTO — MI. 2481 — 543 Yonge St.
285 Craig St. W. — MONTREAL

Designed for



Application



90881

**The No. 90881
RF POWER AMPLIFIER**

This "500" watt, RF power amplifier unit may be used as the basis of a high power amateur band transmitter or as a means for increasing the power output of an existing transmitter. As shipped from the factory, the No. 90881 RF power amplifier is wired for use with the popular RCA or G.E. "812" type tubes, but adequate instructions are furnished for re-adjusting for operation with such other popular amateur style transmitting tubes as Taylor TZ40, Eimac 351, etc. The amplifier is of unusually sturdy mechanical construction, on a 10 1/2" relay rack panel. The panel contains the grid and plate tank tuning capacitor dials, as well as the grid and plate current milliameters. Plug-in inductors are available for operation on 10, 20, 40 or 80 meter amateur bands, from stock, as well as special coils to order for commercial frequencies. The standard Millen No. 90800 exciter unit is an ideal driver for the new No. 90881 RF power amplifier.

**JAMES MILLEN
MFG. CO., INC.**

MAIN OFFICE AND FACTORY
**MALDEN
MASSACHUSETTS**



HAM-ADS

Copy for Ham-Ads must be received before the tenth of the month preceding issue. Rate is 25 cents per line.

COMPLETE station for sale—75 watt xmtr, VFO; Sky Champ rcvr, top-notch condition, \$200. Ve3AWE, phone King 41 ring 2

QSLs for discriminating hams. Distinctive! Colorful. Highest quality! \$1.50 per 100. Samples 10 cents. Ve3QS Print, 344 Pape Ave., Toronto.

WILL SWAP new Brigg & Stratton powered 110v 60c 500 watt plant for good communications receiver or cash. Mechanical and electrical regulation very good. Hydra now available. Also for sale complete Xtal controlled TX 150 watts fone CW in Hammond 1460-F cabinet uses pair 809's. VE3BB, Chapleau, Ont.

FOR SALE or SWAP for Receive: Pair U.S. Army Walkie-Talkie 10-6 meter transceivers. Excellent condition. Best offer takes. Jahn Gillis, 447 Mortimer Ave., Toronto, Ont.

FOR SALE—R1155 converted for spkr. and fane operation, power supply and 8" p.m. speaker. \$75.00 F.O.B. VE3EC, 22 Edgemont Ave. N., Hamilton.

FOR SALE—No. 19 Mk. III Army wireless set. Particulars, Jahn Young, Halkirk, Alta.

FOR SALE—A real buy. 200 watt transmitter, (6L6-807-35-T) complete for CW operation, without power supply. \$60.00 only. VE3BWW, 214 Delaware Ave., Toronto, Ont.

HALLICRAFTER SX284 receiver, as new, with speaker. Lou. Wasser, 1362 Bathurst St., Toronto; KE. 3644.

WILL SELL or TRADE an S-40 Hallicrafters communication receiver. Best offer. Would be interested in a 1155 receiver, not converted, in new condition. Interested also in exchange of technical data pertaining to Panoramic receivers using 5" Cathode Ray tubes like the 5BP1, being well documented on the subject. Who has data or list of parts (values) for the Model S35 Hallicrafters Panoramic receiver? I have the circuit on hand but the values of all components are urgently needed. Anselme Laperrriere, VE2LF, Vercheres, P.Q.

**JAMES MILLEN MFG. CO.
INC.**, Products are represented in Canada by
ASTRAL ELECTRIC CO.
56 Wellington E., Toronto, Ont.

NOW AT YOUR DEALERS

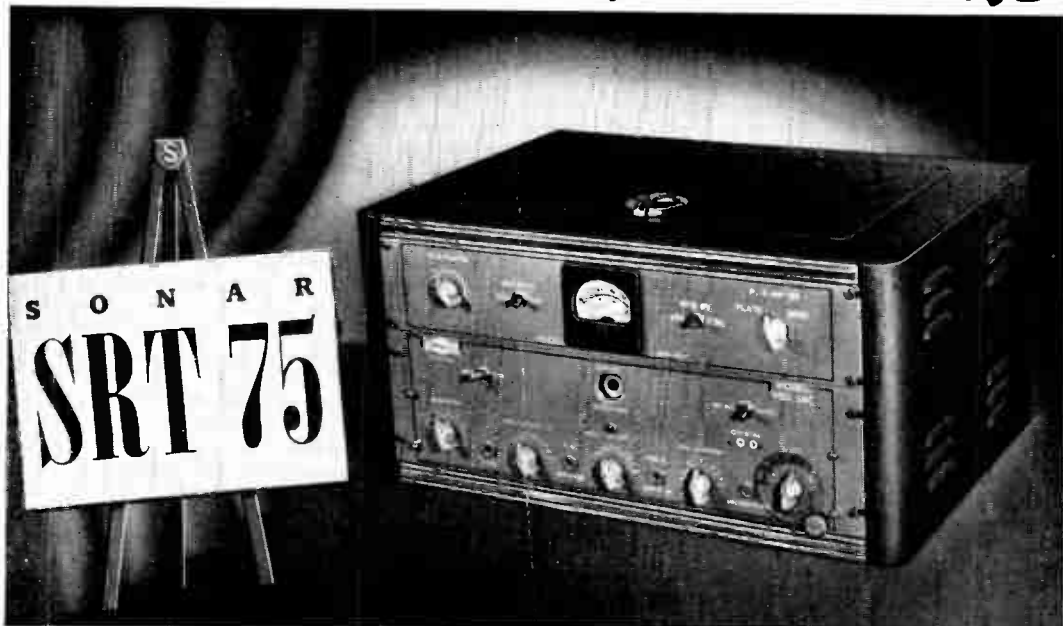

**SONAR-ORIGINATORS OF NBFM EQUIPMENT FOR THE HAM—
WANT TO SAVE YOU MONEY!**

TO-DAY'S BEST BUY!



THE C.F.C., Sonar's Calibrated Frequency Control, has been hailed as the finest VFO on the market today. The variable oscillator is extremely stable and can be checked against the 1000 kc crystal provided in the unit. With fundamental output on 80 and 40, and harmonics for 20, 15, 11, and 10, all plainly marked on the large 5" Dial, you can chase those elusive DX boys and get 'em.

A TERRIFIC BUY
COMPLETE — READY TO USE

\$59⁷⁵

HERE'S HOW — in keeping with our policy to keep prices as low as possible, with the highest possible quality — Sonar now offers the ham an opportunity to buy a complete 75 watt all-band transmitter, factory tested and assembled as a complete unit.—OR—to purchase the units separately and assemble them in a rack or cabinet of their own choice. These units are available individually. The SRT-75 comes complete with tubes and one set of coils for only . . . **\$203⁶⁷**

AMP 50 COMPLETE WITH TUBES AND ONE SET COILS . . . **\$5745**

PS-50 COMPLETE WITH TUBE . . . **\$3345**

VFX-680 COMPLETE WITH TUBES AND ONE SET COILS . . . **\$8745**

COILS FOR ALL BANDS AT YOUR DEALER.

YOU AD 'EM UP AND SAVE



RADIO CORPORATION
59 MYRTLE AVE., B'KLYN 1, N.Y.

CREATORS OF FINE HAM EQUIPMENT XE 10 • VFX 680 • MB 611 • CFC • SRT 75

159
ABOVE PRICES IN UNITED STATES ONLY—IN CANADA: ADD 20% FOR DUTY PLUS 8%
SALES TAX ON DUTY PAID VALUE.

BULK and WEIGHT *are* OUT OF DATE

Old style radio batteries were built with round cells . . . contained pitch, cardboard and air . . . wasted space between the cells. Powerful batteries were big batteries.

The patented flat cell construction of "Eveready" "Mini-Max" Batteries eliminates inside waste space, makes it possible to pack more power into less space, increases dependability by reducing the number of potentially troublesome inside soldered connections.

Always buy "Eveready" "Mini-Max" Batteries for long, trouble-free service.

"EVEREADY" and "MINI-MAX" are registered trade-marks of
CANADIAN NATIONAL CARBON COMPANY LIMITED
805 Davenport Road, Toronto 4, Canada.

